

3

EDITION



TELEVISION
TERMINAL
EQUIPMENT



CUSTOM EQUIPMENT

MONITORS

POWER SUPPLIES

SWITCHERS

AMPLIFIERS

SYNC GENERATORS

MICROWAVE RELAY EQUIPMENT

Stephen M Comer

BROADCAST TERMINAL EQUIPMENT CATALOG

(Third Edition)

PRICE \$1.00



RADIO CORPORATION OF AMERICA

Broadcast and Television Division

Camden, N. J.

	Page
Custom Equipment	5
Switching Equipment	9
Special Effects	27
Intercom Equipment	37
Monitors	43
Amplifiers	59
Generators	69
Power Supplies	75
Racks and Mountings	81
Microwave Relay	95

ABOUT THIS CATALOG

This Catalog is devoted solely to information on RCA Terminal Equipment designed especially for television station and closed-circuit use. Other RCA Broadcast Equipment Catalogs contain similar information on audio, TV camera, film, and test and measuring equipment, AM, FM and TV transmitters, antennas, transmission line equipment and accessories.

The information contained in this catalog is intended to serve as a buying guide for the users of this type equipment. In the belief that broadcast engineers want facts, rather than generalities, the content has purposely been kept brief and factual. Readers who desire more information or individual bulletins on particular equipment items are invited to write to the RCA Broadcast Representative in the RCA Sales Office nearest them (see opposite page).

OTHER RCA TECHNICAL PRODUCTS

The RCA equipment described in this catalog is specifically designed for broadcast station use. In similar manner RCA also manufactures many other electronic products including: TV tape recorders; two-way radio and microwave radio communication equipment; optical and magnetic film recording equipment; sound systems of all types; 16mm projectors and magnetic recorders; industrial inspection and automation equipment; scientific instruments, such as the electron microscope; industrial television systems; intercoms; and many types of custom-built equipment for industry, the military educational and medical services. Information describing these products may be obtained from RCA Sales Offices.

HOW TO ORDER

The RCA Television Terminal Equipment shown in this catalog is sold directly through RCA Broadcast Representatives, who are familiar with broadcast equipment and related problems. One or more of these RCA Representa-

tives are located in each of the RCA Sales Offices listed below. Orders for equipment shown in this catalog, or requests for additional information, should be directed to the nearest one of these offices.

PRICES

The prices of the various equipment units shown in this catalog are given in a separate price list. Prices are listed in the order in which they are shown in the catalog. To determine the price of any equipment first note the page

on which it is shown in the catalog, then consult the price list in accordance with this page number. Equipments are identified by type and MI (Master Item) numbers which are used to identify apparatus on invoices and packing slips.

YOU CAN LOCATE YOUR NEAREST RCA REPRESENTATIVE FROM THIS LIST

RCA SALES OFFICES

1121 Rhodes-Haverty Building
134 Peachtree Street, N.W.
ATLANTA 3, GEORGIA
Jackson 4-7703

•

2301 John Hancock Building
200 Berkeley Street
BOSTON 16, MASSACHUSETTS
Hubbard 2-1700

•

Front and Cooper Streets
CAMDEN 2, NEW JERSEY
Woodlawn 3-8000

•

1186 Merchandise Mart Plaza
CHICAGO 54, ILLINOIS
Delaware 7-0700

•

1600 Keith Building
CLEVELAND 15, OHIO
Cherry 1-3450

7901 Empire Freeway
DALLAS 35, TEXAS
Fleetwood 2-3911

•

12605 Arnold Street
DETROIT 39, MICHIGAN
Kenwood 4-5100

•

1560 North Vine Street
HOLLYWOOD 28, CALIFORNIA
Hollywood 9-2154

•

501 N. LaSalle Street
INDIANAPOLIS, INDIANA
Melrose 6-5321

•

7711 State Line Road
KANSAS CITY 15, MISSOURI
Emerson 1-6770

•

36 West 49th Street
NEW YORK 20, NEW YORK
Judson 6-3800

495 E. 30th Street
PATERSON, NEW JERSEY
Mulberry 4-0972

•

6237 N.E. 18th Avenue
PORTLAND 5, OREGON
Capital 6-6828

•

420 Taylor Street
SAN FRANCISCO 2, CALIFORNIA
Ordway 3-8027

•

2250 1st Avenue, South
SEATTLE 4, WASHINGTON
Main 2-8350

•

1725 K Street, N.W.
WASHINGTON 6, D. C.
Federal 7-8500

CUSTOM TELEVISION EQUIPMENT



DESCRIPTION

The rapid growth of television programming and the increasing complexity of switching operations have shown a definite need for special or "custom" equipment. It has been found in many television stations that standard items of equipment may not satisfy all of the many special switching and operating requirements encountered. These requirements are created by many factors such as the space available for equipment and the nature and number of live shows, auditions, remotes, and originations of network feeds. Since no two television stations have exactly

the same operating requirements, the corresponding equipment needs will differ for each installation. Frequently the most effective means of satisfying these needs is through the utilization of a combination of standard equipment and custom equipment. Furthermore, the use of custom built equipment offers the television station engineer an opportunity for creative system design from the standpoint of equipment appearance, versatility and adaptability to future growth of station needs.

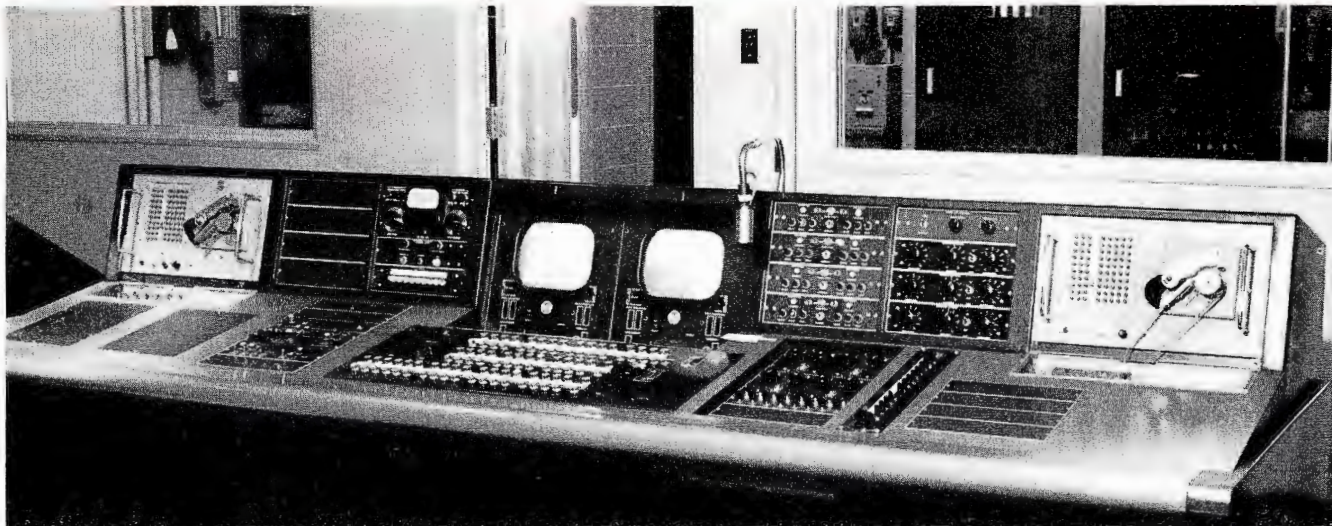

Master Control Console including automation control facilities at Station WKRC, Cincinnati, Ohio.

In addition to a complete line of standard TV Studio Equipment, RCA offers facilities for the design and fabrication of custom studio equipment for TV Studio plants in which it is desirable to augment the functions of standard equipment in order to meet individual station needs. Pictured here are several examples of equipment provided for customers on a custom basis.

Typical of custom facilities designed and constructed by RCA are a broad variety of custom video switching systems. The basic components of the TS-40 Transistor Video Switcher may be assembled to meet an extremely broad

variety of switching requirements varying in size up to 24 video inputs and 10 outputs. If desired, two studio switchers or a studio switcher and master control switcher may be combined in a single system with separate control panels at the operating locations. The custom built control panels illustrated are typical of those supplied for a variety of actual installations. Exact details of custom built video switchers including functional specifications, placement of control levers and grouping of pushbuttons on the control panels are established only after careful analysis with the customer of the functions to be performed.

View of preset, cut-bar video switching control panel at Station WHDH-TV, Boston, Mass. This unique switcher control panel permits preselection of the video source by pushbutton selection. Video "take" is then controlled by cut-bar.

Custom Video Switching Control Panel located in Station WKRC, Cincinnati, Ohio, showing the custom built console that features an RCA TS-40 transistor switching system built to customer specifications, master monitors and station's automation control system.





Custom control panel and console as built by RCA for a closed circuit television installation.

Associated with the custom video switching control panels are other control devices such as special effects pattern selection, multiplexer and projector controls, audio control and television tape control. Proper grouping of these control facilities in many instances may be accommodated most efficiently by means of custom designed consoles of which typical examples are illustrated. In addition, com-

plete video and audio system assembly and rack wiring service is available for entire studio facilities including camera controls, video and audio switching, housing monitoring, intercommunication systems, automation, and signal distribution. Of special interest are the custom video installation in monochrome and color mobile units for which RCA is famous. Views are shown of a typical mobile system. RCA Systems Engineering is available for planning either complete systems or portions of systems and to undertake the development, design, and fabrication of any custom items required.



View of custom switching console in mobile unit.

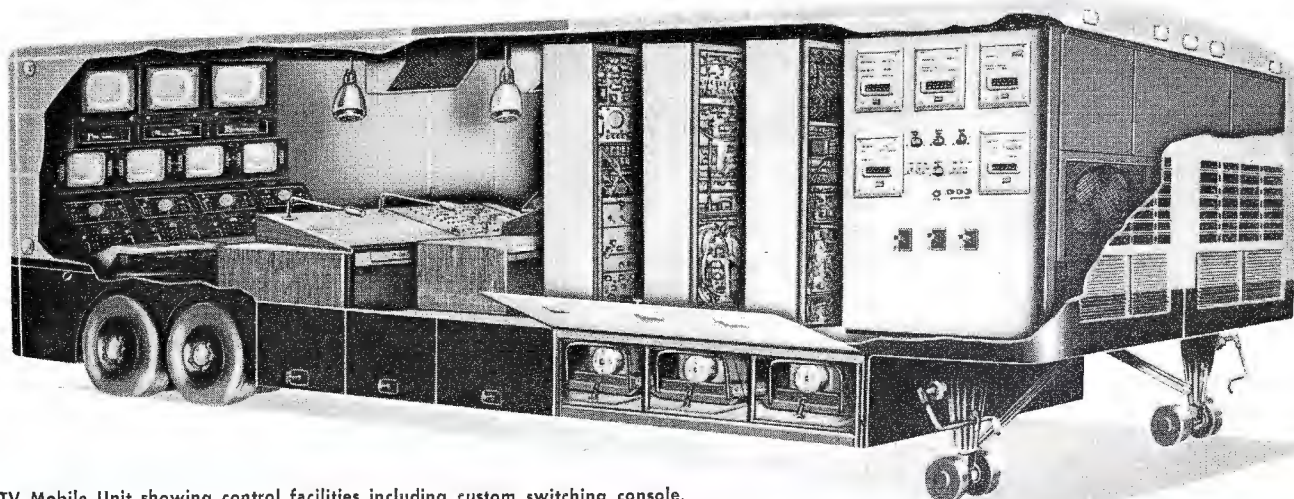

TV Mobile Unit showing control facilities including custom switching console.

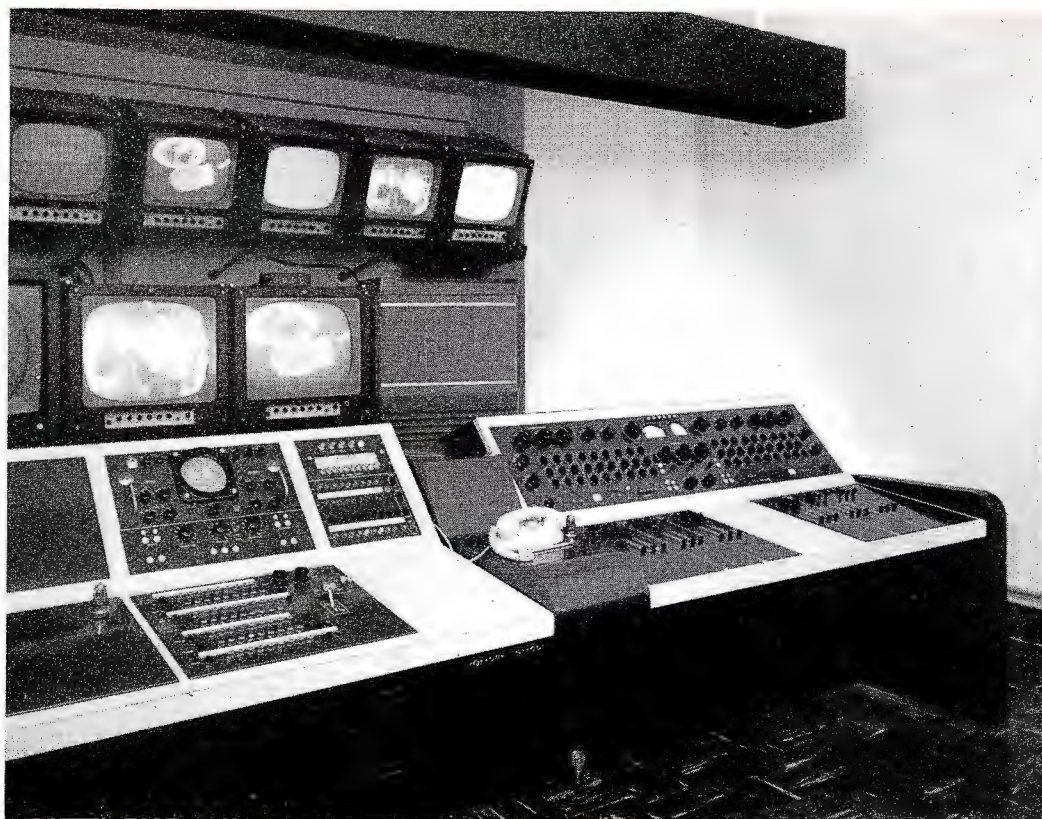

Television tape mixing room at Reeves Sound Studios. RCA custom video switching and effect console shown at left. (Audio mixing console at right designed and built by Reeves' engineers.) Originations from several tapes can be mixed with these facilities to produce one composite TV tape.

At Reeves Sound Studios in New York this custom mixing control console features mounting facility for a Type TO-1 Waveform Monitor above a video switcher control panel. A special effects pattern selector panel is mounted at right above a video monitor input selector panel.



View of the television tape switching control panel at master control in Reeves Sound Studios. The inputs to six RCA Tape Machines are all switchable at this central location.

VIDEO SWITCHING EQUIPMENT

TYPE TS-40

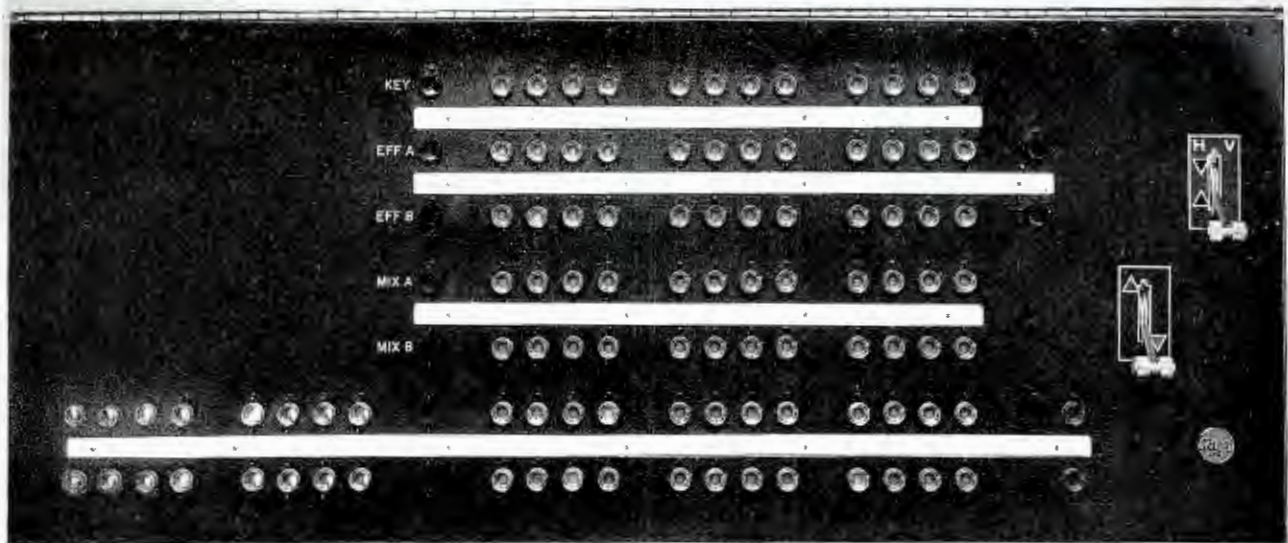

Control Panel for TS-40 Video Switching System A.

FEATURES

- Highly reliable, all-electronic video switching
- Modular design for complete system flexibility—up to 24 inputs, 10 outputs
- Picture transition complete within two microseconds
- Switching occurs during vertical blanking interval
- Interchannel crosstalk isolation at least 55 db
- Plug-in modular construction—completely interchangeable units
- System completely assembled, wired and tested at factory
- Rigid performance specifications assure excellent picture quality

USES

The TS-40 Video Switching Equipment has been designed to meet the most stringent performance demands of television studio and master control switching installations. As a studio switcher it fulfills the functions of "assembly" of television programs by permitting selection between video signals from any of a number of picture sources including studio and film camera, network and remote lines and television tape recorders. A choice of picture transitions is provided including lap-dissolves, fades and superimpositions as well as direct switching. Used in conjunction with the RCA Special Effects System, it provides a brilliant variety of "electronic editing" techniques including wipes, split screen effects, picture inserts and traveling matte effects.

In the role of a master control video switcher, the TS-40 serves the functions of "program distribution" by providing a means of separately selecting the video feeds to a number of individual video output circuits. In a typical instal-

lation these outputs may feed the television transmitter, television tape recorders, network line, house monitoring system, and one or more spare video output lines. In addition to handling the actual switching of video signals, the system provides simultaneous switching of tally light circuits at the individual camera sources. Auxiliary switching circuits are available to control studio warning lights, to operate an external audio switcher, or to perform other switching functions.

The TS-40 Video Switching Equipment is available in the form of a series of pre-wired, assembled and tested systems to meet the majority of television station needs. In addition, the switcher is available on a custom-assembled basis to meet the exact requirements of larger, more complex installations. Up to 24 video inputs and 10 outputs can be provided in a single system. Systems engineering assistance is available from RCA to aid in the planning of custom-built video switching systems upon request.

DESCRIPTION

The most advanced electronic switching circuitry and physical packaging techniques have been utilized to make the TS-40 video switcher as reliable, fast-acting, compact and versatile as possible. The entire switching operation occurs within less than two microseconds and is automatically timed to occur during the vertical blanking interval—literally “between pictures.” The basic switching function is performed by a unique transistor circuit module called a “crosspoint” which takes the place of the video relays, tube circuits or mechanical switch contacts of earlier type switchers. The actual video switching process is entirely electronic in nature, utilizing no mechanical or moving parts. The pushbutton switches located on the TS-40 remote control panel are used only to control a pulse which initiates the action of a transistor crosspoint, which in turn performs the actual video switching function. The performance of the TS-40 switcher is immune to the normal limitations of mechanical wear, contamination by dust or deterioration with age, since no moving parts are involved in any portion of the video switching circuitry.

The simplicity and small size of the transistor crosspoints permit the concentration of an unprecedented amount of switching facility in a small amount of space. This, in turn, results in short lead lengths with the attendant advantages of excellent frequency response and a very high degree of crosstalk isolation. Plug-in modular construction has been used throughout the TS-40 system to simplify installation, facilitate easy removal of units for inspection or maintenance and permit easy expansion to meet changing needs. Absolute uniformity between plug-in units assures complete interchangeability in the system. All units are readily serviceable in the field and need not be returned to the factory for adjustment or repair.

D-C relays are employed in the TS-40 to control “on-air” tally light voltages at the individual camera and camera control locations. The coil voltage for each relay is supplied from the transistor crosspoint which switches the associated picture source on-air. These relays contain extra contacts for auxiliary switching functions such as the control of studio warning lights or simultaneous switching of audio along with video.

The rigid electrical performance specifications of the TS-40 Video Switching Equipment assure consistently high picture quality and freedom from interference due to glitches or other extraneous effects. Crosstalk isolation between video channels is at least 55 db. Differential phase, differential gain and overall amplitude-frequency response performance exceed the requirements for excellent color and monochrome television picture quality.

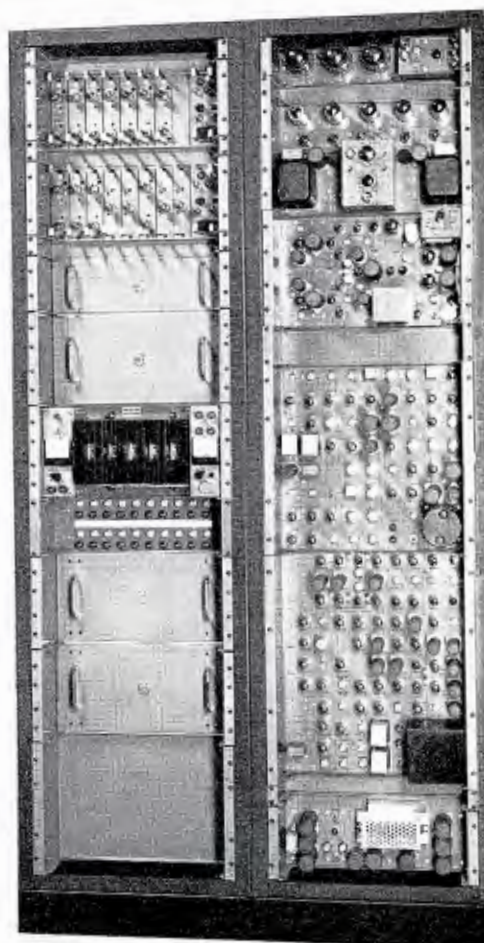

Front view of rack mounted TS-40 Video Switching System A including RCA Special Effects Equipment.

Standard System

Four variations of the TS-40 video switching system are available from RCA on a standard design basis. This series of switchers permits a broad range of choice of facilities to meet the requirements of most television stations. Each system is supplied completely installed in cabinet racks, wired and tested and ready for installation. A remote control panel with illuminated, translucent push buttons is provided for installation by the customer in a location and mounting facility of his choice. The standard switchers are assembled and wired in such a way that the simpler switchers (System C and D) may be expanded later to include the more extensive facilities of the larger switchers (System A and B) through the simple addition of modular plug-in units and substitution of control panels. Detailed information including block diagrams for each of the standard systems is available from RCA in the form of descriptive brochures.

Switching System A

TS-40 System A is the most versatile of the four standard switching systems and offers sufficient operating flexibility to handle all of the video switching requirements of the typical television station with ease. It includes both Special Effects and Lap Dissolve facilities and features a separate switching bus to handle the keying input to the Special Effects Generator.

TS-40 Video Switching System A includes facilities for 12 primary video inputs plus black input, any one of which can be switched to any of 7 output busses. Two output busses are used to feed the video inputs of a Lap-Dissolve Amplifier and two for the inputs of a Special Effects Amplifier. A fifth output bus is used for switching any of the primary inputs to the keying input of the Special Effects Amplifier. The sixth bus is used for Preview and the seventh for the Direct Take or Program bus. The output of the Lap-Dissolve Amplifier appears as an input on the Preview and Program busses and also on the Special Effects Video Switching Busses in order to permit fading and lap-dissolving of picture inserts. The output of the Special Effects Amplifier also appears as an input on the Preview and Program busses. In addition to the 12 primary inputs, eight inputs are provided for Composite Signals on the Preview and Program busses. Sync is added to non-composite signals in a Sync/Blanking Adder Unit as shown in the functional diagram of System A.

Switching System B

TS-40 Video Switching System B provides all of the advantages of System A with the exclusion of a separate switching bus for switching video to the keying input of the Special Effects Generator. It includes facilities for 12 primary inputs plus a black input, any one of which can be switched to any of 6 output busses. Two output busses are used to feed the video inputs of a Lap-Dissolve Amplifier and two for the inputs of a Special Effects Amplifier. The fifth bus is used for Preview and the sixth for Direct Take or Program switching. The output of the Lap-Dissolve Amplifier appears as an input on the Preview and Program busses and also on the Special Effects Video Switching busses to permit fading or lap dissolving of inserts. The output of the Special Effects Amplifier also appears as an input on the Preview and Program busses. In addition to the 12 primary inputs, eight inputs are provided for Composite Signals on the Preview and Program busses. Sync is added to non-composite signals as described under System A.

Switching System C

TS-40 Video Switching System C is similar to System B but is further simplified through utilization of the same pair of output busses to feed the video inputs of both the Lap-Dissolve Amplifier and Special Effects Amplifier. It therefore provides the advantages of Special Effects operation with a minimum of external circuitry.

Block diagram of TS-40 Video Switching System A.

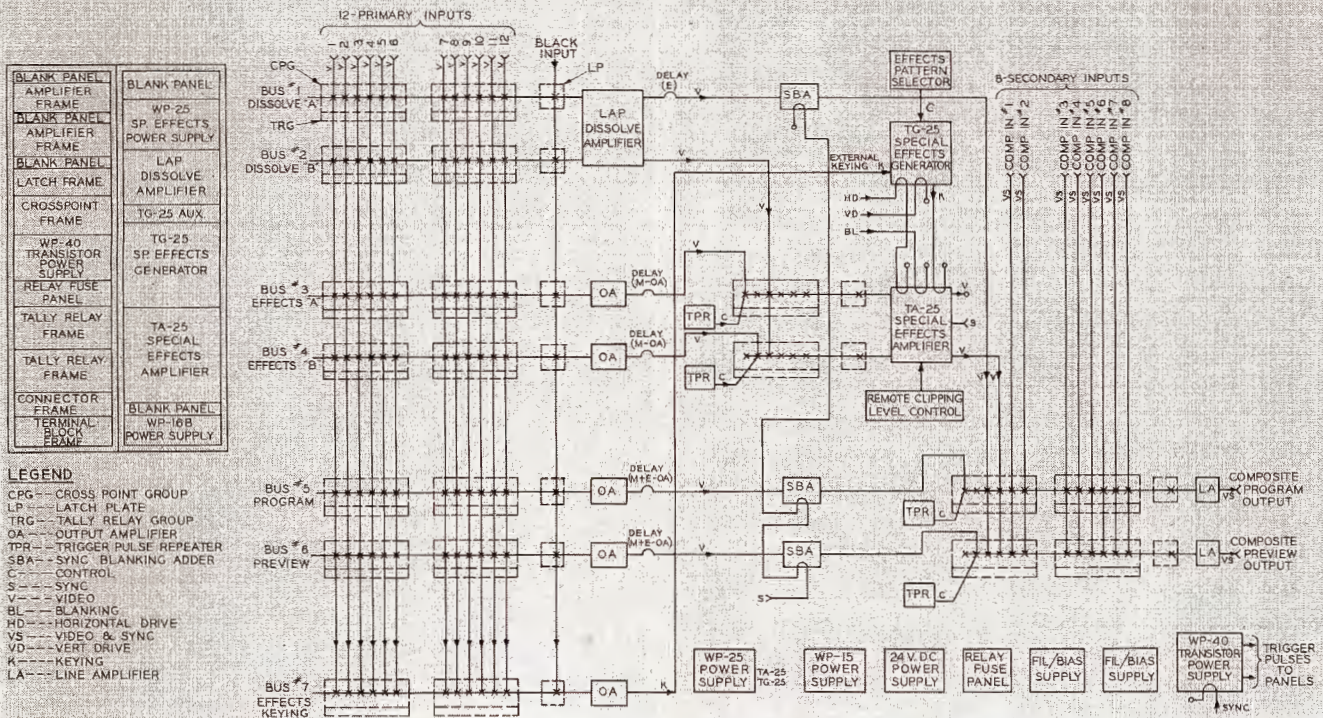

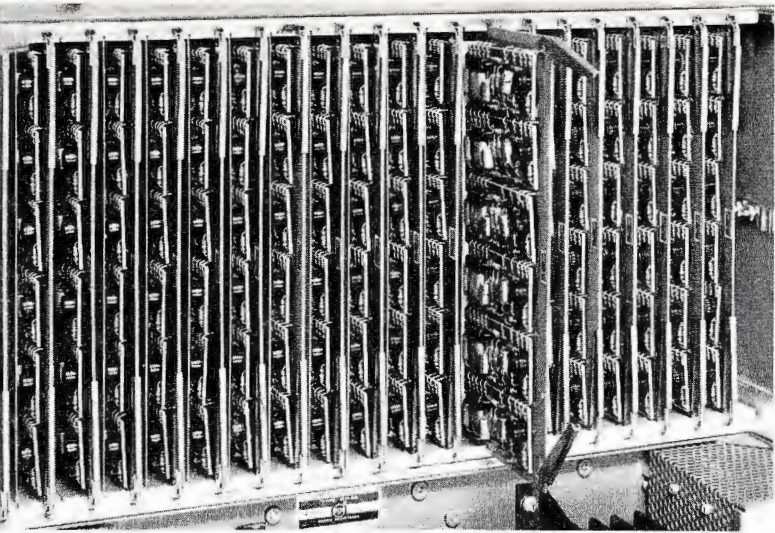

View showing twenty TS-40 "crosspoint" groups mounted in frame with dust cover removed. Each "crosspoint" group, such as the unit withdrawn, contains six transistor "crosspoints." A crosspoint is the equivalent of one video relay. This compact arrangement allows twelve inputs and 10 outputs per crosspoint frame.

System C has facilities for 12 primary inputs plus black, any one of which can be switched to any of 4 output busses. The video signals from two output busses are looped through the inputs of the Lap-Dissolve Amplifier to the inputs of the Special Effects Amplifier. The third bus is used for Preview and the fourth for Program. The outputs of the Lap-Dissolve Amplifier and Special Effects Amplifier appear as inputs on the Program and Preview busses. Eight inputs are also provided for composite signals on the Preview and Take busses. Sync is added to non-composite signals in a Sync/Blanking Adder as described under System A.

Switching System D

TS-40 Video Switching System D is the most economical of the TS-40 standard switching systems and features Lap-Dissolve facilities in addition to separate switching busses for Preview and Program outputs. The system includes facilities for 12 primary inputs plus black input, any one of which can be switched to any of 4 output busses. Two output busses are used to feed the Lap-Dissolve Amplifier inputs. The third bus is used for Preview and the fourth is the Direct Take or Program bus. The output of the Lap-Dissolve Amplifier appears as an input on the Preview and Take busses. Eight inputs are also provided for composite signals on the Preview and Take busses. Sync is added to non-composite signals in a Sync/Blanking Adder unit as described under System A.

The wiring of these switching systems has been designed to permit easy expansion at a later date for increased versatility. Through the addition of the RCA Special Effects Equipment and the proper TS-40 plug-in units, System D may be expanded to the equivalent of System A, B, or C. A new control panel is required to handle the addition of switching busses to the basic switcher. System D thus provides a means of obtaining the advantages of new, modern switching facilities at a minimum of initial investment with provision for growth and expansion later as operating needs increase.

SPECIFICATIONS

Electrical Specifications

The following specifications apply to the entire signal path from any input selected on the Program switching bus to the output of the Program switching bus.

- Amplitude-frequency Response.....Less than 0.3 db down at 8 mc
- Differential Phase.....Less than 1° at 10% to 90% APL
- Differential Gain.....Less than 2% at 10% to 90% APL
- Tilt.....Less than 1% at 60 cycles
- Crosstalk.....At least 50 db below program level measured with 3.58 mc signal at 2.0 volts peak-to-peak fed simultaneously to all video inputs except input of channel under test.

Mechanical Specifications

Control Panel for System	A	B	C	D
Length	38 ⁷ / ₈	38 ⁷ / ₈	38 ⁷ / ₈	35 ¹ / ₂
Width	16	14	10	10
Depth*	5 ¹ / ₂	5 ¹ / ₂	5 ¹ / ₂	5 ¹ / ₂

* Based on mounting table thickness of 1 inch. Knee cover 4¹/₂ inches deep bolts to underside of table.

Equipment Supplied

- TS-40 Video Switching System A, completely assembled, wired and tested in two cabinet racks, with separate Remote Control PanelES-40930
- TS-40 Video Switching System B, completely assembled, wired and tested in two cabinet racks, with separate Remote Control PanelES-40931
- TS-40 Video Switching System C, completely assembled, wired and tested in two cabinet racks, with separate Remote Control PanelES-40932
- TS-40 Video Switching System D, completely assembled, wired and tested in one cabinet rack, with separate Remote Control PanelES-40933

Accessory Equipment

Cables: The following bulk cable is required for interconnection between the rack mounted switcher and remote control panel and must be ordered separately in accordance with individual installation requirements:

MI	Description	Number of Lengths Per System			
		A	B	C	D
13345-17	17-pair	10	10	6	6
13380-8	8-conductor	3	3	3	2
13380-4	4-conductor	1	1	1	1
75	RG-59/U Coaxial	1	1	1	1
43-D	3-conductor	1	1	1	--

STUDIO VIDEO SWITCHER

TYPE TS-11A



FEATURES

- Both color and monochrome signals can be handled simultaneously
- Full preview facilities
- Program transfer switch for previewing fades and lap dissolves
- Sync addition in all output amplifiers
- Sending-end termination for color use
- Switch for "Off-the-air" monitoring
- Extended low frequency roll-off provides bounce-free operation
- Switches composite or non-composite signals
- Contacts for audio-tie facilities built-in on preview channel

USES

The TS-11A is a nine input switcher for use in either studio or master control applications. Five of these inputs are for non-composite signals such as from studio and film cameras. Three of the inputs are for non-composite or composite signals. These may be used for network or remote sources, or, if desired, additional studio or film cameras. The final input can be used for "black" or as a spare. The preview channel contains a tenth input which is used for monitoring the line or off-the-air signal.

Three rows of push buttons, a program transfer switch, and a manual fader are used to carry out the switching functions. Two rows of push buttons feed the manual fader which in turn feeds the program channel. A third row of push buttons feeds the preview channel. Signals from the fader and the preview channels are fed to a program transfer switch which enables the preview channel to be used as the program channel while the two fader channels are being used for previewing rehearsals or pre-setting of lap-dissolves, superimpositions and fades.

DESCRIPTION

A single console housing contains the TS-11A control panel, mixing circuits, output line amplifiers and terminal connections for power, tally, and video circuits. A Master Monitor may be installed in the same console as a preview or line monitor.

Vertically mounted in the lower portion of the console section is the chassis which contains the output amplifiers; sync mixing and interlock circuits; filament and bias supplies; and all power, tally, and video co-ax connections.

The complete switching unit is mounted as one hinged assembly. First the control panel hinges down to permit removal of a Master Monitor from the console without interfering with the pushbuttons and fader lever for access to wiring and terminal connections. Next, the entire unit, both panel and chassis, hinges down to floor level for access to wiring and terminal connections. Finally, the whole assembly may be lifted out after un-plugging the cables.

A stage of isolation is provided between each pushbutton switch and the circuits following to minimize the effects of wiring capacity and to permit the use of a direct video fader circuit. The output of the fader circuit is fed to a gain stage which in turn feeds a cathode follower used to drive cables to the program transfer switch. The circuits for program and for preview are symmetrical to this point to permit switching between the program and preview channels without level or response change. Four input amplifiers are then fed from the program transfer switch. Each amplifier is an independent line amplifier. The feedback circuit used provides for sending end termination of the outgoing lines with excellent frequency response and amplitude linearity. Also, each output amplifier is provided with a sync mixing stage. The addition of sync to a particular output is controlled by the sync interlock circuits.

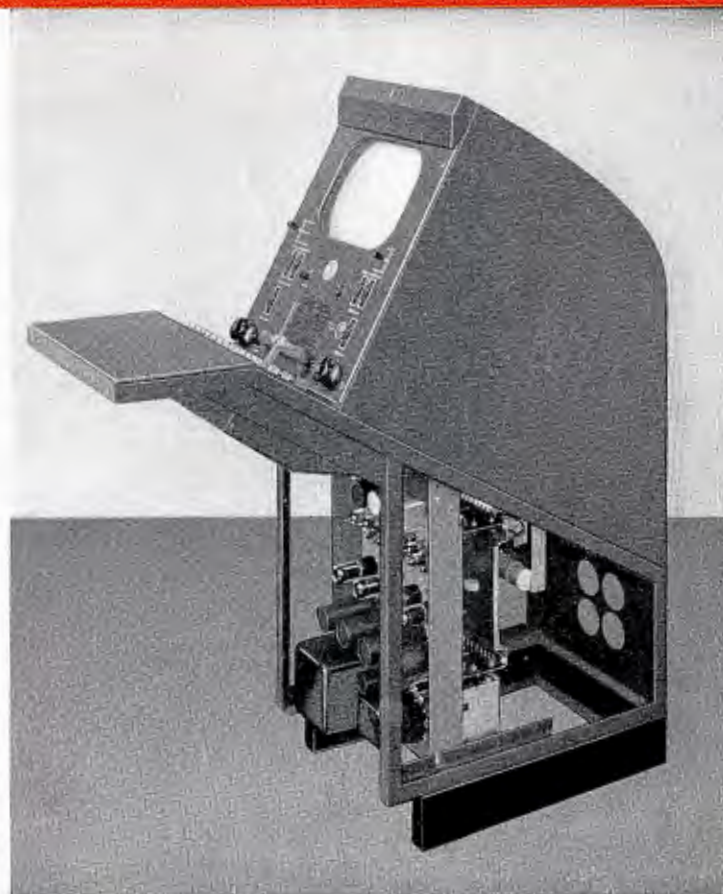

TS-11A Switching System mounted in a single RCA console housing along with TM-6 Master Monitor.

Special care has been taken to eliminate microphonics in the switcher output due to pushbutton operation or to the various disturbances normal to console operation of equipment. This has been accomplished by the use of a shock-mounted pre-amplifier chassis and ruggedized tubes in the main chassis where required.

The low frequency response of all of the amplifier circuits is designed for smooth roll-off to a very low cut-off point, thereby providing bounce-free operation without the complexity of clamp circuits.

Additional contacts are provided on the preview switching channel pushbuttons for use with audio tie relays. This can be used when simultaneous audio-video switching of remote or network circuits is necessary, and particularly when the TS-11A is used in conjunction with an audio consolette.

SPECIFICATIONS

Electrical Specifications

Input Circuits:

- 5—for "local" sources—#1 to #5
- 2—for "local" or "remote" sources—#6 and #7
- 1—for "remote" source—#8
- 1—for "black" (may be used for local picture) #9
- 1—for "line" or "off-the-air" (fed to preview circuit only)

Input Signal Level:

1.0 v. (peak-to-peak, composite video)

Output Circuits:

- 3—for program output (one normally used for "line" monitor)
- 1—for preview output

Output Signal Level:

1.0 v. (peak-to-peak, composite video)

Tally Circuits:

"On Air to Studio Cameras.....+280 v. d-c (through series resistor
or 24 v. d-c (ext. supply)

Inputs #1 to #5 (arc suppression supplied)

"On Air" to Studio or Film Cameras.....6.3 v. a-c (inputs #1 to #9
or 24 v. d-c (ext. supply)

(No arc suppression supplied—normally required
only for 24 v. operation)

Amplifier Circuits—Tube Complement

- 3—6CL6 Pre-amplifiers—switching panel
- 2—5670 Gain stage, cathode followers—amplifier chassis
- 4—5670 Output amplifiers for program and
preview channels
- 4—6BX7 Sync mixers for output amplifiers
- 1—6X4 Bias supply rectifier
- 1—OB2 Voltage regulator
- 1—12AX7 Regulator
- 1—6CL6 Regulator
-
- 21 Total

Amplifier Circuits Overall Transmission Specifications

1. Gain:

Video Inputs (#1—#9).....1 (adjustable $\pm 5\%$)

Monitor Input (#10).....1 (adjustable 0 to 1.05)

2. Frequency Response (values shown for signals fed from sending end terminated lines):

4 cycles to 8 mc..... ± 3 db

3.58 mc referred to 15,750 cycles..... ± 1 db

3. Tilt—60 Cycle Square Wave.....3% max.

4. Hum and Noise:

(Peak-to-peak noise relative to 1 volt).....-50 db

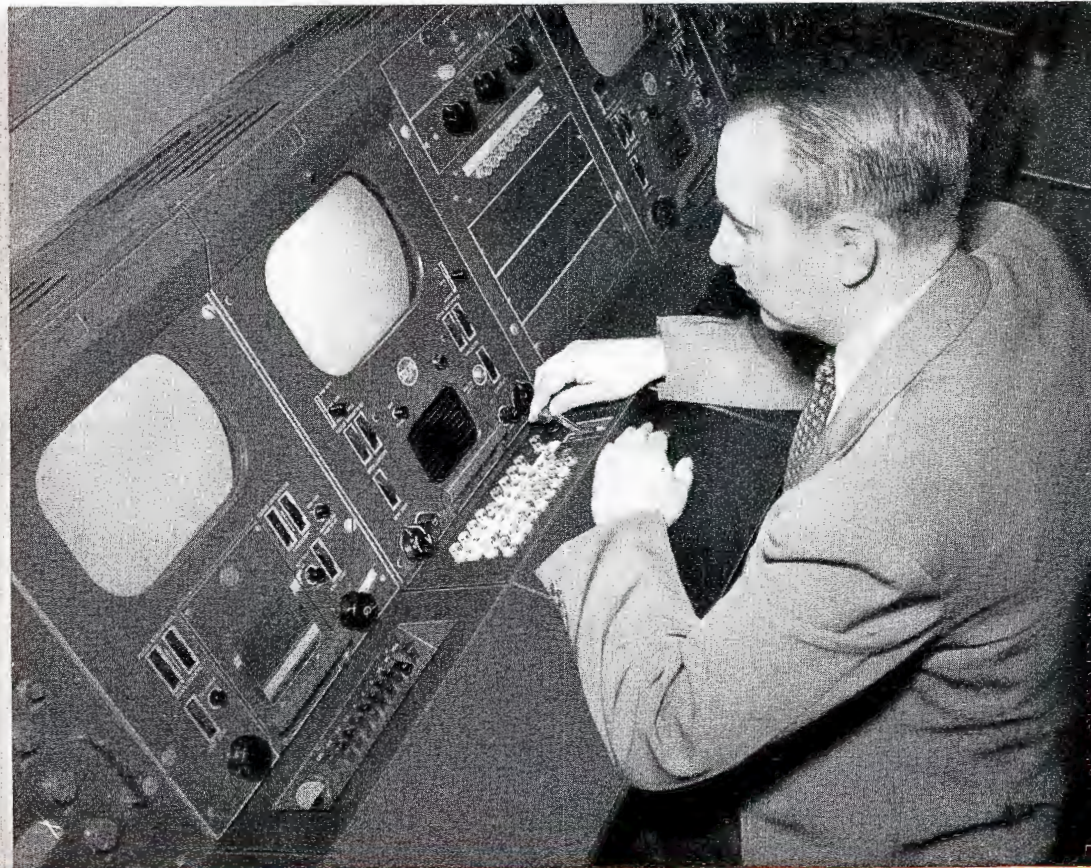

TS-11A Switcher Control Panel
installed at a studio control
location.

SPECIFICATIONS (Continued)

- 5. Cross-talk Attenuation:
 - 1000 cycles55 db
 - 3.58 mc45 db
- 6. Output Impedance.....75 ohms \pm 10%, sending-end terminated
- 7. Input Circuits:
 - Resistance
 - Video Inputs (#1—#9).....75 ohms \pm 5% (non-bridging)
 - Monitor Input (#10)75 ohms \pm 5%
- 8. Isolation Between Program Outputs:
 - 1000 cycles50 db
 - 3.58 mc40 db
- 9. Sync Channel:
 - Input Level.....3.5 to 5.0 v. peak-to-peak
 - Input Impedance.....75 ohms \pm 5% (normally non-bridging)
 - Output Level.....0.1 to 0.5 v. peak-to-peak (adjustable at each output separately, sync-add condition)
- Power Required:
 - A-c.....109, 117, 125 v. a-c 120 watts
 - D-c.....280 volts regulated, 300 ma (normal)
65 ma (max. demand for tally system)
 - Required Supply Rating.....400 ma

Dimensions:
 Main Chassis.....18" x 11½" x 9½"
 Control Panel.....12⅞" x 5⅝" x 3½"
 Weight40 lbs.

Equipment Supplied

- TS-11A Studio Switching System, complete
 Includes the following units:
- 1 TS-11A Switcher Assembly, including tubes in placeMI-26226
 - 1 Master Monitor, Type TM-6C (less Kinescope and CRO)MI-26136-C
 - 1 Blower for TM-6C.....MI-26579-B
 - 1 Kinescope, Type 10SP4 (for TM-6C).....MI-26655
 - 1 Cathode Ray Tube, Type 5ABP1 (for TM-6C).....MI-26667
 - 1 Console Housing, 13-inch.....MI-26786
 - 1 Power Supply Rectifier, Type WP-16B.....MI-26084-B

Accessory

- TV Broadcast Intercom Equipment.....ES-11981
- VoltOhmystWV-97D
- OscilloscopeTO-524D

BLOCK DIAGRAM OF TS-11A SWITCHER

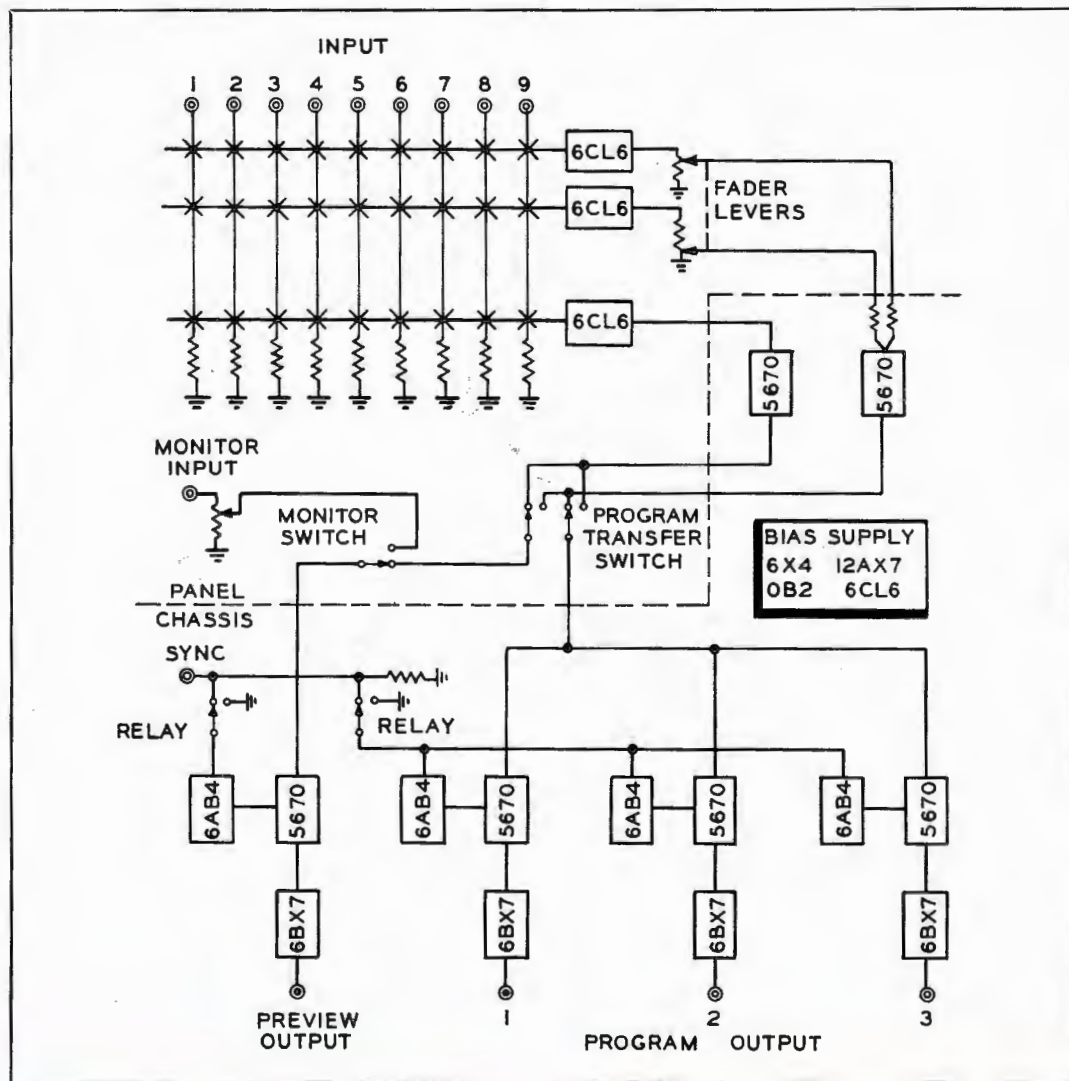

STUDIO VIDEO SWITCHER

TYPE TS-5A



The TS-5A Switcher is shown below with its control panel and amplifier unit mounted with a TM-6C Master Monitor in a standard console housing.



FEATURES

- Ideal for use in nominal local color operations
- System will accommodate five signal inputs
- Provisions for fades, lap dissolves, superimpositions
- Choice of mounting locations
- Provides economical expansion facilities when used with other switching systems

DESCRIPTION

The TS-5A Video Switcher is designed for use by television stations either as an independent switching system or in conjunction with existing systems such as the TC-4A, TS-11A, or similar switchers. In either of these applications, the equipment substantially increases station programming flexibility. Briefly, the TS-5A will allow a single

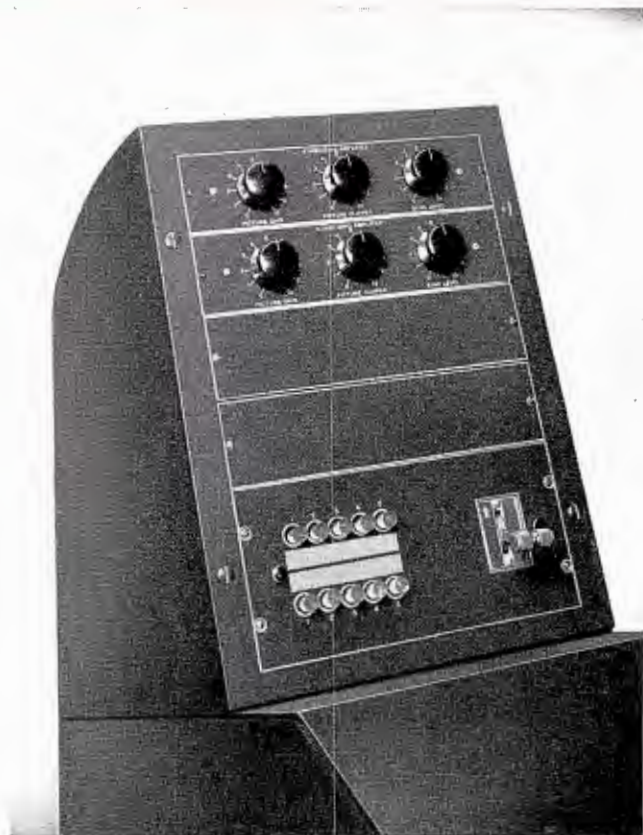

The TS-5A control panel may be mounted in a standard remote control basic frame in the upper face of a console (see above) or in the sloping desk area of the control console (see below).

video operator to do these things: (1) select any signal from five input lines; (2) switch the desired signal into the on-the-air line; (3) fade or dissolve two signals simultaneously at any speed; (4) fade-in or fade-out any one signal; (5) switch instantaneously from one signal to another; (6) superimpose two signals with any desired degree of magnitude for each signal. The switcher is equally adaptable to color. The TS-5A Switching Equipment can be ordered as a complete system including console, master monitor and power supply as RCA ES-26964, or separately as ES-26913.

The TS-5A Video Switcher (ES-26913) is a flexible two-unit equipment designed to fit in a single standard console housing. The units are the TS-5A Switcher Control Panel, MI-26273, and the TS-5A Switcher Amplifier, MI-26274. The pushbutton and fader panel may be located either in the sloping desk area or in a standard remote control basic frame placed in the upper face of the console. The amplifier chassis remains in the lower portion of the console and is within reach of the interconnecting cables supplied, for either location of the control panel.

The TS-5A, when used at studio control points for camera switching, permits such additional programming features as fades, lap dissolves, and superimpositions. Means are provided for pushbutton selection of input channels whose signals are fed in turn through a manual fader control, a mixing circuit and then to twin output line amplifiers.

Primarily intended for a small studio installation, the TS-5A may also be used to advantage in conjunction with other switching systems to expand facilities with a minimum



Close-up view of the fader mechanism located in the control panel of the TS-5A.



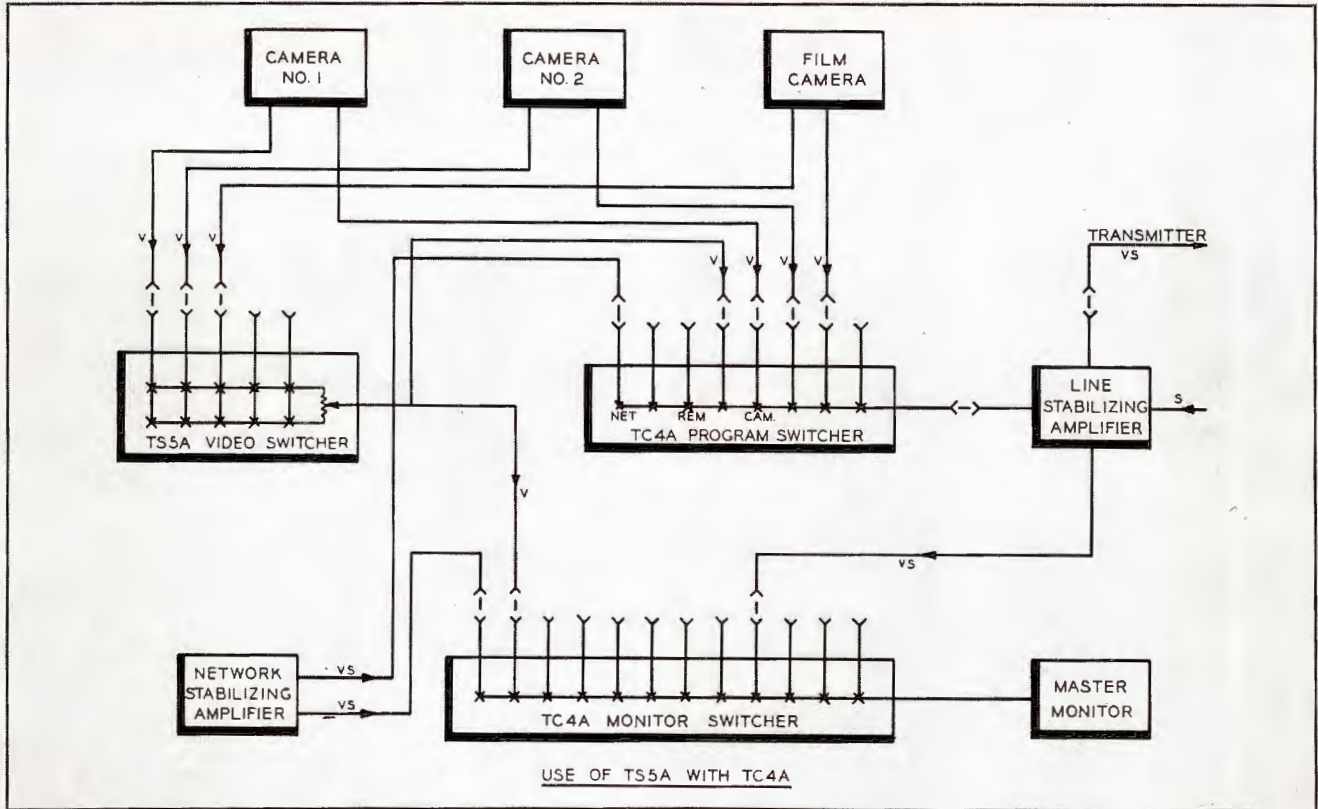

The TS-5A is primarily intended for use in a small studio installation. However, it may be used to advantage to expand facilities of a TC-4A basic-buy console (see block diagram above) or a TS-11A Switching System (see block diagram below).

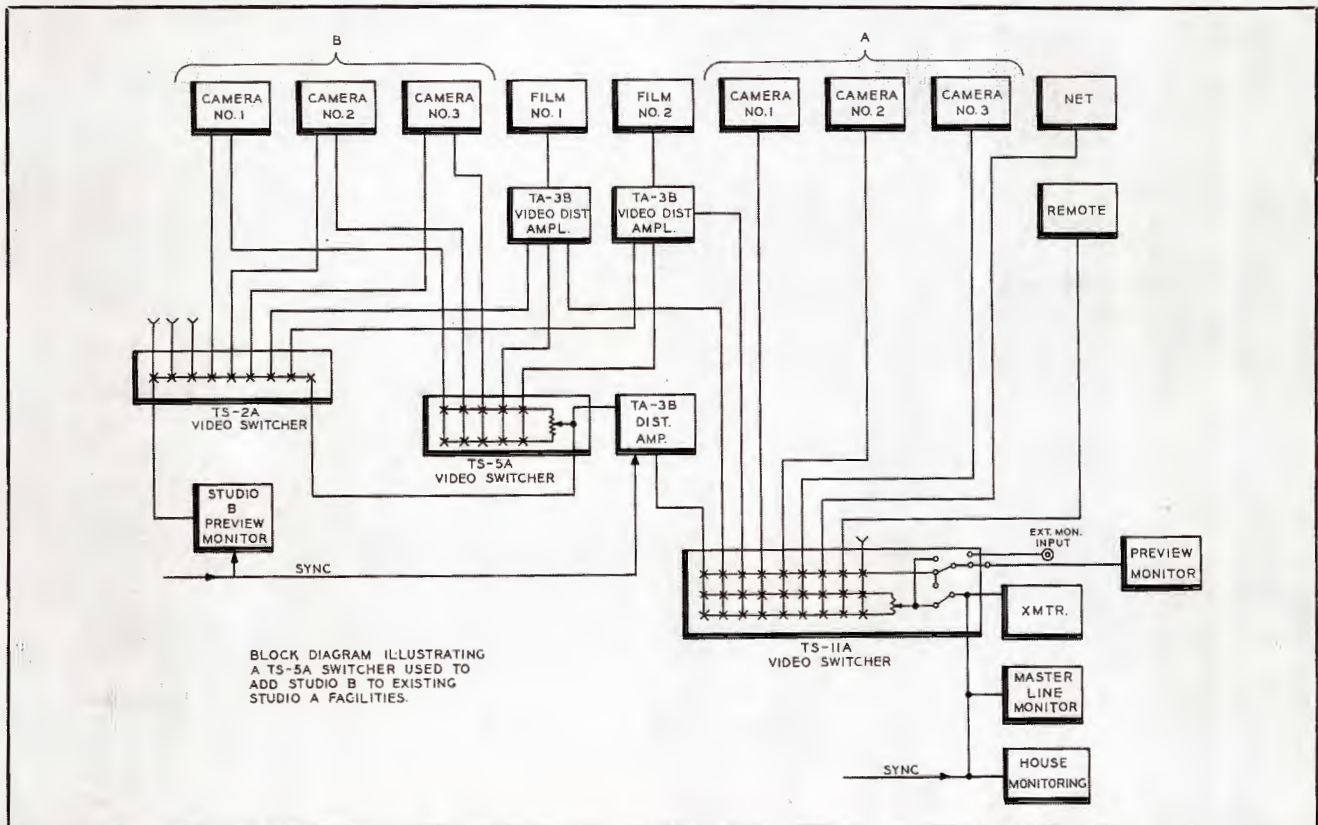

DESCRIPTION (Continued)

of expense. For example, it may be used in conjunction with the TC-4A Audio/Video Control Console to provide for fading and mixing when the station expands to include additional cameras. Also, by proper arrangement of inputs to both switching units, it is possible to use the TS-5A for one program and then to carry the next program through the TC-4A and free the TS-5A for a rehearsal. Similar applications may be carried out with the TS-11A and other switchers. All controls are mounted on the fader control panel. Two rows of five buttons each, rear-illuminated, are mechanically interlocked. Illumination to rows

is controlled by fader lever position to give "on-air" indication. The fader mechanism incorporates new design features including split-lever, optional lock, manual control for video gain potentiometers, and twin-contact relay type limit switches. The equipment operates from 117 volts, 50/60 cycles, 30 watts a-c source. D-c power may be derived from a type 580-D regulated power supply. When the equipment is used in conjunction with another switching system, the existing power supply may be used. When used by itself a TA-3B Distribution Amplifier is necessary for adding Sync to the non-composite signal.

SPECIFICATIONS

Input Circuits:
 Impedance.....75 ohms, internally terminated
 Number.....5, one normally used for "Black"
 Level.....1.4 volts "peak-to-peak"

Output Circuits:
 Load Impedance.....75 ohms
 Number.....2 (designed to feed single terminated lines, may be connected in parallel to feed one double-terminated line)
 Voltage.....1.4 volts "peak-to-peak" composite video
 Gain.....Adjustable for gain of one from any input to either output
 Isolation Between Outputs.....55 db at 1000 cycles; 45 db at 4 mc
 Frequency Response.....±0.3 db from 4 cycles to 8 mc
 ±1 db from 2 cycles to 10 mc
 Hum and Noise Level.....-50 db referred to 1 volt

Power Required:
 A-c.....117 volts, 50/60 cycles, 30 watts
 D-c.....280 volts, regulated, 125 ma

Tube Complement
 1 RCA 6U8 1 6Z01 2 RCA 6CL6

Dimensions:
 Amplifier Chassis.....11 5/8" long, 6 7/8" wide, 6 3/8" high
 Fader Panel.....11 1/8" long, 5 3/8" wide, 3 1/2" deep
 Net Weight.....18 lbs.

Equipment Supplied:
 TS-5A Video Switching System, complete.....ES-26964
 includes the following equipment:
 1 Video Switching System (ES-26913) to include:
 1 TS-5A Control Panel.....MI-26273
 1 TS-5A Line Amplifier.....MI-26274
 1 TA-3B Distribution Amplifier.....MI-26157-B
 1 TM-6C Master Monitor to include:
 1 Chassis.....MI-26136-C
 1 Type 10SP4 Kinescope Tube.....MI-26655
 1 Type 5ABP1 Cathode Ray Tube.....MI-26667
 1 Blower.....MI-26579
 1 Console Housing.....MI-26786
 1 Power Supply, Type WP-16B.....MI-26084-B

Available Accessories

Relay 6.3 Volt Coil, a-c.....MI-26275
 Relay 24 Volt Coil, d-c.....MI-26284
 TA-3B Video Distribution Amplifier.....MI-26157-B
 Control Levers including 1000 ohm potentiometers.....MI-26236-3
 TV Broadcast Intercom Equipment.....ES-11981
 Sync Interlock Relay (for use with TA-3B).....Stock #99155

This block diagram describes the facilities of the TS-5A when used as an independent switcher.

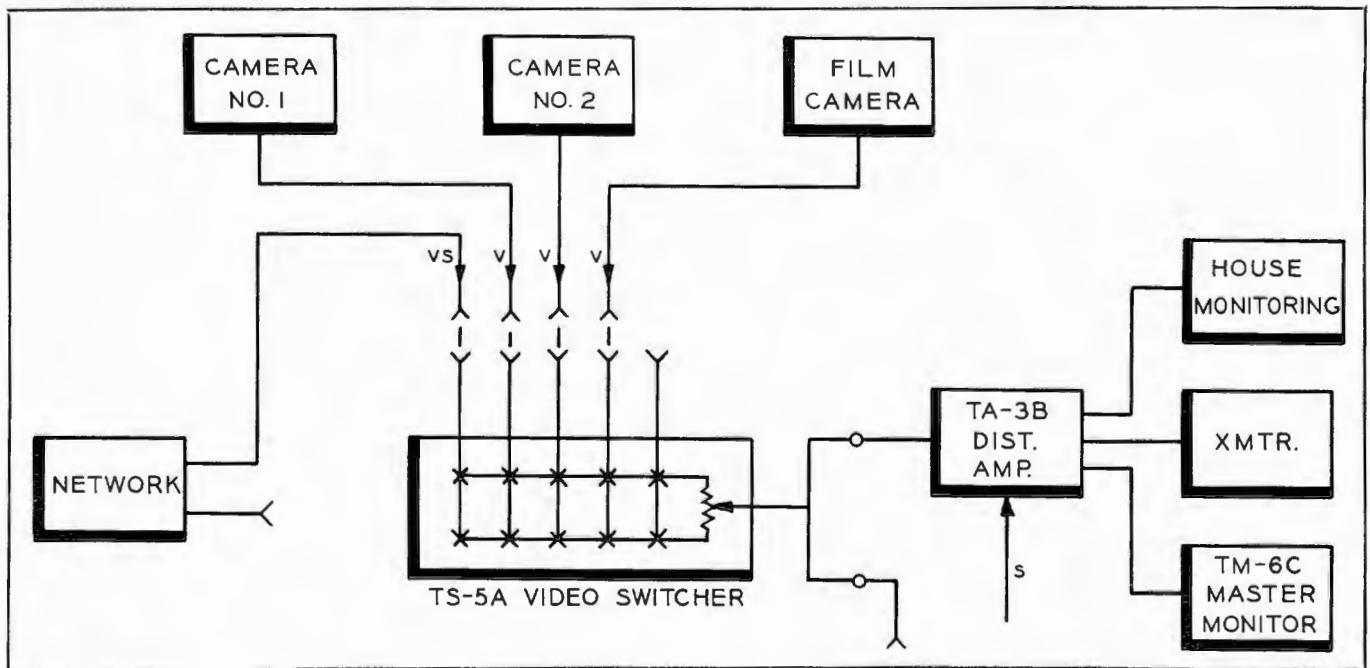

UTILITY VIDEO SWITCHER

TYPE TS-2A

FEATURES

- Inexpensive video switcher
- Ideal as monitor input switch
- Completely self-contained
- Extra contacts provided for special application
- Easily mounted at any convenient location
- Two switchers can be operated in parallel

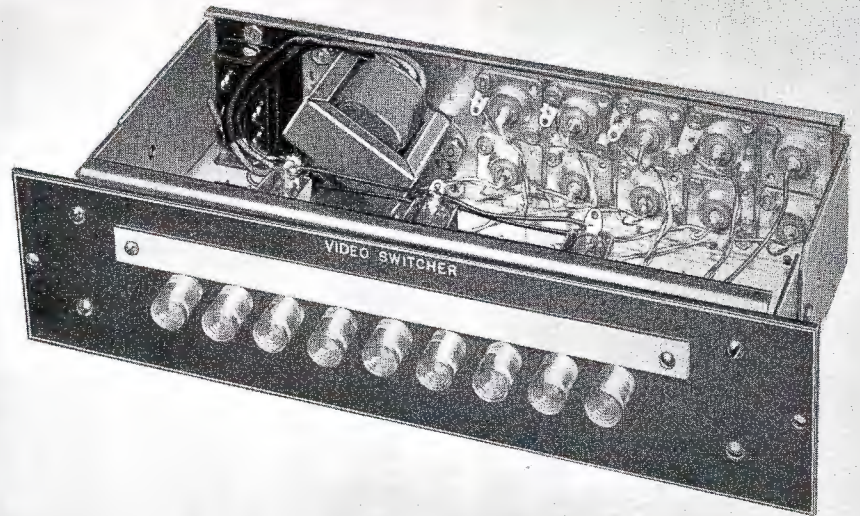

USES

The Video Switcher, MI-26277, is an ideal and inexpensive means of augmenting any present switching installation. Station engineers will find a multitude of uses for this compact unit as a video switcher as well as a monitor switch.

The following is a partial list of its uses:

1. As a preview switcher with TS-5 or TC-4A studio switchers. In this case distribution amplifiers may be required to feed the video switcher if all the cameras' outputs are in use.
2. Input switching to special effects equipment.
3. As a monitor switch in a projection room permitting the operator to view the various film camera outputs as well as the program line for cueing purposes.
4. As monitor switch in an announce booth permitting the announcer to select the program source he requires.
5. As a general purpose rack mounted monitor switch.
6. As a switch for selecting the various monitoring points in a transmitter.
7. Two of these switches can be operated together as a 9 by 2 switcher. However, in this case caution must be exercised so that a single input is not switched to both outputs at the same time.

DESCRIPTION

The MI-26277 Video Switcher is a 9 input—1 output unit. The entire assembly is completely self-contained and is designed to mount in the remote control panel section of a standard RCA console housing. A mechanically interlocked push-button assembly, pilot lamp sockets and a frame supporting the co-ax connectors are all mounted directly on the panel. Each input is terminated in 75 ohms. When any input is switched to the output, the termination is removed to avoid double termination and maintain a 75 ohm terminated output. The push-buttons are clear lucite and light up when depressed. Extra contacts are provided on

the switch to increase its versatility and make it readily adaptable to special applications.

The Switcher may be mounted as follows:

- (a) In the remote control panel area of a standard MI-26276 console housing. This requires an MI-26252 remote control panel adaptor. The console provides room for more of these same switchers plus other remote control panels (up to a total of seven units).
- (b) In the well or desk area of a standard MI-26786 Console Housing. An adaptor, MI-26278-A is required which will accommodate two TS-2A Switchers. Blank Panel, MI-26253, can be inserted in MI-26278-A when only one switcher is to be accommodated.
- (c) In a standard cabinet rack. An MI-26254 rack mounting adaptor is required for this purpose.
- (d) In a desk top or panel according to individual installation requirements. The only power required is a 5 watt, 117 volt a-c source for the push-button lamps.

SPECIFICATIONS

Electrical

Power Requirements:	
Pilot Lamps.....	117 volts, 50/60 cycles, 5 watts
Input Circuits:	
Impedance.....	75 ohms (internally terminated)
Number of Circuits.....	9
Voltage.....	1.4 peak-to-peak (Composite Video)
Output Circuit:	
Impedance.....	75 ohms (termination at input of unit being fed)
Number of Circuits.....	1

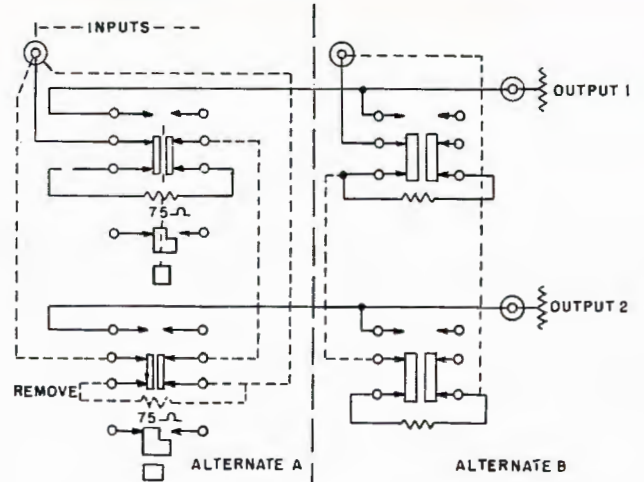

Schematic diagram of TS-2A Video Switcher.

Mechanical

Width	11 1/16"
Height	2 31/32"
Depth (overall)	6 3/4"
Weight (approximate)	3 lbs.

Equipment Supplied

Video Switcher	MI-26277
----------------------	----------

Accessories

Remote Control Panel Adaptor.....	MI-26252
Rack Mounting Adaptor.....	MI-26254
Console Wall Mounting Adaptor.....	MI-26278-A
Blank Panel	MI-26253
Control Levers including 1000 ohm potentiometers.....	MI-26236-3

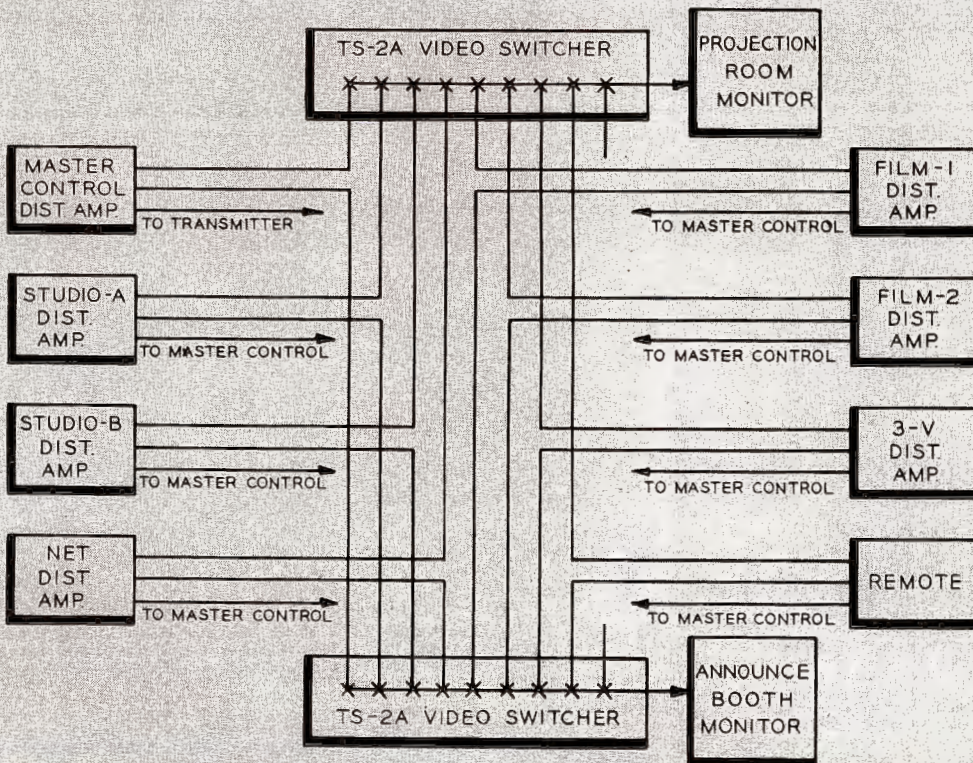

Block diagram showing use of TS-2A as a Monitoring Switcher.

FIELD SWITCHING SYSTEM

TYPE TS-30D

FEATURES

- Fades, lap dissolves, superimpositions, and switches between 6 composite or 4 composite and 2 non-composite signal sources
- Local sync mixing and sync interlock
- Five position monitor input selector
- Clamp circuits designed for color signals
- Tally light indication system
- Complete interconnection system



USES

The RCA TS-30D Field Switching System, when used in combination with a Field Master Monitor such as the RCA Type TM-6C, is the field equivalent of a director's console in a studio. It provides two major services in a setup involving more than one camera. The first is a means of switching between cameras and of monitoring the outgoing signal. The second is the provision of an intercommunication center for the telephone system which enables all operating personnel to talk with each other. Picture signal circuits of the switching unit permit switching between four cameras and two incoming auxiliary lines or, in unusual cases, between six cameras. Communication circuits are limited to a maximum of four cameras. The switcher also makes possible fades, lap dissolves, and superimpositions among other switching techniques. A tally light system indicates the switching status of each input.

While the TS-30D is designed primarily for field pick-up applications, it has also been used successfully in studio installations of a semi-permanent nature. An accessory monitoring system, (ES-26995-B, TM-6C Master Monitor) provides high quality facilities for both color or monochrome applications.

DESCRIPTION

The TS-30D Field Switching System is comprised of the MI-26215-C Switching System, and a Type TY-31A Power Supply (MI-26091) both provided with suitcase type carrying cases and shock mounts, a plate Current Meter (MI-21200-C1), and set of Interconnection Cables (MI-26740-A). Three double earphone headsets provide necessary intercommunication facilities for all operating personnel.

The TS-30D provides two rows of push-buttons for video switching. They are located at the bottom of the front panel, adjacent to the fader assembly. Tally lights above each pair of buttons indicates the "on" or "off" condition of that particular input. Limit switches on the fader assembly prevent the tally circuits of the cameras from operating until the fader arms begin their travel out of the extreme positions. The bottom row of switches is colored white as is one of the fader lever knobs. The top row is black to correspond to the other fader knob. When the fader is in the lower position, switching is accomplished by the white buttons—in the top position by the black.

A fade is accomplished from one row to the other merely

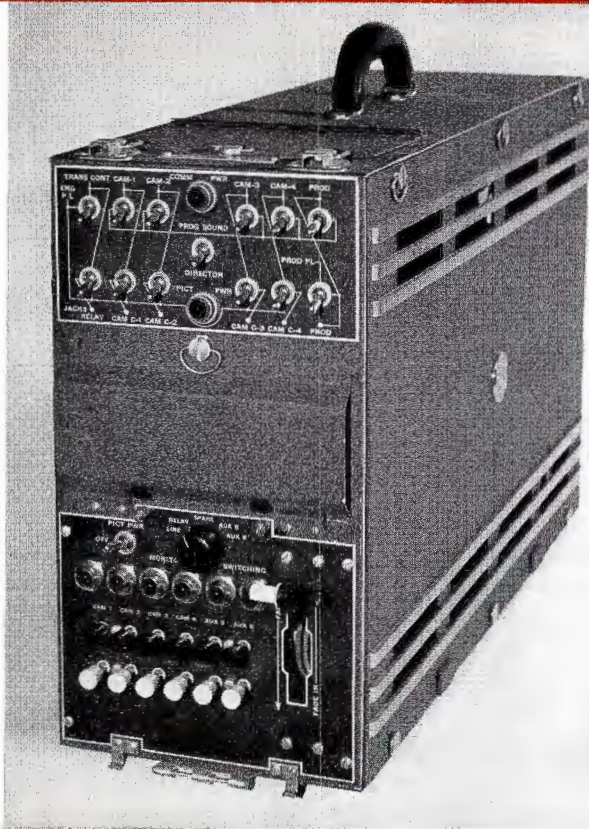

Field Switching Unit MI-26215-C housed in its own portable carrying case.

by selecting the proper button corresponding to the input desired and then moving the fader arm to the opposite position. The fader arms can be operated independently of each other to accomplish super-imposing titles on a picture background, etc.

Overlap type switching is used to conform to industry practice. The video signal is amplified and subjected to clamp action by a circuit especially designed to preserve the color burst when color switching is required. Two 6AG7 power amplifiers drive the picture output line with sending end termination.

The local sync signal is added to the video signal whenever any of the first four inputs are selected. When positions five and six are selected, sync is added when non-composite signals are used, but the mixing circuit is inactive if composite signals are used. This choice is made by means of two selector switches on the main chassis. The clamp pulses are derived from the composite signal always present on the picture output line, thus no loss of stability results from interruption of the clamp action.

A five-position selector switch on the front panel selects

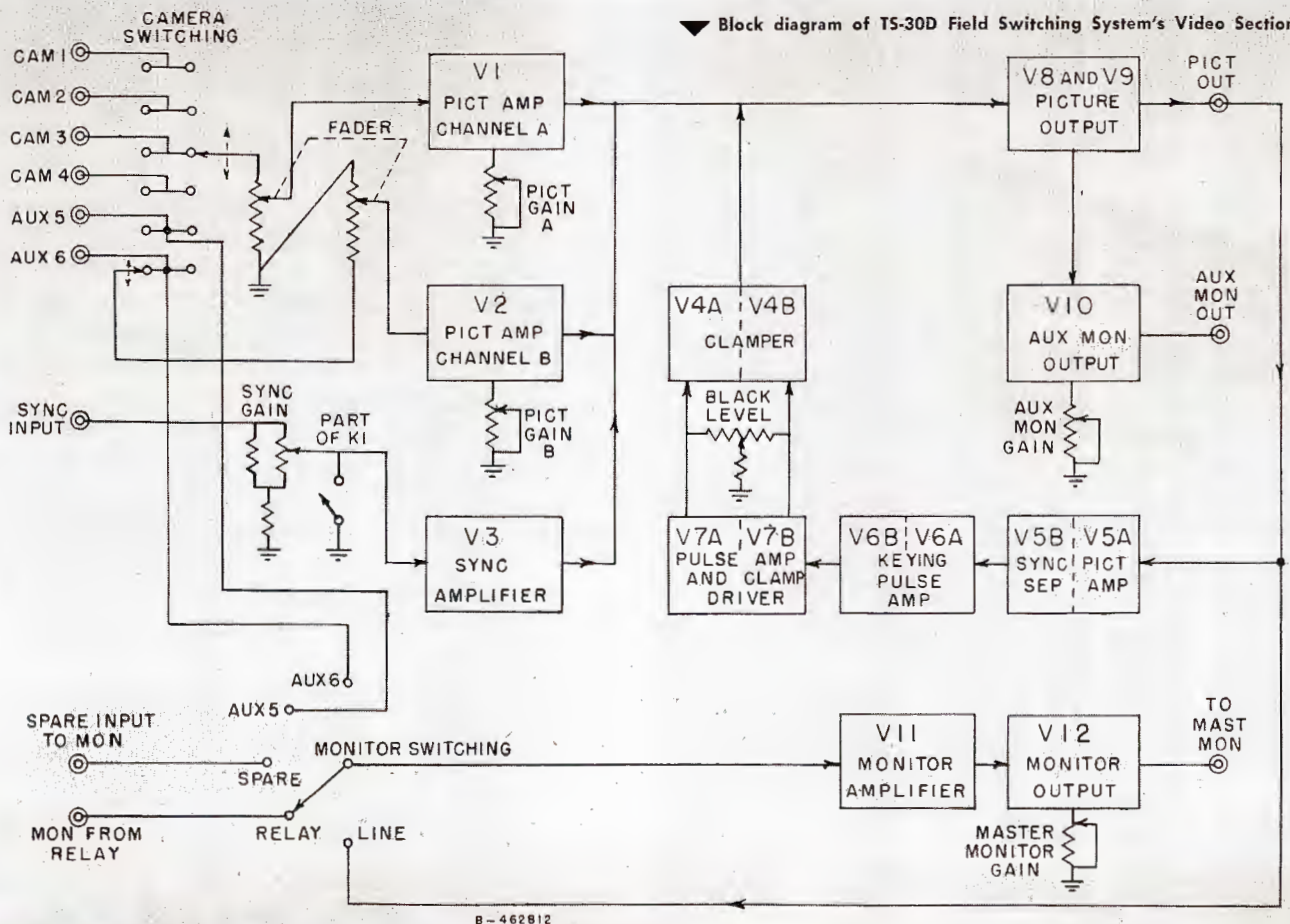

B-462812

inputs to the monitor circuits as desired. These inputs are: Program line output, Monitor output of relay transmitter, Spare input to monitor, Auxiliary input 5, and Auxiliary input 6. Two outputs are provided to drive monitoring lines. The auxiliary monitor output is always connected across the program output line since this output was provided to drive an announcer's monitor. The output to the master monitor is selected by the five position selector switch described above. Gain controls on each of these outputs provide for the optimum signal level necessary to drive the monitors.

Filament power for all tubes in the field switcher is supplied by a transformer in the Field Switching Systems. D-c for plate supply is obtained from an MI-26091-A Field Power Supply which is also capable of providing plate current to a Field Master Monitor at the same time. The power control switch for the Field Power Supply with an associated tally, is located on the front panel of the Field Switching System. The intercommunication system provides talking circuits between the camera men, the camera control operator, the technical director, the program director, and any assistant production personnel who may be stationed near the cameras. It provides also a circuit for distribution of the program sound to all the operators of the system. Each operator may be provided with a telephone set consisting of a double ear phone head band and a microphone. One ear phone in each set reproduces the program sound, and the other reproduces the operators' conversation.

Recessed under the front panel of the Field Switching System is a jack board with accommodations for six telephone sets; one for each camera, one for the program director and one without program sound for the relay transmitter operator.

A group of toggle switches on the upper part of the front panel provides means for making several circuit combinations in the intercommunication system. The following combinations are available:

1. Separate circuit to each camera and relay transmitter.
2. A common circuit to all cameras or any grouping of them.
3. Optional tie-in of operators with program director.
4. Optional tie-in between operators and the engineering PL (Private Line).
5. Optional tie-in of engineering and production PL.
6. Optional circuit for the program director over the program line.

The circuit used for the intercommunication system is the common battery type. The power supply operates from the a-c line and is contained in the Field Switching System. A separate power switch, fuse, and tally are provided so that the intercommunication system may be operated while the rest of the equipment is turned off.

Four separate cables carry the intercommunication and tally circuits between the Field Switching System and the four Field Camera Controls. A jack provides means for a 2 wire circuit to the relay transmitter. Receptacles are provided for connecting the program sound, and the engineering and program phone lines, or PL's, from the main studio or transmitter.

Controls normally used during show time are located on the front panel. Others, used rather infrequently, are located under a small trap door on top of the suitcase. Controls normally preset are located on the chassis and are made accessible by removing the cover on the tube side of the unit.

Individual coaxial connectors are provided for all incoming and outgoing picture and synchronizing lines. All other connections are made with multiple conductor cables to keep the number of connections to a minimum.

A removable front cover is provided to protect the switches and other controls from damage during transportation. Removable side covers are also provided. The wiring side is interlocked and an auxiliary link is supplied to restore power for servicing.

Front view of Switching Unit showing panel detail.

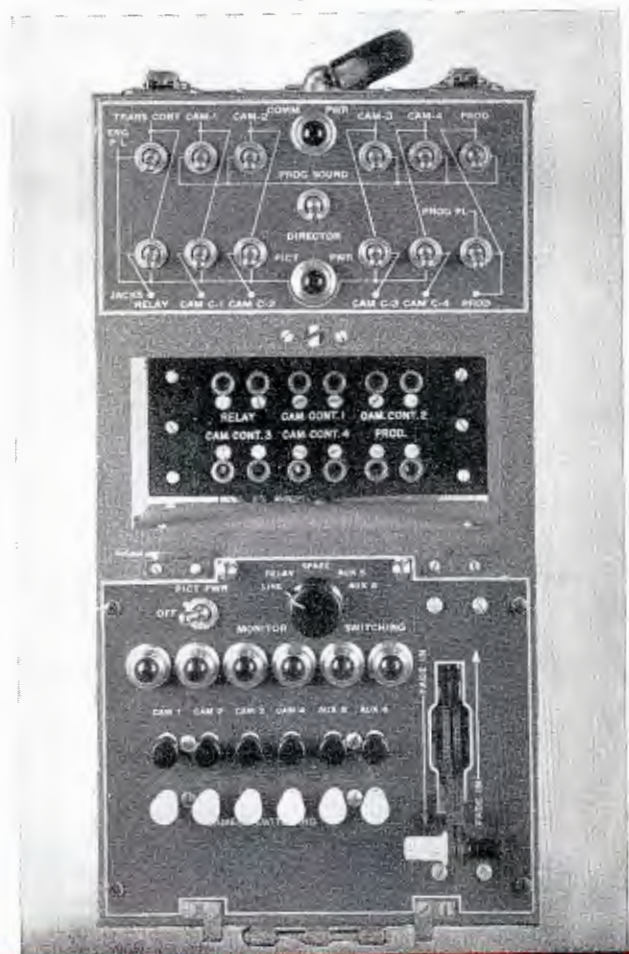

SPECIFICATIONS

Electrical Specifications

- Video Section:
- Inputs (internally terminated with 75 ohms):
- Distribution.....4 camera (less sync)
 - 2 auxiliary (sync optional)
 - 1 sync
- Monitoring2 spares
- Outputs (line output provides 75 ohm internal termination so that both sending and receiving end of 75 ohm coaxial cable may be terminated):
- Distribution.....Auxiliary line output, unity gain across 37.5 ohms
 - Monitor output 75 ohm external termination
 - Monitoring75 ohm external termination
- Communications Section:
- Inputs:
- Program Sound.....Two 500 ohms
 - Private Line (PL).....Two 500 ohms
 - Telephone Circuits6
- Outputs:
- Camera Communications (includes program sound).....4
 - Program Sound (at front panel jacks).....5
 - Relay Communication1
- Power Supply (for communication only).....Self-contained
- Power Requirements:
- Heaters and Communication.....117 volts, 50/60 cycles, 62 watts
 - Plate.....280 volts, 400 milliamperes
 - Field Power Supply.....98-129 volts, 50/60 cycles, 135 watts (full load), 14 amperes, 110 volts
- Output d-c Power (field power supply):
- Unregulated+400 volts
 - Regulated, Maximum at Full Load.....+285 volts
- Current:
- Minimum to Maximum.....1430 milliamperes
 - Regulated.....600 to 1250 milliamperes
 - Unregulated.....1430 milliamperes less regulated and focus current

Tube Complement

Field Switcher:			
4-6AC7	1-6AL5	4-6AG7	3-6SN7-GT
Field Power Supply:			
6-5R4GY	1-6AC7	5-6AS7-G	1-6SL7-GT
1-6Y6-G	2-OD3		

Mechanical Specifications

- Overall Dimensions:
- Field Switcher.....27 1/4" long, 8 1/2" wide, 18 1/2" high
 - Field Power Supply.....26" long, 8 1/2" wide, 18 1/2" high
- Weight:
- Field Switcher.....72 lbs.
 - Field Power Supply58 lbs.

Equipment Supplied

TS-30D Field Switching System, complete.....	ES-26950-C
Includes the following equipment:	
1 Switching System	MI-26215-C
3 Headsets, Double Earphone.....	MI-11744
2 Shock Mounts	MI-26511-A1
1 Set of Cables.....	MI-26740-A
1 Power Supply, Type TY-31A.....	MI-26091-A
1 Plate Current Meter.....	MI-21200-C1

Accessory Equipment

Field Master Monitor System (for use with TK-31A Field Pickup Equipment and TS-30D Field Switcher).....	ES-26955-B
Complete including:	
TM-6C Master Monitor.....	MI-26136-C
Field Carrying Case.....	MI-26521-A
Shockmount	MI-26511-2
Cable, Power, 12-Conductor	MI-26759-8
Cable, Video Transmission Line, Coaxial.....	MI-26759-12
Kinescope 10SP4	MI-26655
CRO Tube 5ABP1.....	MI-26667

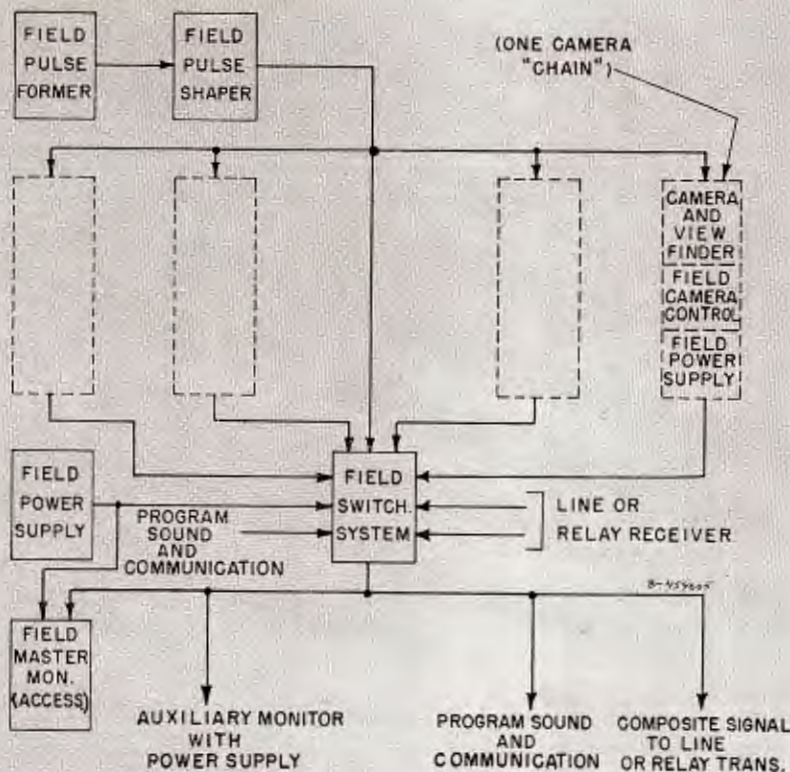

Block diagram, Multiple Field Camera System.

SPECIAL EFFECTS SYSTEM

FEATURES

- More than 150 effects to choose from—wipes, split-screens, picture insets, block, wedge, circular and multiple frequency
- Pre-selection of effects—by means of plug-in selector cards
- Instant pushbutton selection of any pre-selected effect
- Handles color, monochrome, or a combination of the two
- Switching time is only 0.1 microseconds—transition line is invisible when same picture is applied to both video inputs
- Fader lever control for simplified operation
- Illuminated arrows indicate correct direction of lever movement at any time
- Black level precisely and automatically fixed—regardless of difference in picture content between video signals
- Stable setup adjustments—no changes required for entire repertoire of effects
- Provides traveling matte or special pattern effects with external keying signal

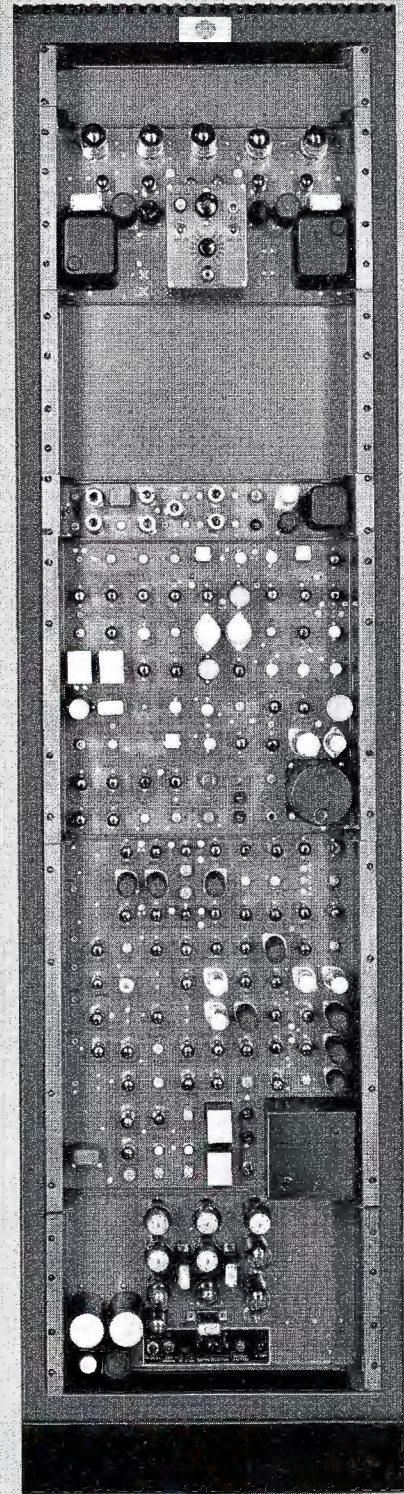

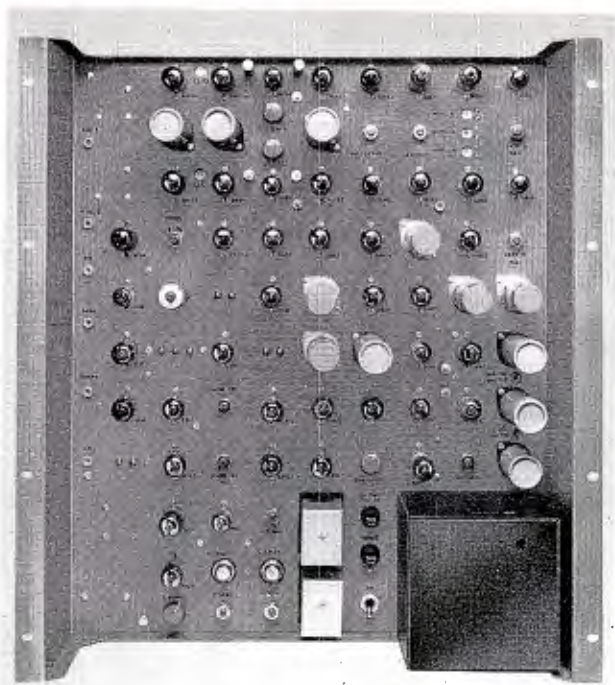

TA-25 Special Effects Amplifier.

USES

The RCA Special Effects System offers the ultimate in convenience for selection and presentation of program effects. It provides as many as 154 transitional and split-screen effects—horizontal and vertical wipes, diagonal and pointed wipes, corner insets, horizontal and vertical splits, rectangular, circular and diamond-shaped iris effects and multiple frequency patterns. In addition a keying signal can be supplied from an external camera source for such effects as inset letters, trademarks, self-keyed video insets and traveling mattes.

DESCRIPTION

The RCA Special Effects System consists of a TA-25 Amplifier, a TG-25 Generator, a Remote Clipping Line Control Panel, a Multiple Frequency Effects Generator, an Effects Pattern Selection Panel, a Fader Lever Control Assembly and a WP-25 Effects Power Supply. This equipment is described in detail on the following pages along with complete equipment specifications.

TA-25 Special Effects Amplifier

The RCA Special Effects Amplifier, Type TA-25, is used to key out certain picture areas from selected backgrounds and to insert picture material from other sources into the keyed out areas. When used with the TG-25 Special

Effects Generator, it becomes a transitional device for wiping off one picture and introducing another. The amplifier may also be keyed by a signal generator by a film or live camera focused on a pattern containing lettering or figures of any desired shape.

The amplifier may also be used to produce self-keying or "traveling matte" effects consisting of a live subject keyed into a background picture. In this case the background picture can be produced from a slide, film or live studio camera. The picture to be inset into the background is produced by a second camera focused on the desired subject which is posed in front of a black backdrop. The signal from the second camera is applied to input A of the amplifier and also to the keying signal input. The background signal is applied to input B. The amplifier then generates a keying signal corresponding to the outline of the live subject, inserting the image of the subject into the area carved out of the background. Thus subject matter can be made to appear in front of a variety of backgrounds readily available from slides and film. Careful control of lighting and signal levels is essential for the successful use of this type of effect.

The TA-25 Special Effects Amplifier is contained on a 21-inch bathtub chassis. All connections are made at the rear of the chassis and all setup adjustments are available at the front.

The TA-25 has three video inputs: picture A, picture B, and keying signal. In operation the A and B inputs are sampled for the presence of color burst. If burst is present on either of these inputs it is gated to the amplifier output. This feature makes simultaneous use of monochrome and color signals possible.

The keying signal is amplified, clipped to remove any traces of noise which might produce spurious keying, and then clamped to insure stability of the keying action and sharp edges at the borders of the patterns. The keying signal gain and the clipping level are adjustable to insure optimum purity of keying for any signal which might be used for the purpose. When used with the Special Effects Generator signal this is simply a set-up adjustment at the Special Effects Amplifier. For special uses such as self-inserts, critical adjustment may be helpful at a switcher or camera control position. For this reason, a Remote Clipping Level Control Panel, MI-40336, is available. When external keying signals are used, it is especially important that this control panel be mounted at a location readily accessible to technical personnel. For instance, any changes in the externally generated signals can be

compensated at the video switcher control position by immediate adjustment of the clipper level and keying gain controls. The Remote Clipping Level Control Panel is a standard 2-21/32 by 11-1/16 inch panel which may be mounted in the MI-26252 remote control panel console mounting adaptor or in the MI-26278 console well mounting adaptor.

After the keying signal has been processed, it is applied to a high speed electronic switching circuit which performs the actual keying operation. This switching circuit admits the signal from channel A whenever the keying signal is at black, and admits the signal from channel B whenever the keying signal is white. The switching function is extremely fast and clean in operation. Because the transition from one picture source to another occurs in less than 0.1 microsecond, there is no visible transition line when the same picture is applied to both picture

inputs of the amplifier. The output of the switch is sampled by an error detector which determines the difference in black level between pictures A and B. A correction signal is then fed back to the switch to equalize black level, regardless of what changes may take place in the input signals or in level due to wipe action.

The amplifier has two outputs. One of these can be either composite or non-composite; the other, non-composite only. Both outputs are sending end terminated.

A tally-light control circuit monitors the keying signal in the clipper and operates appropriate relays for the application of tally voltages to the video switching circuits. If a wipe is made from camera A to camera B, camera A's tally lights come on when the camera A signal is first selected; camera B's tallies come on when the wipe is started. Camera A's tallies go off when the wipe is completed, leaving B's tallies on.

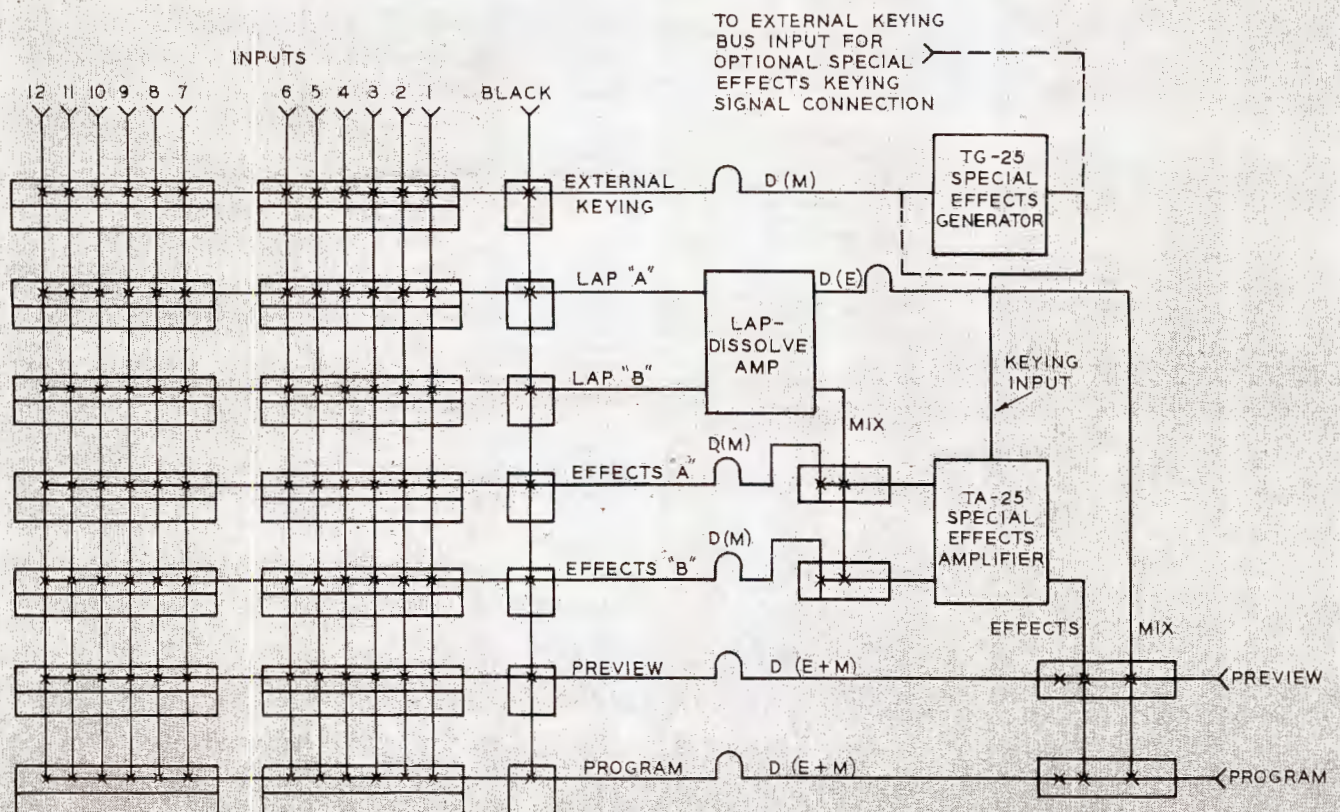

Functional Diagram of RCA Special Effects System, integrated into a TS-40 Transistorized Switching System for maximum flexibility and operating convenience.

TG-25 Special Effects Generator

The TG-25 Special Effects Generator, MI-40337, is used for generating the various effects. This equipment has been designed specifically as a source of keying signals to be used with the RCA TA-25 Special Effects Amplifier. The generator is contained on a 17½ inch bathtub chassis. All connections are made at the rear of the chassis; all adjustments from the front.

All of the rectangular sawtooth and triangular waveforms necessary to produce the 88 effects shown on Chart A are generated by horizontal and vertical drive signals from the local sync generator. Relays are used to switch the various waveforms to the proper signal path. The use of relays makes possible instantaneous selection of the desired effect.

The generator circuitry is stabilized to minimize the effects of differences in tube and component characteristics and also against the effects of aging. Controls are provided for the setup adjustment of symmetry and centering and require touch-up only once in a period of several days as a part of the regular station maintenance practice.

TG-25 Special Effects Generator.

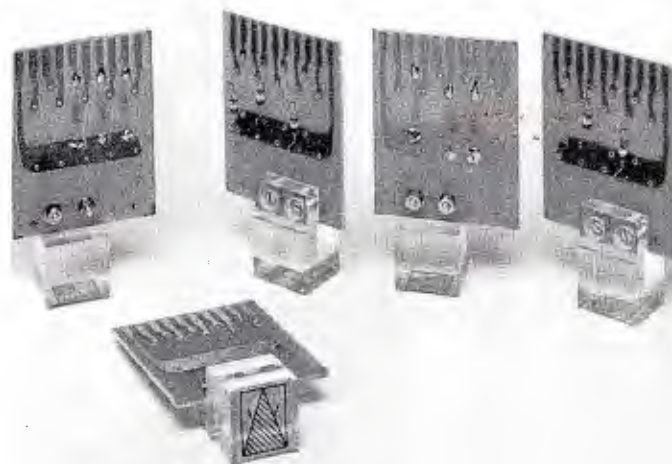
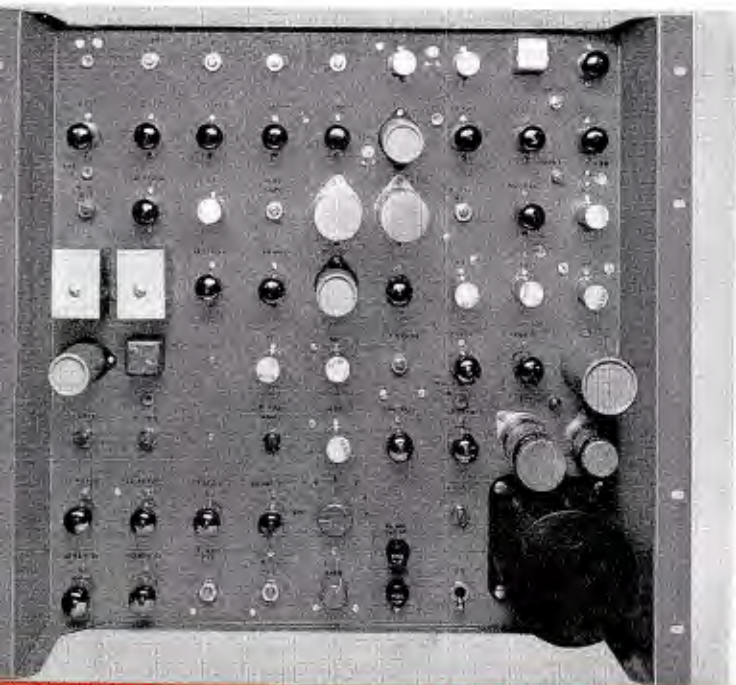

Multiple Frequency Effects Pattern Selectors showing Etched Circuitry and identifying Special Effects Knob.

Multiple Frequency Effects Generator

The Multiple Frequency Effects Generator, MI-40354, provides a wider selection of effects patterns than are available with the TG-25. These patterns, illustrated on Chart B, number 66, making a total of 154 patterns available to the system. The multiple frequency patterns are generated by triggering the basic multi-vibrator circuits in the TG-25 with higher frequency pulses than the basic horizontal and vertical drive pulses. In addition parabolic waveforms are generated to produce patterns with rounded edges; the most common example being the circular iris.

The Multiple Frequency Effects Generator circuits are mounted on a 5¼ inch bathtub chassis which is designed to be mounted directly above the TG-25 Effects Generator. The connections to the TG-25 are all plug-in for ease of installation.

Ten effects selector cards (starred on Chart B) are supplied with each Multiple Frequency Effects Generator. Additional effects are available in kit form as MI-40355. The kit contains cards and diodes for making up an additional 10 effects.

Effects Pattern Selection Panel

The Effects Pattern Selection Panel, MI-40338, has been designed to simplify the selection and presentation of effects. It contains two rows of pushbutton switches and a row of illuminated plug-in pattern selection cards. Ten pushbuttons in the selector row allow instantaneous selection of any one of 10 pattern pre-selector cards. Ten of these cards—one for each pushbutton—can be pre-selected and plugged into the slots corresponding to the pushbuttons.

The plug-in card consists of a printed wiring board having several terminal connections and an illuminated molded handle on which is a small illustration showing the effect which this card will produce. Semi-conductor diodes are connected between terminals on the board. The connection of the diodes determines what effect will be produced by that particular card.

Twenty of the cards corresponding to the most frequently used effects (indicated by star on Chart A) are supplied with each pattern selection panel. In addition there is a kit containing cards and diodes so that the user can make up an additional set of five cards for another five effects. Special Effects Kit, MI-40352, is also available on separate order for those users who wish to have a wider choice of effects. This kit contains cards and diodes for 10 additional patterns. Supplied with each kit is a sheet of transparent effects pattern illustrations which can be cut out and fastened to the card handles when the effects have been chosen.

Switcher Control Panel with Special Effects Control Lever Assembly mounted in upper right corner.

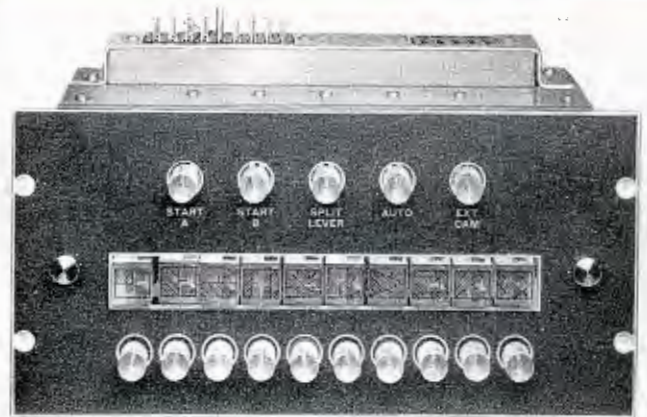
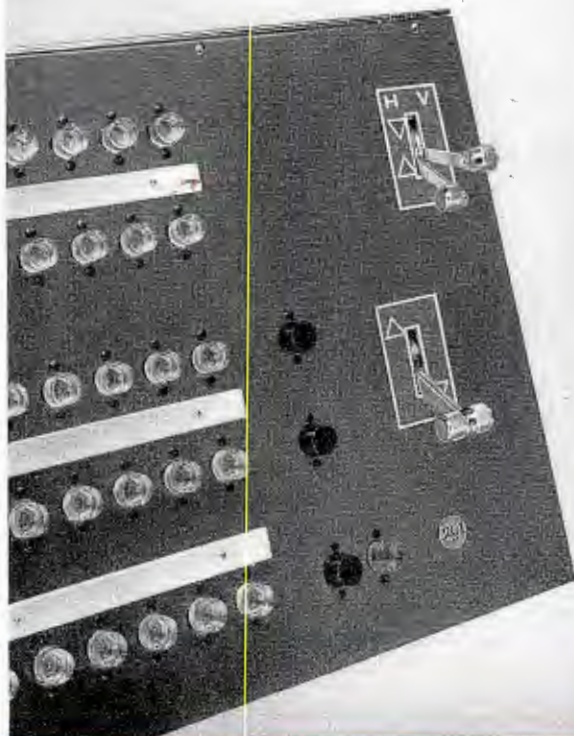

Special Effects Selection Panel.

The pattern selection panel should be mounted adjacent to the video switching control panel so that it will be easily accessible to the programming personnel. The panel is the same size as two standard remote control panels, or 11-1/16 by 5-11/32 inches. It can be mounted in a console by providing a MI-26252 remote control panel console mounting adaptor for it. It is recommended that wherever possible the Effects Pattern Selection Panel be made a part of the video switching control panel. A Trim Frame, MI-40353, is also available on special order for mounting the panel in a flat table top.

Effects Control Lever Assembly

The mechanism used to control the effects is known as the Effects Control Lever Assembly, MI-40340. It is similar to the Lap-Dissolve Control Lever Assembly used in RCA remote controlled video switchers. This assembly may be conveniently mounted on the switcher control panel at the end of the two rows of pushbuttons used to select the video inputs to the TA-25 Special Effects Amplifier. The position of the levers then indicates video busses with which the effect starts and ends.

An escutcheon supplied with the lever assembly has two arrows indicating the proper direction of movement of the levers. Assume that the wipe is to be made from picture A to picture B, pausing several seconds somewhere in the center of the raster. The levers start from position A opposite the picture A video selection buttons. While the director moves the levers, the arrow pointing to the B position remains lit. If he pauses, it indicates to the director in which direction he must move the lever to complete the effect. When the end position is reached, this arrow goes out and the arrow pointing to the A position comes on.

SPECIFICATIONS

Electrical Specifications

TA-25 Special Effects Amplifier

Input Impedance:

Picture A and picture B:
For use with bridging input lines.....High (1 megohm shunted by 22 microfarads)

Modified for use with TS-40 Video Switcher...75 ohms $\pm 5\%$, driven by TS-40 coupling circuit plate

SyncHigh

BlankingHigh

Horizontal Drive.....High

Keying Signal:

For use with bridging input lines.....High

Modified for use with TS-40 Video Switcher...75 ohms $\pm 5\%$, driven by TS-40 coupling circuit plate

Output Impedance (Source and Load):

Output No. 1.....75 ohms, source terminated

Output No. 2.....75 ohms, source terminated

Input Signal Requirements:

Picture A and B.....0.7 volts, non-composite

Keying Signal.....0.7 volts, non-composite

Sync.....3.5 to 5.0 volts

Blanking.....3.5 to 5.0 volts

Horizontal Drive.....3.5 to 5.0 volts

Output Signal Values:

Picture Component.....0-1.0 volts peak-to-peak

Sync Component (Output No. 2 only).....0-0.6 volts peak-to-peak

Frequency Response..... ± 0.5 db, 200 kc to 7.5 mc

Tilt (60 cycle square wave).....Less than 2%

Differential Gain.....Less than 0.25 db, 10-90% APL

Differential Phase.....Less than 1°, 10-90% APL

Output Isolation.....Better than 40 db (60 cycles to 4 mc)

Black level shift due to H wipe.....0.5% maximum

Transition time.....0.1 microseconds

Picture channel delay.....0.055 microseconds

Signal Crosstalk.....Better than 50 db (60 cycles to 4 mc)

Power Requirements:

DC.....+280 volts, 220 ma;

From WP-25 power supply; +150 volts, 160 ma;

-150 volts, 200 ma

AC.....105 to 125 volts or 205 to 240 volts,

50/60 cycles, 125 watts

Tube Complement:

12-12AT7 3-12AX7 4-6AU8 2-5726

8-6BQ7A 1-6AS6 1-6AB4 2-6197

2-6CB6 2-6CQ8 5-5687

TG-25 Special Effects Generator

Input Signal Requirements:

Horizontal Drive.....3.5 to 5.0 volts

Vertical Drive.....3.5 to 5.0 volts

Blanking.....3.5 to 5.0 volts

External Camera0.7 volts, non-composite

Output Signal Level.....0.7 volts peak-to-peak

Output Impedance:

Source.....150 ohms

Load.....75 ohms

Power Requirements:

DC.....24 volts (for relays), 1/2 amp; +280 volts, 70 ma;

From WP-25 Power Supply: +150 volts, 180 ma;

-150 volts, 140 ma

AC.....105 to 125 volts or 205 to 240 volts, 50/60 cycles, 25 watts

Tube Complement:

11-12AT7 4-6AU8 4-6CQ8

3-6BQ7A 1-6CL6 1-12AU7

Multiple Frequency Effects Generator

Input signals are from TG-25 Generator

Output signals go to TG-25 Generator

Power Requirements:

DC.....+280 volts, 19 ma;

From WP-25 Power Supply: +150 volts, 33 ma;

-150 volts, 32 ma

AC.....105 to 125 volts or 205 to 240 volts, 50/60 cycles, 50 watts

Tube Complement:

5-12AT7 2-12AU7A

WP-25 Power Supply

Power Output.....+150 volts dc, 450 ma and -150 volts dc, 450 ma

Power Requirements.....105 to 125 volts, or 205 to 240 volts,

50/60 cycles, 450 watts

Tube Complement:

4-12AX7 5-6080 2-5651

NOTE: A 580-D or WP-15 Power Supply is required for a source of +280 volts DC, 309 ma. In addition, a source of 24 volts DC, 1/2 ampere is required.

Mechanical Data & Ordering Information

Equipment Supplied	Height (inches)	Width (inches)	Depth (inches)	Weight (pounds)	Stock Identification
TA-25 Special Effects Amplifier	21	19	8 1/4	33	MI-40335-A
Remote Clipping Level Control	2-21/32	1 11/16	2	2	MI-40336
TG-25 Special Effects Generator	15-3/4	19	10 1/4	27	MI-40337
Effects Pattern Selection Panel*	5-11/32	1 11/16	8 1/8	10	MI-40338
Multiple Frequency Effects Generator†	5 1/4	19	7 1/2	8	MI-40354
WP-25 Effects Power Supply	10 1/2	19	13 1/4	54	MI-40339
Effects Control Lever Assembly	27/8	1 5/8	2 1/4	11	MI-40340
Effects Module Case					MI-40341
Accessory Equipment:					
Set of 10 Effects Pattern Selectors				2	MI-40352
Set of 10 Multiple Frequency Effects Pattern Selectors				2	MI-40355
WP-16B Power Supply	7	19	13 1/2	50	MI-26084-B
580-D Power Supply	10 1/2	19	12	58	MI-21523-C
BR-84D Cabinet Rack	84	22	18	195	MI-30951-D84
Trim Frame					MI-40353
Shielded Cable, 3-conductor (specify length)					MI-43-C
Shielded Cable, 7-conductor (specify length)					MI-13380-B
Shielded Cable, 17-pair (specify length)					MI-13345-17

* Including 20 Effects Pattern Selector Modules.

† Including 10 Multiple Frequency Effects Pattern Selector Modules.

Rack Layout Using WP-16B or 580-D Power Supplies.

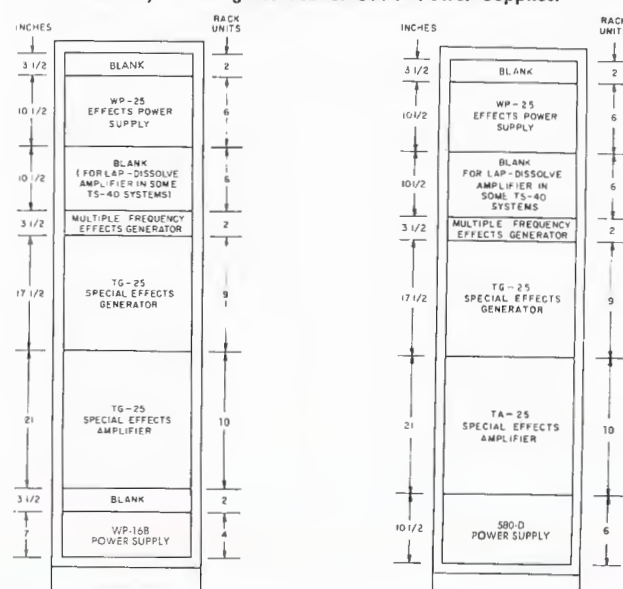
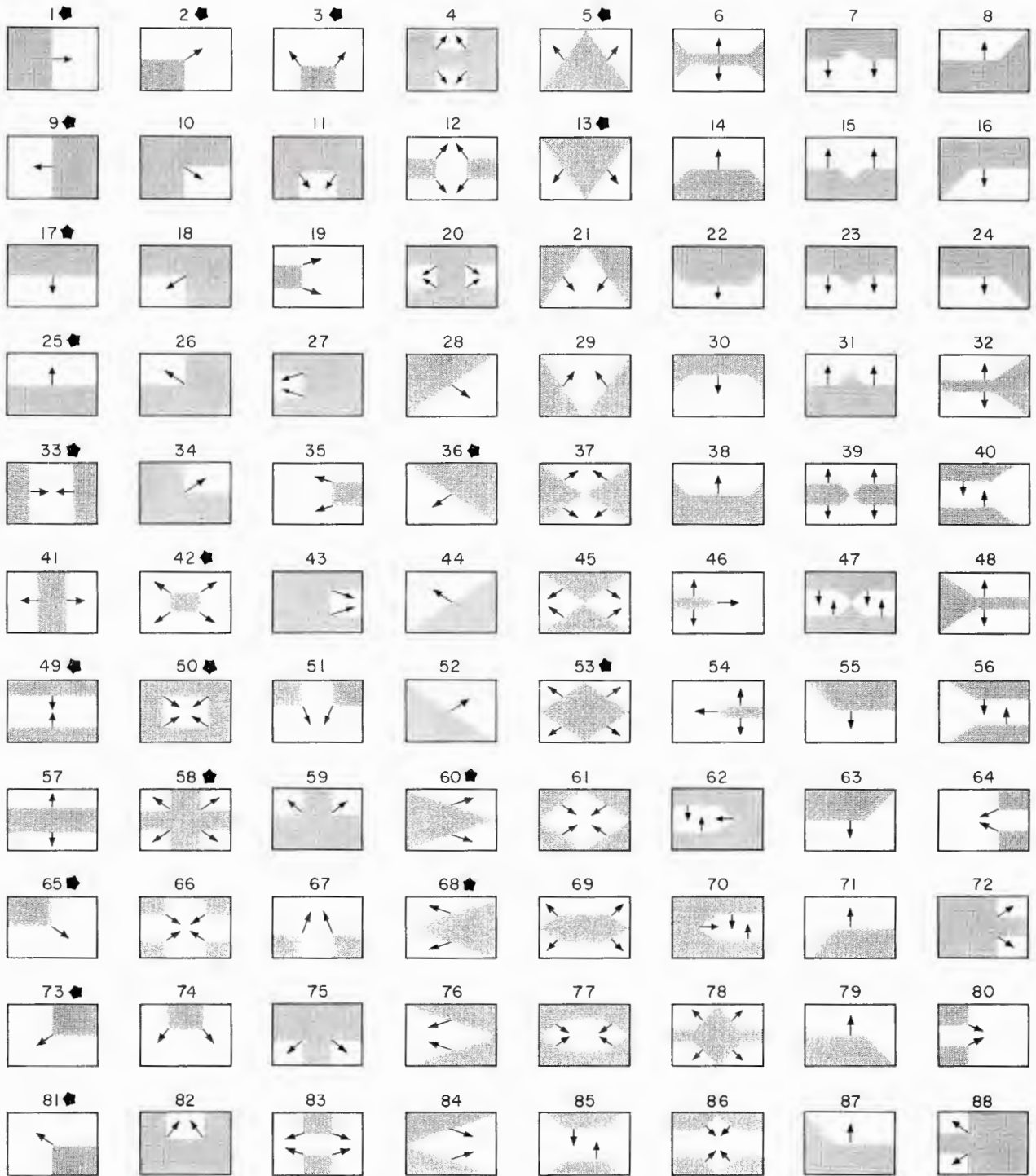
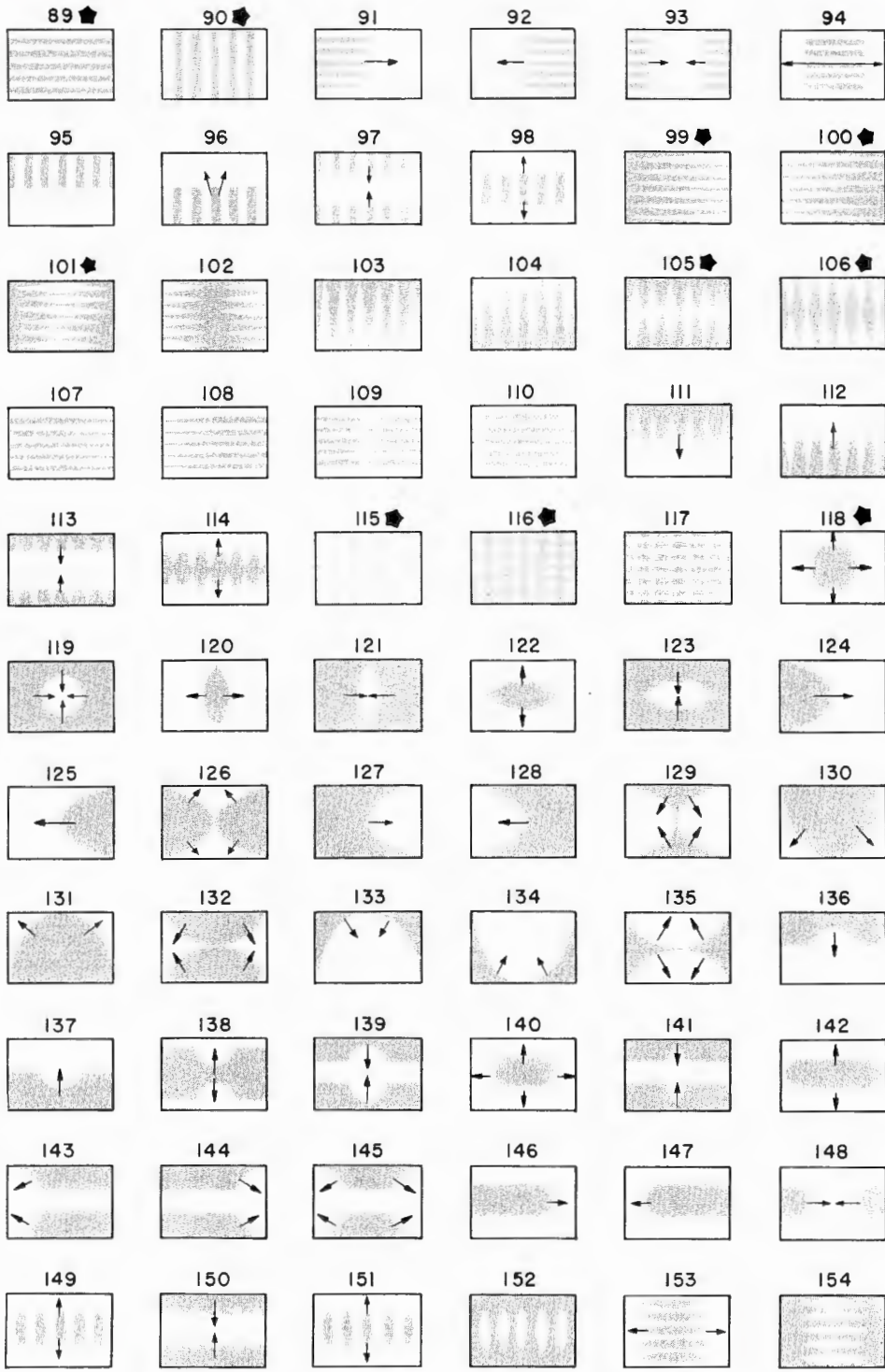

Chart A—Block and Wedge Special Effects Patterns



★ Patterns supplied with Special Effects Pattern Selector Panel.

Chart B—Multiple Frequency and Circular Special Effects Patterns



★ Patterns supplied with Multiple Frequency Effects Generator.

LAP-DISSOLVE AMPLIFIER

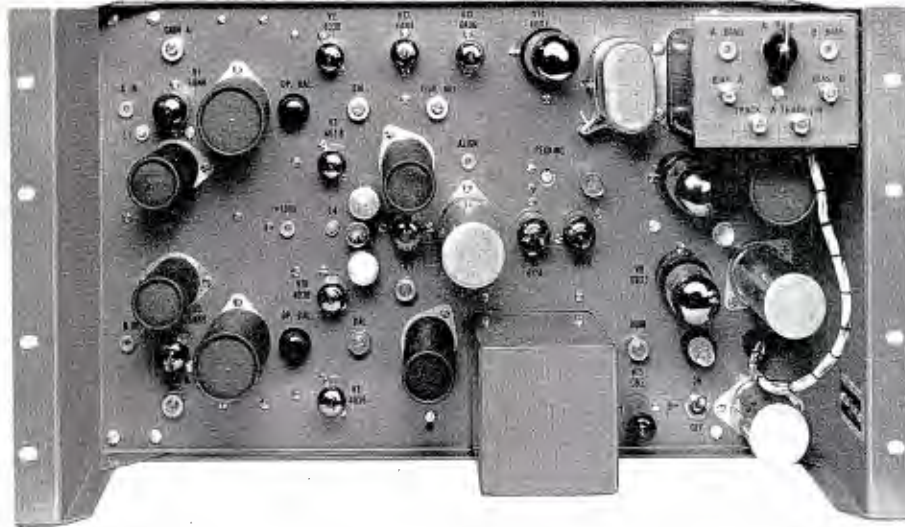

FEATURES

- Provides lap-dissolves, supers and fades to or from black
- Easily integrated with video switching systems
- Excellent performance with color, monochrome, or both
- Linear lap-dissolve characteristic
- Control lever assembly includes tally switching circuits
- Balanced dissolve circuit eliminates need for clamp circuits
- Crosstalk isolation between "On" and "Off" channels better than 50 db
- Dissolves and fades composite or non-composite signals

USES

The Lap-Dissolve Amplifier has been designed for use with video switching systems to provide a choice of interesting and pleasing transitions between two picture sources. Dissolving from one picture to another is accomplished by manipulating a Control Lever Assembly (MI-40357) which is available separately. A fade to or from black can be accomplished in the same manner. A superimposition of one picture over another can also be accomplished by separating the control levers and adjusting the levels of the two pictures independently. The amplifier can make fades and lap-dissolves with either two non-composite or two composite signals as long as both signals are synchronized.

Control Lever Assembly, MI-40357

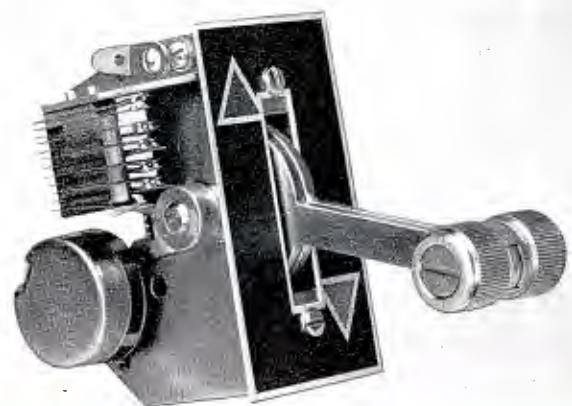

DESCRIPTION

The Lap-Dissolve Amplifier can be used with a variety of remote controlled switching systems. As supplied from the factory it is wired for use with RCA TS-40 Switching Systems. Two Coupling Circuit Plates, one for each input, are used to match the TS-40 output impedance and signal level to the amplifier input. Two coupling capacitors are supplied which replace the coupling circuit plates when the amplifier is used with a switching system other than the TS-40. When the capacitors are used the inputs are high impedance and may be bridged or terminated in 75 ohms.

A gain control is supplied for each input so that both the "A" and "B" channels can be adjusted to have the same gain. The first amplifier stage in each channel provides a boost in low frequency response so that the low frequency portion of the signal has a much higher amplitude than the low frequency components of the control signal which could otherwise cause bounce during a fast dissolve. Compensating networks in later stages provide flat response over the entire frequency range. The signals are then applied to a push-pull amplifier stage, the gain of which is varied from 0 to 100 per cent by means of the control levers. The arrangement is such that when one channel is set for 100 per cent gain, the other is at 0 and vice-versa. The outputs of these amplifiers are fed to a differential amplifier in such a way that the desired video signal components are amplified and the control signal and bounce components are cancelled. The video signal is then fed to the output feedback amplifiers. Two 75 ohm sending-end terminated outputs are provided.

Setup controls are provided for adjusting the amplifier to optimum performance. A self-contained circuit provides regulated voltage for the push-pull stages and a bias voltage supply is also included. The filament transformer is of the regulating type. An external source of 260 ma. at 285 volts regulated d-c is required. The amplifier is built on a standard recessed rack mounting type chassis for easy access to all components.

The Control Lever Assembly, MI-40357, is supplied with an 8-foot length of control cable with plugs attached. Since d-c control voltages are used, the central cable may be any length up to 200 feet. One of the cable plugs is

for the amplifier control voltages and the other is for connecting the limit switches of the assembly to camera tally circuits in the video switching system. The limit switches insure that the camera tally lights will come on as soon as the control levers are moved away from the end position at the start of a fade. The levers are supplied with an escutcheon indicating which direction the individual levers are to be moved for their respective ON/OFF function. The levers are normally locked together for lap-dissolves and fades but can be operated separately for superimposing one picture on another.

SPECIFICATIONS

Electrical

Input Power.....	*105—130 volts, a-c, 60 cycles, 1 ampere 280 volts regulated d-c, 260 ma.
Video Inputs	2
Video Input Level, Non-composite.....	0.1 volt peak-to-peak nominal when using coupling circuit plates for TS-40; 0.7 volts peak-to-peak when using coupling capacitors
Video Input Level, Composite.....	0.13 volts peak-to-peak when using coupling circuit plate for TS-40; 1.0 volt peak-to-peak when using coupling capacitors
Input Impedance.....	75 ohms with coupling circuit plate; 25 μ f; 560,000 ohms bridging with coupling capacitors
Video Outputs	2
Video Output Level, Non-composite.....	0.7 volts peak-to-peak nominal
Video Output Level, Composite.....	1.0 volt peak-to-peak nominal
Output Impedance.....	75 ohms, sending-end terminated
Transition Linearity.....	Adjustable to within 5%
Frequency Response.....	Flat within 2% to 8 megacycles. Down not more than 5% at 10 mc
Transient Response.....	Less than 5% overshoot on square wave with .03 microsecond rise time
Time Delay, Input to Output.....	0.039 microsecond without coupling circuit plate; 0.064 microsecond with coupling circuit plate
Low Frequency Response.....	60 cycle square wave adjustable to 0% tilt
Differential Gain.....	Less than 2.0% any duty cycle 0.7 volts in and 0.7 volt out
Differential Phase.....	Less than 1.0° for 0.7 volts input, any duty cycle
Isolation Between Channels.....	Better than 50 db

Tube Complement

2—6AN8	4—5591/403-B	1—2C51/396A
2—5842/417A	3—6BX7	1—6AN4
1—6AU6	1—OB2	

Mechanical Specifications

Width	19"
Height	10 1/2"
Depth	10"
Weight	21 lbs.
Finish.....	Dark umber gray
Stock Identification	MI-40421-C

Accessories

Control Lever Assembly (one required).....	MI-40357
WP-16A Semiconductor Power Supply.....	MI-26084-A

* A separate version is available on special order for use on 220 volt, 50 cycle power mains

VIDEO PATCH PANEL, PLUGS & CORDS

FEATURES

- Jack and coax connector combined in one piece fitting
- No soldered connections
- Provides fifteen pairs of jacks
- Test point on all cords and plugs
- Flush or recessed mounting
- Improved accessibility to cable connections
- Minimum signal path discontinuity

USES

The new Video Patch Panel Assembly, MI-26219, and associated plugs and cords provide a convenient means for patching video and/or synchronizing signals. Fifteen pairs of jacks provide for a wide range of flexibility in handling a large number of signals.

The new RCA Video Patch Panel Assembly, MI-26219, features a one piece jack-connector mounted on a bakelite strip which reduces to an absolute minimum the discontinuity in the signal path between source and termination. The coaxial cables are connected directly to the UHF type fitting on the rear of the panel and the patch cords and plugs are inserted into the jack portion in front. There are no soldered connections to work loose. These features are especially important for use with color video signals where the signal path between source and termination must be uniform. Side panels on the chassis provide for recessed mounting but they can be removed if flush mounting is desired. Fifteen pairs of jacks are provided for flexibility in patching of special lines. Identification cards are supplied for convenient labeling of each jack circuit.

Video Patch Cord (MI-26818)

The Video Patch Cord, MI-26818 has a test jack and ground jack on each plug so that a cathode ray oscilloscope probe can be inserted for examination of the signal without removing the cord from the jack. This eliminates the need for test jacks on the patch panel thus allowing a larger number of active jacks in the same space. The test point is designed to accept the standard test probe on the

VIDEO PATCH PANEL ASSEMBLY

MI-26219

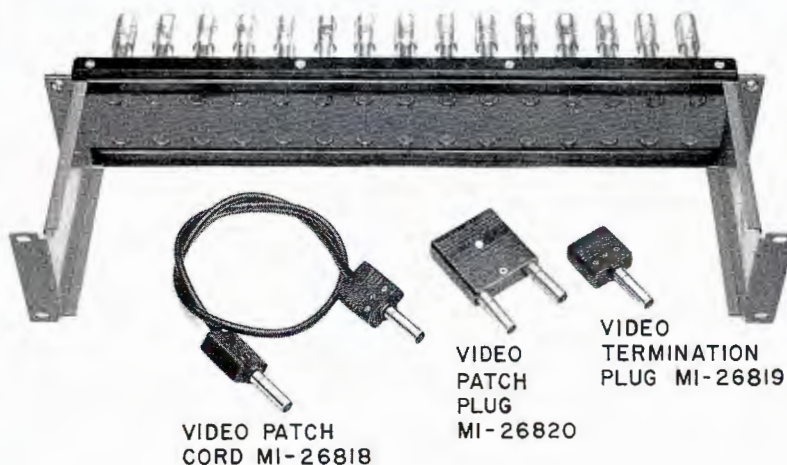
VIDEO PATCH
CORD MI-26818VIDEO
PATCH
PLUG
MI-26820VIDEO
TERMINATION
PLUG MI-26819

Type TO-524-D television oscilloscope. This new patch cord can be used with older type jack panels, MI-26244 or MI-26245.

Video Patch Plugs (MI-26820 and MI-19118)

Patch Plug MI-26820 is designed for use with the new patch panel. The design features easy insertion and removal of the plug. Mechanical ruggedness provides for an unlimited number of patching operations. The plug has a test jack which provides the same features as that on the video patch cord. The MI-26820 plug cannot be used with older type patch panels, MI-26244 and MI-26245; Video Patch Plug, MI-19118 is available for use with these panels.

Video Termination Plug (MI-26819)

To prevent cross-talk, all cables should be terminated at the jack panel in their characteristic impedance. The video termination plug, MI-26819, is ideal for this purpose. It contains a 75 ohm, 1.0 per cent termination resistor and a test jack for examination of the signal on the cable under terminated conditions.

SPECIFICATIONS

Dimensions:	
Recess Mounted.....	19" wide, 3 15/32" high, 8 1/2" deep
Flush Mounted.....	19" wide, 3 15/32" high, 3 3/8" deep
Weight.....	10 lbs. approx.
Finish.....	Umber gray and black bakelite
Stock Identification:	
Video Patch Panel Assembly.....	MI-26219
Video Patch Cord	MI-26818
Video Patch Plug	MI-26820
Video Patch Plug (for use with Jack Panels, MI-26244 and MI-26245).....	MI-19118
Video Termination Plug.....	MI-26819

INTERPHONE EQUIPMENT

FEATURES

- Convenient intercom with studio personnel or remote line as desired
- Can mount to console, desk, or wall
- Designed to be compatible with RCA TV equipment
- Simple circuit with anti-sidetone feature
- Regulated power supply

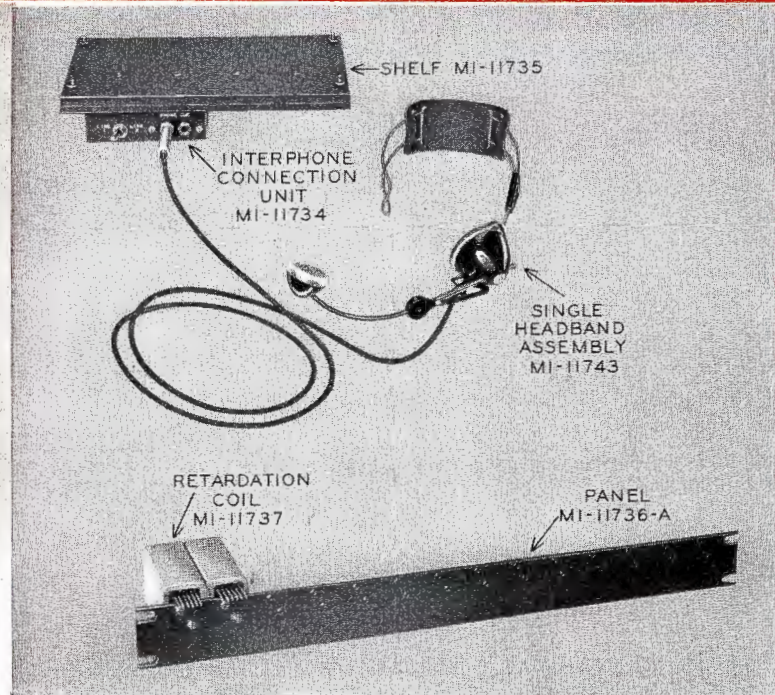

USES

RCA Interphone Equipment is designed to provide convenient switching and headset connection facilities for an internal communication system. Such a system is particularly useful for the radio or television broadcast studio since it allows talking and listening with selected personnel

and with a conference bus or remote private line as desired. Any number of interphone connections may be used. The 24-volt d-c regulated power supply provides interphone power for a system using up to 30 headsets simultaneously.

DESCRIPTION

Heart of the Studio Interphone System is the interphone Connection Unit, MI-11734, which consists of a compact jack box designed for plate mounting. The unit consists of a simple circuit having an induction coil and capacitor to provide an anti-sidetone feature. This results in local sounds being partially cancelled in the local earpiece. The circuit is housed in a small metal box having two phone jacks for use either with a single or a double headset as required, and a two-position toggle switch for selecting a local circuit or a remote line. A cable plug is mounted in the rear.

NOTE: As this catalog is released for printing, the design of a new series of TV intercom components featuring transistor amplifier circuitry is nearing completion. Details will be covered in a separate catalog sheet which will be available from RCA upon request.

A Retardation Coil, MI-11737, permits simultaneous use of four carbon microphones such as one interphone connection unit and three camera headsets on a common battery or power supply. The coil permits a d-c power voltage to be imposed upon the two-wire telephone talking line. This audio frequency choke minimizes the effect of the power supply from lowering the two-wire telephone impedance at voice frequencies, and also allows adequate flow of direct current.

Mounting Panel, MI-11736-A, will permit mounting up to 14 retardation coils in the rack. Either a Single Headband Assembly, MI-11743, or a Double Headband Assembly, MI-11744, can be used for listening and talking with the Studio Interphone System.

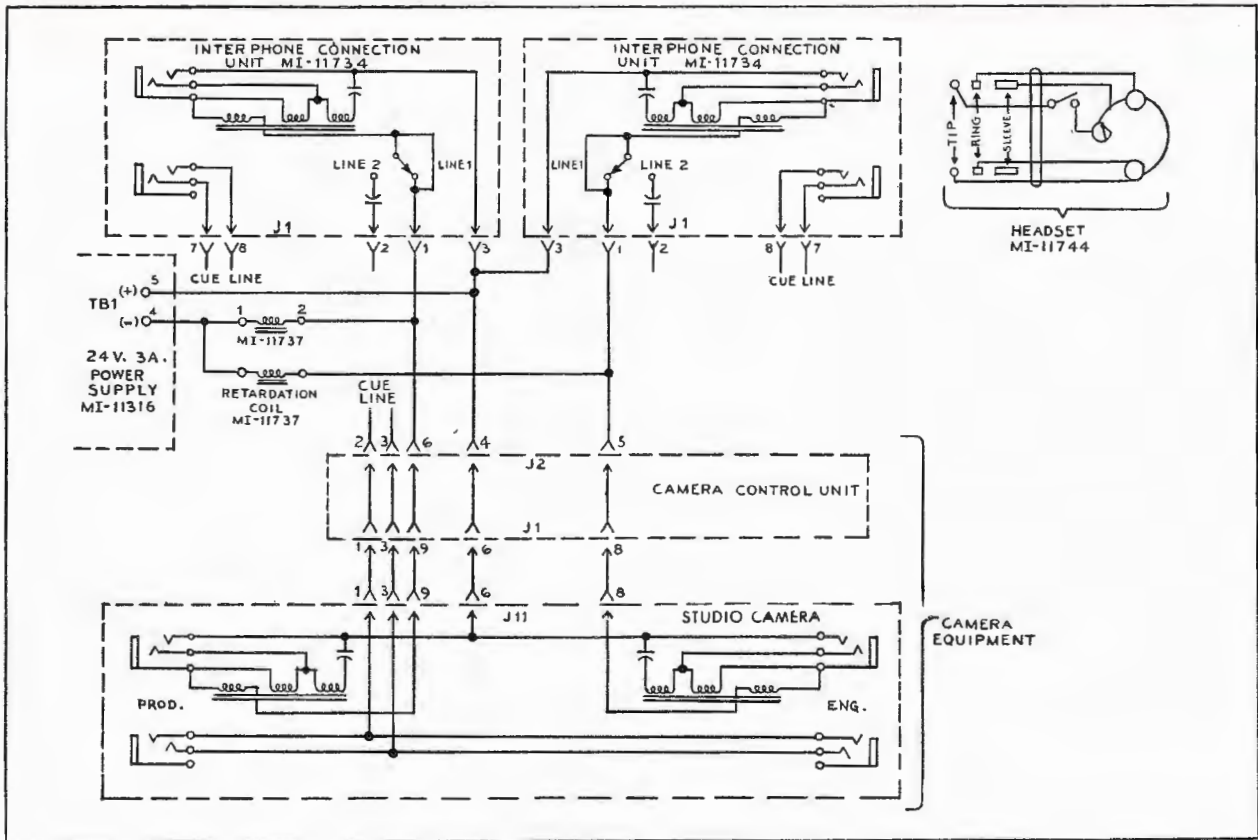

Schematic diagram of typical Interphone System.

SPECIFICATIONS

- D-C Resistance (Headset):
 Microphone Switch On.....70 ohms approximately
 Microphone Switch Off.....Infinite
- Inductance at 1000 Cycles (Headset):
 Microphone Switch On.....70 millihenries approximately
 Microphone Switch Off.....245 millihenries
- D-C Resistance (Retardation Coil).....165 ohms
 Inductance (Retardation Coil).....3.4 henries
 Maximum Recommended Load Current.....125 ma d-c
 Power Supply.....Regulated 24 volts, 3 amps, d-c
- Dimensions:
 Interphone Connection Unit.....4⁵/₈" x 4¹/₄" x 2³/₈"
 Retardation Coil.....4⁵/₈" x 1 45/64" x 1³/₈"
 Mounting Plate.....11" x 6³/₈"
 Retardation Coil Panel, MI-11736.....19" x 1³/₄" x ³/₈"
 Retardation Coil Panel, MI-11736-A.....19" x 1³/₄" x ³/₈"
 Regulated Power Supply.....9" x 7³/₄" x 5³/₄"
- Weight:
 Interphone Connection Unit.....1 lb., 11 ozs.
 Retardation Coil.....15 ozs.
 Retardation Coil Panel, MI-11736.....19 ozs.
 Retardation Coil Panel, MI-11736-A.....18 ozs.
 Single Headband Assembly......6 ozs. (less cord)
 Double Headband Assembly......9 ozs. (less cord)
 Regulated Power Supply.....25 lbs. (net)

Stock Identification of Interphone Components:

- Interphone Connection Unit.....MI-11734
- Retardation Coil.....MI-11737
- Shelf for Mounting MI-11734.....MI-11735
- Panel (Accommodating 14 Retardation Coils).....MI-11736-A
- Single Headband Assembly.....MI-11743
- Double Headband Assembly.....MI-11744
- Regulated Power Supply.....MI-11316

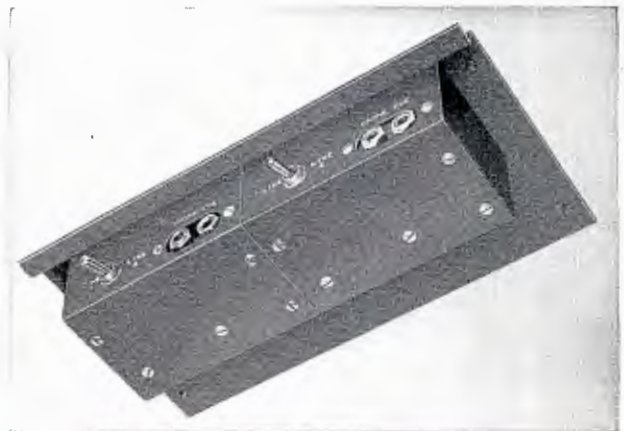

Console Shelf, MI-11735, has mounting accommodations for two Interphone Connection Units.

FEATHERWEIGHT HEADSETS

MI-11749 AND 11750

FEATURES

- Extremely lightweight—smooth, comfortable fit—can be worn for extended periods of time without fatigue
- High sensitivity
- Sturdy bakelite shells and caps
- Six-foot water-resistant cord
- Concealed terminals
- Single or double earphones



USES

The MI-11749 and 11750 Featherweight Headsets are extremely lightweight offering the utmost wearing comfort for those engaged in control room monitoring, remote pickups, and other broadcast applications requiring headphone use. Both Single Headset, MI-11749, or Double Headset, MI-11750, are high quality units of durable molded black plastic, attractive in appearance, sensitive in response, and comfortable for use.

DESCRIPTION

The Featherweight Single Headset, MI-11749, consists of a single durable molded black plastic earphone, 2¼ inches in diameter attached to a ¼-inch wide stainless spring steel headband adjustable for optimum wearing comfort. The phone has concealed terminals and is extremely sensitive, equaling in clarity and volume most double headsets. The headset has a d-c resistance of 2000 ohms and impedance of 9000 ohms. The unit weighs approximately 2 ounces.

The Double Headset, MI-11750, weighs only 4½ ounces, and consists of double earphones identical to those of the single headset, mounted by spring adjustments to a double fabric covered double wire band headband. The unit has a d-c resistance of 5000 ohms and an impedance of 24,000 ohms.

Both headsets are fitted with a 6 foot water-resistant cord with a popular phone style plug. The bakelite body is practically non-breakable. The plug is 2⅞ inches long overall, with 1½-inch prong ¼-inch in diameter which fits all standard jacks. The cord pin tips are held by set screws.

SPECIFICATIONS

	Single Earphone	Double Earphone
D-C Resistance	2,000 ohms	5,000 ohms
Impedance	9,000 ohms	24,000 ohms
Earphones	2¼" dia.	2¼" dia.
Terminals	Concealed	Concealed
Plug	Standard ¼" jack	Standard ¼" jack
Weight	2 ozs.	4½ ozs.
Stock Identification	MI-11749	MI-11750

TRANSISTORIZED INTERCOM EQUIPMENT

FEATURES

- Excellent speech reproduction
- Compact, attractively styled cabinets
- Transistorized Amplifiers—low power consumption
- Easily installed
- Many models available to handle varied intercom needs
- Systems readily rearranged, or expanded— instant call—no warm-up provided

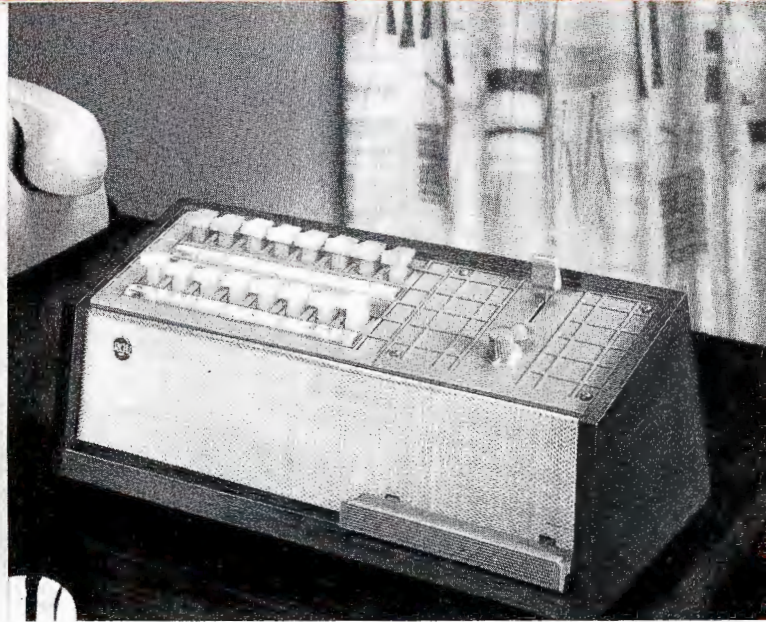

USES

RCA Transistorized Intercom is a new electronic intercommunication system which provides instant two-way voice communication. Its application covers all segments of industry, commerce, and institutions. Multi-Com can be effectively and economically applied wherever walls and distance separate individuals who must communicate. The equipment is easily installed, simple to operate, and requires little maintenance. It features excellent speech characteristics and reproduction quality, permitting the user to talk in normal, conversational tones.

The Intercom system has been designed to offer the high degree of flexibility required to meet a complete range of intercom functions and requirements. A complete system may consist:

- 1) Entirely of master instruments.
- 2) Of one master instrument and one or more remote units.
- 3) Of a combination of a number of master instruments, each with one or more remote or multiple remote units.

Master instruments can be wired for confidential telephone operation.

DESCRIPTION

The RCA Transistorized Intercom equipment consists of master stations and compatible remote units that operate from a central, low-voltage power supply, rated 2 amperes, 30 watts, the voltage of which does not exceed 15 volts. The system permits the master station to call up 32 remote units by voice or any of the remote units to call the master station by signal lights. The system is entirely private for all combinations of units.

Intercom equipment is compact and handsomely styled to complement any office decor. Cabinets provided are of hand-rubbed walnut or blonde finish.

The master station contains a combination of loudspeaker-microphone, volume control, talk-listen switch, station

selector keys, a red busy light, and a chime to give audible indication of a call. The master stations are supplied with 8, 16, 24 or 32 selector keys depending on size system required. The selector keys are of the push type with a simple release mechanism, and are made of a translucent plastic that is illuminated by the call lights. The 8 and 16 key units are housed in cabinets measuring 12¾ inches long, 4½ inches high and 6¼ inches deep. Cabinets housing the larger 24 and 32 key master stations are 19¾ inches long.

The remote units are housed in matching cabinets 5½ inches long, 4½ inches high and 6¼ inches deep. They are equipped with a talk-listen switch and a volume control to adjust listening level.

Both master stations and remote units employ three-inch dynamic loud-speakers that are acoustically and electrically compensated to provide good speech intelligibility without loss of fidelity. The gain of the system permits normal speech at a distance of two feet from the instrument and the sound level output is sufficient for speech to be understood at a distance of three feet from the instrument in noise levels of 92 db. Lines connecting the stations and remote units are at low impedance of approximately telephone level. All amplifiers are completely transistorized and protected against damage due to the application of a reverse supply potential equal to that of the power supply. They consume no power when the station is not in use, generate no heat, yet provide instant communication without any warm-up period.

By means of auxiliary equipment the RCA Transistorized Intercom System can provide many additional service functions. Quiet, confidential talks are made possible by telephone handsets that eliminate use of the talk-listen switch. The receivers mount on a convenient, desk side-hook switch. The system is wired for telephone to telephone communication or for telephone to master communication.

Master Stations are available with an "all-call" switch. This enables the station to call any number of predetermined master or remote stations simultaneously by merely depressing the switch before speaking into the station microphone. Master Stations are also available with a special relay permitting receipt of "all-call" signals from other master station equipment, but which are not provided with "all-call" origination switch. Master stations combining both facilities are also available. In all cases, the number of stations in the system subject to the receipt of an "all-call" need not be the same as the number that can originate an "all-call." Such conference calls are possible without requiring re-adjustment in volume control settings for satisfactory operation.

SPECIFICATIONS

- Power Requirements.....12V. dc, 12V ac from central, low voltage power supply
- System Impedance.....50 ohm balanced line
- Impedance.....Low to match telephone level
- Gain.....Sufficient for normal speech at a distance of 2 feet from the instrument
- Sound Level.....Sufficient that normal speech can readily be understood at a distance of three feet from instrument in noise levels of 92 db.
- Cabinets.....Carefully constructed walnut and blonde cabinets with smooth, hand-rubbed finish
- Dimensions (overall):
 - 8 and 16 Key Masters.....12¾" long, 6¼" deep, 4½" high
 - 24 and 32 Key Masters.....19¾" long, 6¼" deep, 4½" high
 - Remote Units5½" long, 6¼" deep, 4½" high
- Weight:
 - 8 and 16 Key Masters.....5½ lbs.
 - 24 and 32 Key Masters.....7½ lbs.
 - Remote Units2 lbs.

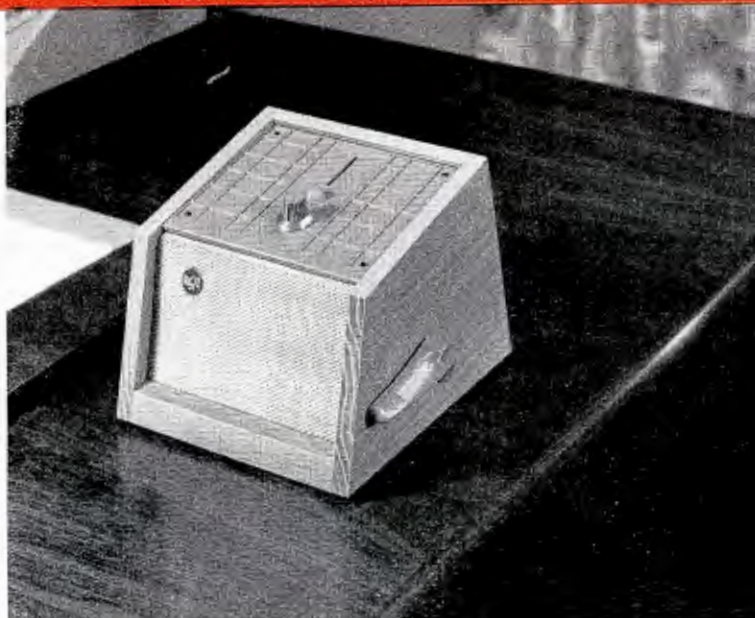

Intercom Remote Unit, MI-38505-B

Equipment Supplied

Type SJR-1W	Remote Unit Walnut Case.....	MI-38505-W
Type SJR-1B	Remote Unit Blonde Case.....	MI-38505-B
Type SXJ-2	Power Supply, 30 watts, 2A.....	MI-38506
Type SXJ-5	Power Supply, 80 watts, 5A.....	MI-38507

MASTER UNIT

Type SJ-8W	8 Station, Walnut Case.....	MI-38508-W
Type SJ-8B	8 Station, Blonde Case.....	MI-38508-B
Type SJ-16W	16 Station, Walnut Case.....	MI-38516-W
Type SJ-16B	16 Station, Blonde Case.....	MI-38516-B
Type SJ-24W	24 Station, Walnut Case.....	MI-38524-W
Type SJ-24B	24 Station, Blonde Case.....	MI-38524-B
Type SJ-32W	32 Station, Walnut Case.....	MI-38532-W
Type SJ-32B	32 Station, Blonde Case.....	MI-38532-B

MASTER UNIT WITH ALL-CALL ORIGINATION ONLY

Type SJ-8WK	8 Station, Walnut Case.....	MI-38509-W
Type SJ-8BK	8 Station, Blonde Case.....	MI-38509-B
Type SJ-16WK	16 Station, Walnut Case.....	MI-38517-W
Type SJ-16BK	16 Station, Blonde Case.....	MI-38517-B
Type SJ-24WK	24 Station, Walnut Case.....	MI-38525-W
Type SJ-24BK	24 Station, Blonde Case.....	MI-38525-B
Type SJ-32WK	32 Station, Walnut Case.....	MI-38533-W
Type SJ-32BK	32 Station, Blonde Case.....	MI-38533-B

MASTER UNIT WITH FACILITY TO RECEIVE ALL-CALL

Type SJ-8WR	8 Station, Walnut Case.....	MI-38510-W
Type SJ-8BR	8 Station, Blonde Case.....	MI-38510-B
Type SJ-16WR	16 Station, Walnut Case.....	MI-38518-W
Type SJ-16BR	16 Station, Blonde Case.....	MI-38518-B
Type SJ-24WR	24 Station, Walnut Case.....	MI-38526-W
Type SJ-24BR	24 Station, Blonde Case.....	MI-38526-B
Type SJ-32WR	32 Station, Walnut Case.....	MI-38534-W
Type SJ-32BR	32 Station, Blonde Case.....	MI-38534-B

MASTER UNIT WITH ALL-CALL TO ORIGINATE AND RECEIVE REMOTES AND MASTERS

Type SJ-8WC	8 Station, Walnut Case.....	MI-38511-W
Type SJ-8BC	8 Station, Blonde Case.....	MI-38511-B
Type SJ-16WC	16 Station, Walnut Case.....	MI-38519-W
Type SJ-16BC	16 Station, Blonde Case.....	MI-38519-B
Type SJ-24WC	24 Station, Walnut Case.....	MI-38527-W
Type SJ-24BC	24 Station, Blonde Case.....	MI-38527-B
Type SJ-32WC	32 Station, Walnut Case.....	MI-38535-W
Type SJ-32BC	32 Station, Blonde Case.....	MI-38535-B

COLOR CONTROL MONITOR

TYPE TM-21B

FEATURES

- Provides accurate, stabilized color picture display at high brightness level
- All components and tubes easily accessible
- Kinescope removable from front
- Only two operating controls—contrast and brightness
- Simplified convergence controls
- Set-up time reduced to a few minutes
- Precision I and Q demodulation
- Automatic brightness tracking
- Normal scan/underscan switch
- Black level DC restoration with feedback stabilization
- Automatic switch to wide band operation for monochrome picture display



USES

The RCA TM-21B Color Control Monitor is a high-quality instrument for use in television broadcast stations and in closed-circuit television systems. It has been designed to reproduce faithfully the information contained in a compatible color signal, with excellent deflection and amplifier linearity, color purity, convergence, and uniformity. Set-up adjustments can be made very rapidly, and need for adjustment has been minimized through the use of highly stabilized circuitry throughout the unit.

Recommended applications for the TM-21B include the following:

1. Control monitor in color camera chains.
2. Color quality control monitor on studio output line.
3. Master control monitor for checking color quality of input signals, including those from network and field pick-ups.
4. Color quality control monitor at the transmitter.
5. High quality color display device for client viewing rooms, executive offices, reception rooms, and theater type studios for live audience viewing.

A number of technical benefits accrue from the use of the TM-21B Color Control Monitor. Accurate color display pinpoints parts of the system requiring adjustment. The monitor provides precision checks of the camera registration, color balance, shading, deflection and transmission system transients, and effects of pedestal adjustments. In addition, it provides a means of observing camera deflection linearity, chroma level, and phase or hue adjustments. The instrument greatly simplifies camera matching and provides a standard against which color performance can be evaluated.

Accurate color display leads to savings in rehearsal time by providing a quick, accurate check on the effects of lighting, background color and other details of the televised scene. No oscilloscope is required for set-up of the TM-21B, only color bar and grating signals are needed. The set-up time is minimized by uniformity between monitors and a simplified set-up procedure, based on a built-in test switch. Long term stability is assured by liberal use of feedback. Time required for monitor adjustments is negligible. Since natural convection cooling is featured, there are no blowers in the monitor to fail or cause noise.

DESCRIPTION

The TM-21B Color Control Monitor features open frame construction with removable side and top covers. Five separate chassis are so mounted that all components, tubes, and controls are readily accessible. Four of these chassis, consisting of the decoder, output amplifiers, deflection and high voltage unit, and power supply are mounted vertically along the two sides of the monitor, with the tubes projecting inward, and the wiring and small components accessible from the outside. A fifth chassis, containing the passive convergence circuits, is mounted as a removable sub-assembly in the center of the front panel.

The two operating controls (brightness and contrast) and all of the set-up controls which require picture viewing during adjustment are mounted on the front panel, along with the power switch and main fuses. The set-up controls are protected by a hinged cover during normal operation. Convenient retractable carrying handles simplify handling and moving.

The safety glass can be easily removed from the front for cleaning the kinescope face. The entire kinescope assembly (including the deflection yoke, convergence coils and purity magnets) is mounted to the front panel, which is hinged to the main frame. To remove the kinescope, the entire panel and kinescope assembly may be swung forward and down, as shown in the illustration.

The relationships between the five chassis are shown in the block diagram. The color video signal is applied to the decoder chassis, where it is processed for use in the other chassis. A sync separator provides the pulses needed to control the deflection circuits and the gated d-c restorers in the output amplifiers. An optional input for external sync permits the monitor to be used for either composite or noncomposite signals. A sync interlock circuit permits remote selection of internal or external sync. In processing the color video signal to drive the output amplifiers, the decoder first separates it into monochrome, I and Q signal components which are then combined in a precision matrix network to yield red, green, and blue signals. Several specialized operations are performed in the M, I, and Q channels.

The M (or monochrome) channel includes a clipper, a pulse adder, a delay line, an aperture compensator, and a notch filter. The clipper is used to remove the sync and burst signals, so that a brightness control pulse may be added in their place. This pulse serves as a clamping reference for the d-c restorers in the output amplifiers, and provides automatic brightness tracking in the red, green, and blue channels. The delay line is used to match the inherently greater delays of the narrow band



Hinged front panel facilitates removal of kinescope and provides exceptional accessibility to components.

I and Q channels. The aperture compensator provides an adjustable boost in the amplitude of the high-frequency components of the signal to compensate for the finite size of the kinescope beams. The aperture compensation circuit is one which does not distort the phase characteristic of the signal. The notch filter provides attenuation at 3.58 megacycles to prevent the color subcarrier from passing through the M channel to the kinescope where it would produce undesirable crosstalk effects. The notch filter is automatically removed from the M channel when a monochrome signal is applied to the monitor, so that monochrome pictures may be displayed with full resolution.

The I and Q channels both include identical diode demodulators, but the video signal applied to the I demodulator is delayed by an amount equal to 90 degrees at 3.58 megacycles. The demodulators are actually fast-acting clamps, keyed at a 3.58 megacycle rate. Since they operate only as switches, they are not subject to gain drift problems. A steady subcarrier signal to operate the demodulators is derived from a burst-controlled oscillator. Filters at the outputs of the demodulators are slightly different for the I and Q channels; the I channel is wider in bandwidth, and includes a small delay line to match its delay to that of the Q channel.

The precision matrix circuit which combines the M, I, and Q signal to produce red, green, and blue is so designed that only one phase-inverting stage is required. Where applicable all circuits in the decoder are highly stabilized by feedback techniques to assure that the color picture display will be a highly accurate reproduction of the scene which appears in front of the camera.

An important feature of the TM-21B decoder is a test switch which enables the monitor to be set up in a very short time. This switch has five positions as follows: red screen test, screen balance, monochrome gain balance, unity chroma, and variable chroma. The first three positions are used only for initial set-up of the monitor. At each position, a specific adjustment is made as described on a check-list mounted within the cover that drops down to reveal the set-up knobs. Unity chroma position is the normal operating position. In this position, the chroma gain is held at unity relative to the monochrome gain by means of stabilized circuits, so the picture yields a true indication of the chroma-to-monochrome ratio of the signal delivered to the monitor input. The last position of the set-up switch brings into play a limited-range chroma gain control. This position is used when it is desired to introduce a non-standard chroma-to-monochrome ratio as a deliberate means of changing the degree of color saturation in the picture display.

The red, green, and blue signals from the decoder are applied to the video output amplifiers, which raise them to the levels needed to drive the three guns of the color kinescope. The three amplifiers are normally identical, and operate with fixed gain. The relative levels of the three signals are established at the outputs of the decoder.

The output amplifiers also contain d-c restorers in the form of feedback-stabilized gated clamps. The previously discussed brightness pulse is used in a clamping reference, and black level is maintained with high precision.

The deflection circuits utilize very conservative design to provide maximum stability of the deflection and convergence functions. A high degree of degenerative feedback and isolation from horizontal crosstalk employed in the vertical deflection circuitry results in excellent interlace stability. Linearity is better than 1 per cent both vertically and horizontally. The regulated high voltage supply is of the flyback type, and delivers all the high-voltage power the kinescope can utilize safely. Automatic circuits provide a high degree of protection against accidental damage resulting from tube failures, loss of horizontal deflection, or severe overdrive. A size switch is provided to reduce both height and width simultaneously to expose all four corners of the picture.

The convergence chassis, a sub-assembly mounted in the center of the front panel, contains only passive circuit elements. The convergence circuits are so designed that all adjustments can be made very rapidly with the aid of a simple grating signal. For ease of convergence, each control is designed to perform some function along

Block diagram showing the five chassis of the TM-21B Color Control Monitor.

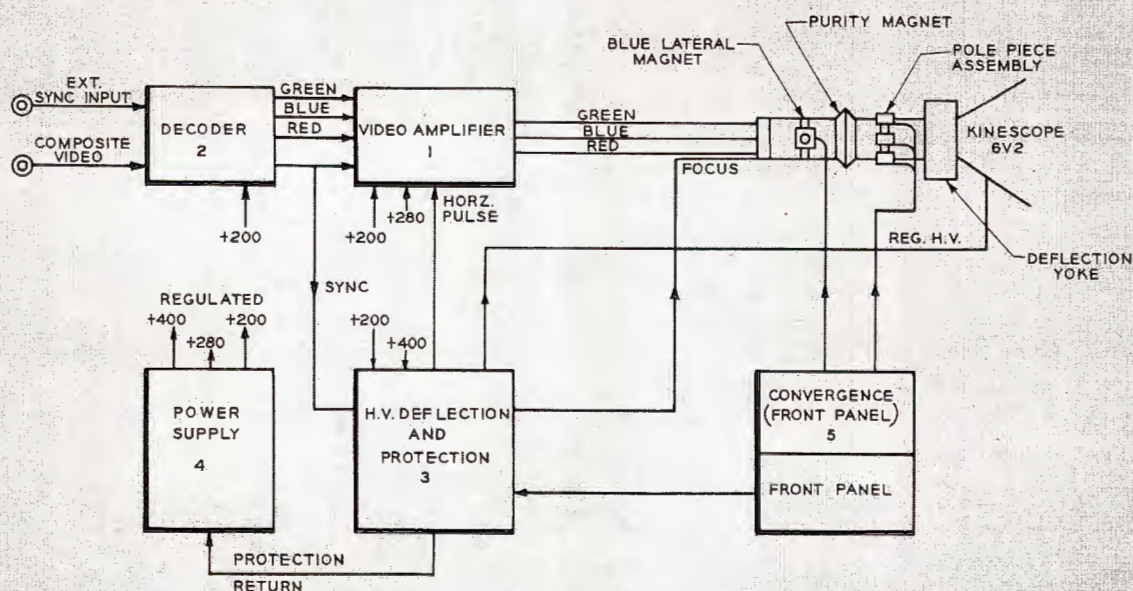

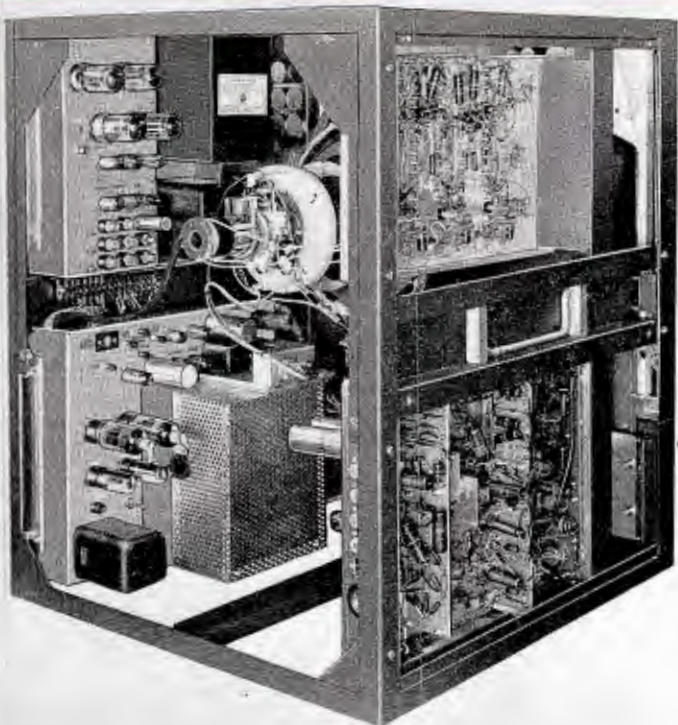

Interior view of TM-21B Monitor showing chassis arrangement designed for ease of maintenance and servicing.

either a horizontal or vertical axis. The vertical dynamic convergence circuit includes a d-c cancellation system which maintains center convergence as the vertical dynamic controls are adjusted. Clamping of the horizontal waveform at the center of each horizontal scan eliminates misconvergence during adjustment of the horizontal dynamic controls. Duplicate convergence controls are provided so that convergence adjustments are maintained regardless of the position of the scan-underscan switch. The arrangement of controls is suitable for a straight-forward step-by-step procedure; the red and green rasters are first brought into convergence, and then the blue raster is matched to the red-green pair. Only five basic types of controls are employed as follows: position, size, linearity, tilt, and bow. Clear labeling makes it easy to visualize the effect of each adjustment.

The power supply chassis provides outputs at three different voltages: +200, +280, and +400 volts. All three voltages are regulated independently, but they are tied together through a common voltage reference arrangement, so that only one calibration adjustment is needed for all three. Each branch of the power supply is separately fused, and indicator lights are used to pin-point the location of any failure.

SPECIFICATIONS

Electrical Specifications

Video Input.....	Composite 0.3 volt to 1.25 volts black to white, blanking negative, high impedance, bridging
Sync Input (Optional).....	2.5 to 6 volts peak-to-peak, negative polarity high impedance, bridging
AC Power Input.....	117 volts nominal, 60 cycles, 900 watts (105 to 125 volts a-c handled by transformer taps)
Tally Light Power Input.....	40 ma. at 24 volts d-c
High Voltage Power Supply Output.....	1.2 ma. at 23 KV
Deflection Linearity.....	Within $\pm 1\%$ horizontally and vertically
Maximum Resolution.....	Color 260-280 lines. Monochrome 400-450 lines
Convergence Accuracy.....	Adjustable for errors less than 1/32 inch along both horizontal and vertical axis for all areas more than 1 inch from the edges of raster and less than 1/8 inch for all areas within 1 inch from edges of raster.
Picture Size.....	Normal scan: standard 21-inch diagonal Underscan: 12.5 by 16 inches
Number of Tubes.....	61 (including kinescope)

Tube Complement:

4-6AL5	1-6AN8	2-6AU4-GTA
6-6BQ7A	2-6CD6-GA	1-6CG7
1-OA2	1-3B2	1-1X2B
4-6AU8	8-6AW8	1-6BC7
1-6W6	1-6X4	8-12AT7
1-5651	4-6080	5-6197
2-6BK4	6-12AX7	1-21CYP22 (Kinescope)

Mechanical Specifications

Dimensions:	
*Height	31 5/8"
Width	27"
Depth	28"
Weight	213 lbs.

* When adjustable glide feet are attached, height is increased a minimum of one inch to a maximum of two inches.

Equipment Supplied

Type TM-21B Color Control Monitor.....	MI-40226-B
Complete with tubes in place and instruction book.	

UTILITY MONITORS

TYPES TM-4BC, TM-4BR, TM-7CC, TM-7CR & TM-8CC

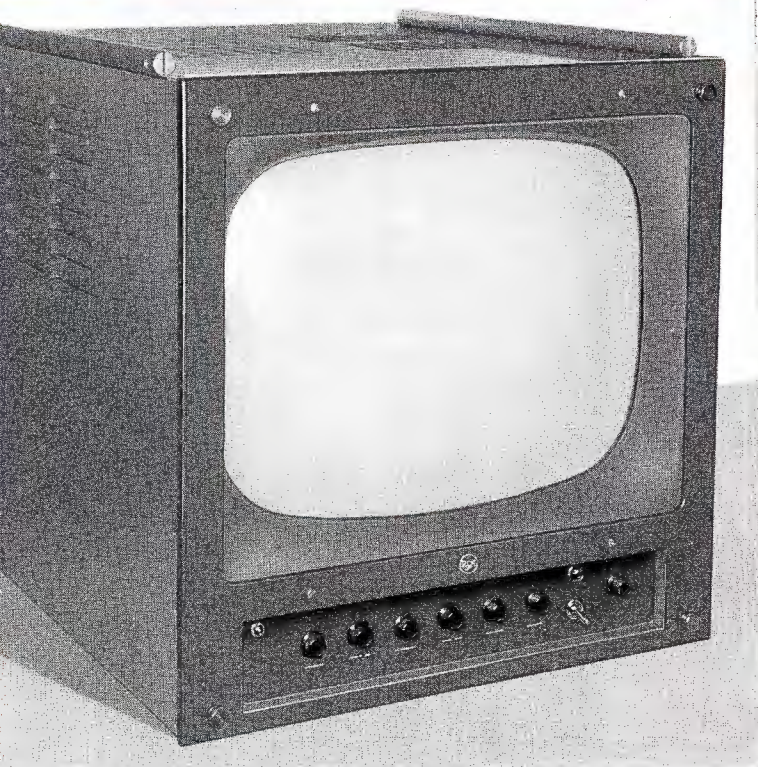

Type TM-7CC Monitor

USES

The RCA TM-4B, TM-7C, and TM-8C series of utility monitors are designed to meet the broadcasters' requirements for a high quality dependable monochrome television monitor which will operate from either composite or non-composite video signals. They are conservatively designed to provide trouble-free, unattended, continuous operation over long periods of time.

Resolution of 800 lines permits the use of these monitors as the display device in either broadcast applications or in closed circuit television systems requiring the presentation of fine detail. For broadcasting and educational television applications the monitors have been attractively styled for program control rooms, client's viewing rooms, classrooms, auditoriums, and other areas in which the cabinets must blend well with the surroundings. The cabinet models can be lined up side by side as in continuity control applications, or if necessary two or more monitors can be stacked. The all-metal cabinets allow these monitors to be placed in locations where wood or plastic cases would be ruled out by fire regulations.

The rack mounted monitors are especially designed for mounting in a cabinet rack or 22-inch console housing.

FEATURES

- Combine economy with high quality performance
- Similar chassis for 14", 17", and 21" models
- Available for either console cabinet mounting or standard rack mounting
- Synchro-Guide horizontal sync circuit for immunity to noise and line voltage changes
- Size can be reduced to make corners visible
- Separate sync drive input with socket for plug-in sync drop relay
- Resolution of 800 lines. Frequency response flat within ± 1.0 db to 10 mc
- DC restoration at black level
- Electrostatic focus

When the 14-inch rack mounted monitor is mounted in an MI-26787 console housing there is enough room in the console to also mount a TO-1 Oscilloscope. This combination can be very effectively used for low cost camera control applications. The 21-inch monitor (TM-8CC) lends itself to those situations where large picture size is paramount, such as in studios (for floor monitor use), offices, clients' viewing rooms, and in control rooms where space is not at a premium. The monitors feature simple operation by means of front panel controls and easily accessible rear apron set-up adjustments.

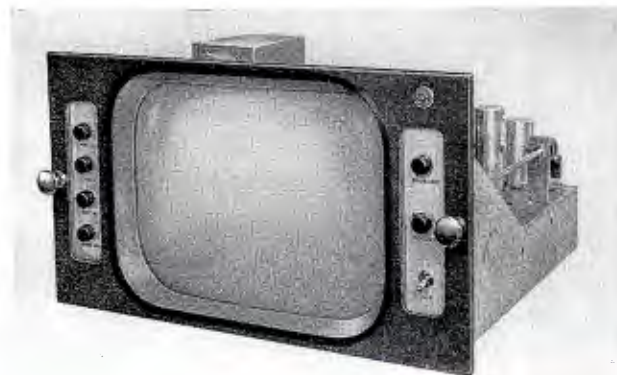

Type TM-4BR Monitor

8-INCH TELEVISION MONITOR

TYPE TM-9



Type TM-9C



Type TM-9N

FEATURES

- High contrast picture with 8-inch aluminized kinescope
- Electrostatic focus
- Resolution in excess of 600 lines
- Designed for continuous duty
- All operating controls on front panel
- Available as either portable or rack mounting units
- Two monitors mount side by side in standard rack

USES

The Eight-Inch Television Monitor, Type TM-9, is a high quality monochrome equipment developed for broadcast and closed-circuit applications where a picture display with good quality is needed and where space is at a premium. The monitor is supplied in three versions: as a monitor chassis less housing (Type TM-9N); in a portable case (Type TM-9C); or as a pair of monitors in a rack-mounting adaptor (Type TM-9/2R).

The TM-9C Portable Monitor is useful as a television program monitor in offices, TV studios and industrial television monitoring locations where small size is essential and the viewing distance is short. In the television control room, it can be used as a program, preview, or continuity monitor for each camera. The design of the unit makes it particularly well suited to these applications since its small size allows a large number of picture displays in a minimum amount of space.

The TM-9/2R Dual Rack-mounted Monitor Assembly permits the location of two picture displays in only 10½-inches of rack-mounting space. This arrangement is particularly useful in industrial applications where the television moni-

tors are to be integrated with other rack-mounted equipment. In television control rooms, the convenient side-by-side mounting of two monitors allows one unit to serve as a continuous line monitor while the other is available as a utility monitor to be "patched in" to any video source. It is also convenient for use in the maintenance shop to provide a quick check on picture quality from the output of equipment under test, or in closed-circuit applications where simultaneous viewing of two or more areas is demanded.

DESCRIPTION

The TM-9 monitor was especially developed for continuous and trouble free operation in broadcast and closed-circuit applications. The video amplifier has a frequency response essentially flat to 8 megacycles, providing resolution in excess of 600 lines resulting in bright, clear, high-contrast pictures.

The RCA 8-Inch Television Monitor in either portable or rack model is fully equipped to operate from either composite or noncomposite video signals. A switch, located on the rear of the chassis, can be used to turn off d-c restoration if desired. The video and sync inputs are of the bridging type so that the signals can be looped past the monitor or terminated. The monitor employs an 8-inch aluminized kinescope tube with electrostatic focus for maximum brightness and contrast even under high ambient light levels.

The portable monitor case with carrying handle, MI-26107 is only 9¼ inches wide, 11⅞ inches high, 17½ inches deep and weighs 47 pounds. The compact chassis model for rack mounting, MI-26108, is so designed as to permit mounting two 8-inch monitors side by side in a standard 19-inch rack by means of a Rack Mounting Adaptor, MI-26109. Only 10½ inches of vertical rack space are required for two independent picture presentations. In both the cabinet and rack-mounted models, the front panel is readily removable for ease in cleaning the picture tube and safety glass. The monitor and housings are finished in a deep umber gray.

All necessary operating controls are located on the front panel and are protected by a hinged cover. The following controls on the front panel are readily accessible to the operator: on-off, brightness, horizontal hold, height, vertical hold, vertical linearity, contrast and width. Secondary controls have also been provided and are located in the chassis. These include: vertical feedback, horizontal linearity, horizontal drive, d-c restorer, and focus. The kinescope may be underscanned to expose all four corners of the raster if desired. This mode of operation is obtained by a simple change of two taps on the horizontal output transformer. The 8-inch Television Monitor operates from

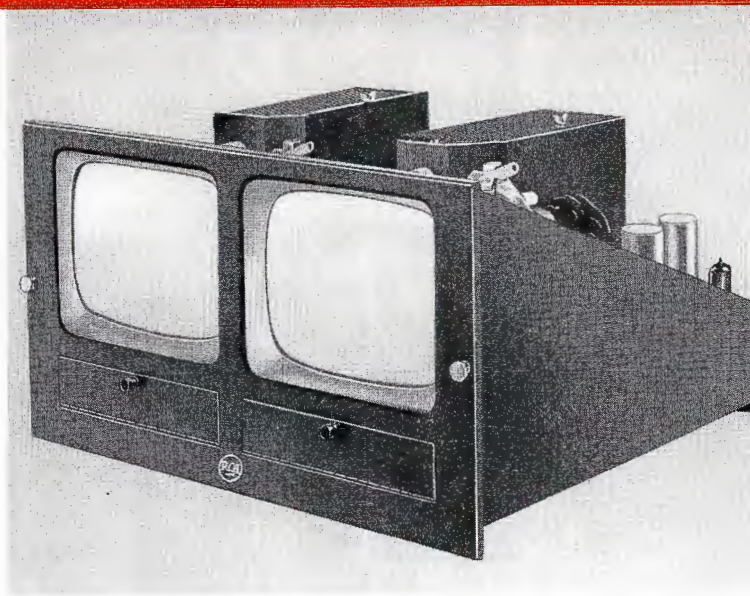

Type TM-9/2R Dual Rack-Mounted Monitors

a power source of 115/230 volts, 60 cycles, 130 watts, fused. A 6-foot power cord is supplied with each equipment.

SPECIFICATIONS

Electrical Specifications

Power Requirements.....	115/130 volts, a-c, 60 cycles, 130 watts
Frequency Response.....	Flat to 8 mc ±2 db
Video Signal Range:	
Composite.....	Nominal 1.0 volt peak-to-peak Minimum 0.35 volt peak-to-peak
Non-composite.....	Nominal 0.7 volt peak-to-peak Minimum 0.25 volt peak-to-peak
External Sync.....	Nominal 4.0 volts peak-to-peak Minimum 2.0 volts peak-to-peak
Video Input Connection.....	Bridged high impedance
Sync Input Connection.....	Bridged high impedance

Tube Complement

6AU6—1st Video	6CG7—Vertical Oscillator
6AU6—Second Video	6AQ5—Vertical Amplifier
6CL6—3rd Video	6CG7—Horizontal Oscillator
12AU7—D.C. Restorer, Ext. Sync Amplifier	6DQ6—Horizontal Amplifier
6BY6A—Sync Separator	6AU4-GTA—Damper
6C4—Sync Amplifier and Phase Inverter	1B3GT—H.V. Rectifier
6AL5—Horizontal Phase Detector	8KP4—Kinescope (Electrostatic Focus—Aluminized)
Power Rectifiers (2) 1N1084	

Mechanical Specifications

	TM-9C MI-26107	TM-9N MI-26108	TM-9/2R ES-26994	Rack Mounting MI-26109
Width	9¼"	8¾"	19"	19"
Height	11⅞"	9⅞"	10½"	10½"
Depth	17½"	17½"	17½"	17½"
Weight	47 lbs.	34 lbs.	79 lbs.	11 lbs.
Finish.....	Light UMBER Gray			

Stock Identification

Type TM-9C 8" Monitor in Cabinet.....	MI-26107
Type TM-9N 8" Monitor, Chassis Only.....	MI-26108
Type TM-9/2R Two 8" Monitors in Rack Mount.....	ES-26994
Includes:	
2 MI-26108 8" Monitors Chassis and	
1 MI-26109 Rack Mounting Adaptor	
Rack Mounting Adaptor Only (for two TM-9N Monitors).....	MI-26109

PROFESSIONAL MONITORS

TM-14C, TM-14R, TM-17C, TM-17R and TM-18C



Type TM-14C Professional Monitor.

FEATURES

- Available in three sizes with 14, 17 or 21-inch kinescope
- Resolution capability in excess of 800 lines
- Electrostatically focused kinescope
- Deflection linearity within $\pm 1\%$ of height
- 110/220 volt 50/60 cycle operation
- Fully regulated ultor and B+ voltages
- Underscan switch permits viewing picture corners and edges
- All operating controls on front panel

DESCRIPTION

The RCA TM-14, TM-17 and TM-18 series of professional video monitors incorporate many features normally found only in master monitors. High resolution and excellent stability allow the use of these monitors in television broadcast control rooms, tape and film editing rooms, client's viewing rooms and any location where better than average detail of display is required. The all-metal cabinets of the TM-14C, TM-17C and TM-18C monitors are attractively styled for use in areas where pleasing appearance as well as exacting performance is required. The TM-14R and TM-17R rack mounted monitors can be mounted in either a standard 19-inch relay rack or a 22-inch console housing, MI-26787.

The RCA Professional series of monitors were designed to provide a high resolution, stable picture display with a minimum of maintenance. The video response is flat to 10 megacycles, assuring resolution in excess of 800 lines. The 6 db point is above 10.5 megacycles. A switch located on the rear apron of the monitor permits switching d-c restoration in or out. All operating controls including electrical focus and electrical centering are mounted on the front panel.

The monitors utilize a newly developed, electrostatic focus kinescope. Smaller spot size gives markedly improved resolution over the entire screen and is particularly notice-

able when viewing the corners. A 70-degree deflection system is employed in all monitors.

A switch is provided to select either composite video or noncomposite video with separate sync inputs. Both video and sync inputs are paralleled receptacles for loop-through operation. The video input is provided with a terminating resistor switch. A switch is also provided to permit switch-

Type TM-14R Professional Monitor.





Type TM-17C Professional Monitor.



Type TM-18C Professional Monitor.

ing d-c restoration on or off. Of special interest is the picture size control, which changes the display from normal full scan to reduced scan, completely showing all four sides and corners. This is accomplished without change in brightness, contrast, or linearity.

A gating circuit has been incorporated to eliminate bending or hooking of vertical lines at the top of the picture regardless of the position of the horizontal hold control. This circuit may be switched out for non-standard sync. The RCA monitors have fully regulated ultor and B+ voltages, and will satisfactorily operate in areas having poor power line regulation. The low voltage power supply utilizes silicon rectifiers in a voltage doubler configuration. All monitors are factory wired for 117 volt operation.

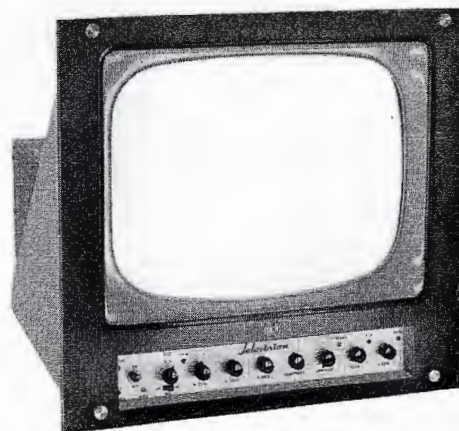

Type TM-17R Professional Monitor.

SPECIFICATIONS

Electrical:

Power Input.....105-125/210-250 volts, 50/60 cycles, 300 watts
 Video Input.....0.25 volts minimum, peak-to-peak composite
 Sync Input (Ext.).....2 to 8 volts peak-to-peak, sync negative
 Video Input Connection.....Bridged high Impedance
 Sync Input Connection.....Bridged high impedance
 Video Frequency Response.....Flat to 8 mc; 6 db point above 10.5 mc

Tube Complement:

3-6AU6	1-6C4	4-1N1084 silicon rectifiers
1-6CB6	1-6AL5	1-14BAP4 (TM-14C and TM-14R only)
2-12BY7	2-6CG7	
2-6080	1-6BL7	1-17DWP4 (TM-17C and TM-17R only)
1-0B2	1-6CB5	
1-12AU7	1-6AU4-GT	1-21AUP4/21AVP4 (TM-18C only)
2-6BY6	1-6BK4	
1-6AN8	1-1B3-GT	

Mechanical:

Type	Kinescope	Mounting	Height	Width	Depth	Weight	Stock Identification
TM-14C	14"	Cabinet	14 ⁵ / ₈ "	17 ¹ / ₆ "	20 ⁵ / ₆ "	99	MI-26194
TM-14R	14"	Rack	14"	19"	20 ¹ / ₂ "	82	MI-26195
TM-17C	17"	Cabinet	17 ³ / ₄ "	18 ¹ / ₂ "	20 ¹ / ₂ "	112	MI-26196
TM-17R	17"	Rack	17 ¹ / ₂ "	19"	20 ¹ / ₂ "	92	MI-26197
TM-18C*	21"	Cabinet	22 ¹ / ₂ "	24"	24 ³ / ₄ "	145	MI-26198

*Note: TM-18C Monitor is shipped with kinescope packed separately.

MASTER MONITOR

TYPE TM-6C

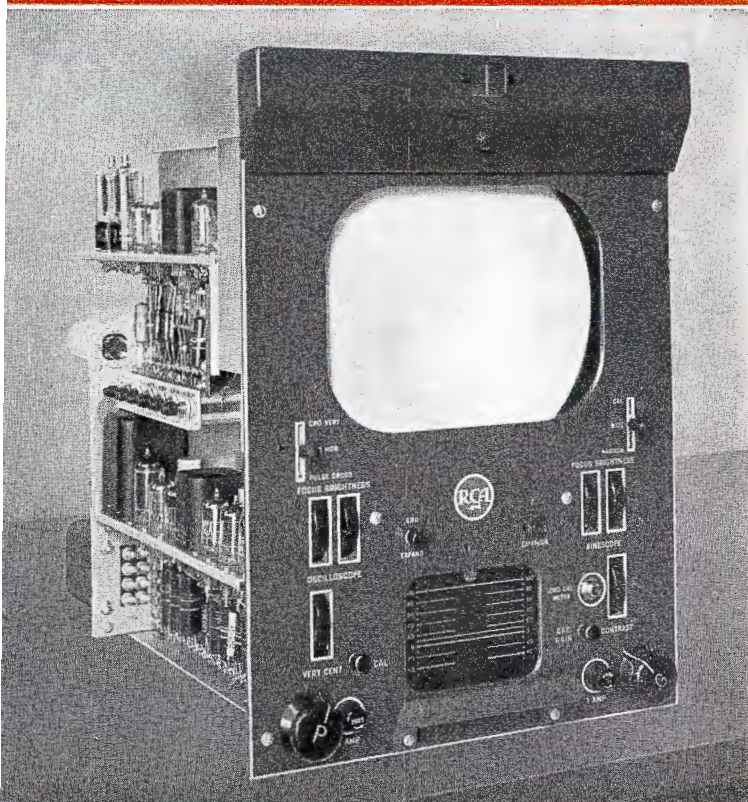

FEATURES

- Precision picture monitor and video waveform monitor combined in a single unit
- Displays red, blue and green signals side-by-side on waveform monitor when used with processing amplifier
- Waveform monitor frequency response switchable between IRE roll-off and flat to 5.5 mc
- CRO gain and calibration controls on front panel for operational use
- Kinescope deflection linearity adjustable to 1 per cent
- Pulse cross display for examination of sync and blanking signals
- Choice of synchronizing methods plus sync interlock for versatile system functions

USES

The RCA TM-6C Master Monitor is a high quality television picture and waveform monitor for both monochrome and color applications. In monochrome film and live camera chains it serves as the camera control monitor providing facilities for the accurate alignment and control of the camera and its associated equipment. When used with a color camera processing amplifier it provides for examination and control of the three color signals from a color film or live camera chain. As a preview monitor with switching systems, video signals of either local, remote, or network origin can be examined in great detail before being switched on the air.

When used as a program line monitor, the TM-6C Master Monitor provides a continuous quality check on all video

signals being fed to the transmitter. At the transmitter location, the TM-6C is used for precisely monitoring and adjusting the signals at the various points in the transmitter and from the demodulator. The pulse cross feature of the instrument permits detailed examination of the sync, blanking, and color sync signals from the local sync generator and composite sync signals from local, remote, or network sources.

The TM-6C monitor fits into the RCA standard console housing MI-26786 or, with a rack mounting adaptor, into a standard BR-84 series cabinet rack. A field carrying case (MI-26521-A) is available for use with the TM-6C for mobile applications.

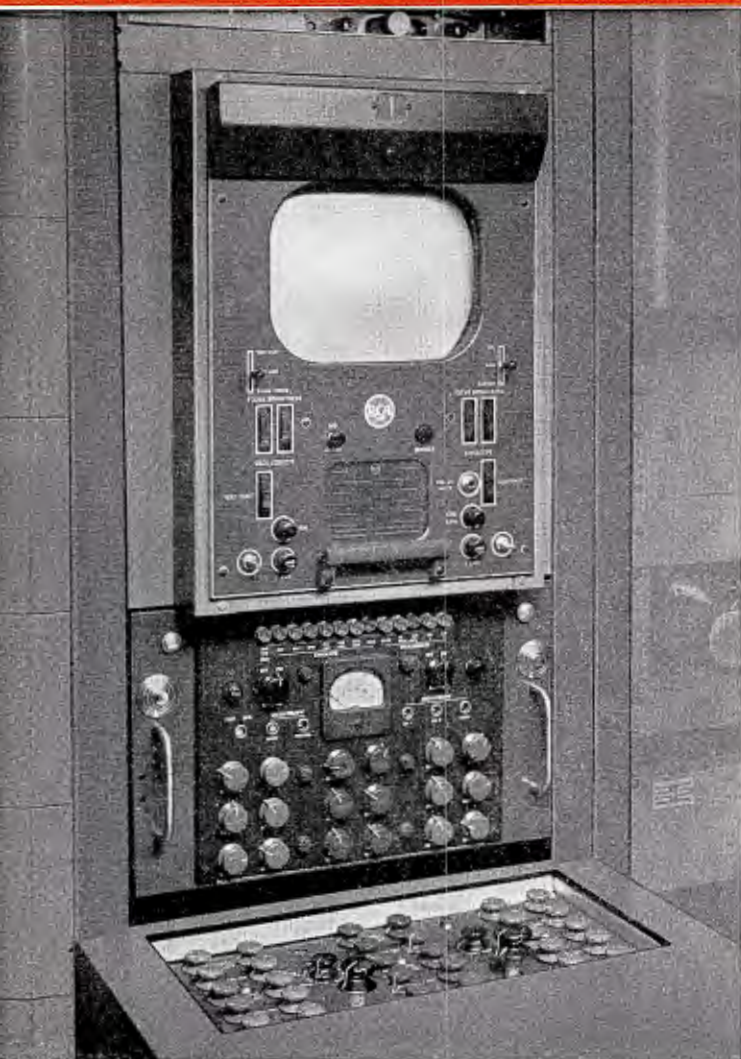

TM-6C Master Monitor is conveniently mounted in rack by means of MI-26526 Rack Mounting Adaptor above the color camera controls.

DESCRIPTION

The TM-6C Master Monitor consists of a picture monitor utilizing a high quality 10-inch aluminized kinescope (RCA Type 10SP4). The associated video circuitry has a frequency response which is flat within ± 1 db to in excess of 7.5 mc, thus providing 600 line resolution. Deflection of the kinescope is linear within 1 percent; thus the monitor is an excellent secondary standard with which camera linearity can be measured and adjusted. A switch on the front panel activates a circuit which delays the horizontal and vertical drive pulses one half a line and half a field respectively, thus providing a pulse cross display on the kinescope. This feature makes possible a rapid and accurate check on sync generator performance by monitoring vertical and horizontal blanking, vertical and horizontal sync, and number of equalizing pulses during the complete vertical sync interval. Widths of all pulses are also readily discernible on a pulse-cross display.

The waveform monitor portion utilizes the RCA Type 5ABP1 Cathode Ray Tube. The vertical amplifier frequency response is flat within ± 0.5 db to 5.5 mc or, by means of a switch on the front panel, the standard IRE roll-off characteristic can be selected. The connections to the CRO vertical amplifier are normally paralleled with the video input to the kinescope, but the oscilloscope can be used independently of the kinescope by disconnecting a jumper between the respective input connectors on the rear apron of the chassis.

Sensitivity of the amplifiers is such that a 0.1 volt input signal will give a deflection of 2 inches on the oscilloscope. A calibration pulse derived from the sync drive signals can be switched into the amplifier circuit so that the level of any incoming signal can be immediately determined. A jack is provided on the front panel for setting the amplitude of this calibration pulse with the RCA plug-in meter (MI-21200-C1). The gain control for the CRO is located on the front panel also.

The CRO time base circuit has two modes of operation, selected by a switch on the side panel. For monochrome use the repetition rate of the CRO sweep is either 30 cycles per second or 7845 cycles per second so that two full fields or two lines appear on the display.

When used with a processing amplifier for color camera control purposes, a unique time base switching signal in the form of a step wave is combined with the normal sawtooth scanning waveforms. Red, blue and green video signals synchronous with the step signal are supplied from the processing amplifier and are displayed side by side on the cathode ray tube. Vertical or horizontal display is selected by the regular horizontal-vertical switch on the front panel. A push-button switch on the processing amplifier also provides facilities for superimposing the R, B, and G signals. When superimposed the level of the three signals is observed to be the same when there is no display flicker. If flicker occurs adjustment of levels is made until the flicker disappears. The push-button switch on the processing amplifier also provides for remotely selecting conventional vertical or horizontal sweep rates for examining colorplexed signals.

A pushbutton on the front panel activates a circuit which provides 16 to 1 expansion of the CRO time base. An auxiliary expansion width control enables the entire screen width to be filled with the vertical or horizontal sync interval. An expansion of this magnitude presents a video signal display broad enough to count the cycles in the color burst signal and to permit examination of minute details in the vertical and horizontal synchronizing signals. Retrace blanking is present on all displays, but it can be removed if desired to apply an external marker to the CRT grid.

An edge-lighted lucite scale calibrated for sync and video or composite signals is provided for accurate adjustment and measurement of levels. Connectors at the rear of the monitor chassis provide for video, sync, drive, and power inputs. The sync and video cables can be terminated at the monitor or can be bridged past the monitor to other destinations.

To achieve a high degree of versatility in the choice of synchronizing methods a switch on the right side of the chassis permits selection of drive, external or internal sync. In the external sync position the mixed sync from the local sync generator is used to synchronize the monitor. This is for applications where non-composite signals are to be monitored such as in previewing in a switching system.

In the internal position, sync from a composite signal is used in the same manner. In these two cases the two controls in the lower corners of the front panel are used to lock-in the vertical and horizontal oscillators. A sync interlock relay (available on separate order as MI-26544)

can be remotely controlled from the studio switching system so that either non-composite or composite sync is selected, depending on the signal being switched. An auxiliary brightness control can be preset so that the kinescope brightness does not change between composite and non-composite signals.

When the sync selector switch is in the drive position, vertical and horizontal drive from a camera control or processing amplifier is used to control the deflection circuits. In this type of service the vertical and horizontal oscillators are inoperative and the two controls in the lower corners of the front panel are used to adjust black level and gain of the camera video signal.

The anode voltages for the kinescope and CRT are supplied by an r-f type regulated supply which although an integral part of the monitor, is also a self-contained unit by itself so that it can easily be removed for servicing or replacement. Regulation of the high-voltage supply prevents blooming and size changes.

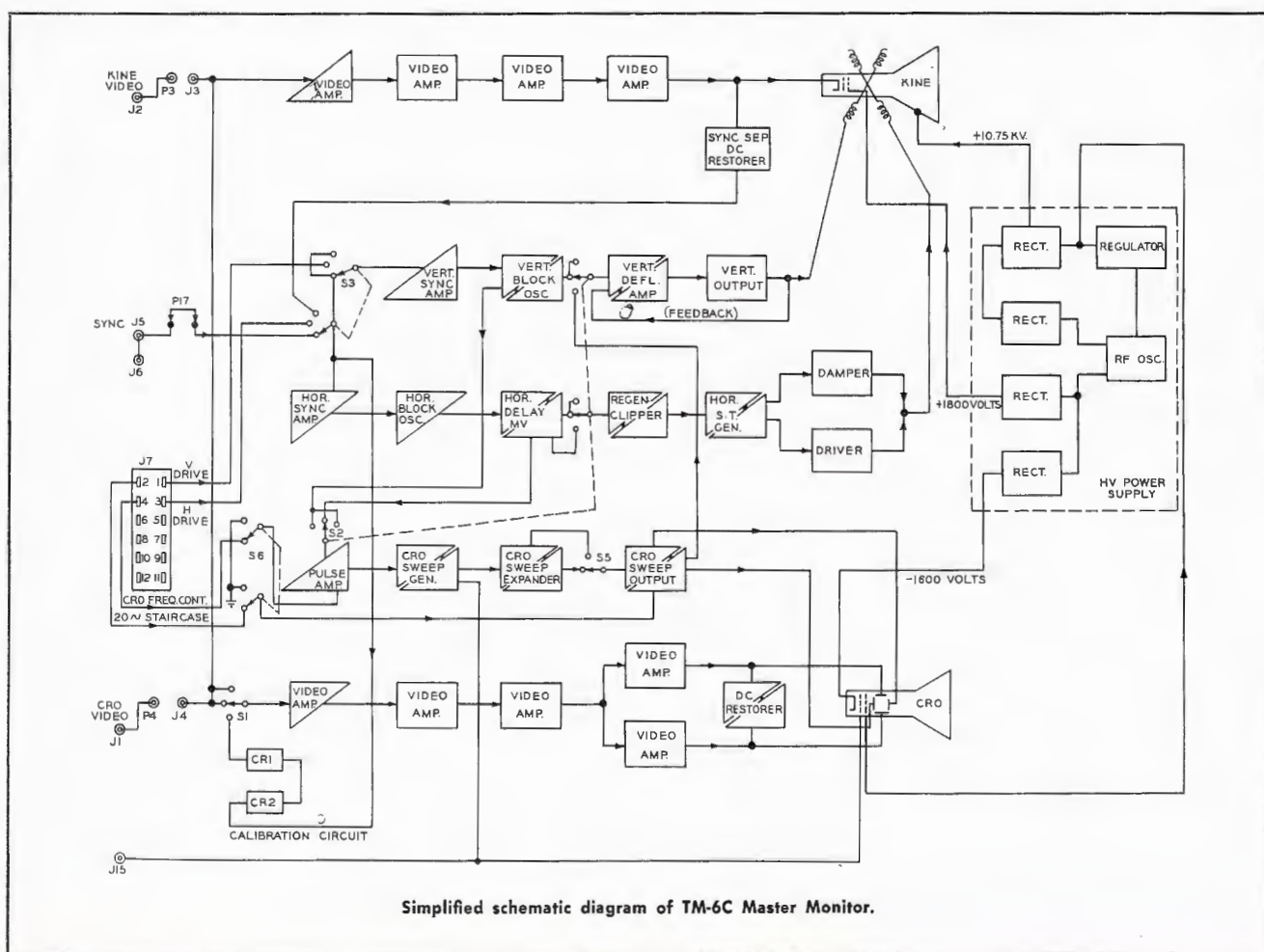

Simplified schematic diagram of TM-6C Master Monitor.

This supply is also available on separate order as MI-26838. An external power supply, RCA Type WP-16A is necessary to supply the B+ and centering current. Bias and driving pulses for camera control service are supplied by the respective camera controls or processing amplifier. A protective power interlock switch removes power from the B+ and high-voltage circuit when the monitor is withdrawn from the cabinet or console housing. This interlock can be reactivated outside the cabinet for servicing purposes.

All operating controls are located on the front panel of the monitor. The most frequently used setup controls are located on a sub-panel at the top of the front panel, accessible by means of a hinged cover.



Hinged cover provides easy access to setup controls.

SPECIFICATIONS

Electrical Specifications

Input Power Required:
 Filament Supply.....105-125 volts, 50/60 cycles, 90 watts
 Plate Supply.....280 volts, d-c regulated, 450 ma
 Centering Current.....450 ma at -4 volts d-c regulated

Miscellaneous Inputs (when used as Camera Monitor):
 Bias (from Monochrome Camera Control).....-18 volts d-c
 Tally Light Relay (from Switcher).....24 volts d-c
 CRO Timebase Staircase (from Color Processing Amplifier 20 cps).....12 volts, peak-to-peak
 Vertical Drive (60 cps).....-4 volts, peak-to-peak, nominal
 Horizontal Drive (15,750 cps).....-4 volts, peak-to-peak, nominal

Input Signal Levels:
 Video (CRO).....0.1 to 4.0 volts peak-to-peak
 Video (Kinescope).....0.1 to 4.0 volts peak-to-peak
 Sync.....3.5 to 5.0 volts peak-to-peak

Input Impedance:
 CRO and Kinescope on Same Input.....20 mmf across 280,000 ohms
 *Kinescope, Separate Input.....7 mmf across 560,000 ohms
 *CRO, Separate Input.....12 mmf across 560,000 ohms

Frequency Response:
 Kinescope.....Flat within ± 1 db to 7.5 mc
 Oscilloscope Vertical Amplifier
 **Wide Band.....Flat within ± 0.5 db to 5.5 mc
 Narrow Band.....IRE Standard Roll-off

Tube Complement

Main Chassis:		
1-5ABP1 (CRT)	1-10SP4 (Kinescope)	4-6197
3-6485	7-12AT7	2-6CB6
1-6AL5	1-12AU7	1-12BH7
2-6BQ6-GT	2-12AX7	
High Voltage Supply:		
4-1X2A/B	1-6BQ7-A	1-6L6

Mechanical Specifications

Length.....20"
 Height.....18"
 Width.....13 1/8"
 Weight.....55 lbs.
 Finish.....Deep umber gray

Equipment Supplied

TM-6C Master Monitor, complete.....ES-26957-A
 Includes the following units:
 1 Master Monitor with High Voltage Power Supply (MI-26838) and all tubes in place except Kinescope and CRO Tube.....MI-26136-C
 1 Blower for TM-6C.....MI-26579-B
 1 Kinescope, Type 10SP4.....MI-26655
 1 Cathode Ray Tube, Type 5ABP1.....MI-26667
 or

TM-6C Field Master Monitor System (for use with TK-31A Camera Equipment and TS-30D Field Switcher).....ES-26955-B
 Includes the following units:
 1 TM-6C Master Monitor.....MI-26136-C
 1 Kinescope, Type 10SP4.....MI-26655
 1 Cathode Ray Tube, Type 5ABP1.....MI-26667
 1 Field Carrying Case.....MI-26521-A
 1 Shockmount.....MI-26511-2
 1 Power Cable, 12-Conductor.....MI-26759-8
 1 Video Transmission Line Cable, Coaxial.....MI-26759-12

Optional and Accessory Equipment

Calibration Meter.....MI-21200-C1
 Sync Interlock Relay.....MI-26544
 Rack Mounting Adaptor.....MI-26526
 Spare High-Voltage Power Supply.....MI-26838
 Tally Light Relay, 6.3 volts a-c.....MI-26279
 Field Power Supply.....MI-26091
 Shock Mount.....MI-26511-A1
 Power Cable (Input to Power Supply).....MI-26759-2

* Can be terminated internally by addition of two jumpers.
 ** Response may be adjusted to be exactly flat at 3.58 mc.

PORTABLE MASTER MONITOR

TYPE TM-35

FEATURES

- Bright 8-inch rectangular picture tube and calibrated 3-inch CRO waveform display
- Self-contained, including power supply
- Regulated high-voltage supply
- Space provided for auxiliary camera control panels and switcher
- Lightweight—in carrying case for field use
- Mounts in 13-inch console or 19-inch rack

USES

The RCA Master Monitor, Type TM-35, is a television video monitor intended for use as a reference in evaluating the picture quality and waveform of a video signal in broadcast and closed-circuit applications. Its high reliability and performance meet the requirements of a camera control monitor, preview monitor or an outgoing line monitor.

The TM-35 Monitor consolidates an 8-inch picture display with a calibrated 3-inch oscilloscope into a single lightweight portable case which can be easily carried for use in field camera pickup systems. Two TM-35's can be mounted side by side in a 22-inch console or standard cabinet rack thus putting multiple camera control positions within easy reach of a single video or technical operator. A single TM-35 can also be mounted in the above and the RCA 13¼-inch console.

The careful periodic examination of a video signal and checking the performance of the camera, amplifying, mixing, switching and distribution equipment is essential in a television system. The versatility of the TM-35 makes it ideally suited as a test instrument for this purpose. Also, the TM-35 is an excellent testing unit for a multihop television microwave system or a multicamera surveillance system.



DESCRIPTION

The Master Monitor, Type TM-35, is designed as a compact lightweight unit with a self-contained power supply. The chassis and case are a single unit with a flush-type handle located above the center of gravity for ease of carrying.

The picture of the video input signal is displayed on a rectangular kinescope utilizing low-voltage electrostatic focus and a 90-degree deflection system. The picture tube operates at 11 kilovolts with regulation for average beam currents of 0 to 300 microamps. High voltage regulation and the use of an aluminum-backed tube permits bright pictures of 200-foot lamberts. This highlight brightness together with a filter safety glass faceplate makes it possible to view the monitor under conditions of high ambient illumination.

The waveform of the video input signal is displayed on a 3-inch CRO tube which provides a means of observing the video signal amplitude and waveform. It has a flat faceplate which minimizes parallax between lines on an illuminated scale and the tube face for measurement of video and sync amplitudes to extremely close tolerances.

An edge-lighted lucite scale calibrated for sync, video or composite signals is located over the CRO. The intensity of the calibration marks is adjustable by means of a knob on the front panel. The CRO is operated at 1/2 horizontal or 1/2 vertical sweep rates to allow inspection of blanking, sync and video at either rate. The amplifier also utilizes d-c restoration on the blackest portion of the waveform.

All the essential operating controls are conveniently located on the front panel. Those of the kinescope are in line above the 8-inch picture tube with the "on-air" tally light in the center. The CRO controls are grouped around the 3-inch waveform display at the lower part of the panel. Power switch and indicator are on the lower right corner of the front panel.

Two front handles act as "protectors" when the unit is moved and are very convenient for moving the monitor from a rack shelf or console mounting. The bottom blank panel portion is removable to accept an accessory panel such as a switcher or remote camera control.

Side covers are easily removable to permit adjustment of

a minimum of set-up controls, and for servicing and maintenance. Holes in the base along the bottom of the covers control air intake to the case. The air is exhausted through the rear by a fan. Cooling air distribution in the case is uniform and the equipment can be operated in ambient temperatures of 50 degrees.

All external connections are made through the rear panel. A permanently attached line cord provides all the power for the unit. Two connectors provide loop through or a terminating facility for the video line. When an input connection is made to a 75-ohm line it actually feeds through to the input amplifier stage and loops back to the output terminals in order to minimize the line loading effect of the monitor. The synchronizing signal, if desired, is either looped through or terminated at a T-connector provided at the single connector. A chassis connector is provided where tally and sync interlock voltages can be applied as required by usage. A blank panel covers an opening which permits mounting the coaxial fittings associated with an accessory switcher or camera remote control panel.

SPECIFICATIONS

Electrical Specifications

Input Power Required.....100-130/200-260 volts, 60 cycles, 180 watts (for 50-cycle operation an alternate ac transformer is available with same voltage rating)

Signal Inputs:

Video (Composite)0.3 to 2.0 volts peak-to-peak
(Non-composite)0.2 to 1.34 volts peak-to-peak
Sync4.0 volts nominal peak-to-peak

Input Impedance:

*Video.....High Impedance (with loop through connectors)
*Sync.....High Impedance (single connector)

Miscellaneous (when auxiliary control panel is used)

Vidicon Camera Control Panel.....9 pin male conn. for remote camera circuits on rear
6 pin male conn. for intercommunication circuits on rear
Dual female telephone conn. for single or double headset on front of panel
TS-4A Switcher Panel.....Four input coaxial connectors
One output coaxial connector

Picture Performance:

Size7 3/4" diagonal
Brightness.....200-foot lamberts maximum in highlights
Bandwidth.....8 mc ±1 db
Resolution.....600 TV lines
Linearity.....±2 percent horizontal and ±1 percent vertical or less

Waveform Performance:

Display.....3-inch flat face CRO with green filter
1/2H or 1/2V line rate
Calibration.....Adjustable edge-lighted IRE scale with regulated reference voltage
BandwidthIRE Roll-off

* Can be terminated by 75 ohms on external coaxial cable connectors.

Tube Complement

3 6AW8A	1 6DQ6A	1 5814A/12AU7
1 6197/6CL6	2 1X2B	1 3WP1
1 6AN8	1 6AU4-GTA	1 68X7-GT
1 8HP4	1 6BK4	1 5687
1 6CG7	1 6201/12AT7	1 5726/6AL5

Mechanical Specifications

Length (including handles and coax. fittings).....20 3/4"
Height (including feet and handles).....15 7/8"
Width8 1/2"
Weight (less auxiliary panels).....49 lbs.
Finish:
Rear top of case.....Armasol Vinyl, light umber gray
Side Panels.....Chemical black with black lacquer

Equipment Supplied

TM-35 Master Monitor complete with Kine, CRO, and in Field Case.....MI-26154

Optional and Accessory Equipment

Sync Interlock Relay.....Stock #99155
Video Transmission Line Cable, Coaxial.....MI-26759-12
Mounting Adaptor (for mounting one TM-35 in 84-inch rack or 22-inch console).....MI-26871
Mounting Adaptor (for mounting two TM-35 in 84-inch rack or 22-inch console).....MI-26872
Mounting Adaptor (for mounting one TM-35 in 13 1/2-inch console)MI-26873
Auxiliary Panels:
Camera Remote Control Panel for TK-15.....MI-26161
Camera Remote Control Panel for TK-205/TK-252.....MI-36213
TS-4A Switcher (4-input mechanical).....MI-26162

VIDEO & PULSE DISTRIBUTION AMPLIFIER

TYPE TA-12

FEATURES

- High degree of isolation between amplifiers
- Etched wiring provides compact size and uniform performance
- Eight amplifiers plus filament bias supply mount in single amplifier frame occupying only 7 inches of rack space
- Plug-in construction for instant replacement
- Amplifier inputs can be bridged for single input, multiple output applications
- Extended low frequency response eliminates low frequency transients
- Frequency response flat within ± 0.3 db between 1 cycle and 8 megacycles

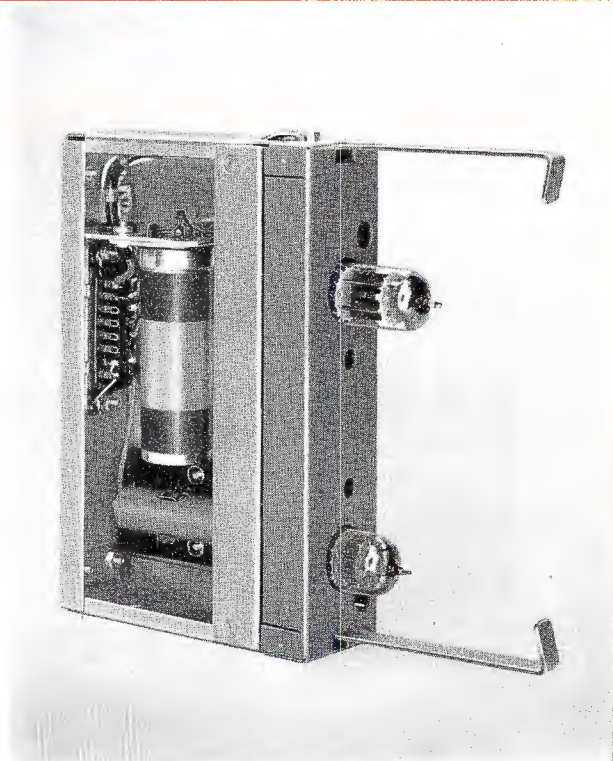

USES

The Video and Pulse Distribution Amplifier, RCA Type TA-12, is a single channel amplifier for use in general signal distribution service. It will accept signals with amplitudes up to 1.0 volt of composite video, 2 volts of sub-carrier (3.58 mc cw.) or 4.0 volts of sync, drive, or blanking. The TA-12 offers a high degree of isolation between output channels when two or more amplifiers are used to provide isolated multiple feeds to as many locations as desired from a single input. Each output provides sending-end termination for improved signal transmission over long lines.

The amplifier is of plug-in construction for instant replacement in case of component failure. However, it is easy to replace tubes without taking the amplifier out of the mounting frame. The use of precision components and etched wiring provide uniformity between amplifiers such that they are readily interchangeable. Up to ten TA-12 amplifiers or eight amplifiers with one filament and bias supply can be mounted in an MI-40325 Amplifier Mounting Frame for installation in a standard cabinet rack.

DESCRIPTION

The Type TA-12 Video and Pulse Distribution Amplifier, MI-40326, is a small, compact, plug-in unit featuring highly advanced circuit techniques and physical design. Up to ten amplifiers may be mounted on an MI-40325 Amplifier Mounting Frame which occupies only 7 inches of rack space. Etched wiring is used to assure that all amplifiers have uniform performance. All components are conservatively rated. The input impedance of the amplifier is very high and the input capacitance is very low so that several amplifiers may be bridged across a common circuit without adversely affecting the high frequency response. The output is sending-end terminated for feeding very long transmission lines with a minimum of signal degradation. The gain of the TA-12 has a nominal value of unity. Two amplifier tubes—a 2C51 and a 5687—form a feedback pair with a high degree of stability so that the gain is unaffected by changes in $B+$, filament voltage and tube and component aging. Low frequency response has been extended to a very low value so that low frequency transients will not occur. Tilt on a 60 cycle square wave is less than 1 per cent.

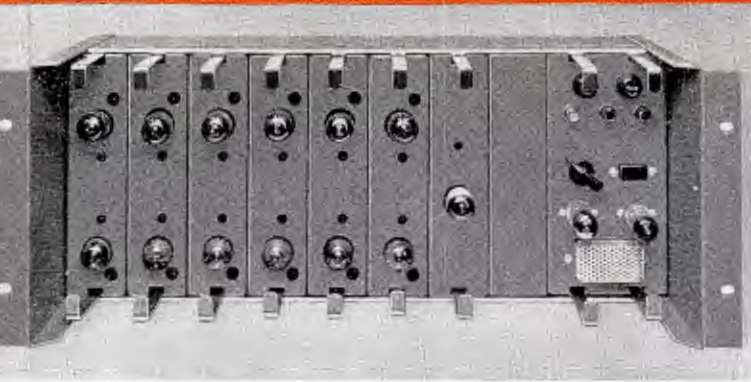

Six TA-12 Video and Pulse Distribution Amplifiers and accessory equipment mounted in MI-40325 Amplifier Frame.

The MI-40325 Amplifier Frame occupies 7 inches of rack space and contains spaces for ten TA-12 amplifiers, or eight amplifiers and one filament bias supply. Each amplifier is supplied with a connecting plate which fastens to the rear of the frame and to which all external connections are made. Signal connections are by standard UHF coax connectors and power connections are made to a blue-ribbon connector. The amplifiers plug into the front of the frame and are accurately guided into the connectors on the plate. Spring catches with release handles protruding from the front secure the amplifiers.

The MI-40327 Filament-Bias Supply furnishes filament power for the tubes and bias voltage for the feedback loops of up to 10 amplifiers. The unit occupies two spaces in the amplifier frame. If a large number of amplifiers are used, up to five supplies can be mounted in one frame. Each amplifier draws 35 milliamperes of regulated current from a conventional external supply such as the WP-16B or 580-D.

MI-40327 Filament and Bias Supply.

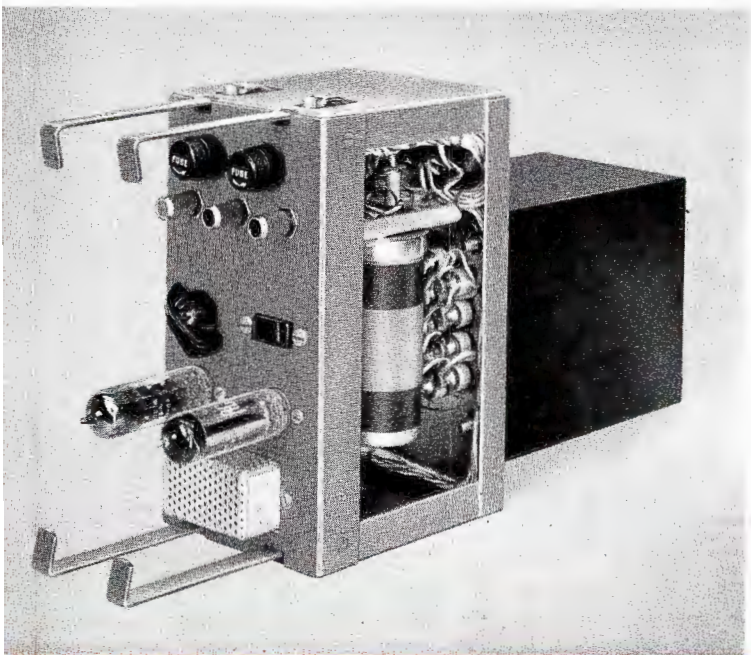

SPECIFICATIONS

Input Signal Levels, Nominal:	
Video, non-composite.....	0.7 volt peak to peak
Video, composite.....	1.0 volt peak to peak
Sub-Carrier (3.58 mc cw.).....	2.0 volts peak to peak
Sync, Blanking, Vertical or Hor. Drive.....	4.0 volts peak to peak
Input Shunt Capacitance:	
Single Amplifier Terminated.....	30.0 mmf
Multiple Amplifier Inputs Bridged.....	15 mmf. each
Input Resistance.....	1.0 megohms
Input Connectors.....	Two, bridged
Output Signal Levels, Nominal.....	Same as input
Output Impedance.....	.75 ohms
Output Connectors.....	One
Gain.....	Adjustable to 1.0
Output Isolation (between two or more amplifiers).....	.45 db to 3.6 mc
Frequency Response:	
1 cycle to 8 megacycles.....	±0.3 db
0.5 cycles to 15 megacycles.....	±1.0 db
Low Frequency Tilt (60 cycle square wave).....	1.0% max.
Differential Gain at 3.58 mc with 1.0 volt composite video signal:	
One Amplifier.....	0.5% max.
Five Amplifiers in Cascade.....	1.5% max.
Differential Phase at 3.58 mc with 1.0 volt composite video signal:	
One Amplifier.....	0.3° max.
Five Amplifiers in Cascade.....	1.0° max.
Hum Level, 60 cycles.....	-55 db
Gain Variation at 3.58 mc:	
+B Voltage Variation from 260 to 300 volts.....	±1.0% max.
Filament Voltage Variation from 5.7 to 6.9 volts.....	±1.0% max.
Power Input.....	280 volts, 35 ma dc -150 volts, 4 ma. dc 6.3 volts, 1.75 amps ac
Tube Complement:	
1-2C51	1-5687
Dimensions: (Overall).....	1 5/8" wide, 6 3/4" high, 8" deep (including handles)
Weight.....	1 1/2 lbs.
Finish.....	Light umber gray
Stock Identification	MI-40326
AMPLIFIER FRAME:	
Capacity.....	8 TA-12 Amplifiers and 1 Filament and Bias Supply or 10 Amplifiers or 5 Filament/Bias Supplies
Dimensions:	
Height.....	7"
Width.....	19"
Depth.....	13"
Weight, empty.....	8 lbs.
Stock Identification	MI-40325
FILAMENT AND BIAS SUPPLY:	
Input Voltage.....	110/220 volts, 50/60 cycles, 125 watts
Output Voltage.....	-150 volts, dc, 40 milliamperes 6.3 volts, ac, 13.5 amperes
Tube Complement:	
1-6X4	1-OA2
Space Required.....	2 unit spaces in Amplifier frame
Dimensions:	
Height.....	6 3/4"
Width.....	3 1/4"
Depth.....	8"
Weight.....	20 lbs.
Stock Identification	MI-40327
Recommended Power Supplies:	
RCA Type 580-D, 400 ma @ 285 Volts.....	MI-21523-C
or	
RCA Type WP-16B, 1600 ma @ 285 Volts.....	MI-26084-B
Other Accessories:	
Sync and Blanking Adder Amplifier.....	MI-40328
Dummy Amplifier Cover.....	MI-40329

VIDEO DISTRIBUTION AMPLIFIER

TYPE TA-3C

FEATURES

- Feedback stabilized amplifier
- Conventional receiving tubes used throughout
- Continuously adjustable gain control
- Excellent color performance
- Sending end termination
- Sync mixing and interlock

DESCRIPTION

The TA-3C Video Distribution Amplifier is a compact, rack mounted unit designed to feed a video signal simultaneously to three output lines. It provides up to 6 db of adjustable gain to recover loss of signal level due to long lines or the use of passive cable equalization. It may be used to mix a synchronizing signal with a blanked video signal to form a composite video signal. A high degree of isolation between the output circuits prevents disturbances on one line from affecting the signal on the other two.

The signal channel consists of two wideband feedback amplifiers connected in cascade. The input circuit is a high impedance type for bridging a low impedance line. Two input coax receptacles are provided which facilitates looping signal lines past the input or terminating with a coax termination when desired. The first feedback amplifier has a gain of 2. It consists of a series voltage amplifier coupled to a high efficiency, series amplifier output stage. A gain control circuit provides the load for this amplifier. The signal from the gain control, which feeds the output feedback amplifier, is adjustable enabling the overall gain of the TA-3C to be varied from 0.5 to 2.0.

A sync mixing channel is incorporated in the first feedback amplifier. The high impedance input to this amplifier makes it possible to loop sync through several amplifier inputs. A gain control for sync level adjustment is accessible from the front of the chassis. Provision is made for an optional plug-in 2.5 ma 8000 ohm relay (Stock #99155) to control sync addition in applications requiring sync interlock.

The second feedback amplifier has unity gain and drives an RC coupling network to which the output lines are connected. It consists of a series configuration voltage amplifier feeding a cathode follower which in turn drives a series output amplifier having several important performance advantages. The transfer linearity is inherently good, the power efficiency is considerably more than twice that of conventional single ended output stages, and the output impedance is inherently low. The output RC coupling



network in conjunction with very low impedance at the output terminal of the feedback amplifier provides a 75 ohm impedance when looking back into each output receptacle and at the same time provides a high degree of isolation between the output signals.

SPECIFICATIONS

Input Power, a-c.....	105-130 volts, 50-60 cycles, 55 watts			
Input Power, d-c.....	280 volts, 150 ma.			
Input Impedance.....	2.2 megohms shunted by 27 mmfd.			
Input Signal Levels:				
Blanked Video Only.....	1.0 volt peak-to-peak, max.			
Composite Video.....	1.4 volts peak-to-peak, max.			
Sync.....	3.5-8.0 volts peak-to-peak			
Gain.....	0.5-2.0 (adjustable)			
Number of Outputs.....	3			
Output Impedance.....	75 ohms (internally terminated)			
Output Signal Levels:				
Blanked Video Only.....	1.0 volt peak-to-peak, max.			
Composite Video.....	1.4 volts peak-to-peak, max.			
Sync.....	0-0.4 volt peak-to-peak			
Isolation:				
Between Input and Output.....	60 db throughout bandpass			
Between Adjacent Amplifier Chassis.....	50 db throughout bandpass			
Between Output Lines.....	40 db at midband 28 db at 4 mc.			
Sine Wave Frequency Response Bandwidth:				
1.0 cycles to 8 mc.....	Flat ± 0.3 db			
0.5 cycle to 10 mc.....	Flat ± 1.0 db			
Low Frequency Square Wave Tilt.....	1.5% max. at 60 cycles			
Differential Gain.....	0.5% nominal, 1.0% max.			
Differential Phase.....	0.5° nominal, 1.0° max.			
Tube Complement:				
1—OB2	3—6BK7B	2—6BX7-GT	1—6X4	1—5687
Overall Dimensions.....	3½" high, 19" wide, 10¾" deep			
Weight.....	12½ lbs.			
Stock Identification (with tubes).....	MI-26157-C			

PULSE DISTRIBUTION AMPLIFIER

TYPE TA-4A

FEATURES

- Regenerates degraded pulse signals
- Restores rise time
- Removes overshoots and spikes
- Eliminates hum, surges and tilt
- Most efficient method of pulse distribution
- Gain control for each output
- Three outputs with sending end termination

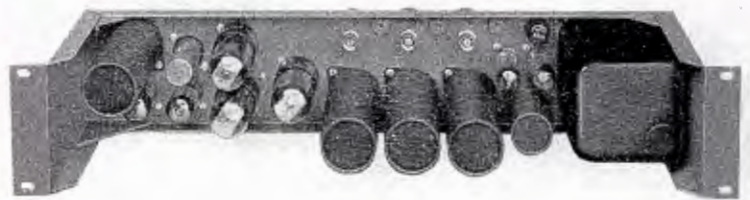

USES

The characteristics of the TA-4A Pulse Distribution Amplifier make it suitable for many applications requiring regeneration and/or distribution of television timing and blanking pulses.

Four typical applications are as follows:

1. To eliminate undesirable characteristics of degraded pulse signals.
2. To provide feeds for one, two or three low impedance lines from a single low or high impedance source.
3. To provide sending end termination for improved long line performance.
4. To provide a high degree of isolation between a pulse signal source and load.

DESCRIPTION

The TA-4A Amplifier is a compact rack mounted unit with self-contained filament and bias supply. Following standard practice an external plate voltage supply such as the RCA 580-D or WP-16B is required.

The input circuit is a bridging type which has sufficiently high impedance to permit bridging a low impedance line without disturbing the signal. The amplifier will operate on negative drive, blanking or sync signals without adjustment. Two input coax receptacles are provided to facilitate looping signal lines through the input or terminating with a coax termination when desired.

Signals fed into the TA-4A are amplified by an over-peaked amplifier stage to provide good sensitivity and minimize delay. The pulse signal is coupled from the amplifier to a regenerative clipping circuit, which produces a new pulse that is dependent on the width and timing of the input pulse but is otherwise independent of it. The

regenerative clipping operation forms an almost ideal pulse with fast rise time and no low frequency disturbances regardless of poor rise time, overshoot, hum, tilt, bounce or similar defects on the incoming signal.

A cathode follower drives paralleled inputs of three individual wideband output amplifiers with the signal from the regenerative clipper. Variable "L" pad gain controls in the plate circuit of each output amplifier provide a 75 ohm terminating impedance for each line and enable independent adjustment of output signal levels. The gain controls are accessible at the front panel as are test jacks for input and output signals. The only additional variable element is a non-critical clipping level control that is set during manufacture and needs no further adjustment in normal applications.

SPECIFICATIONS

Electrical

Input Power, a-c.....	105-130 volts, 50-60 cycles, 55 watts
Input Power, d-c.....	280 volts, 120 ma.
Input Impedance.....	2.7 megohms shunted by 27 mmf.
Input Signals.....	Driving, blanking, or synchronizing pulses
Input Signal Level.....	2-8 volts peak-to-peak
Number of Outputs.....	3
Output Impedance.....	75 ohms (internally terminated)
Output Signal Level.....	0-4 volts peak-to-peak
Isolation between Output Lines.....	45 db
Output Pulse Rise Time.....	0.13 microsecond max.
Output Pulse Tilt.....	1.5% max. on vertical blanking

Tube Complement

3 6W6 1 6U8 1 6BQ7A 1 6X4 1 0B2

Mechanical

Height	3 1/2"
Depth	10 3/8"
Width	19"
Weight	12 1/2 lbs.
Stock Identification (complete with tubes and connectors).....	MI-26158

STABILIZING AMPLIFIER

TYPE TA-9

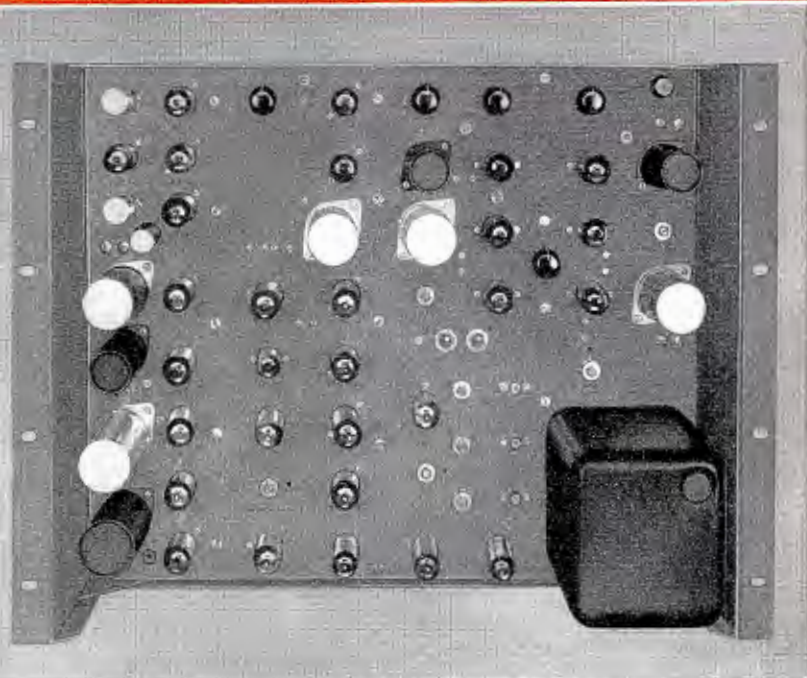

FEATURES

- Newly designed circuitry—feedback clamps, highly immune to noise
- Peak white clipper to prevent transmitter over-modulation; without loss to resolution
- Complete removal of sync from color or monochrome signals
- Composite output signal contains fully re-shaped sync
- Distortion free control of chroma level
- Semi-automatic picture fade
- Adjustable pedestal insertion

USES

The RCA Type TA-9 Stabilizing Amplifier is a versatile equipment designed to remove low frequency disturbances such as hum, bounce, surges and tilt. It can maintain constant sync output over a wide range of variation in the incoming sync ratio. It can also perform such functions as sync processing, base-line clipping, peak white clipping and linearity compensation on either color or monochrome signals.

A stabilizing amplifier is normally used on the output of incoming remote lines or microwave, at the output of master control and the input to the transmitter. At these locations the TA-9 stabilizing amplifier performs the functions described above to provide a properly proportioned, stabilized television signal. An accessory remote control panel for console mounting (MI-40424) allows remote adjustment of master gain, sync level, chroma level, and picture fade.

DESCRIPTION

The TA-9 Stabilizing Amplifier represents a completely new design, featuring the use of feedback clamps which are highly immune to noise. Also included for the first time in a stabilizing amplifier are a separate chrominance channel and a peak white clipper which prevents transmitter over-modulation and operates without loss to detail resolution. Other features of this highly-efficient versatile

unit include: base line clipping, automatic gain control of the sync channel, semi-automatic picture fade, and adjustable pedestal insertion.

The composite picture signal traverses three circuit paths; chrominance, luminance and sync. The input signal is first split into two channels, one for picture information and the other for sync. In the picture channel, the signal is again split into two paths, one carrying mid-band frequencies or chrominance information and the other the luminance information.

The cross-over frequency occurs at the color subcarrier, 3.58 mc, with a complete null at that frequency in the luminance channel. The feedback clamp and clipper circuits are contained in the luminance channel. Since color subcarrier is not present here, sync may be clipped off all the way to the base line, and back-porch clamping may be performed with full effectiveness without damaging the color burst in a color signal.

The chrominance information is passed around the clamp and clipper stages, through a two stage amplifier channel. This allows control over chroma gain and provides proper delay for addition to the luminance signal. Signals from the chrominance and luminance channels are mixed together and fed to the white stretch circuit. Here, an adjustable degree of amplitude non-linearity may be introduced to pre-distort or compensate the signal for later

passage through equipment which may cause compression. An example of this function is the use of the stabilizing amplifier with transmitters which do not contain built-in compensation. A switch is provided to by-pass the pre-distortion function when it is not required.

In the sync channel, separation of sync information is accomplished in a high level clipper. This stage is driven from a gain-regulated amplifier to insure stable and accurate clipping over a wide range of sync signal variation. Also included are noise immunity circuits which provide clamp pulses free from spurious pulses which might otherwise be formed from noise spikes in the incoming signal. The output composite picture signal is finally formed by addition of the reshaped sync to the clamped video signal. If a non-composite output is desired, sync may be cut off completely in either or both channels. If stretched sync is required to compensate for compression in the subsequent equipment the sync level may be increased up to twice the normal level.

One output stage is normally designated as the program line output. The other is normally used for the monitor output and is provided with an input switch to permit monitoring of: (1) The unstretched video signal, (2) The white-stretched signal at the input of the line output amplifier stage, and (3) The signal appearing at the output terminal of the line output stage.

At the picture input, a variable gain amplifier stage may be connected to a remotely located Fade Switch. Operation of this switch will cause the picture portion of a composite signal to fade down to black at a smooth rate without affecting sync. Then as it would normally be used, the output signal may be switched at the regular switching console to provide the "sync only" or "black" switch often used between "Network" and "Local". By means of this switch the process can be reversed to return to normal operation.

After the clamp stage, where accurate reference level is maintained, a white clipper circuit is provided. It may be

put into operation with a switch when it is desired to clip off any signal more than 10 per cent above normal. Since the chrominance is carried around this point, clipping will not wash out fine detail in the clipped white areas of the output picture. A pedestal control feature has been included so that proper setup level can be maintained should incoming signals lack the necessary amount of set up. This control is accomplished by adding an adjustable amount of blanking to the original signal in the luminance channel. It operates with either local or genlocked remote signals. The TA-9 Stabilizing Amplifier is constructed on a standard recessed (bathtub) chassis for rack mounting. The compact unit occupies only 14 inches of rack space.

SPECIFICATIONS

Input Impedance:		
Picture	75 ohms (±1%)	1 meg, 35 mmf
Sync	Bridging	1 meg, 35 mmf
Blanking	Bridging	1 meg, 35 mmf
Output Impedance:		
	(Source)	(Load)
Line Picture	75 ohms	75 ohms
Monitor Picture	75 ohms	75 ohms
Sync	2100 ohms	75 ohms
Input Signal Requirements:		
Composite Video (Black Negative).....	0.25 v. min.; 2.0 v. max.	
Sync-to-Picture Ratio (min.).....	15% of input picture signal	
Local Sync.....	3.5-5.0 volts, negative	
Local Blanking	3.5-5.0 volts, negative	
Output Signal Range:		
Picture Component.....	0-1.0 volt, peak-to-peak	
Sync Component (output video signal).....	0-.8 volt, peak-to-peak	
Sync Output4 volts, peak-to-peak	
Frequency Response.....	Flat ±0.5 db to 7.0 mc	
Tilt (60 cycle square wave).....	.2% max.	
Differential Gain025 db	
Differential Phase.....	Less than 1°	
Isolation Between Outputs.....	Better than 40 db @ 3.58 mc	
Power Requirements:		
Heater Supply.....	117 volts, 50/60 cycles, 120 watts	
Plate Supply.....	280 volts, regulated 400 ma with white stretch	
	280 volts, regulated 375 ma without white stretch	
Dimensions.....	19" wide, 5" deep, 14" high	
Stock Identification	MI-40222	

Accessories

Sync and Blanking Interlock Relay.....	Stock #99155
Remote Control Panel.....	MI-40424

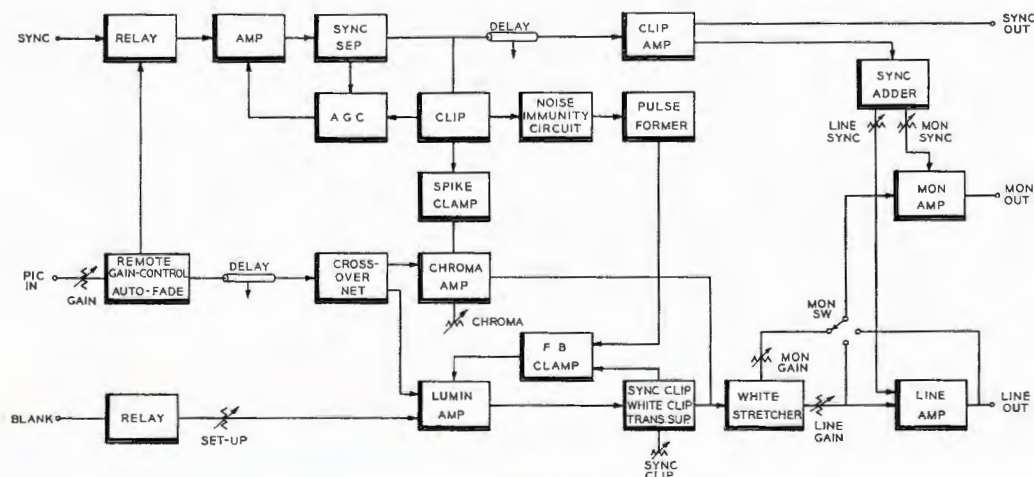

Simplified block diagram of TA-9 Stabilizing Amplifier.

MONOCHROME AGC AMPLIFIER

TYPE TA-21 A



FEATURES

- Maintains constant video output with four to one change in video input
- Adaptable for operation with composite signals
- Local blanking insertion for adjustment of set-up
- Provisions for sync mixing—no driving pulses required
- Maximum reserve gain of 12 db
- Remote control provisions for video level, sync or blanking level and signal by-pass
- Tally light indicates operation of the AGC control circuit

USES

The TA-21A Automatic Gain Control Amplifier has been designed for use in monochrome video systems where it serves as an excellent means of controlling the output level of vidicon and iconoscope film cameras, incoming remote feeds, microwave and input level to the transmitter. Variations in signal amplitude caused by varying film densities, lighting conditions, signal fading, etc. can thus be maintained within ± 1.2 db of a pre-determined value with a four to one signal input variation.

Signal sources containing composite video information may be controlled by the TA-21A AGC Amplifier in conjunction with a TA-9 stabilizing amplifier. In such applications, the stabilizing amplifier is used to stabilize the sync portion of the signal. The automatic level setting feature of the TA-21A provides practically instantaneous correction of either an increase or decrease of video level thereby preventing abrupt level changes from appearing on the air. The TA-21A can also be used as a limiting amplifier by means of one simple re-connection. Input signals with less than normal level are not affected, but when signals of abnormally high level are applied, limiting action maintains the output signal at a normal level.

DESCRIPTION

The TA-21A Monochrome AGC Amplifier is a rack mounted piece of equipment requiring 8¾ inches of rack space. All components and circuits are mounted on a standard bath-tub type chassis for ease of accessibility and maintenance. The amplifier operates from an a-c power line, and a well regulated, 280 volt, d-c power source. Basically the TA-21A is a variable gain device controlled by a d-c potential obtained by rectifying the total peak-to-peak signal. Fast control action is obtained without introducing overshoot surges by applying the control voltage simultaneously to two parallel channels carrying video of opposite polarities. The time interval required for a large pull-up in level or a large pull-down in level is approximately 0.05 second.

As seen in the block diagram, the split phase signals are amplified by separate variable gain 6BC5 tubes and combined in a 6BQ7A amplifier. The combined signal is used for gain control purposes by narrow band amplification in a 6U8 tube and peak-to-peak rectification by a 6AL5 stage. This smoothed d-c provides the control grid bias to the variable gain 6BC5 stages. In the main video circuit, the combined signal from the 6BQ7A enters two identical feedback amplifiers, each consisting of one type 6BQ7A and one type 6BX7 tube which drive two 75 ohm lines through sending end terminations. Sync or blanking of adjustable amount may be added in both outputs. For non-composite signals the basic control loop remains within the AGC Amplifier. When the stabilizing amplifier is added for composite signals, the control point is switched to the output of the stabilizing amplifier to include it in the level control loop. A neon indicator, which is external to the unit, is used to determine when the signal is controlled by the AGC amplifier. The indicator control can be set to indicate when AGC action has assumed control of

the signal, or can be adjusted so the neon lamp lights either above or below this point. The latter would indicate either insufficient or excessive drive to the AGC amplifier. A convenient relay switch is provided to bypass the AGC function when a color signal is encountered. A remote control panel, MI-26299, is available for use in remotely controlling the signal by-pass relay, video level and sync or blanking level.

SPECIFICATIONS

Input Impedance:	
Picture.....	75 ohms ±1%
Sync	Bridging
Control Signal.....	75 ohms ±1%
Source Impedance:	
Output Line #1.....	75 ohms
Output Line #2.....	75 ohms
Input Signal Requirements (black negative):	
Picture, Composite.....	0.25 to 4 volts
Picture, Noncomposite.....	0.17 to 2.8 volts
Sync or Blanking.....	3.5 to 5.0 volts
Control Signal, Composite.....	1.0 volt nominal
Output Signal Values (black negative):	
Picture, Composite.....	1.0 volt
Picture, Noncomposite.....	0.7 volt
Frequency Response (overall).....	±.5 db to 7 mc
Differential Gain and Phase (for average picture level between 10% and 90% at 1.0 volt peak-to-peak composite output):	
Overall.....	1.5% max. diff. gain; 1° max. diff. phase
Bypass Channel.....	1.0% max. diff. gain; 0.2° max. diff. phase
Sixty Cycle Square Wave Tilt.....	2% max.
Recovery Time.....	.05 sec.
Output Level Variation:	
At ±6 db Input.....	0.7 db, -1.0 db
At ±12 db Input.....	1.0 db, -1.2 db
Power Requirements.....	110 volts a-c, 50/60 cycles, 50 watts 280 volts d-c, regulated, 200 ma
Tube Complement.....	2-6U8, 1-6BA6, 1-6AL5, 3-6BQ7A, 1-12AX7, 2-6BC5, 2-6BX7, 1-OB2
Dimensions.....	19" wide, 8¾" high, 9" deep
Weight.....	15 lbs.
Finish.....	Dark umber gray
Stock Identification.....	MI-26296-A

Accessory Equipment

Remote Control Panel.....	MI-26299
---------------------------	----------

Simplified block diagram of TA-21A Monochrome Automatic Gain Control Amplifier

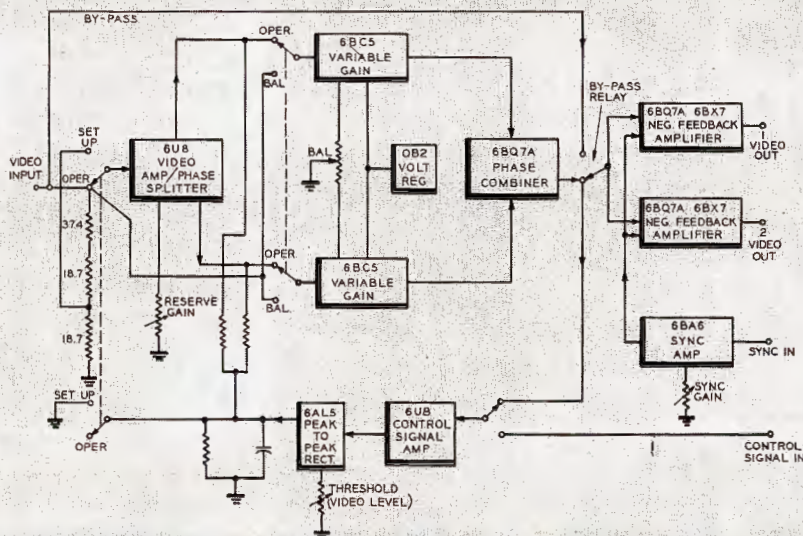

COLORPLEXER EQUIPMENT

TYPE TX-1D

FEATURES

- "Heart" of the RCA Color TV System
- Automatic carrier balance
- Precision matrixing of the color signal
- Choice of input signals
- 360° subcarrier phase shifter
- Automatic sync delay
- Multiple low impedance outputs
- Aperture Compensation
- No modulation clamps required

USES

The RCA Type TX-1D Colorplexer, ES-40951, is the heart of the RCA Color Television System. It produces a composite color television signal from the various individual signals originating in a color television system. The complex circuits of the unit perform these essential functions necessary for transmission of the TV signal according to FCC specifications:

- (1) Cross-mixing or matrixing the red, blue and green video signals from a color television camera chain (either live or film), from a color-slide scanner, or from a color-bar generator, in proper proportion to produce a luminance signal (which is equivalent to a monochrome video signal) and producing two color-difference or chrominance signals.
- (2) Filtering the chrominance signals to maintain their required bandwidth.
- (3) Compensating for delays in the signals introduced by filtering the chrominance signals.
- (4) Amplitude and phase modulating the color difference signals.
- (5) Adding EIA sync signals to the video and color information.
- (6) Producing a burst signal for color synchronization.
- (7) Shifting phase of incoming 3.58 mc subcarrier through 360° to allow matching of several Colorplexer outputs with respect to subcarrier phase.
- (8) Automatically maintaining carrier balance.

An Aperture Compensator, MI-40414, is provided with the unit to compensate for the finite size of the electron scanning beam in the pickup camera. Though housed on a separate chassis, it is connected electrically with the TX-1D

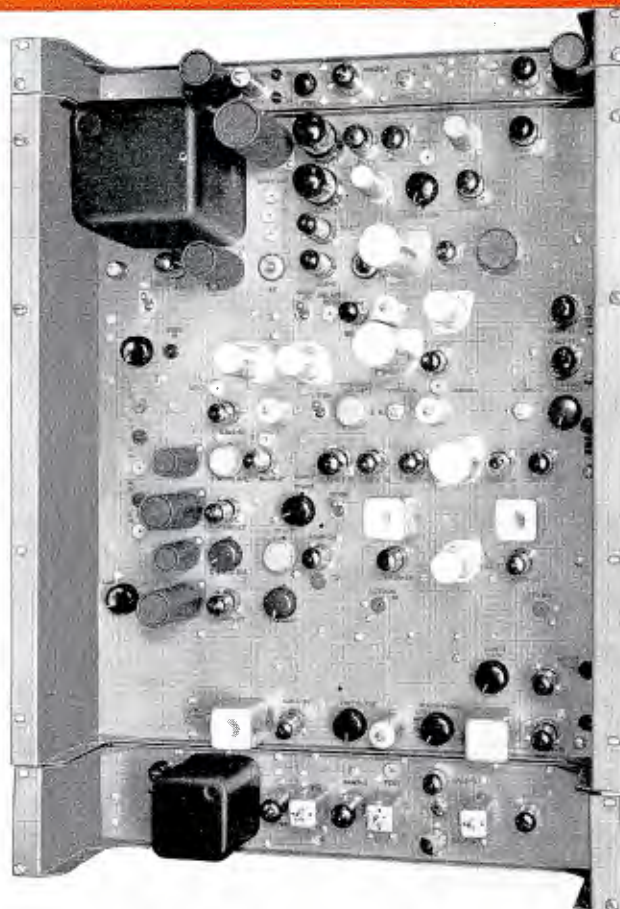

Colorplexer. Controls are provided for adjusting the degree of aperture compensation and sync level. An Automatic Carrier Balance, MI-40416, designed to eliminate carrier instability, is used with the TX-1D. This unit reduces the warm-up time previously required before on-air operation, stabilizes carrier balance and makes possible the elimination of modulator clamp diodes.

DESCRIPTION

The Type TX-1D Colorplexer consists of three units: the Colorplexer which is mounted on a 21-inch chassis designed for rack mounting in standard 19-inch broadcasting racks, an Aperture Compensator, MI-40414, housed on a separate 1¾-inch high chassis, designed to mount above the Colorplexer, and an Automatic Carrier Balance Control, MI-40416, housed on a 3½-inch chassis that can be mounted below the Colorplexer.

The TX-1D Colorplexer consists essentially of matrix and delay, modulator, burst generator and adder circuits. In the matrix and filter section, the red, green, and blue

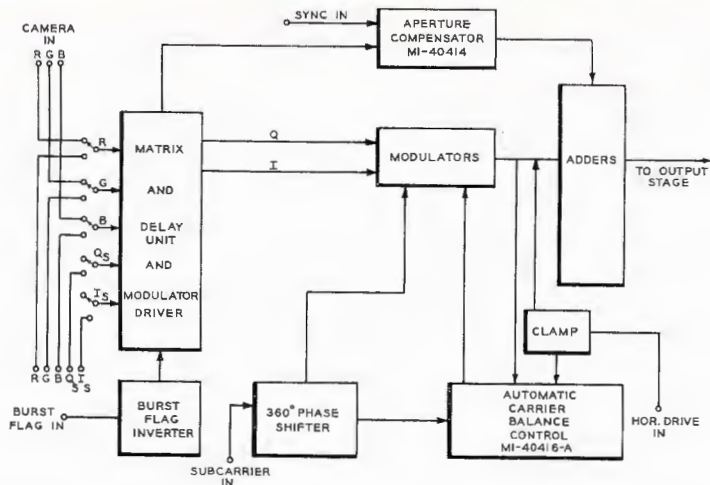

Block diagram of TX-1D Colorplexer Equipment.

signals fed to the unit are transformed to luminance (M), and two color-difference (I and Q) signals which are then adjusted with respect to bandwidth and delay. In the modulator section the two color difference signals are modulated in phase and amplitude to form the chrominance signal. Burst flag is processed and added in the I and Q channels prior to modulation. The modulated output contains the standard color sync burst. In the adder section the operation needed to produce a composite signal from the chrominance, luminance and synchronizing signals is accomplished.

The unit features a special selector switch which gives the operator a choice of inserting either camera signals or test signals from a color bar generator. The color bar generator provides five signals instead of the usual three. In addition to the red, green, and blue video signals, special test pulses are provided which can be inserted into the I and Q channels. These pulses have been found to be very useful for checking the phase adjustments of the I and Q modulators.

Sync pulses are added to the monochrome signal prior to the delay line so as to avoid the need for a separate sync delay line. The subcarrier signal is fed to the doubly-balanced modulators. An adjustable phase shifter with a range of 360° is provided at the subcarrier input. It permits the signals from all the colorplexers in a studio or plant installation to be "lined-up" with respect to subcarrier phase at some common point, such as the output of the switching system. Additional phase-shifting networks are used to provide appropriate phases for the two modulators and the burst flag processor.

The complete color signal—formed by adding the M component (with sync, if desired) and the two subcarrier components, is fed to a gain stage which drives a feedback amplifier. The output of the feedback amplifier drives

multiple low impedance outputs. Horizontal drive is used to trigger the clamp pulse generating circuits.

The Automatic Carrier Balance is mounted on its own 3½-inch chassis, designed for rack mounting with the Colorplexer. No carrier adjustments of the Colorplexer should be required over long periods of time when this unit is used, since it automatically maintains carrier balance. The Automatic Carrier Balance and Aperture Compensator operate from the same power supply as the Colorplexer. All other voltages and signals are obtained from the Colorplexer.

SPECIFICATIONS

Electrical Specifications

(COLORPLEXER)

- Camera Signal Inputs.....75 ohms, .71 volt, peak-to-peak
- Color Bar Generator Signal Inputs.....75 ohms, .71 volt, peak-to-peak
- Sync Generator Signals:
 - 3.58 Mc Subcarrier.....High impedance bridged, 2.0 volts ±10%
 - Burst Flag Signal.....High impedance bridged, 4.0 volts negative
 - Horizontal Drive.....High impedance bridged, 4.0 volts negative
 - EIA Sync.....75 ohms, 4.0 volts negative
- Output Signals.....Three composite sending end terminated outputs, 1 volt sync to peak white. (Sync can be removed for non-composite output).
- Power Requirements.....110-125 volts, 50/60 cycles, 90 watts
+280 volts d-c, 280 ma

(APERTURE COMPENSATOR)

- Sync Input Signal.....High impedance, bridged, 3.5 to 4 volts peak-to-peak, negative
- Monochrome Video Input.....1000 ohms impedance, 0.5 volt black-to-white (approx.)
- Composite Monochrome and Sync Output.....1000 ohms impedance, 0.5 volt peak-to-peak (approx.)
- Power Requirements.....117 volts, 50/60 cycles, 10 watts
+280 volts regulated d-c, 33 ma

(AUTOMATIC CARRIER BALANCE)

- Horizontal Drive.....High impedance bridged, 4.0 volts negative
- Power Requirements.....110 volts, 50/60 cycles, +280 volts d-c, 20 ma

Tube Complement

- Colorplexer.....10—6AU6, 2—OA2, 2—6BX7, 2—6AH6, 4—Stock #204603 (Spec. 6AS6), 1—5726, 1—6X4, 3—6BK7A, 3—12AU7, 1—6BC4
- Aperture Compensator.....1—6BQ7A, 1—6U8
- Automatic Carrier Balance.....2—6AL5, 1—6AN8, 1—6AW8, 1—6AU6

Mechanical Specifications

	Colorplexer	Aperture Compensator	Carrier Balance
Height	21"	1¾"	3½"
Width	19"	19"	19"
Depth	14½"	7"	3"
Weight	34 lbs.	3 lbs.	10 lbs.
Finish	Umber gray	Umber gray	Umber gray

Equipment Supplied

- TX-1D Colorplexer Complete.....ES-40951
- Including the following:
 - 1 Type TX-1D Colorplexer, chassis with tubes in place, two Delay Lines, set of cable connectors and Instruction Book (IB-36252).....MI-40209-C
 - 1 Aperture Compensator complete with tubes in place and cable assembly, and Instruction Book (IB-36243).....MI-40414
 - 1 Automatic Carrier Balance, complete with Instruction Book (IB-36256-A).....MI-40416-A
- Accessories:
 - Type WP-16B Power Supply, 1600 ma.....MI-26084-B
 - Type WA-1E Color Bar Generator.....MI-34001-F

SYNCHRONIZING GENERATORS

STUDIO TYPE TG-2A

FIELD TYPE TG-12A

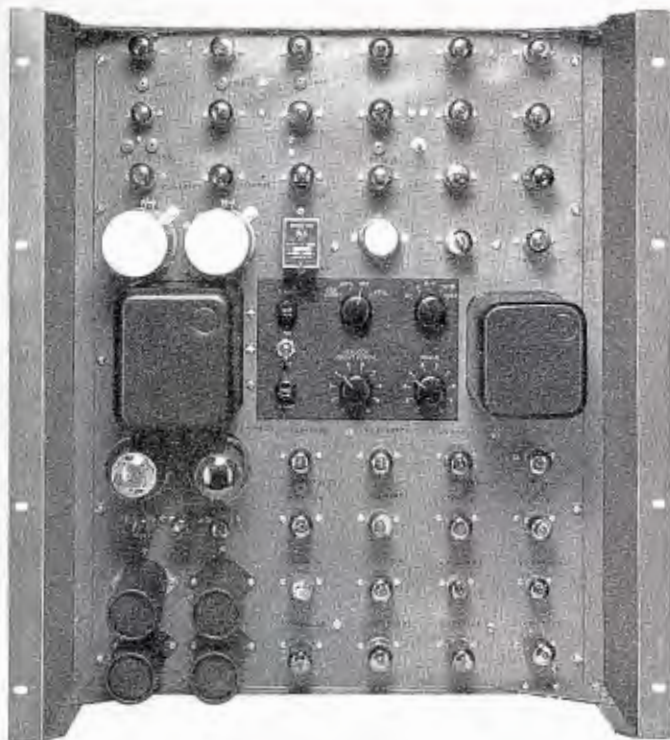

FEATURES

- Built-in Genlock, grating generator, and regulated power supply
- External frequency control switch for Color Frequency Standard
- Stabilized circuit design requires only four operating controls
- All tubes operated well below rated loading to insure long tube life
- Adjustable pulse width & amplitude
- Pulse outputs have sending end terminations
- Number of equalizing pulses, and number of vertical pulses are fixed, by counting circuits
- All controls may be operated from wiring side of chassis to facilitate maintenance

DESCRIPTION

The TG-2A Studio and the TG-12A Field Sync Generators are designed to provide complete synchronizing facilities in the studio or field. Standard EIA Driving, Blanking and Synchronizing signals, as well as a grating and dot pattern for use in linearity testing, are produced. Equipments have been designed for synchronization to an RCA Color Frequency Standard for use in color systems.

The TG-2A Studio Sync Generator and TG-12A Field Sync Generator contain identical circuits, including a built-in regulated power supply. All tubes are operated well below rated loading to insure long tube life. The TG-2A studio model is constructed on a standard bathtub chassis requiring only 21 inches of rack mounted space. Necessary power and remote control connections are made through a conveniently located multi-pin connector on the rear of the chassis. All signal connections are made through coax connectors mounted on a readily accessible panel at

the bottom of the unit. The TG-12A field model is contained in a single suitcase similar to those used on other RCA field TV equipments. The front panel contains a line voltage meter and selector switch for selecting the proper voltage tap on the power transformer. The four operating controls are accessible from either side of the chassis. The set of cables supplied includes all the cables required for connecting the field Sync Generator to the a-c power line and to the field camera control. Fused protection is provided on both sides of the input power line.

Circuits for the generation of driving, blanking, and synchronizing pulses are designed for maximum stability and long life. Pulse widths and delays are accurately stabilized against tube aging. Output circuits for all pulses provide fast rise times and clean baselines. All pulse outputs are internally terminated in 75 ohms to minimize reflections on long lines.

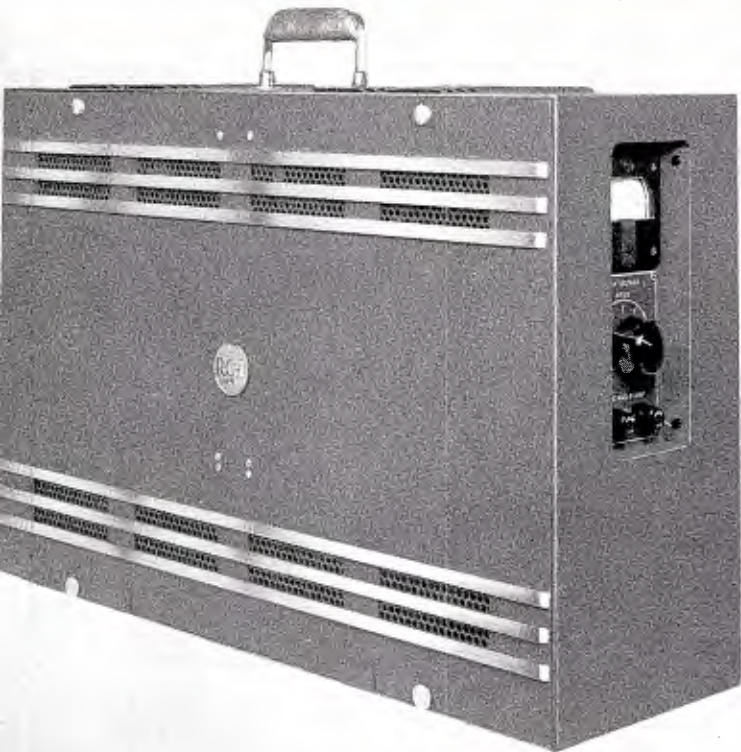

Any one of five methods of controlling the basic frequencies of the synchronizing generator may be selected with the FREQUENCY CONTROL switch on the front panel. These are:

- (1) **Crystal.** The sync generator is locked in to a precision 94.5 kc crystal oscillator, for use when the 60 cycle power line frequency is not stable enough to use as a reference for the television system.
- (2) **"OFF".** The sync generator is allowed to run free; primarily for testing purposes.
- (3) **60-Cycle.** The 60-cycle vertical pulse output from the sync generator is locked in phase with the a-c power line frequency. On this position the 60-cycle phase control on the front panel is operative to allow adjustment of the relative phase of the sync generator vertical pulse and the a-c power line.
- (4) **External.** On this position an external triggering signal may be brought in through a connector on the coaxial jack strip to lock the sync generator to an external frequency-control system, such as a compatible color system frequency standard.
- (5) **Genlock.** The sync generator is synchronized both horizontally and vertically with an EIA synchronizing signal from a remote sync generator. On this position

the GENLOCK FRONT PORCH control is operative to adjust the relative phasing of the local and remote horizontal blanking signals.

Genlock circuits feature horizontal a/c synchronization for best noise immunity, and stabilized design to eliminate set-up adjustments. A relay in the frequency control circuits allows remote control switching to genlock.

Grating generator circuits built into the unit provide a stable pattern of 13 by 17 bars, white on black background with blanking added, which may be used for linearity testing purposes in camera and monitoring equipment. A selector switch in the grating circuits allows choice of horizontal bars, vertical bars, both horizontal and vertical bars, dots at the intersections of the bars or a test position where sync and blanking are mixed for observation of the front porch.

SPECIFICATIONS

Output Voltages:

Sync, Hor. Driving, Vert. Driving
and Blanking Pulse.....4.0 volts peak-to-peak
across 75 ohms, negative

Grating Signal.....1 volt peak-to-peak across 75 ohms

Signal Input Provisions:

Remote Synchronizing Signal.....4.0 volts peak-to-peak,
1 megohm impedance

External Frequency Control Signal.....90 volts peak-to-peak, 31.5 kc
sine wave, 1 megohm impedance

Power Requirements.....102-125 volts, 60 cycles, single phase, 275 watts

Dimensions:

TG-2A (Studio).....21" high, 19" wide, 8³/₈" deep
TG-12A (Field).....16" high, 8¹/₈" wide, 24¹/₂" long

Weight:

TG-2A (Studio).....50 lbs.
TG-12A (Field).....60 lbs.

Tube Complement

13 6U8	1 6AL5	1 5R4GY	1 0B2
12 12AT7	2 12AX7	3 6AS6	
5 6CL6	1 6AS7-G	1 6BQ7-A	

Equipment Supplied

TG-2A Studio Sync Generator.....	MI-26102-A
TG-12A Field Sync Generator.....	MI-26112-A
Field Sync Generator System, complete.....	ES-26921
Comprising the following items:	
1 TG-12A Field Sync Generator.....	MI-26112-A
1 Power Distribution Box.....	MI-26260
1 Shock Mount (for Sync Generator).....	MI-26511-A1
1 Set of Interconnection Cables.....	MI-26736

Accessories

Sync Generator Changeover Switch.....	MI-26289
Sync Generator Changeover Switch Remote Control Panel.....	MI-26267
Pulse Delay Line.....	MI-26886
Color Frequency Standard.....	MI-40201-A
Burst Flag Generator.....	MI-40202-A
Crystal (94.5 kc).....	MI-26545
Pulse Distribution Amplifier.....	MI-26158

COLOR FREQUENCY STANDARD

MI-40201-A

FEATURES

- All components conveniently accessible for service
- Basic oscillator for the RCA Color Television System
- Divider chain produces 31.5 kc (nominal) signal for locking sync generator to frequency standard
- Oven controlled crystal for maximum stability

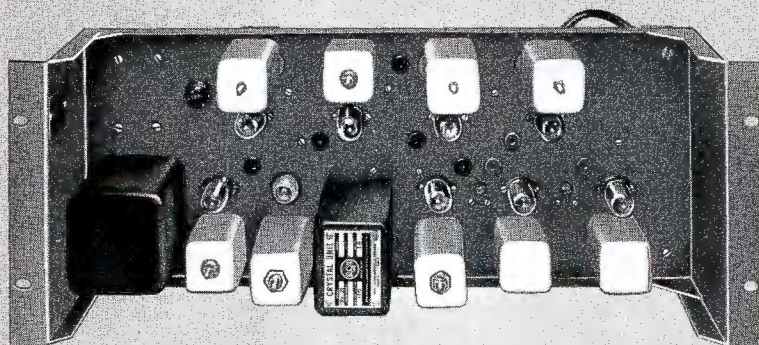

DESCRIPTION

The RCA Color Frequency Standard, MI-40201-A is a dual-function unit, including on one chassis a crystal oscillator for generation of the 3.58 mc color subcarrier and a divider circuit for providing a frequency of 31.4685 kc, which is used to lock the sync generator master oscillator.

Circuitwise, a crystal oscillator, using a crystal mounted in a thermostatically controlled oven to maintain the required stability, generates the basic color sub-carrier frequency of 3.579545 mc. The signal from the oscillator feeds two buffer amplifiers, from which two independent sub-carrier outputs are obtained. In order to obtain a 31.4685 kc signal to lock the master oscillator of the synchronizing generator, a signal from one of the buffer amplifiers is coupled to a counter chain. In the counter chain, there are three dividing stages which are simple, highly reliable, locked oscillators, and a quadrupler stage. The resulting signal is coupled through a buffer amplifier to the 31.4685 kc output.

The Color Frequency Standard is designed to be installed in a standard cabinet rack, requiring only seven inches of vertical rack mounting space.

SPECIFICATIONS

Input Power:	
From A-C Line:	
For Tube Heaters.....	105-125 volts, 30 watts
For Crystal Oven.....	105-125 volts, 14 watts
Line Frequency.....	50 to 60 cycles
From Regulated Power Supply: (WP-16A)	
Plate Voltage.....	280 volts d-c
Plate Current.....	60 ma
Output Signals:	
Two Low-impedance Outputs.....	3.58 mc
Single High-impedance Output.....	31.5 kc
Voltages:	
3.58 mc.....	2 volts peak-to-peak
31.5 kc.....	90 volts peak-to-peak
Tube Complement.....	7—6AU6; 1—6J6
Dimensions:	
Width.....	19"
Height.....	7"
Depth (overall).....	7½"
Weight.....	12½ lbs.
Stock Identification.....	MI-40201-A

Accessory Equipment

VoltOhmyst.....	Type WV-97A
Oscilloscope.....	Type TO-524D
Frequency Monitor.....	Type BW-11AT
Spare Crystal, 3.579545 mc.....	MI-19400-K

BURST FLAG GENERATOR, MI-40202-A**FEATURES**

- Generates keying pulse which permit injection of subcarrier bursts in the Colorplexer
- Burst flag position, width and amplitude are all accurately adjustable
- Number of flag pulses eliminated during vertical blanking is adjustable

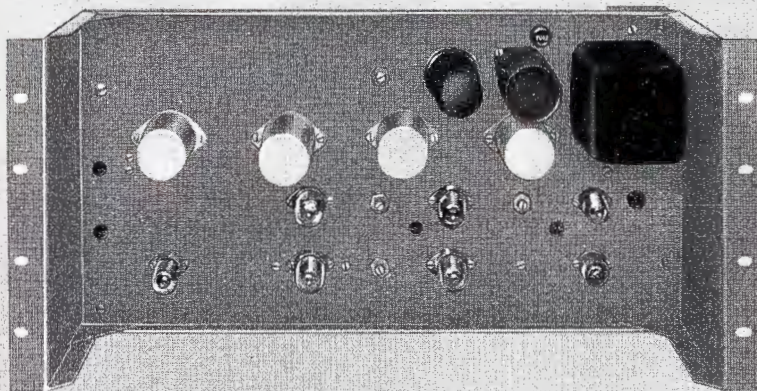
**DESCRIPTION**

The RCA Burst Flag Generator MI-40202-A is a drive-controlled unit which provides keying pulses to the RCA Colorplexer, permitting the insertion of the burst into a composite color television signal. Adjustments are provided to insure accurate placement and width of the burst in the composite signal, and to gate out the necessary number of pulses during vertical blanking time. In addition, the amplitude of the pulses at the output is controllable.

The unit has a simple circuit in which horizontal drive triggers a delay multivibrator which determines the front edge position of the final flag pulse. The output of this multivibrator is differentiated and used to trigger another multivibrator that sets the width of the flag pulse. From this multivibrator the signal is fed to a gating tube, since it is necessary to key out the flag during a portion of the vertical blanking interval. The keying signal applied to the gate tube is derived from a multivibrator triggered by vertical drive. The gate tube drives an amplifier, the output of which is coupled to the output connector.

SPECIFICATIONS**Input Power:****From A-C Line for Tube Heaters:**

Line Rating.....105-125 volts, 25 watts
Line Frequency.....50 to 60 cycles

From Regulated Power Supply: (WP-16A)

Plate Voltage.....280 volts d-c
Plate Current130 ma

Synchronizing Signals:

Vertical Drive.....4 volts peak-to-peak
Horizontal Drive4 volts peak-to-peak

Output Signal4 volts peak-to-peak
width adjustable from 1.8 to 3.0 microseconds

Tube Complement:

2-6AU6 1-6AS6 4-12AT7 1-6L6

Dimensions:

Width19"
Height8¾"
Depth (overall)9"

Weight (approx.).....13½ lbs.

Stock IdentificationMI-40202-A

Accessory Equipment

VoltOhmystType WV-77E

OscilloscopeType TO-524D

SYNC GENERATOR CHANGEOVER SWITCH

MI - 26289

FEATURES

- Remote control of changeover
- Automatic changeover if generator B+ fails
- Interlocked to prevent changeover when B+ is not present in standby generator
- Tally lights for on-air and standby indication
- Choice of terminating or feeding through standby generator signals



USES

The Sync Generator Changeover Switch provides a convenient method of switching from one sync generator to a standby sync generator. Use of the switch will reduce the amount of "Off-Air" time that may be lost because of sync generator troubles, and will also protect equipment against loss of drive signals.

There is provision for feeding through the standby generator signals to permit the simultaneous use of these signals elsewhere in the station, if desired.

The switch contains 7 channels. Four are normally required for monochrome installations where it is necessary to switch simultaneously the sync, blanking, vertical and horizontal drive pulses. The three remaining channels may be used for switching genlock control, burst flag, and color sub-carrier if desired.

The changeover switch may be remotely controlled by means of a push-button switch on an accessory remote panel, MI-26267. The remote control panel also has tally lights to indicate which sync generator is "on the air", whether the standby sync generator is turned on, and whether the remote control position is in control.

DESCRIPTION

The Sync Generator Changeover Switch is contained on a 5¼-inch bathtub chassis for mounting in a standard 19-inch rack. A dust cover protects the rotary type switch and conceals internal wiring. Tally lights to indicate which sync generator is on the air and whether the standby generator is turned on are mounted on the front panel, along with a changeover push-button, remote-local switch, and fuses. A mechanical changeover lever projects through a slot in the front of the dust cover. Twenty-eight coaxial jacks are located on the back of the chassis for sync generator signal inputs and outputs. Mating connectors are supplied for all jacks, and seven of them contain 75 ohm resistors for terminating the standby sync generator outputs. A terminal strip is provided for power input connections. A jack and mating connector are supplied for connecting the remote control panel. The Changeover Switch is shipped complete with relays.

SPECIFICATIONS

External Connections required for Changeover Action,
Relays, and Tally Lamps.....117 volts, 60 cycles, d-c supply of Gen. 1
d-c supply of Gen. 2

Signals Accommodated.....7 from each generator

Dimensions:
Height5¼"

Width19"
Depth6"
Stock IdentificationMI-26289

Accessory

Remote Control Panel for Sync Generator
Changeover SwitchMI-26267

PULSE DELAY LINE

MI-26886



USES

The MI-26886 Pulse Delay Line is a convenient rack-mounted unit designed to serve two Broadcast functions: (1) to delay driving and sync pulses to monochrome equipment when integrating monochrome and color cameras; and (2) to compensate for the time difference between video signals when the points of origin are separated by cables of different lengths. In the first application the pulse delay line will compensate for the delay inherent in colorplexers or other encoding devices.

The delay line sections of the MI-26886 are used by connecting them in series with the signals to be delayed. In cases where more than one delay line is required to obtain the necessary delay or if the delayed pulses are to be bridged through a large number of equipments, it is recommended that a TA-4A Pulse Distribution Amplifier, MI-26158, be used following the delay line to restore the sharpness of the pulse and eliminate any excessive overshots.

DESCRIPTION

The Pulse Delay Line, MI-26886, is composed of six sections. The sections may be connected in series to compensate for an equivalent delay of RG-11/U Cable in increments of 50 feet for lengths from 50 feet to 2000 feet. The equipment is compact, measuring only 7 inches long by 2½ inches wide, and 2¼ inches deep. Four Delay Lines may be mounted on a 5¼ inch blank chassis (MI-26525-3) or six Delay Lines can be accommodated on the 7 inch blank chassis, MI-26525-4.

The delay of each section of the Pulse Delay Line is indicated in the equivalent number of feet of RG-11/U cable. Unused sections should be left open. The cable from the delay line to the equipment being fed should be terminated

FEATURES

- Variable delay from .077 to 3.08 microseconds
- Delay driving, blanking and sync pulses when integrating color and monochrome
- Less than 1 db insertion loss for maximum delay
- Characteristic impedance 75 ohms
- Small in size—designed for rack mounting

at the equipment end in 75 ohms. Since the MI-26886 is not a tapped delay line but a set of delay line sections, the characteristic impedance remains constant regardless of desired delay.

SPECIFICATIONS

Electrical Specifications

Impedance	75 ohms	
Insertion Loss.....	Less than 10%	
Minimum Delay.....	.077 μ sec. (RG-11/U 50 ft.)	
Maximum Delay.....	3.08 μ sec. (RG-11/U 2000 ft.)	
Intermediate Delays.....	Each section represents a delay equivalent to the following lengths of coaxial cable (RG-11/U) to allow selection of any length in steps of 50 ft. up to 2000 ft. (See Schematic Drawing.)	
<i>Equivalent Cable</i>	<i>Delay</i>	<i>Approx. Loss</i>
50 feet	.077 μ sec.	.025 db
100 feet	.15 μ sec.	.05 db
200 feet	.31 μ sec.	.10 db
400 feet	.62 μ sec.	.20 db
450 feet	.69 μ sec.	.225 db
800 feet	1.23 μ sec.	.40 db
Pulse Amplitude.....	4 volts nominal	
Pulse Rise Time.....	.15 μ sec. 10% to 90% amplitude	
Overshoot	10% maximum	

Mechanical Specifications

Connections.....	Standard UHF coax receptacles
Dimensions (overall).....	7" long, 2¼" wide, 2¼" deep
Weight.....	2 lbs. (approx.)
Stock Identification	MI-26886

Accessory

TA-4A Pulse Distribution Amplifier.....	MI-26158
---	----------

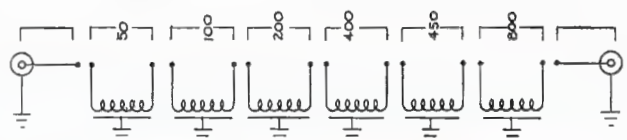

Schematic diagram of Pulse Delay Line MI-26886

SEMICONDUCTOR POWER SUPPLY

TYPE WP-16B

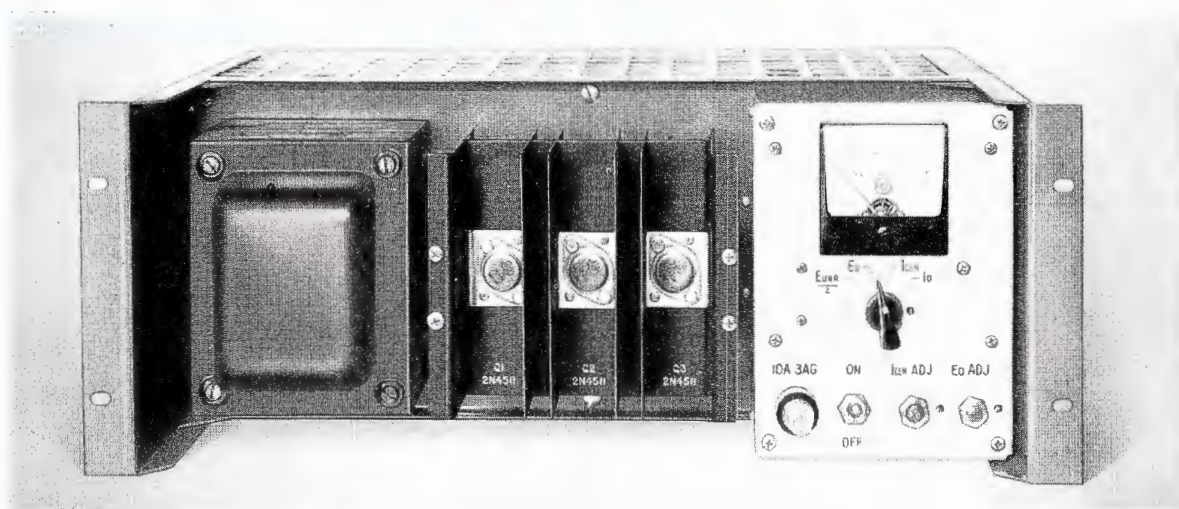

FEATURES

- 1600 ma voltage—regulated output
- Convection cooling—no blowers required
- Requires only 7 inches of rack space
- Standard recessed chassis construction
- Plug-in units for centering and unregulated voltage outputs
- Built-in meter and meter switch for voltage and current measurements
- Voltage regulating power transformer

USES

The WP-16B Semiconductor Regulated Power Supply, M1-26084-B, is a rugged, high-efficiency, lightweight source of precisely regulated voltage, capable of supplying current loads of up to 1600 milliamperes. It has been designed for use with television broadcast and closed circuit equipment; however, it can serve equally well as a power source for almost any equipment requiring a regulated 280 volt d-c power source. The WP-16B can be used as a direct replacement for existing power supplies with a substantial saving in space, weight, power consumption and heat dissipation. Current requirements of an entire monochrome camera chain, live or film, including the master monitor can be supplied by one WP-16B power supply. For a color studio or color film camera chain, two WP-16B power supplies are required.

DESCRIPTION

The WP-16B Semiconductor Regulated Power Supply is contained on a single recessed chassis which is compatible with television equipment now used in most broadcast and closed circuit installations. The chassis occupies only seven inches of rack space so that eleven power supplies can be contained in a single BR-84 equipment rack. The small amount of heat which is generated internally is conducted away by convection cooling through a large heat sink in which the regulating transistors are mounted. As a result, no ventilating fan or blower is required. The supply will operate within the load specifications in an ambient temperature up to 50 degrees centigrade. The WP-16B weighs only 50 pounds. It is 19 inches wide and 13½ inches deep overall.

Since a semiconductor power supply would normally make output voltage available the instant the a-c power switch was thrown, a time delay circuit is provided in the WP-16B to prevent the application of the plate voltage until the filaments of the powered equipment reach operating temperature. In the event of a momentary power failure the relay does not recycle; however, it will recycle and reintroduce the time delay for failures of more than several seconds.

The primary of the power transformer may be connected for either 110 or 220 volt a-c line operation by a simple change of taps. The power transformer is of the regulating type so that the voltage input to the rectifier is constant for the ranges of 95 to 130 volts and 190 to 260 volts. The frequency tolerance is 60 cycles plus or minus 1 cycle per second for the 60-cycle power supply. A separate version of the power supply is available for 50-cycle power line applications.

WP-16B Circuits

A bridge type germanium rectifier drives a capacitor input filter. The combination of rectifier, filter and regulating transformer limits the rate of line current change due to rectifier switching action so that no transient is fed back on the a-c mains to be picked up in the filament circuits of amplifier equipment and thus be visible in the transmitted picture.

The heavy duty regulating transistors, Type 2N458, are located in the negative return of the regulated voltage circuit. Any change in output voltage is immediately sensed by the d-c amplifier consisting of five transistors connected in cascade. The amplified voltage variation is applied instantaneously to the base terminals of the regulating transistors to restore the output voltage to its proper value. A control is provided for adjusting the output voltage to a nominal value of ± 280 volts, but the WP-16B can be operated over an output voltage range of 275 to 290 volts. Three Zener diodes, Type 1N429, connected in series are used as a voltage reference for the d-c amplifier. The d-c amplifier is constructed on a small sub-assembly which is easily accessible in the event that servicing is necessary.

Complete short circuit protection is provided. If a short circuit occurs in the load, the voltage drops to zero and remains thus until the short is cleared, at which time the current and voltage are restored to normal automatically. A fuse in the primary of the power transformer protects the power supply from internal shorts.

The WP-16B has a meter and selector switch on the front panel for ease in adjustment and measurement of output voltage and current, unregulated voltage and current, and centering voltage and current.

Centering Current and Unregulated Voltage Units

Centering current and unregulated voltage are supplied by means of plug-in subchassis units which are powered by separate, non-regulating secondary windings of the power transformer. These units are normally required only when the WP-16B is used with a camera chain and need not be purchased when the supply is to be used for applications requiring only the regulated voltage output.

The Centering Current Plug-in Unit, MI-26083-A, is used for supplying centering current for film and live cameras and master monitors. It contains two transistors and associated circuits mounted on a small sub-assembly. The current is adjustable between 300 and 1200 ma. by means of a control located on the front panel of the power supply.

The Unregulated Voltage Plug-in Unit, MI-26082-A, is used for those applications requiring a higher voltage than that provided by the regulated voltage output. A typical appli-

cation of this voltage is for the deflection circuits of cameras and some types of master monitors. The WP-16B Power Supply is factory wired for an unregulated d-c voltage output of 400 volts. Taps are provided on the power transformer which can be connected to provide output voltage of 360, 380, 420 and 460 volts. The ripple content of the unregulated output is only 5 volts peak-to-peak and the output voltage is maintained within one per cent for a 15 per cent change in line voltage. When the unregulated voltage plug-in unit is used, the capacity of the regulated output is reduced to 1350 milliamperes.

SPECIFICATIONS

Basic Regulated Power Supply

Input	
Voltage.....	95 to 130 volts a-c or 190 to 260 volts a-c
Frequency:	
60 Cycle Unit.....	60 ± 1 cycles per second
50 Cycle Unit.....	50 ± 1 cycles per second
Power Input	560-600 watts
Efficiency:	
Full Load (1600 ma.).....	65%
$\frac{2}{3}$ Load (1000 ma.).....	55%
$\frac{1}{3}$ Load (500 ma.).....	45%
Maximum rate of line current change.....	2×10^3 amp./sec.

Regulated Output

Voltage.....	275-290 volts, adjustable
Current (without unregulated load).....	0-1.6 amperes
Current (with 250 ma unregulated load).....	0-1.35 amperes
Capacitance Loading	Infinite
Stabilization.....	0.05 volts output change for ± 18 volt line change
Long Term Stability.....	Not over 1.0 volt variation
Ripple and Noise.....	Less than 2.5 millivolts peak-to-peak (0.88 millivolt RMS)
Regulation.....	Less than 0.1 volt change, 0-1.6 amperes
Output Impedance.....	Less than 0.15 ohms 0 to 50 kc
Short Circuit Load Performance.....	Self protecting. Normal operation resumed when short is removed
Time delay.....	45 sec. nominal

Semiconductor Complement:

Transistors—1 - 2N333, 2 - 2N1040, 4 - 2N458, 1 - 2N1012
Diodes—3 - 1N429, 1 - 651C4
Rectifier—1 - 4JA211CB2AC1

Mechanical:

Height	7"
Width	19"
Depth	13 $\frac{1}{2}$ "
Weight	50 lbs.

Stock Identification:

WP-16B For 60 Cycle AC Operation.....	MI-26084-B
WP-16B For 50 Cycle AC Operation.....	MI-26094-B

Unregulated Voltage Plug-in Units

Input Voltage.....	From WP-16A basic unit
Output Voltage.....	360, 380, 400, 420 or 460 volts
Output Current.....	250 milliamperes max.
Stabilization.....	1% for 15% change in line voltage
Ripple.....	5 volts peak-to-peak max.
Mounting Space.....	Plugs into basic WP-16B
Diodes—2 - 1N1084	
Stock Identification	MI-26082-A

Centering Current Plug-in Unit

Input.....	From WP-16B basic unit
Output.....	300 to 1200 ma. adjustable regulated constant current
Mounting Space.....	Plugs into WP-16B basic unit
Diodes—2 - 1N1085, 1 - 651C4	
Transistors—1 - 2N458, 1 - 2N1040	
Stock Identification	MI-26083-A

REGULATED POWER SUPPLY

TYPE 580-D

FEATURES

- Extremely well-regulated output
- Unusually low output ripple
- Low output impedance
- Components and connections easily accessible
- Compact, neat in arrangement



USES

The RCA Type 580-D Regulated Power Supply fills the need for a well-regulated source of d-c at loads of 50 to 400 milliamperes. The output is adjustable between 260 and 295 volts, with variations of less than 0.5 volt from minimum to maximum load. Thus it is suitable for laboratory, industrial, and communications applications in which an unusually well-regulated source of d-c is required. As a-c ripple in the output is less than 0.015 volt peak to peak per cent, the output voltage may be used for most purposes without additional filtering.

The Type 580-D is especially suited for use with RCA television equipment, which it matches in appearance and construction.

DESCRIPTION

The regulating circuit employed in the 580-D is of the series type. The output impedance is less than 0.7 ohm.

This Power Supply is assembled on a recessed chassis of the "bath-tub" type. Tubes and filter condensers project from the front of the chassis, while transformers, resistors, and wiring are at the rear. The chassis is standard rack width and may be mounted either in one of the enclosed-

type RCA cabinet racks, or on a standard "open-face" rack. In the latter event a blank panel may be mounted over the Power Supply if desired. Controls are centralized on a small, plainly-marked panel at the bottom of the unit. In addition to the power "on-off" switch there is provision for switching from a load range of 50-80 ma. to 80-400 ma., as well as a potentiometer for adjusting output voltage. A meter selector switch and a meter jack provide for plugging in a meter to read individual tube plate currents, output current, and output voltage. A special meter (MI-21200-C1) is available for this purpose.

SPECIFICATIONS

Output Voltage.....	Adjustable 260 to 295 volts
Output Current.....	50 to 400 ma.
D-c Regulation.....	Less than 0.25 volt, minimum to maximum load
A-c Ripple.....	Less than 0.015 volt peak to peak
Power Supply.....	105/125 volts, 50-60 cycles
Power Input.....	370 watts (maximum)
Tube Complement:	
2—OD3	2—5R4GY
1—6SL7GT	5—6Y6G
1—NE 32	
Dimensions.....	10½" high, 19" wide, 12" deep
Weight	58 lbs.
Stock Identification	MI-21523-C

Accessory

Plate Current Meter.....	MI-21200-C1
--------------------------	-------------

FIELD POWER SUPPLY

TYPE TY-31A



DESCRIPTION

The Type TY-31A Field Power Supply, MI-26091, is a portable unit designed to supply all the d-c current required by the TK-31B Field Camera, Viewfinder and Field Camera Control in one camera chain. It is also a com-

panion unit used with the RCA TS-30D Field Switching System. When used in combination with a Field Master Monitor such as the RCA Type TM-6C, these units form the field equivalent of a director's console in a studio.

The Field Power Supply is contained in a sturdy, portable case. A blower cooling system directs an air stream directly over the tubes. An important feature is the broad range of output current values at which regulated voltage may be obtained. The addition of a relay to withdraw a series regulator under light load provides a regulating range from 1.25 at 285 volts down to about 400 ma. The low end of the output range is especially useful when servicing only one unit of a camera chain, in which case the current drain is low.

SPECIFICATIONS

Input and a-c Power.....	98-129 volts 50/60 cycles, single phase—
	1340 watts full load; 14 amperes, 117 volts
Output d-c Power:	
Unregulated at Full Load.....	400 volts
Regulated, Operating Voltage.....	285 volts
Regulated Voltage Range.....	275 to 295 volts
Current:	
Total Maximum.....	1430 ma
Regulated—min. to max.....	.600 to 1250 ma
Unregulated Max.....	1430 ma less regulated or focus currents
Output Focus Coil:	
Regulated, Operating Current.....	.75 ma
Regulated Current Range.....	.60-90 ma
Tube Complement:	
	6-5R4GY, 5-6AS7-G, 1-6SL7-GT, 1-6Y6-G, 1-6AC, 2-OD3
Dimensions (overall).....	26" long, 8½" wide, 18½" high
Weight58 lbs.
Stock Identification	MI-26091

PLATE CURRENT METER, MI-21200-C1



DESCRIPTION

Plate current Meter, MI-21200-C1, is a two scale meter for checking the plate currents drawn by the regulator tubes in RCA Power Supplies Types WP-15, WP-33, 580-D and TY-31. It also is used for measuring the output voltage and total output current of these power supplies, and for measuring the focus coil current in RCA Image Orthicon Camera Equipment. The 0-150 ma scale is used for these metering functions. By pressing the button on the meter panel, the 0-15 ma scale can be used to measure the signal level calibration voltage in the TM-6C Master Monitor. The proper external shunts are included in each of the equipments with which the meter is used.

SPECIFICATIONS

Range Scales.....	0-150 ma., 0-15 ma.
Approximate Size.....	3½" x 5½" x 2¾"
Net Weight3 lbs.
Finish	Bakelite case
Cable.....	5' 9" cord with plug-in jack
Stock Identification	MI-21200-C1

REGULATED POWER SUPPLY

MI-11318-B



FEATURES

- Simplified design—low cost maintenance
- Silicon diode rectifiers
- Low ripple voltage
- Self regulating power transformer
- Constant DC voltage with variable loads
- Rack space only 5¼ inches

DESCRIPTION

The MI-11318-B Heavy Duty Regulated Power Supply will provide up to 6 amperes d-c at 24 volts to inductive, capacitive or resistive loads. The Supply finds use in Audio and Video relay switching systems, tally light circuits and other equipments requiring a constant d-c source with varying current loads. High reliability affording low cost maintenance makes the MI-11318-B Power Supply an excellent choice. Also available, with identical specifications for 220 volt 50 cycle operation is Regulated Power Supply, MI-591318.

The MI-11318-B Regulated Power Supply is designed for standard 19-inch rack mounting. Mounted on the front panel are the OFF/ON power supply toggle switch, an indicator light for a-c power, and a 3 ampere type MDX time lag fuse. The panel is light umber gray, making a uniform appearance with RCA standard broadcast equipment. Input and output connections are made to the terminal board mounted on the chassis. A neon lamp connected across the primary of the transformer indicates when a-c power is applied.

The Power Supply uses two silicon diodes in a full-wave rectifier circuit. Regulation is obtained through the constant voltage power transformer which allows considerable line voltage change with a minimum voltage at the rectifier input. A capacitor input pi configuration is used to filter the rectifier output.

SPECIFICATIONS

Input:	
60 Cycle Unit.....	100—130 volts o-c, 60 cps, single phase, 144 watts
50 Cycle Unit.....	200—260 volts a-c, 50 cps, single phase, 144 watts
Output.....	6 amperes, 24 volts d-c
Regulation.....	7.5% no load to full load, 2.5% ½ load to full load
Ripple Voltage.....	0.2 volt RMS maximum
Ambient Temperature.....	65°C max.
Finish.....	Light umber gray
Dimensions Overall.....	19" wide, 5¼" high, 9¾" deep
Weight.....	Approx. 25 lbs.
Stock Identification:	
110 volt, 60 cycle.....	MI-11318-B
220 volt, 50 cycle.....	MI-591318

Rear view of MI-11318-B Regulated Power Supply.

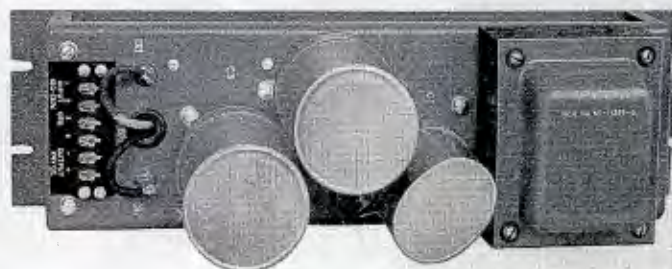

REGULATED POWER SUPPLY, MI-11316

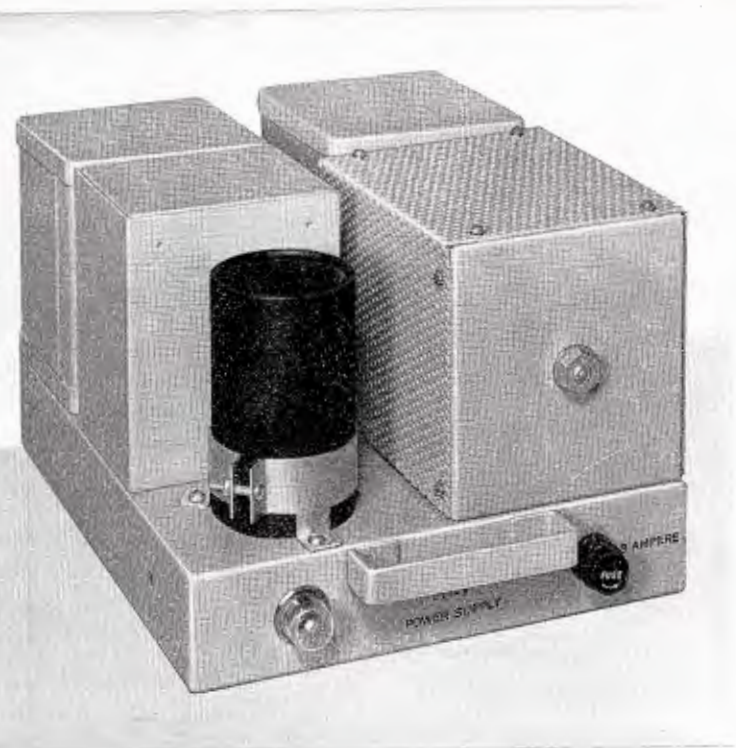

DESCRIPTION

The MI-11316 Power Supply may be used to supply up to 3 amperes a-c at 24 volts to inductive, capacitive or resistive loads. The ability of the power supply to maintain nearly constant output voltage from full load to no load makes it suitable for applications where current re-

quirements are variable and a constant voltage is required. Low ripple voltage makes it suitable for applications where nearly pure d-c is required. Typical applications include relays, signal lights, and intercommunications equipment. The MI-11316 Regulated Power Supply is designed for mounting on the MI-11599 shelf. Two power supplies may be mounted on one shelf. The front panel MI-11598-B may be used to close the front of the shelf and give the uniform appearance of standard broadcast audio equipment. Connections are made to a five point barrier type terminal board. The chassis is secured to the shelf by means of brackets and hardware supplied with the unit.

The neon lamp is connected across the fuse in the primary of the power input circuit. The glowing of this lamp indicates that the fuse has blown.

SPECIFICATIONS

Input.....	100-125 volts, 50/60 cps, single phase, 125 watts
Output.....	3 amperes, 24 volts d-c
Regulation.....	Better than 5% voltage regulation, no load to full load
Ripple.....	60 and 120 cycle components, less than 3% at full load
Dimensions Overall.....	10 5/8" long, 7 3/4" wide, 5 3/4" high
Weight	25 lbs.
Finish.....	Light gray enamel
Stock Identification	MI-11316

MI-11316 POWER SUPPLY SCHEMATIC DIAGRAM

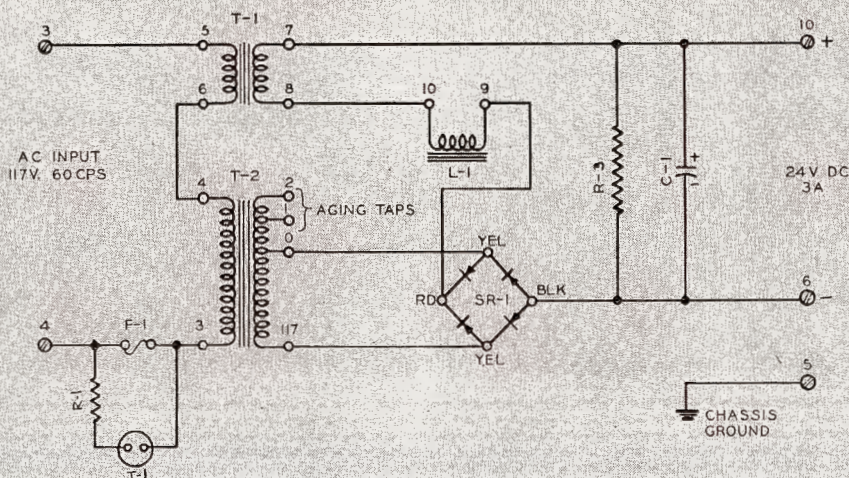

STANDARD CABINET RACKS

BR-84 SERIES



BR-84A

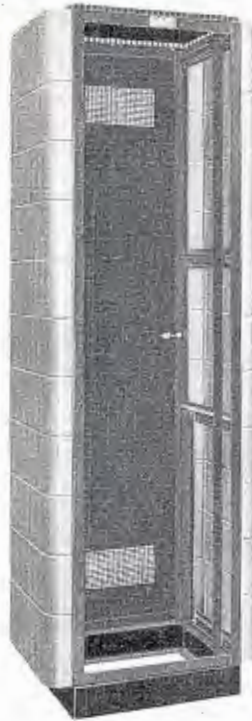

BR-84B



BR-84C

FEATURES

- Cabinets are same height as RCA transmitters—84 inches
- Total panel space 77 inches
- Available in many combinations to suit all studio applications
- Drilled and tapped for 19-inch panels
- Attractively styled to blend with all control room installations
- Suitable for fitting in a flush position to a side or rear wall
- Accommodates the heaviest equipment encountered in studio use

USES

The BR-84 series cabinet rack program is another of the new feature lines of RCA. The cabinet program is presented after years of practical experience in finally developing a flexible scheme for accommodating broadcast equipment.

DESCRIPTION

The five combinations of cabinets and accessories offer a versatile system for accommodating the user's immediate requirements with maximum accessibility for any future growth of the installation. Each rack may be mounted singly or, where desired, tandem together to facilitate the

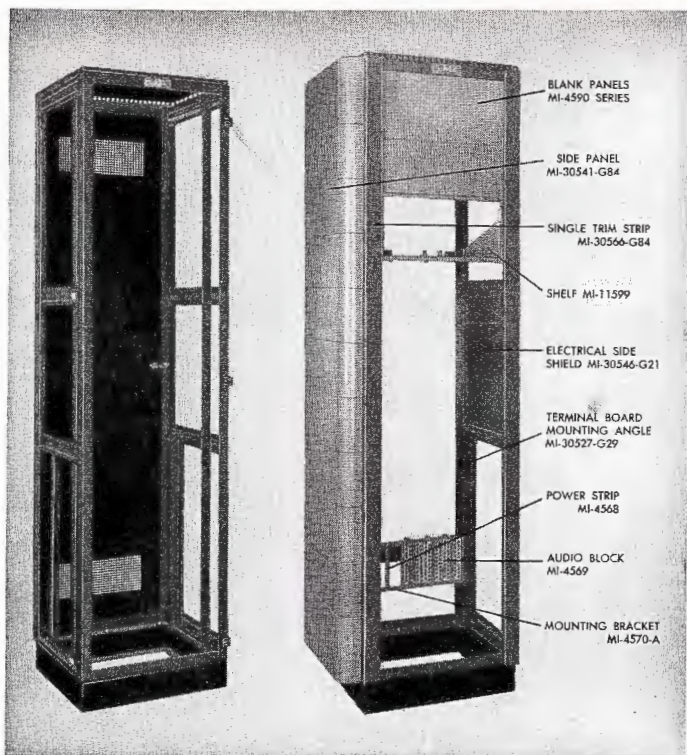

BR-84D

BR-84E with Accessories

grouping of any number of cabinets. The cabinet is of sturdy metal construction, welded and bolted in one standard height and width. The ventilated top with slotted edges provides complete ventilation but protects the equipment from falling articles and dust. Vertical panel mounting angles have tapped holes at RMA standard locations to provide 77 inches of standard 19-inch panel mounting space. These angles may be installed to mount equipment within the cabinet, where doors are used, or flush with the front. When the latter method is desired, trim strips of neat design for panel mounting and clip fitting provide the finished appearance. The front and rear doors are of the universal type and may be hinged on the right or left side, to rotate in an arc of 180 degrees. Electrical side shields are available in two sizes—21 inches for the center section, and 28 inches for the top and bottom sections. If found necessary after assembly, they may be fitted between racks of equipment. Terminal board mounting angles facilitate the mounting of power and audio blocks in a vertical or horizontal position. Additional terminal board mounting angles (MI-30527-G29) are available as accessories.

Units placed adjacently may be rigidly bolted together to produce a secure assembly. The cabinets are finished in a two-tone umber gray, with dimensional characteristics artistically blending with all RCA transmitters.

SPECIFICATIONS

Panel Width	19"
Panel Mounting Space (height).....	77"
Clearance for Door Swing.....	23"
Weight (BR-84A)	225 lbs.
Finish.....	Two-tone umber gray enamel except for the base which is black
Dimensions:	
Height	84"
Width—BR-84-A, -B (with side panels).....	28"
BR-84-C, -D, -E.....	22"
Width of Frame.....	22"
Depth of Frame.....	18"
Depth (including doors and handles).....	24 1/4"
Stock Identification:	
Type BR-84A consisting of one frame, one base, one top cover, one front door (non-ventilated), one rear door (ventilated), one pair of side panels, one set of terminal board mounting angles and one set of panel mounting angles and instruction book.....	ES-30951-A84
Type BR-84B, same as BR-84A, less front door only.....	ES-30951-B84
Type BR-84C, same as BR-84A, less side panels only.....	ES-30951-C84
Type BR-84D, same as BR-84A, less side panels and front door.....	ES-30951-D84
Type BR-84E, same as BR-84A, less side panels, front and rear doors.....	ES-30951-E84

Accessories

One Door (non-ventilated)	MI-30530-G84
One Side Panel.....	MI-30541-G84
One Door (ventilated).....	MI-30535-G84
One Electrical Shield (for mid-section of rack)	
One Per Side.....	MI-30546-G21
One Electrical Shield (for top and bottom sections)	
Two Per Side.....	MI-30546-G28
*One Single Trim Strip	MI-30566-G84
*One Double Trim Strip Used where Two Cabinets Are Placed Together.....	MI-30568-G84
Terminal Board Mounting Bracket.....	MI-4570-A
Blank Panels	MI-4590 to 4595 Series
Audio Terminal Block	MI-4569
Power Terminal Strip.....	MI-4568
Set Terminal Board Mounting Angles.....	MI-30527-G29
Set of 2 Panel Mounting Angles.....	MI-30526-G84
BR-2A Panel and Shelf Assembly.....	MI-11598-B/11599
BR-22A Panel and Shelf Assembly.....	MI-11597
Ground Bus Kit.....	MI-11728

* Trim strips not required if front doors are used.

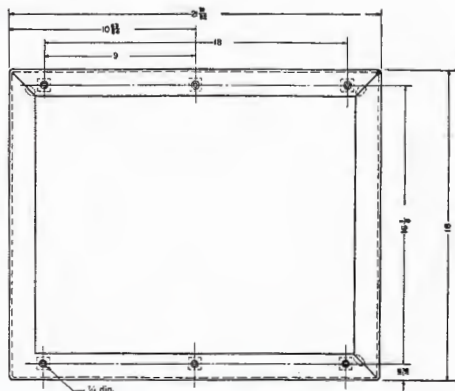

Layout and dimensions of cabinet base

ECONOMY CABINET RACK

TYPE BR-19A



FEATURES

- Lightweight cabinets designed to blend with all control room installations
- Provides flexibility for future expansion
- Constructed of $\frac{1}{8}$ -inch thick cold-rolled steel
- Drilled and tapped for 19-inch panels
- Modern streamlined styling

USES

The BR-19A Cabinet has been designed to accommodate broadcast equipment. The cabinets are of lightweight steel construction and offer new cost economies. They provide facilities for mounting standard 19-inch panels and shelves.

DESCRIPTION

The BR-19A Cabinet Rack is constructed of $\frac{1}{8}$ -inch cold-rolled steel. It is provided with rear door only. All racks have quick detachable, new corner trims which are fastened to the front with two studs. This provides for rapid, finger-tip removal without the use of screwdrivers, etc. The cabinets are designed in keeping with modern streamlined styling, and have adequate ventilation through the use of rear, side, and top louvers and vents. Vertical corner mouldings cover the panel mounting screws and all panels fit into a recess so that the edges of panels are not exposed when the corner mouldings are removed.

The panel mountings consist of angle irons of $\frac{7}{64}$ -inch steel. Holes are accurately drilled and tapped 12-24 thread on universal centers for all types of panels. The BR-19A cabinet is finished in a two-tone umber gray in keeping with other RCA studio equipment.

SPECIFICATIONS

Panel Width	19"
Panel Mounting Space (height).....	77"
Clear Inside Depth.....	16 $\frac{3}{4}$ "
Finish.....	Dark and light umber gray wrinkle
Material.....	$\frac{1}{8}$ " thick cold-rolled steel
Overall Dimensions.....	83 $\frac{1}{2}$ " x 22" x 18"
Weight	140 lbs.
Stock Identification	MI-11550

RACK MOUNTED CONTROL DESK

MI-40415



FEATURES

- Provides efficient grouping of controls
- Minimum of floor space required
- Burn-proof formica desk top
- Blank panels and trim strips afford neat rack appearance

USES

The MI-40415 Rack Mounted Control Desk may be used to mount camera controls for either the TK-41B or TK-26B Color Camera Chains in a standard rack assembly thereby providing a convenient operating control position. Additional rack mounting units can be mounted above and below the table in the rack assembly. The Control Desk permits more control equipment to be centrally grouped for convenient operation than any other type of mounting, and at the same time it reduces materially the amount of floor space required.

DESCRIPTION

The MI-40415 Rack Mounted Control Desk consists of a sturdy metal frame with a burn-proof formica covered plywood working surface that may be mounted on any one of the RCA Type BR-84 series of standard racks to form a convenient control center for television studio equipment. The assembly is supported by a pair of brackets which bolt to the front of the rack, forming a rigid mounting structure. A recessed panel mounts horizontally on the brackets, and accommodates control panels or other units up to 19 $\frac{1}{8}$ inches wide and 10 inches deep.

The table portion of the desk is mounted on the brackets in front of the recessed panel. The table is formica-covered plywood, 22 inches wide, 10 inches deep, and approximately 1-inch thick. The total distance from the front of the rack to the outer edge of the desk is 20 inches. The under side of the control desk is protected by a removable cover. A standard blank panel 1-23/32 inches high and two steel trim strips 55 $\frac{1}{8}$ inches long and 2 $\frac{3}{8}$ inches wide provide an attractive finish for the front of the rack above the desk. All mounting hardware and installation instructions are provided with the equipment.

SPECIFICATIONS

Dimensions (overall):	
Width	22"
Depth	20"
Height	7 $\frac{1}{4}$ "
Rack Mounting Area:	
Above Table	54"
Below Table	17"
Control Mounting Area:	
Width	19 $\frac{1}{8}$ "
Depth	10"
Table Height Above Floor.....	28"
Weight Assembled.....	15 lbs. approximately
Finish	Umber gray
Stock Identification	MI-40415

CONSOLE HOUSINGS AND END SECTIONS

TYPE MI-26786 & MI-26787

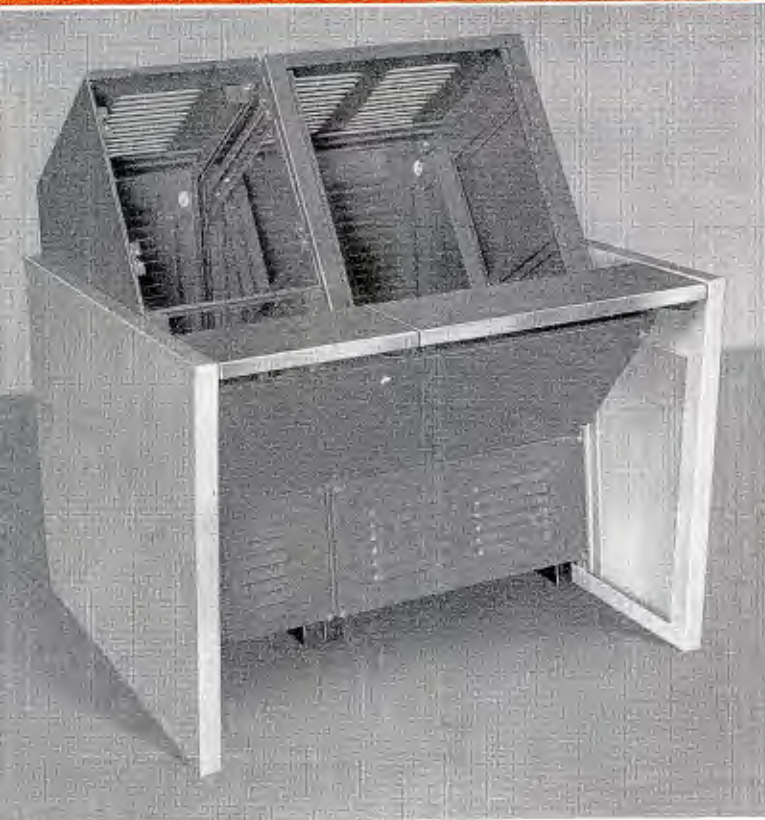

FEATURES

- Choice of housings to suit individual needs
- Sturdy steel frame construction
- Durable, formica-covered desk surface
- Provides convenient mounting for remote control panel equipment, monitors, processing amplifiers, switchers, etc.
- Removable cover plates to allow access
- "Block-building" units substantially increase flexibility of installation
- Two-tone umber gray to match companion studio equipment
- Attractively styled to blend with all control room installations

USES

RCA Standard "Add-a-Unit" Console Housing and End Sections are made available in 13¼-inch and 22-inch width models to suit individual station needs. The two models may be intermixed to provide substantial flexibility in the planning and installation of television control facilities. Any number of console housings may be mounted side-by-side, and individual units may be added or removed to meet changing needs.

The 13¼-inch Console Housing, MI-26786 is available for mounting master monitors, or the television series of remote control panels. The bottom portions of the console housings may be used for housing studio camera controls, film camera controls and the TS-5A or TS-11A Switching Control Chassis.

The 22-inch Console Housing, MI-26787, is especially designed to mount any standard rack equipment including such items as the TM-4BR or TM-7BR Monitor, the color processing amplifier, color camera control and TO-1 Waveform Monitor. By the use of adaptors (MI-26254) this console will also house remote control panels that fit the smaller 13¼-inch Console Housing. Trim "end" sections are available to provide an attractive, finished appearance.

DESCRIPTION

The MI-26786 and MI-26787 Console Housing Sections consist of a steel framework structure, open all around, with enclosing panels. The housings are of sturdy steel construction and are finished in a two-tone umber gray to match companion RCA studio equipment. The operating desk portion is at a 28-inch height and is covered with a durable, burn-resistant, light gray formica surface. Removable front and rear cover plates allow easy access to console monitor units, blower assembly, or other studio units housed in the consoles.

The upper section of each console housing is an adjustable hood which can be moved back or forth, leaving a "well" mounting area of from 6 to 10-inch depth between the desk portion and the front of the hood. The adjustment consists of a simple bolting operation. The well area may be used for operating controls such as film or studio camera controls, or studio switching chassis. Blank panels 5.7 inches and 4.3 inches in depth are included with each console housing to cover the well area and provide a finished appearance when this area is not used to mount equipment.

A Console Adaptor Panel (MI-26252) used in conjunction with the 13¼-inch console allows mounting of six standard remote control panels. Directly below the main mounting area is another section which mounts a seventh standard remote control panel. Blank panels (MI-26253) are available for filling vacant panel mounting space in the 13¼-inch console housing.

A Rack Adaptor (MI-26254) is used to mount a standard remote control panel in the upright section of the 22-inch console. Vacant mounting space in the 22-inch console housing may be filled by the use of standard 19-inch rack mounting panels.

Trim end sections finished in matching umber gray are available to give an attractive appearance to the installation. These accessories may be ordered as MI-26788-1 which consists of a left hand side cover for the hood and a left hand end panel assembly. The side cover and end panel assembly for the right hand side is ordered as MI-26788-2. The left and right hand hood covers only, may be ordered as MI-26789-1 and MI-26789-2 respectively. These accessory covers are made of 0.0598-inch thick cold-rolled steel and are fastened to the console housings by means of screws.

The console housings may be lined up together to give a finished contour. Such block building substantially increases installation flexibility.

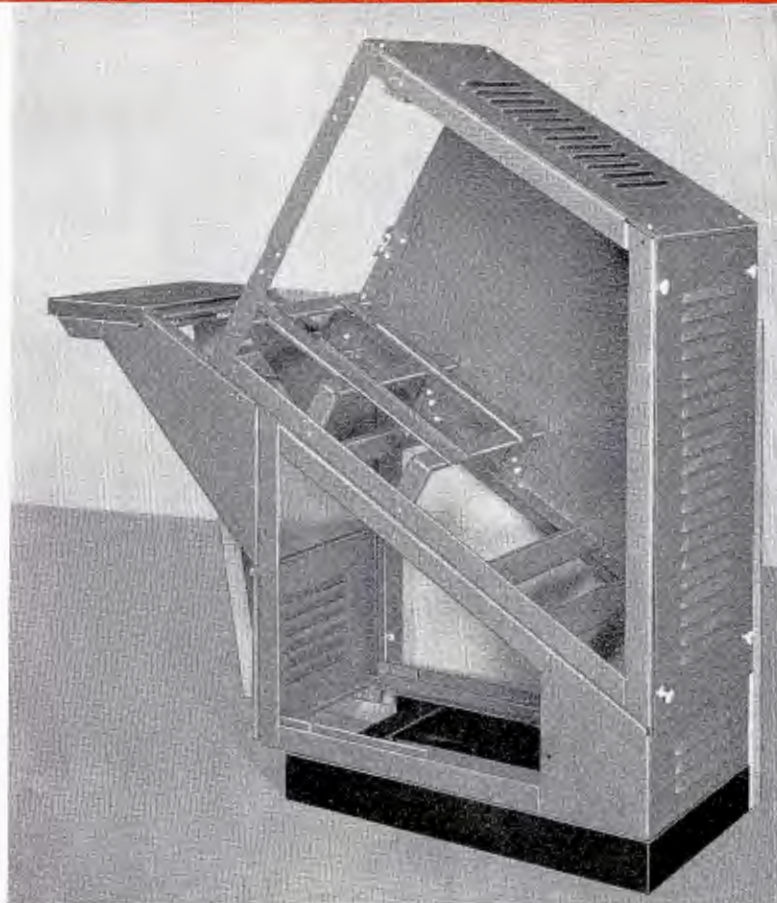

The MI-26786 Console Housing showing construction details. Sturdy framework and detachable panels are styled to blend with all RCA broadcast units.

SPECIFICATIONS

Console Housings Stock		
Identification	MI-26786	MI-26787
Width	13¼"	22"
Height	44.24" max. 42.09" min.	44.24" max. 42.09" min.
Depth	46.02" max. 42.29" min.	46.02" max. 42.29" min.
Upper Panel Mounting Area:		
Width	11⅞"	19"
Height	17½"	19"
Base Mounting Area:		
Width	11⅞"	19"
Height (front)	19"	19"
Height (rear)	8¾"	8¾"
Well Mounting Area:		
Width	11⅞"	19"
Depth	10"	10"
Weight	75 lbs.	100 lbs.
Finish	Two-tone umber gray	Two-tone umber gray

Accessory Equipment

Left Panel Assembly and Side Cover.....	MI-26788-1
Right Panel Assembly and Side Cover.....	MI-26788-2
Upper Left Side Cover only.....	MI-26789-1
Upper Right Side Cover only.....	MI-26789-2
Console Adaptor, 13-inch (for control panels).....	MI-26252
Rack Adaptor, 22-inch (for control panels).....	MI-26254
Console Well Adaptor (for a single remote control panel).....	MI-26212
Console Well Adaptor (for two remote control panels).....	MI-26278-A

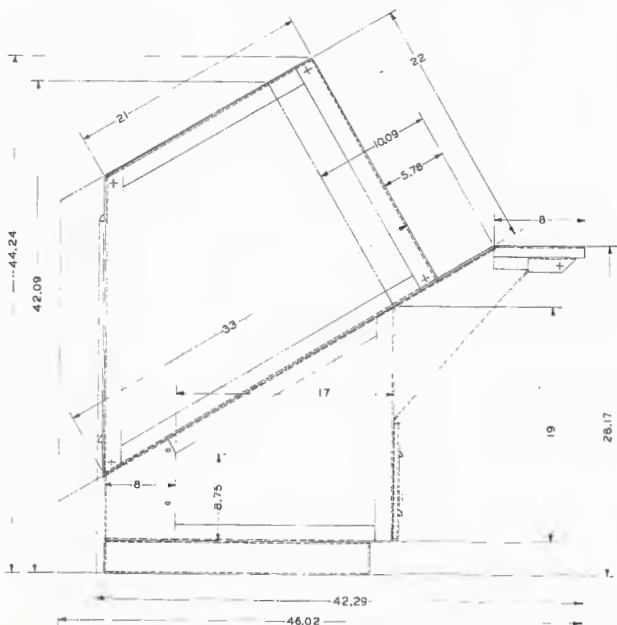

Outline Drawing of Console Housing to show adjustable hood feature, and overall dimensions.

RACK PANELS AND ACCESSORIES

FEATURES

- Convenient for mounting video and audio components, test and other equipment
- Attractively styled to match RCA equipment
- Provides flexibility in rack arrangement
- Available in sizes up to 10½ inches high

DESCRIPTION

RCA's line of Rack Mounting Panels serve as useful accessories for completing rack equipment installations. Unused sections in racks may be filled in by either the line of blank panels or the standard 19-inch recessed "bath tub" type chassis that are convenient for later use in mounting television components, meters, or other special equipment. In addition to providing a neat completed finish to the racks, such panels also serve to keep the racks clean and protect equipment units from small tools or other items that might otherwise be dropped inside the rack.

The chassis are often employed for mounting equalizers, transformers, switches or other items of equipment. One such special housing is available as the Circuit Breaker Chassis, MI-26240, which serves as mounting for the MI-26764 Series of Circuit Breakers. It is employed as a

Circuit Breaker Chassis



Blank Panel



Blank Recessed Chassis

main switch breaker panel between the power line and the television studio equipment to be controlled.

The MI-26240 Circuit Breaker Chassis consists of a standard recessed type chassis suitable for regular 19-inch rack panel mounting. It has individual cutouts for mounting five series MI-26764 circuit breakers available in rating of 10, 20, or 40 amps, all at 115 volts. Cover plates are provided for unused breaker mounting holes.

The series of blank panels includes all standard 19-inch width from 1¾ inches to 10-15/32 inches in height. They are made from ⅜-inch sheet metal, finished and notched to match standard racks. Most of the panels may also be obtained in the 19-inch recessed type chassis 5¼ inches in depth. These units are finished in light umber gray to match companion rack equipment.

The MI-21457-B1 Chassis Trim Cover is a flat piece of perforated steel properly framed so that it will mount horizontally between rack mounted chassis units. It is particularly useful when it becomes necessary to install front mounted units in combination with standard bath-tub chassis in the same rack. In this manner gaping holes in the rack are eliminated, small tools will not be dropped

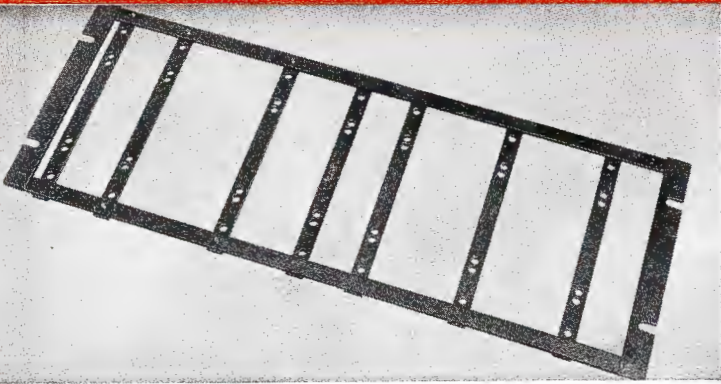

Terminal Block Mounting Bracket MI-4570-A.

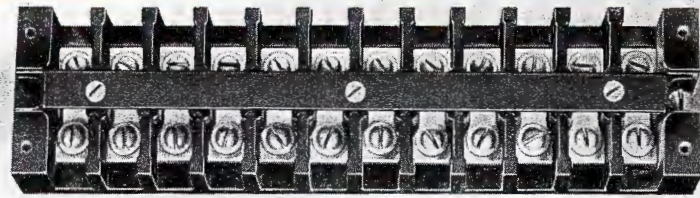

Power Terminal Block MI-4568 with cover removed.



Ground Bus Kit, MI-11728.

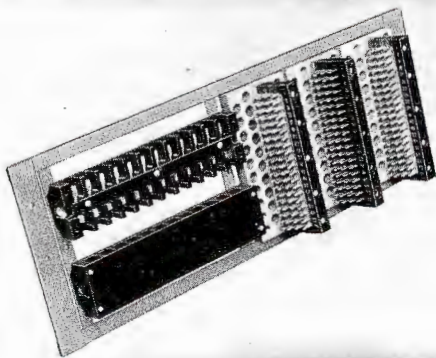

Terminal Block Mounting Bracket MI-4570-A with Terminal Blocks in position.

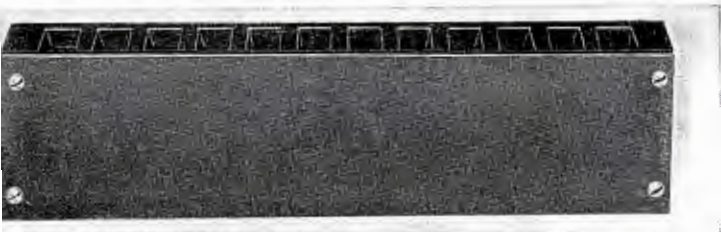

Power Terminal Block MI-4568.

Audio Terminal Block MI-4569.

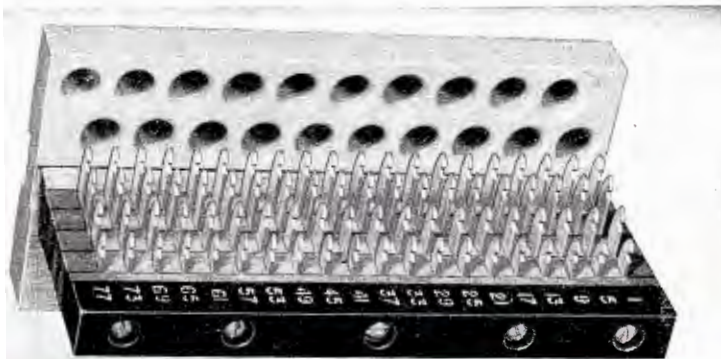

inside of the rack, and neat appearance is coupled with a convenient shelf arrangement. Terminal Block Mounting Bracket, MI-4570-A together with Power Terminal Block, MI-4568, Audio Terminal Block, MI-4569, and Ground Bus Kit, MI-11728, are also recommended for mounting equipment in standard 19-inch cabinet racks.

SPECIFICATIONS

Panels:

Chassis Height	Stock Identification Blank Panel	Stock Identification Recessed Panels
1-23/32"	MI-4590-A	MI-26525-1
2-1/8"	MI-4598-A	
3-15/32"	MI-4591-B	MI-26525-2
5-7/32"	MI-4592-B	MI-26525-3
6-31/32"	MI-4593-A	MI-26525-4
8-23/32"	MI-4594-B	MI-26525-5
10-15/32"	MI-4595-B	MI-26525-6

Chassis Trim Cover:

Dimensions.....167/8" wide, 5/8" high x 1/32" thick
 Stock IdentificationMI-21457-B1

Circuit Breaker Chassis:

Dimensions.....19" wide, 7" high x 5/4" deep
 Weight (approx.).....10 lbs.
 Stock IdentificationMI-26240

Accessory Circuit Breakers (for MI-26240):

10 Amps, 115 Volts.....MI-26764-1
 20 Amps, 115 Volts.....MI-26764-2
 40 Amps, 115 Volts.....MI-26764-3

Terminal Block Mounting Bracket:

Dimensions.....19" wide, 6 1/4" high
 Stock IdentificationMI-4570-A

Power Terminal Block:

Number of Circuits.....12
 Power Rating.....30 amps, 600 volts
 Dimensions.....8 1/4" long, 2" wide, 1 5/8" high
 Stock IdentificationMI-4568

Audio Terminal Block:

Number of Terminals.....80 arranged in 4 rows of 20 each
 Dimensions.....6 1/8" long, 2 5/8" wide, 3-1/32" high
 Stock IdentificationMI-4569

Ground Bus Kit:

Description.....Copper bus bar 5 7/8" long, 1/2" wide x 1/4" thick,
 with 9 holes 8-32 tap and 9 machine screws, binder head,
 8-32 x 1/4" long brass, 2 mounting holes 4 1/2" apart
 Stock IdentificationMI-11728

Control Panels and Mounting Accessories

FEATURES

- Provide remote control for various rack-mounted television equipment
- Small, compact—up to seven panels accommodated in upright section of console
- Permit greater efficiency in central control room operations
- Provisions for adapting panels for mounting in standard cabinet racks
- Complete line of blank panels for filling spaces in racks or consoles available
- Recessed bathtub chassis available for mounting special equipment in racks

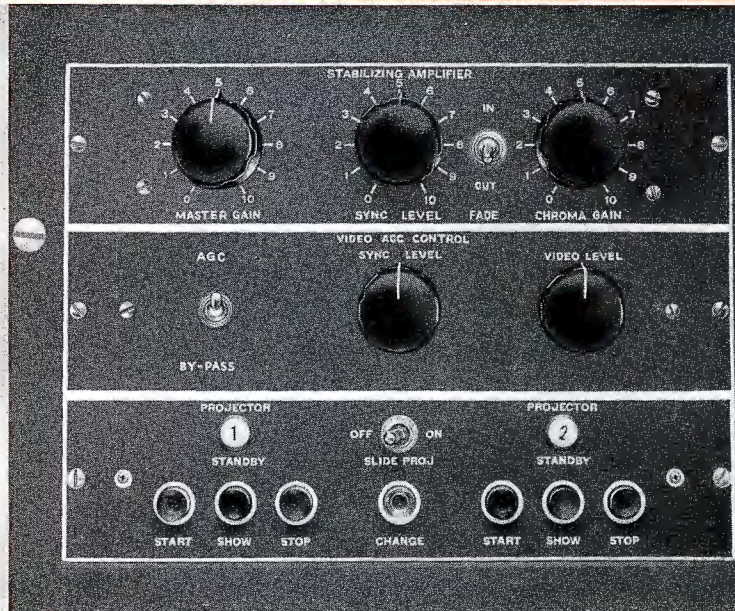

DESCRIPTION

RCA's line of Console and Rack Mounting Panels provide remote control of various rack-mounted television equipment. All basic control panels have been designed to mount in the standard console housing MI-26786, where up to seven panels can be accommodated in the upright section of each console. Such set-up affords a convenient central control position resulting in greater efficiency in control room operations.

Any one of the 2-21/32-inch high remote control panels may be mounted in a standard 19-inch rack or in the 22-inch console housing, MI-26787, by the use of Rack Mounting Adaptor, MI-26254. These adaptors will prove useful to stations preferring the larger 22-inch console or the rack-mounting type desk, MI-40415, as the central operating position.

RCA provides a complete line of 19-inch panels, either blank for filling out unused spaces in television cabinet racks, or recessed "bathtub type" chassis for convenience in mounting television components, meters or special equipment. In addition chassis trim cover, trim strips and other

mounting accessories are provided to meet studio remote control requirements.

RCA's remote control panels are each 11 $\frac{1}{16}$ -inches long. The height of each panel is 2-21/32 inches or a multiple thereof. They are formed of 0.091-inch thick aluminum, and finished a deep umber gray to match other television equipment and components. Reverse etched panel markings offer clear, durable identification of all control functions. Available panels include the following:

Stabilizing Amplifier Panel, MI-40424

This panel has four controls consisting of three potentiometers for controlling master gain, sync level and chroma gain, and a toggle switch which controls fade in and out in the circuits of the stabilizing amplifier.

AGC Amplifier Panel, MI-26299

This AGC amplifier control panel has two potentiometers controlling the video level and sync level, and a toggle switch which serves as the AGC bypass switch.

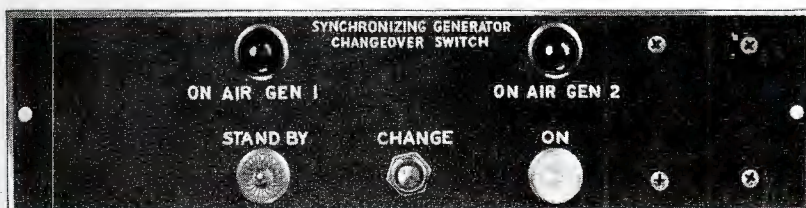

In order to control the selection of sync generators from a remote point, a Sync Generator Remote Control Panel MI-26267 (left) is required. Shown above in the console housing are Remote Control Panels MI-40424 for Stabilizing Amplifier, MI-26299 for AGC Amplifier, and MI-26256 for Film Projector.

Projector Changeover Panel, MI-26256

The control panel contains three groups of switches and indicator lamps, a relay and adjustable resistor, and two terminal boards. It remotely operates any combination of two television motion picture projectors of the RCA TP-6, TP-16, or TP-35 series and a slide projector of the TP-7 or TP-3 series.

Remote Light Control Panel, MI-40103

The light control contains four potentiometers for controlling the light intensity of up to four film or slide projectors. Eight tally lights, four yellow and four red, provide camera 1 or camera 2 identification of each projector with any combination of dual vidicon cameras, 3-V or 1-V.

Remote Sync Generator Changeover Switch Panel, MI-26267

The Sync Generator Changeover Switch may be remotely controlled by means of a push-button switch on the remote panel. Tally lights indicate which sync source is "on-air" and whether the standby sync generator is turned on and also if the remote control position is in control.

Remote Control Panel for TP-15 Multiplexer, MI-40025

Console mounting panel for the TP-15 Multiplexer is equipped to start, stop, or still project any of the motion picture projectors and to operate the slide projectors associated with the film chain. Dual channel controls are provided to enable the operator to select any of the picture sources for either of the camera positions. This control panel is 5" high.

Blank Panel, MI-26253

Blank Panel, MI-26253 is identical in size with other console mounting panels and may be used to finish out any vacant mounting space in 13-inch standard consoles.



Console Adaptor, MI-26252

Console Adaptor, MI-26252

The Console Adaptor allows mounting up to six remote control panels (or blank panels) in the upright section of the 13-inch console housing, MI-26786. It is provided with four fasteners which hold it securely to the flanges of the housing.

Rack Adaptor, MI-26254

This is used to adapt any one of the remote control panels for mounting in 19-inch wide cabinet racks or the 22-inch console.



Rack Adaptor, MI-26254



Blank Panel, MI-26253

SPECIFICATIONS

Panel Dimensions:

All Panels except MI-40025.....	11 ¹ / ₆ " long, 2-21/32" high
Panel MI-40025.....	11 ¹ / ₆ " long, 5" high
Rack Adaptor.....	19" long, 3 ¹ / ₂ " high
Console Adaptor.....	13 ¹ / ₈ " long, 17 ⁷ / ₈ " high

Stock Identification

Stabilizing Amplifier Panel.....	MI-40424
AGC Amplifier Panel.....	MI-26299
Projector Changeover Panel.....	MI-26256
Remote Light Control Panel.....	MI-40103
Remote Sync Generator Changeover Switch Panel.....	MI-26267
Remote Control Panel for TP-15 Multiplexer.....	MI-40025
Blank Panel	MI-26253
Console Adaptor	MI-26252
Rack Adaptor	MI-26254

TV CABLES, PLUGS, CONNECTORS

FEATURES

- Exact replacements for cables and connectors supplied with RCA television studio and field equipment
- Connectors and bulk cable available separately or as wired cable assemblies
- High quality, conservatively rated connectors and cable used throughout



8-Conductor Intercom Cable, MI-26759-11



Pulse Cable MI-26759-9



MI-26759 -22

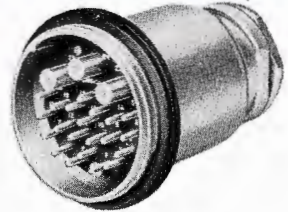

MI-26759 -21



MI-26759 -23



MI-26759 -24

DESCRIPTION

RCA television cables, plugs and connectors are made available for inter-connecting the various components of TV broadcast equipment—studio, control room and remote. Camera, power, pulse, intercom, coax transmission line and inter-connecting cables with companion connectors are available as individual items or in groups for use with various equipment systems. Refer to the individual equipment catalog sheets to determine which cables are required with specific items of video equipment.

Camera Cables

The multi-conductor, flexible camera cables listed here are supplied in convenient lengths complete with necessary male and female connectors. These cables facilitate making required inter-connections between cameras and camera controls. Conductors are stranded and covered with "color-coded" silk and cotton braid insulation. An inner shield of tinned copper braid is provided. Dust caps are provided where necessary.

Stock Identification	Description	Length
MI-26725-E5	25-Conductor, neoprene cover, with straight male and female connectors. With dustcaps.	50 feet
MI-26725-E6	Same as above except length.	100 feet
MI-26725-E7	Same as above except length.	200 feet
MI-26725-E9	25-conductor, neoprene cover, with 90 degree male and a straight female connector.	50 feet
MI-26725-E10	25-conductor, neoprene cover, with 90 degree female and a 90 degree male connector. With dustcaps.	50 feet
MI-40831-1	Control Cable; 33-conductor, flexible rubber-covered, shielded and individually color coded with Jones type male and female connectors.	50 feet
MI-40831-2	Shading Generator Cable; 8-conductor, rubber-covered, flexible, with Jones type male and female connectors.	4 feet
MI-40835	Set of Interconnecting Cables (Camera to Camera Auxiliary): (a) Camera Cable; 20-conductor, flexible, rubber-covered, shielded, and individually color coded with rectangular Cannon type male and female connectors. (b) Coaxial Cable; Type RG-59/U, flexible, rubber-covered.	3 feet 3 feet

(Continued next page)

Camera Cables and Plugs (Continued)

Stock Identification	Description	Length
MI-40868-2	TK-41B Color Camera Cable. 82-conductor, single cable, vinyl covered flexible, with straight male and female connectors.	50 feet
MI-40868-3	Same as above except length.	100 feet
MI-40868-4	Same as above except length.	200 feet

Camera Cable Connectors

The connectors described below include both the 90 degree and straight type for use in making up camera cables in any desired length, using bulk camera cable.

Stock Identification	Type	Description
MI-11719-A	Lacing Cord.	Black #6.
MI-26759-A21	Straight Male Camera Cable Connector.	24-contact for use as a cable termination.
MI-26759-A22	Straight Female Camera Cable Connector.	24-contact for use as cable termination.
MI-26759-23	90° Female Camera Cable Connector.	24-contact for use as cable termination. Designed so that cable enters connector at 90° to axis of contact pins.
MI-26759-24	90° Male Camera Cable Connector.	24-contact for use as cable termination. Designed so that cable enters connector at 90° to axis of contact pins.
MI-26759-A41	Dustcap for male cable connector.	2 1/8" dia. x 1 3/32" deep, internal thread, with #10 chain and fastener.
MI-26759-A42	Dustcap for female cable connector.	2 1/8" dia. 1 1/8" deep, internal thread, with #10 chain and fastener.
MI-26759-45	Coaxial Termination. 75 ohm 1%.	Includes single contact coaxial connector plug, terminal assembly with a 1/2 watt, 75-ohm resistor.
MI-26759-48	Straight Female Connector with waterproof jacket.	24-contact for use as microwave cable termination.
MI-26759-49	Gasket for MI-26759-48.	Buna "N" rubber 1/4" square with knitted monel mesh bonded to rubber.
MI-40529-1	Male connector for color camera cable.	82-contact, for use as cable termination.
MI-40529-2	Female connector for color cable.	82-contact—same as above.
MI-40529-3	Male chassis connector.	82-contact for use with a color camera cable connector.
MI-40529-4	Female chassis connector.	Same as above.
MI-40529-5	60° Adaptor.	For color cable chassis connector.
MI-40529-6	Kellum Grip Kit.	For use with MI-40529-1 or 2.



12-Conductor, Power Cable MI-26759-6 supplied with Jones type connectors.

Camera Cable Connectors (Cont.)

Stock Identification	Type	Description
MI-40531-1	Color Cable Adaptor.	For converting color camera from 3-cable connection to single color camera cable connection.
MI-40531-2	Color Cable Adaptor.	For converting camera control position from a three-camera cable input to a single cable input.
MI-40856	Straight Jones Type Connector with plug button.	Dummy plug, 18-contact, for use as jumper unit to make axis shading of processing amplifier operable when shading amplifier is not used.
MI-40857	Dummy plug.	Two plugs replace two camera subchassis when color film camera is used for monochrome only.

Power and Control Cables and Plugs

The cables and connectors described below are available for use as spare units or replacements for those supplied with RCA television studio equipment.

Stock Identification	Power Cable Description	Length
MI-26759-2	2-conductor, vinyl covered, flexible with male plug and female Cannon type connector with dustcap.	10 feet
MI-26759-6	12-conductor, vinyl covered, flexible with male and female Jones type connectors.	34 inches
MI-26759-7	12-conductor, vinyl covered, flexible with male and female Cannon type connectors and dustcaps.	6 feet
MI-26759-8	12-conductor, vinyl covered, flexible with male and female Jones type connectors.	6 feet
MI-26759-41	18-conductor, vinyl covered, flexible with male and female Jones type connectors.	4 feet
MI-26759-42	12-conductor, vinyl covered, flexible with male and female Jones type connectors.	5 1/2 feet
MI-26759-57	8-conductor, vinyl covered, flexible with straight male and 90° female connector.	36 inches

Coax Cable Assemblies

The coaxial transmission line cable assemblies are made available in several different convenient lengths as shown in the accompanying chart. All are durable, vinyl covered, flexible cables with inner conductor and outer shielded conductor.

Stock Identification	Description	Length
MI-26759-12	Coax Cable Assembly with 2 male plugs and dustcaps. Impedance, 75 ohms.	7 feet
MI-26759-13	Same as MI-26759-12.	25 feet
MI-26759-15	Coax Cable Assembly with 2 male plugs and dustcaps. Impedance, 75 ohms.	100 feet

Pulse and Intercom Cables

The pulse and intercom cable assemblies described here are supplied complete with suitable multi-contact connectors and protective dustcaps.

Stock Identification	Description	Length
MI-26759-9	Pulse Cable—8-conductor, neoprene covered, flexible with straight male and female Cannon type connectors and dustcaps.	7 feet
MI-26759-11	Intercom Cable—8-conductor, vinyl covered, flexible, with male and female Cannon type connectors and dustcaps.	7 feet

Sets of Interconnection Cables

The cables listed below are supplied in groups in accordance with the requirements of the indicated video equipment systems.

MI-26730, INTERCONNECTING CABLES FOR TK-31 FIELD CAMERA EQUIPMENT

Includes:

- 1—10 ft., 2-cond., Power Cable with Plugs and Dust-caps, MI-26759-2
- 1—6 ft., 12-cond., Power Cable with Plugs and Dust-caps, MI-26759-7
- 1—7 ft., 8-cond., Pulse Cable with Plugs and Dust-caps, MI-26759-9
- 1—7 ft., 8-cond., Intercom Cable with Plugs and Dust-caps, MI-26759-11
- 1—7 ft., Coaxial Transmission Cable with Plugs and Dust-caps, MI-26759-12

MI-26736, INTERCONNECTING CABLES FOR TG-12A FIELD SYNC GENERATOR

Includes:

- 1—10 ft., 2-cond., Power Cable with Plugs and Dust-cap, MI-26759-2
- 1—100 ft., 4-cond., Power Cable with Plugs, MI-26759-4
- 1—2 ft., 4-cond., Power Cable with Female Plug, MI-26759-5
- 1—7 ft., Transmission Line Cable with Plugs and Dust-cap, MI-26759-12
- 1—Pulse Termination Plug, MI-26759-17

MI-26740-A, INTERCONNECTING CABLES AND FITTINGS FOR TS-30D FIELD SWITCHING EQUIPMENT

Includes:

- 1—10 ft., 2-cond., Power Cable with Plugs and Dust-caps, MI-26759-2
- 1—6 ft., 12-cond., Power Cable with Plugs and Dust-caps, MI-26759-7
- 1—25 ft., Coaxial Transmission Cable, MI-26759-13
- 1—100 ft., Coaxial Transmission Cable, MI-26759-15
- 1—Set of Coaxial Fittings, MI-26759-18

MI-26746, INTERCONNECTING CABLES FOR TK-11B STUDIO CAMERA CONTROL

Includes:

- 1—34 inch., 12 cond., Power Cable with Plugs, MI-26759-6
- 1—64 inch, Coaxial Transmission Line Cable with Plugs, MI-26759-14

Microwave Cable

The Microwave Cables described below are used with the TVM-1B equipment to connect r-f heads and control units for both transmitter and receiver. Cable assemblies are made available in several different convenient lengths as shown in the accompanying chart.

Stock Identification	Type	Description
MI-26725-E11	Microwave Cable with straight male connector and straight female connector with waterproof jacket and gasket.	25-conductor, neoprene covered, flexible, color coded, shielded cable, 3 coax conductors, impedance 50 ohms, ± 2 ohms, 18 conductors of #22 A.W.G. and 4 conductors of #14 A.W.G. with insulation for 1000 v. RMS max. 20 feet long.
MI-26725-E12	Same as MI-26725-E11	Same as above only 50 feet long.
MI-26725-E13	Same as MI-26725-E11	Same as above only 100 feet long.
MI-26725-E14	Same as MI-26725-E11	Same as above only 150 feet long.
MI-26725-E15	Same as MI-26725-E11	Same as above only 200 feet long.
MI-26725-E16	Same as above with 90° male and straight female connector.	6 feet long.
MI-26725-E18	Same as MI-26725-E16	3 feet, 8 inches long.
MI-26759-46	Power Cable 12-conductor, vinyl covered with male and female Cannon type connectors and dust caps.	10 feet long.
MI-26759-54	Power Cable, 3-conductor, vinyl covered with female Cannon type connector and dust cap and MI-26759-55 male polarized plug with a two-prong adaptor and grounding wire.	10 feet long.
MI-40885	Video Cable adaptor kit for TVT-1B Transmitter.	Permits use of RG-11A/U video cable external to control cable when length exceeds 200 feet.
MI-40886	I.F. Cable Kit for TVR-1B Receiver.	Permits use of RG-8/U I.F. cable external to control cable when length exceeds 200 feet.

Bulk Cable and Accessories

The various cables described in the accompanying table are available to the broadcaster in bulk quantities for making TV interconnections in special or nonstandard lengths as desired.

Stock Identification	Type Cable	Approx. Diam.	Characteristics
MI-43D	MICROPHONE CABLE—3-conductor, rubber covered, with outer neoprene covering, flexible.	0.300"	3 conductors of #20 A.W.G. tinned cadmium bronze, stranded for low impedance circuits.
MI-48	PULSE CABLE—8-conductor, rubber covered, flexible with individual color coding.	0.75"	4 coax conductors of 72 ohms impedance and 4 conductors of #16 A.W.G. with insulation for 600 v d-c
MI-74B	COAXIAL CABLE—Type RG-8/U, flexible, vinyl covered. Single inner conductor and outer shield conductor.	0.405"	Impedance 52 ±2 ohms. Normal capacitance 30.5 MMF/ft.; max. operating voltage 4900 RMS.
MI-75	COAXIAL CABLE—Type RG-59A/U, flexible, vinyl covered. Single inner conductor and outer shield conductor.	0.242"	Impedance, 75 ohms. Normal capacitance 20.5 MMF/ft.; max. operation voltage 2300 RMS.
MI-83A	COAXIAL CABLE—Type RG-11A/U, flexible, vinyl covered. Single inner conductor and outer shield conductor.	0.405"	Impedance, 75 ohms. Normal capacitance 20.5 MMF/ft., max. operating voltage 4000 RMS.
MI-94N	CAMERA CABLE—25-conductor, neoprene-covered, flexible, color coded, shielded cable consisting of: (A) 3 coaxial conductors, (B) 18 stranded, tinned copper conductors, and (C) 1 group of 4 tinned copper conductors.	0.83"	Coax conductor impedance, 50 ohms ±2 ohms, 18 conductors of #22 A.W.G. and 4 of #14 A.W.G. with insulation for 1000 v, RMS max.
MI-13307	MICROPHONE CABLE—2-conductor, flexible, shielded, color coded.	0.285"	2 conductors each consisting of 41 strand tinned copper wire .0063" dia. to meet RMS specifications.
MI-13318-A	COAXIAL CABLE—Type RG-58C/U, flexible, vinyl covered.	0.20"	Impedance 50 ohms. Insulation for 1900 v, RMS.
MI-13319	POWER CABLE—18-conductor, rubber-covered, flexible, shielded and individually color coded.	0.590"	16 conductors of #22 A.W.G., 2 conductors of #16 A.W.G. with insulation for 2500 v. RMS, 60 cycles.

Stock Identification	Type Cable	Approx. Diam.	Characteristics
MI-13320	3-V FILM CAMERA CABLE—33-conductor, flexible, rubber-covered, shielded and individually color coded.	0.75"	27 conductors #22 A.W.G., wire jacketed; 4 conductors #22 A.W.G., wire jacketed; and 2 wires, #22 A.W.G., same shielded.
MI-13321	DELAY CABLE—Type RG-65/U, flexible, shielded	0.75"	Impedance 1000 ohms.
MI-13325	COAXIAL CABLE, flexible, double shielded, rubber cover.	0.305"	Impedance 74.99 ohms at 4 mc, normal capacitance 20 MMF/ft., max voltage 4900 RMS.
MI-13334	POWER CABLE, 24-conductor, stranded wire, black vinyl jacket.	0.525"	4 conductors #16 A.W.G., 6 conductors #20 A.W.G., 14 conductors #22 A.W.G. 600 volts RMS.
MI-13341	POWER CABLE, 26-conductor, shielded, black vinyl jacket.	0.625"	5 conductors #16 A.W.G., twisted and shielded overall as a group, 3 pairs #22 A.W.G. each pair shielded, 15 conductors #22 A.W.G.
MI-13380-2	POWER CABLE—2-conductor, flexible, shielded, black vinyl jacket, non-contaminating.	0.420"	2 conductors #14 A.W.G., 600 v, RMS max.
MI-13380-3	POWER CABLE—Same as above except 3 conductors.	0.450"	Same as above except 3 conductors.
MI-13380-4	POWER CABLE—Same as above except 4 conductors.	0.480"	Same as above except 4 conductors.
MI-13380-5	POWER CABLE—Same as above except 5 conductors.	0.540"	Same as above except 5 conductors.
MI-13380-6	POWER CABLE—Same as above except 6 conductors.	0.610"	Same as above except 6 conductors.
MI-13380-8	POWER CABLE—Same as above except 8 conductors.	0.610"	3 conductors #14 A.W.G.; 5 conductors #18 A.W.G.; 600 v, RMS max.
MI-13380-12	POWER CABLE—Same as above except 12 conductors.	0.625"	12 conductors #18 A.W.G.; 600 v. RMS max.
MI-13394	COLOR CAMERA CABLE—82 conductors.	1.24"	67 conductors #22 A.W.G.; 3 conductors #16 A.W.G.; 4 conductors #14 A.W.G.; 8 coaxial cables, Type RG-58C/U, 50 ohms impedance.
MI-40422-A	Crimping Tool (for use with MI-13325 Cable and MI-40423 fittings).		Crimps adaptor to PL-259 connector and sleeve to shield.
MI-40423	Fittings for adapting MI-13325 Cable to PL-259 Connector.		Consisting of 25 pieces each of inner and outer sleeving.

TV MICROWAVE RELAY SYSTEM

TYPE TVM-1B

FEATURES

- High power (1 watt) conduction cooled transmitter klystron tube
- Video frequency response flat within 0 to 0.5 db from 60 cycles to 7 megacycles
- Less than 0.3 degree differential phase and 0.1 db differential gain using 12 db pre-emphasis
- Wide I-F bandwidth provides ultra-stable system—minimizes effects of tube aging
- Removable subchassis construction and numerous circuit test points for easy maintenance
- Provision for multiplexing high quality sound channels
- Transmitter Monitor provides "Off-Air" signal for positive signal quality check

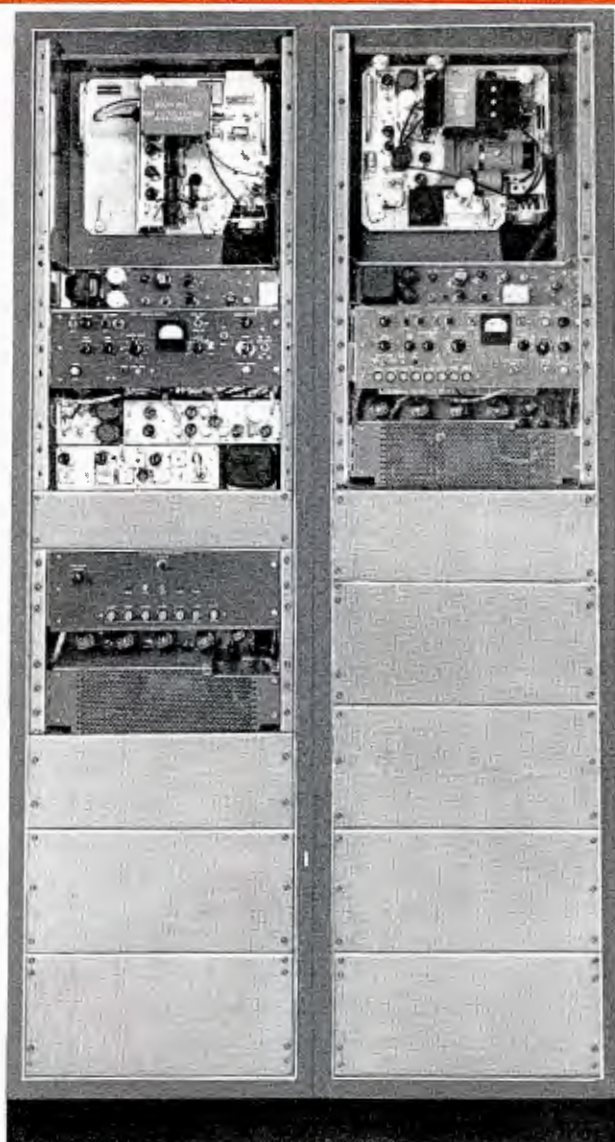

Typical Rack Mounted TVM-1B Microwave Relay Repeater:

TVR-1B Microwave Receiver including AFC/Radiation Switch, MI-26442.

TVT-1B Microwave Transmitter Equipment including Video Presence Detector, MI-26419.

USES

The RCA Type TVM-1B Television Microwave Relay System is a highly reliable, wide-band relay system for transmission of either color or monochrome video signals at frequencies within the range of 5925 to 7425 megacycles. It has been designed to satisfy the rigid requirements of the permanently installed unattended microwave station as well as portable systems. The exceptional stability and transmission fidelity of the system meet the demands of long distance, multiple-hop service as well as single hop applications.

The TVM-1B is used in studio-to-transmitter links (STL), field portable pick-up links, and a variety of inter-city multiple-hop systems applications. Single or multi-channel operation through as many as 12 series hops is possible as a result of the high level of reliability and performance of the TVM-1B equipment. In addition, a complete line of accessories are made available by RCA for reversible, standby, two-way and full diversity service.

Provisions for adding one or two sound channels are available through the use of RCA Type TSD-2B and TSD-3A

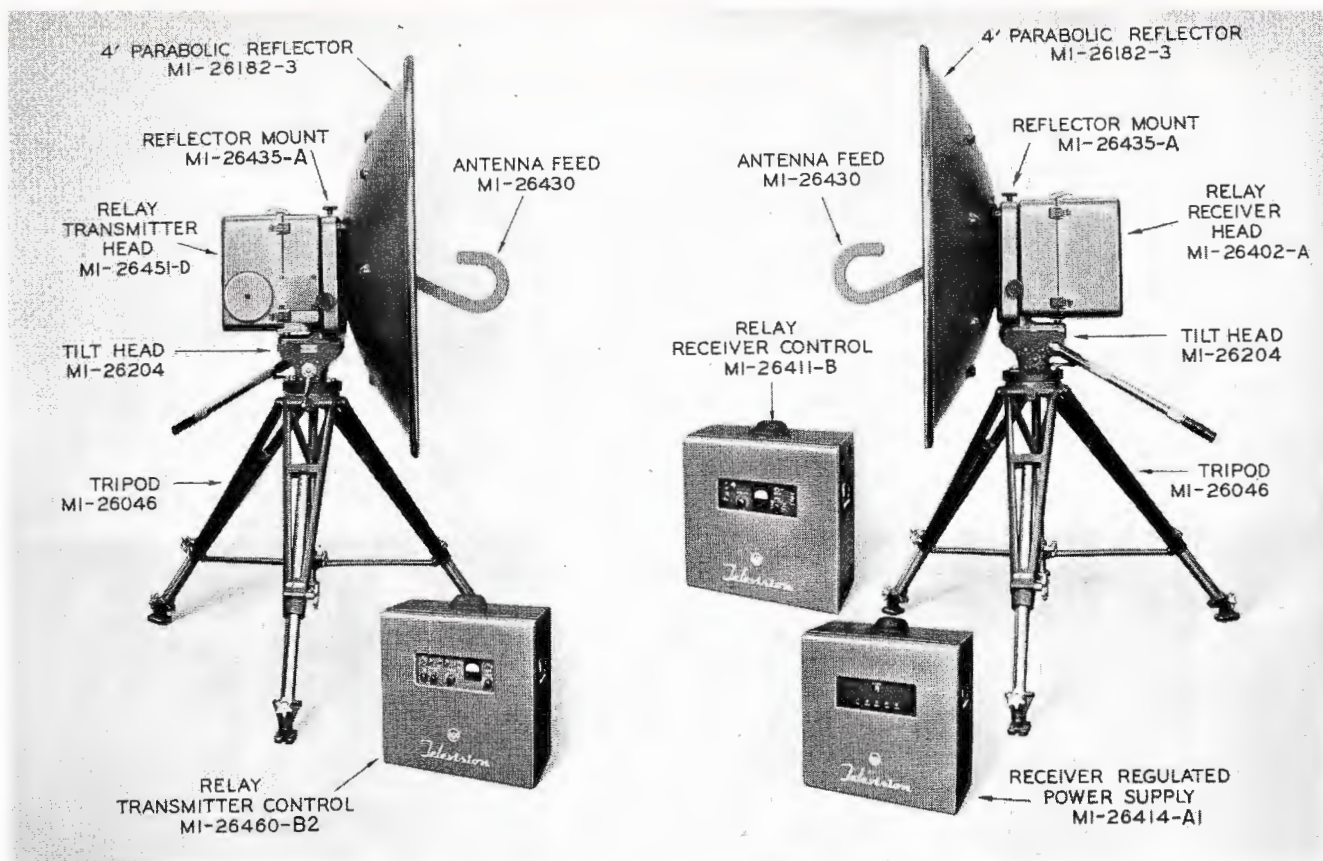

Portable TVM-1B Microwave Relay System.

Sound Diplexers. High quality sound for AM or FM applications may be carried by the TVM-1B simultaneously with TV sound. When used with suitable fault reporting accessories the sound diplexers provide a completely integrated fault reporting system which will maintain a continuous indication of the operation of the system.

SYSTEM DESCRIPTION

The new TVM-1B microwave relay system consists basically of five main units: Transmitter R-F Chassis (MI-26451-D), Transmitter Control (MI-26460-B3), Receiver R-F Chassis (MI-26402-A), Receiver Control (MI-26411-B) and the Receiver Power Supply (MI-26414-A1). The transmitter portion of the system, designated Type TVT-1B, includes the Transmitter R-F Chassis and the Transmitter Control. The receiver portion of the system, designated Type TVR-1B, includes the Receiver R-F Chassis, the Receiver Control and the Receiver Power Supply.

The TVM-1B transmitter provides an average power output of one watt over a frequency range of 5925 to 7425 megacycles. R-F power is generated in the Transmitter R-F Chassis by a conduction cooled klystron oscillator which is frequency modulated by the video signal. At the receiving

point, the R-F carrier is demodulated to the original video signal. The system has been designed for transmission of both color and monochrome television signals with maximum fidelity. Both the transmitter and receiver R-F chassis can be mounted in standard 19-inch cabinet racks by the use of rack mounting adaptors, or in cast aluminum portable cases which can be mounted to the rear of a parabolic reflector on a tripod. If desired, the portable R-F cases may be mounted directly to a tower or building with cable connections to the rack mounted control units. The receiver control chassis and power supply and the transmitter control chassis may be mounted either in a 19-inch rack or in portable carrying cases.

Transmitter R-F Chassis, MI-26451-D

The Transmitter R-F Chassis performs the functions of producing and frequency modulating an R-F signal. R-F energy in the transmitter is developed by a klystron which is cooled conductively by an efficient "heat sink". The use of conductive cooling eliminates the need for a blower in rack mounted installations. Forced air cooling is employed only when the transmitter R-F head is encased in its weather-proof, portable housing, which includes a built-in blower.

The R-F energy is coupled from the klystron to a parabolic antenna by means of waveguide and appropriate waveguide adaptors. The klystron output frequency is controlled by a combination of mechanical adjustment and variation of the d-c voltage applied to the klystron repeller electrode. Modulation voltage developed by the Video Modulator is superimposed upon the d-c repeller voltage, thereby varying this voltage and frequency modulating the R-F output of the klystron. Mechanical adjustment of the klystron frequency is accomplished by varying the penetration of a threaded screw in the waveguide portion of the klystron. This adjustment may be made locally at the transmitter head or remotely by means of a tuning drive motor operated from the Transmitter Control unit.

The video input signal from the Transmitter Control unit is fed to the Video Modulator, which is a shock-mounted sub-chassis of the Transmitter R-F Chassis. The video signal is amplified in three stages and then superimposed upon the klystron d-c repeller voltage. The video modulator chassis also includes a circuit which amplifies the wavemeter markers from a power monitor crystal. Output from this circuit is applied to jacks on the Transmitter R-F Chassis and the Transmitter Control unit for observation on an oscilloscope during transmitter tuning adjustments.

A directional coupler on the main R-F waveguide provides R-F drive and mechanical mounting for a direct frequency indicating wavemeter (MI-26405). The wavemeter is detachable to permit its use at other locations when required. A second directional coupler provides R-F drive to a waveguide discriminator which feeds the optional Automatic Frequency Control and Video Monitor units. The main R-F waveguide includes a solenoid-driven radiation attenuator

Transmitter R-F Chassis showing monitor, video modulator AFC Cavity and klystron heat sink and cover.

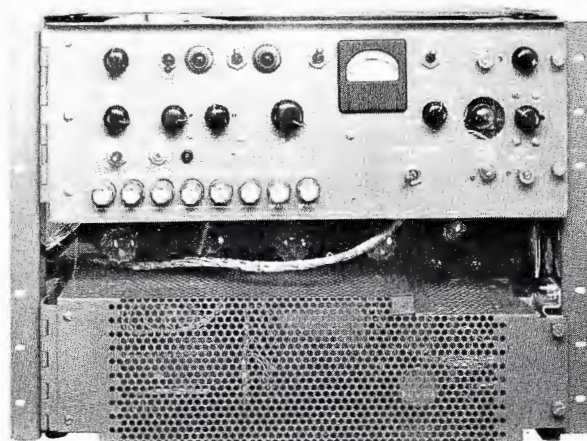
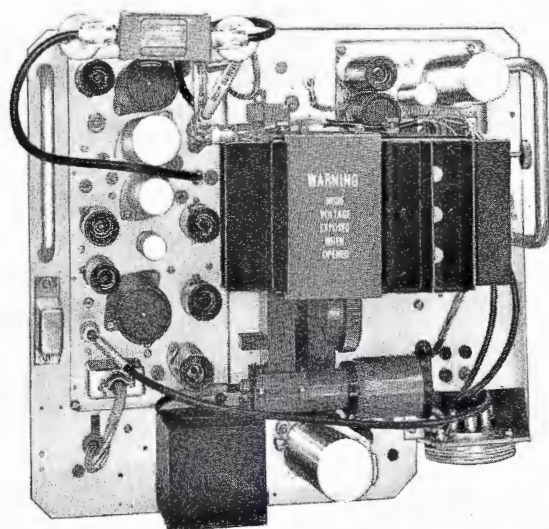

Transmitter Control Unit, MI-26460-B3.

which inserts approximately 45 db of attenuation in the output waveguide section to block radiation during tuning adjustments or "stand-by" periods.

An intercommunication circuit is provided in the control cable between the Transmitter R-F Chassis and Transmitter Control Chassis. A 117-volt a-c convenience outlet is provided at the Transmitter R-F Chassis for use of a soldering iron or test equipment.

Transmitter Control, MI-26460-B3

The Transmitter Control Unit contains the operating controls of the TVM-1B Transmitter equipment and provides a-c and d-c power to the Transmitter R-F Chassis through an interconnecting cable. The power supply portion of this unit is identical to the Receiver Power Supply, with the addition of panels containing transmitter operating controls. The Transmitter Control circuit includes a pre-distortion network which is used to reduce the amplitude of the high energy components of the luminance signal between 15 and 300 kc prior to modulation. This provides a substantial improvement in differential phase and gain performance. Either 8 or 12 db of pre-emphasis can be supplied; the 12 db network (MI-26498-2) is recommended for systems with more than three hops. A de-emphasis network with a reverse attenuation characteristic is provided in the receiver to restore the overall system output to a flat video amplitude-frequency response. A similar de-emphasis network is included in the optional Transmitter Monitor Unit.

The TVM-1B Transmitter controls, connectors, and fuses are located on a hinged panel on the front of the control unit. A "Line Volt Adjust" tap switch provides compensation for variations in power line voltage over the range of 99 to 141 volts. A switch and pilot light provide remote control and status indication of the radiation attenuator

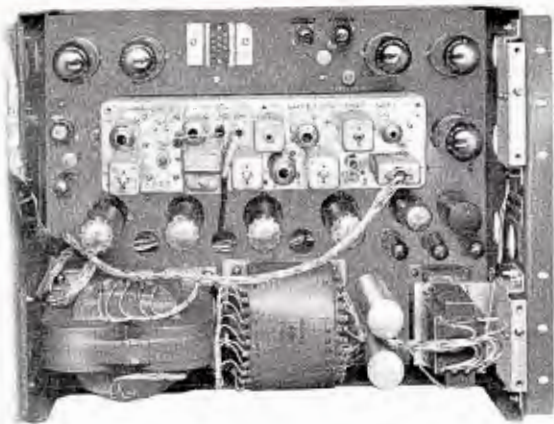

Transmitter Control, front view, panels open.

located in the Transmitter R-F Chassis. A modulation selector switch is used to apply a 60 cycle signal to the input of the Video Modulator circuit for alignment and test purposes. A calibrated step attenuator provides adjustment of the video modulation level over a range of 15 db in $\frac{1}{2}$ db steps. A meter and nine-position meter selector switch provide a convenient check of critical currents and voltages. A two-position momentary contact switch controls the klystron cavity tuning motor in the Transmitter R-F Chassis. Six fuses for protection of transmitter control circuits in addition to two spare fuses are located on the panel for quick access. Audio and video inputs, a-c power connections and the control cable connector are located on the rear of the unit.

Receiver R-F Chassis, MI-26402-A

The Receiver R-F Chassis accepts the transmitter R-F signal and produces an I-F signal which is amplified and fed to the Receiver Control Chassis. The incoming R-F signal from the antenna waveguide is directed to the mixer crystals. R-F output from the klystron local oscillator (130 mc above the incoming R-F) is also directed through a waveguide to the mixer crystals to develop an I-F frequency of 130 megacycles. A balanced mixer is used, resulting in a high degree of cancellation of local oscillator noise.

The receiver klystron frequency is adjustable both mechanically and electrically. The mechanical (klystron cavity) adjustment is performed manually at the Receiver R-F Chassis. The electrical adjustments (klystron repeller voltage) are controlled remotely from the Receiver Control unit. An I-F Preamplifier Subchassis, MI-26480-C, is included in the Receiver R-F Chassis to amplify the I-F signal.

The Receiver R-F Chassis is ruggedly constructed with all components mounted to a vertical aluminum plate. Other features include a 117-volt convenience outlet and an intercommunication circuit terminated in jacks at the Receiver R-F Chassis and the Receiver Control Chassis.

Receiver Control, MI-26411-B

The Receiver Control Unit amplifies and demodulates the I-F signal and contains operating controls for the Receiver R-F Chassis. A seven stage I-F Amplifier, MI-26481-B, increases the signal level from the Receiver R-F Chassis and applies it to the Limiter-Discriminator unit, MI-26482-B. Video output from the discriminator is amplified by the Video Amplifier unit, MI-26483-C. This amplifier provides two independent video output channels with separate amplitude controls for each.

The video signal from the discriminator is passed through a restoration network and a level control prior to being fed into the video amplifier. The restoration network provides the high frequency de-emphasis required to restore the amplitude frequency response of the microwave system to a flat condition. Restoration Network, MI-26497-1 is designed to operate with the 8 db Predistortion Network, MI-26498-1.

An Automatic Frequency Control Unit, MI-26643-A, is included in the Receiver Control Chassis. Any shift in frequency from the I-F center value will develop a proportionate d-c error voltage in the discriminator circuit of the Limiter-Discriminator unit. This voltage is applied to the input of the Automatic Frequency Control unit which then supplies a suitable correction voltage to the repeller (frequency control) electrode of the klystron local oscillator.

An outstanding feature of the TVM-1B microwave equipment is the unusually broad bandwidth of the receiver I-F system which contributes to overall performance stability in several ways. The response of the I-F circuits is essentially flat over a 30 megacycle bandwidth, allowing a

Receiver Head, front view with klystron cover removed.

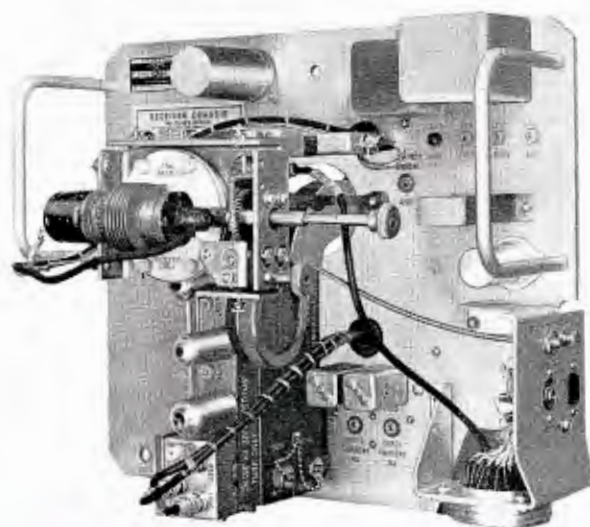

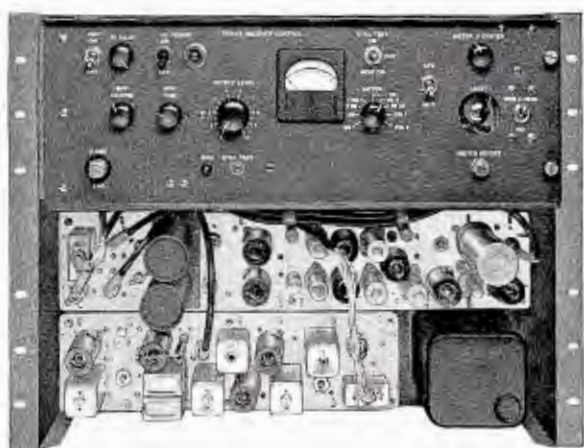

Receiver Control Unit, MI-26411-B.

substantial margin of bandwidth reserve for the handling of a 7 megacycle video signal. This minimizes degradation of the video output signal as a result of minor adjustment errors in tuning or modulation level, and the effects of temperature change or tube aging. In addition, this wide bandwidth stabilizes the receiver's tuning adjustments and permits trouble-free, unattended operation over indefinite periods of time.

The Receiver Control adjustments and controls include an AGC On-Off switch, an I-F gain control and an Automatic/Manual Frequency Control switch. A meter and nine-position meter switch are provided for observation of the AFC control voltage and other operating currents and voltage. Audio and video outputs, a phone jack for an intercommunication handset and power supply cable connections are located on the rear of the unit.

Receiver Control, front view, with panel open.

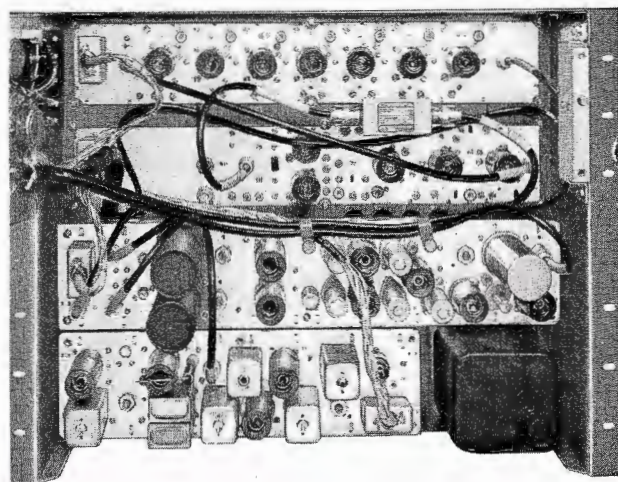

Receiver Power Supply, MI-26414-A1

The Receiver Power Supply furnishes a-c and regulated d-c power to the Receiver R-F Chassis and Receiver Control Chassis. The unit is essentially the same as the power supply portion of the Transmitter Control Chassis with the exception of the front and rear panels. Appropriate internal plug connections enable it to supply the required filament and regulated plate and bias voltages for the Receiver R-F Chassis and Receiver Control Unit. A line voltage tap switch permits operation over an a-c voltage range from 99 to 141 volts. The circuits of the unit are protected by five fuses mounted on the front panel along with two spare fuses.

Microwave Portable Housings

The five basic units of the TVM-1B Microwave Relay System may be housed in five rugged, lightweight portable housings for field use. The Transmitter and Receiver R-F Heads may be installed in a pair of weatherproof, cast



Receiver Power Supply, MI-26414-A1.

aluminum R-F Cases, MI-26471-B and MI-26470 respectively. The rear section of each R-F case is hinged to provide free access to the chassis units for service. A waterproof seal, in addition to a waterproof cable connector, prevent entry of moisture under outdoor operating conditions. R-F gaskets provide thorough protection against interference due to high intensity r-f fields.

The Transmitter Control, Receiver Control and Receiver Power Supply may be mounted in three identical, attractive suitcase type portable housings, MI-26417-D. A rectangular opening in the front of the housing provides access to the operating controls and meters. All cable interconnections are made through another opening at the rear. A quiet operating, low noise blower mounted at the top of the fieldcase provides adequate ventilation.

TVM-1B MICROWAVE RELAY SYSTEM ACCESSORIES

The RCA Type TVM-1B Microwave Relay System is supplemented by a line of accessory items designed for use in either permanently rack-mounted or portable applications. These items are offered by RCA to further implement and expand the basic Type TVM-1B system. Since the need for these units is subject to the requirements of individual installations, they are made available on an optional basis. They are readily integrated into the basic TVM-1B system and may be added to existing installations as the need occurs.

Transmitter Monitor Amplifier, MI-26644-C

The Transmitter Monitor Amplifier, MI-26644-C, has been designed to provide an "off-air" signal from the TVT-1B Microwave Transmitter for a picture or waveform display or for test purposes. When used with a picture monitor, it enables observation of the exact video signal which is being transmitted. The unit may be easily and quickly installed in a "cutout" provided in the Transmitter R-F Chassis.

The source of input signal for this unit is the transmitted R-F energy in the waveguide portion of the Transmitter R-F chassis. Through the use of a balanced discriminator circuit in the waveguide assembly, the actual "on-the-air" signal is detected and fed through a short section of coax cable to the input terminal of the amplifier. The video signal is amplified and fed through the interconnecting control cable to the Transmitter Control Unit where it is brought out on a jack. At this point it is possible to accurately measure the quality of the transmitted signal (differential phase, and differential gain, etc.). Due to the exclusive "Off-the-air" feature, and because of rigidly designed video amplifier circuitry in the monitor, the monitor output signal is truly representative of the transmitted R-F signal. Aside from its use as a picture source, therefore, the Transmitter Monitor Amplifier is an indispensable tool for use in transmitter trouble shooting.

An AFC/Monitor Cavity (MI-26645) is required for use with the Transmitter Monitor Amplifier. This cavity comprises the tunable portion of the waveguide discriminator which feeds the amplifier. In addition, the use of an 8 db or 12 db de-emphasis network is required between the first and second stages of the amplifier in order to compensate for pre-emphasizing in the transmitter and to restore the video amplitude frequency response. Either the 8 db de-emphasis network (MI-26497-1) or the 12 db de-emphasis network (MI-26497-2) may be conveniently installed in its proper location in the circuit through the use of coaxial connectors provided.

Transmitter Automatic Frequency Control Unit, MI-26643-A

The use of the Transmitter AFC Unit, MI-26643-A will improve the frequency stability of the TVT-1B transmitter from .05% to .02%. Its lightweight construction permits rapid installation in the front of the Transmitter Control unit directly behind the hinged front control panel.

The source of input signal for this unit, as in the case of the Transmitter Monitor Amplifier (MI-26644-C) is the transmitted R-F energy in the waveguide portion of the Transmitter R-F chassis (MI-26451-D). The output from the transmitter waveguide discriminator circuit is fed to the input of the AFC unit. Variations in the frequency of the transmitter R-F carrier will produce either a positive or negative error voltage which is used to establish the phase of a 100 KC signal in the AFC unit. The resulting signal is amplified and compared to a phase reference. The d-c output of this "phase comparator" circuit will, when fed to the repeller of the transmitter klystron, correct any off-frequency condition of the tube.

The Transmitter AFC unit is identical with the receiver AFC unit supplied as part of Type TVR-1B Receiver Control. An AFC/Monitor Cavity (MI-26645) is required for use with the Transmitter AFC unit to tune the waveguide discriminator which supplies the required input signal.

AFC/Monitor Cavity, MI-26645

The AFC/Monitor Cavity (MI-26645) comprises the tunable portion of the TVT-1B transmitter and is designed as an accessory unit for the Type TVM-1B waveguide discriminator and is required as a companion unit for either the Transmitter Monitor Amplifier (MI-26644-C) or the Transmitter AFC Unit (MI-26643-A). In the event either of these two accessory items is used (AFC unit or Monitor Amplifier) the other may be added without the necessity of supplying another cavity.

Designed for rapid and easy installation, the AFC/Monitor Cavity may be quickly installed on the transmitter R-F waveguide assembly by securing four bolts supplied with the unit. A vernier "drum type" tubular outer shell is provided with a quick reference scale for easy tuning. A calibration chart supplied with the cavity facilitates rapid frequency adjustments.

Transmitter Video Cable Kit, MI-40885

The Transmitter Video Cable Kit (MI-40885) permits the use of a separate 75 ohm coaxial cable for the video feed from the TVT-1B Transmitter Control Unit to the Transmitter R-F Chassis. The Video Cable Kit is recommended for installation where the Transmitter R-F Chassis and

Transmitter Control unit are interconnected by 200 feet or more of control cable. The use of an external Type RG-11/U (MI-83A) cable minimizes the possibility of a-c hum pick-up and reduces the video cable loss, increasing both the overall signal-to-hum and signal-to-noise ratios for the TVM-1B system.

Receiver I-F Cable Kit, MI-40886

The Receiver I-F Cable Kit (MI-40886) permits the use of a separate 50 ohm coaxial cable between the I-F Pre-amplifier located in the Receiver R-F Chassis and the I-F Amplifier located in the Receiver Control Unit. The I-F Cable Kit is recommended for use in applications where

the Receiver R-F Case and the Receiver Control are interconnected by 200 feet or more of control cable. The use of a separate coaxial cable, type RG-8/U (MI-74A) will reduce the I-F cable loss from approximately 5.5 db per 100 feet to 2.5 db per 100 feet.

Video Cable Equalizer, MI-26721

The Video Cable Equalizer (MI-26721) has been designed to compensate for high frequency roll-off in long runs of microwave control cable. The compact equalizer is readily inserted in the video line at the input to the Transmitter Control Unit. A convenient switch included in the equalizer permits selection of proper equalization for cable lengths of either 100 or 200 feet.

SPECIFICATIONS

Performance Specifications—TVM-1B System

Video

Amplitude Frequency Response (without sound diplexing).....60 cycles to 7 mc; flat within 0.5 db

Amplitude Frequency Response (with sound diplexing).....60 cycles to 3.7 mc; within +0, -1 db
60 cycles to 4.5 mc; with +0, -3 db

Differential Gain:

No De-emphasis.....0.5 db

8 db De-emphasis.....0.25 db

12 db De-emphasis.....0.1 db

Differential Phase (3.58 mc):

No De-emphasis.....3°

8 db De-emphasis.....1°

12 db De-emphasis.....0.3°

Synchronizing Signal Compression.....Negligible

Low Frequency Square Wave Response.....Less than 1% tilt at 60 cycles

Antenna Gain, Approximate, at either transmitter or receiver:

With 4-foot Reflector.....5,000

With 6-foot Reflector.....11,000

Audio (Using TSD-2B or TSD-3A Sound Diplexing System)

Amplitude-Frequency Response.....50-13,000 cps +0, -1 db
50-15,000 cps +0, -2 db

Harmonic Distortion.....Less than 1%, 50-15,000 cps at 14 dbm output

Noise (Referred to +14 dbm Output of 1 kc).....Less than -65 db

TVT-1B Transmitter Specifications

Frequency Range.....5925 to 7425 mc

Power Output.....0.7 to 1.3 watt, 1 watt average

Video Input Level.....0.75 to 4.0 volts, peak-to-peak composite (adjustable by modulation level control)

Video Input Impedance.....75 ohms

Video Output (Using Transmitter Monitor):

Output Impedance.....75 ohms

Output Level.....1.5 volts peak-to-peak

Differential Gain:

No De-emphasis.....0.5 db

8 db De-emphasis.....0.25 db

12 db De-emphasis.....0.1 db

Differential Phase (3.58 mc):

No De-emphasis.....3°

8 db De-emphasis.....1°

12 db De-emphasis.....0.3°

Synchronizing Signal Compression.....Negligible

Low Frequency Square Wave Response.....Less than 1% tilt at 60 cycles

Amplitude Frequency Response.....60 cycles to 7 mc; flat within 0.5 db

Frequency Deviation.....6 mc peak-to-peak (nominal)

Video Pre-emphasis.....8 db or 12 db

AC Power Requirements.....117 volts nominal, 50/60 cycles, 465 watts (line voltage tap switch covers 99 to 141 volt range)

Audio Input (Using TSD-2B or TSD-3A Sound Diplexer Modulator):

Impedance.....150/600 ohms, balanced or unbalanced

Level.....0 dbm minimum

TVR-1B Receiver Specifications

Frequency Range.....5925 to 7425 mc

Local Oscillator Frequency.....Transmitter Frequency plus 130 mc

I-F Center Frequency.....130 mc

I-F Bandwidth, Nominal.....30 mc

Noise Figure.....12 db nominal (13 db maximum)

Normal Deviation for 1.5 Volts Peak-to-peak Output.....6 mc

Video Outputs.....2 at 1.5 volts peak-to-peak;
1 at 0.5 volt peak-to-peak

Video Polarity.....Sync Negative

Video Output Impedance.....75 ohms

Video De-Emphasis.....8 db or 12 db

Power Supply Requirements.....117 volts nominal, 50/60 cycles, 530 watts (line voltage tap switch covers 99 to 141 volt range)

Audio Output (Using TSD-2B or TSD-3A Sound Diplexer Demodulator):

Impedance.....150/600 ohms, balanced or unbalanced

Level.....0 to 14 dbm, variable

Tube Complement

Transmitter R-F Chassis, MI-26451-D.....1-VA-222, 1-1N160

Transmitter Control, MI-26460-B3.....4-5U4-G, 6-6080, 2-6AU6,
3-12AX7, 1-5Y3-GT, 2-OA2, 1-OB2

Receiver R-F Chassis, MI-26402-A.....1-VA-221, 1-1N150, 1-1N150R

Receiver Control, MI-26411-B.....1-12AX7

Receiver Power Supply, MI-26414-A1.....4-5U4-G, 5-6080, 2-6AU6,
1-OB2, 2-12AX7, 1-5Y3-GT, 2-OA2

Automatic Frequency Control,
MI-26643-A.....3-12AX7, 1-12AU7, 1-6AL5

Transmitter Monitor, MI-26644-C.....1-OA2, 2-6688, 1-2C51, 1-5687

Monitoring/AFC Cavity Equipment, MI-26645.....1-1N160, 1-1N160R

Sound Diplexer Modulator,
MI-26443-B or MI-26493-A.....3-6U8, 1-6CL6, 1-6AL5,
1-5Y3, 1-OA2, 1-6AU6

Sound Diplexer Demodulator,
MI-26444-B or MI-26494-A.....5-6AU6, 2-12AU7, 1-6AL5,
1-OA2, 1-5Y3

Video Modulator, MI-26479-C.....2-6688, 1-OA2, 1-6197,
1-12AX7, 1-1N649

I-F Preamplifier, MI-26480-C.....1-417A, 3-6688

Limiter/Discriminator, MI-26482-B.....1-5-6688, 2-1N277,
1-1N160, 1-1N160R, 2-1N252, 1-1N1507

Video Amplifier, MI-26483-C.....2-2C51, 2-5687, 3-6688

SPECIFICATIONS (Continued)

Mechanical Specifications

Dimensions (Overall)	High	Wide	Deep
Transmitter R-F Chassis (in rack adaptor)....	17½"	19"	13"
Transmitter R-F Chassis (in portable housing)	16¾"	20½"	14½"
Transmitter Control (rack mountable).....	14"	19"	8½"
Transmitter Control (in carrying case).....	23"	21"	10¼"
Receiver R-F Chassis (in rack adaptor).....	17½"	19"	13"
Receiver R-F Chassis (in portable housing)....	16¾"	17¼"	14½"
Receiver Control (in carrying case).....	23"	21"	10¼"
Receiver Control (rack mountable).....	14"	19"	8½"
Receiver Power Supply (in carrying case).....	23"	21"	10¼"
Receiver Power Supply (rack mountable).....	14"	19"	8½"

Weight:

MI-26451-D Transmitter Portable R-F Chassis.....	25¼ lbs.
MI-26471-B Portable Housing for Transmitter R-F Chassis.....	23¾ lbs.
MI-26460-B3 Transmitter Control (without case).....	51¾ lbs.
MI-26417-D Field Case for Transmitter Control.....	16¾ lbs.
MI-26402-A Receiver R-F Chassis (without housing).....	17¼ lbs.
MI-26470 Portable Housing for Receiver R-F Chassis.....	23¾ lbs.
MI-26411-B Receiver Control (without case).....	38 lbs.
MI-26414-A1 Receiver Power Supply (without case).....	44¼ lbs.
MI-26417-D Field Case for Receiver Control and Power Supply (two required).....	16¾ lbs.

Equipment Supplied

TVM-1B Rack Mounted Microwave Relay System

TVT-1B Rack Mounted Transmitter System, Including:

1 Transmitter R-F Chassis.....	MI-26451-D
1 Transmitter Rack Mount.....	MI-26449-A
1 Klystron, VA-222	MI-26874-*
1 Transmitter Control	MI-26460-B3
1 Power Cable (10').....	MI-26759-54
1 Frequency Meter	MI-26405
1 Waveguide Adaptor	MI-26462

(* Specify appropriate suffix depending on frequency. (See list below.)

TVR-1B Rack Mounted Receiver System, Including:

1 Receiver R-F Chassis.....	MI-26402-A
1 Receiver Rack Mount.....	MI-26448-A
1 Klystron, VA-221	MI-26404-*
1 Receiver Control	MI-26411-B
1 Receiver Power Supply.....	MI-26414-A1
1 Power Cable (10').....	MI-26759-54
1 Interconnecting Cable	MI-26759-46
1 Waveguide Adaptor	MI-26462

(* Specify appropriate suffix depending on frequency. (See list below.)

KLYSTRON FREQUENCY RANGES

Receiver Type Klystron Tubes:

VA-221-B for Government Band, 7255-7555 mc*.....	MI-26404-1
VA-221-C for STL Band, 6955-7255 mc*.....	MI-26404-2
VA-221-D for STL Band, 6705-7005 mc*.....	MI-26404-3
VA-221-E for Common Carrier Band, 6285-6585 mc*	MI-26404-4
VA-221-F for Common Carrier Band, 5985-6285 mc*	MI-26404-5
VA-221-G for Fixed & Mobile Band, 6585-6705 mc*	MI-26404-6

Transmitter Type Klystron Tubes:

VA-222-B for Government Band, 7125-7425 mc.....	MI-26874-1
VA-222-C for STL Band, 6875-7125 mc.....	MI-26874-2
VA-222-D for Fixed & Mobile Band, 6575-6875 mc.....	MI-26874-3
VA-222-E for Common Carrier Band, 6125-6425 mc.....	MI-26874-4
VA-222-F for Common Carrier Band, 5925-6225 mc.....	MI-26874-5
VA-222-G for Fixed & Mobile Band, 6425-6575 mc.....	MI-26874-6

* Note: Frequency range indicated above for Receiver Klystrons is klystron oscillator frequency which is 130 megacycles above carrier frequency.

TVM-1B Portable Microwave Relay System

TVT-1B Portable Transmitter System, Including:

1 Transmitter R-F Chassis.....	MI-26451-D
1 Transmitter R-F Case.....	MI-26471-B
1 Klystron, VA-222	MI-26874-*
1 Transmitter Control	MI-26460-B3
1 8 db Pre-emphasis Network.....	MI-26498-1
1 Control Carrying Case.....	MI-26417-D
1 Power Cable (10').....	MI-26759-54
1 Reflector Mount	MI-26435-A
1 Frequency Meter	MI-26405

(* Specify appropriate suffix depending on frequency. (See list below.)

TVR-1B Portable Receiver System, Including:

1 Receiver R-F Chassis.....	MI-26402-A
1 Receiver R-F Case.....	MI-26470
1 Klystron, VA-221	MI-26404-*
1 Receiver Control Unit.....	MI-26411-B
1 8 db De-emphasis Network.....	MI-26497-1
1 Receiver Power Supply.....	MI-26414-A1
2 Receiver Control and Power Supply Carrying Case.....	MI-26417-D
1 Power Cable (10').....	MI-26759-54
1 Interconnecting Cable (10').....	MI-26759-46
1 Reflector Mount	MI-26435-A

(* Specify appropriate suffix depending on frequency. (See list below.)

Note 1: Order one of the following cables for interconnection between Transmitter R-F Chassis and Transmitter Control and one cable for interconnection between Receiver R-F Chassis and Receiver Control:

MI-26725-E18 Control Cable, 3 feet
MI-26725-E16 Control Cable, 6 feet
MI-26725-E11 Control Cable, 20 feet
MI-26725-E12 Control Cable, 50 feet
MI-26725-E13 Control Cable, 100 feet*
MI-26725-E14 Control Cable, 150 feet*
MI-26725-E15 Control Cable, 200 feet*

* If cable is 100 feet or longer, order MI-26721 Cable Equalizer.

Note 2: Pre-emphasis and de-emphasis networks are included in the Portable TVM-1B Microwave System but must be ordered separately for the rack mounted system. Order 1 each MI-26498-1 Network for the transmitter at the first station and 1 each MI-26497-1 for the receiver at the last station in installation of up to 3 hops. Order 1 each MI-26498-2 Network for the transmitter at the first station and 1 each MI-26497-2 Network for the receiver at the last station in installations of 4 or more hops. Order 1 De-emphasis Network (MI-26497-1 or MI-26497-2) for each Transmitter Monitor. Networks are not required at repeater stations unless it is desired to take out or insert video at the repeater.

Accessory Equipment

Transmitter Monitor Amplifier.....	MI-26644-C
Transmitter AFC Unit.....	MI-26643-A
Monitor/AFC Cavity	MI-26645
TSD-2B Sound Diplexer Modulator (6.8 mc subcarrier).....	MI-26443-B
TSD-2B Sound Diplexer Demodulator (6.8 mc subcarrier).....	MI-26444-B
TSD-3A Sound Diplexer Modulator (6.2 mc subcarrier).....	MI-26493-A
TSD-3A Sound Diplexer Demodulator (6.2 mc subcarrier).....	MI-26494-A
Pre-emphasis Network, 8 db.....	MI-26498-1
De-emphasis Network, 8 db.....	MI-26497-1
Pre-emphasis Network, 12 db.....	MI-26498-2
De-emphasis Network, 12 db.....	MI-26497-2
Intercom Headset, Single Earphone.....	MI-11743
Video Cable Adaptor Kit for TVT-1B Transmitter.....	MI-40885
I-F Cable Adaptor Kit for TVR-1B Receiver.....	MI-40886
Video Cable Equalizer.....	MI-26721

Note: See separate catalog pages for microwave antennas, waveguide, mounting equipment and multihop control equipment.

MICROWAVE ANTENNAS & MOUNTS

For TVM-1B Microwave Systems



FEATURES

- Complete line of antenna equipment for variety of system applications
- Spun aluminum, close tolerance parabolic reflectors provide high antenna system gain
- Antenna feeds permit horizontal or vertical polarization
- Sturdy, weather resistant mounts for all installation requirements
- Designed for ease of assembly and installation

USES

RCA's Microwave Antennas are designed for use with the RCA Type TVM-1B Microwave Relay Equipment in television relay service. By means of parabolic reflectors, substantial system gains can be achieved, depending on size. The antennas, together with the associated Type RG-50/U Waveguide, maintain a maximum VSWR of 1.10 or better and comply with applicable EIA standard.

Antennas are available for any type of transmission system—studio-transmitter link, remote portable, or multihop systems. A variety of parabolic reflector sizes are available, ranging in size from four to ten feet for permanent installations, and from two to six feet for portable systems. A wide selection of microwave passive reflectors are available. The reflectors enable the parabolic antenna to be located near the ground level below the passive reflector, thus eliminating the need for long waveguide runs required if the parabolic antennas were mounted at the top of a tower.



RCA parabolic reflectors shown at a typical microwave repeater station.

In addition, RCA offers a single source of supply for complete microwave systems including towers, prefabricated steel, concrete, or cinder block buildings, auxiliary power equipment, tower light controls, and other special equipment. RCA representatives are prepared to assist in microwave system design and determining transmission path requirements.

Parabolic Antennas and Mounts

Microwave Parabolic Antennas for the RCA TVM-1B Microwave equipment are available for three types of systems: (a) permanently installed systems, in which RF and control equipment is rack mounted; (b) permanently installed systems, in which control equipment is rack mounted, and RF head units are mounted on the antenna parabola; and (c) portable systems.

ANTENNAS FOR PERMANENTLY INSTALLED RACK MOUNTED SYSTEMS

Antennas for rack mounted systems are available in 4-foot, 6-foot, 8-foot, and 10-foot diameter parabolas, complete with antenna feed. Each size parabola is available with mounting hardware for mounting the antenna vertically on a tower leg or standard 4-inch pipe mast or support; or either horizontally or vertically on a flat mounting surface, such as a wall or roof. The antenna feeds can be installed or removed from the rear of the parabola and are pressure tight. They have provision for continuous polarization adjustment, and are equipped with guy wires for mechanical stability. All feeds are equipped with a UG-343A/U waveguide choke flange.

The parabolic reflectors are of solid surface, spun aluminum, constructed to close surface tolerance for excellent

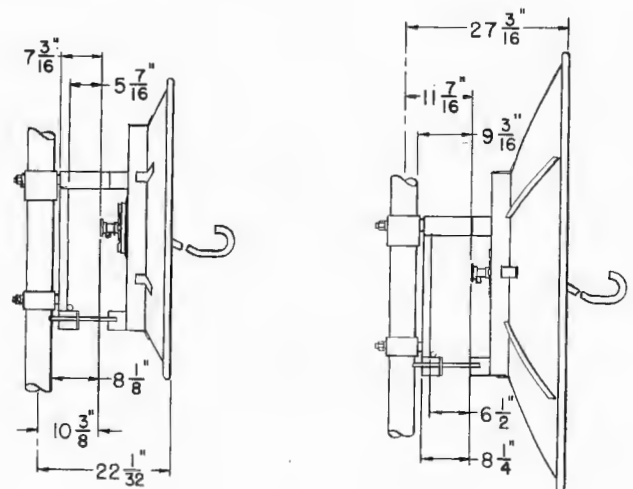
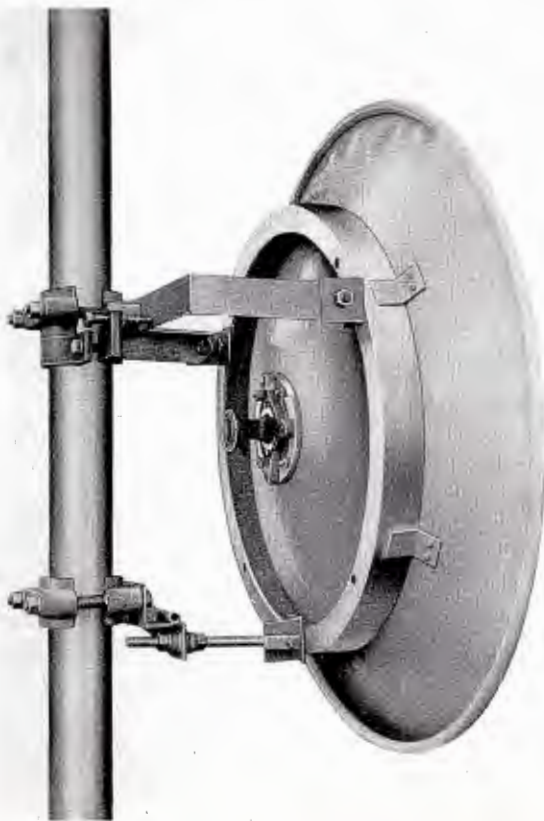

Four-foot Parabolic Antenna, MI-26395-A1 or A3 shown at left on Type T4 Tower Mount. Outline dimensions for 4 and 6-foot antennas MI-26395-A1, A2, A3 and A4 above.

control of sidelobe tolerance, polarization discrimination, and gain. The 4-foot and 6-foot antennas have identical mounting rings on the rear of the parabola. These mounting rings have seven 7/8-inch holes for a three point or a four point mounting.

The Type T4 Tower Mount is a three point suspension unit designed to mount a 4-foot or 6-foot parabola to a 4-inch pipe support or tower leg. The mount includes two hinge points and one threaded adjustable arm for elevation adjustment of ± 5 degrees. Azimuth adjustment is provided by the rotation of the mount on the support. The T4 mount can adequately support a 6-foot parabola with wind load of 40 pounds and one inch of radial ice. All brackets are galvanized and studs are of stainless steel or are treated for corrosion resistance.

The Type M4 Mount is designed to mount a 4-foot or 6-foot parabola to a flat surface, and consists of three ball socket assemblies and three "U" shaped support brackets. The ball sockets attach to the parabola mounting ring with eccentric studs, and the assembly is adjustable at all three ball joints. The M4 mount provides for adjustment of azimuth and elevation of ± 5 degrees. The threaded studs provide smooth, positive motion, ease of alignment, and keep the parabola physically secure during adjustment. All parts are corrosion resistant.

The 8-foot and 10-foot antennas have identical mounting rings on the rear of the parabola. These mounting rings have eight 13/16-inch holes on a 43 1/4-inch diameter.

The T8A tower mount is a three point suspension unit designed to mount an 8-foot or 10-foot parabola to a 4-inch pipe support or tower leg. The center of the parabola is

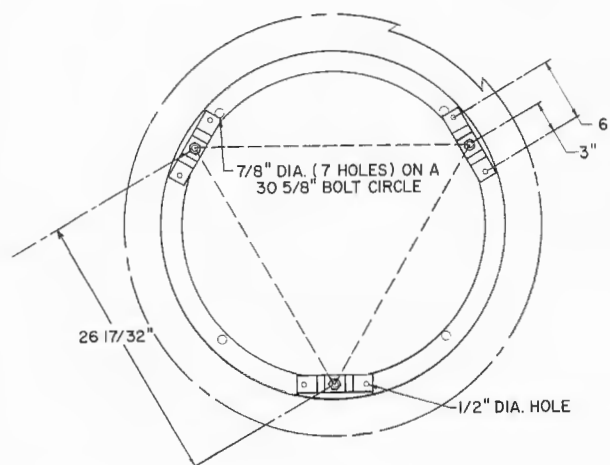
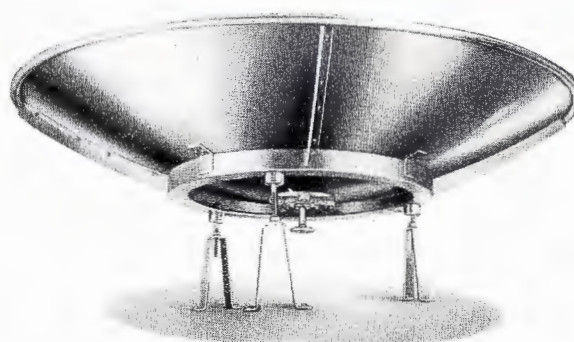

MI-26395-B Series of 4 or 6-foot Antenna on Type M-4 Mount and outline drawing shown above.

8 or 10-foot Parabolic Antenna, MI-26495-A Series mounted on T8A Tower Mount shown below with outline drawing.

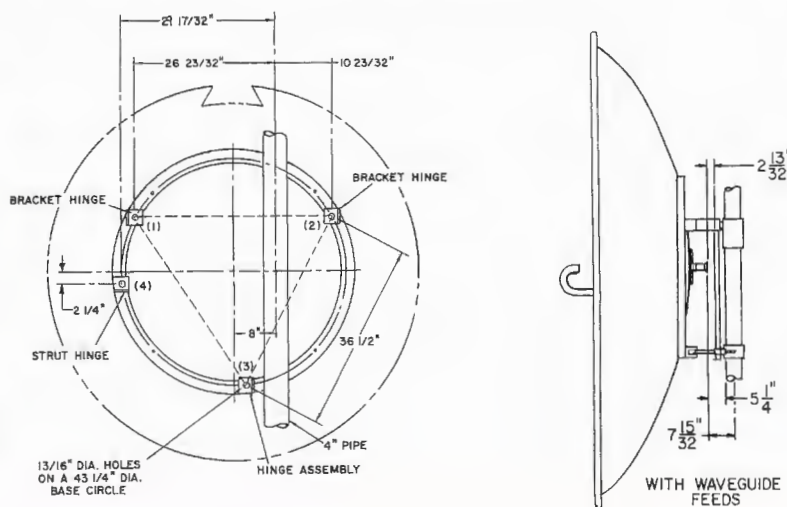

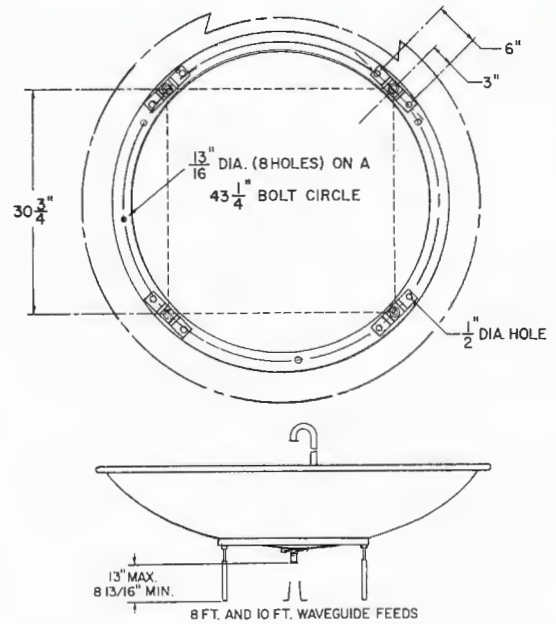
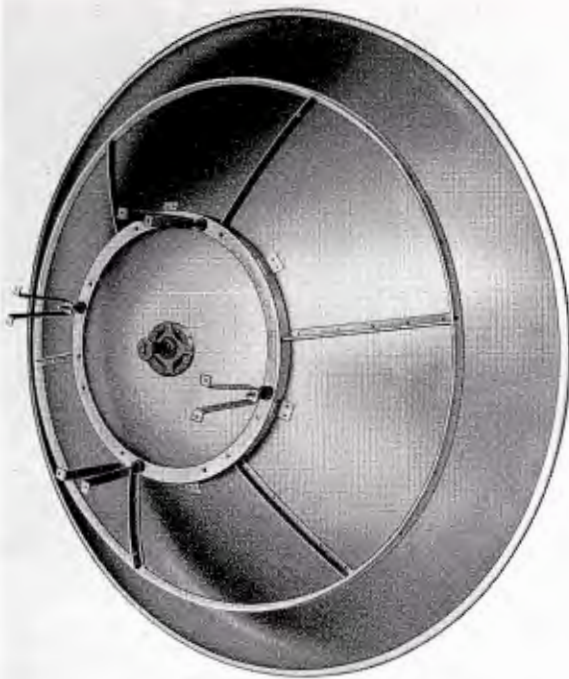

View and outline drawing of 8 or 10-foot Parabolic Antenna with M-8 Mount, MI-26495-B Series.

offset a distance of 8 inches from the center of the support to permit easy access to the feed flange. A stabilizing rod is attached to the parabola rim and the supporting structure to prevent sway. A threaded adjustment is provided for elevation adjustments of ± 5 degrees. Azimuth adjustment is provided by rotation of the mount on the support, with fine adjustment by means of threaded studs on the antenna clamp. The T8A mount can adequately support a 10-foot parabola with a wind load of 40 pounds and one inch of radial ice. All brackets are galvanized and studs are of stainless steel or are treated for corrosion resistance.

The Type M8 mount is designed to support an 8-foot or 10-foot parabola to a flat surface and consists of four ball socket assemblies and four "U" shaped support brackets. The ball sockets attach to the parabola mounting ring with eccentric studs, and the assembly is adjustable at all four ball joints. This mount provides for adjustment of ± 5 degrees in azimuth and elevation.

The RCA Series of microwave antennas for permanently installed, rack-mounted systems are supplied complete including parabolic reflector, antenna feed and mount. Refer to the table designated "Stock Identification" for selection of antenna size, frequency range and mounting facility.

STOCK IDENTIFICATION

Antenna Size	Mount Type	Frequency Range	
		5925 to 6525 mc.	6525 to 7125 mc.
4 Foot	T4	MI-26395A-1	MI-26395A-3
4 Foot	M4	MI-26395B-1	MI-26395B-3
6 Foot	T4	MI-26395A-2	MI-26395A-4
6 Foot	M4	MI-26395B-2	MI-26395B-4
8 Foot	T8A	MI-26495A-1	MI-26495A-3
8 Foot	M8	MI-26495B-1	MI-26495B-3
10 Foot	T8A	MI-26495A-2	MI-26495A-4
10 Foot	M8	MI-26495B-2	MI-26495B-4

Passive Reflectors

A microwave Passive Reflector is used to change the direction of a radiated microwave signal from vertical to horizontal. Thus a radiating or receiving parabolic antenna may be located at ground level, eliminating the need for the long waveguide run which would be necessary if the parabolic antenna were located at the top of a tower.

RCA offers microwave passive reflectors in sizes from 4 by 6 feet to 10 by 15 feet, with larger sizes on special order. These reflectors are fabricated of aluminum with galvanized steel mounting and guy accessories. The reflector face is available in either solid or 50 per cent perforated construction, and the flatness tolerance is plus or minus $\frac{1}{8}$ -inch.

A built-in adjusting mechanism allows for easy adjustment within a range of plus 3 and minus 6 degrees from the normal reflector angle of 45 degrees. Other face slope angles are available on special order. The range of adjustment in the horizontal plane is approximately plus and minus 45 degrees, depending on the supporting structure and mounting position. As an option, passive reflectors may be ordered with an adjusting mechanism to curve the reflector face, which will provide an additional gain in the parabolic antenna passive reflector system of up to 3 db.

All reflectors are supplied complete with the necessary guy hardware, turnbuckles, clips, thimbles, etc. Brackets can be supplied to fit individual tower mounting requirements, and it is suggested that the type and make of tower on which the reflector is to be mounted be specified at the time of ordering. The reflectors are available in "knocked down" condition for crated shipment, and also in "one piece" construction. "One piece" reflectors are shipped direct from the factory by special truck.

STOCK IDENTIFICATION

Passive Reflectors

Reflector Size	One Piece Solid Face Model #	One Piece Perforated Face Model #	Knocked Down Solid Face Model #	Knocked Down Perforated Face Model #
4' x 6'	460PSA	460PPA	46KDSA	46KDPA
6' x 8'	680PSA	680PPA	68KDSA	68KDPA
8' x 10'	8100PSA	8100PPA	810KDSA	810KDPA
10' x 15'	10150PSA	10150PPA	1015KDSA	1015KDPA

The addition of the letter "C" in the Model Number indicates a reflector equipped with an adjustable curved face. For example: Model 68KDSCA indicates a 6' x 8' reflector of knocked down construction, solid face, with adjustable curved face

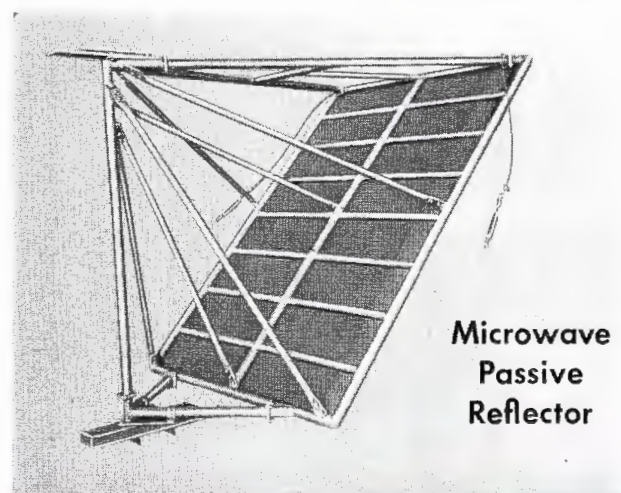

Plastic Dome.

Plastic Domes

Plastic domes for parabolic antennas provide protection of the antenna feed and prevent the accumulation of snow, dirt, leaves, or other debris in the antenna when horizontally mounted. Heated domes are designed to keep antenna equipment free of ice accumulation at sub-freezing temperatures.

Both unheated and heated domes are available for antenna parabolas in the 4-, 6-, 8- and 10-foot sizes. The nominal gain reduction resulting from the use of domes is 0.3 db for the unheated dome, and 1.0 db for the heated type. VSWR contribution is .04 or less.

Stock Identification:

Plastic Dome, 4-foot, unheated, Type R4.....	MI-26384-1
Plastic Dome, 4-foot, heated, Type HR4.....	MI-26384-2
Plastic Dome, 6-foot, unheated, Type R6.....	MI-26386-1
Plastic Dome, 6-foot, heated, Type HR6.....	MI-26386-2
Plastic Dome, 8-foot, unheated, Type R8.....	MI-26388-1
Plastic Dome, 8-foot, heated, Type HR8.....	MI-26388-2
Plastic Dome, 10-foot, unheated, Type R10.....	MI-26390-1
Plastic Dome, 10-foot, heated, Type HR10.....	MI-26390-2

ANTENNA EQUIPMENT FOR REMOTELY LOCATED TRANSMITTER AND RECEIVER HEADS

The Receiver Head unit, MI-26402-A, or the Transmitter Head unit, MI-26451-D, of the RCA TYM-1B Microwave Relay System, may each be mounted in a weatherproof case and attached to the rear of the antenna parabola when necessary or desirable to avoid a long or complicated waveguide feed system. The RF Head units are then interconnected with their respective control units by the necessary length of control cable. Parabolas of 2-foot, 4-foot, and 6-foot diameters are available for this purpose, each with either vertically or horizontally polarized antenna feeds, depending on the system requirements.

The parabolas are constructed of aluminum alloy 1/8-inch thick, with a turned reinforcing lip, and a keyhole slot providing entrance of the antenna feed. The antenna feeds are formed of curved, properly terminated, RG-50/U wave-guide. The non-twisted feed provides horizontal polarization, while the feed with a 90 degree twist provides vertical polarization.

Stock Identification:

2-foot Parabola (less antenna feed).....	MI-26182-5
4-foot Parabola (less antenna feed).....	MI-26182-3
6-foot Parabola (less antenna feed).....	MI-26182-4
Antenna Feed, Horizontal Polarization for 2-foot or 4-foot Parabola.....	MI-26430
Antenna Feed, Vertical Polarization for 2-foot or 4-foot Parabola.....	MI-26431
Antenna Feed, Horizontal Polarization for 6-foot Parabola	MI-26432
Antenna Feed, Vertical Polarization for 6-foot Parabola	MI-26433

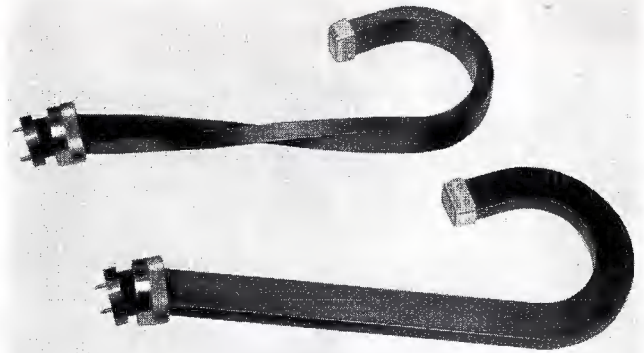

MI-26430 and MI-26431 Antenna Feeds for MI-26182 Series of Parabolic Reflectors.



Reflector Mount, MI-26435-A.

Reflector Mount, MI-26435-A

The MI-26435-A Reflector Mount is used as a mounting device for the parabola antenna and the TVM-1B microwave receiver or transmitter RF case. This arrangement provides easy detachment of either the TVM-1B receiver or transmitter RF chassis, or of the RF chassis, weatherproof case, and antenna feed as a unit, without disturbing the parabola mounting or its orientation. The mount is provided with base mounting holes for attaching to a mounting surface or the MI-26436 Antenna Roof Mount.

Antenna Roof Mount, MI-26436

The Antenna Roof Mount, MI-26436, is used to install the MI-26435-A Reflector Mount on the roof or wall of a building and permits adjustment of the antenna in azimuth and elevation. It is comprised of a metal table, plate, leg and angle assemblies and, when set up, requires a space approximately 31 inches high, 15 1/4 inches wide, and a depth of 34 1/2 inches. The metal table may be attached to the assembly to provide a horizontal surface for either wall or roof mounting. The Antenna Roof Mount is constructed of 1/8-inch cold rolled steel with heavier steel plate used in the table.

Antenna Roof Mount, MI-26436.



Antenna Ring Mount (Gimbal Ring) MI-26207

The MI-26207 Antenna Ring Mount is available for use where it is desirable to mount an MI-26182-3, 4-foot parabola, or an MI-26182-4, 6-foot parabola, to a flat tower face, or a wall where an opening is provided to allow the Transmitter or Receiver RF Head Weatherproof Case to extend through the wall.

The mount consists of a gimbal ring assembly which attaches directly to bosses on the parabola. With the rear ring of the assembly bolted to its support, the middle and front rings which support the antenna assembly and RF Head may be adjusted in both horizontal and vertical planes by means of hinged links and locking bolts. These adjustments provide a 7 degree vertical and horizontal movement. The Antenna Ring Mount has an outside diameter of 24½ inches and weighs approximately 80 pounds.

Stock Identification:

Reflector Mount	MI-26435-A
Antenna Roof Mount.....	MI-26436
Antenna Ring Mount.....	MI-26207

Remote Controlled Parabola Mount

A Type TF-55A Remote Controlled Parabola Mount is available for applications which require adjustment of the azimuth and elevation of a microwave antenna from a remote location. This facility is particularly desirable when the microwave antenna is installed in a location

Type TF-55A Parabola Mount.

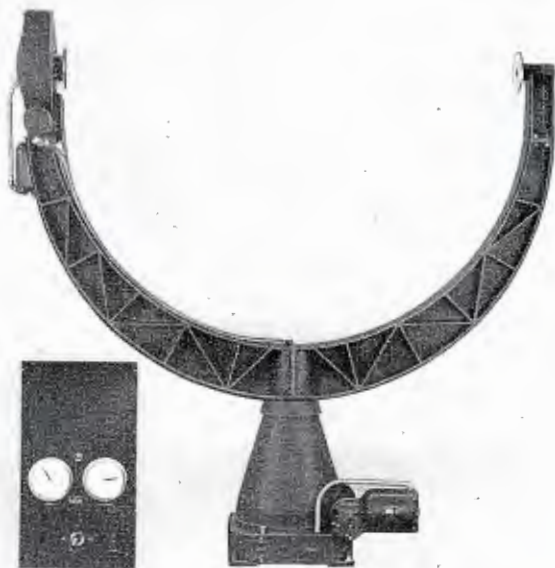

Relay Antenna Gimbal Ring Mount, MI-26207, mounted to bosses of 4 foot parabolic antenna and fixed service support allows horizontal or vertical adjustment of the antenna. View also shows TVM-1A Relay Transmitter Head, MI-26450, attached to parabola by means of Reflector Mount, MI-26435-A.

which is inaccessible to operating personnel, and the antenna adjustments must be changed frequently to accommodate various remote field pickup locations.

The Type TF-55A mount used in conjunction with an MI-26435-A Reflector mount supports either an MI-26182-3, 4-foot parabolic reflector, or an MI-26182-4, 6-foot parabolic reflector and the TVM-1B Microwave Receiver RF Head unit. The mount may be located up to 1500 feet from its rack mounted control panel. It can be rotated 370 degrees in azimuth and 15 degrees up and 30 degrees down from horizontal in elevation. Limit switches are provided to prevent damage from over-travel. The mount is designed to withstand wind velocities to 120 MPH. Motors and all rotating shafts run on sealed, anti-friction bearings

and require no lubrication. The control panel contains switches for changing elevation and azimuth, and dials showing the exact position of the parabola at all times.

Stock Identification:

TF-55A	Remote Controlled Rotating Mount for 4-foot Parabola	MI-26192-1
TF-55A	Remote Controlled Rotating Mount for 6-foot Parabola	MI-26192-2

**ANTENNAS FOR PORTABLE TVM-1B
MICROWAVE SYSTEMS**

When the TVM-1B Microwave is used as a portable system, the RF Head Weatherproof Cases are mounted on the rear of the MI-26182-5, 2-foot parabola, the MI-26182-3, 4-foot parabola or the MI-26182-4, 6-foot parabola, by means of the Reflector Mount, MI-26435. Either horizontally or vertically polarized antenna feeds are available for each size parabola. The parabolas, antenna feeds and reflector mount are identical to those described previously for use with remotely located transmitter and receiver heads. The MI-26435-A Reflector Mount may be attached to an MI-26204 Tilt Head by means of mounting holes provided. The Tilt Head provides a means of antenna orientation both vertically and horizontally. The head is of a sturdy all-metal design in which materials have been carefully selected for outdoor or field use. Lightweight aluminum

Newly styled waterproof case permits RCA microwave relay r-f heads to be mounted on rear of parabolic reflectors in permanent outdoor TV transmission system.

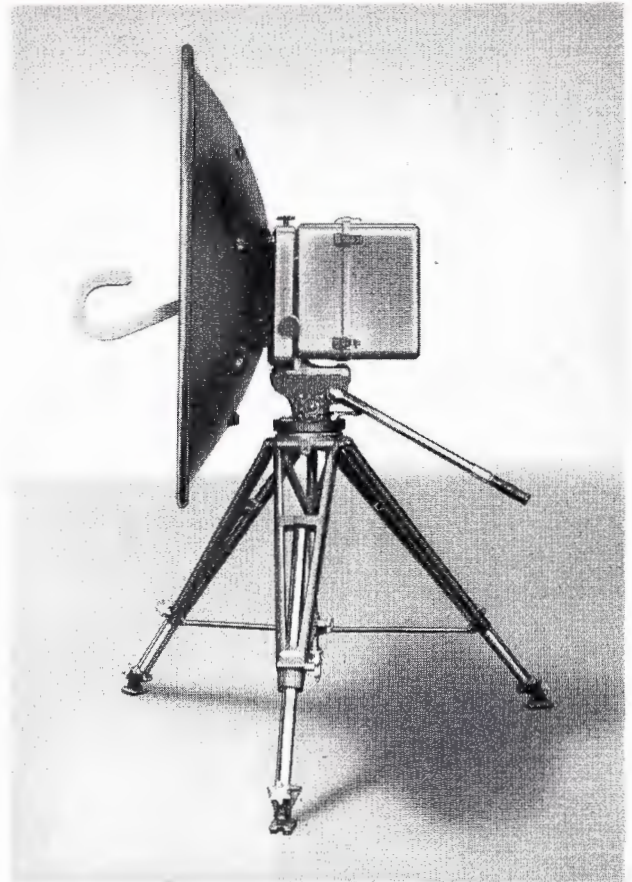
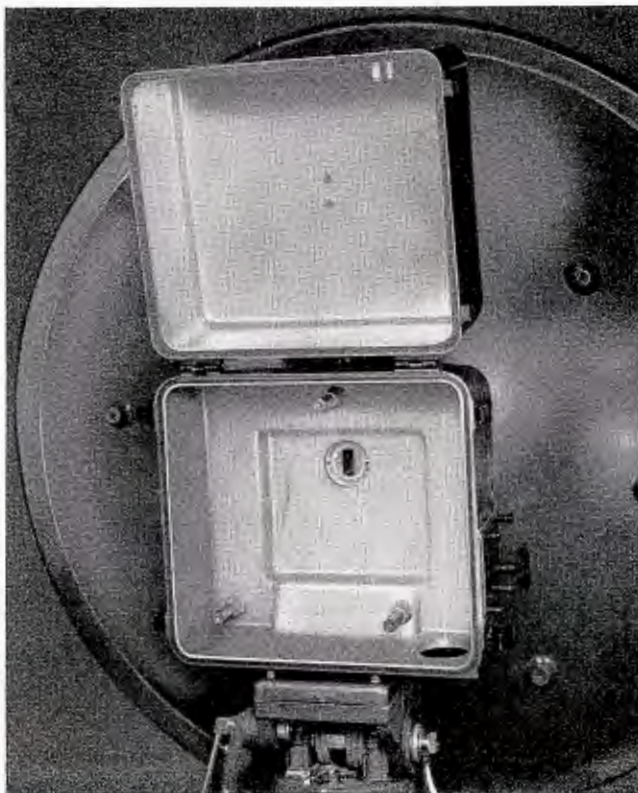

Portable antenna system showing parabolic reflector, feed, and RF Receiver Head in Weatherproof case attached by Reflector Mount, MI-26435-A to an MI-26204 Tilt Head mounted on Metal Tripod.

castings are employed and all surfaces are finished in an umber gray wrinkle. A total rotational angle of 360 degrees and an ample tilt angle are provided together with suitable "degree indicator" scales. Individual positive locking handles maintain proper settings of tilt and rotation.

Two tripods are available, MI-26046-A for use with 2-foot and 4-foot dishes and a long-legged type, MI-26048, for use with 6-foot parabolas. The tripods are designed of aluminum castings and tubular steel construction, providing a compact, lightweight, yet rugged support. It folds into a small-size unit which is easily portable. The tubular portion of each leg is easily adjusted and slides within a long length bearing which is held to close tolerances. Thus, minimum play and maximum rigidity are assured over the working range. A Tie Rod Assembly, MI-26188, is available to provide greater stability for the long-legged metal tripod if required.

Stock Identification:

Metal Tripod	MI-26046-A
Long-Legged Type Tripod.....	MI-26048
Tie Rod Assembly for MI-26048 Tripod.....	MI-26188
Relay Tilt Head.....	MI-26204

RG-50/U WAVEGUIDE COMPONENTS

FOR TVM-1B MICROWAVE SYSTEMS

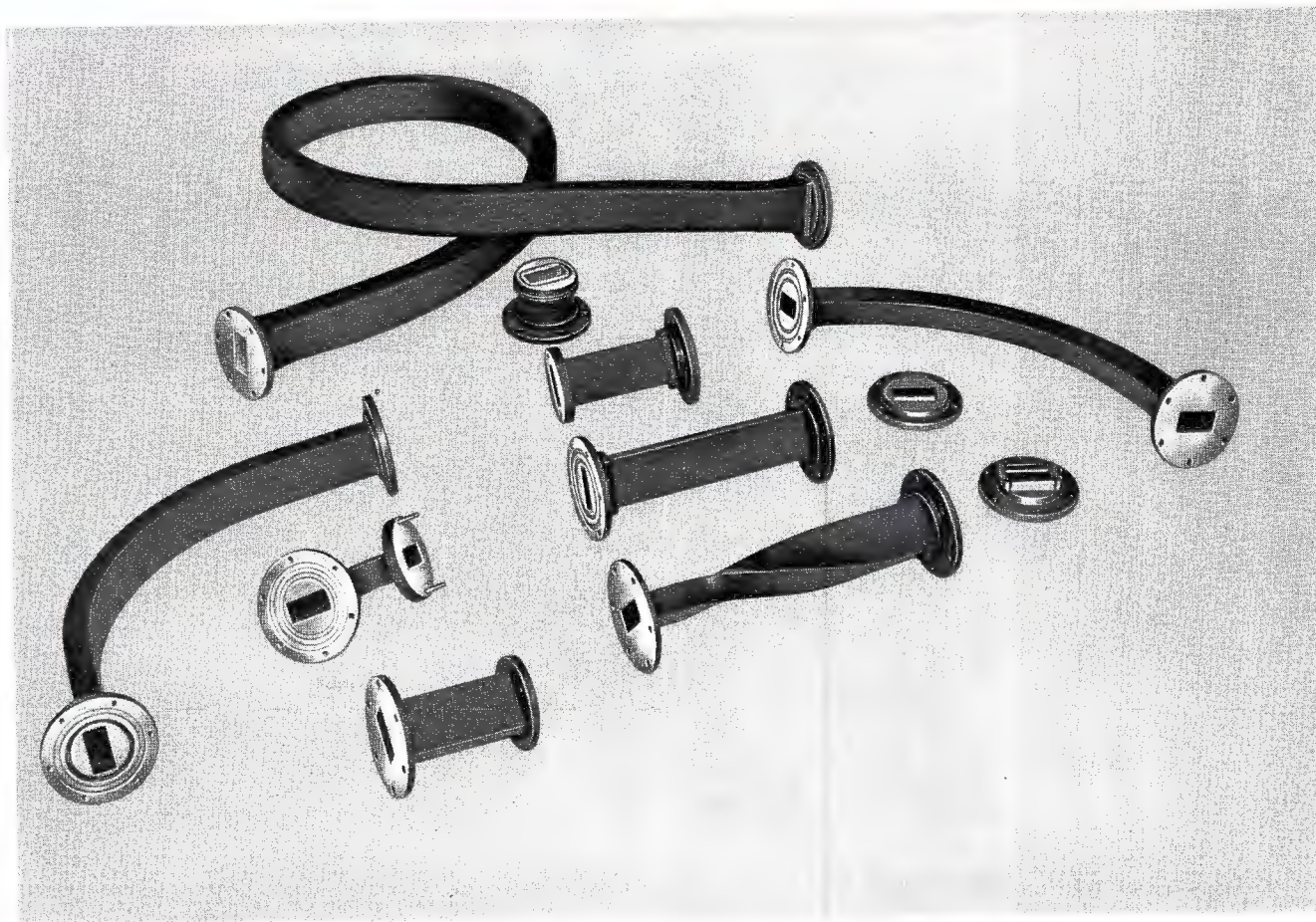

FEATURES

- Complete line of fittings and accessories to suit a wide variety of installations
- Maximum efficiency—minimum attenuation —with low VSWR over a frequency range of 5850 to 8200 mcs
- Pressurization accessories for moisture protection
- Designed for maximum ease of installation
- Sturdy, rugged construction provides permanent, reliable installation

USES

RCA's Type RG-50/U waveguide components have been designed to provide a "low-loss" transfer of radio-frequency energy between the TVT-1B Microwave Transmitter or the TVR-1B Microwave Receiver and their associated antennas. The components are readily assembled to form waveguide runs providing maximum efficiency with low VSWR over a frequency range of 5850 to 8200 megacycles. Equipment is available for permanent or temporary pressurized or non-pressurized runs. Easy adaptation to any engineered system is possible through a wide choice of elbows, adaptors, and other components. RCA engineers are prepared to provide engineered systems and recommend equipment, installation and other needed facilities to achieve best transmission and reception with Type TVM-1B microwave systems.

DESCRIPTION

Waveguide components of the TVM-1B System include all items necessary to conduct r-f energy from a source to a load. They include rigid and flexible waveguide sections, bends, twists, flanges, adaptors, and suitable pressurizing fittings, as well as such special items as directional couplers, switches, terminations, ferrite isolators, circulators, and preselection filters. These items are available from RCA as a single source to provide "matched" equipment for any desired transmission run.

A typical waveguide system including an antenna and several items of RG-50/U rigid and flexible waveguide with minimum of bends and a suitable pressurization system is illustrated. The major portion of the waveguide system is composed of rigid waveguide sections with flexible or special connections to conform to installation requirements.

RG-50/U Waveguide conforms to the industry standard Type WR-137 having inside diameter of 1.372 inches by 0.622 inch with a 0.064-inch wall. Unflanged or flanged sections can be provided. The terminating flanges are soldered to the waveguide sections. The waveguide conforms to standard electrical specifications. The frequency range covers 5850 to 8200 megacycles; the maximum VSWR (per piece) is less than 1.05, and nominal attenuation 3 db per 100 feet.

Standard Waveguide Components

RG-50/U Waveguide components are normally supplied with a choke flange Type UG-343A/U on one end and a flat cover flange, Type UG-344/U on the other as MI-26428. The choke flange has six tapped 10-32 holes while each cover flange has six clearance holes. During installation, each choke flange is normally matched to a cover flange, a rubber O-ring gasket inserted, and the flanges fastened together with machine screws. Pressurized lines use choke-to-flat flange as just described but non-pressurized lines may use flat-to-flat, or flat-to-choke flange connections. Flange connections in the waveguide run should be kept to a minimum since each may introduce a small mismatch.

Type RG-50/U Waveguide is available in 90-degree bends for change of direction. These bends are provided with a variety of flanges over both E and H planes. The MI-26427 waveguide twist is used where a change of polarization

plane is required. Flexible waveguide sections are most practical in cases where complex waveguide bends are encountered. They also are desirable in long runs to compensate for temperature expansion or contraction of the line. Since bends and twists introduce somewhat more attenuation than do straight sections, their use should be restricted wherever possible.

Pressurization equipment prevents the condensation of moisture on the inside walls of microwave waveguide. The MI-26426 Pressurizing Section provides pressurizing access through a spring-loaded valve to the waveguide run. The MI-26463 Mica Window is required to provide a pressure tight seal at the r-f head end of the waveguide installation. A pressure tight cap on the antenna feed provides a barrier at the other end. The waveguide and accessory equipment is usually supported by loose fitting wooden brackets, hangers, or other convenient means.

Specialized Waveguide Components

A number of specialized waveguide items are also available from RCA designed to adapt a standard waveguide run to meet certain switching and diplexing applications. These include directional couplers which are used for splitting or sampling r-f energy in the waveguide. The MI-26466 Directional Coupler provides a means of dividing the power output from one transmitter into two separate antenna systems or from one antenna system into two receivers.

Waveguide Switch, MI-26490, is used in reversible systems to transfer antennas between transmitter and receiver heads. It may also be used in standby systems to provide rapid transfer of the antenna connection from the main to the standby unit. Convenient "answer-back" contacts are provided as an integral part of the switch. These contacts can be connected to provide either a local or a remote indication of the switch position. The Waveguide Termination, MI-26488, is provided for use with the Waveguide Switch to dissipate transmitter power, or terminate the receiver.

The Ferrite Isolator attenuates reflected r-f energy in waveguide runs. Normally in waveguide runs of more than 15 feet sufficient r-f energy is reflected to cause detuning of the transmitter klystron. Since the isolator attenuates the reflected energy by 40 db, this harmful effect is virtually eliminated. The isolator also allows microwave power to be transmitted with negligible attenuation in the forward

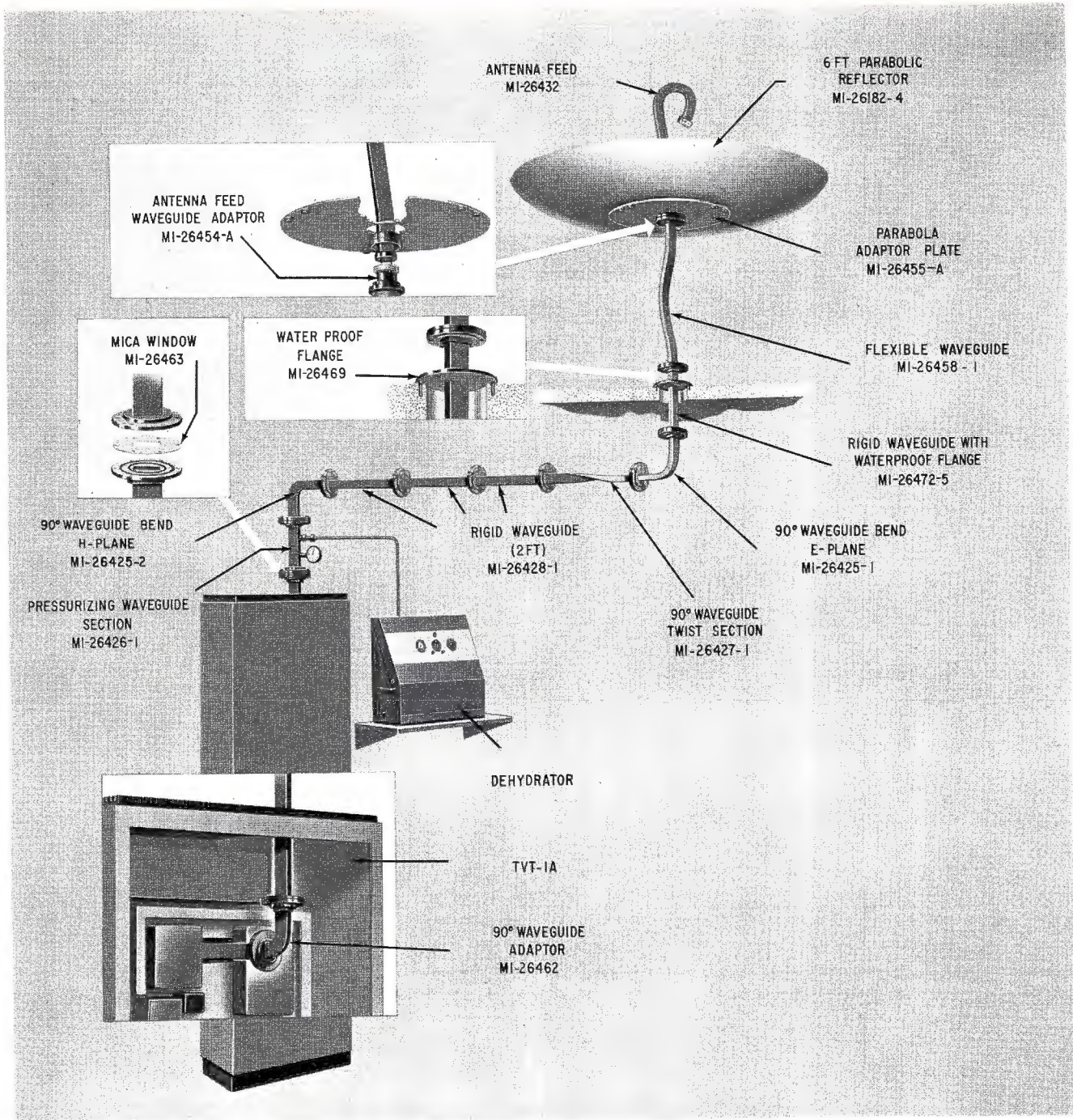

Typical Waveguide Run showing Rack and Antenna Connections.

direction. In the case of the MI-26465-A Isolator, the forward loss amounts to approximately 0.5 db.

The Ferrite Circulator, MI-26489 is used for r-f multiplexing: that is, simultaneous operation of transmitters and receivers to a common antenna system. It is a complex microwave network with four ports and so designed that it permits r-f energy to flow from one port to an adjacent port in

one direction only. The Preselection Filter, MI-26412, is a band-pass filter used to provide r-f preselection or to permit r-f multiplexing when used in conjunction with the ferrite circulator. For bench testing the TVM-1B Microwave System, the MI-26478 Attenuating Coupler is recommended since it can simulate typical path loss conditions by inserting a pre-set amount of attenuation. It also permits accurate receiver analysis since the input power is always known.

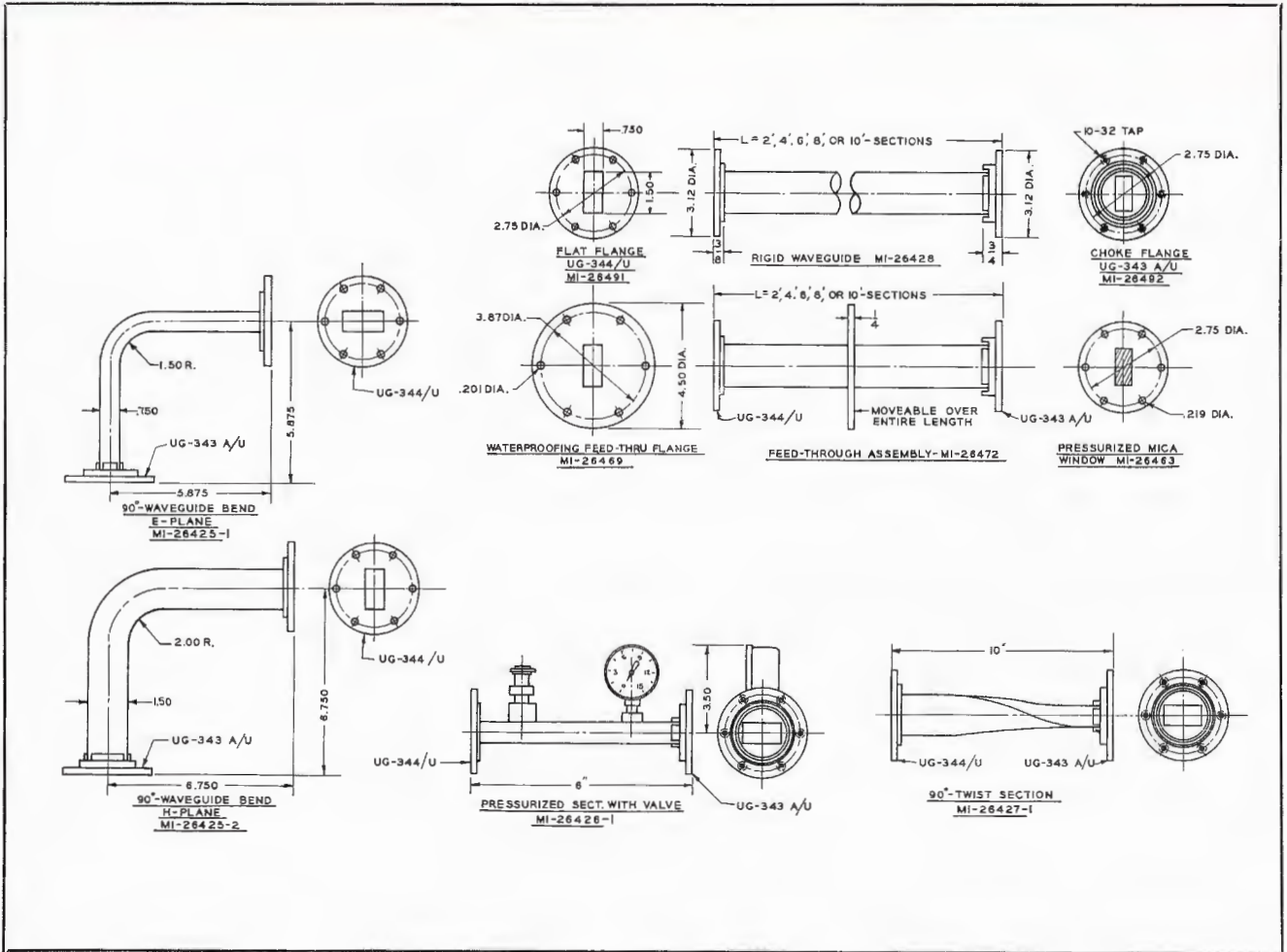

Outline Drawings . . . RG-50/U Waveguide Components

RG-50/U WAVEGUIDE LINE

Flanged Rigid Waveguide, Type RG-50/U

Rigid Waveguide sections are supplied in straight lengths of two to ten feet with one Type RG-344/U flat or cover flange at one end and a RG-343A/U choke flange on the other. The brass terminating flanges are soldered to the waveguide. The waveguide is formed of oxygen free high conductivity copper measuring 1½-inch by ¾" O.D. with a wall thickness of 0.064-inch. Necessary assembly hardware and an O-ring gasket are supplied with each section.

Stock Identification:

- 2-foot section, RG-50/U Waveguide, with flanges.....MI-26428-1
- 4-foot section, RG-50/U Waveguide, with flanges.....MI-26428-2
- 6-foot section, RG-50/U Waveguide, with flanges.....MI-26428-3
- 8-foot section, RG-50/U Waveguide, with flanges.....MI-26428-4
- 10-foot section, RG-50/U Waveguide, with flanges.....MI-26428-5

Unflanged Rigid Waveguides

Unflanged Waveguide sections, MI-26416, are similar to MI-26428 sections except no end flanges are provided. These unflanged sections can be supplied in lengths up

to 12 feet, or can be cut to order where non-standard lengths are required.

Stock Identification:

- 2-foot section, RG-50/U Waveguide, less flanges.....MI-26416-1
- 4-foot section, RG-50/U Waveguide, less flanges.....MI-26416-2
- 6-foot section, RG-50/U Waveguide, less flanges.....MI-26416-3
- 8-foot section, RG-50/U Waveguide, less flanges.....MI-26416-4
- 10-foot section, RG-50/U Waveguide, less flanges.....MI-26416-5
- 12-foot section, RG-50/U Waveguide, less flanges.....MI-26416-6

Flat Flange, Type UG-344/U

This flat flange provides a terminal connection for unflanged waveguide. It may be used with a choke flange in either pressurized or unpressurized waveguide runs, or with another flat flange in unpressurized applications only. The brass flange is ¾-inch long with an outer diameter of 3⅜-inch O.D. Six clearance holes for connecting bolts on a 2¼-inch diameter are provided. The flange is slotted to accommodate the 1½ by ¾-inch O.D. waveguide.

Stock Identification:

- Flat Flange, Type UG-344/U.....MI-26491

Choke Flange, Type UG-343A/U

The Type UG-343A/U is a round brass choke flange 3 7/8-inches in diameter by 3/4-inch long to mate with the UG-344/A flat flange. It is provided with an outer AN-6230-5 groove to accommodate an O-ring gasket placed there for sealing. An inner choke groove acts as a quarter-wave isolation stub to insure proper matching. The opposite end of the flange is slotted to accommodate the RG-50/U Waveguide.

Stock Identification:

Choke Flange, Type UG-343A/U.....MI-26492

90° Waveguide Bends

To provide a 90-degree change of direction in a straight waveguide run, the MI-26425 series of RG-50/U Waveguide Bends are available in either E or H plane. The bends have the same electrical characteristics as straight RG-50/U Waveguide sections.

Stock Identification:

- 90° E Plane Bend, one flat UG-344/U and one choke type UG-343A/U FlangeMI-26425-1
- 90° H Plane Bend, one flat UG-344/U and one choke type UG-343A/U FlangeMI-26425-2
- 90° E Plane Bend, two flat type UG-344/U Flanges.....MI-26425-3
- 90° H Plane Bend, two flat type UG-344/U Flanges.....MI-26425-4
- 90° E Plane Bend, two choke type UG-343A/U Flanges....MI-26425-5
- 90° H Plane Bend, two choke type UG-343A/U Flanges....MI-26425-6

90° Waveguide Twist Sections

A Waveguide Twist Section changes the plane of polarization and permits change of position to meet installation requirements. The twist maintains the uniform low inherent attenuation and all other electrical characteristics of RG-50/U Waveguide sections. The twist comes in a 10-inch section with a choice of end flanges. Standard mounting hardware and O-ring gasket are included.

Stock Identification:

- 90° Waveguide Twist with one flat UG-344/U and one choke UG-343A/U Flange.....MI-26427-1
- 90° Waveguide Twist with two flat UG-344/U Flanges....MI-26427-2
- 90° Waveguide Twist with two choke type UG-343A/U FlangesMI-26427-3

Flexible and Flexible-Twistable Waveguides

These Waveguide sections are designed for use in runs which require many complex bends or twists. Flexible Waveguide simplifies installations by eliminating alignment problems. It also allows for line expansion and contraction. Flexible Waveguide has a pliable jacket which supports its convolutions. The sections have a minimum bend radius of 5 inches in the H plane or 2.5 inches in the E plane. Flexible-Twistable Waveguide is capable of the same degree of bending, and in addition has a twist capability to 90°. All sections may be pressurized up to 45 psi.

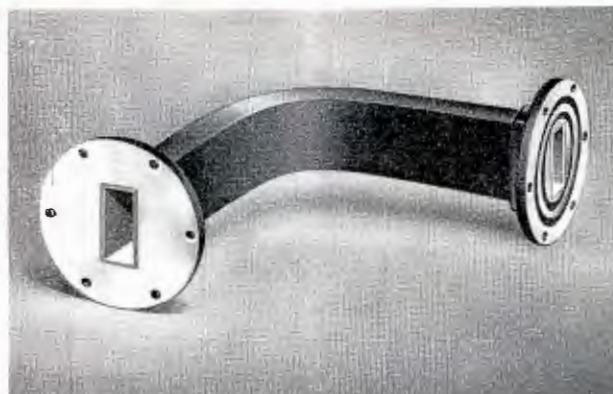

90° E Plane Bend, MI-26425-1

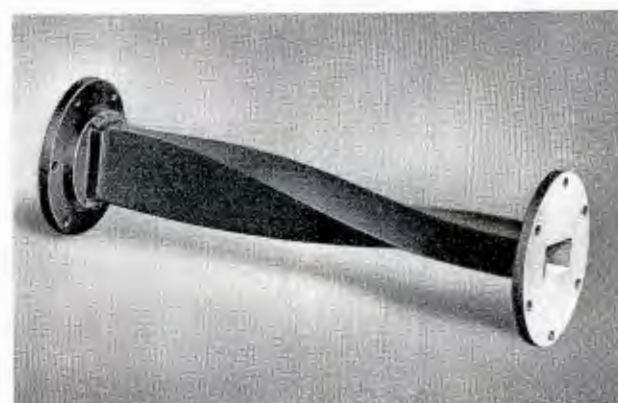

90° Waveguide Twist Section, MI-26427-1

Flexibility is constant from -55°C to 125°C. and the sections have the same dimensions as rigid RG-50/U Waveguide and a max. overall VSWR of 1.10. Attenuation is .09 max. db/ft. The frequency range is 5850 to 8200 megacycles. Each section is terminated with one choke and one flat flange.

Stock Identification:

- Flexible Waveguide, 5 feet long.....MI-26458-1
- Flexible Waveguide, 6 feet long.....MI-26458-2
- Flexible-Twistable Waveguide, 5 feet long.....MI-26468-1
- Flexible-Twistable Waveguide, 6 feet long.....MI-26468-2

Waterproofing Feed-Through Flange

This flange is designed to slip over RG-50/U Waveguide to form a feed-through assembly used for installation through roofs, walls, or bulkheads. The flange is formed of 1/4-inch brass with a diameter of 4 1/2-inches. It is pierced with six mounting holes each 0.201-inch in diameter and spaced on 3 7/8-inch diameter bolt circle. It can be attached to any flat surface. A sealant is required between mating surfaces.

Stock Identification:

- Waterproofing Feed-Through Flange.....MI-26469



Antenna Feed Adaptor, MI-26454-A

Feed-Through Assemblies

Assembled waveguide sections with a waterproof feed-through flange included can be provided to simplify roof, wall or bulkhead passage of any standard waveguide run.

Stock Identification:

- 2-foot Waveguide Section with weatherproof flange.....MI-26472-5
- 4-foot Waveguide Section with weatherproof flange.....MI-26472-4
- 6-foot Waveguide Section with weatherproof flange.....MI-26472-3
- 8-foot Waveguide Section with weatherproof flange.....MI-26472-2
- 10-foot Waveguide Section with weatherproof flange.....MI-26472-1

Pressurizing Section, MI-26426-2

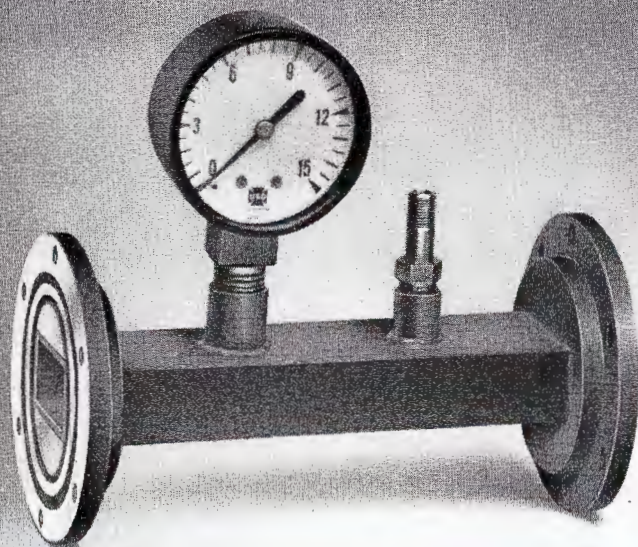

Antenna Feed Adaptor

The Antenna Feed Adaptors provide a coupling between the antenna "button-hook" feed and the end of the waveguide run. They provide a weatherproof connection at the feed end and either a choke flange or flat flange at the other end. The adaptors are therefore suitable for use in pressurizing applications as well as nonpressurized runs. The adaptors are 2 inches in diameter by 1.88 inches long. One end terminates in a 3/8-inch flat or choke flange, and the other end is 2 1/4-inch O.D. and terminates in 29° Acme thread-8 threads per inch to mesh with the Antenna Feed Connector Ring.

Stock Identification:

- Antenna Adaptor with choke flange.....MI-26454-A
- Antenna Adaptor with flat flange.....MI-26454-A1

Pressurizing Sections

RG-50/U Waveguide may be pressurized in accordance with JAN specifications with either dry air or nitrogen gas. The MI-26426 Pressurizing Sections are supplied in standard 6-inch lengths with a choice of flanges. A 0-15 psi pressure gauge, and a conventional Schraeder gas inlet valve and cap for introducing the air or gas into the waveguide run are standard with all sections. The entrance hole into the waveguide is made on one edge of the waveguide causing no disturbance to the electrical field. The pressure adaptors have a VSWR of 1.05 or less across the frequency band.

Stock Identification:

- Pressurizing Waveguide Section, 6-inches long with one flat-type UG-344/U and one choke-type UG-343A/U Flange.....MI-26426-1
- Pressurizing Waveguide Section, 6-inches long with two choke-type UG-343A/U Flanges.....MI-26426-2
- Pressurizing Waveguide Section, 6-inches long with two flat-type UG-344/U FlangesMI-26426-3

Pressurized Mica Window

The Mica Window is required to provide an air-tight seal between the r-f head and the waveguide run when the waveguide run is to be pressurized. The window consists of a round 3/8-inch brass disc assembly with six clearance holes for mounting between a flat and choke flange of adjoining waveguide sections. The disc has a mica window seated in the rectangular hole to insure mechanical rigidity and pressure tightness.

Stock Identification:

- Pressurized WindowMI-26463

Waveguide Adaptors (Waveguide to R-F Case)

These adaptors are required to adapt the r-f case to standard round flanges when waveguide run is used in conjunction with the portable TVM-1A microwave system. The adaptors are 6-inch long straight sections of RG-50/U Waveguide which have a flat or choke flange on one end and a special male connector on the other end to fit the r-f case.

Stock Identification:

Waveguide Adaptor with choke type UG-343A/U Flange MI-26459
Waveguide Adaptor with flat type UG-344/U Flange.....MI-26459-1

90° Waveguide Adaptors (Waveguide to R-F Head)

The 90° Waveguide Adaptors are designed to adapt the r-f head flange to standard round flange. They are intended for use with rack or cabinet mounted TVM-1A microwave equipment since the 90° bend permits waveguide to enter the rack from the top without obstructing the rear door. The adaptor is a standard 90° RG-50/U bend supplied with a flat or choke type flange on the output end and a special flange to fit the r-f head on the other.

Stock Identification:

90° Waveguide Adaptor with choke flange,
type RG-343A/UMI-26462
90° Waveguide Adaptor with flat flange,
type RG-344/UMI-26462-1

Waveguide Adaptor (R-F Case to Attenuating Coupler)

This Adaptor is designed to provide a coupling between the r-f case and the attenuating coupler. It is developed from RG-50/U waveguide 3¾-inches long and has a flat flange silver soldered to one end and a knurled ring assembly on the other to connect with the r-f case.

Stock Identification:

Waveguide Adaptor (R-F Case to Attenuator Coupler).....MI-26476

Directional Coupler

The Directional Coupler, MI-26466 is a 3 port, broad-wall coupling device possessing excellent broadband matching characteristics. It is used in r-f diplexing applications where two receivers or transmitters are connected to a common antenna system. The coupler is a divided section of Type RG-50/U Waveguide with a flat Type UG-344/U flange at each of the three ports. The two transmitters or receivers are connected to the dual port end. The overall length of the assembly is 26.56 inches. The coupler operates over the frequency band of 5850 to 8200 megacycles. Nominal coupling loss is 3 db. The isolation between ports at the dual end is better than 40 db. The maximum VSWR of either path through the waveguide when properly terminated is 1.05.

Stock Identification:

Directional CouplerMI-26466

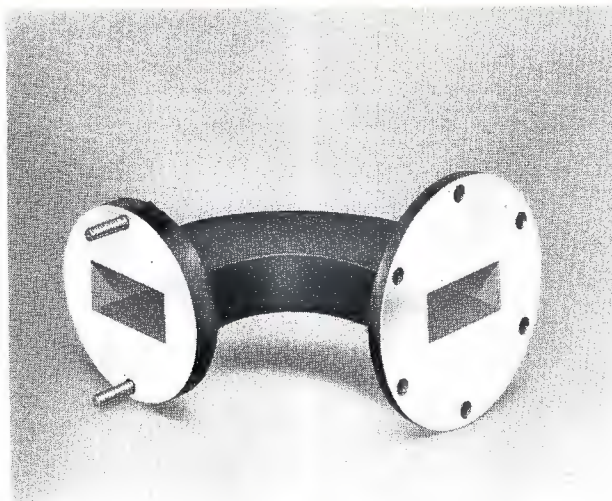

90° Waveguide to R-F Head Adaptor, MI-26462-1

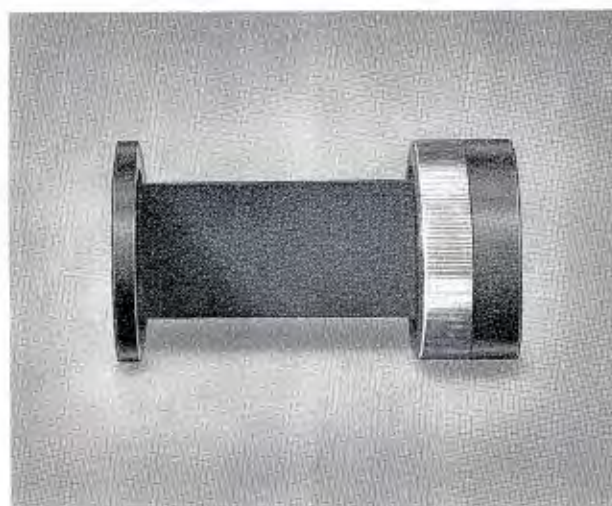

Waveguide Adaptor (R-F to Attenuator Coupler), MI-26476

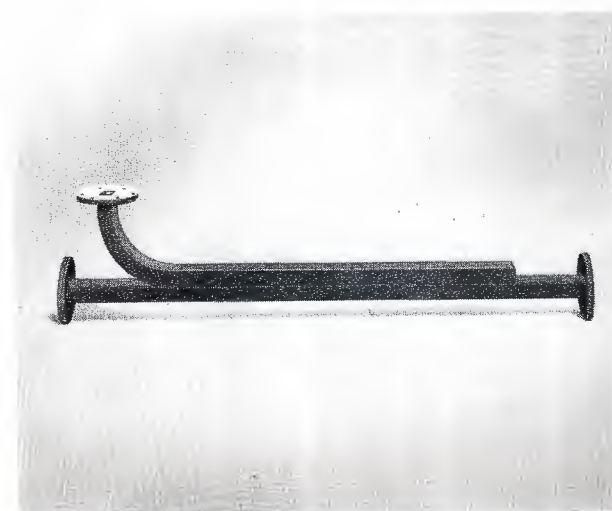

Directional Coupler, MI-26466

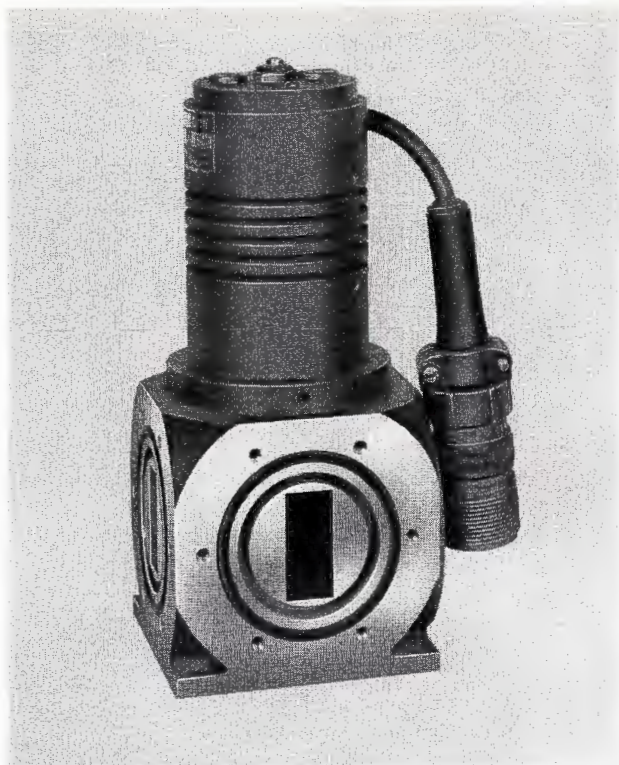

Waveguide Switch, MI-26490

Waveguide Switch

The Waveguide Switch, MI-26490, is used in both reversible and standby system applications where rapid transfer of antennas between r-f heads is required. It is essentially a dual elbow section of RG-50/U Waveguide which can be switched electrically in less time than 100 milliseconds. The

switch is 7-4/5-inches long overall and the base is a cube 3 inches on a side. The switch operating circuit draws 3 amps at 120 V. a-c and ambient operating temperature is -20°C to 55°C. Insertion loss is 0.5 db; VSWR 1.1 maximum; and frequency range 5850-8200 megacycles. Cross talk suppression is at least 50 db. The switch will operate in any physical orientation and can withstand a pressure of 40 psi maximum.

Stock Identification:

Waveguide SwitchMI-26490

Waveguide Termination

The Waveguide Termination, MI-26488, is designed for use with the MI-26490 Waveguide Switch. It is used to terminate either the transmitter or the receiver in standby or reversible system applications, by providing a well matched load at the inactive port of the waveguide switch. It is non-reactive to all radio frequencies and capable of dissipating 10 watts average power. The termination unit is 2½-inches long and supplied with a Type UG-344/U flat flange to connect directly to the waveguide port.

Stock Identification:

Waveguide TerminationMI-26488

Ferrite Isolator, MI-26465-A

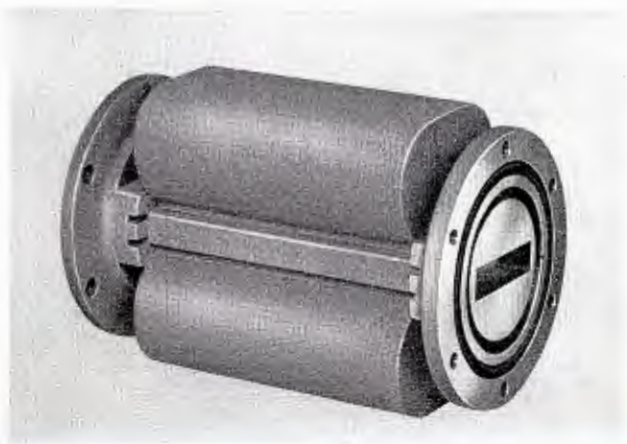

Ferrite Isolator

The Ferrite Isolator is required in long waveguide runs (15 feet or longer) to provide attenuation of reflected r-f energy and prevent these reflections from causing non-linear distortion of the klystron modulation. This resonant absorption type isolator utilizes two heavy permanent magnets and strips of ferrite attached to the top and bottom walls of the waveguide.

The isolator reduces standing waves by 40 db while the forward loss is less than 1 db. It is built to withstand pressures up to 45 psi, and maintains a VSWR of less than 1.15. One end is terminated with a flat flange while the other is terminated with a choke flange. The overall length is 5.410 inches, or 3¾ inches between flanges. The isolators are tuned for the various frequencies shown below.

Stock Identification:

Ferrite Isolator, 5925 to 6425 megacycles.....MI-26465-A1
 Ferrite Isolator, 6425 to 6875 megacycles.....MI-26465-A3
 Ferrite Isolator, 6875 to 7425 megacycles.....MI-26465-A4



Ferrite Circulator, MI-26489

Ferrite Circulator

The Ferrite Circulator, MI-26489, is a complex waveguide network designed to permit multiplexing of either transmitters or receivers into a common antenna system. Due to the presence of ferrite and magnetic material, r-f energy is conducted in a uni-directional pattern from the input port to the adjacent port with relatively little attenuation.

The circulator is designed for insertion in standard waveguide runs using Type RG-50/U sections. The unit is 12¾ inches long overall, 5⅓ inches high and 3.312 inches wide. Four flat flanges are provided. Four separate circulators are available for use in varying frequency bands. The circulator has a maximum forward loss per pass of 0.5 db, minimum isolation of 20 db, and maximum average power rating of 25 watts.

Stock Identification:

Ferrite Circulator, 5925 to 6425 megacycles.....	MI-26489-1
Ferrite Circulator, 6425 to 6875 megacycles.....	MI-26489-2
Ferrite Circulator, 6875 to 7250 megacycles.....	MI-26489-3
Ferrite Circulator, 7125 to 7425 megacycles.....	MI-26489-4

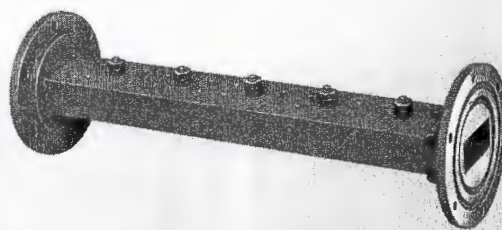

Preselection Filter, MI-26412

Preselection Filter

The Preselection Filter, MI-26412, is used primarily in conjunction with the ferrite circulator, where r-f multiplexing is involved. It may also be used with a TVR receiver to provide image rejection or isolation from very strong adjacent channel signals. It is a pre-tuned bandpass filter which passes a desired 30-mc band of frequencies within the TVM frequency spectrum and rejects all other frequencies. The signal rejection is 60 db at 75 mc from the passband center frequency.

The filter has a maximum insertion loss in the passband of 1 db, and a maximum VSWR of 1.20 in the passband. The bandwidth is 35 megacycles within 3 db limits. Each filter is adjusted to the desired passband frequency at the factory. Specify center frequency when ordering.

Stock Identification:

Preselection Filter, 5925 to 6225 megacycles.....	MI-26412-1
Preselection Filter, 6225 to 6525 megacycles.....	MI-26412-2
Preselection Filter, 6525 to 6825 megacycles.....	MI-26412-3
Preselection Filter, 6825 to 7125 megacycles.....	MI-26412-4
Preselection Filter, 7125 to 7425 megacycles.....	MI-26412-5

Attenuating Coupler

The Attenuating Coupler, MI-26478, is a convenient device for bench testing the microwave transmission system. It attenuates microwave r-f signals by a pre-set amount to simulate typical path loss conditions. It also permits accurate receiver analysis since the input power is always known. The coupler is a section of waveguide, Type RG-50/U, 22¾ inches in length with two ¼-inch long flanges

soldered to either end. The flanges measure 2⅞ inches in diameter and mate directly to the TVM transmitter and receiver r-f head flanges. Adaptors are available to adapt this coupler to standard waveguide runs. A calibrated attenuator rod is provided with stops at both 70 db and 55 db.

Stock Identification:

Attenuating Coupler	MI-26478
---------------------------	----------

Attenuating Coupler, MI-26478



SPECIFICATIONS FOR WAVEGUIDE COMPONENTS

Description	Stock Identification	Frequency	Nominal Forward Attenuation	VSWR	Special Electrical Specs.	Flange Connections Input Output	Length	Other Critical Dimension	Other Remarks
Rigid Waveguide, flanged	MI-26428-1	5850-8200 mcs	3 db/100 ft.	1.05	---	Choke Flat	2'	1 3/4" x 3/4" O.D.	hi-conductivity copper 0.064" wall
Rigid Waveguide, flanged	MI-26428-2	5850-8200 mcs	3 db/100 ft.	1.05	---	Choke Flat	4'	1 3/4" x 3/4" O.D.	copper 0.064" wall
Rigid Waveguide, flanged	MI-26428-3	5850-8200 mcs	3 db/100 ft.	1.05	---	Choke Flat	6'	1 3/4" x 3/4" O.D.	copper 0.064" wall
Rigid Waveguide, flanged	MI-26428-4	5850-8200 mcs	3 db/100 ft.	1.05	---	Choke Flat	8'	1 3/4" x 3/4" O.D.	copper 0.064" wall
Rigid Waveguide, flanged	MI-26428-5	5850-8200 mcs	3 db/100 ft.	1.05	---	Choke Flat	10'	1 3/4" x 3/4" O.D.	copper 0.064" wall
Rigid Waveguide, unflanged	MI-26416-1	5850-8200 mcs	3 db/100 ft.	1.05	---	---	2'	1 3/4" x 3/4" O.D.	copper 0.064" wall
Rigid Waveguide, unflanged	MI-26416-2	5850-8200 mcs	3 db/100 ft.	1.05	---	---	4'	1 3/4" x 3/4" O.D.	copper 0.064" wall
Rigid Waveguide, unflanged	MI-26416-3	5850-8200 mcs	3 db/100 ft.	1.05	---	---	6'	1 3/4" x 3/4" O.D.	copper 0.064" wall
Rigid Waveguide, unflanged	MI-26416-4	5850-8200 mcs	3 db/100 ft.	1.05	---	---	8'	1 3/4" x 3/4" O.D.	copper 0.064" wall
Rigid Waveguide, unflanged	MI-26416-5	5850-2800 mcs	3 db/100 ft.	1.05	---	---	10'	1 3/4" x 3/4" O.D.	copper 0.064" wall
Rigid Waveguide, unflanged	MI-26416-6	5850-2800 mcs	3 db/100 ft.	1.05	---	---	12'	1 3/4" x 3/4" O.D.	copper 0.064" wall
Flat Flange, Type UG-344/U	MI-26491	5850-8200 mcs	---	1.05	---	---	3/8"	3 1/8" O.D.	6 clearance holes on 2 3/4" diameter
Choke Flange, Type UG-343A/U	MI-26492	5850-8200 mcs	---	1.05	---	---	3/4"	3 1/8" O.D.	6 threaded 10-32 holes on 2 3/4" dia.
90° Elbow, E Plane	MI-26425-1	5850-8200 mcs	3 db/100 ft.	1.05	---	Choke Flat	See Dwg.	1 3/4" x 3/4" O.D.	copper 0.064" wall
90° Elbow, H Plane	MI-26425-2	5850-8200 mcs	3 db/100 ft.	1.05	---	Choke Flat	See Dwg.	1 3/4" x 3/4" O.D.	copper 0.064" wall
90° Elbow, E Plane, nonpressurizing	MI-26425-3	5850-8200 mcs	3 db/100 ft.	1.05	---	Flat Flat	See Dwg.	1 3/4" x 3/4" O.D.	copper 0.064" wall
90° Elbow, H Plane, nonpressurizing	MI-26425-4	5850-8200 mcs	3 db/100 ft.	1.05	---	Flat Flat	See Dwg.	1 3/4" x 3/4" O.D.	copper 0.064" wall
90° Elbow, E Plane	MI-26425-5	5850-8200 mcs	3 db/100 ft.	1.05	---	Choke Choke	See Dwg.	1 3/4" x 3/4" O.D.	copper 0.064" wall
90° Elbow, H Plane	MI-26425-6	5850-8200 mcs	3 db/100 ft.	1.05	---	Choke Choke	See Dwg.	1 3/4" x 3/4" O.D.	copper 0.064" wall
90° Waveguide Twist	MI-26427-1	5850-8200 mcs	3 db/100 ft.	1.05	---	Choke Flat	10'	1 3/4" x 3/4" O.D.	copper 0.064" wall
90° Waveguide Twist	MI-26427-2	5850-8200 mcs	3 db/100 ft.	1.05	---	Flat Flat	10'	1 3/4" x 3/4" O.D.	copper 0.064" wall
90° Waveguide Twist	MI-26427-3	5850-8200 mcs	3 db/100 ft.	1.05	---	Choke Choke	10'	1 3/4" x 3/4" O.D.	copper 0.064" wall
Flexible Waveguide	MI-26458-1	8550-8200 mcs	0.09 max. db per ft.	1.10	---	Choke Flat	5'	1 3/4" x 3/4" O.D.	bend radius 2 1/2" E Plane; 5" in H plane; flexibility constant -55° C to 125° C
Flexible Waveguide	MI-26458-2	8550-8200 mcs	0.09 max. db per ft.	1.10	---	Choke Flat	6'	1 3/4" x 3/4" O.D.	bend radius 2 1/2" E Plane; 5" in H plane; flexibility constant -55° C to 125° C
Flexible Waveguide	MI-26468-1	5850-8200 mcs	0.09 max. db per ft.	1.10	---	Choke Flat	5'	1 3/4" x 3/4" O.D.	with 90° twist
Flexible Waveguide	MI-26468-2	5850-8200 mcs	0.09 max. db per ft.	1.10	---	Choke Flat	6'	1 3/4" x 3/4" O.D.	with 90° twist
Waterproofing Flange	MI-26469	5850-8200 mcs	---	1.05	---	---	1/4"	4 1/2" O.D.	6 clearance holes on 3 7/8" diameter

Description	Stock Identification	Frequency	Nominal Forward Attenuation	VSWR	Special Electrical Specs.	Flange Connections Input Output	Length	Other Critical Dimension	Other Remarks
Feed-Through Assembly	MI-26472-1	5850-8200 mcs	3 db/100 ft.	1.05	---	Choke Flat	10'	1 3/4" x 3/4" O.D.	hi-conductivity copper 0.064" wall
Feed-Through Assembly	MI-26472-2	5850-8200 mcs	3 db/100 ft.	1.05	---	Choke Flat	8'	1 3/4" x 3/4" O.D.	copper 0.064" wall
Feed-Through Assembly	MI-26472-3	5850-8200 mcs	3 db/100 ft.	1.05	---	Choke Flat	6'	1 3/4" x 3/4" O.D.	copper 0.064" wall
Feed-Through Assembly	MI-26472-4	5850-8200 mcs	3 db/100 ft.	1.05	---	Choke Flat	4'	1 3/4" x 3/4" O.D.	copper 0.064" wall
Feed-Through Assembly	MI-26472-5	5850-8200 mcs	3 db/100 ft.	1.05	---	Choke Flat	2'	1 3/4" x 3/4" O.D.	copper 0.064" wall
Antenna Feed Adaptor	MI-26454-A	5850-8200 mcs	3 db/100 ft.	1.05	---	Choke 29° Acme thread, 8 threds to inch	1.88"	2" dia.	Greatest O.D. 3/8" over flange
Antenna Feed Adaptor	MI-26454-A1	5850-8200 mcs	3 db/100 ft.	1.05	---	Flat 29° Acme thread 8 threds to inch	1.88"	2" dia.	Greatest O.D. 3/8" over flange
Pressurizing Section	MI-26426-1	5850-8200 mcs	3 db/100 ft.	1.05	---	Choke Flat	6'	1 3/4" x 3/4" O.D.	with 0-15 psi pressure gauge and gas inlet valve
Pressurizing Section	MI-26426-2	5850-8200 mcs	3 db/100 ft.	1.05	---	Choke Choke	6'	1 3/4" x 3/4" O.D.	with 0-15 psi pressure gauge and gas inlet valve
Pressurized Mica Window	MI-26463	5850-8200 mcs	3 db/100 ft.	1.05	---	---	0.11"	3/8" dia.	Window dim.: 1.38" long x 0.62" wide; pressurization to 45 psi
Waveguide to R-F Case Adaptor	MI-26459	5850-8200 mcs	3 db/100 ft.	1.05	---	Choke male connector	6"	3/4" O.D.	Threaded coupling sleeve on one end
Waveguide to R-F Case Adaptor	MI-26459-1	5850-8200 mcs	3 db/100 ft.	1.05	---	Flat male connector	6"	3/4" O.D.	Threaded coupling sleeve on one end
90° Waveguide to R-F Head Adaptor	MI-26462	5850-8200 mcs	3 db/100 ft.	1.05	---	r-f head flange Choke	---	3/4" O.D.	90° bend
90° Waveguide to R-F Head Adaptor	MI-26462-1	5850-8200 mcs	3 db/100 ft.	1.05	---	r-f head flange Flat	---	3/4" O.D.	90° bend
Waveguide Adaptor, R-F case to Attenuating Coupler	MI-26476	5850-8200 mcs	3 db/100 ft.	1.05	---	nut, coupling assy. Flat	4"	---	---
Directional Coupler	MI-26466	5850-8200 mcs	3 db/100 ft.	1.05	---	Flat 2 Flat flanges	26.56"	---	---
Waveguide Switch	MI-26490	5850-8200 mcs	insertion loss 0.5 db	1.10	Switching time 100 millisecc. switch—3 amps, at 120 V. a-c	2 Choke Choke	7-5/4"	Cube Base 3" on side	ambient operating temp. —20°C to 55°C; pressure up to 40 psi
Waveguide Termination	MI-26488	5925-8200 mcs	---	1.10	Dispipation—10 watts average power	Flat None	2 1/2"	---	Non-reactive from 5950-8200 mcs.
Ferrite Isolator	MI-26465-A1	5925-6425 mcs	less than 0.1 db	1.15	Attenuation reflected r-f energy: 40 db	Choke Flat	5.410"	---	Pressure—up to 45 psi
Ferrite Isolator	MI-26465-A3	6425-6875 mcs	less than 0.1 db	1.15	Attenuation reflected r-f energy: 40 db	Choke Flat	5.410"	---	Pressure—up to 45 psi

SPECIFICATIONS FOR WAVEGUIDE COMPONENTS

Description	Stock Identification	Frequency	Nominal Forward Attenuation	VSWR	Special Electrical Specs.	Flange Connections Input Output	Length	Other Critical Dimension	Other Remarks
Ferrite Isolator	MI-26465-A4	6875-7425 mcs	less than 0.1 db	1.15	Attenuation reflected r-f energy: 40 db	Choke Flat	5.410"	---	Pressure—up to 45 psi
Ferrite Circulator	MI-26489-1	5925-6425 mcs	0.5 db per pass	1.15	20 db max. isolation; 25 watts max: ave. power rating	4 Flat	12 $\frac{3}{4}$ "	5 $\frac{1}{8}$ " high 3.312" wide	---
Ferrite Circulator	MI-26489-2	5925-6425 mcs	0.5 db per pass	1.15	20 db min. isolation; 25 watts max: ave. power rating	4 Flat	12 $\frac{3}{4}$ "	---	---
Ferrite Circulator	MI-26489-3	6875-7250 mcs	0.5 db	1.15	20 db min. isolation; 25 watts max: ave. power rating	4 Flat	12 $\frac{3}{4}$ "	---	---
Ferrite Circulator	MI-26489-4	7125-7425 mcs	0.5 db	1.15	20 db min. isolation; 25 watts max: ave. power rating	4 Flat	12 $\frac{3}{4}$ "	---	---
Preselection Filter	MI-26412-1	5925-6225 mcs	60 db signal rejection at 75 mc from pass-band center freq.	1.15	Bandwidth 3 db max. at 35 mcs	Choke Flat	9 $\frac{1}{4}$ "	3 $\frac{1}{8}$ " O.D.	Specify passband center frequency
Preselection Filter	MI-26412-2	6225-6525 mcs	60 db signal rejection at 75 mc from pass-band center freq.	1.15	Bandwidth 3 db max. at 35 mcs	Choke Flat	9 $\frac{1}{4}$ "	3 $\frac{1}{8}$ " O.D.	Specify passband center frequency
Preselection Filter	MI-26412-3	6525-6825 mcs	60 db signal rejection at 75 mc from pass-band center freq.	1.15	Bandwidth 3 db max. at 35 mcs	Choke Flat	9 $\frac{1}{4}$ "	3 $\frac{1}{8}$ " O.D.	Specify passband center frequency
Preselection Filter	MI-26412-4	6825-7125 mcs	60 db signal rejection at 75 mc from pass-band center freq.	1.15	Bandwidth 3 db max. at 35 mcs	Choke Flat	9 $\frac{1}{4}$ "	3 $\frac{1}{8}$ " O.D.	Specify passband center frequency
Preselection Filter	MI-26412-5	7125-7425 mcs	60 db signal rejection at 75 mc from pass-band center freq.	1.15	Bandwidth 3 db max. at 35 mcs	Choke Flat	9 $\frac{1}{4}$ "	3 $\frac{1}{8}$ " O.D.	Specify passband center frequency
Attenuating Coupler	MI-26478	5850-8200 mcs	---	---	55/70 db attenuation	Special Flanged Coupling	22 $\frac{1}{16}$ "	2 $\frac{9}{16}$ " O.D. Flanges	---

MICROWAVE CONTROL EQUIPMENT

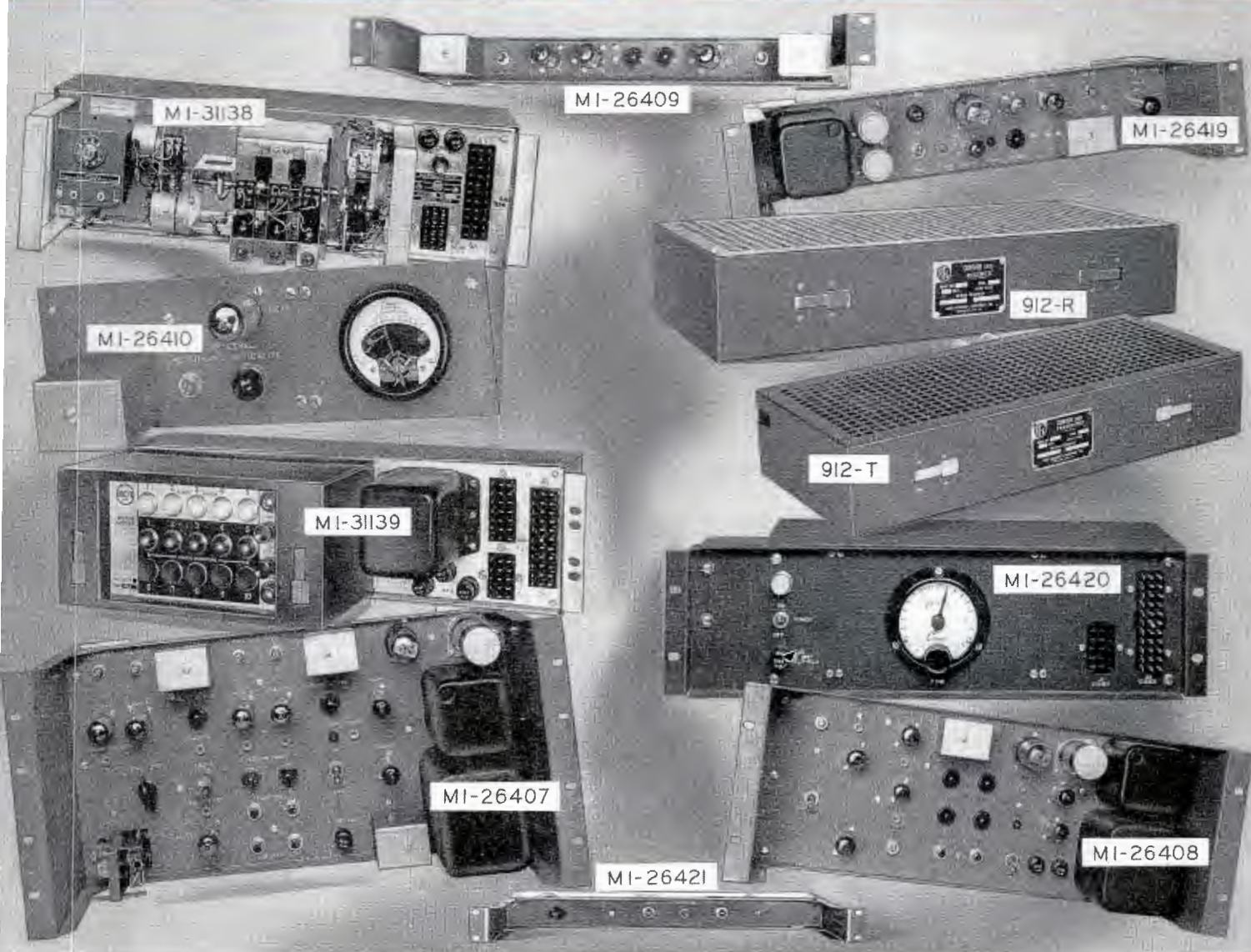

FEATURES

- Facilitates automatic switchover to standby receiver to transmitter
- Provides remotely controlled shutdown of transmitter at unattended location
- Permits diversity operation of receivers for protection against propagation path fade
- Allows remotely controlled reversal of direction of microwave transmission
- Handles wide variety of remotely controlled switching functions to meet individual system requirements

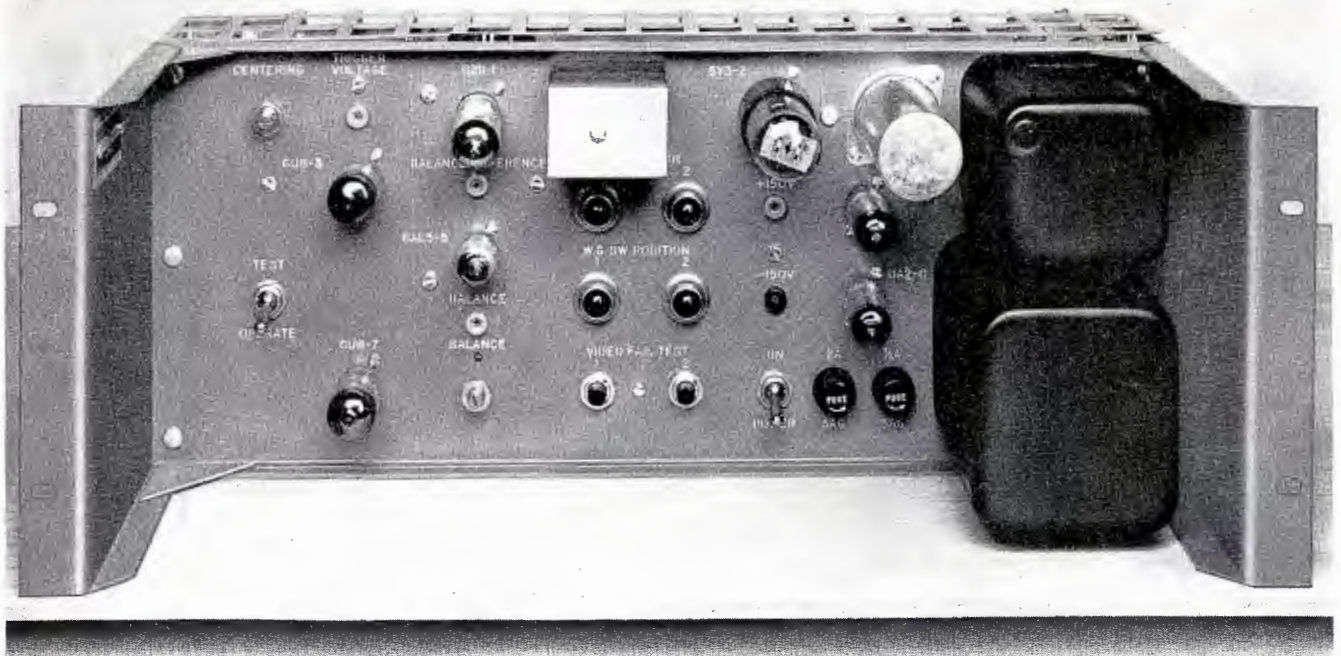

Transmitter Standby Switcher, MI-26408.

USES

In order to meet the widely diversified system requirements of multi-hop microwave installations, RCA has developed a series of accessory control devices for unattended or remotely controlled operation of TVM-1B Microwave Equipment. These devices permit great versatility in microwave system design and provide a means of remote supervision and control of unattended microwave repeater stations.

Functions which the controls will perform include fault sensing, fault reporting, automatic switchover to standby equipment, diversity reception, automatic shutdown of microwave transmitters in remote locations, and reversal of direction of transmission. The sensing units provide reporting information which can be transmitted over any medium such as class D commercial telephone line, separate microwave system, or over a sound-duplexed subcarrier.

Basic Equipment Units in the RCA Fault Indicating Equipment System include a Receiver Diversity Switch, MI-26407; a Transmitter Standby Switch, MI-26408; a Video Failure Indicator, MI-26409; a Low Power and Low Signal Level Indicator, MI-26410; and a Video Presence Detector, MI-26419. These units provide the fault location information and provide local indication of the existence and location of such a fault.

The above equipment will report to a remote station the nature and location of an equipment failure at any loca-

tion in a microwave system, thereby simplifying correction of the fault. They will, also, provide automatic switching to a standby receiver or transmitter at any station in the microwave system, while reporting the failure to the remote station.

Basic Equipment Units in the RCA Fault Reporting and Switching Equipment include an Indicon Encoder, MI-31138; an Indicon Decoder, MI-31139; a Comvor 912T Data Transmitter; a Comvor 912R Data Receiver; a Type TSD-3A Sound Diplexer Modulator and Demodulator, MI-26493/26494; a Delay Timer, MI-26420; and an Antenna Reversing Control, MI-26421. These units may be formed into a system for transmission of fault sensing and locating data from an unattended or attended microwave equipment location, such as a repeater station, to either or both terminal stations of the microwave system. Provisions can also be made for remotely controlling switching of r-f components to effect reversal of the direction of transmission of any microwave system.

Since the Fault Indicating and Reporting Systems required will vary with any given installation, they should be approached on a custom basis. RCA engineers are prepared to determine and quote on requirements for any multiple-hop installation. Three basic types of systems are described in this catalog which must be considered as typical only to illustrate basic systems. Equipment items making up the systems are described on an individual basis.

DESCRIPTION

A highly effective means of improving the reliability of Microwave Systems is to employ, throughout the system, devices which will automatically sense failures or degraded performance; to report the information when it occurs; and to automatically switch defective system components out of the circuit and switch in standby equipments when such standby equipment is available in the system.

Equipment performing these functions will greatly increase the reliability of a system, even beyond that to be expected when human supervision is employed. This is made possible by the fact that these devices determine and report the existence of important specific operating conditions instantaneously, as compared with the methods of analysis and judgment which must be exercised when relying on human observation.

Typical Systems

The uses of the Multi-hop Microwave control equipment described herein are not restricted to the system applications listed. The equipment should be considered as building blocks for an extremely wide variety of systems. Each microwave installation must, therefore, be treated individually to determine which combination of accessories offers the maximum economy and utility. It is possible to use fault sensing and fault reporting facilities without employing any standby equipment. Such a system may have either an attended or unattended sending terminal, from

one to ten unattended repeater stations and an attended receiving terminal. In this type installation, microwave equipment is automatically shut down when trouble develops in order to comply with FCC regulations. Reporting facilities enable the operator to quickly locate and repair failures and thus restore the system to operation. Three typical systems are offered to illustrate only a few of the possible arrangements.

The first system presents (Fig. 1.) a one-hop microwave system employing standby automatic switching and diversity reception. The equipment is shown arranged for space diversity, although it can be rearranged for frequency diversity as well. Two transmitters are used at the sending terminal, and the monitor output from each is looped through a transmitter standby switcher. Failure of video or power output from the in-use transmitter causes the switcher to transfer r-f output connections to the standby transmitter, thus restoring the circuit. At the receiving terminal, video outputs from two receivers are fed into a receiver diversity switcher. This unit, in the event of a fade in signal or failure of the in-use receiver, automatically switches the video output line to the non-faded receiver. Contacts in the transmitter and receiver standby switchers provide a means for local or remote indications of equipment performance. A system of this type may have either an attended or unattended terminal station and from one to ten unattended repeater stations.

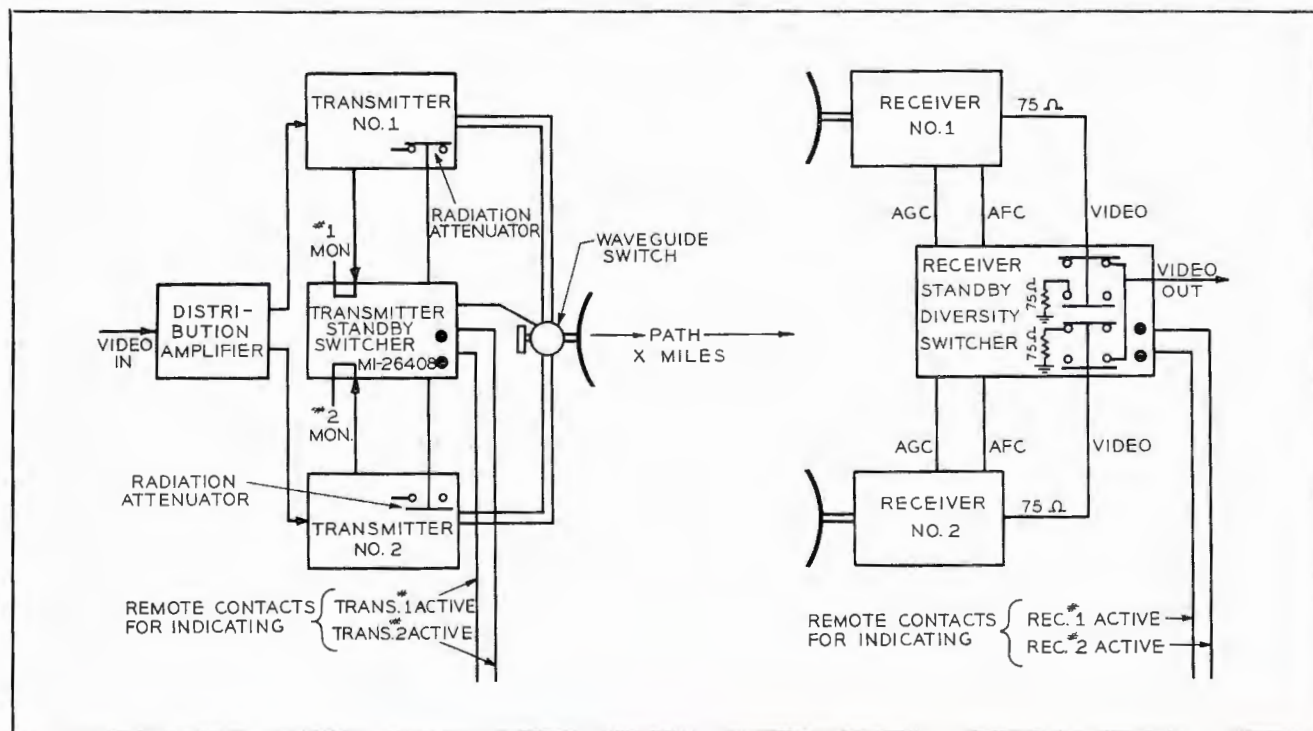

FIG. 1. Block diagram showing diversity and automatic switching units employed in a single-hop microwave link. Although space diversity is illustrated, equipment can be rearranged for frequency diversity as well.

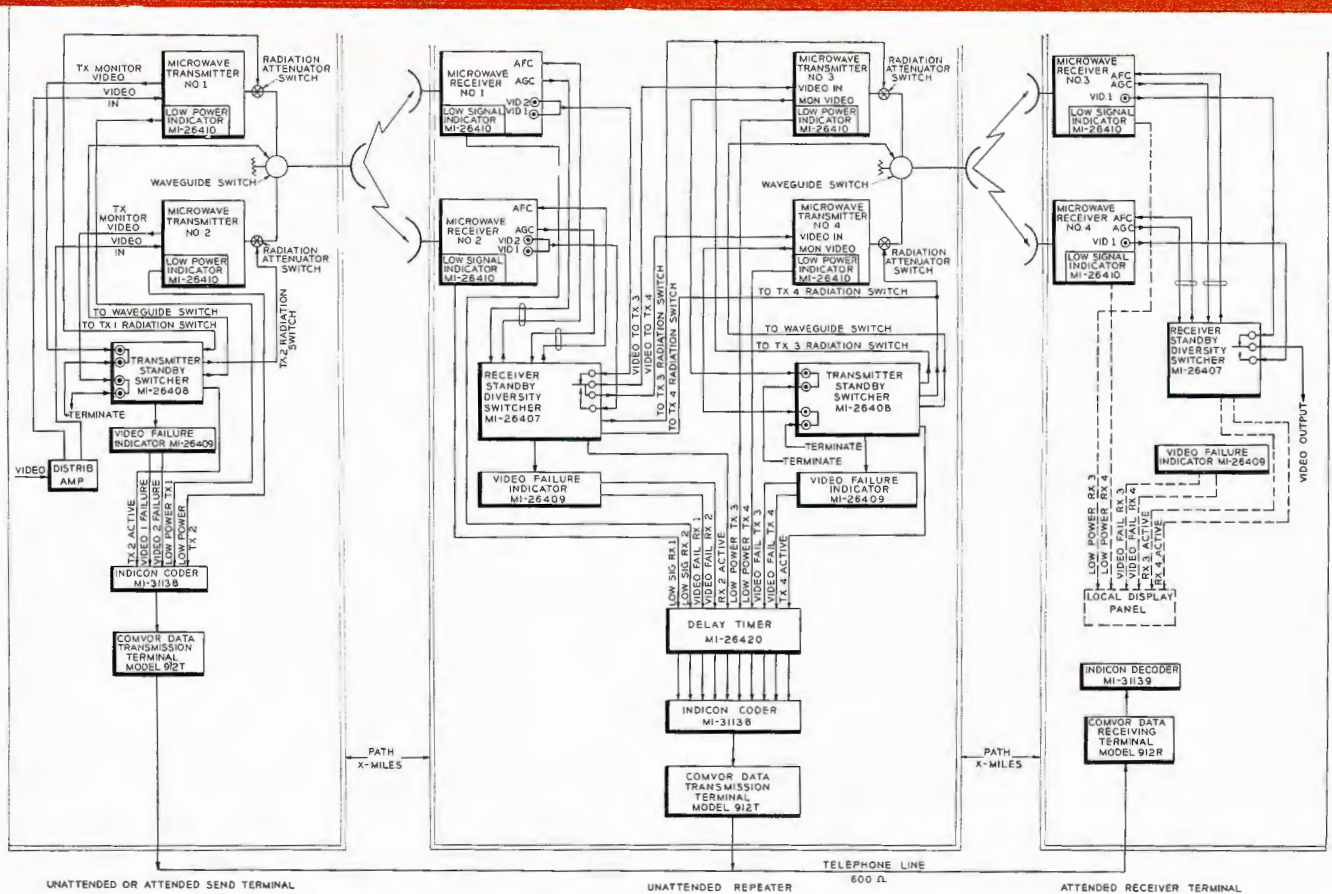

FIG. 2. Block diagram showing diversity and automatic switching units employed in a two-hop system with provisions for relaying fault information from repeater station and unattended terminal station to the receiver terminal station.

The second system, shown in Fig. 2, is a two-hop system employing standby, diversity, fault sensing and fault reporting equipment. Also included in this system are the accessories for relaying fault information from the microwave repeater station and from the unattended transmitter terminal station to the receiver terminal station. At the sending terminal, which may be attended or unattended, the monitoring output from each transmitter is looped through the transmitter standby switcher. Video is sampled and rectified. Failure of output from the radiating transmitter causes the switcher to transfer r-f connection to the standby transmitter, and simultaneously feed video fault-sensing signals to the video failure indicator. Power output failure indications are fed through the Indicon coder to the Comvor transmitter for transmission over a telephone line or radio relay circuit to the Comvor receiver in the attended receiving terminal. Display of these indications is provided at the Indicon Decoder.

Receivers in both the repeater and receiving terminal utilize receiver standby switchers which select the "non-failed" or non-faded receiver outputs, and provide automatic indication of "failed" units. Indications of loss of r-f signal input are provided by the low signal indicators.

Just as in the send terminal, video failure indicators are used in the repeater and receiving terminal. In the repeater, however, fault signals are fed to the indicon coder through a delay timer. An initial fault starts the timing cycle, and upon completion of the cycle the indicon transmits the faults. The amount of time delay is variable, and is set in multiples of 20 seconds for each repeater. In this plan, fault indications are provided locally, and contacts used to activate remote indicators are delayed by the Timer to prevent interference with fault signals from an earlier station.

Fault reporting can be accomplished easily and economically by a party telephone line. This medium offers the most positive control of fault reporting and switching information in one or in both directions on the system. Where telephone lines are not available or the cost of local lines is prohibitive, an alternate method is to employ at each site a companion low-cost microwave system that will transmit the required data and provide voice circuits as well for maintenance and communication. Frequencies are available for this use. An alternate method of relaying fault information to an attended receiving station is by means of a subcarrier on the microwave

relay system itself. This may be accomplished by using a TSD-3A Sound Diplexing system for the reporting function on a subcarrier frequency of 6.2 megacycles, while program sound is handled by a TSD-2B Sound Diplexer operating on a subcarrier frequency of 6.8 megacycles.

The third system (Fig. 3), is a 2-hop system with provision for reversal of waveguide connections to permit transmission in either direction. Only one receiver, and one transmitter are required at each terminal station and at the repeater station. The system may include any number of repeater stations from one to fifteen.

Reversal of direction is accomplished by the use of a waveguide switch at each station to reverse waveguide connections from the microwave receiver and transmitter to the antenna. Operation of the waveguide switches is controlled from the attended master terminal station by means of a Comvor Model 912T Transmitter, which is keyed on at either of two frequencies to differentiate between "northbound" and "southbound" transmission. A Comvor Model 912R receiver at each of the unattended stations receives the audio control tone from the master

terminal by means of a telephone wireline, and converts the tone to a contact closure which operates the waveguide switch in the desired direction. "Answer-back" contacts on the waveguide switch are used to operate an indicon coder and Comvor transmitter at each unattended station to report back to the attended master terminal station the actual position of each waveguide switch. Transmitter and receiver failure indications are also relayed from each of the unattended stations to the master station.

System Components

The control equipment for multi-hop microwave systems consists of basic units which are used to perform a variety of functions in accordance with individual system requirements. A description of each unit and its function follows.

Receiver Standby-Diversity Switch, MI-26407

The Receiver Standby-Diversity Switcher, MI-26407, is designed to permit the utilization of two receivers in the TVM-1B Microwave Relay System for Space or Frequency Diversity reception. Operated in this manner, system "out-age" time resulting from propagational fades is greatly

FIG. 3. Block diagram of a two-hop TVM-1B Microwave System with provision for reversal of waveguide connections to permit transmission in either direction.

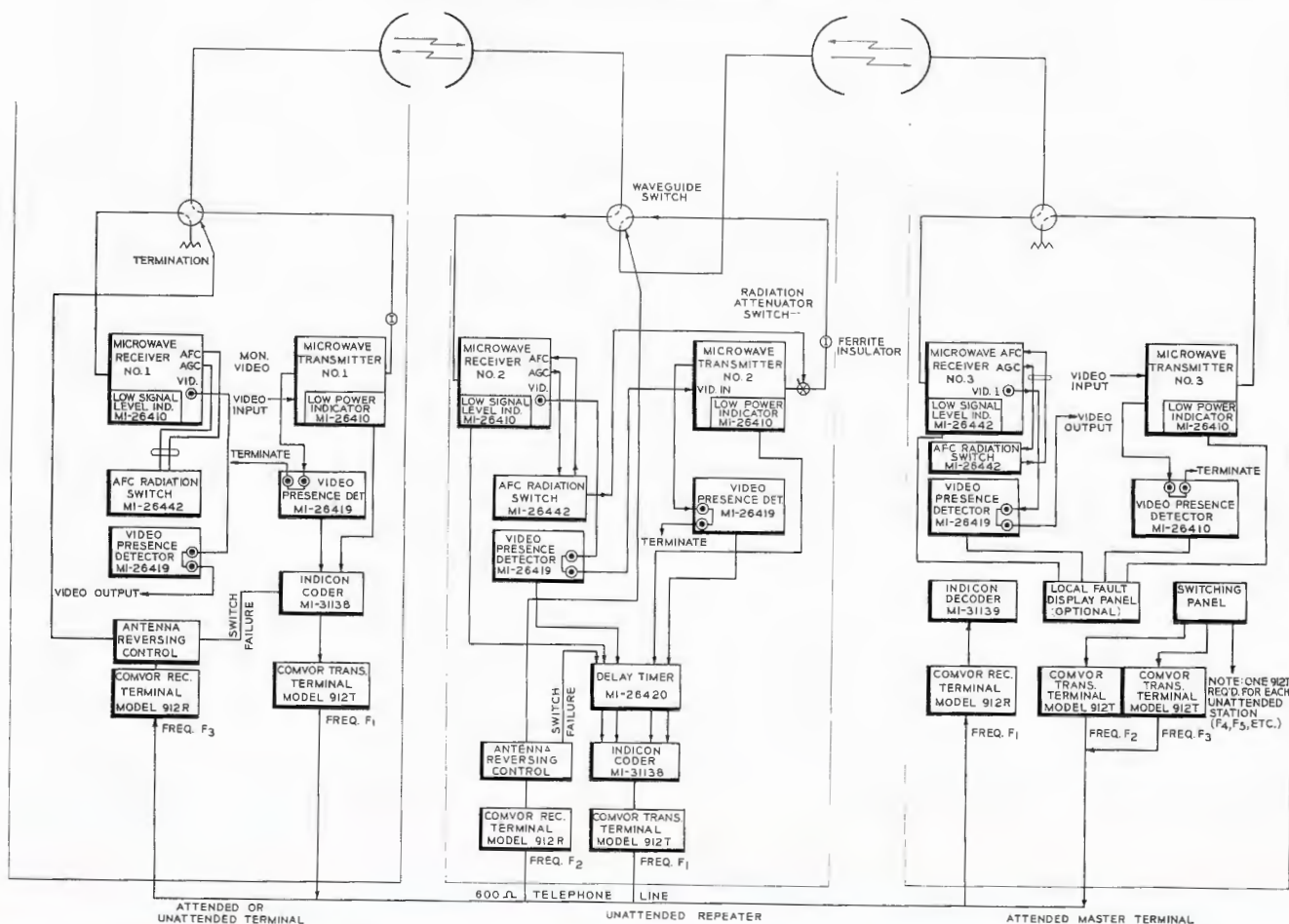



Receiver Diversity Switch, MI-26407.

reduced. The unit also provides standby protection by switching to the active receiver if the video output of either receiver should fail. The video output signals and AGC (Automatic Gain Control) voltages of two receivers are sensed by the Receiver Standby Diversity Switcher so that if one video signal should fail, the unit will select the signal of the second receiver. Switchover will occur only in the event that the second receiver is delivering a usable signal.

The diversity aspect of the unit's function is controlled by the AGC voltage from each receiver, which is compared electrically with the minimum AGC voltage required for an acceptable signal-to-noise ratio. The switching unit contains potentiometers which may be adjusted to cause switchover when a predetermined AGC level is reached. If the AGC voltage of the operating receiver falls below the preset level because of a propagational fade, the switching unit will select the output of the second receiver; however, upon recovery of the signal from a faded condition, no additional switching will occur unless the AGC voltage of the second receiver falls below its preset level.

An additional feature of the Receiver Standby-Diversity Switcher is the provision of protection against "wandering" of the tuning circuit of the TVR-1B receiver upon loss of r-f input. In this event, the AFC is disabled leaving the receiver tuning circuit at a fixed position until the r-f signal is restored. Also, if the AGC voltage of both

receivers should fall below the preset level as a result of signal loss, radiation switches in both following transmitters of standby repeater system will be operated to the off position. This will prevent the transmission of a noise modulated signal and makes it possible to turn off r-f output from a series of unattended stations by tuning off radiation from the first transmitter.

Two sets of relay contacts are available to provide remote identification of the receiver in use. In the event of failure of the built-in power supply of the Standby-Diversity Switcher, a "fail-safe" relay automatically transfers operation to a pre-designated receiver, and a pair of contacts is closed to provide a remote indication of the failure. Built-in test circuits permit a rapid check of normal operation by simulating a fade of the received signal or a failure of the video output signal of either receiver.

SPECIFICATIONS

Input Power Requirement.....	117 volts AC, 50/60 cps, 60 watts
AGC Trigger Voltage Level.....	Adjustable -0.5 volts to -1.5 volts
Video Switchover Level.....	Switchover occurs when "in use" video channel falls 6 to 12 db below standby channel
Switching Time—From failure to completion of switchover:	
Video Failure.....	Approximately 75 milliseconds
Diversity Action.....	Approximately 35 milliseconds total (5 milliseconds of program interruption)
Weight	23 lbs.
Dimensions:	
Depth	11"
Width	19"
Height	8¾"
Stock Identification	MI-26407

Transmitter Standby Switcher, MI-26408

The Transmitter Standby Switcher (pictured on page two), is designed to provide automatic switchover between two TVT-1B Microwave Transmitters in the event of failure of the "in-use" transmitter. The operation of the Transmitter Standby Switcher is similar to the video failure protection function of the Receiver Standby-Diversity Switch, MI-26407. The transmitter switching unit is actuated by a video output sample from the MI-26644 Transmitter Monitor unit which is required for operation with each of the two TVT-1B Transmitters.

By appropriate connections to the two TVT-1B Transmitters, relay control contacts will operate the radiation switches of the transmitters, thereby attenuating the r-f output of the "failed" transmitter and allowing the "non-failed" transmitter to radiate. If both transmitters are "non-failed," only one transmitter radiates, and the other transmitter output is attenuated. Visual identification of the active transmitter is provided by a pair of signal lamps located on the front of the transmitter standby switching unit.

In addition to the control contacts utilized to operate the transmitter radiation switches, two sets of contacts are provided to activate remote indicating devices for identification of the active transmitter, or to activate a waveguide switch used for connecting the output of the active transmitter to the antenna. A pair of signal lamps located on the front panel of the switching unit is used to indicate the position of the waveguide switch. Built-in test circuits permit a check of normal operation by simulating a drop in video level from either transmitter monitor.

SPECIFICATIONS

Input Power Requirement.....	117 volts AC, 50/60 cps, 75 watts
Video Failure Level.....	Switchover occurs when "in use" video channel falls 6 to 12 db below standby channel
Switching Time—from video failure to completion of switchover.....	Approximately 160 milliseconds
Weight	19 lbs.
Dimensions:	
Depth	11"
Width	19"
Height	7"
Stock Identification	MI-26408

Video Failure Indicator, MI-26409

The Video Failure Indicator unit will signal the occurrence of a video failure in a TVM-1B Microwave System. It must be used in conjunction with a Receiver Standby-Diversity Switcher or a Transmitter Standby Switcher since the operating power and input signals are derived from these units. Local indication of equipment failure is provided by indicator lamps, while remote indication is accommodated by means of relay contacts which remain open under non-failed conditions and are closed in the event of failure.

The Video Failure Indicator unit does not distinguish between a video signal and noise, and will therefore, indicate the presence of either so long as the amplitude as applied to the associated switching unit is in excess of the minimum indicating level. Variable controls are provided to permit setting of the indicating levels independent of the adjustment of the switching units.

The Video Failure Indicator consists of a single unit in the form of a rack-mounting, recessed chassis. It occupies only 1¾ inches of vertical rack space.

SPECIFICATIONS

Input Power Requirement (Power derived from associated Receiver Standby-Diversity Switcher or Transmitter Standby Switcher):	
DC	+270 volts DC
	+150 volts DC
	-150 volts DC
Filaments	6.3 volts AC
Video Failure Level.....	Adjustable, 0.15 to 0.3 volts peak-to-peak
Weight	3 lbs
Dimensions:	
Depth	10½"
Width	19"
Height	1¾"
Stock Identification	MI-26409

Video Failure Indicator, MI-26409.

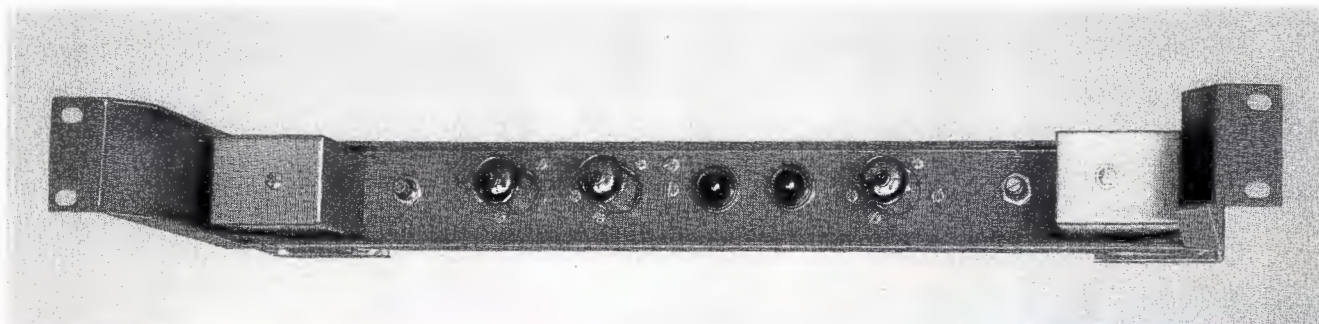

Low Power/Low Signal Indicator, MI-26410

The Low Power/Low Signal Indicator chassis is designed to provide a local and a remote indication of a reduction in the power output of a TVT-1B microwave transmitter or in the signal level of a TVR-1B microwave receiver below a preset minimum level. Transmitter output is based on the crystal current, and receiver signal level is based on the AGC voltage.

As a transmitter low power indicator the unit may be set to indicate any degree of reduction in power output between 3 db and total failure. As a low signal indicator it may be used to indicate any degree of reduction in received signal from 15 db to total failure. The indicating level is established in advance by a potentiometer setting. Power for the indicator is obtained from either the transmitter or receiver head end, or from the transmitter or receiver control with which it is used. Remote indication is accommodated by means of a pair of relay contacts actuated by the level-sensing circuit.

The indicator unit is constructed on a subchassis panel which will mount on the rack mounting chassis of a TVM-1B Transmitter or Receiver Head End. It may also be mounted on a 3½ by 19-inch recessed rack mounting chassis, MI-26418, which is used to mount the device in the portable field case for the transmitter or receiver control when sound diplexing accessories are not used.

SPECIFICATIONS

Input Power Requirement (power derived from associated TVM-1 transmitter or receiver unit).		
DC.....	+285 to 300 volts	
Filaments.....	6.3 volts AC	
Failure Indicating Level (drop in transmitter power or receiver incoming signal)		
As Low Power Indicator.....	from 3 db to total failure	
As Low Signal Indicator.....	from 15 db to total failure	
Weight	2 lbs.	
Dimensions:		
	<i>With MI-26418</i>	<i>Less MI-26418</i>
	<i>Rack Adaptor</i>	<i>Rack Adaptor</i>
Depth	7 3/8"	2 1/8"
Width	19"	9 7/8"
Height	3 1/2"	3 1/4"
Stock Identification	MI-26410	

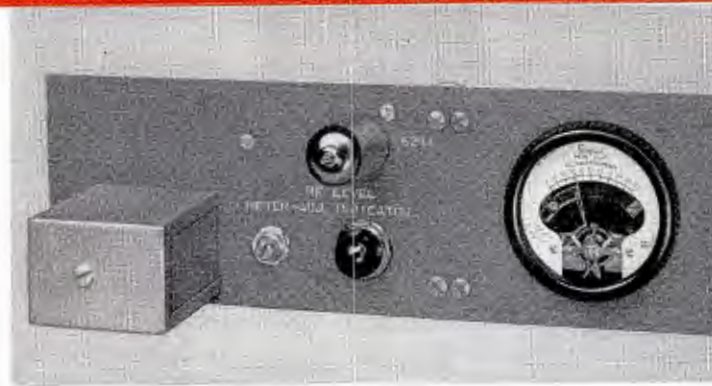

Low Power/Low Signal Indicator, MI-26410.

Video Presence Detector, MI-26419

This unit is similar to the MI-26409 Video Failure Indicator with the exception that it can operate where neither a receiver diversity-standby switcher nor a transmitter standby switcher is available. It may thus be used to indicate the loss of a video signal at the output of a receiver or of a transmitter monitor in a system without standby facilities, and to provide a remote indication at an attended location. The unit with self-contained power supply is in the form of a recessed, rack mounting chassis.

SPECIFICATIONS

Input Power Requirement.....	117 volts AC, 50/60 cps, 30 watts
Video Failure Indication Level.....	Adjustable .06 to 0.4 volts, peak-to-peak
Weight	14 lbs.
Dimensions:	
Depth	9 1/4"
Width	19"
Height	3 1/2"
Stock Identification	MI-26419

Video Presence Detector, MI-26419.

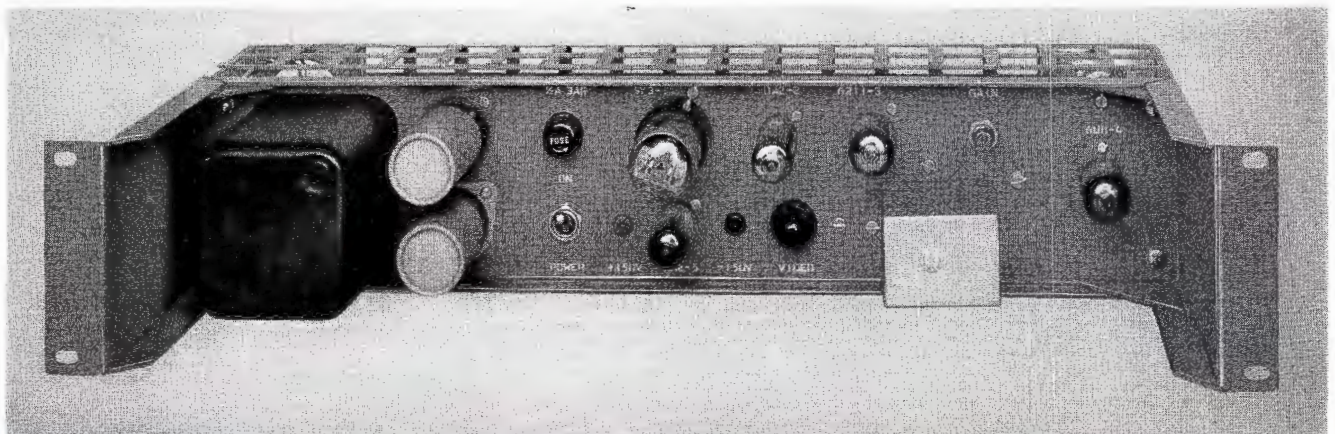



Delay Timer, MI-26420.

Delay Timer, MI-26420

This unit is used to prevent simultaneous transmission of coincident failure in a multi-hop microwave system. The unit is required in a fault reporting system where faults are to be reported from two or more stations over a common system such as a telephone line or a radio relay system. The timer also serves as a junction point for all fault reporting circuits within a station. Delay of the reporting function is accomplished by withholding the application of power to the Indicon Coder for a pre-established time interval. The time interval is adjustable in 5 second increments from zero delay up to a maximum delay of 5 minutes. At the time of installation, a progressively longer delay interval is set up in the reporting function of each successive station in a multiple hop microwave system. Thus, loss of transmission at one station in the system will prevent simultaneous reports from all succeeding stations in the system, and instead will result in consecutive reports from each of the following stations. The unit operates from a 117 volt, 50/60 cycle, ac power source and is designed for rack mounting.

SPECIFICATIONS

Input Power Requirement (including power to Indicon Coder)	125 watts
Delay Interval	Adjustable in 5 second increments, no delay to 5 minutes
Weight	15 lbs.
Dimensions:	
Depth	5"
Width	19"
Height	5 1/4"
Stock Identification	MI-26420

Antenna Reversing Control, MI-26421

The Antenna Reversing Control, MI-26421, is used only in microwave systems in which it is desired to reverse the direction of program transmission. Such a system may consist of one or more hops, and remote control of switching may be provided at either or both terminal stations. The Reversing Control unit serves as a junction for the required connecting circuitry to one or more waveguide switches, and for the connecting circuitry to the "answer-back" micro-switch contacts on the waveguide switches, as well as to the Comvor 912R Data Receiver which is used to actuate the switching operation. Each waveguide switch is provided with micro-switch contacts which may be used to indicate the waveguide switch position in conjunction with suitable reporting equipment. Reporting may be handled by a separate Comvor Data Transmitter in conjunction with a Data Receiver located at the controlling terminal in a telephone line system, or via coded pulses through the Indicon equipment in a fault reporting system.

SPECIFICATIONS

Input Power Requirement	117 volts AC, 50/60 cps, 3-ampere surge load of waveguide switch
Weight	3 lbs.
Dimensions:	
Depth	8 3/4"
Width	19"
Height	1 3/4"
Stock Identification	MI-26421

Antenna Reversing Control, MI-26421.

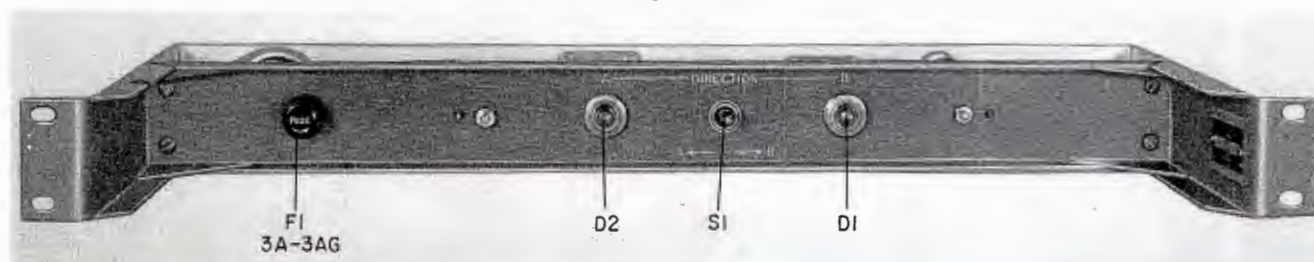

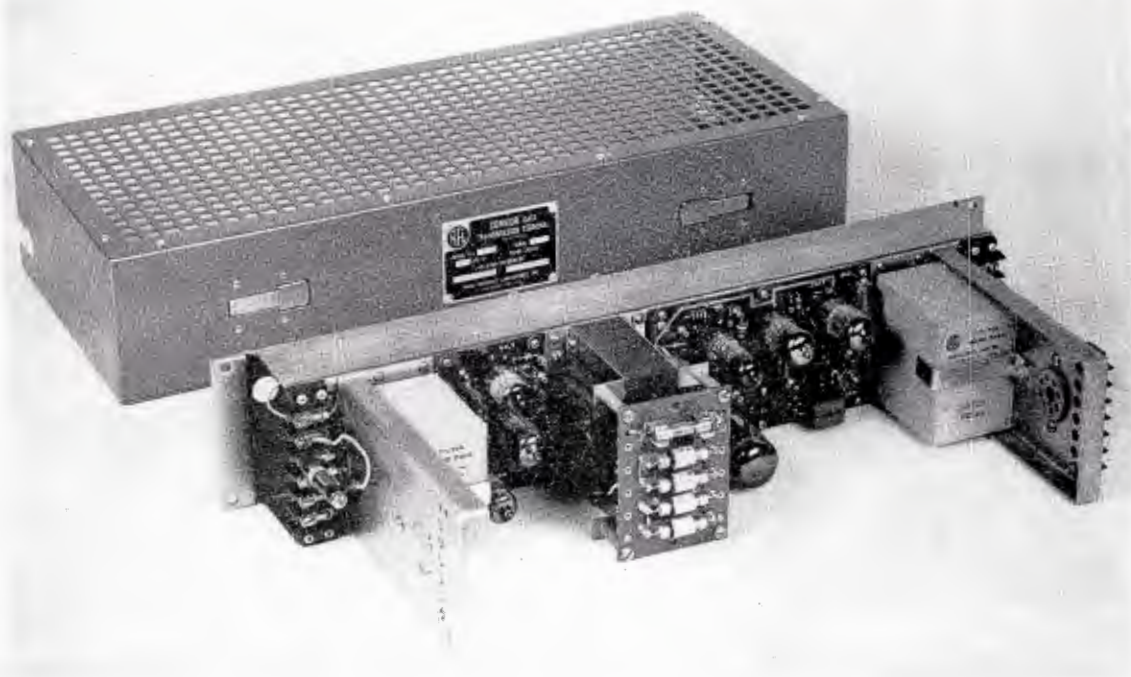

Comvor Data Transmission Terminal comprising Type 912T Data Transmitter and Type 912R Data Receiver.

Comvor 912T Data Transmitter

The Comvor 912T Data Transmitter is an audio frequency generator designed to produce control tones at one of forty-six audio frequencies. These tones are keyed by an Indicon Coder chassis for transmission of fault information by means of a telephone wire line or radio relay link. The transmitter may be used for either "on-off" operation, wherein the audio tone output is keyed on or off, or for "raise-off-lower" operation, wherein the audio tone output is keyed on and off and the frequency of the output tone is shifted by keying. The "on-off" method is normally used in microwave systems for coded fault reporting, and the "raise-off-lower" mode of operation is used for control of switching in reversible systems.

The output level of the 912T Data Transmitter is variable between -30 to 0 dbm. The output channel frequency may be chosen between 300 cycles and 11,000 cycles. Filters are provided to suppress by 20 db or more any harmonics which could cause interference in another channel. A Class "D" commercial telephone line using "party line" connections is suitable for use as a fault reporting medium, providing tone channels are selected within the frequency range of 100 cycles to 3000 cycles. The transmitter is designed for standard rack mounting and requires 3½ inches of rack space.

SPECIFICATIONS

Input Power Requirement.....117 volts, 50/60 cps, 40 watts
 Output Frequency.....Supplied to order,
 single frequency between 300 and 11,000 cps
 Weight10 lbs.
 Dimensions:
 Depth8½" (front projection)
 Width19"
 Height3½"
 Stock IdentificationComvor Type 912T

Comvor Data Receiver, Model 912R

The Comvor 912R Data Receiver is the companion receiver unit for the Data Transmitter. It receives the coded audio tone pulses from the Comvor Transmitter and translates them into contact closures for operation of an Indicon Decoder and its self-contained lamp indicating system. Filters are employed to reject signals outside the audio channel uses. The receiver is supplied with an input impedance of 600 ohms.

SPECIFICATIONS

Input Power Requirements.....117 volts, 50/60 cycles, 40 watts
 Input Frequency.....Supplied to order,
 single frequency between 300 and 11,000 cps
 Weight10 lbs.
 Dimensions:
 Depth8½" (front projection)
 Width19"
 Height3½"
 Stock IdentificationComvor Type 912R

**Indicon Coder, MI-31138,
and Decoder, MI-31139**

The Indicon Coder is a binary coding device designed to produce 15 digits of binary code for remote indicating functions. A 5-digit code starting each transmission identifies the transmitting station. The following 10 digits are coded to report the occurrence of any one of ten faults to be transmitted such as: low transmitter output; low receiver input signal; loss of video at receivers; loss of video at the transmitter; tower light failure; illegal entry; low fuel supply at standby or operating power plant; identification of active receiver or transmitter, and other such functions. The coded pulse output is used to key either a Type 912T Data Transmitter or a microwave subcarrier channel such as the carrier of a TSD-3 Sound Diplexer.

The Indicon Decoder, MI-31139, operates in response to incoming coded signals from one or more coders. A 15-lamp indicator panel presents a visual display of incoming signals; one bank of five lamps identifies the transmitting station, and a second bank of five lamps identifies one of five possible faults being reported by the transmitting station. An additional bank of five lamps can be added to extend fault identification to the ten-fault capability of the encoder. The remaining two lamps are available for identification of local faults at the attended station. The coder and decoder are rack mounting units.

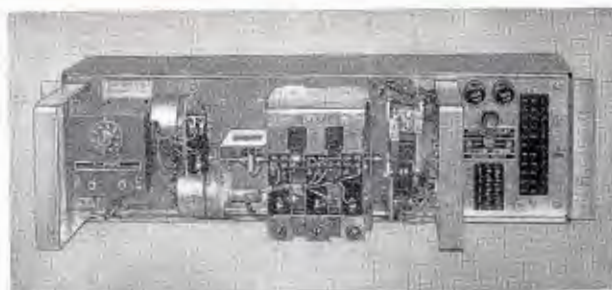

Indicon Coder, MI-31138.

SPECIFICATIONS

Indicon Coder, MI-31138

Input Power Requirement.....117 volts AC, 50/60 cps, 100 watts
 Information Handling Capacity.....Station identification,
 plus up to 10 items of information
 Weight20 lbs.
 Dimensions:
 Depth8⁵/₈" behind panel 4¹/₂" front projection
 Width19"
 Height5¹/₄"
 Stock IdentificationMI-31138

Indicon Decoder, MI-31139

Input Power Requirement.....117 volts, 50/60 cps, 75 watts
 Information Handling Capacity.....Transmitting Station Identification,
 plus up to 10 items of information
 Weight26 lbs.
 Dimensions:
 Depth9⁵/₈"
 Width19"
 Height5¹/₄"
 Stock IdentificationMI-31139

Indicon Decoder, MI-31139.

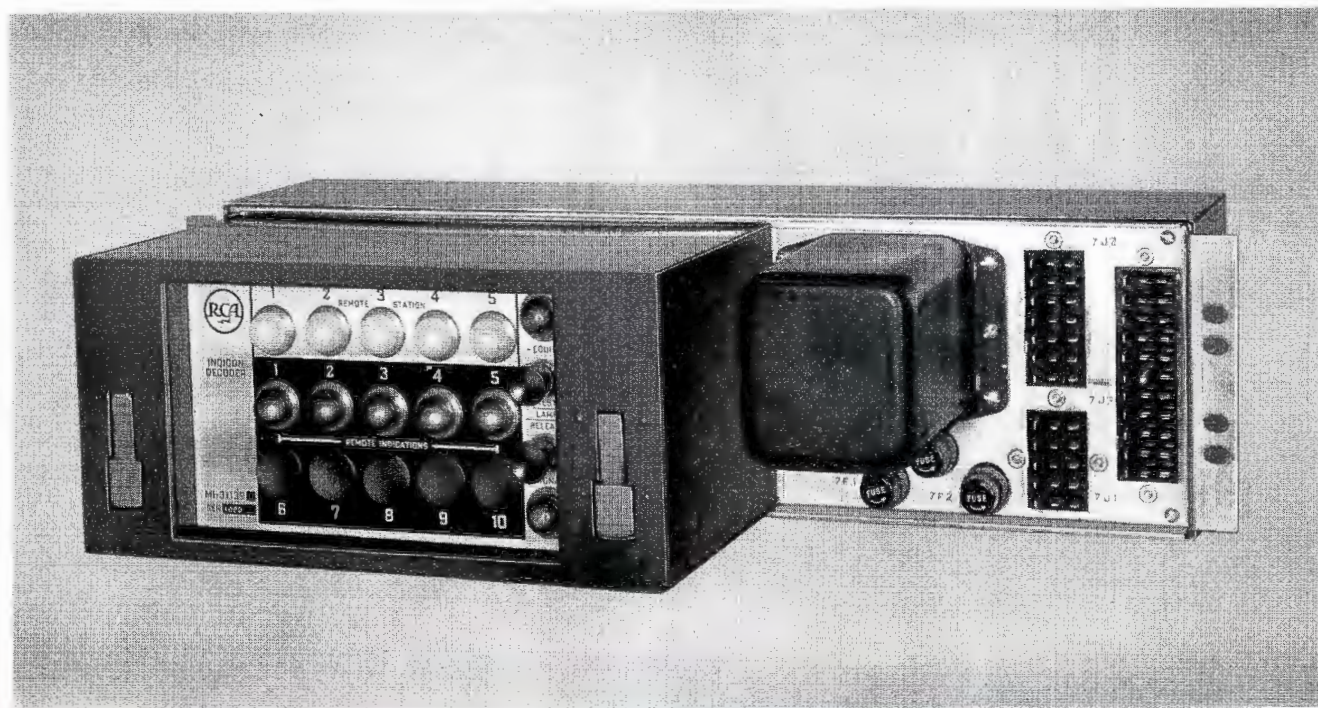

MICROWAVE SOUND DIPLEXING EQUIPMENTS

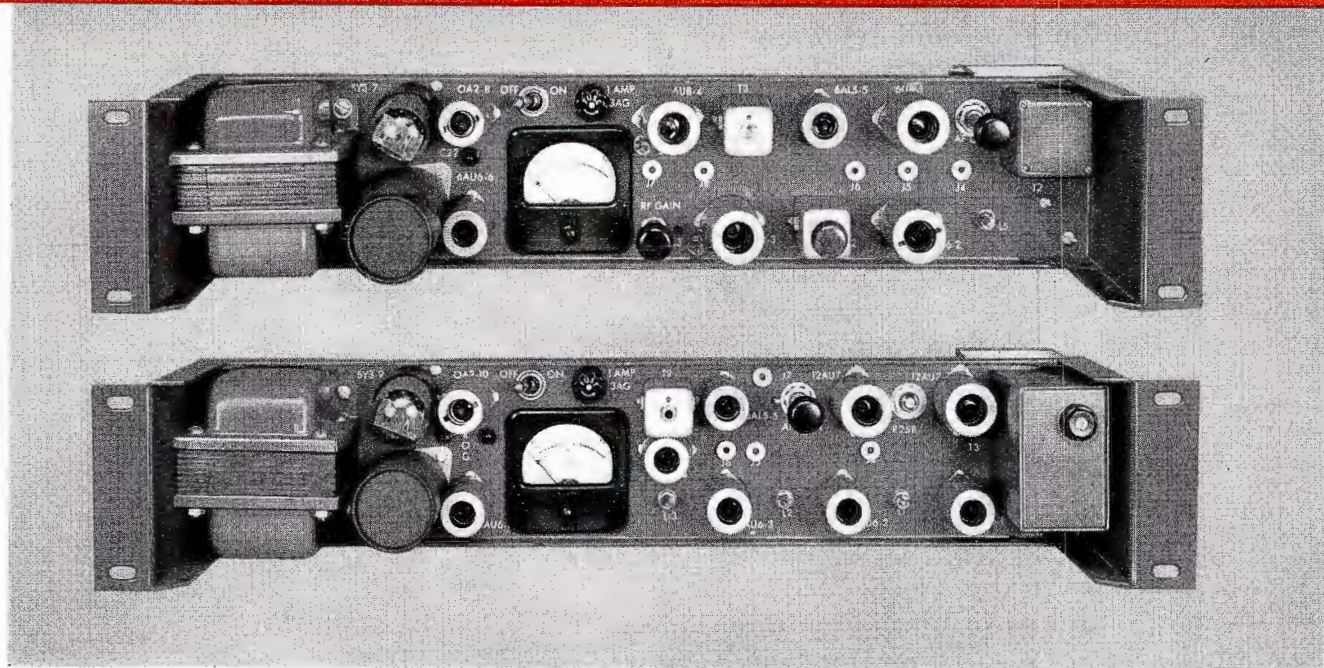

FEATURES

- Provides single or dual sound channels over RCA TVM-1B Microwave system
- Choice of sound sub-carrier at 6.2 or 6.8 mc
- Permits relaying of AM or FM audio along with video and TV audio
- Overall audio response essentially flat from 50 to 15,000 cycles
- Conservatively rated components used throughout
- Liberal use of circuit test points
- Minimum rack space (only 3½ inches) with maximum accessibility
- Calibrated VU meter for accurate audio level adjustments

USES

The RCA TSD-2B and TSD-3A Microwave Sound Diplexing Equipments provide a complete closed circuit sub-carrier system whose function allows the transmission and reception of broadcast quality audio sound signals in conjunction with television monochrome or color picture signals over a microwave system. The Type TSD-2B sound diplexer modulator and demodulator provide a sound sub-carrier at 6.8 mc and the TSD-3A units a second sound sub-carrier at 6.2 mc. This process, accomplished with no visible or audible interference of signals, results

in excellent sound transmission suitable for AM or FM programming. The second channel can also be used as a standby TV audio circuit or an order circuit from studio to transmitter.

The sound sub-carrier systems allows relaying of audio in the following services: studio transmission link (STL), remote pickups or inter-city TV relay systems. Particular attention has been given to the maintaining of full picture resolution with proper phase shift characteristics vital to color picture signals.

DESCRIPTION

The TSD-2B Microwave Sound Diplexing Equipment consists of two units, an MI-26443-B Sound Diplexer Modulator and an MI-26444-B Sound Diplexer Demodulator. Both units are mounted on bath-tub type chassis designed for standard 19-inch rack mounting and occupy only 3½ inches of rack space each. The modulator and demodulator may be mounted in the carrying case of the microwave Receiver Control and Transmitter Control units respectively when used with the portable TVM-1B microwave system. The components are conservatively rated and all tubes work well below their ratings. Minimum lead dress and maximum accessibility are featured in the construction. The units meet rigid vibration and shock requirements. The circuit design is based on military specifications for continuous performance and stability under wide temperature and humidity variations. All radio frequency and audio frequency filters incorporate special circuitry to insure maximum stability. The transmitter AFC discriminator, receiver r-f amplifiers and discriminator all incorporate highly stable circuitry including temperature compensation. All key circuits incorporate test points allowing measurements of r-f, d-c and modulating voltages.

The TSD-3A Microwave Sound Diplexing Equipment comprises two units, the MI-26493-A Sound Diplex Modulator and the MI-26494-A Sound Diplex Demodulator. Both mechanically and electrically, the TSD-3A is similar to the TSD-2B equipment except that it operates at a sub-carrier frequency of 6.2 mc and employs input and output filters to provide crosstalk isolation when used with the TSD-2B.

The audio input to the sound diplexing modulator is amplified and used to frequency modulate an r-f oscillator at a carrier frequency of 6.8 or 6.2 mc respectively. The frequency modulated signal is then amplified and added to the video signal. A discriminator circuit tuned to the sub-carrier frequency feeds the Sound Modulator AFC circuitry and also provides for audio metering. A notch filter prevents high frequency components of the video signal from interfering with the sound subcarrier.

At the output of the TVM-1B receiver, both the video and sound sub-carrier are fed into the sound diplex demodulator. A filter serves to shunt the sound sub-carrier into the sound demodulator and prevent it from appearing on the picture output. The 6.2 or 6.8 mc sub-carrier then passes through two TRF amplifiers, two stages of limiting, and then to the discriminator. The audio signal from the discriminator is then filtered and amplified. A meter is provided for metering audio output. A squelch circuit is also included which prevents noise from appearing at the output when there is no carrier present.

SPECIFICATIONS

Specifications for the two audio channels are listed below for a 60 db microwave transmission path. They apply to both the TSD-2B and TSD-3A Microwave Sound Diplexing Equipments.

Electrical

Overall System including Modulator and Demodulator	
Amplitude Frequency Response.....	Within +0.5 db, -1.5 db from 50 to 15,000 cps
Audio Distortion.....	Less than 1% at +14 dbm output from 50 to 15,000 cps
Audio Signal-to-noise Ratio.....	63 db
Operating Temperature Range.....	-20°C to 85°C
Sound Modulators—MI-26443-B & MI-26493-A	
Audio Input Level.....	-5 dbm (min.) +7 dbm (max.)
Audio Input Impedance (nom.).....	500/600 ohms, balanced or unbalanced
Power Requirements.....	117/234 V a-c, 50/60 cps, 57 watts
Sound Demodulators—MI-26444-B & MI-26494-A	
Audio Output Level (max.).....	+14 dbm
Audio Output Impedance (nom.).....	500/600 ohms, balanced or unbalanced
Power Requirements.....	117/234 V a-c, 50/60 cps, 56 watts

Tube Complement

Modulator Units MI-26443-B & MI-26493-A,	
3—6U8	1—6CL6
1—6AL5	1—6AU6
1—OA2	1—5Y3
Demodulator Units MI-26444-B & MI-26494-A, each	
5—6AU6	1—6AL5
2—12AU7	1—OA2
1—5Y3	

Mechanical

Modulator Units—MI-26443-B & MI-26493-A	
Overall Dimensions.....	3½" high, 19" wide, 7¾" deep
Overall Weight.....	8 lbs. 4 oz.
Finish.....	Umber gray
Demodulator Units—MI-26444-B & MI-26494-A	
Overall Dimensions.....	3½" high, 19" wide, 7¾" deep
Overall Weight.....	9 lbs. 4 oz.
Finish.....	Umber gray

Equipment Supplied

TSD-3A Sound Diplexer Modulator (for TVM-1B Microwave Relay)	
complete including the following.....	MI-26493-A
1 Sound Diplexer Modulator	
2 Video Cables, RG-50/U 1 ft. long each end terminated with Type UG-260/U connectors	
1 Power plug, Hubbell Type 7484	
1 Audio Connector with hood (Viking VP-3/2BC-1 connector and Viking VS-4/16C4 hood)	
1 Instruction book	
TSD-3A Sound Diplexer Demodulator (for TVM-1B Microwave Relay)	
complete including the following.....	MI-26494-A
1 Sound Diplexer Demodulator	
1 Video cable RG-59/U 1 ft. long each end terminated with Type UG-260/U connectors	
1 Power Plug (Hubbell 7484)	
1 Audio Connector with hood	
1 Instruction book	
TSD-2B Sound Diplexer Modulator (for TVM-1B Microwave Relay)	
complete including the following.....	MI-26443-B
1 Sound Diplexer Modulator	
1 Video Cable RG-59/U 3 ft. long each end terminated with Type UG-260/U connectors	
1 Video Cable RG-50/U 4 ft. long each end terminated with Type UG-260/U connectors	
1 Power Plug	
1 Audio Connector with hood	
1 Instruction book	
TSD-2B Sound Diplexer Demodulator (for TVM-1B Microwave Relay)	
complete including the following.....	MI-26444-B
1 Sound Diplexer Demodulator	
1 Video Cable 2 ft. long each end terminated with Type UG-260/U connectors	
1 Video Cable 2 ft. long each end terminated with Type UG-260/U connectors	
1 Power Plug, Hubbell Type 7484	
1 Audio Connector with hood	
1 Instruction book	

INDEX

SWITCHING EQUIPMENT

<i>Page</i>	<i>Type Number</i>	<i>Description</i>	<i>MI Number</i>
5-8	Custom Television Equipment	
9-12	TS-40	Video Switching, System A, completely assembled, wired and tested in two cabinet racks, with separate Remote Control Panel.....	ES-40930
9-12	TS-40	Video Switching, System B, completely assembled, wired and tested in two cabinet racks, with separate Remote Control Panel.....	ES-40931
9-12	TS-40	Video Switching, System C, completely assembled, wired and tested in two cabinet racks, with separate Remote Control Panel.....	ES-40932
9-12	TS-40	Video Switching, System D, completely assembled, wired and tested in one cabinet rack, with separate Remote Control Panel.....	ES-40933
13-16	TS-11A	Studio Switcher	26226
17-20	TS-5A	Video Switcher System.....	ES-26964
17-20	TS-5A	Video Switcher (Complete).....	ES-26913
17-20	TS-5A	Control Panel	26273
17-20	TS-5A	Line Amplifier	26274
20	Relay 6.3 Volt Coil, a-c.....	26275
20	Relay 24 Volt Coil, d-c.....	26284
20	Control Levers including 1000 ohm potentiometers.....	26236-3
20	Sync Interlock Relay (for use with TA-3C).....	Stock #99155
21-22	TS-2A	Video Switcher	26277
23-26	TS-30D	Field Switching System.....	ES-26950-C
23-26	TS-30D	Field Switcher	26215-C

SPECIAL EFFECTS EQUIPMENT

27-34	Special Effects Equipment	
27-34	TA-25	Special Effects Amplifier.....	40335-A
27-34	Remote Clipping Level Control.....	40336
27-34	TG-25	Special Effects Generator.....	40337
27-34	Effects Pattern Selection Panel.....	40338
27-34	Multiple Frequency Effects Generator.....	40354
27-34	WP-25	Effects Power Supply.....	40339
27-34	Effects Control Lever Assembly.....	40340
27-34	Effects Module Case.....	40341
27-34	Set of Ten Effects Pattern Selectors.....	40352
27-34	Set of Ten Multiple Frequency Effects Pattern Selectors.....	40355
35-36	Lap Dissolve Amplifier.....	40421-C
35-36	Control Lever Assembly.....	40357

INTERPHONE AND INTERCOM EQUIPMENT

37	Video Patch Panel Assembly.....	26219
37	Video Patch Cord.....	26818
37	Video Patch Plug.....	26820
37	Video Patch Plug (for use with Jack Panels MI-26244 and MI-26245)	19118
37	Video Termination Plug.....	26819
38-39	Interphone Connection Unit.....	11734
38-39	Retardation Coil	11737
38-39	Shelf for Interphone Connection Unit.....	11735
38-39	Panel for Fourteen Retardation Coils.....	11736-A
38-39	Single Headband Assembly.....	11743
38-39	Double Headband Assembly.....	11744
40	Featherweight Headset with Single Earphone.....	11749
40	Featherweight Headset with Double Earphone.....	11750
41-42	SJR-1W	Remote Unit, Walnut Case.....	38505-W
41-42	SJR-1B	Remote Unit, Blonde Case.....	38505-B
41-42	SXJ-2	Power Supply, 30 Watts.....	38506
41-42	SXJ-5	Power Supply, 80 Watts.....	38507
41-42	Intercom Master Unit	
41-42	SJ-8W	8 Station, Walnut Case.....	38508-W
41-42	SJ-8B	8 Station, Blonde Case.....	38508-B

INTERPHONE AND INTERCOM EQUIPMENT (Continued)

Page	Type Number	Description	MI Number
41-42	SJ-16W	16 Station, Walnut Case.....	38516-W
41-42	SJ-16B	16 Station, Blonde Case.....	38516-B
41-42	SJ-24W	24 Station, Walnut Case.....	38524-W
41-42	SJ-24B	24 Station, Blonde Case.....	38524-B
41-42	SJ-32W	32 Station, Walnut Case.....	38532-W
41-42	SJ-32B	32 Station, Blonde Case.....	38532-B
41-42	Master Unit, All-Call Origination Only	
41-42	SJ-8WK	8 Station, Walnut Case.....	38509-W
41-42	SJ-8BK	8 Station, Blonde Case.....	38509-B
41-42	SJ-16WK	16 Station, Walnut Case.....	38517-W
41-42	SJ-16BK	16 Station, Blonde Case.....	38517-B
41-42	SJ-24WK	24 Station, Walnut Case.....	38525-W
41-42	SJ-24BK	24 Station, Blonde Case.....	38525-B
41-42	SJ-32WK	32 Station, Walnut Case.....	38533-W
41-42	SJ-32BK	32 Station, Blonde Case.....	38533-B
41-42	Master Unit, Receive All-Call Only	
41-42	SJ-8WR	8 Station, Walnut Case.....	38510-W
41-42	SJ-8BR	8 Station, Blonde Case.....	38510-B
41-42	SJ-16WR	16 Station, Walnut Case.....	38518-W
41-42	SJ-16BR	16 Station, Blonde Case.....	38518-B
41-42	SJ-24WR	24 Station, Walnut Case.....	38526-W
41-42	SJ-24BR	24 Station, Blonde Case.....	38526-B
41-42	SJ-32WR	32 Station, Walnut Case.....	38534-W
41-42	SJ-32BR	32 Station, Blonde Case.....	38534-B
41-42	Master Unit with All-Call To Originate and Receive Remotes and Masters	
41-42	SJ-8WC	8 Station, Walnut Case.....	38511-W
41-42	SJ-8BC	8 Station, Blonde Case.....	38511-B
41-42	SJ-16WC	16 Station, Walnut Case.....	38519-W
41-42	SJ-16BC	16 Station, Blonde Case.....	38519-B
41-42	SJ-24WC	24 Station, Walnut Case.....	38527-W
41-42	SJ-24BC	24 Station, Blonde Case.....	38527-B
41-42	SJ-32WC	32 Station, Walnut Case.....	38535-W
41-42	SJ-32BC	32 Station, Blonde Case.....	38535-B

MONITORS

43-46	TM-21B	Color Control Monitor.....	40226-B
47-48	TM-4BC	Utility Monitor, 14" Cabinet Model.....	26113-B
47-48	TM-4BR	Utility Monitor, 14" Rack Model.....	26114-B
47-48	TM-7CC	Utility Monitor, 17" Cabinet Model.....	26141-C
47-48	TM-7CR	Utility Monitor, 17" Rack Model.....	26142-C
47-48	TM-8CC	Utility Monitor, 21" Cabinet Model.....	26997-C
48	Sync Interlock Relay.....	26544
49-50	TM-9C	8" Television Monitor, Cabinet Model.....	26107
49-50	TM-9N	8" Television Monitor, Chassis Only.....	26108
49-59	TM-9/2R	8" Dual Television Monitor, Rack Mounted.....	ES-26994
50	Rack Mounting Adaptor Only (for two TM-9N Monitors).....	26109
51-52	TM-14C	Professional Monitor, 14" Cabinet Model.....	26194
51-52	TM-14R	Professional Monitor, 14" Rack Model.....	26195
51-52	TM-17C	Professional Monitor, 17" Cabinet Model.....	26196
51-52	TM-17R	Professional Monitor, 17" Rack Model.....	26197
51-52	TM-18C	Professional Monitor, 21" Cabinet Model.....	26198
53-56	TM-6C	Master Monitor	ES-26957-A
53-56	TM-6C	Field Master Monitor System.....	ES-26955-B
56	Blower for TM-6C.....	26579-B
56	High Voltage Power Supply for TM-6C.....	26838
56	Spare Tally Light Relay, 6.3 volts a-c for TM-6C.....	26279
56	Field Power Supply for TM-6C.....	26091
56	Shock Mount	26511-A1
56	10SP4	Kinescope for TM-6C.....	26655

MONITORS (Continued)

Page	Type Number	Description	MI Number
56	5ABP1	Cathode Ray Tube for TM-6C.....	26667
56	Field Carrying Case for TM-6C.....	26521-A
56	Shock Mount for TM-6C.....	26511-2
57-58	TM-35	Portable Master Monitor.....	26154

AMPLIFIERS

59-60	TA-12	Video Pulse and Distribution Amplifier.....	40326
59-60	Amplifier Frame for TA-12.....	40325
59-60	Filament and Bias Supply for TA-12.....	40327
60	Sync and Blanking Adder Amplifier.....	40328
60	Dummy Amplifier Cover.....	40329
61	TA-3C	Video Distribution Amplifier.....	26157-C
62	TA-4A	Pulse Distribution Amplifier.....	26158
63-64	TA-9	Stabilizing Amplifier	40222
65-66	TA-21A	Monochrome AGC Amplifier.....	26296-A
67-68	TX-1D	Colorplexer Unit	40209-C
67-68	Aperture Compensator for TX-1D.....	40414
67-68	Automatic Carrier Balance for TX-1D.....	40416-A

GENERATORS

69-70	TG-2A	Studio Sync Generator.....	26102-A
69-70	TG-12A	Field Sync Generator System.....	ES-26921
69-70	TG-12A	Field Sync Generator.....	26112-A
70	Power Distribution Box.....	26260
70	Shock Mount for TG-12A.....	26511-A1
70	Crystal 94.5 kc.....	26545
71	Color Frequency Standard.....	40201-A
71	Crystal 3.579545 mc.....	19400-K
72	Burst Flag Generator.....	40202-A
73	Sync Generator Changeover Switch.....	26289
73	Remote Control Panel for Sync Generator Changeover Switch.....	26267
74	Pulse Delay Line.....	26886

POWER SUPPLIES

75-76	WP-16B	Semiconductor Power Supply, 60 cycles a-c.....	26084-B
75-76	WP-16B	Semiconductor Power Supply, 50 cycles a-c.....	26094-B
75-76	Unregulated Voltage Plug-In Unit.....	26082-A
75-76	Centering Current Plug-In Unit.....	26083-A
77	580-D	Regulated Power Supply.....	21523-C
78	TY-31A	Field Power Supply.....	26091
78	Plate Current Meter.....	21200-C1
79	Regulated Power Supply, 110 volt, 60 cycle.....	11318-B
79	Regulated Power Supply, 220 volt, 50 cycle.....	591318
80	Regulated Power Supply.....	11316

RACKS AND MOUNTING EQUIPMENT

81-82	BR-84A	Standard Cabinet Rack.....	ES-30951-A84
81-82	BR-84B	Standard Cabinet Rack.....	ES-30951-B84
81-82	BR-84C	Standard Cabinet Rack.....	ES-30951-C84
81-82	BR-84D	Standard Cabinet Rack.....	ES-30951-D84
81-82	BR-84E	Standard Cabinet Rack.....	ES-30951-E84
82	Cabinet Door (Non-ventilated).....	30530-G84
82	Side Panel	30541-G84
82	Door (Ventilated)	30535-G84
82	Electrical Shield (for mid-section of rack).....	30546-G21
82	Electrical Shield (for top and bottom rack sections).....	30546-G28
82	Single Trim Strip.....	30546-G84
82	Double Trim Strip.....	30568-G84
82	Terminal Board Mounting Angles (set).....	30527-G29

RACKS AND MOUNTING EQUIPMENT (Continued)

Page	Type Number	Description	MI Number
82	Panel Mounting Angles (set).....	30526-G84
82	BR-2A	Panel and Shelf Assembly.....	11498-B/11599
82	BR-22A	Panel and Shelf Assembly.....	11597
83	BR-19A	Cabinet Rack	11550
84	Rack Mounted Control Desk.....	40415
85-86	Console Housing, 13¼" wide.....	26786
85-86	Console Housing, 22" wide.....	26787
86	Left Panel Assembly and Side Cover.....	26788-1
86	Right Panel Assembly and Side Cover.....	26788-2
86	Upper Left Side Cover Only.....	26789-1
86	Upper Right Side Cover Only.....	26789-2
86	Console Well Adaptor (for Single Remote Control Panel).....	26212
86	Console Well Adaptor (for 2 Remote Control Panels).....	26278-A
87-88	Blank Panel, 1-23/32" high.....	4590-A
87-88	Blank Panel, 2½" high.....	4598-A
87-88	Blank Panel, 3-15/32" high.....	4591-B
87-88	Blank Panel, 5-7/32" high.....	4592-B
87-88	Blank Panel, 6-31/32" high.....	4593-A
87-88	Blank Panel, 8-23/32" high.....	4594-B
87-88	Blank Panel, 10-15/32" high.....	4595-B
87-88	Blank Recessed Chassis, 1-23/32" high.....	26525-1
87-88	Blank Recessed Chassis, 3-15/32" high.....	26525-2
87-88	Blank Recessed Chassis, 5-7/32" high.....	26525-3
87-88	Blank Recessed Chassis, 6-31/32" high.....	26525-4
87-88	Blank Recessed Chassis, 8-23/32" high.....	26525-5
87-88	Blank Recessed Chassis, 10-15/32" high.....	26525-6
88	Chassis Trim Cover.....	21457-B1
88	Circuit Breaker Chassis.....	26240
88	Circuit Breaker, 10 amps., 115 volts.....	26764-1
88	Circuit Breaker, 20 amps., 115 volts.....	26764-2
88	Circuit Breaker, 40 amps., 115 volts.....	26764-3
88	Terminal Block Mounting Bracket.....	4570-A
88	Power Terminal Block.....	4568
88	Audio Terminal Block.....	4569
88	Ground Bus Kit.....	11728
89-90	Stabilizing Amplifier Panel.....	40424
89-90	AGC Amplifier Panel.....	26299
90	Projector Changeover Panel.....	26256
90	Remote Light Control Panel.....	40103
90	Remote Sync Generator Changeover Switch Panel.....	26267
90	Remote Control Panel for TP-15 Multiplexer.....	40025
90	Blank Panel	26253
90	Console Adaptor	26252
90	Rack Adaptor	26254

CABLES, PLUGS AND CONNECTORS

91-94	TV Cables, Plugs & Connectors	
91	Camera Cable (50' length, 25 conductor, with connectors).....	26725-E5
91	Camera Cable (100' length, 25 conductor, with connectors).....	26725-E6
91	Camera Cable (200' length, 25 conductor, with connectors).....	26725-E7
91	Camera Cable (50' length, 25 conductor, with 90° male and straight female connectors).....	26725-E9
91	Camera Cable (50' length, 25 conductor, with 90° male and female connectors).....	26725-E10
91	Camera Cable (50' length, 33 conductor, with Jones type male and female connectors).....	40831-1
91	Shading Generator Cable (4' length, 8 conductor, with Jones type male and female connectors).....	40831-2
91	Two Interconnecting Cables (3' length, one 20 conductor with Cannon type male and female connectors, second RG-59/U Coaxial Cable)	40835
92	Color Camera Cable (50' length, 82 conductor with straight male and female connectors).....	40868-2

CABLES, PLUGS AND CONNECTORS (Continued)

Page	Type Number	Description	MI Number
92	Color Camera Cable (100' length, 82 conductor with straight male and female connectors).....	40868-3
92	Color Camera Cable (200' length, 82 conductor with straight male and female connectors).....	40868-4
92	Lacing Cord, Black #6.....	11719-A
92	Straight Male Camera Cable Connector, 24 contact.....	26759-A21
92	Straight Female Camera Cable Connector, 24 contact.....	26759-A22
92	90° Female Camera Cable Connector, 24 contact.....	26759-23
92	90° Male Camera Cable Connector, 24 contact.....	26759-24
92	Dust Cap for MI-26759-A21.....	26759-A41
92	Dust Cap for MI-26759-A22.....	26759-A42
92	Coaxial Termination, 75 ohms.....	26759-45
92	Straight Female Coupling with Waterproof Jacket.....	26759-48
92	Gasket for MI-26759-48.....	26759-49
92	Male Connector for Color Camera Cable, 82 contact.....	40529-1
92	Female Connector for Color Camera Cable, 82 contact.....	40529-2
92	Male Chassis Connector, 82 contact.....	40529-3
92	Female Chassis Connector, 82 contact.....	40529-4
92	60° Adaptor for Color Cable Chassis Connector.....	40529-5
92	Kellum Grip Kit.....	40529-6
92	Color Cable Adaptor.....	40531-1
92	Color Cable Adaptor.....	40531-2
92	Straight Jones Type Connector with Plug Button.....	40856
92	Dummy Plug for Monochrome Operation of TK-26B Camera.....	40857
92	Power Cable (10' length, 2 conductor with male connector and female connector with dust cap).....	26759-2
92	Power Cable (34" length, 12 conductor with Jones type male and female connectors).....	26759-6
92	Power Cable (6' length, 12 conductor, with Cannon type male and female connectors with dustcaps).....	26759-7
92	Power Cable (6' length, 12 conductor, with Jones type male and female connectors).....	26759-8
92	Power Cable (4' length, 18 conductor, with Jones type male and female connectors).....	26759-41
92	Power Cable (5½' length, 12 conductor, with Jones type male and female connectors).....	26759-42
92	Power Cable (36" length, 8 conductor, with straight male and 90° female connectors).....	26759-57
93	Coaxial Cable Assembly (7' length, with two male plugs and dustcaps).....	26759-12
93	Coaxial Cable Assembly (25' length, with two male plugs and dustcaps).....	26759-13
93	Coaxial Cable Assembly (100' length, with two male plugs and dustcaps).....	26759-15
93	Pulse Cable (7' length, 8 conductor, with straight male and female connectors with dustcaps).....	26759-9
93	Intercom Cable (7' length, 8 conductor, with male and female connectors with dustcaps).....	26759-11
93	Interconnecting Cables for TK-31 Field Camera Equipment.....	26730
93	Interconnecting Cables for TG-12A Field Sync Generator.....	26736
93	Interconnecting Cables and Fittings for TS-30D Field Switching Equipment.....	26740-A
93	Interconnecting Cables for TK-11B Studio Camera Control.....	26746
93	Microwave Cable with straight male connector and straight female connector with waterproof jacket and gasket, 20' length, 25 conductor	26725-E11
93	Same as above only 50' length.....	26725-E12
93	Same as above only 100' length.....	26725-E13
93	Same as above only 150' length.....	26725-E14
93	Same as above only 200' length.....	26725-E15
93	Same as above with 90° male and straight female connector and 6' length.....	26725-E16
93	Same as above with 90° male and straight female connector and 3'8" length.....	26725-E18
93	Microwave Power Cable 10' length, 12 conductor with male and female Cannon type connectors and dustcaps.....	26759-46
93	Microwave Power Cable 10' length, 3 conductor with female Cannon type connector and dustcap and male polarized plug with two-prong adaptor and grounding wire.....	26759-54

CABLES, PLUGS AND CONNECTORS (Continued)

Page	Type Number	Description	MI Number
93	Video Cable Adaptor Kit for TVT-1B Transmitter.....	40885
93	I-F Cable Kit for TVR-1B Receiver.....	40886
94	Microphone Cable, 3 conductor.....	43D
94	Pulse Cable, 8 conductor.....	48
94	RG-8/U	Coaxial Cable, single inner conductor and outer shield conductor.....	74B
94	RG-59A/U	Coaxial Cable, single inner conductor and outer shield conductor.....	75
94	RG-11A/U	Coaxial Cable, single inner conductor and outer shield conductor.....	83A
94	Camera Cable, 25 conductor, neoprene covered.....	94N
94	Microphone Cable, 2 conductor.....	13307
94	RG-58C/U	Coaxial Cable	13318-A
94	Power Cable, 18 conductor.....	13319
94	3-V Film Camera Cable, 33 conductor.....	13320
94	RG-65/U	Video Delay Cable, 1000 ohms.....	13321
94	Coaxial Cable, 74.99 ohms double shielded.....	13325
94	Power Cable, 24 conductor.....	13334
94	Power Cable, 26 conductor, shielded.....	13341
94	Power Cable, 2 conductor.....	13380-2
94	Power Cable, 3 conductor.....	13380-3
94	Power Cable, 4 conductor.....	13380-4
94	Power Cable, 5 conductor.....	13380-5
94	Power Cable, 6 conductor.....	13380-6
94	Power Cable, 8 conductor.....	13380-8
94	Power Cable, 12 conductor.....	13380-12
94	Color Camera Cable, 82 conductor.....	13394
94	Crimping Tool	40422-A
94	Fittings for Adapting MI-13325 Cable to a PL-259 Connector.....	40423

MICROWAVE RELAY EQUIPMENT

95-102	TVM-1B	Rack Mounted Microwave Relay System	
95-102	TVM-1B	Portable Microwave Relay System	
96-97	TVT-1B	Transmitter R-F Chassis.....	26451-D
97	Frequency Meter	26405
97-98	TVT-1B	Transmitter Control	26460-B3
97	8-db Pre-emphasis Network.....	26498-1
97	12-db Pre-emphasis Network.....	26498-2
98	8-db De-emphasis Network.....	26497-1
98	12-db De-emphasis Network.....	26497-2
98	TVR-1B	Receiver R-F Chassis.....	26402-A
98-99	TVR-1B	Receiver Control	26411-B
99	TVR-1B	Receiver Power Supply.....	26414-A1
99	TVT-1B	Transmitter R-F Case.....	26471-B
99	TVR-1B	Receiver R-F Case.....	26470-A
99	TVT-1B	Control Carrying Case.....	26417-D
99	TVR-1B	Receiver Control and Power Supply Carrying Case.....	26417-D
100	Transmitter Monitor Amplifier.....	26644-C
100	Transmitter AFC Unit.....	26643-A
100	Monitor/AFC Cavity	26645
100-101	Video Cable Adaptor Kit for TVT-1B Transmitter.....	40885
101	I-F Cable Adaptor Kit for TVR-1B Receiver.....	40886
101	Video Cable Equalizer.....	26721
102	TVT-1B	Transmitter Rack Mount.....	26449-A
102	VA-222	Klystron	26874
102	TVR-1B	Receiver Rack Mount.....	26448-A
102	VA-221	Klystron	26404
103-110	TVM-1B	Microwave Antennas and Mounts	
103-106	4-ft. Parabolic Reflector, 5925-6525 mc, tower mount.....	26395A-1
103-106	4-ft. Parabolic Reflector, 5925-6525 mc, surface mount.....	26395B-1
103-106	4-ft. Parabolic Reflector, 6525-7125 mc, tower mount.....	26395A-3
103-106	4-ft. Parabolic Reflector, 6525-7125 mc, surface mount.....	26395B-3
103-106	6-ft. Parabolic Reflector, 5925-6525 mc, tower mount.....	26395A-2
103-106	6-ft. Parabolic Reflector, 5925-6525 mc, surface mount.....	26395B-2

MICROWAVE RELAY EQUIPMENT (Continued)

Page	Type Number	Description	MI Number
103-106	6-ft. Parabolic Reflector, 6525-7125 mc, tower mount.....	26395A-4
103-106	6-ft. Parabolic Reflector, 6525-7125 mc, surface mount.....	26395B-4
103-106	8-ft. Parabolic Reflector, 5925-6525 mc, tower mount.....	26495A-1
103-106	8-ft. Parabolic Reflector, 5925-6525 mc, surface mount.....	26495B-1
103-106	8-ft. Parabolic Reflector, 6525-7125 mc, tower mount.....	26495A-3
103-106	8-ft. Parabolic Reflector, 6525-7125 mc, surface mount.....	26495B-3
103-106	10-ft. Parabolic Reflector, 5925-6525 mc, tower mount.....	26495A-2
103-106	10-ft. Parabolic Reflector, 5925-6525 mc, surface mount.....	26495B-2
103-106	10-ft. Parabolic Reflector, 6525-7125 mc, tower mount.....	26495A-4
103-106	10-ft. Parabolic Reflector, 6525-7125 mc, surface mount.....	26495B-4
106-107	Passive Reflector, 4-ft. x 6-ft., solid face.....	460PSA
106-107	Passive Reflector, 4-ft. x 6-ft., perforated face.....	460PPA
106-107	Passive Reflector, 4-ft. x 6-ft., knocked down, solid face.....	46KDSA
106-107	Passive Reflector, 4-ft. x 6-ft., knocked down, perforated face.....	46KDPA
106-107	Passive Reflector, 6-ft. x 8-ft., solid face.....	680PSA
106-107	Passive Reflector, 6-ft. x 8-ft., perforated face.....	680PPA
106-107	Passive Reflector, 6-ft. x 8-ft., knocked down, solid face.....	68KDSA
106-107	Passive Reflector, 6-ft. x 8-ft., knocked down, perforated face.....	68KDPA
106-107	Passive Reflector, 8-ft. x 10-ft., solid face.....	8100PSA
106-107	Passive Reflector, 8-ft. x 10-ft., perforated face.....	8100PPA
106-107	Passive Reflector, 8-ft. x 10-ft., knocked down, solid face.....	810KDSA
106-107	Passive Reflector, 8-ft. x 10-ft., knocked down, perforated face.....	810KDPA
106-107	Passive Reflector, 10-ft. x 15-ft., solid face.....	10150PSA
106-107	Passive Reflector, 10-ft. x 15-ft., perforated face.....	10150PPA
106-107	Passive Reflector, 10-ft. x 15-ft., knocked down, solid face.....	1015KDSA
106-107	Passive Reflector, 10-ft. x 15-ft., knocked down, perforated face.....	1015KDPA
107	R4	Plastic Dome, 4-ft., unheated.....	26384-1
107	HR4	Plastic Dome, 4-ft., heated.....	26384-2
107	R6	Plastic Dome, 6-ft., unheated.....	26386-1
107	HR6	Plastic Dome, 6-ft., heated.....	26386-2
107	R8	Plastic Dome, 8-ft., unheated.....	26388-1
107	HR8	Plastic Dome, 8-ft., heated.....	26388-2
107	R10	Plastic Dome, 10-ft., unheated.....	26390-1
107	HR10	Plastic Dome, 10-ft., heated.....	26390-2
107-108	2-ft. Parabola (less antenna feed).....	26182-5
107-108	4-ft. Parabola (less antenna feed).....	26182-3
107-108	6-ft. Parabola (less antenna feed).....	26182-4
107-108	Antenna Feed, horizontal polarization for 2-ft. or 4-ft. parabola.....	26430
107-108	Antenna Feed, vertical polarization for 2-ft. or 4-ft. parabola.....	26431
107-108	Antenna Feed, horizontal polarization for 6-ft. parabola.....	26432
107-108	Antenna Feed, vertical polarization for 6-ft. parabola.....	26433
108	Reflector Mount.....	26435-A
108	Antenna Roof Mount.....	26436
109	Antenna Ring Mount (Gimbal Ring).....	26207
109-110	TF-55A	Remote Controlled Rotating Mount for 4-ft. Parabola.....	26192-1
109-110	TF-55A	Remote Controlled Rotating Mount for 6-ft. Parabola.....	26192-2
110	Metal Tripod for Portable Microwave Antenna System.....	26046-A
110	Long-Legged Type Tripod for Portable Microwave Antenna System.....	26048
110	Tie Rod Assembly for MI-26048 Tripod.....	26188
110	Relay Tilt Head.....	26204
111-122	RG-50/U	Waveguide Components for TVM-1B Microwave Systems	
114	RG-50/U	Rigid Waveguide, flanged.....	26428-Series
114	RG-50/U	Rigid Waveguide, unflanged.....	26416-Series
114	UG-344/U	Flat Flange.....	26491
115	UG-343A/U	Choke Flange.....	26492
115	RG-50/U	Waveguide Bends (90° Elbows).....	26425-Series
115	Waveguide Twist Sections.....	26427-Series
115	Flexible Waveguide Sections.....	26458-Series
115	Flexible-Twistable Waveguide Sections.....	26468-Series
115	Waterproofing Feed-Through Flange.....	26469
116	Feed-Through Assembly.....	26472-Series

MICROWAVE RELAY EQUIPMENT (Continued)

<i>Page</i>	<i>Type Number</i>	<i>Description</i>	<i>MI Number</i>
116	Antenna Feed Adaptor, choke input.....	26454-A
116	Antenna Feed Adaptor, flat input.....	26454-A1
116	Pressurizing Section	26426-Series
116	Pressurized Mica Window.....	26463
117	Waveguide to R-F Case Adaptor, choke input.....	26459
117	Waveguide to R-F Case Adaptor, flat input.....	26459-1
117	90° Waveguide to R-F Head Adaptor, choke input.....	26462
117	90° Waveguide to R-F Head Adaptor, flat input.....	26462-1
117	Waveguide Adaptor, R-F Case to Attenuating Coupler.....	26476
117	Directional Coupler	26466
118	Waveguide Switch	26490
118	Waveguide Termination	26488
118	Ferrite Isolator	26465-Series
119	Ferrite Circulator	26489-Series
119	Preselection Filter	26412-Series
119	Attenuating Coupler	26478
123-124	TSD-3A	Sound Diplexer Modulator.....	26493-A
123-124	TSD-3A	Sound Diplexer Demodulator.....	26494-A
123-124	TSD-2B	Sound Diplexer Modulator.....	26443-B
123-124	TSD-2B	Sound Diplexer Demodulator.....	26444-B
125-135	Microwave Control Equipment	
129-130	Receiver Standby Diversity Switch.....	26407
131	Transmitter Standby Switcher.....	26408
131	Video Failure Indicator.....	26409
132	Low Power-Low Signal Indicator.....	26410
132	Video Presence Detector.....	26419
133	Delay Timer	26420
133	Antenna Reversing Control.....	26421
134	912T	Data Transmitter	Comvor Type 912T
134	912R	Data Receiver	Comvor Type 912R
135	Indicon Coder	31138
135	Indicon Decoder	31139

RCA REGIONAL OFFICES

Atlanta 3, Ga.

134 Peachtree Street, N. W., Jackson 4-7703

Boston 16, Mass.

200 Berkeley Street, Hubbard 2-1700

Camden 2, N. J.

Front & Cooper Streets, Woodlawn 3-8000

Chicago 54, Ill.

1186 Merchandise Mart Plaza, Delaware 7-0700

Cleveland 15, Ohio

1600 Keith Bldg., Cherry 1-3450

Dallas 35, Texas

7901 Empire Freeway, Fleetwood 2-3911

Detroit 39, Mich.

12605 Arnold Street, Kenwood 4-5100

Hollywood 28, Calif.

1560 N. Vine Street, Hollywood 9-2154

Indianapolis, Ind.

501 N. LaSalle Street, Melrose 6-5321

Kansas City 15, Mo.

7711 State Line Road, Emerson 1-6770

New York 20, N. Y.

36 W. 49th Street, Judson 6-3800

Paterson, N. J.

495 E. 30th Street, Mulberry 4-0972

Portland 5, Ore.

6237 N.E. 18th Avenue, Capital 6-6828

San Francisco 2, Calif.

420 Taylor Street, Ordway 3-8027

Seattle 4, Wash.

2250 First Avenue, South, Main 2-8350

Washington 6, D. C.

1725 K Street, N. W., Federal 7-8500



RADIO CORPORATION OF AMERICA
BROADCAST & TELEVISION EQUIPMENT
CAMDEN, NEW JERSEY