

# American Beauty

## ELECTRIC SOLDERING IRONS

These Irons embody features that specialized experience—since 1894—has demonstrated to be desirable for efficient and lasting service. Hundreds of thousands in use throughout the world in manufacturing plants, service, maintenance and repair shops, Army and Navy Services, telephone, telegraph and radio stations.

**No. 3138**—Designed primarily for production and maintenance in radio, telephone, telegraph, ignition switchboard and telephone installation work and similar industrial applications.

**No. 3158**—For the same purposes as the No. 3138 but for work requiring an iron of greater capacity.

**No. 3178**—For use on still heavier work; for light commutators and service and production work. A very useful iron for general purposes.

**No. 3198**—For heavy work of all kinds. Supplies a large volume of heat at high temperature. Used by manufacturers in many different lines; for shop, service, production work, etc. Each of the above irons is equipped with a baffle plate, at the shank, to prevent free conduction of heat to the handle.

**No. 3128**—Designed for lighter work than the No. 3138 in similar applications. Has plug-type  $\frac{1}{4}$ " diameter tip with a heating element of chrome nickel but without compression winding as used in the higher-wattage No. 3138-3198 series. Element and casing with handle springs and terminal assembly built as a unit.

**No. S-76**—Designed for work of the same kind as the No. 3128 but has a screw-type  $\frac{1}{8}$ " diameter tip which screws on the metal head of the core of the chrome nickel heating element. Element with casing and handle springs and terminal assembly built as a unit.

Made in standard voltages and for 32 volts. No. 3138 also made for 6, 12, 24 and 55 volts. Nos. 3138-3198 can be equipped with three-conductor cord, one wire grounded, at slight additional charge. Separate heat-insulating stand supplied with each iron.

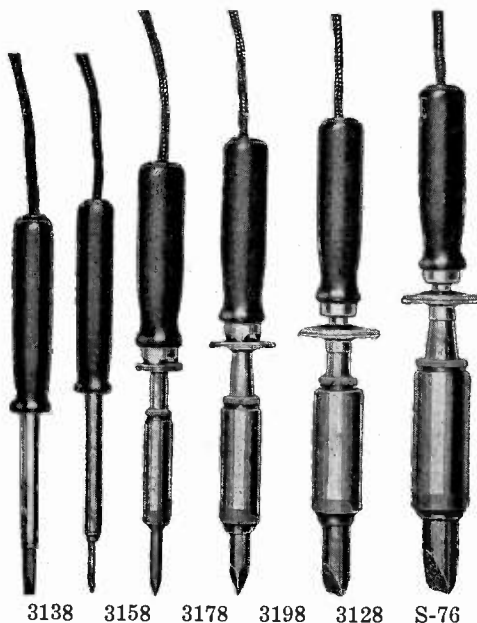

3138 3158 3178 3198 3128 S-76



Top No. 3128 — Bottom No. S-76

### SPECIFICATIONS

| Cat. No. | Diameter of Tip   | Watts | Net Weight          | Length Over All    | Casing Diameter    | Approx. Ship. Wt.    | List Price Each | Net Price Each (Less than 6) | Net Price Each (6 or more) |
|----------|-------------------|-------|---------------------|--------------------|--------------------|----------------------|-----------------|------------------------------|----------------------------|
| 3138     | $\frac{3}{8}$ "   | 100   | 16 oz.              | 12 $\frac{1}{2}$ " | $\frac{7}{8}$ "    | 2 lbs.               | \$ 8.00         | \$ 5.36                      | \$ 5.08                    |
| 3158     | $\frac{5}{8}$ "   | 200   | 28 oz.              | 13 $\frac{5}{8}$ " | 1 $\frac{1}{4}$ "  | 3 lbs.               | 9.60            | 6.41                         | 6.07                       |
| 3178     | $\frac{7}{8}$ "   | 300   | 42 oz.              | 14 $\frac{3}{8}$ " | 1 $\frac{9}{16}$ " | 4 lbs.               | 12.90           | 8.59                         | 8.11                       |
| 3198     | 1 $\frac{1}{8}$ " | 550   | 60 oz.              | 15"                | 1 $\frac{3}{4}$ "  | 5 $\frac{1}{2}$ lbs. | 16.80           | 11.18                        | 10.58                      |
| 3128     | $\frac{1}{4}$ "   | 60    | 7 $\frac{1}{2}$ oz. | 12 $\frac{1}{4}$ " | $\frac{9}{16}$ "   | 16 oz.               | 5.00            | 3.34                         | 3.18                       |
| S-76     | $\frac{7}{16}$ "  | 50    | 6 oz.               | 11 $\frac{1}{8}$ " | $\frac{9}{16}$ "   | 14 oz.               | 5.00            | 3.34                         | 3.18                       |

## American Beauty COPPER TIPS

These copper tips are made from commercially pure, drawn bar, copper rod. Except for the No. 3734 screw-on type tip for the No. S-76 iron, each tip is designed to fit into, and to the full length of, core of heating unit of the particular iron for which it is intended. Maximum area of contact between the tip and heating unit is thus assured. Tips are of uniform diameter throughout their entire length. Each tip is held in place in core of heating unit by a recessed set-screw. Removal for cleaning or replacement is therefore easy. Standard shaped tips with which the various models are equipped are shown in the illustration; but pyramidal, instead of chisel type, and vice versa, can be supplied when so specified without additional charge. For No. 3138 a special, long, semi-chisel shaped tip No. 3738-S can be supplied for telephone and switchboard work.



3798 for 3198 Iron  
3778 for 3178 Iron  
3758 for 3158 Iron  
3738S for 3138 Iron  
3738 for 3138 Iron  
3728 for 3128 Iron  
3734 for S-76 Iron

## American Beauty TEMPERATURE REGULATING STANDS

For use on (AC) Alternating Current Only

This is a thermostatically controlled device for the regulation of the temperature of an electric soldering iron while at rest. When placed on this stand, soldering iron is maintained at working temperature, ready for instant use or, if desired, at a lower temperature. Through an adjustment on bottom of the stand, thermostat may be set for the maintenance of any desired temperature—from very low, or warm, to full working temperature. Body of stand is of molded plastic. Soldering iron cradle proper is of metal. Stand is equipped with cord and attachment plug-cap for connection to current and with a receptacle for connection of the electric soldering iron. It is designed for use with electric soldering irons up to 660 watts capacity and on circuits up to 240 volts.

|          |            |            |           |
|----------|------------|------------|-----------|
| Cat. No. | Net Weight | List Price | Net Price |
| 475      | 27 oz.     | \$5.50     | \$3.88    |

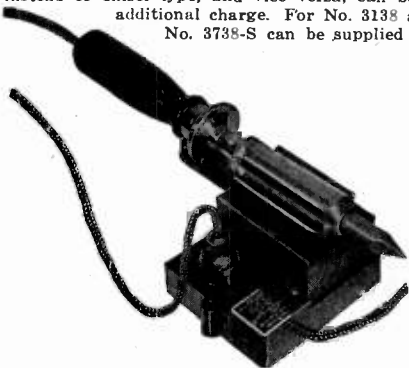

# ESICO

REG. U. S. PAT. OFF.

## ELECTRIC SOLDERING IRONS FOR HOME, PROFESSIONAL MECHANIC AND FACTORY

### ● GREEN LABEL LINE

For intermittent duty. Meets all requirements of the home craftsman.



No. 415—List \$1.95— $\frac{3}{8}$ " Tip—55 Watts



No. 416—List \$2.95— $\frac{1}{4}$ " Tip—60 Watts



No. 417—List \$3.95— $\frac{3}{8}$ " Tip—100 Watts



No. 418—List \$4.95— $\frac{1}{2}$ " Tip—130 Watts

### ● ORANGE LABEL LINE

For Professional Mechanics—light or heavy soldering where iron must withstand operation for eight hour periods or more on frequent occasions.



No. 62—List \$4.95— $\frac{1}{4}$ " Tip—60 Watts



No. 63—List \$5.95— $\frac{3}{8}$ " Tip—100 Watts



No. 64—List \$6.95— $\frac{1}{2}$ " Tip—130 Watts



No. 65—List \$7.95— $\frac{5}{8}$ " Tip—200 Watts



No. 67—List \$8.95— $\frac{7}{8}$ " Tip—300 Watts



No. 69—List \$10.95— $1\frac{1}{8}$ " Tip—500 Watts

### ● RED LABEL LINE

For Production Line Continuous Operation. These Irons are of most rugged construction.



No. 38—List \$6.95— $\frac{3}{8}$ " Tip—100 Watts



No. 58—List \$8.95— $\frac{5}{8}$ " Tip—200 Watts



No. 78—List \$10.95— $\frac{7}{8}$ " Tip—300 Watts



No. 98—List \$12.95— $1\frac{1}{8}$ " Tip—550 Watts

### ● Thermostatic Temperature Control Stand

The iron can be maintained at any desired temperature while in the stand. This is the only way to control the tip temperature of an iron. Control of element temperature is not satisfactory. There is too much of a lag between element and tip temperature.

Years ago we developed a thermostatically controlled iron, which regulated the element temperature (just as presently marketed thermostatically controlled irons do) but we discarded the iron as it would permit the tip to cool.

When the stand is properly adjusted, it is impossible for the iron to overheat or to burn off its tin.

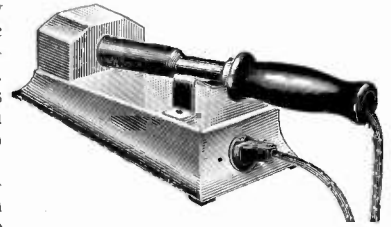

List Price

Cat. No. 5 Irons up to 1" dia. tip .....\$ 6.50  
Cat. No. 6 Irons up to  $1\frac{1}{8}$ " dia. tip ..... 6.50

### ● Soldering Pots

Ruggedly constructed, cast iron pots for production work. Elements are easily replaced even while pots are hot.

Net Price

Cat. No. 12— $1\frac{1}{2}$ " dia. Cap.  
 $\frac{3}{4}$  lbs. ....\$ 4.50  
Cat. No. 36— $2\frac{1}{2}$ " dia. Cap.  
 $2\frac{1}{4}$  lbs. .... 5.50  
Cat. No. 60— $3\frac{1}{2}$ " dia. Cap.  
 $3\frac{3}{4}$  lbs. .... 6.50



### ● Spot Soldering Machine

Model "F" is a treadle operated machine which feeds solder forward as the iron moves away from the work. Suitable for spot soldering where a mechanical connection has first been made. Net price .....\$15.00

Model "N" is a treadle operated machine for the advancement of the iron, but without a solder feed attachment. Net price .....\$7.50

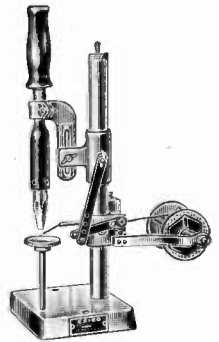

### ● Glue Pots

The catalogue No. 700 Glue Pot is of two quart capacity. It is the water jacket type and has a gasket sealed element and thermostat completely protected from moisture. Thermostat is normally set at 150 degrees for use with glue, but can be set at various temperatures for use with wax, etc. Net price \$18.50



## ELECTRIC SOLDERING IRON CO., INC.

# DRAKE



# RADIO IRONS

### Suggested for Maintenance Work and for the Radio Service Man



60 Watt Iron with  $\frac{3}{8}$ " Tip. An excellent iron for light work. Porcelain element. Six ft. cord and small stand.

No. 315 ..... List \$1.90  
Element ..... List \$1.00      Tip ..... List \$0.90  
Shipping Weight 1 lb.

100 Watt Iron with  $\frac{3}{8}$ " Tip. An ideal iron for those who require a hotter iron than our No. 315. Porcelain element. Six ft. cord and small stand.

No. 316 ..... List \$3.20  
Element ..... List \$1.50      Tip ..... List \$1.80  
Shipping Weight  $1\frac{1}{2}$  lbs.



80 Watt Iron with  $\frac{3}{8}$ " Tip. Recommended for light radio work. Mica wound element. Six ft. cord and large stand.

No. 225 ..... List \$4.40  
Element ..... List \$3.40      Tip ..... List \$1.25  
Shipping Weight  $1\frac{1}{2}$  lbs.

100 Watt Iron with  $\frac{3}{8}$ " Tip. Recommended for general radio work. Mica wound element. Six ft. cord with large stand.

No. 325 ..... List \$5.00  
Element ..... List \$4.00      Tip ..... List \$1.25  
Shipping Weight 2 lbs.



125 Watt Iron with  $\frac{3}{8}$ " Tip. An extra hot iron for the serviceman. Mica wound element. Six ft. cord and large stand.

No. 326 ..... List \$6.00  
Element ..... List \$5.00      Tip ..... List \$1.25  
Shipping Weight 2 lbs.

200 Watt Iron with  $\frac{5}{8}$ " Tip. Recommended for medium heavy work. Mica wound element. Six ft. cord and large stand.

No. 425 ..... List \$10.00  
Element ..... List \$9.00      Tip ..... List \$ 2.00  
Shipping Weight 2 lbs.

### INDUSTRIAL IRONS



60 Watt Iron with  $\frac{1}{4}$ " Tip. An extra small iron for midget sets. Only 9" long.

No. 400 ..... List \$5.50  
Element ..... List \$4.50      Tip ..... List \$0.60  
Shipping Weight 2 lbs.

100 Watt Iron with  $\frac{3}{8}$ " Tip. Only 10 inches over all. Ideal for close work on radio sets.

No. 600-10 ..... List \$8.00  
Element ..... List \$7.00      Tip ..... List \$1.25  
Shipping Weight 2 lbs.

140 Watt Iron with  $\frac{3}{8}$ " Tip. An extra hot iron for high speed work on production lines.

No. 600 Special ..... List \$8.50  
Element ..... List \$7.50      Tip ..... List \$1.25  
Shipping Weight 2 lbs.



80 Watt Iron with  $\frac{3}{8}$ " Tip. Recommended for fine instruments, light telephone and other light soldering.

No. 450 ..... List \$6.00  
Element ..... List \$5.00      Tip ..... List \$1.25  
Shipping Weight 2 lbs.

100 Watt Iron with  $\frac{3}{8}$ " Tip. The standard 100 watt iron. Ideal for switchboards and radio sets.

No. 600 ..... List \$7.50  
Element ..... List \$6.50      Tip ..... List \$1.25  
Shipping Weight 2 lbs.

200 Watt Iron with  $\frac{5}{8}$ " Tip. For general factory work such as art glass, medium tin work.

No. 800 ..... List \$10.00  
Element ..... List \$9.00      Tip ..... List \$ 2.00  
Shipping Weight 3 lbs.



### MODEL 350 MIDGET

Recommended for voice coil leads on speaker cones, meter connections, test equipment, hearing aids, crystal pickups, headphone leads, etc. This iron is a continuous duty 35 watt iron with a nickle-chromium element wound over mica insulation on a steel core.

No. 350 ..... List \$5.00  
Element ..... List \$4.00      Tips, ea. .... List \$0.25  
Shipping Weight 1 lb.

# DRAKE



**SOLDER GUN  
HEAT CONTROLS  
SOLDER POTS**

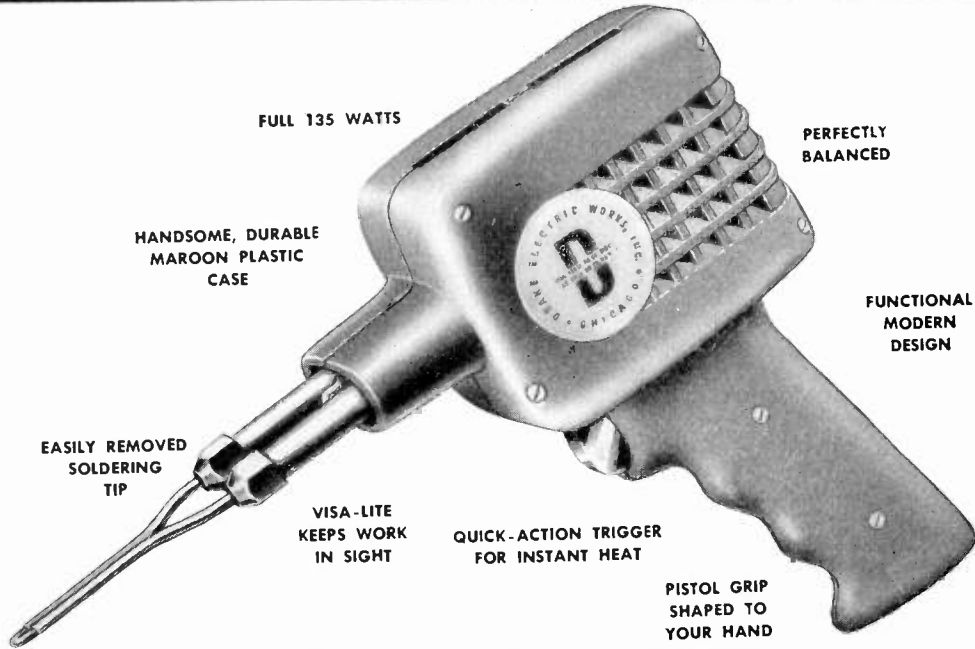

FULL 135 WATTS

PERFECTLY  
BALANCED

HANDSOME, DURABLE  
MAROON PLASTIC  
CASE

FUNCTIONAL  
MODERN  
DESIGN

EASILY REMOVED  
SOLDERING  
TIP

VISA-LITE  
KEEPS WORK  
IN SIGHT

QUICK-ACTION TRIGGER  
FOR INSTANT HEAT

PISTOL GRIP  
SHAPE TO  
YOUR HAND

### DRAKE "INSTANT HEAT" SOLDER GUN

A new addition to the famous "Drake" family of complete soldering aids. Instant-heat solder gun for quick soldering requirements. Saves power since gun only operates when trouble-free trigger is squeezed. Equipped with built-in spotlight, properly focused to light soldering spot. Attractive maroon plastic case properly louvered for cool operation. Balance engineered by one of America's most famous industrial designers. Complete with easily removed tips, one 3 1/2" tip for ordinary soldering; one 6 1/2" tip for deep chassis soldering. Operates on 110-120 volt, 60-cycles A.C., 135 watts. Shpg. wt., 3 lbs.

No. 900 Solder Gun, complete with 2 tips; one 1/2" and one 6 1/2" ..... List Price \$20.00  
No. 901 Extra 3 1/2" Tips (4 to pkg.) List Price \$0.50    No. 902 Extra 6 1/2" Tips (2 to pkg.) List Price \$0.50

### DRAKE HEAT CONTROLS

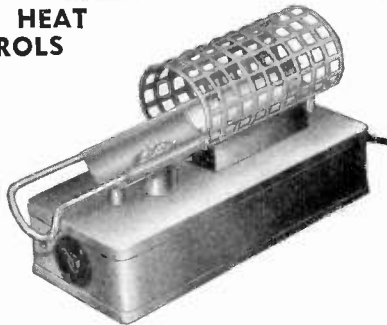

New thermostatically controlled, automatic, heat controls. Ideal for production applications where iron must be kept at correct soldering temperatures at all times. Complete with oxide removing "Magic Cup." Choice of with or without hood. Operates on 110 to 240 volts and will handle any iron to 660 watts. Shpg. wt., either model: 3 lbs.

No. 305 Less Hood ..... List Price \$7.50  
No. 305H With Hood ..... List Price \$8.50

#### Standard Models

These standard economy models have stand-by switch instead of thermostats. Keep switch in low position until iron is almost ready for use. A flip of the switch and the iron is ready for use in a few moments. Variable resistor allows individual adjustment to meet the requirements of each soldering operation. Operates on 110 volts. Shpg. wt., either model: 3 lbs.

No. 300 Less Hood ..... List Price \$5.50  
No. 300H With Hood ..... List Price \$6.00

### Drake Solder Pots For Production Line

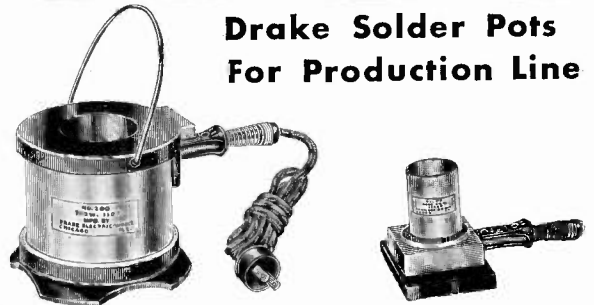

#### Model No. 200—300 Watt Unit

An ideal electric solder pot for production use. Used in factory production of tinned wire ends, terminal tinning and countless other volume tinning applications. Holds 2 lbs. of bar solder in 2 1/2" diameter 2" deep cast iron well. Complete with detachable Underwriters' Approved cord and plug, and bale type carrying handle. Genuine nichrome element. Shipping weight 6 lbs.

No. 200 ..... List Price \$6.50

#### Model No. 100—150 Watt Unit

Designed for light tinning. Ideal for occasional jobs. Suited especially for tinning ends of stranded wires to prevent fraying. Can also be used for soldering cord tips to cables. One piece cast iron construction holds heat longer. Size of pot 1 1/2" diameter 1" deep. Holds 1 lb. of bar solder. Complete with Underwriters' Approved cord and detachable plug. Shipping weight 3 lbs.

No. 100 ..... List Price \$5.00





# CALROD\* SOLDERING IRONS

## FOR EVERY RADIO REQUIREMENT

### MANUFACTURING — SERVICE

\*Reg. U. S. Pat. Off.

- **HIGH-SPEED SOLDERING.** You can solder as fast and continuously as the nature of the work will allow.
- **UNIFORM PERFORMANCE.** Operating characteristics remain constant day after day. No appreciable decrease in efficiency even after months of service.
- **LONG LIFE AND LOW MAINTENANCE.** Long

life is assured and over-all costs are kept low because sturdy construction eliminates need of frequent repairs.

- **EASY, LOW-COST REPAIR.** Assembling and disassembling are easy.
- **THEY NEED NOT BE RETURNED TO THE FACTORY FOR REPAIR.** Irons can be repaired on the job without special tools or skill.

Cat. No. 6A161

Listed Under Re-examination Service of Underwriters' Laboratories

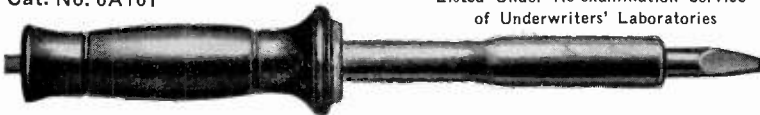

Watts 75 Volts 115

Calorized tip ..... \$9.55\*†  
IRONCLAD tip ..... 10.20\*†

Tip diam. See note below\*



\* For light, intermittent soldering such as radio assembly and repair and installation, switchboard, ignition, wiring devices, meters and instruments, or very light high-speed soldering of similar products.

WEIGHTS: Less cord, 15 oz. With cord, 20 oz. Shipping, 26 oz. Equal to old-style copper—1 1/4-lb.

\*Cat. No. 6A161 and Cat. No. 6A162 can be supplied with either a 3/8- or 1/2-inch diameter tip at prices given. The long 1/2-inch diameter tip projects 3/8 inches from the shell. Price of iron with long calorized tip—\$10.10; with long IRONCLAD tip—\$10.90.

For light, high-speed soldering, such as assembly of radios, telephones, switchboards, appliances, meters, and instruments, and installation and repair of wiring and wiring devices, ignition. Excellent for service and repair men.  
WEIGHTS: Less cord, 15 oz. With cord, 20 oz. Shipping, 26 oz. Equal to old-style copper—1 3/4 lb.

Cat. No. 6A162



Watts 100 Volts 115

Calorized tip ..... \$9.55\*†  
IRONCLAD tip ..... 10.20\*†

Tip diam. See note above\*

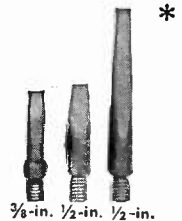

\* For light, high-speed soldering, such as assembly of radios and switchboards, medium intermittent soldering on tinware, wiring, plumbing, and tinsmithing. Excellent general-purpose iron for shop and farm.

WEIGHTS: Less cord, 16 oz. With cord, 21 oz. Shipping, 27 oz. Equal to old-style copper—2-lb.

Cat. No. 6A200



Watts 100 Volts 115

Calorized tip ..... \$10.80\*†  
IRONCLAD tip ..... 12.20\*†

Tip diam. 3/4 inch

For medium, high-speed soldering of automobile and airplane assembly, electric equipment, light tanks and containers of copper and steel. Excellent general-purpose iron for manufacturing plant.  
WEIGHTS: less cord, 24 oz. With cord, 29 oz. Shipping, 34 oz. Equal to old-style copper—3-lb.

Cat. No. 6A201



Watts 200 Volts 115

Calorized tip ..... \$13.55\*†  
IRONCLAD tip ..... 15.10\*†

Tip diam. 1 inch

Cat. No. 6A202



Watts 300 Volts 115

Calorized tip ..... \$16.40\*†  
IRONCLAD tip ..... 17.95\*†

Tip diam. 1 1/4 inch

For heavy work such as light commutators, large-diameter pipe, medium-gauge copper or steel tank and container material, roofing, heavy tinware.  
WEIGHTS: Less cord, 37 oz. With cord, 42 oz. Shipping, 48 oz. Equal to old-style copper—4-lb.

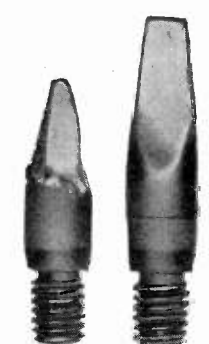

Effect of solder (250 C for 363.5 hours) on plain copper (left) and Ironclad copper (right) soldering tips.

### ASK ABOUT IRONCLAD TIPS

IRONCLAD TIPS MEAN

- No Filing
- Lower Upkeep Cost
- Less Maintenance
- Longer Life

Note—230-volt irons available on request. Same prices apply. Above prices include supporting stand.

† Mfg.'s suggested retail price.

ASK YOUR DISTRIBUTOR FOR A COPY OF BULLETIN GEA-4519.



# MIDGET SOLDERING IRONS

FOR MANUFACTURING AND SERVICE  
OF RADIO AND ELECTRONIC EQUIPMENT

## APPLICATION

This 8-inch, 1 $\frac{3}{4}$ -ounce featherweight iron for close-quarter soldering with pin-point precision is used where conventional irons might cause damage . . . be clumsy to handle . . . be more expensive to operate. The Midget literally goes places with greater efficiency and less power . . . with no sacrifice in heat or speed. With its fingertip operation, this iron will help make an expert out of any solderer in a short time.

The Midget has chisel-shaped Ironclad copper tips either  $\frac{1}{8}$ - or  $\frac{1}{4}$ -inch diameter, as desired.

### THIS MIDGET DOES A BIG JOB IN

- Boosting Production Rates
- Increasing Operator Efficiency
- Cutting Down Employee Fatigue
- Saving on Repair and Maintenance
- Reducing Rejects
- Manufacturing and Repairing:

Radios and other electronic equipment

Meters

Instruments

Jewelry

Appliances

. . . and many other products  
requiring precision soldering

**RATING: 6 VOLTS, 25 WATTS**

| Description   | Cat. No. | Price† |
|---|----------|--------|
| ★ $\frac{1}{8}$ -in. Ironclad copper tip (pyramid-shaped) | 6A212    | \$5.40 |
| ★ $\frac{1}{4}$ -in. Ironclad copper tip (chisel-shaped)  | 6A210    | 5.40   |
| $\frac{1}{8}$ -in. Renewal tip and heater assembly        | 6A213    | 3.00   |
| $\frac{1}{4}$ -in. Renewal tip and heater assembly        | 6A211    | 3.00   |

Net weight iron less cord 1 $\frac{3}{4}$  oz.

Net weight iron including cord 5 oz.

Shipping weight complete iron 8 oz.

Standard package consists of 6 irons of one tip size. Tip and heater assemblies can be purchased in any quantities.



$\frac{1}{8}$ -in. dia tip, Cat. No. 6A212



$\frac{1}{4}$ -in. dia tip, Cat. No. 6A210

### SPECIAL TRANSFORMERS (OPTIONAL) FOR G-E MIDGET SOLDERING IRONS

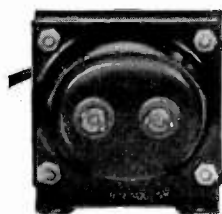

Single-tap, Cat. No. 84G392

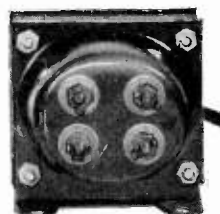

Four-tap, Cat. No. 84G370

Specially designed 115-volt transformers are available as optional equipment in two types:

1. Single-tap 115/6 volts—for use where only one soldering heat is required
2. Four-tap 115/6.3/6/5.7/5.4 volts — gives wide range of heats (from 20 to 30 watts) for close temperature control of tips

Transformers are small, lightweight, but sturdy. Their 6-foot extension cords can be plugged in any 115-volt a-c circuit.

| Description | Cat. No. | Price† |
|-------------|----------|--------|
| Single-tap  | 84G392   | \$5.20 |
| Four-tap    | 84G370   | 7.80   |

Publication Reference .....GEA-4519

## THE MIDGET OFFERS MAJOR ADVANTAGES

**Low-cost soldering**—Solders more efficiently, using only approximately one-fourth wattage normally used.

**Fingertip operation**—Only 8 inches long, weighs but 1 $\frac{3}{4}$  ounces. Styled for fingertip grip.

**Quick, continuous heat**—Famous G-E Calrod\* heater built into Ironclad copper tip for rapid heat transfer.

**Easy renewal**—Ironclad tip and heater can be replaced as a unit merely by unscrewing from handle.

**Long life, low maintenance**—Low voltage permits use of heavy, long-lasting resistant wire. Reduced servicing with long-lasting Ironclad copper tip.

\* Registered U.S. Patent Office.

† Manufacturers' suggested retail price.



# ELECTRIC SOLDERING IRONS



**GENERAL INFORMATION**—Equipped with 6 ft. (10,000 cycle) approved heater cord (covered with twine braid for extra long wear) and rubber plug. Continental or English type plugs 25c extra list. Metal stand furnished with each iron. Heating elements made of best grade nickel-chromium resistance wire, insulated with finest mica obtainable. Elements in the plug tip irons are replaceable by the user and in the screw tip irons replaceable at

the factory. Tips in all irons are replaceable; made of hard drawn pure copper. Case is made from solid Hexacon steel (except No. 50 and P-30), affording it great mechanical strength, preventing denting. Terminal easily accessible and constructed to relieve cord strain. Smooth, cool, comfortable handle—readily replaceable. Voltage range: 32 to 250. Standard voltages 110/120, 121/130, 220/250. All other voltages \$1.00 extra list.

## SCREW TIP IRONS



No. 50—For light soldering on radio, telephone and electrical apparatus. 50 Watts. Tip diam.,  $\frac{1}{8}$ ". Ship. wt., 1 lb. Equal to  $\frac{1}{2}$ -lb. old style copper.....each \$4.50

No. 60—Medium light soldering on telephone, radio, apparatus and linemen's kits. 60 Watts. Tip diam.,  $\frac{1}{8}$ ". Ship. wt.,  $1\frac{1}{8}$  lb. Equal to 1-lb. old style copper.....each \$6.25



No. 85—A high speed tool for telephone, radio and home use. 90 Watts. Tip diam.,  $\frac{1}{8}$ ". Ship. wt.,  $1\frac{1}{4}$  lb. Equal to  $1\frac{1}{2}$ -lb. old style copper.....each \$7.00



No. 120—Light tinware, toys, typewriter, light auto, etc. A high speed iron. 120 Watts. Tip diam.,  $\frac{5}{16}$ ". Ship. wt.,  $1\frac{3}{8}$  lb. Equal to 2-lb. old style copper.....each \$8.00



No. 130—Same as No. 120 except has larger tip and 10 more watts capacity. 130 Watts. Tip diam.,  $\frac{7}{16}$ ". Ship. wt.,  $1\frac{5}{8}$  lb. Equal to 2-lb. old style copper.....each \$8.75

No. 170—Medium tinware, small cans, auto repairs, pipes, gutters, toys, small motors. 175 Watts. Tip diam., 1". Ship. wt.,  $2\frac{1}{4}$  lb. Equal to  $2\frac{1}{2}$ -lb. old style copper.....each \$10.00



No. 225—Medium tinware, cans, auto repairs, metal patterns, light roofing, small branders. 250 Watts. Tip diam.,  $1\frac{1}{8}$ ". Ship. wt.,  $2\frac{5}{8}$  lb. Equal to 3-lb. old style copper.....each \$11.00



No. 350—Heavy tinware, large cans, autos, roofing, refrigerators, ship and airplane. 350 Watts. Tip diam.,  $1\frac{3}{8}$ ". Ship. wt.,  $3\frac{3}{8}$  lb. Equal to 4-lb. old style copper.....each \$13.00



No. 500—Auto repairs, sinks, roofs, cans, armatures, large branders, tinsmiths, etc. 500 Watts. Tip diam.,  $1\frac{1}{2}$ ". Ship. wt., 4 lb. Equal to 5-lb. old style copper.....each \$15.00

No. 700—For extra heavy soldering and large branders. 700 Watts. Tip diam.,  $1\frac{3}{4}$ ". Ship. wt., 5 lbs. Equal to 7-lb. old style copper.....each \$27.50

OPERATE ON A.C. OR D.C., ANY CYCLE

## PLUG TIP IRONS



No. P-30—For extremely light soldering on finest wire and delicate instruments. 40 Watts. Tip diam.,  $\frac{1}{4}$ ". Ship. wt.,  $\frac{5}{8}$  lb. Equal to  $\frac{1}{4}$ -lb. old style copper.....each \$4.50

No. P-70—For light soldering on radio and telephone apparatus and electrical instruments. 80 Watts. Tip diam.,  $\frac{3}{8}$ ". Ship. wt.,  $1\frac{1}{8}$  lb. Equal to 1-lb. old style copper.....each \$6.00



No. P-100—A high speed tool for telephone switchboards, electrical instruments, etc. 100 Watts. Tip diam.,  $\frac{3}{8}$ ". Ship. wt.,  $1\frac{1}{4}$  lb. Equal to  $1\frac{1}{2}$ -lb. old style copper.....each \$7.00

No. P-125—For light tinware, toys, typewriter type bars, small cans, auto, etc. 130 Watts. Tip diam.,  $\frac{5}{16}$ ". Ship. wt.,  $1\frac{1}{2}$  lb. Equal to 2-lb. old style copper.....each \$8.50



No. P-150—Extra high speed iron for radios, electrical apparatus and where a light iron with small diameter is required. 150 Watts. Tip diam.,  $\frac{3}{8}$ ". Ship. wt.,  $1\frac{3}{8}$  lb. Equal to 2-lb. old style copper.....each \$7.75

No. P-151—Same as No. P-150, except where a larger tip is desired. 175 Watts. Tip diam.,  $\frac{1}{2}$ ". Ship. wt.,  $1\frac{3}{4}$  lb. Equal to  $2\frac{1}{2}$ -lb. old style copper.....each \$8.25



No. P-200—For medium tinware, cans, auto repairs, light roofing, sheet metal, etc. 200 Watts. Tip diam.,  $\frac{5}{8}$ ". Ship. wt.,  $2\frac{1}{2}$  lb. Equal to  $2\frac{3}{4}$ -lb. old style copper.....each \$9.50

No. P-250—Same as No. P-200, except where greater speed is required for manufacturing. 250 Watts. Tip diam.,  $\frac{5}{8}$ ". Ship. wt.,  $2\frac{1}{4}$  lb. Equal to 3-lb. old style copper.....each \$10.75



No. P-300—For heavy tinware, large cans, auto, roofing, refrigerator work, etc. 300 Watts. Tip diam.,  $\frac{7}{8}$ ". Ship. wt.,  $2\frac{3}{8}$  lb. Equal to 4-lb. old style copper.....each \$12.50



No. P-550—For auto radiators, copper sinks, roofs, heavy armatures, large branders, etc. 550 Watts. Tip diam.,  $1\frac{1}{8}$ ". Ship. wt.,  $4\frac{1}{8}$  lb. Equal to 5-lb. old style copper.....each \$15.00

SPECIFY VOLTAGE WHEN ORDERING

## HEXACON HATCHET TYPE IRON

For same use as Plug Tip irons of equal wattage, shown above. Replaceable elements and all other features of Plug Tip Irons.

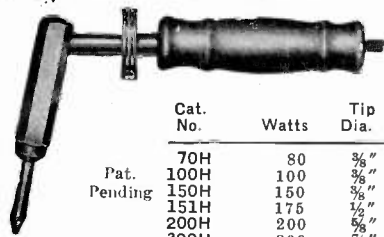

Perfect Balance  
Less Fatigue  
Better Soldered Joints

|         | Cat. No. | Watts | Tip Dia.         | Ship. Wt.           | Price   |
|---------|----------|-------|------------------|---------------------|---------|
|         | 70H      | 80    | $\frac{3}{8}$ "  | $1\frac{3}{8}$ lbs. | \$ 8.00 |
| Pat.    | 100H     | 100   | $\frac{3}{8}$ "  | $1\frac{1}{2}$ lbs. | 9.00    |
|         | 150H     | 150   | $\frac{3}{8}$ "  | 2 lbs.              | 9.75    |
| Pending | 151H     | 175   | $\frac{1}{2}$ "  | 2 lbs.              | 10.25   |
|         | 200H     | 200   | $\frac{5}{16}$ " | $2\frac{3}{8}$ lbs. | 11.50   |
|         | 300H     | 300   | $\frac{7}{8}$ "  | $2\frac{3}{8}$ lbs. | 14.50   |

## HEXACON FEATHERWEIGHT HATCHET IRON

So light its weight is hardly noticeable, but more powerful than most larger irons. Hatchet design makes iron effortless to use. No transformer or other cumbersome and expensive equipment required.

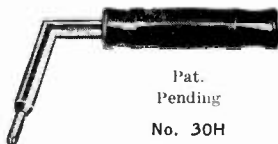

List Price.....\$5.00

Weight:  $5\frac{1}{2}$  ozs. (less cord).  
\*Watts: 40, 50 or 60.

Both  $\frac{1}{8}$ " and  $\frac{1}{4}$ " dia. tips furnished with each iron.

Shipping weight: 1 lb.

\*Specify watts when ordering.



# SOLDERMASTER Royal Blue Line ELECTRIC SOLDERING IRONS



**GENERAL INFORMATION**—Replaceable elements. Best grade of Madagascar mica for insulation. No. 55 has brass-heated cartridge element. Best grade nickel-chrome resistance wire. Replaceable hard drawn copper tips. All one piece swaged cases

**CHROME PLATED.** Equipped with 6 ft. Underwriters' Approved heater cord, rubber plug. Continental or English type plug 25c extra list. Stand for resting iron furnished.

VOLTAGES 110/120 220/250 A.C. or D.C., ANY CYCLE  
SPECIFY VOLTAGE WHEN ORDERING

## SCREW TIP IRONS



No. 55B—For light soldering, radio apparatus, etc. 55 Watts. Tip diam.,  $\frac{1}{8}$ ". Ship. wt., 13 oz.....each \$2.50



No. 76B—For light work, electrical instruments, etc. 75 Watts. Tip diam.,  $\frac{1}{2}$ ". Ship. wt., 15 oz.....each \$4.00



No. 100B—Same as No. 76B except used where more speed is required and heavier work is done. For home use. 90 Watts. Tip diam.,  $\frac{1}{2}$ ". Ship. wt., 16 oz.....each \$4.50



No. 150B—Ideal size for garage and repair work. For home use. 170 Watts. Tip diam.,  $\frac{3}{8}$ ". Ship. wt., 24 oz.....each \$7.00



No. 300B—For heavy steel metal, auto radiators, etc. 275 Watts. Tip diam.,  $1\frac{1}{8}$ ". Ship. wt., 38 oz.....each \$10.00

## PLUG TIP IRONS



No. 71B—For light work, radio repairs, etc. 75 Watts. Tip diam.,  $\frac{3}{8}$ ". Ship. wt., 16 oz.....each \$4.00



No. 101B—For same work as No. 71B, but where more speed is required or heavier work is done. For home use. 100 Watts. Tip diam.,  $\frac{3}{8}$ ". Ship. wt., 18 oz.....each \$4.50



No. 121B—High speed iron for radio and electrical repairs. 125 Watts. Tip diam.,  $\frac{3}{8}$ ". Ship. wt.,  $1\frac{3}{4}$  lbs.....each \$5.50



No. 201B—For same work as No. 150B, except where plug tip is desired. 200 Watts. Tip diam.,  $\frac{5}{8}$ ". Ship. wt., 34 oz.....each \$8.00



No. 301B—For same work as No. 300B, except where plug tip is desired. 300 Watts. Tip diam.,  $\frac{7}{8}$ ". Ship. wt., 46 oz.....each \$10.00

## DISPLAYS

Increase your sales with these silent salesmen. Irons securely mounted, but readily removable for sale. Individually packed in cartons ready for shipment. Catalog number and wattage shown on front of display. Complete catalog information and price list on back.

### SCROLL TYPE DISPLAY

Striking, Modernistic, All Metal Panel



#### No. 1 DISPLAY Illustrated

Size 15" x 17 $\frac{1}{2}$ " (Nos. 1B, 2B, and 3B also same size)

This Display Panel Also Furnished With  
Five or Seven Irons (See Below)

|   | Ship. Wt. | List Price |
|---|-----------|------------|
| No. 1B—Nine Iron with Nos. 55B, 76B, 100B, 150B, 300B, 71B, 101B, 201B, 301B..... | 20 lbs.   | \$54.50    |
| No. 2B—Seven Iron with Nos. 55B, 76B, 100B, 150B, 300B, 71B, 101B.....            | 17 lbs.   | 36.50      |
| No. 3B—Five Iron with Nos. 55B, 76B, 100B, 150B, 300B.....                        | 15 lbs.   | 28.00      |
| No. 4B—Five Iron with Nos. 71B, 101B, 121B, 201B, 301B.....                       | 16 lbs.   | 32.00      |

### ATTRACTIVE THREE COLOR CARDBOARD DISPLAY



This same display card also furnished with No. 5B and No. 5DB, but mounted with irons listed below.

#### No. 6B DISPLAY Illustrated

Size 12" x 16 $\frac{1}{2}$ "

(Nos. 5B, 5DB also same size)

|   | Ship. Wt. | List Price |
|---|-----------|------------|
| No. 5B—Three Iron with Nos. 55B, 76B, 100B.....   | 4 lbs.    | \$11.00    |
| No. 5DB—Three Iron with Nos. 55B, 100B, 150B on display and 2 No. 55B and 1 No. 100B for stock..... | 8 lbs.    | 23.50      |
| No. 6B—Three Iron with Nos. 71B, 101B, 121B.....  | 5 lbs.    | 14.00      |

# KWIKHEAT



## SOLDERING IRONS

# THERMOSTATICALLY CONTROLLED

### HOT IN 90 SECONDS - 225 WATTS <sup>110/</sup>/<sub>120</sub> V. A.C.



- New Bevelled Tips give 30% more heat
- Three times faster heating
- Maintains constant temperature
- Tips stay tinned 10 times longer
- Cannot overheat
- Temperatures are pre-set

# \$11<sup>00</sup>

LIST

### Self-Contained Thermostat Patented Feature

KWIKHEAT Thermostatically Controlled Soldering Iron is the only iron containing a built-in thermostat. This enables it to heat up ready for use in 90 seconds! Fully guaranteed! KWIKHEAT's patented thermostat maintains perfect temperature for best soldering . . . prevents overheating . . . prolongs life of iron . . . reduces cost of tip maintenance. Cool plastic handle . . . light weight . . . 6 interchangeable tip styles make one KWIKHEAT equivalent to several soldering irons of different voltage.

LIST PRICE **\$11<sup>00</sup>**

### SPECIFICATIONS

**Type #300:**

**225 Watts - 100/125 V. A.C.**

**Weight of iron with # tip: 13 1/2 ozs.**

**Length of iron with tip: 13 1/4 inches**

**Length of cord: 6 feet**

**Core made of tellurium copper alloy**

**Tips: \$1.25 each      Set of 5: \$5.50**

**SIX INTERCHANGEABLE TIP STYLES Each \$1.25**

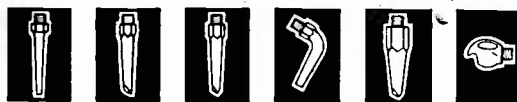

|       |        |        |          |       |           |
|-------|--------|--------|----------|-------|-----------|
| #0    | #1     | #2     | #3       | #4    | #5        |
| LIGHT | MEDIUM | MEDIUM | MED. LT. | HEAVY | 1-OZ. POT |

★ **UNGAR Electric Tool Co., Inc.** ★

LOS ANGELES 54

Manufacturers of

# Ungar Electric Soldering Pencils

## 8 New Features

- 1. Full Length CORD**  
65 strand Extra Flexible
- 2. New, Cooler HANDLE**  
of Durable Molded Plastic  
(Patent applied for)
- 3. UNDERWRITERS' Listed**  
Seal on Complete Pencil Set
- 4. Ceramic SEPARATORS**  
for DOUBLE Safety
- 5. Spring Action Rivet**  
Assures positive contact at all times
- 6. Extra Length Brass Shell**  
Firmly engages all threads  
Keeps Heating Unit Tight
- 7. 20 watt ELEMENT**  
1,000 hours operation 56¢  
110-120 volt A.C.—D.C.
- 8. 4 INTERCHANGEABLE TIPS** • ample copper heats to 600° in 90 sec.



No. 538  
Tellurium  
1/8" Chisel tip

No. 537  
Tellurium  
1/8" Pencil tip

No. 539  
Tellurium  
3/8" Chisel tip

No. 536  
Tellurium  
3/8" Pyramid

*New* → →

*Feather-Light*

for hard-to-reach Jobs

*Heavy-Rugged*

for all Standard Soldering

**No. 776 - HANDLE & CORD SET**  
Packed 25 per case—Price \$1.00 ea.

**No. 536 - PYRAMID TIP**  
Packed 10 per box—Price \$1.00 ea.

**No. 537 - PENCIL TIP**  
Packed 10 per box—Price \$1.00 ea.

**No. 538 - CHISEL TIP**  
Packed 10 per box—Price \$1.00 ea.

**No. 539 - CHISEL TIP**  
Packed 10 per box—Price \$1.00 ea.

(Discounts: 1 to 9 - 20%  
10 or more - 35%)



# WELLER SOLDERING GUNS

## FOR ALL YOUR SOLDERING

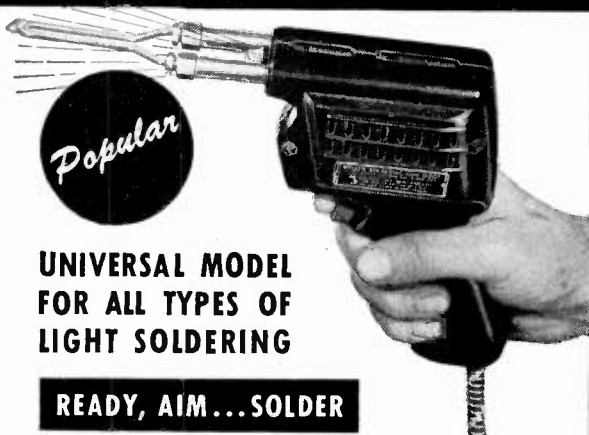

**UNIVERSAL MODEL  
FOR ALL TYPES OF  
LIGHT SOLDERING**

**READY, AIM... SOLDER**

Fast 5 second heat comes on the instant trigger is pulled. No wasted time or current. No need to unplug gun between jobs.

**TRIGGER ACTION**

Just pull the trigger switch . . . model S-107 has single heat 100 watts; model D-207 offers dual heat with two switch positions 100 and 135 watts.

**FLEXIBLE TIPS**

Flexible tips can be easily formed to slip through chassis wiring; handles difficult, deep corner jobs with ease.

**PREFOCUSED SPOTLIGHT**

Built-in Solderlite eliminates blind soldering—locates the work quickly and shows you exactly what you are doing.

**TWO TYPE WELLER TIPS**

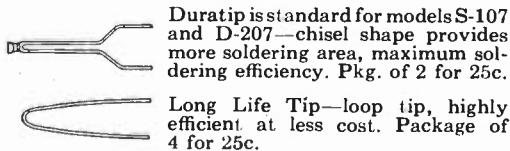

**HEAVY-DUTY MODEL  
HANDLES ALL  
SOLDERING UP TO  
250 WATTS**

**DUAL HEAT**

Model WD-250 has 200 watts normal heat on first switch position, and 250 watts instant heat on second trigger position. Model WS-200 provides 200 watts single heat.

**5 SECOND HEAT**

Pull the trigger switch, and solder. Fast 5 second heating eliminates waiting. Heat goes off automatically when trigger is released . . . no wasted time or current, no need to unplug gun between jobs.

**NEW DESIGN**

Streamlined design gives perfect balance and soldering ease. Improved transformer engineering provides light weight, compact unit with increased capacity and efficiency. 'Over and under' terminal positions assure maximum visibility with built-in spotlight.

**LONGER REACH**

Greater 5¼" length reaches into remote spots with ease.

**RIGID-TIP**

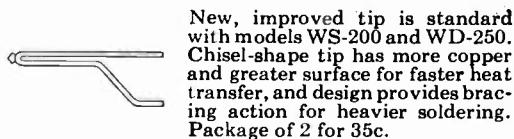

**UNDERWRITERS' LABORATORIES APPROVED**

Weller Guns S-107 and D-207 are U.L. approved. Also approved in Canada under CSA App. No. 7508.



**SOLDERING TIPS**

*new Weller handy guide to faster, easier soldering—20 pages fully illustrated. Price 10c.*

**WELLER**  
MANUFACTURING COMPANY

| MODEL  | WATTS                | CYCLES | VOLTS | LENGTH* | NET PRICE |
|--------|----------------------|--------|-------|---------|-----------|
| S-107  | single heat<br>100   | 60     | 115   | 4"      | \$11.95   |
| WS-200 | single heat<br>200   | 60     | 115   | 5¼"     | 12.95     |
| D-207  | dual heat<br>100/135 | 60     | 115   | 4"      | 13.95     |
| WD-250 | dual heat<br>200/250 | 60     | 115   | 5¼"     | 14.95     |

\*Length—dimension from front of housing to tip.

U.S. Pat. No. 2405866, Other Pat. Pending.

Printed in U.S.A.

# KESTER FLUX-CORE SOLDER

*Standard for the Radio and TV Field*



- Kester Plastic Rosin-Core Solder
- Kester "Resin-Five" Core Solder
- Kester Radio Solder
- Kester Acid-Core Solder
- Kester "A" Flux-Core Solder
- Kester Nosput Flux-Core Solder
- Kester Knorust Flux-Core Solder
- Specialized Flux-Core Solders
- Solid Wire and Bar Solders
- Kester Preforms, Rings, Pellets, Washers, Ribbon
- External Rosin Soldering Fluxes
- Other Fluxes
- Kester Soldering Iron Brackets

**FOR PEAK SOLDERING EFFICIENCY, IT'S KESTER!** Kester offers every conceivable type of Solder product. Strand sizes as small as .008" diameter in Flux-Core Solder, unusual alloys and varying Flux contents or Core sizes.

**A COMPLETE TECHNICAL SERVICE.** If you're not getting peak efficiency or have a specific problem in your soldering operations, take advantage of the facilities of Kester's Technical Department. . . . It costs you nothing.

STANDARD FOR INDUSTRY  
SINCE 1899

**KESTER  
SOLDER**

**KESTER SOLDER COMPANY**  
4201 Wrightwood Ave., Chicago 39, Illinois  
Factories Also At  
Newark, New Jersey • Brantford, Canada



# KRAEUTER

The choice of skilled mechanics

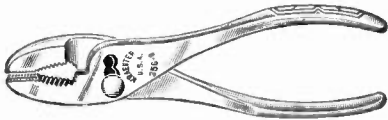

## "GRIPRITE" COMBINATION PLIERS

The finest quality combination pliers. Designed for heavy duty. Slightly tapered nose. sharp deep milled teeth and grooved jaws for gripping cotter pins and wire. Knurled handles. The 8" and 10" sizes have three slip joint adjustments which give a wide range of parallel grips.

| No. | Length | Finish      | Wt. per doz. | Price    |      |
|-----|--------|-------------|--------------|----------|------|
|     |        |             |              | per doz. | Each |
| 356 | 5½ in. | Full Nickel | 3½ lbs.      | \$1.50   |      |
| 356 | 6 in.  | Full Nickel | 5¼ lbs.      | 1.60     |      |
| 356 | 8 in.  | Full Nickel | 8¾ lbs.      | 2.00     |      |
| 356 | 10 in. | Full Nickel | 14 lbs.      | 2.50     |      |

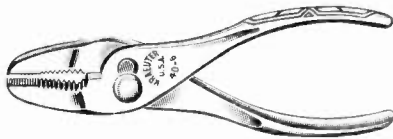

## THIN NOSE COMBINATION PLIERS

The tapered jaws and thin nose of these pliers enable the mechanic to grip objects difficult to reach in tight, narrow working spaces. Knurled handles, milled gripping teeth and wire cutters.

| No. | Length | Finish        | Wt. per doz. | Price    |      |
|-----|--------|---------------|--------------|----------|------|
|     |        |               |              | per doz. | Each |
| 40  | 5 in.  | Nickel Plated | 2¼ lbs.      | \$       |      |
| 40  | 6 in.  | Nickel Plated | 4¼ lbs.      | \$1.25   |      |



## MECHANICS' SIDE CUTTING PLIERS

Gripping pliers with side cutters. Tapered nose, milled teeth and grooved jaws for gripping cotter pins and wire. Knurled handles. The cutters are very handy for light wire work.

| No.  | Length | Finish      | Wt. per doz. | Price    |      |
|------|--------|-------------|--------------|----------|------|
|      |        |             |              | per doz. | Each |
| 1973 | 5½ in. | Full Nickel | 3½ lbs.      | \$2.20   |      |
| 1973 | 7 in.  | Full nickel | 7¼ lbs.      | 2.50     |      |



## LINEMEN'S SIDE CUTTING PLIERS

Designed for heavy work to meet the requirements of linemen. Drop forged from selected plier steel, skilfully hardened and tempered. Powerful wire cutters, a well balanced head and deep milled gripping jaw surface for holding and bending wire.

| No.  | Length | Finish      | Wt. per doz. | Price    |      |
|------|--------|-------------|--------------|----------|------|
|      |        |             |              | per doz. | Each |
| 1801 | 6 in.  | Blue Temper | 5¼ lbs.      | \$2.45   |      |
| 1801 | 7 in.  | Blue Temper | 7½ lbs.      | 2.75     |      |
| 1801 | 8½ in. | Blue Temper | 11¼ lbs.     | 3.75     |      |

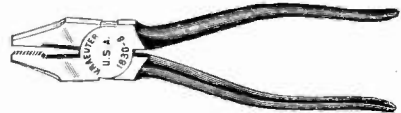

## ELECTRICIANS' SIDE CUTTING PLIERS

Used extensively in electric wiring of fixtures, appliances and other general repair work.

Very popular with mechanics on production work where electric wiring is required in the finished product.

| No.  | Length | Finish      | Wt. per doz. | Price    |      |
|------|--------|-------------|--------------|----------|------|
|      |        |             |              | per doz. | Each |
| 1830 | 4 in.  | Blue Temper | 1½ lbs.      | \$1.75   |      |
| 1830 | 5 in.  | Blue Temper | 2¼ lbs.      | 1.90     |      |
| 1830 | 6½ in. | Blue Temper | 4¾ lbs.      | 2.10     |      |
| 1830 | 7 in.  | Blue Temper | 6¾ lbs.      | 2.35     |      |
| 1830 | 8 in.  | Blue Temper | 8¼ lbs.      | 2.75     |      |



## IGNITION PLIERS

Very narrow head, serrated gripping teeth and well shaped handle grips. Three slip joint positions. Generally used on distributor, generator, magneto and carburetor work.

| No. | Length | Finish      | Wt. per doz. | Price    |      |
|-----|--------|-------------|--------------|----------|------|
|     |        |             |              | per doz. | Each |
| 643 | 5 in.  | Blue Temper | 1 lb.        | \$1.60   |      |

THIS IS ONLY A PARTIAL LISTING OF KRAEUTER TOOLS

SEND FOR CATALOG



# KRAEUTER

The choice of skilled mechanics

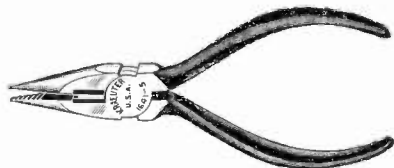

## SHORT CHAIN NEEDLE NOSE PLIERS

Short tapered jaws for bending and looping wire. The short nose gives these pliers extra leverage and gripping strength. Used for wiring switches and other open electric work.

| No.  | Length              | Finish      | Wt. per doz. | Price  |      |
|------|---------------------|-------------|--------------|--------|------|
|      |                     |             |              | Each   | Each |
| 1641 | 5 in.               | Blue Temper | 2¾ lbs.      | \$2.00 |      |
| 1643 | Same without Cutter |             | 2¾ lbs.      | 1.75   |      |

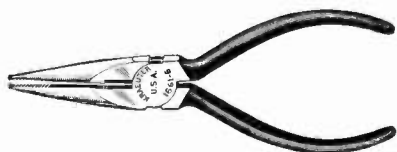

## LONG CHAIN NEEDLE NOSE PLIERS

Long tapered jaws and needle nose. Used extensively in all industries . . . from switchboard, electric fixture and appliance wiring . . . to motor ignition, aviation and general manufacturing work.

| No.  | Length              | Finish      | Wt. per doz. | Price  |      |
|------|---------------------|-------------|--------------|--------|------|
|      |                     |             |              | Each   | Each |
| 1661 | 6 in.               | Blue Temper | 3½ lbs.      | \$2.30 |      |
| 1671 | Same without Cutter |             | 3½ lbs.      | 1.80   |      |



## EXTRA LONG CHAIN NOSE PLIERS

Extra long tapered jaws with narrow pointed nose. Used extensively in automotive . . . electric . . . aviation and general production and repair work.

Length of jaw 2¾ in.

| No.  | Length              | Finish      | Wt. per doz. | Price  |      |
|------|---------------------|-------------|--------------|--------|------|
|      |                     |             |              | Each   | Each |
| 1781 | 7 in.               | Blue Temper | 3¾ lbs.      | \$2.65 |      |
| 1771 | Same without Cutter |             | 3¾ lbs.      | 2.15   |      |

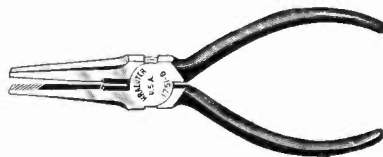

## LONG FLAT NOSE PLIERS

Adaptable to many uses where a tool with long flat sturdy jaws is required. Jaws are scored to give a good gripping and holding surface.

| No.  | Length              | Finish      | Wt. per doz. | Price  |      |
|------|---------------------|-------------|--------------|--------|------|
|      |                     |             |              | Each   | Each |
| 1751 | 6 in.               | Blue Temper | 3 lbs.       | \$2.40 |      |
| 1741 | Same without Cutter |             | 3 lbs.       | 1.90   |      |

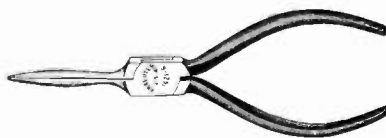

## LONG NEEDLE OR SNIPE NOSE PLIERS

Especially designed for difficult and awkward jobs where no other tool will serve. The long slender jaws make it adaptable to many uses. A very popular plier for fine work.

2<sup>3</sup>/<sub>32</sub> in. Jaw

| No.  | Length | Finish      | Wt. per doz. | Price  |      |
|------|--------|-------------|--------------|--------|------|
|      |        |             |              | Each   | Each |
| 1621 | 6 in.  | Blue Temper | 2¼ lbs.      | \$2.10 |      |

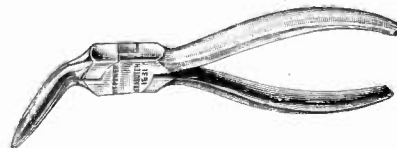

## CURVED NEEDLE OR SNIPE NOSE PLIERS

To reach that place down in under or around an obstruction. Very useful where greater visibility is required in holding small objects at an angle.

| No.  | Length | Finish      | Wt. per doz. | Price  |      |
|------|--------|-------------|--------------|--------|------|
|      |        |             |              | Each   | Each |
| 1631 | 5½ in. | Blue Temper | 2¼ lbs.      | \$2.35 |      |

THIS IS ONLY A PARTIAL LISTING OF KRAEUTER TOOLS

SEND FOR CATALOG



# KRAEUTER

The choice of skilled mechanics

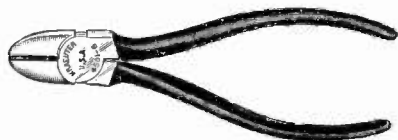

## DIAGONAL "OBLIQUE" CUTTING PLIERS

Made especially for close cutting. Used extensively in electrical work, radio manufacturing, telephone and automotive ignition work.

| No.  | Size   | Finish      | Wt. per doz. | Price  |      |
|------|--------|-------------|--------------|--------|------|
|      |        |             |              | Each   | Each |
| 4501 | 4½ in. | Blue Temper | 1½ lbs.      | \$1.80 |      |
|      | 5 in.  | " "         | 2¾ lbs.      | 2.05   |      |
|      | 6 in.  | " "         | 3¾ lbs.      | 2.35   |      |

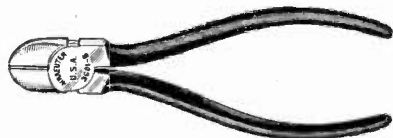

## SHORT NOSE DIAGONAL CUTTING PLIERS

An excellent cotter pin tool. Specially designed with short nose. Very popular with aviation and automotive mechanics.

| No.  | Size | Finish      | Wt. per doz. | Price  |      |
|------|------|-------------|--------------|--------|------|
|      |      |             |              | Each   | Each |
| 3601 | 6    | Blue Temper | 4½ lbs.      | \$2.50 |      |



## "HIGH POWER" DIAGONAL CUTTING PLIERS

This type diagonal plier has the joint very close to the end of the cutter to give added leverage which makes cutting easy. A well balanced tool adaptable to the work in many trades.

| No.  | Length | Finish      | Wt. per doz. | Price  |      |
|------|--------|-------------|--------------|--------|------|
|      |        |             |              | Each   | Each |
| 4610 | 7 in.  | Blue Temper | 5¾ lbs.      | \$2.30 |      |



No. 4206



## WIRE STRIPPING DIAGONAL CUTTING PLIERS

Narrow head and notched cutters for stripping fine wire .062 diameter. The spring in the handle makes this a very fast cutting tool. Used by manufacturers of electric fixtures, appliances, radio and radio tubes.

| No.  | Length | Finish      | Wt. per doz. | Price  |      |
|------|--------|-------------|--------------|--------|------|
|      |        |             |              | Each   | Each |
| 2612 | 6½ in. | Blue Temper | 3 lbs.       | \$2.85 |      |

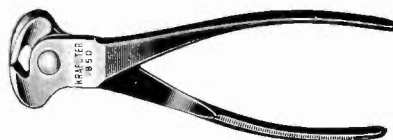

No. 1850

## END CUTTING NIPPERS

Powerful end nippers carefully edged to insure sharp enduring cutters. Compact jaws and close riveted joint.

| No.  | Length | Finish      | Wt. per doz. | Price  |      |
|------|--------|-------------|--------------|--------|------|
|      |        |             |              | Each   | Each |
| 1850 | 5 in.  | Blue Temper | 4½ lbs.      | \$2.00 |      |
| 1850 | 6 in.  | Blue Temper | 6 lbs.       | 2.25   |      |
| 1850 | 7 in.  | Blue Temper | 8 lbs.       | 2.50   |      |
| 1850 | 8 in.  | Blue Temper | 10½ lbs.     | 2.90   |      |

NOTE: These pages contain only a partial listing of KRAEUTER Tools. Ask for complete catalog describing the entire extensive KRAEUTER line.

All prices subject to change without notice.

## HARD WIRE DIAGONAL CUTTING PLIERS

Designed and edged for the purpose of cutting hard wire . . . in small sizes not larger than 1/8" diameter . . . not intended for cutting soft wire.

| No.  | Length | Finish      | Wt. per doz. | Price  |      |
|------|--------|-------------|--------------|--------|------|
|      |        |             |              | Each   | Each |
| 4206 | 6 in.  | Blue Temper | 4½ lbs.      | \$2.50 |      |

THIS IS ONLY A PARTIAL LISTING OF KRAEUTER TOOLS

SEND FOR CATALOG



# KRAEUTER

The choice of skilled mechanics

## Professional Line

### SPECIAL NEEDLE POINT PLIERS

Designed for light fine professional work. The special needle points of these pliers make them invaluable where delicate adjustments have to be made.

(NOSE OF THESE PLIERS NOT GUARANTEED)

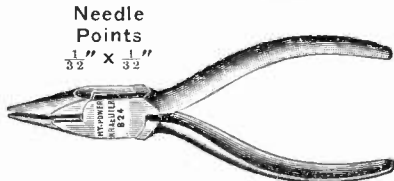

#### SHORT NOSE NEEDLE POINT PLIERS

| No. | Length | Finish         | Price        |        |
|-----|--------|----------------|--------------|--------|
|     |        |                | Wt. per.doz. | Each   |
| 824 | 4½ in. | Full Polished  | 1½ lbs.      | \$2.50 |
| 834 | Same   | without cutter |              | 2.20   |

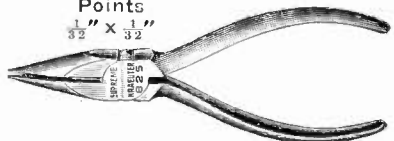

#### MEDIUM NOSE NEEDLE POINT PLIERS

| No. | Length | Finish         | Price        |        |
|-----|--------|----------------|--------------|--------|
|     |        |                | Wt. per.doz. | Each   |
| 825 | 5 in.  | Full Polished  | 2¼ lbs.      | \$2.50 |
| 835 | Same   | without cutter |              | 2.25   |

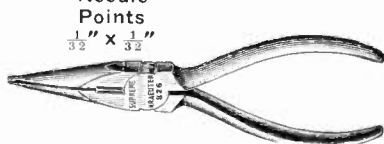

#### LONG NOSE NEEDLE POINT PLIERS

| No. | Length | Finish         | Price        |        |
|-----|--------|----------------|--------------|--------|
|     |        |                | Wt. per.doz. | Each   |
| 826 | 6 in.  | Full Polished  | 3 lbs.       | \$2.70 |
| 836 | Same   | without cutter |              | 2.35   |

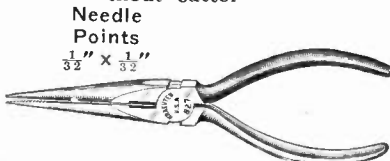

#### EXTRA LONG NOSE NEEDLE POINT PLIERS

| No. | Length | Finish         | Price        |        |
|-----|--------|----------------|--------------|--------|
|     |        |                | Wt. per.doz. | Each   |
| 827 | 7 in.  | Full Polished  | 3¾ lbs.      | \$3.00 |
| 837 | Same   | without cutter | 3¾ lbs.      | 2.75   |

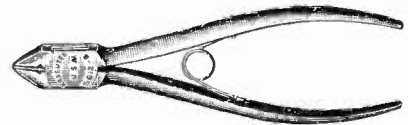

#### NEEDLE POINT DIAGONAL CUTTING PLIERS

| No.  | Length | Finish                 | Price        |        |
|------|--------|------------------------|--------------|--------|
|      |        |                        | Wt. per.doz. | Each   |
| 5612 | 6½ in. | Full Polished          | 3 lbs.       | \$3.30 |
|      |        | (With Stripping Notch) |              |        |

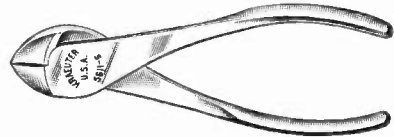

#### OVAL HEAD DIAGONAL CUTTING PLIERS

| No.  | Length | Finish        | Price        |        |
|------|--------|---------------|--------------|--------|
|      |        |               | Wt. per.doz. | Each   |
| 5611 | 5 in.  | Full Polished | 2¼ lbs.      | \$2.75 |

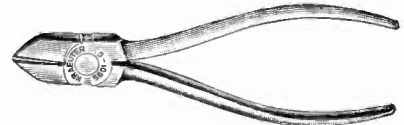

#### NEEDLE POINT DIAGONAL CUTTING PLIERS

| No.  | Length | Finish        | Price        |        |
|------|--------|---------------|--------------|--------|
|      |        |               | Wt. per.doz. | Each   |
| 5601 | 4½ in. | Full Polished | 2 lbs.       | \$2.50 |
| 5601 | 5 in.  | Full Polished | 2¼ lbs.      | 2.70   |
| 5601 | 6 in.  | Full Polished | 3 lbs.       | 3.10   |

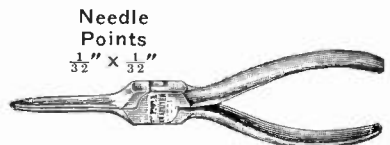

#### NEEDLE POINT SNIPE NOSE PLIERS

| No. | Length | Finish        | Price        |        |
|-----|--------|---------------|--------------|--------|
|     |        |               | Wt. per.doz. | Each   |
| 842 | 6 in.  | Full Polished | 2¼ lbs.      | \$2.50 |

THIS IS ONLY A PARTIAL LISTING OF KRAEUTER TOOLS

SEND FOR CATALOG



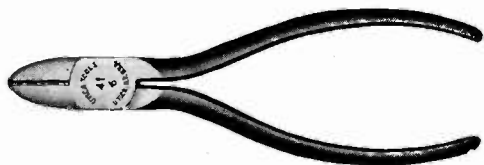

**No. 41 • Electricians' Diagonal Pliers—**

Hardened and tempered in oil. Special narrow nose for radio and electrical work.

No. 41.....4 inches, 5 inches and 6 inches  
Can be furnished with insulation stripper.

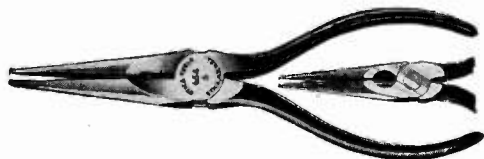

**No. 654 • Utica Long Needle Nose Side Cutting Plier**

This is a long, fine, spring-tempered nose side cutting plier, drop forged and with hand-honed cutting knives.

Utica Finish Size.....6 inches and 7 inches

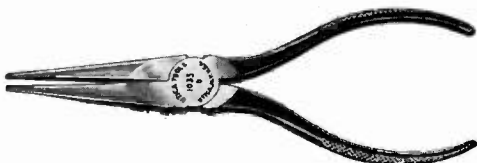

**No. 1033 • Utica Long Chain Needle Nose Plier**

This is a long needle nose type of plier without a side cutter. It has a spring-tempered needle nose with a fine balance for delicate work.

Utica Finish Size.....6 inches and 7 inches

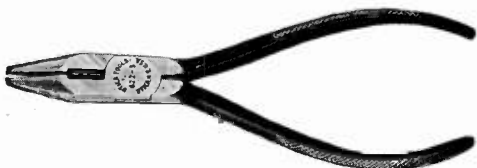

**No. 622 • Utica Short Chain Nose Mechanic's Plier**

This plier is a Short Chain Nose Side Cutting Plier, hand-honed cutting knives. It makes an all around Electrical Mechanic's plier.

Utica Finish Size ..... 5 inches

**No. 44S—Special Diagonal Pliers with Spring**

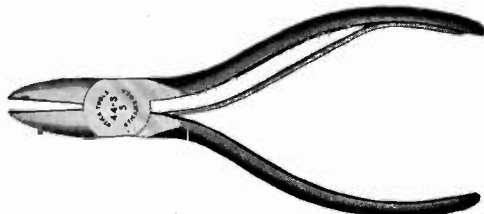

A slim nose cutting plier designed especially for radio and electrical work. Extra fine hand honed edges permit nearly flush cuts.

Utica Finish Size..... 5 inches and 6 inches

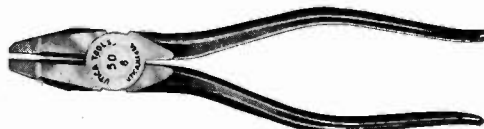

**No. 50 • Utica Standard Side Cutting Plier**

An ideal tool for electrical work. Drop forged and skillfully tempered. Its cutting qualities are unsurpassed by any side cutting plier.

Utica Finish Size ..... 5, 6, 7, 8 inches

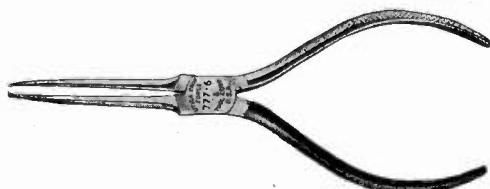

**No. 777 • Utica Long Needle Nose Plier**

This plier has a long, half-round, spring-tempered nose for very fine work in assembling small electrical apparatus.

Utica Finish Size .....6 inches

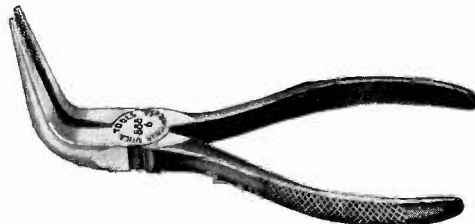

**No. 888 • Curved Needle Nose Pliers—**

This is a long curved spring-tempered Needle Nose Plier for use in deep and narrow places. It may be used without turning or twisting the hand in the assembling of small fixtures, electrical apparatus, etc.

Utica Finish Size .....6 inches

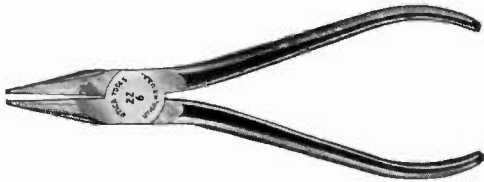

**No. 22 • Utica Chain Nose Plier**

This is a Short Chain Nose Plier forged from a fine quality of steel with fine points particularly adapted for the use of Jewelers, Opticians, Telephone Installers, Electricians and Radio Assemblers.

Utica Finish Size .....4, 4½, 5, 6 inches

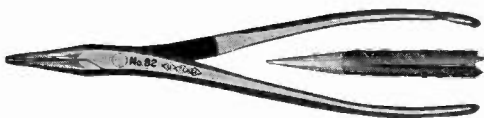

**No. 82 • Utica Chain Nose Wiring Plier**

This is a special Radio Repair man's plier, new in design, having a chain nose for those who prefer this type of construction.

Utica Finish Size ..... 8 inches

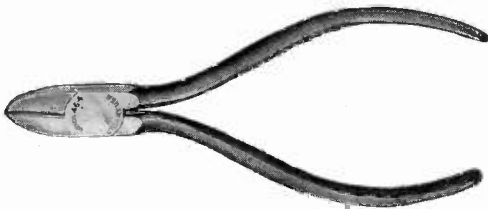

**No. 46 • Midget Diagonal Plier**

A small Diagonal for radio and electrical work. Hand honed edges with a slim nose for use in cramped quarters.

Utica Finish Size.....4 inches



**No. 91 • Thin Adjustable 22½° Angle Wrenches, Alloy Steel**

Both the handle and jaw are drop forged from a high grade Alloy Steel, hardened and tempered in oil. Will not break or wear in the gear teeth and allow play in the wrench, permitting the jaw to slip off the nut.

It will give better service and last longer than any other wrench.

Size ..... 4, 6, 8, 10, 12 inch

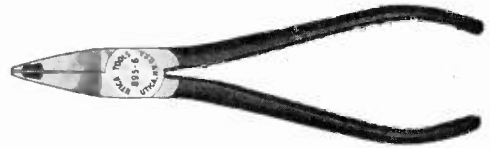

**No. 895 Utica Radio Plier**

This is a General Radio Repair Man's Plier. It has a center cutter and flat scored nose for looping and bending.

Utica Finish Size .....6 inches

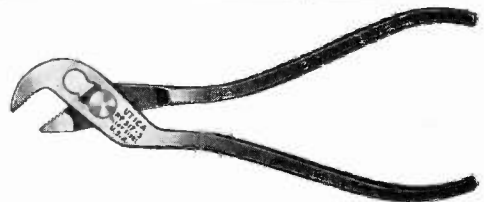

**No. 517 Utica Ignition Plier**

This ignition Plier with its unique design will fit all ignition units, spring tempered. A great little tool for the hard to get at adjustments.

No. 517 ..... 5 inches

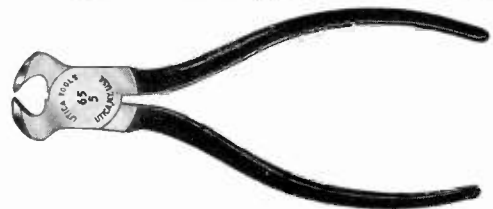

**No. 65 • Utica Jeweler's End Cutting Nipper**

This Nipper is forged from a fine grade of steel, carefully tempered. A light, strong End Cutting Nipper, used by Electricians and Machinists. The keen cutting edges and "Perfect Fit" handles make this a very popular tool.

Utica Finish Size.....4½ and 5 inches

**No. 100BX • Utica-Smith Pocket Armor Cutters**

No. 100BX—Utica-Smith Pocket Armor Cutters 7" Alloy Steel

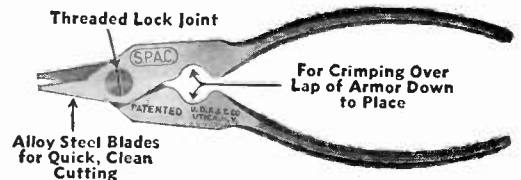

The easiest, quickest tool made for cutting armored cable. Fully illustrated instructions packed with each tool.

Utica Finish Size ..... 7 inches

Quality

**XCELITE**

Tools

REG. TRADE MARK

Creators of

**SHOCK-PROOF BREAK-PROOF AMBER PLASTIC HANDLE  
SCREWDRIVERS**

TIP is properly ground and gauged to fit screw slot accurately. Ground on a flat belt grinder with grain running lengthwise with the blade "B" eliminates the indentations of crosswise grinding, always sources of tip weakness and breakage "A". Xcelite grinding insures uniformity right down to the edge of the tip; insuring perfect fit in the screw slot.

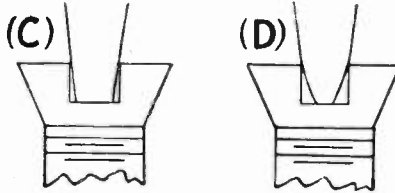
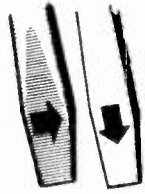

Note illustration "C" showing perfect rectangle of Xcelite Tip, insuring grip in screw slot. Illustration "D" shows "dubbed-off" result of ordinary grinding with the tendency to lift out of the screw under turning pressure.

SIZE is clearly marked on the handle. Easier to select the correct size — easier to reorder. Number on handle is catalog number, also it gives size of screwdriver. For example: No. 144 means 1/4" diameter blade; 4" long. Letters "R" or "S" signify round or square blade.

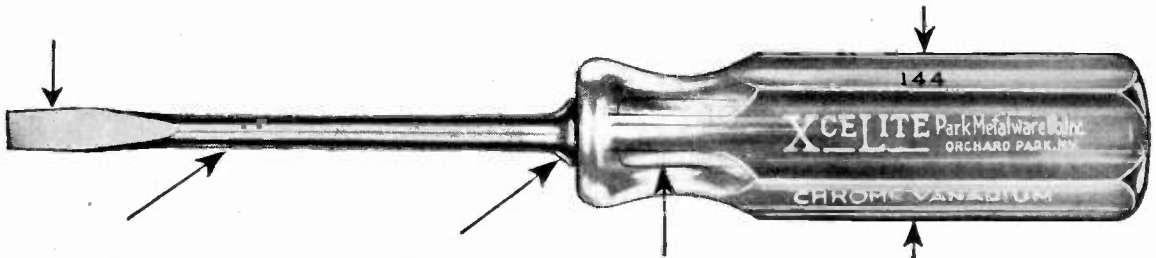

**BLADE** is skillfully forged of SAE 6150 Chrome Vanadium Electric Furnace Steel. Polished Blades.

**FLANGE** on the blade of handle resists shock of pounding.

**EMBEDDED END** of blade, winged design, prevents turning of the blade in the handle.

**HANDLE** is of genuine Xcelite plastic, full size and correctly shaped for grip and balance.

**XCELITE SHOCKLESS SCREWDRIVERS  
Complete Xcelite Screwdriver Price List**

**Square Blades**

**Round Blades**

| Number    | Size Blade | List  | Weight<br>Box of 10 |
|-----------|------------|-------|---------------------|
| S-183     | 1/8" x 3"  | \$.45 | 1/2 lb.             |
| S-184     | 1/8" x 4"  | .45   | 1/2 lb.             |
| S-185     | 1/8" x 5"  | .45   | 1/2 lb.             |
| †SH-183   | 1/8" x 3"  | .60   | 1/2 lb.             |
| †SH-184   | 1/8" x 4"  | .60   | 1/2 lb.             |
| †SH-185   | 1/8" x 5"  | .60   | 1/2 lb.             |
| S-3163    | 1/8" x 3"  | .75   | 1 3/4 lb.           |
| S-3164    | 1/8" x 4"  | .80   | 1 3/4 lb.           |
| S-3166    | 1/8" x 6"  | .90   | 2 lb.               |
| S-3168    | 1/8" x 8"  | .95   | 2 lb.               |
| S-31610   | 1/8" x 10" | 1.05  | 2 1/4 lb.           |
| S-142     | 1/4" x 2"  | .90   | 1 3/4 lb.           |
| S-144     | 1/4" x 4"  | .95   | 2 lb.               |
| S-146     | 1/4" x 6"  | 1.00  | 2 1/2 lb.           |
| S-148     | 1/4" x 8"  | 1.10  | 3 lb.               |
| S-5162    | 1/8" x 2"  | .95   | 2 lb.               |
| S-5166    | 1/8" x 6"  | 1.20  | 3 3/4 lb.           |
| S-5168    | 1/8" x 8"  | 1.30  | 4 1/4 lb.           |
| S-51610   | 1/8" x 10" | 1.40  | 4 3/4 lb.           |
| S-388     | 3/8" x 8"  | 1.60  | 6 lb.               |
| ††S-3812  | 3/8" x 12" | 2.25  | 1 1/4 lb.           |
| ††S-7166  | 1/2" x 6"  | 1.80  | 1 1/4 lb.           |
| ††S-71612 | 1/2" x 12" | 2.35  | 1 1/2 lb.           |
| ††S-71618 | 1/2" x 18" | 2.60  | 1 1/2 lb.           |
| ††S-3818  | 3/8" x 18" | 2.50  | 1 1/2 lb.           |
| S-1424    | 1/4" x 24" | 2.25  | 1 1/4 lb.           |

1  
in  
box

| Number     | Size Blade | List  | Weight<br>Box of 10 |
|------------|------------|-------|---------------------|
| *R-3322    | 3/32" x 2" | \$.30 | 1/2 lb.             |
| *R-3323    | 3/32" x 3" | .30   | 1/2 lb.             |
| *R-3324    | 3/32" x 4" | .30   | 1/2 lb.             |
| **R-181    | 1/8" x 2"  | .30   | 1/2 lb.             |
| *R-183     | 1/8" x 3"  | .30   | 1/2 lb.             |
| *R-184 1/2 | 1/8" x 4"  | .30   | 1/2 lb.             |
| ††R-184    | 1/8" x 4"  | .50   | 1/2 lb.             |
| ††R-186    | 1/8" x 6"  | .55   | 3/4 lb.             |
| ††R-188    | 1/8" x 8"  | .60   | 1 lb.               |
| ††R-1810   | 1/8" x 10" | .65   | 1 lb.               |
| R-5323     | 3/32" x 3" | .60   | 1 lb.               |
| R-5324     | 3/32" x 4" | .60   | 1 lb.               |
| R-5325     | 3/32" x 5" | .60   | 1 lb.               |
| R-5328     | 3/32" x 8" | .70   | 1 1/4 lb.           |
| R-3163     | 1/8" x 3"  | .70   | 1 1/2 lb.           |
| R-3164     | 1/8" x 4"  | .75   | 1 1/2 lb.           |
| R-3166     | 1/8" x 6"  | .85   | 1 1/2 lb.           |
| R-3168     | 1/8" x 8"  | .90   | 1 3/4 lb.           |
| R-31610    | 1/8" x 10" | 1.00  | 2 lb.               |
| R-31618    | 1/8" x 18" | 1.75  | (pk. 1)             |
| R-144      | 1/4" x 4"  | .90   | 2 lb.               |
| R-146      | 1/4" x 6"  | .95   | 2 1/4 lb.           |
| R-148      | 1/4" x 8"  | 1.05  | 2 1/2 lb.           |
| R-5166     | 5/16" x 6" | 1.15  | 3 1/2 lb.           |
| R-5168     | 5/16" x 8" | 1.25  | 4 lb.               |

\*\*24 of this number used on #24 display.  
\*These numbers have 1/8" dia. handles.  
††These numbers have 5/16" dia. handles. For insulated blades any size in round list add 25 cents to list price.  
There's an Xcelite Screwdriver "sized" to fit every job.  
Note: We have standardized our packages on the decimal system instead of in dozens, in accordance with Government practice. All screwdrivers and nut drivers will be packed ten in a box, except where otherwise noted (exceptions are large sizes or slow moving items). Weights given above are correct to the nearest quarter-pound limit.

**Stubbies**

|        |           |     |           |
|--------|-----------|-----|-----------|
| S-3161 | 1/8" x 1" | .55 | 3/4 lb.   |
| S-141  | 1/4" x 1" | .65 | 1 1/4 lb. |
| S-5161 | 1/8" x 1" | .65 | 3/4 lb.   |

††Large double-grip handles.

†Screwholding type used on SH-10 Display.

# Quality

# XCELITE

# Tools

REG. TRADE MARK

## DUAL-PURPOSE SCREWDRIVERS



### IN ROLL KIT

No. CK-3...\$3.95 List  
Contains RB-1, RB-2, RB3 and Combination Handle.

No. CK-2...\$3.10 List  
Contains RB-1, RB-2 and Combination Handle.

See Below for Individual Listing of Blade Sizes.

### IN PLASTIC BOX

No. BC22 Containing RB1, RB2 and Reg. Handle.....\$3.10  
No. BC23 Containing RB1, RB2, RB3 and Reg. Handle..... 3.95

### OR INDIVIDUALLY

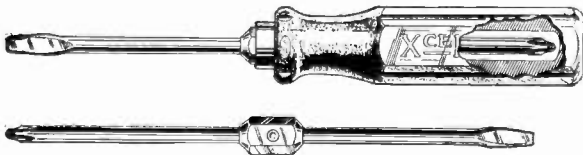

### BLADE COMBINATIONS

(Please Order by Number)

- No. 1—No. 1 Phillips and  $\frac{1}{8}$ " Xcelite
- No. 2—No. 2 Phillips and  $\frac{1}{4}$ " Xcelite
- No. 3—No. 3 Phillips and  $\frac{1}{8}$ " Xcelite

#### COMPLETE

(Regular Type)

|              |                   |
|--------------|-------------------|
| No. CR1..... | List Price \$1.60 |
| No. CR2..... | 1.60              |
| No. CR3..... | 1.60              |

#### BLADES ONLY

(Regular Type)

|              |                   |
|--------------|-------------------|
| No. RB1..... | List Price \$0.90 |
| No. RB2..... | .90               |
| No. RB3..... | .90               |

#### HANDLES ONLY

|                     |                   |
|---------------------|-------------------|
| No. 25 Regular..... | List Price \$0.75 |
|---------------------|-------------------|

#### STUBBY TYPE



#### COMPLETE

(Stubby Type)

|              |        |
|--------------|--------|
| No. CS1..... | \$1.30 |
| No. CS2..... | 1.30   |

#### BLADES ONLY

(Stubby Type)

|              |        |
|--------------|--------|
| No. SB1..... | \$0.65 |
| No. SB2..... | .65    |

#### HANDLES ONLY

|                    |        |
|--------------------|--------|
| No. 26 Stubby..... | \$0.65 |
|--------------------|--------|

## DETACHABLE REAMERS

No. 61...\$1.35 List  
 $\frac{1}{8}$ " —  $\frac{1}{8}$ "

No. 62...\$1.65 List  
 $\frac{1}{4}$ " —  $\frac{1}{2}$ "

No. 63...\$1.95 List  
 $\frac{7}{8}$ " —  $\frac{11}{16}$ "

Detachable to fit your Xcelite No. 14 Nut Driver or "Combination-Detachable" Screwdriver! Short enough to get in where ordinary reamers can't! Enlarge holes in plastic, sheet metal, wood!

### REAMER SETS IN BOX

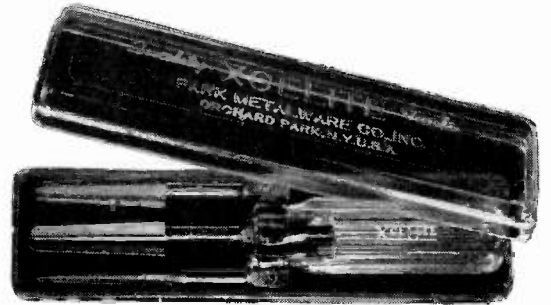

No. BR32 Contains Reg. Handle, No. 61 and 62 Reamers.....\$4.25  
No. BR33 Contains Reg. Handle, No. 61, 62 and 63 Reamers..... 5.95

### REAMERS IN PLASTIC ROLL KIT

No. RK-42 Contains Reg. Handle, No. 61 and 62 Reamers.....\$4.25  
No. RK-43 Contains Reg. Handle, No. 61, 62 and 63 Reamers..... 5.95

### Xcelite-



### Phillips

| No.   | Point Size | Length Blade | Diameter Blade   | Weight     | List Price |
|-------|------------|--------------|------------------|------------|------------|
| X-108 | 1          | 6"           | $\frac{3}{16}$ " | 2 lbs.     | \$1.05     |
| X-101 | 1          | 3"           | $\frac{3}{16}$ " | 1 1/4 lbs. | .95        |
| X-102 | 2          | 4"           | $\frac{1}{4}$ "  | 2 lbs.     | 1.25       |
| X-103 | 3          | 6"           | $\frac{5}{16}$ " | 3 lbs.     | 1.65       |
| X-104 | 4          | 8"           | $\frac{3}{8}$ "  | 3 lbs.     | 2.05       |

#### SHORT STUBBY TYPE

|        |   |                  |                   |      |
|--------|---|------------------|-------------------|------|
| SX-101 | 1 | $\frac{3}{16}$ " | $\frac{7}{8}$ lb. | .90  |
| SX-102 | 2 | $\frac{1}{4}$ "  | 2 lbs.            | 1.00 |



### XCELITE

### Clutch Head Screwdrivers

| Type G No. | Type A No. | Size             | Diameter Blade  | Length Blade | List Price Each |
|------------|------------|------------------|-----------------|--------------|-----------------|
| G-183      | A-183      | $\frac{1}{8}$ "  | $\frac{3}{8}$ " | 3"           | \$1.10          |
| G-5324     | A-5324     | $\frac{3}{32}$ " | $\frac{1}{4}$ " | 4"           | 1.20            |
| G-3164     | A-3164     | $\frac{3}{8}$ "  | $\frac{1}{4}$ " | 4"           | 1.20            |
| G-146      | A-146      | $\frac{1}{4}$ "  | $\frac{1}{8}$ " | 6"           | 1.60            |
| G-5166     | A-5166     | $\frac{1}{16}$ " | $\frac{3}{8}$ " | 6"           | 1.95            |

Note: Both above types are the same size and the same price. Order by Number.

Quality

**XCELITE**

Tools

REG. TRADE MARK

**XCELITE PLIERS**

XceLite Pliers are fully guaranteed against defects of material and workmanship. Any plier showing such defects will be willingly replaced if returned to us.



No. 51 — XceLite Long Needle Nose and Side Cutter PLIERS, 7" ..... **\$2.80**

No. 52 — XceLite Long Needle Nose PLIERS (Without Side Cutters)

This plier is identical with the above except it does not have the side cutters ..... **\$2.40**

No. 54 — XceLite Diagonal PLIER, 4" ..... **\$2.60**

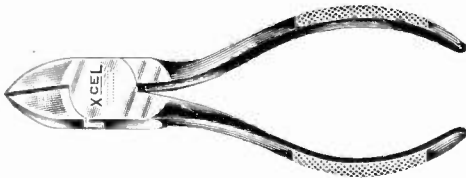

No. 55 — XceLite Diagonal PLIER, 5" ..... **\$2.60**



No. 57 — XceLite Extra Long Duck Bill PLIER, 7" ..... **\$2.70**

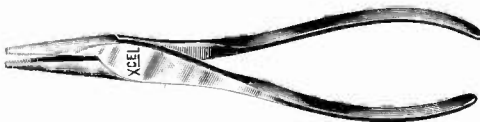

No. 59 — XceLite Chain Nose Electrician's PLIER, 7 3/4" ..... **\$3.10**



No. 60 — XceLite Side Cutting PLIER, 6" ..... **\$2.60**

**XCELITE NUT DRIVERS**

6" Overall Length

| Number | Size   | Polished | Chrome Plated |
|--------|--------|----------|---------------|
| 6      | 3/8"   | \$0.75   | \$0.85        |
| 7      | 7/32"  | .75      | .85           |
| 8      | 1/4"   | .75      | .85           |
| 9      | 9/32"  | .75      | .85           |
| 10     | 5/16"  | .75      | .85           |
| 11     | 11/32" | .75      | .85           |
| 12     | 3/8"   | .75      | .85           |
| 14     | 7/16"  | 1.15     |               |
| 16     | 1/2"   | 1.15     |               |



9" Overall Length

| Number | Size   | List   |
|--------|--------|--------|
| A-6    | 3/16"  | \$0.95 |
| A-7    | 7/32"  | .95    |
| A-8    | 1/4"   | .95    |
| A-9    | 9/32"  | .95    |
| A-10   | 5/16"  | .95    |
| A-11   | 11/32" | .95    |
| A-12   | 3/8"   | .95    |
| A-14   | 7/16"  | 1.15   |
| A-16   | 1/2"   | 1.15   |

Stubbies

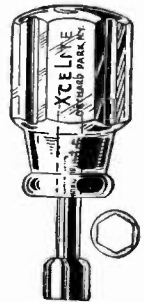

3 1/4" Overall Length

| Number | Nut Size | List   |
|--------|----------|--------|
| S-8    | 1/4"     | \$0.70 |
| S-10   | 5/16"    | .70    |
| S-12   | 3/8"     | .70    |

**HOLLOW SHAFT NUT DRIVERS**



| No. and Length Overall | Nut Size | Depth of Hole | Weight per Box | List   | Insulated List |
|------------------------|----------|---------------|----------------|--------|----------------|
| HS-10 6"               | 3/4"     | 5"            | 1 lbs.         | \$1.05 | \$1.30         |
| HS-11 6"               | 11/16"   | 5"            | 1 lbs.         | 1.05   | 1.30           |
| HS-12 6"               | 5/8"     | 5"            | 1 lbs.         | 1.05   | 1.30           |
| HS-14 7"               | 7/8"     | 5"            | 1 1/2 lbs.     | 1.20   | 1.45           |
| HS-16 7"               | 1/2"     | 5"            | 1 1/2 lbs.     | 1.25   | 1.50           |
| HS-18 7"               | 9/16"    | 5"            | 1 3/8 lbs.     | 1.30   | 1.55           |
| HS-20 7"               | 5/8"     | 5"            | 1 7/8 lbs.     | 1.50   | 1.75           |

**XCELITE NO. 3 De Lux**

**RADIO AND ELECTRICAL KIT**



Set includes:

R-142, R-3163, R-5166, R-184, R-144, X-101 and R-3166.

No. 3 ..... \$6.95  
No. 3C Chrome Plated \$7.65

**NO. 4 ALL PURPOSE KIT**

Kit same as shown above. Set includes:

S-142, S-144, X-102, S-184, S-3166, S-5166 and S-388.  
No. 4 Polished ..... \$8.60      No. 4C Chrome ..... \$9.35

Quality

**XCELITE**

Tools

REG. TRADE MARK

**NO. 17 NUT DRIVER SET**

Amber Handles — Highly Polished Blades

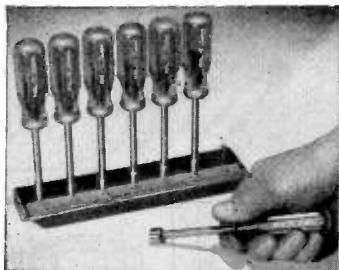

Consisting of:

| Number | Size  |
|--------|-------|
| 6      | 3/8"  |
| 7      | 7/16" |
| 8      | 1/2"  |
| 9      | 5/8"  |
| 10     | 3/4"  |
| 11     | 7/8"  |
| 12     | 1"    |

Complete with Rack ..... \$5.75

**6" XCEL Adjustable SOCKET WRENCH (with Attachments)**

A whole set of tools in one! Fits any size nut, hexagon or square, round or odd shaped, from 1/8" to 1".

List Price, \$3.50

Individually boxed, packed 6 to a self-selling display carton.

Weight, 6 lbs.

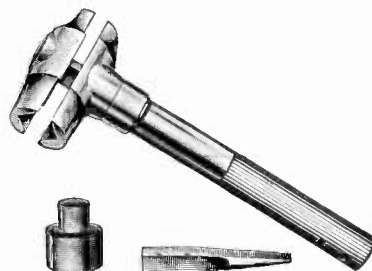

**NO. 137 NUT DRIVER SET With Colored Handles**

Consisting of:

| Number | Size  |
|--------|-------|
| 6      | 3/16" |
| 8      | 1/4"  |
| 10     | 5/16" |
| 11     | 3/8"  |
| 12     | 7/16" |
| HS-16  | 1/2"  |
| HS-18  | 9/16" |

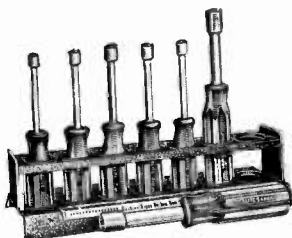

No. 137 Polished Finished ..... \$7.40  
 No. 137C Chrome Plated ..... 8.15

**No. 117 SET With Colored Handles**

Set consists of Nos. 6, 7, 8, 9, 10, 11, and 12. Furnished in either full polished or chrome finish. Complete with same type stand as No. 137.

No. 117 Set Polished Finish ..... \$6.45  
 No. 117C Chrome Plated ..... 7.25

**SCREW-HOLDING SCREWDRIVER**



1



2



3



4

The Xcelite Screw-Holding Screw Driver is a tool for which electricians, radio men and mechanics everywhere have long searched. It is a genuine Xcelite product with a unique attachment that instantly and rigidly holds and starts any screw, even one without a head. Spring holder remains in place either above, below or exactly at the driver point. Grasps the screw at the head or 3/8" below giving three point suspension for greater rigidity. Can also be used for removing screws. Comes in 1/8" square blade, 3", 4" and 5". Packed 12 assorted lengths on metal display.

List Price ..... \$6.35  
 Display, complete ..... \$6.35  
 Refills, each ..... .60

**Delux No. 127 NUT DRIVER SET**

NEW LARGER HANDLES — BRIGHTER COLORS

Makes Size Selection Easy.

Set consists of Nos. 6, 7, 8, 9, 10, 11, & 12. Furnished in either full polished or chrome finish.

No. 127 Polished Finish ..... \$6.50  
 No. 127C Chrome Plated ..... 7.30

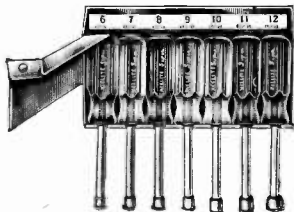

**READY FOR QUICK WORK**

The metal container can be fastened to the wall or work bench by screws which are inaccessible when locked. Red Wrinkle finish.



**THE ORIGINAL  
SPINTITE  
(TRADE MARK REGISTERED)  
WRENCHES**



**SUPER DELUXE SPINTITES**

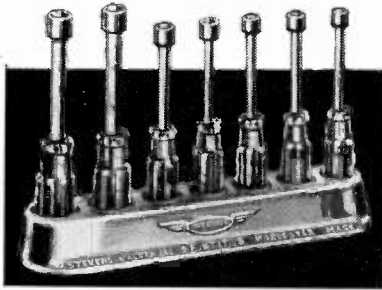

The wrench that works like a screwdriver! The super deluxe Spintite for panel or switchboard work — deep drilled with extra deep sockets. Beautifully plated and finished. A *must* for radio and electrical work.

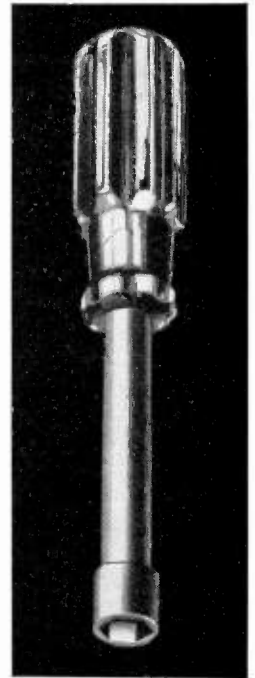

| Number | Size            | Length            | Drill Depth     | List Price |
|--------|-----------------|-------------------|-----------------|------------|
| 3006   | $\frac{3}{16}$  | 6"                | 1 $\frac{3}{4}$ | \$1.10     |
| 3007   | $\frac{7}{32}$  | 6"                | 2 $\frac{1}{4}$ | 1.10       |
| 3008   | $\frac{1}{4}$   | 6"                | 2 $\frac{1}{4}$ | 1.10       |
| 3009   | $\frac{9}{32}$  | 6"                | 2 $\frac{1}{4}$ | 1.10       |
| 3010   | $\frac{5}{16}$  | 6"                | 2 $\frac{1}{4}$ | 1.10       |
| 3011   | $\frac{11}{32}$ | 6"                | 2 $\frac{1}{4}$ | 1.10       |
| 3012   | $\frac{3}{8}$   | 6 $\frac{5}{8}$ " | 5 $\frac{1}{8}$ | 1.10       |
| 3014   | $\frac{7}{16}$  | 6 $\frac{5}{8}$ " | 5 $\frac{1}{8}$ | 1.35       |
| 3016   | $\frac{1}{2}$   | 6 $\frac{5}{8}$ " | 5 $\frac{1}{8}$ | 1.35       |
| 3018   | $\frac{9}{16}$  | 6 $\frac{5}{8}$ " | 5 $\frac{1}{8}$ | 2.45       |

**REGULAR SPINTITES  
THE ORIGINAL SPINTITE WRENCH**

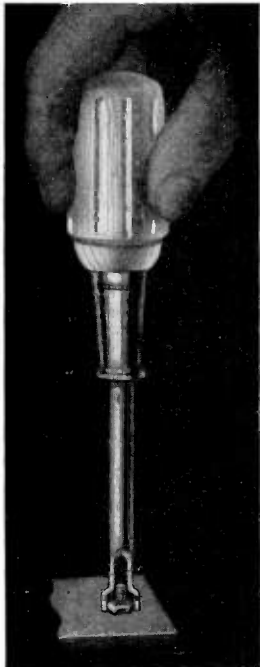

Works like a screwdriver—features cold forged sockets, drilled shanks, special tool steel, hardened and tempered, ferrules and shanks are bright plated and the hardwood handles have natural rubbed finish.

| Number | Size            | Length            | Nut Size                        | List Price |
|--------|-----------------|-------------------|---------------------------------|------------|
| 3406   | $\frac{3}{16}$  | 6"                | 2 & 3                           | \$0.70     |
| 3407   | $\frac{7}{32}$  | 6"                |                                 | .70        |
| 3408   | $\frac{1}{4}$   | 6"                | 4                               | .70        |
| 3409   | $\frac{9}{32}$  | 6"                |                                 | .70        |
| 3410   | $\frac{5}{16}$  | 6"                | 5 & 6                           | .70        |
| 3411   | $\frac{11}{32}$ | 6"                | 8                               | .70        |
| 3412   | $\frac{3}{8}$   | 6"                | 10                              | .70        |
| 3414   | $\frac{7}{16}$  | 7 $\frac{1}{8}$ " | 12 & $\frac{1}{4}$              | 1.00       |
| 3416   | $\frac{1}{2}$   | 7 $\frac{1}{8}$ " |                                 | 1.00       |
| 3418   | $\frac{9}{16}$  | 7 $\frac{1}{8}$ " |                                 | 1.75       |
| 3420   | $\frac{5}{8}$   | 7 $\frac{1}{8}$ " | $\frac{5}{16}$<br>$\frac{3}{8}$ | 1.75       |

**T-73 SET**

Set of popular sizes in wood stand.

**CONTENTS**

|      |            |
|------|------------|
| 3406 | 3412       |
| 3408 | 3414       |
| 3410 | 3416       |
| 3411 | Wood Stand |

List Price ..... \$6.50

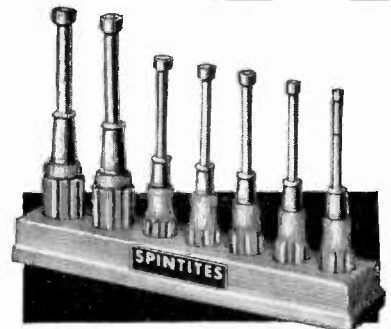



# THE ORIGINAL SPINTITE

(TRADE MARK REGISTERED)

## WRENCHES

### DELUXE SPINTITES

For the mechanic who appreciates fine tools we offer these shining Spintites with transparent shockproof handles.

| Number | Size            | Length            | Nut Size           | List Price |
|--------|-----------------|-------------------|--------------------|------------|
| 3906   | $\frac{3}{16}$  | 6"                | 2 & 3              | \$1.00     |
| 3907   | $\frac{1}{8}$   | 6"                |                    | 1.00       |
| 3908   | $\frac{1}{4}$   | 6"                | 4                  | 1.00       |
| 3909   | $\frac{9}{32}$  | 6"                |                    | 1.00       |
| 3910   | $\frac{5}{16}$  | 6"                | 5 & 6              | 1.00       |
| 3911   | $\frac{11}{32}$ | 6"                | 8                  | 1.00       |
| 3912   | $\frac{3}{8}$   | 6"                | 10                 | 1.00       |
| 3914   | $\frac{7}{8}$   | 7 $\frac{1}{8}$ " | 12 & $\frac{1}{4}$ | 1.25       |
| 3916   | $\frac{1}{2}$   | 7 $\frac{1}{8}$ " |                    | 1.25       |
| 3918   | $\frac{9}{16}$  | 7 $\frac{1}{8}$ " | $\frac{5}{16}$     | 2.10       |
| 3920   | $\frac{5}{8}$   | 7 $\frac{1}{8}$ " | $\frac{3}{8}$      | 2.10       |

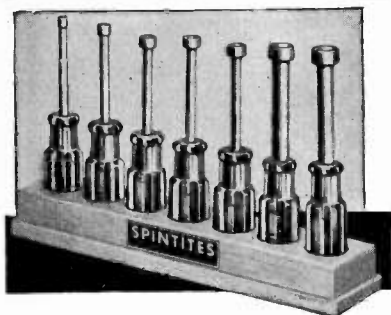
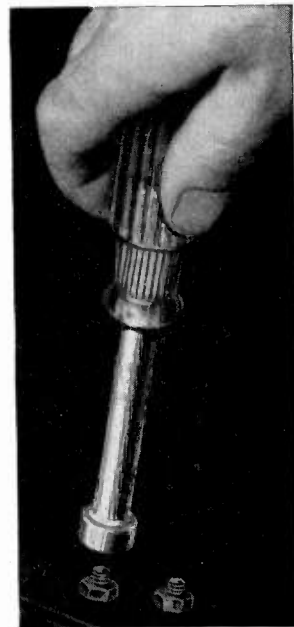

#### T-8 SET

Just right for a place on the mechanic's bench. Seven popular sizes.

#### CONTENTS

|      |            |
|------|------------|
| 3906 | 3912       |
| 3908 | 3914       |
| 3910 | 3916       |
| 3911 | Wood Stand |

List Price.....\$7.75

ALL PRICES SUBJECT TO CHANGE WITHOUT NOTICE

### JUMBO SPINTITES



A rugged special Spintite for use on all types of hardened or self tapping cap screws. Shanks and sockets are made of alloy tool steel with a very high degree of hardness. Plastic grip is oversize for greater leverage. Depth of broach is less than thickness of screw heads to prevent marring panels.

| Number | Size           | Length            | Handle Size       | List Price |
|--------|----------------|-------------------|-------------------|------------|
| 3058   | $\frac{1}{4}$  | 8 $\frac{1}{2}$ " | 1 $\frac{1}{8}$ " | \$3.15     |
| 3059   | $\frac{9}{32}$ | 8 $\frac{1}{2}$ " | 1 $\frac{1}{8}$ " | 3.15       |
| 3062   | $\frac{3}{8}$  | 8 $\frac{1}{2}$ " | 1 $\frac{1}{8}$ " | 3.15       |
| 3066   | $\frac{1}{2}$  | 8 $\frac{1}{2}$ " | 1 $\frac{1}{8}$ " | 4.70       |
| 3068   | $\frac{9}{16}$ | 8 $\frac{1}{2}$ " | 1 $\frac{1}{8}$ " | 4.70       |

### EXTRA LONG SPINTITE



A special Spintite for those hard-to-get-at places. Medium sized, easily controlled plastic grip and extra long shaft made of chrome alloy steel. It belongs in the tool kit of every assembler and repairman.

| Number | Size            | Length | Drill Depth       | List Price |
|--------|-----------------|--------|-------------------|------------|
| 3206   | $\frac{3}{8}$   | 10"    | 1 $\frac{1}{2}$ " | \$1.75     |
| 3207   | $\frac{7}{32}$  | 10"    | 1 $\frac{1}{2}$ " | 1.75       |
| 3208   | $\frac{1}{4}$   | 10"    | 1 $\frac{1}{2}$ " | 1.75       |
| 3209   | $\frac{9}{32}$  | 10"    | 1 $\frac{1}{2}$ " | 1.75       |
| 3210   | $\frac{1}{8}$   | 10"    | 1 $\frac{1}{2}$ " | 1.75       |
| 3211   | $\frac{11}{32}$ | 10"    | 1 $\frac{1}{2}$ " | 1.75       |
| 3212   | $\frac{3}{8}$   | 10"    | 1 $\frac{1}{2}$ " | 1.75       |
| 3214   | $\frac{7}{8}$   | 10"    | 1 $\frac{1}{2}$ " | 2.75       |
| 3216   | $\frac{1}{2}$   | 10"    | 1 $\frac{1}{2}$ " | 2.75       |
| 3218   | $\frac{9}{16}$  | 10"    | 1 $\frac{1}{2}$ " | 4.40       |
| 3220   | $\frac{5}{8}$   | 10"    | 1 $\frac{1}{2}$ " | 4.95       |

# THE ORIGINAL SPINTITE

(TRADE MARK REGISTERED)

## WRENCHES



### CHUCK TYPE SPINTITES

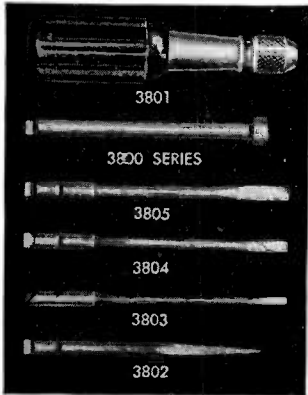

| Number | Description                | Size                             | Length           | Nut Size           | List Price |
|--------|----------------------------|----------------------------------|------------------|--------------------|------------|
| 3801   | Universal Handle           |                                  |                  |                    | \$1.55     |
| 3802   | Ream Awl                   | $\frac{1}{16}$ to $\frac{3}{16}$ | 4 $\frac{5}{8}$  |                    | .70        |
| 3803   | Screwdriver                | $\frac{1}{8}$ X 4                | 4 $\frac{5}{8}$  |                    | .70        |
| 3804   | Screwdriver                | $\frac{3}{16}$ X 4               | 4 $\frac{5}{8}$  |                    | .70        |
| 3805   | Screwdriver                | $\frac{1}{4}$ X 4                | 4 $\frac{5}{8}$  |                    | .70        |
| 3806   | Spintite Shank             | $\frac{3}{16}$                   | 4 $\frac{7}{16}$ | 2 & 3              | .50        |
| 3808   | Spintite Shank             | $\frac{1}{4}$                    | 4 $\frac{3}{8}$  | 4                  | .50        |
| 3810   | Spintite Shank             | $\frac{5}{16}$                   | 4 $\frac{5}{8}$  | 5 & 6              | .50        |
| 3811   | Spintite Shank             | $\frac{11}{32}$                  | 4 $\frac{5}{8}$  | 8                  | .50        |
| 3812   | Spintite Shank             | $\frac{3}{8}$                    | 4 $\frac{5}{8}$  | 10                 | .50        |
| 3814   | Spintite Shank             | $\frac{7}{16}$                   | 4 $\frac{3}{4}$  | 12 & $\frac{1}{4}$ | .70        |
| 3816   | Spintite Shank             | $\frac{1}{2}$                    | 4 $\frac{3}{4}$  |                    | .70        |
| 3850   | Screwdriver, Cross Point   | No. 2                            | 4 $\frac{5}{8}$  |                    | 1.00       |
| 3852   | Four way Neutralizing Tool | 5                                | 5                |                    | 1.35       |

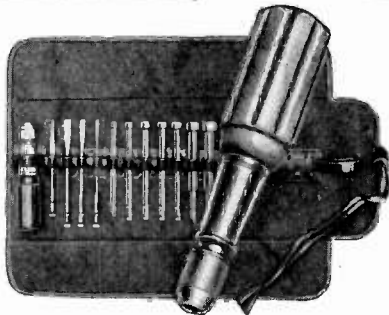

SET T-51  
CONTENTS

|      |      |      |
|------|------|------|
| 3801 | 3805 | 3811 |
| 3802 | 3806 | 3812 |
| 3803 | 3808 | 3814 |
| 3804 | 3810 | 3816 |

in Leatherette Roll  
List Price.....\$9.25

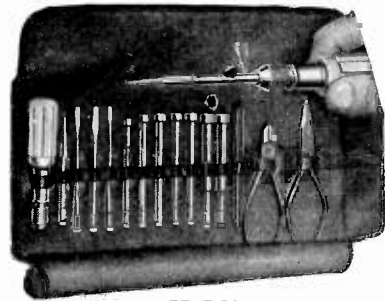

SET T-52  
CONTENTS

|      |      |      |
|------|------|------|
| 3801 | 3805 | 3811 |
| 3802 | 3806 | 3812 |
| 3803 | 3808 | 3814 |
| 3804 | 3810 | 3816 |

6" Long Nose Pliers  
6" Cutting Pliers  
Neutralizing Tool  
List Price.....\$15.50



#### SQUARE SPINTITES

| No.  | Size           | List   | No.  | Size            | List   |
|------|----------------|--------|------|-----------------|--------|
| 3505 | $\frac{5}{32}$ | \$1.00 | 3511 | $\frac{11}{32}$ | \$1.25 |
| 3506 | $\frac{3}{16}$ | 1.00   | 3512 | $\frac{3}{8}$   | 1.25   |
| 3507 | $\frac{7}{32}$ | 1.00   | 3513 | $\frac{13}{32}$ | 1.50   |
| 3508 | $\frac{1}{4}$  | 1.00   | 3514 | $\frac{7}{16}$  | 1.50   |
| 3509 | $\frac{9}{32}$ | 1.00   | 3516 | $\frac{1}{2}$   | 1.85   |
| 3510 | $\frac{5}{16}$ | 1.00   | 3520 | $\frac{5}{8}$   | 1.85   |



#### STUBBY SPINTITES

| No.  | Size           | List   | No.  | Size            | List   |
|------|----------------|--------|------|-----------------|--------|
| 4406 | $\frac{3}{16}$ | \$0.70 | 4411 | $\frac{11}{32}$ | \$0.70 |
| 4407 | $\frac{7}{32}$ | .70    | 4412 | $\frac{3}{8}$   | .70    |
| 4408 | $\frac{1}{4}$  | .70    | 4414 | $\frac{7}{16}$  | 1.00   |
| 4409 | $\frac{9}{32}$ | .70    | 4416 | $\frac{1}{2}$   | 1.00   |
| 4410 | $\frac{5}{16}$ | .70    |      |                 |        |



#### KNURLED SPINTITES

Tapered knurls to take care of variations in size.

| Number | Diameter        | List Price |
|--------|-----------------|------------|
| 3710   | $\frac{5}{16}$  | \$1.50     |
| 3711   | $\frac{11}{32}$ | 1.60       |
| 3712   | $\frac{3}{8}$   | 1.80       |

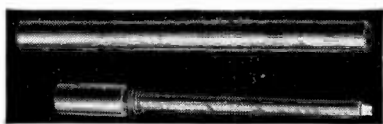

#### FOUR-IN-ONE NEUTRALIZING AND ALIGNING TOOL

Made entirely of shock-proof plastic this tool has wrenches on each end, key slot, and screwdriver tip.

3852.....List Price \$1.35



#### SPECIAL SPINTITE FOR BAT TYPE SWITCHES

Deep cavity accommodates bat handle, fine knurl is tapered to adjust for variations in knurled rings.

6337.....List Price \$2.75

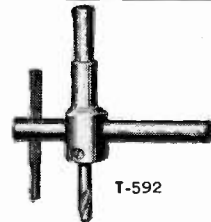

#### PANEL CUTTERS

|                       | List Price |
|-----------------------|------------|
| T-564—For Bit Brace   | \$4.80     |
| T-592—For Drill Chuck | 4.80       |

ALL PRICES SUBJECT TO CHANGE WITHOUT NOTICE



# THE ORIGINAL SPINTITE

(TRADE MARK REGISTERED)

## WRENCHES



SET NUMBER S-211

### SET NUMBER S-211

1/4 Inch Square Drive — 11 Pieces

- 6 HEX SOCKETS
- 3 SQUARE SOCKETS
- 1 HINGE HANDLE
- 1 CROSS BAR
- ALL IN HEAVY ENAMELED METAL BOX
- Special Low Price

### SET NUMBER S-217

1/4 Inch Square Drive — 17 Pieces

- 8 Hex Sockets
- 3 Square Sockets
- 1 Reversible Ratchet
- 1 Hinge Handle
- 1 Cross Bar
- 1 Sliding Tee Handle
- 1 Short Extension
- 1 Long Extension

AN EXCELLENT COMBINATION OF SOCKET WRENCHES AND ATTACHMENTS FOR FINE WORK ON IGNITION, ELECTRICAL, RADIO OR HOBBY WORK.

—Alloy Steel

—Bright Plated



SET NUMBER S-217

## WALDEN WORCESTER SCREWDRIVERS

### SQUARE SHANK SCREWDRIVER

Plastic Handle



| Number | Size     | List Price |
|--------|----------|------------|
| SS4    | 4 x 1/4  | \$1.20     |
| SS6    | 6 x 5/16 | 1.65       |
| SS8    | 8 x 3/8  | 2.05       |
| SS12   | 12 x 3/8 | 2.45       |

### CROSSPOINT SCREWDRIVER

Wood Handle



| Number | Size     | List Price |
|--------|----------|------------|
| SC3    | 3 x 5/8  | \$0.75     |
| SC4    | 4 x 1/4  | .75        |
| SC6    | 6 x 5/16 | .95        |
| SC8    | 8 x 3/8  | 1.30       |

### ROUND SHANK SCREWDRIVER

Plastic Handle



| Number | Size        | List Price |
|--------|-------------|------------|
| SM2    | 2 1/4 x 1/8 | \$0.40     |
| SR3    | 3 x 3/16    | .90        |
| SR4    | 4 x 1/4     | 1.20       |
| SR6    | 6 x 5/16    | 1.55       |
| SR6A   | 6 x 3/16    | 1.15       |
| SR8    | 8 x 3/8     | 2.00       |
| SR12   | 12 x 3/8    | 2.30       |

### STUBBY SCREWDRIVER

Plastic Handle



| Number | Size        | List Price |
|--------|-------------|------------|
| SS2    | 1 1/2 x 1/4 | \$0.80     |

ALL PRICES SUBJECT TO CHANGE WITHOUT NOTICE

# VACO PRODUCTS COMPANY • CHICAGO 11, ILLINOIS • U. S. A.



Hand Forged Chrome Vanadium Screw and Nut Drivers With Amberyl\* S/B\* (Slo-Burn)  
Fire Safe Break and Shock Proof Handles

\*Trade Marks Registered U. S. Pat. Off.

## ROUND BLADE SCREW DRIVERS

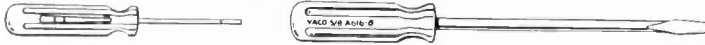

Pocket Styles\*—3/32" & 1/8" Blades.  
\*High carbon tool steel blades only.

| Stock Number | Handle Diameter and Length | Blade Diameter and Length | Weight per Doz. |
|--------------|----------------------------|---------------------------|-----------------|
| A 010        | 1 3/32" x 1 3/4"           | 3/32" x 1 5/8"            | 1/4 lb.         |
| A 130-2      | 1/2" x 1 7/8"              | 3/8" x 2"                 | 1/2 lb.         |
| A 130-3      | 1/2" x 1 7/8"              | 3/8" x 3"                 | 2/3 lb.         |
| A 116-2      | 1/2" x 2 1/2"              | 3/32" x 2"                | 2/3 lb.         |
| A 116-3      | 1/2" x 2 1/2"              | 3/32" x 3"                | 1/3 lb.         |

Electrician and Regular Cabinet Styles — 3/16" Blades.

| Stock Number | Handle Diameter and Length | Blade Diameter and Length | Weight per Doz. |
|--------------|----------------------------|---------------------------|-----------------|
| A 316-3      | 7/8" x 3 1/2"              | 3/16" x 3"                | 1 1/4 lbs.      |
| A 316-4      | 7/8" x 3 1/2"              | 3/16" x 4"                | 1 1/2 lbs.      |
| A 316-6      | 7/8" x 3 1/2"              | 3/16" x 6"                | 1 3/4 lbs.      |
| A 316-8      | 7/8" x 3 1/2"              | 3/16" x 8"                | 2 lbs.          |
| A 316-10     | 7/8" x 3 1/2"              | 3/16" x 10"               | 2 1/2 lbs.      |

## Heavy Duty General Service Round Blade Styles — 5/16" Blades.

| Stock Number | Handle Diameter and Length | Blade Diameter and Length | Weight per Doz. |
|--------------|----------------------------|---------------------------|-----------------|
| A 516-6      | 1-1/16" x 4"               | 5/16" x 6"                | 4 lbs.          |
| A 516-8      | 1-1/16" x 4"               | 5/16" x 8"                | 4 1/2 lbs.      |
| A 516-10     | 1 1/8" x 4 3/4"            | 5/16" x 10"               | 5 1/2 lbs.      |
| A 516-12     | 1 1/8" x 4 3/4"            | 5/16" x 12"               | 6 1/2 lbs.      |

## Electrician and Cabinet Styles—1/8" Blades.

| Stock Number | Handle Diameter and Length | Blade Diameter and Length | Weight per Doz. |
|--------------|----------------------------|---------------------------|-----------------|
| A 216-2*     | 5/8" x 2 3/4"              | 1/8" x 2"                 | 3/4 lb.         |
| A 216-4      | 3/4" x 3"                  | 1/8" x 4"                 | 1 lb.           |
| A 216-6      | 3/4" x 3"                  | 1/8" x 6"                 | 1 1/4 lbs.      |
| A 216-8      | 3/4" x 3"                  | 1/8" x 8"                 | 1 1/2 lbs.      |
| A 216-10     | 3/4" x 3"                  | 1/8" x 10"                | 1 3/4 lbs.      |

## General Service Round Blade Styles—1/4" Blades.

| Stock Number | Handle Diameter and Length | Blade Diameter and Length | Weight per Doz. |
|--------------|----------------------------|---------------------------|-----------------|
| A 416-4      | 1" x 3 5/8"                | 1/4" x 4"                 | 2 1/4 lbs.      |
| A 416-5      | 1" x 3 5/8"                | 1/4" x 5"                 | 2 1/2 lbs.      |
| A 416-6      | 1" x 3 5/8"                | 1/4" x 6"                 | 2 3/4 lbs.      |
| A 416-8      | 1" x 3 5/8"                | 1/4" x 8"                 | 3 1/4 lbs.      |
| A 416-10     | 1" x 3 5/8"                | 1/4" x 10"                | 3 1/2 lbs.      |

## RADIO ALIGNING TOOLS NON-METALLIC ALIGNER

No metal — completely non-capacitance. Bone fibre blade may be repointed as required.



| Stock Number | Handle Diameter and Length | Blade Diameter and Length | Weight per Doz. |
|--------------|----------------------------|---------------------------|-----------------|
| AT 55        | 1/2" x 2 1/2"              | 3/16" x 4"                | 3/4 lb.         |

## VACO Super Hard NUT DRIVERS

Color Coded Hollow Handles For Quick Size Identification. For Use on Hardened Steel Self-Threading Sheet Metal Screws, Etc.



| Stock Number | Hexagon Size (Across Flats) | Handle Diameter and Length | Color Code | Fits Muehlane Screw Nos. |
|--------------|-----------------------------|----------------------------|------------|--------------------------|
| S 61         | 3/16"                       | 1" x 3 5/8"                | Brown      | 2 and 3                  |
| S 82         | 1/8"                        | 1" x 3 5/8"                | Red        | 4                        |
| S 103        | 5/16"                       | 1" x 3 5/8"                | Green      | 5 and 6                  |
| S 114        | 11/32"                      | 1" x 3 5/8"                | Ivory      | 8                        |
| S 125        | 3/8"                        | 1" x 3 5/8"                | Blue       | 10                       |
| S 146        | 7/16"                       | 1" x 3 5/8"                | Orange     | 12 and 1 1/4"            |
| S 167        | 1/2"                        | 1" x 3 5/8"                | Yellow     | 5/16"                    |

## VACO EXTRA HARD NUT DRIVERS

Size Stamped on Each Shaft for Easy Identification  
Solid Amberlyl S/B Fire Safe Handles



| Stock Number | Hexagon Size | Handle Diameter and Length | Weight per Doz. |
|--------------|--------------|----------------------------|-----------------|
| S 5          | 5/32"        | 7/8" x 3 1/2"              | 1 lb. 8 oz.     |
| S 6          | 3/16"        | 7/8" x 3 1/2"              | 1 lb. 10 oz.    |
| S 7          | 7/32"        | 7/8" x 3 1/2"              | 1 lb. 11 oz.    |
| S 8          | 1/4"         | 7/8" x 3 1/2"              | 1 lb. 12 oz.    |
| S 9          | 9/32"        | 7/8" x 3 1/2"              | 1 lb. 14 oz.    |
| S 10         | 5/16"        | 7/8" x 3 1/2"              | 2 lbs.          |
| S 11         | 11/32"       | 7/8" x 3 1/2"              | 2 lbs. 8 oz.    |
| S 12         | 7/16"        | 7/8" x 3 1/2"              | 2 lbs. 12 oz.   |
| S 14         | 7/16"        | 7/8" x 3 1/2"              | 2 lbs. 14 oz.   |
| S 15         | 15/32"       | 7/8" x 3 1/2"              | 2 lbs. 15 oz.   |
| S 16         | 1/2"         | 7/8" x 3 1/2"              | 3 lbs.          |

## Extra Large Size

| Stock Number | Hexagon Size | Handle Diameter and Length | Weight per Doz. |
|--------------|--------------|----------------------------|-----------------|
| S 17         | 17/32"       | 1-1/16" x 4"               | 4 1/2 lbs.      |
| S 18         | 9/16"        | 1-1/16" x 4"               | 4 1/2 lbs.      |
| S 19         | 19/32"       | 1-1/16" x 4"               | 4 1/2 lbs.      |
| S 20         | 1"           | 1-1/16" x 4"               | 4 1/2 lbs.      |

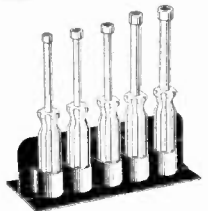

No. 5 500  
METAL  
BENCH HOLDER

Furnished with 1 each of five most popular sizes: S 8, S 10, S 11, S 12, S 14. Weight each . . . 1 1/2 lbs.

## ALL HOLLOW SHAFT NUT DRIVERS



| Stock Number | Hexagon Size (Across Flats) | Handle Diameter and Length | Weight per Doz. |
|--------------|-----------------------------|----------------------------|-----------------|
| S 160        | 1/2"                        | 1" x 3 5/8"                | 3 lbs. 4 oz.    |
| S 180        | 9/16"                       | 1" x 3 5/8"                | 3 lbs. 8 oz.    |

## S 700

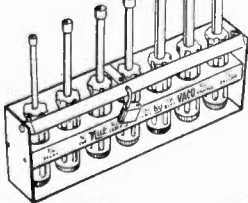

## VACO WALL OR BENCH PADLOCK TYPE NUT DRIVER STAND

Holds One Complete Driver Outfit . . . from 3/16" to 1/2".

| Stock Number       | Weight (Packed) |
|--------------------|-----------------|
| S 700              | 2 1/4 lbs.      |
| S 700 (Stand only) | 1 lb. 2 oz.     |

## VACO AMBERYL ELECTROLYTIC CONDENSER NUT DRIVERS

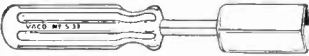

Weight per box . . . 3 lbs.

Packed 1 each of following sizes in display box, or assorted as desired:  
No. S 32 for 31/32" Nuts  
No. S 34 for 1" Nuts  
No. S 36 for 1-5/32" Nuts

## AMBERYL HANDLE PHILLIPS SCREW DRIVERS



| Stock Number | Point Number | Handle Diameter and Length | Blade Diameter and Length | Takes Screws Number | Weight per Doz. |
|--------------|--------------|----------------------------|---------------------------|---------------------|-----------------|
| P 01         | 1            | 3/8" x 3"                  | 1/8" x 2 1/2"             | 4 and smaller       | 3/4 lb.         |
| P 2          | 1            | 7/8" x 3 1/2"              | 3/16" x 3"                | 4 and smaller       | 1 1/4 lbs.      |
| P 3          | 2            | 1" x 3 5/8"                | 1/4" x 4 3/4"             | 5 to 9              | 2 1/2 lbs.      |
| P 4          | 3            | 1-1/16" x 4"               | 5/16" x 6"                | 10 to 16            | 3 1/2 lbs.      |
| P 4          | 4            | 1-1/16" x 4 1/2"           | 3/8" x 8"                 | 18 and larger       | 6 lbs.          |
| P 5          | 2            | 1 1/4" x 2 1/2"            | 1/2" x 1 3/4"             | 5 to 9              | 1 1/4 lbs.      |
| P 6          | 1            | 1 1/8" x 1 3/4"            | 3/16" x 1 1/4"            | 4 and smaller       | 1 lb. 2 oz.     |
| P 12†        | 1            | 1 1/2" x 2 1/2"            | 1/4" x 2 1/2"             | 4 and smaller       | 11 oz.          |
| P 101‡       | 1            | 3/4" x 3"                  | 3/16" x 3"                | 4 and smaller       | 1 1/4 lbs.      |

## WOOD HANDLE PHILLIPS SCREW DRIVERS

High Carbon Tool Steel Blades . . . Chrome Vanadium Blades Also Available.



| Stock Number | Handle Diameter and Length | Blade Diameter and Length | Takes Screws Number | Weight per Doz. |
|--------------|----------------------------|---------------------------|---------------------|-----------------|
| WP 10        | 1" x 4"                    | 3/16" x 3"                | 4 and smaller       | 1 1/4 lbs.      |
| WP 20        | 1 1/8" x 5"                | 1/4" x 4 3/4"             | 5 to 9              | 2 1/2 lbs.      |
| WP 30        | 1 1/4" x 6"                | 5/16" x 6"                | 10 to 16            | 3 1/2 lbs.      |
| WP 40        | 1-5/16" x 7"               | 3/8" x 8"                 | 18 and larger       | 5 lbs.          |
| WP 50 (Stub) | 1-5/16" x 2 1/2"           | 1/4" x 2 1/2"             | 5 to 9              | 1 lb.           |
| WP 60 (Stub) | 1-5/16" x 2 1/2"           | 3/16" x 1 1/4"            | 4 and smaller       | 1 lb.           |

## VACOMBO Nut Setter Kit No. ZS 60

Kit Consists of:

- 1 — ZH 1 Amberlyl Handle with Clutch
- 1 — ZS 8 Hex. Wrench 1/4" x 3"
- 1 — ZS 10 Hex. Wrench 5/16" x 3"
- 1 — ZS 11 Hex. Wrench 11/32" x 3"
- 1 — ZS 12 Hex. Wrench 3/8" x 3"
- 1 — ZS 14 Hex. Wrench 7/16" x 3"
- 1 — ZR 77 Seven Section Leatherette Tool Roll

Also Available — 6" Extension No. ZX 56  
3/16" Hex. Wrench No. ZS 6  
1/2" Hex. Wrench No. ZS 16  
Weight packed . . . 9 oz.

## VACOMBO Screw Driver Kit No. ZB 50

Kit Consists of:

- 1 — ZH 1 Amberlyl Handle with Clutch, 1" x 3 5/8"
- 1 — ZB 24 Blade 3/8" x 4" Out of Handle
- 1 — ZB 34 Blade 3/16" x 4" Out of Handle
- 1 — ZB 45 Blade 1/4" x 5" Out of Handle
- 1 — ZP 14 Blade No. 1 Phillips x 4"
- 1 — ZP 24 Blade No. 2 Phillips x 4"
- 1 — ZR 77 Seven Section Leatherette Tool Roll

Also Available — 6" Extension No. ZX 56  
Specifications: Amberlyl S/B (Slo-Burn) Fire Safe Handle — Oil Tempered Chrome Vanadium Blades — Bright Calcium Rust-Proof Plated Finish.  
Weight packed . . . 8 oz.

## VACO DUPLEX REVERSIBLE SCREW DRIVERS with Amberlyl S/B (Slo-Burn) Plastic Handle



A Phillips bit on one end and a regular bit on other end

| Specifications   | Blade Diameter  |
|--|---|
| DU2 Light Duty —<br>DUH 4 Heavy Duty<br>Chrome vanadium steel blade. Long lasting Amberlyl handle of high dielectric and impact strength . . . impervious to most alkalis and acids. | No. 1 Phillips 3/16" x 2 3/4"<br>Regular 3/16" x 2 3/4"<br>No. 2 Phillips 1/4" x 2 3/4" |
| Stock Number DU 2  | Length 1" x 3 5/8"  |
| DUH 4  | Length 1 1/16" x 4"   |

A Flip of the Wrist Does It . . . From Phillips to Regular.



Precision engineered blade may easily be inserted or removed and reversed to provide either a regular or Phillips bit. Ideal for automobiles, radios, refrigerators, household utilities, toys, etc., where straight slot screws and cross slot screws are frequently used in combination.

# ALPHA tri-core solders

An American Solder for American Production Methods

INSURE PERFORMANCE—SPECIFY ALPHA TRI-CORE



## TRI-CORE ROSIN-FILLED SOLDER

Craftsmen prefer this faster, easier sequence solder. It provides more uniform fluxing and stronger joints for Radio, Electrical, and Automotive work. Saves time, money and labor for manufacturing or repair service.

WHY TRI-CORE ROSIN-FILLED IS THE IMPROVED SOLDER:

- three independently filled cores assure flux continuity, eliminate risk of empty flux sections.
- thinner solder walls speed melting, cut soldering time by 25% or more.
- no activating chloride agent to produce acid conditions and toxic vapors.
- forms a clean, smooth, strong joint without carbonizing.
- three cores instead of one at no premium in price.
- all gauges from 1/4" and heavier down to 0.020" and finer.



## TRI-CORE "LEAKPRUF" ACID-FILLED SOLDER

Why put up with old-fashioned, leaky acid-cored solders? Mechanics acclaim Tri-Core's cleaner job, long shelf life, and guaranteed leakproof feature. Now you can protect yourself as well as your reputation for better craftsmanship with this development in the field of acid-cored solders!

WIDELY PREFERRED FOR BETTER SOLDERING:

- The only three cored acid-filled solder.
- No solder waste due to fluxless areas.
- Highly soluble flux washes off with water.
- Non-toxic, and emits no offensive odors.
- Virtually non-sputtering, reduces hazards.
- Readily solders stainless steel, monel, nickel, etc.
- Leakproof; drip-proof; chalk-like flux will not leak to damage tools.
- The only acid core solder that can be formed into rings and other shapes, or cut to lengths without flux loss.



## ALPHA SOLID SOLDER WIRE

Alpha's specialized know-how in lead and tin metallurgy and completely modern production facilities assures you of the finest solder wire available. Alpha's unique extrusion process assures a completely homogenized and uniform solder wire throughout. Supplied in any diameter and composition for your needs.

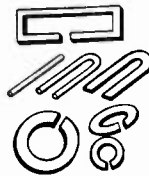

## ALPHA PREFORMS

Alpha's preformed solders, in any shape or diameter required, cut many hours from your production time. Whether you use induction heating, flame jigs or heating ovens, we can swiftly supply your requirements in washers, rings, cut shapes, drops, pellets, solder foil, or other special shapes.



## HANDY CAN PACKAGING

Alpha tri-core, rosin-filled, handy-cans: retail list 25c, packed in eye-appealing, sales-compelling, self-selling, safety flange tins. 12 cans per metal-edged display carton. 12 cartons per shipping container. Weight: 1 gross—25 pounds.

Alpha tri-core, "Leak-Pruf" acid-filled handy-cans: retail list 25c, packed in multiple color lithographed safety flange tins. 12 cans per metal-edged display carton. 12 cartons per shipping container. Weight: 1 gross—25 pounds.

## STANDARD PACKING

1 LB. SPOOLS packed in individual cartons; 50 cartons per shipping container. 5 LB. SPOOLS packed 10 spools per shipping container. 20 LB. SPOOLS packed 2 or 3 spools per shipping container.

## SPECIAL ALLOYS

STANDARD ALPHA TRI-CORE SOLDERS ARE 40/60. Also available in 25/75—35/65—45/55—50/50—60/40. ALPHA SOLID SOLDER wire in all alloy ratios.

Available in all diameters from 1/4" and heavier, down to 0.020" and finer.

# ALPHA METALS, INC.





# RADIO CHASSIS PUNCHES KNOCKOUT PUNCHES AND CUTTERS

Greenlee Tool Co., Rockford, Illinois



No. 730

## Nos. 730 and 731 RADIO CHASSIS PUNCHES

No. 730 Round Punch *shown at left*, quickly cuts accurate, round holes in radio chassis for sockets, plugs, and other receptacles. No reaming or filing—hole is smooth, perfect. Operates simply with an ordinary wrench for drive power. Just insert in a  $\frac{3}{8}$ " or  $\frac{1}{2}$ " drilled hole and turn drive nut. 13 sizes from  $\frac{1}{2}$ " to  $2\frac{1}{4}$ " as shown in table at right. Individually packed. Odd-size holes for meters can be made with other punches and cutters shown below.



No. 731

No. 731 Square Punch (*left*) easily makes full or partial cuts so that any square or oblong shaped hole can be rapidly made. Available in three sizes for making  $\frac{3}{8}$ ",  $\frac{3}{4}$ ", and 1" square holes. Simple to operate, turn with an ordinary wrench. Drive screw fits into  $\frac{1}{2}$ " hole in the metal. Individually packed.



## No. 735 KNOCKOUT PUNCH SET

For fast, easy cutting of holes in metal up to  $\frac{1}{8}$ -inch or 10-gauge thickness. Insert in small opening and drive with an ordinary wrench. Speeds radio set work, cuts cleanly, no reaming and filing. Set includes four punches for making  $\frac{7}{8}$ ",  $1\frac{3}{32}$ ",  $1\frac{1}{2}$ ",  $1\frac{1}{16}$ " inch holes. Packed in leather case.

## No. 737 KNOCKOUT PUNCH SET

Similar to the No. 735 set, but consists of two punches . . . for cutting holes  $1\frac{1}{16}$ " and  $2\frac{3}{8}$ " inch diameter. Packed in leather case.



## Nos. 738 and 739 KNOCKOUT PUNCHES

For cutting holes  $2\frac{7}{8}$ " diameter (No. 738) and  $3\frac{1}{2}$ " diameter (No. 739) in metal up to  $\frac{1}{8}$ " or 10 gauge thickness. Similar in design and operation to that of smaller GREENLEE Knockout Punches. Packed and sold individually.



## No. 740 KNOCKOUT CUTTER

Excellent tool for making meter openings and other large holes needed in radio work. Quickly cuts holes  $1\frac{1}{8}$ ",  $2\frac{3}{8}$ ",  $2\frac{7}{8}$ ",  $3\frac{1}{2}$ "-diameter. Operation is simple . . . driven with ordinary wrench. Special discs can be furnished for cutting odd-size holes from  $1\frac{1}{8}$ " to  $3\frac{1}{2}$ "-inch diameter. Packed in leather case.

|                         |         |            |
|-------------------------|---------|------------|
|                         | Price   | Wt. (lbs.) |
| No. 740 Knockout Cutter | \$15.00 | 4½         |

## No. 730 List Price and Weight in Pounds Each

|   | Price  | Weight            |
|---|--------|-------------------|
| $\frac{1}{2}$ " Complete                                  | \$2.15 | $\frac{1}{4}$ lb  |
| AV1760 Punch  | 1.25   | $\frac{1}{4}$ lb  |
| AV1759 Die  | .65    | $\frac{1}{4}$ lb  |
| $\frac{3}{8}$ " Complete                                  | 2.15   | $\frac{1}{4}$ lb  |
| AV1742 Punch  | 1.25   | $\frac{1}{4}$ lb  |
| AV1743 Die  | .65    | $\frac{1}{4}$ lb  |
| AV1675 for $\frac{1}{2}$ " & $\frac{3}{8}$ " Punches      | .25    |                   |
| $\frac{3}{4}$ " Complete                                  | 2.15   | $\frac{1}{4}$ lb  |
| AV113 Punch   | 1.25   | $\frac{1}{4}$ lb  |
| AV114 Die   | .65    | $\frac{1}{4}$ lb  |
| $\frac{7}{8}$ " Complete                                  | 2.15   | $\frac{3}{8}$ lb  |
| AV121 Punch   | 1.25   | $\frac{3}{8}$ lb  |
| AV122 Die   | .65    | $\frac{3}{8}$ lb  |
| AV322 Screw for $\frac{3}{4}$ " & $\frac{7}{8}$ " Punches | .25    |                   |
| 1" Complete   | 2.35   | $\frac{3}{8}$ lb  |
| AV87 Punch  | 1.35   | $\frac{3}{8}$ lb  |
| AV88 Die  | .75    | $\frac{3}{8}$ lb  |
| $1\frac{1}{8}$ " Complete                                 | 2.50   | $\frac{1}{2}$ lb  |
| AV1763 Punch  | 1.45   | $\frac{1}{2}$ lb  |
| AV1764 Die  | .80    | $\frac{1}{2}$ lb  |
| $1\frac{1}{8}$ " Complete                                 | 2.50   | $\frac{1}{2}$ lb  |
| AV91 Punch  | 1.45   | $\frac{1}{2}$ lb  |
| AV92 Die  | .80    | $\frac{1}{2}$ lb  |
| $1\frac{3}{32}$ " Complete                                | 2.50   | $\frac{1}{2}$ lb  |
| AV83 Punch  | 1.45   | $\frac{1}{2}$ lb  |
| AV84 Die  | .80    | $\frac{1}{2}$ lb  |
| $1\frac{3}{8}$ " Complete                                 | 2.50   | $\frac{1}{2}$ lb  |
| AV115 Punch   | 1.45   | $\frac{1}{2}$ lb  |
| AV116 Die   | .80    | $\frac{1}{2}$ lb  |
| $1\frac{1}{4}$ " Complete                                 | 2.50   | $\frac{3}{4}$ lb  |
| AV117 Punch   | 1.45   | $\frac{3}{4}$ lb  |
| AV118 Die   | .80    | $\frac{3}{4}$ lb  |
| $1\frac{3}{8}$ " Complete                                 | 2.85   | $\frac{3}{8}$ lb  |
| AV119 Punch   | 1.65   | $\frac{3}{8}$ lb  |
| AV120 Die   | .95    | $\frac{3}{8}$ lb  |
| $1\frac{1}{2}$ " Complete                                 | 3.20   | 1 lb              |
| AV89 Punch  | 1.90   | $\frac{3}{8}$ lb  |
| AV90 Die  | 1.05   | $\frac{1}{2}$ lb  |
| AV112 Screw for 1" to $1\frac{1}{2}$ " inclusive          | .25    |                   |
| $2\frac{1}{4}$ " Complete                                 | 6.20   | $2\frac{1}{4}$ lb |
| AV437 Punch   | 3.20   | $\frac{7}{8}$ lb  |
| AV438 Die   | 2.50   | 1 lb              |
| AV304 Screw for $2\frac{1}{4}$ " Punch                    | .50    | $\frac{1}{2}$ lb  |

## No. 731 List Price and Weight in Pounds Each

|  |                 |        |
|--|-----------------|--------|
| $\frac{3}{8}$ " No. 731 Square Radio Chassis Punch | \$3.35 complete |        |
| AV-2891 $\frac{3}{8}$ " Square Punch               | 1.40            | \$1.40 |
| AV-2881 $\frac{3}{8}$ " Square Die                 | 1.15            |        |
| AV-2886 Drive Screw                                | .60             |        |
| AV-2929 Drive Nut                                  | .20             |        |
| $\frac{3}{4}$ " No. 731 Square Radio Chassis Punch | \$3.90 complete |        |
| AV-2882 $\frac{3}{4}$ " Square Punch               | 1.65            | \$1.65 |
| AV-2883 $\frac{3}{4}$ " Square Die                 | 1.35            |        |
| AV-2914 Drive Screw                                | .70             |        |
| AV-2929 Drive Nut                                  | .20             |        |
| 1" No. 731 Square Radio Chassis Punch              | \$4.50 complete |        |
| AV-2884 1" Square Punch                            | 1.80            | \$1.80 |
| AV-2885 1" Square Die                              | 1.50            |        |
| AV-2887 Drive Screw                                | 1.00            |        |
| AV-2929 Drive Nut                                  | .20             |        |

## Nos. 735, 737, 738, 739 List Price and Weight in Pounds Each

|                            | Price   | Weight |
|----------------------------|---------|--------|
| No. 735 Knockout Punch Set | \$10.00 | 2¾ lb  |
| No. 737 Knockout Punch Set | 10.00   | 4¼ lb  |
| No. 738 Knockout Punch     | 14.00   | 5¾ lb  |
| No. 739 Knockout Punch     | 19.00   | 7¼ lb  |

### Extra Parts

|   |      |  |
|---|------|--|
| No. 735 Knockout Punch Set                              |      |  |
| No. AV121— $\frac{7}{8}$ " Punch                        | 1.25 |  |
| No. AV122— $\frac{7}{8}$ " Die                          | .65  |  |
| No. AV123—1" Punch                                      | 1.45 |  |
| No. AV124—1" Die  | .80  |  |
| No. AV125—1½" Punch                                     | 1.65 |  |
| No. AV126—1½" Die                                       | .95  |  |
| No. AV127—1½" Punch                                     | 1.90 |  |
| No. AV128—1½" Die                                       | 1.05 |  |
| No. AV322— $\frac{3}{8}$ " x $1\frac{1}{2}$ " Cap Screw | .25  |  |
| No. AV249— $\frac{3}{4}$ " x $2\frac{3}{8}$ " Cap Screw | .35  |  |
| No. 737 Knockout Punch Set                              |      |  |
| No. AV439—1½" Punch                                     | 2.30 |  |
| No. AV440—1½" Die                                       | 2.00 |  |
| No. AV441—2¾" Punch                                     | 3.20 |  |
| No. AV442—2¾" Die                                       | 2.50 |  |
| No. AV304— $\frac{3}{4}$ " x $2\frac{3}{4}$ " Cap Screw | .50  |  |
| No. 738 Knockout Punch                                  |      |  |
| No. AV1429—2¾" Punch                                    | 5.40 |  |
| No. AV1430—2¾" Die                                      | 5.00 |  |
| No. AV1433—Drive Nut                                    | 1.35 |  |
| No. AV1434—Drive Screw                                  | 2.75 |  |
| No. 739 Knockout Punch                                  |      |  |
| No. AV1431—3½" Punch                                    | 8.00 |  |
| No. AV1432—3½" Die                                      | 7.50 |  |
| No. AV1433—Drive Nut                                    | 1.35 |  |
| No. AV1434—Drive Screw                                  | 2.75 |  |



# Harry Davies Molding Co.

Molders of Plastics

1428 NORTH WELLS STREET • CHICAGO 10, ILL.

STANDARD COLORS FOR DAVIES KNOBS: Black, Walnut, Red or Ivory. Others to order. Quality radio knobs for standard 1/4" shaft. Set screw, spring, or knurled hole mounting, or 1/4" brass bushing.

## ELECTRONIC INSTRUMENT KNOBS

|   |          |        |         |   |          |        |         |  |          |        |                |
|---|----------|--------|---------|---|----------|--------|---------|--|----------|--------|----------------|
|  | Type No. | Width  | Height  |  | Type No. | Width  | Height  |  | Type No. | Width  | Skirt diameter |
|   | 4100     | 1 1/8" | 5/8"    |   | 4100-P   | 1 1/8" | 7/8"    |  | 4104     | 1 1/8" | 1 1/2"         |
|   | 4101     | 1 3/8" | 1 1/16" |   | 4101-P   | 1 3/8" | 1 1/16" |  | 4106     | 1 3/8" | 1 1/2"         |
|   | 4102     | 1 5/8" | 3/4"    |   | 4102-P   | 1 5/8" | 1 1/16" |  | 4108     | 1 5/8" | 3"             |
|   | 4103     | 2 3/8" | 7/8"    |   | 4103-P   | 2 3/8" | 1 9/16" |  | 4109     | 2 3/8" | 2 1/16"        |



**No. 1400.** (With pointer).  
Height 1 3/32". Diameter 1 1/16".  
**No. 1450.** (No pointer).  
Height 1 3/32". Diameter 1 1/16".  
Set screw, spring, or knurled hole mounting.



**No. 1700.**  
Height 1 9/32". Diameter 3/4".  
Set screw, spring, or knurled hole mounting.



**No. 2500.**  
Height 3/4". Diameter 3/4".  
**No. 2600.**  
Height 7/8". Diameter 7/8".  
Set screw, spring, or knurled hole mounting.



**No. 2965.**  
Short Shank. Dia. 7/8"; Hgt. from 1/2" to 1 1/2".  
Medium Shank. Dia. 7/8"; Hgt. from 9/16" to 1 1/2".  
Long Shank. Dia. 7/8"; Hgt. from 9/16" to 1 1/2".

This type knob can be supplied with arrow; Off-On; Tuning; Volume; Tone; Batt-Elec.; Band Switch; Radio-Phono, or Dot markings.  
Set screw, spring, or knurled hole mounting.



**No. 3008.**  
Dia. 1 1/4"; Hgt. 3/4".  
**No. 3009.**  
Dia. 1 1/2"; Hgt. 3/4".  
**No. 3000**  
Long Shank Dia. 1 3/4"; Hgt. 3/4", 1", 1 1/4" and 1 1/2".

Short Shank. Dia. 1 3/4". Hgt. 3/4", 1", 1 1/4" and 1 1/2".  
1/4" molded hole or brass insert. Plain or threaded hole. Set screw or knurled hole mounting.



|                 |                |         |      |
|-----------------|----------------|---------|------|
|                 | Length overall | Hgt.    | Dia. |
| <b>No. 2110</b> | 1 5/8"         | 1 9/32" | 3/4" |
| <b>No. 2100</b> | 2 1/2"         | 5/8"    | 3/4" |

Molded hole or brass insert, set screw mounting.  
**No. 2110-P** 1 5/16" 1 9/32" 3/4"  
**No. 2100-P** 2 13/16" 5/8" 3/4"  
Metal insert and pointer, set screw mounting.



**No. 2300**—Zephyr bar knob.  
Length 1 1/4".  
**No. 2350**—Zephyr bar knob.  
Length 2".  
Molded hole, set screw mounting.  
**No. 2300-A**—Zephyr bar knob.  
Length 1 1/4".  
**No. 2350-A**—Zephyr bar knob.  
Length 2".  
1/4" brass insert and set screw.



**No. 1800 Series**  
These can be furnished in either plain or recessed tops. Dia. 7/16"; Heights range from 1" to 1 3/8". Also supplied with studs of various lengths.



**No. 5149** — Rectangular touch tuning knob. Push on, self-locating.  
**No. 5149-A**—Oval touch tuning knob. Push on, self-locating.  
Hgt. 13/16" - 1 1/32".



**No. 1750**—Touch Tuning. Push on, self-locating.

**No. 1760**—Touch Tuning, Recessed top, push on, self-locating. Dia. 3 1/64", Hgt. 9/16", 1 1/16", 1 3/16", 1 5/16".

**No. 1770**—Binding Post and Switch knob. No. 6-32 and No. 8-32 brass inserts. Dia. 3 1/64". Hgt. 1/2", 5/8", 3/4", 7/8".



**No. 2710**  
Height 1/2". Dia. 3/4".  
Metal-faced insert or plain insert.  
Female thread available 8-32, 10-32 and 10-24.



**No. 2150**  
Streamlined bar knob.  
Length 1 1/4".



**No. 1780**  
Push button knob.  
Dia. 1/2", Hgt. 1", 1 1/8", 1 7/32", 1 3/8".

**No. 1790**

Recessed top. Dimensions same as No. 1780.

**FACTORY & GENERAL OFFICES — 1428 NO. WELLS ST., CHICAGO 10, ILL.**  
Branch Offices: Baltimore, Cincinnati, Grand Rapids, New York, Los Angeles and Milwaukee  
Foreign Office: Toronto, Canada

# ERSIN MULTICORE SOLDER



SEVEN POUND REELS



ONE POUND CARTONS



Our claim is a simple one: We believe that ERSIN MULTICORE is the finest cored solder in the World!

Ersin Multicore is solder in the form of wire containing three cores of non-corrosive Ersin Resin Flux. No extra flux is required. The use of Ersin Multicore guarantees that the correct proportion of flux to solder is used and maximum fluxing action occurs at the correct melting point of the solder. Only by using solder

wire with three cores of flux is it possible to be sure the flux is always present—that there will not be lengths of wire without flux which result in “dry” or high-resistance joints.

In addition to this advantage, Ersin Multicore is the *only* cored solder in the world containing ERSIN, an extra-active non-corrosive flux. It is high grade rosin homogeneously activated by a process which confers on the rosin the vigorous fluxing action characteristic of the more active fluxes.

You enjoy speedy and a consistently high precision standard of soldering and attain just that extra rapidity which guarantees economy of operation. Ersin Flux not only removes surface oxides prior to soldering, but prevents formation during the soldering period. You can satisfactorily solder components which are highly oxi-

dized—ones on which it would be necessary to undertake additional mechanical or chemical cleansing processes when using any other type of flux.

In Ersin Flux, the protective qualities of the original rosin are preserved. Joints made with Ersin Multicore Solder will not corrode even after prolonged exposure to any degree of humidity. The flux residue is impervious to moisture. It is hard and not sticky. It avoids accumulation of dirt and impurities on the joint.

Every reel or carton of Ersin Multicore is clearly marked both as to Gauge and Alloy, showing the actual content of Tin and Lead. You know exactly what you are getting when you buy Ersin Multicore Solder! Multicore costs a fraction more initially, but is unquestionably most economical in the long run.

Ersin Multicore Solder is available in all Tin/Lead alloys and in standard wire gauge from 10 to 22. (14, 16 and 18 s.w.g. are most popular.)

Ersin Multicore is the only solder which offers you these two fundamental advantages: (1) Multicore construction, providing three cores which assure perfect joints; (2) Ersin Flux, our *exclusive* fast non-corrosive flux.

Ersin Multicore is the answer for those who seek the finest Cored Solder in the World!



*The Original Three Cored Solder*

# ROGAN **KNOBS** FROM STOCK MOLDS

For All Types of Instruments and Apparatus . . . Low Cost . . . Immediate Delivery

**ROGAN BROTHERS** • Compression Molders and Branders of Plastics • 2506 W. Irving Pk. Rd., Chicago 18



**TYPE RB-901**



**TYPE RB-501**



**TYPE RB-111**



**TYPE RB-121**



**TYPE RB-31**



**TYPE RB-301**

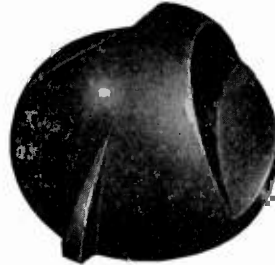

**TYPE RB-11**

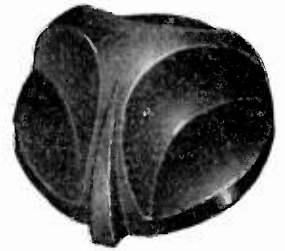

**TYPE RB-21**

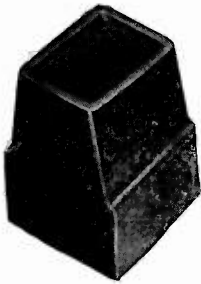

**TYPE RB-821**



**TYPE RB-51**



**TYPE RB-41**



**RB-11 with RB-1000**

## WIDE SELECTION OF SHAPES AND SIZES

Shown above, are but a few of the many Rogan plastic knobs available to you from our regular stock molds. These are supplied without tool charge, resulting in considerable savings in cost, faster delivery. Choice of a wide selection of sizes, shapes and colors. Molded of phenolic or urea thermosetting materials, which will not soften, warp, or scratch easily. Heat resisting materials can be used so knobs can withstand 350-400° F. continuous heat. Most knobs supplied with 1/4" shaft hole and set screws. Special shaft hole sizes and means of fastening can be supplied to specifications at nominal cost.

## KNOBS CAN BE BRANDED, AS REQUIRED

Rogan's famous "deep relief" branding process, applied after molding, provides sharp perfect marking at low cost. Any type marking, graduations or numerals can be branded on blank knobs to fit your requirements. Rogan knobs are available in black, brown or walnut, when molded of phenolic materials; and in all light pastel colors when molded of urea materials. Whatever your knob requirements may be, Rogan is equipped to supply you faster, better, more economically. The complete line of Rogan knobs with specifications is shown in the new Rogan catalog. Write for your copy now.



## WALSCO STAPLE DRIVER

### "NEW IMPROVED GUARANTEED MODEL"

Patent No. 2,285,384

Pays for itself on the first job!

- A sensational tool for installing wires and cables, that saves time and money.
- Used by Radio, Public Address and Intercom Technicians.
- Staples into corners and other inaccessible places.
- Staples on hard surfaces such as plaster, hardwood, etc.
- Can be loaded in 10 seconds.

This tool automatically positions the staple — then one or two strokes with the palm of the hand and the staple is driven home neatly, quickly, and accurately. A small trigger regulates the feeding mechanism to enable the operator to strike the handle on hard surfaces as often as necessary before a second staple leaves the magazine. Staples come in strips, are large enough for cables and wires up to 1/4" diameter. An adjustable regulator controls the depth to which the staple is driven into surface, thus preventing damage to the insulation of the wire.

| Cat. No.   | List Price | Dealer's Net |
|--|------------|--------------|
| 500—Staple Driver Complete, including box of staples | \$8.25     | \$4.95       |
| 507—Rubber Cap for Head of Staple Driver             | 0.37       | 0.22         |
| 530—Box of 250 Carbon Steel Staples                  | 0.60       | 0.36         |
| 552—Box of 1000 Carbon Steel Staples                 | 2.25       | 1.35         |

Staples put up in handy strips; available in plain, brown or ivory finish.

## WALSCO TUBE PULLERS



The first practical tube pullers ever devised for the electronic trade. Lift out tubes by wedging action between base and socket, without applying strain to the glass. Tubes are securely held while extracting or inserting. Made of tempered steel throughout. Attractively and durably finished.

| Cat. No.   | List Price |
|--|------------|
| 565—Standard Puller, for all metal, GT, Locktal and most regular glass tubes. Also for extracting vibrators and for pulling knobs                              | \$1.95     |
| 566—Right-Angle Puller, for metal, GT, Locktal and most regular glass tubes. Designed for extracting and inserting tubes without removing chassis from cabinet | 2.40       |
| 567—Standard Puller, for all Miniature Tubes. Pulls out straight and thereby prevents tube breakage or bending of pins   | 1.95       |
| 568—Right-Angle Puller, for Miniature Tubes  | 2.40       |

## GRILLE CLOTH



Highest quality, acoustically perfect cloth available to match wainut, mahogany or light wood finishes.

| Cat. No. | Size   | List Price |
|----------|--|------------|
| 360      | 12" x 12"  | \$0.60     |
| 361      | 18" x 24"  | 1.50       |
| 362      | 1 yard x 52" (packaged)                                    | 6.25       |
| 362-1    | 1 yard x 40" (packaged)                                    | 4.95       |
| 362 BU   | 52" wide material in bulk, minimum order: 5 yards, per yd. | 5.75       |

## GRILLE SCREENING

(Flocked)

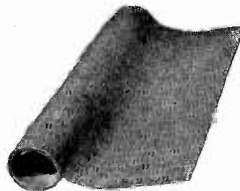

Galvanized, rayon-flock covered screening. Attractive, weatherproof and modern. For auto radios, P.A. and Intercom. speakers, etc.

| Cat. No. | Size      | List Price |
|----------|-----------|------------|
| 374-1    | 8" x 11"  | \$0.85     |
| 376-1    | 18" x 24" | 2.90       |
| 378-1    | 36" x 36" | 9.00       |

## ORNAMENTAL METAL GRILLE

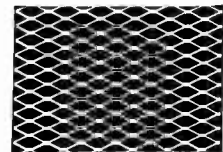

Heavy perforated grille, beautifully "brushed brass" plated and lacquered with gold finish effect. For use over cloth or screening in custom-built radios, high quality P.A. speakers, juke boxes, etc.

| Cat. No. | Size      | List Price |
|----------|-----------|------------|
| 382      | 12" x 18" | \$2.75     |
| 384      | 18" x 24" | 5.00       |
| 386      | 24" x 36" | 9.50       |

PRICES FOR BULK QUANTITIES AND SPECIAL SIZES QUOTED ON REQUEST

For Bulk Quantity Prices on these items, see WALSCO INDUSTRIAL AND BULK PRICE LIST, pages U-47 to U-50.

## WALSCO UNIBELT

A NEW UNIVERSAL DIAL-DRIVE BELT ADJUSTABLE TO FIT ANY DIAL DRIVE

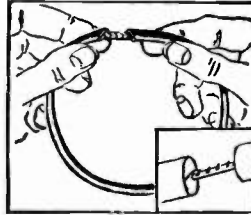

Covered by Patent No. 2,300,706

- Eliminates need for stocking 96 different sizes of belts.
- Unibelt gives the Radio Man the correct size belt for every make and model set.
- Easily installed in a few minutes. No need for taking dial mechanism apart.
- Put up on spools in continuous lengths which will make five or more average belt replacements.
- New patented construction incorporates special stainless steel core and pure latex covering.
- Belts cannot stretch, and when properly installed will not slip, fray or break.
- Unconditionally guaranteed.

The ingenious construction of the New WALSCO Unibelt makes it possible to assemble any size belt by merely cutting the desired length and joining the ends with a simple "zipper-like" connector. The connected belt cannot stretch and has a breaking strength of over 60 lbs. ONLY ONE SIZE NEEDED for any belt replacement job.

| Cat. No.  | List Price | Dealer's Net |
|---|------------|--------------|
| 303—5-ft. spool Unibelt (with 10 connectors and instructions) | \$2.75     | \$1.65       |

## WALSCO DIAL DRIVE BELTS

- Precision Made.
- No Stretch — No Slip.
- Smooth and Uniform.
- Exceptionally Strong.

Available for any type of radio set. Specially constructed to give long lasting, trouble-free service. Treated for maximum friction and to provide accurate tuning. WALSCO Dial Belts are uniformly thick throughout the entire length and are precision made and guaranteed to fit perfectly.

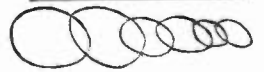

All Sizes..... List Price Each, \$0.25

Also put up in Kits of 25, 50, 100 and 150 Belts

| Cat. No.   | List Price |
|--|------------|
| 565—Standard Puller, for all metal, GT, Locktal and most regular glass tubes. Also for extracting vibrators and for pulling knobs                              | \$1.95     |
| 566—Right-Angle Puller, for metal, GT, Locktal and most regular glass tubes. Designed for extracting and inserting tubes without removing chassis from cabinet | 2.40       |
| 567—Standard Puller, for all Miniature Tubes. Pulls out straight and thereby prevents tube breakage or bending of pins   | 1.95       |
| 568—Right-Angle Puller, for Miniature Tubes  | 2.40       |

### WALSCO DIAL CABLES AND CORDS

WALSCO Dial Cables and Cords are manufactured to meet the most rigid standards of the Government, Radio Industry and Engineering Laboratories. The finest raw materials are used and production is controlled to supply a uniform product with an absolute minimum stretch factor. All standard Cords are made with NYLON braid, known to have the highest abrasion resistance. These selected materials, plus special chemical treatment after fabrication, make WALSCO Cords the finest on the market. WALSCO Dial Cords are used by leading manufacturers as a standard component.



25-ft. and 100-ft. spools are packaged in clear plastic, re-usable storage boxes with sliding lids.

**HEAVY CORD**—Diameter .062"—Same as used on many Philco and Majestic sets. Very durable, and treated to prevent slipping.

No. 33 ..... 25 ft. .... List Price \$1.75  
No. 33-1C ..... 100 ft. .... List Price 4.60

**BRONZE CABLE**—16-Strand Braided—Diameter .039"—Breaking Strength 50 lbs.—A braided cable with good flexibility and abrasion resistance. "Fiber-glass" is used as core material and the braid is constructed of special hard Cadmium bronze. Does not unravel.

No. 31 ..... 25 ft. .... List Price \$1.20  
No. 31-1C ..... 100 ft. .... List Price 3.45  
No. 31-5C ..... 500 ft. .... List Price 14.00

**PHOSPHOR BRONZE CABLE**—42-Strand—Diameter .032"—Breaking Strength 60 lbs.—A very flexible metal cable constructed of 42 strands of hard Phosphor bronze over a "Fiber-glass" core. Extremely durable. Used for replacement of dial cables and many special applications where a strong, stranded cable is required.

No. 30 ..... 25 ft. .... List Price \$1.50  
No. 30-1C ..... 100 ft. .... List Price 5.00  
No. 30-5C ..... 500 ft. .... List Price 20.00

**SPECIAL THIN BRONZE CABLE**—Diameter .022"—An extra-thin cable for dial drives, flexible connections, pigtailed, and many other applications—wherever a thin, but strong cable is required.

No. 32 ..... 25 ft. .... List Price \$1.20  
No. 32-1C ..... 100 ft. .... List Price 3.45  
No. 32-5C ..... 500 ft. .... List Price 14.00

STANDARD PACKAGE—12

The following cords cover over 80% of the replacement demand. With one spool of each kind on hand, the serviceman has the proper size for practically any set manufactured since 1934. Constructed with "Fiber-glass" or linen core and "pre-stretched," these are the most efficient cords available. The braided sleeves are made of Nylon.

| Cat. No.              | Diam. | Breaking Strength | LIST PRICES |         |
|-----------------------|-------|-------------------|-------------|---------|
|                       |       |                   | 25          | 100 500 |
| <b>"SPECIAL THIN"</b> |       |                   |             |         |
| 35                    | .025" | 25 lbs.           | \$1.25      |         |
| 35-1C                 | .025" | 25 lbs.           |             | \$4.50  |
| 35-5C                 | .025" | 25 lbs.           |             | \$13.00 |
| <b>STANDARD</b>       |       |                   |             |         |
| 39                    | .032" | 30 lbs.           | \$1.25      |         |
| 39-1C                 | .032" | 30 lbs.           |             | \$4.50  |
| 39-5C                 | .032" | 30 lbs.           |             | \$13.00 |
| <b>MEDIUM</b>         |       |                   |             |         |
| 34                    | .042" | 35 lbs.           | \$1.25      |         |
| 34-1C                 | .042" | 35 lbs.           |             | \$4.50  |
| 34-5C                 | .042" | 35 lbs.           |             | \$16.00 |

### WALSCO ALL-PURPOSE WIRE STRIPPER

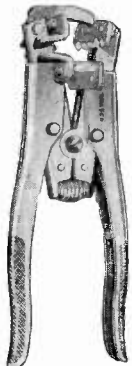

All these features in ONE model:  
• Strips all wires from 16 to 22-gauge • Strips 300-ohm twin lead • Has built-in wire cutter • Has automatic locking device which prevents crushing of stranded wire • Made entirely of steel and will last a lifetime.

Strips insulation quickly and cleanly. Precision-ground blades will not nick or cut wire strands. Especially made for wire types and sizes used in electronic work, but equally applicable for automotive, aviation, and telephone trade.

Blades are hardened and precision-ground, and will last for thousands of stripping and cutting operations. Can readily be replaced when dulled.

Operation is extremely easy, requires no particular skill or experience. From 700 to 1000 wires can be stripped per hour. Equally adaptable for the production line or for use "on the job."

| Cat. No. | Description  | Price   | Net    |
|----------|--|---------|--------|
| 590      | —WALSCO All-Purpose Wire Stripper  | \$10.95 | \$6.57 |
| 590-1    | —Replacement Blade Set for No. 590   | 2.00    | 1.20   |
| 591      | —Special "Wide-Range" Model for Electrical Trade. Strips all wire gauges from No. 10 to No. 22 | 10.95   | 6.57   |
| 591-1    | —Replacement Blade Set for No. 591   | 2.00    | 1.20   |

### WALSCO PROTECTO-TUBE

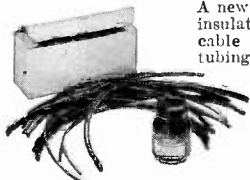

A new synthetic tubing especially designed for insulating handles of pliers, screwdriver blades, cable connector ends, test prods, etc. This tubing is highly abrasion-resistant for long wear, and will not crack or shatter. Special Expanding Solution is furnished as part of the kit and "swells" tubing to permit easy application. Upon drying, tubing shrinks on tight.

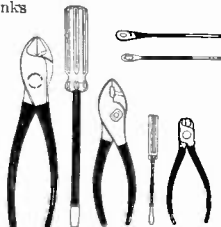

Protecto-Tube Kit, containing approx. 12 ft. assorted sizes and colors of WALSCO Protecto-Tube, jar of Expanding Solution, and instructions.

Cat. No. K-18.....List Price \$1.65

### POPULAR DIAL CORD IN SMALL PACKAGES

| Cat. No.  | List Price |
|---|------------|
| 3070—Approximately 10 ft. Special Thin Cord (Type 35) | \$0.40     |
| 3080—Approximately 8 ft. Medium Cord (Type 34)        | 0.40       |
| 3090—Approximately 8 ft. Standard Cord (Type 39)      | 0.40       |

(Standard Package . . . 20; available on display card or box)

### WALSCO STANDARD TEST RECORDS FOR TESTING AND ADJUSTING RECORD PLAYERS, CHANGERS, PICK-UPS, AND AMPLIFIERS

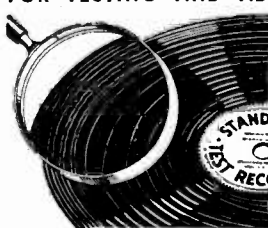

These records are designed to provide the electronic engineer and serviceman with a quick, inexpensive, and accurate means of checking the mechanical performance of record changers. They will also indicate any defects in pick-up, amplifier, or speaker, and may be used for accurate measurements of performance of these components. All records are made of long-wearing, plastic material, and are unbreakable in normal use.

Cat. No. 720-6—Set of six 12" records consisting of one each of the following: Record No. 720, 721, 725, 726, 727, 728.

With this set, all mechanical and electrical performance characteristics of a phonograph system can be quickly and accurately checked. No laboratory or well-equipped service shop should be without this set. List Price \$9.90

Cat. No. 720—10" record with accelerated pitch. Playing time approximately 45 sec. Lead-in grooves modulated with 3 tones to indicate set-down position of pick-up. Proper tripping action indicated by tone signals at end of record. Both sides of record identical. List Price \$1.65

Cat. No. 721—10" record. One side with accelerated pitch and without starting spiral for checking "feed-in" of pick-up. Other side same as No. 720. List Price \$1.65

Cat. No. 725—10" record. One side: Sweep Frequency Record at N.A.B. standard level. Range 10,000 to 50 c.p.s. Cross-over to constant amplitude at 500 c.p.s. Other side same as No. 720. List Price \$1.90

Cat. No. 726—10" record. One side: Test Frequency Record at N.A.B. standard level. Range 10,000 to 50 c.p.s. in 16 steps. Other side same as No. 720. List Price \$1.90

Cat. No. 727—10" record. One side contains 1000 and 400-cycle tone for 1 min. each. Especially designed for testing irregular turntable speed ("WOW"). Other side same as No. 720. List Price \$1.90

Cat. No. 728—10" record. One side contains silent (unmodulated) groove for checking turn-table rumble. Other side same as No. 720. List Price \$1.65

Cat. No. 730-4—Set of four 12" records of same design as No. 720. Designed for use in connection with set No. 720-6 in checking performance of intermix changers. List Price \$9.90





# WALSCO ELECTRONIC HARDWARE

The 99 Line

The 40 Line

IN PERMANENT TRANSPARENT PLASTIC PACKED IN HANDY STORAGE BOXES WITH SLIDING TOPS ECONOMICAL PLASTIC BAGS



## WALSCO PHONO-MOTOR DRIVES

Precision made to assure constant uniform speed and made of abrasion-resistant synthetic rubber to assure long wear. For attaching, use WALSCO Rubber Cement.

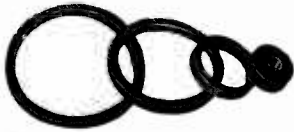

| Cat. No.  | I.D.         | O.D.   | Thick | No. of Drives per pkg. | Used on  | List Price per pkg. |
|-----------|--------------|--------|-------|------------------------|--|---------------------|
| †2560-16  | 2"           | 2 3/8" | 3/8"  | 2                      | Gen. Indust. Mod. LX & RX  | \$0.40              |
| †2560-17  | 1 1/2"       | 1 3/4" | 1/8"  | 2                      | Alliance, Seeburg, G.E. V. M. 400  | 0.40                |
| †2560-18  | 7/8"         | 1 1/8" | 1/8"  | 3                      | Seeburg, R.C.A., G.E.  | 0.40                |
| †2560-19  | 1 1/8"       | 1 3/8" | 1/8"  | 4                      | Philco, R.C.A., etc.   | 0.40                |
| †2560-20  | 5 3/8"       | 6"     | 3/8"  | 1                      | Detroit  | 0.40                |
| *2560-22  | 1 7/8"       | 1 3/4" | 1/8"  | 3                      | G.I. Recorder/Changer  | 0.40                |
| *2560-23A | 1 1/8"       | 1 3/8" | 1/8"  | 2                      | R.C.A., RP-176, 177 and most pre-war R.C.A. Changers. Also on G.E. 809-J, etc. | 0.40                |
| *2560-23B | 4 1/2"       | 5 1/2" | 3/8"  | 1                      | Same as # 2560-23A   | 1.00                |
| *2560-24  | 2 7/8"       | 3 3/8" | 1/8"  | 1                      | R.C.A. 960015, 960260, 960276. Also most Admiral and Crescent postwar changers | 0.50                |
| †2560-25  | Spring-Drive |        |       | 1                      | Detroit - Utah   | 0.40                |

## WALSCO KEY WRENCHES



### FOR HEX AND SPLINE SOCKET SCREWS

WALSCO features three sets of socket wrenches made of special alloy steel to fit all standard socket screws used in radio and electronic equipment.

| Cat. No. | Description   | List Price |
|----------|---|------------|
| †3580    | Assortment of 4 small HEX wrenches. Fits set screws No. 4 to 1/4" and cap screws No. 2 to 8.      | \$0.40     |
| †3581    | Assortment of 3 medium HEX wrenches. Fits set screws 1/4" to 3/8" and cap screws No. 3 to 10.     | 0.40       |
| †3584    | Assortment of 4 small SPLINE wrenches. Fits all set screws up to 1/4" and cap screws up to No. 8. | 0.40       |



## WALSCO HEX & SPLINE WRENCH KIT

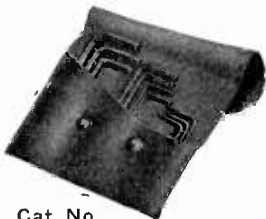

A handy kit containing a complete range of wrench sizes as used in the electronic trade. The case is made of durable leatherette with double snap button closure and contains both hex (Allen) and spline (Bristol) wrench keys for No. 2 to 3/8" screws.

| Cat. No.       | List Price | Dealer's Net |
|----------------|------------|--------------|
| 560—Wrench Kit | \$1.65     | \$0.99       |

Standard Package — 25

## WALSCO SPEAKER ADJUSTMENT SHIMS



- MADE OF NON-MAGNETIC METAL
- STRONG AND FLEXIBLE, SPRING TEMPER
- CORROSION-RESISTANT

4 Shims of each of 4 sizes supplied in handy plastic case with screw top and pencil clip. As easy to carry as a fountain pen. Marked for easy identification. Sizes supplied—.004", .006", .008" and .010". Indispensable to the serviceman in adjusting voice coils.

| Cat. No.                               | List Price |
|--|------------|
| †2550—16 Assorted Shims—4 of each size | \$0.60     |

## WALSCO PHONOGRAPH PICKUP SET SCREWS

Precision knurled head steel screws, antique bronze finished for all popular pickups and recording heads. The assortment contains several each of the popular numbers and one each of the other sizes.



| Cat. No. | Approx. No. Units per pkg. | Used On                | Size          | List Price per pkg. |
|----------|----------------------------|------------------------|---------------|---------------------|
| †2570    | 10                         | Assorted               | 7 diff. sizes | \$0.40              |
| *2571    | 10                         | Shure and others       | 2-56 x 5/8"   | 0.40                |
| *2572    | 10                         | Most Astatic & Webster | 2-64 x 3/4"   | 0.40                |
| *2576    | 6                          | Most RCA, etc.         | 1-72 x 1"     | 0.40                |

## WALSCO TURNTABLE RETAINING CLIPS

For holding phono turntable securely to spindle. Indispensable for portable phonographs or to prevent damage when shipping record changer units.



| Cat. No.      | List Price per pkg. |
|---------------|---------------------|
| *3424—4 Clips | \$0.40              |

## WALSCO PHONO PANEL MOUNTING SPRINGS

An assortment of various sizes of conical springs as used in mounting record changer units.



| Cat. No.                 | List Price per pkg. |
|--------------------------|---------------------|
| *3385—8 Assorted Springs | \$0.40              |

## WALSCO PICKUP CARTRIDGE MOUNTING SCREWS

An assortment containing small machine and self-tapping screws of various lengths, sizes and styles as required in fastening cartridge to pickup arm. Especially useful when threads are stripped or replacement of different cartridge requires longer screws.



| Cat. No.                         | List Price |
|----------------------------------|------------|
| *3365—Apprx. 30 Screws & Spacers | \$0.40     |

## WALSCO DIAL CORD CLIPS

For fastening the end of dial drive cord. The assortment contains the proper sizes for all standard thicknesses of cord.



| Cat. No.                     | List Price per pkg. |
|------------------------------|---------------------|
| *2770—Approximately 35 Clips | \$0.40              |

## WALSCO HARDWARE ASSORTMENT

A wonderful assortment of screws, nuts, washers, springs, clamps, eyelets, grommets, terminals, etc. Only regular hardware included. Just the thing for the experimenter, ham and technician. In plastic jar.



| Cat. No.                               | List Price | Dealer's Net |
|--|------------|--------------|
| K3003—"1000 Piece" Hardware Assortment | \$1.65     | \$0.99       |

## WALSCO GLASS JARS AND PLASTIC BOXES

Handy for storing small hardware items to keep them clean and rust-free.

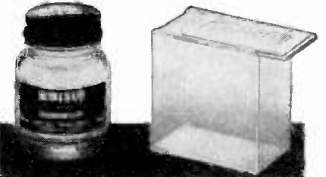

| Cat. No.   | List Price |
|--|------------|
| 998 Plastic Box with Sliding Lid                 | \$0.25     |
| (Standard Package . . . 24)                      |            |
| 999 Glass Jar, 2 oz. size (Standard Package: 36) | \$1.20     |

For Bulk Quantity Prices on these items, see WALSCO INDUSTRIAL AND BULK PRICE LIST, pages U-47 to U-50.

\*Std. Pack: Display Box of 20 Individual Packages. Add suffix "B" to part number to indicate one standard package. Example: 1-3310-B consists of standard box containing 20 packages = 3330.  
 †Available Either in Standard Display Box of 20 Packages or on Standard Display Card of 20 Packages.  
 When ordering add suffix "B" for box or suffix "D" for display card. See example above.





# WALSCO ELECTRONIC HARDWARE

The **99** Line

The **40** Line

IN PERMANENT *Transparent* PLASTIC STORAGE BOXES with SLIDING TOPS • PACKED IN HANDY ECONOMICAL PLASTIC BAGS



## WALSCO RUBBER GROMMETS

For protecting cables from abrasion when passing through chassis holes. Also used for vibrationless mounting of parts.

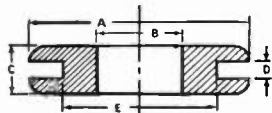

| Dimensions |      |       |      |      | THE 40 LINE |                        | THE 99 LINE |                        |
|------------|------|-------|------|------|-------------|------------------------|-------------|------------------------|
| A          | B    | C     | D    | E    | Cat. No.    | Approx. Quan. per pkg. | Cat. No.    | Approx. Quan. per pkg. |
| 1/4"       | 1/8" | 1/8"  | 1/8" | 1/4" | *3341       | 15                     | 3341-99     | 100                    |
| 3/8"       | 1/4" | 3/16" | 1/8" | 3/8" | *3342       | 12                     | 3342-99     | 75                     |
| 1/2"       | 3/8" | 1/4"  | 1/8" | 1/2" | *3343       | 10                     | 3343-99     | 65                     |
| 5/8"       | 3/4" | 1/4"  | 1/8" | 5/8" | *3344       | 10                     | 3344-99     | 50                     |
| 3/4"       | 1/2" | 3/8"  | 1/8" | 3/4" | *3345       | 8                      | 3345-99     | 40                     |
| Assorted   |      |       |      |      | *3340       | 12                     |             |                        |

## WALSCO CHASSIS MOUNTS



Made of resilient synthetic rubber to give chassis or other components a floating effect and to reduce "microphonics." Essential wherever vibration will affect operation.

| Dimensions |      |      |      | THE 40 LINE |                        | THE 99 LINE |                        |
|------------|------|------|------|-------------|------------------------|-------------|------------------------|
| A          | B    | C    | D    | Cat. No.    | Approx. Quan. per pkg. | Cat. No.    | Approx. Quan. per pkg. |
| 3/4"       | 1/2" | 1/4" | 3/8" | *2742       | 6                      | 2742-99     | 30                     |
| 1"         | 1/2" | 1/4" | 1/2" | *2744       | 4                      | 2744-99     | 20                     |
| Assorted   |      |      |      | *2740       | 10                     |             |                        |

## WALSCO RUBBER WASHER AND BUMPER ASSORTMENT

An assortment of the various kinds of rubber washers, bumpers, and spacers used in the electronic and radio industry for shockless, vibrationless mounting, for eliminating rattles and microphonics, etc.

Cat. No. \*3440—20 Assorted Washers and Bumpers ..... List Price per pkg. \$0.40

## WALSCO CORD STRAINRELIEFS

FOR POSJ WIRE



Provides a grommet and strain relief in one piece. For use on appliance cord sets. Use WALSCO Rubber Cement (Cat. No. 112) for attaching to cord. Prevents insulation of wire from being damaged by sharp-edged holes in metal chassis or cabinets.

Cat. No. \*3348—4 Strainreliefs ..... List Price per pkg. \$0.40

## WALSCO CABINET FEET



Made of oil resistant synthetic rubber. Wood screws are supplied with screw-type feet but machine or selftapping screws may be used. The rubber tack feet have steel tacks securely molded in.

PKGS. OF SCREW-TYPE FEET, INDIVIDUAL SIZES

| Diam.    | Height | THE 40 LINE |       | THE 99 LINE |       |
|----------|--------|-------------|-------|-------------|-------|
|          |        | Cat. No.    | Quan. | Cat. No.    | Quan. |
| 3/8"     | 3/8"   | *3351       | 12    | 3351-99     | 50    |
| 1/2"     | 3/8"   | *3352       | 8     | 3352-99     | 50    |
| 3/4"     | 3/8"   | *3353       | 8     | 3353-99     | 30    |
| Assorted |        | *3350       | 12    |             |       |

PKGS. OF RUBBER TACK FEET

|          |         |    |
|----------|---------|----|
| 1/2"     | 3355-99 | 50 |
| 3/8"     | 3356-99 | 50 |
| Assorted | *3355   | 12 |

## WALSCO SPADE BOLTS

Indispensable for attaching condensers, coils, cans, and similar items. For Experimenters, Servicemen and Manufacturers of electronic equipment. Stud size 6-32. Hole size for No. 6 screw.

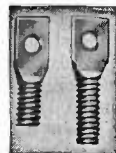

| Approx. Length | THE 40 LINE |                        | THE 99 LINE |                        |
|----------------|-------------|------------------------|-------------|------------------------|
|                | Cat. No.    | Approx. Quan. per pkg. | Cat. No.    | Approx. Quan. per pkg. |
| 5/8"           |             |                        | 3271-99     | 125                    |
| 3/4"           |             |                        | 3272-99     | 100                    |
| Assorted       | *3270       | 25                     |             |                        |

## WALSCO RIVET ASSORTMENT

Various sizes of hollow, solid and split rivets in brass, copper and aluminum as used in everyday repair and experimental work. Sizes range approximately from 1/16" to 3/16" in diam. and up to 3/4" in length.



Cat. No. \*2620—Approx. 60 asstd. Rivets ..... List Price per pkg. \$0.40

## WALSCO EYELET ASSORTMENT

Brass eyelets of various diameters and lengths. A handy item for every repair shop.

Cat. No. \*2630—Approx. 55 Eyelets ..... List Price per pkg. \$0.40

## WALSCO SMALL COTTER & HAIR PINS

Package contains an assortment of most popular sizes of cotter and hair pins. A valuable aid in the repair of radios and phonograph mechanisms.

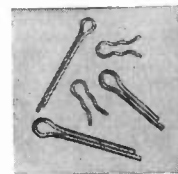

Cat. No. \*2650—Approx. 50 Assorted Cotter and Hair Pins ..... List Price per pkg. \$0.40

## WALSCO SPEAKER CONE PATCHES

A quick and inexpensive means for patching tears and holes in speaker cones. Made of specially flexible material and backed with an adhesive which forms a permanent bond with the cone.

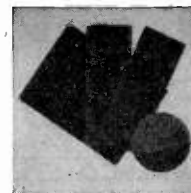

Cat. No. \*2553—10 Assorted Patches ..... List Price per pkg. \$0.40

## WALSCO SPEAKER DUST FELTS

Special, thin felt disks to keep metal particles and dust out of voice coils. Use Walsco Radio Cement to attach to cone.

Cat. No. \*2775—Approx. 25 assorted sizes ..... List Price per pkg. \$0.40

For Bulk Quantity Prices on these items, see WALSCO INDUSTRIAL AND BULK PRICE LIST, pages U-47 to U-50.

\*Std. Pack: Display Box of 20 Individual Packages. Add suffix "B" to part number to indicate one standard package. Example: 1-3330-B consists of standard box containing 20 packages #3330.  
†Available Either in Standard Display Box of 20 Packages or on Standard Display Card of 20 Packages.  
When ordering add suffix "B" for box or suffix "D" for display card. See example above.



# WALSCO ELECTRONIC HARDWARE

The 99 Line

The 40 Line

IN PERMANENT *Transparent* PLASTIC PACKED IN HANDY STORAGE BOXES with SLIDING TOPS ECONOMICAL PLASTIC BAGS



## WALSCO SNAP-HOLE PLUGS

A round, flat head, metal button with spring flanges that snap right into the hole. Used to seal adjustments, cover unused holes, etc.



| Description        | THE 40 LINE |                | THE 99 LINE |                |
|--------------------|-------------|----------------|-------------|----------------|
|                    | Cat. No.    | Quan. per pkg. | Cat. No.    | Quan. per pkg. |
| For 1/4" hole..... | *3501       | 8              | 3501-99     | 50             |
| For 3/8" hole..... | *3502       | 8              | 3502-99     | 50             |
| For 1/2" hole..... | *3503       | 6              | 3503-99     | 40             |
| For 5/8" hole..... | *3504       | 6              | 3504-99     | 30             |
| For 3/4" hole..... | *3505       | 5              | 3505-99     | 25             |
| For 1" hole.....   | *3506       | 4              | 3506-99     | 20             |
| Assorted.....      | †3500       | 8              |             |                |

## WALSCO TERMINAL LUGS

Available in the six popular sizes which meet most of the requirements of the radio and electronic field. Accurate forming facilitates easy handling. Made of tinned brass.



| Figure No.                      | THE 40 LINE |               | THE 99 LINE |               |
|---------------------------------|-------------|---------------|-------------|---------------|
|                                 | Cat. No.    | Approx. Quan. | Cat. No.    | Approx. Quan. |
| 1.....                          | *3281       | 30            | 3281-99     | 150           |
| 2.....                          | *3282       | 25            | 3282-99     | 150           |
| 3.....                          | *3283       | 25            | 3283-99     | 150           |
| 4.....                          | *3284       | 25            | 3284-99     | 150           |
| 5.....                          | *3285       | 25            | 3285-99     | 125           |
| 6.....                          | *3286       | 40            | 3286-99     | 150           |
| Assorted.....                   | †3280       | 40            |             |               |
| Asst. Solderless Terminals..... | *3288       | 8             |             |               |

## WALSCO VENTILATING HOLE PLUGS

For amplifiers, transmitters, portable radios, amateur equipment, etc., wherever ventilation is required.



|                           |                     |
|---------------------------|---------------------|
| Cat. No.                  | List Price per pkg. |
| †3320—Assorted Plugs..... | \$0.40              |

## WALSCO CABLE CLAMPS

Heavy gauge steel, Cadmium plated, 3/8" wide. Perfectly punched and formed with No. 6 or No. 8 mounting holes. Available in 3 sizes for cables from 1/8" to 1/4" in diameter.

| For Cables               | THE 40 LINE |                | THE 99 LINE |                |
|--------------------------|-------------|----------------|-------------|----------------|
|                          | Cat. No.    | Quan. Per pkg. | Cat. No.    | Quan. per pkg. |
| 1/8" to 1/8" Diam. ....  | *3331       | 20             | 3331-99     | 125            |
| 3/16" to 1/4" Diam. .... | *3332       | 18             | 3332-99     | 100            |
| 1/4" to 1/2" Diam. ....  | *3333       | 15             | 3333-99     | 75             |
| Assorted.....            | †3330       | 20             |             |                |

## WALSCO GRID CAP ASSORTMENT

An assortment of Grid Caps for all standard metal and glass tubes. Made of high quality spring brass, or steel and plated.



|   |                     |
|---|---------------------|
| Cat. No.                                  | List Price per pkg. |
| †2600—Approximately 15 Assorted Caps..... | \$0.40              |

## WALSCO SPRING CONNECTOR CLIPS (FAHNESTOCK TYPE)

For fast connection and good electrical contact. No tools required for connecting or disconnecting. Made of spring brass or phosphor bronze.

| For Wires                  | THE 40 LINE |               | THE 99 LINE |               |
|----------------------------|-------------|---------------|-------------|---------------|
|                            | Cat. No.    | Approx. Quan. | Cat. No.    | Approx. Quan. |
| #16 gauge and smaller..... | *2731       | 20            | 2731-99     | 100           |
| #12 to #18 gauge.....      | *2732       | 12            | 2732-99     | 75            |
| Assorted.....              | *2730       | 12            |             |               |

## WALSCO FUSE CLIPS

Made of spring brass, nickel plated for single hole mounting.



|                              |                     |
|------------------------------|---------------------|
| Cat. No.                     | List Price per pkg. |
| *2720—10 Assorted Clips..... | \$0.40              |

## WALSCO ANGLE BRACKET ASSORTMENT

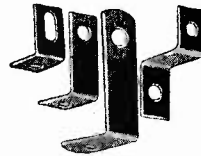

Handy brackets of various lengths and shapes as needed by every repairman, experimenter, "ham", etc. Precision made, of steel, or brass and plated.

|   |                     |
|---|---------------------|
| Cat. No.                                      | List Price per pkg. |
| *2610—Approximately 15 Assorted Brackets..... | \$0.40              |

## WALSCO TERMINAL STRIPS



For mounting parts which are to be insulated from chassis, and for wire distribution. Made with high-grade phenolic insulation. Solder-coated terminals.

|  |                     |
|--|---------------------|
| Cat. No.                                     | List Price per pkg. |
| *2660—Assortment of various size Strips..... | \$0.40              |

## WALSCO PHONO PLUGS AND JACKS

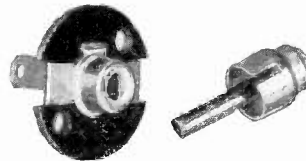

Standard plugs and jacks as used for connecting record players or pick-ups; also used on auto radio antennas. Used for all single conductor, shielded cable connections.

|                               |                     |
|-------------------------------|---------------------|
| Cat. No.                      | List Price per pkg. |
| †2580—Package of 4 Plugs..... | \$0.40              |
| †2585—Package of 2 Jacks..... | 0.40                |

## WALSCO PHONE TIPS



Fit all standard tip jacks. Easy to solder. Made of brass, nickel-plated. These are the conventional tips so often needed by both experimenters and service men.

| Phone Tips | THE 40 LINE |               | THE 99 LINE |               |
|------------|-------------|---------------|-------------|---------------|
|            | Cat. No.    | Approx. Quan. | Cat. No.    | Approx. Quan. |
|            | †2725       | 12            | 2725-99     | 60            |

## MINIATURE PLUG AND JACK

### TWO-CONDUCTOR PRECISION TYPE

Ideal for hearing aids, speaker extensions, carbon microphones, and numerous other installations. Needs no screws; molded plastic case cements together. Illustration shown approximately one-half size.



|          |                            |            |
|----------|----------------------------|------------|
| Cat. No. | Description                | List Price |
| †790     | —1 Plug (type PL-291)..... | \$0.55     |
| †791     | —1 Jack (type JK-48).....  | 0.75       |

For Bulk Quantity Prices on these items, see WALSCO INDUSTRIAL AND BULK PRICE LIST, pages U-47 to U-50.



# WALSCO ELECTRONIC HARDWARE

The 99 Line

The 40 Line

IN PERMANENT *Transparent* PLASTIC STORAGE BOXES with SLIDING TOPS • PACKED IN HANDY ECONOMICAL PLASTIC BAGS



## WALSCO METAL WASHERS

Precision steel washers, Cadmium plated, in standard small sizes for innumerable uses.



| For Screw Size | Dimensions |       |        | THE 40 LINE |               | THE 99 LINE |               |
|----------------|------------|-------|--------|-------------|---------------|-------------|---------------|
|                | I.D.       | O.D.  | Thick. | Cat. No.    | Approx. Quan. | Cat. No.    | Approx. Quan. |
| # 4            | .125"      | 1/8"  | 3/32"  | *3511       | 100           |             |               |
| # 6            | .149"      | 3/16" | 3/32"  | *3512       | 100           | 3512-99     | 500           |
| # 8            | .175"      | 7/32" | 3/32"  | *3513       | 100           | 3513-99     | 500           |
| # 10           | .203"      | 7/16" | 3/32"  | *3514       | 75            | 3514-99     | 300           |
| 1/4"           | .265"      | 1/2"  | 3/32"  | *3515       | 60            | 3515-99     | 300           |
| Assorted       |            |       |        | †3510       | 80            |             |               |

## WALSCO LOCK WASHERS

Made of special steel and rust-proofed. Sizes listed below are the most popular ones in the radio and electrical appliance field.



| For Screw Size | THE 40 LINE |               | THE 99 LINE |               |
|----------------|-------------|---------------|-------------|---------------|
|                | Cat. No.    | Approx. Quan. | Cat. No.    | Approx. Quan. |
| # 6            | *3592       | 50            | 3592-99     | 300           |
| # 8            | *3593       | 45            | 3593-99     | 250           |
| # 10           | *3594       | 40            | 3594-99     | 250           |
| 1/4"           |             |               | 3595-99     | 200           |
| 3/8"           |             |               | 3596-99     | 120           |
| Assorted       | †3590       | 50            |             |               |

## WALSCO KNOB FELT WASHERS

Keep cabinets from being scratched and make knobs turn smoothly. Made of tough brown felt with 1/4" hole to fit standard control and condenser shafts. O.D. is approx. 3/4" and thickness 3/32".



| Felt Washers in cellophane bag | THE 40 LINE |                | THE 99 LINE |                |
|--------------------------------|-------------|----------------|-------------|----------------|
|                                | Cat. No.    | Quan. per pkg. | Cat. No.    | Quan. per pkg. |
|                                | †3490       | 45             | 3490-99     | 250            |

## WALSCO MICA WASHERS AND SHIMS

An assortment of flat and round shims and washers. Required by experimenters and for repairing of trimmers, soldering irons, heater elements, etc.

| Cat. No.             | List Price per pkg. |
|----------------------|---------------------|
| *3428—Assorted sizes | \$0.40              |

## WALSCO INSULATING WASHERS

Precision made of high-grade vulcanized fibre or phenolic material. Used on electronic and electrical equipment to insulate parts from chassis, etc.

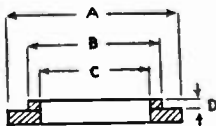
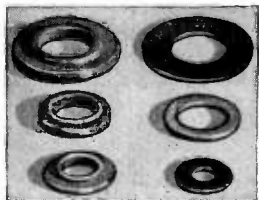

Overall thickness of extruded washers is approximately 3/32" and of the flat washers 3/32".

In the "99 LINE," WALSCO Insulating Washers come in packages of either flat or extruded washers. In the "40 LINE" the packages contain both flat and extruded washers.

| Dimensions     | Fits Screw Size | THE 40 LINE |                | THE 99 LINE |                |
|----------------|-----------------|-------------|----------------|-------------|----------------|
|                |                 | Cat. No.    | Quan. per pkg. | Cat. No.    | Quan. per pkg. |
| A B C          | # 6             | *3431       | 15 and 15      | 3431-F-99   | 250            |
| 1/8 1/8 .136   | # 8             | *3432       | 15 and 15      | 3432-F-99   | 250            |
| 3/16 3/16 .165 | # 10            | *3433       | 15 and 15      | 3433-F-99   | 250            |
| 1/4 .308 .195  | 1/4"            | *3434       | 12 and 12      | 3434-F-99   | 200            |
| 3/8 3/8 3/8    | 3/8"            | *3435       | 10 and 10      | 3535-F-99   | 200            |
| 1/2 1/2 1/2    | 1/2"            | †3430       | 15 and 15      |             |                |
| Assorted       |                 |             |                |             |                |

## WALSCO SPRING (FRICTION) WASHERS



Used in record changers, automatic tuning assemblies, etc. Assortment contains many popular sizes of phosphor bronze and spring steel washers.

| Cat. No.                                 | List Price per pkg. |
|--|---------------------|
| †3425—Approx. 15 Assorted Spring Washers | \$0.40              |

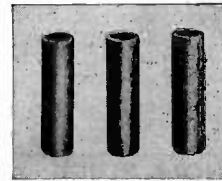

## WALSCO FUSE INSULATORS

Standard fibre insulators for use on automobile radios. Two lengths included fit all standard 1/4" diameter fuses.

| Cat. No.                             | List Price per pkg. |
|--------------------------------------|---------------------|
| †2690—Approx. 16 Assorted Insulators | \$0.40              |

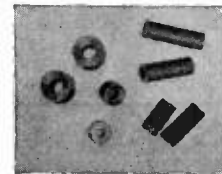

## WALSCO METAL AND INSULATING SPACERS

A popular assortment of spacers of various lengths, with hole size to accommodate #6 and #8 screws. Often used for mounting sockets, switches, and for raising panels, chassis, and condensers.

| Cat. No.                                     | List Price per pkg. |
|--|---------------------|
| *2670—Approx. 12 Assorted Insulating Spacers | \$0.40              |
| *2680—Approx. 12 Assorted Metal Spacers      | 0.40                |

## WALSCO SNAP-IN TRIMOUNTS

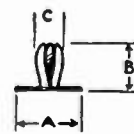

Faster than screws. Use them on modern radio sets, back covers, dial scales, chassis, built-in antennae, etc., to speed assembly and repairs.

| Dimensions     | For Hole | THE 40 LINE |                | THE 99 LINE |                |
|----------------|----------|-------------|----------------|-------------|----------------|
|                |          | Cat. No.    | Quan. per pkg. | Cat. No.    | Quan. per pkg. |
| 1/8 1/8 1/8    | 1/8"     | *3462       | 20             | 3462-99     | 125            |
| 3/16 3/16 3/16 | 3/16"    | *3464       | 18             | 3464-99     | 100            |
| 1/4 1/4 1/4    | 1/4"     | *3465       | 15             | 3465-99     | 100            |
| Assorted       |          | †3460       | approx. 20     |             |                |

## WALSCO RETAINING RINGS AND "C" WASHERS

A necessity in the servicing of volume controls, record changers, etc. The rings are tempered spring steel. The washers are annealed.



| Cat. No. | Description                | Approx. No. of units per pkg. | List Price per pkg. |
|----------|----------------------------|-------------------------------|---------------------|
| †3420    | Assorted Rings & Washers   | 35                            | \$0.40              |
| *3422    | "C" Washers for 1/4" Shaft | 25                            | 0.40                |
| *3423    | "C" Washers for 3/8" Shaft | 25                            | 0.40                |

| THE 40 LINE | THE 99 LINE | Ea. Pkg. — \$1.65 List |           |
|-------------|-------------|------------------------|-----------|
|             |             | Flat                   | Extruded  |
| Cat. No.    | Cat. No.    | Cat. No.               | Cat. No.  |
| *3431       | 3431-F-99   | 3431-E-99              | 3431-E-99 |
| 15 and 15   | 250         | 250                    | 100       |
| *3432       | 3432-F-99   | 3432-E-99              | 3432-E-99 |
| 15 and 15   | 250         | 250                    | 100       |
| *3433       | 3433-F-99   | 3433-E-99              | 3433-E-99 |
| 15 and 15   | 250         | 250                    | 100       |
| *3434       | 3434-F-99   | 3434-E-99              | 3434-E-99 |
| 12 and 12   | 200         | 3434-E-99              | 75        |
| *3435       | 3535-F-99   | 3535-E-99              | 3535-E-99 |
| 10 and 10   | 200         | 3535-E-99              | 75        |
| 15 and 15   |             |                        |           |

For Bulk Quantity Prices on these items, see WALSCO INDUSTRIAL AND BULK PRICE LIST, pages U-47 to U-50.

\*Std. Pack: Display Box of 20 Individual Packages. Add suffix "B" to part number to indicate one standard package. Example: †3330-B consists of standard box containing 20 packages #3330. †Available Either in Standard Display Box of 20 Packages or on Standard Display Card of 20 Packages. When ordering add suffix "B" for box or suffix "D" for display card. See example above.



# WALSCO ELECTRONIC HARDWARE

The 99 Line

The 40 Line

IN PERMANENT TRANSPARENT PLASTIC PACKED IN HANDY STORAGE BOXES with SLIDING TOPS • ECONOMICAL PLASTIC BAGS



## WALSCO STEEL MACHINE SCREWS

Round head, cadmium-plated, steel machine screws. Available in assortments or individual sizes, conveniently packaged for experimenters, servicemen and amateurs.



**WALSCO Standard Machine Screw Ass'tm't**  
All the standard sizes used in electronic and similar work are combined in this handy, inexpensive assortment. It contains Nos. 6, 8, 10 screws— $\frac{1}{4}$  to 1" long.

|                 | THE 40 LINE |               | THE 99 LINE |               |
|-----------------|-------------|---------------|-------------|---------------|
|                 | Cat. No.    | Approx. Quan. | Cat. No.    | Approx. Quan. |
| Assorted Screws | †3560       | 40            | 3560-99     | 200           |

## WALSCO Small Machine Screw & Nut Ass'tm't

A special assortment of extra small screws (Nos. 2 and 4), and nuts so often needed in electronic and experimental work for fastening small parts, to replace rivets, etc.

| Cat. No.  | List Price |
|---|------------|
| †3360—Approximately 30 Assorted Screws and 30 Assorted Nuts, per pkg. | \$0.40     |

## PACKAGES OF SCREWS — INDIVIDUAL SIZES

| Size                      | THE 40 LINE |               | THE 99 LINE |               |
|---------------------------|-------------|---------------|-------------|---------------|
|                           | Cat. No.    | Approx. Quan. | Cat. No.    | Approx. Quan. |
| # 6-32 x $\frac{1}{4}$ "  | †3100       | 40            | 3100-99     | 225           |
| # 6-32 x $\frac{3}{8}$ "  | †3110       | 35            | 3110-99     | 225           |
| # 6-32 x $\frac{1}{2}$ "  | †3120       | 35            | 3120-99     | 200           |
| # 6-32 x $\frac{3}{4}$ "  | *3130       | 30            | 3130-99     | 175           |
| # 6-32 x 1"               |             |               | 3132-99     | 150           |
| # 8-32 x $\frac{1}{4}$ "  | *3135       | 30            | 3135-99     | 200           |
| # 8-32 x $\frac{3}{8}$ "  | †3140       | 30            | 3140-99     | 175           |
| # 8-32 x $\frac{1}{2}$ "  | †3150       | 30            | 3150-99     | 160           |
| # 8-32 x $\frac{3}{4}$ "  | †3160       | 25            | 3160-99     | 140           |
| # 8-32 x 1"               |             |               | 3162-99     | 125           |
| # 10-32 x $\frac{1}{4}$ " | *3165       | 20            | 3165-99     | 150           |
| # 10-32 x $\frac{3}{8}$ " | *3167       | 20            | 3167-99     | 125           |
| # 10-32 x 1"              | *3169       | 15            | 3169-99     | 100           |

## WALSCO SMALL ESCUTCHEON AND WOOD SCREW ASSORTMENT



This assortment contains the extra small sizes of hard-to-get wood screws as needed by radio men, model builders, etc., for fastening name plates, escutcheons and numerous other devices.

| Cat. No.                                   | List Price |
|--|------------|
| †3550—Approx. 30 Assorted Screws, per pkg. | \$0.40     |

## WALSCO Standard Wood Screw Assortment

Handy assortment for workshop or home. Contains round and flathead screws of popular sizes in brass and steel.



| Cat. No.                          | List Price |
|-----------------------------------|------------|
| †3553—Approx. 30 Screws, per pkg. | \$0.40     |

## WALSCO THREADED STEEL RODS



These rods have many uses in service and repair work and are made from the finest cold rolled steel to give maximum strength. Each package contains one each

| Cat. No.                                | List Price |
|---|------------|
| †2640—1 each 6-32 and 8-32 Threaded Rod | \$0.40     |

## WALSCO SHEET METAL AND SELF-TAPPING SCREWS

These screws cut their own threads in either metal or plastic. Just drill a hole and drive in the screw—no nut or tapping required. Ideal for mounting parts to chassis, replacing rivets and eyelets, etc.



| Size                   | THE 40 LINE |               | THE 99 LINE |               |
|------------------------|-------------|---------------|-------------|---------------|
|                        | Cat. No.    | Approx. Quan. | Cat. No.    | Approx. Quan. |
| Assorted               | †3470       | 30            | 3470-99     | 125           |
| # 6 x $\frac{1}{4}$ "  | †2910       | 30            | 2910-99     | 150           |
| # 6 x $\frac{3}{8}$ "  | *2911       | 25            | 2911-99     | 150           |
| # 6 x $\frac{1}{2}$ "  | *2912       | 25            | 2912-99     | 150           |
| # 6 x $\frac{3}{4}$ "  | *2914       | 20            | 2914-99     | 125           |
| # 6 x 1"               | *2916       | 20            | 2916-99     | 100           |
| # 8 x $\frac{1}{4}$ "  | *2919       | 25            | 2919-99     | 125           |
| # 8 x $\frac{3}{8}$ "  | *2920       | 25            | 2920-99     | 125           |
| # 8 x $\frac{1}{2}$ "  | *2922       | 20            | 2922-99     | 125           |
| # 8 x $\frac{3}{4}$ "  | *2924       | 15            | 2924-99     | 100           |
| # 8 x 1"               | *2926       | 15            | 2926-99     | 100           |
| # 10 x $\frac{3}{8}$ " | *2930       | 20            | 2930-99     | 100           |
| # 10 x $\frac{1}{2}$ " | *2932       | 16            | 2932-99     | 100           |
| # 10 x $\frac{3}{4}$ " | *2934       | 15            | 2934-99     | 100           |

## WALSCO RACK SCREWS & CUP WASHERS



For mounting panels in racks and cabinets, fastening record-players and recording chassis, etc. Enhances appearance of any assembly. The oval head screws are nickel plated—so are the cup washers.

| Size                                 | THE 40 LINE |               | THE 99 LINE |               |
|--------------------------------------|-------------|---------------|-------------|---------------|
|                                      | Cat. No.    | Approx. Quan. | Cat. No.    | Approx. Quan. |
| # 6-32 x $\frac{5}{8}$ " Screws      | *3543       | 30            | 3543-99     | 175           |
| # 8-32 x $\frac{5}{8}$ " Screws      | *3541       | 25            | 3541-99     | 125           |
| # 10-32 x $\frac{5}{8}$ " Screws     | *3542       | 20            | 3542-99     | 100           |
| # 6 Washers ( $\frac{1}{8}$ " O.D.)  | *3544       | 50            | 3544-99     | 300           |
| # 8 Washers ( $\frac{1}{4}$ " O.D.)  | *3545       | 40            | 3545-99     | 250           |
| # 10 Washers ( $\frac{3}{8}$ " O.D.) | *3546       | 25            | 3546-99     | 200           |
| Asstd. Screws & Washers              | †3540       | 12            |             |               |

## WALSCO ORNAMENTAL HEAD SCREWS

Antique bronze finished; rosette head. For mounting of speakers, etc.



| Size                       | THE 40 LINE |                        | THE 99 LINE |                        |
|----------------------------|-------------|------------------------|-------------|------------------------|
|                            | Cat. No.    | Approx. Quan. per pkg. | Cat. No.    | Approx. Quan. per pkg. |
| # 6-32 x $\frac{3}{4}$ "   | *2951       | 20                     | 2951-99     | 125                    |
| # 6-32 x 1"                | *2952       | 20                     | 2952-99     | 125                    |
| # 8-32 x 1 $\frac{1}{4}$ " | *2953       | 12                     | 2953-99     | 80                     |
| Assorted                   | †2950       | 15                     |             |                        |

## WALSCO STEEL SET SCREWS

Precision, hardened steel set screws in all popular sizes for radio knobs, record changers, home and automobile radios, or wherever set screws are needed.



| Size                      | THE 40 LINE |               | THE 99 LINE |               |
|---------------------------|-------------|---------------|-------------|---------------|
|                           | Cat. No.    | Approx. Quan. | Cat. No.    | Approx. Quan. |
| # 6-32 x $\frac{3}{8}$ "  | †3210       | 12            |             |               |
| # 8-32 x $\frac{3}{8}$ "  | †3220       | 12            | 3220-99     | 75            |
| # 8-32 x $\frac{1}{2}$ "  | †3230       | 12            |             |               |
| # 10-32 x $\frac{1}{2}$ " | †3237       | 12            |             |               |
| Assorted                  | †3480       | 15            | 3480-99     | 75            |

For Bulk Quantity Prices on these items, see WALSCO INDUSTRIAL AND BULK PRICE LIST, pages U-47 to U-50.



# WALSCO ELECTRONIC HARDWARE

The **99** Line

The **40** Line

IN PERMANENT **Transparent PLASTIC** PACKED IN **HANDY ECONOMICAL PLASTIC BAGS** with **SLIDING TOPS**

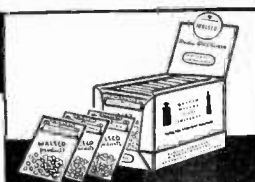

## WALSCO MACHINE SCREW NUTS



Walsco nuts are "Small Pattern" as preferred in the electronic and electric trade. Precision made and plated.

| Size     | THE 40 LINE |       | THE 99 LINE |       |
|----------|-------------|-------|-------------|-------|
|          | Cat. No.    | Quan. | Cat. No.    | Quan. |
| # 4-40   |             |       |             |       |
| # 6-32   | *3180       | 35    | 3180-B-99   | 150   |
| # 8-32   | *3190       | 30    | 3190-B-99   | 125   |
| # 10-32  | *3195       | 25    | 3195-B-99   | 100   |
| Assorted | †3520       | 35    |             |       |

## WALSCO SPECIAL MOUNTING NUTS

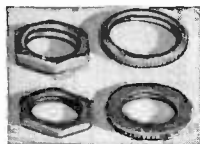

Various kinds of nuts used on volume controls, switches, jacks, potentiometers, etc. A "must" for every radioman and electrician. All nuts are cadmium or nickel plated.

| Description                          | THE 40 LINE |       | THE 99 LINE |       |
|--------------------------------------|-------------|-------|-------------|-------|
|                                      | Cat. No.    | Quan. | Cat. No.    | Quan. |
| 3/8" x 32 Vol. Control Hex Nut....   | *3531       | 12    | 3531-99     | 100   |
| 3/8" x 32 Toggle Switch Hex Nut....  | *3532       | 10    | 3532-99     | 50    |
| 3/8" x 32 Toggle Switch Ring Nut.... | *3533       | 8     | 3533-99     | 50    |
| Assorted                             | †3530       | 15    |             |       |

**WALSCO ACORN NUTS**  
Greatly improves the appearance on panel assemblies, test instruments, cabinets, etc. These PAL type steel nuts are self-locking and bright cadmium plated.  
Cat. No. List per pkg.  
\*2960—12 Assorted Nuts ..... \$0.40

## WALSCO KNURLED THUMB NUTS



Precision-made, Brass Nuts. List Price per pkg.  
Cat. No. per pkg.  
\*2971—Approx. 12 Nuts, 6-32 ..... \$0.40  
\*2972—Approx. 12 Nuts, 8-32 ..... 0.40  
\*2973—Approx. 6 Nuts, 10-32 ..... 0.40

## WALSCO WING NUTS



Handy for experimental work and hobby craft. Made of Steel and plated. List Price per pkg.  
Cat. No. per pkg.  
\*2975—10 Nuts, 6-32 ..... \$0.40  
\*2976—10 Nuts, 8-32 ..... 0.40  
\*2977—8 Nuts, 10-32 ..... 0.40

## WALSCO SPEED NUTS

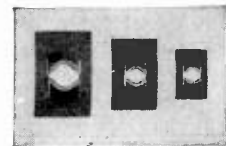

Self-locking and easy to install. Often required for replacement on many record changers, tuning units, etc. List Price per pkg.  
Cat. No. per pkg.  
\*2980—Approx. 30 Assorted Speed Nuts..... \$0.40

## WALSCO TWIN-LEAD WIRING NAILS

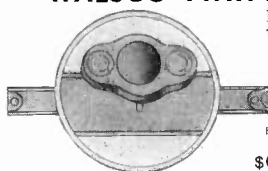

Designed for attaching 300-ohm leads to walls, moldings, etc. Ornamental head greatly improves the appearance of the installation. WALSCO nails have no appreciable effect on the impedance of the line as the heads consist almost entirely of insulating material.

| Cat. No.                 | THE 40 LINE |       | THE 99 LINE |       |
|--------------------------|-------------|-------|-------------|-------|
|                          | Cat. No.    | Quan. | Cat. No.    | Quan. |
| WALSCO Wiring Nails..... | 2552        | 35    | 2552-99     | 200   |

## WALSCO DIAL DRIVE SPRINGS

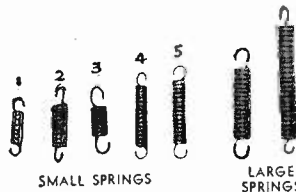

Made of fine music wire for greater flexibility. Available in all standard sizes. Carefully looped at each end, rust-proofed and cadmium plated.

Illustration Approximately two-thirds actual size

| Springs                     | THE 40 LINE |                | THE 99 LINE |                |
|-----------------------------|-------------|----------------|-------------|----------------|
|                             | Cat. No.    | Quan. per pkg. | Cat. No.    | Quan. per pkg. |
| Assorted (Large and Small)  | 3400        | 10             | 3400-99     | 50             |
| Assorted Small Springs..... | 3410        | 10             |             |                |

| Cat. No. | Dimensions     |       |                | No. of springs per pkg. | List Price |
|----------|----------------|-------|----------------|-------------------------|------------|
|          | Overall Length | Diam. | Wire Thickness |                         |            |
| *3411    | 1/2"           | 3/8"  | .016"          | 1                       | \$0.40     |
| *3412    | 5/8"           | 3/8"  | .018"          | 2                       | 0.40       |
| *3413    | 1 1/8"         | 3/8"  | .020"          | 3                       | 0.40       |
| *3414    | 3/4"           | 7/8"  | .016"          | 4                       | 0.40       |
| *3415    | 3/4"           | 7/8"  | .020"          | 5                       | 0.40       |

## WALSCO RADIO KNOB SPRINGS



The modern method of fastening knobs to shafts. Available in all regular sizes and shapes. The assortment is complete and most useful to radio shops. Finest grade of selected steel is used.

| Cat. No. | Picture No. Assorted | Approx. No. of Springs per pkg. | List per pkg. |
|----------|----------------------|---------------------------------|---------------|
|          |                      |                                 |               |
| *3451    | 10                   | 0.40                            |               |
| *3452    | 2                    | 0.40                            |               |
| *3455    | 5                    | 0.40                            |               |
| *3456    | 6                    | 0.40                            |               |
| *3457    | 7                    | 0.40                            |               |
| *3458    | 8                    | 0.40                            |               |
| *3459    | 9                    | 0.40                            |               |

(Bulk Prices Upon Request)

## WALSCO EXPANSION SPRINGS

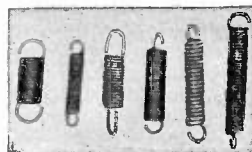

Very handy for radio and electrical shops, laboratories, etc. The assortments contain various sizes of springs for many applications: record changers—to name one of a thousand.

| Cat. No.                             | List per pkg. |
|--------------------------------------|---------------|
| †3290—10 Assorted Large Springs..... | \$0.40        |
| †3390—10 Assorted Small Springs..... | 0.40          |

## WALSCO COMPRESSION SPRINGS

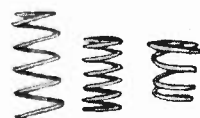

A hard-to-get item. The Walsco assortments contain all of the springs often needed for repair work on radio and electronic equipment, motors, appliances, etc. Available in two assortments.

| Cat. No.                             | List per pkg. |
|--------------------------------------|---------------|
| †3370—20 Assorted Small Springs..... | \$0.40        |
| †3380—15 Assorted Large Springs..... | 0.40          |

## WALSCO ESCUTCHEON PIN ASSORTMENT



Brass finished pins in various sizes and lengths from 1/4" to 1".

| Cat. No.                      | List per pkg. |
|-------------------------------|---------------|
| †3555—Approx. 100 Asstd. Pins | \$0.40        |

For Bulk Quantity Prices on these items, see **WALSCO INDUSTRIAL AND BULK PRICE LIST, pages U-47 to U-50.**

\*Std. Pack: Display Box of 20 Individual Packages. Add suffix "B" to part number to indicate one standard package. Example: 1 #3330-B consists of standard box containing 20 packages #3330.  
†Available Either in Standard Display Box of 20 Packages or on Standard Display Card of 20 Packages. When ordering add suffix "B" for box or suffix "D" for display card. See example above.



## WALSCO RADIO CEMENT

**Vibration-Proof Heat Resisting**  
**Unsurpassed Adhesive Power**

An elastic cement especially made for the manufacture and repairing of speakers and for general radio work. Unaffected by vibration, dries fast and will never become brittle with age. • The latest developments in synthetic resins and gums are incorporated in Walsco Radio Cement.

• In addition to its use for speaker repair, Walsco Radio Cement can be used for repairing cabinets, loose tube bases, grid caps, etc. It will provide a strong bond between almost any materials and is not affected by high temperature, moisture or oil. All bottles come with built-in brush and have an evaporation-proof cap liner.



| Cat. No.               | List Price |
|------------------------|------------|
| 51—1 3/4 oz. tube..... | \$0.55     |
| 52—2 oz. bottle.....   | 0.60       |
| 54—4 oz. bottle.....   | 1.10       |
| 58—8 oz. bottle.....   | 1.75       |
| 59—1 pt. bottle.....   | 3.30       |
| 50-GL—1 gal. can.....  | 12.50      |

Also available in 5, 15, 50 gal. containers.

## WALSCO PLASTIC CEMENT

Especially made to repair broken plastic cabinets, knobs, etc. Waterproof, heat-resisting, and heavier in substance than Walsco Radio Cement. Unexcelled as "Household Cement," "Model Airplane Cement," etc. Cements Plastics, Metal, Wood, Glass, etc. Dries fast and forms an exceedingly strong bond.

| Cat. No.               | List Price |
|------------------------|------------|
| 41—1 3/4 oz. tube..... | \$0.55     |
| 42—2 oz. bottle.....   | 0.60       |
| 44—4 oz. bottle.....   | 1.10       |
| 48—8 oz. bottle.....   | 1.75       |



## WALSCO VINYLITE CEMENT

This adhesive uses the new Vinylite plastic resin as a base and has remarkable properties such as high tackiness, extreme flexibility when dry and excellent adhesion to metals, plastics, leather, cardboard and paper. Fast drying. Also an excellent thermoplastic cement for joining nonporous materials (e.g. metals). In this case the cement is applied to both surfaces and dried after which the parts are pressed together and bond established by heating with flatiron, soldering iron, etc.



| Cat. No.             | List Price |
|----------------------|------------|
| 25—2 oz. bottle..... | \$0.70     |

## WALSCO ALL-PURPOSE RUBBER CEMENT

For cementing rubber parts to metal or wood, rubber mounts to chassis, rubber cushions to lids, etc.—gives an especially strong bond. A Radio Serviceman should always have a bottle on his work bench.

| Cat. No.              | List Price |
|-----------------------|------------|
| 112—2 oz. bottle..... | \$0.60     |
| 114—4 oz. bottle..... | 1.10       |



## CEMENTS—SOLVENTS COIL DOPE—IMPRECONE

### WALSCO FABRIC CEMENT

**Does Not Penetrate the Fabric**

Especially made for attaching grille cloth, turntable felt, covering of portable radios, etc. Dries very fast; is unaffected by moisture, sunlight, and high temperature and does not become brittle. Indispensable to Radio Dealers and Servicemen—eliminates the danger of spoiling the outside of a grille cloth, turntable felt, or other fabrics, since it does not penetrate the material.

| Cat. No.               | List Price |
|------------------------|------------|
| 21—1 3/4 oz. tube..... | \$0.55     |



### WALSCO WOOD GLUE

An "extra strength" adhesive incorporating the latest chemical developments and resins. A "must" item for every repair shop. Bottle caps have non-sticking rubber gaskets.

| Cat. No.              | List Price |
|-----------------------|------------|
| 222—2 oz. bottle..... | \$0.60     |
| 224—4 oz. bottle..... | 1.00       |



### WALSCO CEMENT SOLVENT AND THINNER

This Cement-Solvent is used for loosening cement on speaker cones, voice coils, and other parts where cement has been applied previously. Recommended also for thinning Walsco Radio Cement, Plastic Cement, and Fabric Cement.

| Cat. No.             | List Price |
|----------------------|------------|
| 62—2 oz. bottle..... | \$0.50     |
| 64—4 oz. bottle..... | 0.65       |
| 68—8 oz. bottle..... | 0.90       |
| 69—1 pt. bottle..... | 1.40       |



### WALSCO POLYSTYRENE CEMENT AND COIL DOPE

**For Bonding Polystyrene Parts and Coil Coating in Radio and High Frequency Work**  
A Polystyrene solution with a high solid content. Can be brushed on or parts can be dipped. Renders coils or other parts moisture-proof. Holds windings firmly in place due to a certain amount of shrinkage upon drying. Electrical losses due to coating with this cement are negligible—even if used for high or ultra-high frequency work.

| Cat. No.              | List Price |
|-----------------------|------------|
| 154—4 oz. bottle..... | \$1.00     |

Larger Sizes on Request

### WALSCO Polystyrene Solvent and Thinner

This thinner is especially designed for use with Walsco Polystyrene Cement where regular thinner cannot be used.

| Cat. No.              | List Price |
|-----------------------|------------|
| 164—4 oz. bottle..... | \$0.60     |

### WALSCO IMPRECONE

An impregnating fluid which will render speaker cones moisture-repellent and impervious to fungus and mildew. Also prevents the drying out of cones under heat or adverse climatic conditions. Restores brittle cones to original texture. Developed for use in drive-in theatre installations, on outdoor speakers, car radios, etc.

| Cat. No.              | List Price |
|-----------------------|------------|
| 98 —8 oz. bottle..... | \$ 1.60    |
| 98-GL—1 gal. can..... | 17.50      |



For Bulk Quantity Prices on these items, see WALSCO INDUSTRIAL AND BULK PRICE LIST, pages U-47 to U-50.

# WALSCO products

Help The Radio Man

WALTER L. SCHOTT COMPANY, BEVERLY HILLS, CALIFORNIA

## CLEANERS — LUBRICANTS "CONTACTENE"—"NO SLIP"



### WALSCOLUB - B

A recently-developed chemical compound in thin paste form. WALSCOLUB - B counteracts oxidation, prevents corrosion of metals and eliminates noise on band switches, push buttons, tuners, volume and other controls, as well as air-exposed electrical contacts, attenuators, etc. WALSCOLUB-B will not change electrical properties. It is superior to any graphite compound for this purpose. Ideal on metal surfaces to prevent rust. Servicemen: Its use will save you both time and money. Once you have tried it, you will never be without it! Large, handy applicator tube.

Available also in 1-lb., 5-lb. and 25-lb. containers for industrial users. Prices on request.

|                        |            |
|------------------------|------------|
| Cat. No.               | List Price |
| 22—1 3/4 oz. tube..... | \$0.55     |

### WALSCO CONTACTENE

New Improved "Contact Cleaning Fluid"

- Cleans contacts and controls.
- Keeps controls and contacts noise-free.
- Lubricates and reduces friction.



A fast-evaporating combination of special solvents affording greatest cleaning power without affecting insulating materials. Contains "No-Ox," which after evaporation of the solvents, forms a thin film that protects the contacts. Contactene is recommended for treating volume controls, band switches, tuning condensers, springs, etc., to eliminate noisy operation. Bottles come with built-in brushes.

|                      |            |
|----------------------|------------|
| Cat. No.             | List Price |
| 82—2 oz. bottle..... | \$0.50     |
| 84—4 oz. bottle..... | 0.75       |
| 88—8 oz. bottle..... | 1.00       |
| 89—1 pt. bottle..... | 1.80       |

### WALSCO Motor and Gear Lubricant

The latest development in chemicals for lubricating purposes. Much superior to greases because of its higher lubricating and lasting qualities. Its viscosity does not change with temperature. Used on phonograph motors, record changers, and all appliances that require a grease-type lubricant. In large handy "applicator" tube.



|                        |            |
|------------------------|------------|
| Cat. No.               | List Price |
| 23—1 3/4 oz. tube..... | \$0.55     |

### WALSCO "NO-SLIP"

A newly developed chemical composition that greatly increases the friction of pulleys, cords or belts. Contracts, "sets" and shrinks the fibres at the same time. Stops instantly any slippage of Dial Belts, Dial Cords, etc. Easily applied with brush. Indispensable to any radio man.

|                         |            |
|-------------------------|------------|
| Cat. No.                | List Price |
| 401—1/2 oz. bottle..... | \$0.45     |
| 402— 2 oz. bottle.....  | 0.75       |

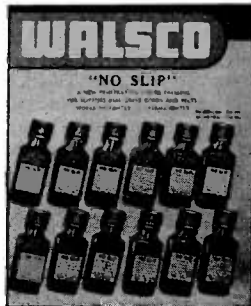

### WALSCO "NO-OX"\*

#### "The Miracle Electronic Contact Fluid"



Fast-acting liquid chemical formulated with a neutral, non-gumming special lubricating base. The answer to the radio-man's need for an outstanding contact and control cleaner. Contains no solvents; its corrosion-dissolving action is entirely chemical. Cleans, lubricates and preserves. Proved in tens of thousands of applications by radio laboratories, service shops, broadcasting companies, motion picture, sound and recording studios, etc. "NO-OX" is highly recommended for treatment of volume and tone controls, attenuators, mixers, relay contacts and similar equipment.

|                          |            |
|--------------------------|------------|
| Cat. No.                 | List Price |
| 101—1 oz. bottle.....    | \$0.85     |
| 102—2 oz. bottle.....    | 1.60       |
| 100-16—1 pt. bottle..... | 12.50      |

\* Mfd. under exclusive licensing agreement with NO-OX Laboratories. Trade mark registered.

### WALSCOFLUX

A non-corrosive flux. Quick acting, easy to apply. May be safely used for all electrical, radio and telephone work. Helps to keep the iron tip clean.



|                                       |            |
|---------------------------------------|------------|
| Cat. No.                              | List Price |
| 220—2 oz. bottle with applicator..... | \$0.60     |

### WALSCO SOLDERING PASTE

A high-quality paste, fast acting and safe for most electrical and electronic uses.

|                    |            |
|--------------------|------------|
| Cat. No.           | List Price |
| 221—2 oz. can..... | \$0.30     |

|                                  |      |
|----------------------------------|------|
| 221-D—Display of 24 No. 221..... | 7.20 |
|----------------------------------|------|



### WALSCO CARBON TETRACHLORIDE

For general cleaning and spot removing. Dissolves dirt and grease instantly. May be used on most delicate parts. Chemically pure, rapid drying, non-explosive and non-inflammable. A safe cleaning fluid.

|                          |            |
|--------------------------|------------|
| Cat. No.                 | List Price |
| 214 — 4 oz. bottle.....  | \$0.60     |
| 219 — 16 oz. bottle..... | 1.65       |
| 214GL—1 gal. can.....    | 6.25       |



### WALSCO RADIO DIAL OIL

A light-bodied lubricating oil for all electronic and electrical appliances — absolutely free of acids or gummy substances. Also recommended as a rust preventive for radio chassis, tools, machinery, etc.



|                      |            |
|----------------------|------------|
| Cat. No.             | List Price |
| 72—2 oz. bottle..... | \$0.45     |
| 74—4 oz. bottle..... | 0.60       |

### WALSCO CONTACTENE INJECTOR

For applying WALSCO Contactene, NO-OX, Dial Oil, etc., to spots which are not accessible with ordinary applicators. "Injector Needle" will permit application of contact chemicals to most volume controls without unsoldering connections or taking control apart.

This tool is made with a highest quality surgical-grade needle, and an oil-resistant rubber bulb.

|                                  |            |
|----------------------------------|------------|
| Cat. No.                         | List Price |
| 989 —Contactene Injector.....    | \$0.75     |
| 989 D—Display of 12 No. 989..... | 9.00       |



For Bulk Quantity Prices on these items, see WALSCO INDUSTRIAL AND BULK PRICE LIST, pages U-47 to U-50.



### WALSCO SCRATCH REMOVING POLISH

"Makes Scratches Disappear"

A blend of polishing and staining ingredients. Removes scratches from cabinets, radios, furniture, etc., and polishes at the same time. Very easy to apply. Will not change shade of finish. Comes in two shades: "Dark" for walnut, mahogany, etc., "Light" for light maple, light oak, etc.



| Cat. No.          |       | List Price               |
|-------------------|-------|--------------------------|
| Dark              | Light |                          |
| 414               | 434   | 4 oz. bottle.....\$0.50  |
| 416               | 438   | 8 oz. bottle.....0.75    |
| Standard Package: |       | 4 oz. bottles.....1 doz. |
|                   |       | 8 oz. bottles.....2 doz. |

### WALSCO SUPER POLISH

"A Concentrated White Cream Wax Polish"

Does two things: First, it removes any old polish, grease or dirt that may be on the cabinet or furniture. Second, it forms a hard, dry and durable film that will protect the object for a long time, giving it a "brand new" appearance. Requires very little rubbing.

| Cat. No.          |   | List Price               |
|-------------------|---|--------------------------|
| 412               | 4 |                          |
| 418               | 8 | 8 oz. bottle.....0.75    |
| Standard Package: |   | 4 oz. bottles.....1 doz. |
|                   |   | 8 oz. bottles.....2 doz. |

### WALSCOCLEAR (Formula 91)

A scientific preparation for cleaning plastics such as television filters, lenses, optical systems, vinyl and LP records, etc.

WALSCOCLEAR contains a new chemical discovery that counteracts the dust-attracting electrostatic effect which usually interferes with proper polishing of plastic articles.

WALSCOCLEAR is very easy to apply, gives a wonderful polish, and is absolutely harmless to all plastics.

| Cat. No. |  | List Price |
|----------|--|------------|
| 91       | 4  |            |
| 91D      | Display of 12 bottles of No. 91.....6.00 |            |



### WALSCO RECORDGRIP

Positively stops slipping of phonograph records on changers. Indispensable for new plastic light-weight and vinyl records, to assure uniform speed and undistorted reproduction. "Recordgrip" is transparent and easily applied to the records by marking an "X" on the record label on each side. Application is permanent and one stick is sufficient for several dozen records.

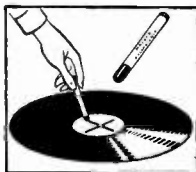

| Cat. No. |   | List Price                         |
|----------|---|------------------------------------|
| 405      | — |                                    |
| 405-D    | — | Display of 20 No. 405 Sticks 10.00 |

### WALSCO INSECTENE

A new WALSCO development to control insects such as spiders, beetles and roaches, often found in juke boxes, radio cabinets, and amplifiers. Will kill insects on contact, and provides a coating with long-lasting repellent action. WALSCO Insectene is best applied to cabinets and chassis with a brush or regular insecticide spray gun. Harmless to wiring and parts.

| Cat. No. |   | List Price           |
|----------|---|----------------------|
| 448      | — |                      |
| 448GL    | — | 1 gal. can.....12.50 |



### WALSCO AIR-DRY WRINKLE VARNISH

Easy to apply in one coat. WALSCO Air-Dry Wrinkle Varnish provides a film that is hard, tough, and very resistant to wear. Repairs and replaces original wrinkle finish of manufactured equipment. No baking required. WALSCO Wrinkle Varnish will air-dry at room temperature.

Standard colors: grey and black. Other colors upon request.



| Cat. No. |   | List Price                          |
|----------|---|-------------------------------------|
| 145      | — |                                     |
| 147      | — | 16 oz. can (specify color).....3.00 |

### WALSCO CRYSTALLIZING LACQUER

Easily applied to metal, wood, cardboard, etc.—does not require experience. No spraying equipment or baking oven necessary. Brushed on, will dry in about thirty minutes, leaving an absolutely professional finish. Identical to finish found on commercial chassis, panels, speakers and transformers. WalSCO Lacquer Sealer, Cat. No. 142, should be used as undercoat if this lacquer is to be applied on porous materials or over other finishes. Available colors: Black, Green, Grey, Brown, Clear. Specify color when ordering.



| Cat. No. |   | List Price                 |
|----------|---|----------------------------|
| 122      | — |                            |
| 129      | — | 16 oz. can.....3.00        |
| 142      | — | Sealer, 2 oz. jar.....0.50 |

### WALSCO SATIN FINISH LACQUER (TELEPHONE)

Made for commercial and amateur use on cabinets, chassis, panels, meters, racks, etc. This "satin finish" lacquer dries very fast and produces the "original finish" of most standard telephone and communication equipment. It air dries. May be brushed or sprayed.



| Cat. No. |     | List Price         |
|----------|-----|--------------------|
| 172      | 182 |                    |
| 179      | 189 | 1 pt. can.....2.50 |

### WALSCO INSULATING VARNISH

WalSCO "air-dry" varnish is fast-drying and produces excellent results when used on radio coils, transformers, solenoids, motors, and all electrical appliances. Withstands heat and is extremely resistant to acid, oil, and grease. It is non-corrosive and moisture-proof. An all-around clear insulating varnish.



| Cat. No. |   | List Price          |
|----------|---|---------------------|
| 192      | — |                     |
| 193      | — | 1 pt. can.....2.00  |
| 194      | — | 1 gal. can.....9.00 |

### WALSCO LIGHT BULB COLORING

A transparent, heat and moisture-resisting dipping lacquer especially made for coloring bulbs such as used in radio dials, signal systems, auto dash lights, and fancy illumination. Big jars permit dipping of even larger bulbs.

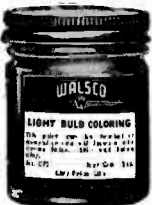

| Cat. No. |          | List Price           |
|----------|----------|----------------------|
| 116      | Red      |                      |
| 117      | Blue     | — 2 oz. jar.....0.60 |
| 118      | Green    | — 2 oz. jar.....0.60 |
| 119      | Assorted | — Kit of 3.....1.60  |

For Bulk Quantity Prices on these items, see WALSCO INDUSTRIAL AND BULK PRICE LIST, pages U-47 to U-50.

# WALSCO products

Help The Radio Man

WALTER L. SCHOTT COMPANY, BEVERLY HILLS, CALIFORNIA

## REFINISHING and REPAIR KITS

### WALSCO RADIO CABINET PATCHING OUTFIT

"The Most Popular Kit on the Market"



A complete kit especially designed for radio men who have little experience in cabinet work. Over 95% of all cabinet-finish damages can be repaired with this kit. The kit contains two shades of Spirit Walnut Stain, Dark Brown Lacquer, Plastic Wood, two shades of Ivory Spirit Enamel, Patching Lacquer, Super Polish, Alcohol, Brushes, Garnet Finishing Paper, French Polishing Pad, and Steel Wool, together with complete Instruction Booklet.

| Cat. No.                                | List   | Dealer's Net |
|---|--------|--------------|
| K-10—In sturdy box with hinged lid..... | \$6.50 | \$3.90       |
| K-10-W—In California redwood case.....  | 7.50   | 4.50         |

### WALSCO RADIO CABINET REPAIR KIT

A very handy compact and inexpensive kit that fills the requirements of many shops and stores. Especially useful for the Dealer or Serviceman who has only occasional cabinet repairs. The kit contains one bottle each of the following: Ivory Spirit Enamel—light and dark; Lacquer Enamel—Dark Brown; Spirit Stain; Super Polish; French Varnish; Finishing Paper; Steel Wool; Polishing Cloth; Instruction Booklet.



| Cat. No. | List   | Dealer's Net |
|----------|--------|--------------|
| K-9..... | \$3.00 | \$1.80       |

### WALSCO STICK SHELLAC KIT



An inexpensive kit for servicemen who have some experience in cabinet refinishing. Combined with Radio Cabinet Patching Outfit (K-10) it makes a most economical and completely professional kit for repairing radio cabinets. The shellac sticks match in color almost any cabinet on the market. The WalSCO shellac rubbing fluid makes it possible to smooth the patch without any

effort or skill. Kit includes: six colors Stick Shellac, Alcohol Lamp, Burn-in Spatula, bottle of Shellac Rubbing Fluid, Felt, Steel Wool, Alcohol and Instructions.

| Cat. No.  | List   | Dealer's Net |
|-----------|--------|--------------|
| K-11..... | \$3.50 | \$2.10       |

### REFILLS OF POPULAR REFINISHING MATERIALS AS CONTAINED IN ABOVE KITS

| Cat. No.  | Stains                           | List Price |
|---|----------------------------------|------------|
| 287—Spirit Stain, 2 oz.....                             | (Walnut, Mahogany, Maple, Black) | \$0.30     |
| 288—Spirit Stain, 8 oz.....                             |                                  | 1.40       |
| 289—Blending Stain (Lt. Brown, Med. Brown).....         |                                  | 0.75       |
| Patching Lacquer (Improved French Varnishing Materials) |                                  |            |
| 290—4 oz. bottle.....                                   |                                  | 1.20       |
| 291—16 oz. bottle.....                                  |                                  | 3.50       |
| Stick Shellac Rubbing Fluid                             |                                  |            |
| 295—4 oz. bottle.....                                   |                                  | .75        |
| 296—16 oz. bottle.....                                  |                                  | 1.75       |
| Stick Shellac   |                                  |            |
| 299—Set of 8 assorted colors.....                       |                                  | 1.50       |

### WALSCO "SUPER-CHIEF" REFINISHING KIT

A "Must" Item



This is the most complete kit of its kind on the market. Designed by WalSCO for radio dealers. It contains everything which is needed to make an old radio look like new—all handy in one box-type carrying case. Contents of kit can be used by either skilled or unskilled refinishers, to completely refinish old radios and trade-ins, or to quickly patch up scratches, mars, etc. This kit will pay for itself on the first or second job. Every first-class radio dealer should have one. Kit contains the following:

|                                 |                                 |
|---------------------------------|---------------------------------|
| Spirit Stain Dark Walnut        | Scratch Removing Polish (Dark)  |
| Spirit Stain Black              | Scratch Removing Polish (Light) |
| Spirit Stain Mahogany           | Patching Lacquer                |
| Spirit Stain Maple              | Alcohol Lamp                    |
| Super Polish                    | Alcohol                         |
| Spirit Stain Light Walnut       | Spatula                         |
| Blending Stain Light Brown      | Felt                            |
| Blending Stain Medium Brown     | Polishing Cloth                 |
| Lacquer Enamel Light Ivory      | Polishing Pad                   |
| Lacquer Enamel Dark Brown       | Garnet Paper (8 sheets)         |
| Lacquer Enamel Dark Ivory       | Instruction Book                |
| Shellac Rubbing Fluid           | Brushes (8 different sizes)     |
| Stick Shellac (8 asstd. shades) |                                 |

| Cat. No.  | List    | Dealer's Net |
|-----------|---------|--------------|
| K-26..... | \$18.50 | \$11.10      |

### WALSCO FURNITURE REFINISHING KIT

Ideal for touch-up work on radios, furniture, pianos, etc. Scratches, mars, dents, broken edges can be repaired quickly. Contains: Super Polish, Patching Lacquer, Alcohol, Spirit Stains in Walnut, Mahogany, Maple and Black; Shellac Rubbing Fluid, Plastic Wood, six colors Stick Shellac, Alcohol Lamp, Spatula, Brushes, Garnet Finishing Paper, Complete Instruction Book. Kit furnished in California Redwood case with hinged lid.



| Cat. No.  | List   | Dealer's Net |
|-----------|--------|--------------|
| K-15..... | \$8.00 | \$4.80       |

### WALSCO PHONO TURNTABLE FELTS

Made of high-quality brown felt, accurately die-cut with concentric center hole. Use WALSCO Radio Cement or WALSCO Fabric Cement for attaching.

| Cat. No.                     | List Price |
|------------------------------|------------|
| 350-8 — 7 7/8" diameter..... | \$0.45     |
| 350-9 — 8 7/8" diameter..... | 0.60       |
| 350-10— 9 7/8" diameter..... | 0.65       |
| 350-12—11 7/8" diameter..... | 0.75       |



For Bulk Quantity Prices on these items, see WALSCO INDUSTRIAL AND BULK PRICE LIST, pages U-47 to U-50.

## INSULATING TUBING FLOCK FINISH — DIAL CRYSTALS

### WALSCO FLOCK FINISH SPRAY KIT

For flock finishing of radio cabinets, speaker grilles, interior of record and other cabinets, turntables, jewelry and gift boxes, toys, novelties and many automotive and hobby uses. This original WALSCO Flock Kit is very easy to use and requires no skill — anyone can obtain expert results. Contains everything to produce a colorful, velvet-like and durable flock finish. The kit includes patented felt flock spray gun, ivory and brown felt flock, undercoats to match, thinner, brushes and complete instructions.

Cat. No. K-50—Complete Flocking Kit..... List Price, \$11.90

### WALSCO FELT FLOCK MATERIALS

#### Felt Flock

Made of precision cut, lustrous rayon. Packed in 3 1/4 oz. containers (covers 7 to 10 square feet). List Price.....\$1.65

| Cat. No. | Color  | Cat. No. | Color  |
|----------|--------|----------|--------|
| 470      | Brown  | 475      | Green  |
| 471      | Ivory  | 476      | Silver |
| 472      | Blue   | 477      | White  |
| 473      | Taupe  | 478      | Black  |
| 474      | Red    | 479      | Canary |
| 474-1    | Maroon |          |        |

List Price  
Flock per pound (specify color).....\$5.50

#### Flock Undercoat

Provides proper adhesive and color base for felt flock. Packaged in half-pint cans (covers 10-15 square feet of non-porous surface). List Price.....\$1.65

| Cat. No. | Color | Cat. No. | Color        |
|----------|-------|----------|--------------|
| 480      | Brown | 484-1    | Maroon       |
| 481      | Ivory | 485      | Green        |
| 482      | Blue  | 486      | Silver-White |
| 483      | Taupe | 488      | Black        |
| 484      | Red   | 489      | Canary       |

List Price  
Undercoat per gal (specify color)....\$14.40



#### Undercoat Thinner

For thinning of Undercoat, if necessary, and washing out brushes.

Cat. No. 468—Half-pint can..... List Price \$0.55

#### Felt Flock Spray Gun

Same as contained in WALSCO Flock Finish Spray Kit

Cat. No. 455..... List Price \$4.35

### WALSCO INSULATING TUBING (SPAGHETTI)

#### WALSCO RAYOFLEX

A new type "spaghetti tubing" made of heavily lacquered rayon braid. More flexible and superior in many other respects to the conventional varnished tubing. Good dielectric strength (4,000 to 5,000 volts). RAYOFLEX has a smooth and tough surface inside and out. Meets ASTM and VTA Specifications # B2. Sizes up to # 6 are packed in handy boxes.

| Cat. No. | Size B & S Gauge No. | Approx. inch | Quantity per pkg.* | List Price per pkg. |
|----------|----------------------|--------------|--------------------|---------------------|
| 630      | 18                   | .042         | 10 ft.             | \$0.95              |
| 631      | 15                   | .059         | 10 ft.             | 0.95                |
| 632      | 12                   | .085         | 8 ft.              | 0.95                |
| 633      | 9                    | .118         | 5 ft.              | 0.95                |
| 634      | 6                    | .166         | 5 ft.              | 0.95                |
| 635      | 2                    | 3/4"         | 30 in.             | 0.56                |
| 636      | 0                    | 7/8"         | 30 in.             | 0.65                |
| 637      | 00                   | 1"           | 30 in.             | 0.69                |
| 638      | 0000                 | 1 1/2"       | 30 in.             | 1.15                |

\*For larger quantities, write for quotation. Available in: Black, Blue, Red, Yellow. Please specify color when ordering.

#### WALSCO FLEXITUBE

A high-grade synthetic extruded vinylite tubing for electronic and electrical insulation. Extremely flexible and resistant to abrasion. High dielectric strength (average 12,000-volt). Resistant to cold or heat from minus 65°F to plus 185°F. (Minus 54°C to 85°C). This tubing is impervious to water, oil, alcohol and most acids and alkalis.

| Cat. No. | Size B & S Gauge No. | Approx. I.D. inch | Quantity per pkg.* | List Price, per pkg. |
|----------|----------------------|-------------------|--------------------|----------------------|
| 600      | 18                   | .042              | 1 20 ft.           | \$0.95               |
| 601      | 16                   | .053              | 1.4 20 ft.         |                      |
| 602      | 14                   | .066              | 1.6 18 ft.         |                      |
| 603      | 12                   | .085              | 2 16 ft.           |                      |
| 604      | 10                   | .106              | 2.7 14 ft.         |                      |
| 605      | 8                    | .133              | 3.5 12 ft.         |                      |
| 606      | 6                    | .166              | 4 10 ft.           |                      |
| 607      | 4                    | .208              | 5 6 ft.            |                      |
| 608      | 2                    | .263              | 6.5 6 ft.          |                      |

\*For larger quantities, write for quotation. Available in: Black, Green, Red, Clear. Please specify color when ordering.

### WALSCO INSULATING CAMBRIC

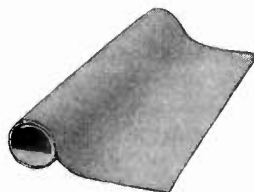

High-voltage (5000-v.) insulating material for repairing transformers, field coils, solenoids, relays, etc. Yellow color; very flexible and durable.

Cat. No. 645 — Roll of approx. 210 sq. in. .... \$0.75  
645-D—Display of 10 No. 645 rolls.... 7.50

### WALSCO STROBOSCOPE DISK

For checking proper speed of turntables. Lines on disk appear to be stationary on correct speed when observed under 60-cycle AC lighting (preferably fluorescent). For checking 78, 45, and 33 1/2 rpm. speeds.



Cat. No. 949—Stroboscope Disk..... List Price \$0.15  
Standard Packing: 25

### WALSCO PLASTIC DIAL CRYSTALS

Can be cut with scissors. Easily press-fitted or cemented in place. Solves the replacement problem on radio dials, instruments, etc.

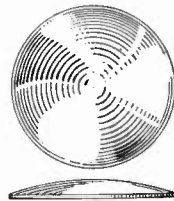

Cat. No. 990—6" Maximum Diameter..... List Price \$1.10  
992—9" Maximum Diameter..... 1.80  
994—8" x 10" Flat Sheet..... 1.65

### HANDY ASSORTMENTS



#### RAYOFLEX

| Cat. No.  | List Price |
|---|------------|
| 640—12 ft. of Assorted sizes and colors, from size 18 to 9  | \$ 0.90    |
| 640-D—36 Assortments of # 640 in Display Box                | 32.40      |
| 641—6 ft. of Assorted sizes and colors, from size 9 to 1/2" | 0.90       |
| 641-D—24 Assortments of # 641 in Display Box                | 21.60      |

#### FLEXITUBE

| Cat. No.  | List Price |
|---|------------|
| 620—20 ft. of Assorted sizes and colors, from size 18 to 10 | \$ 0.90    |
| 620-D—36 Assortments of # 620 in one Display Box            | 32.40      |
| 621—12 ft. of Assorted sizes and colors, from size 10 to 2  | 0.90       |
| 621-D—24 Assortments of # 621 in one Display Box            | 21.60      |

### WALSCO ULTRA-FLEXIBLE MINIATURE WIRES



For all connections in electronic devices requiring special thin and flexible leads such as phono pick-ups, miniature earphones, relays, etc. All wires, except tinsel, are 30-gauge, stranded.

| Cat. No.   | List Price |
|--|------------|
| 304 —Single-conductor, shielded, for pick-up leads, etc., 25-ft. spool   | \$1.75     |
| 3040—Same as No. 304, but package of 54" length  | 0.40       |
| 305 —Single-conductor, shielded, with black cotton overbraid, 25-ft. spool   | 2.40       |
| 3050—Same as No. 305, but package of 48" length  | 0.40       |
| 307 —Two conductors, parallel, color-coded, shielded, 25-ft. spool   | 2.70       |
| 308 —Two conductors, tinsel, twisted, with flesh-colored plastic insulation. Designed for headphones, hearing aids, etc., 25-ft. spool | 3.60       |

For Bulk Quantity Prices on these items, see WALSCO INDUSTRIAL AND BULK PRICE LIST, pages U-47 to U-50.

### WALSCO ALIGNMENT TOOLS

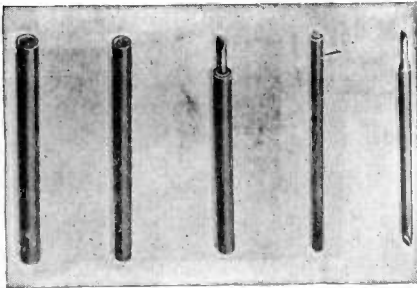

1 2 3 4 5

**WALSCO 1/4" HEX I. D. NEUTRALIZING WRENCH.**  
Very durable. Can be cut if corners become rounded from wear. Over-all length—7 1/2", O.D.—3/8" round.

| Cat. No.                 | Picture No. | List Price |
|--------------------------|-------------|------------|
| §2500—Bone Fibre Wrench  | 2           | \$0.40     |
| §2503—Polystyrene Wrench | 2           | 0.40       |

**WALSCO 5/16" HEX. I. D. NEUTRALIZING WRENCH.**  
Same construction as 1/4" wrench listed above. Over-all length—7 1/2", O. D.—3/8".

| Cat. No.                 | Picture No. | List Price |
|--------------------------|-------------|------------|
| §2505—Bone Fibre Wrench  | 1           | \$0.40     |
| §2508—Polystyrene Wrench | 1           | 0.40       |

**WALSCO FIBRE HEX-WRENCH-AND-SCREW-DRIVER.**  
Standard 1/4" hex wrench combined with a fibre screw driver.

| Cat. No.               | Picture No. | List Price |
|------------------------|-------------|------------|
| §2510—Combination Tool | 3           | \$0.60     |

**WALSCO DUPLEX ALIGNMENT SCREWDRIVER.**

Precision made. Ground or molded to fit large or small screws. Width of blade on large end—1/4"; on small end—1/8". Thickness to conform to standard slot dimensions. Over-all length—6".

| Cat. No.                      | Picture No. | List Price |
|-------------------------------|-------------|------------|
| §2520—Fibre Screwdriver       | 5           | \$0.50     |
| §2521—Polystyrene Screwdriver | 5           | 0.40       |

**WALSCO METAL TIP ALIGNMENT SCREWDRIVER.**

Polystyrene handle. This tool combines the low capacity effect of an alignment tool with the mechanical strength of a metal screwdriver. Diameter—1/4"; over-all length—6".

| Cat. No.                    | Picture No. | List Price |
|-----------------------------|-------------|------------|
| §2525—Alignment Screwdriver | 4           | \$0.45     |

**WALSCO TUNING WAND.**

Made from Polystyrene rod with inductance-increasing powdered iron core on one end and inductance-reducing brass piece on opposite end. Over-all length—6".

| Cat. No.          | List Price |
|-------------------|------------|
| §2540—Tuning Wand | \$0.50     |

(Picture not shown, but similar to Picture #1.)

**WALSCO TV-FM ALIGNMENT TOOL KIT.**

Complete set of all tools required for receiver alignment.

| Cat. No.                         | List Price |
|----------------------------------|------------|
| 580—12 tools in leatherette case | \$11.50    |
| 581—12 tools on wall rack        | 11.50      |

### WALSCO TIRE STATIC NEUTRALIZING KIT

• Reduces or Eliminates Automobile Radio Tire Static.

• Dissipates Body Contact Shock /Door-handle Sparks!.

This kit contains a special injector gun and 5 packages of WALSCO Static Neutralizing Powder (one for each tire, including spare). The powder is blown into each tire in a very simple operation, which takes just a few minutes and lasts for the life of the tire.

| Cat. No.  | List Price |
|---|------------|
| 980—Tire Static Neutralizing Kit, complete with injector, powder and instructions | \$2.50     |
| 982—Injector gun only   | 1.50       |
| 985—Powder only (enough for 5 passenger-car tires)                                | 1.00       |

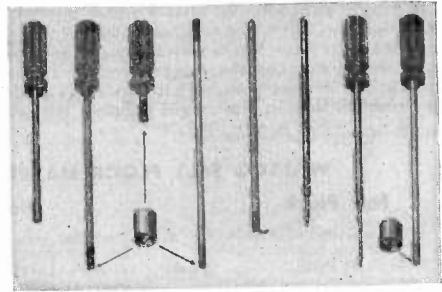
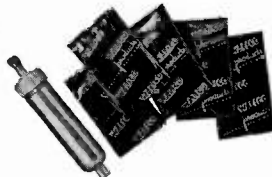

6 7 8 9 10 11 12 13

### WALSCO TV OSCILLATOR ALIGNMENT TOOLS.

| Cat. No.  | Picture No. | List Price |
|---|-------------|------------|
| §2518—For Philco Receivers                      | 6           | \$1.60     |
| §2522—For Receivers, "Standard Coil" Front Ends | 12          | 1.00       |

**WALSCO TV I.F. ALIGNMENT SCREWDRIVERS.**

Standard Tools for all TV and FM sets. Made of new flexible low-loss plastic with thin precision screwdriver tips.

| Cat. No.   | Picture No. | List Price |
|--|-------------|------------|
| §2516—8 1/2" long, for No. 6 Studs                             | 7           | \$1.00     |
| §2517—3" long, for No. 6 Studs                                 | 8           | .95        |
| §2519—7" long—1 end for No. 6 Studs; other end for No. 4 Studs | 9           | .95        |
| §2524—8 1/2" long, Slotted Type, for No. 6 Studs               | 13          | 1.00       |

**WALSCO WIRE DRESSING AND ALIGNMENT TOOL.**

Made with thin (3/32") polystyrene handle, 7" long. Special tool on one end for dressing wires and finding loose connections or shorts. Other end has low capacity screwdriver tip.

| Cat. No.                               | Picture No. | List Price |
|--|-------------|------------|
| §2512—Wire Dressing and Alignment Tool | 10          | \$0.55     |

**WALSCO "K-TRAN" ALIGNMENT TOOL.**

For adjustment of all miniature (K-Tran) I.F. transformers. Made of tough bone fibre. One end is machined to fit "K-Tran" slots; other end is equipped with low-capacity metal screwdriver tip.

| Cat. No.                      | Picture No. | List Price |
|-------------------------------|-------------|------------|
| §2515—"K-Tran" Alignment Tool | 11          | \$0.75     |

### WALSCO SERVICE TWEEZERS

These handy holding tools are made of fine spring steel and are polished nickel-plated. They have numerous uses in the shop and laboratory, such as starting screws and nuts in difficult places, holding wires and small parts together when soldering, clamping cemented items, installing dial cord and record-changer springs, looping and untying knots on drive cord, etc.

| Cat. No. | List Price |
|----------|------------|
|----------|------------|

570—Self - Closing Tweezer with cross-over action, 6 1/2" long, serrated, blunt points ..... \$0.95

(Standard Package: Display card with 10 tweezers . . . Cat. No. 570D)

571—Heavy-Duty Tweezer with slide-lock feature. Length 6 1/2", serrated, blunt points ..... \$1.20  
(Standard Package: Display card with 10 tweezers . . . Cat. No. 571D)

572—Precision Tweezer with narrow, pointed ends especially suitable for delicate work. Over-all length 4 1/2" ..... \$0.55  
(Standard Package: Display card with 20 tweezers . . . Cat. No. 572-D)

575—Tweezer Kit, made of durable leatherette, containing one each of the above listed tweezers ..... \$3.25  
(Standard Package: Display of 12 kits . . . Cat. No. 575D)

§579—WALSCO EE-ZEE Starting Tool—A handy tool for starting screws and nuts, inserting springs, etc. Front part of tool is flexible. Will reach into places which are inaccessible with fingers or pliers ..... \$0.75

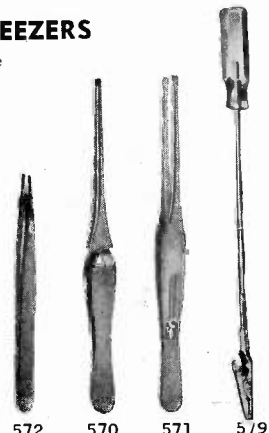

For Bulk Quantity Prices on these items, see WALSCO INDUSTRIAL AND BULK PRICE LIST, pages U-47 to U-50.



# WALSCO ELECTRONIC HARDWARE

The 99 Line

BULK PACK

IN PERMANENT *Transparent* PLASTIC STORAGE BOXES with SLIDING TOPS • PROMPT DELIVERY FOR INDUSTRIAL AND OTHER QUANTITY USERS



## HOLE PLUGS



### THE "99 LINE"

### BULK PACK

#### Description

99c Net, Ea. Pkg.

Part No. Quantity per Package

Bulk Part No.

Net Prices, per Thousand

#### SNAP-HOLE PLUGS, Steel, Bright Nickel-Plated

|                  |         |    |
|------------------|---------|----|
| Fits 1/8" hole   |         |    |
| Fits 1/4" hole   |         |    |
| Fits 3/8" hole   | 3501-99 | 50 |
| Fits 1/2" hole   | 3502-99 | 50 |
| Fits 5/8" hole   | 3503-99 | 40 |
| Fits 3/4" hole   | 3504-99 | 30 |
| Fits 7/8" hole   | 3505-99 | 25 |
| Fits 1" hole     |         |    |
| Fits 1 1/8" hole | 3506-99 | 20 |
| Fits 1 1/4" hole |         |    |

|             |                 |
|-------------|-----------------|
| 250 to 4999 | 5M and up       |
| 3501-1      | \$14.30 \$11.00 |
| 3501-1A     | 15.75 12.10     |
| 3501-2      | 14.30 11.00     |
| 3501-3      | 14.30 11.00     |
| 3501-4      | 15.75 12.10     |
| 3501-5      | 20.00 15.40     |
| 3501-6      | 20.00 15.40     |
| 3501-7      | 24.30 18.70     |
| 3501-8      | 31.45 24.20     |
| 3501-9      | 33.00 25.00     |
| 3501-10     | 34.30 26.40     |

#### VENTILATING HOLE PLUGS

|                             |  |
|-----------------------------|--|
| Snap-fit for 1" hole        |  |
| Eyelet-type for 1 1/8" hole |  |
| Eyelet-type for 3/4" hole   |  |

|        |                           |
|--------|---------------------------|
| 3320-1 | Prices quoted on request. |
| 3320-2 | 18.00 14.50               |
| 3320-8 | 22.00 17.50               |



## SNAP-IN TRIMOUNTS



| Dimensions |        |      | For Hole |             |
|------------|--------|------|----------|-------------|
| A          | B      | C    |          |             |
| 9/8"       | 1 1/8" | 3/8" | 1/8"     | 3462-99 125 |
| 1 1/8"     | 1 3/8" | 3/8" | 1/4"     | 3464-99 100 |
| 1 3/8"     | 1 5/8" | 3/8" | 3/8"     | 3465-99 85  |

|              |               |
|--------------|---------------|
| 1000 to 9999 | 10M and up    |
| 3460-2       | \$4.60 \$3.50 |
| 3460-4       | 5.45 4.20     |
| 3460-5       | 7.15 5.50     |



## GROMMETS, CABINET FEET AND CHASSIS MOUNTS



### RUBBER GROMMETS

| Dimensions, inches |      |      |      |      |             |
|--------------------|------|------|------|------|-------------|
| A                  | B    | C    | D    | E    |             |
| 1 1/8"             | 1/8" | 1/8" | 1/8" | 1/4" | 3341-99 100 |
| 1 1/4"             | 1/8" | 3/8" | 1/8" | 1/4" | 3342-99 75  |
| 1 1/2"             | 1/4" | 1/2" | 1/8" | 3/8" | 3343-99 65  |
| 1 3/4"             | 3/8" | 3/4" | 1/8" | 1/2" | 3344-99 50  |
| 1 7/8"             | 1/2" | 5/8" | 1/8" | 5/8" | 3345-99 40  |

|             |                 |
|-------------|-----------------|
| 500 to 9999 | 10M and up      |
| 3340-1      | \$ 5.90 \$ 4.55 |
| 3340-2      | 7.20 5.55       |
| 3340-3      | 9.20 7.05       |
| 3340-4      | 10.50 8.05      |
| 3340-5      | 14.40 11.10     |

### CORD STRAIN RELIEFS

|               |  |
|---------------|--|
| For POSI Wire |  |
|---------------|--|

|        |             |
|--------|-------------|
| 3340-9 | 26.20 20.15 |
|--------|-------------|

### RUBBER FEET

| SCREW-TYPE: | Diameter | Height |             |
|-------------|----------|--------|-------------|
|             | 3/8"     | 3/8"   | 3351-99 50* |
|             | 1/2"     | 3/8"   | 3352-99 50* |
|             | 3/4"     | 3/8"   | 3353-99 30* |

(\*Wood screws included.)

|         |             |
|---------|-------------|
| 3350-1† | 6.55 5.05   |
| 3350-2† | 7.05 5.45   |
| 3350-3† | 14.10 10.85 |

(†No screws included.)

| TACK FEET:    |         |    |
|---------------|---------|----|
| 3/8" diameter | 3355-99 | 50 |
| 1/2" diameter | 3356-99 | 50 |

|         |            |
|---------|------------|
| 3350-5  | 11.15 8.60 |
| 3350-15 | 11.50 8.85 |

### CHASSIS MOUNTS

| Dimensions, inches |      |      |      |            |
|--------------------|------|------|------|------------|
| A                  | B    | C    | D    |            |
| 3/4"               | 1/2" | 1/4" | 3/8" | 2742-99 30 |
| 1"                 | 1/2" | 1/4" | 1/2" | 2744-99 20 |

|        |             |
|--------|-------------|
| 2740-2 | 20.95 16.10 |
| 2740-4 | 26.20 20.15 |

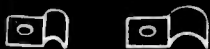

## CABLE CLAMPS

Steel, cadmium plated



| For Cables            | Mounting Hole Size |             |
|-----------------------|--------------------|-------------|
| 1/8" to 3/8" diameter | # 6                | 3331-99 125 |
| 3/8" to 1/2" diameter | # 8                | 3332-99 100 |
| 1/2" to 3/4" diameter | # 8                | 3333-99 75  |

|              |               |
|--------------|---------------|
| 1000 to 9999 | 10M and up    |
| 3330-1       | \$4.25 \$3.30 |
| 3330-2       | 4.95 3.80     |
| 3330-3       | 5.60 4.30     |



# WALSCO ELECTRONIC HARDWARE

The '99 Line

BULK PACK

IN PERMANENT *Transparent* PLASTIC STORAGE BOXES with SLIDING TOPS • PROMPT DELIVERY FOR INDUSTRIAL AND OTHER QUANTITY USERS

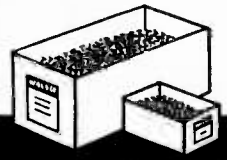

THE "99 LINE"

BULK PACK

Description

99c Net, Ea. Pkg.

Bulk Part No. Net Prices, per Thousand

DIAL DRIVE SPRINGS, Steel, Cadmium-Plated

| O/L      | Diameter | Wire Size | Part No. | Quantity per Package | Bulk Part No. | Net Prices, per Thousand |
|----------|----------|-----------|----------|----------------------|---------------|--------------------------|
| 1/2"     | 1/8"     | .016"     | 3410-1   | 250                  | 3410-1        | \$11.75                  |
| 5/8"     | 3/8"     | .018"     | 3410-2   | 5M                   | 3410-2        | \$8.95                   |
| 9/8"     | 1/2"     | .020"     | 3410-3   | 10M                  | 3410-3        | \$8.95                   |
| 1 1/8"   | 5/8"     | .016"     | 3410-4   | 15M                  | 3410-4        | \$9.20                   |
| 1 1/4"   | 3/4"     | .020"     | 3410-5   | 20M                  | 3410-5        | \$9.35                   |
| 1 3/4"   | 1"       | .022"     | 3400-1   | 25M                  | 3400-1        | \$10.00                  |
| 2"       | 1 1/4"   | .022"     | 3400-2   | 30M                  | 3400-2        | \$10.50                  |
| Assorted |          |           | 3400-99  | 50                   |               |                          |

PHONO PANEL MOUNTING SPRINGS, Spring Steel, Cadmium-Plated

| A      | B    | C    | Wire Thickness | Part No. | Net Prices, per Thousand |
|--------|------|------|----------------|----------|--------------------------|
| 1"     | 3/8" | 7/8" | .075"          | 3385-1   | 11.15                    |
| 1 1/8" | 1/2" | 1"   | .062"          | 3385-2   | 11.75                    |
| 3/4"   | 3/4" | 3/4" | .047"          | 3385-3   | 11.00                    |

KNOB SPRINGS

|         |        |       |      |
|---------|--------|-------|------|
| Style 1 | 3450-1 | 10.65 | 8.20 |
| Style 2 | 3450-2 | 10.00 | 7.70 |
| Style 5 | 3450-5 | 8.85  | 6.80 |
| Style 6 | 3450-6 | 5.30  | 4.10 |
| Style 7 | 3450-7 | 4.30  | 3.30 |
| Style 8 | 3450-8 | 3.70  | 2.85 |
| Style 9 | 3450-9 | 3.90  | 3.00 |



TERMINAL LUGS

SOLDER TYPE

| Style | Available for Screw Numbers (Specify) | Part No. | Quantity | Net Price |
|-------|---------------------------------------|----------|----------|-----------|
| 1     | #6, #8, #10                           | 3281-99  | 150      | \$4.15    |
| 2     | #6, #8                                | 3282-99  | 150      | \$3.30    |
| 3     | #6, #8                                | 3283-99  | 150      | \$3.85    |
| 4     | #6, #8, #10, 1/4"                     | 3284-99  | 150      | \$4.75    |
| 5     | #6, #8                                | 3285-99  | 125      | \$5.25    |
| 6     | #6, #8, #10                           | 3286-99  | 150      | \$2.25    |

SCREW TYPE

|                           |          |            |           |         |         |
|---------------------------|----------|------------|-----------|---------|---------|
| 7 with #8-32 x 3/8" Screw | 3288-3-1 | 100 to 999 | 1M and up | \$38.90 | \$29.00 |
|---------------------------|----------|------------|-----------|---------|---------|

SOLDERLESS TYPE

| Style    | Fits Screw # | Fits Wire Gauge # | Part No.  | Quantity    | Net Price |
|----------|--------------|-------------------|-----------|-------------|-----------|
| 8        | 8            | 16 to 20          | 3288-1-6  | 250 to 4999 | \$19.30   |
| 8        | 8            | 16 to 20          | 3288-1-8  | 5M          | \$14.85   |
| 8        | 10           | 16 to 20          | 3288-1-10 | 10M         | \$14.85   |
| Assorted |              |                   | 3288-99   | 35          |           |

EYELET TYPE

|    |          |              |            |        |        |
|----|----------|--------------|------------|--------|--------|
| 9  | 3288-2-1 | 1000 to 9999 | 10M and up | \$2.85 | \$2.20 |
| 10 | 3288-2-2 |              |            | 4.00   | 3.10   |
| 11 | 3288-2-3 |              |            | 3.15   | 2.40   |
| 12 | 3288-2-4 |              |            | 4.00   | 3.10   |
| 13 | 3288-2-5 |              |            | 7.45   | 5.70   |



PLUGS AND JACKS

MINIATURE PLUGS AND JACKS, Not Assembled

|                                |         |            |           |          |          |
|--------------------------------|---------|------------|-----------|----------|----------|
| 2-Conductor Plug (type PL-291) | 2590 BU | 100 to 999 | 1M and up | \$235.00 | \$185.00 |
| 2-Conductor Jack (type JK-48)  | 2591 BU |            |           | \$75.00  | \$85.00  |

PHONO PLUGS AND JACKS

|                                 |        |       |       |
|---------------------------------|--------|-------|-------|
| Shielded, Single-Conductor Plug | 2580-1 | 39.50 | 29.75 |
| Shielded, Single-Conductor Jack | 2580-6 | 62.00 | 47.50 |





# WALSCO ELECTRONIC HARDWARE

The '99 Line

BULK PACK

IN PERMANENT TRANSPARENT PLASTIC STORAGE BOXES WITH SLIDING TOPS • PROMPT DELIVERY FOR INDUSTRIAL AND OTHER QUANTITY USERS

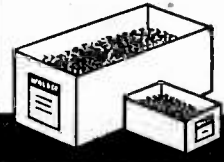

## MACHINE SCREWS

THE '99 LINE'

Description

99c Net, Ea. Pkg.

BULK PACK

Part No. Quantity per Package  
ROUND HEAD, Steel, Cadmium-Plated

Bulk Part No. Net Prices, per Thousand

| Sizes          | Part No. | Quantity per Package | Bulk Part No. | Net Prices, per Thousand | 10M and up   |
|----------------|----------|----------------------|---------------|--------------------------|--------------|
| Assorted       | 3560-99  | 200                  |               |                          | 1000 to 9999 |
| # 2-56 x 3/16" |          |                      | 3561-2-1A     | \$2.05                   | \$1.60       |
| # 2-56 x 3/8"  |          |                      | 3561-2-3      | 2.15                     | 1.65         |
| # 2-56 x 1/2"  |          |                      | 3561-2-4      | 2.25                     | 1.75         |
| # 4-40 x 1/4"  |          |                      | 3561-4-2      | 2.20                     | 1.70         |
| # 4-40 x 3/8"  |          |                      | 3561-4-3      | 2.25                     | 1.75         |
| # 4-40 x 1/2"  |          |                      | 3561-4-4      | 2.40                     | 1.85         |
| # 4-40 x 1"    |          |                      | 3561-4-8      | 3.00                     | 2.30         |
| # 6-32 x 1/4"  | 3100-99  | 225                  | 3561-6-2      | 2.45                     | 1.90         |
| # 6-32 x 3/8"  | 3110-99  | 225                  | 3561-6-3      | 2.65                     | 2.00         |
| # 6-32 x 1/2"  | 3120-99  | 200                  | 3561-6-4      | 2.85                     | 2.20         |
| # 6-32 x 3/4"  | 3130-99  | 175                  | 3561-6-6      | 3.25                     | 2.50         |
| # 6-32 x 1"    | 3132-99  | 150                  | 3561-6-8      | 3.80                     | 2.90         |
| # 8-32 x 1/4"  | 3135-99  | 200                  | 3561-8-2      | 3.05                     | 2.35         |
| # 8-32 x 3/8"  | 3140-99  | 175                  | 3561-8-3      | 3.40                     | 2.60         |
| # 8-32 x 1/2"  | 3150-99  | 160                  | 3561-8-4      | 3.65                     | 2.80         |
| # 8-32 x 3/4"  | 3160-99  | 140                  | 3561-8-6      | 4.20                     | 3.25         |
| # 8-32 x 1"    | 3162-99  | 125                  | 3561-8-8      | 4.90                     | 3.75         |
| # 10-32 x 1/2" | 3165-99  | 150                  | 3561-10-4     | 4.35                     | 3.35         |
| # 10-32 x 3/4" | 3167-99  | 125                  | 3561-10-6     | 5.15                     | 3.95         |
| # 10-32 x 1"   | 3169-99  | 100                  | 3561-10-8     | 5.85                     | 4.50         |

### BINDING HEAD, Brass

|               |  |  |          |      |      |
|---------------|--|--|----------|------|------|
| # 6-32 x 1/4" |  |  | 3565-6-2 | 4.25 | 3.25 |
| # 6-32 x 3/8" |  |  | 3565-6-3 | 4.85 | 3.75 |
| # 6-32 x 1/2" |  |  | 3565-6-4 | 5.50 | 4.25 |
| # 8-32 x 1/4" |  |  | 3565-8-2 | 6.10 | 4.70 |
| # 8-32 x 3/8" |  |  | 3565-8-3 | 6.90 | 5.35 |

## SHEET METAL AND SELF TAPPING SCREWS

### HEX HEAD, Slotted, Type "B" — Blunt Point

| Sizes       | Part No. | Quantity per Package | Bulk Part No. | Net Prices, per Thousand | 10M and up   |
|-------------|----------|----------------------|---------------|--------------------------|--------------|
| Assorted    | 3470-99  | 125                  |               |                          | 1000 to 9999 |
| # 6 x 1/8"  | 2910-99  | 150                  | 3471-6-2      | \$3.45                   | \$2.65       |
| # 6 x 3/8"  | 2911-99  | 150                  | 3471-6-3      | 3.65                     | 2.80         |
| # 6 x 1/2"  | 2912-99  | 150                  | 3471-6-4      | 3.80                     | 2.95         |
| # 6 x 3/4"  | 2914-99  | 125                  | 3471-6-6      | 4.30                     | 3.30         |
| # 6 x 1"    | 2916-99  | 100                  | 3471-6-8      | 4.70                     | 3.60         |
| # 8 x 1/4"  | 2919-99  | 125                  | 3471-8-2      | 4.30                     | 3.30         |
| # 8 x 3/8"  | 2920-99  | 125                  | 3471-8-3      | 4.25                     | 3.30         |
| # 8 x 1/2"  | 2922-99  | 125                  | 3471-8-4      | 4.55                     | 3.50         |
| # 8 x 3/4"  | 2924-99  | 100                  | 3471-8-6      | 5.25                     | 4.05         |
| # 8 x 1"    | 2926-99  | 100                  | 3471-8-8      | 6.00                     | 4.60         |
| # 10 x 3/8" | 2930-99  | 100                  | 3471-10-3     | 5.25                     | 4.05         |
| # 10 x 1/2" | 2932-99  | 100                  | 3471-10-4     | 5.50                     | 4.25         |
| # 10 x 3/4" | 2934-99  | 100                  | 3471-10-6     | 6.20                     | 4.75         |

### BINDING HEAD, Type "A" — Pointed

|            |  |  |          |      |      |
|------------|--|--|----------|------|------|
| # 6 x 1/4" |  |  | 3475-6-2 | 3.75 | 2.90 |
| # 6 x 3/8" |  |  | 3475-6-3 | 4.05 | 3.10 |
| # 6 x 1/2" |  |  | 3475-6-4 | 4.25 | 3.25 |
| # 8 x 3/8" |  |  | 3475-8-3 | 4.70 | 3.65 |
| # 8 x 1/2" |  |  | 3475-8-4 | 5.00 | 3.85 |
| # 8 x 3/4" |  |  | 3475-8-6 | 5.80 | 4.45 |

### ROUND HEAD, THREAD-CUTTING, Steel, Cadmium-Plated

|               |  |  |          |      |      |
|---------------|--|--|----------|------|------|
| # 6-32 x 1/4" |  |  | 3477-6-2 | 6.50 | 4.75 |
| # 6-32 x 3/8" |  |  | 3477-6-3 | 7.00 | 5.25 |
| # 6-32 x 1/2" |  |  | 3477-6-4 | 7.90 | 5.85 |
| # 8-32 x 3/8" |  |  | 3477-8-3 | 8.00 | 5.95 |
| # 8-32 x 1/2" |  |  | 3477-8-4 | 8.50 | 6.30 |
| # 8-32 x 3/4" |  |  | 3477-8-6 | 9.30 | 7.00 |





# WALSCO ELECTRONIC HARDWARE

The '99 Line

BULK PACK

IN PERMANENT *Transparent* PLASTIC STORAGE BOXES with SLIDING TOPS • PROMPT DELIVERY FOR INDUSTRIAL AND OTHER QUANTITY USERS

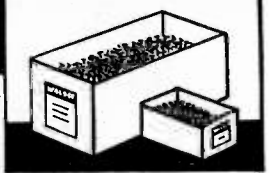

## SET SCREWS

Steel, hardened

| Description                                   | THE "99 LINE" |                      | BULK PACK     |                          |
|---|---------------|----------------------|---------------|--------------------------|
|   | Part No.      | Quantity per Package | Bulk Part No. | Net Prices, per Thousand |
| <b>HEADLESS TYPE, Slotted, Cadmium-Plated</b> |               |                      |               |                          |
| Assorted                                      | 3480-99       | 75                   |               | 500 to 999 10M and up    |
| # 6-32 x 1/8"                                 |               |                      | 3481-6-1      | \$9.85 \$7.55            |
| # 6-32 x 1/8"                                 |               |                      | 3481-6-1A     | 8.55 6.55                |
| # 6-32 x 1/4"                                 |               |                      | 3481-6-2      | 8.70 6.70                |
| # 8-32 x 1/8"                                 |               |                      | 3481-8-1      | 9.85 7.55                |
| # 8-32 x 1/8"                                 |               |                      | 3481-8-1A     | 8.55 6.55                |
| # 8-32 x 1/4"                                 | 3220-99       | 75                   | 3481-8-2      | 8.70 6.70                |
| # 10-32 x 1/8"                                |               |                      | 3481-10-1A    | 8.55 6.55                |
| # 10-32 x 1/4"                                |               |                      | 3481-10-2     | 8.70 6.70                |

### HEX — ALLEN-HEAD

|                |  |  |            |                      |
|----------------|--|--|------------|----------------------|
| # 4-40 x 1/4"  |  |  | 3482-4-1   | 100 to 999 1M and up |
| # 5-40 x 1/4"  |  |  | 3480-5-1   | \$53.95 \$41.50      |
| # 6-32 x 1/8"  |  |  | 3480-6-1   | 54.60 42.00          |
| # 6-32 x 1/8"  |  |  | 3480-6-1A  | 55.25 42.50          |
| # 6-32 x 1/4"  |  |  | 3480-6-2   | 55.90 43.00          |
| # 6-32 x 1/4"  |  |  | 3480-6-2A  | 55.90 43.00          |
| # 8-32 x 1/8"  |  |  | 3480-8-1   | 55.90 43.00          |
| # 8-32 x 1/8"  |  |  | 3480-8-1A  | 56.55 43.50          |
| # 8-32 x 1/4"  |  |  | 3480-8-2   | 57.20 44.00          |
| # 10-32 x 1/8" |  |  | 3480-10-1A | 57.20 44.00          |
| # 10-32 x 1/4" |  |  | 3480-10-2  | 57.85 44.50          |
| 1/4-20 x 1/4"  |  |  | 3480-1/4-2 | 59.15 45.50          |

## MISC. SCREWS

### WOOD SCREWS

| Size       | Head      | Finish          |          | 1000 to 999 10M and up |
|------------|-----------|-----------------|----------|------------------------|
| # 2 x 1/4" | Oval Hd.  | Statuary Bronze | 3550-2-2 | \$3.70 \$2.85          |
| # 2 x 3/8" | Oval Hd.  | Statuary Bronze | 3550-2-3 | 3.90 3.00              |
| # 2 x 1/2" | Round Hd. | Statuary Bronze | 3550-2-4 | 4.05 3.10              |
| # 3 x 3/8" | Round Hd. | Blued           | 3550-3-3 | 3.30 2.55              |
| # 6 x 1/2" | Round Hd. | Blued           | 3550-6-4 | 3.75 2.90              |
| # 6 x 7/8" | Flat Hd.  | Cadmium-Plated  | 3550-6-7 | 4.75 3.70              |
| # 8 x 5/8" | Round Hd. | Blued           | 3550-8-5 | 4.40 3.40              |

### ORNAMENTAL HEAD SCREWS, Steel, Statuary Bronze Finish

|                 |         |     |           |           |
|-----------------|---------|-----|-----------|-----------|
| # 6-32 x 3/4"   | 2951-99 | 125 | 2951-6-6  | 3.80 2.90 |
| # 6-32 x 1"     | 2952-99 | 125 | 2951-6-8  | 4.45 3.45 |
| # 8-32 x 1 1/4" | 2953-99 | 80  | 2951-8-10 | 6.65 5.10 |

### RACK SCREWS, Oval Head, Steel, Nickel-Plated

|                |         |     |           |           |
|----------------|---------|-----|-----------|-----------|
| # 6-32 x 5/8"  | 3543-99 | 175 | 3541-6-5  | 3.05 2.35 |
| # 8-32 x 5/8"  | 3541-99 | 125 | 3541-8-5  | 4.00 3.05 |
| # 10-32 x 3/4" | 3542-99 | 100 | 3541-10-6 | 5.15 3.95 |
| # 12-24 x 5/8" |         |     | 3541-12-5 | 6.30 4.85 |

## MISC. FASTENERS

### SPADE BOLTS, Steel, Cadmium-Plated

|                   |         |     |        |                        |
|-------------------|---------|-----|--------|------------------------|
| # 6-32 x 5/8" O/L | 3271-99 | 125 | 3270-1 | 1000 to 999 10M and up |
| # 6-32 x 3/4" O/L | 3272-99 | 150 | 3270-2 | \$5.25 \$4.50          |
|                   |         |     |        | 4.00 3.15              |

### HAIR-PIN COTTERS

| Dimensions |        |       |        |           |
|------------|--------|-------|--------|-----------|
| A          | B      | C     |        |           |
| 3/8"       | 1 1/8" | .026" | 2650-1 | 1.90 1.50 |
| 3/8"       | 3/8"   | .026" | 2650-2 | 1.90 1.50 |
| 1/2"       | 3/4"   | .032" | 2650-3 | 2.80 2.25 |

### THREADED ROD, Steel

|                 |  |  |        |                      |
|-----------------|--|--|--------|----------------------|
| # 6-32; 8" long |  |  | 2640-1 | 100 to 999 1M and up |
| # 8-32; 8" long |  |  | 2640-2 | \$45.25 \$34.80      |
|                 |  |  |        | 47.60 36.60          |



# WALSCO ELECTRONIC HARDWARE

The '99 Line

BULK PACK

IN PERMANENT *Transparent* PLASTIC STORAGE BOXES with SLIDING TOPS • PROMPT DELIVERY FOR INDUSTRIAL AND OTHER QUANTITY USERS

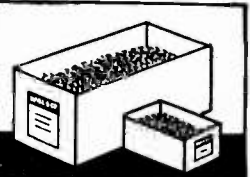

## HEX NUTS



THE '99 LINE'

BULK PACK

| Description                                    |                    |           | Part No.          | Quantity per Package | Bulk Part No. | Net Prices, per Thousand |            |
|--|--------------------|-----------|-------------------|----------------------|---------------|--------------------------|------------|
| Thread Size                                    | Width Across Flats | Thickness | 99c Net, Ea. Pkg. |                      |               | 1000 to 9999             | 10M and up |
| <b>SMALL PATTERN, Steel, Cadmium-Plated</b>    |                    |           |                   |                      |               |                          |            |
| Assorted                                       |                    |           | 3520-99           | 175                  |               |                          |            |
| 2-56   | 3/16"              | 1/16"     |                   |                      | 3521-2        | \$3.75                   | \$2.75     |
| 4-40   | 3/8"               | 1/8"      | 3175-99           | 200                  | 3521-4        | 4.25                     | 3.25       |
| 6-32   | 1/2"               | 3/32"     | 3180-99           | 200                  | 3521-6        | 3.25                     | 2.50       |
| 8-32   | 5/8"               | 7/32"     | 3190-99           | 200                  | 3521-8        | 3.50                     | 2.70       |
| 10-32  | 3/4"               | 1/2"      | 3195-99           | 175                  | 3521-10       | 3.60                     | 2.75       |
| <b>STANDARD PATTERN, Steel, Cadmium-Plated</b> |                    |           |                   |                      |               |                          |            |
| 6-32   | 5/8"               | 7/16"     |                   |                      | 3522-6        | 3.20                     | 2.45       |
| 8-32   | 3/4"               | 1/2"      |                   |                      | 3522-8        | 3.65                     | 2.80       |
| 10-32  | 7/8"               | 1/2"      |                   |                      | 3522-10       | 3.95                     | 3.05       |
| <b>BRASS NUTS, Nickel-Plated</b>               |                    |           |                   |                      |               |                          |            |
| 4-36   | 1/4"               | 3/32"     |                   |                      | 3523-4X†      | 4.75                     | 3.50       |
| 4-40   | 1/4"               | 3/32"     |                   |                      | 3523-4†       | 4.75                     | 3.50       |
| 6-32   | 1/2"               | 7/32"     | 3180-B-99*        | 150                  | 3523-6†       | 3.50                     | 2.75       |
| 8-32   | 5/8"               | 1/2"      | 3190-B-99*        | 100                  | 3523-8†       | 6.50                     | 5.00       |
| 10-32  | 3/4"               | 1/2"      | 3195-B-99*        | 100                  | 3523-10†      | 6.90                     | 5.35       |

(\*Nickel-Plated)

(†Brass, Add 10% for Nickel Plating)



## MOUNTING NUTS



| Thread Size   | Width Across Flats | Thickness |         |    | 1000 to 9999 | 10M and up      |
|---|--------------------|-----------|---------|----|--------------|-----------------|
| <b>VOLUME CONTROL HEX NUTS, Steel, Cadmium-Plated</b> |                    |           |         |    |              |                 |
| 3/8-32  | 1 1/4"             | 3/8"      | 3531-99 | 85 | 3530-1       | \$ 6.65 \$ 5.10 |
| <b>VOLUME CONTROL HEX NUTS, Brass</b>                 |                    |           |         |    |              |                 |
| 3/8-32  | 1 1/8"             | 3/2"      |         |    | 3530-1B      | 16.00 12.50     |
| <b>TOGGLE SWITCH HEX NUTS, Steel, Cadmium-Plated</b>  |                    |           |         |    |              |                 |
| 1 1/2-32  | 1 1/8"             | 3/2"      | 3532-99 | 50 | 3530-2       | 11.00 8.45      |
| <b>TOGGLE SWITCH RING NUTS, Brass, Nickel-Plated</b>  |                    |           |         |    |              |                 |
| 1 1/2-32  | 1 1/2"             | 5/8"      | 3533-99 | 50 | 3530-3       | 12.10 9.30      |
| <b>ELECTRIC SWITCH AND FIXTURE NUTS</b>               |                    |           |         |    |              |                 |
| 1/2 P   | 1 1/2"             | 1/8"      |         |    | 3530-4       | 11.30 8.60      |



## SPECIAL NUTS



KNURLED THUMB NUTS, Brass

| #   | Thread Size | Width Across Flats | Thickness | Part No. | Quantity | 1000 to 9999 | 10M and up |
|---|-------------|--------------------|-----------|----------|----------|--------------|------------|
| # 6-32  | 6-32        | 1/2"               | 1/8"      | 2971-6   | 85       | \$ 8.00      | \$ 6.15    |
| # 8-32  | 8-32        | 5/8"               | 1/8"      | 2971-8   | 85       | 8.00         | 6.15       |
| # 10-32   | 10-32       | 3/4"               | 1/8"      | 2971-10  | 85       | 22.85        | 17.60      |
| <b>WING NUTS, Zamack Metal, Nickel-Plated</b>     |             |                    |           |          |          |              |            |
| # 6-32  | 6-32        | 1/2"               | 1/8"      | 2976-6   | 85       | 6.50         | 4.95       |
| # 8-32  | 8-32        | 5/8"               | 1/8"      | 2976-8   | 85       | 10.75        | 8.30       |
| # 10-32   | 10-32       | 3/4"               | 1/8"      | 2976-10  | 85       | 12.90        | 10.00      |
| <b>ACORN NUTS, PAL TYPE, Steel, Nickel-Plated</b> |             |                    |           |          |          |              |            |
| # 6-32  | 6-32        | 1/2"               | 1/8"      | 2961-6   | 85       | 10.65        | 8.20       |
| # 8-32  | 8-32        | 5/8"               | 1/8"      | 2961-8   | 85       | 12.25        | 9.40       |
| # 10-32   | 10-32       | 3/4"               | 1/8"      | 2961-10  | 85       | 15.25        | 11.70      |
| <b>SPEED NUTS, Tempered Steel, Parkerized</b>     |             |                    |           |          |          |              |            |
| # 6-32  | 6-32        | 1/2"               | 1/8"      | 2981-6   | 85       | 5.15         | 3.95       |
| # 8-32  | 8-32        | 5/8"               | 1/8"      | 2981-8   | 85       | 5.15         | 3.95       |
| # 10-24   | 10-24       | 3/4"               | 1/8"      | 2981-10  | 85       | 5.65         | 4.35       |
| 1/4-20  | 1/4-20      | 1 1/4"             | 1/8"      | 2981-1/4 | 85       | 8.20         | 6.30       |



# WALSCO ELECTRONIC HARDWARE

The 99 Line

BULK PACK

IN PERMANENT *Transparent* PLASTIC STORAGE BOXES with SLIDING TOPS • PROMPT DELIVERY FOR INDUSTRIAL AND OTHER QUANTITY USERS

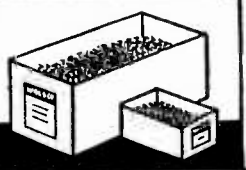

## INSULATING WASHERS

Phenolic Fibre



### THE "99 LINE"

### BULK PACK

| Fits Screw No.       | Description |            |                 |       | Part No.  | 99c Net, Ea. Pkg.<br>Quantity per Package | Bulk Part No. | Net Prices, per Thousand |            |
|----------------------|-------------|------------|-----------------|-------|-----------|---|---------------|--------------------------|------------|
|                      | A           | B          | C               | D     |           |   |               | 1000 to 9999             | 10M and up |
| <b>EXTRUDED TYPE</b> |             |            |                 |       |           |   |               |                          |            |
| 6                    | 5/8"        | 1 1/8"     | .136"           | 3/32" | 3431-E-99 | 100                                       | 3432-6        | \$5.25                   | \$4.05     |
| 8                    | 3/8"        | 1 1/4"     | .165"           | 3/32" | 3432-E-99 | 100                                       | 3432-8        | 5.25                     | 4.05       |
| 10                   | 3/8"        | .308"      | .195"           | 3/32" | 3433-E-99 | 100                                       | 3432-10       | 5.25                     | 4.05       |
| 1/4"                 | 1/2"        | 1 1/2"     | .255"           | 3/32" | 3434-E-99 | 75  | 3432-1/4      | 5.75                     | 4.40       |
| 3/8"                 | 5/8"        | 1 1/2"     | .380"           | 3/32" | 3435-E-99 | 75  | 3432-3/8      | 7.05                     | 5.40       |
| <b>FLAT TYPE</b>     |             |            |                 |       |           |   |               |                          |            |
| 6                    | O.D. 5/8"   | I.D. .136" | Thickness 3/32" |       | 3431-F-99 | 250                                       | 3431-6        | 1.50                     | 1.15       |
| 8                    | 3/8"        | .165"      | 3/32"           |       | 3432-F-99 | 250                                       | 3431-8        | 1.90                     | 1.45       |
| 10                   | 3/8"        | .195"      | 3/32"           |       | 3433-F-99 | 250                                       | 3431-10       | 1.90                     | 1.45       |
| 1/4"                 | 1/2"        | .255"      | 3/32"           |       | 3434-F-99 | 200                                       | 3431-1/4      | 2.30                     | 1.75       |
| 3/8"                 | 5/8"        | .380"      | 3/32"           |       | 3435-F-99 | 200                                       | 3431-3/8      | 2.60                     | 2.00       |



## MISC. WASHERS



### FLAT METAL WASHERS, Steel, Cadmium-Plated

| Fits Screw No. | O.D. | Thickness | Part No. | Quantity | 1000 to 9999 | 10M and up |
|----------------|------|-----------|----------|----------|--------------|------------|
| 4              | 3/8" | 3/32"     | 3511-4   | 500      | \$ .90       | \$ .70     |
| 6              | 3/8" | 3/32"     | 3512-99  | 500      | .95          | .75        |
| 8              | 3/8" | 3/32"     | 3513-99  | 500      | .95          | .75        |
| 10             | 3/8" | 3/32"     | 3514-99  | 300      | 1.40         | 1.05       |
| 1/4"           | 1/2" | 3/32"     | 3515-99  | 300      | 1.65         | 1.25       |

### LOCK WASHERS, Int. Teeth, Steel, Cadmium-Plated

| Fits Screw No. | Part No. | Quantity | 1000 to 9999 | 10M and up |
|----------------|----------|----------|--------------|------------|
| 4              | 3591-4   | 250      | 2.35         | 1.80       |
| 6              | 3592-99  | 250      | 2.15         | 1.65       |
| 8              | 3593-99  | 250      | 2.20         | 1.70       |
| 10             | 3594-99  | 250      | 2.20         | 1.70       |
| 1/4"           | 3595-99  | 200      | 2.90         | 2.20       |
| 3/8"           | 3596-99  | 100      | 5.05         | 3.90       |

### SPRING (FRICTION) WASHERS

| I.D.  | O.D. | Thickness | Part No. | Quantity | 1000 to 9999 | 10M and up |
|-------|------|-----------|----------|----------|--------------|------------|
| 1/8"  | 1/8" | .010"     | 3425-1   | 500      | 7.00         | 5.50       |
| 3/16" | 3/8" | .008"     | 3425-2   | 500      | 7.75         | 6.00       |
| 1/4"  | 1/2" | .012"     | 3425-3   | 500      | 8.75         | 6.75       |

### CUP WASHERS, Steel, Nickel-Plated

| Fits Screw No. | Part No. | Quantity | 1000 to 9999 | 10M and up |
|----------------|----------|----------|--------------|------------|
| 6              | 3544-99  | 300      | 1.50         | 1.15       |
| 8              | 3545-99  | 250      | 1.80         | 1.40       |
| 10             | 3546-99  | 200      | 2.40         | 1.85       |
| 12             |          |          | 2.90         | 2.25       |

### "C" WASHERS, Soft Steel, Cadmium-Plated

| Fits Shaft | A    | B    | C     | Thickness | Part No. | Quantity | 1000 to 9999 | 10M and up |
|------------|------|------|-------|-----------|----------|----------|--------------|------------|
| 1/4"       | .260 | 1/8" | 1/16" | 3/32"     | 3420-2   | 500      | 4.15         | 3.20       |
| 3/8"       | 3/8" | 1/8" | 1/8"  | 3/32"     | 3420-3   | 500      | 3.60         | 2.75       |

### KNOB FELT WASHERS, Brown

| O.D. | I.D. | Thickness | Part No. | Quantity | 1000 to 9999 | 10M and up |
|------|------|-----------|----------|----------|--------------|------------|
| 3/4" | 1/4" | 3/32"     | 3490-99  | 250      | 1.75         | 1.10       |



## PHONE TIPS



|          |         |    |        |             |           |
|----------|---------|----|--------|-------------|-----------|
| 1/8" O/L | 2725-99 | 60 | 2725-1 | 250 to 4999 | 5M and up |
|          |         |    |        | \$9.05      | \$6.95    |



# WALSCO ELECTRONIC HARDWARE

The 99 Line

BULK PACK

IN PERMANENT TRANSPARENT PLASTIC STORAGE BOXES with SLIDING TOPS • PROMPT DELIVERY FOR INDUSTRIAL AND OTHER QUANTITY USERS

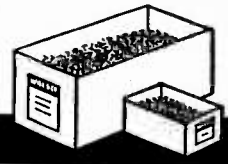

## MISC. CLIPS

### THE "99 LINE"

| Length   | Width | Mtg. Hole Size | Description | 99c Net, Ea. Pkg. |                      | BULK PACK             |                          |         |
|--|-------|----------------|-------------|-------------------|----------------------|-----------------------|--------------------------|---------|
|  |       |                |             | Part No.          | Quantity per Package | Bulk Part No.         | Net Prices, per Thousand |         |
| <b>SPRING CLIPS, Spring Brass, Nickel-Plated</b> |       |                |             |                   |                      |                       |                          |         |
| 1 1/8"   | 3/8"  | 4 and 5        | .....       | 2731-99           | 100                  | 2730-1                | \$5.65                   |         |
| 1 1/8"   | 1/2"  | 6              | .....       | 2732-99           | 75                   | 2730-2                | 7.65                     |         |
| <b>GRID CAPS</b>                                 |       |                |             |                   |                      |                       |                          |         |
| For Glass Tubes.....                             |       |                |             |                   |                      | 250 to 4999 5M and up |                          |         |
| For Metal and "GT" Tubes.....                    |       |                |             |                   |                      | 2600-1                | \$17.50                  | \$13.50 |
|  |       |                |             |                   |                      | 2600-4                | 6.00                     | 3.90    |
| <b>FUSE CLIPS</b>                                |       |                |             |                   |                      |                       |                          |         |
| For 1/4" Fuses.....                              |       |                |             |                   |                      | 2720-1                | 8.00                     | 5.75    |
| For 3/8" Fuses.....                              |       |                |             |                   |                      | 2720-2                | 14.00                    | 10.80   |

## FUSE INSULATORS

|                             |                         |
|-----------------------------|-------------------------|
| 1 1/8" long, 1/4" I.D. .... | 1000 to 9999 10M and up |
| 5/8" long, 1/4" I.D. ....   | 2690-1 \$3.35 \$2.55    |
|                             | 2690-2 2.95 2.30        |

## ANGLE BRACKETS

| Material                     | Dimensions |      |      |       |   |
|------------------------------|------------|------|------|-------|---|
|                              | A          | B    | C    |       |   |
| Brass, cadmium-plated        | 7/8"       | 1/4" | 1/4" | ..... | 2610-1 500 to 9999 10M and up \$5.70 \$4.65 |
| Steel, cadmium-plated        | 1/2"       | 5/8" | 1/8" | ..... | 2610-2 6.50 5.40                            |
| Brass (one hole tapped 6-32) | 3/2"       | 1/2" | 1/8" | ..... | 2610-5 9.75 7.50                            |

## INSULATING TUBING

### FLEXITUBE

Extruded vinyl tubing; dielectric strength: 15,000 v. Available in Black, Green, Red, and Clear. Please specify color.

| Part No. | Size, B & S Gauge No. | Approx. I.D. |     |       |  |
|----------|-----------------------|--------------|-----|-------|--|
|          |                       | Inches       | MM. |       |  |
| R 600    | 18                    | .042         | 1   | ..... | 100 to 1999* ft. 2M* ft. and up \$15.00/M ft. \$8.82/M ft. |
| R 601    | 16                    | .053         | 1.4 | ..... | 15.00/M ft. 8.82/M ft.                                     |
| R 602    | 14                    | .066         | 1.6 | ..... | 15.60/M ft. 10.37/M ft.                                    |
| R 603    | 12                    | .085         | 2   | ..... | 16.00/M ft. 11.91/M ft.                                    |
| R 604    | 10                    | .106         | 2.7 | ..... | 18.00/M ft. 12.20/M ft.                                    |
| R 605    | 8                     | .133         | 3.5 | ..... | 22.20/M ft. 13.30/M ft.                                    |
| R 606    | 6                     | .166         | 4   | ..... | 26.00/M ft. 16.00/M ft.                                    |
| R 607    | 4                     | .208         | 5   | ..... | 32.00/M ft. 23.00/M ft.                                    |
| R 608    | 2                     | .263         | 6.5 | ..... | 45.00/M ft. 30.00/M ft.                                    |

### RAYOFLEX

Lacquered-rayon tubing, radio grade. Meets A.S.T.M. Specifications B-2. Available in Black, Blue, Red, and Yellow. Please specify color.

| Part No.  | Size, B & S Gauge No. | Approx. I.D. |     |       |   |
|---|-----------------------|--------------|-----|-------|---|
|   |                       | Inches       | MM. |       |   |
| (Following sizes supplied in continuous lengths.) |                       |              |     |       |   |
| R 630   | 18                    | .042         | 1   | ..... | 100 to 1999* ft. 2M* ft. and up \$39.50/M ft. \$30.40/M ft. |
| R 631   | 15                    | .059         | 1.5 | ..... | 43.70/M ft. 33.60/M ft.                                     |
| R 632   | 12                    | .085         | 2   | ..... | 51.90/M ft. 39.90/M ft.                                     |
| R 633   | 9                     | .118         | 3   | ..... | 60.00/M ft. 46.20/M ft.                                     |
| R 634   | 6                     | .166         | 4   | ..... | 67.80/M ft. 52.20/M ft.                                     |
| (Following sizes supplied in 30-inch lengths.)    |                       |              |     |       |   |
| R 635   | 2                     | 1/4"         | 6.5 | ..... | 106.80/M ft. 82.20/M ft.                                    |
| R 636   | 0                     | 1/2"         | 8.5 | ..... | 143.20/M ft. 110.20/M ft.                                   |
| R 637   | 00                    | 3/4"         | 9.5 | ..... | 171.80/M ft. 132.20/M ft.                                   |
| R 638   | 0000                  | 1"           | 13  | ..... | 236.80/M ft. 182.20/M ft.                                   |

\*Various sizes and colors, but not less than 100 ft. of any one size or color, may be combined in one order to take advantage of quantity discounts. Sizes other than listed above can be supplied. Prices quoted on request.



### DIAL CABLE AND CORDS



| Part No.   | Description  | 3000 to 14,999 ft. | 15M ft. and up |
|--|--|--------------------|----------------|
| <b>METAL CABLES</b>  |  |                    |                |
| R 30   | Phosphor bronze cable, twisted, 42-strand, .032" diameter..... | \$20.00/M ft.      | \$15.40/M ft.  |
| R 31   | Bronze cable, braided, 16-strand, .038" diameter.....          | 10.00/M ft.        | 8.00/M ft.     |
| R 32   | Bronze cable, braided, 8-strand, .026" diameter.....           | 11.00/M ft.        | 8.50/M ft.     |
| <b>NYLON CORDS</b>   |  |                    |                |
| Constructed with impregnated fibreglass core, and black nylon braid.<br>Construction combines minimum stretch, high coefficient of friction, and maximum resistance to abrasion. |  |                    |                |
| R 35   | "Special-Thin" Cord, approximately .026" diameter.....         | 9.00/M ft.         | 6.05/M ft.     |
| R 39   | Standard Cord, approximately .032" diameter.....               | 12.75/M ft.        | 9.20/M ft.     |
| R 34   | Medium Cord, approximately .040" diameter.....                 | 13.50/M ft.        | 9.90/M ft.     |
| R 33   | Heavy-Duty Cord, approximately .060" diameter.....             | 17.50/M ft.        | 13.50/M ft.    |



### GRILLE CLOTH, SCREENING AND METAL GRILLE



| Part No.   | Description  | 5 to 49 yd.   | 50 yd. and up                  |
|--|--|---------------|--------------------------------|
| <b>GRILLE CLOTH</b>  |  |               |                                |
| R 362 BU   | Available in a variety of colors and patterns. Average width of material is 52"..... | \$3.45/yd.    | \$2.30/yd.                     |
| <b>FLOCKED GRILLE SCREENING</b>  |  |               |                                |
|  | Color  | Width, inches |                                |
| R 374-1 BU   | Brown  | 11            | 10 to 99 ft. \$ .45/lin. ft.   |
| R 374-3 BU   | Light Ivory  | 11            | 100 ft. and up \$ .35/lin. ft. |
| R 376-1 BU   | Brown  | 18            | .45/lin. ft. .35/lin. ft.      |
| R 376-3 BU   | Light Ivory  | 18            | .65/lin. ft. .50/lin. ft.      |
| R 378-1 BU   | Brown  | 36            | .65/lin. ft. .50/lin. ft.      |
| R 378-3 BU   | Light Ivory  | 36            | 1.30/lin. ft. 1.00/lin. ft.    |
|  |  |               | 1.30/lin. ft. 1.00/lin. ft.    |
| Note: Grille Cloth and Flocked Grille Screening also available in "cut-to-order" sizes..... Prices Quoted on Request |  |               |                                |

### ORNAMENTAL METAL GRILLE

|       |   |                          |
|-------|---|--------------------------|
| R 380 | Available in a variety of finishes and in any size up to 48" width..... | Prices Quoted on Request |
|-------|---|--------------------------|



### CHEMICALS AND FINISHES



| Part No.                       | Description  | 1-gal. Cans             | 5-gal. Cans             |
|--------------------------------|--|-------------------------|-------------------------|
| <b>INDUSTRIAL ADHESIVES</b>    |  |                         |                         |
| R 21                           | WALSCO Fabric Cement.....                                    | \$7.50/gal.             | \$5.80/gal.             |
| R 40                           | WALSCO Plastic Cement.....                                   | 6.50/gal.               | 5.00/gal.               |
| R 50                           | WALSCO Radio Cement.....                                     | 6.50/gal.               | 5.00/gal.               |
| R 110                          | WALSCO Rubber Cement.....                                    | 7.50/gal.               | 5.80/gal.               |
| R 150                          | WALSCO Polystyrene Cement.....                               | 7.50/gal.               | 5.80/gal.               |
| <b>SOLVENTS &amp; THINNERS</b> |  |                         |                         |
| R 1                            | For Lacquer No. 120.....                                     | 4.00/gal.               | 3.10/gal.               |
| R 2                            | For Cement No. R 110 and Wrinkle Varnish No. R 145.....      | 1.25/gal.               | .95/gal.                |
| R 60                           | For Cements Nos. R 20, R 40, and R 50.....                   | 2.80/gal.               | 2.15/gal.               |
| R 160                          | For Cement No. R 150.....                                    | 2.50/gal.               | 1.95/gal.               |
| R 214                          | Carbon-Tetrachloride.....                                    | 3.50/gal.               | 2.70/gal.               |
| <b>SPECIAL CHEMICALS</b>       |  |                         |                         |
| R 22                           | WALSCOLUB-B.....   | 1-lb. Cans \$1.50/lb.   | 5-lb. Cans \$1.20/lb.   |
| R 190                          | Insulating Varnish.....                                      | 1-gal. Cans \$7.90/gal. | 5-gal. Cans \$6.25/gal. |
| <b>POLISHES</b>                |  |                         |                         |
| R 410                          | WALSCO Super Polish.....                                     | 2.85/gal.               | 2.25/gal.               |
| R 414                          | Scratch-Removing Polish, Dark.....                           | 2.50/gal.               | 1.95/gal.               |
| R 430                          | Scratch-Removing Polish, Light.....                          | 2.50/gal.               | 1.95/gal.               |
| <b>LACQUERS AND FINISHES</b>   |  |                         |                         |
| R 120                          | Crystallizing Lacquer: Black, Green, Grey, Clear, Brown..... | 10.00/gal.              | 8.15/gal.               |
| R 145                          | Wrinkle Varnish — Air-Dry: Grey or Black.....                | 9.00/gal.               | 7.90/gal.               |

# ICA INSULINE RADIO PRODUCTS ICA

## ICA Bakelite Double Phone Plug

- 
- No. List  
24B—Black ..... \$ .50  
24R—Red ..... .50  
34B—Black barrel only ..... .20  
34R—Red barrel only ..... .20  
34P—Plug only ..... .40

## ICA Midget Phone Plug

- Overall length— $2\frac{1}{4}$ " Diameter of barrel  $\frac{1}{8}$ ".
- 
- No. List  
29B—Black ..... \$ .50  
29R—Red ..... .50  
29P—Plug only ..... .40  
39B—Black barrel only ..... .20  
39R—Red barrel only ..... .20

## ICA Stubby Shielded Phone Plug

- Barrel Measures  $\frac{1}{8}$ " diameter x 1" long.
- 
- No. 27 List \$ .80  
No. 37—Barrel only ..... List \$ .45

## ICA Midget Shielded Phone Plug

- Diameter of Barrel  $\frac{1}{8}$ ". Overall size of Plug  $2\frac{1}{4}$ ".
- 
- No. 30 List \$ .70  
No. 40—Barrel only ..... List \$ .40

## ICA 3-Wire Microphone Plug

- 
- Has solder connections for cable or microphone use. Barrel molded of bakelite; brass parts, nickel plated.
- No. 1901 ..... List \$1.00

## ICA Shielded Double Phone Plug

- Nickel Barrel  
Brass Shell  
Nickel Plated
- 
- Supplied with fibre insulating tube.
- No. 25 ..... List \$ .90  
No. 35—Barrel only ..... List \$ .50

## Wire Connector with Banana Plug Receptacle

- Ideal for quick splicing for testing point.
- 
- No. 1933 ..... List \$ .30

## ICA Shielded 3-Way Portable

- Microphone Jack
- 
- For all types of microphones. Sturdily constructed of brass parts with phosphor bronze springs. Nickel plated and thoroughly insulated.
- No. 1904 ..... List \$1.50

## ICA Bakelite Portable Jacks

- Single Open Circuit
- 
- No. 1911—Overall Size  $1\frac{1}{2}$ " Diameter  $\frac{3}{8}$ " ..... List \$ .70  
No. 1903—Portable Jack, black Bakelite barrel ..... List \$1.10

## ICA Shielded Portable Jack

- Single Open Circuit
- 
- No. 1913— $2\frac{1}{8}$ " Long,  $\frac{1}{8}$ " Diameter ..... List \$1.25

## Phone Plug Adapter

- Soldering or wiring not necessary.
- 
- No. 33 ..... List \$ .45

## ICA De Luxe Phone Jacks

- New Design  
Greater Efficiency
- 
- New design. Tension fatigue minimized. — Spring members made of phosphor bronze. Hooked type soldering lugs—Cannot turn or short. For standard  $\frac{1}{4}$ " plug.
- No. List  
1920—Single Open Circuit..... \$ .75  
1921—Single Closed Circuit..... .85  
1922—Three-Way Microphone Jack ..... 1.10

## ICA Phone Jacks

- Smaller type precision made jacks for limited space. Complete with nut and metal washer.
- 
- No. List  
1870—Single open circuit..... \$ .50  
1871—Single closed circuit..... .55  
1872—3-way mike jack..... .60

## ICA Panel Mounting Jacks

- Small and Compact
- 
- No. List  
325—Single Open Circuit..... \$ .50  
1905—3-Way Microphone Jack ..... .75

## ICA Insulated Tip Jacks

- With receptacle for standard phone tips.
- 
- No. List  
889B—Black ..... \$ .15  
889R—Red ..... .15

## Insulated Banana Jacks

- With receptacle for banana plugs.
- No. 888B—Black ..... List \$ .15  
No. 888R—Red ..... List .15

## ICA Bakelite Insulated Tip Jacks

- Moulded of Low-Loss Bakelite
- 
- No. List  
1889—Black ..... \$ .20  
1890—Red ..... .20

## Bakelite Banana Type Jacks

- No. 1891—Black ..... List \$ .20  
No. 1892—Red ..... List .20

## ICA Combination Banana Plug or Phone Tip Jack

- Made to take banana plug or standard phone tips interchangeably. Insulated cap in black and red — With washers and nuts.
- 
- No. 528R—Red ..... List \$ .20  
No. 528B—Black ..... List .20

## Microphone Connectors

- 
- No. 1929—For use on chassis unit or in microphone. Single contact ..... List \$ .30  
No. 1930—Closed circuit connector, With spring actuated contact ..... List .40

## Microphone Connectors

- 
- Shielded cable type. Single contact.
- No. List  
1931—Female connection ..... \$ .50  
1932—Male connection ..... .40

## ICA Insulated Binding Posts with Jack for Banana Type Plug

- 
- Length  $1\frac{3}{8}$ " overall when top is up. Extends  $\frac{5}{8}$ " above panel when top is screwed down. Fitted with 8/32 screw  $\frac{1}{8}$ " long, and two hex nuts.
- No. List  
622—Red ..... \$ .25  
623—Black ..... .25

## ICA All Metal Binding Post

- Designed for high amperage use and where low resistance connections are necessary on test equipment, etc. Nickel plated brass. Dimensions same as No. 617 below.
- 
- No. 620 ..... List \$ .20

## ICA Bakelite Binding Posts

- $\frac{1}{8}$ " Diameter Head with Brass Threaded insert, Nickel Plated Screw and Knurled nut.
- 
- No. List  
617—Red ..... \$ .18  
618—Black ..... .18

## ICA Vise-Grip Binding Post

- Engineered on principle of a vise. Can cause no damage to even finest wire strands. Wire hole and designating symbol always in alignment. Two styles.
- 
- No. 630 Series—Has 6/32 Male Threaded Shank ..... List \$ .50  
No. 690 Series—Has 6/32 Female Thread ..... List \$ .50

- | No. | Marking            | No. | Marking            |
|-----|--------------------|-----|--------------------|
| 630 | ANT                | 690 | ANT                |
| 631 | GND                | 691 | GND                |
| 632 | A                  | 692 | A                  |
| 633 | G                  | 693 | G                  |
| 634 | +                  | 694 | +                  |
| 635 | —                  | 695 | —                  |
| 636 | Rec.               | 696 | Rec.               |
| 637 | PLAIN (No Marking) | 697 | PLAIN (No Marking) |

## Bakelite Binding Post Heads

- Bakelite Heads only with Brass Threaded Insert for 8/32 Screw.
- 
- No. 628—Red ..... List \$ .10  
No. 629—Black ..... List .10

## Insulated Midget Phone Tip Plug

- Fits all standard jacks. Tip is threaded. Overall length  $1\frac{1}{4}$ ".
- 
- No. List  
876R—Red ..... \$ .15  
876B—Black ..... .15
- ICA Midget Sharp Point Threaded Phone Tip—Non-Insulated
- No. 365 ..... List \$ .15

## U. S. Army and Navy Specification Plugs

- Manufactured to meet the very exacting specifications of the U. S. Army Signal Corps and U. S. Navy. Will fit all standard jacks.
- 
- No. P.L. 55—2 Conductor Plug (long) ..... List \$ .85  
No. P.L. 68—3 Conductor Microphone Plug ..... List \$1.75

## ICA Insulated Solderless Plug

- 
- 2" long — fits all standard phone tip jacks.
- No. 885B—Black ..... List \$ .18  
No. 885R—Red ..... List .18

## ICA Sr. Solderless Plugs

- 
- $1\frac{1}{8}$ " overall length.
- No. 358  
List \$ .10

## ICA Jr. Solderless Plugs

- 
- $1\frac{1}{8}$ " overall length. Tip  $\frac{1}{4}$ ".
- No. 359  
List \$ .10

## ICA Brass Tip Jacks

- Nickel Plated
- 
- No. 357  
List \$ .10

## ICA Insulated Needle Point Tip Plug

- 
- 886B — Black  
List \$ .18  
886R — Red  
List \$ .18
- Above with Insulating Sleeve
- No. 341B—Black ..... List \$ .10  
No. 341R—Red ..... List .10

## ICA Split Banana Plugs

- For positive and durable spring action. Allows spring to fit into jack, cannot bend out of shape — Complete with two nuts.
- 
- No. 403 ..... List \$1.12

# ICA INSULINE ICA

## RADIO PRODUCTS

### ICA Insulated Solderless Split Banana Plugs



Set screw provided at side of barrel to fasten screw without soldering.

1 1/2" Long  
 No. 883B—Black ..... List \$.20  
 No. 883R—Red ..... List .20

2 1/2" Long  
 With sleeve covering set screws.  
 No. 882B—Black ..... List \$.40  
 No. 882R—Red ..... List .40

4" Long  
 With sleeve covering set screws.  
 No. 881B—Black ..... List \$.50  
 No. 881R—Red ..... List .50

With Solderless Wire Nut  
 No. 434B—Black ..... List \$.20  
 No. 434R—Red ..... List .20

### ICA Transmitting Banana Jacks

No. 402  
 Nickel Plated Brass  
 List \$.09



### Insulated Spade Lug

Insulated Spade Lug with banana plug receptacle on lead end.  
 No. 887B—Black ..... List \$1.16  
 No. 887R—Red ..... List .16  
 10 in Standard Carton



### Beryllium Banana Plugs



Approved by the Signal Corps and other government agencies. These plugs are used in all government equipment. Made of Beryllium copper and guaranteed for its spring and durability. Threaded plug accommodates 6/32 nuts.



No. 419—Overall size 1 1/4" long. Shank length 1/4" long. Diameter of shank 1/8".  
 No. 420—Overall size 1 1/4" long. Threaded shank length 3/8" long threaded for 6/32 nuts.  
 No. 419—Rivet type ..... \$1.15  
 420—Threaded shank—3/8" ..... .25

### ICA Spade Lug



Can be used on any size screw or terminal up to size 10. Receptacle fits all I.C.A. and other make Banana Plugs.

No. 879 ..... List \$5.50 C  
 100 in Standard Package

### Plugs and Jacks

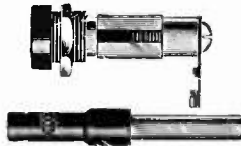

A new line of heavy duty transmitting plugs and jacks. Plug-in type with positive grip contacts. Equipped with heavy insulated threaded heads and handles for safe handling on high R.F. currents. Supplied with large hex nuts for panel mounting.

Handle 1,000 Volts at 10 Amps

| No.                   | List  |
|-----------------------|-------|
| 450—Medium Plug-RED   | \$.55 |
| 451—Medium Plug-BLACK | .55   |
| 452—Medium Jack-RED   | .95   |
| 453—Medium Jack-BLACK | .95   |
| 454—Giant Plug-RED    | .75   |
| 455—Giant Plug-BLACK  | .75   |
| 456—Giant Jack-RED    | 1.15  |
| 457—Giant Jack-BLACK  | 1.15  |

### ICA Alligator Clips

Good firm grip. Ideal for work in tight places. Overall length 2".  
 No. 364 ..... List \$1.10



### ICA Alligator Clip with Screw Connection



Good firm bite. Convenient screw connection eliminates the necessity for soldering. Overall length 2".  
 No. 376 ..... List \$1.22

### ICA Insulated Alligator Clips



No. 884B—Black ..... List \$.20  
 No. 884R—Red ..... List .20

### ICA Insulated Alligator Clip with Phone Tip Jack



Has standard phone tip jack in insulated sleeve. Will accommodate phone tip or solderless plug tips.  
 No. 525R—Red ..... List \$.45  
 No. 525B—Black ..... List .45

### ICA Insulated Combination



Jack Alligator Clip



An insulated alligator clip with a dual purpose Jack in catalin sleeve—Equipped with the new combination Jack which takes either solderless phone tip or Banana plug. Overall length—3 1/4".  
 No. 520R—Red ..... List \$.50  
 No. 520B—Black ..... List .50

### ICA SHIELDED 3-WIRE MICROPHONE PLUG

Shielded Nickel Barrel



No. 1900 ..... List \$1.45

### ICA SHEARING PUNCHES

Now! No Hammering Necessary to Punch Chassis Holes

Shearing is accomplished with a wrench which forces shear punch into die. Made of High Grade Steel.



| No. | Size of Hole | List   |
|-----|--------------|--------|
| 723 | 3/8"         | \$4.25 |
| 725 | 3/4"         | 4.25   |
| 724 | 1"           | 4.75   |
| 726 | 1 1/8"       | 5.00   |
| 727 | 1 1/4"       | 5.00   |
| 728 | 1 3/8"       | 5.00   |
| 729 | 1 1/2"       | 5.00   |
| 730 | 1 3/4"       | 5.50   |

### ICA IMPROVED ALL-PURPOSE CIRCLE CUTTER

Will Cut Holes from 1/2 to 8 Inches  
 Cutting bar holder is 7/8" in diameter and also accommodates a centering drill or any size pilot pin. Cutting bar is 3/8" square and is arranged to hold a 1/8" high speed cutting bit.



No. 775 ..... List \$6.60

### ICA PLUG AND JACK

Used on RCA recording units, receivers and auto sets.

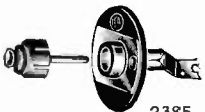

| No.                  | List  |
|----------------------|-------|
| 2383—Pin Plug        | \$.10 |
| 2385—Socket & Shield | .15   |

### ICA SQUARE HOLE SHEARING PUNCH

This new punch permits the cutting of any size odd-shape hole (square rectangular, hexagon, oblong, etc.) on any size panel or chassis. Good for Enlarging or punching TRANSFORMER Holes.



No. 790 ..... List \$16.50

### REPLACEMENT DRILLS AND CUTTERS

Used as replacement on ICA No. 775 and No. 780 circle cutters as well as on other make cutters.

|  |            |
|--|------------|
| No. 776—Replacement drill for No. 775 Circle Cutter  | List \$.60 |
| No. 777—Replacement cutter for No. 775 Circle Cutter | List .85   |
| No. 781—Replacement drill for No. 780 Circle Cutter  | List .60   |
| No. 782—Replacement cutter for No. 780 Circle Cutter | List .90   |



### ICA UNIVERSAL MULTI-PURPOSE CUTTING TOOL

This handy tool can be used for counter-sinking, beading, drilling or cutting holes. Equipped with 3/8" drill for holes from 1/8" diameter up to 3" diameter. Can be used either in drill press or hand brace. Also acts as a boring tool when used in a lathe.



No. 780 ..... List \$4.00

### ICA RIVET AND EYELET PUNCH SET

A Universal Tool that can be used for either riveting or eyeletting. Holder is made of cast iron with hexagonal sides, thus permitting the tool to be placed in a vise without slipping.



No. 785—Complete with ample assortment of eyelets and rivets.  
 List \$4.00

### RIVET AND EYELET ASSORTMENT

Additional eyelets and rivets can be purchased separately.  
 No. 5265—(Assortment of 100)..... List \$.80

### RIVET & EYELET SETTING TOOL



No. 786 ..... List \$9.00



# ICA INSULINE RADIO PRODUCTS

## ICA SOLDERING IRONS



ICA Highest Quality Soldering Irons are "Best By Test". Each model is submitted to the most severe tests and results prove conclusively that ICA irons are equal, if not superior, to any soldering iron on the market today.

### 60 WATT IRON

No. 1960-A—105-120 Volts ..... List \$5.00  
No. 1963—220 Volts ..... List 5.00

### 85 WATT IRON

No. 1962-A—105-120 Volts ..... List \$6.50  
No. 1964—220 Volts ..... List 6.50

### 115 WATT IRON

No. 1961-A—105-120 Volts ..... List \$7.50  
No. 1965—220 Volts ..... List 7.50

## REPLACEMENT ELEMENTS FOR ICA SOLDERING IRONS

Due to the construction of the ICA Soldering Irons, burnt out elements can be easily removed and replaced by anyone.



| 105-120 Volts |       |        | 220 Volts |       |        |
|---------------|-------|--------|-----------|-------|--------|
| No.           | Watts | List   | No.       | Watts | List   |
| 1985          | 60    | \$3.00 | 1990      | 60    | \$3.00 |
| 1986          | 85    | 3.50   | 1991      | 85    | 3.50   |
| 1987          | 115   | 3.50   | 1992      | 115   | 3.50   |

## REPLACEMENT TIPS

For ICA Soldering Irons



Available in All Sizes

Made of a special copper alloy. Electrolytically pure. For replacement in ICA Soldering Irons. Can also be used in American Beauty and irons of similar construction.

| No.  | Watts | Tips  | Diam. | Length | List   |
|------|-------|-------|-------|--------|--------|
| 1970 | 60    | Flat  | 3/8"  | 3"     | \$6.00 |
| 1972 | 85    | Point | 3/8"  | 3 1/2" | .80    |
| 1971 | 115   | Point | 7/8"  | 3 1/2" | 1.00   |

## ICA UNBREAKABLE "TURN-TITE" SOCKET WRENCHES



7" long. Handle is of ribbed shockproof unbreakable material.

| No. | Socket | List  | No. | Socket                     | List  |
|-----|--------|-------|-----|----------------------------|-------|
| 940 | 3/8"   | \$.95 | 944 | 3/4"                       | \$.95 |
| 941 | 1/2"   | .95   | 945 | 7/8"                       | .95   |
| 942 | 5/8"   | .95   | 946 | 1 1/2"                     | .95   |
| 943 | 1 1/4" | .95   | 949 | Set of 7 wrenches as above | 6.65  |

## ICA UNBREAKABLE VOLUME CONTROL WRENCH



Socket is 3/8" diameter.

No. 937 ..... List \$1.75

## ICA "TURN-TITE" SOCKET WRENCHES

### HOLLOW SHAFTS



Made of hardened steel, cadmium plated, with sturdy Black japanned wood handles.

| 6 Inches Long |       | 9 Inches Long |       |
|---------------|-------|---------------|-------|
| No.           | List  | No.           | List  |
| 898—3/8"      | \$.45 | 900—3/8"      | \$.55 |
| 890—1/4"      | .45   | 894—1/4"      | .55   |
| 891—5/8"      | .45   | 895—5/8"      | .55   |
| 892—3/8"      | .45   | 896—3/8"      | .55   |
| 893—1 1/8"    | .45   | 897—1 1/8"    | .55   |
| 899—1 1/2"    | .45   | 901—1 1/2"    | .55   |
| 910—Set of 6  |       | 911—Set of 6  |       |

## ICA FLEXIBLE SOCKET WRENCH



Especially designed for hard-to-reach spots. Can actually be used around corners or under obstructing objects.

No. 913—1/4" Hex ..... List \$1.50  
No. 914—1/8" Hex ..... List 1.50

## ICA LOCK SOCKET WRENCH AND SCREW DRIVER SET

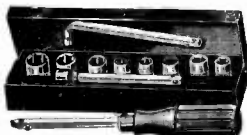

The all-purpose socket wrench, packed in neat, enameled steel case. Includes sturdy 6 1/2" Wood Grip Screw Driver—4" L Handle—3 3/4" Extension Adaptor, 1/4", 1/2", 3/8", 1/2" and 1/2" Hex—3/8" Round Knurled Socket—1/4" and 5/16" Square Sockets.

No. 999 ..... List \$2.75

## ICA AMBER COLORED UNBREAKABLE MIDGET SCREW DRIVER



Particularly shaped to fit into set screws of knobs. No. 1013 has convenient pocket clip. No. 1013—4 3/4" length ..... List \$2.25  
No. 1017—7" length ..... List .75

## ICA FLEXIBLE SCREW DRIVER

For the Hard to Reach Spots



Allows access to screws in hard to reach and out of the way places. Can go under objects or around corners.

No. 935 ..... List \$2.00

## ICA COMPLETE NEUTRALIZING TOOL KIT

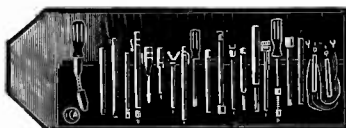

The kit consists of one of each of the following ICA tools, described herein:—Nos. 882, 1008, 987, 1015, 977, 996, 992, 985, 990, 1024, 1019, 1026, 1022, 1002, 1013, 1028, 1039, 1029, 1033, 935, 937.

No. 995—Kit, Complete with Carrying Case ..... List \$20.00

## ICA UTILITY NEUTRALIZING AND ALIGNING TOOL KIT



A handy Service Man's Kit containing carefully selected tools suitable for varied uses. Packed in vest pocket leatherette case.

No. 997 ..... List \$3.00

## ICA NEUTRALIZING AND ALIGNING TOOL KIT

The Kit consists of twelve separate and distinct parts, some of which can be employed for several operations. These units telescope into each other, forming four separate tools when assembled.

No. 998 ..... List \$6.50  
Complete with Carrying Case



## ICA DE LUXE NEUTRALIZING AND ALIGNING TOOL KIT

Complete for Every Service Need

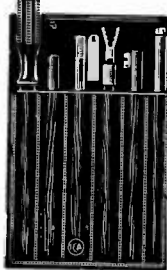

Consists of fourteen tools, most of which telescope into one another, forming six units when assembled into the attractive black leatherette case. The complete kit in carrying case can be kept in the pocket. Tools complete with carrying case.

No. 994 ..... List \$7.50

## ICA NEUTRALIZING AND ALIGNMENT TOOL KIT — SIGNAL CORPS No. TE45-A

ICA Catalog No. 993



This versatile kit, designed for and used by the Signal Corps, is also strongly recommended for general service use. Compact, and contained in a handsome leatherette case, this kit consists of the following:

- |                          |   |
|--------------------------|---|
| 1—No. 935 Screw Driver   | 1—Bone Fibre No. 1015 Neutralizing Tool |
| 1—5" Screw Driver        | 2—No. 980—Hex Tools, 1/4" I.D.          |
| 1—Insulated Screw Driver | 2—No. 981—Hex Tools, 5/16" I.D.         |
- No. 993 ..... List \$6.75

## ICA DIAL CABLE ADJUSTER



Handy aid to replacing slipped-off dial cable over drive drum. Permits easy manipulation in cramped places.

No. 437 ..... List \$.75

## ICA 4-in-1 NEUTRALIZING TOOLS, SCREW DRIVER AND WRENCH

Made of Fenoline Fully Insulated

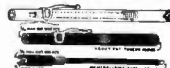

No. 1019—Complete ..... List \$.85

## ICA 5-IN-1 NEUTRALIZING AND COMPENSATING TOOL

Same features as the 4-in-1 tool described above with an additional all metal screw driver.



No. 1022 ..... List \$1.35

# ICA INSULINE ICA

## RADIO PRODUCTS

### ICA ALIGNMENT WRENCH

For RCA, Philco, etc.



Used on all makes Air Trimmer. Made of 1/2" Fenoline Rod—8 1/2" long—one end has hollow shaft hexagon wrench—other end has an especially shaped hook.  
No. 1008.....List \$1.50

### ICA BALANCING TOOL



Fits into No. 1019 Neutralizing Tool.  
No. 1026.....List \$ .50

### INSULATED NEUTRALIZING WRENCHES



Hexed—Full Length

For Philco, Majestic and Other Receivers

3/8" Diameter

No. 985—6" long.....List \$2.25  
No. 986—8" long.....List .35  
No. 980—5" long.....List .25  
No. 981—5" long, 7/16" dia.....List .30

### ICA Alignment Tool for Philco Receivers

For Air Trimmer Sets



Has specially designed metal clip for air trimmers. Made of narrow fibre rod, 3/32" diam. by 6" long.  
No. 1033.....List \$ .60

### ICA Insulated Adjustable Neutralizing Tools



Absolutely no metal parts. Screw driver slides into inside of neutralizing wrench.  
No. 990—Extending from 6 to 10".....List \$ .90  
No. 991—Extending from 12 to 16".....List 1.00

### ICA NEUTRALIZING AND ALIGNING TOOL



U. S. Army No. TL138A — ICA No. 1011 Used for general radio tuning and aligning. Approved by U. S. Army and Navy.  
No. 1011.....List \$1.00

### ICA NEUTRALIZING AND ALIGNING TOOL



Machined of bakelite rod 9/32 inch diameter. Designed for Western Electric Co. Approved by U. S. Army and Navy.  
No. 1006.....List \$1.25

### ICA ALL PURPOSE ALIGNING TOOL



Handle is of 3/8" Fenoline. End has Socket Screw Driver for neutralizing all iron core tuning systems.  
No. 1002.....List \$ .75

### ICA TEST-LITE

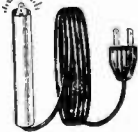

Provides a steady, bright light—without annoying flickering—for dark, narrow spaces around chassis, cabinets, etc. Plugs into any AC-DC socket, 105-125 volt., 4 1/2 ft. cord.  
Includes standard 6 volt lamp, No. 47, .15 amp., and plug complete.  
No. 938.....List \$1.50

### ICA Neutralizing Tools with Metal Nibs

Patent No. U.S. 83,321. Sturdy, unbreakable, will outlast all other type neutralizing tools.  
No. 996.....List \$1.50

### ICA BONE FIBRE SCREW DRIVER



Of 1/8" bone fibre rod with a sturdy blade.  
No. 1029.....List \$ .70

### ICA BONE FIBRE SCREW DRIVER



Double Edged—No Metal—Fully Insulated Made of 1/4" Bone Fibre Rod  
No. 1039.....List \$ .40

### ICA NEUTRALIZING TOOL

For Push Button Tuners



The Socket is 3/8" in diameter, and contains a screw driver blade.  
No. 1003.....List \$ .75

### ICA SET TRIMMER NEUTRALIZING TOOLS

For Philco, Zenith, RCA, etc.



Fits the smallest size trimmer condensers. Trimmer end is 3/32" diam. to fit 1/4" hole.  
No. 992—6" long.....List \$1.00  
No. 933—10" long.....List 1.25

### ICA NARROW SHAFT ALIGNMENT TOOL



RCA—Zenith—etc. 3/32" Bakelite Shaft  
No. 987.....List \$ .85

### ICA ALIGNMENT TOOLS

For RCA Receivers



Narrow shaft Neutralizing Tools made of Bone Fibre—3/32" wide. Has screw nib inserted in Brass Collar on end.  
No. 1015.....List \$ .75

### ICA MAGIC TUNING ALIGNMENT TOOL

Consists of a Bakelite rod with a Brass cylinder at one end, and a special finely divided iron core at the other end.  
No. 977.....List \$1.00

### ICA FORK TYPE NEUTRALIZING WRENCH and SCREW DRIVER

For RCA and Other Sets  
No. 1024.....List \$ .50

### ICA Fenoline Neutralizing Screw Drivers



Made of Fenoline. Strong and sturdy. Completely insulated for neutralizing and aligning coils, condensers, receivers, etc.  
No. 1028.....List \$ .40

### ICA ALL-PURPOSE TEST LEAD KIT

Complete For Every Testing Need

Equipped with one pair of test leads which have 48" of red and black kinkless live rubber wire. One end has insulated removable banana-type plugs.

Included in this test kit:  
1 pr. test leads.  
1 pr. insulated alligator clips—red and black.  
1 pr. insulated spade lugs—red and black.  
1 pr. insulated needle points—red and black.  
No. 1005—Kit, complete  
List \$3.50



### ICA PHONO-NEEDLE POINT TEST LEADS

With Slim Handles and Flexible Wire

Flexible rubber-covered, kinkless wire, 48" long. Tenite handles 4" long.

No. List  
382—With Phone Tips.....\$ .90  
381—With Spade Terminals......90  
379—With Alligator Clips.....1.10



### ICA DE LUXE EXTRA-FLEXIBLE TEST LEADS

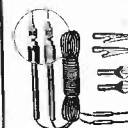

Slim Handles & Solderless Plugs  
48" Extra-Flexible Test Leads with 4" Tenite handles. New non-kinking, rubber insulated wire.  
No. List  
355—With Phone Tips.....\$ .90  
356—With Spade Terminals......90

### ICA PENCIL TYPE TEST LEADS

Finger-Grip Molded Tips

All connections are properly soldered providing low resistance connections vital in all precision tests. The Molded Finger Grip Tips are provided with rivets for easy removal of wire. Length of test leads is 48". Handles are 5" long.  
No. 373.....List \$1.75

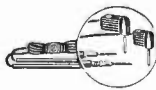

### NEW ICA SLIM-LINE TEST LEADS

Long vinyl-insulated shaft permits probing in closely wired circuits without fear of shorting. Black and red Tenite handles. 48" wire lead. With molded phone tip plug.  
No. 438.....List \$1.50 Pr.



### ICA HEAVY DUTY LABORATORY TEST LEADS

Long Slim Handles and Removable Phono Needle Chuck  
Extra long slim red and black handles knurled at end for finger grip ease. Handles 6" long, 50" of heavy duty kinkless, flexible rubber wire.  
No. List  
400—With knurled grip handle, Insulated solderless plug.....\$1.65  
388—With alligator clip.....1.50  
391—With spade lugs.....1.40  
392—With non insulated phone tips.....1.40

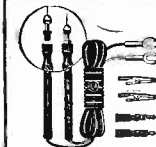

### ICA Slim Handle Test Leads

Made of sturdy Tenite Handles. 50" of Kinkless Live Rubber wire. Handles 6" Long—Overall Length 7". Prods have pointed large phone tip plugs.  
No. List  
313—Phone Tips on end.....\$1.25  
314—Spade Lugs on end.....1.25  
315—Alligator Clips on end.....1.40



### ICA UNBREAKABLE TEST PRODS

Long Metal Prod with Shock-proof Rubber Handles  
One end has standard needle point Tips. Other end has Insulated Solderless Plugs. Supplied with 50" Kinkless Rubber Wire.  
No. 332—With Phone Tips Non Insulated.....List \$1.00  
No. 331—Insulated Solderless Plug Ends.....List \$1.15



# ICA INSULINE ICA

## RADIO PRODUCTS



### ICA ALL PURPOSE TEST LEADS

Made of sturdy Tenite Tubing. Slim handles, 6" long. Overall length 7 1/4". Rubber covered wire 50" long.

With Interchangeable Tips  
 No. 312—Complete Kit ..... List \$2.50

### NON-KINK FLEXIBLE TEST LEAD WIRE

Flexible rubber covered wire that will not kink or wear down in service. Consists of very fine tinned stranded copper wire with a heavy wall of live rubber insulation.



No. 307—100 ft. spool, Black..... List \$4.00  
 No. 309—100 ft. spool, Red..... List 4.00

### ICA FENOLINE PHONO. NEEDLE POINT TEST PRODS With Removable Chuck



5 Inch Test Prod  
 No. 389R—Red ..... List \$.40  
 No. 389B—Black ..... List .40  
 7 Inch Test Prod  
 No. 334R—Red ..... List .40  
 No. 334B—Black ..... List .40

### ICA SOLDERLESS PLUG TEST PRODS With Solderless Plug Chuck



5 1/4 Inch Long Prods  
 No. 390R—Red ..... List \$.40  
 No. 390B—Black ..... List .40  
 7 1/4 Inch Long Prods  
 No. 335R—Red ..... List .50  
 No. 335B—Black ..... List .50

### HIGH VOLTAGE ICA HEAVY-DUTY BAKELITE TEST PROD HANDLES



No. 480—Black Bakelite ..... List \$1.15

### HIGH VOLTAGE HEAVY-DUTY BAKELITE TEST PRODS

Measures 2" overall



No. 485—Black Bakelite ..... List \$.55

### ICA HEAVY-DUTY TEST PRODS



Slim tapped Tenite handle fitted with threaded heavy-duty phone tip. Length 5".

No. 387R—Red ..... List \$.50  
 No. 387B—Black ..... List .50

## Latest Television Servicing Tools

### ICA SAFE-T-TESTER

A new, unique, non-short-ing prod that makes contact only when pressure is applied to barrel. Ideal for cramped spaces where probing is necessary. Specially applicable to television needs.



No. 446..... List \$1.50

### TRAN-ALIGNER



Newly designed all-insulated aligning tool for standard IF and RF and "K-Tran" midjet transformers. Trim fiber; milled at one end, screw driver at other end. 2 1/2" length blade; 6" overall.

No. 978..... List \$.75 each

### SLIM-ALIGNER



Alignment tool with extra thin recessed blade and slim metal shaft for cramped probing in television receivers. Fiber handle. Especially suitable for "Admiral" and similar make television sets.

No. 6161..... List \$1.00 each

### STUB ALIGNER



Ideal when cramped space demands short insulated tuning tool. Exposed nib for screw driver type controls not carrying high voltages. Tough fibre. Length: 2 1/2" x 1/4" diameter.

No. 6155..... List \$.40 each

### HEAVY DUTY TEST LEADS

Engineered for TV's high voltage measurements. Insulated to withstand 15,000 volts D.C. Thick-walled bakelite handles with finger guards. 48" heavy duty cable.

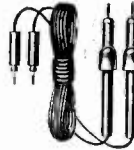

No. 4317..... \$3 per pair Dealer Net

### TUNING WAND



Extra thin diameter to fit small coil openings in television sets. Flexible vinylite. Brass insert in one end; molded powdered iron core in other end. Lowers or increases inductance. Suitable for "Zenith," etc., TV sets.

No. 6163..... List \$1.00 each

### DEEP-NIB ALIGNER



Tough fibre. Metal nib entirely insulated and set within barrel end. For tuning IF and RF shielded coils and trimmers. Small enough to fit under television tubes without removing. Length: 2 1/2" x 1/4" diameter.

No. 6156..... List \$.50 each

### TELEVISION "CHANNEL TUNER"



A narrow all-insulated screw driver of machined fiber. Ideal for deep, inaccessible tuning. Overall: 7" Length. 1/8" blade on 4 1/2" shaft.

No. 6157..... List \$.75 each

### RF AND SIGNAL TRACER PROBE

Germanium Crystal Circuit. Assures accurate analysis of circuit defects. May be used with audio amplifier for audible tracing or with V.T.V.M. for RF and AF measurements. Low input capacitance. The ideal probe for the audio section of television circuits. The sturdy bakelite barrel has sealed tenite ends with solderless phone tip and includes 48" RG59/U coaxial cable with phone plug and 18" rubber covered ground lead with alligator clip.



No. 4310..... \$7.50 Dealer Net

### "BIG STRETCH" ALIGNER



Extra thin, extra long (9"), bone fibre aligning tool, 6 1/2" blade. Specially designed for adjustment of nested iron cores of "Admiral," "Zenith" and similar make TV sets. Permits use on RCA front ends and normally inaccessible areas.

No. 6162..... List \$1.00 each

### TUNING WRENCH



Insulated fibre tuning wrench with extra thin recessed blade. Extra thin screw driver blade on other end (4 3/4" L.). Tenite handle. Especially designed for "Zenith" TV sets, etc.

No. 6164..... List \$.75 each

### DUAL ALIGNER



Dual purpose narrow shaft, fibre alignment tool for trimmers, IF transformers, etc. Recessed screw nib on one end; metal screw driver on other end.

No. 6166..... List \$.75 each

# ICA INSULINE ICA

## RADIO PRODUCTS

### ICA GRIP-RITE MOLDED PHONE TIP PLUG



Replacement for ICA and Weston — as well as other make Test Leads.

|           |       |
|-----------|-------|
| No.       | List  |
| 868—Red   | \$.50 |
| 869—Black | .50   |

### ICA PHONO NEEDLE CHUCKS

Push' on type can be forced into handles — Threaded type can be screwed into handles. Machined of brass, nickel plated with needle point.

|                                    |       |
|------------------------------------|-------|
| No.                                | List  |
| 508—Push-on Type, Overall size 1"  | \$.15 |
| 509—Threaded Type, Overall size 1" | .18   |

### HEAVY-DUTY PHONE TIP

Made of high quality heavy brass with nickel plated finish. Used on test leads, prods, etc. (Overall length is 1 1/2").

|                    |             |
|--------------------|-------------|
| No. 361—Heavy-Duty | List \$ .13 |
| No. 360—Standard   | List 2.00C  |

### ICA CHROME SILVER DIAL PLATES

2 3/4" and 4" diameter. Two types, calibrated 180 degrees 0-100 and 325 degrees, 0-100.

|      |         |        |        |        |
|------|---------|--------|--------|--------|
| No.  | Degrees | Dial   | Calib. | List   |
| 2196 | 325     | 2 3/4" | 0-100  | \$1.15 |
| 2197 | 180     | 2 3/4" | 0-100  | 1.15   |
| 2194 | 325     | 4"     | 0-100  | 1.40   |
| 2195 | 180     | 4"     | 0-100  | 1.40   |



### ICA BRASS BLACK SATIN FINISH DIAL PLATES

With Etched Silver Numerals

|      |         |        |        |        |
|------|---------|--------|--------|--------|
| No.  | Degrees | Dial   | Calib. | List   |
| 2230 | 325     | 3 1/2" | 0-100  | \$ .60 |
| 2232 | 180     | 3 1/2" | 0-100  | .60    |
| 2233 | 180     | 2"     | 100-0  | .45    |
| 2234 | 325     | 2"     | 0-100  | .45    |
| 2236 | 180     | 2"     | 0-100  | .45    |



### ICA CHROME SILVER DIALS

With Finger Grip Flange Knobs

Beautiful dial plates accurately Etcho-engraved with black numerals and calibrations.

|      |        |         |         |        |
|------|--------|---------|---------|--------|
| No.  | Size   | Degrees | Calibr. | List   |
| 2170 | 3 3/4" | 325     | 0-100   | \$2.10 |
| 2171 | 3 3/4" | 180     | 0-100   | 2.10   |
| 2168 | 4"     | 325     | 0-100   | 2.75   |
| 2169 | 4"     | 180     | 0-100   | 2.75   |



### ICA MINIATURE DIALS

Beautiful Chrome Silver dials with black etched numerals. Finger grip black knob. Only 1 1/8" diameter. Fit 1/4" shafts.

|               |       |
|---------------|-------|
| No.           | List  |
| 2164—10-0-180 | \$.85 |
| 2165—10-0-270 | .85   |



### ICA CHROME SILVER DIAL PLATES

Attractive grain satin finish. Black Etcho Engraving on Chrome Silver Background Plates.

|      |         |        |        |       |
|------|---------|--------|--------|-------|
| No.  | Degrees | Dial   | Calib. | List  |
| 2294 | 180     | 2"     | 0-100  | \$.80 |
| 2295 | 325     | 2"     | 0-100  | .80   |
| 2296 | 180     | 3 1/2" | 0-100  | 1.25  |
| 2297 | 325     | 3 1/2" | 0-100  | 1.25  |
| 2298 | 180     | 4"     | 0-100  | 1.40  |
| 2299 | 325     | 4"     | 0-100  | 1.40  |



### ICA ETCHED DIAL PLATES

#### RECTANGULAR TYPES

Made of brass—finished in black with etched silver markings. Calibrated for 300 degree rotation. Marked 0 to 10. Will fit on 3/8" bushing. Size 2 1/4" x 1-11/16".

|      |                                   |       |
|------|-----------------------------------|-------|
| No.  | Marking                           | List  |
| 2244 | Record                            | \$.30 |
| 2245 | Microphone                        | .30   |
| 2246 | Gain                              | .30   |
| 2247 | Tone                              | .30   |
| 2248 | Plain (Calibrated but not worded) | .30   |



### RADIO REPLACEMENT AND INSTRUMENT KNOBS

|   |   |   |
|---|---|---|
|   |   |   |
| A | B | E |

|      |      |        |        |       |
|------|------|--------|--------|-------|
| No.  | Type | Color  | Size   | List  |
| 1125 | A    | Black  | 1 1/4" | \$.15 |
| 1127 | A    | Red    | 1 1/4" | .20   |
| 1126 | B    | Black  | 2 1/4" | .20   |
| 1128 | B    | Red    | 2"     | .24   |
| 1153 | E    | Black  | 1 3/4" | .30   |
| 1154 | E    | Walnut | 1 3/4" | .30   |

|   |   |   |   |
|---|---|---|---|
|   |   |   |   |
| J | K | L | M |

|      |      |        |        |       |
|------|------|--------|--------|-------|
| No.  | Type | Color  | Size   | List  |
| 248  | J    | Black  | 1 1/2" | \$.20 |
| 249  | J    | Black  | 1 1/2" | .22   |
| 1076 | K    | Walnut | 3/4"   | .18   |
| 1049 | L    | Walnut | 3/8"   | .16   |
| 1050 | L    | Walnut | 1"     | .18   |
| 1174 | M    | Black  | 3/8"   | .20   |
| 1089 | N    | Walnut | 3/8"   | .18   |
| 1090 | N    | Walnut | 1 1/2" | .20   |
| 1147 | U    | Black  | 7/8"   | .18   |
| 1148 | U    | Walnut | 7/8"   | .18   |
| 1077 | T    | Walnut | 7/8"   | .15   |
| 1078 | T    | Walnut | 7/8"   | .18   |
| 1272 | V    | Black  | 3/4"   | .20   |
| 1273 | V    | Walnut | 3/4"   | .20   |

### ICA KNOB ASSORTMENTS



Walnut Bakelite  
**JUNIOR ASSORTMENT**  
 No. 1048—50 Knobs. Contains 5 each of 10 popular type knobs listed above.  
 List \$8.90

**MASTER ASSORTMENT**  
 No. 1043—100 Knobs. Contains 12 different type popular knobs including pointer knobs.  
 List \$17.50

### ICA INDICATING PLATES

Made of heavy brass with black satin background. Silvered "Etcho Gravured" numerals and lettering. 3/8" center mounting hole. 1 3/8" Diameter.

|                               |         |       |
|-------------------------------|---------|-------|
| No.                           | Degrees | List  |
| 2259—Marked 1 to 6            | 180     | \$.35 |
| 2450—Marked 1 to 5 (Volume)   | 325     | .35   |
| 2451—Marked 1 to 5 (Tone)     | 325     | .35   |
| 2452—Marked 1 to 10           | 325     | .35   |
| 2453—Marked Off-On—with arrow | 325     | .35   |

### ICA NAME PLATES

1-INCH ROUND

|                           |             |
|---------------------------|-------------|
| No. 2237—For "Microphone" | List \$2.00 |
| No. 2238—For "Phono"      |             |
| No. 2239—For "On Off"     |             |

|   |   |   |
|---|---|---|
|   |   |   |
| F | G | H |

|         |      |        |               |       |
|---------|------|--------|---------------|-------|
| No.     | Type | Color  | Size          | List  |
| 1270    | F    | Black  | 1 1/2"        | \$.25 |
| 1271    | F    | Black  | 2 1/2"        | .30   |
| 1137    | G    | Walnut | 5/8" x 3/4"   | .18   |
| 1138    | G    | Walnut | 3/4" x 1 1/2" | .16   |
| 1139    | G    | Walnut | 1" x 3/4"     | .18   |
| 1087    | H    | Walnut | 1"            | .20   |
| 1088    | H    | Black  | 1"            | .20   |
| 1133    | I    | Walnut | 3/4" x 3/4"   | .16   |
| 1134    | I    | Walnut | 1" x 3/8"     | .18   |
| 1274    | S    | Black  | 1 1/2" x 3/8" | .25   |
| 1274-S* | S    | Black  | 1 1/2" x 3/8" | .32   |
| 1275    | S    | Black  | 2" x 3/8"     | .28   |

\*With 2 Set Screws.

|   |   |
|---|---|
|   |   |
| P | Q |

|      |      |        |      |       |
|------|------|--------|------|-------|
| No.  | Type | Color  | Size | List  |
| 1081 | P    | Black  | 7/8" | \$.12 |
| 1082 | P    | Red    | 7/8" | .12   |
| 1084 | P    | Brown  | 7/8" | .12   |
| 1085 | P    | White  | 7/8" | .13   |
| 1116 | Q    | Walnut | 7/8" | .18   |
| 1117 | Q    | Walnut | 1"   | .20   |
| 1135 | R    | Walnut | 3/4" | .15   |
| 1136 | R    | Walnut | 3/4" | .18   |
| 1310 | W    | Black  | 3/4" | .12   |
| 1311 | W    | Walnut | 3/4" | .13   |
| 1312 | W    | Ivory  | 3/4" | .14   |
| 1320 | W    | Black  | 3/4" | .14   |
| 1321 | W    | Walnut | 3/4" | .15   |
| 1322 | W    | Ivory  | 3/4" | .16   |
| 1330 | X    | Black  | 3/4" | .14   |
| 1331 | X    | Walnut | 3/4" | .15   |
| 1332 | X    | Ivory  | 3/4" | .16   |

### ICA FINGER-GRIP POINTER KNOBS



Moulded of black bakelite with 1/4" hole. Pointer type knobs have white indicators. Flange type knobs have white indicating line.

With 1/4" Brass Inserts

|                            |             |
|----------------------------|-------------|
| <b>TYPE A—WITH POINTER</b> |             |
| No. 1166—1 1/4"            | List \$6.00 |
| No. 1168—1 1/2"            | List .75    |
| No. 1170—2 3/4"            | List .95    |

|                            |             |
|----------------------------|-------------|
| <b>TYPE A—LESS POINTER</b> |             |
| No. 1165—1 1/4"            | List \$4.45 |
| No. 1167—1 1/2"            | List .55    |
| No. 1169—2 3/4"            | List .75    |

|                           |             |
|---------------------------|-------------|
| <b>TYPE B—WITH FLANGE</b> |             |
| No. 1171—2 3/4"           | List \$7.75 |
| No. 1172—3"               | List .90    |

NOTE: Above Knobs also furnished with 2 set screws. Order by adding "S" to each number.

### ICA VERNIER DIAL MARKER



Complete with self-tapping screws for mounting on metal, wood, bakelite or brass panels.

|                                |             |
|--------------------------------|-------------|
| No. 218a—For 2 3/4"—325° Dials | List \$5.50 |
| No. 2190—For 2 3/4"—180° Dials | List .50    |
| No. 2191—For 1"—325° Dials     | List .50    |
| No. 2192—For 4"—180° Dials     | List .50    |

# ICA INSULINE ICA

## RADIO PRODUCTS



**ICA "Insulex" R.F. CHOKE COIL**  
Silk Wire Wound  
Supplied with wire leads for mounting.

No. 277  
Inductance  
2.5 M.H.  
D.C. Resist.  
32 ohms  
Current Cap.  
150 ma.  
List \$3.50

### ICA "INSULEX" R.F. CHOKES



| Cat. No. | Inductance | D.C. Resis. | Current Cap. | List  |
|----------|------------|-------------|--------------|-------|
| 1777     | 2.5        | 30          | 150          | \$.60 |
| 1775     | 5.5        | 57          | 150          | .75   |
| 1774     | 10         | 73          | 150          | .80   |
| 1772     | 30         | 136         | 125          | .90   |
| 1773     | 60         | 196         | 125          | 1.15  |
| 1771     | 80         | 222         | 125          | 1.25  |



### IRON CORE HIGH "Q" R.F. CHOKES

| No.  | Ind. M.H. | D.C. Res. ohms | List   |
|------|-----------|----------------|--------|
| 6200 | 2.5       | 17             | \$1.20 |
| 6201 | 3.5       | 22             | 1.30   |
| 6202 | 5.5       | 28             | 1.35   |
| 6203 | 10        | 55             | 1.35   |
| 6204 | 30        | 83             | 1.60   |
| 6205 | 60        | 142            | 1.95   |
| 6206 | 80        | 168            | 2.10   |
| 6207 | 125       | 214            | 2.60   |



### ICA TRANSMITTING R.F. CHOKES

Tapered Sections

Wound on Insulex low-loss core. Has a continuous universal winding in five tapered sections. Designed for maximum impedance in amateur bands from 160 meters downward.

| No. | Ind. M.H. | Cur. Res. Ma. | Res. Ohms | List   |
|-----|-----------|---------------|-----------|--------|
| 266 | 2.8       | 1000          | 5         | \$2.75 |
| 267 | 5.3       | 600           | 12.5      | 2.50   |

### HEAVY DUTY TRANSMITTING CHOKES



| No. | Ind. M.H. | Cur. Res. Ma. | D.C. Res. Ohms | List   |
|-----|-----------|---------------|----------------|--------|
| 280 | 2.5       | 1000          | 5              | \$2.50 |
| 278 | 5.6       | 600           | 12             | 2.25   |

### INSULEX INSULATORS

Made of WHITE Glazed Insulex. This new line of insulators meets the demand for a perfect, non-porous low loss product. Used by broadcast-ers, amateurs, ex-perimenters and set-builders. All feed-thru have cork washers.



| No.  | Description | Ht.    | Base Size     | Mtg. Hole | List  |
|------|-------------|--------|---------------|-----------|-------|
| 2300 | Little Pete | 1"     | 1/2" x 7/8"   | 1/8"      | \$.12 |
| 2301 | Junior Pete | 1 1/8" | 3/4" x 1 1/4" | 1/8"      | .15   |
| 2302 | Big Pete    | 1 1/2" | 1" x 1 1/2"   | 1/8"      | .18   |
| 2303 | Beehive     | 2 3/8" | 2" Diam.      | 1/8"      | .25   |
| 2304 | Jack Type   | 1 1/2" | 1" x 1 1/2"   | 1/8"      | .25   |

### FEED-THRU INSULATORS

| No.  | Description | Ht.    | Base Diam. | Mtg. Hole | List  |
|------|-------------|--------|------------|-----------|-------|
| 2305 | Sub-Panel   | 1 3/8" | 5/8"       | 5/16"     | \$.20 |
| 2306 | Sub-Panel   | 2"     | 3/4"       | 3/16"     | .25   |
| 2307 | Sub-Panel   | 2 3/4" | 7/8"       | 1/8"      | .28   |
| 2334 | Large       | 4"     | 1 1/2"     | 5/8"      | .70   |
| 2320 | Jack Type   | 1 3/8" | 3/4"       | 7/16"     | .35   |
| 2321 | Jack Type   | 2 3/8" | 7/8"       | 7/16"     | .40   |

### ICA MIDGET PRECISION CONDENSERS

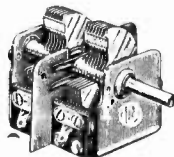

Better mechanical design insures constancy of calibration and uniformity between units. Ball-bearings on both ends of shaft insure long life without wear or side play. Heavy brass springs make direct contact with rotor shaft, insuring a clean wiping contact at all times.

| No. | Single Gang Condenser | List   |
|-----|-----------------------|--------|
| 533 | 135 mmfd.             | \$3.00 |
| 542 | 365 mmfd.             | 3.00   |

| No. | Two Gang Condenser | List |
|-----|--------------------|------|
| 538 | 135 mmfd.          | 3.50 |
| 534 | 365 mmfd.          | 3.50 |

| No. | Three Gang Condenser | List |
|-----|----------------------|------|
| 532 | 135 mmfd.            | 4.50 |
| 531 | 365 mmfd.            | 4.50 |

### SUPERHETERODYNE TYPE

Designed for 455KC IF. RF section is 27 plates; 435 Mmfd. Oscillator Section is 19 plates; 173 Mmfd. Measurements similar to two gang condensers shown above.

No. 545..... List \$3.50

### ICA CERAMIC PADDING CONDENSERS



Compact, yet rugged Padding Condensers. Designed for aligning tandem condensers, short wave band switch coils, antenna trimmers, etc. Uses high grade Mica and Phosphor Bronze Spring contacts.

| No. | Min. Cap.   | Max. Cap. | List  |
|-----|-------------|-----------|-------|
| 611 | 4.0 mmfd.   | 40 mmfd.  | \$.50 |
| 612 | 12.0 mmfd.  | 100 mmfd. | .50   |
| 613 | 70.0 mmfd.  | 350 mmfd. | .55   |
| 614 | 160.0 mmfd. | 600 mmfd. | .55   |

### GIANT INSULEX INSULATORS

Heavy Duty—Will Withstand 10,000 Volts

| No.    | Description | Ht.    | Base Diam. | Mtg. Hole | List  |
|--------|-------------|--------|------------|-----------|-------|
| *2330  | Stand Off   | 4 1/2" | 3 1/2"     | 1/4"      | \$.95 |
| **2331 | Stand Off   | 4 1/2" | 3 1/2"     | 1/2"      | .90   |
| *2332  | Feed thru   | 4"     | 2"         | 7/8"      | .95   |
| **2333 | Feed thru   | 4"     | 2"         | 7/8"      | .90   |

\*With Wing Nuts \*\*With Screws and Nuts

### ICA AIRCRAFT TYPE INSULATOR

A strain insulator made of Insulex. Particularly adaptable for aircraft, automobile and boat installation. Two 1/4" mounting holes. Distance between holes 3/4".



No. 2325..... List \$.12

### CERAMIC RODS

Made of Alsmag. Suitable for mounting insulators, condensers, coils, etc.

Available in two lengths.

| No.  | Lgth.  | Dia. | Tap. | List  |
|------|--------|------|------|-------|
| 2310 | 1 1/4" | 1/2" | 6-32 | \$.28 |
| 2311 | 3 1/4" | 1/2" | 6-32 | .40   |



### ICA BASE-MOUNTING BAKELITE SOCKETS



| No.                                | List    |
|------------------------------------|---------|
| 2480—4 Prong                       | \$.45   |
| 2481—5 Prong                       | .50     |
| 2482—6 Prong                       | .55     |
| 2483—7 Prong comb. large and small | .60     |
| 2489—8 Prong OCTAL                 | .65     |
| 2490—Contact for above Sockets     | \$2.50C |



### ICA "INSULEX" BASE MOUNTING SOCKETS

Especially adapted for ultra short-wave work and transmitters.

| No.                                | List  |
|------------------------------------|-------|
| 290—4 Prong                        | \$.90 |
| 291—5 Prong                        | .90   |
| 292—6 Prong                        | 1.00  |
| 294—Comb. 7 Prong, large and small | 1.00  |
| 300—8 Prong OCTAL                  | 1.00  |

### BAKELITE WAFER SOCKETS



Wafer socket of punched bakelite for miniature seven pin button base tubes. Phosphor bronze contacts. Standard mounting centers.

No. 1122..... List \$.15

### BAKELITE WAFER SOCKET

Similar to No. 1122 above but with grounding strap.

No. 1124..... List \$.17

### ICA "INSULEX" WAFER SOCKETS



An ideal low loss socket designed for ultra high frequency reception.

| No.                                    | List    |
|--|---------|
| 2600—4 Prong                           | \$.50   |
| 2601—5 Prong                           | .50     |
| 2602—6 Prong                           | .55     |
| 2603—7 Prong, large                    | .60     |
| 2604—7 Prong, small                    | .60     |
| 2605—8 Prong OCTAL for new metal tubes | .65     |
| 2636—Contact for above Sockets         | \$5.00C |



### ICA BAKELITE WAFER SOCKETS

| No.                 | List  |
|---------------------|-------|
| 1118—4 Prong        | \$.13 |
| 1096—5 Prong        | .13   |
| 1095—6 Prong        | .13   |
| 1119—7 Prong, small | .13   |
| 1120—7 Prong, large | .15   |
| 1121—8 Prong OCTAL  | .16   |
| 1123—Loktal Wafer   | .16   |

### CERAMIC BEAD INSULATORS



3/8" Diam.

Used for construction of short concentric link lines.

No. 2315—(100 beads)..... List \$1.25

# ICA INSULINE RADIO PRODUCTS ICA

## ACORN TUBE WAFER SOCKET



Of Navy approved ceramic with silver plated contacts. Can be easily inserted and removed and no amount of vibration will cause the tube to become loose.

No. 961 ..... List \$1.00  
No. 2466—Contact only ..... \$2.50C

## ICA ROTARY SWITCHES

Rated 3 Amps. at 125 Volts. Overall Length of shafts 1 1/2". Made by H & H for ICA. Underwriters Approved.



| No.   | Threaded Shank | Description | List  |
|-------|----------------|-------------|-------|
| 1228* | 3/8"           | S.P.S.T.    | \$.55 |
| 1229* | 1"             | S.P.S.T.    | .65   |
| 1286  | 3/8"           | S.P.D.T.    | .75   |
| 1287  | 1"             | S.P.D.T.    | .90   |
| 1288  | 3/8"           | D.P.D.T.    | 1.30  |
| 1289  | 1"             | D.P.D.T.    | 1.45  |

\*Rated 30 Amps. at 250 V.

## MOLDED BAKELITE SOCKET

For Miniature Tubes  
Black molded general purpose bakelite with mounting saddle.



Standard mounting centers. Phosphor bronze contacts.

No. 2475 ..... List \$2.20  
Same as above but mica filled.

## ICA TOGGLE SWITCHES

Furnished in Nickel or Antique Bronze. Capacity 1 Amp. 250 Volts. 3 Amps. 125 Volts. Mfd. by H & H for ICA.



| No.  | Shank Length | Description | Finish | Net   |
|------|--------------|-------------|--------|-------|
| 1230 | 3/8"         | S.P.S.T.    | Nickel | \$.50 |
| 1232 | 3/8"         | S.P.S.T.    | Bronze | .55   |
| 1233 | 3/8"         | S.P.S.T.    | Bronze | .60   |
| 1235 | 3/8"         | S.P.S.T.    | Nickel | .55   |
| 1236 | 3/8"         | S.P.D.T.    | Nickel | .65   |
| 1237 | 3/8"         | S.P.D.T.    | Nickel | .75   |
| 1238 | 3/8"         | D.P.S.T.    | Nickel | .95   |
| 1365 | 3/8"         | D.P.D.T.    | Nickel | 1.10  |
| 1366 | 3/8"         | D.P.D.T.    | Nickel | 1.15  |

## ICA MOLDED BAKELITE SNAP-ON SOCKETS



Octal—Loktal  
Mounted in cadmium plated steel "Saddle." Equipped with 4 grounding lugs on saddle—Positive grip contacts.

No. 2470—Octal Socket ..... List \$.15  
Mtg Center 1 1/2"—Chassis Hole 1 1/8"  
No. 2471—Loktal Socket ..... List \$.20  
Mtg Center 1 1/8"—Chassis Hole 1"

## BAT-HANDLE TOGGLE SWITCH

Made by H & H. Identical to toggle switches listed above, except that handle is longer and shaped like a baseball bat.



Less on and off plate.  
Nickel plated only—7/16" shank.  
Packed 5 in a standard carton.

| No.           | Description | List  |
|---------------|-------------|-------|
| 1296—S.P.S.T. | .....       | \$.50 |
| 1297—S.P.D.T. | .....       | .70   |
| 1298—D.P.S.T. | .....       | .95   |
| 1299—D.P.D.T. | .....       | 1.10  |

## ICA BAKELITE KNIFE SWITCHES

Hardware of brass, heavily nickel-plated. Mounted on highly polished bases of black BAKELITE. Firm contact assured.



| No.  | Description | List  | No.  | Description | List   |
|------|-------------|-------|------|-------------|--------|
| 1216 | S.P.S.T.    | \$.85 | 1220 | 3 P.D.T.    | \$2.00 |
| 1217 | S.P.D.T.    | 1.00  | 1221 | 4 P.S.T.    | 2.50   |
| 1218 | D.P.S.T.    | 1.15  | 1222 | 4 P.D.T.    | 3.00   |
| 1219 | D.P.D.T.    | 1.35  | 1364 | 5 P.D.T.    | 3.50   |
| 1360 | 3 P.S.T.    | 1.85  |      |             |        |

## ICA SLIDER SWITCHES

SMALL . . . . . COMPACT. Switch dimensions: 1 1/2" x 1/2" x 1/4". S.P.S.T. includes chrome mounting plate.



| No.  | Description | List  |
|------|-------------|-------|
| 1255 | S.P.S.T.    | \$.35 |
| 1259 | S.P.D.T.    | .40   |
| 1260 | D.P.D.T.    | .50   |
| 1264 | D.P.S.T.    | .45   |

## MINIATURE BAKELITE SWITCHES

Can be mounted on panel or base. Black Bakelite base—highly nickel-plated brass parts with insulated handles.

| No.  | Description | Base Size     | List  |
|------|-------------|---------------|-------|
| 2223 | S.P.S.T.    | 1 1/4" x 1/2" | \$.35 |
| 2224 | S.P.D.T.    | 1 1/4" x 1/2" | .60   |
| 2225 | D.P.D.T.    | 1 1/4" x 1"   | .75   |
| 2226 | D.P.S.T.    | 1 1/4" x 1"   | .70   |



## ICA HI-POWER SWITCH

Push Button Type



Designed to break primary circuit when rack door is open. D.P.S.T. Made by H & H for ICA. Capacity 12 Amp. 125 Volt. Overall size 1 1/2" long. 3/4" wide. 3/8" high. 7/16" shank.

No. 1280 ..... List \$2.25

## ICA PUSH BUTTON SWITCH

Single pole 2 circuit momentary switch. One circuit is "ON"; other normally "OFF." One Amp. 125 Volt, made by H & H for ICA. Shank 5/8" long.



No. 1282 ..... List \$.95

## ICA EXTRA HEAVY DUTY SWITCH

D.P.D.T. With Neutral Center



An extra large heavy duty, Double Pole, Double Throw Switch with neutral position in the center for use in heavy current circuits such as transmitters, power amplifiers, motors, etc. Contacts have fast "break" which reduces the tendency to arc. Rated at 10 Amps, 125 Volts. Size of switch case, 2 1/8" long, 1" high, 1 1/4" wide. Mounting sleeve diameter 3/4".

No. 1283 ..... List \$5.50

## "ON-OFF" PLATE

For Toggle Switch



Nickel Plated  
No. 1300 List \$0.4  
Antique Bronze  
No. 1300BR List \$0.50

## ICA POWER SWITCH

(Toggle Type)

Characteristics and dimensions same as No. 1280 described above.  
No. 1281  
List \$1.50



## ICA ROTARY CANOPY SWITCH

Single pole switch 1/4" shank with brown bakelite knob and 6" leads—1 ampere—250 volts.

No. 1257 ..... List \$.50



## GT AND GT/G TYPE TUBE SHIELDS

Latest type seamless, drawn shell type. Length 2 1/4".



| No.                | For Tube Diam. | List  |
|--------------------|----------------|-------|
| 1744—Open top*     | 1.218"         | \$.15 |
| 1745—Closed top*   | 1.218"         | .15   |
| 1746—Open top**    | 1.165"         | .15   |
| 1747—Closed top**† | 1.165"         | .15   |

\*For GT and GT/G tubes with large metal base.  
\*\*For GT tubes with small metal base.  
†For Loktal tubes.

## ICA 807 TUBE SHIELD



For use with Transmitter Pentodes, and Tetrodes, to prevent oscillation. Can also be used on RK 20, RK 39 and 804 tubes.  
No. List  
1545 ..... \$6.00

## ICA GRID CAP SHIELDS

(For Metal Tubes)



Fits firmly over grid cap, affording complete shielding. Slotted cap permits passage of grid wire.

| No.                       | List   |
|---------------------------|--------|
| 1552                      | \$0.10 |
| 1558—With Bakelite Insert | .20    |

## ICA COIL SHIELDS

With Detachable Base

A sturdy coil shield made of aluminum with a detachable base.

| No.                       | List  |
|---------------------------|-------|
| 1539—2 1/8" x 3" High     | \$.60 |
| 1540—2 1/2" x 3 1/2" High | .70   |
| 1549—3" x 3 1/2" High     | .75   |



## FORM FIT TUBE SHIELDS



A tube shield that assures a snug, positive fit. Vertical grooves provide flexibility. Includes ground clip as illustrated. Protects tubes against excessive vibration.

No. 1727B—For GT; GT/G and Loktal tubes.  
Length 2 1/2" ..... List \$1.15

No. 1729B—For GT and GT/G tubes.  
Length 2 3/4" ..... List \$1.15

## ICA ALUMINUM TUBE SHIELD

For 55, 57, 68, etc. type tubes



| No.                          | List  |
|------------------------------|-------|
| 1708—1 1/8" mounting centers | \$.40 |
| 1709—1 1/2" mounting centers | .40   |



# ICA INSULINE ICA

## RADIO PRODUCTS

### ICA SHAFT COUPLINGS AND EXTENSION RODS



Brass Couplings and Reducers

| No.  | Length | Hole               | O.D. | List  |
|------|--------|--------------------|------|-------|
| 2105 | 3/4"   | 1/4" coupler       | 1/2" | \$.20 |
| 2106 | 3/4"   | 3/8" coupler       | 5/8" | .20   |
| 2107 | 3/4"   | 1/2" coupler       | 3/4" | .20   |
| 2111 | 1 1/8" | 1/4" to 1/4" shaft | 1/2" | .20   |
| 2112 | 1 1/8" | 1/4" to 3/8" shaft | 5/8" | .20   |
| 2113 | 1 1/8" | 3/8" to 1/2" shaft | 3/4" | .20   |

ICA Fenoline Couplings and Reducers

| No.  | Length | Hole         | O.D. | List  |
|------|--------|--------------|------|-------|
| 2116 | 3/4"   | 1/4" coupler | 1/2" | \$.20 |
| 2109 | 3/4"   | 3/8" coupler | 5/8" | .20   |
| 2110 | 1 1/8" | 1/4" shaft   | 1/2" | .20   |

Long Extension Couplings

Made of Brass with extra long extension

| No.  | Length | I.D. | O.D. | List  |
|------|--------|------|------|-------|
| 2123 | 1 3/4" | 1/4" | 1/2" | \$.25 |

### ALUMINUM IDLER PULLEYS



Precision made. Distortion free non-warping. Permits closer tolerances. Supplied in any quantity in any type—with or without shoulders. Listed are typical sizes without shoulders, hole diam., .125".

| No. | O.D.   | Cord Diam. | List   |
|-----|--------|------------|--------|
| 601 | 3/8"   | 1/4"       | \$2.00 |
| 602 | 7/8"   | 1/2"       | 2.20C  |
| 603 | 1 1/2" | 3/8"       | 2.30C  |
| 604 | 2 1/8" | 1/2"       | 2.50C  |
| 605 | 3 1/8" | 5/8"       | 3.00C  |

### BAKELITE AND FENOLINE TUBING

ICA tubing is strong mechanically, has extremely low electrical absorption and is highly resistant to moisture. Absolute perfection in winding of coils is assured by the use of ICA tubing—thus affording relief from complaints or failure in performance.

Finished in Natural and Black Colors  
Small sizes up to one inch in Black only.  
1/8" Wall Thickness, Full Lengths.  
Approximately 36 to 48"

| BAKELITE |        |         | FENOLINE |        |         |
|----------|--------|---------|----------|--------|---------|
| No.      | O.D.   | Per Ft. | No.      | O.D.   | Per Ft. |
| 100      | 1/4"   | \$.95   | 161      | 1/4"   | \$.85   |
| 101      | 3/8"   | 1.15    | 162      | 3/8"   | 1.00    |
| 102      | 1/2"   | 1.20    | 163      | 1/2"   | 1.00    |
| 103      | 5/8"   | 1.30    | 164      | 5/8"   | 1.05    |
| 104      | 3/4"   | 1.40    | 165      | 3/4"   | 1.10    |
| 105      | 7/8"   | 1.55    | 166      | 7/8"   | 1.15    |
| 106      | 1"     | 1.65    | 167      | 1"     | 1.25    |
| 147      | 1 1/8" | 1.75    | 134      | 1 1/8" | 1.15    |
| 148      | 1 1/4" | 1.95    | 135      | 1 1/4" | 1.35    |
| 149      | 1 1/2" | 2.05    | 136      | 1 1/2" | 1.40    |
| 150      | 1 3/4" | 2.25    | 137      | 1 3/4" | 1.55    |
| 151      | 2"     | 2.50    | 138      | 2"     | 1.70    |
| 152      | 2 1/4" | 2.70    | 139      | 2 1/4" | 1.85    |
| 153      | 2 1/2" | 3.15    | 140      | 2 1/2" | 2.05    |
| 154      | 2 3/4" | 3.50    | 141      | 2 3/4" | 2.45    |
| 155      | 3"     | 4.00    | 142      | 3"     | 2.65    |
| 156      | 3 1/4" | 4.20    | 143      | 3 1/4" | 2.85    |
| 157      | 3 1/2" | 4.50    | 144      | 3 1/2" | 3.35    |
| 158      | 3 3/4" | 4.50    |          |        |         |
| 159      | 4"     | 5.50    |          |        |         |

### ICA LARGE LOW-LOSS RIBBED COIL FORMS



AMBER BAKELITE  
1 3/8" Diameter  
3 3/8" High

| No.  | Prong   | List  |
|------|---------|-------|
| 1051 | 4 Prong | \$.60 |
| 1052 | 5 Prong | .80   |
| 1053 | 6 Prong | .85   |

### ICA SMALL RIBBED COIL FORMS

Made of Amber Color Bakelite  
1 3/8" diam., 2 1/4" high

| No.  | Prong   | List  |
|------|---------|-------|
| 2158 | 4 Prong | \$.45 |
| 2159 | 5 Prong | .50   |
| 2160 | 6 Prong | .50   |

### ICA INSULATED BUSHINGS



|         |       |           |            |           |             |
|---------|-------|-----------|------------|-----------|-------------|
| No. 670 | Black | 1/4" Hole | 3/8" Diam. | 3/8" Long | List \$1.15 |
| No. 671 | Red   | 1/4" Hole | 3/8" Diam. | 3/8" Long | List .15    |
| No. 672 | Black | 1/4" Hole | 1/2" Diam. | 1/2" Long | List .20    |
| No. 673 | Red   | 1/4" Hole | 1/2" Diam. | 1/2" Long | List .20    |

ICA BRASS EXTENSION RODS

|          |           |           |             |
|----------|-----------|-----------|-------------|
| No. 2117 | 6" Length | 1/4" O.D. | List \$2.20 |
| No. 2118 | 12" L.    | 1/4" O.D. | List .40    |

FENOLINE EXTENSION RODS

|          |           |           |             |
|----------|-----------|-----------|-------------|
| No. 2120 | 6" Length | 1/4" O.D. | List \$3.30 |
|----------|-----------|-----------|-------------|

### BAKELITE BUSHINGS

Molded Bakelite Bushings for complete insulation. Strong seamless threads. Heat resisting to 300 F. Complete with stamped lock nuts.



| No.           | Hole Size | List  |
|---------------|-----------|-------|
| 606           | 1/4"      | \$.10 |
| 607           | 3/8"      | .12   |
| 608           | 1/2"      | .13   |
| 609           | 5/8"      | .14   |
| 610 (2 holes) | 3/8"      | .15   |

### STOCK SIZES OF BLACK AND BROWN FENOLINE TUBING

Individual lengths tubing in following diam.: 1"; 1 1/4"; 1 1/2"; 1 3/4"; 2"; 2 1/4"; 2 3/4"; 3"; Wall thickness 1/16".

| No.  | Length | O.D. | List   |
|------|--------|------|--------|
| 2131 | 3"     | 1"   | \$1.65 |
| 2132 | 4"     | 1"   | .80    |
| 2133 | 6"     | 1"   | 1.15   |

When ordering, specify exact diameter.

### SPECIAL LENGTH BAKELITE TUBING

Cut to Order — Wall Thickness to 1/16"  
Outside diameters range from 1" to 4". Prices on request. Other diameters and thicknesses quoted on request.

### ICA "INSULOID" RODS

| No.  | Color | Size       | List  |
|------|-------|------------|-------|
| 2175 | Black | 12" x 1/4" | \$.45 |
| 2176 | Black | 24" x 1/4" | .80   |
| 2179 | Black | 12" x 3/8" | .60   |
| 2180 | Black | 24" x 3/8" | 1.20  |
| 2183 | Black | 12" x 1/2" | .80   |
| 2184 | Black | 24" x 1/2" | 1.60  |

### BAKELITE RODS FENOLINE RODS

Lengths of 18" to 24"

| No. | Diam. | List       | No. | Diam. | List      |
|-----|-------|------------|-----|-------|-----------|
| 175 | 1/4"  | \$1.30 ft. | 168 | 1/4"  | \$.80 ft. |
| 178 | 3/8"  | 1.50 ft.   | 169 | 3/8"  | 1.10 ft.  |
| 176 | 1/2"  | 1.80 ft.   | 170 | 1/2"  | 1.40 ft.  |
| 177 | 3/4"  | 2.50 ft.   |     |       |           |

### ICA TRANSMITTING COIL FORMS

Made of Low - Loss RX-47 Dielectric. Rugged and durable. Amber color. Size of body affords 3 3/4" of winding space.



|          |         |             |
|----------|---------|-------------|
| No. 2670 | 4 Prong | List \$1.00 |
| No. 2671 | 5 Prong | List 1.05   |
| No. 2672 | 6 Prong | List 1.10   |

### ICA SMALL BAKELITE COIL FORMS



1 1/4" diam., 2 1/4" high

| No.   | Prong   | List  |
|-------|---------|-------|
| 1108B | 4 Prong | \$.45 |
| 1113B | 5 Prong | .45   |
| 1114B | 6 Prong | .45   |

### ICA SHORT WAVE AND BROADCAST PLUG-IN COILS



Wound on Low-Loss Bakelite Forms

| No.  | 4 PRONG—2 WINDINGS                                      | List  |
|------|---|-------|
| 1471 | Set of 4 short wave coils —covering 9 1/2 to 174 Meters | \$.35 |
| 1473 | Set of 2 Broadcast coils covering 160 to 550 Meters     | 2.50  |

### ICA BAKELITE FLEXIBLE SHAFT COUPLING

Flexible phosphor bronze spring contact mounted on a round bakelite disc. 1 1/8" diam. Has 1/4" bushing.



|          |             |
|----------|-------------|
| No. 2142 | List \$6.50 |
|----------|-------------|

### ICA INSULEX FLEXIBLE SHAFT COUPLING

Flexible phosphor bronze spring contact. Mounted on Insulex disc for efficient low-loss coupling. 1 1/8" diam. 1/4" bushing.



|          |             |
|----------|-------------|
| No. 2143 | List \$7.50 |
|----------|-------------|

### ICA PANEL BEARING ASSEMBLY

Will fit on panels up to 3/8" thickness.

|          |                   |             |
|----------|-------------------|-------------|
| No. 1248 | Overall length 3" | List \$4.00 |
| No. 1249 | Overall length 6" | List .50    |
| No. 1250 | Bearings only     | List .18    |



### ICA FLEXIBLE SPAGHETTI TUBING

20 Foot Lengths



A flexible tubing, heavily varnished, in attractive colors. Average dielectric strength, 5000 volts. Will accommodate from No. 10 to No. 18 wires. Furnished in one length —20 feet long on handy spools.

| No. | Color  | Per Spool | List   |
|-----|--------|-----------|--------|
| 210 | Red    |           | \$1.25 |
| 211 | Yellow |           | 1.25   |
| 212 | Brown  |           | 1.25   |
| 213 | Green  |           | 1.25   |
| 214 | Black  |           | 1.25   |

500 Foot Spools, spaghetti tubing, same grade and colors as above. Specify color per spool.

|         |              |
|---------|--------------|
| No. 197 | List \$28.50 |
|---------|--------------|

### ICA SPAGHETTI TUBING

For No. 10 to No. 18 gauge wire. Guaranteed not to crack. Furnished in 30" lengths.

| No. | Color  | per length | List  |
|-----|--------|------------|-------|
| 182 | Red    |            | \$.15 |
| 183 | Yellow |            | .15   |
| 184 | Brown  |            | .15   |
| 185 | Green  |            | .15   |
| 186 | Black  |            | .15   |

### SMALL SIZE SPAGHETTI TUBING

|     |        |             |
|-----|--------|-------------|
| 200 | Red    | List \$1.15 |
| 201 | Yellow | .15         |
| 202 | Black  | .15         |

### LARGE SIZE SPAGHETTI TUBING

Supplied in 36" lengths. Diameter 9/64" I.D. x 3/16" O.D.

No. 196—Supplied in black only  
List—per length \$.50

### ICA GIANT SLEEVING

Made of high voltage insulation saturated cambric material. Inside diameter 3/8". For Insulating Resistors, Small Condensers, Wire Cables. Leads, etc. 36" lengths.

No. 198..... List \$5.00



# ICA INSULINE ICA

## RADIO PRODUCTS

### RUBBER INSULATED GRID CAPS

For Transmitting Tubes

New improved type. Insulation made of special soft rubber over spring bronze.

|                     |             |
|---------------------|-------------|
| For 866 Type Tubes  |             |
| No. 870—With Leads  | List \$ .30 |
| For Receiving Tubes |             |
| 872—With 12" Lead   | .20         |
| For New Metal Tubes |             |
| 874—With 12" Lead   | .20         |



### FENOLINE INSULATED GRID CAPS

Improved type for standard and transmitting tubes. Sturdy cadmium plated brass clip. Furnished with 12" wire.

|  |             |
|--|-------------|
| For 866 Transmitting Tubes                         |             |
| No. 683—Black                                      | List \$ .50 |
| For Standard Glass Receiving Tubes with small caps |             |
| No. 680—Red  | List \$ .25 |
| No. 681—Black                                      | List \$ .25 |



### INSULATED DUAL GRID CAPS

Designed for metal and glass tubes. Equipped with 12" insulated lead.

No. 877—Black List \$ .40



### SPRING ACTION GRID CAPS

For all types of tubes. Positive contact. All grid caps are hot tinned ready for soldering.

|   |          |
|---|----------|
| No.   | List     |
| 1550—For standard glass receiving tubes with small caps (.860 dia.) | \$12.50M |
| 1551—For tubes with miniature caps (.250 dia.)                      | 12.50M   |
| 1553—For glass tubes  | 1.50C    |
| 1554—For glass tubes  | 1.50C    |



1553



1554



1550



1551

### ICA TERMINAL STRIPS

Made of 3/32" heavy black Bakelite, engraved in white. Terminals are brass cadmium plated.

| No.  | Terminals | Marking                       | Mtg. Ctrs. | Size        | List   |
|------|-----------|-------------------------------|------------|-------------|--------|
| 2420 | 2         | Plain                         | 1 1/2      | 7/8 x 2 1/4 | \$ .18 |
| 2419 | 2         | A & G                         | 1 1/2      |             | .18    |
| 2418 | 2         | Output                        | 1 1/2      |             | .18    |
| 2417 | 2         | Input                         | 1 1/2      |             | .18    |
| 2414 | 3         | Plain                         | 2          | 7/8 x 2 3/4 | .27    |
| 2415 | 3         | 1, 2, 3                       | 2          |             | .30    |
| 2413 | 4         | Plain                         | 2 1/2      | 7/8 x 3 3/4 | .36    |
| 2408 | 4         | 1, 2, 3, 4                    | 2 1/2      |             | .40    |
| 2405 | 5         | Plain                         | 3          | 7/8 x 4     | .45    |
| 2406 | 5         | 1, 2, 3, 4, 5                 | 3          |             | .50    |
| 2404 | 6         | Plain                         | 3 1/2      | 7/8 x 4 5/8 | .54    |
| 2402 | 6         | 1, 2, 3, 4, 5, 6              | 3 1/2      |             | .60    |
| 2412 | 7         | Plain                         | 4          | 7/8 x 5 1/4 | .63    |
| 2411 | 7         | 1, 2, 3, 4, 5, 6, 7           | 4          |             | .70    |
| 2410 | 8         | Plain                         | 4 1/2      | 7/8 x 5 3/4 | .72    |
| 2409 | 8         | 1, 2, 3, 4, 5, 6, 7, 8        | 4 1/2      |             | .80    |
| 2424 | 9         | Plain                         | 5          | 7/8 x 6 3/8 | .81    |
| 2423 | 9         | 1, 2, 3, 4, 5, 6, 7, 8, 9     | 5          |             | .90    |
| 2422 | 10        | Plain                         | 5 1/2      | 7/8 x 7     | .90    |
| 2421 | 10        | 1, 2, 3, 4, 5, 6, 7, 8, 9, 10 | 5 1/2      |             | 1.00   |



Type A

### BAKELITE TERMINAL MOUNTING STRIPS

Mounting tie strips for fastening Resistors, Condensers, etc. Mounting Lug hole diameter .140". Type A shows non-ground mounting lug. Type B shows combination grounding-mounting lug:



Type B

| No.  | Type | Terminals | Mtg. Centers | Mounting Lugs | List    |
|------|------|-----------|--------------|---------------|---------|
| 2434 | A    | 1         | } One Hole   | 1             | \$3.00C |
| 2455 | B    | 1         |              | 1             | 3.00C   |
| 2435 | A    | 2         | } One Hole   | 1             | 4.00C   |
| 2456 | B    | 2         |              | 1             | 4.00C   |
| 2436 | A    | 3         | } One Hole   | 2             | 7.00C   |
| 2436 | B    | 3         |              | 2             | 7.00C   |
| 2457 | A    | 4         | } One Hole   | 2             | 8.50C   |
| 2437 | B    | 4         |              | 2             | 8.50C   |
| 2458 | A    | 5         | } One Hole   | 2             | 10.00C  |
| 2438 | B    | 5         |              | 2             | 10.00C  |
| 2459 | A    | 6         | } One Hole   | 2             | 12.00C  |
| 2439 | B    | 6         |              | 2             | 12.00C  |
| 2460 | A    | 7         | } One Hole   | 2             | 13.50C  |
| 2440 | B    | 7         |              | 2             | 13.50C  |
| 2461 | A    | 8         | } One Hole   | 2             | 15.00C  |
| 2441 | B    | 8         |              | 2             | 15.00C  |
| 2462 | A    | 8         | } One Hole   | 2             | 15.00C  |
| 2462 | B    | 8         |              | 2             | 15.00C  |



No. 2425—Terminal Lugs only (less screws).....List \$6.00C  
 No. 2426—Terminal Screws, 3/8" long.....List 1.50C

### FUSE MOUNTINGS

Flush Type Mounting



Bakelite base. For standard radio or automotive fuses. Countersunk center hole for mounting.

Equipped with two soldering lugs.

No. 2340—Single pole .....List \$ .20  
 No. 7201—Double pole .....List .35

### Panel Type

Takes standard type radio—automotive fuse. Equipped with 6/32 screws for mounting on panels.

No. 2341—Single pole .....List \$ .25  
 No. 7203—Double pole .....List .40

### For AG 1" Long Type Fuse

| No.   | List   |
|---|--------|
| 7202—For smaller type fuse. Bakelite base. 1 3/8" x 1/2" x 1/8" Flush Mount | \$ .20 |
| 7204—Double pole. 1 3/8" x 1" x 1/8" Flush Mount                            | .35    |
| 7205—Same as 7202. Panel Mount  | .25    |
| 7206—Same as 7204. Panel Mount  | .25    |

### BAKELITE TERMINAL STRIPS

Brown bakelite 1/16" thick. Suitable light duty radio work, experimental purposes, etc.



| No.  | Terminals                 | Mtg. Ctrs. | List   |
|------|---------------------------|------------|--------|
| 2520 | 2                         | 1 1/2      | \$ .10 |
| 2521 | 3                         | 1 3/4      | .14    |
| 2522 | 4                         | 2          | .18    |
| 2523 | 5                         | 2 1/8      | .22    |
| 2524 | 6                         | 2 1/4      | .26    |
| 2528 | Terminal Lug & Screw only |            | 3.50 C |

### TWIN JACK STRIP



With two terminals. Takes standard phone tips. Base width 1 1/4". 1 1/8" between mounting holes.

No. 2443.....List \$ .20

### TERMINAL LUGS



| No.                       | List   |
|---------------------------|--------|
| 2444                      | \$.65C |
| 2445 # 6 Hole             | 1.25C  |
| 2446                      | .75C   |
| 2447                      | 1.25C  |
| 2463                      | 1.85C  |
| 2448 # 6 Hole—Combination | 1.25C  |
| 2638 # 8 Hole—Combination | 1.25C  |

# ICA INSULINE RADIO PRODUCTS ICA

## FILTERVOLT NOISE FILTER

An efficient filter for disturbances caused by electrical appliances. For use with any all-wave or broadcast receiver.

Rated conservatively at 250 watts for 32, 110 and 220 volt AC or DC circuits. Can be installed either at the radio or at the source of disturbance.

Contains heavy duty R.F. chokes, large filter capacitor, and has a "PI" Filter circuit arrangement.

No. 338..... List \$7.50



## ICA FILTERVOLT

Improves extremely noisy radio reception due to interruptions in power line caused by electrical appliances, lights, etc.

No. 394  
List \$4.50



## DUPLEX FILTERVOLT

Eliminates Radio Noises Caused By—

- Electric Shavers
- Refrigerators
- Fans • Elevators
- Motors, etc.



Unit is equipped with Dual outlet, both sides being filtered for noise elimination. Packed 25 to a standard carton.

No. 90..... List \$1.50

## UNIVERSAL VOLTAGE REGULATOR

Voltage fluctuation often occurs not gradually but suddenly, thus bringing a tremendous strain on the tubes. This regulator protects tubes through scientific regulation of current fluctuations. Housing body and end rings are neatly constructed and of perforated japanned metal. For all Radio Sets, AC, DC.



No. 92..... List \$1.50

## ICA 3-IN-1 RADIO TUNER



Functions as either an Antenna Tuner, Wave Trap, or Aerial Eliminator. Operates on any make or model radio set.

As an Antenna Tuner, it will improve the reception of a weak station. As a Wave Trap, it will separate interfering stations and improve selectivity. As an Aerial Eliminator, it makes unnecessary the outdoor aerial. Easily installed within a few minutes.

No. 93—Complete with instructions List \$1.00

## ICA DELUXE SIGNA-TONE

### AUDIO OSCILLATOR — CODE PRACTICE SET — KEYING MONITOR

The ICA Signatone is a perfected Audio Oscillator, having 3 different output frequencies and a continuously variable volume control. The Audio notes are similar to those of high quality commercial CW stations.

1. **CODE PRACTICE SET**—A number of phones and keys may be connected for intercommunication or for classroom or radio club instruction in code.

2. **KEYING MONITOR**—An invaluable aid in improving any ham's "fist". Will follow the "bug" at all speeds. No well-equipped station should be without this keying monitor.



No. 4300



No. 4301

3. **MODULATION SIGNAL**—The steady note of the Signatone is ideal for adjusting both the Modulator and modulated stages of your transmitter for a maximum modulation percentage of not over 100.

4. **SIGNAL TRACER**—By feeding the output of the Signatone into each stage of your modulator and listening to the output of that stage, defects and "bugs" can easily be located. Complete with tube and self-contained speaker, for 110 V AC-DC.

No. 4300—\*Dealer Net Cost ..... \$12.00  
No. 4301—Classroom Model (No Speaker)—Dealer Net Cost ..... 9.00

## ICA EAR PHONES

Complete With Head Bands

Made of molded Bakelite and light-weight nickel-plated metal. 2000 ohms.



No. 23—Double Head Phone..... List \$4.50

## EAR CUSHIONS



Made of soft rubber. Ideal for the amateur wireless operator, etc. Used by all leading air lines.

No. 195..... List \$1.10 pr.

## DOUBLE PHONE CORDS



No. 192—Tips on both ends..... \$ .85  
193—Spades on one end, tips on other..... 85

## ICA TENNA-SCOPE LOOP

For Midgets or Portables

Eliminates necessity of outdoor or indoor antenna. Replaces the antenna coil in portable or midget sets. Easily assembled.

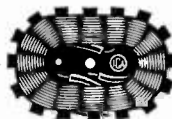

No. 4385..... List \$1.25

## ICA TENNA-SCOPE



A new style built-in tuned radio antenna. Easily connected. Eliminates use of outside aerial and ground. Features: Better selectivity — Higher signal to noise ratio — Easily connected, no soldering.

No. 4380..... List \$3.00

## ICA MORSE CODE RECORDS



Learn the International Morse Code Quickly, Easily — Uses EYE - EAR Method. The Complete Linguaphone Code Equipment consists of 5 Double-faced, electrically transcribed records in durable album. Contents: 3 Tables, 10 Lessons.

No. 1800—Complete..... Dealer Net \$10.00  
No. 1800R—Records only Dealer Net Ea. 1.95  
No. 1800B—Booklet only Dealer Net Ea. .90

## ICA "TRIPLEX"

Radio & Telegraph Code Practice Set  
Blinker Light  
Radio Signal—Telegraph

No. 70—Single Unit (less batteries) ..... \$3.25  
71—Double Unit (50 ft. wire) ..... 6.85



## ICA RECORD-PLAYER SWITCH

Replacement for RCA Switch 9824A



Recommended for quickly connecting Record Players, F.M. attachments, Television attachments, Microphones and similar devices into the audio amplifier of existing radio receivers.

No. 1740..... List \$2.25

## RESISTOR CORDS

A series of replacement resistor cords for practically all AC-DC requirements.



| No. | Resistance-Ohms | List   |
|-----|-----------------|--------|
| 513 | 185             | \$1.15 |
| 514 | 160             | 1.15   |
| 515 | 190             | 1.15   |
| 516 | 220             | 1.15   |
| 517 | 290             | 1.15   |
| 518 | 340             | 1.15   |
| 519 | 640             | 1.25   |

## UNIVERSAL RESISTOR CORD

Replacement Resistor Cord for all makes receivers. From 22 to 330 ohms on one cord. Instructions with each cord.

No. 205..... List \$1.70

# ICA INSULINE ICA

## RADIO PRODUCTS

### RADIO HARDWARE



ICA offers a wide variety of radio hardware items suitable for practically any use in the radio-electronic and allied fields. ICA hardware is offered in standard package quantities or in handsome glass display jars for convenient storing.



ities or in handsome glass display jars for convenient storing.

#### ROUND HEAD MACHINE SCREWS NICKEL-PLATED

| Jar*<br>Cat. No. | Qty.*<br>Each Jar | Bulk<br>Cat. No. | Qty.<br>Bulk Pkge. | Description       | Bulk List |
|------------------|-------------------|------------------|--------------------|-------------------|-----------|
| —                | —                 | 5504             | 1000               | 2-56 x 1/4" long  | \$4.00M   |
| 5000             | 100               | 5500             | 1000               | 4-36 x 1/2" long  | 5.00M     |
| 5001             | 100               | 5501             | 1000               | 4-36 x 1/2" long  | 5.50M     |
| 5002             | 75                | 5502             | 1000               | 4-36 x 3/4" long  | 5.75M     |
| 5007             | 90                | 5507             | 1000               | 6-32 x 1/2" long  | 5.00M     |
| —                | —                 | 5511             | 1000               | 6-32 x 3/8" long  | 5.00M     |
| 5008             | 80                | 5508             | 1000               | 6-32 x 1/2" long  | 5.50M     |
| 5009             | 70                | 5509             | 1000               | 6-32 x 3/4" long  | 6.50M     |
| 5010             | 50                | 5510             | 1000               | 6-32 x 1" long    | 8.50M     |
| 5014             | 75                | 5514             | 1000               | 8-32 x 3/8" long  | 7.00M     |
| 5015             | 70                | 5515             | 1000               | 8-32 x 1/2" long  | 9.00M     |
| 5017             | 40                | 5517             | 1000               | 8-32 x 1" long    | 9.00M     |
| 5022             | 60                | 5521             | 1000               | 10-32 x 1/2" long | 9.00M     |

#### BINDING HEAD MACHINE SCREWS

| Jar*<br>Cat. No. | Qty.*<br>Each Jar | Bulk<br>Cat. No. | Qty.<br>Bulk Pkge. | Description      | Bulk List |
|------------------|-------------------|------------------|--------------------|------------------|-----------|
| —                | —                 | 5546             | 100                | 6-32 x 3/8" long | \$1.25C   |
| 5030             | 80                | 5547             | 100                | 6-32 x 1/4" long | 1.25C     |
| 5031             | 75                | 5548             | 100                | 6-32 x 3/8" long | 1.25C     |

#### OVAL HEAD MACHINE SCREWS NICKEL PLATED

| Jar*<br>Cat. No. | Qty.*<br>Each Jar | Bulk<br>Cat. No. | Qty.<br>Bulk Pkge. | Description       | Bulk List     |
|------------------|-------------------|------------------|--------------------|-------------------|---------------|
| 5042†            | 40                | 5710†            | 100                | 10-32 x 3/8" long | \$1.00C-8.50M |

†For Transmitting Racks.

#### PARKER-KALON SELF-TAPPING SCREWS

| Jar*<br>Cat. No. | Qty.*<br>Each Jar | Bulk<br>Cat. No. | Qty.<br>Bulk Pkge. | Description        | Bulk List |
|------------------|-------------------|------------------|--------------------|--------------------|-----------|
| —                | —                 | 5562             | 1000               | No. 3 x 3/8" long  | \$1.50C   |
| 5051             | 50                | 5555             | 1000               | No. 4 x 1/2" long  | 1.60C     |
| 5052             | 50                | 5556             | 1000               | No. 6 x 1/4" long  | 2.00C     |
| 5053             | 45                | 5557             | 1000               | No. 6 x 3/8" long  | 2.25C     |
| 5054             | 40                | 5558             | 1000               | No. 7 x 1/2" long  | 2.75C     |
| 5055             | 35                | 5559             | 1000               | No. 10 x 3/4" long | 2.75C     |

#### ESCUTCHEON PLATE SCREWS

| Jar*<br>Cat. No. | Qty.*<br>Each Jar | Bulk<br>Cat. No. | Qty.<br>Bulk Pkge. | Description       | Bulk List |
|------------------|-------------------|------------------|--------------------|-------------------|-----------|
| 5182             | 100               | 5677             | 100                | No. 1 x 3/4" long | \$15.00M  |

#### FLAT STEEL PLATED WASHERS

| Jar*<br>Cat. No. | Qty.*<br>Each Jar | Bulk<br>Cat. No. | Qty.<br>Bulk Pkge. | Description      | Bulk List |
|------------------|-------------------|------------------|--------------------|------------------|-----------|
| 5090             | 100               | 5595             | 1000               | For No. 6 Screw  | \$2.50M   |
| 5091             | 100               | 5596             | 1000               | For No. 8 Screw  | 2.50M     |
| 5092             | 100               | 5597             | 1000               | For No. 10 Screw | 2.50M     |
| 5093             | 100               | 5603             | 1000               | For 1/4" Screw   | 4.50M     |
| —                | —                 | 5607             | 1000               | For 3/8" Screw   | 5.00M     |

#### EVERLOCK LOCK WASHERS

| Jar*<br>Cat. No. | Qty.*<br>Each Jar | Bulk<br>Cat. No. | Qty.<br>Bulk Pkge. | Description      | Bulk List    |
|------------------|-------------------|------------------|--------------------|------------------|--------------|
| 5085             | 100               | 5592             | 1000               | For No. 6 Screw  | \$.55C-3.75M |
| 5086             | 90                | 5593             | 1000               | For No. 8 Screw  | .60C-4.00M   |
| 5087             | 80                | 5594             | 1000               | For No. 10 Screw | .65C-4.50M   |

#### KANTLINK SPLIT TYPE LOCKWASHERS

| Jar*<br>Cat. No. | Qty.*<br>Each Jar | Bulk<br>Cat. No. | Qty.<br>Bulk Pkge. | Description                 | Bulk List |
|------------------|-------------------|------------------|--------------------|-----------------------------|-----------|
| 5080             | 125               | 5589             | 1000               | For 6-32 Screw-3/8" thick   | \$3.50M   |
| 5081             | 125               | 5590             | 1000               | For 8-32 Screw-3/8" thick   | 3.50M     |
| 5082             | 100               | 5591             | 1000               | For 10-32 Screw-3/8" thick  | 3.50M     |
| 5083             | 75                | 5602             | 1000               | For 1/4-32 Screw-3/8" thick | 5.50M     |

#### FLAT FIBRE WASHERS

| Jar*<br>Cat. No. | Qty.*<br>Each Jar | Bulk<br>Cat. No. | Qty.<br>Bulk Pkge. | Description            | Bulk List |
|------------------|-------------------|------------------|--------------------|------------------------|-----------|
| 5100             | 125               | 5601             | 1000               | 3/8" Diam. 1/8" Thick  | \$6.25M   |
| —                | —                 | 5612             | 1000               | 1/2" Diam. 1/8" Thick  | 7.25M     |
| 5102             | 90                | 5609             | 1000               | 3/8" Diam. 3/16" Thick | 8.00M     |
| —                | —                 | 5626             | 1000               | 1/2" Diam. 3/16" Thick | 7.50M     |
| 5101             | 100               | 5605             | 1000               | 3/8" Diam. 1/8" Thick  | 7.50M     |
| 5104             | 50                | 5610             | 1000               | 1/2" Diam. .020 Hole   | 8.00M     |
| 5105             | 50                | 5611             | 1000               | 3/8" Diam. 3/16" Thick | 9.75M     |

#### FIBRE SHOULDER WASHERS

| Jar*<br>Cat. No. | Qty.*<br>Each Jar | Bulk<br>Cat. No. | Qty.<br>Bulk Pkge. | Description                            | Bulk List |
|------------------|-------------------|------------------|--------------------|--|-----------|
| —                | —                 | 5618             | 100                | 3/8" Overall Diam. 1/8" Shoulder Diam. | \$1.25C   |
| 5111             | 50                | 5620             | 100                | 1/2" Overall Diam. 3/8" Shoulder Diam. | 1.25C     |
| 5110             | 50                | 5615             | 100                | 3/8" Overall Diam. 1/4" Shoulder Diam. | 1.25C     |
| 5114             | 50                | 5619             | 100                | 1/2" Overall Diam. 3/8" Shoulder Diam. | 1.25C     |
| 5115             | 40                | 5616             | 100                | 1/2" Overall Diam. 3/8" Shoulder Diam. | 1.35C     |
| 5112             | 50                | 5624             | 100                | 1/2" Overall Diam. 3/8" Shoulder Diam. | 1.35C     |
| 5113             | 50                | 5628             | 100                | 3/8" Overall Diam. 1/2" Shoulder Hgt.  | 1.50C     |

#### CUP WASHERS

| Jar*<br>Cat. No. | Qty.*<br>Each Jar | Bulk<br>Cat. No. | Qty.<br>Bulk Pkge. | Description     | Bulk List    |
|------------------|-------------------|------------------|--------------------|-----------------|--------------|
| 5212             | 45                | 5712             | 100                | Hole Size No. 8 | \$.75C-5.50M |
| 5213             | 20                | 5713             | 100                | No. 10          | .80C-5.50M   |

#### STEEL HEXAGON NUTS — NICKEL PLATED

| Jar*<br>Cat. No. | Qty.*<br>Each Jar | Bulk<br>Cat. No. | Qty.<br>Bulk Pkge. | Description   | Bulk List |
|------------------|-------------------|------------------|--------------------|---------------|-----------|
| 5070             | 100               | 5572             | 1000               | 4-36 x 1/4"   | \$4.00M   |
| —                | —                 | 5573             | 1000               | 4-36 x 3/8"   | 3.25M     |
| 5074             | 80                | 5577             | 1000               | 6-32 x 1/8"   | 5.00M     |
| 5071             | 90                | 5576             | 1000               | 6-32 x 1/4"   | 4.50M     |
| 5072             | 80                | 5580             | 1000               | 8-32 x 1/8"   | 5.00M     |
| 5073             | 50                | 5584             | 1000               | 10-32 x 3/8"  | 7.50M     |
| 5075             | 12                | 5583             | 1000               | 1/4-20 x 1/8" | 1.20C     |
| —                | —                 | 5579             | 1000               | 3/4-32 x 3/8" | 1.00C     |
| 5076             | 10                | 5575             | 1000               | 3/8-32 x 1/2" | 2.00C     |

#### BRASS HEXAGON NUTS — NICKEL PLATED

| Jar*<br>Cat. No. | Qty.*<br>Each Jar | Bulk<br>Cat. No. | Qty.<br>Bulk Pkge. | Description   | Bulk List     |
|------------------|-------------------|------------------|--------------------|---------------|---------------|
| —                | —                 | 5564             | 100                | 4-36 x 3/8"   | \$ .75C-6.00M |
| —                | —                 | 5566             | 100                | 6-32 x 1/4"   | .75C-6.00M    |
| —                | —                 | 5567             | 100                | 6-32 x 3/8"   | .85C-6.50M    |
| —                | —                 | 5570             | 100                | 8-32 x 1/8"   | 1.00C-7.50M   |
| —                | —                 | 5574             | 100                | 3/8-32 x 1/2" | 1.75C         |

#### RACK SCREW AND WASHER ASSORTMENT

Packed in ICA handy jars. Includes 20 Oval Head Screws (10-32 x 3/8") and 20 Cup Washers (10-32). List \$6.50

#### BRASS EYELETS

| Jar*<br>Cat. No. | Qty.*<br>Each Jar | Bulk<br>Cat. No. | Qty.<br>Bulk Pkge. | Diam. Shank | Length | Bulk List |
|------------------|-------------------|------------------|--------------------|-------------|--------|-----------|
| 5172             | 80                | 5672             | 1000               | .115        | 3/8"   | \$10.00M  |
| 5171             | 90                | 5671             | 1000               | .125        | 1/2"   | 9.50M     |
| 5170             | 100               | 5670             | 1000               | .132        | 3/4"   | 8.50M     |

#### NICKEL PLATED TUBULAR STEEL RIVETS

| Jar*<br>Cat. No. | Qty.*<br>Each Jar | Bulk<br>Cat. No. | Qty.<br>Bulk Pkge. | Diam. Shank | Length | Bulk List |
|------------------|-------------------|------------------|--------------------|-------------|--------|-----------|
| —                | —                 | 5730             | 1000               | 1/8"        | 3/8"   | \$ 8.00M  |
| 5160             | 100               | 5663             | 1000               | 1/8"        | 1/2"   | 8.00M     |
| 5161             | 80                | 5664             | 1000               | 1/8"        | 3/4"   | 10.00M    |
| 5162             | 70                | 5665             | 1000               | 1/8"        | 1/2"   | 10.50M    |

#### STEEL CABLE CLAMPS, PLATED

| Jar*<br>Cat. No. | Qty.*<br>Each Jar | Bulk<br>Cat. No. | Qty.<br>Bulk Pkge. | Description                   | Bulk List |
|------------------|-------------------|------------------|--------------------|-------------------------------|-----------|
| 5200             | 35                | 5697             | 1000               | Length 3/4" Diam. Bend 3/8"   | \$1.25C   |
| 5201             | 30                | 5698             | 1000               | Length 1 1/8" Diam. Bend 1/2" | 1.50C     |

#### NICKEL PLATED SPRING CLIP

| Jar*<br>Cat. No. | Qty.*<br>Each Jar | Bulk<br>Cat. No. | Qty.<br>Bulk Pkge. | Description              | Bulk List |
|------------------|-------------------|------------------|--------------------|--------------------------|-----------|
| 5190             | 40                | 5691             | 100                | Width 1/8" Length 1 1/8" | \$1.65C   |
| 5191             | 40                | 5692             | 100                | Width 1/8" Length 1 1/8" | 1.75C     |
| 5192             | 30                | 5693             | 100                | Width 3/8" Length 1"     | 2.00C     |

\*ALL JARS LIST AT \$.65 PER JAR. BULK QUANTITIES LIST AS SHOWN. ORDER BY CATALOG NUMBER.

# ICA INSULINE ICA

## RADIO PRODUCTS

### ICA RADIO HARDWARE



#### ICA FLEXIBLE RUBBER GROMMETS

| Jar* Cat. No. | Qty.* Each Jar | Bulk Cat. No. | Qty. Bulk Pkge. | (3) Hole Size | (1) O.D. | (2) Thick-ness | (4) Slot | (5) Mtg. Width | Bulk List |
|---------------|----------------|---------------|-----------------|---------------|----------|----------------|----------|----------------|-----------|
| 5120          | 15             | 5633          | 100             | 7/8           | 1 1/2    | 3/16           | 1/2      | 1 1/2          | \$3.85C   |
| 5121          | 12             | 5634          | 100             | 7/8           | 1 1/2    | 1/4            | 1/2      | 1 1/2          | 4.30C     |
| 5122          | 15             | 5635          | 100             | 7/8           | 1 1/2    | 1/4            | 1/2      | 1 1/2          | 3.90C     |
| 5123          | 12             | 5639          | 100             | 7/8           | 1 1/2    | 1/4            | 1/2      | 1 1/2          | 3.00C     |
| 5125          | 10             | 5637          | 100             | 7/8           | 1 1/2    | 1/4            | 1/2      | 1 1/2          | 3.50C     |
| —             | —              | 5641          | 100             | 1             | 1 1/2    | 1/4            | 1/2      | 1 1/2          | 7.00C     |
| —             | —              | 5642          | 100             | 7/8           | 1 1/2    | 1/4            | 1/2      | 1 1/2          | 3.90C     |
| 5127          | 12             | 5687          | 100             | 7/8           | 1 1/2    | 1/4            | 1/2      | 1 1/2          | 3.75C     |



#### ANGLE BRACKETS

†One Hole Tapped — One Plain.  
‡One Slot — One Hole.

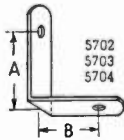

| Jar* Cat. No. | Qty.* Each Jar | Bulk Cat. No. | Qty. Bulk Pkge. | A   | B     | Width | Bulk List Price |
|---------------|----------------|---------------|-----------------|-----|-------|-------|-----------------|
| 5205          | 16             | 5702          | 100             | 3/8 | 3/8   | 1/2   | \$2.50C         |
| 5206          | 15             | 5703          | 100             | 3/8 | 3/8   | 1/2   | 2.50C           |
| 5207          | 25             | 5704          | 100             | 3/8 | 1 1/8 | 3/8   | 4.00C           |
| —             | —              | 5705          | 100             | 3/8 | 1/2   | 3/8   | 4.50C           |
| —             | —              | 5706          | 100             | 3/8 | 1/2   | 3/8   | 2.00C           |
| —             | —              | 5707          | 100             | 3/8 | 1/2   | 3/8   | 3.00C           |

#### PILOT LIGHT CONTACT



For making center connection inside pilot light socket.

No. 2465  
List \$5.00M

#### ICA UTILITY GLASS JARS

For use on service bench to store hardware, etc. 2 1/2" high x 1 1/2" deep.  
No. 5400—List \$1.12



### BRASS TINNED TERMINAL LUGS

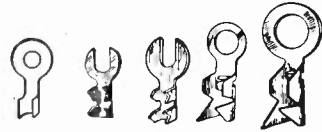

| Jar* Cat. No. | Qty.* Each Jar | Bulk Cat. No. | Qty. Bulk Pkge. | Length | Hole Size | Bulk List     |
|---------------|----------------|---------------|-----------------|--------|-----------|---------------|
| —             | —              | 5645          | 100             | 1 1/2  | No. 8     | \$7.5C- 6.00M |
| —             | —              | 5654          | 100             | 7/8    | 3/4       | .80C- 6.00M   |
| 5135          | 125            | 5646          | 100             | 1 1/2  | No. 6     | .60C- 4.00M   |
| —             | —              | 5656          | 100             | 1 1/2  | No. 6     | 5.00M         |
| 5136          | 100            | 5647          | 100             | 1 1/2  | No. 10    | .65C- 5.00M   |
| 5137          | 75             | 5649          | 100             | 1 1/2  | No. 8     | 1.00C- 8.00M  |
| 5141          | 75             | 5648          | 100             | 1      | No. 8     | 1.00C- 8.00M  |
| —             | —              | 5655          | 100             | 1 1/2  | No. 8     | .80C- 6.50M   |
| —             | —              | 5653          | 100             | 1 1/2  | No. 6     | .85C- 7.00M   |
| 5138          | 100            | 5650          | 100             | 1 1/2  | No. 8     | 1.00C- 8.00M  |
| 5139          | 75             | 5651          | 100             | 1 1/2  | No. 10    | 1.75C-11.00M  |
| 5140          | 50             | 5652          | 100             | 1 1/2  | 3/4       | 2.50C-16.00M  |

### EVERLOCK TERMINAL LUGS

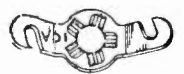

| 5483 | 5484 | 5482 | 5481 | 5480  |
|------|------|------|------|-------|
| —    | —    | 5480 | 100  | No. 6 |
| 5145 | 50   | 5481 | 100  | 1/4   |
| 5146 | 60   | 5482 | 100  | No. 4 |
| 5147 | 55   | 5483 | 100  | No. 6 |
| 5148 | 50   | 5484 | 100  | No. 8 |

### DISPLAY "SALESMAN" MERCHANDISER OF HARDWARE AND RADIO ESSENTIALS



With this ICA display assortment you can now sell hardware in a packaged form. This assortment includes — all sizes Round Head Machine Screws — Nickel plated nuts to match — Parker-Kalon self-tapping screws — Kant-Link lock washers — Shake-Proof washers — plain washers — flat fibre washers — flexible grommets — lugs — eyelets — rivets — escutcheon plate screws — midget fuse clips — spade bolts — spring clips — clamps — angles — rack screws — and washers, etc.

EACH ITEM INDIVIDUALLY PACKED IN A GLASS DISPLAY JAR. Each jar contains an ample quantity of individual type and size hardware used by dealers, servicemen and amateurs. A complete radio hardware assortment, beautifully put up in these jars and stacked in a handsome durable metal rack which holds 36 jars.

- No. 5275—DISPLAY RACK—Contains 36 jars. A representative assortment of radio hardware, such as screws — nuts — bolts — washers — grommets, etc. List \$23.40
- No. 5276—DISPLAY RACK—Contains 36 jars. A representative assortment of radio hardware and essentials such as fibre washers — lugs — metal washers — grommets — spring clips — fuse clips — angle brackets, etc. List \$23.40
- No. 5405—METAL DISPLAY AND UTILITY RACK—Consists of 4 shelves for storing 36 hardware jars — small parts and miscellaneous items. Measures 12" high by 17 3/4" wide by 8" deep. List \$5.50

#### EVERYMAN'S 1000-PIECE RADIO HARDWARE ASSORTMENT

An assortment of hardware commonly used by dealers, servicemen, amateurs, experimenters, etc. Contains 1000 pieces of assorted machine screws — wood screws — nuts — bolts — rivets — eyelets — lugs — lock washers — rubber grommets, etc.



No. 5250.....List \$3.00

#### ICA ALL-PURPOSE RADIO HARDWARE AND ESSENTIAL EQUIPMENT

Packed in a handy indestructible metal utility case.

This De Luxe assortment includes such items as knob set screws — escutcheon screws — Parker-Kalon self-tapping screws — rubber grommets — screws — nuts, etc.

No. 5251.....List \$4.75



#### ICA ANGLE AND BRACKET ASSORTMENT

A complete assortment of 30 popular angles and brackets, nickel plated finish.

No. 5800.....List \$ .75

#### ICA RUBBER GROMMET ASSORTMENT

Assortment contains popular sizes used in Radio and Electrical Work.

No. 5810.....List \$ .75

Contains 28 Rubber Grommets  
No. 5811.....List \$1.50  
Contains 60 Rubber Grommets

#### ICA FIBRE WASHER ASSORTMENT

A representative assortment of fibre washers both plain and shoulder, to fit all popular size screws and bolts.

No. 5805.....List \$ .75

Contains 100 assorted washers

#### ICA MASTER SCREW AND NUT ASSORTMENT

Contains a substantial quantity of all the popular sizes machine screws, wood screws, Parker-Kalon self-tapping screws and nuts to match.

No. 5252.....List \$5.50

\*ALL JARS LIST AT \$.65 PER JAR. BULK QUANTITIES LIST AS SHOWN. ORDER BY CATALOG NUMBER.

# ICA INSULINE ICA

## RADIO PRODUCTS

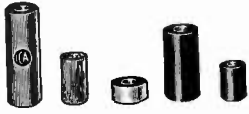

### ICA INSULATED AND BRASS SPACERS AND BUSHINGS

Used for raising sub panels, chassis, condensers, etc. For manufacturers, experimenters and laboratory use.

#### Made of High Quality Brass

| No.  | Diameter | Length | List per C |
|------|----------|--------|------------|
| 5760 | 1/4"     | 1/4"   | \$3.50     |
| 5761 | 1/4"     | 3/8"   | 4.00       |
| 5762 | 1/4"     | 1/2"   | 4.25       |
| 5763 | 1/4"     | 3/4"   | 5.00       |
| 5767 | 1/2"     | 1"     | 5.50       |
| 5764 | 3/8"     | 1/4"   | 4.25       |
| 5765 | 3/8"     | 1/2"   | 5.00       |
| 5766 | 3/8"     | 3/4"   | 5.50       |
| 5768 | 3/8"     | 1"     | 5.75       |

#### Made of Fenolite Insulation

|      |      |      |      |
|------|------|------|------|
| 5775 | 1/4" | 1/4" | 3.75 |
| 5776 | 1/4" | 3/8" | 4.50 |
| 5777 | 1/4" | 1/2" | 5.00 |
| 5778 | 1/4" | 3/4" | 5.50 |
| 5782 | 1/4" | 1"   | 7.00 |
| 5779 | 3/8" | 1/4" | 5.00 |
| 5780 | 3/8" | 1/2" | 6.00 |
| 5781 | 3/8" | 3/4" | 6.50 |
| 5783 | 3/8" | 1"   | 5.75 |

| Threaded Brass Bushings—1/4" Diameter |                |      |      |
|---------------------------------------|----------------|------|------|
| 5785                                  | for 6/32 screw | 1/4" | 4.25 |
| 5786                                  | "              | 3/8" | 5.25 |
| 5787                                  | "              | 1/2" | 6.50 |
| 5788                                  | "              | 3/4" | 7.50 |
| 5794                                  | "              | 1"   | 8.00 |
| 5790                                  | for 8/32 screw | 1/4" | 4.25 |
| 5791                                  | "              | 3/8" | 5.25 |
| 5792                                  | "              | 1/2" | 6.50 |
| 5795                                  | "              | 1"   | 8.00 |

| Molded Bakelite Spacer Bushing |   |         |  |
|--------------------------------|---|---------|--|
| No.                            |   | List    |  |
| 2365                           | Suitable for either spacer or bushing. With brass eyelet. | \$2.50C |  |
| 2366                           | Same as above—without eyelet                              | 2.00C   |  |

### SPACER AND BUSHING ASSORTMENTS

Brass and Insulated

Assortment of 25 spacers and bushings in 1/4" & 3/8". Diameters from 1/4" to 3/4" long. Ideal for raising sub panels, chassis, etc.

|                                    |   |        |
|------------------------------------|---|--------|
| No.                                |   | List   |
| 5260                               | Insulated Assortment  | \$1.25 |
| 5261                               | Brass Assortment  | 1.25   |
| Threaded Brass Bushing Assortments |   |        |
| 5262                               | 16 Assorted Brass bushings. Threaded for 6/32 from 1/4" to 3/4" lengths | 1.25   |
| 5263                               | 16 Assorted Brass bushings. Threaded for 8/32 from 1/4" to 3/4" lengths | 1.25   |

### MAST ANTENNAS FOR STANDARD RECEPTION

DE LUXE WINDOW ANTENNAS  
8 Feet—12 Feet

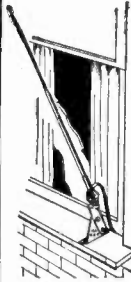

Made of Admiralty Brass with Beautiful Nickel-Plated Finish

- For Homes, Apartments, Hotels, Office Buildings, and places where it is inconvenient to install outdoor aerials or to improve reception on indoor installations.
- Quickly and easily installed.
- Adjustable Bracket at base, permits the antenna to be focused in any position for best reception.
- Furnished completely assembled with mounting flange, insulator and lead-in strip.

Individually boxed.

|  |                               |             |
|--|-------------------------------|-------------|
| 3 Section Telescopic Antenna Opens to 96"  | No. 4527B                     | List \$4.45 |
| Adjustable Bracket at base, convenient to install outdoor aerials or to improve reception on indoor installations. | No. 4529—3 Sec., Opens to 75" | List \$3.25 |
| 10 to a Standard Carton—Weight 1 1/2 lbs.  |                               |             |

### 4 Section Extra Long Window Antenna

12 Feet Long

Ideal for DX Reception and Rural Sections where extra length is needed for best results.

|          |             |
|----------|-------------|
| No. 4513 | List \$6.75 |
|----------|-------------|

### HOME ANTENNAS

12 Feet—4 Sections

Made of Admiralty Brass—Guaranteed Rust Proof

- The Latest Type Home Antenna suggested by leading Radio Set Manufacturers for best results.
- Eliminates unsightly and dangerous wires.
- Clear, noise-free reception with no power line interference.
- Very sturdy construction—made of Admiralty Brass with Beautiful Nickel-Plated Finish.
- Guaranteed Rust-proof for the Life of Antenna.
- Universal Bracket allows permanent and convenient installation on soil pipe, window pipe, chimney, roof, gables, cornices, wall copings, etc.
- Individually boxed.

Vertical Mast with all accessories for Universal Mounting—Including Lead-in Wire, Insulators, etc.

|   |             |
|---|-------------|
| No. 4516                                  | List \$6.95 |
| 10 to a Standard Carton—Weight 3 1/2 lbs. |             |

### Television Antennas . . . Television Accessories

Since 1927, Insuline Corporation of America has been pioneering in the development of Television accessories. ICA now boasts of a complete line of television antennas of all types as well as the newest accessories and servicing tools.

Consult other pages for ICA's latest.

- Antennas—outdoor types
- Antennas—indoor types
- Servicing Tools
- Servicing Kits
- Accessories
  - Filters
  - Installation Kits
  - Mounting Brackets
  - Guy Wire, etc.

Send for latest complete  
Television Catalog

### ICA BAKELITE RADIO PANELS

Black, Polished Mirror Finish

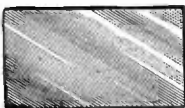

| 1/8" Thickness |         |        |     | 3/16" Thickness |        |     |      |
|----------------|---------|--------|-----|-----------------|--------|-----|------|
| No.            | Size    | List   | No. | Size            | List   | No. | Size |
| 832            | 7 x 10  | \$1.55 | 842 | 7 x 10          | \$2.25 |     |      |
| 833            | 7 x 12  | 1.85   | 843 | 7 x 12          | 2.75   |     |      |
| 834            | 7 x 14  | 2.00   | 844 | 7 x 14          | 3.25   |     |      |
| 835            | 7 x 18  | 3.00   | 845 | 7 x 18          | 4.10   |     |      |
| 836            | 7 x 21  | 3.10   | 846 | 7 x 21          | 4.65   |     |      |
| 837            | 7 x 24  | 3.50   | 847 | 7 x 24          | 5.50   |     |      |
| 840            | 7 x 30  | 4.50   | 850 | 7 x 30          | 6.75   |     |      |
| 860            | 10 x 12 | 2.75   | 863 | 10 x 12         | 4.15   |     |      |
| 861            | 10 x 18 | 3.65   | 864 | 10 x 18         | 5.65   |     |      |

### ICA FULL SIZE BAKELITE SHEETS

Black Glossy Finish

| No. | Size      | Thickness | App. Wt. | List    |
|-----|-----------|-----------|----------|---------|
| 852 | 38" x 49" | 1/8"      | 6 lbs.   | \$21.50 |
| 853 | 38" x 49" | 3/16"     | 8 lbs.   | 27.00   |
| 854 | 38" x 49" | 1/4"      | 12 lbs.  | 44.00   |
| 857 | 38" x 49" | 3/8"      | 16 lbs.  | 55.00   |
| 858 | 38" x 49" | 1/2"      | 20 lbs.  | 66.00   |

Prices on other sizes or thicknesses quoted on request

### ICA ALUMINUM PANELS

ICA Aluminum panels and sheets have a bright silver finish and are supplied in the following sizes:

| No.  | Size   | List   | No.  | Size    | List   |
|------|--------|--------|------|---------|--------|
| 1194 | 7 x 10 | \$1.35 | 1200 | 7 x 24  | \$3.50 |
| 1195 | 7 x 12 | 1.60   | 3157 | 10 x 12 | 2.75   |
| 1196 | 7 x 14 | 1.75   | 3158 | 10 x 18 | 3.15   |
| 1198 | 7 x 18 | 2.35   | 3159 | 10 x 24 | 5.50   |
| 1199 | 7 x 21 | 2.85   |      |         |        |

SEE OTHER PAGES FOR ICA'S COMPLETE LINE OF RELAY RACK PANELS AND CHASSIS BASES (STEEL OR ALUMINUM), RACK CABINETS, AMPLIFIER CHASSIS, SPEAKER CABINETS, ETC. SPECIAL SIZE CABINETS AND CHASSIS MADE TO SPECIFICATIONS.

# PLUGS—MICROPHONE CONNECTORS

## Single Contact Female Microphone Connector



This microphone connector assures a completely shielded connection. All metal parts are chrome plated brass except spring. Used extensively for making connections from microphone to amplifier. When used with our part No. 505 and 500, any combination of connection can be arranged. Equipped with coupling ring.  
**No. 506 LIST PRICE 50c**

## Single Contact Male Microphone Connector



Similar to microphone connector No. 506 above except that it has a male thread  $\frac{3}{8}$ -27 and no coupling ring.  
**No. 505 LIST PRICE 40c**

## PHONE PLUG ADAPTER



For use with the connector 506 shown at the top. Fits any standard phone jacks. No wiring or soldering necessary to make connection. Made of nickel plated brass.  
**No. 223 LIST PRICE 45c**

## DOUBLE PHONE PLUG



A two way phone plug. Will accommodate 2 sets head-phone tips or lugs. Fits all standard jacks. Handle is molded bakelite. Metal parts are nickel plated brass. Available in red and black.  
**No. 211 LIST PRICE 50c**  
**No. 224—Barrel only LIST PRICE 20c**

## SHIELDED TWO-WAY PHONE PLUG



Identical to our part No. 211 phone plug except that barrel is made of nickel plated brass for shielding purposes.  
**No. 221—Plug LIST PRICE 85c**  
**No. 222—Barrel only LIST PRICE 50c**

## MALE CHASSIS CONNECTORS



**No. 500.** This mike connector is used on the chassis or in the mike. It is the open circuit type. Mounts in a  $\frac{3}{8}$ " hole. Supplied with insulating washers, solderless lug and nut. Fits  $\frac{5}{8}$ -27 connections.

**No. 501.** Similar to above, except for shortening feature when disconnected. Ideal for use with multiple mixer amplifier. Supplied with insulating washers, lug and nuts.

**No. 502.** Is an open circuit pressure connector, similar to No. 500 except the spring contact protrudes to make pressure contact. Supplied with insulating washers, solderless lug and nuts.

**No. 507.** Similar to No. 500 except equipped with a linen base bakelite plate for mounting centers, 1-5/32".

**No. 508.** Similar to No. 500 except equipped with mounting plate for mounting centers 1-5/32".

**No. 509.** Similar to No. 502 except equipped with mounting plate for mounting centers 1-5/32".

| No. | Contact Action | Mounting       | Fig. | List Price |
|-----|----------------|----------------|------|------------|
| 500 | Open           | Locknut        | A    | 30c        |
| 501 | Shorting       | Locknut        | B    | 40c        |
| 502 | Pressure       | Locknut        | B    | 40c        |
| 507 | Open           | Bakelite Plate | C    | 30c        |
| 508 | Shorting       | Bakelite Plate | D    | 40c        |
| 509 | Pressure       | Bakelite Plate | D    | 40c        |

## SHIELDED PHONE PLUG



A newly designed shielded 2 conductor miniature phone plug that fits all standard jacks. One conductor is brought through the entire plug to the tip where the connection is soldered to a tinned insert. The other conductor is connected to a lug under the shell. The  $\frac{1}{4}$  inch shank is ground to very exacting tolerances. Supplied with an internal rubber cord grip.  
**No. 231 LIST PRICE 55c**

## SHIELDED CAP



Used with our No. 500, 505 and 507 for shielding purposes. Equipped with ball chain to prevent loss.  
**No. 504 LIST PRICE 55c**

## SIGNAL CORP PLUGS



**PL-55 PLUG**

PL-55 plug is a standard 2 conductor phone plug used by the U. S. Army, Signal Corps and U. S. Navy. It fits the standard Signal Corps JK-34A and JK-24 jacks. Supplied with solderless lugs.  
**LIST PRICE .....\$1.35**



**PL-68 PLUG**

PL-68 plug is a 3 conductor microphone plug. It is designed for use with the JK-33 Signal Corps and Navy type jacks. Supplied with solderless lugs.  
**LIST PRICE .....\$1.75**



**PL-47 PLUG**

PL-47 is a 2 conductor Signal Corps phone plug that fits all standard jacks and Signal Corps jacks numbers JK-24 and JK-34A. Generally used in switchboard work with braided cords. For strain relief the cord is threaded into the plug. Black handle.  
**LIST PRICE .....\$2.00**

**PL-48 PLUG**

Identical to the PL-47 except for the red handle.  
**LIST PRICE .....\$2.00**

# TELEGRAPH Apparatus Co.

412 SOUTH GREEN ST.

CHICAGO 7, ILLINOIS



# PLUGS • JACKS • CLIPS • SWITCHES • KNOBS

## TELEGRAPH APPARATUS CO.

### JK-24 JACK



JK-24 jack is a Signal Corps jack of distinctive design. Its construction assures an unvarying distance from the front of the sleeve to the jack springs. This jack is used generally in switch board work. The Signal Corps PL-55, PL-47 and PL-48 plugs are used in conjunction with this jack.

LIST PRICE .....\$1.75

### 3AG FUSE MOUNTINGS



Very sturdily constructed on  $\frac{3}{8}$ " black bakelite. Bottom rivets are recessed to permit mounting on metal. Clips are made of spring tempered nickel plated brass. Have center holes for mounting.

| No. | Type             | LIST PRICE |
|-----|------------------|------------|
| 700 | Single           | 20c        |
| 701 | Double           | 30c        |
| 702 | Clips Only Per C | \$1.75     |

### RCA TYPE PIN PLUG AND JACK



Used on RCA and most other receivers for a shielded phono connection. Can also be used as a shielded auto antenna connection.

| No. | Des.          | LIST PRICE |
|-----|---------------|------------|
| 400 | Pin Plug      | 9c         |
| 401 | Shielded Jack | 15c        |

### MINIATURE BAKELITE 7 PIN TUBE SOCKETS

#### SADDLE MOUNTING

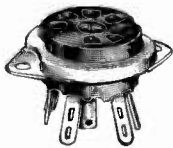

Bottom Mount  
With Center Shield

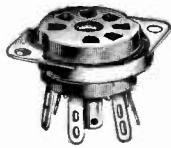

Top Mount  
With Center Shield



Top Mount Base and  
Center Shield

| No.  | Insulation           | Mounting | LIST PRICE |
|------|----------------------|----------|------------|
| 1100 | Black Bakelite       | Bottom   | \$0.20     |
| 1105 | Mica Filled Bakelite | Bottom   | .25        |
| 1107 | Black Bakelite       | Top      | .20        |
| 1108 | Mica Filled Bakelite | Top      | .25        |
| 1150 | Black Bakelite       | Top      | .30        |
| 1151 | Mica Filled Bakelite | Top      | .40        |

### BLANK WALL PLATES



**SINGLE WALL PLATE** made of chrome plated steel. Supplied with two oval mounting screws.

No. 1201 .....List Price 30c

**2 GANG WALL PLATE** identical to above except mounted with four mounting screws. Fits larger outlet box.

No. 1202 .....List Price 60c

### PL-54 PLUG



PL-54 plug is designed to fit only the Signal Corps and Navy type JK-26 jack. Supplied with solderless lugs.

LIST PRICE .....\$1.35

### SLIDE SNAP SWITCH



A very popular switch used in many radio circuits—tone — B.F.O. — phono, etc. Ribbed black bakelite handle. Housing is cadmium plated steel. High quality insulating material. Mounting centers  $1\frac{1}{8}$ ".

| No. | Type | LIST PRICE |
|-----|------|------------|
| 601 | SPST | 26c        |
| 602 | SPDT | 33c        |
| 603 | DPST | 38c        |
| 604 | DPDT | 49c        |

### FAHNESTOCK CLIPS



Millions of these spring binding posts clips have already been used. Grips wire with just enough pressure for good electrical contact. Made of spring tempered brass. \*Bronze

| No. | Fig. | Length           | Width           | Max. Wire | Mtg. Hole | List Price Per C |
|-----|------|------------------|-----------------|-----------|-----------|------------------|
| 3   | A    | $1\frac{1}{8}$ " | $\frac{3}{8}$ " | 10        | 8         | \$2.00           |
| 10  | A    | $\frac{3}{4}$ "  | $\frac{1}{8}$ " | 14        | 6         | 1.65             |
| *15 | B    | $\frac{1}{2}$ "  | $\frac{3}{8}$ " | 16        | 4         | 1.55             |
| 9   | C    | $2\frac{1}{8}$ " | $\frac{3}{8}$ " | 10        | 8         | 10.00            |
| 18  | C    | $1\frac{1}{2}$ " | $\frac{1}{8}$ " | 14        | 6         | 9.00             |

### JK-26 JACK



JK-26 jack is a Signal Corps cable type jack. It is used on the end of a cord as a 2 conductor connection and is used only in conjunction with the PL-54 plug.

LIST PRICE .....\$1.25

### BANTAM OPEN AND CLOSED CIRCUIT JACKS



Fig. A

Fig. B

Small sized jacks that fit all standard phone plugs. The contact material is spring tempered nickel silver which will retain its resiliency permanently assuring good contact. Fits  $\frac{3}{16}$ " hole in panels up to  $\frac{3}{8}$ " thick. Supplied with nut and metal washer. Solder terminals tinned for easy soldering. Available in open and closed circuit.

| No. | Fig. | Type   | LIST PRICE |
|-----|------|--------|------------|
| 102 | A    | Open   | 40c        |
| 103 | B    | Closed | 45c        |

### BAKELITE KNOBS

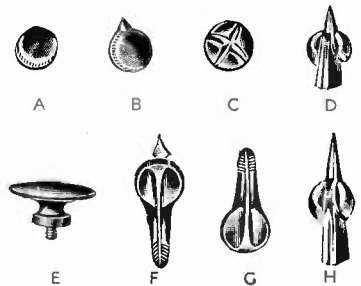

These knobs are all made of a very high grade bakelite and are available in various colors as listed below. All are for  $\frac{1}{4}$ " shafts and are set screw type, except for telegraph knob.

| No.  | Fig. | Color  | Length           | Dia.            | LIST PRICE |
|------|------|--------|------------------|-----------------|------------|
| 1500 | A    | Black  | $1\frac{1}{8}$ " | $\frac{1}{8}$ " | 12c        |
| 1501 | A    | Walnut | $1\frac{1}{8}$ " | $\frac{1}{8}$ " | 12c        |
| 1502 | A    | Red    | $1\frac{1}{8}$ " | $\frac{1}{8}$ " | 12c        |
| 1503 | A    | Ivory  | $1\frac{1}{8}$ " | $\frac{1}{8}$ " | 13c        |
| 1504 | B    | Black  | $1\frac{1}{8}$ " | $\frac{1}{8}$ " | 12c        |
| 1505 | B    | Walnut | $1\frac{1}{8}$ " | $\frac{1}{8}$ " | 12c        |
| 1506 | B    | Red    | $1\frac{1}{8}$ " | $\frac{1}{8}$ " | 12c        |
| 1507 | B    | Ivory  | $1\frac{1}{8}$ " | $\frac{1}{8}$ " | 13c        |
| 1508 | C    | Black  | $\frac{3}{4}$ "  | $\frac{3}{4}$ " | 12c        |
| 1509 | C    | Walnut | $\frac{3}{4}$ "  | $\frac{3}{4}$ " | 12c        |
| 1510 | C    | Red    | $\frac{3}{4}$ "  | $\frac{3}{4}$ " | 13c        |
| 1512 | D    | Black  | $1\frac{1}{4}$ " | $\frac{1}{4}$ " | 15c        |
| 1513 | D    | Walnut | $1\frac{1}{4}$ " | $\frac{1}{4}$ " | 15c        |
| 1514 | D    | Red    | $1\frac{1}{4}$ " | $\frac{1}{4}$ " | 21c        |
| 1515 | D    | Ivory  | $1\frac{1}{4}$ " | $\frac{1}{4}$ " | 21c        |
| 1516 | E    | Black  | Telegraph Knob   |                 | 40c        |
| 1517 | F    | Black  | 2"               |                 | 22c        |
| 1518 | F    | Walnut | 2"               |                 | 22c        |
| 1519 | G    | Black  | $1\frac{5}{8}$ " | $\frac{3}{4}$ " | 15c        |
| 1520 | G    | Walnut | $1\frac{5}{8}$ " | $\frac{3}{4}$ " | 15c        |
| 1521 | H    | Black  | 2"               |                 | 19c        |
| 1522 | H    | Walnut | 2"               |                 | 19c        |
| 1523 | H    | Red    | 2"               |                 | 24c        |
| 1524 | H    | Ivory  | 2"               |                 | 24c        |



# PLUGS • JACKS • CONNECTORS

TELEGRAPH APPARATUS CO.

## INSULATED SOLDERLESS PHONE TIP PLUG



A standard insulated solderless phone tip plug which fits our parts 101, 106, 108 phone tip jacks. Metal parts are nickel plated brass. Overall length 2-3/16". The high lustre insulated handle is 1" long. Available in red, black, green and yellow.

No. 202.....LIST PRICE 18c

## SOLDERLESS PHONE TIP PLUG



A standard solderless phone tip plug. Identical to No. 202 above, except for insulated handle.

No. 203 LIST PRICE 10c

## INSULATED SOLDERLESS JR. PHONE TIP PLUG



A standard insulated solderless junior phone tip plug made to fit our parts #101 and 106 phone tip jacks. Metal parts are nickel plated brass. The high lustre insulated handle is 1" long. Available in black, red, green and yellow. Overall length 1 7/8".

No. 204.....LIST PRICE 18c

## SOLDERLESS JR. PHONE TIP PLUG



A standard solderless junior phone tip plug identical to No. 204 above except for insulated handle.

No. 205 LIST PRICE 10c

## Insulated Solderless SPRING BANANA PLUG



This insulated non-collapsible solderless spring banana plug is designed to give the greatest area of contact. Connection is made by a side set screw.

Metal parts are nickel plated brass except the four leaf banana spring which is nickel plated phosphor bronze. The high lustre insulated handle is 1" long. Available in red, black, green and yellow. Overall length 1-11/16".

No. 208 LIST PRICE 20c

## Giant Banana Plug & Jack



Designed to handle heavy high frequency currents. Made of nickel plated spring brass.

No. 225—Jack LIST PRICE 30c  
226—Plug with threaded shank 35c  
227—Plug with 10-32 hole with screw 35c

## SPRING BANANA PLUG INSULATED



In this spring banana plug no metal parts are exposed around the insulated handle. Connection is made by soldering to special type tubular lug which is an integral part of metal body. Non-collapsible four leaf banana spring gives maximum area of contact. Metal parts are nickel plated brass except banana spring which is nickel plated phosphor bronze. The high lustre insulated handle is 1" long. Available in red, black, green and yellow.

No. 209.....LIST PRICE 18c

## INSULATED SOLDERLESS SPRING BANANA PLUG

(INTERNAL SOLDERLESS FASTENER)



An insulated spring banana plug identical in appearance to our part No. 209 except that connection is made to an internal solderless fastener. The high lustre insulated handle is available in red, black, green and yellow.

No. 210.....LIST PRICE 20c

## Insulated Phone Tip Jack



An insulated phone tip jack which makes very positive contact. Contact springs are made of phosphor bronze. Metal parts are nickel plated brass. The high lustre insulated head is 3/8" in diameter. Available in red, black, green and yellow. Fits 1/4" hole in panels up to 1/4" thick. Supplied with nut and insulating washer.

No. 101 LIST PRICE 15c

## PHONE TIP JACK



A phone tip jack identical to our part No. 101 above except that it has a non-insulated 5/16" hex head. Metal parts are nickel plated brass.

Fits 1/4" hole in panels up to 3/8" thick.

No. 106 LIST PRICE 10c

## Open Circuit Phone Jack



Made to fit all stand-phone plugs. Contact spring made of nickel plated phosphor bronze and body made of nickel plated brass. Highest quality insulating material used. Fits 3/8" hole in panels up to 3/16" thick. Supplied with one metal washer.

No. 100 LIST PRICE 30c

## SPRING BANANA PLUG



This spring banana plug is used extensively for plug-in coils, etc. Greater surface contact gives low RF resistance. Threaded shank is 6-32 thread, 3/8" long. Overall length 1-3/16". All metal parts are nickel plated brass except the four leaf banana spring which is nickel plated phosphor bronze. Supplied with soldering lug.

No. 206.....LIST PRICE 11c

## SPRING BANANA PLUG



Identical to our part No. 206 above except that threaded shank is 3/4" long.

No. 207.....LIST PRICE 12c

## SPRING BANANA PLUG



Identical to No. 206 spring banana plug except that instead of threaded shank it has a female 6-32 thread. Supplied with soldering lug and 6-32 screw.

No. 212.....LIST PRICE 12c

## BANANA JACK



A standard banana jack made of nickel plated brass. Overall length 5/8". Fits 1/4" hole in panel. Supplied with solder lug and nut.

No. 105.....LIST PRICE 9c

## INSULATED BANANA JACK



All metal parts are nickel plated brass. The high lustre insulated head is available in red, black, green and yellow. Fits 1/4" hole in panels up to 3/8" thick. Supplied with solder lug, insulated washer and nut.

No. 107.....LIST PRICE 15c

## Insulated Combination Banana Plug & Phone Tip Jack



An insulated combination banana plug and phone tip jack made to fit our parts Nos. 206, 207, 202, 203, 208, 209, 210, 212, and 220. The phosphor bronze contact springs assure positive contact. Fits 1/4" hole in panels up to 3/8" thick. The high lustre insulated head is

available in red, black, green and yellow.

No. 108 LIST PRICE 20c

## STANDARD PHONE TIP



A standard phone tip made of nickel plated brass. Used extensively for connections on head

phone cords.

No. 220.....LIST PRICE, PER 100 \$2.00

# TEST PRODS • SHAFT COUPLINGS • CLIPS

TELEGRAPH APPARATUS CO.

## AUTO ANTENNA CONNECTOR Instantly Detachable



Comes apart by slight twist. Makes an ideal single contact shielded connector.  
No. 402 LIST PRICE 10c

## AUTO FUSE CONNECTOR



Used in the battery lead of auto radio for protection. Fits a 3AG type fuse.  
No. 403 LIST PRICE 14c

## Insulated Alligator Clips



Sturdy clips made with thin jaws, fine meshing teeth and strong spring to assure hard bite. Handles 1" long.

No. 333—Red LIST PRICE 20c  
No. 334—Black LIST PRICE 20c

## PANEL BEARING ASSEMBLY



The accurately reamed hole in bearing assures smooth, non-binding operation. Equipped with

bowed spring washer which eliminates sliding forward and backward. Shaft is 1/4" in diameter. Fits 3/8" hole in panels up to 1/8" thick. Made of brass.  
No. 1022—3" Shaft LIST PRICE 35c  
No. 1023—6" Shaft LIST PRICE 50c

## DE LUXE FINGER GRIP PHONO-NEEDLE AND PHONE TIP TEST LEADS

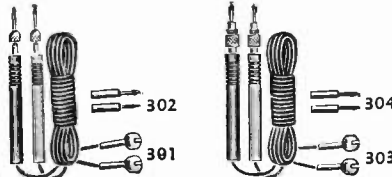

Needle Point

Phone Tip Point

A deluxe test lead set with a ribbed finger grip will eliminate fatigue and slipping. Made of high quality insulating material 6 1/2" long, one each red and black. Supplied with a good grade of true kinkless wire 48" long. Available with phone tips or spade lugs on end as illustrated.

| No. | Type       | LIST PRICE PER SET |
|-----|------------|--------------------|
| 301 | Spade lugs | \$1.20             |
| 302 | Phone tips | 1.20               |
| 303 | Spade lugs | 1.20               |
| 304 | Phone tips | 1.20               |

## PANEL BEARING



Accurately machined bearing made to fit 1/4" shafts. Fits 3/8" hole in panels up to 1/8" thick. Supplied with one mounting nut. Body made of brass.

No. 1021 LIST PRICE 15c

## SHAFT EXTENDERS, COUPLINGS AND REDUCERS



A



B



C

| EXTENDER FIG. A |               |           |            |                |            |
|-----------------|---------------|-----------|------------|----------------|------------|
| Brass No.       | Insulated No. | Hole Dia. | Shaft Dia. | Overall Length | List Price |
| 1014            | 914           | 3/8       | 1/4        | 1 1/8          | 18c        |
| 1015            | 915           | 1/4       | 1/4        | 1 1/8          | 18c        |
| 1017            | 917           | 1/4       | 3/8        | 1 1/8          | 18c        |

| EXTRA LENGTH EXTENDER |        |                |            |  |  |
|-----------------------|--------|----------------|------------|--|--|
| No.                   | Length | Overall Length | List Price |  |  |
| 1016                  | 1/4    | 1 3/4          | 25c        |  |  |

| COUPLING FIG. B |               |           |           |                |            |
|-----------------|---------------|-----------|-----------|----------------|------------|
| Brass No.       | Insulated No. | Hole Dia. | Hole Dia. | Overall Length | List Price |
| 1011            | 911           | 1/4       | to 3/8    | 3/4            | 18c        |
| 1012            | 912           | 1/4       | to 1/4    | 3/4            | 18c        |

| REDUCER FIG. C. |           |              |            |  |  |
|-----------------|-----------|--------------|------------|--|--|
| No.             | Reduces a | to           | LIST PRICE |  |  |
| No. 1009        | 3/8" hole | to 1/4" hole | 10c        |  |  |

| BRASS AND FIBRE 1/4" SHAFTING |          |        |      |            |  |
|-------------------------------|----------|--------|------|------------|--|
| No.                           | Material | Length | Dia. | LIST PRICE |  |
| No. 1018                      | Brass    | 6"     | 1/4" | 20c        |  |
| No. 1019                      | Brass    | 12"    | 1/4" | 40c        |  |
| No. 1024                      | Fibre    | 6"     | 1/4" | 25c        |  |
| No. 1025                      | Fibre    | 12"    | 1/4" | 50c        |  |

## Microphone Base Flanges & Extension Rods

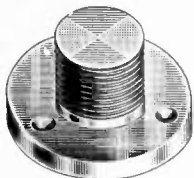

Male Type



New mike stand items for which there has long been a demand. With the male type Base Flange the microphone can be attached directly to the desk, table, pulpit, etc.

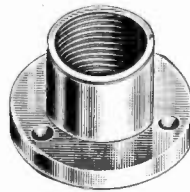

Female Type

| No.     | Type              | LIST PRICE |
|---------|-------------------|------------|
| No. 515 | Male Flange       | \$0.75     |
| No. 516 | Female Flange     | .75        |
| No. 517 | 6" Extension Rod  | \$0.75     |
| No. 518 | 12" Extension Rod | 1.00       |

## DE LUXE FINGER GRIP PHONO-TIP TEST PROD REMOVABLE PHONO-NEEDLE CHUCK



A ribbed finger grip phono-tip test prod identical to the prod used in the De Luxe test lead at the left.

| No. | Color | Length | LIST PRICE |
|-----|-------|--------|------------|
| 311 | Red   | 4 1/2" | 45c        |
| 312 | Red   | 6 1/2" | 50c        |
| 313 | Black | 4 1/2" | 45c        |
| 314 | Black | 6 1/2" | 50c        |

## DE LUXE FINGER GRIP SOLDERLESS TIP TEST PROD



Identical to the above except prods are equipped with solderless phone tips.

| No. | Color | Length | LIST PRICE |
|-----|-------|--------|------------|
| 319 | Red   | 4 1/2" | 45c        |
| 320 | Red   | 6 1/2" | 50c        |
| 321 | Black | 4 1/2" | 45c        |
| 322 | Black | 6 1/2" | 50c        |

## NEEDLE POINT TEST PRODS REMOVABLE PHONO-NEEDLE CHUCK



Test prods are made of non-breakable extruded plastic and available in red and black. Chuck can be removed from prod as well as phono-needle from chuck. All brass parts are nickel plated.

| No. | Color | Length | List Price |
|-----|-------|--------|------------|
| 315 | Red   | 4"     | 35c        |
| 316 | Red   | 6"     | 40c        |
| 317 | Black | 4"     | 35c        |
| 318 | Black | 6"     | 40c        |

## SOLDERLESS TIP TEST PRODS



Identical to above except that test prods are equipped with solderless phone tips.

| No. | Color | Length | List Price |
|-----|-------|--------|------------|
| 323 | Red   | 4"     | 35c        |
| 324 | Red   | 6"     | 40c        |
| 325 | Black | 4"     | 35c        |
| 326 | Black | 6"     | 40c        |

## PHONO-NEEDLE AND PHONE TIP TEST LEADS

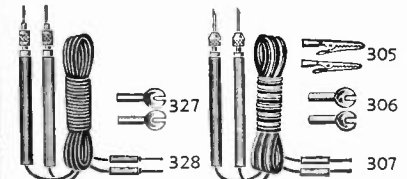

Solderless Tip Type      Phono Tip Type

Prods are made of non-breakable extruded plastic, 4" long, one each red and black. Supplied with rubber covered kinkless wire 48" long. Insulated for high voltage. Available with non-insulated phone tips, spade lugs or alligator clips as illustrated.

| No. | Type            | List Price |
|-----|-----------------|------------|
| 305 | Alligator Clips | \$1.10     |
| 306 | Spade Lugs      | 1.00       |
| 307 | Phone Tips      | 1.00       |
| 327 | Spade Lugs      | 1.00       |
| 328 | Phone Tips      | 1.00       |

### INSULATED PHONE TIP JACK



Will accommodate all standard phone tip plugs, of the insulated and non-insulated types. Recommended for use with our Nos. 200 and 201 phone tip plugs. Insulated head  $\frac{3}{8}$ " dia. available in Black, Red, Yellow and Green. Mounts in a  $\frac{1}{4}$ " hole. Supplied complete with insulating shoulder washer and nut. Specify color.

No. 202.....\$15.00 per C

### INSULATED BANANA JACK



Will accommodate all standard banana type plugs. Mounts in a  $\frac{1}{4}$ " hole in panels up to  $\frac{3}{8}$ " thick. Insulated head  $\frac{3}{8}$ " dia. available in Black, Red, Yellow and Green. Supplied complete with insulating shoulder washer, soldering lug, and nut. Specify color.

No. 205.....\$15.00 per C

### INSTRUMENT BANANA JACK



Made of brass, nickel plated. Jack receptacle is countersunk and will accept all standard Banana type plugs for a snug and positive contact. Insulated head is  $\frac{1}{2}$ " diameter and supplied complete with insulating washer, lock washer, heavy duty soldering lug and nut. Available in Black, Red, Yellow and Green. Specify color.

No. 219.....\$19.00 per C

### INSULATED COMBINATION JACK



This combination jack will accommodate all standard plugs, of the phone tip type or banana type construction. Mounts in a  $\frac{1}{4}$ " hole in panels up to  $\frac{1}{2}$ " thick. Over-all length 1  $\frac{3}{8}$ ". Supplied complete with insulating shoulder washer and nut. Insulated head available in Black, Red, Yellow and Green. Specify color.

No. 206.....\$20.00 per C

### INSULATED SOLDERLESS BANANA PLUGS



Spring type construction, and will fit all standard banana jacks. Tapped hole is provided in rear of plug and small screw machine stud is provided so that wire can be wrapped around and tightened without the need of soldering. Insulated handle is  $\frac{3}{4}$ " long and available in Black, Red, Yellow and Green. Specify color.

No. 211.....\$20.00 per C



This plug constructed the same as No. 211 described above, but the plug portion is made of hexagon brass. Plug is also supplied with screw machine stud. Insulated handle 1" long and available in Black, Red, Yellow and Green colors. Specify color.

No. 212.....\$25.00 per C

### INSULATED SOLDERLESS PHONE TIP PLUGS



Insulated sleeve  $\frac{3}{4}$ " long, and available in Black, Red, Yellow and Green. Will fit all standard phone tip jacks and specially recommended for use with our No. 202 insulated jack. The wire fits through the sleeve of plug, and is wrapped around the screw portion, and then tightened with the knurled nut provided, making soldering unnecessary. Specify color.

| No. | Type                  | Per C   |
|-----|-----------------------|---------|
| 200 | Plug with No. 105 Tip | \$18.00 |
| 201 | Plug with No. 106 Tip | 17.00   |

### INSULATED PHONE TIP PLUG



Insulated sleeve  $\frac{3}{4}$ " long, available in Black, Red, Yellow and Green. The phone tip will plug into all standard phone tip jacks, and the insulated sleeve is so designed to accommodate all standard banana type plugs.

No. 215.....\$15.00 per C

Phone tip only — less insulated sleeve.  
No. 125.....\$8.00 per C

### INSULATED PHONO NEEDLE TIP PLUG



Insulated sleeve  $\frac{3}{4}$ " long, available in Black, Red, Yellow and Green. The body of the plug will accommodate all standard banana type plugs. The sharp needle point phone tip will pierce through corrosion for positive contact.

No. 216.....\$20.00 per C

Needle tip only — less insulated sleeve.  
No. 217.....\$12.00 per C

### INSULATED SHORT PHONE TIP



Will fit all standard phone tip jacks of the insulated or non-insulated types. Insulated sleeve  $\frac{3}{4}$ " long, and available in Black, Red, Yellow and Green. Specify colors.

No. 203.....\$15.00 per C

### INSULATED BANANA PLUG Spring Type



Will fit all standard banana type jacks. A set screw is provided in the side of the plug to secure the wire to the plug without soldering. Insulated sleeves  $\frac{7}{8}$ " long available in Black, Red, Yellow and Green colors. Over-all length 1  $\frac{1}{2}$ ". Specify color.

No. 204.....\$20.00 per C

### INSULATED BANANA PLUG Split Type



The banana plug is of the split type construction. Insulated handle  $\frac{7}{8}$ " long. A set screw is provided in the side of the plug, to secure the wire to the plug without soldering. Available in Black, Red, Yellow and Green colors. Specify colors.

No. 213.....\$20.00 per C

### BANANA PLUG AND PHONE TIP JACK COMBINATION



Insulated banana type plug of the spring type construction will fit all standard banana type jacks, and the top of the insulated sleeve of the plug will accommodate all standard phone tips. Insulated handle 1" long. Available in Black, Red, Yellow and Green. Specify color.

No. 214.....\$45.00 per C

### INSULATED BINDING POSTS



Knurled Insulated Head threaded eliminating the necessity for using a brass bushing. Each Binding Post complete with 6-32 x  $\frac{3}{8}$ " screw and lockwasher. Available in Black and Red Colors. Specify Colors.

| No. | Head Diameter   | Per C   |
|-----|-----------------|---------|
| 207 | $\frac{3}{8}$ " | \$15.00 |
| 208 | $\frac{1}{2}$ " | 15.00   |

| Head Only |                 | Per C   |
|-----------|-----------------|---------|
| 209       | $\frac{3}{8}$ " | \$ 6.50 |
| 210       | $\frac{1}{2}$ " | 7.00    |

### INSULATED SPADE LUG



Insulated sleeve  $\frac{3}{8}$ " diameter,  $\frac{3}{4}$ " long and available in Red and Black colors. The barrel of the insulated sleeve will accommodate all standard type banana plugs.

| No. | Type          | Per C   |
|-----|---------------|---------|
| 218 | Insulated Lug | \$15.00 |
| 129 | Lug only      | 2.00    |

### ALLIGATOR CLIP



Clips are made so that the jaws match accurately, permitting them to grip all sizes wire accurately. The barrel of clip will accommodate all standard banana type plugs. Made of steel, cadmium plated. Over-all length 2". No. 300.....\$10.00 per C

### INSULATED ALLIGATOR CLIP



Embodies our No. 300 Alligator Clip. Insulated handle  $\frac{3}{4}$ " long and will accommodate all standard banana type plugs. Insulated handle available in Black and Red colors. Specify color required.

No. 301.....\$20.00 per C

### ALLIGATOR CLIP PHONE TIP JACK



Insulated phone tip jack with No. 300 Alligator Clip. The jack portion will accommodate all standard phone tip plugs. Insulated handle 1" long available in Black and Red colors. Over-all length 2  $\frac{1}{2}$ ". Specify color.

No. 304.....\$45.00 per C

### ALLIGATOR CLIP COMBINATION JACK



The insulated jack portion will accommodate all standard phone tip or banana type plugs. Insulated handle 1  $\frac{1}{4}$ " long available in Black and Red colors. Over-all length 3". Specify color.

No. 305.....\$50.00 per C

# SMITH

*Electronic Components*  
HERMAN H. SMITH, INC.

## H AND H TOGGLE SWITCHES

Rated 1 Amp. 250 Volts, 3 Amps. 125 Volts. Switches are nickel plated and supplied with mounting nut.

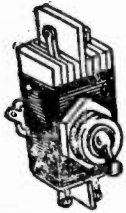

| No. | Type                | Shaft  | Each   |
|-----|---------------------|--------|--------|
| 500 | SPST                | 1 1/8" | \$0.60 |
| 501 | SPST                | 1 1/2" | .66    |
| 502 | SPDT                | 1 1/8" | .75    |
| 503 | SPDT                | 1 1/2" | .85    |
| 504 | DPST                | 1 1/8" | 1.15   |
| 505 | DPST                | 1 1/2" | 1.25   |
| 506 | DPDT                | 1 1/8" | 1.30   |
| 507 | DPDT                | 1 1/2" | 1.40   |
| 508 | On & Off Name Plate |        | .05    |

## BAT HANDLE TOGGLE SWITCHES

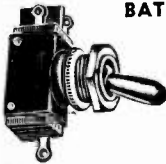

These switches are the same as described above with bat shaped handle. Shaft length 1 1/8".

| No. | Type | Each   |
|-----|------|--------|
| 510 | SPST | \$0.60 |
| 511 | SPDT | .75    |
| 512 | DPST | 1.15   |
| 513 | DPDT | 1.30   |

## ROTARY TOGGLE SWITCHES



Made by H & H, rated at 1 Amp. 250 Volts, 3 Amps. 125 Volts. Switches are nickel plated and supplied with mounting nut.

| No. | Type | Threaded Over-all |        | Each   |
|-----|------|-------------------|--------|--------|
|     |      | Shank             | Length |        |
| 570 | SPST | 3/8"              | 1 1/2" | \$0.80 |
| 571 | SPDT | 3/8"              | 1 1/2" | .90    |
| 572 | DPST | 3/8"              | 1 1/2" | 1.40   |
| 573 | DPDT | 3/8"              | 1 1/2" | 1.70   |

## SLIDE LEVER SWITCHES



Rated 1 1/2" Amps. 110 Volts. Size 1 3/8" x 1/2". Mounting centers 1 1/8".

| No. | Type | Each   |
|-----|------|--------|
| 515 | SPST | \$0.30 |
| 516 | SPDT | .35    |
| 517 | DPST | .45    |
| 518 | DPDT | .50    |

## HEAVY DUTY POWER SWITCHES



These Heavy Duty Power Switches are made by H & H and are specially recommended for use in amplifiers, transmitters, motors and all heavy current circuits where heavy current is carried. Available in 3 types with neutral off in center position.

Rated at 10 Amps. 125 Volts. Measures 2" long, 1" high, 1 1/4" wide, mounting sleeve diameter 5/8".

| No. | Type | Each   |
|-----|------|--------|
| 574 | DPDT | \$6.00 |
| 575 | TPDT | 9.00   |
| 576 | 4PDT | 13.25  |

## PUSH BUTTON MOMENTARY SWITCH



Two-circuit slow make and break Momentary Switch made by H & H. Solder lug, one circuit normally "ON", one circuit normally "OFF". 5/8" slotted sleeve, rated at 75 Watts. 125 Volts.

No. 580.....\$1.05 each

Casein buttons in Black and Red colors can be obtained for the above switch.....\$.40 each

## BANANA TYPE PLUG



This plug is hexed brass, nickel plated. The spring is made of phosphor bronze assuring positive and lasting contact. Plug is constructed with a 6-32 female thread inside and is supplied with a 6-32 screw and soldering lug.

No. 100.....\$12.00 per C

## SPLIT TYPE BANANA PLUG



Made of hexed brass, heavily nickel plated over-all. Will fit all standard banana type jacks. Over-all length 1 1/4". Threaded portion 6-32 x 1/2" long. Supplied with two 6-32 hexagon nuts.

No. 104.....\$12.00 per C

## BANANA TYPE PLUG Spring Type



Plug and spring are made of brass, nickel plated. The spring type of construction assures positive and lasting contact. Plug is threaded 6-32 and the threaded portion is 1/2" long. Supplied with two 6-32 hexagon nuts.

No. 103.....\$12.00 per C

## MIDGET PLUGS AND JACKS Banana Type



Midget banana type plugs and jacks, for use where a minimum amount of space is available. Both plugs and jacks made of brass, nickel plated. A hexagon nut is provided with each plug and jack.

| No. | Item | Per C  |
|-----|------|--------|
| 111 | Plug | \$9.00 |
| 112 | Jack | 9.00   |

## PHONE TIP JACK



Will accommodate all standard phone tip plugs of insulated and non-insulated types. Made of brass, nickel plated. Mounts in a 1/4" dia. hole in panels up to 3/8" thick, and is supplied with hexagon nut.

No. 107.....\$10.00 per C

## METAL BINDING POST



Made of brass, heavily nickel plated over-all. Supplied complete with screw and washer.

No. 110.....\$25.00 per C

## MOLDED BAKELITE SWITCHES



Made by H & H, rated at 3 Amps. 250 Volts, 6 Amps. 125 Volts. Bat Lever type with silver plated contacts. 1 1/8" slotted sleeve.

| No. | Type | Shaft  | Each   |
|-----|------|--------|--------|
| 520 | SPST | 1 1/8" | \$1.05 |
| 521 | SPDT | 1 1/2" | 1.20   |
| 522 | DPST | 1 1/8" | 1.40   |
| 523 | DPDT | 1 1/2" | 1.70   |

## BANANA PLUG JACK



Recommended as the mate for the No. 100 Banana type plug, but will accommodate all standard banana type plugs. Jack is made of brass, heavily nickel plated over-all. Mounts in a 1/4" hole and will fit in panels up to 1/8" thick. Jack is furnished with 1/4"-32 nut and soldering lug.

No. 101.....\$12.00 per C

## BANANA PLUG JACK



Will accommodate all standard banana type plugs and specially recommended as the mate for Nos. 103 and 104 banana plugs. Made of brass, nickel plated, and mounts in 1/4" hole in panels up to 3/8" thick. Supplied with nut and soldering lug.

No. 109.....\$10.00 per C

## MIDGET PHONE JACK



Signal Corps type J 670 — Single open circuit midget phone jack. It mounts in 3/8" hole in panels up to 1/4" thick. Bushing is brass, nickel plated. Springs made of phosphor bronze, and the springs are insulated from the frame by heavy

duty bakelite washers.  
No. 122.....\$35.00 per C

## SOLDERLESS PHONE TIPS



These tips are constructed so that the wire fits through the body of the tip, and is wrapped around the screw portion, and tightened with the knurled nut provided, making soldering unnecessary.

| No. | Length | Per C   |
|-----|--------|---------|
| 105 | 1 1/2" | \$10.00 |
| 106 | 1 1/8" | 10.00   |

## SOLDER TYPE PHONE TIPS



Made of brass, nickel plated. Over-all length 1". Dia. of tip will fit all standard phone tip jacks.

No. 108.....\$20.00 per M

## LARGE DIAMETER PHONE TIP

Material of Brass and Nickel plated finish. The barrel is drilled extra large to accommodate heavy wire. Diameter of hole 1/8" — length of barrel 3/2" and over-all length 1".

No. 123.....\$30.00 per M

## THREADED PHONE TIPS



Available in either the Solderless Phone Tip type, or the Phono Needle Point type. The chuck is threaded 1/4"-32.

| No. | Type           | Per C   |
|-----|----------------|---------|
| 124 | Solderless Tip | \$15.00 |
| 128 | Needle Point   | 15.00   |

## MINI-MAX CONNECTING STRIP



This fastening connecting strip is spaced so that it will snap into all 67 1/2-Volt Mini-Max "B" batteries such as Eveready Nos. 455, 466 and Burgess Nos. XX30, XX45.

No. 1205.....\$25.00 per C

# SMITH

# Electronic Components

HERMAN H. SMITH, INC.

## HEAVY DUTY BAKELITE BARRIER TERMINAL STRIPS



This latest type of construction of bakelite strip is made of molded bakelite of very high tensile strength. The barriers between each terminal prevent any possibility of short circuits and leakage between terminals. The terminals and screws are brass, nickel plated. These strips are manufactured by the KULKA ELECTRIC MFG. CO. INC., Design Patent No. 136,762 and are exclusively distributed by us to the Radio Parts Distributors.

### COLUMN A

All the Barrier Terminal Strips enumerated in Column A for the 1500, 1600 and 1700 series are made with screw type terminals exactly as shown in the illustration at top of page.

### COLUMN B



All the Barrier Strips enumerated in Column B for the 1500, 1600 and 1700 series are supplied with the two-solder connection lug illustrated above.

### COLUMN C



All the Barrier Strips enumerated in Column C for the 1500, 1600 and 1700 series are supplied with the bottom type connection lug illustrated above.

### COLUMN D

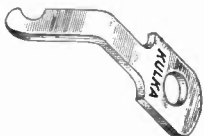

All the Barrier Strips enumerated in Column D for the 1500, 1600 and 1700 series are supplied with the bottom type connection lug illustrated above.

### No. 1500 SERIES

Height  $\frac{11}{16}$ " Width  $\frac{3}{8}$ " Thickness  $\frac{1}{16}$ ". Terminals are  $\frac{3}{16}$ " on centers. Screws 6-40x $\frac{1}{4}$ " long, Binding Head.

| Col. A |           |        | Col. B |           |        | Col. C |           |        | Col. D |           |        |
|--------|-----------|--------|--------|-----------|--------|--------|-----------|--------|--------|-----------|--------|
| No.    | Terminals | Each   | No.    | Terminals | Each   | No.    | Terminals | Each   | No.    | Terminals | Each   |
| 1501   | 1         | \$0.14 | 1511   | 1         | \$0.17 | 1521   | 1         | \$0.17 | 1531   | 1         | \$0.17 |
| 1502   | 2         | .22    | 1512   | 2         | .29    | 1522   | 2         | .29    | 1532   | 2         | .29    |
| 1503   | 3         | .30    | 1513   | 3         | .40    | 1523   | 3         | .40    | 1533   | 3         | .40    |
| 1504   | 4         | .38    | 1514   | 4         | .52    | 1524   | 4         | .52    | 1534   | 4         | .52    |
| 1505   | 5         | .46    | 1515   | 5         | .63    | 1525   | 5         | .63    | 1535   | 5         | .63    |
| 1506   | 6         | .54    | 1516   | 6         | .75    | 1526   | 6         | .75    | 1536   | 6         | .75    |
| 1507   | 7         | .62    | 1517   | 7         | .86    | 1527   | 7         | .86    | 1537   | 7         | .86    |
| 1508   | 8         | .70    | 1518   | 8         | .98    | 1528   | 8         | .98    | 1538   | 8         | .98    |
| 1509   | 9         | .78    | 1519   | 9         | 1.09   | 1529   | 9         | 1.09   | 1539   | 9         | 1.09   |
| 1510   | 10        | .86    | 1520   | 10        | 1.21   | 1530   | 10        | 1.21   | 1540   | 10        | 1.21   |

### No. 1600 SERIES

Height  $\frac{1}{2}$ " Width  $1\frac{1}{8}$ " Thickness  $\frac{3}{16}$ ". Terminals are  $\frac{1}{16}$ " on centers. Screws 6-32x $\frac{1}{4}$ " long, Binding Head.

| Col. A |           |        | Col. B |           |        | Col. C |           |        | Col. D |           |        |
|--------|-----------|--------|--------|-----------|--------|--------|-----------|--------|--------|-----------|--------|
| No.    | Terminals | Each   | No.    | Terminals | Each   | No.    | Terminals | Each   | No.    | Terminals | Each   |
| 1601   | 1         | \$0.18 | 1611   | 1         | \$0.22 | 1621   | 1         | \$0.22 | 1631   | 1         | \$0.22 |
| 1602   | 2         | .28    | 1612   | 2         | .37    | 1622   | 2         | .37    | 1632   | 2         | .37    |
| 1603   | 3         | .38    | 1613   | 3         | .52    | 1623   | 3         | .52    | 1633   | 3         | .52    |
| 1604   | 4         | .49    | 1614   | 4         | .67    | 1624   | 4         | .67    | 1634   | 4         | .67    |
| 1605   | 5         | .59    | 1615   | 5         | .82    | 1625   | 5         | .82    | 1635   | 5         | .82    |
| 1606   | 6         | .69    | 1616   | 6         | .97    | 1626   | 6         | .97    | 1636   | 6         | .97    |
| 1607   | 7         | .80    | 1617   | 7         | 1.12   | 1627   | 7         | 1.12   | 1637   | 7         | 1.12   |
| 1608   | 8         | .90    | 1618   | 8         | 1.27   | 1628   | 8         | 1.27   | 1638   | 8         | 1.27   |
| 1609   | 9         | 1.00   | 1619   | 9         | 1.42   | 1629   | 9         | 1.42   | 1639   | 9         | 1.42   |
| 1610   | 10        | 1.11   | 1620   | 10        | 1.57   | 1630   | 10        | 1.57   | 1640   | 10        | 1.57   |
| 1611P  | 11        | 1.21   | 1641   | 11        | 1.72   | 1644   | 11        | 1.72   | 1647   | 11        | 1.72   |
| 1612P  | 12        | 1.31   | 1642   | 12        | 1.87   | 1645   | 12        | 1.87   | 1648   | 12        | 1.87   |
| 1613P  | 13        | 1.42   | 1643   | 13        | 2.02   | 1646   | 13        | 2.02   | 1649   | 13        | 2.02   |

### No. 1700 SERIES

Height  $\frac{5}{8}$ " Width  $1\frac{1}{8}$ " Thickness  $\frac{3}{16}$ ". Terminals are  $\frac{1}{16}$ " on centers. Screws 8-32x $\frac{1}{2}$ " long, Binding Head.

| Col. A |           |        | Col. B |           |        | Col. C |           |        | Col. D |           |        |
|--------|-----------|--------|--------|-----------|--------|--------|-----------|--------|--------|-----------|--------|
| No.    | Terminals | Each   | No.    | Terminals | Each   | No.    | Terminals | Each   | No.    | Terminals | Each   |
| 1701   | 1         | \$0.21 | 1711   | 1         | \$0.27 | 1721   | 1         | \$0.27 | 1731   | 1         | \$0.27 |
| 1702   | 2         | .33    | 1712   | 2         | .45    | 1722   | 2         | .45    | 1732   | 2         | .45    |
| 1703   | 3         | .46    | 1713   | 3         | .64    | 1723   | 3         | .64    | 1733   | 3         | .64    |
| 1704   | 4         | .59    | 1714   | 4         | .82    | 1724   | 4         | .82    | 1734   | 4         | .82    |
| 1705   | 5         | .71    | 1715   | 5         | 1.01   | 1725   | 5         | 1.01   | 1735   | 5         | 1.01   |
| 1706   | 6         | .84    | 1716   | 6         | 1.19   | 1726   | 6         | 1.19   | 1736   | 6         | 1.19   |
| 1707   | 7         | .97    | 1717   | 7         | 1.38   | 1727   | 7         | 1.38   | 1737   | 7         | 1.38   |
| 1708   | 8         | 1.09   | 1718   | 8         | 1.56   | 1728   | 8         | 1.56   | 1738   | 8         | 1.56   |
| 1709   | 9         | 1.22   | 1719   | 9         | 1.75   | 1729   | 9         | 1.75   | 1739   | 9         | 1.75   |
| 1710   | 10        | 1.35   | 1720   | 10        | 1.93   | 1730   | 10        | 1.93   | 1740   | 10        | 1.93   |
| 1711P  | 11        | 1.47   | 1751   | 11        | 2.12   | 1754   | 11        | 2.12   | 1757   | 11        | 2.12   |
| 1712P  | 12        | 1.60   | 1752   | 12        | 2.30   | 1755   | 12        | 2.30   | 1758   | 12        | 2.30   |
| 1713P  | 13        | 1.73   | 1753   | 13        | 2.49   | 1756   | 13        | 2.49   | 1759   | 13        | 2.49   |

### SOLDER TYPE LUGS Brass Hot Tinned

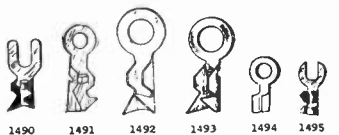

| No.  | Length           | Hole            | Per M   |
|------|------------------|-----------------|---------|
| 1484 | $\frac{5}{8}$ "  | No. 6           | \$ 7.00 |
| 1485 | $\frac{5}{8}$ "  | No. 6           | 6.00    |
| 1486 | $\frac{5}{8}$ "  | No. 6 & No. 8   | 6.00    |
| 1487 | $\frac{5}{8}$ "  | No. 6           | 4.00    |
| 1488 | $\frac{3}{4}$ "  | No. 6           | 8.00    |
| 1489 | $\frac{7}{8}$ "  | No. 8           | 8.00    |
| 1490 | 1"               |                 | 10.00   |
| 1491 | $1\frac{1}{8}$ " | No. 8           | 12.00   |
| 1493 | 1"               | $\frac{1}{4}$ " | 20.00   |
| 1492 | $1\frac{1}{2}$ " | $\frac{1}{4}$ " | 20.00   |
| 1494 | $\frac{5}{8}$ "  | No. 6 & No. 8   | 7.50    |
| 1495 | $\frac{5}{8}$ "  | No. 8           | 7.00    |

### TIE DOWN TERMINAL STRIPS

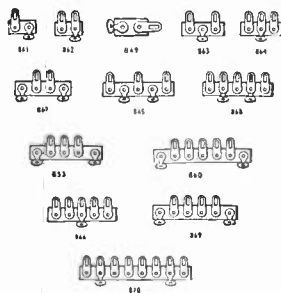

| No. | Per C  | No. | Per C  |
|-----|--------|-----|--------|
| 849 | \$2.75 | 865 | \$5.50 |
| 853 | 5.50   | 866 | 5.80   |
| 860 | 9.00   | 867 | 4.60   |
| 861 | 2.75   | 868 | 6.25   |
| 862 | 3.25   | 869 | 6.40   |
| 863 | 3.65   | 870 | 8.30   |
| 864 | 4.20   |     |        |



### TERMINAL BOARDS Screw Type

Brass, hot tinned lugs mounted on  $\frac{1}{8}$ " bakelite. Lugs are spaced  $\frac{1}{8}$ " center to center.

| No. | Terminals | Mounting Center  | Per C   |
|-----|-----------|------------------|---------|
| 872 | 2         | $1\frac{1}{8}$ " | \$10.00 |
| 873 | 3         | $1\frac{3}{8}$ " | 15.00   |
| 874 | 4         | $2\frac{1}{8}$ " | 25.00   |
| 875 | 5         | $2\frac{3}{8}$ " | 30.00   |
| 876 | 6         | $3\frac{1}{8}$ " | 35.00   |
| 877 | 7         | $3\frac{3}{8}$ " | 40.00   |

### TERMINAL LUGS AND SCREWS

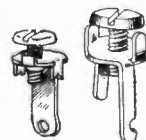

1478 1479

Recommended for heavy duty terminal strips. Lugs are tapped with screw inserted. No. 1478 lug, brass, cadmium plated and No. 1479 lug, brass, hot tinned.  
No. 1478.....\$3.50 per C  
No. 1479..... 6.00 per C

# SMITH

# Electronic Components

HERMAN H. SMITH, INC.

## PANEL INDICATOR 1/2 INCH JEWEL

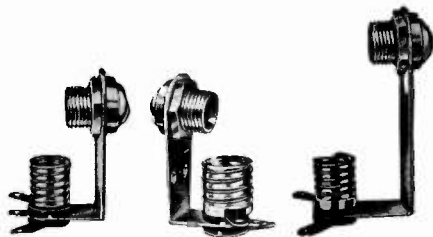

These panel indicator assemblies are available in the candelabra, miniature screw, or bayonet base type sockets. Jewel holder is made of brass, nickel plated. Jewel mounts in a single 1/8" dia. hole. Candelabra and bayonet base types can also be secured with a universal adjustable bracket for use where more accurate focus of the jewel to lamp filament is required. Facetted jewel available in Red, Green, Amber, Blue, Opal and Clear colors.

| No.  | Type                                       | Each   |
|------|--|--------|
| 1900 | Miniature Screw Socket                     | \$0.34 |
| 1901 | Candelabra 110 Volt                        | .34    |
| 1902 | Candelabra 110 Volt with Universal Bracket | .42    |
| 1903 | Bayonet Base                               | .34    |
| 1904 | Bayonet Base with Universal Bracket        | .38    |

## PANEL INDICATOR 3/4 INCH JEWEL



Available with candelabra 110 Volt, miniature bayonet base, and miniature screw type sockets. Jewel holder is made of brass, nickel plated. Jewel mounts in a single 1/8" dia. hole. Facetted jewels available in Red, Green, Amber, Blue, Opal and Clear colors.

| No.  | Type                   | Each   |
|------|------------------------|--------|
| 1905 | Miniature Screw Socket | \$0.73 |
| 1906 | Miniature Bayonet Base | .80    |
| 1907 | Candelabra Socket      | .73    |

## PANEL INDICATOR 3/8 INCH JEWEL

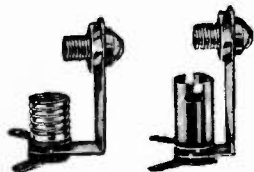

Available with miniature screw type socket, min. bayonet base, or candelabra type sockets. Jewel holder made of brass, nickel plated. Jewel mounts in a single 1/8" dia. hole. Facetted jewels available in Red, Green, Amber, Blue, Opal and Clear colors.

| No.  | Type                   | Each   |
|------|------------------------|--------|
| 1908 | Miniature Screw Socket | \$0.38 |
| 1909 | Miniature Bayonet Base | .42    |

## 1 INCH OPEN TYPE PANEL INDICATOR

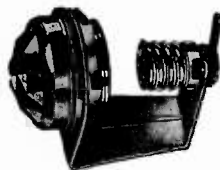

**Jewel Removable from Front of Panel**  
This type of panel indicator has the added feature of being able to remove the bulb from the front of the panel. Jewel holder made of brass, chromium plated finish. Jewel mounts in a single 1" dia. hole. The embossed rib in the center of the bracket supplies additional strength, assuring perfect alignment. Available in three types: Miniature screw socket, Miniature bayonet socket and Candelabra type socket. Facetted

jewels available in the following colors: Red, Green, Amber, Blue, Opal, Clear.

| No.  | Type                   | Each   |
|------|------------------------|--------|
| 1917 | Miniature Screw Socket | \$1.22 |
| 1918 | Miniature Bayonet Base | 1.25   |
| 1919 | Candelabra             | 1.28   |

## GLASS JEWELS



Jewels are available in Red, Green, Amber, Blue, Opal and Clear colors in smooth or facetted types. Jewel holders are brass, nickel plated, and are supplied with mounting nut.

| 3/8 Inch Jewel<br>MOUNTS IN 3/8" HOLE |          |        | 3/4 Inch Jewel<br>MOUNTS IN 1/2" HOLE |          |        |
|---------------------------------------|----------|--------|---------------------------------------|----------|--------|
| No.                                   | Type     | Each   | No.                                   | Type     | Each   |
| 1940                                  | Smooth   | \$0.20 | 1913                                  | Smooth   | \$0.55 |
| 1941                                  | Facetted | .20    | 1914                                  | Facetted | .55    |

| 1/2 Inch Jewel<br>MOUNTS IN 1/2" HOLE |          |        | 1 Inch Jewel<br>MOUNTS IN 1" HOLE |          |        |
|---------------------------------------|----------|--------|-----------------------------------|----------|--------|
| No.                                   | Type     | Each   | No.                               | Type     | Each   |
| 1911                                  | Smooth   | \$0.23 | 1915                              | Smooth   | \$1.07 |
| 1912                                  | Facetted | .23    | 1916                              | Facetted | 1.07   |

## 1/2 INCH OPEN TYPE PANEL INDICATOR

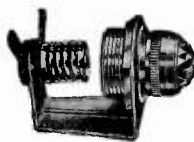

**Jewel Removable from Front of Panel**  
Jewel holder made of brass, nickel plated. Mounts in a single 1/8" dia. hole. The embossed rib in the center of the bracket gives additional strength and assures perfect alignment. The bulb is easily removable from the front of the panel. Available with Miniature screw type or Miniature bayonet base type sockets, with facetted jewels in the following colors: Red, Green, Amber, Blue, Opal, Clear.

| No.  | Type                          | Each   |
|------|-------------------------------|--------|
| 1920 | Miniature Screw Socket        | \$0.50 |
| 1921 | Miniature Bayonet Base Socket | .55    |

## CLIP-ON TYPE PILOT LIGHT SOCKETS



This type of socket is available with the clip up or down, and can be used by clipping on to the variable condenser or the chassis. This design socket is made with the miniature screw base, miniature bayonet base, or candelabra 110 Volt types. All brackets are cadmium plated.

| No.  | Type                        | Per C   |
|------|-----------------------------|---------|
| 1922 | Miniature Screw Up Clip     | \$13.00 |
| 1923 | Miniature Screw Down Clip   | 13.00   |
| 1924 | Miniature Bayonet Up Clip   | 15.00   |
| 1925 | Miniature Bayonet Down Clip | 15.00   |
| 1926 | Candelabra Up Clip          | 17.00   |
| 1927 | Candelabra Down Clip        | 17.00   |

## BRACKET TYPE PILOT LIGHT SOCKETS



Available with an up or down type of bracket for the miniature screw type, miniature bayonet base, and for the candelabra 110 Volt type sockets. Brackets are made of steel, cadmium plated.

| No.  | Type                           | Per C   |
|------|--------------------------------|---------|
| 1928 | Miniature Screw Up Bracket     | \$13.00 |
| 1929 | Miniature Screw Down Bracket   | 13.00   |
| 1930 | Miniature Bayonet Up Bracket   | 15.00   |
| 1931 | Miniature Bayonet Down Bracket | 15.00   |
| 1932 | Candelabra Up Bracket          | 17.00   |
| 1933 | Candelabra Down Bracket        | 17.00   |

## UNMOUNTED TYPE SOCKETS



These unmounted sockets can be secured for the miniature screw shell, miniature bayonet base or for the candelabra 110 Volt types of sockets.

| No.  | Type                   | Per C   |
|------|------------------------|---------|
| 1934 | Miniature Screw Base   | \$10.50 |
| 1935 | Miniature Bayonet Base | 11.50   |
| 1936 | Candelabra 110 Volt    | 13.50   |

## CLIP-IN SOCKET



This clip-in socket is of the bayonet base type construction, and is assembled with two solder lugs. The special clip in bracket is made of steel, cadmium plated, and is so designed that it clips into the dial directly.

No. 1938.....\$14.00 per C



## RUBBER GROMMETS

A: Outside Dia.; B: Inside Dia.; C: Panel Hole; D: Thickness Over-all; E: Panel Thickness.

| No.  | A      | B     | C      | D     | E     | Per C  |
|------|--------|-------|--------|-------|-------|--------|
| 2185 | 5/8"   | 1/8"  | 1/4"   | 3/16" | 1/16" | \$2.00 |
| 2171 | 1/4"   | 1/16" | 1/8"   | 1/16" | 1/16" | 2.50   |
| 2172 | 3/8"   | 1/8"  | 1/4"   | 1/16" | 1/16" | 3.00   |
| 2176 | 1/2"   | 3/16" | 3/8"   | 1/16" | 1/16" | 3.00   |
| 2170 | 5/8"   | 3/8"  | 3/4"   | 3/16" | 1/16" | 3.50   |
| 2173 | 3/4"   | 1/2"  | 3/4"   | 1/8"  | 1/16" | 3.00   |
| 2174 | 1"     | 3/4"  | 1"     | 1/8"  | 1/16" | 3.25   |
| 2175 | 1 1/8" | 7/8"  | 1 1/8" | 1/8"  | 1/16" | 3.50   |
| 2177 | 1 1/4" | 1"    | 1 1/4" | 1/8"  | 1/16" | 3.25   |



### NEUTRALIZING AND ALIGNMENT TOOL



A complete, fully insulated neutralizing tool, screw driver and wrench combination. The fibre wrench portion has a  $\frac{1}{4}$ " hexed socket on one end and a  $\frac{1}{8}$ " hexed socket on the other end. A  $\frac{1}{4}$ " metal screw driver nib on the inside portion of the tool fits into the fibre tube itself.

|                                      |              |
|--------------------------------------|--------------|
| No. 320.....                         | \$0.85 each  |
| No. 700—Display of 12 No. 320 Tools, | \$10.20 each |

### ALIGNING TOOL



For Peanut I.F.'s • For RCA Front End For "K" Tran. Transformers

Slender, yet sturdy, this tool is specially adapted for aligning peanut I.F.'s and the difficult-to-get-at front end of some receivers. Available in bulk or on attractive display card.

|                                      |              |
|--------------------------------------|--------------|
| No. 326.....                         | \$0.75 each  |
| No. 778—Display of 24 No. 326 Tools, | \$18.00 each |

### MIDGET ALIGNING TOOL WITH RECESSED NIB



This recessed nib aligning tool is another essential for television servicing. Constructed from fibre with thin recessed nib for slug tuning. Only  $2\frac{1}{2}$ " long, it makes those hard-to-get-at slugs accessible while chassis is still in cabinet. Available in bulk or on attractive display card.

|                                      |              |
|--------------------------------------|--------------|
| No. 327.....                         | \$0.50 each  |
| No. 779—Display of 48 No. 327 Tools, | \$24.00 each |

### ALIGNMENT SCREW DRIVER



Fibre handle  $\frac{3}{8}$ " dia. x 6" long, and fitted with a screw driver nib for aligning of coils, padding condensers, etc.

|  |             |
|--|-------------|
| No. 321.....                           | \$0.40 each |
| No. 775—Display of 24 No. 321 Drivers, | \$9.60 each |

### ALIGNMENT TOOL FOR PUSH-BUTTON RECEIVERS



This tool is especially designed for aligning push-button receivers and for adjusting iron core I.F. transformers and R.F. coils. There is a recessed screw driver nib on one end and a screw driver blade on the other. Both ends knurled for easy grip.

|                                      |              |
|--------------------------------------|--------------|
| No. 325.....                         | \$0.75 each  |
| No. 777—Display of 24 No. 325 Tools, | \$18.00 each |

### FIBRE ALIGNMENT SCREW DRIVERS



Made of bone hard fibre and supplied in three sizes.

| No.                                    | O.D.            | Length | Each   |
|--|-----------------|--------|--------|
| 307                                    | $\frac{3}{8}$ " | 7"     | \$0.40 |
| 308                                    | $\frac{1}{2}$ " | 6"     | .50    |
| 328                                    | $\frac{1}{4}$ " | 7"     | .35    |
| 701—Display of 24 No. 307 Drivers..... |                 |        | 9.60   |
| 702—Display of 18 No. 308 Drivers..... |                 |        | 9.00   |
| 782—Display of 36 No. 328 Drivers..... |                 |        | 12.60  |

### TEST PROD "MAKE YOUR OWN R. F. PROBE"



An exceptionally sturdy fibre prod with rear of prod designed to accommodate 1N-34 crystal and condensers, necessary for use as an R.F. Probe. Heavy duty removable screw type tip for easy soldering.

|                                      |              |
|--------------------------------------|--------------|
| No. 630.....                         | \$1.00 each  |
| No. 781—Display of 12 No. 630 Prods, | \$12.00 each |

### SOLDERLESS TEST PROD HANDLES



Insulated handles, available in Black and Red colors. The wire is fed through the insulated handle and is wrapped around the screw portion of the plug and then tightened with the knurled nut provided, making soldering unnecessary. Specify color.

| No. | Over-all Length  | Each   |
|-----|------------------|--------|
| 302 | $5\frac{1}{4}$ " | \$0.40 |
| 303 | $6\frac{3}{4}$ " | .50    |

### PHONO NEEDLE TEST PROD HANDLES



Insulated handles available in Black and Red colors. Wires can be assembled to the metal chuck by unscrewing the chuck from the prod handle. Specify color.

| No. | Over-all Length  | Each   |
|-----|------------------|--------|
| 317 | 5"               | \$0.40 |
| 318 | $6\frac{3}{4}$ " | .50    |

### FIBRE TEST PROD HANDLES

Handles are made of fibre and can be obtained with either solderless tips or phono needle tips. Constructed same as our numbers 302 and 317. Handles available in Black and Red colors. Specify color.

| No. | Type           | Length           | Each   |
|-----|----------------|------------------|--------|
| 323 | Solderless Tip | $5\frac{1}{4}$ " | \$0.30 |
| 324 | Needle Point   | $5\frac{1}{4}$ " | .30    |

### HEXED FIBRE TUBES



Made of bone hard fibre, and constructed so that if the hex wears out, it can be cut off and the balance of the tube can be used.

| $\frac{1}{4}$ " HEX |        |      | $\frac{5}{16}$ " HEX |        |      |
|---------------------|--------|------|----------------------|--------|------|
| No.                 | Each   | Size | No.                  | Each   | Size |
| 309                 | \$0.30 | 6"   | 313                  | \$0.30 | 6"   |
| 310                 | .35    | 8"   | 314                  | .35    | 8"   |
| 311                 | .45    | 10"  | 315                  | .45    | 10"  |
| 312                 | .50    | 12"  | 316                  | .50    | 12"  |

### FAHNESTOCK SPRING BATTERY CLIPS



Clips are made of brass, nickel plated and are available in the single and double clip types.

| No. | Type   | Length           | Will Take         | Per C  |
|-----|--------|------------------|-------------------|--------|
| 533 | Single | $\frac{3}{4}$ "  | No. 14 B & S Wire | \$1.65 |
| 534 | Single | 1"               | No. 10 B & S Wire | 2.00   |
| 535 | Double | $1\frac{1}{2}$ " | No. 10 B & S Wire | 9.00   |
| 536 | Double | $2\frac{1}{8}$ " | No. 10 B & S Wire | 10.00  |

### TEST LEADS WITH SOLDERLESS TIPS



Fibre handles colored Red and Black, 4" long x  $\frac{3}{8}$ " diameter. Flexible rubber covered wire leads 50" long also colored Red and Black. Available with standard phone tips, spade lugs or alligator clips.

| No. | Type            | Per Pr. |
|-----|-----------------|---------|
| 600 | Phone Tips      | \$1.10  |
| 601 | Spade Lugs      | 1.10    |
| 602 | Alligator Clips | 1.25    |

### PHONO NEEDLE TEST LEADS



Fibre handles colored Red and Black, 4" long x  $\frac{3}{8}$ " diameter. Tips are very sharp phonograph needles. Flexible rubber covered wires 50" long also colored Red and Black. Available with standard phone tips, spade lugs, or alligator clips.

| No. | Type            | Per Pr. |
|-----|-----------------|---------|
| 613 | Phone Tips      | \$1.10  |
| 614 | Spade Lugs      | 1.10    |
| 615 | Alligator Clips | 1.25    |

### ALL SOLDERLESS TEST LEADS



The insulated handles and the insulated plugs are both of the solderless type construction. Insulated handles, Red and Black, are our No. 302, and the plugs are our No. 200. Flexible rubber covered wire leads 50" long.

|              |                 |
|--------------|-----------------|
| No. 603..... | \$1.65 per pair |
|--------------|-----------------|

### HEAVY DUTY TEST LEADS



Heavy duty fibre handles  $\frac{1}{2}$ " O.D. x  $5\frac{3}{8}$ " long, with fibre guard between handle and metal tip to prevent any possibility of shocks. Flexible wire leads 50" long, colored Red and Black. Test leads are available with

standard phone tip, spade lugs or alligator clips.

| No. | Type            | Per Pr. |
|-----|-----------------|---------|
| 620 | Phone Tips      | \$2.25  |
| 621 | Spade Lugs      | 2.25    |
| 622 | Alligator Clips | 2.50    |

### ALLIGATOR CLIP TEST LEADS



Made of very flexible Red and Black wire with alligator clips at each end.

| No. | Wire Length | Per Pr. |
|-----|-------------|---------|
| 604 | 12"         | \$0.75  |
| 605 | 24"         | .85     |
| 606 | 30"         | .95     |
| 607 | 48"         | 1.05    |



### BAKELITE FLAT PULL CAP



Approved and listed with U. L. This handy unit consists of two halves of bakelite held together by a screw and nut. The prongs are of heavy brass and have screw terminals for connecting wire leads. Attractively designed for visible use and with an "easy-grip" shape to facilitate insertion and removal from any receptacle. Colors: Brown and Ivory.

| No. | Color | Per C.  |
|-----|-------|---------|
| 854 | Brown | \$17.00 |
| 855 | Ivory | 21.00   |

### BAKELITE PONY CAP



Bakelite Pony Cap with Brass Prongs.

| No. | Color | Per C.  |
|-----|-------|---------|
| 858 | Brown | \$13.00 |
| 859 | Ivory | 17.00   |

### ATTACHMENT PLUG CAP



A snug-fitting, sturdy, bakelite base designed for use with standard attachment plug caps. Has slot finding features on its face and heavy spring contacts for positive and lasting electrical contact. 660 Watts — 250 Volts.

No. 857.....\$17.00 per C

### RUBBER ATTACHMENT — PLUG



Rubber handle attachment plug: Cord Hole  $\frac{3}{8}$ " (.375). Rated at 15 Amps. 125 Volts. Blades are made of Brass.

No. 850.....\$15.00 per C

### BAKELITE HANDLE PLUG Foreign Type



Moulded bakelite handle foreign type plug. Blades are made of brass, and of the Continental Type spacing.

No. 851.....\$25.00 per C

### AMERICAN-FOREIGN PLUG ADAPTER

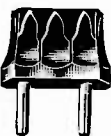

Streamlined bakelite plug adapter, which adapts from American to foreign type plugs. The plugs will fit snugly into the adapter. The foreign type plugs are made of brass, and are of Continental Type spacing.

No. 852.....\$30.00 per C

### AMERICAN-FOREIGN PLUG ADAPTER British Type



Streamlined bakelite plug adapter, which adapts from American to foreign type plugs. The plugs will fit snugly into the adapter. Prongs are made of brass and are of the BRITISH TYPE spacing.

No. 856.....\$30.00 per C

### MICROPHONE CONNECTOR Single Contact Male



A completely shielded single contact connector. Made of brass and heavily chrome plated. Mate for No. 116 female connector.

No. 115.....\$0.40 each

### MICROPHONE CONNECTOR Single Contact Female



Mate for our No. 117 chassis connector. This connector is used extensively for making connections from microphone to amplifier. Comes equipped with coupling ring. All metal parts are made of brass, heavily chrome plated, except the spring.

No. 116.....\$0.50 each

### CHASSIS CONNECTOR Single Contact Male



This type connector is recommended for use on the chassis or in the microphone. Made of brass, heavily nickel plated. Threaded  $\frac{3}{8}$ "-27, and mounts in a  $\frac{3}{8}$ " hole. Supplied complete with washers, soldering lug and nut.

No. 117.....\$0.30 each

### CLOSED CIRCUIT CHASSIS CONNECTOR



Same as No. 117 Connector except that circuit closes when female microphone connector (our No. 116) is removed. Supplied with washers, soldering lug and nut.

No. 114.....\$0.40 each

### FUSE MOUNTING BASES



Black bakelite, panel mount type. Will accommodate the 3 A G Auto type cartridge fuse.

| No. | Type   | Each   |
|-----|--------|--------|
| 530 | Single | \$0.20 |
| 531 | Double | .30    |

### FUSE CLIPS



Clips are made of spring brass, nickel plated. Will accommodate the 3 A G Auto type cartridge fuse. Clips  $\frac{1}{4}$ " wide x  $\frac{3}{8}$ " high.

No. 532.....\$1.75 per C

### CAP AND CHAIN



Made of brass, heavily nickel plated. The cap seals open end units against dust, eliminating noisy connections. Used with any threaded one or two-conductor chassis unit.

No. 118.....\$0.50 each



### PHONO ADAPTER ATTACHMENT PLUG

Phonograph pick-up and auto radio connection plug.

No. 1201.....\$8.00 per C

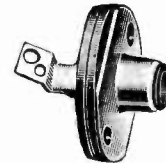

### PHONO JACK

Mate for the No. 1201 plug. Jack mounted on bakelite and metal back supplied for use with phonograph attachment.

No. 1203, \$12.00 per C



### MOTOROLA TYPE PLUG

Attachment plug for all Motorola auto-radio receivers and many other types of auto radios.

No. 1200.....\$10.00 per C



### MOTOROLA SHIELDED JACK

Shielded Jack for Automobile Chassis which takes standard Motorola Plug.

No. 1207.....\$18.00 per C

### LEAD-IN ADAPTER



Lead-in adapter converts Motorola plug to Delco type plug.

No. 1204.....\$11.00 per C



### RUBBER FEET BUMPER

Rubber Bumper —  $\frac{5}{8}$ " dia. x  $\frac{3}{8}$ " thick. Recessed to accommodate a self-tapping screw, machine screw, wood screw or a tack.

No. 2184.....\$4.00 per C

Insert Rubber Bumper — O.D. of shoulder  $\frac{1}{2}$ " x  $\frac{3}{8}$ " thick. Insert  $\frac{1}{8}$ " long tapered from  $\frac{1}{8}$ " to  $\frac{1}{4}$ ".

No. 2183.....\$3.00 per C



### FELT FEET

Available in two types, either with a 6-32 x  $\frac{3}{8}$ " machine screw or with an "Anchor Fast" nail, which will stay in place, and will not back up, pull out, or "pop."

| No.  | Type                 | Per C. |
|------|----------------------|--------|
| 2181 | With Machine Screw   | \$6.50 |
| 2182 | With Stronghold Nail | 7.00   |



### PHONO TIP JACK

Brass, nickel plated jacks with positive contact springs mounted on  $\frac{1}{8}$ " bakelite. Jacks are  $\frac{1}{8}$ " center to center. Jacks will accommodate standard

phone tips of either solderless or solder types.  
No. 878.....\$20.00 per C

# SMITH

*Electronic Components*  
HERMAN H. SMITH, INC.

## STEEL MACHINE SCREWS Round Head, Cadmium Plated

Available in bulk quantities, or can be obtained packed 1,000 or a gross to the box.

| No.  | Per M  | Size         | No.  | Gross  |
|------|--------|--------------|------|--------|
| 1000 | \$3.40 | 6-32 x 1/4"  | 1018 | \$0.61 |
| 1001 | 3.60   | 6-32 x 3/8"  | 1019 | .61    |
| 1002 | 3.90   | 6-32 x 1/2"  | 1020 | .65    |
| 1003 | 4.20   | 6-32 x 5/8"  | 1021 | .65    |
| 1004 | 4.55   | 6-32 x 3/4"  | 1022 | .72    |
| 1005 | 5.20   | 6-32 x 1"    | 1023 | .85    |
| 1006 | 4.20   | 8-32 x 1/4"  | 1024 | .65    |
| 1007 | 4.55   | 8-32 x 3/8"  | 1025 | .72    |
| 1008 | 5.20   | 8-32 x 1/2"  | 1026 | .85    |
| 1009 | 5.50   | 8-32 x 5/8"  | 1027 | .98    |
| 1010 | 5.50   | 8-32 x 3/4"  | 1028 | 1.10   |
| 1011 | 6.50   | 8-32 x 1"    | 1029 | 1.25   |
| 1012 | 5.50   | 10-32 x 1/4" | 1030 | 1.10   |
| 1013 | 6.00   | 10-32 x 3/8" | 1031 | 1.17   |
| 1014 | 6.50   | 10-32 x 1/2" | 1032 | 1.25   |
| 1015 | 7.15   | 10-32 x 5/8" | 1033 | 1.40   |
| 1016 | 7.65   | 10-32 x 3/4" | 1034 | 1.45   |
| 1017 | 7.80   | 10-32 x 1"   | 1035 | 1.55   |



## RACK SCREWS Oval Head, Steel, Nickel Plated

Specially recommended for mounting panels in racks and cabinets. Available in gross packages or packed 1000 to the box.

| No.  | Per M  | Size         | No.  | Gross  |
|------|--------|--------------|------|--------|
| 1102 | \$6.50 | 6-32 x 1/4"  | 1090 | \$0.98 |
| 1103 | 6.85   | 6-32 x 1/2"  | 1091 | 1.05   |
| 1104 | 7.15   | 6-32 x 3/4"  | 1092 | 1.17   |
| 1105 | 7.80   | 6-32 x 1"    | 1093 | 1.30   |
| 1106 | 6.70   | 8-32 x 1/4"  | 1094 | 1.10   |
| 1107 | 7.80   | 8-32 x 1/2"  | 1095 | 1.25   |
| 1108 | 9.10   | 8-32 x 3/4"  | 1096 | 1.45   |
| 1109 | 9.20   | 8-32 x 1"    | 1097 | 1.55   |
| 1110 | 8.45   | 10-32 x 1/4" | 1098 | 1.45   |
| 1111 | 9.20   | 10-32 x 1/2" | 1099 | 1.55   |
| 1112 | 10.40  | 10-32 x 3/4" | 1100 | 1.60   |
| 1113 | 12.35  | 10-32 x 1"   | 1101 | 1.80   |



## COUNTERSUNK WASHERS Brass, Nickel Plated

Recommended for use with Rack Screws designated above.

| No.  | Per M  | Size | No.  | Gross  |
|------|--------|------|------|--------|
| 1115 | \$6.80 | 6    | 1118 | \$1.05 |
| 1116 | 7.20   | 8    | 1119 | 1.10   |
| 1117 | 7.20   | 10   | 1120 | 1.10   |

## FLAT AND SHAKEPROOF WASHERS

| No.  | Per M  | Type                         | No.  | Gross  |
|------|--------|------------------------------|------|--------|
| 1150 | \$1.65 | No. 6 Brass N.P.             | 1146 | \$0.30 |
| 1151 | 2.00   | No. 8 Brass N.P.             | 1147 | .40    |
| 1152 | 2.00   | No. 10 Brass N.P.            | 1148 | .40    |
| 1127 | 3.50   | No. 4 Shakeproof Int. Teeth  | 1121 | .55    |
| 1128 | 3.75   | No. 6 Shakeproof Int. Teeth  | 1122 | .60    |
| 1129 | 3.75   | No. 8 Shakeproof Int. Teeth  | 1123 | .60    |
| 1130 | 3.75   | No. 10 Shakeproof Int. Teeth | 1124 | .60    |
| 1132 | 4.00   | 1/4" Shakeproof Int. Teeth   | 1126 | .60    |
| 1131 | 7.50   | 3/8" Shakeproof Int. Teeth   | 1125 | 1.10   |
| 1139 | 3.50   | No. 4 Shakeproof Ext. Teeth  | 1133 | .55    |
| 1140 | 3.75   | No. 6 Shakeproof Ext. Teeth  | 1134 | .60    |
| 1141 | 3.75   | No. 8 Shakeproof Ext. Teeth  | 1135 | .60    |
| 1142 | 3.75   | No. 10 Shakeproof Ext. Teeth | 1136 | .60    |
| 1144 | 4.00   | 1/4" Shakeproof Ext. Teeth   | 1138 | .65    |
| 1143 | 7.50   | 3/8" Shakeproof Ext. Teeth   | 1137 | 1.10   |

## FANCY HEAD BRONZE FINISH SCREWS

| No.  | Size          | Per M   |
|------|---------------|---------|
| 1160 | 6-32 x 3/4"   | \$10.70 |
| 1161 | 6-32 x 1"     | 11.40   |
| 1162 | 6-32 x 1 1/4" | 12.50   |
| 1163 | 6-32 x 1 1/2" | 14.00   |
| 1164 | 8-32 x 3/4"   | 13.50   |
| 1165 | 8-32 x 1"     | 14.30   |
| 1166 | 8-32 x 1 1/4" | 16.25   |
| 1167 | 8-32 x 1 1/2" | 21.50   |



## SPECIAL NUTS



Machined of Brass Nickel Plated. Correct sizes for volume controls and toggle switches.

| No.  | Type            | Dimensions         | Per M   |
|------|-----------------|--------------------|---------|
| 1195 | Volume Control  | 3/8-32 x 1/2 x 3/8 | \$20.00 |
| 1196 | Toggle Switch   | 15-32 x 1/8 x 3/8  | 25.00   |
| 1197 | Toggle Ring Nut | 15-32 x 3/8 x 1/8  | 30.00   |

## BRASS MACHINE SCREWS Round Head, Nickel Plated

Available in bulk quantities, or can be obtained packed 1,000 or a gross to the box.

| No.  | Per M  | Size         | No.  | Gross  |
|------|--------|--------------|------|--------|
| 1044 | \$6.10 | 4-36 x 1/4"  | 1036 | \$0.90 |
| 1045 | 6.25   | 4-36 x 3/8"  | 1037 | .95    |
| 1046 | 6.40   | 4-36 x 1/2"  | 1038 | .98    |
| 1047 | 6.10   | 4-40 x 1/4"  | 1039 | .90    |
| 1048 | 6.25   | 4-40 x 3/8"  | 1040 | .95    |
| 1049 | 6.40   | 4-40 x 1/2"  | 1041 | .98    |
| 1050 | 6.40   | 6-32 x 1/4"  | 1070 | .98    |
| 1051 | 6.80   | 6-32 x 3/8"  | 1071 | 1.05   |
| 1052 | 7.10   | 6-32 x 1/2"  | 1072 | 1.10   |
| 1053 | 7.35   | 6-32 x 5/8"  | 1073 | 1.17   |
| 1054 | 7.80   | 6-32 x 3/4"  | 1074 | 1.25   |
| 1055 | 12.75  | 6-32 x 1"    | 1075 | 1.85   |
| 1056 | 9.45   | 8-32 x 1/4"  | 1076 | 1.40   |
| 1057 | 9.90   | 8-32 x 3/8"  | 1077 | 1.45   |
| 1058 | 10.25  | 8-32 x 1/2"  | 1078 | 1.55   |
| 1059 | 11.65  | 8-32 x 5/8"  | 1079 | 1.70   |
| 1060 | 12.75  | 8-32 x 3/4"  | 1080 | 2.30   |
| 1061 | 16.95  | 8-32 x 1"    | 1081 | 2.50   |
| 1062 | 9.75   | 10-32 x 1/4" | 1082 | 1.45   |
| 1063 | 12.00  | 10-32 x 3/8" | 1083 | 1.75   |
| 1064 | 13.00  | 10-32 x 1/2" | 1084 | 1.95   |
| 1065 | 13.60  | 10-32 x 5/8" | 1085 | 2.00   |
| 1066 | 14.60  | 10-32 x 3/4" | 1086 | 2.15   |
| 1067 | 16.95  | 10-32 x 1"   | 1087 | 2.45   |

## HEXAGON NUTS Brass, Nickel Plated

| No.  | Per M  | Size         | No.  | Gross  |
|------|--------|--------------|------|--------|
| 1188 | \$7.80 | 4-36 x 1/4"  | 1182 | \$1.15 |
| 1168 | 7.80   | 4-40 x 1/4"  | 1169 | 1.15   |
| 1189 | 7.80   | 6-32 x 1/4"  | 1183 | 1.15   |
| 1190 | 7.80   | 6-32 x 3/8"  | 1184 | 1.15   |
| 1191 | 9.75   | 8-32 x 1/4"  | 1185 | 1.45   |
| 1192 | 9.75   | 8-32 x 3/8"  | 1186 | 1.45   |
| 1193 | 9.75   | 10-32 x 1/8" | 1187 | 1.45   |

## Steel, Cadmium Plated

| No.  | Per M  | Size        | No.  | Gross  |
|------|--------|-------------|------|--------|
| 1179 | \$5.15 | 6-32 x 1/4" | 1176 | \$0.85 |
| 1180 | 6.25   | 6-32 x 3/8" | 1177 | .98    |
| 1181 | 6.25   | 8-32 x 1/8" | 1178 | .98    |

## EYELET TYPE SOLDER LUGS

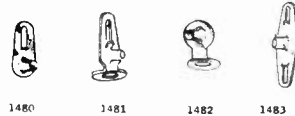

Made of brass. Nos. 1480, 1481 and 1482 are hot tinned and No. 1483 cadmium plated. Specially recommended for mounting on terminal strips.

| No.  | Length | Hole       | Per M   |
|------|--------|------------|---------|
| 1480 | 5/8"   | 3/16" slot | \$ 4.50 |
| 1481 | 5/8"   | No. 8      | 10.00   |
| 1482 | 1 1/4" | No. 8      | 7.50    |
| 1483 | 1 1/8" |            | 7.50    |

## BRASS AND STEEL ANGLES

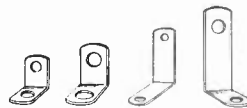

| No.  | Material   | Size          | Per C  |
|------|------------|---------------|--------|
| 1474 | Brass N.P. | 1/2" x 1/2"   | \$2.50 |
| 1475 | Brass N.P. | 5/8" x 5/8"   | 5.00   |
| 1476 | Steel H.T. | 3/4" x 3/4"   | 2.00   |
| 1477 | Steel H.T. | 5/8" x 1 1/8" | 2.00   |

## TAPPED ANGLE BRACKET



Made of steel, cadmium plated. Size 1/2" x 1/2", with one 8-32 tapped hole and one plain .165 hole.

No. 1473.....\$4.50 per C

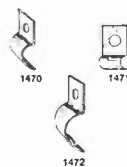

## CABLE CLAMPS

|      |   |        |
|------|---|--------|
| 1470 | Steel, Cadmium plated, No. 8 hole, 1. 3/4", w. 3/8". Fits 1/4" cable      | \$1.25 |
| 1471 | Steel, Cadmium plated, No. 8 hole, 1. 5/8", w. 3/8". Fits 3/8-1/4" cable. | 1.25   |
| 1472 | Steel, Cadmium plated, No. 8 hole, 1. 1", w. 3/8". Fits over 1/2" cable.  | 1.50   |

# SMITH

*Electronic Components*  
HERMAN H. SMITH, INC.

## BRASS BUSHINGS



These brass bushings are ideal for use in raising sub panels, chassis, condensers, transformers, etc. Hole in bushing to accommodate a No. 6 or No. 8 screw.

| No.  | Per C  | 1/4" O.D. Length | No.  | Per C  |
|------|--------|------------------|------|--------|
| 2100 | \$3.50 | 1/4"             | 2105 | \$3.50 |
| 2101 | 4.00   | 3/8"             | 2106 | 4.00   |
| 2102 | 4.25   | 1/2"             | 2107 | 4.25   |
| 2103 | 5.00   | 3/4"             | 2108 | 5.00   |
| 2104 | 5.50   | 1"               | 2109 | 5.50   |
|      |        | 3/8" O.D.        |      |        |
| 2110 | \$4.25 | 1/4"             | 2115 | \$4.25 |
| 2111 | 4.75   | 3/8"             | 2116 | 4.75   |
| 2112 | 5.00   | 1/2"             | 2117 | 5.00   |
| 2113 | 5.50   | 3/4"             | 2118 | 5.50   |
| 2114 | 6.25   | 1"               | 2119 | 6.25   |

## THREADED BRASS BUSHINGS

Brass bushings 1/4" O.D. Threaded 6-32 and 8-32.

| Threaded 6-32 |        | Threaded 8-32 |      |        |
|---------------|--------|---------------|------|--------|
| No.           | Per C  | Length        | No.  | Per C  |
| 2120          | \$4.25 | 1/4"          | 2125 | \$4.25 |
| 2121          | 5.25   | 3/8"          | 2126 | 5.25   |
| 2122          | 6.50   | 1/2"          | 2127 | 6.50   |
| 2123          | 7.50   | 3/4"          | 2128 | 7.50   |
| 2124          | 8.50   | 1"            | 2129 | 8.50   |

## KNURLED BATTERY NUTS Brass, Nickel Plated



| No.  | Dimensions         | Per C  |
|------|--------------------|--------|
| 1198 | 6-32 x 1/4" x 1/8" | \$2.50 |
| 1199 | 8-32 x 1/4" x 1/8" | 2.50   |

## MINI-SHIELDS

### The Perfect Shield For Mini-Tubes

These new Mini-Shields are formed to fit snugly and yet expand to a constant snug fit on larger tubes to automatically compensate for the considerable variation in physical dimensions of miniature tubes as commercially produced.

Specially shaped serrations spaced to engage the lower mini-shield ribs catch and hold the shield firmly which actually tightens against vibrations or other forces tending to jiggle the tube loose.

These shields are made so that three rows of dimples pressing against the tube provide a gentle but firm snug fit. The three prong spring base clip grips the shield positively, cradling the tube within the shield and retaining it firmly in the socket secure against vibration. These Mini-Shields are available in two sizes to accommodate tubes 1 1/2" long and 2" long.

| No. | Type              | Over-all Length | Per C   |
|-----|-------------------|-----------------|---------|
| 550 | For 2" Tube       | 1 3/4"          | \$12.00 |
| 551 | For 1 1/2" Tube   | 1 1/4"          | 10.00   |
| 553 | 3-Prong Base Clip |                 | 5.00    |
| 554 | Single Clips      |                 | 3.00    |

## FIBRE SHOULDER WASHERS

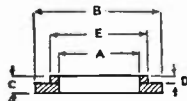

- A. Inside Diameter
- B. Outside Diameter
- C. Thickness Over-all
- D. Height of Shoulder
- E. Diameter of Shoulder

| No.  | A    | B    | C    | D    | E    | Per M   |
|------|------|------|------|------|------|---------|
| 2150 | .140 | .375 | .093 | .031 | .237 | \$10.50 |
| 2151 | .110 | .250 | .062 | .031 | .187 | 8.50    |
| 2152 | .136 | .250 | .093 | .031 | .187 | 9.00    |
| 2153 | .136 | .312 | .093 | .031 | .187 | 10.00   |
| 2154 | .250 | .500 | .068 | .028 | .312 | 11.00   |
| 2155 | .172 | .375 | .093 | .031 | .246 | 9.75    |
| 2156 | .196 | .375 | .093 | .031 | .308 | 9.75    |
| 2157 | .375 | .750 | .093 | .031 | .500 | 13.00   |
| 2158 | .385 | .625 | .093 | .031 | .500 | 12.50   |

## FLAT FIBRE WASHERS

| No.  | I.D. | O.D. | Thickness | Per M  |
|------|------|------|-----------|--------|
| 2160 | .136 | .250 | 1/16"     | \$8.25 |
| 2161 | .110 | .250 | 1/16"     | 8.25   |
| 2162 | .140 | .375 | 1/16"     | 7.50   |
| 2163 | .172 | .375 | 1/16"     | 7.50   |
| 2164 | .196 | .375 | 1/16"     | 7.50   |
| 2165 | .250 | .500 | 1/16"     | 8.00   |
| 2166 | .250 | .500 | 3/32"     | 8.25   |
| 2167 | .312 | .500 | 1/16"     | 8.00   |
| 2168 | .385 | .625 | 1/16"     | 9.75   |
| 2169 | .375 | .750 | 1/16"     | 12.00  |

## MINI-SPRING FOR MINI-TUBES For Table Radios • Electronic Equipment Radio Receivers



The Mini-Tube guard gives support to the Mini-Tube in two ways. It maintains a direct axial pressure downwards plus a sideways support that keeps the tube upright and perpendicular to the chassis. The spring action is constant and resilient permanently. If your radio equipment has an inclined chassis . . . or the tubes are mounted upside down or horizontally . . . or if it is subject to any vibration . . . or if your demand is constantly superior trouble-free reception, Mini-Tube guards are the only way to insure that tubes stay in place forever.

| No. | Type    | Per C   |
|-----|---------|---------|
| 560 | Short   | \$12.00 |
| 561 | Medium  | 12.00   |
| 562 | Long    | 12.00   |
| 563 | 9-Prong | 12.00   |

## GRID CAP SHIELD



Shield is slotted on the side, for passage of the grid lead wire. The shield fits snugly over the grid cap of the tube, completely shielding same. Shield is cadmium plated finish.

No. 537.....\$10.00 per C

## BRASS AND INSULATED COUPLINGS



For use on electronic equipment wherever a shaft extension is required. O.D. 7/8" x 3/4" long.

| No. | Material  | Type         | Each   |
|-----|-----------|--------------|--------|
| 120 | Brass     | 1/4" to 1/2" | \$0.20 |
| 140 | Insulated | 1/4" to 1/2" | .20    |
| 131 | Brass     | 3/8" to 1/2" | .20    |

## STEEL SPADE BOLTS



Steel, cadmium plated finish, threaded 6-32, thread length 1/8", length over-all 3/4".

No. 1500.....\$8.45 per M

## BRASS AND INSULATED EXTENDERS



For use on electronic equipment wherever a shaft extension is required. Over-all length 1 3/4", shaft length 1 1/2".

| No. | Material  | Type         | Each   |
|-----|-----------|--------------|--------|
| 130 | Insulated | 1/4" to 1/2" | \$0.30 |
| 150 | Brass     | 1/4" to 1/2" | .30    |
| 132 | Brass     | 3/8" to 1/2" | .30    |

## THREADED BRASS RODS

Rods ordinarily supplied in 2-foot lengths; if one-foot length is required, please specify.

| No.  | Size      | Per Foot |
|------|-----------|----------|
| 1400 | 6-32      | \$0.30   |
| 1401 | 8-32      | .30      |
| 1402 | 10-32     | .40      |
| 1403 | 1/4" - 20 | .45      |

## BEARING FOR PANEL ASSEMBLY



Made of brass, and fits in 3/8" diameter hole in panels up to 1/4" thick. Bearing is made to accommodate 1/4" shafts.

No. 119.....\$0.20 each

## PANEL BEARING ASSEMBLY



This panel bearing is accurately machined and is specially recommended for use as dial drives, or for mounting volume controls, switches, etc. Over-all length 1 1/8". Supplied with nut. Drive shaft 1/4" O.D.

No. 126.....\$25.00 per C

## BRASS AND INSULATED RODS

These rods are available in both brass and insulated material.

| No.  | Type      | Length | Dia. | Each   |
|------|-----------|--------|------|--------|
| 1404 | Brass     | 6"     | 1/4" | \$0.20 |
| 1405 | Brass     | 12"    | 1/4" | .40    |
| 1406 | Insulated | 6"     | 1/4" | .20    |
| 1407 | Insulated | 12"    | 1/4" | .40    |

We are also in a position to supply brass and insulated rods of various diameters and will gladly quote upon receipt of inquiry.

## TELEVISION ANTENNA ACCESSORIES

### CLAMP STAND OFF FOR ANTENNA MAST

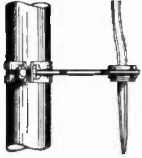

A quick method for securing the antenna line down the mast. Simply slip clamp over the mast and tighten. It is not necessary to hold the nut to tighten. For antennas already installed, open the clamp and slip it around the mast. Thirty seconds and

the operation is complete! Available in two sizes and supplied completely assembled with 3 1/2" screw eyes with molded polyethylene inserts as shown above for twin lead, coaxial cables or with universal insert which accommodates either twin lead or coaxial cables.

#### For 7/8" and 1" Masts

| No.  | Type                  | Per C   |
|------|-----------------------|---------|
| 1255 | With Twin Lead Insert | \$13.00 |
| 1261 | With Coaxial Insert   | 15.00   |
| 1266 | With Universal Insert | 13.00   |

#### For 1 1/8" and 1 1/4" Masts

|      |                       |       |
|------|-----------------------|-------|
| 1256 | With Twin Lead Insert | 13.00 |
| 1262 | With Coaxial Insert   | 15.00 |
| 1267 | With Universal Insert | 13.00 |

### LAG SCREW EXPANSION SHIELD



This expansion shield is extensively used in television antenna installations. Made of a special alloy — 100% rust-proof. Newly designed threads hold greater load and external corrugations (ribs) give additional strength on masonry. This shield is 1" long x 1/2" O.D. and takes our standard 1/4" x 1 1/4" lag screw.

No. 1230.....\$18.00 per C

### STUD ANCHORS



Stud Anchor consists of Cone-Headed Bolt, Lead Alloy Sleeve-Metal Cone and Square Nut completely assembled as at left.

The bolt has two fins on its tapered section to lock into lead sleeve after the anchor has been set. This prevents the bolt from turning when the square nut is tightened Fits into a 1/2" hole and is 2" long over-all.

Instructions for Installation: Drill hole proper diameter and depth — place Star Stud in anchor into hole, head of the bolt first — remove the square nut — place setting tool or piece of pipe over bolt and hammer anchor solidly.

No. 1232.....\$18.00 per C

### DRIVE IN EXPANSION SHIELD

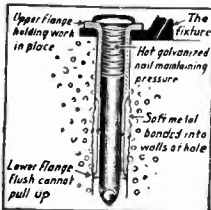

This is an expansion shield which uses nails as an expansion on locking pin. Drill 3/4" hole in the masonry and pass shield through mounting hole of object being attached so that top flange remains above fixtures. The nail, under the hammer blow, forces the lead into all the irregularities of the masonry hole, then passes through and locks anchor flange of bottom under the lead. The length of the shield is 1 1/2".

No. 1233.....\$15.00 per C

### GUY WIRE

An exceptionally high grade of steel galvanized guy wire for anchoring antenna masts. Available in two sizes, STANDARD—6 strands of No. 20; EXTRA HEAVY—6 strands of No. 18.

| 6 STRANDS No. 20 |        |                 | 6 STRANDS No. 18 |        |                 |
|------------------|--------|-----------------|------------------|--------|-----------------|
| No.              | Each   | Length          | No.              | Each   | Length          |
| 1250             | \$0.80 | 50-foot Coil    | 1271             | \$1.25 | 50-foot Coil    |
| 1251             | 1.50   | 100-foot Coil   | 1272             | 2.50   | 100-foot Coil   |
| 1252             | 7.00   | 500-foot Spool  | 1273             | 12.30  | 500-foot Spool  |
| 1253             | 13.20  | 1000-foot Spool | 1274             | 24.50  | 1000-foot Spool |

This Guy Wire is also available in both sizes in 50-Foot Connected Coils, two dozen coils to the carton.

6 STRANDS No. 20 No. 1278 \$16.50 Each Carton  
6 STRANDS No. 18 No. 1279 \$22.00 Each Carton  
Each Carton: 24 Coils — 1200 Feet

### SCREW EYE STAND OFF INSULATORS With Molded Polyethylene Inserts



This screw eye has a special low-loss polyethylene insert and is specially designed for use in 300-ohm line television installations.

#### Twin Lead Insert

| No.  | Size   | Per C  |
|------|--------|--------|
| 1210 | 3 1/2" | \$6.95 |
| 1240 | 7 1/2" | 9.00   |

#### Coaxial Cable Insert

|      |        |      |
|------|--------|------|
| 1260 | 3 1/2" | 7.80 |
| 1270 | 7 1/2" | 9.75 |

#### Universal Insert

|      |        |      |
|------|--------|------|
| 1265 | 3 1/2" | 6.95 |
| 1280 | 7 1/2" | 9.00 |

### EYE BOLT ASSEMBLY



This is the only Eye Bolt Anchor designed for anchoring antenna guy wire in brick or masonry. Made of 1/4" material, over-all length 2 1/2", fits into hole, closing gap 3/32". Rust-proofed. Can only be used with our No. 1229 tamping tool shown on Page U-76b.

No. 1227.....\$18.00 per C

### EYE BOLT



Sturdy steel eye bolt for use where guy wire is necessary for T.V. mast installation. Inside diameter 3/8", shank length 1 1/8", thread length 1 1/4".

No. 1249.....\$8.00 per C

### BRIDLE RING



Heavy duty steel bridle ring 5/8" long. Another essential item where guy wire is used in T.V. mast installation.

No. 1238.....\$10.00 per C

### ANCHOR BOLT



Rust-proofed anchor designed for lasting and permanent anchorage for fastening wall mounts and pipe straps to masonry. Free tamping tool with each 100 Bolts.

| No.  | Bolt Length | Per C   |
|------|-------------|---------|
| 1246 | 2"          | \$15.00 |
| 1247 | 3"          | 18.00   |
| 1248 | 4"          | 22.00   |

### TOGGLE BOLT



A spring wing toggle bolt useful for mounting objects against hollow concrete. Clamp is galvanized steel and screw is 1/4" O.D. x 3" long.

No. 1223.....\$22.00 per C

### WOOD SCREW ANCHOR



Especially designed to give permanent anchorage in any kind of masonry for 300-ohm and coaxial stand-offs. Tapped for wood screw. Free tamping tool with each 100 anchors.

No. 1226.....\$11.00 per C

### LAG BOLT



| No.  | Size          | Per C  |
|------|---------------|--------|
| 1213 | 1/4" x 1 1/4" | \$6.00 |

# SMITH

# Electronic Components

HERMAN H. SMITH, INC.

## TELEVISION ANTENNA ACCESSORIES

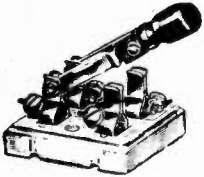

### MIDGET KNIFE SWITCHES

Midget knife switches ideal for use in rear of television receiver where two antennas are used. Screw terminals placed for easy connection and two holes in each type base for mounting.

| No.  | Type    | Type Base | Each   |
|------|---------|-----------|--------|
| 1241 | S P S T | Porcelain | \$0.40 |
| 1242 | S P D T | Bakelite  | .50    |
| 1243 | D P S T | Porcelain | .70    |
| 1244 | D P D T | Bakelite  | .80    |



### MIDGET TURNBUCKLES

| No.  | Diameter of Bolt | Over-all Length Closed | Over-all Length Extended | List Price Each |
|------|------------------|------------------------|--------------------------|-----------------|
| 1215 | 5/8"             | 3 3/8"                 | 4 5/8"                   | \$0.21          |
| 1216 | 7/8"             | 4"                     | 5 5/8"                   | .23             |
| 1217 | 1"               | 4 1/2"                 | 6 3/8"                   | .25             |
| 1218 | 1 1/4"           | 5 1/2"                 | 7 5/8"                   | .30             |
| 1219 | 1 1/2"           | 6 3/4"                 | 9 1/4"                   | .50             |
| 1220 | 1 3/4"           | 7 1/2"                 | 10 1/2"                  | .75             |

### CARBIDE TIPPED MASONRY DRILLS



These drills are carbide tipped and have a spiral fluted body. It penetrates freely and easily, giving clean, accurate holes. Individually packed complete with operating instructions.

| No.  | Size | Each   |
|------|------|--------|
| 1234 | 1/4" | \$3.75 |
| 1236 | 3/8" | 4.75   |
| 1235 | 1/2" | 6.00   |

### TAMPING TOOLS

An absolutely essential item for T.V. antenna installation to insure proper setting of all anchor bolts in masonry.



| No.  | Description                     | Each   |
|------|---------------------------------|--------|
| 1228 | No. 2 Tool for 1/4" Bolts       | \$2.00 |
| 1229 | No. 6 Tool for Eye & Loop Bolts | 4.75   |

### LEAD ANCHORS FOR WOOD SCREWS



This is a new design anchor which gives greater holding power; requiring a smaller installation hole for the corresponding size screws. It takes more sizes of screws grouped in a more convenient series than other designs. It also has a larger range of holding power through various sizes of hole diameters. These anchors are 3/8" O.D., take a 10-12-14 wood screw and are forced into a 3/8" or 1/2" hole.

| No.  | Length | Per C   |
|------|--------|---------|
| 1231 | 1"     | \$ 7.00 |
| 1239 | 1 1/2" | 10.00   |

### RUBBER STAND-OFF



Made of 1/8" heavy duty rubber, this stand-off is especially designed for either coaxial cable or standard twin-lead cable. Fits on any mast or cross arm with O.D. varying from 1" to 1 1/4".

No. 1263.....\$10.00 per C

### PORCELAIN STAND-OFF



Made to accommodate twin 300-ohm lead-in wire. Moisture-Proof Porcelain maintains firm grip on wire. Screw for mounting in either wood or masonry.

No. 1245.....\$20.00 per C

### SOLDERLESS TERMINAL LUGS

These lugs are easily applied and do not require the use of any special tool. They are designed to give a trim appearance to an otherwise unsightly wire connection. They fold neatly over the stranding and confine it directly under binding screw or nut and automatically insure greatest possible contact. The cushion-like construction of these lugs, when closed, permits binding nut or screw to sink into the soft copper and so serves the purpose of a lock nut and is therefore vibration-proof. Packed 100 per box.



| No.  | Wire Size | Type       | Length | Per C  |
|------|-----------|------------|--------|--------|
| 1459 | 18 to 14  | Double Cup | 3/8"   | \$3.50 |
| 1460 | 18 to 10  | " "        | 1/2"   | 3.75   |
| 1461 | 18 to 10  | " "        | 5/8"   | 4.00   |
| 1462 | 18 to 14  | Single Cup | 1/4"   | 1.50   |
| 1463 | 18 to 14  | " "        | 3/8"   | 1.75   |



### AIRPLANE INSULATOR

White glazed, low absorption porcelain insulator 2" long.

No. 1283.....\$9.00 per C



### ANTENNA HANK

Cotton covered copper antenna hank.

No. 1222.....\$30.00 per C

### ANTENNA CONNECTOR



For use as connection of auto radio antenna lead-in to auto radio receiver.

No. 1300.....\$10.00 per C

### FUSE RETAINER



Recommended for use in auto radio power supply cables.

No. 1301.....\$15.00 per C

### Parts for No. 1300 Antenna Connector and No. 1301 Fuse Retainer

| No.  | Item                               | Per C  |
|------|------------------------------------|--------|
| 1305 | Male Cap for No. 1300 and No. 1301 | \$2.50 |
| 1306 | Female Shell for No. 1300          | 2.50   |
| 1307 | Contact for No. 1300 and No. 1301  | 2.50   |
| 1308 | Spring for No. 1300 and No. 1301   | .50    |
| 1309 | Washer for No. 1300 and No. 1301   | .40    |
| 1310 | Insulating Tube for No. 1301       | .60    |
| 1311 | Female Shell for No. 1301          | 5.50   |

### JUMBO FUSE HOLDERS



For use with Philco and Motorola Auto Receivers; all parts comprising bushings, springs, contacts, etc., are furnished un-assembled, packed in individual envelopes.

| No.  | Type        | Length      | Each   |
|------|-------------|-------------|--------|
| 1302 | For 9 Amp.  | 2" Long     | \$0.25 |
| 1303 | For 14 Amp. | 2 1/2" Long | .30    |

# THE NEW IMPROVED JFD REMOTE-O-CABLE REPLACER

The Most Efficient Auto  
Radio Tuning Cable-  
Servicing Machine  
in Use Today!

Completely redesigned to meet MOD-ERN Servicing requirements, the NEW JFD REMOTE-O-CABLE REPLACER is a vital necessity in the workshop of every auto-radio serviceman.

1. SWEDGES SHAFTHING TO PREVENT UNRAVELLING.
2. CUTS SHAFTHING TO EXACT LENGTH.
3. REPLACES OLD FITTINGS ON NEW SHAFTHING.
4. CASING GROOVE MAKES CUTTING EASY.

ANY JOB PROMPTLY DONE AND DELIVERED—The Remote-O-Cable Replacer + 50 feet of shafting and casing + an assortment of fittings and you are fully equipped.

USE OLD FITTINGS ON NEW SHAFTHING—No need to wait for special lengths or odd fittings.

NO DELAY—Shafting of any length immediately available.

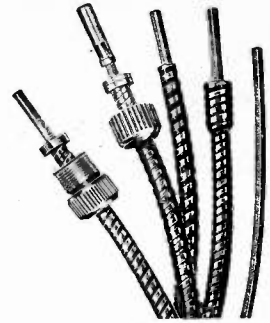
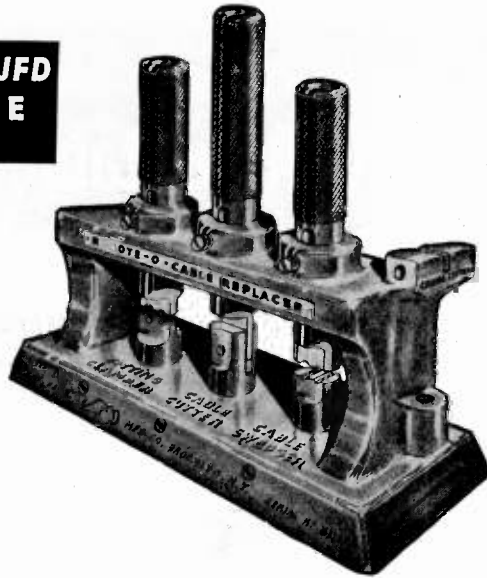

**SERVICEMEN'S  
NET COST  
\$67.52**

Size: Length, 10½". Width, 4¼". Height, 13". Weight, 29¼ lbs.

NO LOSS OF HEADS OR SHAFTHING—Shafting of any make radio immediately changed to fit any dashboard head.

FRONT—REAR—ANYWHERE—Radio control in any part of the car.

EXACT LENGTH OF SHAFTHING DOES IT—Maximum tuning efficiency.

## AUTO RADIO CONTROL SHAFTHING AND CASING

### UNSWEDGED "LIVE" SHAFTHING

Type CB  
.130 gauge  
\$0.18 per ft. List  
Type CA  
.150 gauge  
\$0.23 per ft. List

### NON-RAVELLING DEAD SHAFTHING

Type CD  
.130 gauge  
\$0.20 per ft. List  
Type CC  
.150 gauge  
\$0.26 per ft. List

### CASING FOR ALL SHAFTHINGS

Type HB  
.130 gauge  
\$0.18 per ft. List  
Type HA  
.150 gauge  
\$0.23 per ft. List

## AUTO RADIO CONTROL SHAFTHING AND CASING CUT TO LENGTH

.130 CABLE AND CASING — List Prices

|  | 18"    | 24"    | 30"    | 36"    | 42"    | 48"    |
|--|--------|--------|--------|--------|--------|--------|
| Shafting only<br>CB .130 Gauge                 | \$0.50 | \$0.60 | \$0.71 | \$0.81 | \$0.92 | \$1.02 |
| Casing only<br>HB for .130 Gauge               | .50    | .60    | .71    | .81    | .92    | 1.02   |
| Shafting & Casing<br>Complete<br>CB<br>HB .130 | 1.00   | 1.20   | 1.42   | 1.62   | 1.84   | 2.04   |

.150 CABLE AND CASING — List Prices

|  | 18"    | 24"    | 30"    | 36"    | 42"    | 48"    |
|--|--------|--------|--------|--------|--------|--------|
| Shafting only<br>CA .150 gauge                 | \$0.57 | \$0.70 | \$0.84 | \$0.96 | \$1.10 | \$1.22 |
| Casing only<br>HA for .150 gauge               | .57    | .70    | .84    | .96    | 1.10   | 1.22   |
| Shafting & Casing<br>Complete<br>CA<br>HA .150 | 1.14   | 1.40   | 1.68   | 1.92   | 2.20   | 2.44   |



## Auto Radio Tuning Cable Fittings Gear & Couplers

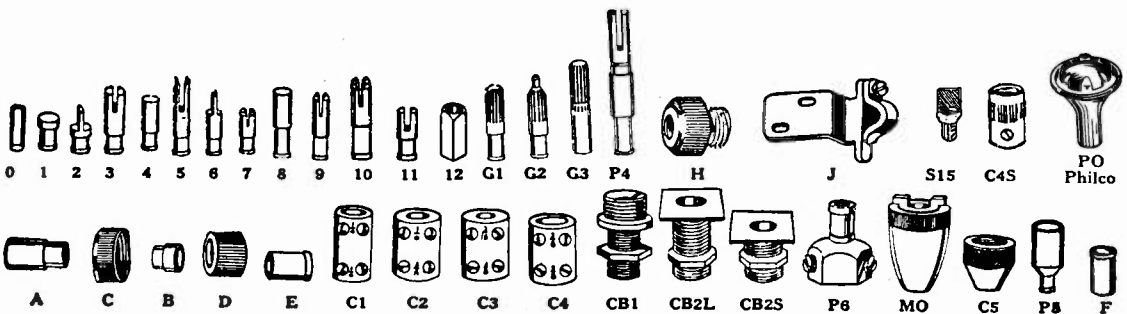

Nos. 0, 1, 7, B, E..... Lots of 20 @ \$0.10 ea. List  
Nos. C, D..... Lots of 20 @ .10 ea. List  
Nos. 2, 4, 8, 11, F..... Lots of 20 @ .10 ea. List  
Nos. 3, 5, A..... Lots of 20 @ .13 ea. List

Nos. 6, 9, 10, 12, C1, C2, C3, C4, C5, J, S15  
Lots of 10 @ \$0.20 ea. List  
Nos. C4S, CB1, CB2L, CB2S, P5, P6..... Lots of 5 @ .33 ea. List  
Nos. M0130, M0150..... Lots of 10 @ .30 ea. List  
Nos. G1, G2, G3, P4, H, PO..... Lots of 5 @ .25 ea. List



# Improved • Air-Cooled AC-DC Adjustable Ballasts



**Just**  
**3 Adjustable Ballasts**  
Replace Over **3000**  
Exact Duplicate AC-DC Resistance Tubes!

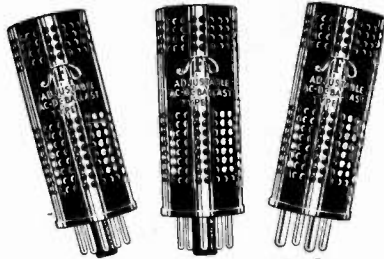

Type A  
8 Prong

Type B  
8 Prong

Type C  
4 Prong

**Dealer's and Serviceman's Kit**  
Improved • Air-Cooled  
**AC-DC Adjustable Ballasts**

**No. 770—SERVICEMEN'S KIT**  
contains 5 Ballasts: 2 Type A, 2 Type B,  
1 Type C Ballasts together with listing of  
over 2500 replacements and complete in-  
structions.....List Price \$7.50

**JFD IMPROVED AIR-COOLED ADJUST-  
ABLE AC-DC BALLASTS HAVE  
THESE IMPROVEMENTS:**

1. Air-Cooled Perforated Shell
2. Larger Insulating Surface
3. Longer Life, Heavier Resistance Wire
4. Exact Adjustments made

**LIST PRICE \$1.50 ea.**

Over 3,000,000 JFD Adjustable Ballasts have been sold since 1934 — practically every one still in use, giving service and satisfaction.

**GET THIS FREE  
AC-DC BALLAST  
TUBE MANUAL!**

Contains valuable information on how to adapt adjustable ballasts to all service jobs. Simply send 12 flaps from JFD Dial Belt envelopes and 10c in stamps (to cover mailing) to JFD MANUFACTURING CO. INC., 4117 Ft. Hamilton Parkway, Brooklyn 19, New York, U. S. A. (Further Details on Page 37.)

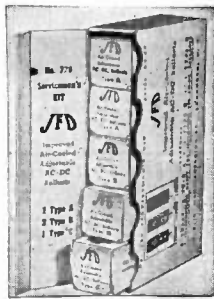

| USE JFD BALLASTS | TO REPLACE AC-DC RESISTANCE TUBES |                        |                                 |
|------------------|-----------------------------------|------------------------|---------------------------------|
|                  | Beginning with Letter             | With Numbers Including | Ending with letter              |
| "A" Ballasts     | K, L, M, BK, BL, or BM            | 6 through 42           | A, B, C, D, F, G, or H          |
| "B" Ballasts     | K, L, M, BK, BL, or BM            | 45 through 105         | A, B, C, D, F, G, H, S1, S2, S3 |
| "C" Ballasts     | All 4 prongs                      | 80 through 350         | R, R4, R8, L, L4, L8            |

## AC-DC STANDARD TUBES—RMA STANDARD CODING

| Type No. | List Price     | Type No. | List Price | Type No. | List Price | Type No. | List Price | Type No. | List Price |      |      |
|----------|----------------|----------|------------|----------|------------|----------|------------|----------|------------|------|------|
| 10A      | Addison \$1.00 | M36B     | 1.00       | M42D     | 1.00       | L49B     | 1.00       | BK55D    | 1.00       | M73B | 1.00 |
| 17A      | 1.00           | M36C     | 1.00       | M42E     | 1.00       | L49BJ    | 1.25       | K55F     | 1.00       | K74B | 1.00 |
| K17B     | 1.00           | M36D     | 1.00       | M42F     | 1.00       | L49C     | 1.00       | K55H     | 1.00       | K74C | 1.00 |
| K17C     | 1.00           | 42A      | 1.00       | M42H     | 1.00       | L49CJ    | 1.25       | KX55A    | 1.25       | K74D | 1.00 |
| L17B     | 1.00           | 42B2     | 1.25       | 49A      | 1.00       | L49D     | 1.00       | KX55B    | 1.25       | 80A  | 1.00 |
| L17C     | 1.00           | K42B     | 1.00       | K49B     | 1.00       | L49DJ    | 1.25       | KX55C    | 1.25       | K80B | 1.00 |
| K22B     | 1.00           | K42BJ    | 1.25       | K49BJ    | 1.25       | L49E     | 1.00       | L55B     | 1.00       | K80C | 1.00 |
| K23B     | 1.00           | BK42B    | 1.00       | BK49B    | 1.00       | L49F     | 1.00       | L55C     | 1.00       | K80D | 1.00 |
| L23B     | 1.00           | BL42B    | 1.00       | K49C     | 1.00       | LX49B    | 1.25       | L55CP    | 1.25       | K80F | 1.00 |
| L23C     | 1.00           | K42C     | 1.00       | BK49C    | 1.00       | LX49C    | 1.25       | L55D     | 1.00       | K80H | 1.00 |
| 33A      | 1.00           | BK42C    | 1.00       | K49CJ    | 1.25       | LX49D    | 1.25       | L55F     | 1.00       | L80B | 1.00 |
| 33AG     | 1.00           | BL42C    | 1.00       | K49D     | 1.00       | M49B     | 1.00       | L55H     | 1.00       | L80C | 1.00 |
| 36A      | 1.00           | K42D     | 1.00       | BK49D    | 1.00       | M49C     | 1.00       | M55B     | 1.00       | M80C | 1.00 |
| K36B     | 1.00           | BK42D    | 1.00       | K49E     | 1.00       | M49D     | 1.00       | M55C     | 1.00       | M80B | 1.00 |
| BK36B    | 1.00           | KX42A    | 1.25       | K49F     | 1.00       | M49H     | 1.00       | M55D     | 1.00       | M80C | 1.00 |
| K36BJ    | 1.25           | KX42B    | 1.25       | K49H     | 1.00       | 50       | 1.00       | M55E     | 1.00       | K87B | 1.00 |
| K36C     | 1.00           | KX42C    | 1.25       | KX49A    | 1.00       | K52H     | 1.00       | M55H     | 1.00       | 90A  | 1.00 |
| K36D     | 1.00           | L42B     | 1.00       | KX49B    | 1.25       | 55A      | 1.00       | 60R30    | 1.25       | K90B | 1.00 |
| K36H     | 1.00           | L42BJ    | 1.25       | KX49C    | 1.25       | K55A     | 1.00       | 62A      | 1.00       | K90C | 1.00 |
| KX36A    | 1.25           | L42C     | 1.00       | KX49D    | 1.25       | K55B     | 1.00       | K67B     | 1.00       | 92A  | 1.00 |
| KX36B    | 1.25           | L42CJ    | 1.25       | KY49A    | 1.25       | BK55B    | 1.00       | K67BJ    | 1.25       | K92B | 1.00 |
| KX36C    | 1.25           | L42D     | 1.00       | KY49B    | 1.25       | BL55B    | 1.00       | K67C     | 1.00       | K92C | 1.00 |
| L36B     | 1.00           | L42DJ    | 1.25       | KY49C    | 1.25       | BM55B    | 1.00       | K67D     | 1.00       | K92D | 1.00 |
| L36C     | 1.00           | L42E     | 1.00       | KZ49A    | 1.25       | K55C     | 1.00       | L67C     | 1.00       | K92F | 1.00 |
| L36D     | 1.00           | M42B     | 1.00       | KZ49B    | 1.25       | BK55C    | 1.00       | K72B     | 1.00       | K92H | 1.00 |
| L36DJ    | 1.25           | M42C     | 1.00       | KZ49C    | 1.25       | K55D     | 1.00       | K73C     | 1.00       |      |      |





Plug-in type

# RESISTOR BALLASTS

STEP-DOWN FROM 220 VOLTS TO 110 VOLTS

220 VOLTS

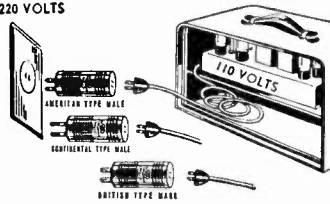

JFD STEP-DOWN BALLAST

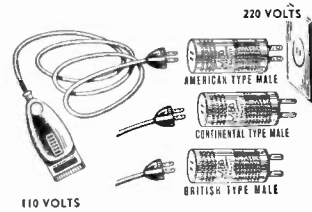
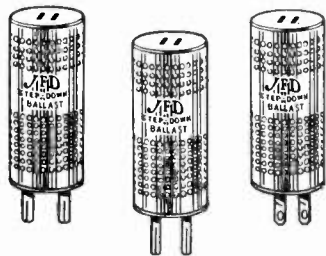

Use JFD voltage reducing ballasts on 220 volt current supply if you want to operate 110 volt appliances. Excellent for radios, floor lamps, clocks, therapeutic lamps, electric blankets, etc.

| Catalog No. | Resist. | Current | Voltage Drop | Watts | Male End    | Female End | Load   | List Price |
|-------------|---------|---------|--------------|-------|-------------|------------|--|------------|
| 450         | 97      | 1.13    | 220-110      | 125   | American    | American   | 125 W Infra Red Therapeutic Lamp             | \$2.40     |
| 451B        | 97      | 1.13    | 220-110      | 125   | British     | American   | 125 W Infra Red Therapeutic Lamp             | 2.40       |
| 451C        | 97      | 1.13    | 220-110      | 125   | Continental | American   | 125 W Infra Red Therapeutic Lamp             | 2.40       |
| 456         | 250     | .44     | 220-110      | 65    | American    | American   | 35-65 W Radio Heating Pads                   | 2.40       |
| 457B        | 250     | .44     | 220-110      | 65    | British     | American   | 35-65 W Radio Heating Pads                   | 2.40       |
| 457C        | 250     | .44     | 220-110      | 65    | Continental | American   | 35-65 W Radio Heating Pads                   | 2.40       |
| 458         | 300     | .35     | 220-110      | 38    | American    | American   | 4-5 Tube AC-DC Radio, .3 Amp tubes           | 2.40       |
| 459B        | 300     | .35     | 220-110      | 38    | British     | American   | 4-5 Tube AC-DC Radio, .3 Amp tubes           | 2.40       |
| 459C        | 300     | .35     | 220-110      | 38    | Continental | American   | 4-5 Tube AC-DC Radio, .3 Amp tubes           | 2.40       |
| 462         | 500     | .22     | 220-110      | 25    | American    | American   | General Use                                  | 2.40       |
| 463B        | 500     | .22     | 220-110      | 25    | British     | American   | General Use                                  | 2.40       |
| 463C        | 500     | .22     | 220-110      | 25    | Continental | American   | General Use                                  | 2.40       |
| 464         | 560     | .20     | 220-110      | 25    | American    | American   | 5 Tube AC-DC Radio Using .15 Amp tubes       | 2.40       |
| 465B        | 560     | .20     | 220-110      | 25    | British     | American   | 5 Tube AC-DC Radio Using .15 Amp tubes       | 2.40       |
| 465C        | 560     | .20     | 220-110      | 25    | Continental | American   | 5 Tube AC-DC Radio Using .15 Amp tubes       | 2.40       |
| 466         | 660     | .167    | 220-110      | 8     | American    | American   | General Use                                  | 2.40       |
| 467B        | 660     | .167    | 220-110      | 8     | British     | American   | General Use                                  | 2.40       |
| 467C        | 660     | .167    | 220-110      | 8     | Continental | American   | General Use                                  | 2.40       |
| 468         | 1345    | .082    | 220-110      | 9     | American    | American   | Electric Razor                               | 2.40       |
| 469B        | 1345    | .082    | 220-110      | 9     | British     | American   | Electric Razor                               | 2.40       |
| 469C        | 1345    | .082    | 220-110      | 9     | Continental | American   | Electric Razor                               | 2.40       |
| 470         | 6000    | .018    | 220-110      | 2     | American    | American   | Electric Clock                               | 2.40       |
| 471B        | 6000    | .018    | 220-110      | 2     | British     | American   | Electric Clock                               | 2.40       |
| 471C        | 6000    | .018    | 220-110      | 2     | Continental | American   | Electric Clock                               | 2.40       |
| 472         | 110     | .950    | 220-110      | 105   | American    | American   | 15-7 Watt Xmas lights in parallel            | 2.40       |
| 473B        | 110     | .950    | 220-110      | 105   | British     | American   | 15-7 Watt Xmas lights in parallel            | 2.40       |
| 473C        | 110     | .950    | 220-110      | 105   | Continental | American   | 15-7 Watt Xmas lights in parallel            | 2.40       |
| 474         | 960     | .115    | 220-110      | 13    | American    | American   | Schick Razor                                 | 2.40       |
| 475B        | 960     | .115    | 220-110      | 13    | British     | American   | Schick Razor                                 | 2.40       |
| 475C        | 960     | .115    | 220-110      | 13    | Continental | American   | Schick Razor                                 | 2.40       |
| 476         | 1100    | .1      | 220-110      | 11    | American    | American   | Packard Razor                                | 2.40       |
| 477B        | 1100    | .1      | 220-110      | 11    | British     | American   | Packard Razor                                | 2.40       |
| 477C        | 1100    | .1      | 220-110      | 11    | Continental | American   | Packard Razor                                | 2.40       |
| 478         | 475     | .230    | 220-110      | 26    | American    | American   | 6 tube AC-DC Radio Using .15 Amp tubes       | 2.40       |
| 479B        | 475     | .230    | 220-110      | 26    | British     | American   | 6 tube AC-DC Radio Using .15 Amp tubes       | 2.40       |
| 479C        | 475     | .230    | 220-110      | 26    | Continental | American   | 6 tube AC-DC Radio Using .15 Amp tubes       | 2.40       |
| 480         | 300     | .300    | 220-110      | 33    | American    | American   | Remington Razor                              | 2.40       |
| 481B        | 300     | .300    | 220-110      | 33    | British     | American   | Remington Razor                              | 2.40       |
| 481C        | 300     | .300    | 220-110      | 33    | Continental | American   | Remington Razor                              | 2.40       |
| 482         | 785     | .140    | 220-110      | 16    | American    | American   | Portable Radio Total Current drain .140 Amp. | 2.40       |
| 483B        | 785     | .140    | 220-110      | 16    | British     | American   | Portable Radio Total Current drain .140 Amp. | 2.40       |
| 483C        | 785     | .140    | 220-110      | 16    | Continental | American   | Portable Radio Total Current drain .140 Amp. | 2.40       |
| 484         | 430     | .255    | 220-110      | 28    | American    | American   | Detrola Automatic Phono Turntable            | 2.40       |
| 485B        | 430     | .255    | 220-110      | 28    | British     | American   | Detrola Automatic Phono Turntable            | 2.40       |
| 485C        | 430     | .255    | 220-110      | 28    | Continental | American   | Detrola Automatic Phono Turntable            | 2.40       |
| 488         | 2000    | .055    | 220-110      | 6     | American    | American   | General Use                                  | 2.40       |
| 489B        | 2000    | .055    | 220-110      | 6     | British     | American   | General Use                                  | 2.40       |
| 489C        | 2000    | .055    | 220-110      | 6     | Continental | American   | General Use                                  | 2.40       |
| 490         | 143     | .87     | 220-110      | 96    | American    | American   | 65-130 Watt 110 Volt Radio                   | 2.40       |
| 491B        | 143     | .87     | 220-110      | 96    | British     | American   | 65-130 Watt 110 Volt Radio                   | 2.40       |
| 491C        | 143     | .87     | 220-110      | 96    | Continental | American   | 65-130 Watt 110 Volt Radio                   | 2.40       |

## JFD FOREIGN ADAPTER

Converts American Male Plug to Continental and British Male Plugs  
Converts Foreign receptacles into the standard American type—in a jiffy!

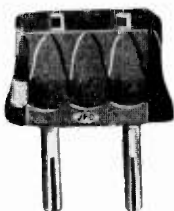

No. 2-449—with Continental type prongs. List Price .....\$0.33  
No. 2-450—with British type prongs. List Price .....\$0.33

## JFD Bakelite Handle Cap for Use in Foreign Countries

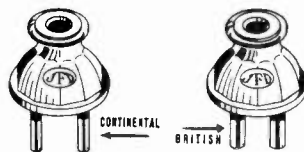

Comes with Continental or British Prongs

No. 2-451—Cap with Continental type prongs .....\$0.25  
2-452—Cap with English type prongs .....30

## JFD Wire Measuring Outfit (COUNTER MODEL)



Here is a compact, sturdy wire measuring outfit that can be set up easily on counter, bench or table. More than pays for itself in time saved and exact wire measurements. Measures up to 1000 feet. Very simple to set up and operate—it works silently. Take-up reel is adjustable.

Cat. No. 66-C Complete Outfit



# New Enlarged Line of AC-DC RESISTANCE LINE CORDS

## STANDARD 3 TERMINALS AC-DC RESISTANCE CORDS

FLEXIBLE, STURDY CORDS, 3-TERMINAL TYPE, WITH COLOR-CODED, TINNED LEADS

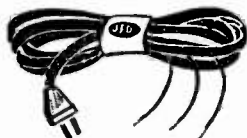

Attractive individual  
Cartons

| No.   | Ohms               | List   |
|-------|--------------------|--------|
| *2180 | 135                | \$1.17 |
| *2181 | 160                | 1.17   |
| *2182 | 180                | 1.17   |
| *2183 | 200                | 1.17   |
| 2184  | 220                | 1.17   |
| 2185  | 250                | 1.17   |
| 2186  | 280                | 1.17   |
| 2187  | 300                | 1.17   |
| 2188  | 330                | 1.17   |
| 2189  | 350                | 1.17   |
| 2190  | 390                | 1.17   |
| 2450  | 450 (High Resist.) | 1.72   |

\*Note: 135, 160, 180, and 200 ohm cords can also be used for single light 20 and 15 watt fluorescent fixtures.

## TAPPED 4 TERMINAL AC-DC RESISTANCE CORDS

Pilot light resistor shunt built into the line cord. Used on Emerson, Zenith, Sperton, R. C. A., General Electric, Wells-Gardner, Sears Roebuck, Fada, Admiral, Air King, Detrola, Crosley, Garod, and others.



| No.  | List, Ea. |
|--|-----------|
| 2176—160 OHMS—TAPPED AT 24 OHMS<br>For sets using tubes having a voltage drop of approximately 69 volts as 2-25 volt tubes and 3-6.3 volt tubes plus single pilot light or similar combination .....   | \$1.38    |
| 2195—165 OHMS—TAPPED AT 30 OHMS<br>There is a large demand for this tapped line cord .....   | 1.38      |
| 2177—180 OHMS—TAPPED AT 25 OHMS<br>For sets using tubes having a voltage drop of approximately 63 volts as 2-25 volt tubes and 2-6.3 volt tubes plus a single pilot light or similar combination .....   | 1.38      |
| 2178—200 OHMS—TAPPED AT 25 OHMS<br>For sets using tubes having a voltage drop of approximately 57 volts as 1-25 volt tube, 1-12 volt tube and 3-6.3 volt tubes and a single pilot light. May also be used for sets using tubes having a voltage drop of 63 volts, (2-25 volt and 2-6.3 volt tubes) if high line voltage (125 volts) is encountered.... | 1.38      |
| 2179—200 OHMS—TAPPED AT 40 OHMS<br>For sets using tubes having a voltage drop of approximately 57 volts as 1-25 volt tube, 1-12 volt tube and 3-6.3 volt tubes and two pilot lights in series .....  | 1.38      |

| No.  | List, Ea. |
|--|-----------|
| 2174—280 OHMS—TAPPED AT 40 OHMS<br>For sets using tubes having a voltage drop of approximately 32 volts as 2-12 volt tubes and 1-6.3 volt tube or 5-6.3 volt tubes or similar combinations using 2 pilot light in series ..... | \$1.38    |
| 2164—360 OHMS—TAPPED AT 80 OHMS<br>Used in Garod Model BP-20. See No. 2196 for specifications .....  | 1.72      |
| 2166—430 OHMS—TAPPED AT 80 OHMS<br>For Farnsworth Model CD59. See No. 2196 for specifications .....  | 1.72      |
| 2156—510 OHMS—TAPPED AT 80 OHMS<br>For Fada. See No. 2196 for specifications .....   | 1.72      |
| 2196—560 OHMS—TAPPED AT 80 OHMS<br>Tapped at 80 ohms for plate of rectifier. Designed with voltage dropping resistor to plate of rectifier. Avoids necessity of using B+ resistor. This cord used extensively .....            | 1.72      |
| 2158—960 OHMS—TAPPED AT 80 OHMS<br>For G. E. Model L622. See No. 2196 for specifications .....   | 1.72      |
| 2165—1950 OHMS—TAPPED AT 360 OHMS<br>Used extensively in sets such as Crosley Model 27BD, Admiral Model 28-G-5, and other sets with similar circuits .....   | 2.06      |

## HIGH RESISTANCE CORDS



| No.  | List Price |
|--|------------|
| 2197 For 3-way portable radios. AC-DC battery. New high resistance type cord, has 560 ohms resistance. Many thousands of sets using this identical cord are now in use. This popular replacement cord should be stocked by every serviceman! Individually packaged ..... | \$1.72     |

| No.   | List Price |
|---|------------|
| 2157—For AC-DC Sets.<br>This cord has 960 ohms resistance, and is used wherever 45Z3 rectifier tube is employed. (For pocket type radios, such as: Admiral, Fada Sentinel, Sonora, Motorola, Detrola, Farnsworth, etc.) Individually packaged ..... | 1.72       |

## REPLACEMENT LINE CORD FOR MOTOROLA SETS



| No.  | List Price |
|--|------------|
| 2198—8 ft. cord containing 2 resistance elements—1100 and 280 ohms. Has 4 terminals. Essential replacement for all Motorola portables. Nos. 41D, 51D, 52D, 41H. .... | \$2.06     |

## COMBINATION ANTENNA WIRE and STRAIGHT AC CORD



| No.  | List Price |
|--|------------|
| 2168—3-wire cord with special female socket to fit sets which have three prong male plug, used in Sentinel, Admiral, Belmont, Sonora, etc. Individually packaged ..... | \$1.72     |

## UNIVERSAL AC-DC RESISTANCE LINE CORDS

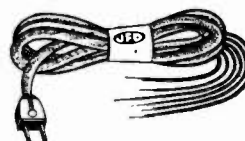

| No.  | List Price |
|--|------------|
| 2175—This line cord replaces AC-DC cords from 220 ohms to 300 ohms. Can be used for either standard three terminal or tapped cord..... | \$1.72     |



# STEP-DOWN — AC-DC RESISTOR LINE CORDS

(Step-Down from 220 V. to 110 V.)  
JFD STEP-DOWN LINE CORDS FOR RADIOS

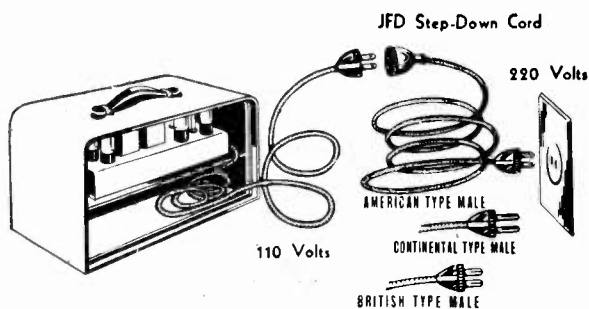

| Cat. No. | Description  | List Price |
|----------|--|------------|
| 2191     | 220V-110V Stepdown for 4, 5, 6 tube sets drawing .3 amps. American Male Plug                 | \$2.40     |
| 2193C    | 220V-110V Stepdown for 4, 5, 6 tube sets drawing .3 amps. Continental Male Plug              | 2.40       |
| 2193B    | 220V-110V Stepdown for 4, 5, 6 tube sets drawing .3 amps. British Male Plug                  | 2.40       |
| 2192     | 220V-110V Stepdown for 5 tube sets drawing .15 amps. American Male Plug                      | 2.40       |
| 2194C    | 220V-110V Stepdown for 5 tube sets drawing .15 amps. Continental Male Plug                   | 2.40       |
| 2194B    | 220V-110V Stepdown for 5 tube sets drawing .15 amps. British Male Plug                       | 2.40       |
| 2430A    | 220V-110V Stepdown for 6 tube sets drawing .150 amps. American Male and Female Plugs         | 2.40       |
| 2431B    | 220V-110V Stepdown for 6 tube sets drawing .150 amps. British Male and American Female Plugs | 2.40       |

| Cat. No. | Description  | List Price |
|----------|--|------------|
| 2432C    | 220V-110V Stepdown for 6 tube sets drawing .150 amps. Continental Male and American Female Plugs | \$2.40     |

## JFD STEP-DOWN LINE CORDS FOR ELECTRIC RAZORS

| Cat. No. | Description   | List Price |
|----------|---|------------|
| 2203     | 220V-110V Stepdown for Remington Rand Razor 15W. American Female and American Male  | \$2.60     |
| 2203B    | 220V-110V Stepdown for Remington Rand Razor 15W. American Female and British Male   | 2.60       |
| 2203C    | 220V-110V Stepdown for Remington Rand Razor 15W. American Female and Continental Male   | 2.60       |
| 2204     | 220V-110V Stepdown for Schick Razor 9W, Sunbeam Shavemaster 15W, Williams Roto-Shaver, Gillette, Gem 10W with American Female and American Male   | 2.60       |
| 2204B    | 220V-110V Stepdown for Schick Razor 9W, Sunbeam Shavemaster 15W, Williams Roto-Shaver, Gillette, Gem 10W with American Female and British Male    | 2.60       |
| 2204C    | 220V-110V Stepdown for Shick Razor 9W, Sunbeam Shavemaster 15W, Williams Roto-Shaver, Gillette, Gem 10W with American Female and Continental Male | 2.60       |
| 2205     | 220V-110V Stepdown for Packard Razor 6W with American Female and American Male  | 2.60       |
| 2205B    | 220V-110V Stepdown for Packard Razor 6W with American Female and British Male   | 2.60       |

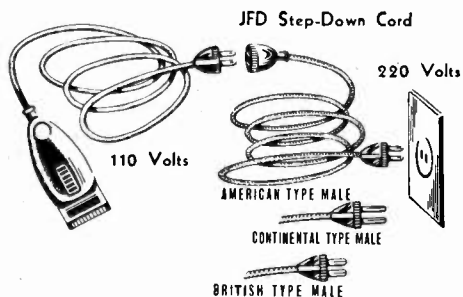

| Cat. No. | Description   | List Price |
|----------|---|------------|
| 2205C    | 220V-110V Stepdown for Packard Razor 6W with American Female and Continental Male | \$2.60     |

## JFD AC-DC LINE CORDS FOR FLUORESCENT FIXTURES

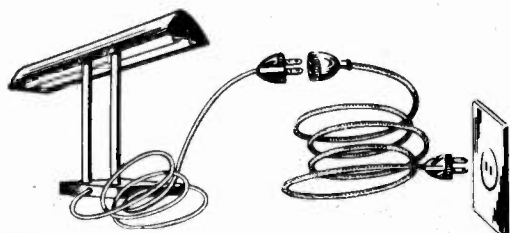

| Cat. No. | Description   | List Price |
|----------|---|------------|
| 2181FL   | 165 ohm, for 20 watt bulb, 117 volts, 6 feet long                   | \$1.17     |
| 2181FL-2 | Two 165 ohm windings, for two 20 watt bulbs, 117 volts, 6 feet long | 2.00       |
| 2182FL   | 180 ohm, for 15 watt bulb, 117 volts, 6 feet long                   | 1.17       |
| 2200FL   | Two 180 ohm windings, for two 15 watt bulbs, 117 volts, 6 feet long | 2.00       |

GENERAL



CEMENT

**RADIO CEMENTS FOR ALL PURPOSES**



**G-C RADIO SERVICE CEMENT**

The best Cement for repairing radios and speakers. Excellent for repairing and replacing torn cones. Vibration-proof, water-proof and fast drying. Brushes attached.

| No.          | List   |
|--------------|--------|
| 30-2 2-oz.   | \$0.50 |
| 34-2 Tube    | .50    |
| 30-4 4-oz.   | 1.00   |
| 30-6 6-oz.   | 1.40   |
| 30-8 8-oz.   | 1.75   |
| 30-16 16-oz. | 3.30   |

**G-C RADIO SERVICE SOLVENT**

Best Solvent for loosening cement on speaker cones, frames, etc. Will dissolve all cements on speakers. Brush attached.

| No.          | List   |
|--------------|--------|
| 31-2 2-oz.   | \$0.50 |
| 31-4 4-oz.   | .65    |
| 31-6 6-oz.   | .85    |
| 31-8 8-oz.   | .95    |
| 31-16 16-oz. | 1.40   |

**G-C CEMENT THINNER**

Made of same solvents as G-C Service Cement. Best thinner for all cements.

| No.          | List   |
|--------------|--------|
| 28-2 2-oz.   | \$0.50 |
| 28-4 4-oz.   | .65    |
| 28-8 8-oz.   | .95    |
| 28-16 16-oz. | 1.40   |

**G-C SPEAKER CEMENT**

Best grade cement put up in handy tubes. For radio and speaker repairs. Water-proof, vibration-proof, fast drying.

| No.             | List   |
|-----------------|--------|
| 34-2 2-oz. Tube | \$0.50 |

**G-C PLASTIC CEMENT**

For cementing broken plastic cabinets, knobs, dial and crystal assemblies, grille cloth, etc. Fast drying. Brush attached.

| No.           | List   |
|---------------|--------|
| 32-2A 2-oz.   | \$0.60 |
| 32-8A 8-oz.   | 1.75   |
| 32-16A 16-oz. | 3.30   |



**G-C BAKELITE CEMENT**

For cementing bakelite to bakelite and bakelite to other materials. For repairing knobs, cabinets, panels, for inserts in moldings, attaching labels to plastics, etc. Brush attached.

| No.          | List   |
|--------------|--------|
| 32-2 2-oz.   | \$0.60 |
| 32-8 8-oz.   | 2.20   |
| 32-16 16-oz. | 4.15   |

**G-C VINYLITE CEMENT**

Clear transparent adhesive, air drying. For cementing metals, plastics, paper, leather, etc. Used also as thermoplastic cement for non-porous materials. Sets on cooling. Brush attached.

| No.        | List   |
|------------|--------|
| 58-2 2-oz. | \$0.60 |
| 58-8 8-oz. | 1.75   |

**G-C HOUSEHOLD & MODEL CEMENT**

Best cement for model makers, household, and office use. For airplanes, railroads, ships, toys, etc. Will cement wood, paper, plastics, metal, china, ceramics, etc. Fast drying, water-proof. Brush attached.

| No.        | List   |
|------------|--------|
| 45-2 2-oz. | \$0.50 |
| 45-3 Tube  | .50    |

**G-C FABRIC TO METAL CEMENT**

For cementing cloth and felt to metal or plastics. Best for grille cloth, phono turntable felts, upholstery, fabrics, etc. Fast drying, water-proof.

| No.          | List   |
|--------------|--------|
| 22-4 4-oz.   | \$0.70 |
| 22-8 8-oz.   | 1.00   |
| 22-16 16-oz. | 1.95   |

**G-C GRAY RUBBER CEMENT**

General purpose for cloth, paper, rubber, etc. Has great tackiness and adhesion for radio, shop, auto, or hobby use.

| No.          | List   |
|--------------|--------|
| 23-4 4-oz.   | \$0.70 |
| 23-8 8-oz.   | 1.00   |
| 23-16 16-oz. | 1.95   |

**G-C GRILLE CLOTH CEMENT**

Rubber base cement for grille cloth, leatherette, fabric, upholstery, etc. Will not penetrate, stain, or shrink.

| No.          | List   |
|--------------|--------|
| 38-4 4-oz.   | \$0.70 |
| 38-8 8-oz.   | 1.00   |
| 38-16 16-oz. | 1.95   |



**G-C RUBBER TO METAL DIAL DRIVE CEMENT**

For cementing rubber drives to shafts, rubber mountings, gaskets, hose, weather stripping, for radios, refrigerators, autos, etc.

| No.          | List   |
|--------------|--------|
| 35-2 2-oz.   | \$0.50 |
| 35-3 Tube    | .50    |
| 35-4 4-oz.   | 1.00   |
| 35-8 8-oz.   | 1.75   |
| 35-16 16-oz. | 3.30   |

**G-C WOOD GLUE**

New white resin water-proof glue for radio cabinets, furniture, chairs, etc. Will not injure finish. Extra strong.

| No.          | List   |
|--------------|--------|
| 39-2 2-oz.   | \$0.60 |
| 39-4 4-oz.   | .70    |
| 39-8 8-oz.   | 1.00   |
| 39-16 16-oz. | 1.65   |

**G-C ELECTRICAL AND RESISTOR CEMENT**

Heat-proof cement, hardens like porcelain. Same as on resistors, flat irons, etc.

| No.        | List   |
|------------|--------|
| 27-2 2-oz. | \$0.60 |

**G-C FILM CEMENT**

New improved cement for all safety and nitrate film. Sets fast. Brush attached.

| No.        | List   |
|------------|--------|
| 33-1 1-oz. | \$0.40 |

**G-C ACRYLIC CEMENT**

Welds and cements lucite, plexiglass, and other acrylic materials. Strong, fast drying. Brush attached.

| No.        | List   |
|------------|--------|
| 40-2 2-oz. | \$0.60 |

**G-C LABEL CEMENT**

Sticks labels to anything — metal, glass, wood, tin, bakelite, plastics, etc. Good for cementing labels to bins, racks, water-proofing labels, etc.

| No.        | List   |
|------------|--------|
| 46-2 2-oz. | \$0.60 |
| 46-8 8-oz. | 1.50   |



**G-C ART-X RUBBER CEMENT**

Transparent, pure, real rubber cement for artist and layout work. Will not stain or shrink paper, can be easily removed. Handy for panel layout, photo mounting, etc.

| No.          | List   |
|--------------|--------|
| 33-4 4-oz.   | \$0.50 |
| 33-8 8-oz.   | .75    |
| 33-16 16-oz. | 1.25   |

**G-C No. 67 PAINT THINNER**

For Ruf-Koat, Krome-Koat, B-K Cement, Insulating Varnish, Rubber Cements, and ordinary paints.

| No.          | List   |
|--------------|--------|
| 67-2 2-oz.   | \$0.50 |
| 67-4 4-oz.   | .65    |
| 67-8 8-oz.   | .95    |
| 67-16 16-oz. | 1.40   |

**G-C Q-DOPE THINNER**

Will cut and dissolve Q-Dope and other polystyrene coil dopes and cements. Will soften and weld polystyrene rods tubes, sheets, etc.

| No.        | List   |
|------------|--------|
| 41-2 2-oz. | \$0.50 |
| 41-4 4-oz. | .65    |
| 41-8 8-oz. | 1.00   |

**G-C LACQUER THINNER**

Will thin all lacquers, lacquer enamels, telephone black or gray, touch-up lacquers, airplane dopes, model cements, etc.

| No.          | List   |
|--------------|--------|
| 29-2 2-oz.   | \$0.50 |
| 29-4 4-oz.   | .65    |
| 29-8 8-oz.   | .95    |
| 29-16 16-oz. | 1.40   |

**G-C SAMPLER KIT**

What kind of cement shall I use? Get this kit and experiment with all types of cements available. Cements for all applications included so you can try them yourself for your application. Save time — get the answer quicker. 10 — 2-oz. bottles in Kit.

| No.     | List   |
|---------|--------|
| 345 Kit | \$6.00 |



**G-C COIL DOPE KIT**  
 For high frequency coils, ultra low loss. Contains 2-oz. bottle Polystyrene Q-Dope, 2-oz. Thinner, and 2 brushes. The best!  
 No. 888 Kit List \$1.00

**G-C CEMENT & SOLVENT KIT**  
 "Handy to carry with you." Contains bottle G-C Radio Cement and G-C Solvent, with brushes.  
 No. 343 Kit List \$0.75

**G-C CONTACT & ATTENUATOR KIT**  
 For cleaning and lubricating attenuator, tuners, contacts, all-wave switches, condenser bearings, etc. Eliminates noise and prevents corrosion.  
 No. 777 Kit List \$1.00

**G-C INSULATING & DIPPING VARNISH**  
 For treating field coils, noisy or buzzing transformers and chokes. Air dries to a tough insulating film. Can be brushed or dipped.  
 No. 56-2 2-oz. \$0.60  
 56-4 4-oz. .85  
 56-8 8-oz. 1.10  
 56-16 16-oz. 1.95

**G-C LIQUIDOPE**  
 All wave nitrocellulose base dope for coils. Air dries fast to tough film, that insures toughness and firmness. Use for sealing, doping, supporting coils, etc.  
 No. 36-2 2-oz. \$0.60  
 36-8 8-oz. 1.40  
 36-16 16-oz. 2.50

**G-C Q-DOPE**  
 Liquid polystyrene ultra low loss coil dope for RF, UHF, and VHF components. Will not change R.F. circuit values. Performs — 70°F to 160°F. Also use as Polystyrene Cement.  
 No. 37-2 2-oz. \$0.60  
 37-4 4-oz. .85  
 37-8 8-oz. 1.40  
 37-16 16-oz. 2.50



**G-C FUNGUS VARNISH**  
 Used on radio equipment and instruments to insulate and prevent fungus growth in moist or humid climates. Air dry, brush or spray.  
 No. 57-2 2-oz. \$0.60  
 57-8 8-oz. 1.10  
 57-16 16-oz. 1.65

**G-C CONTACT & CRYSTAL CLEANER**  
 Extra pure cleaner. Fast drying for cleaning contacts and crystals. Will not injure delicate parts.  
 No. 127-2 2-oz. \$0.50  
 127-4 4-oz. .65  
 127-8 8-oz. .85  
 127-16 16-oz. 1.20

**G-C RED ELECTRONIC CONTACT CLEANER**  
 The best and only all-purpose cleaner. Dissolves the dirt and removes corrosion. Leaves protective film on contacts to prevent corrosion.  
 No. 210-2 2-oz. \$0.50  
 210-4 4-oz. .70  
 210-8 8-oz. 1.00  
 210-16 16-oz. 1.80

**G-C RADIO CHASSIS CLEANER**  
 Clean the chassis and make extra money on every repair job. Satisfy your customer. For radio chassis, panels, testers, etc. Non-explosive cleaner.  
 No. 123-8 8-oz. \$0.70  
 123-16 16-oz. 1.10  
 123-G 1 Gal. 4.25

**G-C CARBON TETRA-CHLORIDE**  
 100% pure for cleaning and degreasing electrical contacts, controls, motors. Absolutely safe — will not burn. Also kills bugs, roaches, etc.  
 No. 211-2 2-oz. \$0.50  
 211-4 4-oz. .65  
 211-8 8-oz. .95  
 211-16 16-oz. 1.65  
 211-32 32-oz. 2.70  
 211-G 1 Gal. 6.90

**G-C CONTACT DOPE**  
 Ideal cleaner and lubricant for switches, controls and contacts. Resists corrosion and oxidation. Eliminates noise.  
 No. 1213 Tube \$0.40  
 1214 2-oz. .60

**CARB-O-TET**  
 Specially made from 100% Carbon-Tet materials.  
 215-G 1 Gal. \$4.15



**G-C CARBON CONTROL CLEANER**  
 Fix noisy carbon controls without taking apart. Just squirt cleaner along shaft and job is done. Save money. Applicator supplied.  
 No. 212-2 2-oz. \$0.60

**G-C GRAFOLINE**  
 Noiseless lubricant for air exposed switch contacts, rheostats, relays, wire volume controls, tube prongs, etc. Increases current capacity of switch controls. Cleans also.  
 No. 120-2 2-oz. \$0.60

**G-C CARBON-X**  
 New improved formula. Fix those old noisy carbon controls, touch up noisy spots on worn controls. Brush in bottle.  
 No. 1204 1-oz. \$0.75  
 1205 2-oz. 1.00

**G-C LUBE-REX**  
 Lubriplate — white lubricant for push buttons, phonographs, Philco mystery controls, guns, fishing reels, dials, etc. Prevents corrosion, repels water.  
 No. 1206 2-oz. Tube \$0.60  
 1209 2-oz. Bottle .60

**G-C SILICONE COMPOUND**  
 "The miracle moisture and water-proofing compound for Television and FM" A permanent water-proofing material for TV and FM leads.  
 No. 81001-oz. Tube \$1.65  
 Dealer's Net .99

**G-C LIQUID SOLDER FLUX**  
 Non-corrosive flux for radio and electrical work. Solders faster, smoother.  
 No. 42-2 2-oz. \$0.60  
 42-8 8-oz. 1.75



**G-C CHEMICAL LABORATORY**  
 Complete assortment of 20 popular radio chemicals and cements in 2-oz. bottles, put up on steel rack. Very neat for the radio bench and home work shop. Rack sets on bench or hangs on wall. Steel Rack is FREE.  
 No. 997 Lab List \$11.70  
 Dealer's Net 6.99

**G-C CHEMICAL KIT**  
 Pocket size kit of 8 popular radio chemicals and cements, for fast repairs on the job. Put up in neat leatherette case. Easy to carry.  
 No. 999 List \$3.30  
 — Refills available at your jobbers —

**G-C DELUXE CHEMICAL LAB**  
 Practical larger laboratory of popular chemicals and cements to fit needs of average shop — 2-oz., 4-oz., and 8-oz. bottles. Larger bottles of more popular items. Rack sets on bench or hangs on wall. Steel rack is FREE.  
 No. 998 List \$14.30  
 Dealer's Net 8.49

GENERAL



CEMENT

# PAINTS—KITS—COMPOUNDS



### G-C RUF-KOAT WRINKLE VARNISH

Air Dry or Bake

The only finish that will air dry and give professional wrinkle job without baking. Same as used by leading manufacturers. Don't experiment — use the best. Apply and let dry. Colors: Black, Gray, Brown, Green, Red and Blue (Specify Color).

| No.          | List   |
|--------------|--------|
| 60-2 2-oz.   | \$0.60 |
| 60-4 4-oz.   | 1.00   |
| 60-8 8-oz.   | 1.75   |
| 60-16 16-oz. | 3.00   |

### G-C KRISTAL KOAT CRYSTALLIZING LACQUER

Makes beautiful floral pattern when dry. Strictly air drying. For chassis, panels, decorations on metal, wood, paper, etc. Colors: Black, Gray, Brown, Green, Red, Blue and Clear. (Specify Color).

| No.          | List   |
|--------------|--------|
| 63-2 2-oz.   | \$0.60 |
| 63-4 4-oz.   | 1.00   |
| 63-8 8-oz.   | 1.75   |
| 63-16 16-oz. | 3.00   |

### G-C TELEPHONE BLACK OR GRAY

High grade lacquer enamel covers well, dries fast. Black is satin ebony finish similar to telephones. Gray is pleasing shade. For panels, racks, parts, etc. (Specify Color).

| No.          | List   |
|--------------|--------|
| 62-2 2-oz.   | \$0.60 |
| 62-8 8-oz.   | 1.40   |
| 62-16 16-oz. | 2.50   |

### G-C GENERAL SCRATCH STICK

Removes scratches. Simply run over scratches and they will disappear. Handy to carry in your pocket or tool box for emergency repairs. Also sell to housewives.

| No.                    | List   |
|------------------------|--------|
| 909 Seratch Stik       | \$0.40 |
| 909-D Display 12 Stiks | 4.80   |



### G-C KROME-KOAT ALUMINUM PAINT

Fast drying, ready mixed, leaves chrome-like finish. For PA equipment, speakers, chassis, towers, antennas, etc.

| No.          | List   |
|--------------|--------|
| 61-2 2-oz.   | \$0.60 |
| 61-4 4-oz.   | .85    |
| 61-8 8-oz.   | 1.40   |
| 61-16 16-oz. | 2.20   |

### G-C PORCELAIN GLAZE

Fills in nicks and dents on porcelain and duco refrigerators, sinks, washing machines, etc. Fill in and let dry.

| No.           | List   |
|---------------|--------|
| 911 2-oz.     | \$0.60 |
| 911-16 16-oz. | 3.85   |

### G-C SPIRIT VARNISH

Fast drying walnut spirit varnish for touching up nicks and scratches. Will not raise the finish.

| No.           | List   |
|---------------|--------|
| 161-2 2-oz.   | \$0.60 |
| 161-4 4-oz.   | .85    |
| 161-8 8-oz.   | 1.40   |
| 161-16 16-oz. | 2.20   |

### G-C PENETRATING STAIN

Spirit type stain, penetrates and will not injure finish. Covers scratches, dents, darkens corners on cabinets, etc. Walnut.

| No.           | List   |
|---------------|--------|
| 162-2 2-oz.   | \$0.50 |
| 162-4 4-oz.   | .85    |
| 162-8 8-oz.   | 1.40   |
| 162-16 16-oz. | 2.20   |

### G-C MICROPHONE CARBON GRANULES

Polished pure carbon granules for microphones.

| No.                                    | List   |
|--|--------|
| 1281 100 Size                          | \$0.80 |
| Highest Sensitivity                    |        |
| 1282 80 Size                           | .80    |
| Best for General Use                   |        |
| 1283 60 Size                           | .80    |
| Best for Hard Use — Sound Trucks, etc. |        |

### G-C SCRATCH REMOVER LIQUID

New liquid! Removes scratches instantly. Simply wipe over scratches. Handy to have in tool box.

| No.         | List   |
|-------------|--------|
| 917 2-oz.   | \$0.50 |
| 923 1/2-oz. | .30    |

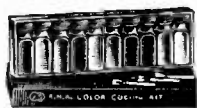

### G-C RMA COLOR CODING KIT

Complete kit of all standard RMA colors to code resistors, condensers, parts, etc. Chart included. Ten bottles.

|         |             |
|---------|-------------|
| No. 677 | List \$1.95 |
|---------|-------------|

### G-C TOUCH UP CODING KIT

Five bottles, 4 colors and solvent for coding and sealing parts, adjustments, wires, etc. Red, Green, Blue, Yellow and Solvent.

|         |             |
|---------|-------------|
| No. 675 | List \$0.85 |
|---------|-------------|

### G-C DIAL LITE COLOR KIT

Long lasting coloring for dials, signals, lamps, panels, hobby work, etc. Red, Green, Blue, Amber, Purple and Solvent in kit.

| No.                          | List   |
|------------------------------|--------|
| 66-6 Kit                     | \$1.00 |
| 66-5 Kit no purple           | .85    |
| 66-2 2-oz. (Specify color)   | .60    |
| 66-16 16-oz. (specify color) | 2.50   |

### G-C LUMINOUS KITS

Complete kits of luminous paint that glows in the dark. Many uses in shop and home. See it at night. Easy to use — apply and let dry.

| No.   | List   |
|---|--------|
| 184-0 DeLuxe kit contains Powder, Mix-Koat, Top Koat and Brush. | \$2.50 |
| 184-1 Regular kit contains Powder, Mix-Koat and Brush.          | \$1.65 |

### G-C LUMINOUS MATERIALS

#### LITE-KOAT POWDER

| No.         | List   |
|-------------|--------|
| 185-1 1-oz. | \$0.95 |
| 185-2 2-oz. | 1.65   |

#### COVER-KOAT

To protect and cover luminous material.

| No.         | List   |
|-------------|--------|
| 187-2 2-oz. | \$0.60 |
| 187-8 8-oz. | 1.25   |

#### MIX-KOAT

To mix with powder.

| No.         | List   |
|-------------|--------|
| 186-2 2-oz. | \$0.60 |
| 186-8 8-oz. | 1.25   |

#### MIX-KOAT AND COVER-KOAT THINNER

| No.         | List   |
|-------------|--------|
| 188-2 2-oz. | \$0.60 |
| 188-8 8-oz. | 1.25   |



### G-C DIAL OIL

Made with graphite. Special for lubricating dials, drives, and fine mechanisms. Long lasting.

| No.        | List   |
|------------|--------|
| 1245 4-oz. | \$0.50 |

### G-C REFRIGERATOR AND APPLIANCE OIL

Non-gumming oil for household appliances and small motors. The best general purpose oil.

| No.        | List   |
|------------|--------|
| 1250 4-oz. | \$0.50 |

### G-C SOLDERING PASTE

The best non-corrosive paste for radio and electrical work. Solders faster and smoother.

| No.            | List   |
|----------------|--------|
| 1207 2-oz. can | \$0.30 |

### G-C NON-STICK IRON TIP COMPOUND

Prevents soldering iron tips from burning into iron. Saves your iron and tips.

| No.        | List   |
|------------|--------|
| 1201 2-oz. | \$0.60 |

### G-C NON-SLIP COMPOUND

#### Powder Compound

For dial cords, belts, pulleys, etc. Good for V or flat belts on refrigerators, motors, etc.

| No.  | List   |
|------|--------|
| 1210 | \$0.50 |

#### Liquid Compound

Penetrating, fast-drying liquid, prevents slipping on dial cords, pulleys, belts. Increases life of cords and belts.

| No.          | List   |
|--------------|--------|
| 1211 1/4-oz. | \$0.30 |
| 1215 2-oz.   | .60    |



GENERAL



CEMENT

**CABINET REPAIR KITS - POLISHES**



**G-C FRENCH EMULSION**

Best pad lubricant to use with French Varnish Polishing Method.

No. 164-4 4-oz. List \$0.55

**G-C FRENCH VARNISH**

Used by craftsmen to repair furniture and blend in the finish. Can be applied with pad, brush or spray. Dries fast.

No. 160-2 2-oz. List \$0.60  
160-4 4-oz. .75  
160-8 8-oz. 1.40

**G-C WINDOW CLEANER CONCENTRATE**

Mix with quart of water and make your own high-grade window cleaner. Makes glass sparkle.

No. 122-5 6-oz. List \$0.50

**G-C SPOT CLEANER**

Safe high-grade cleaner with special applicator in cap. Non-explosive.

No. 124-2 6-oz. List \$0.60

**G-C STRIP-X**

Strips enamel from magnet wire. Dip wire in and wipe insulation off—ready for soldering.

No. 26-2 2-oz. List \$0.60

**G-C CONE RECONDITIONER**

Apply to old dried out cones to restore plasticizer and bring back original tones.

No. 25-8 8-oz. List \$0.95  
25-16 16-oz. 1.65



**G-C RUBBING OIL**

Rub down newly finished or repaired cabinets to produce rich satin sheen finish.

No. 163-16 16-oz. List \$0.75

**G-C FLOOR WAX**

High-grade heavy duty commercial self-polishing floor wax. Gives hard, durable finish.

No. 97-G 1 Gal List \$6.55

**G-C LEMON OIL POLISH**

Inexpensive polish for removing dust, finger marks, treating dust rags, mops, etc. Picks up dust.

No. 91-8 8-oz. List \$0.45  
91-16 16-oz. .60

**G-C SCRATCH REMOVER POLISHES DARK**

Polish contains stains to remove scratches. Sell to housewives.

No. 92-2 2-oz. List \$0.30  
92-8 8-oz. .50  
92-8-L 8-oz. Lab. size .50  
92-16 16-oz. .85

**G-C SCRATCH REMOVER POLISHES LIGHT**

For light woods; polishes and removes scratches at same time. Popular with housewives.

No. 93-2 2-oz. List \$0.30  
93-8 8-oz. .50  
93-16 16-oz. .85

**G-C CREME-O-WAX POLISH**

White non-staining hard wax base polish produces a hard glossy finish. Excellent for radios, pianos, refrigerators, furniture, etc.

No. 95-2 2-oz. List \$0.30  
95-8 8-oz. .60  
95-8-L 8-oz. Lab. size .60  
95-16 16-oz. .90



**G-C REFRIGERATOR PATCH KIT**  
"New Improved Kit"

Supplies everything necessary to repair porcelain or Duco nicks, dents, or scratches. Kit contains bottle of pure white lacquer enamel and bottles of Yellow, Blue, Brown, and Black tinting colors, solvent, spatula, porcelain patch stick, sandpaper, and brushes. Useful on refrigerators, washers, ranges, table tops, etc. Directions included.

No. 902 List \$4.35

**G-C DELUXE CABINET REPAIR KIT**  
"New Improved Kit"

Comes in handy metal box. Contains ten shades of shellac sticks, bottles of light and dark oil stain, bottles of metal shading varnish, polish, General Scratch Stik, alcohol lamp (with alcohol), spatula, small brushes, steel wool, sandpaper, and wiping cloth. Everything necessary for a practical repair job. No special skill required. Directions included.

No. 901 List \$5.45

**G-C MASTER DELUXE CABINET REPAIR KIT**  
"New, Most Complete Kit"

A complete cabinet repair kit put in a permanent metal box. All finishes supplied are spirit soluble and will not cut or damage surrounding finishes on cabinets, etc. Kit contains 10 shellac sticks, alcohol lamp, French varnishes, rubbing felt and fluid, enamels, glue, steel wool, sandpaper, polish, directions, etc. Nothing else needed! The best buy on the market!

No. 900 List \$9.95



**G-C FRENCH VARNISH KIT**

Kit for French polishing. Only way to blend repairs with adjoining finish. Kit includes varnish, emulsion, pad, and instructions.

No. 160-0 List \$1.40

**G-C MAGIC SCRATCH KIT**

Combination of 6 shades fillers and light and dark scratch fluid. Easy to use on emergency jobs.

No. 915 List \$1.40

**G-C MASTER CABINET TOUCH-UP KIT**  
"Ideal Quick Touch-Up Kit"

A complete, fast touch-up kit for repairing scratches and dents. Works on wood and plastic cabinets. The spirit finishes will not cut into the adjoining surface or injure surrounding finish. Contains French varnish, emulsion, colored enamels, stains, polishes, and filler. Sandpaper, steel wool, rubbing cloth and directions included. Brushes attached to caps of all finish bottles. Put up in metal box.

No. 907 List \$3.25

**G-C RADIO-REFRIGERATOR CABINET PATCH KIT**  
"New Improved Kit"

A kit of the shellac patch sticks to fill all needs. Patches wood, plastics, bakelite and porcelain. Nine shellac sticks for the light and dark shades of wood, and black and white, alcohol lamp (with alcohol), spatula, steel wool, sandpaper and wiping cloth are packed in the metal box. Directions included.

No. 903 List \$3.85

# GRILLE CLOTH—FLOCK KITS

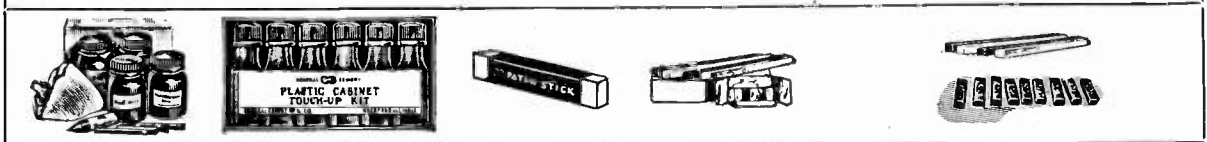

| <p><b>G-C TOUCH-UP KIT</b></p> <p>Practical for touching up small scratches and dents. Includes light and dark varnish and spirit stains, filler, cloth, brushes, etc.</p> <table border="1"> <tr><th>No.</th><th>List</th></tr> <tr><td>905 Kit</td><td>\$1.10</td></tr> </table> | No.    | List             | 905 Kit | \$1.10 | <p><b>G-C PLASTIC TOUCH-UP KIT</b></p> <p>Kit contains 6 colors touch-up lacquer enamels to fix up plastic and colored cabinets. Walnut, Ivory, Black, Red, Blue, Green, and brushes.</p> <table border="1"> <tr><th>No.</th><th>List</th></tr> <tr><td>910 Kit</td><td>\$1.40</td></tr> </table> | No. | List | 910 Kit | \$1.40 | <p><b>G-C PORCELAIN PATCH STICK</b></p> <p>Made for white porcelain refrigerators, sinks, ranges, fixtures, etc. Simply melt into nick and smooth off.</p> <table border="1"> <tr><th>No.</th><th>List</th></tr> <tr><td>908 Stick</td><td>\$0.40</td></tr> </table> | No. | List | 908 Stick | \$0.40 | <p><b>G-C SHELLAC STICK KIT</b></p> <p>Handy assortment of 10 colors to take care of any shade of wood. Same as in G-C Kits.</p> <table border="1"> <tr><th>No.</th><th>List</th></tr> <tr><td>925 Kit</td><td>\$1.80</td></tr> </table> | No. | List | 925 Kit | \$1.80 | <p><b>G-C SHELLAC STICKS</b></p> <p>High grade sticks for filling dents and nicks in wood cabinets and furniture. Sticks 7" long.</p> <table border="1"> <tr><th>No.</th><th>List</th><th>No.</th><th>List</th></tr> <tr><td>929 Lt. Walnut</td><td>\$0.50</td><td>979 Dk. Oak</td><td>\$0.50</td></tr> <tr><td>930 Dk. Walnut</td><td>.50</td><td>980 Transparent</td><td>.50</td></tr> <tr><td>933 Black</td><td>.50</td><td>981 Lt. Transp.</td><td>.50</td></tr> <tr><td>934 White</td><td>.50</td><td>982 Walnut</td><td>.50</td></tr> <tr><td>935 Maple</td><td>.50</td><td>983 Mahogany</td><td>.50</td></tr> <tr><td>978 Lt. Oak</td><td>.50</td><td>984 Blonde Maple</td><td>.50</td></tr> </table> | No. | List | No. | List | 929 Lt. Walnut | \$0.50 | 979 Dk. Oak | \$0.50 | 930 Dk. Walnut | .50 | 980 Transparent | .50 | 933 Black | .50 | 981 Lt. Transp. | .50 | 934 White | .50 | 982 Walnut | .50 | 935 Maple | .50 | 983 Mahogany | .50 | 978 Lt. Oak | .50 | 984 Blonde Maple | .50 |
|--|--------|------------------|---------|--------|---|-----|------|---------|--------|--|-----|------|-----------|--------|--|-----|------|---------|--------|--|-----|------|-----|------|----------------|--------|-------------|--------|----------------|-----|-----------------|-----|-----------|-----|-----------------|-----|-----------|-----|------------|-----|-----------|-----|--------------|-----|-------------|-----|------------------|-----|
| No.  | List   |                  |         |        |   |     |      |         |        |  |     |      |           |        |  |     |      |         |        |  |     |      |     |      |                |        |             |        |                |     |                 |     |           |     |                 |     |           |     |            |     |           |     |              |     |             |     |                  |     |
| 905 Kit  | \$1.10 |                  |         |        |   |     |      |         |        |  |     |      |           |        |  |     |      |         |        |  |     |      |     |      |                |        |             |        |                |     |                 |     |           |     |                 |     |           |     |            |     |           |     |              |     |             |     |                  |     |
| No.  | List   |                  |         |        |   |     |      |         |        |  |     |      |           |        |  |     |      |         |        |  |     |      |     |      |                |        |             |        |                |     |                 |     |           |     |                 |     |           |     |            |     |           |     |              |     |             |     |                  |     |
| 910 Kit  | \$1.40 |                  |         |        |   |     |      |         |        |  |     |      |           |        |  |     |      |         |        |  |     |      |     |      |                |        |             |        |                |     |                 |     |           |     |                 |     |           |     |            |     |           |     |              |     |             |     |                  |     |
| No.  | List   |                  |         |        |   |     |      |         |        |  |     |      |           |        |  |     |      |         |        |  |     |      |     |      |                |        |             |        |                |     |                 |     |           |     |                 |     |           |     |            |     |           |     |              |     |             |     |                  |     |
| 908 Stick  | \$0.40 |                  |         |        |   |     |      |         |        |  |     |      |           |        |  |     |      |         |        |  |     |      |     |      |                |        |             |        |                |     |                 |     |           |     |                 |     |           |     |            |     |           |     |              |     |             |     |                  |     |
| No.  | List   |                  |         |        |   |     |      |         |        |  |     |      |           |        |  |     |      |         |        |  |     |      |     |      |                |        |             |        |                |     |                 |     |           |     |                 |     |           |     |            |     |           |     |              |     |             |     |                  |     |
| 925 Kit  | \$1.80 |                  |         |        |   |     |      |         |        |  |     |      |           |        |  |     |      |         |        |  |     |      |     |      |                |        |             |        |                |     |                 |     |           |     |                 |     |           |     |            |     |           |     |              |     |             |     |                  |     |
| No.  | List   | No.              | List    |        |   |     |      |         |        |  |     |      |           |        |  |     |      |         |        |  |     |      |     |      |                |        |             |        |                |     |                 |     |           |     |                 |     |           |     |            |     |           |     |              |     |             |     |                  |     |
| 929 Lt. Walnut   | \$0.50 | 979 Dk. Oak      | \$0.50  |        |   |     |      |         |        |  |     |      |           |        |  |     |      |         |        |  |     |      |     |      |                |        |             |        |                |     |                 |     |           |     |                 |     |           |     |            |     |           |     |              |     |             |     |                  |     |
| 930 Dk. Walnut   | .50    | 980 Transparent  | .50     |        |   |     |      |         |        |  |     |      |           |        |  |     |      |         |        |  |     |      |     |      |                |        |             |        |                |     |                 |     |           |     |                 |     |           |     |            |     |           |     |              |     |             |     |                  |     |
| 933 Black  | .50    | 981 Lt. Transp.  | .50     |        |   |     |      |         |        |  |     |      |           |        |  |     |      |         |        |  |     |      |     |      |                |        |             |        |                |     |                 |     |           |     |                 |     |           |     |            |     |           |     |              |     |             |     |                  |     |
| 934 White  | .50    | 982 Walnut       | .50     |        |   |     |      |         |        |  |     |      |           |        |  |     |      |         |        |  |     |      |     |      |                |        |             |        |                |     |                 |     |           |     |                 |     |           |     |            |     |           |     |              |     |             |     |                  |     |
| 935 Maple  | .50    | 983 Mahogany     | .50     |        |   |     |      |         |        |  |     |      |           |        |  |     |      |         |        |  |     |      |     |      |                |        |             |        |                |     |                 |     |           |     |                 |     |           |     |            |     |           |     |              |     |             |     |                  |     |
| 978 Lt. Oak  | .50    | 984 Blonde Maple | .50     |        |   |     |      |         |        |  |     |      |           |        |  |     |      |         |        |  |     |      |     |      |                |        |             |        |                |     |                 |     |           |     |                 |     |           |     |            |     |           |     |              |     |             |     |                  |     |



| <p><b>G-C FELT KOAT FLOCK KIT</b></p> <p>New G-C kit with special blower gun. Distributes flock evenly and applies a thick velvet-like coat. Kit is complete with gun, brown and ivory flock, brown and ivory undercoat, thinner, brush, etc. Gives professional job on turntables, cabinets, grilles, tool boxes, toys, signs, etc. Has thousands of applications.</p> <table border="1"> <tr><th>No.</th><th>List</th></tr> <tr><td>180-2 Kit</td><td>\$10.50</td></tr> </table> | No.     | List | 180-2 Kit | \$10.50 | <p><b>G-C FELT KOAT KITS</b></p> <p>Complete flock kit with flock undercoat, thinner and brushes and shaker type can for applying flock. Colors: Brown, Blue, Taupe, Black, White, Ivory, Red, Green, Silver and Gold. (Specify Color).</p> <table border="1"> <tr><th>No.</th><th>List</th></tr> <tr><td>180-0 DeLuxe Kit</td><td>\$3.00</td></tr> <tr><td>180-1 Reg. Kit (No brush or thinner)</td><td>2.15</td></tr> </table> | No. | List | 180-0 DeLuxe Kit | \$3.00 | 180-1 Reg. Kit (No brush or thinner) | 2.15 | <p><b>G-C FLOCK BLOWER GUN</b></p> <p>It's easy to apply flock and be sure to get a good job with the G-C Patented Gun. Gun can also be used for dusting and cleaning.</p> <table border="1"> <tr><th>No.</th><th>List</th></tr> <tr><td>180-3 Gun</td><td>\$4.35</td></tr> <tr><td>180-4-N Cleaning Nozzle for Gun</td><td>.65</td></tr> </table> | No. | List | 180-3 Gun | \$4.35 | 180-4-N Cleaning Nozzle for Gun | .65 | <p><b>G-C FLOCK UNDERCOAT</b></p> <p>Material is first applied on surface to be flocked. Then flock is applied. Used on metal, wood, paper, etc. Colors: Brown, Taupe, Blue, Black, White, Ivory, Red, Green, Silver and Gold. (Specify Color).</p> <table border="1"> <tr><th>No.</th><th>List</th></tr> <tr><td>180-4 4-oz.</td><td>\$1.10</td></tr> <tr><td>180-8 8-oz.</td><td>1.95</td></tr> <tr><td>180-16 16-oz.</td><td>3.00</td></tr> </table> | No. | List | 180-4 4-oz. | \$1.10 | 180-8 8-oz. | 1.95 | 180-16 16-oz. | 3.00 | <p><b>G-C RUBBER BASE UNDER-COAT</b></p> <p>Use as flock sizing on fabrics, upholstering, turntables, etc. Makes pliable coating.</p> <table border="1"> <tr><th>No.</th><th>List</th></tr> <tr><td>182-4 4-oz.</td><td>\$1.00</td></tr> <tr><td>182-8 8-oz.</td><td>1.75</td></tr> <tr><td>182-16 16-oz.</td><td>2.50</td></tr> </table> <p><b>FLOCK SIZING THINNER</b></p> <table border="1"> <tr><th>No.</th><th>List</th></tr> <tr><td>181-4 4-oz.</td><td>\$0.45</td></tr> <tr><td>181-8 8-oz.</td><td>.60</td></tr> <tr><td>181-16 16-oz.</td><td>.85</td></tr> <tr><td>181-G 1 Gal.</td><td>4.15</td></tr> </table> | No. | List | 182-4 4-oz. | \$1.00 | 182-8 8-oz. | 1.75 | 182-16 16-oz. | 2.50 | No. | List | 181-4 4-oz. | \$0.45 | 181-8 8-oz. | .60 | 181-16 16-oz. | .85 | 181-G 1 Gal. | 4.15 |
|--|---------|------|-----------|---------|--|-----|------|------------------|--------|--------------------------------------|------|--|-----|------|-----------|--------|---------------------------------|-----|---|-----|------|-------------|--------|-------------|------|---------------|------|--|-----|------|-------------|--------|-------------|------|---------------|------|-----|------|-------------|--------|-------------|-----|---------------|-----|--------------|------|
| No.  | List    |      |           |         |  |     |      |                  |        |                                      |      |  |     |      |           |        |                                 |     |   |     |      |             |        |             |      |               |      |  |     |      |             |        |             |      |               |      |     |      |             |        |             |     |               |     |              |      |
| 180-2 Kit  | \$10.50 |      |           |         |  |     |      |                  |        |                                      |      |  |     |      |           |        |                                 |     |   |     |      |             |        |             |      |               |      |  |     |      |             |        |             |      |               |      |     |      |             |        |             |     |               |     |              |      |
| No.  | List    |      |           |         |  |     |      |                  |        |                                      |      |  |     |      |           |        |                                 |     |   |     |      |             |        |             |      |               |      |  |     |      |             |        |             |      |               |      |     |      |             |        |             |     |               |     |              |      |
| 180-0 DeLuxe Kit   | \$3.00  |      |           |         |  |     |      |                  |        |                                      |      |  |     |      |           |        |                                 |     |   |     |      |             |        |             |      |               |      |  |     |      |             |        |             |      |               |      |     |      |             |        |             |     |               |     |              |      |
| 180-1 Reg. Kit (No brush or thinner)   | 2.15    |      |           |         |  |     |      |                  |        |                                      |      |  |     |      |           |        |                                 |     |   |     |      |             |        |             |      |               |      |  |     |      |             |        |             |      |               |      |     |      |             |        |             |     |               |     |              |      |
| No.  | List    |      |           |         |  |     |      |                  |        |                                      |      |  |     |      |           |        |                                 |     |   |     |      |             |        |             |      |               |      |  |     |      |             |        |             |      |               |      |     |      |             |        |             |     |               |     |              |      |
| 180-3 Gun  | \$4.35  |      |           |         |  |     |      |                  |        |                                      |      |  |     |      |           |        |                                 |     |   |     |      |             |        |             |      |               |      |  |     |      |             |        |             |      |               |      |     |      |             |        |             |     |               |     |              |      |
| 180-4-N Cleaning Nozzle for Gun  | .65     |      |           |         |  |     |      |                  |        |                                      |      |  |     |      |           |        |                                 |     |   |     |      |             |        |             |      |               |      |  |     |      |             |        |             |      |               |      |     |      |             |        |             |     |               |     |              |      |
| No.  | List    |      |           |         |  |     |      |                  |        |                                      |      |  |     |      |           |        |                                 |     |   |     |      |             |        |             |      |               |      |  |     |      |             |        |             |      |               |      |     |      |             |        |             |     |               |     |              |      |
| 180-4 4-oz.  | \$1.10  |      |           |         |  |     |      |                  |        |                                      |      |  |     |      |           |        |                                 |     |   |     |      |             |        |             |      |               |      |  |     |      |             |        |             |      |               |      |     |      |             |        |             |     |               |     |              |      |
| 180-8 8-oz.  | 1.95    |      |           |         |  |     |      |                  |        |                                      |      |  |     |      |           |        |                                 |     |   |     |      |             |        |             |      |               |      |  |     |      |             |        |             |      |               |      |     |      |             |        |             |     |               |     |              |      |
| 180-16 16-oz.  | 3.00    |      |           |         |  |     |      |                  |        |                                      |      |  |     |      |           |        |                                 |     |   |     |      |             |        |             |      |               |      |  |     |      |             |        |             |      |               |      |     |      |             |        |             |     |               |     |              |      |
| No.  | List    |      |           |         |  |     |      |                  |        |                                      |      |  |     |      |           |        |                                 |     |   |     |      |             |        |             |      |               |      |  |     |      |             |        |             |      |               |      |     |      |             |        |             |     |               |     |              |      |
| 182-4 4-oz.  | \$1.00  |      |           |         |  |     |      |                  |        |                                      |      |  |     |      |           |        |                                 |     |   |     |      |             |        |             |      |               |      |  |     |      |             |        |             |      |               |      |     |      |             |        |             |     |               |     |              |      |
| 182-8 8-oz.  | 1.75    |      |           |         |  |     |      |                  |        |                                      |      |  |     |      |           |        |                                 |     |   |     |      |             |        |             |      |               |      |  |     |      |             |        |             |      |               |      |     |      |             |        |             |     |               |     |              |      |
| 182-16 16-oz.  | 2.50    |      |           |         |  |     |      |                  |        |                                      |      |  |     |      |           |        |                                 |     |   |     |      |             |        |             |      |               |      |  |     |      |             |        |             |      |               |      |     |      |             |        |             |     |               |     |              |      |
| No.  | List    |      |           |         |  |     |      |                  |        |                                      |      |  |     |      |           |        |                                 |     |   |     |      |             |        |             |      |               |      |  |     |      |             |        |             |      |               |      |     |      |             |        |             |     |               |     |              |      |
| 181-4 4-oz.  | \$0.45  |      |           |         |  |     |      |                  |        |                                      |      |  |     |      |           |        |                                 |     |   |     |      |             |        |             |      |               |      |  |     |      |             |        |             |      |               |      |     |      |             |        |             |     |               |     |              |      |
| 181-8 8-oz.  | .60     |      |           |         |  |     |      |                  |        |                                      |      |  |     |      |           |        |                                 |     |   |     |      |             |        |             |      |               |      |  |     |      |             |        |             |      |               |      |     |      |             |        |             |     |               |     |              |      |
| 181-16 16-oz.  | .85     |      |           |         |  |     |      |                  |        |                                      |      |  |     |      |           |        |                                 |     |   |     |      |             |        |             |      |               |      |  |     |      |             |        |             |      |               |      |     |      |             |        |             |     |               |     |              |      |
| 181-G 1 Gal.   | 4.15    |      |           |         |  |     |      |                  |        |                                      |      |  |     |      |           |        |                                 |     |   |     |      |             |        |             |      |               |      |  |     |      |             |        |             |      |               |      |     |      |             |        |             |     |               |     |              |      |



| <p><b>G-C FELT-KOAT FLOCK</b></p> <p>Genuine Rayon Flock, <math>\frac{1}{8}</math>" length fibers accurately cut, give beautiful even finish. One pound covers approximately 90 sq. ft. Colors: Brown, Taupe, Blue, Black, White, Ivory, Red, Green, Silver, and Gold. (Specify Color).</p> <table border="1"> <tr><th>No.</th><th>List</th></tr> <tr><td>180-5 2-oz. Can</td><td>\$1.00</td></tr> <tr><td>180-6 1/2-lb. Bag</td><td>3.00</td></tr> <tr><td>180-7 1-lb. Bag</td><td>5.00</td></tr> </table> | No.         | List | 180-5 2-oz. Can | \$1.00 | 180-6 1/2-lb. Bag | 3.00 | 180-7 1-lb. Bag | 5.00 | <p><b>G-C GENERAL SCRATCH STICK</b></p> <p>Removes scratches. Simply run over scratches and they will disappear. Handy to carry in your pocket or tool box for emergency repairs. Also sell to housewives.</p> <table border="1"> <tr><th>No.</th><th>List</th></tr> <tr><td>909 Scratch Stik</td><td>\$0.40</td></tr> <tr><td>909-D Display 12 Stiks</td><td>4.80</td></tr> </table> <p><b>1-A SKRATCH STIK DEAL — WIRE DISPLAY FOR DEALERS</b></p> <p>Dealers and servicemen — Display the No. 1-A Skratch Stik deal in your shop or store and sell Skratch Stiks to your customers. Every home and office needs one. You can earn extra profit with this self-selling display.</p> <table border="1"> <tr><td>No. 1-A Deal 12 Skratch Stiks Wire</td><td>List \$5.35</td></tr> <tr><td>Dealer's Net</td><td>2.88*</td></tr> </table> | No. | List | 909 Scratch Stik | \$0.40 | 909-D Display 12 Stiks | 4.80 | No. 1-A Deal 12 Skratch Stiks Wire | List \$5.35 | Dealer's Net | 2.88* | <p><b>G-C LUGGAGE FABRIC</b></p> <p>Airplane type fabric for portables, test instruments, cabinets, etc. Colors: Gray and Brown. (Specify Color).</p> <table border="1"> <tr><th>No.</th><th>List</th></tr> <tr><td>960 18" x 18"</td><td>\$0.85</td></tr> <tr><td>961 36" x 18"</td><td>1.65</td></tr> <tr><td>962 Any length, 36" wide, per yard</td><td>3.05</td></tr> </table> | No. | List | 960 18" x 18" | \$0.85 | 961 36" x 18" | 1.65 | 962 Any length, 36" wide, per yard | 3.05 | <p><b>G-C INSTRUMENT FABRIC</b></p> <p>Leatherette fabric to cover cabinets and instruments. Same as used by manufacturers. Colors: Black and Brown. (Specify Color).</p> <table border="1"> <tr><th>No.</th><th>List</th></tr> <tr><td>965 18" x 16"</td><td>\$0.85</td></tr> <tr><td>966 18" x 32"</td><td>1.65</td></tr> <tr><td>967 Any length, per yard</td><td>3.05</td></tr> </table> | No. | List | 965 18" x 16" | \$0.85 | 966 18" x 32" | 1.65 | 967 Any length, per yard | 3.05 |
|---|-------------|------|-----------------|--------|-------------------|------|-----------------|------|---|-----|------|------------------|--------|------------------------|------|------------------------------------|-------------|--------------|-------|--|-----|------|---------------|--------|---------------|------|------------------------------------|------|--|-----|------|---------------|--------|---------------|------|--------------------------|------|
| No.   | List        |      |                 |        |                   |      |                 |      |   |     |      |                  |        |                        |      |                                    |             |              |       |  |     |      |               |        |               |      |                                    |      |  |     |      |               |        |               |      |                          |      |
| 180-5 2-oz. Can   | \$1.00      |      |                 |        |                   |      |                 |      |   |     |      |                  |        |                        |      |                                    |             |              |       |  |     |      |               |        |               |      |                                    |      |  |     |      |               |        |               |      |                          |      |
| 180-6 1/2-lb. Bag   | 3.00        |      |                 |        |                   |      |                 |      |   |     |      |                  |        |                        |      |                                    |             |              |       |  |     |      |               |        |               |      |                                    |      |  |     |      |               |        |               |      |                          |      |
| 180-7 1-lb. Bag   | 5.00        |      |                 |        |                   |      |                 |      |   |     |      |                  |        |                        |      |                                    |             |              |       |  |     |      |               |        |               |      |                                    |      |  |     |      |               |        |               |      |                          |      |
| No.   | List        |      |                 |        |                   |      |                 |      |   |     |      |                  |        |                        |      |                                    |             |              |       |  |     |      |               |        |               |      |                                    |      |  |     |      |               |        |               |      |                          |      |
| 909 Scratch Stik  | \$0.40      |      |                 |        |                   |      |                 |      |   |     |      |                  |        |                        |      |                                    |             |              |       |  |     |      |               |        |               |      |                                    |      |  |     |      |               |        |               |      |                          |      |
| 909-D Display 12 Stiks  | 4.80        |      |                 |        |                   |      |                 |      |   |     |      |                  |        |                        |      |                                    |             |              |       |  |     |      |               |        |               |      |                                    |      |  |     |      |               |        |               |      |                          |      |
| No. 1-A Deal 12 Skratch Stiks Wire  | List \$5.35 |      |                 |        |                   |      |                 |      |   |     |      |                  |        |                        |      |                                    |             |              |       |  |     |      |               |        |               |      |                                    |      |  |     |      |               |        |               |      |                          |      |
| Dealer's Net  | 2.88*       |      |                 |        |                   |      |                 |      |   |     |      |                  |        |                        |      |                                    |             |              |       |  |     |      |               |        |               |      |                                    |      |  |     |      |               |        |               |      |                          |      |
| No.   | List        |      |                 |        |                   |      |                 |      |   |     |      |                  |        |                        |      |                                    |             |              |       |  |     |      |               |        |               |      |                                    |      |  |     |      |               |        |               |      |                          |      |
| 960 18" x 18"   | \$0.85      |      |                 |        |                   |      |                 |      |   |     |      |                  |        |                        |      |                                    |             |              |       |  |     |      |               |        |               |      |                                    |      |  |     |      |               |        |               |      |                          |      |
| 961 36" x 18"   | 1.65        |      |                 |        |                   |      |                 |      |   |     |      |                  |        |                        |      |                                    |             |              |       |  |     |      |               |        |               |      |                                    |      |  |     |      |               |        |               |      |                          |      |
| 962 Any length, 36" wide, per yard  | 3.05        |      |                 |        |                   |      |                 |      |   |     |      |                  |        |                        |      |                                    |             |              |       |  |     |      |               |        |               |      |                                    |      |  |     |      |               |        |               |      |                          |      |
| No.   | List        |      |                 |        |                   |      |                 |      |   |     |      |                  |        |                        |      |                                    |             |              |       |  |     |      |               |        |               |      |                                    |      |  |     |      |               |        |               |      |                          |      |
| 965 18" x 16"   | \$0.85      |      |                 |        |                   |      |                 |      |   |     |      |                  |        |                        |      |                                    |             |              |       |  |     |      |               |        |               |      |                                    |      |  |     |      |               |        |               |      |                          |      |
| 966 18" x 32"   | 1.65        |      |                 |        |                   |      |                 |      |   |     |      |                  |        |                        |      |                                    |             |              |       |  |     |      |               |        |               |      |                                    |      |  |     |      |               |        |               |      |                          |      |
| 967 Any length, per yard  | 3.05        |      |                 |        |                   |      |                 |      |   |     |      |                  |        |                        |      |                                    |             |              |       |  |     |      |               |        |               |      |                                    |      |  |     |      |               |        |               |      |                          |      |

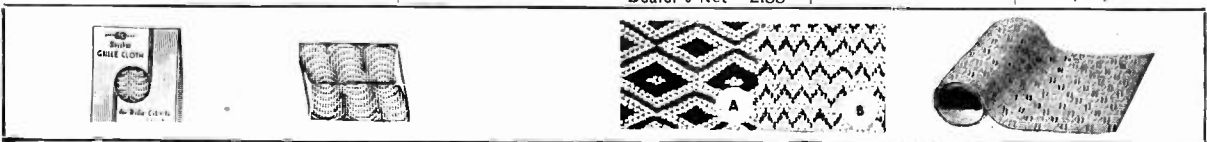

| <p><b>G-C CABINET SPEAKER GRILLE CLOTH</b></p> <p>Beautiful modern patterns of Brown, Gold and light colors to match Walnut, Mahogany and Ivory cabinets. Specify "Ivory" when ivory is wanted.</p> <table border="1"> <tr><th>No.</th><th>Size</th><th>List</th><th>No.</th><th>Size</th><th>List</th></tr> <tr><td>940</td><td>18" x 20"</td><td>\$1.25</td><td>954</td><td>5" x 10"</td><td>\$0.35</td></tr> <tr><td>941</td><td>9" x 18"</td><td>.58</td><td>949-1</td><td>1-Yd. Pkgs., 40" Wide</td><td>5.75</td></tr> <tr><td>942</td><td>12" x 12"</td><td>.60</td><td>949-1R</td><td>40" Wide Cont. lgh., per yd.</td><td>4.95</td></tr> <tr><td>943</td><td>14" x 18"</td><td>.70</td><td>949-2R</td><td>50" Wide Cont. lgh., per yd.</td><td>5.60</td></tr> <tr><td>944</td><td>24" x 13"</td><td>.90</td><td>950</td><td>Roll 9" x 12"</td><td>.50</td></tr> <tr><td>945</td><td>18" x 13"</td><td>.70</td><td></td><td></td><td></td></tr> <tr><td>946</td><td>8" x 8"</td><td>.28</td><td></td><td></td><td></td></tr> <tr><td>947</td><td>9 1/2" x 10"</td><td>.30</td><td></td><td></td><td></td></tr> <tr><td>948</td><td>6" x 6"</td><td>.25</td><td></td><td></td><td></td></tr> </table> | No.          | Size   | List   | No.                          | Size   | List | 940 | 18" x 20" | \$1.25 | 954 | 5" x 10" | \$0.35 | 941 | 9" x 18" | .58 | 949-1 | 1-Yd. Pkgs., 40" Wide | 5.75 | 942 | 12" x 12" | .60 | 949-1R | 40" Wide Cont. lgh., per yd. | 4.95 | 943 | 14" x 18" | .70 | 949-2R | 50" Wide Cont. lgh., per yd. | 5.60 | 944 | 24" x 13" | .90 | 950 | Roll 9" x 12" | .50 | 945 | 18" x 13" | .70 |  |  |  | 946 | 8" x 8" | .28 |  |  |  | 947 | 9 1/2" x 10" | .30 |  |  |  | 948 | 6" x 6" | .25 |  |  |  | <p><b>G-C SPARKLE GRILLE CLOTH</b></p> <p>Juke box metallic grille cloth. Beautiful gold pattern. Sparkles in the light. Very good for ivory cabinets also.</p> <table border="1"> <tr><th>No.</th><th>List</th></tr> <tr><td>957 Large Pattern, per Yd.</td><td>\$10.00</td></tr> <tr><td>958 Small Pattern, per Yd.</td><td>10.00</td></tr> </table> | No. | List | 957 Large Pattern, per Yd. | \$10.00 | 958 Small Pattern, per Yd. | 10.00 | <p><b>G-C METAL FLOCKED GRILLE SCREEN</b></p> <p>Very popular. Both sides flocked with rayon over galvanized metal screen. Used on radios, P.A. speakers, intercoms, auto radios, etc. Waterproof, durable. Colors: Brown, Ivory, Maroon.</p> <table border="1"> <tr><th>No.</th><th>Size</th><th>Color</th><th>List</th></tr> <tr><td>951-1</td><td>8" x 11"</td><td>Brown</td><td>\$0.85</td></tr> <tr><td>951-3</td><td>8" x 11"</td><td>Ivory</td><td>.85</td></tr> <tr><td>951-5</td><td>8" x 11"</td><td>Maroon</td><td>.85</td></tr> <tr><td>952-1</td><td>18" x 24"</td><td>Brown</td><td>2.90</td></tr> <tr><td>952-3</td><td>18" x 24"</td><td>Ivory</td><td>2.90</td></tr> <tr><td>952-5</td><td>18" x 24"</td><td>Maroon</td><td>2.90</td></tr> <tr><td>953-1</td><td>36" x 36"</td><td>Brown</td><td>8.95</td></tr> <tr><td>953-3</td><td>36" x 36"</td><td>Ivory</td><td>8.95</td></tr> <tr><td>953-5</td><td>36" x 36"</td><td>Maroon</td><td>8.95</td></tr> </table> | No. | Size | Color | List | 951-1 | 8" x 11" | Brown | \$0.85 | 951-3 | 8" x 11" | Ivory | .85 | 951-5 | 8" x 11" | Maroon | .85 | 952-1 | 18" x 24" | Brown | 2.90 | 952-3 | 18" x 24" | Ivory | 2.90 | 952-5 | 18" x 24" | Maroon | 2.90 | 953-1 | 36" x 36" | Brown | 8.95 | 953-3 | 36" x 36" | Ivory | 8.95 | 953-5 | 36" x 36" | Maroon | 8.95 |
|---|--------------|--------|--------|------------------------------|--------|------|-----|-----------|--------|-----|----------|--------|-----|----------|-----|-------|-----------------------|------|-----|-----------|-----|--------|------------------------------|------|-----|-----------|-----|--------|------------------------------|------|-----|-----------|-----|-----|---------------|-----|-----|-----------|-----|--|--|--|-----|---------|-----|--|--|--|-----|--------------|-----|--|--|--|-----|---------|-----|--|--|--|--|-----|------|----------------------------|---------|----------------------------|-------|--|-----|------|-------|------|-------|----------|-------|--------|-------|----------|-------|-----|-------|----------|--------|-----|-------|-----------|-------|------|-------|-----------|-------|------|-------|-----------|--------|------|-------|-----------|-------|------|-------|-----------|-------|------|-------|-----------|--------|------|
| No.   | Size         | List   | No.    | Size                         | List   |      |     |           |        |     |          |        |     |          |     |       |                       |      |     |           |     |        |                              |      |     |           |     |        |                              |      |     |           |     |     |               |     |     |           |     |  |  |  |     |         |     |  |  |  |     |              |     |  |  |  |     |         |     |  |  |  |  |     |      |                            |         |                            |       |  |     |      |       |      |       |          |       |        |       |          |       |     |       |          |        |     |       |           |       |      |       |           |       |      |       |           |        |      |       |           |       |      |       |           |       |      |       |           |        |      |
| 940   | 18" x 20"    | \$1.25 | 954    | 5" x 10"                     | \$0.35 |      |     |           |        |     |          |        |     |          |     |       |                       |      |     |           |     |        |                              |      |     |           |     |        |                              |      |     |           |     |     |               |     |     |           |     |  |  |  |     |         |     |  |  |  |     |              |     |  |  |  |     |         |     |  |  |  |  |     |      |                            |         |                            |       |  |     |      |       |      |       |          |       |        |       |          |       |     |       |          |        |     |       |           |       |      |       |           |       |      |       |           |        |      |       |           |       |      |       |           |       |      |       |           |        |      |
| 941   | 9" x 18"     | .58    | 949-1  | 1-Yd. Pkgs., 40" Wide        | 5.75   |      |     |           |        |     |          |        |     |          |     |       |                       |      |     |           |     |        |                              |      |     |           |     |        |                              |      |     |           |     |     |               |     |     |           |     |  |  |  |     |         |     |  |  |  |     |              |     |  |  |  |     |         |     |  |  |  |  |     |      |                            |         |                            |       |  |     |      |       |      |       |          |       |        |       |          |       |     |       |          |        |     |       |           |       |      |       |           |       |      |       |           |        |      |       |           |       |      |       |           |       |      |       |           |        |      |
| 942   | 12" x 12"    | .60    | 949-1R | 40" Wide Cont. lgh., per yd. | 4.95   |      |     |           |        |     |          |        |     |          |     |       |                       |      |     |           |     |        |                              |      |     |           |     |        |                              |      |     |           |     |     |               |     |     |           |     |  |  |  |     |         |     |  |  |  |     |              |     |  |  |  |     |         |     |  |  |  |  |     |      |                            |         |                            |       |  |     |      |       |      |       |          |       |        |       |          |       |     |       |          |        |     |       |           |       |      |       |           |       |      |       |           |        |      |       |           |       |      |       |           |       |      |       |           |        |      |
| 943   | 14" x 18"    | .70    | 949-2R | 50" Wide Cont. lgh., per yd. | 5.60   |      |     |           |        |     |          |        |     |          |     |       |                       |      |     |           |     |        |                              |      |     |           |     |        |                              |      |     |           |     |     |               |     |     |           |     |  |  |  |     |         |     |  |  |  |     |              |     |  |  |  |     |         |     |  |  |  |  |     |      |                            |         |                            |       |  |     |      |       |      |       |          |       |        |       |          |       |     |       |          |        |     |       |           |       |      |       |           |       |      |       |           |        |      |       |           |       |      |       |           |       |      |       |           |        |      |
| 944   | 24" x 13"    | .90    | 950    | Roll 9" x 12"                | .50    |      |     |           |        |     |          |        |     |          |     |       |                       |      |     |           |     |        |                              |      |     |           |     |        |                              |      |     |           |     |     |               |     |     |           |     |  |  |  |     |         |     |  |  |  |     |              |     |  |  |  |     |         |     |  |  |  |  |     |      |                            |         |                            |       |  |     |      |       |      |       |          |       |        |       |          |       |     |       |          |        |     |       |           |       |      |       |           |       |      |       |           |        |      |       |           |       |      |       |           |       |      |       |           |        |      |
| 945   | 18" x 13"    | .70    |        |                              |        |      |     |           |        |     |          |        |     |          |     |       |                       |      |     |           |     |        |                              |      |     |           |     |        |                              |      |     |           |     |     |               |     |     |           |     |  |  |  |     |         |     |  |  |  |     |              |     |  |  |  |     |         |     |  |  |  |  |     |      |                            |         |                            |       |  |     |      |       |      |       |          |       |        |       |          |       |     |       |          |        |     |       |           |       |      |       |           |       |      |       |           |        |      |       |           |       |      |       |           |       |      |       |           |        |      |
| 946   | 8" x 8"      | .28    |        |                              |        |      |     |           |        |     |          |        |     |          |     |       |                       |      |     |           |     |        |                              |      |     |           |     |        |                              |      |     |           |     |     |               |     |     |           |     |  |  |  |     |         |     |  |  |  |     |              |     |  |  |  |     |         |     |  |  |  |  |     |      |                            |         |                            |       |  |     |      |       |      |       |          |       |        |       |          |       |     |       |          |        |     |       |           |       |      |       |           |       |      |       |           |        |      |       |           |       |      |       |           |       |      |       |           |        |      |
| 947   | 9 1/2" x 10" | .30    |        |                              |        |      |     |           |        |     |          |        |     |          |     |       |                       |      |     |           |     |        |                              |      |     |           |     |        |                              |      |     |           |     |     |               |     |     |           |     |  |  |  |     |         |     |  |  |  |     |              |     |  |  |  |     |         |     |  |  |  |  |     |      |                            |         |                            |       |  |     |      |       |      |       |          |       |        |       |          |       |     |       |          |        |     |       |           |       |      |       |           |       |      |       |           |        |      |       |           |       |      |       |           |       |      |       |           |        |      |
| 948   | 6" x 6"      | .25    |        |                              |        |      |     |           |        |     |          |        |     |          |     |       |                       |      |     |           |     |        |                              |      |     |           |     |        |                              |      |     |           |     |     |               |     |     |           |     |  |  |  |     |         |     |  |  |  |     |              |     |  |  |  |     |         |     |  |  |  |  |     |      |                            |         |                            |       |  |     |      |       |      |       |          |       |        |       |          |       |     |       |          |        |     |       |           |       |      |       |           |       |      |       |           |        |      |       |           |       |      |       |           |       |      |       |           |        |      |
| No.   | List         |        |        |                              |        |      |     |           |        |     |          |        |     |          |     |       |                       |      |     |           |     |        |                              |      |     |           |     |        |                              |      |     |           |     |     |               |     |     |           |     |  |  |  |     |         |     |  |  |  |     |              |     |  |  |  |     |         |     |  |  |  |  |     |      |                            |         |                            |       |  |     |      |       |      |       |          |       |        |       |          |       |     |       |          |        |     |       |           |       |      |       |           |       |      |       |           |        |      |       |           |       |      |       |           |       |      |       |           |        |      |
| 957 Large Pattern, per Yd.  | \$10.00      |        |        |                              |        |      |     |           |        |     |          |        |     |          |     |       |                       |      |     |           |     |        |                              |      |     |           |     |        |                              |      |     |           |     |     |               |     |     |           |     |  |  |  |     |         |     |  |  |  |     |              |     |  |  |  |     |         |     |  |  |  |  |     |      |                            |         |                            |       |  |     |      |       |      |       |          |       |        |       |          |       |     |       |          |        |     |       |           |       |      |       |           |       |      |       |           |        |      |       |           |       |      |       |           |       |      |       |           |        |      |
| 958 Small Pattern, per Yd.  | 10.00        |        |        |                              |        |      |     |           |        |     |          |        |     |          |     |       |                       |      |     |           |     |        |                              |      |     |           |     |        |                              |      |     |           |     |     |               |     |     |           |     |  |  |  |     |         |     |  |  |  |     |              |     |  |  |  |     |         |     |  |  |  |  |     |      |                            |         |                            |       |  |     |      |       |      |       |          |       |        |       |          |       |     |       |          |        |     |       |           |       |      |       |           |       |      |       |           |        |      |       |           |       |      |       |           |       |      |       |           |        |      |
| No.   | Size         | Color  | List   |                              |        |      |     |           |        |     |          |        |     |          |     |       |                       |      |     |           |     |        |                              |      |     |           |     |        |                              |      |     |           |     |     |               |     |     |           |     |  |  |  |     |         |     |  |  |  |     |              |     |  |  |  |     |         |     |  |  |  |  |     |      |                            |         |                            |       |  |     |      |       |      |       |          |       |        |       |          |       |     |       |          |        |     |       |           |       |      |       |           |       |      |       |           |        |      |       |           |       |      |       |           |       |      |       |           |        |      |
| 951-1   | 8" x 11"     | Brown  | \$0.85 |                              |        |      |     |           |        |     |          |        |     |          |     |       |                       |      |     |           |     |        |                              |      |     |           |     |        |                              |      |     |           |     |     |               |     |     |           |     |  |  |  |     |         |     |  |  |  |     |              |     |  |  |  |     |         |     |  |  |  |  |     |      |                            |         |                            |       |  |     |      |       |      |       |          |       |        |       |          |       |     |       |          |        |     |       |           |       |      |       |           |       |      |       |           |        |      |       |           |       |      |       |           |       |      |       |           |        |      |
| 951-3   | 8" x 11"     | Ivory  | .85    |                              |        |      |     |           |        |     |          |        |     |          |     |       |                       |      |     |           |     |        |                              |      |     |           |     |        |                              |      |     |           |     |     |               |     |     |           |     |  |  |  |     |         |     |  |  |  |     |              |     |  |  |  |     |         |     |  |  |  |  |     |      |                            |         |                            |       |  |     |      |       |      |       |          |       |        |       |          |       |     |       |          |        |     |       |           |       |      |       |           |       |      |       |           |        |      |       |           |       |      |       |           |       |      |       |           |        |      |
| 951-5   | 8" x 11"     | Maroon | .85    |                              |        |      |     |           |        |     |          |        |     |          |     |       |                       |      |     |           |     |        |                              |      |     |           |     |        |                              |      |     |           |     |     |               |     |     |           |     |  |  |  |     |         |     |  |  |  |     |              |     |  |  |  |     |         |     |  |  |  |  |     |      |                            |         |                            |       |  |     |      |       |      |       |          |       |        |       |          |       |     |       |          |        |     |       |           |       |      |       |           |       |      |       |           |        |      |       |           |       |      |       |           |       |      |       |           |        |      |
| 952-1   | 18" x 24"    | Brown  | 2.90   |                              |        |      |     |           |        |     |          |        |     |          |     |       |                       |      |     |           |     |        |                              |      |     |           |     |        |                              |      |     |           |     |     |               |     |     |           |     |  |  |  |     |         |     |  |  |  |     |              |     |  |  |  |     |         |     |  |  |  |  |     |      |                            |         |                            |       |  |     |      |       |      |       |          |       |        |       |          |       |     |       |          |        |     |       |           |       |      |       |           |       |      |       |           |        |      |       |           |       |      |       |           |       |      |       |           |        |      |
| 952-3   | 18" x 24"    | Ivory  | 2.90   |                              |        |      |     |           |        |     |          |        |     |          |     |       |                       |      |     |           |     |        |                              |      |     |           |     |        |                              |      |     |           |     |     |               |     |     |           |     |  |  |  |     |         |     |  |  |  |     |              |     |  |  |  |     |         |     |  |  |  |  |     |      |                            |         |                            |       |  |     |      |       |      |       |          |       |        |       |          |       |     |       |          |        |     |       |           |       |      |       |           |       |      |       |           |        |      |       |           |       |      |       |           |       |      |       |           |        |      |
| 952-5   | 18" x 24"    | Maroon | 2.90   |                              |        |      |     |           |        |     |          |        |     |          |     |       |                       |      |     |           |     |        |                              |      |     |           |     |        |                              |      |     |           |     |     |               |     |     |           |     |  |  |  |     |         |     |  |  |  |     |              |     |  |  |  |     |         |     |  |  |  |  |     |      |                            |         |                            |       |  |     |      |       |      |       |          |       |        |       |          |       |     |       |          |        |     |       |           |       |      |       |           |       |      |       |           |        |      |       |           |       |      |       |           |       |      |       |           |        |      |
| 953-1   | 36" x 36"    | Brown  | 8.95   |                              |        |      |     |           |        |     |          |        |     |          |     |       |                       |      |     |           |     |        |                              |      |     |           |     |        |                              |      |     |           |     |     |               |     |     |           |     |  |  |  |     |         |     |  |  |  |     |              |     |  |  |  |     |         |     |  |  |  |  |     |      |                            |         |                            |       |  |     |      |       |      |       |          |       |        |       |          |       |     |       |          |        |     |       |           |       |      |       |           |       |      |       |           |        |      |       |           |       |      |       |           |       |      |       |           |        |      |
| 953-3   | 36" x 36"    | Ivory  | 8.95   |                              |        |      |     |           |        |     |          |        |     |          |     |       |                       |      |     |           |     |        |                              |      |     |           |     |        |                              |      |     |           |     |     |               |     |     |           |     |  |  |  |     |         |     |  |  |  |     |              |     |  |  |  |     |         |     |  |  |  |  |     |      |                            |         |                            |       |  |     |      |       |      |       |          |       |        |       |          |       |     |       |          |        |     |       |           |       |      |       |           |       |      |       |           |        |      |       |           |       |      |       |           |       |      |       |           |        |      |
| 953-5   | 36" x 36"    | Maroon | 8.95   |                              |        |      |     |           |        |     |          |        |     |          |     |       |                       |      |     |           |     |        |                              |      |     |           |     |        |                              |      |     |           |     |     |               |     |     |           |     |  |  |  |     |         |     |  |  |  |     |              |     |  |  |  |     |         |     |  |  |  |  |     |      |                            |         |                            |       |  |     |      |       |      |       |          |       |        |       |          |       |     |       |          |        |     |       |           |       |      |       |           |       |      |       |           |        |      |       |           |       |      |       |           |       |      |       |           |        |      |

# GENERAL CEMENT RADIO DIAL CORDS and CABLES

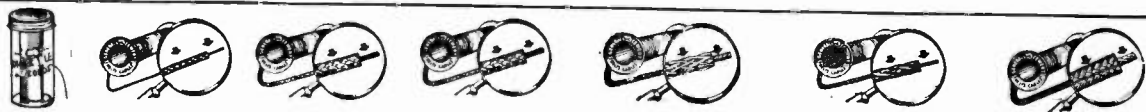

## THE THREE MOST POPULAR CORDS USED

| G-C No. 75<br>STANDARD THIN<br>NYLON CORD   | G-C No. 75-A<br>EXTRA THIN<br>NYLON CORD   | G-C No. 74<br>MEDIUM<br>NYLON CORD   | G-C No. 70<br>BRAIDED<br>BRONZE CABLE   | G-C No. 71<br>42-STRAND<br>BRONZE CABLE   | G-C No. 73<br>HEAVY<br>NYLON CORD  |
|---|--|--|---|---|--|
| .028" diam. Most popular; used on 95% of sets. Braided nylon over fibre glass core. In plastic container. | .025" diam. Used on RCA, GE, Strom-Carl, etc. Braided nylon over fibre glass core. In plastic container. | .040" diam. Very popular; used by RCA, Philco, GE, etc. Braided nylon over fibre glass core. In plastic container. | .040" diam.; used on radio dials, instruments and for aircraft reel-in antenna cable. Phosphor bronze braided over fibre glass core for strength. In plastic container. | .040" diameter; 42 strands twisted phosphor bronze over fibre glass core. Radio dials, aircraft reel-in antennas, etc. Durable and flexible. In plastic containers. | .062" diameter; used on Philco, Majestic, Brunswick, etc. Very strong, chemically treated to prevent slipping. In plastic container. |
| No. Spool List  | No. Spool List   | No. Spool List   | No. Spool List  | No. Spool List  | No. Spool List   |
| 75-25 25 ft. \$1.25   | 75A-25 25 ft. \$1.25   | 74-25 25 ft. \$1.25  | 70-25 25 ft. \$1.25   | 71-25 25 ft. \$1.25   | 73-25 25 ft. \$1.50  |
| 75-50 50 ft. 2.40   | 75A-50 50 ft. 2.40   | 74-50 50 ft. 2.40  | 70-50 50 ft. 2.40   | 71-50 50 ft. 2.50   | 73-50 50 ft. 2.75  |
| 75-100 100 ft. 4.50   | 75A-100 100 ft. 4.50   | 74-100 100 ft. 4.50  | 70-100 100 ft. 4.50   | 71-100 100 ft. 4.50   | 73-100 100 ft. 5.00  |
| 75-11 Env. .40  | 75A-11 Env. .40  | 74-11 Env. .40   | 70-11 Env. .40  | 71-11 Env. .40  | 73-11 Env. .40   |



| G-C No. 76<br>SPECIAL THIN<br>BRONZE CABLE  | G-C No. 73-X<br>EXTRA HEAVY<br>NYLON CORD  | G-C No. 78<br>BRAIDED<br>LINEN CORD   | G-C No. 79<br>MONEL<br>METAL CABLE  | G-C No. 80<br>EXTRA THIN<br>METAL CABLE  | G-C No. 82<br>EXTRA THIN<br>PHOSPHOR<br>BRONZE CABLE  |
|---|--|---|---|--|---|
| .025" diam. braided bronze as used on GE, RCA, and others. Also for flexible connections on speakers, cones, etc. In plastic container. | .072" diameter. Extra heavy cord as used by Philco and others. Chemically treated to prevent slipping. In plastic container. | .040" diameter, same as used on Emerson radios, instruments, drawing boards, etc. Extra strong and durable. In plastic container. | .035" diam. Strong and durable, non-corrosive cable for radio dials and instruments. Preferred by many to bronze cable. In plastic container. | .015" diameter. Very strong twisted steel cable. Popular on foreign and export receivers, instruments, dials, etc. In plastic container. | .012" diam. twisted of 7 strands .004" phosphor bronze. Used on dial instruments and Army and Navy Radar Equipment. In plastic container. |
| No. Spool List  | No. Spool List   | No. Spool List  | No. Spool List  | No. Spool List   | No. Spool List  |
| 76-25 25 ft. \$1.25   | 73X-25 25 ft. \$1.50   | 78-25 25 ft. \$1.25   | 79-25 25 ft. \$1.25   | 80-25 25 ft. \$1.25  | 82-25 25 ft. \$1.25   |
| 76-50 50 ft. 2.40   | 73X-50 50 ft. 2.75   | 78-50 50 ft. 2.40   | 79-50 50 ft. 2.40   | 80-50 50 ft. 2.40  | 82-50 50 ft. 2.40   |
| 76-100 100 ft. 4.50   | 73X-100 100 ft. 5.00   | 78-100 100 ft. 4.50   | 79-100 100 ft. 4.50   | 80-100 100 ft. 4.50  | 82-100 100 ft. 4.50   |
| 76-11 Env. .40  | 73X-11 Env. .40  | 78-11 Env. .40  |   |  |   |

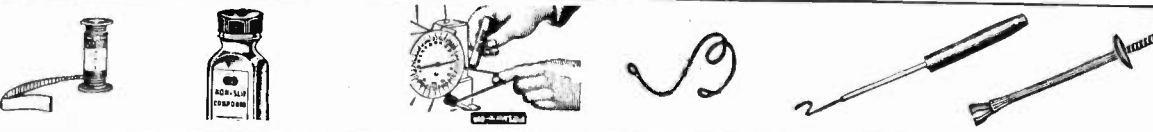

| G-C PHOSPHOR<br>BRONZE<br>BELTING   | G-C NON-SLIP<br>COMPOUNDS  | G-C CORD<br>DRESSING   | G-C READY<br>MADE CABLES   | G-C DIAL CABLE<br>TOOL  | G-C HANDY<br>PICK-UP TOOL  |
|---|--|--|--|---|--|
| This belting is required to make repairs on some of the older model sets. For Atwater Kents — 5/8" wide x .005" thick. No. List 61-25 25 ft. \$1.50 For Brunswicks — 3/4" wide x .006" thick. 62-25 25 ft. \$2.00 | <b>Powder Compound</b> For dials, cords, pulleys, belts. Prevents slipping. No. List 1210 2-oz. \$0.50<br><b>Liquid</b> Penetrating liquid shrinks fibers, prevents slipping on dial cord and belts. 1215 2-oz. 0.60 | Easy way to treat slipping cords. Simply rub on stick and job is done. Prevents and stops slipping. No. List 1212 Stick \$0.25 | For popular sets. Save time in repairing these sets. No. Model List R7 Brunswick, 15, 22 Front. \$0.50 R8 Brunswick, 15, 22 Rear .50 R9 GE, A88, A82, A87 .50 R10 Majestic, 70, 71, 72 .50 | Handy tool to aid in stringing new dial cord and replacing cables slipped off pulleys and drums. It's like an extra hand. Speeds up the job. No. List 5096 \$0.75 | Very handy for every one. Picks up pieces in hard-to-get-at places. Will hold and start screws, nuts, etc. Will pay for itself in short time. No. List 5089 \$1.50 |



| G-C DIAL CABLE<br>RACK  | G-C DIAL SPRING<br>KITS  | G-C No. 77-SK<br>DIAL CORD KIT  | G-C No. 78-SK<br>DIAL CORD KIT  | G-C DIAL CORD<br>CLIPS   |
|---|--|---|---|--|
| Very handy, includes popular cables. Hangs on wall or on bench. Handy measuring rule or sign. Kit includes rack and five 25 ft. spools each Nos. 71, 73, 74, 75 and 76 cables. No. List 7-A-25 \$6.50 | Handy kit of springs as used on dial cord drives. Six sizes included. No. List 1054-E 10 Assorted \$0.40 1054-SE 10 Small Springs .40 1055 Kit 25 Asst. Springs 1.20 1056 Kit 100 Asst. Springs 4.40 | Contains four 25 ft. spools most popular cord; 75-25, 74-25, 76-25, 71-25, and free assortment of dial cord clamps and eyelets. No. List 77-SK Cable Kit \$4.75 | Combination kit in 10 ft. lengths of all G-C Dial Cables. Each in separate envelope, packed in leatherette box. Handy for servicemen and experimenters. No. List 78-SK Cable Kit \$4.65 | Handy clip and eyelet assortment used to fasten to ends of dial cords, etc. Required on every set. No. List 1028-E Assortment \$0.40 |

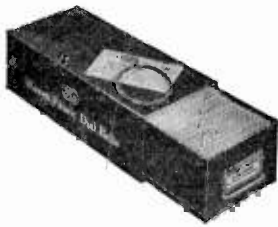

**G-C SERVICEMEN'S DIAL BELT KITS**

General Cement Belts are approved replacements for all sets. They are made of best quality material and will not stretch. They are specially treated to prevent slipping. They are the best. Sizes available for all sets. They are easy to install as they are made to fit. No adjustments necessary.

**BELTS — 25c List Each**

Servicemen! Have an assortment of belts on hand for prompt replacement. Kits contain only the more popular belts used. KIT INCLUDES ATTRACTIVE STEEL BOX—BELT SCALE AND COMPLETE LISTING OF OVER 100 MODELS.

**G-C SERVICEMEN'S KITS**

**List Price**  
No. G-25—Kit of 25 popular belts ... \$ 7.50  
No. G-50—Kit of 50 popular belts ... 14.75  
No. G-100—Kit of 100 (includes every size) 25.00

**INSTRUCTIONS — FOR MEASURING BELTS**

To determine size of belt, if the old belt is available, cut the belt and measure for stretched out length. This will be "cut length" of belt. If old belt is not available or is worn out so that it cannot be properly measured, stretch a thin thread around belt pulleys on set. (Be sure to use thin thread as a thick cord will give an inaccurate reading.) Measure the thread, it will be our "circumference around pulleys." In measuring belts always remember that the circumference around pulleys is not the same as stretched out or cut length. A belt when cut, develops approximately 3/16" extra length when stretched out, depending on thickness of belt.

**G - C RADIO BELT SPECIFICATIONS**

LISTED AS PER BELT NO.

LISTED AS PER BELT SIZE

| GC Belt No. | Circumference Around Pulleys | Cut Length | GC Belt No. | Circumference Around Pulleys | Cut Length |
|-------------|------------------------------|------------|-------------|------------------------------|------------|
| 101         | 6-23/32"                     | 6-29/32"   | 148         | 14-33/64"                    | 14-3/4"    |
| 102         | 6-5/64"                      | 7-5/64"    | 149         | 15-1/64"                     | 15-13/64"  |
| 103         | 7-15/32"                     | 7-21/32"   | 150         | 15-61/64"                    | 15-9/64"   |
| 104         | 8-1/64"                      | 8-31/64"   | 151         | 14-57/64"                    | 15-5/64"   |
| 105         | 7-1/2"                       | 7-11/16"   | 152         | 10-1/2"                      | 10-11/16"  |
| 106         | 7-1/4"                       | 7-7/16"    | 153         | 8-39/64"                     | 8-51/64"   |
| 107         | 7-11/16"                     | 7-7/8"     | 154         | 12-1/32"                     | 12-7/32"   |
| 108         | 8-21/32"                     | 8-27/32"   | 155         | 7-35/64"                     | 7-23/32"   |
| 109         | 8-21/32"                     | 8-11/16"   | 156         | 7-9/32"                      | 7-15/32"   |
| 110         | 8-5/64"                      | 8-31/64"   | 157         | 1-1/64"                      | 7-13/64"   |
| 111         | 7-15/16"                     | 8-1/8"     | 158         | 6-15/16"                     | 7-1/8"     |
| 112         | 8-43/64"                     | 8-55/64"   | 159         | 8-1/32"                      | 8-7/32"    |
| 113         | 8-3/32"                      | 8-9/32"    | 160         | 8-11/16"                     | 8-7/8"     |
| 114         | 8-15/64"                     | 8-27/64"   | 161         | 6-55/64"                     | 7-3/64"    |
| 115         | 9-13/64"                     | 9-25/64"   | 162         | 8-13/64"                     | 8-25/64"   |
| 116         | 9-5/16"                      | 9-1/2"     | 163         | 9-19/64"                     | 9-31/64"   |
| 117         | 9-1/16"                      | 9-1/4"     | 164         | 10-1/4"                      | 10-7/16"   |
| 118         | 10-23/64"                    | 10-35/64"  | 165         | 17-1/16"                     | 17-1/4"    |
| 119         | 9-17/32"                     | 9-25/32"   | 166         | 19-7/16"                     | 19-5/8"    |
| 120         | 10-47/64"                    | 10-57/64"  | 167         | 8-13/16"                     | 9"         |
| 121         | 10-11/16"                    | 10-7/8"    | 168         | 12-13/16"                    | 13"        |
| 122         | 10-3/8"                      | 10-9/16"   | 169         | 17-13/32"                    | 17-19/32"  |
| 123         | 9-7/8"                       | 10-1/16"   | 170         | 16-19/64"                    | 16-31/64"  |
| 124         | 10-17/64"                    | 10-29/64"  | 171         | 11-3/16"                     | 11-3/8"    |
| 125         | 10-25/64"                    | 10-37/64"  | 172         | 8-3/16"                      | 8-3/8"     |
| 126         | 10-1/16"                     | 10-1/4"    | 173         | 11-7/16"                     | 11-5/8"    |
| 127         | 9-59/64"                     | 10-7/64"   | 174         | 7-27/64"                     | 7-13/16"   |
| 128         | 10-19/64"                    | 10-31/64"  | 175         | 21-5/16"                     | 21-1/2"    |
| 129         | 10-41/64"                    | 10-53/64"  | 176         | 22-31/64"                    | 22-47/64"  |
| 130         | 11-5/64"                     | 11-17/64"  | 177         | 7-13/32"                     | 7-19/32"   |
| 131         | 11-9/64"                     | 11-21/64"  | 178         | 12-1/2"                      | 12-11/16"  |
| 131W        | 11-9/32"                     | 11-15/32"  | 179         | 17-37/64"                    | 17-49/64"  |
| 132         | 10-31/32"                    | 11-5/32"   | 180         | 10-27/32"                    | 11-1/32"   |
| 133         | 10-61/64"                    | 11-9/64"   | 181         | 18-9/16"                     | 18-3/4"    |
| 134         | 11-3/8"                      | 11-9/16"   | 182         | 15-13/16"                    | 16"        |
| 135         | 11"                          | 11-3/16"   | 183         | 15-7/16"                     | 15-5/8"    |
| 136         | 11-25/64"                    | 11-37/64"  | 184         | 16-27/64"                    | 16-39/64"  |
| 137         | 11-5/32"                     | 11-15/32"  | 185         | 16-15/16"                    | 17-1/8"    |
| 138         | 12"                          | 12-3/16"   | 186         | 14-7/32"                     | 14-13/32"  |
| 139         | 12-9/32"                     | 12-15/32"  | 187         | 15-17/64"                    | 15-29/64"  |
| 140         | 12-7/32"                     | 12-13/32"  | 188         | 19-47/64"                    | 19-59/64"  |
| 141         | 11-3/4"                      | 11-15/16"  | 189         | 18-1/2"                      | 18-11/16"  |
| 142         | 12-3/32"                     | 12-1/4"    | 190         | 17-5/8"                      | 17-13/16"  |
| 143         | 11 13/16"                    | 12"        | 191         | 22-49/64"                    | 22-61/64"  |
| 144         | 12-15/32"                    | 12-21/32"  | 192         | straight belt                | 16"        |
| 145         | 12-39/64"                    | 12-51/64"  | 193         | straight belt                | 12-7/16"   |
| 146         | 13-1/8"                      | 13-11/16"  | 194         | 11-21/32"                    | 11-27/32"  |
| 147         | 14-27/64"                    | 14-39/64"  |             |                              |            |

| Circumference Around Pulleys | Cut Length | GC Belt No. | Circumference Around Pulleys | Cut Length         | GC Belt No. |
|------------------------------|------------|-------------|------------------------------|--------------------|-------------|
| 6-23/32"                     | 6-29/32"   | 101         | 11"                          | 11-3/16"           | 135         |
| 6-55/64"                     | 7-3/64"    | 102         | 11-5/64"                     | 11-17/64"          | 130         |
| 6-57/64"                     | 7-5/64"    | 103         | 11-9/64"                     | 11-21/64"          | 131         |
| 6-15/16"                     | 7-1/8"     | 104         | 11-5/16"                     | 11-15/32"          | 137         |
| 7-1/64"                      | 7-13/64"   | 105         | 11-9/32"                     | 11-15/32"          | 171         |
| 7-1/4"                       | 7-7/16"    | 106         | 11-3/8"                      | 11-9/16"           | 131W        |
| 7-9/32"                      | 7-19/32"   | 107         | 11-25/64"                    | 11-37/64"          | 134         |
| 7-13/32"                     | 7-21/32"   | 108         | 11-7/16"                     | 11-5/8"            | 136         |
| 7-1/2"                       | 7-11/16"   | 109         | 11-21/32"                    | 11-27/32"          | 173         |
| 7-35/64"                     | 7-23/32"   | 110         | 11-3/4"                      | 11-15/16"          | 194         |
| 7-11/16"                     | 7-7/8"     | 111         | 11-13/16"                    | 12"                | 141         |
| 7-3/4"                       | 7-15/16"   | 112         | 12"                          | 12-3/16"           | 143         |
| 7-15/16"                     | 8-1/8"     | 113         | 12-1/32"                     | 12-7/32"           | 138         |
| 8-1/32"                      | 8-13/64"   | 114         | 12-3/32"                     | 12-1/4"            | 139         |
| 8-1/32"                      | 8-7/32"    | 115         | 12-7/32"                     | 12-13/32"          | 142         |
| 8-3/16"                      | 8-9/32"    | 116         | 12-11/32"                    | 12-13/32"          | 140         |
| 8-3/16"                      | 8-3/8"     | 117         | 12-15/32"                    | 12-7/16"-str. belt | 193         |
| 8-13/64"                     | 8-25/64"   | 118         | 12-19/32"                    | 12-15/16"          | 139         |
| 8-15/64"                     | 8-27/64"   | 119         | 12-23/32"                    | 12-21/32"          | 144         |
| 8-25/64"                     | 8-37/64"   | 120         | 12-27/32"                    | 12-11/16"          | 178         |
| 8-1/2"                       | 8-11/16"   | 121         | 12-31/32"                    | 12-51/64"          | 145         |
| 8-39/64"                     | 8-51/64"   | 122         | 13-1/16"                     | 13"                | 168         |
| 8-21/32"                     | 8-27/32"   | 123         | 13-3/16"                     | 13-3/8"            | 146         |
| 8-43/64"                     | 8-55/64"   | 124         | 14-7/32"                     | 14-13/32"          | 186         |
| 8-1/16"                      | 8-7/8"     | 125         | 14-27/64"                    | 14-39/64"          | 147         |
| 8-13/16"                     | 9"         | 126         | 14-33/64"                    | 14-3/4"            | 148         |
| 9-1/16"                      | 9-1/4"     | 127         | 14-57/64"                    | 15-5/64"           | 151         |
| 9-13/64"                     | 9-25/64"   | 128         | 15-1/64"                     | 15-13/64"          | 149         |
| 9-19/64"                     | 9-31/64"   | 129         | 15-17/64"                    | 15-29/64"          | 187         |
| 9-5/16"                      | 9-1/2"     | 130         | 15-7/16"                     | 15-5/8"            | 183         |
| 9-17/32"                     | 9-23/32"   | 131         | 15-13/16"                    | 16"                | 182         |
| 9-7/8"                       | 10-1/16"   | 132         | 15-13/16"                    | 16"-str. belt      | 192         |
| 9-59/64"                     | 10-7/64"   | 133         | 15-61/64"                    | 16-9/64"           | 150         |
| 10-1/16"                     | 10-1/4"    | 134         | 16-19/64"                    | 16-31/64"          | 170         |
| 10-1/4"                      | 10-7/16"   | 135         | 16-27/64"                    | 16-39/64"          | 184         |
| 10-17/64"                    | 10-29/64"  | 136         | 16-15/16"                    | 17-1/8"            | 185         |
| 10-19/64"                    | 10-31/64"  | 137         | 17-1/16"                     | 17-1/4"            | 165         |
| 10-23/64"                    | 10-35/64"  | 138         | 17-13/32"                    | 17-19/32"          | 169         |
| 10-25/64"                    | 10-37/64"  | 139         | 17-37/64"                    | 17-49/64"          | 179         |
| 10-1/2"                      | 10-11/16"  | 140         | 17-5/8"                      | 17-13/16"          | 190         |
| 10-25/64"                    | 10-37/64"  | 141         | 18-1/2"                      | 18-11/16"          | 181         |
| 10-1/2"                      | 10-11/16"  | 142         | 18-27/64"                    | 18-3/8"            | 189         |
| 10-45/64"                    | 10-57/64"  | 143         | 19-1/16"                     | 19-5/8"            | 166         |
| 10-11/16"                    | 10-7/8"    | 144         | 19-47/64"                    | 19-59/64"          | 188         |
| 10-45/64"                    | 10-57/64"  | 145         | 21-5/16"                     | 21-1/2"            | 175         |
| 10-27/32"                    | 11-1/32"   | 146         | 22-35/64"                    | 22-47/64"          | 176         |
| 10-61/64"                    | 11-9/64"   | 147         | 22-19/64"                    | 22-61/64"          | 191         |
| 10-31/32"                    | 11-5/32"   | 148         |                              |                    | 132         |

Buy a G-C Belt Kit and Get a Free Belt Replacement Guide

**G-C RADIO AND PHONO DRIVES**

**G-C RADIO DIAL GLASS AND CLOCK CRYSTALS**

Round convex replacement glass crystals for radios, clocks, auto radios, instruments, panels, dash board.

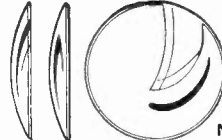

| No.                           | List   | No. | List                     |
|-------------------------------|--------|-----|--------------------------|
| 1024-SE Env. Asst. 5 Small    | \$0.40 | 12  | Emerson, Majestic \$0.10 |
| 1024-LE Env. Asst. 5 Large    | .40    | 13  | Small AK .25             |
| 1024-E Env. Asst. 10 Dial     | .80    | 15  | Philco .10               |
| 1025 Box 25 Asst. Drives 1.50 |        | 16  | General Industries, .25  |
| 1026 Box 100 Asst.            | 6.00   |     |                          |
| 1 AK Small                    | .10    | 17  | RX-1-X .25               |
| 2 AK Large                    | .10    |     |                          |
| 3 Stewart-Warner              | .10    |     |                          |
| 4 Kennedy, Wells-G.           | .10    |     |                          |
| 5 Stewart-Warner              | .10    |     |                          |
| 6 RCA                         | .10    |     |                          |
| 7 Stewart-Warner              | .10    |     |                          |
| 8 Stewart-Warner              | .10    |     |                          |
| 9 Atwater-Kent                | .10    |     |                          |
| 10 Stewart-Warner             | .10    |     |                          |
| 11 Lge. Atwater-Kent          | .10    |     |                          |

| No. | Diam.  | List   | No. | Diam.  | List   |
|-----|--------|--------|-----|--------|--------|
| 25  | 1 3/4" | \$0.55 | 64  | 6 3/4" | \$0.65 |
| 26  | 1 7/8" | .55    | 66  | 7"     | .75    |
| 26A | 2"     | .55    | 67  | 7 1/4" | .75    |
| 27  | 2 1/8" | .55    | 68  | 7 1/2" | .75    |
| 28  | 2 1/4" | .55    | 69  | 7 3/4" | .75    |
| 29  | 2 3/8" | .55    | 70  | 7 7/8" | .75    |
| 30  | 2 1/2" | .55    | 71  | 7 7/8" | .75    |
| 31  | 2 5/8" | .55    | 72  | 7 3/4" | .75    |
| 32  | 2 3/4" | .55    | 73  | 7 7/8" | .75    |
| 33  | 2 7/8" | .55    | 74  | 8"     | .75    |
| 34  | 3"     | .55    | 75  | 8 1/8" | .85    |
| 35  | 3 1/8" | .55    | 76  | 8 1/4" | .85    |
| 36  | 3 3/8" | .55    | 77  | 8 3/8" | .85    |
| 37  | 3 1/2" | .55    | 78  | 8 3/4" | .85    |
| 38  | 3 5/8" | .55    | 79  | 8 7/8" | .85    |
| 39  | 3 3/4" | .55    | 80  | 8 3/4" | .85    |
| 40  | 3 7/8" | .55    | 81  | 8 7/8" | .85    |
| 41  | 4"     | .65    | 82  | 9"     | .85    |
| 42  | 4 1/8" | .65    | 83  | 9 1/8" | .85    |
| 43  | 4 1/4" | .65    | 84  | 9 1/4" | .85    |
| 44  | 4 1/2" | .65    |     |        |        |

**G-C PLASTIC CRYSTAL**

Clear plastic crystal in flat sheet. For radio dials, clocks, dashboards, etc. Can be cut to size, fitted and cemented in place.  
No. 92 8" x 10" List \$1.45

DC65 Kit of 65 Crystals \$38.50  
DC25 Kit of 25 Popular Crystals 13.75

GENERAL



CEMENT

# RADIO KNOBS - KITS



**MAJESTIC BAKELITE KNOBS**  
Popular pattern. Set screw type.  $\frac{7}{8}$ " diam.,  $\frac{1}{4}$ " shaft.  
No. List  
1100 Walnut \$0.16  
1100-1 Ivory .20

**ROYAL BAKELITE KNOBS**  
Beautiful pattern. Set screw type.  $\frac{7}{8}$ " diam.,  $\frac{1}{4}$ " shaft.  
No. List  
1105 Walnut \$0.16  
1105-1 Ivory .20

**YANKEE BAKELITE KNOBS**  
Set screw type.  $\frac{3}{4}$ " and 1" diam.,  $\frac{1}{4}$ " shaft.  
No. List  
1109  $\frac{3}{4}$ " Wln. \$0.16  
1110 1" Walnut .16  
1109-1  $\frac{3}{4}$ " Ivory .20  
1110-1 1" Ivory .20

**MODERN LARGE KNOB**  
Knurl shaft or set screw types.  $1\frac{1}{8}$ " diameter.  
No. List  
Knurl Shaft Type  
1176 Walnut \$0.12  
Set Screw Type  
1177 Walnut .16

**NEW LARGE KNOB**  
Knurl shaft or set screw types.  $1\frac{1}{8}$ " diameter.  
No. List  
Knurl Shaft Type  
1178 Walnut \$0.12  
Set Screw Type  
1179 Walnut .16

**POPULAR LARGE KNOB**  
Knurl shaft or set screw types.  $1\frac{1}{8}$ " diameter.  
No. List  
Knurl Shaft Type  
1180 Walnut \$0.12  
Set Screw Type  
1181 Walnut .16



**MIDGET BAKELITE KNOBS**  
Set Screw Type  
For small sets.  $\frac{1}{8}$ " diam.,  $\frac{1}{4}$ " shaft.  
No. List  
Pointer Type  
1115 Walnut \$0.12  
1116 Ivory .13  
1117 Red .13  
1118 Black .12

For small sets.  $\frac{1}{8}$ " diam., set screw  $\frac{1}{4}$ ".  
No. List  
Non-Pointer Type  
1111 Walnut \$0.12  
1112 Ivory .13  
1113 Red .13  
1114 Black .12

**STREAMLINE POINTERS**  
The most popular pointer knob.  $\frac{3}{4}$ " shaft, set screw type  $1\frac{1}{4}$ " long.  
No. List  
1136 Black \$0.15  
1136-W Walnut .16  
1137 Red .18  
1137-1 Ivory .20

A very popular pointer knob.  $\frac{3}{4}$ " shaft, set screw type, 2" long.  
No. List  
1135 Black \$0.20  
1135-W Walnut .24  
1138 Red .24  
1138-1 Ivory .26

**MODERN POINTER BAR KNOBS**  
Brass Bushing  
For intercomms and instruments. Black. Set screw,  $\frac{1}{4}$ " shaft,  $2\frac{1}{2}$ " long.  
No. List  
1130 Black \$0.38  
1130-W Walnut .38

For intercomms and instruments. Black finish. Set screw,  $\frac{1}{4}$ " shaft, 1" long.  
No. List  
1131 Black \$0.35  
1131-W Walnut .35



**INSTRUMENT KNOB**  
A heavy duty knob for communication equipment, instruments.  $\frac{1}{4}$ " brass insert, set screw.  $1\frac{3}{4}$ " O.D. x  $\frac{7}{8}$ ".  
No. List  
1175 Black \$0.35

**STREAMLINE POINTERS**  
Brass Bushing  
Brass insert.  $\frac{1}{4}$ " shaft, set screw.  $1\frac{1}{4}$ " long.  
No. List  
1170 Black \$0.25  
1170-W Walnut .25  
1172 Red .30  
1172-1 Ivory .30

Brass insert.  $\frac{1}{4}$ " shaft, set screw. 2" long.  
No. List  
1171 Black \$0.30  
1171-W Walnut .30  
1173 Red .36  
1173-1 Ivory .36

**POPULAR BAR KNOB**  
For intercomms, instruments, appliances. Bakelite with set screw.  $\frac{1}{4}$ " hole,  $1\frac{1}{2}$ " long.  
No. List  
1132 Walnut \$0.20

**POPULAR PLASTIC KNOB**  
 $\frac{1}{8}$ " diameter with  $\frac{1}{2}$ " shank extension for  $\frac{1}{4}$ " knurled shaft.  
No. List  
1153 Walnut \$0.12  
1154 Ivory .13

**ATTRACTIVE PLASTIC KNOB**  
 $\frac{1}{8}$ " diameter, flush type for  $\frac{1}{4}$ " knurled shafts.  
No. List  
1155 Walnut \$0.12  
1156 Ivory .13



**MIDGET TYPE PLASTIC KNOB**  
 $\frac{3}{8}$ " diam.,  $\frac{3}{8}$ " shank for  $\frac{1}{4}$ " knurled shafts.  
No. List  
1157 Walnut \$0.12  
1158 Ivory .13

**MIDGET TYPE PLASTIC KNOB**  
 $\frac{3}{8}$ " diam. flush type for  $\frac{1}{4}$ " knurled shafts.  
No. List  
1159 Walnut \$0.12  
1160 Ivory .13

**ACORN PLASTIC KNOB**  
 $\frac{3}{8}$ " diam.,  $\frac{1}{8}$ " shank for  $\frac{1}{4}$ " knurled shafts.  
No. List  
1182 Walnut \$0.12  
1183 Ivory .13

**PUSH-ON KNURL KNOB**  
 $\frac{1}{8}$ " diam. flush type for  $\frac{1}{4}$ " knurled shafts.  
No. List  
1184 Walnut \$0.12  
1185 Ivory .13

**PUSH-ON KNURL KNOB**  
 $\frac{1}{8}$ " diam.,  $\frac{1}{8}$ " shank for  $\frac{1}{4}$ " knurled shafts.  
No. List  
1186 Walnut \$0.12  
1187 Ivory .13

**POINTER TYPE PLASTIC KNOB**  
 $\frac{1}{8}$ " diam.,  $\frac{1}{8}$ " shank for  $\frac{1}{4}$ " knurled shafts.  
No. List  
1188 Walnut \$0.12  
1189 Ivory .13



**MIDGET TYPE PLASTIC KNOBS**  
 $\frac{3}{8}$ " diam.,  $\frac{1}{2}$ " shank for  $\frac{1}{4}$ " knurled shafts.  
No. List  
1197 Walnut \$0.12  
1198 Ivory .13

$\frac{3}{8}$ " diam., flush shank for  $\frac{1}{4}$ " knurled shafts.  
No. List  
1193 Walnut \$0.12  
1194 Ivory .13

**SPRING AND D-SHAFT KNOBS**  
Spring type.  $\frac{1}{8}$ " diam. Fits  $\frac{1}{4}$ " flat shafts.  
No. List  
1151 Walnut \$0.12  
1152 Ivory .13

D- or flat shaft type.  $\frac{5}{8}$ " diam.  
No. List  
1161 Walnut \$0.12  
1162 Ivory .13

**SPRING AND D-SHAFT KNOBS**  
D- or flat shaft type.  $\frac{3}{8}$ " diam.  
No. List  
1163 Walnut \$0.13  
1164 Ivory .14

D- or flat shaft type. 1" diam.  
No. List  
1165 Walnut \$0.14  
1166 Ivory .15



**G-C AUTO RADIO KNOBS**  
 $\frac{1}{8}$ " diam. x  $\frac{1}{8}$ " high. For  $\frac{1}{4}$ " and  $\frac{3}{8}$ " shafts. Brass bushing with set screw.  
No. List  
 $\frac{1}{4}$ " Shaft  
1191 Pearl Gray \$0.30  
1192 Maroon .30  
 $\frac{3}{8}$ " Shaft  
1167 Pearl Gray .30  
1168 Maroon .30

Set screw type auto radio knob.  $\frac{1}{8}$ " diam. x  $\frac{7}{8}$ " high. For either  $\frac{1}{4}$ " or  $\frac{3}{8}$ " shafts with bushing.  
No. List  
1195 Pearl Gray \$0.30  
1196 Maroon .30

**G-C AUTO RADIO KNOBS**  
Chrome plated. For  $\frac{1}{4}$ " and  $\frac{3}{8}$ " shafts. Set screw mounting.  
No. List  
1169  $\frac{1}{4}$ " \$0.30  
1174  $\frac{3}{8}$ " .30

**G-C KNOB SET SCREW ASST.**  
Handy set screw assortments for radio knobs, shafts, pulleys. 6-32, 8-32, and 10-32.  
No. List  
1060 50 Asst. \$1.10  
1061 100 Asst. 2.00  
1062-E 20 Asst. .40  
6605 30 Asst. .65

**G-C RADIO KNOB KITS**

Popular plastic knobs in assorted kits, all kinds of knobs included.



| No.  | Quantity   | List   |
|------|--|--------|
| 1140 | 35 Asstd. Push-on Buttons  | \$3.95 |
| 1141 | 28 Asstd. Spring Knobs   | 3.95   |
| 1142 | 24 Asstd. Set Screw Knobs  | 3.95   |
| 1143 | 30 Asstd. All Type Knobs   | 3.95   |
| 1144 | 15 Asstd. Auto Radio Knobs, for $\frac{1}{4}$ " and $\frac{3}{8}$ " shafts | 3.95   |

**G-C RADIO KNOB PULLER**

Very handy in removing knobs that are hard to pull off. Simply slip behind knob and pull off. Saves the cabinet and the knobs.



| No.  | List   |
|------|--------|
| 1063 | \$0.40 |



**G-C KNOB SPRING KITS**  
Twelve types of knob springs or wedges in kit.  
No. List  
1049-E Env. 20 Asstd. \$0.40  
1050 Kit 35 .85  
1051 Kit 100 1.65  
6619 Jar 35 Asstd. .65

**G-C KNOB FELTS**  
Used behind knobs. Saves cabinet.  
No. List  
1065-E Env. 50 \$0.40  
6641 Jar 70 .65

**G-C KNOB BUSHINGS**  
Reduce from  $\frac{1}{4}$ " to  $\frac{3}{8}$ ". For auto radios.  
No. List  
6751 \$0.40



GENERAL



CEMENT

PHONO NEEDLES and ACCESSORIES



**G-C MASTER POINT PHONO NEEDLES**

**G-C CATHEDRAL TONE**

Long life, excellent tone needle made with osmium alloy tip to insure uniform reproduction and long life. Will save the records and give excellent reproduction for a long time.

| No.    | Each       | List   |
|--------|------------|--------|
| 1430   |            | \$0.75 |
| 1431-D | Display    |        |
|        | 12 # 1430. | 9.00   |

**G-C SYMPHONIC NEEDLE**

Superior quality long life needle designed to give excellent tone. Special osmium alloy tip gives true reproduction with less pressure on the records. Will last indefinitely.

| No.    | Each       | List   |
|--------|------------|--------|
| 1435   |            | \$1.00 |
| 1435-D | Display    |        |
|        | 12 # 1435. | 12.00  |

**G-C CONCERT GRAND**

Very finest "long life" curved "spring action" needle that will bring out the finest tones in music. Special osmium alloy tip insures long life. Tip is perfectly formed to fit record grooves. The best.

| No.    | Each       | List   |
|--------|------------|--------|
| 1436   |            | \$1.50 |
| 1436-D | Display    |        |
|        | 12 # 1436. | 18.00  |

**G-C RECORD-LIFE LUBRICANT**

Simply wipe record with "Record-Life" and the needle will glide over the record smoothly. Prevents record and needle wear; also eliminates noises and scratching sounds. Use also for making records.

| No.   | 1oz.  | List   |
|-------|-------|--------|
| 125-1 |       | \$0.30 |
| 125-2 | 2-oz. | .60    |
| 125-4 | 4-oz. | .85    |
| 125-6 | 6-oz. | 1.00   |

**G-C REK-O-DOPE**

Required lubricant when recording and cutting records. All purpose, it cools, cleans, lubricates, and hardens grooves when cut. Rek-O-Dope will give better tone and longer life.

| No.   | 1-oz. | List   |
|-------|-------|--------|
| 126-1 |       | \$0.30 |
| 126-2 | 2-oz. | .60    |
| 126-4 | 4-oz. | .85    |
| 126-6 | 6-oz. | 1.00   |

**G-C CORD CONNECTOR**

Handy cord connector to connect phono motors to radio sets, for appliances, vacuum cleaners, sewing machines, etc.

| No. | List   |
|-----|--------|
| 868 | \$0.65 |



**G-C JUKE SPECIAL PHONO NEEDLE**

Long life needle. Preferred by operators on coin machines, automatic records, etc. Precious osmium tip will give long, hard service and tone quality, even when used with heavy pick-ups. Will give thousands of plays.

| No.    | Each       | List   |
|--------|------------|--------|
| 1437   |            | \$1.00 |
| 1437-D | Display    |        |
|        | 12 # 1437. | 12.00  |

**G-C RECORDING STYLUS**

The best cutting stylus made from alloy steel will give several hours of good cutting. Make your own recordings.

| No.    | List       |      |
|--------|------------|------|
| 1433   | \$0.50     |      |
| 1434-D | Display    |      |
|        | 12 # 1433. | 6.00 |

**G-C SERVICEMAN'S NEEDLE PACKET**

Handy package containing ten assorted high quality G-C Master-Point Needles. Packaged in attractive folder which protects the needle packages so that they are fresh and new when you make your sale.

| No.  | List   |
|------|--------|
| 1432 | \$9.50 |

**G-C RECORD TURNTABLE FELT**

Re-cover phono turntables with ready cut felts. Dark brown.

| No.                      | Dia.              | List   |
|--------------------------|-------------------|--------|
| 1292                     | 7 7/8"            | \$0.45 |
| 1296                     | 8 7/8"            | .60    |
| 1293                     | 9 7/8"            | .65    |
| 1294                     | 11 7/8"           | .75    |
| 1295                     | 15 7/8"           | 1.30   |
| Brown Felt — By The Yard |                   |        |
| 1298                     | 36" Wide, per yd. | 5.50   |

**G-C DETROLA SPRING DRIVE**

Genuine replacement for Detrola turntables. Spring drive with core inside. Used on Detrola, Utah, and Trela models, etc.

| No.    | List           |        |
|--------|----------------|--------|
| 20-1-E | Detrola Spring | \$0.50 |

**G-E — RCA PHONO DRIVES**

Special V and Rim drives for RCA, RP-176 and G-E, 809-J turntables.

| No.  | List              |        |
|------|-------------------|--------|
| 22   | Large Tire, each  | \$1.00 |
| 23-E | Env. 2 Rim Drives | .40    |



**G-C PHONO NEEDLE STYLUS SCREWS**

Here's the hard-to-get replacement thumb set screws for pick-up arms and recording heads!

| No.    | List                    |         |
|--------|-------------------------|---------|
| 1052   | 15 Asst. Stylus Screws  | \$ 1.65 |
| 1052-E | Env. 7 Asst. Screws     | .40     |
| 1053   | 100 Asst. Stylus Screws | 11.00   |

**Individual Phono Screw Specifications**

|     |  |     |
|-----|--|-----|
| P1  | For Shure Brothers, etc.                                 | .10 |
| P2  | For Astatic, RCA, Seeburg, Webster, etc.                 | .10 |
| P3  | For Astatic, Stromberg-Carlson, Universal, Webster, etc. | .10 |
| P4  | For Rek-O-Cut, Webster, etc.                             | .15 |
| P5  | For RCA, etc.  | .15 |
| P6  | For RCA, etc.  | .10 |
| P7  | For Webster, etc.  | .15 |
| P8  | For Shure Brothers, etc.                                 | .15 |
| P9  | For RCA, Astatic, Webster, etc.                          | .15 |
| P10 | For Audex, etc.  | .15 |

**CARTRIDGE MOUNTING SCREWS**

For mounting cartridges in Phono Pick-Up Arms.

| No.     | List                |        |
|---------|---------------------|--------|
| 6005-E  | Env. 60 4-36 x 1/4" | \$0.40 |
| 6005-AE | Env. 60 4-40 x 1/4" | .40    |

**G-C STA-PUT PHONO-GEAR LUBRICANT**

New "STA-PUT" lubricant for phono motors, gears, shafts, etc. Will not run or drip—it "Stays Put." Recommended by RCA, G-E, and others.

| No.   | List  |        |
|-------|-------|--------|
| 1223  | Tube  | \$0.60 |
| 122-2 | 2-oz. | .60    |

**G-C PHONO NEEDLE AND PARTS CUP**

Standard size bakelite cup for phono needles and parts. It makes handy holder for screws, nuts, parts, etc., on the service bench.

| No.  | List       |        |
|------|------------|--------|
| 1399 | Needle Cup | \$0.10 |

**G-C SHIELDED PHONO PICK-UP WIRE**

Handy package of single conductor shielded wire as used on phono pick-ups, etc. Enough wire for several jobs in package.

| No.    | List     |        |
|--------|----------|--------|
| 1738-E | Envelope | \$0.40 |

**G-C RECORD CLEANING PAD**

Specialty treated soft felt pad for cleaning and removing dust from records. Saves records.

| No.  | List    |        |
|------|---------|--------|
| 1290 | 4" x 4" | \$0.25 |
| 1291 | 6" x 6" | .45    |



**G-C PICK-UP & CARTRIDGE SCREW ASS'T.**

Contains small size screws and bushings such as used on cartridges of pick-up arms. Very handy in replacing cartridges or repairing stripped threads.

| No.    | List       |        |
|--------|------------|--------|
| 6000-E | 30 Screws, | \$0.40 |



**G-C PHONO TURNTABLE DRIVES RUBBER REPLACEMENT DRIVES**

Exact duplicates for replacement of popular friction type phono turntable drives. Use G-C # 35-2 Rubber-to-Metal Cement for cementing rubber to rim.

| No.    | List                                | No.    | List                              |        |
|--------|-------------------------------------|--------|-----------------------------------|--------|
| 16     | For General Industries RX-LX Motors | 21-A   | For General Electric Models       | \$0.15 |
| 16-E   | Env. 2 No. 16 Drives                | 21-A-E | Env. 2 No. 21-A                   | .40    |
| 17     | For Alliance Model and Motorola     | 22     | RCA RP-176, G-E 809-J, large tire | 1.00   |
| 17-E   | Env. 2 No. 17 Drives                | 23     | RCA RP-176, G-E 809-J, rim drive  | .20    |
| 18     | For RCA                             | 23-E   | Env. 2 No. 23 Drives              | .40    |
| 18-E   | Env. 3 No. 18 Drives                | 24-E   | Crescent 3 3/4" O.D.              | .40    |
| 19     | For Philco, RCA, etc.               | 24-A-E | Admiral, Crescent, 3 1/4" O.D.    | .40    |
| 19-E   | Env. 4 No. 19 Drives                | 24-B-E | Admiral 3 3/4" O.D.               | .40    |
| 20-E   | Detrola Rubber Drive                |        |                                   |        |
| 20-1-E | Detrola Spring Drive                |        |                                   |        |



GENERAL



CEMENT

SWITCHES — SPAGHETTI TUBING



**G-C TOGGLE SWITCH**

S.P.S.T. Radio and appliance switch. Open housing, underwriters approved. Made by Cutler-Hammer, 3 amp., 125 volt. Nickel Plated.

| No.           | List   |
|---------------|--------|
| 1339 S.P.S.T. | \$0.45 |

**G-C PUSH-ON PUSH-OFF SWITCH**

For vacuum cleaners, appliances, test equipment. Made by H & H for G-C. Rated at 3 amps., 125 volts. Nickel Plated.

| No.           | List   |
|---------------|--------|
| 1338 S.P.S.T. | \$1.45 |

**G-C BAT HANDLE SWITCH WITH WIRE LEADS**

For vacuum cleaners, appliances, radio sets, etc. Made by H & H for G-C. Rated at 3 amps., 125 volts. Nickel Plated.

| No.           | List   |
|---------------|--------|
| 1335 S.P.S.T. | \$0.95 |

**G-C ON-OFF PLATE**

Will fit the G-C, H & H, Cutler-Hammer, and other makes of standard switches.

| No.               | List   |
|-------------------|--------|
| 1329 On-Off Plate | \$0.05 |

**G-C BAT HANDLE TOGGLE SWITCH**

Tear drop handle general purpose switch. Made by H & H for G-C. 3 amps., 125 volts. Nickel Plated.

| No.           | List   |
|---------------|--------|
| 1330 S.P.S.T. | \$0.60 |
| 1331 S.P.D.T. | .75    |
| 1332 D.P.S.T. | 1.20   |
| 1333 D.P.D.T. | 1.30   |

**G-C TOGGLE SWITCHES**

Ball handle general purpose switch. Made by H & H for G-C. 3 amps., 125 volts. Nickel Plated.

| No.                  | List   |
|----------------------|--------|
| 1300 S.P.S.T.*       | \$0.60 |
| 1301 S.P.S.T.†       | .70    |
| 1302 S.P.D.T.*       | .80    |
| 1303 S.P.D.T.†       | .85    |
| 1304 D.P.S.T.*       | 1.20   |
| 1305 D.P.S.T.†       | 1.25   |
| 1306 D.P.D.T.*       | 1.30   |
| 1307 D.P.D.T.†       | 1.40   |
| * 1/2" Shank Length. |        |
| † 3/4" Shank Length. |        |



**G-C PUSH BUTTON SWITCH**

Two circuit, "slow make and quick break" momentary contact switch. One circuit normally on, other off; pushing button reverses circuits in use. Made by H & H for G-C. 3 amps., 125 volts. Shank 1/2" long.

| No.                                    | List   |
|--|--------|
| 1340 Switch                            | \$1.20 |
| For 1340 Switch Red or Black (Specify) |        |
| 1343 Button                            | \$0.35 |

**G-C ROTARY SWITCHES**

Best grade enclosed rotary switches. Made by H & H for G-C. 3 amps., 125 volts. Shafts 1/2" long.

| No.                  | List   |
|----------------------|--------|
| 1320 S.P.S.T.*       | \$0.85 |
| 1321 S.P.S.T.†       | 1.00   |
| 1322 S.P.D.T.*       | .95    |
| 1323 S.P.D.T.†       | 1.15   |
| 1324 D.P.S.T.†       | 1.45   |
| 1325 D.P.D.T.*       | 1.45   |
| 1326 D.P.D.T.†       | 1.70   |
| * 3/8" Shank Length. |        |
| † 1" Shank Length.   |        |

**G-C NEUTRAL CENTER SWITCH**

Handy radio, appliance and tester switch with 3 positions, On-Off-On. Rated 15 amps., 110 volts; 1/8" shank. Nickel Plated.

| No.           | List   |
|---------------|--------|
| 1308 S.P.D.T. | \$1.25 |
| 1309 D.P.D.T. | 2.00   |

**G-C EXTRA HEAVY DUTY POWER SWITCH**

Three position for motors, projectors, transmitters, movie equipment, etc. Made by H & H for G-C. 10 amps., 125 volts. Neutral off in center. Size 2" x 1" x 1 1/2", shank 3/4" diameter.

| No.           | List   |
|---------------|--------|
| 1352 D.P.D.T. | \$5.50 |
| 1353 S.P.D.T. | 8.25   |
| 1354 A.P.D.T. | 12.00  |

**G-C HEAVY DUTY POWER SWITCH**

Push button, D.P.S.T. safety switch for transformers, racks, transmitters, refrigerators and high frequency work. Made by H & H for G-C. 12 amps., 125 volts. Nickel Plated.

| No.           | List   |
|---------------|--------|
| 1351 D.P.S.T. | \$2.20 |

**G-C HEAVY DUTY POWER SWITCH**

D.P.S.T. toggle power switch for motors, appliances, projectors, etc. Made by H & H for G-C. 12 amps., 125 volts. Nickel Plated.

| No.           | List   |
|---------------|--------|
| 1350 D.P.S.T. | \$1.55 |



**G-C SLIDE SWITCHES**

For phonographs, tone controls, auto lights, electric trains, etc. 1/2" wide x 1 1/8" center mounting.

| No.           | List   |
|---------------|--------|
| 1355 S.P.S.T. | \$0.35 |
| 1357 S.P.D.T. | .40    |
| 1358 D.P.S.T. | .45    |
| 1359 D.P.D.T. | .50    |

**G-C RADIO FRICTION TAPE**

This narrow 3/8" tape was particularly made for radio work. It eliminates waste and tearing of tape. It saves time and is handy to carry with you.

| No. | Roll        | List   |
|-----|-------------|--------|
| 870 | 65 ft. 3/8" | \$0.55 |
| 871 | 65 ft. 3/8" | .95    |

**G-C PLASTIC TUBING KITS**

Handy kits of assorted colors and sizes. Ideal for experimenters and servicemen.

| No.                     | List          |
|-------------------------|---------------|
| 635 Kit of 25 ft. Asst. | \$0.90        |
| 635-D Display 8         | No. 635 7.20  |
| 636 Kit of 15 ft. Asst. | 1.25          |
| 636-D Display 8         | No. 636 10.00 |

**G-C ASSORTED SPAGHETTI KIT**

An assortment of 7 1/2" lengths of spaghetti sleeving; 26 lengths to the kit. Sizes include from No. 17 wire to 3/8" I.D. A very handy bundle to have for repair jobs.

| No.                | List   |
|--------------------|--------|
| 550 Kit 26 Lengths | \$0.65 |

**G-C SPAGHETTI ASSORTMENT**

"A Box Full of Spaghetti"

Here's a buy you can't beat on a spaghetti assortment. A variety of sizes and colors are included of high grade varnish tubing. Put up in attractive box.

| No. | List   |
|-----|--------|
| 551 | \$1.25 |

**G-C SPAGHETTI ON SPOOLS**

"Approved by ASTM" 5000-Volt Dielectric Strength

Best grade varnished tubing put on convenient 20-ft. spools. Will fit wire from No. 12 to No. 18. Colors: Black, Red, Yellow, Green, Blue. Specify color.

| No. | Spool  | List   |
|-----|--------|--------|
| 499 | 20-ft. | \$1.95 |

**G-C COATED SLEEVING**

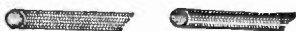

Best grade varnished sleeving. Dielectric strength 2000 volts. Colors: Black, Red, Yellow, Green, Brown. Specify color.

| No. | Size                     | List   |
|-----|--------------------------|--------|
| 525 | No. 20, fit 20 wire      | \$0.11 |
| 528 | No. 17, fit 18 wire      | .12    |
| 531 | No. 14, fit 14 wire      | .15    |
| 533 | No. 12, fit 12 wire      | .15    |
| 537 | 1/8" I.D.                | .20    |
| 540 | 3/8" I.D.                | .30    |
| 543 | 1/2" I.D.                | .35    |
| 546 | 3/4" I.D. (resist. size) | .60    |
| 547 | 1" I.D.                  | .75    |

**G-C GENFLEX PLASTIC TUBING**

"MADE OF EXTRUDED PLASTIC"

High grade extremely flexible plastic tubing for Radio and Electronic Insulation work. Resistant to cold or heat. High dielectric strength, average 8,000 volts. Put up in attractive individual boxes for easy handling. Colors: Black, Red, Green, Clear (Specify)

| No. | Wire | Pkg.   | List   |
|-----|------|--------|--------|
| 603 | 18   | 20 ft. | \$0.95 |
| 605 | 16   | 20 ft. | .95    |
| 607 | 14   | 20 ft. | .95    |
| 609 | 12   | 20 ft. | .95    |
| 611 | 10   | 15 ft. | .95    |
| 613 | 8    | 15 ft. | .95    |

All sizes available in continuous lengths on special order of 1,000 feet or more.

**G-C RADIO SPAGHETTI**



Best grade Radio and Television spaghetti. Smooth coated, with best varnishes. Very flexible. 5000 volt dielectric. Approved by ASTM. Colors: Black, Red, Yellow, Green, Brown. Specify color. 30" lengths.

| No. | Size                     | List   |
|-----|--------------------------|--------|
| 500 | No. 20, fit 20 wire      | \$0.18 |
| 503 | No. 17, fit 18 wire      | .18    |
| 506 | No. 14, fit 14 wire      | .20    |
| 508 | No. 12, fit 12 wire      | .20    |
| 512 | 1/8" I.D.                | .35    |
| 515 | 3/8" I.D.                | .50    |
| 518 | 1/2" I.D.                | .50    |
| 521 | 3/4" I.D. (resist. size) | .75    |
| 522 | 1" I.D.                  | .95    |
| 523 | 1 1/2" I.D.              | 1.20   |

GENERAL



CEMENT

RADIO SOCKETS—PLUGS—JACKS



**G-C STANDARD TUBE SOCKETS**

**BAKELITE SOCKETS**  
High quality molded bakelite sockets with plated bronze contacts. Three grounding lugs on base of each socket. 1 1/2" mounting centers.

| BAKELITE SOCKETS      |        | WAFER SOCKETS       |        |
|-----------------------|--------|---------------------|--------|
| No.                   | List   | No.                 | List   |
| 1528 8-prong Octal    | \$0.15 | 1534 4-prong        | \$0.15 |
| 1528-L 8-prong Loctal | .25    | 1535 5-prong        | .15    |
|                       |        | 1536 6-prong        | .15    |
|                       |        | 1537 7-pr. Small    | .15    |
|                       |        | 1537-L 7-pr. Large  | .18    |
|                       |        | 1538 8-pr. Octal    | .18    |
|                       |        | 1538-28-pr. Octal   | .18    |
|                       |        | 1538-L 8-pr. Loctal | .20    |

**G-C MINIATURE TUBE SOCKETS**

**BAKELITE MINIATURE SOCKET**  
For Miniature Tubes  
High quality molded bakelite socket with metal saddle mounting. Made with phosphor bronze plated contacts for 7-prong tubes. Standard 7/8" mounting centers.

**WAFER MINIATURE SOCKET**  
For Miniature Tubes  
High grade bakelite sockets for new miniature tubes. Phosphor bronze contacts, for 7-prong tubes. Standard 7/8" mtg. centers.

| No.                  | List   |
|----------------------|--------|
| 1540 Bakelite Socket | \$0.25 |

| No.                                    | List   |
|--|--------|
| 1541 Wafer Socket                      | \$0.15 |
| 1542 Wafer Socket with grounding strap | .17    |



**G-C 860 CAP**  
Spring action flat brown bakelite cap. Approved brass blades.

**G-C 861 CAP**  
Spring action, finger grip rubber caps. Approved. screw terminal brass blade.

**G-C 865 CAP**  
Modern flush type rubber cap. Easy to assemble. No exposed screws or wires.

**G-C 867 PLUG**  
Popular screw plug for standard sockets.

**G-C CUBE TAP**  
New type spring action cube tap with 3 outlets always available.

**G-C CORD CONNECTOR**  
Brown bakelite with bronze contacts.

| No.     | List   |
|---------|--------|
| 860 Cap | \$0.25 |

| No.     | List   |
|---------|--------|
| 861 Cap | \$0.25 |

| No.     | List   |
|---------|--------|
| 865 Cap | \$0.25 |

| No.      | List   |
|----------|--------|
| 867 Plug | \$0.17 |

| No.       | List   |
|-----------|--------|
| 862 Brown | \$0.30 |

| No.       | List   |
|-----------|--------|
| 863 Brown | \$0.25 |



**G-C SURFACE BLOCK**  
3-plug. Bakelite outlet for extension cords. Can fasten to wall or base.

**G-C AUTO ANTENNA PLUG**  
Shielded connector plug as used on Motorola and other auto radios.

**G-C ANTENNA CONNECTOR JACK**  
Shielded jack to fit the 1740 plug for auto antenna and phono-graph connection.

**G-C PHONO PLUG**  
For all phonographs and auto radio connections; RCA, Zenith, Philco and others.

**G-C PHONO JACK**  
Used for phonograph attachments. To be used with 1742 plug.

**G-C EXTENSION JACK AND CONNECTOR**  
For extending radio ant. cables and phono attachments. Fits 1740 or 1742 plugs.

| No.       | List   |
|-----------|--------|
| 866 Brown | \$0.50 |

| No.  | List   |
|------|--------|
| 1740 | \$0.15 |

| No.  | List   |
|------|--------|
| 1741 | \$0.25 |

| No.                  | List   |
|----------------------|--------|
| 1742                 | \$0.10 |
| 1742-E Env. of 4, 40 |        |

| No.                  | List   |
|----------------------|--------|
| 1743                 | \$0.15 |
| 1743-E Env. of 8, 40 |        |

| No.  | List   |
|------|--------|
| 1744 | \$0.20 |

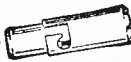

**G-C MOTOROLA LEAD ADAPTER**  
Adapter plug used to adapt bayonet type connector to Motorola type.

**G-C ADAPTER SHELL**  
Used to change the Motorola fitting to bayonet type connector.

**G-C ANTENNA CONNECTOR**  
Used for connections on auto antenna and ground lines.

**G-C JUMBO FUSE HOLDER**  
14 amp. fuse holder, 2 1/4" long x 1/2" diameter.

**G-C FUSE CONNECTOR**  
Regular Type  
Used on auto radios and other equipment. Completely assembled.

**G-C ANTENNA CONNECTOR END**  
To be used with regular antenna connectors. With bushing.

| No.  | List   |
|------|--------|
| 1745 | \$0.40 |

| No.  | List   |
|------|--------|
| 1746 | \$0.12 |

| No.  | List   |
|------|--------|
| 1747 | \$0.15 |

| No.  | List   |
|------|--------|
| 1748 | \$0.30 |

| No.  | List   |
|------|--------|
| 1749 | \$0.20 |

| No.  | List   |
|------|--------|
| 1750 | \$0.10 |



**G-C REPLACEMENT PARTS FOR ANTENNA AND FUSE CONNECTORS**

| No.      | Description                              | List   |
|----------|--|--------|
| (a) 1791 | Sleeve of Fuse Connector                 | \$0.05 |
| 1791-G   | Box of 144 No. 1791                      | 7.20   |
| (b) 1792 | Sleeve of Antenna Connector              | .05    |
| 1792-G   | Box of 144 No. 1792                      | 5.00   |
| (c) 1793 | End piece for Antenna and Fuse Connector | .04    |
| 1793-G   | Box of 144 No. 1793                      | 7.20   |
| (d) 6720 | Auto Fuse Insulator Sleeve               | .02    |
| 6720-G   | Box of 144 No. 6720                      | 1.50   |
| (e) 1796 | Spring for Antenna and Fuse Connector    | .01    |
| 1796-G   | Box of 144 No. 1796                      | 1.40   |
| (f) 1795 | Bakelite Bushing                         | .04    |
| 1795-G   | Box of 144 No. 1795                      | 4.00   |

**G-C TERMINAL STRIPS SCREW TYPE**  
Laminated bakelite strips, rigidly constructed, terminals will not turn and short.

| No.  | Contacts | List   |
|------|----------|--------|
| 1772 | 2        | \$0.18 |
| 1773 | 3        | .27    |
| 1774 | 4        | .36    |
| 1775 | 5        | .45    |
| 1776 | 6        | .54    |
| 1777 | 7        | .63    |
| 1778 | 8        | .72    |
| 1779 | 9        | .81    |
| 1780 | 10       | .90    |

**G-C TERMINAL STRIPS SOLDER TYPE**  
Mounted on laminated bakelite strips. Lugs securely fastened and will not turn.

| No.  | Contacts | List   |
|------|----------|--------|
| 1781 | 1        | \$0.05 |
| 1782 | 2        | .06    |
| 1783 | 3        | .07    |
| 1784 | 4        | .11    |
| 1785 | 5        | .12    |
| 1786 | 6        | .13    |
| 1787 | 7        | .14    |
| 1788 | 8        | .15    |
| 1789 | 9        | .18    |
| 1790 | 10       | .20    |

**G-C PHONO SPRING KIT**  
Kit contains assorted springs same as are used on phono turntables. With this kit you can replace the broken or weak spring without waiting or delay in service.

| No.             | List   |
|-----------------|--------|
| 6478 Kit of 50  | \$2.50 |
| 6479 Kit of 100 | 4.40   |

**G-C AUTO FUSE INSULATOR SLEEVE**  
Insulating sleeve to fit regular fuse holders.

| No.                | List   |
|--------------------|--------|
| 6720-E Env. of 16, | \$0.40 |



**G-C INSULATING CAMBRIC 10,000 Volts**  
Yellow varnished cambric. .010" thick.

| No. | List                       |        |
|-----|----------------------------|--------|
| 549 | Roll over 210 sq. in.      | \$0.75 |
| 548 | 36" x 36", vd., any length | 4.00   |

**G-C LAMINATED BAKELITE PANELS**  
1/8" thick. Black.

| No. | List             |        |
|-----|------------------|--------|
| 590 | 6" x 6" x 1/8"   | \$0.60 |
| 591 | 6" x 12" x 1/8"  | 1.10   |
| 592 | 12" x 12" x 1/8" | 2.20   |

**G-C FIBEROID "FISH PAPER"**  
Fish paper has many uses around the shops for repair jobs where electrical insulation is required. .010" — 240 sq. in. roll.

| No. | List |        |
|-----|------|--------|
| 560 | Roll | \$0.50 |

**G-C RUBBER KIT ASSORTMENT**  
Handy kit to keep in the shop. Contains various sizes of rubber grommets, chassis mounts, etc. An exceptional buy.

| No.  | List       |        |
|------|------------|--------|
| 7600 | Rubber Kit | \$1.00 |

**G-C RADIO CORD SETS**  
Handy replacement cord sets, ready to attach to radio sets and appliances. Approved Brown parallel wire with plugs attached.

| No.   | List      |        |
|-------|-----------|--------|
| 885   | 6 ft.     | \$0.45 |
| 886-P | 7 1/2 ft. | .60    |

**G-C EXTENSION CORDS**  
G-C extension cords are made of approved wire ready to use with a plug on one end and a 3-way tap on the other end. Brown.

| No. | List      |        |
|-----|-----------|--------|
| 887 | 6 ft.     | \$0.75 |
| 889 | 7 1/2 ft. | .90    |

GENERAL



CEMENT

**SIGNAL LIGHTS — CONNECTORS — CLIPS**



**G-C ONE-INCH JEWEL SIGNAL LIGHT**

For signal devices of all types. Bulbs change from the front; for socket bases as listed below. One-inch mounting hole. Jewel colors: Red, Green, Blue, Amber, Opal, and Clear (Specify Jewel Color).

| No.  | Socket       | Jewel  | List   |
|------|--------------|--------|--------|
| 7901 | 110-V. Cand. | Facett | \$1.40 |
| 7902 | 110-V. Cand. | Smooth | 1.40   |
| 7903 | Min. Bayonet | Facett | 1.40   |
| 7904 | Min. Bayonet | Smooth | 1.40   |
| 7905 | Min. Screw   | Facett | 1.40   |
| 7906 | Min. Screw   | Smooth | 1.40   |

**G-C 3/4-INCH JEWEL SIGNAL LIGHT**

All purpose signal light with faceted jewels in colors of Red, Green, Blue, Amber, Opal, Clear. 1 1/8" mounting hole. Jewel removed from front. (Specify Jewel Color)

| No.  | Socket         | List   |
|------|----------------|--------|
| 7907 | Min. Screw     | \$0.80 |
| 7908 | Min. Bayonet   | .80    |
| 7909 | 110-V. Candel. | .80    |

**G-C 1/2-INCH JEWEL SIGNAL LIGHT**

Popular signal light, requires only 7/16" mounting hole. Faceted jewel removed from front. Colors: Red, Green, Blue, Amber, Opal, Clear. (Specify Jewel Color).

| No.  | Socket         | List   |
|------|----------------|--------|
| 7910 | Min. Screw     | \$0.35 |
| 7911 | Min. Bayonet   | .40    |
| 7912 | 110-V. Candel. | .40    |

**G-C PANEL JEWELS**

Complete assemblies in 1", 3/4", and 1/2" diameters. Fit panels up to 1/4" thick. Brass nickel-plated. Colors: Red, Green, Blue, Amber, Opal, Clear. (Specify Jewel Color).

| No.  | Dia. | Jewel  | Mtg. Hole | List   |
|------|------|--------|-----------|--------|
| 7913 | 1/2" | Facett | 7/16"     | \$0.25 |
| 7914 | 1/2" | Smooth | 7/16"     | .25    |
| 7915 | 3/4" | Facett | 1 1/8"    | .60    |
| 7916 | 1"   | Facett | 1"        | 1.10   |



**G-C CLIP-ON PILOT LIGHT SOCKETS**

Clip up and clip down types for replacements. Cadmium-plated.

| No.  | Type                   | List   |
|------|------------------------|--------|
| 7920 | Min. Screw Clip Up     | \$0.15 |
| 7921 | Min. Screw Clip Down   | .15    |
| 7922 | Min. Bay. Clip Up      | .17    |
| 7923 | Min. Bay. Clip Down    | .17    |
| 7924 | 110-V. Cand. Clip Up   | .20    |
| 7925 | 110-V. Cand. Clip Down | .20    |

**G-C BRACKET-TYPE PILOT LIGHT SOCKETS**

Sturdy bracket-up or bracket-down type. Cadmium-plated.

| No.  | Type                        | List   |
|------|-----------------------------|--------|
| 7926 | Min. Screw Bracket Up       | \$0.15 |
| 7927 | Min. Screw Bracket Down     | .15    |
| 7928 | Min. Bay. Bracket Up        | .17    |
| 7929 | Min. Bay. Bracket Down      | .17    |
| 7930 | 110-V. Candel. Bracket Up   | .20    |
| 7931 | 110-V. Candel. Bracket Down | .20    |

**G-C UNMOUNTED PILOT LIGHT SOCKETS**

Cadmium plated. Ideal for replacements or special assemblies.

| No.  | Type              | List   |
|------|-------------------|--------|
| 7932 | Min. Screw Base   | \$0.15 |
| 7933 | Min. Bayonet Base | .14    |
| 7934 | 110-V. Candelabra | .16    |

**G-C PILOT LAMP INSTALLER**

Makes it easy to install miniature dial bulbs, neon and candelabra lamps in hard-to-get-at places. All rubber.

| No.  | List             |
|------|------------------|
| 7935 | Installer \$0.40 |

**G-C DOUBLE ALLIGATOR CLIP**

Brand New! A clip on both ends. Handiest connector made for joining wires, making temporary circuits, repairs; for tests, experiments, etc. Cadmium-plated.

| No.    | List          |
|--------|---------------|
| 7758-E | Env. 2 \$0.40 |



**G-C MALE MICROPHONE CONNECTOR**

Completely shielded, sturdy, single contact connector. Brass, bright chrome-plated. Steel spring cord protector.

| No.  | List             |
|------|------------------|
| 7940 | Connector \$0.45 |

**G-C FEMALE MICROPHONE CONNECTOR**

Single contact female type used with No. 7940, 7941 and 7943 connectors. Complete, brass chrome-plated.

| No.  | List             |
|------|------------------|
| 7942 | Connector \$0.55 |

**G-C MICROPHONE CHASSIS UNIT CONNECTOR**

Single contact male connector for chassis. Used with type 7942 female connector. Supplied complete. Brass nickel-plated.

| No.  | List             |
|------|------------------|
| 7941 | Connector \$0.35 |

**G-C MICROPHONE CONNECTOR**

Single contact, closed circuit type, prevents open circuit noises when microphone is disconnected. Chassis type, use with type No. 7942 female connector. Brass, nickel-plated.

| No.  | List             |
|------|------------------|
| 7943 | Connector \$0.55 |

**G-C MICROPHONE CONNECTOR CAP**

Chrome plated cap with anchor chain for all connectors. Seal against dirt and prevent thread damage.

| No.  | List                 |
|------|----------------------|
| 7944 | Connector Cap \$0.50 |

**G-C INSULATED ALLIGATOR CLIP**

Solder type with Red or Black insulated sleeve. Strong spring. Nickel plated.

| No.    | List            |
|--------|-----------------|
| 5064   | Red Clip \$0.20 |
| 5064-E | Env. of 2, .40  |
| 5065   | Black Clip .20  |
| 5065-E | Env. of 2, .40  |



**G-C CROCODILE CLIP**

Set screw type. Teeth nest together to assure perfect contact with wires, etc. Cadmium-plated.

| No.  | List        |
|------|-------------|
| 7757 | Clip \$0.30 |

**G-C WEE-PEE-WEE CLIP**

Very small and thin nosed with set screw for wire. Phosphor bronze. Ideal for coil work.

| No.  | List        |
|------|-------------|
| 7755 | Clip \$0.30 |

**G-C PEE-WEE CLIP**

Popular test clip. Interlocking jaws assure positive contact. Set screw type.

| No.  | List        |
|------|-------------|
| 7756 | Clip \$0.12 |

**G-C ALLIGATOR CLIP**

Solder type, non-insulated. Strong spring for positive contact. Nickel-plated.

| No.    | List           |
|--------|----------------|
| 5063   | Clip \$0.12    |
| 5063-E | Env. of 3, .40 |

**G-C ALLIGATOR CLIP**

Wire fastens under set screw. Handy for all types of connectors. Cadmium-plated.

| No.  | List        |
|------|-------------|
| 7752 | Clip \$0.18 |

**G-C SCREW TYPE INSULATED ALLIGATOR CLIP**

Very popular. Bright polished handles. Set screw for wire.

| No.  | List             |
|------|------------------|
| 7750 | Blk. Clip \$0.25 |
| 7751 | Red Clip .25     |



**G-C AMMETER CONNECTOR**

Easily clips to the ends of screws. Positive fast connector.

| No.    | List            |
|--------|-----------------|
| 6307   | Each \$0.12     |
| 6307-G | Box 144 \$16.05 |

**G-C SMALL CLIP**

1/2" long by 3/32" wide. Handles up to No. 16 wire. No 6 Mtg. Hole.

| No.    | List         |
|--------|--------------|
| 6301   | Each \$0.03  |
| 6301-G | Box 144 2.30 |

**G-C MEDIUM CLIP**

3/4" long by 1/8" wide. Handles up to No. 14 wire. No 6 Mtg. Hole.

| No.    | List         |
|--------|--------------|
| 6302   | Each \$0.03  |
| 6302-G | Box 144 2.50 |

**G-C LARGE CLIP**

1 1/8" long by 3/8" wide. No. 8 Mtg. Hole.

| No.    | List         |
|--------|--------------|
| 6303   | Each \$0.04  |
| 6303-G | Box 144 2.65 |

**G-C MEDIUM SOLDER LUG CLIP**

3/4" long by 5/16" wide. No. 6 Mtg. Hole.

| No.    | List         |
|--------|--------------|
| 6306   | Each \$0.04  |
| 6306-G | Box 144 3.40 |

**G-C DOUBLE CLIP**

1 1/2" long by 1/8" wide. No. 6 Mtg. Hole.

| No.    | List            |
|--------|-----------------|
| 6304   | Each \$0.14     |
| 6304-G | Box 144 \$21.40 |

**G-C FAHNESTOCK CLIPS**

(Also see other listing Page U-105)



**G-C TEST LEAD WIRE**  
Ideal long-life replacement wire, extra flexible, 6000 volt insulation. Red and Black (Specify color).  
No. List  
5049 Env. 1 Red, 1 Black, 50" long, \$0.50  
5049-C 100-ft. 5.00  
5049-M 1000-ft. 45.00

**G-C MASTER TEST LEADS**  
Heavy duty type. Very best. 6000 volt test, 50" extra flexible wire. Solderless connectors. Polished, colored plastic prods, removable tips. Brass nickel-plated. One Red, one Black lead.  
No. List  
5050 Test Leads \$1.50

**G-C TEST PRODS**  
Solderless type non-breakable fibre. Removable tip, brass nickel-plated.  
No. Size Color List  
5041 5 1/4" Red \$0.40  
5042 5 1/4" Black .40  
5043 7 1/4" Red .50  
5044 7 1/4" Black .50

**G-C LOW-LOSS DELUXE TEST PRODS**  
New polished low-loss material. Non-breakable. Moisture resistant. Withstands high voltages. Solderless type, brass nickel-plated.  
No. List  
5045 Red \$0.50  
5046 Black .50

**G-C NEEDLE POINT TEST PRODS**  
Adjustable chuck tip for needle. 6" polished plastic handles in Red or Black. Brass nickel-plated chuck removable. Includes needle. (Specify color).  
No. List  
7701 .50



**G-C MODERN PHONE TIP PLUG**  
New type safety tip plug fits standard phone tip jack. Solderless connectors, brass plated nickel contact.  
No. List  
7704 Red \$0.50  
7705 Black .50

**G-C INSULATED TEST PROD TIPS**  
Unbreakable polished plastic insulated handles. Solderless connectors, brass nickel-plated.  
No. List  
5061 Red \$0.24  
5061-E Env. 2 .40  
5062 Black .24  
5062-E Env. 2 .40

**G-C TEST PROD TIPS**  
Solderless type, brass nickel-plated. Non-insulated. Wire fastens easily.  
No. List  
5060 \$0.15  
5060-E Env. 3 .40

**G-C PHONO NEEDLE POINT TEST PROD CHUCK**  
Threaded chuck fits 1/4"-20 threaded hole. Needle removable. Brass nickel-plated. Includes needle.  
No. List  
7702 \$0.20

**G-C HEAVY DUTY PHONE PLUG**  
Standard type as used on test prods, leads, etc. Fits snugly in 1/4" hole. Brass nickel-plated.  
No. List  
7706 \$0.15



**G-C SOLID STANDARD PHONE TIP**  
Solid brass type made to RMA specifications. Bright nickel-plated.  
No. List  
6321-E Env. 8 \$0.40  
6321-G Pkg. 144 6.75

**G-C STANDARD PHONE TIP**  
Made of drawn brass with hole through center for easy soldering of wire at tip. Bright nickel-plated.  
No. List  
6320 Env. 16 \$0.40  
6320-G Pkg. 144 2.95  
6629 Jar 30 .65

**G-C PHONO NEEDLE POINT TEST PROD CHUCK**  
Push on type fits snugly in 1/4" hole. Brass nickel-plated.  
No. List  
7703 \$0.20

**G-C INSULATED PHONE TIP PLUG**  
Fits standard phone tip jacks. Polished non-breakable low-loss plastic insulated handles. Brass, nickel-plated tip. Minimum contact exposure.  
No. List  
7710 Red \$0.20  
7711 Black .20

**G-C INSULATED SPADE LUG**  
Tapered spade lug fits all screws or terminal strips up to No. 10. Insulated female end fits banana plugs.  
No. List  
7712 Red \$0.20  
7713 Black .20



**G-C PHONO TIP JACKS**  
Standard type with phosphor bronze spring contacts. Fits 1/4" hole and panels up to 3/8" thick. Brass parts nickel-plated.  
No. List  
7714 \$0.15

**G-C INSULATED PHONE TIP JACKS**  
Standard insulated type phosphor bronze spring contacts. 3/8" insulated head. Fits 1/4" hole and panels up to 3/8" thick. Brass parts nickel-plated.  
No. List  
7715 Red \$0.20  
7716 Black .20

**G-C SPRING BANANA PLUG**  
Insulated solderless type with polished insulated handles. Non-collapsible spring action plug. Metal parts nickel-plated.  
No. List  
7730 Red \$0.30  
7731 Black .30

**G-C SET SCREW TYPE BANANA PLUG**  
Insulated set screw type. Polished insulated plastic handles. Non-collapsible spring action banana type plug. Nickel-plated metal parts.  
No. List  
7732 Red \$0.25  
7733 Black .25

**G-C SMALL BANANA PIN PLUGS**  
Approved silver-plated plugs with straight shank. Can be riveted or soldered. For wires, multiple plugs, etc.  
No. List  
6400 Env. 10 \$0.40



**G-C SPRING BANANA PLUG**  
Standard size with 6-32 threaded shank. Use on plug-in coils, terminal strips, etc. Complete with lug and nut. Brass nickel-plated.  
No. List  
7736 \$0.15

**G-C SPRING BANANA PLUG**  
Standard size with 6-32 female thread on end. Supplied with screw and solder lug. Brass nickel-plated.  
No. List  
7737 \$0.15

**G-C BANANA JACK**  
Standard size banana pin jack. Fits 1/4" hole up to 3/8" thick panel. Nut and lug supplied. Brass nickel-plated.  
No. List  
7740 \$0.15

**G-C INSULATED BANANA JACK**  
Standard size with polished plastic insulators. Fits 1/4" hole, up to 3/8" thick panel. Nut, lug, and insulators supplied. Brass, nickel-plated.  
No. List  
7741 Red \$0.20  
7742 Black .20

**G-C RCA PHONO PIN PLUG AND JACK**  
RCA types used on many type receivers. Also used as auto antenna connectors.  
No. List  
1742 Mdg. Plg. \$0.10  
1742-E Env. 4 .40  
1743 Midget Jck. .15  
1743-E Env. 3 .40

**G-C INSULATED BANANA PLUG OR PHONE TIP JACK**  
Standard size insulated combination jack. Brass nickel-plated with phosphor bronze spring contacts. Fits 1/4" hole, panels up to 3/8" thick.  
No. List  
7744 Red \$0.30  
7745 Black .30

GENERAL



CEMENT

# ALIGNMENT TOOLS - KITS

## G-C COMBINATION ALIGNMENT TOOL



Popular bone fibre tool. Consists of screwdriver with metal nib, 1/4" slotted hex wrench and 1/8" hex wrench on other end.

|      |        |
|------|--------|
| No.  | List   |
| 5014 | \$0.85 |

## ALIGNMENT COMBINATION TOOLS

### G-C No. 5015 ALIGNMENT TOOL



Popular combination tool. Bone fibre. Includes metal screwdriver tip to fit hex wrench, 1/8" hex wrench, 1/4" slotted hex wrench and fibre screwdriver with metal nib.

|      |        |
|------|--------|
| No.  | List   |
| 5015 | \$1.35 |

### G-C DELUXE COMBINATION ALIGNMENT TOOL



Most useful tool designed to use in cramped quarters. Bone Fibre. Consists of short screwdriver with metal nib and 1/4" hex side wrench with slotted 1/4" hex end wrench, 1/8" hex wrench and heavy metal screwdriver tip.

|      |        |
|------|--------|
| No.  | List   |
| 5016 | \$1.35 |

### G-C INSULATED HEX WRENCH AND DRIVER



Combination insulated 1/4" hex wrench and screwdriver. Screwdriver can be extended for extra length. Made of bone fibre.

|                      |        |
|----------------------|--------|
| No.                  | List   |
| 5005 Extends 7"-13"  | \$0.75 |
| 5006 Extends 11"-17" | 1.00   |

## ALIGNMENT SCREWDRIVERS

### G-C NON-EXTENSION INSULATED WRENCH AND DRIVER



Combination tool 1/4" hex wrench on one end and screwdriver on other. 6" overall length. Made of bone fibre.

|      |        |
|------|--------|
| No.  | List   |
| 5007 | \$0.40 |

### G-C ALIGNMENT SCREWDRIVER



Popular insulated tool. New low inductance material with metal nib. Strong and flexible. Two sizes.

|                |        |
|----------------|--------|
| No.            | List   |
| 5000 1/4" x 6" | \$0.40 |
| 5088 3/8" x 6" | .40    |

### G-C BONE FIBRE ALIGNMENT SCREWDRIVER



Indispensable for all sets. Tough black bone fibre resists chipping. Can be reground. 1/4" blade on each end.

|         |        |
|---------|--------|
| No.     | List   |
| 5004 7" | \$0.40 |

### G-C POLYSTYRENE ALIGNMENT SCREWDRIVER



For U.H.F. sets. Best low loss material. 1/4" blades on both ends. Blades easily reground.

|         |        |
|---------|--------|
| No.     | List   |
| 5008 7" | \$0.40 |

### G-C DUPLEX NO-METAL ALIGNMENT SCREWDRIVER



In polystyrene or hard bone fibre. 1/4" blade on one end and 1/8" blade on other. 6" long. Tips easily reground.

|                  |        |
|------------------|--------|
| No.              | List   |
| 5009 Bone Fibre  | \$0.40 |
| 5010 Polystyrene | .40    |

### G-C DUPLEX ALIGNMENT SCREWDRIVER



Made of Genflex low-loss material. Especially strong. 1/4" driver on end and 3/8" on other. Metal tips for extra strength.

|      |        |
|------|--------|
| No.  | List   |
| 5001 | \$0.75 |

### G-C RCA TYPE ALIGNING SCREWDRIVER



Especially for push button adjustments. Narrow screwdriver on one end and recessed screw nib on other. 1/4" Bone Fibre.

|      |        |
|------|--------|
| No.  | List   |
| 5003 | \$0.75 |

### G-C PHILCO, RCA TYPE TRIMMER TOOL



For neutralizing air trimmers. 3/8" bone fibre. Special clip-on end, metal tip on other.

|      |        |
|------|--------|
| No.  | List   |
| 5086 | \$0.60 |

### G-C BALANCING TOOL



For adjustments in close quarters. Two 1/4" hex wrenches; one on side and other on end. Fibre screwdriver with metal tip.

|      |        |
|------|--------|
| No.  | List   |
| 5084 | \$0.60 |

### G-C DUPLEX TUBE TAPPER



Handy soft rubber mallet on one end and insulated 1/4" bone fibre screwdriver on other.

|      |        |
|------|--------|
| No.  | List   |
| 5081 | \$0.65 |

### G-C MULTI-PURPOSE TOOL



For neutralizing padding condensers and iron core tuners. One end metal screwdriver, other sleeve socket screwdriver. Best steel, fibre handle.

|      |        |
|------|--------|
| No.  | List   |
| 5091 | \$0.75 |

### G-C NEUTRALIZING TOOL



U.S.A. type TL-138-B. Special short tool. Bone Fibre.

|      |        |
|------|--------|
| No.  | List   |
| 5066 | \$0.50 |

### G-C U.S.A. TYPE TL-138-A ALIGNING TOOL



To Government specifications. Sturdy. For tuning and aligning. 6" long. Bone Fibre.

|      |        |
|------|--------|
| No.  | List   |
| 5098 | \$1.00 |

### G-C CABLE EYELET TOOL



For eyelets and rivets on dial cables, part assemblies, etc. Includes clincher punch and base. Tempered steel.

|     |        |
|-----|--------|
| No. | List   |
| 741 | \$1.00 |

### G-C DIAL CABLE TOOL



Makes it easy to replace dial cords and springs. A necessity in cramped quarters.

|                      |        |
|----------------------|--------|
| No.                  | List   |
| 5096 Dial Cable Tool | \$0.75 |

### G-C FLEXIDRIVER



Flexible shaft for "hard to get places." Insulated guide for tip. Army-Navy approved. 7" overall length.

|      |        |
|------|--------|
| No.  | List   |
| 5019 | \$2.00 |

## G-C ALL-PURPOSE ALIGNMENT TOOL KIT

Most popular kit. Seventeen tools designed into nine basic tools some of which telescope into each other. Roll type leatherette case. Includes one each G-C tools Nos. 5001, 5003, 5004, 5011, 5016, 5017, 5053, 5056, 5057.



|          |        |
|----------|--------|
| No.      | List   |
| 5023 Kit | \$6.25 |

## G-C PROFESSIONAL ALIGNMENT TOOL KITS

Complete kits. Be prepared to service every set with these DeLuxe Alignment Kits. These are the preferred kits for radio men. In a handy roll-type leatherette case or a steel partitioned box. Kits contain one each of the following G-C tools described on these pages: Nos. 5000, 5001, 5002, 5003, 5004, 5005, 5011, 5012, 5013, 5015, 5016, 5017, 5018, 5019, 5031, 5032, 5033, 5034, 5035, 5051, 5053, 5056, 5057, 5081, 5082, 5083, 5084, 5085, 5086, 5087.

|                            |         |
|----------------------------|---------|
| No.                        | List    |
| 5024 Kit in Roll Type Case | \$19.95 |
| 5025 Kit in Steel Box      | 19.95   |

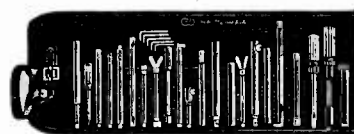

No. 5024



No. 5025

## G-C ALIGNMENT TOOLS AND WRENCHES

### G-C INSULATED ALIGNING WRENCHES



Popular sizes. Hexed full-length bone fibre tubing. Just cut off to renew when worn.

| No.  | Length | Flat Diam. | Across | List   |
|------|--------|------------|--------|--------|
| 5051 | 5"     | 1 1/8"     | 7/16"  | \$0.30 |
| 5052 | 5"     | 1 1/4"     | 3/8"   | .25    |
| 5053 | 6"     | 1 1/2"     | 3/8"   | .35    |
| 5054 | 8"     | 1 3/4"     | 3/8"   | .40    |
| 5055 | 12"    | 1 7/8"     | 3/8"   | .50    |

### G-C PHILCO TYPE ALIGNMENT WRENCH



5/8" Hex Wrench on one end, metal hook for air trimmers on other. For RCA, Victor, Philco, etc. Bone fibre handle.

| No.  | List   |
|------|--------|
| 5085 | \$1.50 |

### G-C DUPLEX WRENCH ALIGNMENT TOOL



Long life 1/4" hex wrench on one end and 1/8" hex wrench on other. Brass nickel-plated. Tapered bone fibre handle.

| No.  | List   |
|------|--------|
| 5017 | \$1.25 |

### G-C DUPLEX ALLIGATOR WRENCH



RCA, Philco type. Metal alligator wrench on one end, alignment screwdriver with metal tip on other. 3/8" shaft. Insulated bone fibre.

| No.  | List   |
|------|--------|
| 5011 | \$0.50 |

### G-C DOUBLE ALLIGATOR ALIGNING WRENCH



5/8" bone fibre handle with alligator wrench on one end and 1/4" brass hex wrench on other. Popular.

| No.  | List   |
|------|--------|
| 5012 | \$0.50 |

### G-C INSPECTION MIRROR



New! For close inspection of parts in hard-to-get-at quarters, under chassis, etc. Long handle.

| No.  | List   |
|------|--------|
| 5090 | \$0.50 |

### G-C WRENCH AND SCREWDRIVER ALIGNING TOOL



Popular 1/4" hex wrench on one end, 3/32" metal nib screwdriver on other. Bone fibre insulated handle.

| No.  | List   |
|------|--------|
| 5013 | \$0.85 |

### G-C BAKELITE 5/16" WRENCH



Molded 5/16" hex wrench with reinforced brass collar. Metal screwdriver tip included.

| No.  | List   |
|------|--------|
| 5083 | \$0.50 |

### G-C "STRATO" TUNING WAND



Chrome brass cylinder, iron core on ends of low-loss genflex rod. Inserting core in coil increases inductance, brass end decreases inductance. Checks tuning fast.

| No.  | List   |
|------|--------|
| 5002 | \$1.00 |

### G-C TEST PROBE



Checks loose connections and parts. Metal hook on one end and insulated fibre tip on other.

| No.  | List   |
|------|--------|
| 5082 | \$0.60 |

### G-C SCREWDRIVER



Insulated. One size for knobs, other for small parts. Best tempered steel.

| No.  | List             |
|------|------------------|
| 5056 | 1/8" x 3" \$0.25 |
| 5057 | 3/16" x 3" .75   |

### G-C BAKELITE ALIGNMENT TOOL



U. S. Army type TL-207. Combination 5/16" Hex Wrench with telescoping screwdriver. Moulded bakelite, reinforced with metal.

| No.  | List   |
|------|--------|
| 5027 | \$2.25 |

### G-C ARMY-NAVY TYPE NEUTRALIZING TOOL



Approved. Double end bakelite tool 5/8" diam. x 6" long.

| No.  | List   |
|------|--------|
| 5099 | \$1.25 |

### G-C ZENITH PUSH-BUTTON WRENCH



5/8" hex on one end, slotted on other. Tempered steel, nickel-plated. Necessity for Zenith sets.

| No.  | List   |
|------|--------|
| 5094 | \$0.17 |

### G-C CONTACT ADJUSTER



Handy for contacts on switches, jacks, condenser plates, relays, pinball-coin machines, radios. Tempered steel, nickel-plated.

| No.  | List   |
|------|--------|
| 5095 | \$0.17 |

### G-C TELEVISION AND F-M WRENCH AND SCREWDRIVER



Adjusts smallest trimmer condensers. Small 3/32" screwdriver on one end, reinforced 5/16" hex wrench on other. 6" long. Bone fibre.

| No.  | List   |
|------|--------|
| 5067 | \$1.00 |

## G-C TELEVISION AND F-M TOOLS

### G-C TELEVISION ALIGNING WRENCH



New Television Tool! 1/4" socket wrench. 5/8" steel shaft with insulated handle. Approx. 6" overall length.

| No.  | List   |
|------|--------|
| 5080 | \$0.75 |

### G-C T-V AND F-M ALIGNING TOOL



Socket-type screwdriver of tempered steel. Bone fibre handle.

| No.  | List   |
|------|--------|
| 5018 | \$0.75 |

### G-C BENDIX-RCA TELEVISION SCREWDRIVER



For push buttons, television and F.M. Small diameter. Metal tip on one end and recessed tip on other. Insulated bone fibre.

| No.  | List   |
|------|--------|
| 5087 | \$0.75 |

### G-C K-TRAN ALIGNING TOOL



Special bone fibre screwdriver one end, reinforced 5/16" hex wrench driver on other. Especially for F-M and television sets.

| No.  | List   |
|------|--------|
| 5097 | \$0.75 |

### G-C DELUXE ALIGNMENT KIT

Fourteen most popular tools including Flexible Shaft Screwdriver and Tuning Wand, designed into seven basic tools, some of which telescope together. Contains one each Nos. 5002, 5004, 5011, 5014, 5016, 5017, 5019. In leatherette roll-type case.



| No.  | Kit | List   |
|------|-----|--------|
| 5026 | Kit | \$7.50 |

### G-C NX ALIGNING KIT

Popular approved Army - Navy Kit for all sets. Fourteen tool applications, some telescoping together, to form five basic tools. Contains Nos. 5004, 5011, 5017, 5016, 5010, and leatherette case.



| No.  | Kit | List   |
|------|-----|--------|
| 5020 | Kit | \$6.50 |

### G-C VEST POCKET ALIGNING KIT

Easy - to - carry all-purpose kit of popular tools. Four tools with telescoping parts making them equivalent to six. Contains Nos. 5012, 5000, 5003, 5004 and leatherette case.



| No.  | Kit | List   |
|------|-----|--------|
| 5022 | Kit | \$3.00 |

### G-C TE-45A NEUTRALIZING KIT

Approved by U. S. Signal Corps. All popular balancing tools to make an all-purpose kit. Contains two each Nos. 5051, 5052, and one each Nos. 5019, 5003, 5000, and 5" screwdriver in roll-type leatherette case.



| No.  | Kit | List   |
|------|-----|--------|
| 5021 | Kit | \$6.75 |



# GENERAL CEMENT BATTERY PLUGS—KITS—STAPLES

## G-C RADIO BATTERY PLUGS



| Part No. | Voltage                                    | For Burgess No.          | For Eveready No.     | For R.C.A. No.             | For Philco No.          | For Ray-O-Vac No.                | List Price |
|----------|--|--------------------------|----------------------|----------------------------|-------------------------|----------------------------------|------------|
| 7803     | 45 "B" Large                               | A30, B30, M30, Z30       | 482, 738, 762        | VS012, VS013, VS014, VS015 | P210, P305              | 430P, P7830, P5303               | \$0.11     |
| 7804     | Same as No. 7826                           | except has               |                      | Fahnestock                 | Clips.                  |                                  | .30        |
| 7805     | Same as No. 7829                           | except has               |                      | Fahnestock                 | Clips.                  |                                  | .45        |
| 7806     | 4 1/2 "A"                                  | G-3                      | 746                  | VS002                      | P100                    | P-83A                            | .11        |
| 7807     | 45 "B" Small                               | A30, B30, M30, Z30       | 482, 738, 762        | VS012, VS013, VS014, VS015 | P210, P305              | 430P, P7830, P5303               | .11        |
| 7808     | 1 1/2 "A"                                  | 4F, 4FL, 6F, 8F, 8FL, TE | 741, 742, 743, 1052P | VS004, VS005, VS007, VS008 | P94, P96, P8F1          | P94A, P94L, PX, P96A, P98A, P98L | .11        |
| 7809     | 1 1/2 "A"-90 "B"                           | 17GD60, 5DA60, 6TA60     | 758                  | VS022, VS043               | P60D11L                 | AB82, 10793                      | .13        |
| 7810     | 6 "A"                                      | 2F4, 2F4L, F4PI, T5      | A509, 718, 744, 747  | VS009, VS010, VS011        | P4F4R                   | P691A, P696L, P698A, P698L       | .11        |
| 7811     | 6 "A"-90 "B"                               | 2F1B60, etc.             |                      |                            |                         |                                  | .15        |
| 7812     | 7 1/2 "A"                                  | G-5                      | 687                  | VS003                      |                         | P85A                             | .13        |
| 7813     | 1 1/2 "A"-63 "B"                           | 6FA60, 4GA41, 4GA42      |                      | VS037                      | P60A-4L, P11A4G         | AB419                            | .13        |
| 7814     | 7 1/2 "A"-90 "B"                           | G5A42, F5A60             |                      | VS038                      | P87, P841               | AB794                            | .25        |
| 7815     | 67 1/2 "B"                                 | XX30, XX45               | 455, 467             | VS016, VS056               |                         | P4367                            | .09        |
| 7816     | 67 1/2 "B"                                 | XX30, XX45               | 455, 467             | VS016, VS056               |                         | P4367                            | .11        |
| 7817     | Same as No. 7803                           | except has               |                      | Fahnestock                 | Clips.                  |                                  | .30        |
| 7818     | Same as No. 7808                           | except has               |                      | Fahnestock                 | Clips.                  |                                  | .25        |
| 7819     | 6 "A"-75 "B"                               | G4B50, etc.              |                      |                            |                         |                                  | .15        |
| 7820     | 6 "A"-90 "B"                               | F4B60                    |                      | VS048                      |                         |                                  | .20        |
| 7821     | 6 "A"-90 "B"                               | 2F4A60                   |                      | VS044                      | P60A8F4                 | AB694                            | .13        |
| 7822     | 9 "A"-90 "B"                               | 4FA60                    |                      |                            |                         |                                  | .25        |
| 7823     | Same as No. 7824                           | except has               |                      | Fahnestock                 | Clips.                  |                                  | .25        |
| 7824     | 3 "A"-90 "B"                               | 20P2                     | X125                 | VS025                      | P8024                   | P9403                            | .11        |
| 7825     | Batt. Packs                                | Usalite                  | AB5671               |                            | P60A110                 |                                  | .18        |
| 7826     | 4 1/2 "C"                                  | 2370PI                   | X771                 | VS030                      | P3D, P37-08, 3738, etc. | P231W                            | .15        |
| 7827     | 135 "B"-9 "C"                              |                          |                      |                            | 34, 34A, 39, 39A        |                                  | .30        |
| 7829     | 22 1/2 "C"                                 | 5156PI                   | 768                  | VS031                      | P15B5                   | P5151                            | .22        |
| 7830     | 2 prong large with one thin and one thick. | Popular on               |                      | Portables.                 |                         |                                  | .15        |
| 7831     | 9 "A"-90 "B"                               | F6A60, G6M60             | 753, 754             | VS018, VS019               | P841A                   | AB878, AB994                     | .25        |

## G-C RADIO BATTERY PLUGS



For all plug-in radio batteries. It pays to have an assortment to be ready for all repairs. Plugs as listed above. Complete with box and handy reference chart.

|          |                                |              |
|----------|--------------------------------|--------------|
| No. 7801 | 100 Ass'd. Plugs, Metal Box    | List \$12.00 |
| No. 7800 | 50 Ass'd. Plugs, Cardboard Box | List 6.50    |

## G-C INSULATED BELL STAPLES

Saddle-type insulated staples for holding wires in place and out of the way.

| No.  | Fig.          | Size        | List   |
|------|---------------|-------------|--------|
| 1751 | 1             | 3/8" x 1/2" | \$0.25 |
| 1752 | Box 50, No. 1 |             | .40    |
| 1753 | 2             | 3/8" x 5/8" | .25    |
| 1754 | Box 50, No. 2 |             | .40    |
| 1755 | 3             | 3/8" x 3/4" | .25    |
| 1756 | Box 50, No. 3 |             | .40    |
| 1757 | 5             | 1/2" x 5/8" | .25    |
|      | Box 50, No. 5 |             |        |

No. 1 No. 2 No. 3 No. 5 No. 6 No. 7 No. ID



| No.  | Fig.                   | Size | List   |
|------|------------------------|------|--------|
| 1758 | Box 100, No. 5         |      | \$0.40 |
| 1759 | Fig. 6, 1/4" x 3/4"    |      | .40    |
| 1760 | Fig. 7, 1/4" x 7/8"    |      | .40    |
| 1761 | Box 100, No. 7         |      | .40    |
|      | Extra Large Cable Size |      |        |
|      | Fig. 10, 3/8" x 3/4"   |      | .70    |
|      | Box 100, No. 10        |      |        |



## G-C DIAL AND KNOB REPAIR KIT

Handy assortment of knob springs, set screws, dial springs, idler pulleys and drive rubbers in box.

|          |              |             |
|----------|--------------|-------------|
| No. 1015 | 70-pc. Kit,  | List \$2.25 |
| No. 1016 | 150-pc. Kit, | List 4.50   |

## G-C PLASTIC JAR HARDWARE ASSORTMENT

Approximately 1000 assorted screws, nuts, washers, springs, clamps, eyelets, grommets, terminals, etc. No cast-offs — only regular hardware. Plastic jar with screw cap.

|            |                 |             |
|------------|-----------------|-------------|
| No. 6064   | 1000 Ass'd.     | List \$1.65 |
| No. 6056-E | Env. 100 Ass'd. | List .40    |

## G-C HELL BOX

A grand assortment of useful hardware: screws, nuts, lugs, clips, washers, clamps, etc. Thousands of items needed every day. Metal hinged box.

|          |             |
|----------|-------------|
| No. 6500 | List \$3.25 |
|----------|-------------|

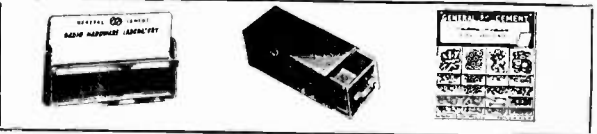

## G-C STEEL HARDWARE RACK

Steel racks, hold No. 4002 2 oz. glass bottles or plastic jars. Attractively finished. Welded construction. Heavy steel. Two sizes.

| No.  | Size    | List   |
|------|---------|--------|
| 4010 | 20 Jars | \$2.00 |
| 4012 | 40 Jars | 3.75   |

## G-C STEEL STOCK BOXES

Slide-in drawer type cabinet box for parts. Made so can be stacked. Attractive finish, steel welded construction with handle. Size 13 1/2" long, 6" wide, 4" high.

| No.  | List   |
|------|--------|
| 4001 | \$3.25 |

## G-C SERVICEMEN'S HARDWARE ASSORTMENT

Inexpensive complete hardware assortments. Similar to larger hardware lab Ass't No. 1 like No. 6601; and No. 2 like No. 6602 (Page U-139). Items individually packaged.

| No.      | Ass't. | List   |
|----------|--------|--------|
| 6303-D   | #1     | \$8.00 |
| 6603-2-D | #2     | 8.00   |



## G-C VENTILATING PLUGS

To ventilate chassis, amplifier, racks, transmitters, etc. Snaps into 1-inch hole. Plated.

| No.    | List          |
|--------|---------------|
| 1709-E | Env. 2 \$0.40 |

## G-C PLASTIC HARDWARE JARS

4 oz. sizewise mouthed plastic jar with screw type cap. Ideal for hardware.

| No.  | List   |
|------|--------|
| 4000 | \$0.35 |

## G-C GLASS HARDWARE JARS

Wide mouthed jars, for storing small radio parts, screws, nuts, etc. Includes cap.

| No.  | List         |
|------|--------------|
| 4002 | 2-oz. \$0.15 |
| 4004 | 4-oz. .22    |
| 4008 | 8-oz. .30    |
| 4009 | 16-oz. .40   |



## G-C SOLDERING COOLANT AND FLUX ATTACHMENT

Here's a handy attachment that you can put on any soldering iron and speed up production and repairs. No waiting for solder to cool. Dip the brush in a coolant of water or alcohol and cool the solder instantly. Also can be used for soldering flux or paste.

| No. | List   |
|-----|--------|
| 720 | \$0.25 |

## G-C SOLDERING WIRE COUPLERS

New patented connectors to be used when re-connecting cut wires and leads, when making tests, etc. Saves time! Simply slip between wires and solder. Assorted lengths.

| No.    | List   |
|--------|--------|
| 7500-E | \$0.40 |

## G-C STAPLE DRIVER STAPLES

Hardened steel staples in cartridge form to fit staple drivers. Lacquer coated.

| No. | List           |
|-----|----------------|
| 430 | Box 250 \$0.60 |

## F-V LINE TACKS



For holding 300-ohm lead wire to base boards, etc.

| No.    | List           |
|--------|----------------|
| 8020-E | Env. 30 \$0.40 |
| 8020-G | Box 144 1.25   |

**G-C STANDARD SPEEDEX WIRE STRIPPER**

Fast operating precision made hand tool for stripping insulation from all types of wire. Very easy to operate. Strips 750 to 1000 wires per hour. Used by girls or men. All blades are interchangeable and easily replaced



| Standard Models |                |        |       |   |        |
|-----------------|----------------|--------|-------|---|--------|
| No.             | Wire           | List   | No.   | Wire  | List   |
| 733             | 12 to 20       | \$6.00 | 733-G | For # 18 P.O. S.J. or parallel wire                     | \$6.00 |
| 733-A           | 14 to 30       | 6.00   |       |   |        |
| 733-B           | 10 to 18       | 6.00   |       |   |        |
| 733-C           | 8 to 10        | 6.00   | 733-H | For the new 300-ohm television and FM transmission line | 6.00   |
| 733-D           | 16, 18, 20, 22 | 6.00   |       |   |        |
| 733-E           | 14, 16, 18     | 6.00   |       |   |        |
| 733-F           | 10, 12, 14     | 6.00   |       |   |        |

**G-C AUTOMATIC SPEEDEX WIRE STRIPPER**

Similar to standard models except has the "stay open feature" with the new Speedex "Trig-O-Matic Action." Automatically holds jaws open until wire is removed, and prevents bending or crushing of fine wires. Has on-off mechanism so tool can be used as standard model if desired.



| Automatic Models |                |        |       |   |        |
|------------------|----------------|--------|-------|---|--------|
| No.              | Wire           | List   | No.   | Wire  | List   |
| 744              | 12 to 20       | \$8.00 | 744-G | For # 18 P.O. S.J. or parallel wire                     | \$8.00 |
| 744-A            | 14 to 30       | 8.00   |       |   |        |
| 744-B            | 10 to 18       | 8.00   |       |   |        |
| 744-C            | 8 to 10        | 8.00   | 744-H | For the new 300-ohm television and FM transmission line | 8.00   |
| 744-D            | 16, 18, 20, 22 | 8.00   |       |   |        |
| 744-E            | 14, 16, 18     | 8.00   |       |   |        |
| 744-F            | 10, 12, 14     | 8.00   |       |   |        |

**G-C SPEEDEX WIRE STRIPPER KIT**

Wire stripper complete with seven different size blades put up in a specially designed permanent steel box. For wires No. 8 to No. 30. Helps keep all the parts together in one kit. Available with automatic or standard model strippers.



| No.                                      | List    | No.  | List  |
|--|---------|--|-------|
| 733-K Standard Stripper Kit, with blades | \$15.00 | 744-K DeLuxe Automatic Stripper Kit, with blades | 17.00 |

**G-C SHUR-GRIP PLIER WRENCH**

Here's a universal handy all-purpose plier wrench. This is something new and different from the average Grip Wrench. It works with a short pawl against the cam handle, giving it extra power. IT UNLOCKS WITHOUT SNAPPING THE FINGERS. Jaws are forged from alloy steel and specially heat treated for toughness and durability. It is a high quality tool.



| No.               | List   | Dealer's Net |
|-------------------|--------|--------------|
| 767 7" Shur-Grip  | \$3.50 | \$1.80*      |
| 770 10" Shur-Grip | 3.95   | 1.95*        |



**G-C SPEEDEX REPLACEMENT BLADES**

Fit standard and automatic models. Blades interchangeable.

| No.  | List   |
|--|--------|
| 3W 12 to 20  | \$1.50 |
| 3W-A 14 to 30  | 1.50   |
| 3W-B 10 to 18  | 1.50   |
| 3W-C 8 to 10   | 1.50   |
| 3W-D 16, 18, 20, 22  | 1.50   |
| 3W-E 14, 16, 18  | 1.50   |
| 3W-F 10, 12, 14  | 1.50   |
| 3W-G Blades for parallel No. 18 P.O.S.J. or similar                      | 1.50   |
| 3W-H Blades for the new 300-ohm television and FM twin transmission line | 1.50   |



**G-C SPEEDEX STRIPPER BENCH HOLDER**

Bench type holder for any model Speedex Wire Stripper. Converts a hand operated tool to a bench type and increases production up to 2,500 wire strippings per hour. Steel.

| No.              | List   |
|------------------|--------|
| 755 Bench Holder | \$3.75 |



**G-C SPEEDEX TRIG-O-MATIC PLATE (Patent Pend.)**

Converts any standard model Speedex Stripper to an Automatic Model. Easy to install.

| No.                          | List   |
|------------------------------|--------|
| 756 Trig-O-Matic Plate, only | \$2.00 |



**G-C SOLDER IRON TIPS**

Best grade hard-drawn copper, bright plated to resist corrosion. Heats fast and holds heat.

| No.                        | List   |
|----------------------------|--------|
| 8124 1/4" x 3" Tip         | \$0.45 |
| 8124-D Display 12 No. 8124 | 5.40   |
| 8125 3/8" x 4 1/2" Tip     | .55    |
| 8125-D Display 12 No. 8125 | 6.60   |
| 8126 3/8" x 4 1/2" Tip     | .60    |
| 8126-D Display 12 No. 8126 | 7.20   |
| 8127 1/4" x 4" Tip         | .75    |
| 8127-D Display 12 No. 8127 | 9.00   |



**G-C INSPECTION LITE**

Portable type, lights up those "hard-to-see" spots. Operates on 110-120 volts AC or DC. Cord approx. 6 ft. long. Molded handle and non-inflammable clear plastic shield over bulb.

| No.                              | List   |
|----------------------------------|--------|
| 705 Inspection Light             | \$1.95 |
| 704 Replacement Bulb for No. 705 | .17    |
| 704-S Clear Plastic Shield       | .17    |



**G-C LO-VOLT TESTER**

For 0-15 volts AC or DC. For all low voltage testing on cars, generators, batteries, bell circuits, etc. Shielded bulb easily replaced. Molded plastic handle and insulators.

| No.                      | List   |
|--------------------------|--------|
| 5125 Lo-Volt Tester      | \$1.25 |
| 5126 Bulb for No. 5125   | .25    |
| 5127 Shield for No. 5125 | .15    |



**G-C THERMO-VOLT CIRCUIT TESTER**

Tests from 15 to 60 volts AC or DC on thermostats, aircraft, trains, marine lighting, 28-32 volt light plants, etc. Molded plastic case and insulated tips.

| No.  | List   |
|------|--------|
| 5150 | \$1.75 |



**GC CARBON BRUSH KIT**

Complete assortment replacement brushes, for vacuum cleaners, washing machines, ironers, pumps, fans, etc. Contains 92 brushes and 18 springs.

| No.  | List   |
|------|--------|
| 7000 | \$8.25 |

**G-C CHASS-EZ**  
(Pat. Pending)

New wonder tool makes the Serviceman's job easier. Its simplicity is its chief merit. Chassis can be installed on "Chass-Ez" in five seconds. All one unit — no extra bolts or nuts to adjust. Heavy steel, riveted construction, nicely plated.



|                        |        |
|------------------------|--------|
| No.                    | List   |
| 5207                   | \$3.65 |
| Dealer's Net Only 1.95 |        |

**G-C PHONO TURNTABLE STAND**

New improved model, adjustable and inexpensive. Adaptable to all turntables. Raises the turntable 15 inches above bench and can be pivoted on the swivel joints for easy examination or repairs. Sturdy steel construction. Plated.



|                        |        |
|------------------------|--------|
| No.                    | List   |
| 5205                   | \$7.30 |
| Dealer's Net Only 4.38 |        |

**G-C RADIO JACKS**

Permanent type adjustable jacks. All metal construction. Adjustable to fit any set or conditions. Easily and quickly adjusted. Two jacks supplied with three extension rods — one extra long. You need several sets in your shop.

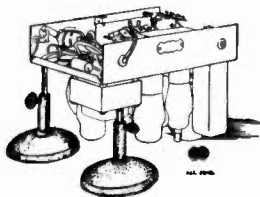

|                        |        |
|------------------------|--------|
| No.                    | List   |
| 711                    | \$2.15 |
| Dealer's Net Only 1.29 |        |

**G-C RADIO CHASSIS GUARDS**

Inexpensive guards that protect the chassis and tubes when servicing. Set can be turned in any position. Easily applied and adjustable to all sets. Permanent plated metal construction.

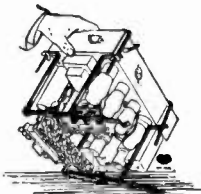

|                        |        |
|------------------------|--------|
| No.                    | List   |
| 709                    | \$2.50 |
| Dealer's Net Only 1.50 |        |

**G-C MINIATURE TUBE PIN STRAIGHTENER**

Saves tubes! Straightens without damage the pins on the fragile miniature tubes such as 1S5, 6AK5, 9002, etc. Just insert tube between guide pillars into precision base die and tube prongs are straightened and properly spaced. All metal.



|                      |        |
|----------------------|--------|
| No.                  | List   |
| 5191 For 7-pin tubes | \$1.00 |
| 8105 For 9-pin tubes | 1.00   |

**G-C TUBE AND PARTS EXTRACTOR**

U. S. Signal Corps part No. TL 201. Handy prong tool for extracting tubes and picking up parts. Rubber cushions on prongs.



|                     |        |
|---------------------|--------|
| No.                 | List   |
| 5092 Tube Extractor | \$1.50 |

**G-C NE-O-LITE**

Simple, safe, electrical circuit tester. Uses neon glow lamp which varies in brightness according to voltages. Tests cords, appliances, automotive ignition circuit, fuses, radios, electric fences, etc. For 60-volts AC to 560 volts AC or DC. Molded plastic, handy vest pocket size. Buy a display and sell your customers.

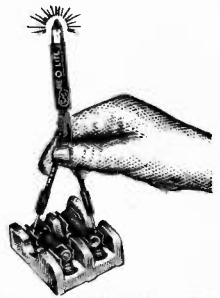

|                            |        |
|----------------------------|--------|
| No.                        | List   |
| 5100 Ne-O-Lite             | \$0.50 |
| 5112-D Display 12 No. 5100 | 6.00   |

**G-C NE-O-LITE WIRE**



Wire same as used on Ne-O-Lite Testers, # 18 stranded, rubber covered with a red or black braid, varnished. For ignition wiring, motor wiring, etc. Red or Black — Specify color.

|              |        |
|--------------|--------|
| No.          | List   |
| 5113 100 Ft. | \$3.75 |

**G-C RESISTOR FOR NEON LAMP**



Required resistor when using No. 717 neon lamp on voltages of 60 to 550 volts AC or DC. Connect in series.

|     |        |
|-----|--------|
| No. | List   |
| 718 | \$0.10 |

**G-C NEON GLOW LAMPS**



NE-T2 lamp as used in testers, appliances, as pilot light, etc.

|     |        |
|-----|--------|
| No. | List   |
| 717 | \$0.20 |

**G-C AMO MINIATURE TUBE PULLER**  
(Pat. Pending)

Prevents burned fingers and broken tubes. Makes it easy to remove and install tubes such as 6AG5, 50B5, etc. Works on suction and vacuum principle. Operates just by pressing on the tube and to release, just press the release button. Tube protected by rubber sleeve. Gets where your fingers can't reach. Permanent metal.



|                      |        |
|----------------------|--------|
| No.                  | List   |
| 5093 For 7-pin tubes | \$1.65 |
| 8106 For 9-pin tubes | 1.65   |

**G-C FIBRELOID SPEAKER SHIMS**

Shims made of tough and flexible fibreloid. Non-magnetic. 4 each of 5 sizes — twenty in all: Sizes, .005", .0075", .010", .0125", and .015". Color coded. Supplied in gold lettered leatherette snap case with instructions.



|         |        |
|---------|--------|
| No.     | List   |
| 702 Kit | \$0.65 |

**G-C SWEDISH STEEL SPEAKER SHIMS**

Makes it easier to center speaker voice coil. Permanent flexible Swedish steel. 4 shims each of 4 sizes coded for identification: .004", .006", .008" and .010" thick. Supplied in gold stamped leatherette partitioned snap case. Complete with instructions.



|         |        |
|---------|--------|
| No.     | List   |
| 701 Kit | \$0.70 |

**NEW! G-C SPEAKER SHIM KIT**

For every type of speaker adjustment. A generous supply of Fibreloid and bronze shim stock in the various widths and thicknesses needed for speakers. Non-magnetic material. Stock can be cut to exact requirements. A long-lasting assortment. Complete instructions.

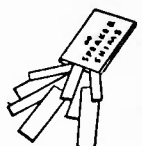

|          |        |
|----------|--------|
| No.      | List   |
| 7720 Kit | \$2.00 |



**G-C RECORDING WIRE**

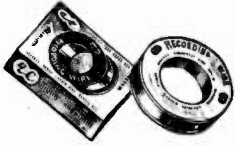

For all wire recorders. Includes plastic leads. Permanent recordings which can be replayed indefinitely. Finest quality reproduction on stainless steel wire. Standard RMA spool fits Webster, Air King, Sears Roebuck, etc.

| No.  | Leaders with Spools                               | Dealer's Net |
|------|---|--------------|
| 5171 | 1-hr. Spool                                       | \$3.25*      |
| 5172 | ½-hr. Spool                                       | 1.95*        |
| 5173 | ¼-hr. Spool                                       | 1.30*        |
| 5174 | Leaders only, for Armour type recorders, per pair | .15*         |
| 5176 | Empty Rewind Spool                                | .45*         |

**G-C REPLACEMENT AUTO AERIALS**

**FORD ROOF AERIAL**

Ford-Mercury Part No. 51A-18813-A1



Replacement aerial for all Ford and Mercury Roof Aerials of 1941-42-46-47-48 that operate from behind the dividing post of the windshield. Made of Admiralty brass tubing with stainless steel extension rod, triple chrome plated. Free sliding with positive contacts insure noise-free reception. Easy to install, fits without changes, replaces original aerial. Comes complete with knob and set screw.

| No.  | Ford Roof Aerial | List   |
|------|------------------|--------|
| 7056 | Ford Roof Aerial | \$2.25 |

**BUICK REPLACEMENT ANTENNA**

Buick Part No. 980,688

Standard Buick Roof Aerial Mast. The replacement mast for Buick Roof Aerials on models 1940 through 1949. Easy to replace — merely tightens into position with a set screw. Admiralty brass tubes with a stainless steel top rod. Chrome-plated. Each mast individually packed in a paper tube. Standard packing — 10 tubes to a carton.

| No.  | Buick Antenna Mast | List   |
|------|--------------------|--------|
| 7057 | Buick Antenna Mast | \$2.75 |

**G-C IGNITION SUPPRESSORS**



A rugged long-life assortment of bakelite auto radio ignition suppressors. Resistance, 10,000 ohms (V-8 types, 50,000 ohms). Resistors, moisture-proofed to eliminate variations due to weather changes. Impervious to heat, oil, moisture and mild acids. All metal parts brass. Good for more than 50,000 miles.

| No.      | List                                    | No.      | List                               |
|----------|---|----------|------------------------------------|
| (a) 1501 | Bracket Type \$0.30                     | (e) 1505 | Screw Type, Universal \$0.30       |
| (b) 1502 | Ford V8 .30                             | (f) 1506 | Snap-On Type .30                   |
| (c) 1503 | Ford V8 Brush Type, 33, 34, 35 Cars .30 | (g) 1507 | Distributor Type .30               |
| (d) 1504 | Ford V8 Brush Type, 36 to 40 Cars .30   | (h) 1508 | Cable type for Splicing Cables .30 |

**G-C SPRING MAKER**

(Pat. Pending)

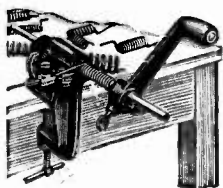

Makes all types of coil springs — compression or extension types — with any number of coils or degree of wire pitch. Designed for simple adjustment and operation with any size spring wire. Necessary wherever springs must be made fast or to special specifications. Liberal supply spring wire furnished with each winder. Fastens to any bench.

| No.  | List  | Dealer's Net |
|------|---|--------------|
| 5209 | Spring Winder and Asst. Spring Wire \$16.58 | \$9.95*      |
| 5210 | Replacement Asst. Spring Wire 2.50          | 1.50*        |

**G-C STATIC POWDER AND INJECTOR GUN**



It really works, cuts down auto radio static. Inject powder in tubes, and eliminate wheel tire static. Easy to apply. Powder also cuts down tire trouble by eliminating those pin-point tube leaks caused by tire static discharge. Powder blown into tube with G-C Injector Gun. Every car should be treated with G-C Static Chaser Powder.

| No.  | List   |
|------|--|
| 5604 | Injector Gun, only \$1.50                                |
| 5605 | Packet Static Powder for 5 tires (1 car) 1.00            |
| 5606 | Kit, one No. 5604 Injector, and one No. 5605 Powder 2.50 |

**G-C DIAL POINTER KIT**

A complete kit of 10 assorted dial pointers. Pointers come in a clear transparent plastic case which keeps the pointers in perfect condition.



| No.  | List   |
|------|--------|
| 6810 | \$2.95 |

**G-C DIAL POINTERS**

Popular replacement pointers.

| No.      | List  |
|----------|---|
| (a) 6801 | 8" Rotary Pointer for ¼" shaft, gold \$0.35           |
| (b) 6802 | 5" 360° Rotary Pointer for ¼" shaft, gold and red .35 |
| (c) 6803 | 2" Slide Pointer, red translucent .25                 |
| (d) 6804 | 2¼" Slide Pointer, white enamel .25                   |

**G-C VACUUM CLEANER BELTS**

Dealers and servicemen earn extra money by selling belts. Display in your store for "over the counter sales." Best grade live rubber belts marked for identification. Popular belt assortments on displays.



| No.    | List                                |
|--------|-------------------------------------|
| 1010-D | Asst. 12 Belts, Most Popular \$2.80 |
| 7010-D | Asst. 12 Popular Flat Belts 2.70    |
| 7011-D | Asst. 12 Popular Round Belts 3.00   |

(Individual belts available — see your Distributor)

**G-C HUB CAP STATIC SPRINGS**

Eliminate wheel static noise developed by poor electrical contact between front axle and wheels. Springs have riveted metal points for firm, smooth contact. Plated.



| No.  | List                 |
|------|----------------------|
| 1058 | Each \$0.12          |
| 1059 | Box, 24 Springs 2.75 |

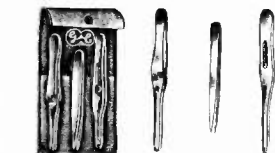

**G-C TWEEZERS AND KIT**

For the shop or laboratory to pick up and examine small parts, start screws and nuts, to get in hard-to-get spots, stringing dial cord, fastening springs, etc.

| No.   | List  |
|-------|---|
| 7950  | Tweezer Kit, beautiful leatherette case and one each tweezers described below \$3.25                                      |
| 7946* | 6½" Self-closing tweezers. Opens when squeezed. Serrated, blunt points .80  |
| 7947* | 6½" Heavy duty type with slide lock feature. Holds wires or parts tight like an extra finger. Serrated, blunt points 1.20 |
| 7948  | 4½" Precision Tweezer. Narrow pointed ends for delicate work. 0.55  |

\*Standard Jobber's quantity: 12 tweezers on display card — Add suffix "P"

**G-C TOOL HANDLE INSULATING TUBES**



A new idea for insulating your handle tools. A supply of special insulating tubing in assorted sizes is included in kit to insulate all types of handles on pliers, cutters, screw driver blades, etc. You simply soak the tubing for a few minutes in G-C Service Solvent and the tubing will swell. Slip it over the handles and allow it to dry. It will shrink on drying and give it a professional appearance. (G-C Service Solvent is not included in kit.)

| No.    | List                      |
|--------|---------------------------|
| 8118-E | Env. Asstd. Tubing \$0.40 |
| 8118-D | Display of 20 Env. 8.00   |

GENERAL



CEMENT

WRENCH KITS—TOOL SETS—BUSHINGS



**G-C SHAFT COUPLINGS, EXTENSIONS AND REDUCERS**

| BRASS FITTINGS |   |        | INSULATED FITTINGS |   |        |
|----------------|---|--------|--------------------|---|--------|
| No.            |   | List   | No.                |   | List   |
| 6701           | 1/4" to 1/2" coupling                           | \$0.25 | 6721               | 1/4" to 1/2" coupling                           | \$0.25 |
| 6702           | 1/4" to 3/8" coupling                           | .30    | 6722               | 1/4" to 3/8" coupling                           | .30    |
| 6703           | 1/4" to 1/2" coupling                           | .25    | 6723               | 1/4" to 3/16" coupling                          | .25    |
| 6704           | 3/8" to 1/2" coupling                           | .30    | 6724               | 3/8" to 1/2" coupling                           | .30    |
| 6705           | 1/4" hole to 1/4" shaft extension               | .30    | 6725               | 1/4" hole to 1/4" shaft extension               | .30    |
| 6709           | 1/4" hole to 3/8" shaft extension and increaser | .30    | 6731               | 1/4" hole to 3/8" shaft extension and increaser | .30    |
| 6710           | 3/8" hole to 1/2" shaft extension and reducer   | .30    | 6732               | 3/8" hole to 1/2" shaft extension and reducer   | .30    |
| 6711           | 3/8" hole to 3/8" shaft extension               | .30    | 6733               | 3/8" hole to 3/8" shaft extension               | .30    |
| 6712           | 1/2" x 6" brass shaft                           | .20    | 6734               | 1/2" x 6" fibre shaft                           | .30    |
| 6713           | 1/2" x 12" brass shaft                          | .35    | 6735               | 1/2" x 12" fibre shaft                          | .55    |
| 6714           | 3/4" x 6" brass shaft                           | .35    | 6736               | 3/4" x 6" bakelite shaft                        | .60    |
| 6715           | 3/4" x 12" brass shaft                          | .60    | 6737               | 3/4" x 12" bakelite shaft                       | 1.00   |
| 6716           | 1/4" hole x 1/4" round shaft x 4" long          | .35    | 6738               | 3/8" x 6" fibre shaft                           | .45    |
|                |   |        | 6739               | 3/8" x 12" fibre shaft                          | .80    |



**G-C REDUCING BUSHINGS**

For knobs and shafts. A split bushing that really works. Brass. Easy to use.

| No.    |                                   | List   |
|--------|-----------------------------------|--------|
| 6751-E | 1/4" to 1/8" reduction, 8 in Env. | \$0.40 |
| 6751-G | 144 No. 6751 (Gross)              | 6.50   |



**G-C SHAFT EXTENSIONS**

Popular 1/4" shaft extension with flat shaft for spring type push-on knobs.

| No.  |  | List   |
|------|--|--------|
| 6755 | 1/4" x 4 1/2" Long Flat Shaft Extension  | \$0.35 |
| 6716 | 1/4" x 4 1/2" Long Round Shaft Extension | .35    |



**G-C BRASS AND INSULATED SPACERS AND BUSHINGS**

Spacers and Bushings needed for insulating and spacing of parts. Needed on chassis, sub-panels, etc.

| No.    | Assortments  | List   |
|--------|--|--------|
| 6617   | Hardware Lab. Jar 12 Assorted Spacers and Bushings             | \$0.65 |
| 6760-E | Env. 12 Asst. Ins. Spacers                                     | .40    |
| 6762   | 15 Asst. Threaded Brass Bushings 6-32 thread, 1/4" to 3/4" lg. | 1.25   |
| 6763   | 15 Asst. Threaded Brass Bushings 8-32 thread, 1/4" to 3/4" lg. | 1.25   |
| 6775-E | Env. 12 1/4" x 1/4" Ins. Spacers                               | .40    |
| 6776-E | Env. 8 1/4" x 3/8" Ins. Spacers                                | .40    |
| 6779-E | Env. 6 3/8" x 1/4" Ins. Spacers                                | .40    |
| 6761-E | Env. 12 Asst. Metal Spacers                                    | .40    |
| 6765-E | Env. 10 1/4" x 1/4" Metal Spacers                              | .40    |
| 6766-E | Env. 8 1/4" x 3/8" Metal Spacers                               | .40    |
| 6769-E | Env. 6 3/8" x 1/4" Metal Spacers                               | .40    |

| BRASS |      |        |        | INSULATED |      |        |        |
|-------|------|--------|--------|-----------|------|--------|--------|
| No.   | O.D. | Length | List   | No.       | O.D. | Length | List   |
| 6765  | 1/4" | 1/4"   | \$0.04 | 6775      | 1/4" | 1/4"   | \$0.04 |
| 6766  | 1/4" | 3/8"   | .05    | 6776      | 1/4" | 3/8"   | .05    |
| 6767  | 1/4" | 1/2"   | .05    | 6777      | 1/4" | 1/2"   | .05    |
| 6768  | 1/4" | 3/4"   | .06    | 6778      | 1/4" | 3/4"   | .06    |
| 6769  | 3/8" | 1/4"   | .05    | 6779      | 3/8" | 1/4"   | .05    |
| 6770  | 3/8" | 1/2"   | .06    | 6780      | 3/8" | 1/2"   | .06    |
| 6771  | 3/8" | 3/4"   | .07    | 6781      | 3/8" | 3/4"   | .07    |

**THREADED BRASS BUSHINGS**

| Thread |      |      |        | Thread |      |      |      |        |        |
|--------|------|------|--------|--------|------|------|------|--------|--------|
| No.    | O.D. | Size | Length | List   | No.  | O.D. | Size | Length | List   |
| 6785   | 1/4" | 6-32 | 1/4"   | \$0.05 | 6790 | 1/4" | 8-32 | 1/4"   | \$0.05 |
| 6786   | 1/4" | 6-32 | 3/8"   | .07    | 6791 | 1/4" | 8-32 | 3/8"   | .07    |
| 6787   | 1/4" | 6-32 | 1/2"   | .08    | 6792 | 1/4" | 8-32 | 1/2"   | .08    |
| 6789   | 1/4" | 6-32 | 3/4"   | .09    | 6793 | 1/4" | 8-32 | 3/4"   | .09    |



**G-C ALLEN-HEX WRENCHES AND KITS**

Essential key wrenches for every repair man. Made of special alloy steel properly hardened. Used on knobs, dials, phono needles, motors, pulleys, etc.

| HEX KEY WRENCHES |  |        |
|------------------|--|--------|
| No.              |  | List   |
| 5030-E           | Env. 4 Asstd. Wrenches                                   | \$0.40 |
| 5029-E           | Kit 6 Asstd. Wrenches in Leatherette Case                | .75    |
| 5029-A-E         | Env. 3 Hex Key Wrenches for No. 1/4" to 7/16" Set Screws | .40    |
| 5031             | No. 4  | .12    |
| 5032             | No. 5  | .12    |
| 5033             | No. 8  | .12    |
| 5034             | No. 10   | .12    |
| 5035             | 1/4"   | .12    |
| 5036             | 5/16"  | .13    |
| 5037             | 3/8"   | .13    |
| 5038             | 7/16"  | .16    |



**G-C BRISTO-SPLINE WRENCHES AND KITS**

Very popular "Bristo" or "Spline" type wrenches as used on phono needles, motors, pulleys, knobs, etc. Made of alloy steel, properly hardened.

| No.    |   | List   |
|--------|---|--------|
| 5069-E | Env. 4 Asstd. Wrenches                    | \$0.40 |
| 5070-E | Kit 6 Asstd. Wrenches in Leatherette Case | .75    |
| 5071   | No. 4                                     | .12    |
| 5071-A | No. 5                                     | .12    |
| 5072   | No. 6                                     | .12    |
| 5073   | No. 8                                     | .12    |
| 5074   | No. 10                                    | .12    |
| 5075   | 1/4"                                      | .12    |
| 5076   | 5/16"                                     | .13    |
| 5077   | 3/8"                                      | .13    |
| 5078   | 7/16"                                     | .16    |



**G-C 8-PIECE VEST POCKET SET**

Handiest tool! Seven sockets, 1/4", 5/16", 3/8", 1/2", 5/8", 3/4", 7/8" hex; 3/8" round knurled, 1/4" square, complete with "L" handle. Ball type socket assembly. Baked enamel box.

| No. | List   |
|-----|--------|
| 712 | \$1.60 |



**G-C 6-PIECE SLIP-ON WRENCH SET**

Handle holds five sockets, sizes 1/4", 5/16", 3/8", 1/2", and 5/8". Easily assembled. Tempered steel, plated.

| No. | List   |
|-----|--------|
| 715 | \$2.00 |

**G-C FUSE PULLERS**

For cartridge fuses. Heavy duty construction of high dielectric material.

| No.  |                                     | List   |
|------|-------------------------------------|--------|
| 5525 | Midget size, for fuses 1/4" x 1/2"  | \$0.60 |
| 5526 | Large size, for fuses 1/2" x 1 1/2" | 1.25   |



**G-C ELECTRONIC HARDWARE LABORATORIES**

Complete assortment of hardware. Rack contains several thousand essential electronic hardware items. Packed in clear jars with screw caps. Assortments as below: Free Steel Rack!

| No.  |   | List    | Dealer's Net |
|------|---|---------|--------------|
| 6604 | DeLuxe Hdwe. Laboratory, 40 jars, as in assortments No. 6601 and 6602, as below                     | \$26.00 | \$15.60*     |
| 6601 | No. 1, 20 jar asst. 1 each jars G-C No. 6605 through 6624 (see hardware pages U-140, U-141, U-142). | 13.00   | 7.80*        |
| 6602 | No. 2, 20 jar asst. 1 each jars G-C No. 6625 through 6644 (see hardware pages U-140, U-141, U-142). | 13.00   | 7.80*        |

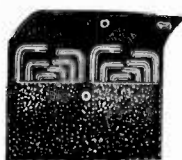

**G-C ALLEN-BRISTO WRENCH KIT**

Complete wrench kit for hex and spline type screws used in electronic field. Double snap button case of durable leatherette. Fit No. 2 to 3/8" screws.

| No.  | List   |
|------|--------|
| 5028 | \$1.65 |

Dealer's Net .99\*



**G-C UNIVERSAL MAST BRACKET**

"The best on the market"

Permanent, easy to install and easy to adjust mast bracket that can be used on roofs, chimneys, walls, gables, and most anywhere. Masts 30 to 40 feet and up to 1 3/8" diameter can be assembled down and swung up into position. It's made of best grade of aircraft aluminum.

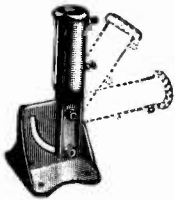

|                        |        |
|------------------------|--------|
| No.                    | List   |
| 8000 Universal Bracket | \$7.50 |

**G-C CHIMNEY MOUNT**

"Made of Cast Aircraft Aluminum"

Here's a better quality bracket for better installations. One man can install this on any chimney. Only one piece to handle with this "Cast Bracket." It will hold masts up to 1 3/8" diameter.

It is supplied complete with 24 ft. of galvanized strapping and all necessary hardware. It will not rust and mar the appearance of the home. Brackets can also be used for flat wall mounting, angle and gable mounting.

|  |        |
|--|--------|
| No.  | List   |
| 8001 Pair of brackets, complete with strapping and all hardware. | \$7.50 |
| 8002 Pair of brackets only with lag screws. No strapping.        | 5.00   |
| 8003 Straps and hardware only.                                   | 2.50   |



**G-C CHIMNEY QUICK MOUNT**

"Made of Steel—Heavily Plated—Won't Rust"

Here's a chimney bracket for the inexpensive installation that can be installed in a few minutes. Only one piece to handle with a minimum of loose parts. Heavy steel 1/8" thick heavily plated. Brackets will support masts

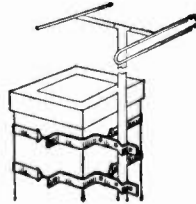

up to 1 3/8" diameter. All straps and hardware included.

|  |        |
|--|--------|
| No.  | List   |
| 8005 Chimney Quick Mount with Straps and Hardware. | \$4.25 |

**G-C CORNER AND FLAT MAST BRACKETS**

Made of aircraft aluminum this bracket will support all sizes of masts 3/4" to 1 3/8" diameter. They are easy to install, only two screws or bolts necessary for each bracket. The brackets will make a neat, attractive installation that your customer will be proud of. Supplied complete with lag screws.

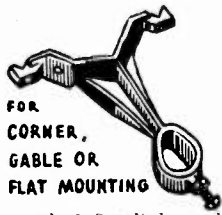

|                         |        |
|-------------------------|--------|
| No.                     | List   |
| 8002 Brackets, per pair | \$5.00 |

**NEW G-C POLYETHYLENE STAND-OFF INSULATORS**

**G-C REGULAR STAND-OFF**



Universal type, can be used for flat 300-ohm twin lead and RG-59 cables. Heavy gauge stand-offs made with genuine polyethylene insulator and Bethanized steel screw hooks that are rust-proof and weather-proof.

| No.  | Length | Screw Type             | List   |
|------|--------|------------------------|--------|
| 8027 | 3 1/2" | Wood Screw             | \$0.10 |
| 8028 | 5 1/2" | Wood Screw             | .13    |
| 8029 | 7 1/2" | Wood Screw             | .14    |
| 8030 | 12"    | Wood Screw             | .25    |
| 8031 | 3 1/2" | Machine Screw and Nuts | .12    |
| 8032 | 5 1/2" | Machine Screw and Nuts | .15    |

**G-C MAST-STAND-OFF**

Specially made for masts for quick installation

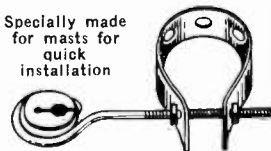

This can be used for flat 300-ohm twin lead and RG-590 cables. It is made with genuine polyethylene insulators and with a quick adjustment strap to fit any size mast. One size will fit masts 3/4" to 1 1/2".

| No.  | Length | List   |
|------|--------|--------|
| 8033 | 3 1/2" | \$0.15 |
| 8034 | 7 1/2" | .21    |

**G-C SILICONE COMPOUND**



A permanent waterproofing material for TV and FM lead connections. Eliminates electrical and signal leakage due to moisture film. Maintains stability of transmission lines, ignition systems, etc. Non-corrosive and chemically inert. Effective to 400° C. In tubes.

|               |        |
|---------------|--------|
| No.           | List   |
| 8100 1-oz.    | \$1.65 |
| Dealer's Net, | .99    |

**G-C CLEAR PICTURE 300-OHM POLYETHYLENE TWIN LINE**

Very high grade approved genuine 300-ohm polyethylene twin line specially made for Television and FM work. It is made of brown polyethylene with 2 stranded wires. One tinned and one copper wire makes it easy to trace lines.

| No.  | Quantity       | List   |
|------|----------------|--------|
| 8040 | 50-ft. Coil    | \$2.50 |
| 8042 | 100-ft. Coil   | 4.50   |
| 8043 | 1000-ft. Spool | 42.00  |



**NEW G-C TELEVISION SAF-T-RACK**

"Makes it easy to work with"

Here's a very simple and sturdy rack to use in repairing the heavy television chassis. Simply set it on the rack and tilt it on the side. The sturdy hooks will hold the chassis on its side so you can work on the set. It will prevent damage to the tube and make it easy to work on it. Every shop needs several of these G-C Saf-T-Racks.

|                 |        |
|-----------------|--------|
| No.             | List   |
| 8045 Saf-T-Rack | \$3.95 |



**NEW G-C TELEVISION ALIGNMENT KIT**

A new kit with new tools specially designed for adjusting and aligning Television Receivers.

Kit contains Special Television Tools:

| No.                               | List   |
|-----------------------------------|--------|
| 1-5067 Trimmer Tool               |        |
| 1-5018 Tuner Wrench               |        |
| 1-5066 Short TV Tool              |        |
| 1-5080 Television Wrench          |        |
| 1-5087 RF Tuner Tool              |        |
| 1-5091 Trimmer Tool               |        |
| 1-5097 K-Tran Tool                |        |
| 1-5002 Tuning Wand                |        |
| 1-8195 Channel Tuning Tool        |        |
| 1-8196 Special Short Tool         |        |
| 1-Leatherette Case                |        |
| No. 8050 Television Alignment Kit | \$8.75 |



**G-C 300-OHM FIBRE HEAD WIRING NAILS**

These nails are specially made for nailing down 300-ohm twin line on wood work, along base boards, rafters, etc. They make installation easy.

|                         |        |
|-------------------------|--------|
| No.                     | List   |
| 8020-E Env., 30         | \$0.40 |
| 8020-D Display, 20 Env. | 8.00   |
| 8020-G 144              | 1.25   |
| 8020-M 1000             | 8.50   |



**G-C CHIMNEY & MAST HOOK**

Cadmium-plated steel hook, same as used for chimney straps and masts. Hook is welded for extra strength. Supplied with nut.

|                          |        |
|--------------------------|--------|
| No.                      | List   |
| 8049-E Env., 2           | \$0.40 |
| 8049-DX Display, 20 Env. | 8.00   |
| 8049-G 144               | 20.00  |



**G-C CHIMNEY STRAP**

Galvanized annealed strap with 1/4" punched holes. This is the same as used on chimney brackets. This strap is extra strong and yet very flexible to handle.

|      |         |        |
|------|---------|--------|
| No.  | Coil    | List   |
| 8051 | 12-ft.  | \$0.75 |
| 8052 | 100-ft. | 6.25   |

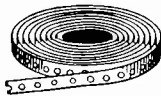

**G-C FLOATING GUY RING**

Galvanized guy washer for supporting masts. Will fit 3/4" mast and 1" masts. Allows mast to be turned.

|                |        |
|----------------|--------|
| No.            | List   |
| 8055-E Env., 3 | \$0.40 |
| 8055-G 144     | 15.00  |
| 8058 4 1/2" 1  | .25    |



**G-C TURNBUCKLES**

Extra strong cadmium-plated turnbuckles for guy wires and cables make it easy to install tall masts and towers.

| Length | No.    | Clsd.  | Qun. | List   |
|--------|--------|--------|------|--------|
|        | 8056-E | 3"     | 2    | \$0.40 |
|        | 8057-E | 3 1/2" | 2    | .40    |
|        | 8058   | 3 3/4" | 1    | .25    |



**G-C MAST STRAPS**

Made of galvanized steel these straps are used for fastening masts, poles to walls, roofs, chimneys, etc.

|                 |        |
|-----------------|--------|
| No.             | List   |
| 8130 Each       | \$0.06 |
| 8130-G Box, 144 | 8.00   |



**G-C U BOLT**

For mounting and extending antenna poles and masts. Ideal for strapping 2 masts together or for fastening masts to buildings, plates, etc. Made of rust-proof Bethanized steel. Supplied with nuts.

|      |        |
|------|--------|
| No.  | List   |
| 8123 | \$0.30 |

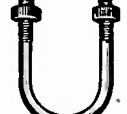



GENERAL



CEMENT

# TELEVISION ACCESSORIES



### G-C 1/4-20 BOLTS

Round head, steel, cadmium-plated.

| No.    | Length | List   |
|--------|--------|--------|
| 7144-G | 1/2"   | \$2.65 |
| 8061-G | 3/4"   | 3.25   |
| 8062-G | 1"     | 3.70   |
| 7145-G | 1 1/4" | 4.00   |
| 7146-G | 2 1/2" | 6.90   |

#### 1000 to Box

|        |        |       |
|--------|--------|-------|
| 7144-M | 1/2"   | 15.95 |
| 8061-M | 3/4"   | 19.50 |
| 8062-M | 1"     | 22.20 |
| 7145-M | 1 1/4" | 24.20 |
| 7146-M | 2 1/2" | 41.25 |

### G-C 1/4-20 NUTS

Steel — cadmium-plated.

| No.                      | Square Nuts List |
|--------------------------|------------------|
| 8063-E Env., 25          | \$0.40           |
| 8063-D Display, 20 Envs. | 8.00             |
| 8063-G Bx., 144          | 2.15             |

#### Hexagon Nuts

|                          |        |
|--------------------------|--------|
| 7235-E Env., 25          | \$0.40 |
| 7235-D Display, 20 Envs. | 8.00   |
| 7235-G Bx., 144          | 2.35   |

### G-C 1/4" LAG SCREWS

Steel, cadmium-plated lag screws specially made for Television Antenna, installations and brackets.

| No.                      | 1 3/4" Length List |
|--------------------------|--------------------|
| 8064-E Env., 4           | \$0.40             |
| 8064-D Display, 20 Envs. | 8.00               |
| 8064-G Bx., 144          | 13.50              |
| 2" Length                |                    |
| 8065-E Env., 4           | .40                |
| 8065-D Display, 20 Envs. | 8.00               |
| 8065-G Bx., 144          | 13.50              |

### G-C WOOD SCREWS

Round head steel, cadmium-plated screws, for Television work.

| No.             | 8x1 1/4" Lg. List |
|-----------------|-------------------|
| 8071-E Env., 15 | \$0.40            |
| 8071-G Bx., 144 | 3.05              |
| #10x1 1/2" Long |                   |
| 8073-E Env., 12 | .40               |
| 8073-G Bx., 144 | 4.05              |
| 12x1 1/2" Long  |                   |
| 8075-E Env., 10 | .40               |
| 8075-G Bx., 144 | 4.80              |
| 14x1 3/4" Long  |                   |
| 8076-E Env., 8  | .40               |
| 8076-G Bx., 144 | 6.80              |

### G-C SCREWEYES

Steel, cadmium-plated screw eyes for Television Antenna installations; for fastening guy wires, etc.

| No.                      | List   |
|--------------------------|--------|
| 8078-E Envlp.            | \$0.40 |
| 8078-D Display, 20 Envs. | 8.00   |
| 8078-G Bx., 144          | 4.90   |

### G-C GUY WIRE CLAMPS

The neatest, quickest way for fastening ends of guy wire cables on towers and masts. Easily adjusted with a screw driver. Galvanized steel.

| No.  | Wire Size | List   |
|------|-----------|--------|
| 8081 | 1/8"      | \$0.55 |
| 8082 | 3/8"      | .55    |

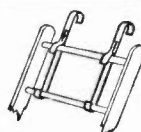

### G-C DRIV-IN ANCHORS

These Drive-Ins are easy to use and are very handy for fastening masts and brackets to masonry and concrete. They carry the load. Will fit 1/4" hole.

| No.                      | List   |
|--------------------------|--------|
| 8083-E Env., 2           | \$0.40 |
| 8083-D Display, 20 Envs. | 8.00   |
| 8083-G Bx., 144          | 20.00  |

### G-C LEAD ANCHORS

Very popular lead anchors for wood screws; will fit 1/4" and 3/8" holes and will take #10, 12, and 14 wood screws.

| No.                      | 1" Long List |
|--------------------------|--------------|
| 8084-E Env., 8           | \$0.40       |
| 8084-D Display, 20 Envs. | 8.00         |
| 8084-G Bx., 144          | 12.50        |
| 1 1/2" Long              |              |
| 8085-E Env., 2           | .40          |
| 8085-D Display, 20 Envs. | 8.00         |
| 8085-G Bx., 144          | 17.50        |

### G-C LAG SCREW — EXPANSION SHIELD

Will fit 1/4" lag screws. Made of special alloy, 100% rust-proof (supplied without lag screws). Used for Television Masts and Brackets, and other work. The shield is 1" long x 1/2" O.D. 1/2" drill is required.

| No.             | List   |
|-----------------|--------|
| 8088 Env., 12   | \$3.00 |
| 8088-G Bx., 144 | 32.00  |

### G-C LADDER HOOKS

Every service man needs a hook ladder when installing Television antennas. Make your own hook ladder by fastening these hooks to your ladder. Sold in pairs, complete with bolts for easy installation.

| No.                  | List   |
|----------------------|--------|
| 8215 Hooks, per pair | \$5.00 |

### G-C SOLDERLESS CONNECTOR KIT

For Television Antenna, Radio and Electrical Work

Complete kit of terminals and a handy tool to install solderless terminals on ends of wire. Handy for indoor and outdoor use, as it eliminates soldering.

| No.               | List   |
|-------------------|--------|
| 8175 Complete Kit | \$9.95 |
| 8176 Tool Only    | 6.60   |

### G-C 300-OHM CONNECTOR

A handy connector to splice 300-ohm (twin line). Easy to use. Retains characteristics of wire and makes a secure connection.

| No.                      | List   |
|--------------------------|--------|
| 8095-E Env., 2           | \$0.40 |
| 8095-D Display, 20 Envs. | 8.00   |

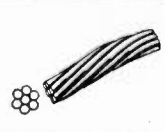
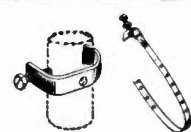
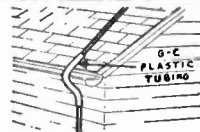

### G-C CARBIDE-TIPPED MASONRY DRILL

Drill is carbide-tipped and has a spiral fluted body. It makes holes easily and accurately in the hardest masonry.

| No.  | Size | List   |
|------|------|--------|
| 8096 | 1/4" | \$3.75 |
| 8097 | 3/8" | 4.00   |
| 8098 | 1/2" | 4.75   |
| 8099 | 3/4" | 6.00   |

### G-C 300-OHM LINE PROTECTIVE PLASTIC TUBING

Clear plastic tubing to fit over the 300-ohm twin line and protect the wire from grounding and rubbing on corners of buildings, eaves, etc. Used for lead in protection also.

| No.            | List   |
|----------------|--------|
| 625 Box, 8 ft. | \$0.95 |

### G-C GROUND CLAMPS

Popular C type clamp will fit pipes up to 1 3/8" diameter. Makes a secure ground.

| No.  | List   |
|--|--------|
| 8120   | \$0.25 |
| Popular strap type ground will fit pipes 3/8" to 2". |        |
| No.  | List   |
| 8121   | \$0.10 |

### G-C SPEEDEX STRIPPER for the 300-ohm Twin Cable

Makes stripping of the 300-ohm cable very simple and easy. Just squeeze the handles and the job is done.

| No.   | Model List |
|---|------------|
| 733-H Regular                                     | \$6.00     |
| 744-H Automat.                                    | 8.00       |
| (For other size Speedex Strippers, see Page U-98) |            |

### G-C TELEVISION GUY WIRE

High grade galvanized steel twisted Television guy wire for tall masts and towers. Extra strength steel completely galvanized to prevent rust and corrosion. Available in 2 sizes that will take care of most requirements.

| Four Strands No. 20 Wire (approx. 3/32" diam.) |        |  |
|--|--------|--|
| No.  | List   |  |
| 8107-C 100-ft. Coil                            | \$1.30 |  |
| 8107-M 1000-ft. Coil                           | 12.25  |  |
| Six Strands No. 20 Wire (approx. 1/8" diam.)   |        |  |
| No.  | List   |  |
| 8109-C 100-ft. Coil                            | \$1.75 |  |
| 8109-M 1000-ft. Coil                           | 17.20  |  |

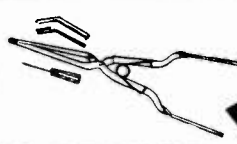

### G-C POPULAR KNOB ASSORTMENTS

| No.                                   | List   |
|---------------------------------------|--------|
| 35 of all Types Popular Knobs         |        |
| 1120 35 Asstd.                        | \$1.67 |
| 25 of all Asstd. Set Screw Knobs Only |        |
| 1149 25 Asstd.                        | 1.67   |
| 60 Auto Push-Button Knob Assortment   |        |
| 8026 60 Asstd.                        | 1.67   |

### G-C AUTO RADIO SHEET METAL SCREWS

Special short sheet metal screws such as used on auto radio chassis covers, etc. No. 8 x 3/4" self-tapping hex head slotted. Steel, cadmium-plated. List

|                          |        |
|--------------------------|--------|
| 8102-E Env., 30          | \$0.40 |
| 8102-D Display, 20 Envs. | 8.00   |
| 8102-G Bx., 144          | 1.75   |

### G-C PLASTIC STOCK BOXES AND TRAYS

Clear polystyrene boxes for stocking small parts, screws, nuts, bolts, condensers, resistors, etc. See what you have in clear plastic boxes. Boxes supplied with covers.

| No.  | Depth  | List   |
|------|--------|--------|
| 8022 | 4x4x3" | \$0.55 |
| 8023 | 4x8x3" | 1.10   |

### G-C PHONO DRIVES: Admiral, Crescent

Made of best grade of pure rubber, genuine replacement drives.

| No.  | List   |
|--|--------|
| 24-E Env., 1; Crescent, 3 3/4" O.D.                  | \$0.40 |
| 24-AE Env., 1; Admiral, Crescent, 3 1/4" O.D.        | .40    |
| 24-BE Env., 1; Admiral, Part No. 406A18, 3 3/4" O.D. | .40    |

### G-C LONG NOSE PLIERS

Very handy pliers to reach into places and hold parts. Ideal for installing radio dial cords. Available in straight nose and curved nose styles.

| No.  | Style    | List   |
|------|----------|--------|
| 5192 | Straight | \$0.85 |
| 5193 | Curved   | .85    |

### G-C MINI-MAX STRIP

Used for connecting 67 1/2-volt "B" batteries, such as Eveready 455, 466; Burgess XX80, XX45.

| No.  | List       |        |
|------|------------|--------|
| 8115 | Connectors | \$0.30 |



4-IN-1 CARD DISPLAY OR BOX 20 ENVELOPES TO A CARD BOX When Card is wanted Specify "D" after No. When Box is wanted Specify "B" after No.

DESCRIPTION AND SPECIFICATIONS

Table listing G-C ROUND HEAD MACHINE SCREWS with columns for Part No., Quantity in Env., Part No., Quantity in Jar, Part No., List Price, Part No., List Price.

Table listing G-C BINDING HEAD MACHINE SCREWS with columns for Part No., Quantity in Env., Part No., List Price, Part No., List Price.

Table listing G-C OVAL HEAD RACK AND CABINET SCREWS with columns for Part No., Quantity in Jar, Part No., List Price, Part No., List Price.

Table listing G-C THREADED STEEL RODS with columns for Package, Part No., List Price.

Table listing G-C ORNAMENTAL HEAD SCREWS with columns for Part No., Quantity in Jar, Part No., List Price, Part No., List Price.

Table listing G-C WOOD SCREWS with columns for Part No., Quantity in Jar, Part No., List Price, Part No., List Price.

Table listing G-C SHEET METAL SCREWS with columns for Part No., Quantity in Jar, Part No., List Price, Part No., List Price.

Table listing G-C ESCUTCHEON PLATE SCREWS with columns for Part No., Quantity in Jar, Part No., List Price, Part No., List Price.

Table listing G-C SPADE BOLTS or MOUNTING SCREWS with columns for Part No., Quantity in Jar, Part No., List Price, Part No., List Price.

Table listing G-C RADIO KNOB SET SCREWS with columns for Part No., Quantity in Jar, Part No., List Price, Part No., List Price.

Table listing CUP POINT and G-C RADIO KNOB SET SCREWS with columns for Part No., Quantity in Jar, Part No., List Price, Part No., List Price.



4-IN-1 CARD DISPLAY OR BOX 20 ENVELOPES TO A CARD BOX When Card is wanted Specify "D" after No. When Box is wanted Specify "B" after No.

DESCRIPTION AND SPECIFICATIONS

Table listing G-C RADIO KNOB SET SCREWS - Continued with columns for Part No., Quantity in Jar, Part No., List Price, Part No., List Price.

Table listing G-C BRISTO SET SCREWS with columns for Part No., Quantity in Jar, Part No., List Price, Part No., List Price.

Table listing G-C ALLEN HEX SET SCREWS with columns for Part No., Quantity in Jar, Part No., List Price, Part No., List Price.

Table listing G-C HEXAGON NUTS with columns for Part No., Quantity in Jar, Part No., List Price, Part No., List Price.

Table listing G-C BRASS HEXAGON NUTS with columns for Part No., Quantity in Jar, Part No., List Price, Part No., List Price.

Table listing G-C MOUNTING NUTS with columns for Part No., Quantity in Jar, Part No., List Price, Part No., List Price.

Table listing G-C TIMMERMAN SPEED NUTS with columns for Part No., Quantity in Jar, Part No., List Price, Part No., List Price.

Table listing G-C ACORN NUTS with columns for Part No., Quantity in Jar, Part No., List Price, Part No., List Price.

Table listing G-C KNURLED THUMB NUTS with columns for Part No., Quantity in Jar, Part No., List Price, Part No., List Price.

Table listing G-C WING NUTS with columns for Part No., Quantity in Jar, Part No., List Price, Part No., List Price.

PRICES ON CROSS HOLES AND LARGER QUANTITIES QUOTED ON REQUEST.

PRICES ON CROSS HOLES AND LARGER QUANTITIES QUOTED ON REQUEST.



**4-IN-1 CARD DISPLAY OR BOX**  
20 ENVELOPES TO A CARD BOX  
When Card is wanted Specify "D" after No.  
When Box is wanted Specify "X" after No.

**PLASTIC ENVELOPES**  
Transparent and Unbreakable  
List Price **40c**

**GLASS JARS**  
For Hardware Rocks  
List Price **65c**

**BOXES OF 144**  
(One Gross)  
Specify "Q" after Part No.

**BOXES OF 1000**  
Specify "M" after Part No.

| DESCRIPTION AND SPECIFICATIONS | Part No. | Quantity in Box | List Price | Part No. | Quantity in Box | List Price | Part No. | Quantity in Box | List Price |
|--------------------------------|----------|-----------------|------------|----------|-----------------|------------|----------|-----------------|------------|
|--------------------------------|----------|-----------------|------------|----------|-----------------|------------|----------|-----------------|------------|

**G-C METAL WASHERS**

| Assorted Metal Washers            | 6150-E    | 100     |           |        |     |
|-----------------------------------|-----------|---------|-----------|--------|-----|
| Assorted No. 4 and No. 6 Washers  | 6612      | 135     |           |        |     |
| Assorted No. 8 and No. 10 Washers | 6613      | 100     |           |        |     |
| Screw Size                        | Hole Size | O.D.    | Thickness |        |     |
| No. 4                             | 1/8"      | 9/32"   | 1/32"     | 6154-E | 100 |
| No. 6                             | 5/32"     | 3/8"    | 1/32"     | 6155-E | 80  |
| No. 8                             | 3/16"     | 7/16"   | 1/32"     | 6156-E | 80  |
| No. 10                            | 13/64"    | 3/8"    | 1/32"     | 6157-E | 100 |
| No. 10                            | 13/64"    | 7/16"   | 1/32"     | 6158-E | 75  |
| No. 10                            | 13/64"    | 1/2"    | .049      | 6159-E | 75  |
| No. 12                            | .228      | 7/16"   | .021      | 6160-E | 75  |
| No. 1/4"                          | 9/32"     | 5/8"    | 1/16"     | 6161-E | 75  |
| No. 1/4"                          | 17/64"    | 1/2"    | 1/16"     | 6162-E | 75  |
| No. 5/16"                         | 7/16"     | 11/16"  | 1/16"     | 6163-E | 75  |
| No. 3/8"                          | 3/8"      | 1 1/16" | 1/16"     | 6164-E | 75  |

**G-C LOCK WASHERS**

**INTERNAL LOCK WASHERS**

| Assorted Lock Washers, All Types | 1717-E | 65     | 6614 | 90 |  |
|----------------------------------|--------|--------|------|----|--|
| Assorted Internal Lock Washers   | 7320-E | 60     |      |    |  |
| Screw Size                       | O.D.   |        |      |    |  |
| Internal Lock Washers, No. 2     | 7322-E | 45     |      |    |  |
| No. 3                            | 7323-E | 45     |      |    |  |
| No. 4                            | 7324-E | 45     |      |    |  |
| No. 6                            | 9/32"  | 7326-E | 60   |    |  |
| No. 8                            | 21/64" | 7328-E | 60   |    |  |
| No. 10                           | 9/16"  | 7330-E | 60   |    |  |
| No. 1/4"                         | 9/16"  | 7332-E | 60   |    |  |
| No. 5/16"                        | 19/32" | 7333-E | 60   |    |  |
| No. 3/8"                         | 11/16" | 7334-E | 60   |    |  |
| No. 3/8"                         | 9/16"  | 7335-E | 60   |    |  |
| No. 15/32"                       | 19/32" | 7338-E | 60   |    |  |

**EXTERNAL LOCK WASHERS**

| Assorted External Lock Washers  | 7350-E | 60 |        |        |        |
|---------------------------------|--------|----|--------|--------|--------|
| External Lock Washers, No. 4    |        |    | 7354-G |        | 7354-M |
| External Lock Washers, No. 6    | 7356-E | 60 |        | 7356-G | 7356-M |
| External Lock Washers, No. 8    | 7358-E | 60 |        | 7358-G | 7358-M |
| External Lock Washers, No. 10   |        |    | 7360-G |        | 7360-M |
| External Lock Washers, No. 1/4" |        |    | 7361-G |        | 7361-M |
| External Lock Washers, No. 3/8" |        |    | 7363-G |        | 7363-M |

**SPLIT TYPE LOCK WASHERS**

| Assorted Split Type Lock Washers | 6502-E | 60        |        |    |          |
|----------------------------------|--------|-----------|--------|----|----------|
| Screw Size                       | O.D.   | Thickness |        |    |          |
| No. 4                            | 3/16"  | 1/32"     | 6503-E | 65 | 6503-100 |
| No. 6                            | 15/64" | 1/32"     | 6504-E | 65 | 6504-100 |
| No. 8                            | 15/64" | .025      | 6505-E | 55 | 6505-90  |
| No. 10                           | 5/16"  | .050      | 6506-E | 50 | 6506-90  |
| No. 1/4"                         | 7/16"  | 5/64"     | 6507-E | 50 | 6507-80  |

**G-C SPRING FRICTION WASHERS**

| Assorted Spring Friction Washers | 6190-E | 25        |        |    |          |
|----------------------------------|--------|-----------|--------|----|----------|
| Screw Size                       | O.D.   | Thickness |        |    |          |
| 9/64"                            | 5/16"  | .012      | 6191-E | 25 | 6191-100 |
| 3/16"                            | 3/8"   | .008      | 6192-E | 25 | 6192-100 |
| 3/16"                            | 7/16"  | .008      | 6193-E | 25 | 6193-100 |
| 1/4"                             | 9/16"  | .012      | 6194-E | 25 | 6194-100 |

**G-C CUP FINISHING WASHERS**

**NICKEL PLATED**

| Assorted Screws and Washers  | 6039-E | 30 | 6628 | 45 |        |
|--|--------|----|------|----|--------|
| Assorted Cup Washers <td>6159-E</td> <td>40</td> <td></td> <td></td> <td></td> | 6159-E | 40 |      |    |        |
| Cup Washers, No. 6   | 6161-E | 40 | 6161 | 65 | 6161-G |
| Cup Washers, No. 8   | 6162-E | 40 | 6162 | 65 | 6162-G |
| Cup Washers, No. 10  | 6163-E | 40 | 6163 | 65 | 6163-G |

**G-C C-WASHERS and RETAINING RINGS**

| Assorted C-Washers | 6180-E | 50             | 6636 | 85     |    |
|--------------------|--------|----------------|------|--------|----|
| Shaft Diam.        | A      | B              | D    |        |    |
| 3/16"              | .111   | .125           | .031 | 6182-E | 40 |
| 1/4"               | .234   | .156           | .031 | 6183-E | 40 |
| 1/2"               | .260   | .187           | .031 | 6184-E | 40 |
| 1/4"               | 9/32"  | O.D. Wire Ring | .029 | 6185-E | 50 |

**G-C COTTER PINS**

| Assorted Cotter Pins | 6440-E           | 60 | 6642 | 90 |        |
|----------------------|------------------|----|------|----|--------|
| Diameter             | Length Under Eye |    |      |    |        |
| Cotter Pins, 1/16"   | 1/2"             |    |      |    | 7301-G |
| Cotter Pins, 1/16"   | 1"               |    |      |    | 7303-G |
| Cotter Pins, 1/16"   | 1-1/4"           |    |      |    | 7304-G |
| Cotter Pins, 3/32"   | 1/2"             |    |      |    | 7305-G |

**G-C HAIR PIN COTTERS**

| Assorted Hair Pin Cotters | 6475-E | 50   | 6637   | 75 |        |
|---------------------------|--------|------|--------|----|--------|
| A                         | B      | C    |        |    |        |
| 9/32"                     | 1/16"  | .026 | 6476-E | 75 | 6476-G |
| 3/8"                      | 1/16"  | .026 | 6477-E | 75 | 6477-G |
| 13/32"                    | 3/32"  | .026 | 6478-E | 75 | 6478-G |
| 1/2"                      | 5/32"  | .026 | 6479-E | 75 | 6479-G |
| 21/32"                    | 3/16"  | .032 | 6480-E | 75 | 6480-G |

**G-C FLAT FIBRE WASHERS**

| Assorted Flat Fibre Washers | 1718-E | 60   | 6634   | 85 |        |
|-----------------------------|--------|------|--------|----|--------|
| Screw Size                  | O.D.   |      |        |    |        |
| No. 6                       | 1/35   | 1/4" | 6513-E | 60 | 6513-G |
| No. 8                       | 11/64" | 3/8" | 6514-E | 60 | 6514-G |
| No. 10                      | .196   | 3/8" | 6515-E | 50 | 6515-G |
| No. 1/4"                    | 1/4"   | 1/2" | 6516-E | 40 | 6516-G |
| No. 3/8"                    | 3/8"   | 5/8" | 6517-E | 40 | 6517-G |
| No. 15/32"                  | 15/32" | 3/4" | 6518-E | 40 | 6518-G |



**4-IN-1 CARD DISPLAY OR BOX**  
20 ENVELOPES TO A CARD BOX  
When Card is wanted Specify "D" after No.  
When Box is wanted Specify "X" after No.

**PLASTIC ENVELOPES**  
Transparent and Unbreakable  
List Price **40c**

**GLASS JARS**  
For Hardware Rocks  
List Price **65c**

**BOXES OF 144**  
(One Gross)  
Specify "Q" after Part No.

**BOXES OF 1000**  
Specify "M" after Part No.

| DESCRIPTION AND SPECIFICATIONS | Part No. | Quantity in Box | List Price | Part No. | Quantity in Box | List Price |
|--------------------------------|----------|-----------------|------------|----------|-----------------|------------|
|--------------------------------|----------|-----------------|------------|----------|-----------------|------------|

**G-C EXTRUDED FIBRE WASHERS**

| Extruded and Flat Fibre Washers | 6512-E | 30   |      |            |        |
|---------------------------------|--------|------|------|------------|--------|
| Assorted Extruded Fibre Washers | 6520-E | 40   |      |            |        |
| A                               | B      | C    | D    | Screw Size |        |
| 5/16"                           | .187   | .140 | .039 | No. 6      | 6525-E |
| 3/8"                            | .250   | .169 | .031 | No. 8      | 6526-E |
| 1/2"                            | .375   | .250 | .032 | 1/4" Shaft | 6528-E |
| 5/8"                            | .437   | .380 | .031 | 3/8" Shaft | 6529-E |

**G-C SNAP BUTTON HOLE PLUGS**

| Assorted Hole Plugs              | 1716-E  | 10      |        |    |         |
|----------------------------------|---------|---------|--------|----|---------|
| No. 1710 Assort. 50 Plugs in Box | 1709-E  | 4       |        |    |         |
| Ventilating Plugs, 1" Hole Size  |         |         | 1709-G |    | 1709-M  |
| For Hole Dia.                    | A       | B       | C      |    |         |
| 1/8"                             | 13/32"  | 1/4"    | 1716-E | 10 | 1716-AM |
| 3/8"                             | 7/16"   | 1/4"    | 1717-E | 10 | 1717-BM |
| 1/2"                             | 21/32"  | 3/8"    | 1718-E | 10 | 1718-G  |
| 5/8"                             | 15/16"  | 1/2"    | 1719-E | 8  | 1719-G  |
| 3/4"                             | 15/16"  | 1/2"    | 1720-E | 6  | 1720-G  |
| 1"                               | 1-5/32" | 1-1/32" | 1721-E | 6  | 1721-G  |
| 1-1/8"                           | 1-5/16" | 1-1/32" | 1722-E | 4  | 1722-M  |
| 1-1/4"                           | 1-7/16" | 1-1/32" | 1723-E | 4  | 1723-M  |

**G-C SNAP-IN TRIMOUNTS**

| No. 1720 Assort. 100 Trimounts | List Price | \$1.20 |        |    |        |
|--------------------------------|------------|--------|--------|----|--------|
| Assorted Trimounts             | 1719-E     | 25     | 6620   | 45 |        |
| To Fit Hole                    | A          | B      |        |    |        |
| 1/8"                           | 9/32"      | 3/16"  | 1721-E | 25 | 1721-G |
| 1/8"                           | 9/32"      | 13/64" | 1722-E | 25 | 1722-M |
| .136                           | 11/32"     | 17/64" | 1723-E | 25 | 1723-M |
| .136                           | 23/64"     | 9/32"  | 1724-E | 25 | 1724-M |
| 5/32"                          | 3/16"      | 1/2"   | 1725-E | 18 | 1725-M |
| 5/32"                          | 3/16"      | 11/32" | 1726-E | 18 | 1726-M |
| 5/32"                          | 3/16"      | 11/32" | 1727-E | 18 | 1727-M |

**G-C DIAL CORD CLIPS**

| Assorted Dial/Cable Clips | 6220-E | 45    | 6621   | 75 |        |
|---------------------------|--------|-------|--------|----|--------|
| Used on Cord No.          | A      | B     |        |    |        |
| 75 - 75A                  | 1/8"   | 7/64" | 6221-E | 45 | 6221-G |
| 74 - 74A                  | 1/4"   | 5/32" | 6222-E | 45 | 6222-G |
| 73 - 73X                  | 3/16"  | 9/64" | 6223-E | 45 | 6223-G |

**G-C SOLDERING LUGS**

| No. 1020 100 Assort. Solder Lugs | List Price | \$0.90 |         |    |         |
|----------------------------------|------------|--------|---------|----|---------|
| Assorted Soldering Lugs          | 1019-E     | 45     | 6618    | 75 |         |
| Hole Size                        | Fig. No.   | Length |         |    |         |
| Solder Lugs, No. 6               | M          | 11/16" | 7441-E  | 30 | 7441-M  |
| Solder Lugs, No. 8               | M          | 11/16" | 7442-E  | 30 | 7442-M  |
| Solder Lugs, No. 10              | A          | 11/16" | 1021-AE | 30 | 1021-AM |
| Solder Lugs, No. 6               | B          | 23/32" | 1021-BE | 30 | 1021-BM |
| Solder Lugs, No. 8               | B          | 23/32" | 7445-E  | 30 | 7445-M  |
| Solder Lugs, No. 6               | 11/16"     | C      | 1021-CE | 30 | 1021-CM |
| Solder Lugs, No. 6               | 9/16"      | F      | 1021-FE | 30 | 1021-FM |
| Solder Lugs, No. 8               | 9/16"      | F      | 7451-E  | 30 | 7451-M  |
| Solder Lugs, No. 6               | 7/8"       | H      | 7454-E  | 30 | 7454-M  |
| Solder Lugs, No. 8               | 7/8"       | H      | 7455-E  | 30 | 7455-M  |
| Solder Lugs, No. 10              | 7/8"       | H      | 7456-E  | 30 | 7456-M  |
| Solder Lugs, No. 4               | 13/16"     | K      | 7458-E  | 30 | 7458-M  |
| Solder Lugs, No. 8               | 13/16"     | K      | 7460-E  | 30 | 7460-M  |
| Solder Lugs, No. 10              | 13/16"     | K      | 7461-E  | 30 | 7461-M  |
| Solder Lugs, No. 6               | 5/8"       | L      | 7462-E  | 30 | 7462-M  |
| Solder Lugs, No. 8               | 5/8"       | L      | 7463-E  | 30 | 7463-M  |

**G-C CABLE HOLDER CLAMPS**

| Assorted Cable Clamps | 6250-E        | 25    | 6644   | 40 |        |
|-----------------------|---------------|-------|--------|----|--------|
| To Fit Cable          | Mounting Hole |       |        |    |        |
| 1/8"                  | to 3/16"      | No. 6 | 6251-E | 25 | 6251-G |
| 3/16"                 | to 1/4"       | No. 6 | 6252-E | 35 | 6252-G |
| 1/4"                  | to 5/16"      | No. 6 | 7503-E | 20 | 7503-M |
| 5/16"                 | to 1/2"       | No. 6 | 6253-E | 20 | 6253-M |
| 3/4"                  | No. 10        |       | 7505-E | 20 | 7505-M |

**G-C GRID CAPS**

| Assorted Grid Caps   | 6290-E | 16 | 6635 | 25 |        |
|----------------------|--------|----|------|----|--------|
| Class Tube Grid Caps | 6291-E | 15 |      |    | 6291-M |
| Metal Tube Grid Caps | 6292-E | 15 |      |    | 6292-M |

**G-C FUSE CLIPS**

| Assorted Fuse Clips                   | 6311-E | 10 |        |  |        |
|---------------------------------------|--------|----|--------|--|--------|
| For 1/4" Glass Fuses, No. 6 Mtg. Hole |        |    | 6311-G |  | 6311-M |

**G-C FAHNESTOCK CLIPS**

| Assorted Fahnestock Clips | 6300-E             | 18    | 6639      | 30     |        |
|---------------------------|--------------------|-------|-----------|--------|--------|
| Fig.                      | Length             | Width | Mtg. Hole |        |        |
| A                         | 1/2"               | 3/32" | 6         | 6301-E | 15     |
| B                         | 3/4"               | 5/16" | 6         | 6302-E | 12     |
| C                         | 1-1/16"            | 3/8"  | 8         | 6303-E | 10     |
| D                         | 1-3/4"             | 3/8"  | 8         | 6304-E | 3      |
| E                         | 3/4"               | 5/16" | 6         | 6306-E | 12     |
| F                         | Ammeter Connectors |       | 6307-E    | 3      | 6307-M |

**G-C ANGLES and BRACKETS**

| Assorted Angles and Brackets | 6260-E | 15    |           |        |    |
|------------------------------|--------|-------|-----------|--------|----|
| A                            | B      | C     | Hole Size |        |    |
| 1/4"                         | 3/16"  | 9/32" | 6         | 6261-E | 15 |
| 3/8"                         | 1/4"   | 9/32" | 6         | 6262-E | 20 |
| 1/2"                         | 7/16"  | 3/8"  | 6         | 6263-E | 15 |
| 3/16"                        | 5/8"   | 3/8"  | 6         | 6264-E | 15 |
| 6-32 Thread                  |        |       |           |        |    |

PRICES ON CROSS BOXES - 1000 BOXES AND LARGER QUANTITIES QUOTED ON REQUEST.

PRICES ON CROSS BOXES - 1000 BOXES AND LARGER QUANTITIES QUOTED ON REQUEST.



**4-IN-1 CARD DISPLAY OR BOX**  
20 ENVELOPES TO A CARD BOX  
When Card is wanted Specify "D" after No.  
When Box is wanted Specify "X" after No.

**PLASTIC ENVELOPES**  
Transparent and Unbreakable  
List Price **40c**

**GLASS JARS**  
For Hardware Boxes  
List Price **65c**

**BOXES OF 144**  
(One Gross)  
Specify "G" after Part No.

**BOXES OF 1000**  
Specify "M" after Part No.

DESCRIPTION AND SPECIFICATIONS

| G-C DIAL PULLEYS      |                 | G-C RADIO KNOB SPRINGS |                 |
|-----------------------|-----------------|------------------------|-----------------|
| Part No.              | Quantity in Jar | Part No.               | Quantity in Jar |
| Assorted Dial Pulleys |                 | 1049-E                 | 20              |
|                       |                 | 6619                   | 35              |
|                       |                 | 1050                   | 35              |
|                       |                 | 1051                   | 35              |

Assorted Knob Springs

| Fig. No. | Width  | Length | Shaft Diam. | Part No. | Quantity in Jar |
|----------|--------|--------|-------------|----------|-----------------|
| K1       | 9/32"  | 7/16"  | 1/4"        | 6460-E   | 20              |
| K2       | 1/2"   | 1/2"   | 1/4"        | 6461-E   | 20              |
| K3       | 9/32"  | 5/16"  | 1/4"        | 6462-E   | 20              |
| K4       | 3/8"   | 5/32"  | 1/4"        | 6463-E   | 15              |
| K5       | 7/32"  | 13/32" | 1/4"        | 6464-E   | 10              |
| K6       | 9/32"  | 3/8"   | 1/4"        | 6465-E   | 10              |
| K6-S     | 9/32"  | 1/4"   | 1/4"        | 6466-E   | 10              |
| K7       | 9/32"  | 1/2"   | 1/4"        | 6467-E   | 20              |
| K8       | 9/32"  | 3/8"   | 1/4"        | 6468-E   | 10              |
| K9       | 11/32" | 1/4"   | 1/4"        | 6469-E   | 10              |
| K10      | 3/8"   | 3/8"   | 1/4"        | 6470-E   | 20              |
| K11      | 3/8"   | 7/16"  | 1/4"        | 6471-F   | 20              |
| K12      | 3/8"   | 7/16"  | 3/16"       | 6472-G   | 20              |

(Additional Listings on Knob Springs on Page 25)

**G-C DIAL DRIVE TENSION SPRINGS AND PHONO SPRINGS**

| Part No.                           | Quantity in Jar   | Part No. | Quantity in Jar |
|------------------------------------|-------------------|----------|-----------------|
| Ass't. Regular Dial Drive Springs  | 1054-E 10         | 6616     | 15              |
| Ass't. Small Dial Drive Springs    | 1054-SE 10        |          |                 |
| No. 1055 Kit of 25 Ass't. Springs  | List Price \$1.10 |          |                 |
| No. 1056 Kit of 100 Ass't. Springs | List Price \$4.00 |          |                 |
| Ass't. Large Tension Springs       | 6421-E 8          |          |                 |
| Ass't. Small Tension Springs       | 6420-E 10         |          |                 |

(Additional Listings on Dial Drive Springs on Page 18)

**G-C PHONOGRAPH SPRINGS**

| Part No.                             | Quantity in Jar   | Part No. | Quantity in Jar |
|--------------------------------------|-------------------|----------|-----------------|
| No. 6478 Kit of 50 Springs           | List Price \$2.25 |          |                 |
| No. 6479 Kit of 100 Springs          | List Price \$4.00 |          |                 |
| Ass't. Small Phono Turntable Springs | 6480-E 10         |          |                 |
| Ass't. Large Phono Turntable Springs | 6481-E 8          |          |                 |

**G-C COMPRESSION SPRINGS**

| Part No.                         | Quantity in Jar | Part No. | Quantity in Jar |
|----------------------------------|-----------------|----------|-----------------|
| Ass't. Small Compression Springs | 6430-E 20       | 6643     | 30              |
| Ass't. Large Compression Springs | 6431-E 15       |          |                 |

**G-C BRASS EYELETS**

| Part No.                  | Quantity in Jar | Part No. | Quantity in Jar |
|---------------------------|-----------------|----------|-----------------|
| Ass't. Rivets and Eyelets | 1027-E 55       | 6622     | 85              |
| Ass't. Eyelets and Clamps | 1028-E 60       |          |                 |
| Eyelet Assortment         | 6900-E 55       |          |                 |

**G-C CORD STRAIN RELIEFS**

Will Fit P.O.S.J. Cord 6675-E 4 6675-C 6675-M

**G-C RADIO KNOB FELTS**

3/8" O.D. x 1/4" Hole, Brown 1065-E 45 6641 75 1065-C 1065-M

**G-C TERMINAL STRIP ASSORTMENT**

Assorted Terminal Strips 6855-E 4



**4-IN-1 CARD DISPLAY OR BOX**  
20 ENVELOPES TO A CARD BOX  
When Card is wanted Specify "D" after No.  
When Box is wanted Specify "X" after No.

**PLASTIC ENVELOPES**  
Transparent and Unbreakable  
List Price **40c**

**GLASS JARS**  
For Hardware Boxes  
List Price **65c**

**BOXES OF 144**  
(One Gross)  
Specify "G" after Part No.

**BOXES OF 1000**  
Specify "M" after Part No.

DESCRIPTION AND SPECIFICATIONS

| G-C RIVETS                |                 | G-C ESCUTCHEON PINS |                 |
|---------------------------|-----------------|---------------------|-----------------|
| Part No.                  | Quantity in Jar | Part No.            | Quantity in Jar |
| Ass't. Rivets and Eyelets | 1027-E 55       | 6622                | 85              |
| Rivet Assortment          | 6850-E 60       |                     |                 |
| Shank Dia.                |                 | Length Under Head   |                 |
| Rivets .059               | 5/32"           |                     |                 |
| Rivets .059               | 3/16"           |                     |                 |
| Rivets .059               | 1/4"            |                     |                 |
| Rivets .088               | 3/16"           |                     |                 |
| Rivets .098               | 3/16"           |                     |                 |
| Rivets .121               | 1/8"            |                     |                 |
| Rivets .121               | 5/32"           |                     |                 |
| Rivets .121               | 3/16"           |                     |                 |
| Rivets .121               | 7/32"           |                     |                 |
| Rivets .121               | 1/4"            |                     |                 |
| Rivets .121               | 5/16"           |                     |                 |
| Rivets .121               | 3/8"            |                     |                 |
| Rivets .127               | 1/2"            |                     |                 |
| Rivets .121               | 5/8"            |                     |                 |
| Rivets .146               | 5/16"           |                     |                 |
| Rivets .146               | 17/32"          |                     |                 |

**G-C VOICE COIL DUST FELTS**

| Part No.           | Quantity in Jar | Part No. | Quantity in Jar |
|--------------------|-----------------|----------|-----------------|
| Assorted Dust Felt | 1079-E 25       | 6640     | 50              |
| Dust Felt 1/2"     | 1080-E 25       | 1080-C   | 1080-M          |
| Dust Felt 3/4"     | 1081-E 25       | 1081-C   | 1081-M          |
| Dust Felt 1"       | 1082-E 25       | 1082-C   | 1082-M          |
| Dust Felt 1-1/4"   | 1083-E 20       | 1083-C   | 1083-M          |
| Dust Felt 1-1/2"   | 1084-E 20       | 1084-C   | 1084-M          |
| Dust Felt 1-3/4"   | 1085-E 20       | 1085-C   | 1085-M          |
| Dust Felt 2-1/4"   | 1085-AE 20      | 1085-AC  | 1085-AM         |

**G-C RUBBER GROMMETS**

| Part No.                             | Quantity in Jar   | Part No. | Quantity in Jar |
|--------------------------------------|-------------------|----------|-----------------|
| Assorted Soft Grommets               | 1039-E 15         | 6626     | 20              |
| Assorted Grommets                    | 1044-E 15         | 6625     | 25              |
| No. 1040 Kit of 50 Assorted Grommets | List Price \$1.05 |          |                 |

**G-C PURE GUM GROMMETS**

| Part No.                            | Quantity in Jar   | Part No. | Quantity in Jar |
|-------------------------------------|-------------------|----------|-----------------|
| Assorted Pure Gum Grommets          | 7580-E 15         |          |                 |
| No. 7581 Kit of 100 Ass't. Grommets | List Price \$2.25 |          |                 |

**G-C RUBBER CHASSIS MOUNTS**

| Part No.                              | Quantity in Jar   | Part No. | Quantity in Jar |
|---------------------------------------|-------------------|----------|-----------------|
| Assorted Chassis Mounts               | 1038-E 10         |          |                 |
| No. 1030 Kit 25 Ass't. Chassis Mounts | List Price \$1.80 |          |                 |

**G-C CHASSIS FELT FEET**

| Part No.   | Quantity in Jar | Part No. | Quantity in Jar |
|--|-----------------|----------|-----------------|
| Ass't. Screw Type Chassis Felt Feet                  | 1086-E 4        |          |                 |
| 1/2" x 3/16" x 1/2" No. 6 x 1/2" Sheet Metal Pointed | 1086-BE 4       | 1086-BG  | 1086-BM         |
| 1/2" x 3/16" x 1/2" No. 6 x 1/2" Sheet Metal Pointed | 1087-E 4        | 1087-C   | 1087-M          |
| 3/4" x 1/4" x 1/2" No. 6 x 1/2" Sheet Metal Pointed  | 1088-E 4        | 1088-C   | 1088-M          |
| 3/4" x 1/4" x 1/2" No. 32 Machine                    | 1089-E 4        | 1089-C   | 1089-M          |

**G-C RUBBER FEET**

| Part No.                      | Quantity in Jar | Part No.   | Quantity in Jar |
|-------------------------------|-----------------|------------|-----------------|
| Ass't. Screw Type Rubber Feet | 1075-AE 12      |            |                 |
| O.D.                          |                 | H.H.       |                 |
| 3/8"                          | 3/16"           | 1075-BE 12 | 1075-BM         |
| 1/2"                          | 1/4"            | 1075-CE 10 | 1075-CM         |
| 5/8"                          | 5/16"           | 1075-FE 8  | 1075-FM         |

**G-C RUBBER BUTTON BUMPERS**

| Part No.                      | Quantity in Jar   | Part No. | Quantity in Jar |
|-------------------------------|-------------------|----------|-----------------|
| Ass't. Rubber Button Bumpers  | List Price \$3.50 |          |                 |
| 3/8" O.D. Rubber Tack Bumpers | 1075-E 10         | 6624     | 18              |
| 1075-C                        | 1075-M            |          |                 |

**G-C FELT PADS**

| Part No.                         | Quantity in Jar   | Part No. | Quantity in Jar |
|----------------------------------|-------------------|----------|-----------------|
| No. 1071 100 Assorted Felt Pads  | List Price \$0.60 |          |                 |
| 3/8" O.D. x 1/4" Thick Felt Pads | 1069-E 40         | 6623     | 60              |
| 1071-C                           | 1071-M            |          |                 |

PRICES ON CROSS BOXES - 1000 BOXES AND LARGER QUANTITIES QUOTED ON REQUEST.





*Thank You!*

When writing for additional  
information or when ordering  
from sources of supply listed  
in this book, please mention

*RADIO'S MASTER*