

Studer A807
Professional
Universal Tape Recorder

Operating Instructions

Prepared and edited by:
Studer Professional Audio AG
Technical Documentation
Althardstrasse 30
CH-8105 Regensdorf - Switzerland
<http://www.studer.ch>

Copyright by Studer Professional Audio AG
Printed in Switzerland
Order no. 10.27.3072 (Ed. 1002)

Subject to change

Studer is a registered trade mark of Studer Professional Audio AG, Regensdorf

Operating Instructions

Safety	Operation and waste disposal Maintenance and Repair Electronic compatibility
Section 1	General information Quick reference description Standard versions Options Accessories Technical data
Section 2	Operation Putting into operation Connections Operating instructions Programming Care instructions

The complete Operating and Service Instructions are available with the ordering number 10.27.1421



To reduce the risk of electric shock, do not remove covers (or back). No user-serviceable parts inside. Refer servicing to qualified service personnel.

Afin de prévenir un choc électrique, ne pas enlever les couvercles (où l'arrière) de l'appareil. Il ne se trouve à l'intérieur aucune pièce pouvant être réparée par l'utilisateur.

Um die Gefahr eines elektrischen Schlages zu vermeiden, entfernen Sie keine Geräteabdeckungen (oder dessen Rückwand). Überlassen Sie Wartung und Reparatur qualifiziertem Fachpersonal.

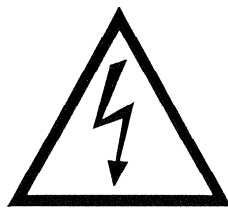

This symbol is intended to alert the user to presence of uninsulated “**dangerous voltage**” within the apparatus that may be of sufficient magnitude to constitute a risk of electric shock to a person.

Ce symbole indique à l'utilisateur qu'il existe à l'intérieur de l'appareil des “**tensions dangereuses**”. Ces tensions élevées entraînent un risque de choc électrique en cas de contact.

Dieses Symbol deutet dem Anwender an, dass im Geräteinnern die Gefahr der Berührung von “**gefährlicher Spannung**” besteht. Die Grösse der Spannung kann zu einem elektrischen Schlag führen.



This symbol is intended to alert the user to the presence of **important instructions** for operating and maintenance in the enclosed documentation.

Ce symbole indique à l'utilisateur que la documentation jointe contient d'**importantes instructions** concernant le fonctionnement et la maintenance.

Dieses Symbol deutet dem Anwender an, dass die beigelegte Dokumentation **wichtige Hinweise** für Betrieb und Wartung enthält.

CAUTION:

Lithium battery. Danger of explosion by incorrect handling. Replace by battery of the same make and type only.

ATTENTION:

Pile au lithium. Danger d'explosion en cas de manipulation incorrecte. Ne remplacer que par un modèle de même type.

ACHTUNG:

Explosionsgefahr bei unsachgemäßem Auswechseln der Lithium-batterie. Nur durch den selben Typ ersetzen.

ADVARSEL:

Lithiumbatteri. Eksplosionsfare. Udskiftning må kun foretages af en sagkyndig og som beskrevet i servicemanualen (DK).

FIRST AID

(in case of electric shock)

1. Separate the person as quickly as possible from the electric power source:
 - by switching off the equipment
 - or by unplugging or disconnecting the mains cable
 - pushing the person away from the power source by using dry insulating material (such as wood or plastic).
 - *After having sustained an electric shock, always consult a doctor.*

WARNING!

DO NOT TOUCH THE PERSON OR HIS CLOTHING BEFORE THE POWER IS TURNED OFF, OTHERWISE YOU STAND THE RISK OF SUSTAINING AN ELECTRIC SHOCK AS WELL!

2. If the person is unconscious:
 - check the pulse,
 - reanimate the person if respiration is poor,
 - lay the body down, turn it to one side, call for a doctor immediately.

PREMIERS SECOURS

(en cas d'électrocution)

1. Si la personne est dans l'impossibilité de se libérer:
 - Couper l'interrupteur principal
 - Couper le courant
 - Repousser la personne de l'appareil à l'aide d'un objet en matière non conductrice (matière plastique ou bois)
 - *Après une électrocution, toujours consulter un médecin.*

ATTENTION!

NE JAMAIS TOUCHER UNE PERSONNE QUI EST SOUS TENSION, SOUS PEINE DE SUBIR EGALEMENT UNE ELECTROCUTION.

2. En cas de perte de connaissance de la personne électrocutée:
 - Contrôler le pouls
 - Si nécessaire, pratiquer la respiration artificielle
 - Placer l'accidenté sur le flanc et consulter un médecin.

ERSTE HILFE

(bei Stromunfällen)

1. Bei einem Stromunfall die betroffene Person so rasch wie möglich vom Strom trennen:
 - Ausschalten des Gerätes
 - Ziehen oder Unterbrechen der Netzzuleitung
 - Betroffene Person mit isoliertem Material (Holz, Kunststoff) von der Gefahrenquelle wegstossen
 - *Nach einem Stromunfall sollte immer ein Arzt aufgesucht werden.*

ACHTUNG!

EINE UNTER SPANNUNG STEHENDE PERSON DARF NICHT BERÜHRT WERDEN. SIE KÖNNEN DABEI SELBST ELEKTRISIERT WERDEN!

2. Bei Bewusstlosigkeit des Verunfallten:
 - Puls kontrollieren,
 - bei ausgesetzter Atmung künstlich beatmen,
 - Seitenlagerung des Verunfallten vornehmen und Arzt verständigen.

Installation

Vor der Installation des Gerätes müssen die hier aufgeführten und auch die weiter in dieser Anleitung mit  bezeichneten Hinweise gelesen und während der Installation und des Betriebes beachtet werden.

Untersuchen Sie das Gerät und sein Zubehör ist auf allfällige Transportschäden.

Ein Gerät, das mechanische Beschädigung aufweist oder in welches Flüssigkeit oder Gegenstände eingedrungen sind, darf nicht ans Netz angeschlossen oder muss sofort durch Ziehen des Netzsteckers vom Netz getrennt werden. Das Öffnen und Instandsetzen des Gerätes darf nur von Fachpersonal unter Einhaltung der geltenden Vorschriften durchgeführt werden.

Falls dem Gerät kein konfektioniertes Netzkabel beiliegt, muss dieses durch eine Fachperson unter Verwendung der mitgelieferten Kabel-Gerätendose IEC320/C13 oder IEC320/C19 und unter Berücksichtigung der einschlägigen, im jeweiligen Lande geltenden Bestimmungen angefertigt werden; siehe unten.

Vor Anschluss des Netzkabels an die Netzsteckdose muss überprüft werden, ob die Stromversorgungs- und Anschlusswerte des Gerätes (Netzspannung, Netzfrequenz) innerhalb der erlaubten Toleranzen liegen. Die im Gerät eingesetzten Sicherungen müssen den am Gerät angebrachten Angaben entsprechen.

Ein Gerät mit einem dreipoligen Gerätestecker (Gerät der Schutzklasse I) muss an eine dreipolige Netzsteckdose angeschlossen und somit das Gerätegehäuse mit dem Schutzleiter der Netzinstallation verbunden werden (Für Dänemark gelten Starkstrombestimmungen, Abschnitt 107).

Installation

Before you install the equipment, please read and adhere to the following recommendations and all sections of these instructions marked with .

Check the equipment for any transport damage.

A unit that is mechanically damaged or which has been penetrated by liquids or foreign objects must not be connected to the AC power outlet or must be immediately disconnected by unplugging the power cable. Repairs must only be performed by trained personnel in accordance with the applicable regulations.

Should the equipment be delivered without a matching mains cable, the latter has to be prepared by a trained person using the attached female plug (IEC320/C13 or IEC320/C19) with respect to the applicable regulations in your country - see diagram below.

Before connecting the equipment to the AC power outlet, check that the local line voltage matches the equipment rating (voltage, frequency) within the admissible tolerance. The equipment fuses must be rated in accordance with the specifications on the equipment.

Equipment supplied with a 3-pole appliance inlet (equipment conforming to protection class I) must be connected to a 3-pole AC power outlet so that the equipment cabinet is connected to the protective earth conductor of the AC supply (for Denmark the Heavy Current Regulations, Section 107, are applicable).

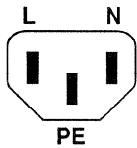
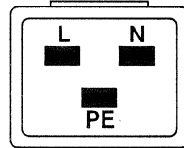
 <p>IEC 320 / C13</p>	 <p>IEC 320 / C19</p>
Female plug (IEC320), view from contact side: L live; brown N neutral; blue PE protective earth; green and yellow	National American Standard: Black White green
Connecteur femelle (IEC320), vue de la face aux contacts: L phase; brun N neutre; bleu PE terre protective; vert et jaune	Standard national américain: Noir Blanc Vert
Ansicht auf Steckkontakte der Kabel-Gerätsteckdose (IEC320): L Phase; braun N Nulleiter; blau PE Schutzleiter; gelb/grün	USA-Standard: Schwarz Weiss grün

Zugentlastung für den Netzanschluss

Zum Verankern von Steckverbindungen ohne mechanische Verriegelung (z.B. IEC-Kaltgerätedosen) empfehlen wir die folgende Anordnung:

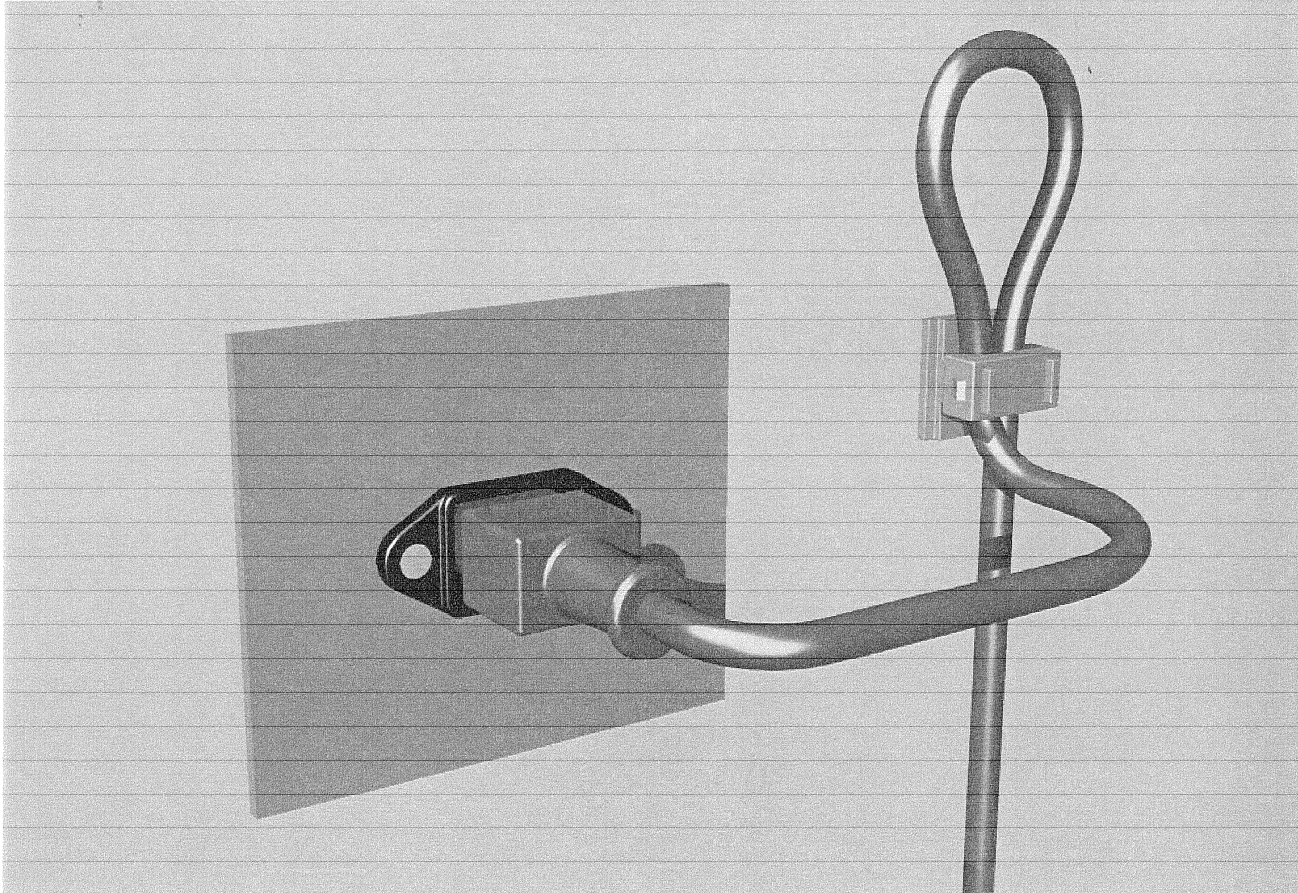

Mains connector strain relief

For anchoring connectors without a mechanical lock (e.g. IEC mains connectors), we recommend the following arrangement:

Vorgehen: Der mitgelieferte Kabelhalter ist selbstklebend. Bitte beachten Sie bei der Montage die folgenden Regeln:

1. Der Untergrund muss sauber, trocken und frei von Fett, Öl und anderen Verunreinigungen sein. Temperaturbereich für optimale Verklebung: 20...40° C.
2. Entfernen Sie die Schutzfolie auf der Rückseite des Kabelhalters und bringen sie ihn mit kräftigem Druck an der gewünschten Stelle an. Lassen sie ihn unbelastet so lange wie möglich ruhen – die maximale Klebekraft ist erst nach rund 24 Stunden erreicht.
3. Die Stabilität des Kabelhalters wird erhöht, wenn Sie ihn zusätzlich verschrauben. Zu diesem Zweck liegen ihm eine selbstschneidende Schraube sowie eine M4-Schraube mit Mutter bei.
4. Legen Sie das Kabel gemäss Figur in den Halter ein und pressen Sie die Klemme kräftig auf, bis das Kabel fixiert ist.

Procedure: The cable clamp shipped with your unit is auto-adhesive. If mounting, please follow the rules below:

1. The surface to be adhered to must be clean, dry, and free from grease, oil or other contaminants. Best application temperature range is 20...40° C.
2. Remove the plastic protective backing from the rear side of the clamp and apply it firmly to the surface at the desired position. Allow as much time as possible for curing. The bond continues to develop for as long as 24 hours.
3. For improved stability, the clamp can be fixed with a screw. For this purpose, a self-tapping screw and an M4 bolt and nut are included.
4. Place the cable into the clamp as shown in the illustration above and firmly press down the internal top cover until the cable is fixed.

Lufttemperatur und Feuchtigkeit

Allgemein

Die Betriebstauglichkeit des Gerätes oder Systems ist unter folgenden Umgebungsbedingungen gewährleistet:

EN 60721-3-3, Set IE32, Wert 3K3.

Diese Norm umfasst einen umfassenden Katalog von Parametern; die wichtigsten davon sind: Umgebungstemperatur +5...+40 °C; rel. Luftfeuchtigkeit 5...85% – d.h. weder Kondensation noch Eisbildung; abs. Luftfeuchtigkeit 1...25 g/m³; Temperatur-Änderungsrate <0,5 °C/min. In den folgenden Abschnitten wird darauf näher eingegangen.

Unter den genannten Bedingungen startet und arbeitet das Gerät oder System problemlos. Ausserhalb dieser Spezifikationen möglicherweise auftretende Probleme sind in den folgenden Abschnitten beschrieben.

Umgebungstemperatur

Geräte und Systeme von Studer sind allgemein für einen Umgebungstemperaturbereich (d.h. Temperatur der eintretenden Kühlluft) von +5...+40 °C ausgelegt. Bei Installation in einem Schrank muss der vorgesehene Luftdurchsatz und dadurch die Konvektionskühlung gewährleistet sein. Folgende Tatsachen sind dabei zu berücksichtigen:

1. Die zulässige Umgebungstemperatur für den Betrieb der Halbleiter-Bauelemente beträgt 0 °C bis +70 °C (commercial temperature range for operation).
2. Der Luftdurchsatz der Anlage muss gewährleisten, dass die austretende Kühlluft ständig kühler ist als 70 °C.
3. Die mittlere Erwärmung der Kühlluft soll 20 K betragen, die maximale Erwärmung an den heissen Komponenten darf somit um weitere 10 K höher liegen.
4. Zum Abführen einer Verlustleistung von 1 kW bei dieser zulässigen mittleren Erwärmung ist eine Luftmenge von 2,65 m³/min notwendig.

Beispiel: Für ein Rack mit einer Leistungsaufnahme $P = 800 \text{ W}$ ist eine Kühlluftmenge von $0,8 * 2,65 \text{ m}^3/\text{min}$ nötig, entsprechend $2,12 \text{ m}^3/\text{min}$.

5. Soll die Kühlfunktion der Anlage (z.B. auch bei Lüfter-Ausfall oder Bestrahlung durch Spotlampen) überwacht werden, so ist die Temperatur der Abluft unmittelbar oberhalb der Einschübe an mehreren Stellen im Rack zu messen; die Ansprechtemperatur der Sensoren soll 65 bis 70 °C betragen.

Reif und Tau

Das unversiegelte System (Steckerpartien, Halbleiteranschlüsse) verträgt zwar leichte Eisbildung (Reif). Mit blosssem Auge sichtbare Betauung führt jedoch bereits zu Funktionsstörungen. In der Praxis kann mit einem zuverlässigen Betrieb der Geräte bereits im Temperaturbereich ab -15 °C gerechnet werden, wenn für die Inbetriebnahme des kalten Systems die folgende allgemeine Regel beachtet wird:

Wird die Luft im System abgekühlt, so steigt ihre relative Feuchtigkeit an. Erreicht diese 100%, kommt es zu Niederschlag, meist in der Grenzschicht zwischen der Luft und einer kühleren Oberfläche, und somit zur Bildung von Eis oder Tau an empfindlichen Systemstellen (Kontakte, IC-Anschlüsse etc.). Ein störungsfreier Betrieb mit interner Betauung, unabhängig von der Temperatur, ist nicht gewährleistet.

Air temperature and humidity

General

Normal operation of the unit or system is warranted under the following ambient conditions defined by:

EN 60721-3-3, set IE32, value 3K3.

This standard consists of an extensive catalogue of parameters, the most important of which are: ambient temperature +5...+40 °C, relative humidity 5...85% – i.e. no formation of condensation or ice; absolute humidity 1...25 g/m³; rate of temperature change <0,5 °C/min. These parameters are dealt with in the following paragraphs.

Under these conditions the unit or system starts and works without any problem. Beyond these specifications, possible problems are described in the following sections.

Ambient temperature

Units and systems by Studer are generally designed for an ambient temperature range (i.e. temperature of the incoming air) of +5...+40 °C. When rack mounting the units, the intended air flow and herewith adequate cooling must be provided. The following facts must be considered:

1. The admissible ambient temperature range for operation of the semiconductor components is 0 °C to +70 °C (commercial temperature range for operation).
2. The air flow through the installation must provide that the outgoing air is always cooler than 70 °C.
3. Average heat increase of the cooling air shall be 20 K, allowing for an additional maximum 10 K increase at the hot components.
4. In order to dissipate 1 kW with this admissible average heat increase, an air flow of 2,65 m³/min is required.

Example: A rack dissipating $P = 800 \text{ W}$ requires an air flow of $0,8 * 2,65 \text{ m}^3/\text{min}$ which corresponds to $2,12 \text{ m}^3/\text{min}$.

5. If the cooling function of the installation must be monitored (e.g. for fan failure or illumination with spot lamps), the outgoing air temperature must be measured directly above the modules at several places within the rack. The trigger temperature of the sensors should be 65 to 70 °C.

Frost and dew

The unsealed system parts (connector areas and semiconductor pins) allow for a minute formation of ice or frost. However, formation of dew visible with the naked eye will already lead to malfunctions. In practice, reliable operation can be expected in a temperature range above -15 °C, if the following general rule is considered for putting the cold system into operation:

If the air within the system is cooled down, the relative humidity rises. If it reaches 100%, condensation will arise, usually in the boundary layer between the air and a cooler surface, together with formation of ice or dew at sensitive areas of the system (contacts, IC pins, etc.). Once internal condensation occurs, troublefree operation cannot be guaranteed, independent of temperature.

Vor der Inbetriebnahme muss das System auf allfällige interne Betauung oder Eisbildung überprüft werden. Nur bei sehr leichter Eisbildung kann mit direkter Verdunstung (Sublimation) gerechnet werden; andernfalls muss das System im abgeschalteten Zustand gewärmt und getrocknet werden.

Das System ohne feststellbare interne Eisbildung oder Betauung soll möglichst homogen (und somit langsam) mit eigener Wärmeleistung aufgewärmt werden; die Lufttemperatur der Umgebung soll ständig etwas tiefer als diejenige der Systemabluft sein.

Ist es unumgänglich, das abgekühlte System sofort in warmer Umgebungsluft zu betreiben, so muss diese entfeuchtet sein. Die absolute Luftfeuchtigkeit muss dabei so tief sein, dass die relative Feuchtigkeit, bezogen auf die kälteste Oberfläche im System, immer unterhalb 100% bleibt.

Es ist dafür zu sorgen, dass beim Abschalten des Systems die eingeschlossene Luft möglichst trocken ist (d.h. vor dem Abschalten im Winter den Raum mit kalter, trockener Luft belüften und feuchte Gegenstände, z.B. Kleider, entfernen).

Die Zusammenhänge sind im folgenden Klimatogramm ersichtlich. Zum kontrollierten Verfahren gehören Thermometer und Hygrometer sowie ein Thermometer innerhalb des Systems.

Beispiel 1: Ein Ü-Wagen mit einer Innentemperatur von 20 °C und 40% relativer Luftfeuchtigkeit wird am Abend abgeschaltet. Sinkt die Temperatur unter +5 °C, bildet sich Tau oder Eis.

Beispiel 2: Ein Ü-Wagen wird morgens mit 20 °C warmer Luft von 40% relativer Luftfeuchtigkeit aufgewärmt. Auf Teilen, die kälter als +5 °C sind, bildet sich Tau oder Eis.

Before putting into operation, the system must be checked for internal formation of condensation or ice. Only with a minute formation of ice, direct evaporation (sublimation) may be expected; otherwise the system must be heated and dried while switched off.

A system without visible internal formation of ice or condensation should be heated up with its own heat dissipation, as homogeneously (and subsequently as slow) as possible; the ambient temperature should then always be lower than the outgoing air.

If it is absolutely necessary to operate the system immediately within warm ambient air, this air must be dehydrated. In such a case, the absolute humidity must be so low that the relative humidity, related to the coldest system surface, always remains below 100%.

Ensure that the enclosed air is as dry as possible when powering off (i.e. before switching off in winter, aerate the room with cold, dry air, and remove humid objects as clothes from the room).

These relationships are visible from the following climatogram. For a controlled procedure, thermometer and hygrometer as well as a thermometer within the system will be required.

Example 1: An OB-van having an internal temperature of 20 °C and rel. humidity of 40% is switched off in the evening. If temperature falls below +5 °C, dew or ice will be forming.

Example 2: An OB-van is heated up in the morning with air of 20 °C and a rel. humidity of 40%. On all parts being cooler than +5 °C, dew or ice will be forming.

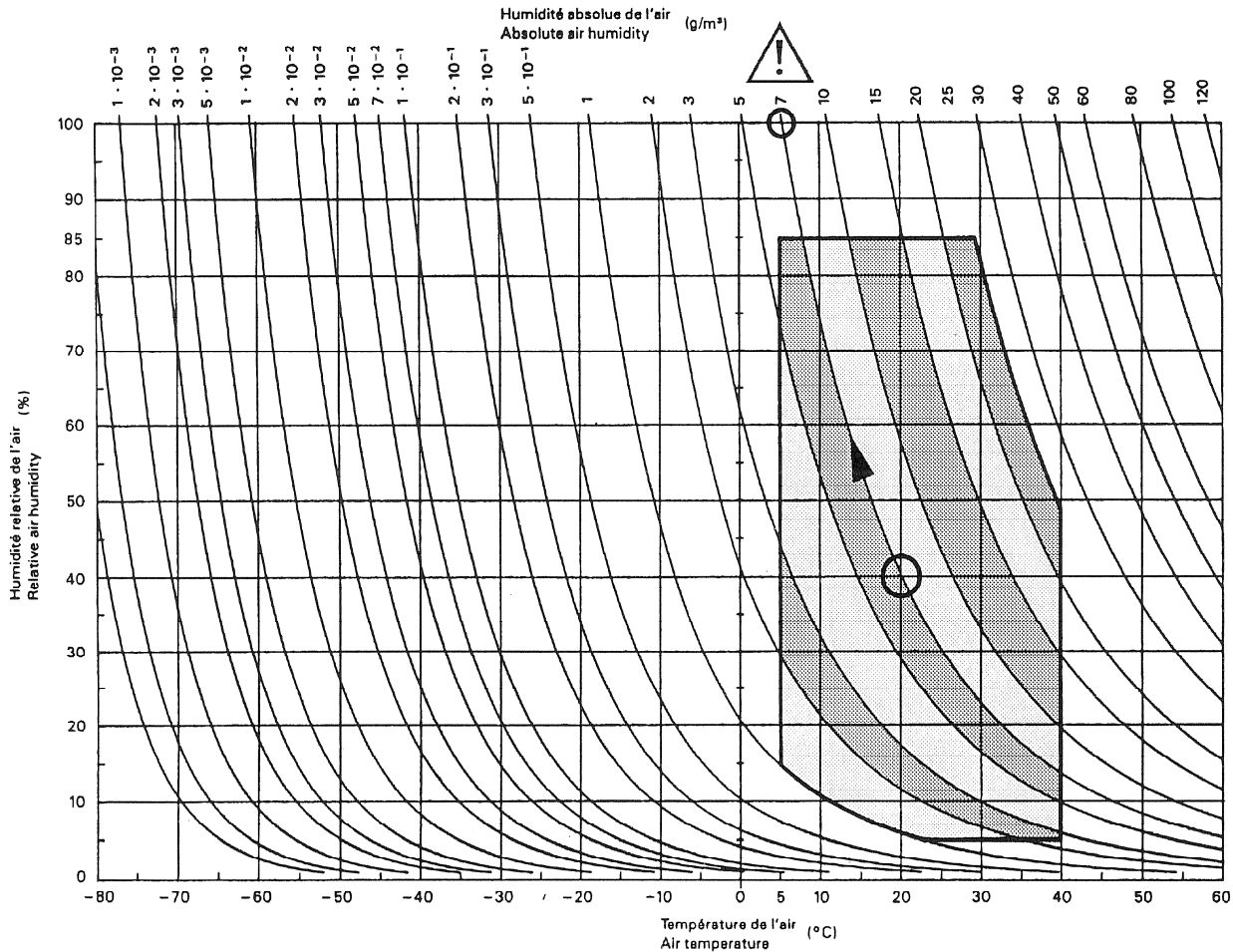

Figure B.3 – Climatogramme pour catégorie 3K3
Climatogram for class 3K3

Wartung und Reparatur

Durch Entfernen von Gehäuseteilen, Abschirmungen etc. werden stromführende Teile freigelegt. Deshalb müssen u.a. die folgenden Grundsätze beachtet werden: Eingriffe in das Gerät dürfen nur von Fachpersonal unter Einhaltung der geltenden Vorschriften vorgenommen werden.

Vor Entfernen von Gehäuseteilen muss das Gerät ausgeschaltet und vom Netz getrennt werden.

Bei geöffnetem, vom Netz getrenntem Gerät dürfen Teile mit gefährlichen Ladungen (z. B. Kondensatoren, Bildröhren) erst nach kontrollierter Entladung, heiße Bauteile (Leistungshalbleiter, Kühlkörper etc.) erst nach deren Abkühlen berührt werden.

Bei Wartungsarbeiten am geöffneten, unter Netzspannung stehenden Gerät dürfen blanke Schaltungs- teile und metallene Halbleitergehäuse weder direkt noch mit nichtisoliertem Werkzeug berührt werden.

Zusätzliche Gefahren bestehen bei unsachgemäßer Handhabung besonderer Komponenten:

- *Explosionsgefahr* bei Lithiumzellen, Elektrolyt-Kondensatoren und Leistungshalbleitern
- *Implosionsgefahr* bei evakuierten Anzeigeeinheiten
- *Strahlungsgefahr* bei Lasereinheiten (nichtionisierend), Bildröhren (ionisierend)
- *Verätzungsgefahr* bei Anzeigeeinheiten (LCD) und Komponenten mit flüssigem Elektrolyt.

Solche Komponenten dürfen nur von ausgebildetem Fachpersonal mit den vorgeschriebenen Schutzmitteln (u.a. Schutzbrille, Handschuhe) gehandhabt werden.

Maintenance and Repair

The removal of housing parts, shields, etc. exposes energized parts. For this reason the following precautions should be observed:

Maintenance should only be performed by trained personnel in accordance with the applicable regulations.

The equipment should be switched off and disconnected from the AC power outlet before any housing parts are removed.

Even if the equipment is disconnected from the power, parts with hazardous charges (e.g. capacitors, picture tubes) must not be touched until they have been properly discharged. Touch hot components (power semiconductors, heat sinks, etc.) only when cooled off.

If maintenance is performed on a unit that is opened and switched on, no uninsulated circuit components and metallic semiconductor housings must be touched neither with your bare hands nor with uninsulated tools.

Certain components pose additional hazards:

- *Explosion hazard* from lithium batteries, electrolytic capacitors and power semiconductors
- *Implosion hazard* from evacuated display units
- *Radiation hazard* from laser units (non-ionizing), picture tubes (ionizing)
- *Caustic effect* of display units (LCD) and such components containig liquid electrolyte.

Such components should only be handled by trained personnel who are properly protected (e.g. safety goggles, gloves).

Elektrostatische Entladung (ESD) bei Wartung und Reparatur

Electrostatic Discharge (ESD) during Maintenance and Repair



ATTENTION:

Observe precautions for handling devices sensitive to electrostatic discharge!

ATTENTION:

Respecter les précautions d'usage concernant la manipulation de composants sensibles à l'électricité statique!

ACHTUNG:

Vorsichtsmassnahmen bei Handhabung elektrostatisch entladungsgefährdeter Bauelemente beachten!

Viele ICs und andere Halbleiter sind empfindlich gegen elektrostatische Entladung (ESD). Unfachgerechte Behandlung von Baugruppen mit solchen Komponenten bei Wartung und Reparatur kann deren Lebensdauer drastisch vermindern.

Bei der Handhabung der ESD-empfindlichen Komponenten sind u.a. folgende Regeln zu beachten:

- ESD-empfindliche Komponenten dürfen ausschliesslich in dafür bestimmten und bezeichneten Verpackungen gelagert und transportiert werden.
- Unverpackte, ESD-empfindliche Komponenten dürfen nur in dafür eingerichteten Schutzzonen (EPA, z.B. Gebiet für Feldservice, Reparatur- oder Serviceplatz) gehandhabt und nur von Personen berührt werden, die durch ein Handgelenkband mit Serienwiderstand mit dem Massepotential des Reparatur- oder Serviceplatzes verbunden sind. Das gewartete Gerät wie auch Werkzeug, Hilfsmittel, EPA-taugliche (elektrisch halbleitende) Arbeits-, Ablage- und Bodenmatten müssen ebenfalls mit diesem Potential verbunden sein.
- Die Anschlüsse der ESD-empfindlichen Komponenten dürfen unkontrolliert weder mit elektrostatisch aufladbaren (Gefahr von Spannungsdurchschlag), noch mit metallischen Oberflächen (Schockentladungsfahr) in Berührung kommen.
- Um undefinierte transiente Beanspruchung der Komponenten und deren eventuelle Beschädigung durch unerlaubte Spannung oder Ausgleichsströme zu vermeiden, dürfen elektrische Verbindungen nur am abgeschalteten Gerät und nach dem Abbau allfälliger Kondensatorladungen hergestellt oder getrennt werden.

Many ICs and semiconductors are sensitive to electrostatic discharge (ESD). The life of components containing such elements can be drastically reduced by improper handling during maintenance and repair work.

Please observe the following rules when handling ESD sensitive components:

- ESD sensitive components should only be stored and transported in the packing material specifically provided for this purpose.
- Unpacked ESD sensitive components should only be handled in ESD protected areas (EPA, e.g. area for field service, repair or service bench) and only be touched by persons who wear a wristlet that is connected to the ground potential of the repair or service bench by a series resistor. The equipment to be repaired or serviced and all tools, aids, as well as electrically semiconducting work, storage and floor mats should also be connected to this ground potential.
- The terminals of ESD sensitive components must not come in uncontrolled contact with electrostatically chargeable (voltage puncture) or metallic surfaces (discharge shock hazard).
- To prevent undefined transient stress of the components and possible damage due to inadmissible voltages or compensation currents, electrical connections should only be established or separated when the equipment is switched off and after any capacitor charges have decayed.

SMD-Bauelemente

SMD Components

Der Austausch von SMD-Bauelementen ist ausschliesslich geübten Fachleuten vorbehalten. Für verwüstete Platinen können keine Ersatzansprüche geltend gemacht werden. Beispiele für korrekte und falsche SMD-Lötverbindungen in der Abbildung weiter unten.

SMDs should only be replaced by skilled specialists. No warranty claims will be accepted for circuit boards that have been ruined. Proper and improper SMD soldering joints are depicted below.

Bei Studer werden keine handelsüblichen SMD-Teile bewirtschaftet. Für Reparaturen sind die notwendigen Bauteile lokal zu beschaffen. Die Spezifikationen von Spezialbauteilen finden Sie in der Serviceanleitung.

Studer does not keep any commercially available SMDs in stock. For repair the corresponding devices should be purchased locally. The specifications of special components can be found in the service manual.

<p>Demontage/Dismounting</p>			
<p>Montage/Mounting</p>		<p>Beispiele/Examples</p>	

Störstrahlung und Störfestigkeit

Das Gerät entspricht den Schutzanforderungen auf dem Gebiet elektromagnetischer Phänomene, wie u.a. in den Richtlinien 89/336/EWG und FCC, Part 15, aufgeführt:

1. Vom Gerät erzeugte elektromagnetische Strahlung ist soweit begrenzt, dass bestimmungsgemässer Betrieb anderer Geräte und Systeme möglich ist.
2. Das Gerät weist eine angemessene Festigkeit gegen elektromagnetische Störungen auf, so dass sein bestimmungsgemässer Betrieb möglich ist.

Das Gerät wurde getestet und erfüllt die Bedingungen der im Kapitel „Technische Daten“ aufgeführten EMV-Standards. Die Limiten dieser Standards gewährleisten mit angemessener Wahrscheinlichkeit sowohl den Schutz der Umgebung wie auch entsprechende Störfestigkeit des Gerätes. Absolute Garantie, dass keine unerlaubte elektromagnetische Beeinträchtigung während des Betriebes entsteht, ist jedoch nicht gegeben.

Um die Wahrscheinlichkeit solcher Beeinträchtigung weitgehend auszuschliessen, sind u.a. folgende Massnahmen zu beachten:

- Installieren Sie das Gerät gemäss den Angaben in der Betriebsanleitung, und verwenden Sie das mitgelieferte Zubehör.
- Verwenden Sie im System und in der Umgebung, in denen das Gerät eingesetzt ist, nur Komponenten (Anlagen, Geräte), die ihrerseits die Anforderungen der oben erwähnten Standards erfüllen.
- Sehen Sie ein Erdungskonzept des Systems vor, das sowohl die Sicherheitsanforderungen (die Erdung der Geräte gemäss Schutzklasse I mit einem Schutzleiter muss gewährleistet sein), wie auch die EMV-Belange berücksichtigt. Bei der Entscheidung zwischen stern- oder flächenförmiger bzw. kombinierter Erdung sind Vor- und Nachteile gegeneinander abzuwägen.
- Benutzen Sie abgeschirmte Kabel, wo vorgesehen. Achten Sie auf einwandfreie, grossflächige, korrosionsbeständige Verbindung der Abschirmung zum entsprechenden Steckeranschluss und dessen Gehäuse. Beachten Sie, dass eine nur an einem Ende angeschlossene Kabelabschirmung als Sende- bzw. Empfangsantenne wirken kann (z.B. bei wirksamer Kabellänge von 5 m oberhalb von 10 MHz), und dass die Flanken digitaler Kommunikationssignale hochfrequente Aussendungen verursachen (z.B. LS- oder HC-Logik bis 30 MHz).
- Vermeiden Sie Bildung von Masseschleifen oder vermindern Sie deren unerwünschte Auswirkung, indem Sie deren Fläche möglichst klein halten und den darin fließenden Strom durch Einfügen einer Impedanz (z.B. Gleichtaktdrossel) reduzieren.

Electromagnetic Compatibility

The equipment conforms to the protection requirements relevant to electromagnetic phenomena that are listed in the guidelines 89/336/EC and FCC, part 15.

1. The electromagnetic interference generated by the equipment is limited in such a way that other equipment and systems can be operated normally.
2. The equipment is adequately protected against electromagnetic interference so that it can operate correctly.

The unit has been tested and conforms to the EMC standards applicable to residential, commercial and light industry, as listed in the section „Technical Data“. The limits of these standards reasonably ensure protection of the environment and corresponding noise immunity of the equipment. However, it is not absolutely warranted that the equipment will not be adversely affected by electromagnetic interference during operation.

To minimize the probability of electromagnetic interference as far as possible, the following recommendations should be followed:

- Install the equipment in accordance with the operating instructions. Use the supplied accessories.
- In the system and in the vicinity where the equipment is installed, use only components (systems, equipment) that also fulfill the above EMC standards.
- Use a system grounding concept that satisfies the safety requirements (protection class I equipment must be connected with a protective ground conductor) that also takes into consideration the EMC requirements. When deciding between radial, surface or combined grounding, the advantages and disadvantages should be carefully evaluated in each case.
- Use shielded cables where shielding is specified. The connection of the shield to the corresponding connector terminal or housing should have a large surface and be corrosion-proof. Please note that a cable shield connected only single-ended can act as a transmitting or receiving antenna (e.g. with an effective cable length of 5 m, the frequency is above 10 MHz) and that the edges of the digital communication signals cause high-frequency radiation (e.g. LS or HC logic up to 30 MHz).
- Avoid ground loops or reduce their adverse effects by keeping the loop surface as small as possible, and reduce the noise current flowing through the loop by inserting an additional impedance (e.g. common-mode rejection choke).

Class A Equipment - FCC Notice

This equipment has been tested and found to comply with the limits for a Class A digital device, pursuant to Part 15 of the FCC Rules. These limits are designed to provide a reasonable protection against harmful interference when the equipment is operated in a commercial environment. This equipment generates, uses, and can radiate radio frequency energy and, if not installed and used in accordance with the instruction manual, may cause harmful interference to radio communications. Operation of this equipment in a residen-

tial area is likely to cause harmful interference in which case the user will be required to correct the interference at his own expense.

Caution:

Any changes or modifications not expressly approved by the manufacturer could void the user's authority to operate the equipment. Also refer to relevant information in this manual.

CE-Konformitätserklärung

Der Hersteller,

Studer Professional Audio AG,
CH-8105 Regensdorf,

erklärt in eigener Verantwortung, dass das Produkt

**Studer A807 MkII, professionelles Bandgerät,
(ab Serie-Nr. 15250),**

auf das sich diese Erklärung bezieht, entsprechend den Bestimmungen der EU-Richtlinien und Ergänzungen

- Elektromagnetische Verträglichkeit (EMV):
89/336/EWG + 92/31/EWG + 93/68/EWG
- Niederspannung:
73/23/EWG + 93/68/EWG

mit den folgenden Normen und normativen Dokumenten übereinstimmt:

- Sicherheit:
Schutzklasse 1, EN 60065:1993; IEC 65:1985
- EMV:
EN 50081-1:1992, EN 50082-1:1992.

Regensdorf, 16. Juni 1995



B. Hochstrasser, Geschäftsleiter



P. Fiala, Leiter QS

CE Declaration of Conformity

The manufacturer,

Studer Professional Audio AG,
CH-8105 Regensdorf,

declares under his sole responsibility that the product

**Studer A807 MkII, professional tape recorder,
(on from serial No. 15250),**

to which this declaration relates, according to following regulations of EU directives and amendments

- Electromagnetic Compatibility (EMC):
89/336/EEC + 92/31/EEC + 93/68/EEC
- Low Voltage (LVD):
73/23/EEC + 93/68/EEC

is in conformity with the following standards or other normative documents:

- Safety:
Class 1, EN 60065:1993; IEC 65:1985
- EMC:
EN 50081-1:1992, EN 50082-1:1992.

Regensdorf, June 16, 1995



B. Hochstrasser, Managing director



P. Fiala, Manager QA

Addendum

To Section 1.1:

A807 MkII is a tape recorder intended for professional use. It is assumed that the unit is operated by trained personnel only and serviced by skilled experts only. The electrical connections may be connected only to the voltages and signals specified in this manual. For operation, the tape reel adapters or tape pancake adapters have to be locked.

To Section 2.2:

The unit may be operated only with all covers completely closed and with locked tape transport in order to prevent electric shock hazards to the operating personnel as well as damage caused by dust or undesired effects by electromagnetic interference.

To Sections 2.3.1, 2.4.2:

Before operating the unit please read sections 2.4.2 and 2.4.4.



A807 MkII is extensively protected against faulty manipulations. However, it is necessary to observe the following precautions when working in the area of the tape reels in order to avoid personal injury. It is strictly to be avoided to touch parts of the tape transport before the reels have come to a complete stop.



The operating personnel has to be informed about these precautions. It is strictly to be avoided that the unit is touched by untrained persons during operation.



The tape transport must by no means be tilted during operation, particularly during fast wind operations! Because of the high winding speed and the thereby caused gyroscopic forces the tape, the reels and the tape transport can be damaged - risk of personal injury!



Manipulations inside the unit may only be done by skilled experts. Fuses must be replaced by exactly the same value and rating only.

Section 2.4.20:

Remote control connections may be established or separated only if all involved units are switched off.

Section 2.6.3:

Before connecting the computer to the A807 MkII as well as before separating the connection, make sure both units are switched off.

Sections 2.4.6, 2.7:

- When cleaning the capstan shaft make sure that no cleaning fluid penetrates into the bearing!
- Never use cleaner for anodized surfaces for cleaning the tape heads!

1 General information

1.1	Quick Reference Description	1
1.2	Standard Versions	3
1.2.1	Full-track versions	3
1.2.2	Stereo versions	3
1.2.3	Two-track versions	5
1.2.4	Timecode versions.....	6
1.2.5	4-Track 1/2" -versions.....	8
1.3	Options (only for 1/4"-Recorder)	9
1.3.1	Options for 1/4"- and 1/2"-versions	10
1.4	Accessories and service aids	11
1.4.1	Standard accessories.....	11
1.4.2	Consoles.....	11
1.4.3	Consoles accessories	12
1.4.4	Remote controls.....	13
1.4.5	Remote displays.....	15
1.4.6	Reel adapters	15
1.4.7	Service utensils	16
1.4.8	Accessories	17
1.5	Technical data	18
1.5.1	Technical data 1/4"	18
1.5.2	Technical data 1/4" Timecode.....	24
1.5.3	Technical data 1/4" reproduce, CCIR.....	25
1.5.4	Technical data 4-track 1/2"	26
1.5.5	Dimensions A807 MKII 1/4" (in mm)	29
1.5.6	Dimensions A807 MKII 1/2" (in mm)	31
1.6	Instructions for service personal	33
1.6.1	Abbreviations	33
1.6.2	Powers of ten.....	34
1.6.3	Letters and color codes.....	34

1.1 Quick Reference Description

With its compact and rugged design, its system flexibility, and the high operating convenience afforded by its microprocessor, the STUDER A807 tape recorder satisfies all requirements of a universal studio machine, be it radio or television studios, recording studios, theater, film, auditoriums, or scientific institutes.

Its salient features are:

- Highly stable die-cast aluminum alloy chassis for the tape transport, the headblock, and other assemblies. The new design extends the possible tape capacity and allows operation with **1000m** standard tape.
- Hall-commutated brushless DC capstan motor with capacitive tacho sensor for highly accurate tape speed and outstanding acceleration and deceleration rates.
- Fast tape deck with high tape spooling speeds and gentle processing of the tapes by electronically controlled tape tension, 2 controlled AC spooling motors with photoelectric tacho sensors and noncontacting tape tension sensor.
- Precision electronic tape counter with real-time indication. Photoelectric scanning of the guide roller rotation.
- Easy editing: motor-assisted with variable spooling speed (SHUTTLE mode) or manually by turning the right-hand reel (one-handed editing). For cueing in spooling mode, the high end of the frequency response is lowered.
- Monitor speaker below the tape deck cover or in the penthouse.
- Manually operable shield above the reproduce head; can remain closed in spooling mode.

Due to the enormous system flexibility, a suitable A807 version is available for any type of application:

- The basic version is available as a mono, 2-channel or stereo machine with or without external instrument panel. Special versions are available for timecode applications and for 1/2" tape (four channels).
- Can be operated in horizontal, inclined, or vertical position.
- Three of four available tape speeds can be selected: 3.75 / 7.5 / 15 / 30ips. Depending on the configuration either the slowest or the fastest speed is not available.
- The 1/2"-4-track tape recorder is available with the tape speed configuration: 7.5 / 15 / 30ips (19 / 38 / 76cm) only.
- The inputs and outputs are balanced and floating, with input/output transformers.
- Either with selector switch for two tape types with different calibration data, or with selector switch for NAB/CCIR equalization.
- Zero locator and transfer locator for up to 3 addresses as standard features.
- Dolby HX PRO headroom extension system as standard feature.
- Equipped with varispeed (variable tape speed).

- Keys for input and output selection on models equipped with VU meters:
Input selection:
MIC ON (microphone input; this input does not exist on units equipped with external instrument panel); LINE ON (line input). The microphone inputs are always equipped with a 48V phantom power (changeover to 24 or 12V possible).
Output selection:
INPUT, REPRO, and SYNC (reproduction via record head).
VU-meter panel with input and output selection keys, level potentiometer for recording.
- Adjustable for line voltages of 100 to 140V / 200 to 240VAC, $\pm 10\%$, 50...60Hz.
- Can be remote controlled from a terminal or personal computer via an RS232 interface.
- Connection facilities for fader start circuit, parallel and serial remote control.

High operating convenience afforded by microprocessor control:

- The last operating state is saved when the machine is switched off: tape counter, locator addresses, tape speed, setting of the input and output selectors. The STOP mode is automatically activated when the machine is powered on again.
- Drop in by pressing only the REC key in play mode (internally programmable)
- Drop out by pressing PLAY during a recording.
- Reduced spooling speed (LIBRARY WIND): A lower spooling speed can be selected for producing pancakes that are to be saved in the library.
- REVERSE PLAY
- TAPE DUMP (waste basket mode with disabled take-up motor).
- LAP TIME (second time level for measuring individual tape segments without influencing the main tape counter).
- Adjustment of the audio parameters and setting of "soft jumpers" via the keyboard.
- LOC START positions the magnetic tape automatically at the address at which the last play or record command (for standstill) was entered.

The following options are available:

- Mono/stereo switch with or without test generator (60, 125Hz, 1, 10, 16kHz).
- Tape scissors and tape marker as well as a headblock cover plate with integrated scissors/splicing block.
- Additional splicing block for units without VU-meter.
- Synchronizer interface.
- Extern connection for INSERT-Input (slave points).
- Audio remote port.
- Elapsed time meter.
- Noise reduction port.

1.2 Standard Versions

1.2.1 Full-track versions

Order No.

A807-1 VU

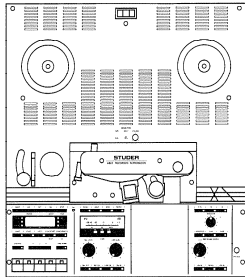

- Machine for 1/4" tape.
- Mono with full-track erase head.
- With channel control.
- Microphone input with phantom power
- Monitor speaker built into tape deck cover.
- VU-meter with input level potentiometer integrated in the operator panel
- Maximum reel diameter 300mm (11.8"). 1000m band.
- Three tape speeds (3.75 / 7.5 / 15ips).
- Varispeed (variable tape speed).
- Chassis version.

60.116.07212

A807-1 VUK**

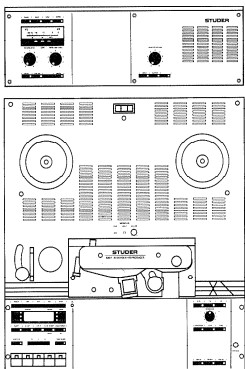

- Machine for 1/4" tape.
- Mono with full-track erase head.
- With channel control.
- Monitor speaker and VU-meter with an input level potentiometer and channel control as well as output level potentiometer built into the instrument panel.
- Maximum reel diameter 300mm (11.8"). 1000m band.
- Three tape speeds (3.75 / 7.5 / 15ips).
- Varispeed (variable tape speed).
- Console version.

60.116.07213

1.2.2 Stereo versions

Order No.

A807-0.75

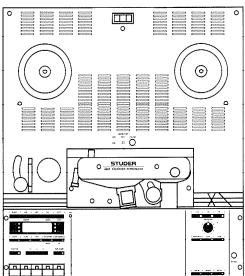

- Machine for 1/4" tape.
- Stereo with 0.75mm track separation, full track erase head.
- Without channel control.
- Monitor speaker built into tape deck cover.
- Maximum reel diameter 300mm (11.8"). 1000m band.
- Three tape speeds (3.75 / 7.5 / 15ips).
- Varispeed (variable tape speed).
- Chassis version.

60.116.07221

A807-0.75 VU

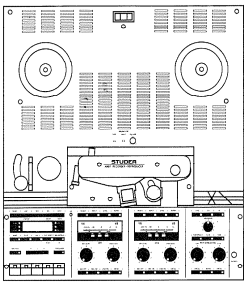

- Machine for 1/4" tape.
- Stereo with 0.75mm track separation, overlapping erasure.
- Microphone input with phantom power.
- Monitor speaker built into tape deck cover.
- VU-meter with input level potentiometer and channel control as well as output level potentiometer built into the operator panel.
- Maximum reel diameter 300mm (11.8"). 1000m band.
- Three tape speeds (3.75 / 7.5 / 15ips).
- Varispeed (variable tape speed).
- Chassis version.

60.116.07222

A807-0.75 VUK**

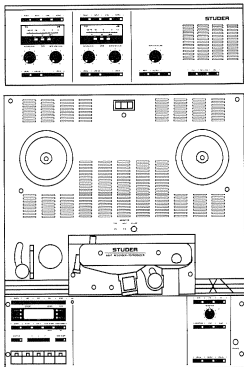

- Machine for 1/4" tape.
- 2-Track/stereo with 0.75mm track separation, overlapping erasure.
- Monitor speaker and VU-meter with input level potentiometer and channel control as well as output level potentiometer built into the instrument panel.
- Maximum reel diameter 300mm (11.8"). 1000m band.
- Three tape speeds (3.75 / 7.5 / 15ips).
- Varispeed (variable tape speed).
- Console version.

60.116.07224

A807-0.75 VUK HS**

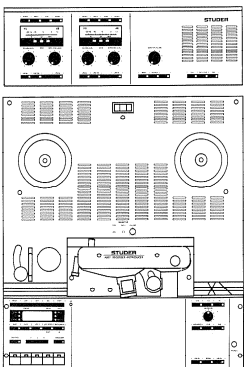

- Machine for 1/4" tape.
- 2-Track/stereo with 0.75mm track separation, overlapping erasure.
- Monitor speaker and VU-meter with input level potentiometer and channel control as well as output level potentiometer built into the instrument panel.
- Maximum reel diameter 300mm (11.8"). 1000m band.
- Three tape speeds (7.5 / 15 / 30ips).
- Varispeed (variable tape speed).
- Console version.

60.116.07225

A807-0.75 PBO*

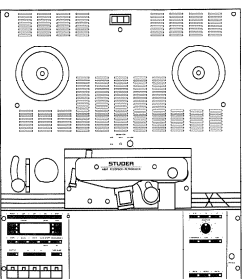

- Machine for 1/4" tape.
- Stereo with 0.75mm track separation, reproduce-only (recording electronics not retrofittable).
- Without channel control.
- Monitor speaker built into tape deck cover.
- Maximum reel diameter 300mm (11.8"). 1000m band.
- Three tape speeds (3.75 / 7.5 / 15ips).
- Varispeed (variable tape speed).
- Chassis version.

60.116.07226

A807-0.75 VU PBO*

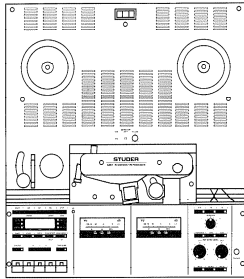

- Machine for 1/4" tape.
- Stereo with 0.75mm track separation, reproduce-only (recording electronics not retrofittable).
- Without channel control.
- Monitor speaker built into tape deck cover.
- VU-meter with output level potentiometer integrated in operator panel.
- Maximum reel diameter 300mm (11.8").
- Three tape speeds (3.75 / 7.5 / 15ips). 1000m band.
- Varispeed (variable tape speed).
- Chassis version.

60.116.07227

1.2.3 Two-track versions

Order No.

A807-2 F

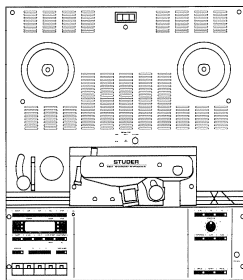

- Machine for 1/4" tape.
- 2-Track/stereo with 2mm track separation, full-track erase head.
- Without channel control.
- Monitor speaker built into tape deck cover.
- Maximum reel diameter 300mm (11.8"). 1000m band.
- Three tape speeds (3.75 / 7.5 / 15ips).
- Varispeed (variable tape speed).
- Chassis version.

60.116.07230

A807-2/2

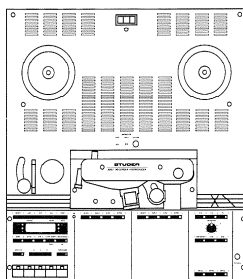

- Machine for 1/4" tape.
- 2-Track/stereo with 2mm track separation, overlapping erasure.
- With channel control, without VU-meter and input/output level potentiometers.
- Monitor speaker built into tape deck cover.
- Maximum reel diameter 300mm (11.8"). 1000m band.
- Three tape speeds (3.75 / 7.5 / 15ips).
- Varispeed (variable tape speed).
- Chassis version.

60.116.07231

A807-2/2 VU

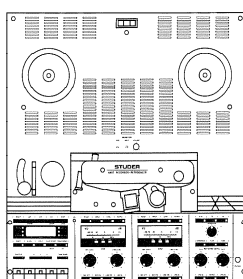

- Machine for 1/4" tape.
- 2-Track/stereo with 2mm track separation, overlapping erasure.
- Microphone input with phantom power.
- Monitor speaker built into tape deck cover.
- VU-meter with input level potentiometers and channel control as well as output level potentiometer integrated in the operator panel.
- Maximum reel diameter 300mm (11.8"). 1000m band.
- Three tape speeds (3.75 / 7.5 / 15ips).
- Varispeed (variable tape speed).
- Chassis version.

60.116.07232

A807-2/2 VU HS

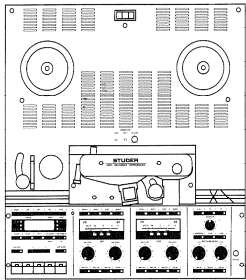

- Machine for 1/4" tape.
- 2-Track/stereo with 2mm track separation.
- Microphone input with phantom power.
- Monitor speaker built into tape deck cover.
- VU-meter with input level potentiometer and channel control as well as output level potentiometer built into the operator panel.
- Maximum reel diameter 300mm (11.8"). 1000m band.
- Three tape speeds (7.5 / 15 / 30ips).
- Varispeed (variable tape speed).
- Chassis version.

60.116.07264

A807-2/2 VUK**

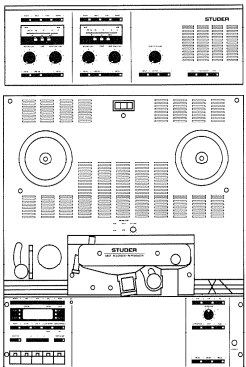

- Machine for 1/4" tape.
- 2-Track/stereo with 2mm track separation, overlapping erasure.
- Monitor speaker and VU-meter with input level potentiometer and channel control as well as output level potentiometer built into the instrument panel.
- Maximum reel diameter 300mm (11.8"). 1000m band.
- Three tape speeds (3.75 / 7.5 / 15ips).
- Varispeed (variable tape speed).
- Console version.

60.116.07234

A807-2/2 VUK HS**

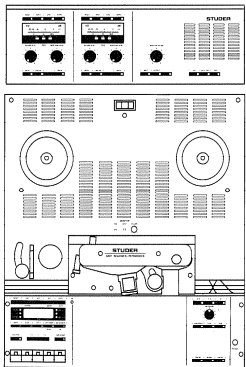

- Machine for 1/4" tape.
- 2-Track/stereo with 2mm track separation, overlapping erasure.
- Monitor speaker and VU-meter with input level potentiometer and channel control as well as output level potentiometer built into the instrument panel.
- Maximum reel diameter 300mm (11.8"). 1000m band.
- Three tape speeds (7.5 / 15 / 30ips).
- Varispeed (variable tape speed).
- Console version.

60.116.07265

1.2.4 Timecode versions

Order No.

A807-2 TC VU

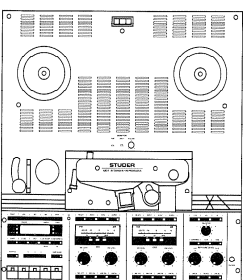

- Machine for 1/4" tape.
- 2-Track/stereo with 2mm track separation.
- Microphone input with phantom power.
- With time code head and electronics.
- Monitor speaker built into tape deck cover.
- VU-meter with input level potentiometer and channel control as well as output level potentiometer built into the operator panel.
- Maximum reel diameter 300mm (11.8"). 1000m band.
- Three tape speeds (3.75 / 7.5 / 15ips).
- Varispeed (variable tape speed).
- Console version.

60.116.07242

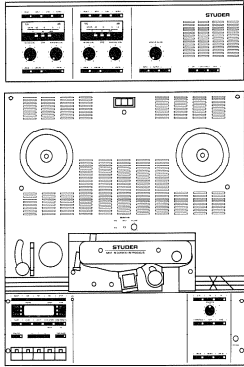
A807-2 TC VUK**

- Machine for 1/4" tape.
- 2-Track/stereo with 2mm track separation.
- Microphone input with phantom power.
- With time code head and electronics.
- Monitor speaker built into tape deck cover.
- VU-meter with input level potentiometer and channel control as well as output level potentiometer built into the operator panel.
- Maximum reel diameter 300mm (11.8"). 1000m band.
- Three tape speeds (3.75 / 7.5 / 15ips).
- Varispeed (variable tape speed).
- Console version.

60.116.07243

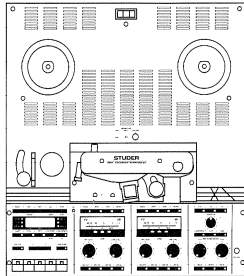
A807-2 TC VU HS

- Machine for 1/4" tape.
- 2-Track/stereo with 2mm track separation.
- Microphone input with phantom power.
- With time code head and electronics.
- Monitor speaker built into tape deck cover.
- VU-meter with input level potentiometer and channel control as well as output level potentiometer built into the operator panel.
- Maximum reel diameter 300mm (11.8"). 1000m band.
- Three tape speeds (7.5 / 15 / 30ips).
- Varispeed (variable tape speed).
- Console version.

60.116.07245

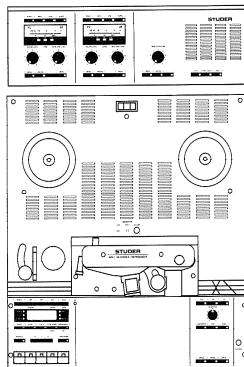
A807-2 TC VUK HS**

- Machine for 1/4" tape.
- 2-Track/stereo with 2mm track separation.
- With time code head and electronics.
- Monitor speaker and VU-meter with input level potentiometer and channel control as well as output level potentiometer built into the instrument panel.
- Maximum reel diameter 300mm (11.8"). 1000m band.
- Three tape speeds (3.75 / 7.5 / 15ips).
- Varispeed (variable tape speed).
- Console version.

60.116.07246

- Notes:**
- * A807 PBO and A807 VU PBO (Playback only) versions cannot be upgraded with record facilities.
 - ** On request, special instrument panels for 19" rack mounting (in place of the wooden side panels) are available for all VUK versions. The rack mounting brackets 1.727.071.00 must be ordered in this case.

1.2.5 4-Track 1/2" -versions

Order No.

A807-4 1/2" VUK HS

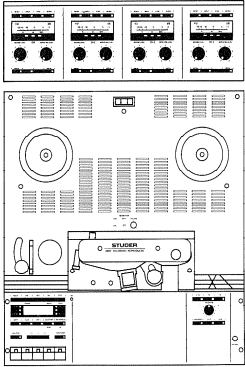

- Machine for 1/2" tape.
- 4-track with 4-track erase head.
- Overbridge equipped with VU-Meters, channel mode selectors and peak indicators.
- Built-in monitor loudspeaker.
- In- and outputs transformer equipped.
- Maximum reel diameter 11.1" (282mm). 760m tape.
- Three tape speeds (7.5 / 15 / 30ips).
- Varispeed (variable tape speed).
- Console version.

60.116.07060

A807-4 1/2" TC VUK HS

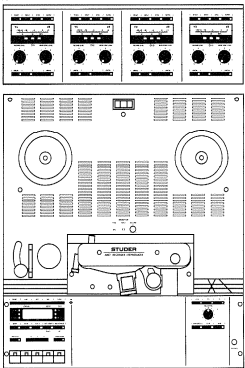

- Machine for 1/2" tape.
- 4-track with 4-track erase head.
- Time code centre track.
- Time code head and-electronics.
- Overbridge equipped with VU-Meter, channel mode selector and peak indicators.
- Built-in monitor loudspeaker.
- In- and outputs transformer equipped.
- Maximum reel diameter 11.1" (282mm). 760m tape.
- Three tape speeds (7.5 / 15 / 30ips).
- Varispeed (variable tape speed).
- Console version.

60.116.07261

A807-4 1/2" TC HS

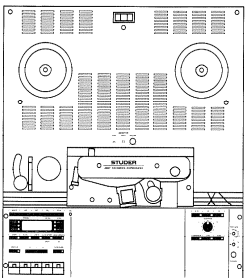

- Machine for 1/2" tape.
- 4-track with 4-track erase head.
- Time code centre track.
- Time code head and-electronics.
- With **external** channel remote control for 4-audio channels and 1 time code channel.
- Built-in monitor loudspeaker.
- Maximum reel diameter 11.1" (282mm). 760m tape.
- Three tape speeds (7.5 / 15 / 30ips).
- Varispeed (variable tape speed).
- Console version.

60.116.07259

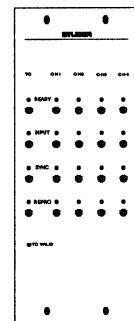

Additional Manuals

- Operating instruction manual MKII (English)
- Operating and service instruction manual MKII (English)
- Operating instruction manual MKII (German)
- Operating and service instruction manual MKII (German)

10.27.3071
10.27.1421
10.27.3081
10.27.1411

1.3 Options (only for 1/4"-Recorder)		Order No.
Tape scissors	Kit for all versions (Except: Time code versions).	20.807.894.00
	Kit for Time code versions.	20.807.889.00
Tape marker	Kit for all versions.	20.807.896.00
Tape scissors and tape marker	Kit for all versions (Except: Time code versions).	20.807.895.00
	Kit for Time code versions	20.807.890.00
Cutting/splicing block	For installation on the operator panel For versions with VU-meters installed in the instrument panel or for versions without VU-meter.	20.807.173.00
	Headblock cover designed as a cutting/splicing block. For all versions. (Except: Time code versions).	20.807.172.00
	For Time code versions.	20.807.887.00
Mono/stereo switch	For all record/reproduce versions.	20.807.176.00
Mono/stereo switch with test generator	For all versions. With built-in booster amplifier for 10 and 20dB and test generator (60, 125Hz; 1, 10, 6kHz).	20.807.174.00
Mono/stereo switch for (PBO) reproduce-only	For all (PBO) reproduce only versions.	20.807.168.00
12V Phantom power conversion kit (instead of 48V)	For all versions with balanced microphone input.	20.807.175.00
Noise reduction system control Interface	Switches the noise reduction system in accordance to the record- resp. reproduce command to the corresponding function. (Opencollector-outputs, active Low-as well as active High-Level.	20.807.946.00
Audio insert interface	For symmetrical in- and output insert points (reproduce- and record path) for an external device (E.G. noise reduction system).	20.807.950.00
Headblock assembly with azimuth adjustment knob	For record and reproduce head.	20.807.949.00
Stereo monitor penthouse	Comprising: Stereo monitor speaker, volume control and selector for input/reproduce/auxiliary/input signal. Including wiring and connection material. Suitable for all Stereo-Versions without external VU-overbridge. (Only for consoles 20.020.205.07/.17).	20.807.163.00

Stereo monitor penthouse with VU meters	Comprising: 2 VU meters (CH1/CH2), stereo monitor speaker, volume control and selector for input/reproduce/auxiliary input signal. Including wiring and connection material. Suitable for all Stereo-Versions without external VU-overbridge. (Only for consoles 20.020.205.07/.17)	20.807.164.00
Mono monitor penthouse with VU meter	Comprising: 1 VU meter, monitor speaker, volume control and selector for input/reproduce signal. Including wiring and connection material. Suitable for all Mono-Versions without external VU-overbridge. (Only for consoles 20.020.205.07/.17)	20.807.166.00
Reel shelf	Serves as a storage area; in place of the penthouse. Only installable on consoles with penthouse (20.020.205.07/.17)	21.811.560.00

1.3.1 Options for 1/4"- and 1/2"-versions **Order No.**

Elapsed time meter	Electromechanical hour meter	20.807.911.00
Audio channel remote control interface	Required for external channel remote control unit 1.328.512.00 (2-channel version) or 1.328.515.00 (4-channel version)	20.807.947.00
Synchronizer control port	Kit for all versions (Standard for TC-versions)	20.807.177.00
Special light barrier	Conversion kit light-barrier for clear leader tape detection. Stops and parks tape recorder at the end and beginning of sequential takes. Delay adjustable. (Suitable for A807 MKI versions)	10.023.513.00
	Conversion kit light-barrier for clear leader tape detection. Stops and parks tape recorder at the end and beginning of sequential takes. Delay adjustable. (Suitable for A807 MKII versions)	10.023.528.00

1.4 Accessories and service aids

1.4.1 Standard accessories	Order No.
Set:	20.020.302.32
1 Power cord 2.5m, EURO connector	10.223.001.01
1 Set of audio connectors, XLR (per channel)	
1 Allen screwdriver 2.0mm	26.06.1020
1 Allen screwdriver 2.5mm	10.258.003.09
1 Allen screwdriver 3.0mm	10.258.003.10
1 Allen screwdriver 4.0mm	26.06.1040
5 Fuses 5x20mm, 1A SLOW	51.01.0117
5 Fuses 5x20mm, 1.6A SLOW	51.01.0119
5 Fuses 5x20mm, 2A SLOW	51.01.0120
5 Fuses 5x20mm, 3.15A SLOW	51.01.0122
5 Fuses 5x20mm, 4A SLOW	51.01.0123
2 VU-meter bulbs 6V/30mA	51.02.0144
1 Label set	1.727.101.08
6 S-screw IS M3x6	21.51.2354

1.4.2 Consoles	Order No.
<ul style="list-style-type: none"> ■ A807 console complete with wooden side panels. Tilt mechanism integrated in console complete with castors. ■ Operational height: 840mm. 	
<div style="border: 1px solid black; padding: 2px; display: inline-block;">1/4" Consoles:</div> <p>Console with Penthouse-Support for machines with VU overbridge, reel shelf or external monitor panel.</p> <ul style="list-style-type: none"> ■ With traverse 20.020.205.07 ■ With pedestal rack 19"/3U 20.020.205.17 <p>Console without Penthouse</p> <ul style="list-style-type: none"> ■ With traverse 20.020.205.27 ■ With pedestal rack 19"/3U 20.020.205.37 	
<div style="border: 1px solid black; padding: 2px; display: inline-block;">TC-Penthouse extension:</div> <ul style="list-style-type: none"> ■ For installing the local control unit of the synchronizer TLS 4000-LCU. Fits on top of the existing penthouse. Includes wooden side panels. 	1.058.058.00
<div style="border: 1px solid black; padding: 2px; display: inline-block;">1/2" Consoles:</div> <p>Console with Penthouse-Support for VUK-versions.</p> <ul style="list-style-type: none"> ■ With traverse for 4-1/2" machine 20.020.205.10 ■ With pedestal rack 19"/3U 20.020.205.20 	

1.4.3 Consoles accessories

Order No.

19" pedestal Rack	<ul style="list-style-type: none"> ■ Retrofit kit for three 19" modules with a height 1.058.057.00 of 40.58mm each. (For 1/4" and 1/2" consoles). 	
Overbridge with shelf	<ul style="list-style-type: none"> ■ Instead of penthouse. (Only for consoles 20.020.205.07/.17) 	21.811.560.00
Side brackets	<ul style="list-style-type: none"> ■ Pair of side brackets, for enlargement of overall width of recorder surface, keeps reels within profile of console. 	1.058.081.00
Blanking panels for rack base	<p>Filler panels for 19" pedestal rack:</p> <ul style="list-style-type: none"> ■ 1U width, anodized finish ■ 2U width, anodized finish ■ 3U width, anodized finish <p>Filler panels for 19" pedestal rack:</p> <ul style="list-style-type: none"> ■ 1U width, gray paint finish ■ 2U width, gray paint finish ■ 3U width, gray paint finish <p>1 unit = 40,58mm</p> <p>Screw for 19" rack mounting</p> <ul style="list-style-type: none"> ■ M6 x 12 ■ M6 x 16 ■ Washer for 19" rack mounting, M6 	<p>1.918.001.00</p> <p>1.918.002.00</p> <p>1.918.003.00</p> <p>1.918.011.00</p> <p>1.918.012.00</p> <p>1.918.013.00</p> <p>21.99.0164</p> <p>21.99.0167</p> <p>23.99.0121</p>

1.4.4 Remote controls	Order No.
Desk-Top Version	<ul style="list-style-type: none"> ■ Parallel transport remote controller table cabinet, with 15m connection cable (vacant space for 1.328.253.00 varispeed controller) 1.328.250.00 ■ Varispeed controller for installation into cabinet of controller 1.328.253.00 ■ 25 pin D-connector Secondary (pass through) connector for installation into cabinet of 20.820.366.00 controller 1.328.254.00
Installation version	<ul style="list-style-type: none"> ■ Parallel transport remote controller STUDER standard module dimension, 1 module width, with 15m connection cable 20.820.367.00 ■ Varispeed controller STUDER standard module dimension, 1 module width (without connection cable) 1.328.290.00 ■ Varispeed controller deluxe version with digital readout of speed deviation in halftones STUDER standard module dimension, 1 module width (without connection cable) 1.328.280.00 ■ Flat ribbon cable, 0.3m for connecting varispeed controller 1.328.290.00 or 1.328.280.00 to parallel transport remote controller 20.820.367.00 1.023.102.03 ■ Connection cable, 15m for connecting varispeed controller 1.328.290.00 or 1.328.280.00 to A807 tape recorder directly. 1.328.292.00 ■ Audio channel remote control for 2 channels and TC channel STUDER standard modul, dimension 1 module width, with 15m connection cable. (Requires machine option 20.807.947.00). 1.328.512.00 ■ Audio channel remote control for 4 channels and TC channel STUDER standard modul, dimension 2 module width, with 15m connection cable. (Requires machine option 20.807.947.00). 1.328.515.00

Connectors to options and remote control ports

Required only if non STUDER devices are to be connected. All Studer remote controls are equipped with mating connectors to machine ports.

- **Connector to serial remote control port**
9-pin D-connector, screw-lock type
(Key position 6)
 - **Connector to parallel remote control port**
25-pin D-connector, screw-lock type
(Key position 24).
 - **Connector to synchronizer**
25-pin D-connector, screw-lock type
(Key position 8)
 - **Connector to noise reduction system control interface port**
(option 20.807.946.00)
15-pin D-connector, screw-lock type
(Key position 12)
 - **Connector to audio channel remote control interface**
(option 20.807.947.00)
15-pin D-connector screw-lock type
(Key position 6)
 - **Connector to serial TC-display port**
9-pin D-connector, screw-lock type
(Key position 4)
 - **Connector to Audio-Insert Interface**
25-pin D-connector, screw-lock type
(no Key position)

20.020.303.40

20.020.303.16

20.020.303.37

20.020.303.33

20.020.303.34

20.020.303.20

20.020.303.12

Table cabinet

- for STUDER standard modul remote control accepting 6 STUDER standard modules. 1.328.095.00

Filler panels for table cabinet

- Filler panels for 19" pedestal rack:
- 1 module width, anodized finish 1.038.341.00
 - 2 module width, anodized finish 1.038.342.00
 - 3 module width, anodized finish 1.038.343.00
- Filler panels for 19" pedestal rack:
- 1 module width, gray paint finish 1.328.185.00
 - 2 module width, gray paint finish 1.328.186.00
 - 3 module width, gray paint finish 1.328.187.00
 - 5 module width, gray paint finish 1.328.189.00

1.4.5 Remote displays	Order No.		
Remote counter			
<ul style="list-style-type: none"> ■ Serial remote counter RS232 with 5-digit display, counter reset and zero loc function for desk top use or installation into mounting frame 1.328.275.31-33, with 15m connection cable. (H = 50,8 x W = 157 x D = 130mm) 	20.020.100.30		
<ul style="list-style-type: none"> ■ Remote counter display with 5-digit indication, for desk top use, or installation into mounting frame 1.328.330.31-33, without cables. Up to three remote counters may be connected onto one machine. (Requires machine interface option 20.807.947.00) 	1.328.330.00		
<ul style="list-style-type: none"> Connection cable, 15m long, for connecting remote counter display to machine directly D-type 15 pol/9 pol. 	1.328.333.81		
<ul style="list-style-type: none"> Connection cable, 15m long, for connecting an additional remote counter display to another one. D-type 9 pole. 	1.862.421.00		
TC remote counter			
<ul style="list-style-type: none"> ■ Serial TC display with additional TC valid and time code frame rate indicators for desk top use, complete with 15m connection cable. <u>This display suitable for A807 TC machines only.</u> (H = 50,8 x W = 157 x D = 130mm) 	21.328.285.00		
Mounting frames			
STUDER standard module dimension, 5 module width (190 x 202.9mm) with mounting position for installing of:			
	For	For	For
	1.328.330.00	21.328.285.00	20.020.100.30
<ul style="list-style-type: none"> ■ 1 remote counter 	1.328.330.31	1.328.285.31	1.328.275.31
<ul style="list-style-type: none"> ■ 2 remote counters 	1.328.330.32	1.328.285.32	1.328.275.32
<ul style="list-style-type: none"> ■ 3 remote counters 	1.328.330.33	1.328.285.33	1.328.275.33

1.4.6 Reel adapters	Order No.
<ul style="list-style-type: none"> ■ DIN hub 1/4", metallic 	10.200.003.01
<ul style="list-style-type: none"> ■ DIN adapter with tape reel flange, for 1/4" hub (11,8") 	1.013.047.81
<ul style="list-style-type: none"> ■ NAB adapter, standard, for 1/4" Reel 	89.01.0354
<ul style="list-style-type: none"> ■ NAB adapter, professional, with aluminium hand piece, for 1/4" reel 	1.013.332.00
<ul style="list-style-type: none"> ■ NAB-AEG open reel adapter 	1.013.257.00
<ul style="list-style-type: none"> ■ NAB metal reel, empty, 1/4" (10.5") 	10.213.001.01
<ul style="list-style-type: none"> ■ NAB metal reel, empty, 1/2" (10.5") 	10.213.001.04

1.4.7 Service utensils		Order No.
STUDER tape splicing kit 1/4"	Comprising a cutting and editing block, one antimagnetic cutting blade, splicing tabs, and a grease pen for marking the tape.	10.030.452.40
STUDER cleaning kit in carrying case	<ul style="list-style-type: none"> ■ Contains 1 bottle of head cleaner, 1 bottle of aluminite cleaner, lint-free non woven fleece squares, and a piece of buckskin. 	10.496.010.00
Head cleaner:	<ul style="list-style-type: none"> ■ Replacement bottle ■ 1 litre 	10.496.021.00 10.496.022.00
Aluminite cleaner:	<ul style="list-style-type: none"> ■ Replacement bottle ■ 1 litre 	10.496.025.00 10.496.026.00
Service tools:	<ul style="list-style-type: none"> ■ Tool case (basic kit) with soldering iron and demagnetizing choke for 110V. ■ Tool case (basic kit) with soldering iron and demagnetizing choke for 220V. ■ Supplementary tool kit for A807 tape recorder, including extension cord for the capstan motor (1.727.216.00) and the spooling motors (1.727.217.00) ■ Extension cable for capstan motor control PCB ■ Extension cable for spooling motor control PCB 	20.020.001.20 20.020.001.21 20.020.001.38 1.727.216.00 1.727.217.00

1.4.8 Accessories		Order No.
Wooden side panels	<ul style="list-style-type: none"> ■ Wooden side panels with recessed carrying grips. 	1.727.069.00
Transport cover	<ul style="list-style-type: none"> ■ Transport cover, also offers space for two tape reels and the connection cables. (Wooden side panels 1.727.069.00 are required). 	1.727.074.81
Carrying case	<ul style="list-style-type: none"> ■ Made of aluminum, extremely sturdy, requires rack mounting kit (1.727.071.00). The tape recorder can be operated directly when the lid is opened. 	10.386.001.01
Rack mounting kit	<ul style="list-style-type: none"> ■ Contains two mounting brackets and mounting accessories for installing an A807 into a 19" rack. This kit is not required for STUDER consoles. 	1.727.071.00
Dust covers	<ul style="list-style-type: none"> ■ Dust cover plastic for machines in economy studio console without overbridge ■ Dust cover plastic for machines in economy studio console with overbridge ■ Dust cover plastic for table top machine in vertical operating position (with wooden side panels) ■ Dust cover plastic for table top machine in horizontal operating position (with wooden side panels) 	<p>10.578.807.02</p> <p>10.578.807.03</p> <p>10.578.807.04</p> <p>10.578.807.05</p>

1.5 Technical data

1.5.1 Technical data 1/4"

Spooling motors:	Two direct driving external-rotor AC asynchronous motors with active 3-phase control, controlled frequency correction, and switched motor output stages.	
Capstan motor:	Brushless DC motor with hall element commutation.	
Tape deck control:	Via microprocessor, for all functions and function transitions.	
Tape counter:	5-Position LED indication in hours, minutes, and seconds at all tape speeds, from zero in reverse direction with negative sign, decrementing. Range:	-9h 59min 59s ... 29h 59min 59s
Starting time:	At 15ips tape speed, 1000m tape with DIN hub or 762m (2500ft) tape with NAB reel (for reaching 200% of the specified wow-and-flutter rating)	approx. 0.8s
Winding time:	for 760m tape for 1000m tape	< 90s < 120s
Braking time:	from winding speed	approx. 3s
Winding at reduced speed:	LIBRARY WIND mode	approx. 5m/s
Tape reels:	Max. reel diameter Min. hub diameter, left Min. hub diameter, right Reel adapter	11,5" / 300mm 1.8" / 45mm 2.4" / 60mm NAB/DIN, Ciné, 3-prong
	The maximum pancake capacity with professional magnetic tape (thickness 50µm) is	3280ft (1000m)
Tape width:		1/4" / 6.3mm
Tape speeds:	Switch selectable Standard version:	38.1, 19.05, 9.525cm/s 15, 7.5, 3.75ips
	High speed version:	76.2, 38.1, 19.05cm/s 30, 15, 7.5ips
Tape speed deviation:		max. ±0.2%

Varispeed:	Variable tape speed in semitones (ST).	3.75ips +7...-1.5 ST 7.5ips +7...-7 ST 15ips +7...-7 ST 30ips +7...-7 ST
Wow and flutter:	Peak value weighted, according to DIN 45507 or IEC publ. 386. Ambient air temperature 0...+40°C, Nominal tape speeds.	3.75ips: ±0.10% 7.5ips: ±0.07% 15ips: ±0.05% 30ips: ±0.05%
Tape slip:		Max. 0.1%
Tape tension:	Controlled in all tape transport functions, measured with spring dynamometer; in record and play mode. Factory setting based on horizontal operating position. Nominal: (70 p) Adjustable:	0.7N 0.5...1.8N
Line inputs:	Via transformer, Input impedance: Connector:	balanced, floating 30Hz ... 20kHz ≥7,5kΩ XLR, IEC 268-12
Input levels:	<ul style="list-style-type: none"> ■ NAB: For operating level (0VU) Internally adjustable ■ CCIR: For peak level (0VU +6dB) Internally adjustable ■ UNCAL: (for versions with VU meters and input /output level potentiometers). Max. increase of the input sensitivity Max. admissible input level Internal adjustment range of the working magnetic flux with the above input levels: 	+4dBu -30 ... +12dBu +6dBu -24 ... +18dBu 10dB +24dBu 100 ... 1000nWb/m
Microphone inputs:	Via transformer, Input impedance:	balanced, floating >1.2kΩ
Input level:	Without attenuator (max. -26dBu): With attenuator (max. 2.6dBu/1kHz; 0dBu/40Hz)	-82dBu -54dBu
Noise factor:	Rq = 200Ω	<5dB
Phantom power:	(Convertible to +12V)	+48V
Output meters:	VU versions: LED peak program meter:	VU-meter 0VU +6 / +9 / +12dB
Line outputs:	Via transformer, Source impedance: (1kHz) Connector:	balanced, floating <50Ω XLR, IEC 268-12

- Output level:**
- **NAB**
For operating level (0VU, into 600Ω load) +4dBu
Internally adjustable -17 ... +12dBu
 - **CCIR:**
For peak level (0VU +6dB) into 600Ω load +6dBu
Internally adjustable -11 ... +18dB
 - **UNCAL:** (for versions with VU meters and input/output level potentiometers).
Max. increase of the reproduce gain 10dB
Max. output level into 600Ω load +24dBu
into 200Ω load +22dBu

Internal adjustment range of the reproduce gain for working magnetic flux of 100 ... 1000nWb/m

Headphones output: Short-circuit-proof, $R_L > 600\Omega / R_i = 220\Omega$; max. 5.0V

Monitor speaker: Output of power amp. max. 0.7W

Equalizations: Switch-selectable NAB/CCIR/AES

Equalization time constants:

	3.75ips	7.5ips	15ips	30ips
NAB	90/3180μs	50/3180μs	50/3180μs	17,5/∞μs (AES)
CCIR	90/3180μs	70/∞μs	35/∞μs	17,5/∞μs (AES)

Frequency response, record/reproduce mode:

	3.75ips	7.5ips	15ips	30ips
±2dB	30Hz...12kHz	30Hz...16kHz	30Hz...20kHz	40Hz...22kHz
±1dB	30Hz...8kHz	30Hz...12kHz	50Hz...18kHz	60Hz...20kHz

Frequency response, sync track reproduction :

	3.75ips	7.5ips	15ips	30ips
±2dB	40Hz...5kHz	40Hz...10kHz	40Hz...12kHz	50Hz...12kHz

**Signal-to-noise ratio
record/reproduce mode:**

CCIR: Equalization according to CCIR, measured with tape type AGFA PER528, BASF LGR50 or equivalent tape.

■ Full track, 6.3mm track width:

	3.75ips	7.5ips	15ips	30ips
nWb/m	250	320	320	320
Unweighted according to CCIR468-II	57dB	61dB	62dB	64dB
Weighted according to CCIR468-II	48dB	51dB	52dB	54dB
Weighted according to ASA-A (IEC179)	62dB	64dB	65dB	67dB

■ Stereo 2.75mm track width:

	3.75ips	7.5ips	15ips	30ips
nWb/m	400	510	510	510
Unweighted according to CCIR468-II	57dB	61dB	62dB	64dB
Weighted according to CCIR468-II	48dB	51dB	53dB	54dB
Weighted according to ASA-A (IEC179)	62dB	65dB	66dB	68dB

■ 2-Track, 2mm track width:

	3.75ips	7.5ips	15ips	30ips
nWb/m	400	510	510	510
Unweighted according to CCIR468-II	56dB	60dB	61dB	63dB
Weighted according to CCIR468-II	47dB	50dB	52dB	53dB
Weighted according to ASA-A(IEC179)	61dB	64dB	65dB	67dB

NAB: Equalization according to NAB, measured with magnetic tape SCOTCH 3M 226 or equivalent type.

- Full track, 6.3mm track width:

	3.75ips	7.5ips	15ips	30ips
nWb/m	510	1040	1040	1040
Linear, RMS, 30Hz...20kHz	62dB	73dB	71dB	74dB
RMS value, ASA-A weighted according to DIN 45633; IEC 179B	66dB	76dB	74dB	78dB

- Stereo, 2.75mm track width:

	3.75ips	7.5ips	15ips	30ips
nWb/m	510	1040	1040	1040
Linear, RMS, 30Hz...20kHz	58dB	69dB	67dB	70dB
RMS value, ASA-A weighted according to DIN 45633; IEC 179B	63dB	73dB	71dB	75dB

- 2-Track, 2mm track width:

	3.75ips	7.5ips	15ips	30ips
nWb/m	510	1040	1040	1040
Linear, RMS, 30Hz...20kHz	56dB	68dB	66dB	69dB
RMS value, ASA-A weighted according to DIN 45633; IEC 179B	61dB	72dB	70dB	74dB

Sync mode:

- All versions:
RMS value, ASA-A (IEC179 / DIN 45633):
Same values as measured with tape in Record - sync - play mode

Harmonic distortion

K3: (RL = 600Ω)

CCIR: Peak level, record/reproduce, measured with tape type 3M226.

3,75ips	/	315Hz	(400nWb/m)	1,5%
7,5ips	/	1kHz	(510nWb/m)	1,2%
15ips	/	1kHz	(510nWb/m)	1,0%
30ips	/	1kHz	(510nWb/m)	1,0%

NAB: Peak level, record/reproduce, measured with tape type 3M226.

3,75ips	/	315Hz	(400nWb/m)	1,0%
7,5ips	/	1kHz	(510nWb/m)	1,0%
15ips	/	1kHz	(510nWb/m)	1,0%
30ips	/	1kHz	(510nWb/m)	1,0%

Channel separation:	According to DIN 45521, at 15ips / 1kHz	≥55dB
Erase efficiency:	With 2-track erase head, at 15ips / 1kHz With full track erase head, at 15ips / 1kHz	≥75dB ≥78dB
Erase and bias frequency:	At all tape speeds	153.60kHz
Power requirements:	Switch-selectable:	100/120/140/200/220/240V ±10% 50...60Hz
Power fuse:	100...140V 200...240V	3.15A / 250V slow 1.60A / 250V slow
Power consumption:	Idle Recording (2 CH) Fast forward/rewind Maximum connected load	approx. 70VA approx. 150VA approx. 180VA 300VA
Admissible power failure:	For retaining the operational state	max. 100ms
Parallel interface:	For controlling the tape transport functions, the variable tape speed (varispeed), and the fader start input.	25 pin D-type
Serial interface:	(RS232) for remote control of all functions.	9 pin D-type
Ambient temperature range:	Operation:	32...104°F (0...40°C)
Relative humidity:	Noncondensing	20...90%
Operating position:	From horizontal to vertical.	
Safety standards:	EN 60065 / 1993; IEC 65 / 1985	
EMC standards:	EN 50081-1 / 1992; EN 50082-1 / 1992	
<u>Betriebslage</u>	The technical data apply to any operating position between horizontal and vertical.	
Weight:	Chassis version approx.	30kg

We reserve the right to make changes as technical progress may warrant.

1.5.2 Technical data 1/4" Timecode

The time code channel corresponds to the IEC publication 461, DIN 45511, part 7.

Track width/track location:	In center of tape	0.38mm
Code format:	80-Bit address code (switch selectable 24/25/29.97/30 frames/second)	SMPTE/EBU
Tape speeds:	76,2cm/s 30ips 38,1cm/s 15ips 19,05cm/s 7,5ips 9,5cm/s 3,75ips	
Magnetic flux of the time code track:		729nWb/mpp ±3dB
Time code channel input:	With transformer balanced and floating Input impedance	≥ 10kΩ
Input level:	nominal: 2,0 Vpp* minimum: 0,25Vpp* maximum: 4,0 Vpp*	
Time code channel output:	With transformer Output impedance Output level: Load ≥200Ω	balanced and floating ≤40Ω 2Vpp*
Crosstalk from code channel to audio channel:	Relative to 510nWb/m tape flux of the audio track, for all components of the time code signal.	≥90dB
Time code delay unit:	(TIME CODE DELAY UNIT) Selectable time code delay for: Coincident time code and audio track recording or reproduction at 24/25/29.97/30 frames/sec	
Coincidence error:	at 38,1cm/s (15ips)	±4ms
Timecode display:	internal LED showing valid code	

* Vpp = peak-peak

1.5.3 Technical data 1/4" reproduce, CCIR

Frequency response,
reproduce:

	3.75ips	7.5ips	15ips
±1dB	30Hz...8kHz	30Hz...12kHz	50Hz...18kHz
±2dB	30Hz...12kHz	30Hz...16kHz	30Hz...20kHz

Signal-to-noise ratio
reproduce mode:

Equalization according to CCIR, measured with tape type AGFA PER 528.

- Full track, 6.3mm track width:

	3.75ips	7.5ips	15ips
nWb/m	250	320	320
Linear, RMS 30Hz - 20kHz	57dB	60dB	61dB
CCIR468-II (DIN 45405) quasi peak	47dB	50dB	52dB

- Stereo 2.75mm track width:

	3.75ips	7.5ips	15ips
nWb/m	400	510	510
Linear, RMS 30Hz - 20kHz	57dB	60dB	61dB
CCIR468-II (DIN 45405) quasi peak	48dB	51dB	53dB

- 2-Track, 2mm track width:

	3.75ips	7.5ips	15ips
nWb/m	400	510	510
Linear, RMS 30Hz - 20kHz	56dB	59dB	61dB
CCIR468-II (DIN 45405) quasi peak	46dB	49dB	51dB

1.5.4 Technical data 4-track 1/2"

Tape speeds:	76,2cm/s 38,1cm/s 19,05cm/s	30ips 15ips 7.5ips	
Tape speed deviation:			max. ±0,2%
Tape width:			1/2" (12,6mm)
Track width:			4 x 0,069 inch (4 x 1,75mm)
Wow and flutter:	Peak value weighted, according to DIN 45507 or IEC		
	30ips 15ips 7.5ips	max. 0,05% max. 0,05% max. 0,07%	
Winding time:			< 90s
Braking time:	from winding speed		app. 3s
Tape tension:	nominal		110gr.
Tape reels	NAB-reel diameter		265mm
Equilization	NAB/CCIR switchable		

Equilization time constants:

	7.5ips	15ips	30ips
NAB	50/3180µs	50/3180µs	17,5/∞µs
CCIR	70/∞µs	35/∞µs	17,5/∞µs

Frequency response, record/reproduce:

	7.5ips	15ips	30ips
±1dB	30Hz...12kHz	50Hz...18kHz	100Hz...20kHz
±3dB	30Hz...16kHz	30Hz...20kHz	40Hz...22kHz

Frequency, response sync track reproduction:

	7.5ips	15ips	30ips
±2dB	40Hz...8kHz	40Hz...12kHz	60Hz...12kHz

CCIR

Signal to-noise ratio
record/reproduce mode:

Equalization relative to 510nWb/m magnetic tape AGFA PEM 469

	7.5ips	15ips	30ips
Linear, RMS 30Hz - 20kHz	58dB	60dB	62dB
CCIR468-II (DIN 45405) quasi peak	48dB	51dB	53dB
RMS value, ASA-A weighted according to IEC-publ. 179 (DIN 45633)	63dB	65dB	67dB

Signal to-noise ratio
record/sync mode:

Equalization relative to 510nWb/m magnetic tape AGFA PEM 469

	7.5ips	15ips	30ips
RMS value, ASA-A weighted according to IEC-publ. 179 (DIN 45633)	63dB	65dB	67dB

NAB

Signal to-noise ratio
record/reproduce mode:

Equalization relative to 510nWb/m magnetic tape Scotch-3M 226

	7.5ips	15ips	30ips
Linear, RMS 30Hz - 20kHz	61dB	59dB	62dB
RMS value, ASA-A weighted according to IEC-publ. 179 (DIN 45633)	66dB	64dB	67dB

**Signal to-noise ratio
record/sync mode:**

Equalization relative to 510nWb/m magnetic tape Scotch-3M 226

	7.5ips	15ips	30ips
RMS value, ASA-A weighted according to IEC-publ. 179 (DIN 45633)	65dB	63dB	67dB

NAB and CCIR

**Harmonic distortion
record/reproduce mode:**

1kHz, 510nWb/m

	7.5ips	15ips	30ips
max.:	1,0%	1,0%	1,0%

Channel separation:

According to DIN 45521, 1kHz

≥55dB

Erase efficiency:

1kHz, 510nWb/m 38cm/s (15ips)

≥75dB

Power requirements:

(at nominal voltage):

Idle approx.:	100VA
Recording approx.:	200VA
Spooling approx.:	220VA
Max. power consumption:	360VA

Admissible power failure:

- For retaining the operational state max. 100ms.

1.5.5 Dimensions A807 MKII 1/4" (in mm)

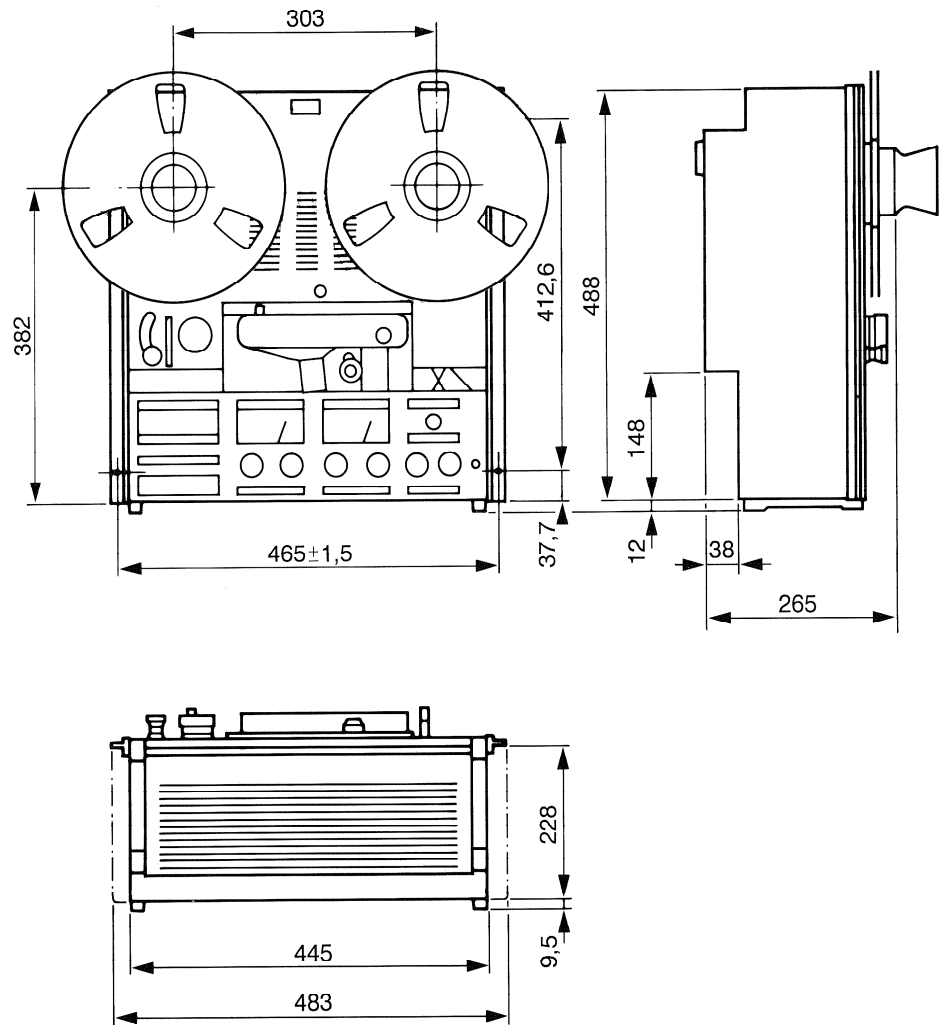

Dimensions A807 MKII 1/4" (in mm)

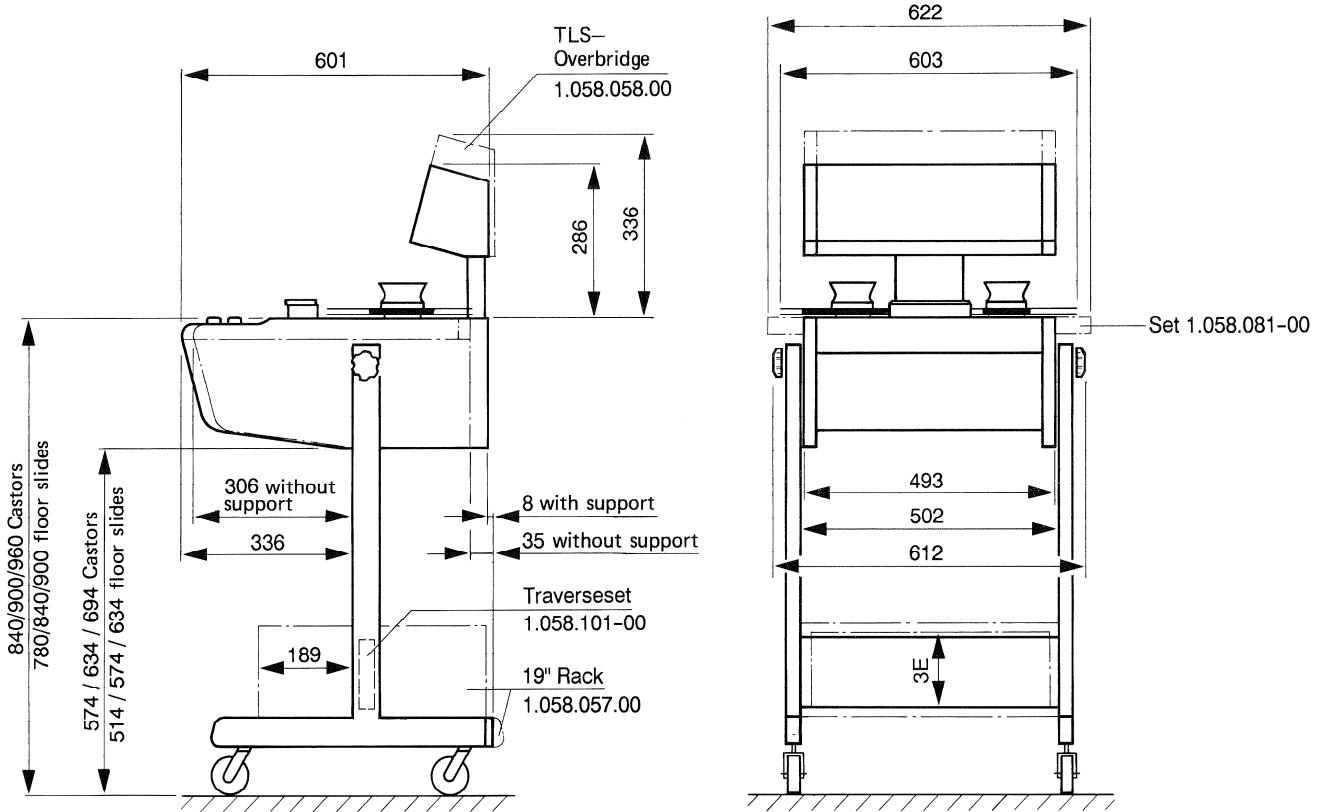

1.5.6 Dimensions A807 MKII 1/2" (in mm)

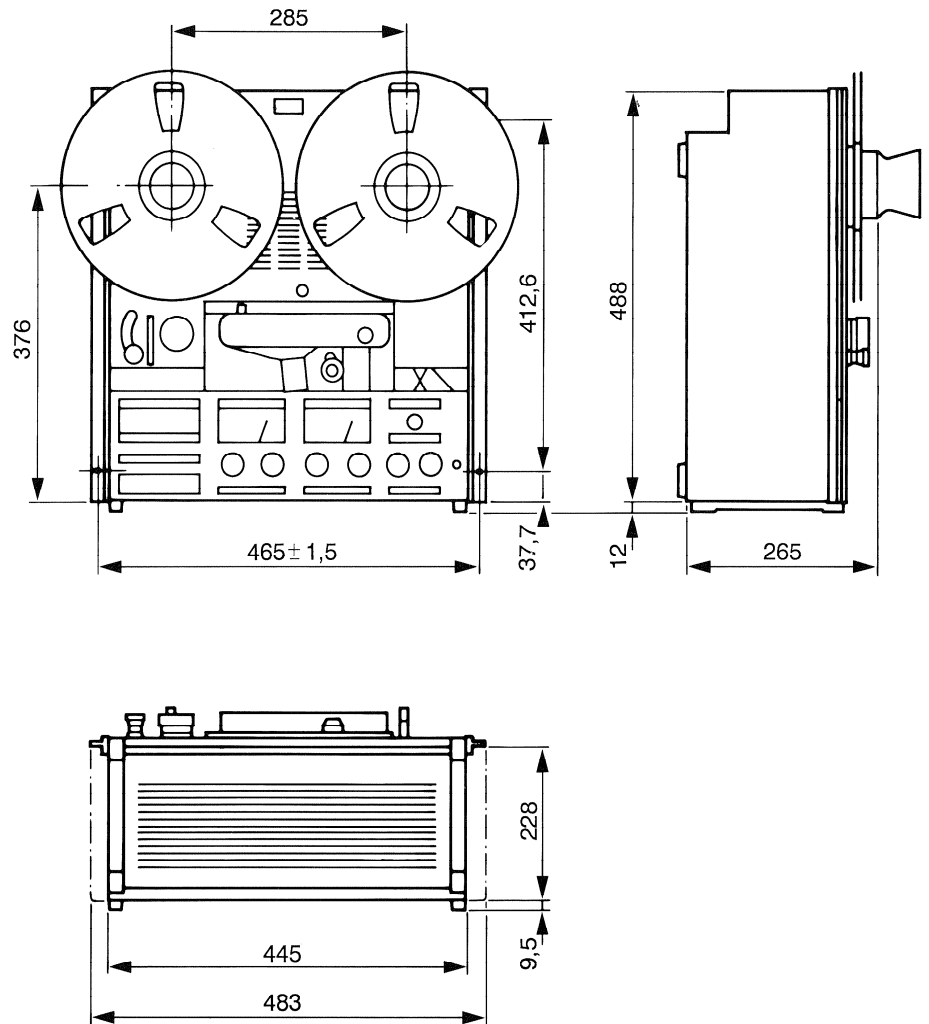

Dimensions A807 MKII 1/2" (in mm)

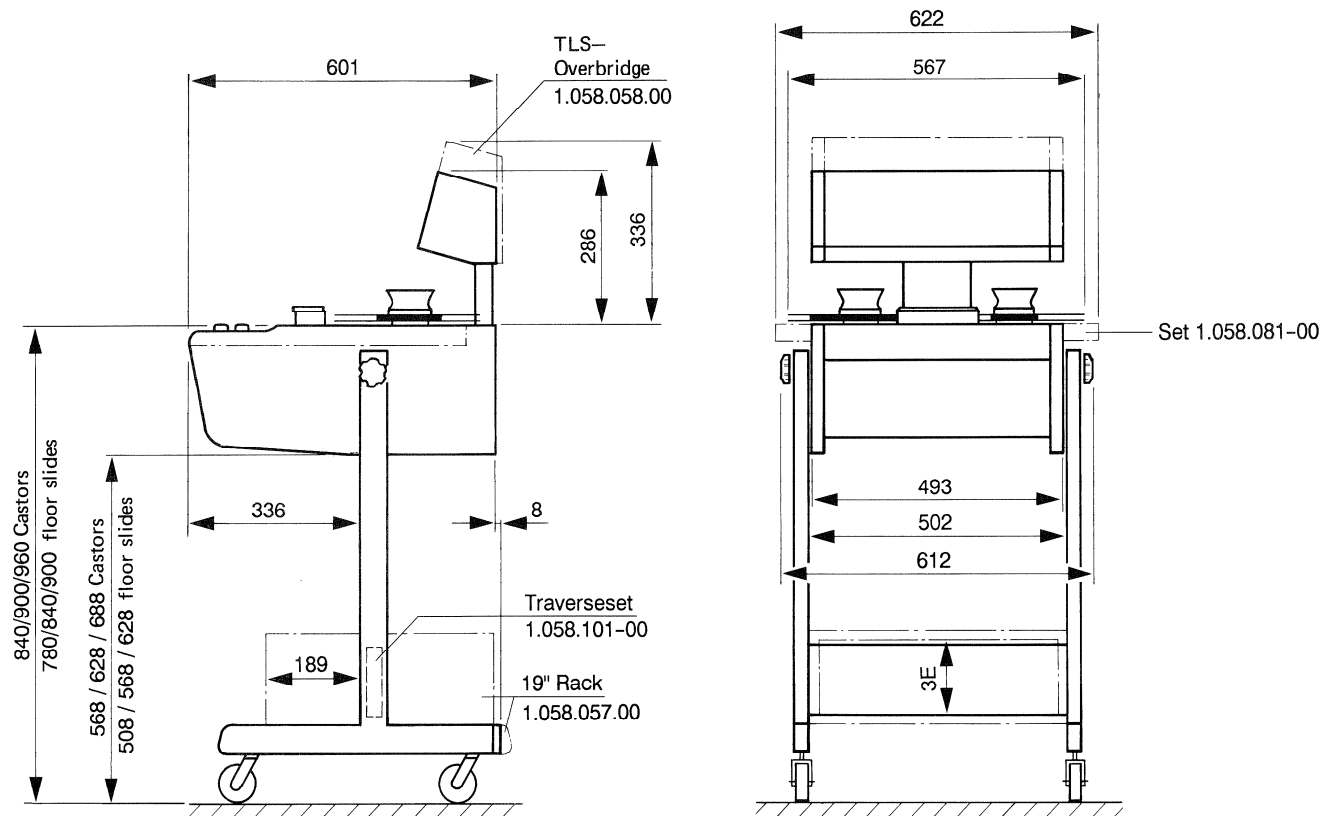

Packing:

Tape recorder with VU meter panel:
 Box: 82 x 84 x 120/126/132 cm (depending on console height).

Tape recorder without VU meter panel:
 Box: 82 x 84 x 93/99/105 cm (depending on console height).

Gross weight:

Depending on configuration: 73...119kg.

1.6 Instructions for service personal

1.6.1 Abbreviations

A	Assenbly
ANT	Antenna
B	Bulb
BA	Battery, rechargeable battery
BR	Optocoupler (bulb --> LDR)
C	Capacitor
D	Diode, DIAC
DL	LED
DLQ	Optocoupler (LED --> phototransistor)
DLR	Optocoupler (LED --> LDR)
DLZ	LED-array, 7-segment-display
DP	Photodiode
DZ	Rectifier
E	Electronic component
EF	Headphones
F	Fuse
FL	Filter
H	Head (audio, erase)
HC	Hybrid-circuit (thick-/thin-film)
HE	Hall-element
IC	Integrated circuit
J	Socket (female)
JS	Jumper
K	Relay, contactor
L	Inductor
LS	Loudspeaker
M	Motor
ME	Meter
MIC	Microphone
MP	Mechanical part
P	Connector (male)
PU	Phone cartridge
Q	Transistor, FET, Thyristor, TRIAC
QP	Phototransistor
QPZ	Phototransistor-array
R	Resistor
RP	Light-sensitive resistor, LDR
RT	Temperature-dependent resistor
RZ	Resistor network
S	Switch
T	Transformer
TL	Delay line
TP	Test point, test socket
W	Wire, standard wire
X	Base, holder
XB	Lamp base
XF	Fuse holder
XIC	IC-socket
Y	Crystal, piezo element
Z	Network, array

1.6.2 Powers of ten

Designation	Abbreviation	Value
Tera-	T	10^{12}
Giga-	G	10^9
Mega-	M	10^6
Kilo-	k	10^3
Milli-	m	10^{-3}
Mikro-	μ	10^{-6}
Nano-	n ($m\mu$)	10^{-9}
Pico-	p ($\mu\mu$)	10^{-12}
Femto-	f	10^{-15}

() = Abbreviation commonly used in the USA

1.6.3 Letters and color codes

Resistors:

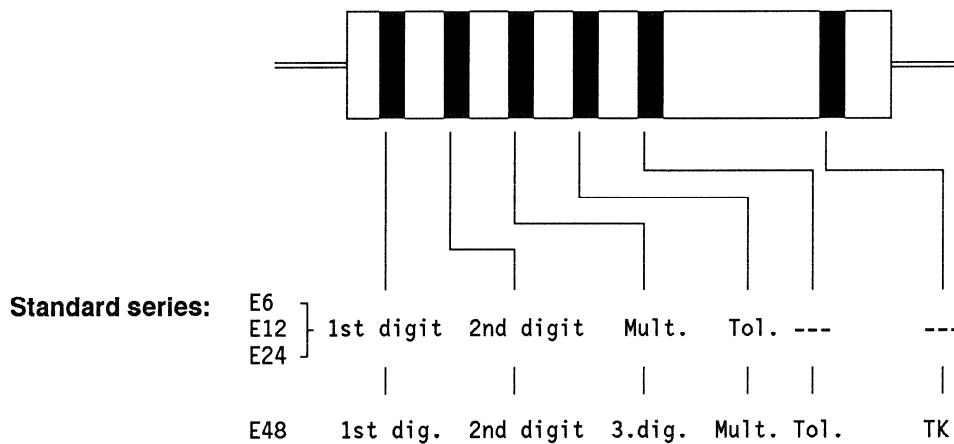

Color	Digit	Multiplier	Tolerance	TK
silver	-	0,01	10,0%	-
gold	-	0,1	5,0%	-
black	0	1	-	-
brown	1	10	1,0%	$100 \times 10^{-6}/K$
red	2	100	2,0%	$50 \times 10^{-6}/K$
orange	3	1k	-	$15 \times 10^{-6}/K$
yellow	4	10k	-	$25 \times 10^{-6}/K$
green	5	100k	0,5%	-
blue	6	1M	0,25%	-
violet	7	10M	0,1%	-
grey	8	-	-	-
white	9	-	-	-

No TK-designation = $50 \times 10^{-6}/K$
 Only 1 black ring = 0Ω (jumper)

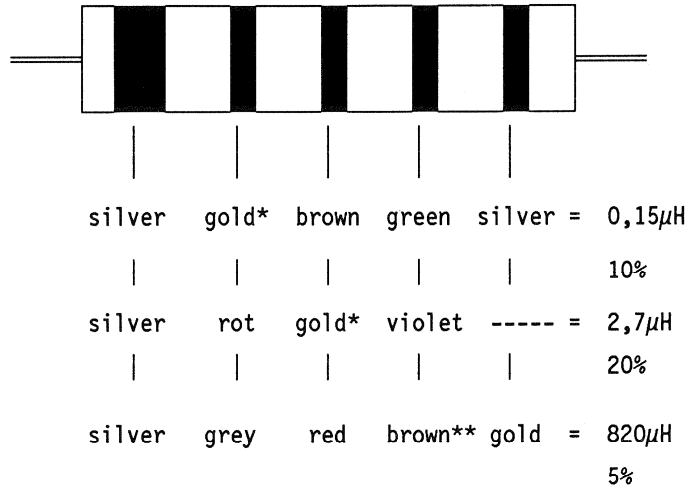
Examples:

* Decimal point

** Multiplier

Inductors and transformers on ferrite cores:

Inductors and transformers on ferrite cores are marked with three colored dots (color coding same as in the two left-hand columns of the Section "Resistors"). These dots designate the last three digits of the STUDER standard number. The large dot marks the start. The first digits of the standard number (1.022.--- are always the same.)

Example:

- Driver transformer, 150kHz.
- Standard number: 1.022.211
- Color code: red (large dot), brown, brown

Terminal 1 of the winding form is usually identified with a lobe; if not, the winding form is marked with a yellow dot near terminal 1.

Capacitors:

Frequently, the tolerance is specified by a letter behind the printed capacitance rating:

D	= 0,5%
F	=1%
G	=2%
J	=5%
K	=10%
M	=20%

Molded RF coils:

For identifying molded RF coils, a wide silver ring and four narrow rings of different colors are used. The wide silver ring marks the start of the counting direction. The second, third, and fourth ring specify the inductance in Microhenry (μH). The second and the third ring designate the numeric value and the fourth ring is either a multiplier, or if its color is gold, the decimal point. The fifth ring designates the tolerance in percent (\pm).

Color	Digit	Multiplier	Tolerance
gold	-	-	5%
silver	-	-	10%
black	0	1	-
brown	1	10	1%
red	2	100	2%
orange	3	10 ³	-
yellow	4	10 ⁴	-
green	5	10 ⁵	0,5%
blue	6	10 ⁶	-
violet	7	10 ⁷	-
grey	8	10 ⁸	-
white	9	10 ⁹	-
without	-	-	20%

2 Start up procedure, operating

2.1	Unpacking and Checking	1
2.2	Installation Site and Setup	1
2.2.1	Assembling the console	1
2.3	Connectors 1/4" version.....	3
	Connectors 1/2"-channel version.....	4
2.3.1	Power connection, voltage selector	5
2.3.2	Audio inputs and outputs.....	6
2.3.3	Remote control connectors.....	6
2.3.4	Headphones socket.....	15
2.4	Operating instructions	16
2.4.1	Controls	16
2.4.2	Power switch [1].....	30
2.4.3	Indications at power on time	30
2.4.4	Inserting the tape	31
2.4.5	Tape speed [50].....	33
2.4.6	Play mode [33]	33
2.4.7	Reverse play mode	33
2.4.8	Varispeed control [52]	34
2.4.9	Record mode REC [35]	34
2.4.10	SYNC reproduction SYNC [38].....	35
2.4.11	Spooling mode < > [31/32]	36
2.4.12	Producing pancakes at reduced spooling speeds	36
2.4.13	Stop mode STOP [34]	36
2.4.14	Locator Z-LOC, LOC1 (LOC2, LOC3, LOC START) [24-27]	37
2.4.15	Programmable functions	38
2.4.16	Fader start	40
2.4.17	Tape timer [22].....	41
2.4.18	Auxiliary timer LAP [20]	42
2.4.19	MONO/INSERT [55] (not available by 4-channel versions)	43
2.4.20	Remote control.....	44
2.4.21	External VU-meter panel.....	44
2.4.22	External stereo monitor panel.....	44
2.4.23	Test generator (option) (only for 2-channel versions)	45
2.4.24	Editing, cutting the tape	46
2.4.25	"Waste basket mode" TAPE DUMP [30].....	47
2.5	Programming.....	50
2.5.1	Hardware jumpers 1/4" and 1/2" versions.....	50
2.5.2	Soft jumpers (for all versions)	54
2.5.3	Programming the audio parameters	59
2.6	Serial interface RS232.....	61
2.6.1	RS 232 Standard interface	61
2.6.2	RS 232 Interface of the A807	62
2.6.3	Working with the serial interface RS 232.....	63
2.7	Care Instructions.....	69

2.1 Unpacking and Checking

The A807 tape recorder is shipped in a special packing that protects the machine from damage in transit. Care should be exercised when unpacking the machine so that its surfaces do not become marred. Check that the material is complete by comparing the packing content with the shipping list.

Save the original packing material

because it provides the best protection in case your tape recorder needs to be transported again. Check all items for possible damage in transit. If you discover any damage, immediately notify the forwarding agent as well as the nearest STUDER dealer.

2.2 Installation Site and Setup

The A807 should be installed in a dust-free and an adequately ventilated environment. The performance data of the tape recorder are guaranteed for an ambient temperature range of 0°C to +40°C with a relative humidity of 20% to 90% (noncondensing).

Install the tape recorder in such a way that sufficient space is available all around the machine for unobstructed cooling. Particularly in recessed locations there is a possibility of heat accumulation. When the machine is in operation, the air circulation zone should neither be misused as a storage area nor be obstructed with manuals etc.

The tape recorder must not be installed in the vicinity of strong electromagnetic fields. General sources of interference are: strong load fluctuations on adjacent power circuits, high-power transformers, elevator motors, electrical welding plants, as well as nearby radio and television transmitters.

2.2.1 Assembling the console

The console is shipped in disassembled condition.

First screw the console legs [3] to the traverse [4] or to the rack base [5] by means of the four yellow galvanized M6x14mm [1] and M6x16mm screws [2] respectively and the serrated washers, and close the lead-through holes with the four plastic caps.

Subsequently insert the casters [6] into the holes of the console legs [3]. The two lockable casters fit into the tapered, longer legs on the front. The height of the casters can be adjusted with the headless screws [7] in the legs, directly above the casters. Remove any rack-mount brackets or side panels that may still be present. The feet and the two upper screws located underneath on the front of the equipment should also be removed.

Install the handrest [8] with the four M4x10mm screws [9] on the front of the equipment. (The upper two screws are to be installed with lock washers).

CONSOLE WITH OVERBRIDGE 1/4"

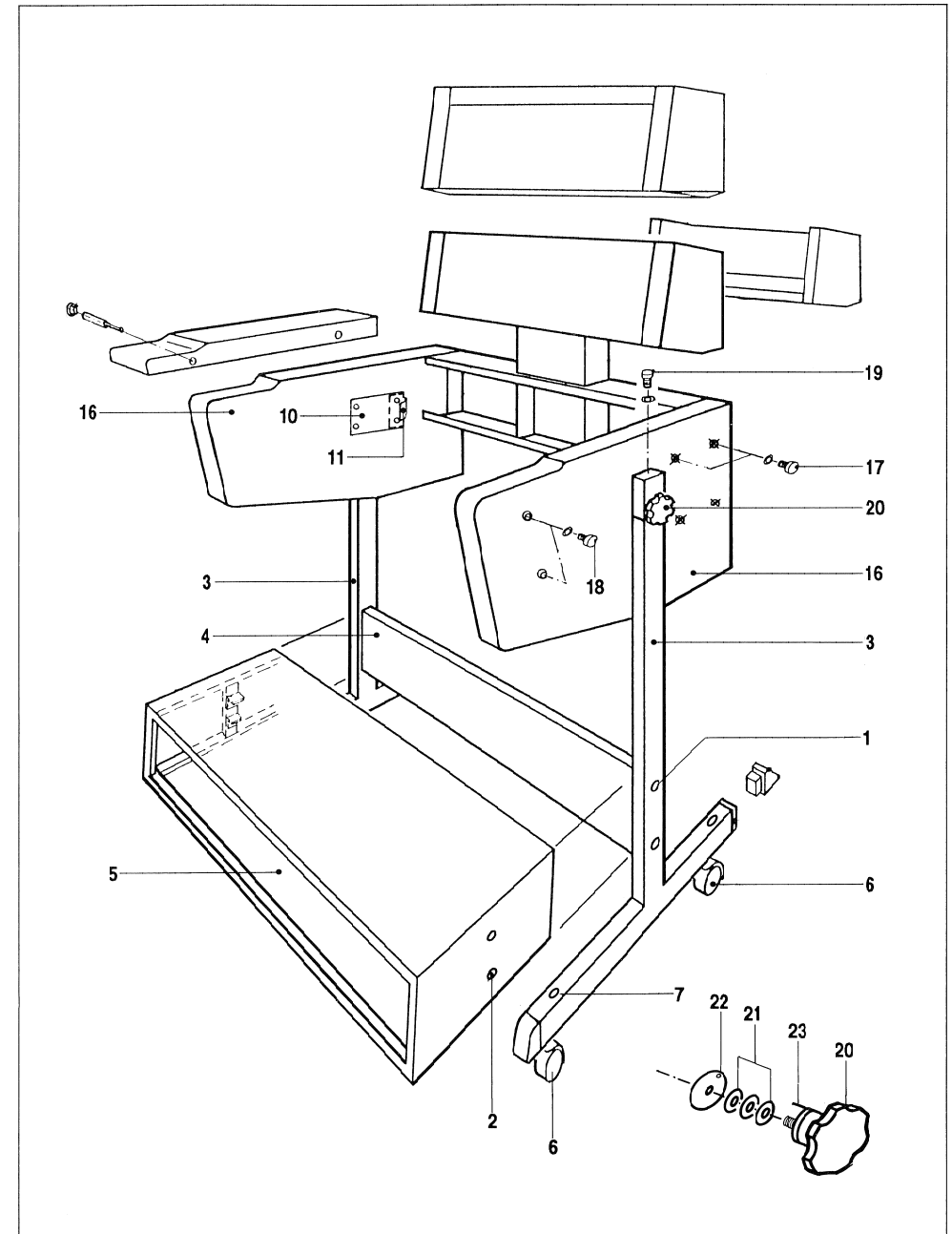

Console without rack base and penthouse:

Fasten each wooden side panels to the machine with 4 burnished M5x30mm screws and washers.

Console with rack base

Remove the two rear fixing screws of the pivot pin flange [10] in the wooden side panels and loosen the two front screws by 2 - 3 turns. Slide the perforated part of the U-shaped contact tab [11] between the wooden side panel and the rear section of the pivot pin flange. Reinsert the countersunk-head screws and tighten all four screws. In case no penthouse has to be installed, fasten each wooden side panel to the machine with 4 burnished M5x30mm screws and lock washers, otherwise proceed directly to the installation instruction: console with penthouse.

Console with penthouse

Fasten each of the L-shaped connection plates [12] with two M5 bolts [13] on the rear of the machine sides. Screw the penthouse traverse [14] with the remaining four M5 bolts [15] to the connection plates [12]. Fasten each wooden side panel [16] with 4 burnished M5x18mm [17] and 2 M5x30mm screws [18] and washers to the machine.

Set the machine on the console frame and fasten it on both sides with 2 M5 x 50mm screws [19]. If the operating position of the machine needs to be changed frequently, the two hexagon-socket-head screws can be replaced by the bypacked starwheels [20]. When installing these wheels make sure that the disc springs [21] and the pressure discs [22] are reinstalled in their original sequence.

Important The locking pin [23] must engage in the hole of the pressure disc [22]!

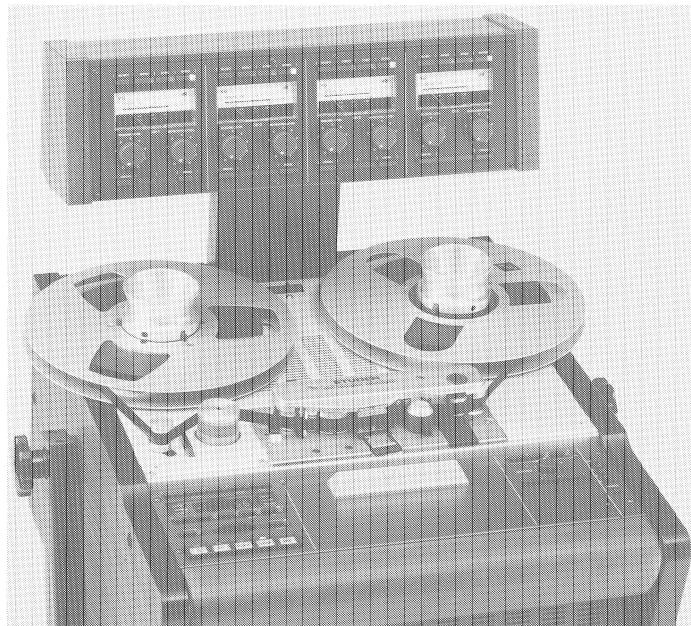

A807 MKII 1/2" with 4 canal panel

HAND REST AND OVERBRIDGE SUPPORT

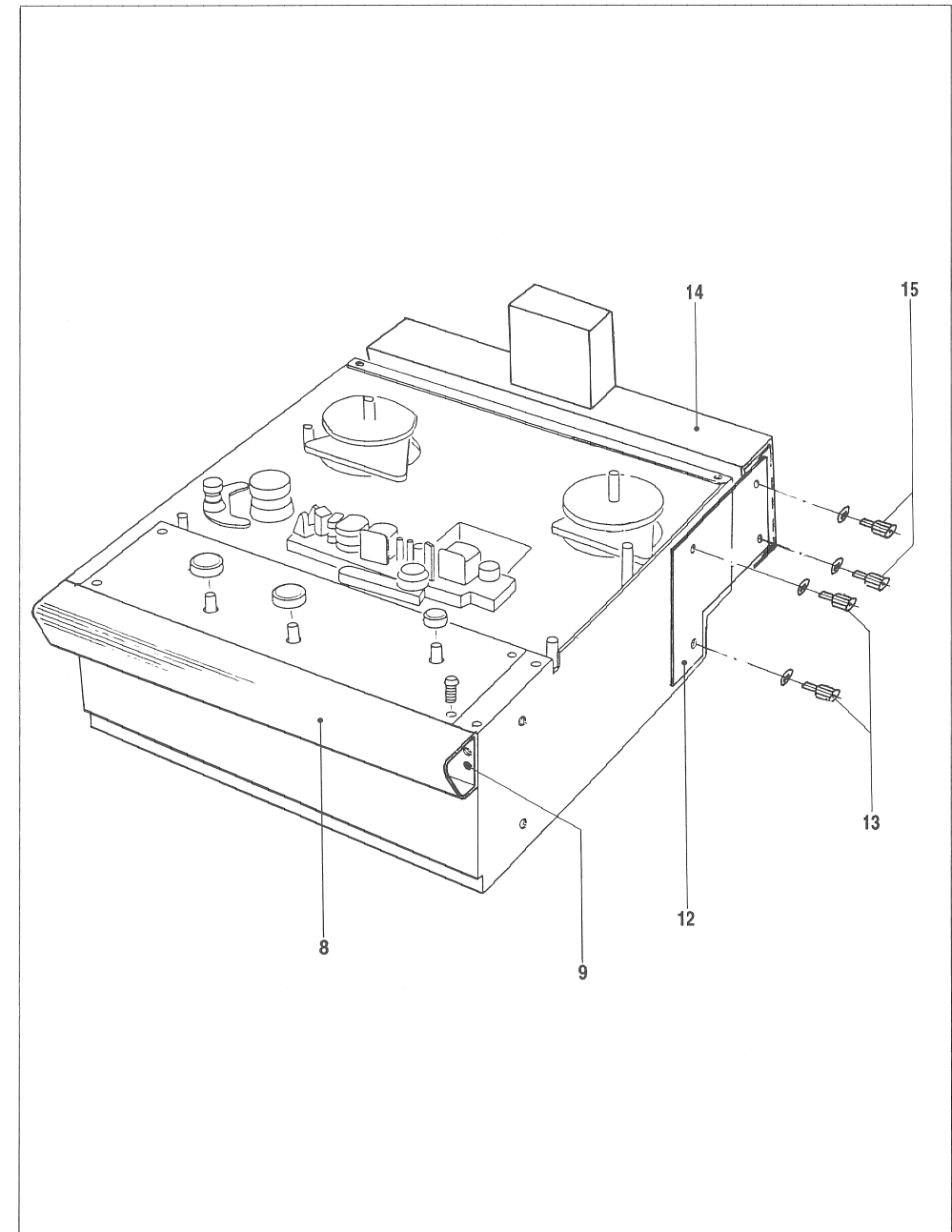

2.3 Connectors 1/4" version

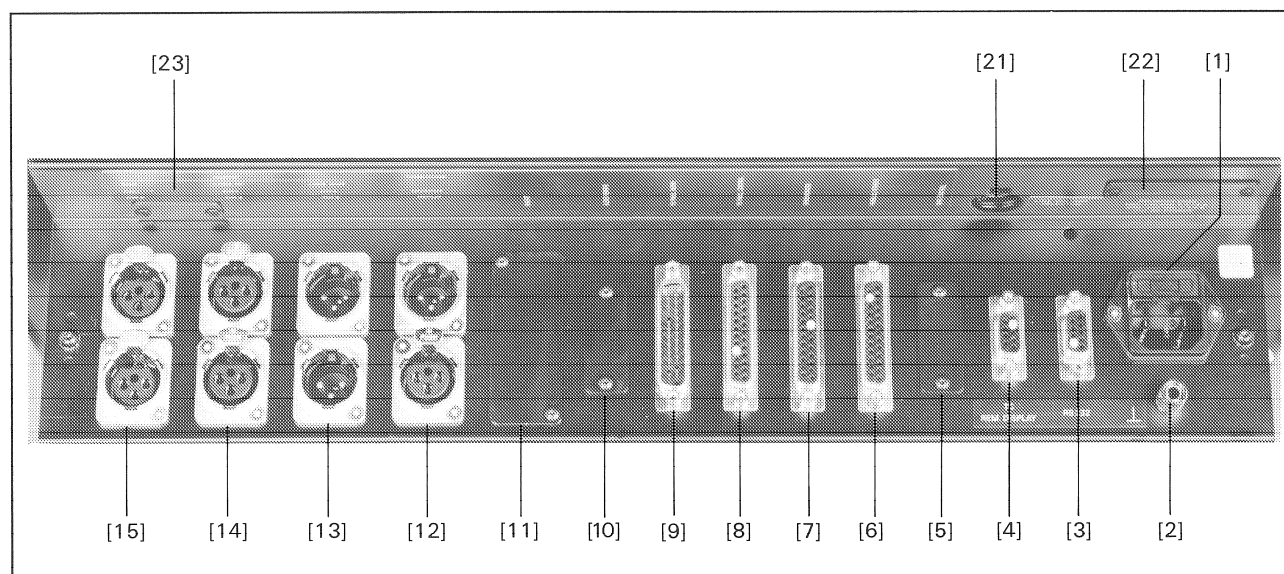

Fig 2.3.1

[1] AC POWER	Power inlet with primary fuse
[2]	Ground socket
[3] RS 232	Serial interface
[4] TC REM. DISPLAY	Connector for timecode remote display
[5] NRS CONTROL	Connector for the control of a noise reduction system
[6] PARALLEL REMOTE	Connector for parallel remote control
[7] SYNCHRONIZER	Connector for optional synchronizer (standard by TC versions, otherwise option)
[8] VU PANEL CONTROL	Connector for instrument panel (only VUK versions)
[9] VU PANEL AUDIO	Connector for instrument panel (only VUK versions)
[10] AUDIO REMOTE	Connector for the audio channel remote control functions
[11] INSERT	Connector for the insert points of external units (filter) in the record- and/or reproduce path of the A807. or: symmetric AUX INPUT by versions with Stereo monitor panel.
[12] TC INPUT/OUTPUT	Timecode in/output
[13] LINE OUT. CH1/CH2	Output channel 1 + 2
[14] LINE IN CH1/CH2	Input channel 1 + 2

- | | |
|-----------------------|---|
| [15] MIC CH1/CH2 | Microfon input channel 1 + 2 |
| [21] LINE VOLTAGE | Power, voltage selector |
| [22] ELAPSE COUNTER | Time meter, working hour (option) |
| [23] PHANTOM POWERING | Switches the phantom power on and off.
Connectors 1/2" 4-channel version |

Connectors 1/2" 4-channel version

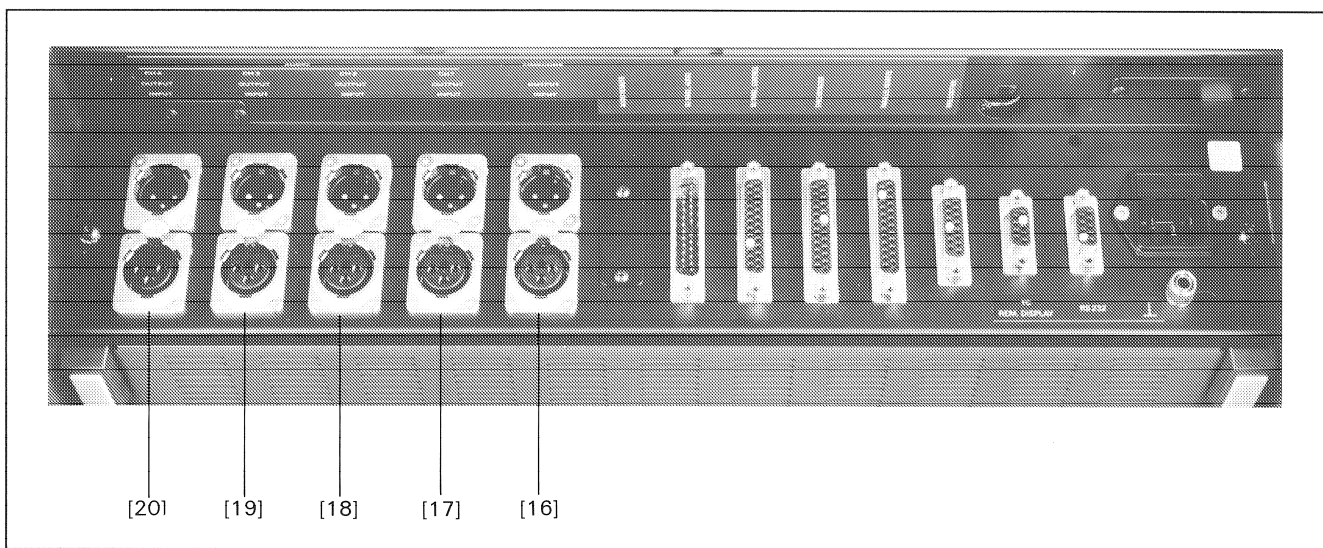

Fig. 2.3.2

- | | | |
|------------------|--------|---------------------------------------|
| [1]...[10] | | Same configuration with 1/4" version. |
| [16] TIMECODE | IN/OUT | Timecode in/output |
| [17] LINE IN/OUT | CH1 | Line in/output channel 1 |
| [18] LINE IN/OUT | CH2 | Line in/output channel 2 |
| [19] LINE IN/OUT | CH3 | Line in/output channel 3 |
| [20] LINE IN/OUT | CH4 | Line in/output channel 4 |

2.3.1 Power connection, voltage selector

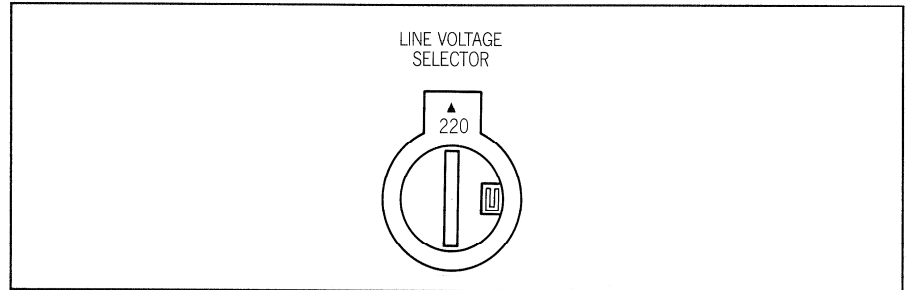

Fig. 2.3.3

Important: Before you connect the recorder to the AC power source for the first time, check that the setting of the line voltage selector (Fig. 2.3.3) agrees with your local line voltage.

The following voltage can be set:

100, 120, 140, 200, 220, 240 VAC, $\pm 10\%$; 50 to 60 Hz.

Disconnect the recorder from the AC outlet before you make any changes! Adjust the line voltage selector with a screwdriver so that the required voltage rating becomes visible through the cutout in the housing.

After the line voltage has been adjusted, the power fuse in the power inlet may possibly have to be replaced with a correctly rated fuse. Lift the cap with the aid of a screw driver. The upper of the two fuses is the spare fuse.

100 V - 140 V AC: T 3,15 A/250 V (SLOW)
200 V - 240 V AC: T 1,60 A/250 V (SLOW)

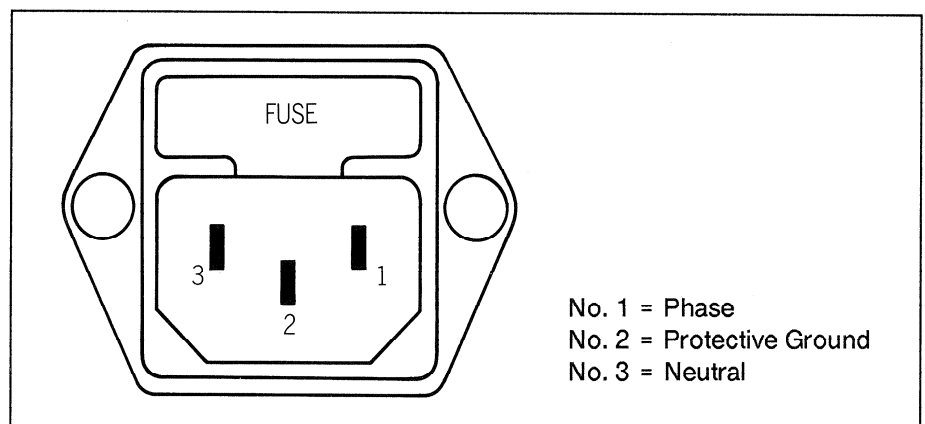

Fig. 2.3.4

2.3.2 Audio inputs and outputs

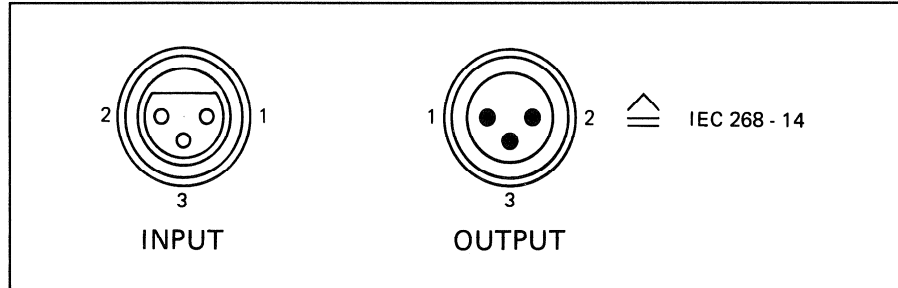

Fig. 2.3.5

The balanced inputs and outputs are terminated on XLR sockets or connectors (described in the IEC recommendation 268-14).

Pin 1 = AUDIO SHIELD
 Pin 2 = A-LINE (HOT)
 Pin 3 = B-LINE (COLD)*

This configuration refers to inputs and outputs of the line and TC signals as well as to the microphone inputs. The microphone phantom power (48V or optionally 12V) can be enabled or disabled with switch [23] (Fig. 2.3.1).

* In unbalanced operation the wiring "B" is necessary to change on 0 Volt socket.

2.3.3 Remote control connectors

RS 232

Connector for a serial RS 232 connection with a max. length of 10m.

Connector set: Part No. 20.020.303.40

Pin assignment of the RS 232 connector

PIN	SIGNAL NAME	COMMENT
01	---	
02	SN-DATA	DATA signal output from A807
03	---	
04	---	
05	+24V RMT	24V supply (max. 300mA)
06	KEY	
07	---	
08	RCV DATA	DATA signal input to A807
09	0.0V	Ground

TC Remote display

Connector for remote timecode data display

Connector set:	Part No. 20.020.303.20
----------------	------------------------

Pin assignment of the TC remote display connector

PIN	SIGNAL NAME	COMMENT
01	---	
02	TX-DSPLY	DATA for Timecode display
03	DSP-DTCT	CLOCK
04	KEY	
05	+24V RMT	+24V supply (max. 300mA)
06	---	
07	---	
08	---	
09	0.0V	Ground

NRS control

Connector for the control of an externally connected noise control system

Connector set:	Part No. 20.020.303.33
----------------	------------------------

Pin assignment of the NRS control connector

PIN	SIGNAL NAME	COMMENT
01	B-DBY-01 *	Control Signal for Dolby System CH 1
02	B-DBY-02 *	Control Signal for Dolby System CH 2
03	B-DBY-03 *	Control Signal for Dolby System CH 3
04	B-DBY-04 *	Control Signal for Dolby System CH 4
05	B-TLC-01 ▲	Control Signal for Telcom System CH 1
06	B-TLC-02 ▲	Control Signal for Telcom System CH 2
07	B-TLC-03 ▲	Control Signal for Telcom System CH 3
08	B-TLC-04 ▲	Control Signal for Telcom System CH 4
09	---	
10	---	
11	---	
12	KEY	
13	---	
14	+24V	+24V supply (max. 300mA)
15	0,0V	Ground

* Open collector output, aktiv LOW. No internal pull-up resistor.
Max. level 30V. max power 200mA.

▲ Open collector output, same up, still activ HIGH.

Parallel remote control connector

A parallel remote control with the following capabilities can be connected to this 25-pin connector (female, D-type):

- Remote control of the tape transport functions with feedback (<, >, PLAY, STOP, REC).
- RESET TIMER (resets the tape timer to 00.00.00).
- ZERO LOC (automatically searches the tape timer address 00.00.00).
- LOC START (automatically searches the tape address at which the last PLAY or RECORD command was entered).
- LIFTER (disables the tape lifter in spooling mode).
- FADER (enables the fader start circuit).
- VARISPEED (variable tape speed).

Connector set	Part No. 20.020.303.16
---------------	------------------------

Pin assignment of the PARALLEL REMOTE connector:

PIN	SIGNAL NAME	DESIGNATION
01	+0.0	Ground (GND, 0V)
02	BR-REW *	Status indicator lamp REWIND
03	BR-FORW *	Status indicator lamp FORWARD
04	BR-VRSPD *	Status indicator lamp VARISPEED (alternatingly LOW and HIGH when active)
05	SR-VRSPD ▲	Switch for VARISPEED command
06	SR-FADRY ▲	Switch for FADER START READY command
07	BR-LOCST *	Status indicator lamp LOC START
08	BR-FADRY *	Status indicator lamp FADER START READY
09	BR-REC *	Status indicator lamp RECORD
10	SR-RESET ▲	Switch for RESET TIMER command
11	FAD1	Input FADER START command, line A
12	FAD2	Input FADER START command, line B (FADER START is active when 5 to 24V DC or AC are available across pins 11 and 12).
13	IR-REFEX	Input for external capstan PLL reference (nominal: 9.6kHz, TTL level recommended; max. input voltage +10V).
14	SR-0LOC ▲	Switch for ZERO LOC command
15	BR-PLAY *	Status indicator lamp PLAY
16	BR-STOP *	Status indicator lamp STOP
17	SR-LIFT ▲	Switch for LIFTER command
18	SR-LOCST ▲	Switch for LOC START command
19	SR-REC ▲	Switch for RECORD command
20	SR-REW ▲	Switch for REWIND command
21	SR-FORW ▲	Switch for FORWARD command
22	SR-PLAY ▲	Switch for PLAY command
23	SR-STOP ▲	Switch for STOP command
24	KEY	Connector coding
25	+24 VRMT	+24V supply (max. 300mA)

- * Open collector output, active LOW. No internal pull-up resistor. Maximum HIGH level +30V, maximum current 200mA (built-in current limiting resistor 22Ω).
- ▲ Switch input. LOW level activates the command. Internal pull-up resistor, 3,9kΩ to +24V. Maximum HIGH level = +30V.

Logical levels:	LOW =	0V bis +4V
	HIGH =	+7,5V bis +30V

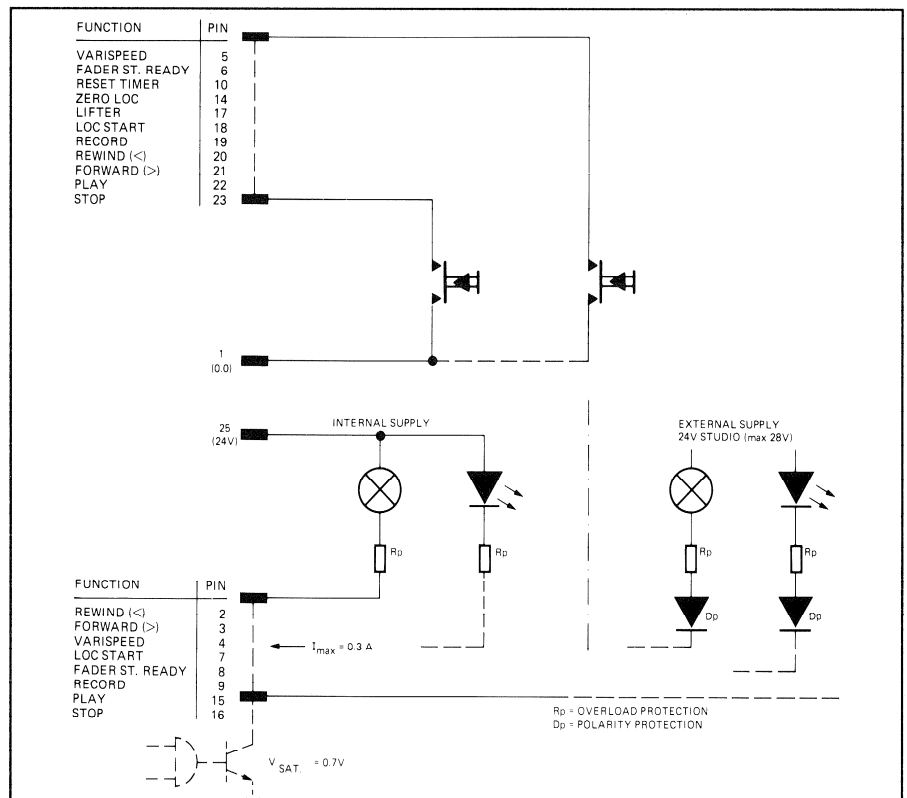

Fig. 2.3.6 Connection diagram, parallel remote control.

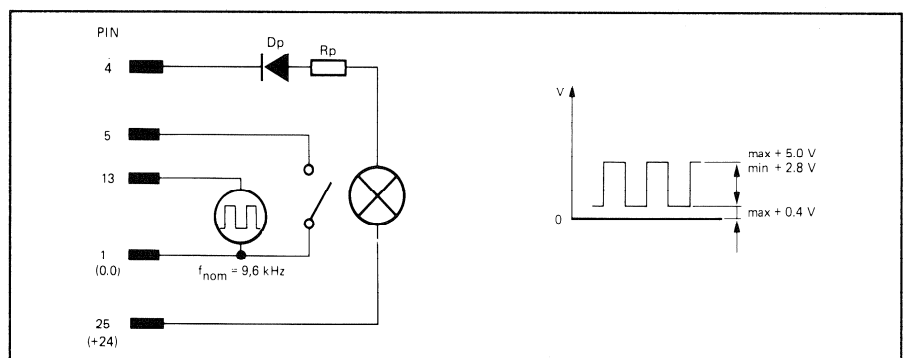

Fig. 2.3.7 Connection diagram, varispeed control.

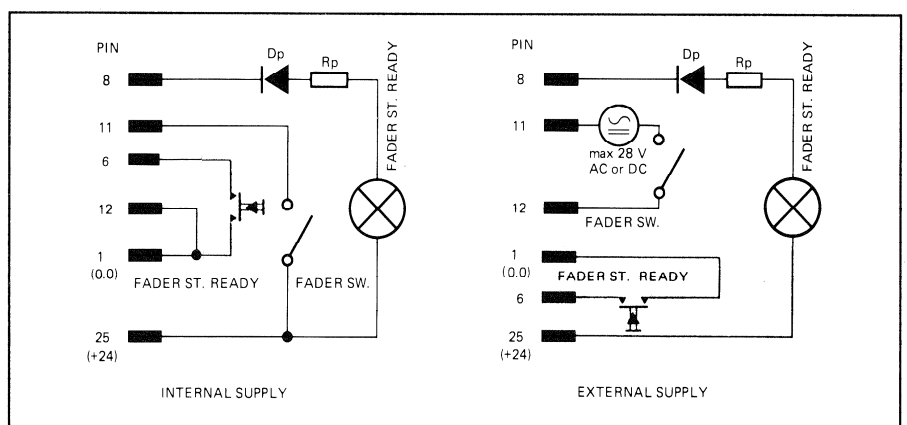

Fig. 2.3.8 Connection diagram, fader start circuit.

Important:

When incandescent bulbs are used as status indicator lamps, their inrush current must not exceed 0.3 A!

Connector for external synchronizer

A 25-pin connector (female, D-type) is available for connecting an external synchronizer.

Connector set	Part No. 20.020.303.15
---------------	------------------------

Pin assignment of the SYNCHRONIZER connector:

PIN	SIGNAL NAME	DESIGNATION
01	+ 0,0	Ground (GND, 0 V)
02	BR-REW *	Status indicator lamp REWIND
03	BR-FORW *	Status indicator lamp FORWARD
04	BR-VRSPD *	Status indicator lamp VARISPEED (alternatingly LOW and HIGH when active).
05	SR-VRSPD ▲	Switch for VARISPEED command
06	---	
07	OR-MVCLK *	Output for TAPE MOVE CLOCK signal (16 pulses/s at 7.5 ips, pulse duty factor 50%).
08	KEY	Connector coding
09	BR-REC *	Status indicator lamp RECORD
10	OR-MVDIR *	Output for TAPE MOVE DIRECTION signal (REW. = LOW, FORW. = HIGH).
11	OR-CMCLK *	Output for CAPSTAN MOTOR MOVE CLOCK signal (1200 pulses/s at 7.5 ips).
12	OR-SYENB *	Output for SYNCHRONIZER ENABLE signal (LOW when tape is tensioned and the recorder. is operational, HIGH when the tape is not tensioned).
13	IR-REFEX	Input for external capstan PLL reference (nominal: 9.6 kHz, TTL level recommended; max. input voltage +30 V).
14	+ 0.0	Ground (GND, 0 V)
15	BR-PLAY *	Status indicator lamp PLAY
16	BR-STOP *	Status indicator lamp STOP
17	SR-LIFT ▲	Switch for LIFTER command
18	SR-MUTE ▲	Switch for MUTE command (no influence on time code channel)
19	SR-REC ▲	Switch for RECORD command
20	SR-REW ▲	Switch for REWIND command
21	SR-FORW ▲	Switch for FORWARD command
22	SR-PLAY ▲	Switch for PLAY command
23	SR-STOP ▲	Switch for STOP command
24	KEY	Connector coding
25	+ 24VRMT	+24 V supply (max. 300 mA)

* Open collector output, active LOW. No internal pull-up resistor. Maximum HIGH level +30 V, maximum current 200 mA (built-in current limiting resistor 22 Ω).

▲ Switch input. LOW level activates the command. Internal pull-up resistor, 3,9 kΩ to +24 V. Maximum HIGH level = +30 V.

Logical levels:	LOW =	0 V bis + 4 V
	HIGH =	+7,5V bis +30 V

VU PANEL CONTROL

Connector for the operation of a VU meter panel.

Pin assignment of the VU panel connector: 2-channel.

PIN	SIGNAL NAME	DESIGNATION
01	0,0	Ground (GND, 0 V)
02	+ 5.6V	Supply voltage
03	+ 15V	Supply voltage
04	---	
05	EXT-D5	Panel matrix
06	EXT-D6	Panel matrix
07	EXT-D7	Panel matrix
08	---	
09	---	
10	EXT-DATA	External panel, data
11	EXT-CLK	External panel, clock
12	EXT-ENLD	External panel, enable LED
13	---	
14	0.0	Ground (GND, 0 V)
15	---	
16	---	
16	- 15 V	Supply voltage
17	KEY	Code
18	---	
19	---	
20	---	
21	---	
22	---	
23	---	
24	---	
25	---	

Pin assignment of the VU panel connector: 4-channel.

PIN	SIGNAL NAME	DESIGNATION
01	+ 0,0VD	Digital ground (GND, 0 V)
02	+ 5,6V	Supply voltage
03	+ 15V	Supply voltage
04	---	
05	EXT-D4	Panel matrix
06	EXT-D5	Panel matrix
07	EXT-D6	Panel matrix
08	EXT-D7	Panel matrix
09	---	
10	---	
11	---	
12	A-VUMTR1	Audio VU-meter signal 1
13	A-VUMTR2	Audio VU-meter signal 2
14	0,0VA	Audio ground (0 V)
15	---	
16	-15V	Supply voltage
17	KEY	Code
18	EXT-DATA	External panel data
19	EXT-CLK	External panel clock
20	EXT-ENMX	External panel enable matrix
21	EXT-ENLD	External panel enable LED
22	---	
23	---	
24	A-VUMTR3	Audio VU-meter signal 3
25	A-VUMTR4	Audio VU-meter signal 4

VU PANEL AUDIO

Connector for the operation of a VU meter panel

Pin assignment of the VU meter connector: 2-channel AUDIO.

PIN	SIGNAL NAME	DESIGNATION
01	A-LVOUA1	Audio, to output level 1 control potentiometer.
02	A-LVOUC1	Audio, ground for output-level 1 potentiometer.
03	A-LVINB1	Audio, from input level 1 control potentiometer.
04	0 AUDIO	0V Audio
05	A-MONIT1	Audio, monitor signal 1
06	A-PHIN1	Audio, headphone amplifier input 1
07	A-LSA	Audio, headphone amplifier output A
08	A-LVOUA2	Audio, to output level 2 control potentiometer.
09	A-LVOUC2	Audio, ground for output level 2 potentiometer.
10	A-LVINB2	Audio, from input level 2 control potentiometer.
11	KEY	Code
12	A-MONIT2	Audio, monitor signal 2
13		
14	A-LVOUB1	Audio, from output level 1 contr. potentiometer.
15	A-LVINC1	Audio, ground for input level 1 potentiometer.
16	A-LVINA1	Audio, to input level 1 control potentiometer.
17	KEY	Code
18	A-PREOU1	Audio, preamplifier output 1
19	A-PHIN2	Audio, headphone amplifier input 2
20	A-LSB	Audio, loudspeaker amplifier output B
21	A-LVOUB2	Audio, from output level 2 contr. potentiometer.
22	A-LVINC2	Audio, ground for input level 2
23	A-LVINA2	Audio, to input level 2 control potentiometer.
24	---	
25	A-PREOU2	Audio, preamplifier output 2

Pin assignment of the VU meter connector: 2-channel AUDIO.

PIN	SIGNAL NAME	DESIGNATION
01	A-LVINA1	Audio, to input level 1 control potentiometer.
02	A-LVINB1	Audio, from input level 1 control potentiometer.
03	A-LVINC1	Audio, ground for input level 1 control pot.
04	A-LVOUA1	Audio, to input level 1 control potentiometer.
05	A-LVOUB1	Audio, from input level 1 control potentiometer.
06	A-LVOUC1	Audio, ground for input level 1 control pot.
07	KEY	Code
08	A-LVINA2	Audio, to input level 2 control potentiometer.
09	A-LVINB2	Audio, from input level 2 control potentiometer.
10	A-LVINC2	Audio, ground for input level 2 control pot.
11	A-LVOUA2	Audio, to input level 2 control potentiometer.
12	A-LVOUB2	Audio, from input level 2 control potentiometer.
13	A-LVOUC2	Audio, ground for input level 2 control pot.
14	A-LVINA3	Audio, to input level 3 control potentiometer.
15	A-LVINB3	Audio, from input level 3 control potentiometer.
16	A-LVINC3	Audio, ground for input level 3 control pot.
17	A-LVOUA3	Audio, to input level 3 contr. potentiometer.
18	A-LVOUB3	Audio, from input level 3 control potentiometer.
19	A-LVOUC3	Audio, ground for input level 3 control pot.
20	A-LVINA4	Audio, to input level 4 contr. potentiometer.
21	A-LVINB4	Audio, from input level 4 control potentiometer.
22	A-LVINC4	Audio, ground for input level 4 control pot.
23	A-LVOUA4	Audio, to input level 4 control potentiometer.
24	A-LVOUB4	Audio, from input level 4 control potentiometer.
25	A-LVOUC4	Audio, ground for input level 4 control pot.

AUDIO REMOTE

Connector for the control of the Audio switching

Pin assignment of the audio remote connector:

PIN	SIGNAL NAME	DESIGNATION
01	0.0VD	Ground (GND, 0V)
02	ARC-DATA	Audio remote control data
03	ARC-CLK	Audio remote control clock
04	ARC-MXEN	Audio remote control enable matrix
05	ARC-LDEN	Audio remote control enable LED
06	ARC-DPEN	Audio remote control enable display
07	KEY	Connector coding
08	+0.0VD	Digital ground (GND, 0V)
09	----	
10	ARC-D0	Panel matrix
11	ARC-D7	Panel matrix
12	ARC-D6	Panel matrix
13	ARC-D5	Panel matrix
14	ARC-D4	Panel matrix
15	+24V RTM	+24V supply (max. 300mA)

Insert

Connector for insert routing

Connector set:	Part No. 20.020.303.12
----------------	------------------------

Pin assignment of the insert routing connector:

PIN	SIGNAL NAME	BEDEUTUNG
01	A-PRAS-1	Cabel screen
02	A-PRAA-1	Audio, from preamplifier CH1
03	A-PRAB-1	Audio, from preamplifier CH1
04	A-RINS-1	Cabel screen
05	A-RINA-1	Audio, to the record amplifier CH1
06	A-RINB-1	Audio, to the record amplifier CH1
07	A-PRAS-2	Cabel screen
08	A-PRAA-2	Audio, from preamplifier CH2
09	A-PRAB-2	Audio, from preamplifier CH2
10	A-RINS-2	Cabel screen
11	A-RINA-2	Audio, to the record amplifier CH2
12	A-RINB-2	Audio, to the record amplifier CH2
13	INSRT-ON	Insert on.
14	A-TAPS-1	Cabel screen
15	A-TAPA-1	Audio, from reproduce amplifier CH1
16	A-TAPB-1	Audio, from reproduce amplifier CH1
17	A-DRVS-1	Cabel screen
18	A-DRVA-1	Audio, to the output amplifier CH1
19	A-DRVB-1	Audio, to the output amplifier CH1
20	A-TAPS-2	Cabel screen
21	A-TAPA-2	Audio, from reproduce amplifier CH2
22	A-TAPB-2	Audio, from reproduce amplifier CH2
23	A-DRVS-2	Cabel screen
24	A-DRVA-2	Audio, to the output amplifier CH2
25	A-DRVB-2	Audio, to the output amplifier CH2

Insert AUX

Standard option: Stereo monitor panel

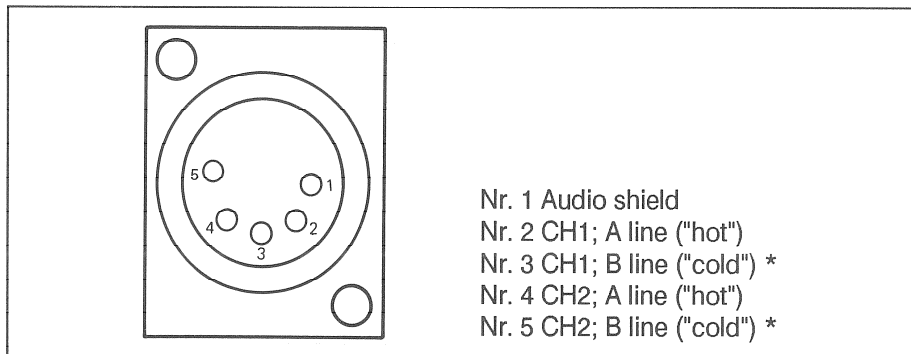

Fig. 2.3.9

The balanced AUX INPUT on tape recorders with a stereo monitor panel is terminated on a 5-pin XLR connector

* For unbalanced wiring, conductors 5 and 3 are to be interconnected with conductor audio 0Volt.

Timecode in- output

1/4" and 4-channel TC-versions

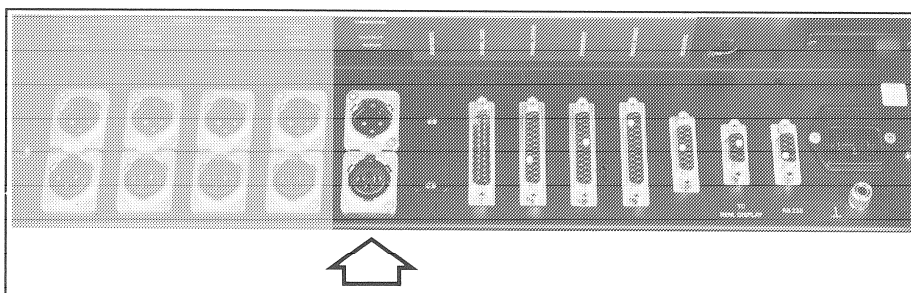
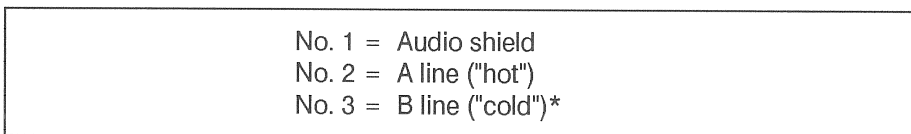

Fig. 2.3.10



* By unbalanced operation the wiring "B" is necessary to change on 0Volt socket.

2.3.4 Headphones socket

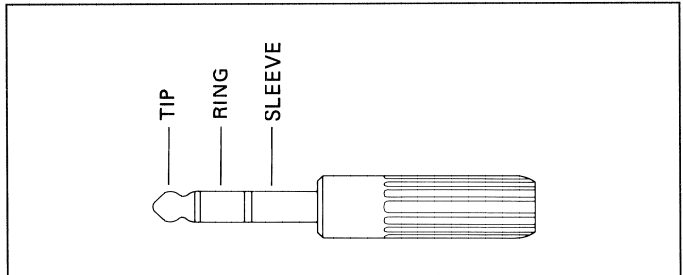

Fig. 2.3.11

TIP	=	Left-hand channel
RING	=	Right-hand channel
SLEEVE	=	Shield

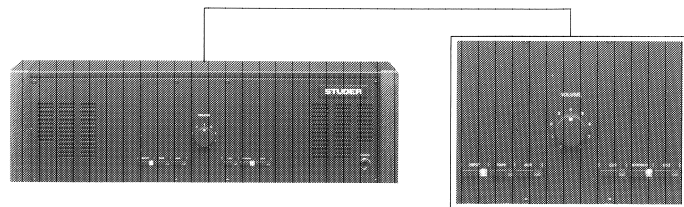

Fig. 2.4.8 see 2/29

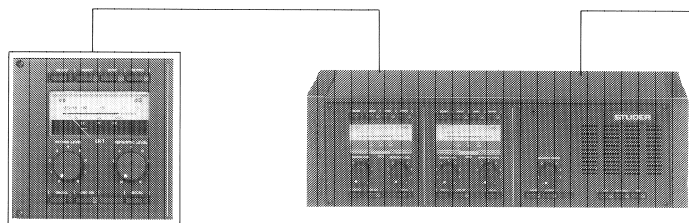

Fig. 2.4.4 see 2/23

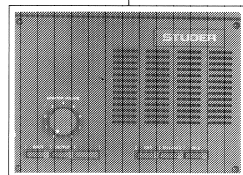

Fig. 2.4.7 see 2/29

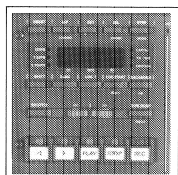
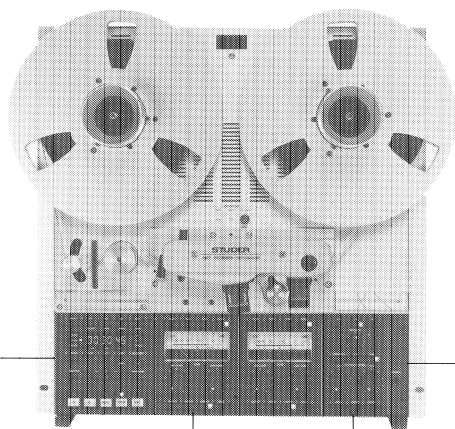

Fig. 2.4.2 see 2/17

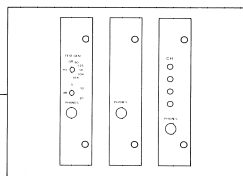

Fig. 2.4.6 see 2/28

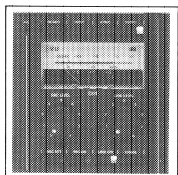

Fig. 2.4.3 see 2/23

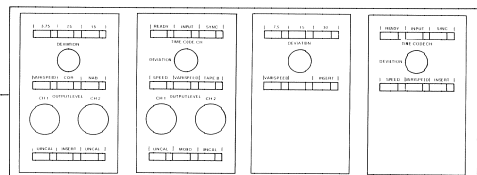

Fig. 2.4.5 see 2/25

2.4. Operating instructions

2.4.1 Controls

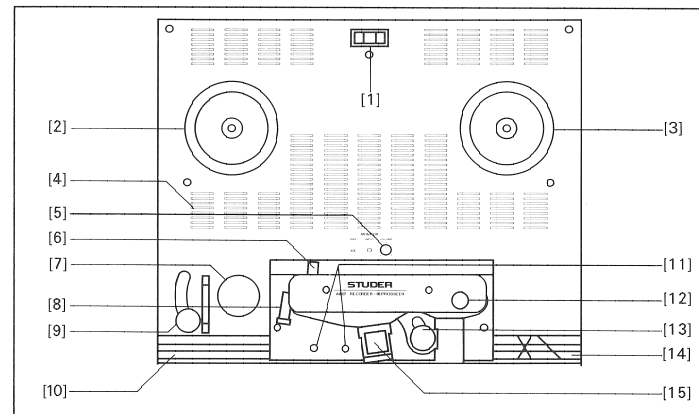

Fig. 2.4.1 Description 1-15

- [1] Power switch
- [2] Left-hand spindle
- [3] Right-hand spindle
- [4] Monitor speaker

Power switch, switches the tape recorder on and off.
 Left hand reel support, supply motor.
 Right-hand reel support, take-up motor.
 (Only in versions without instrument panel).

- [5] VOLUME

Volume control for the monitor speaker [4]. When this button is pressed, the tape signal is reproduced, when the button is pulled, the input signal is reproduced.

- [6] Tape lift slide

For soft click-free fade-in/fade-out of a recording. (Lifts the tape off the erase head).

- [7] Tacho roller

Tape move sensor: Supplies the pulses for the tape counter and signals the tape move status to the electronics.

- [8] Light barrier

For detecting the transparent leader or a torn tape. Also stops the tape timer.

- [9] Tape sensor lever
- [10] Splicing block
- [11] Scissors

Monitors the tape tension.
 Only for 1/4" versions
 Only for 1/4" versions

- [13] Pinch roller

Presses the tape against the capstan shaft. In spooling mode, cueing of the tape is possible by pressing the pinch roller toward the capstan shaft. The closer the tape is moved to the capstan shaft, the louder the signal. The pinch roller cannot be pressed completely against the capstan.

- [14] Cutting block
- [15] Head shield

For cutting the tape (Only for 1/4" versions).
 In front of the reproduce head(s). Can be opened and closed by hand.

**Left control field
[16 - 35]**

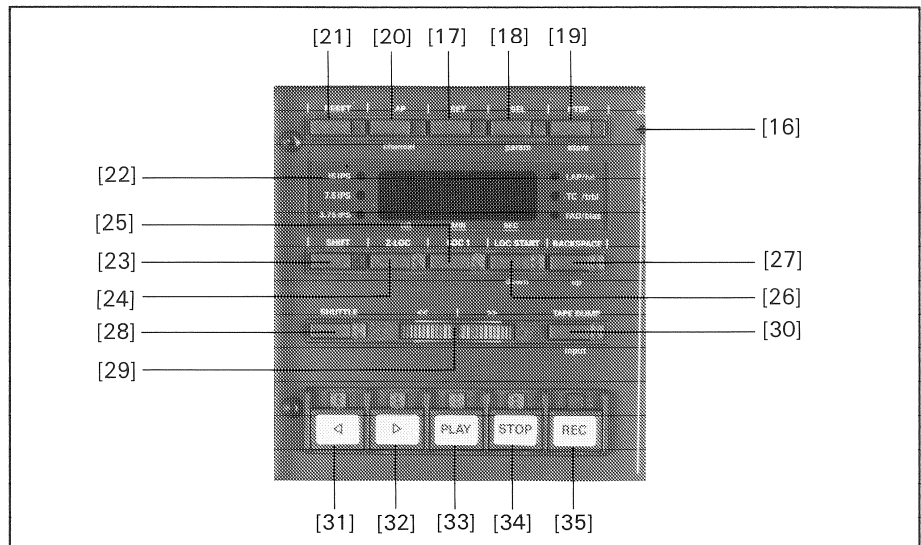

Fig. 2.4.2 This control field is identical in all versions. [16-35]

[16] "adj":

Microswitch, switches the tape recorder to alignment mode for programming the audio parameters or, when pressed together with the SHIFT [23] key, switches to the soft jumper program (refer to sections 2.5.3 and 2.5.4).

Use a pencil or an other pointed tool to operate the microswitch "adj.". Press the microswitch again to return to the normal operating status. When "adj." has been activated, some of the operating keys change their function; the designations printed in yellow will become valid.

[17] SET

Normal key function:

Setup key for entering a LOC address. (SET ADDRESS) or for entering a new tape timer value (SET TIMER). The current counter reading is blocked at the moment the key is pressed (first digit flashes) and can be read into a LOC memory either directly or after it has been modified with the SEL and STEP keys.
To store the new counter reading, simultaneously press the SHIFT [23] key and SET [17]. The LOCATOR addresses are also updated by the amount of the change.

Key function in "adj." mode:

Key funktion in "SHIFT + adj." mode:

[18] SEL

Digit selection key. After SET [17] has been pressed you can select the digit(s) to be modified. The selected digit flashes.
Note: Reset sets all digits to zero. The tape timer content is not changed.

(param)

This key causes the next parameter (param) to be addressed in the menu.

	Normal key function:	Key function in "adj." mode:	Key funktion in "SHIFT + adj." mode:
[19] STEP	Step key. Increments the digit selected with the SEL [18] in SET mode. Smaller values can be set by incrementing past the digit 9 (5).	store stores the audio parameter (e. g. after an adjustment).	store stores the choosen condition of the selected soft jumper function.
[20] LAP	Second separat counter for measuring a specific tape segment without influence the original counter position. The tape timer can be set to zero (RESET [21] key) as desired. When the LAP function is active, the red LAP LED on the right-hand side of the display window [22] is light.	channel selects an audio channel for adjustment: A 1 = channel 1 A 2 = channel 2	channel (Function) Selection of a soft jumper. The first two digits indicate the selected soft jumper. The next digit(s) indicate the status of the selected function and are advanced with each depression of the channel key. For paging backward to the preceding digit, simultaneously press the SHIFT [23] and channel keys.
[21] RESET	Reset key, sets the tape timer or the LAP counter to zero (00.00.00). The LOCATE addresses always relate to the actual tape address. They are automatically converted when the counter is reset so that always the same tape address is searched.		
[22] DISPLAY	Real-time tape counter with indication of the actual playing time for all tape speeds, in hours, minutes, and seconds. Can be changed over for displaying a second timer (LAP [20] key) for relative time measurement with operator selectable reference. Indicator LED for: <ul style="list-style-type: none"> ■ Selected tape speed ■ LAP = Second timer ■ TC = Timecode (Only for TC versions) ■ FAD = FADER READY Flashing dots between digits: <ul style="list-style-type: none"> ■ A locator address is displayed 	Displays the selected audio parameters (decimal). (For detailed information refer to the Section Audio 4.2.6). LED's indicate the following audio parameters: lvl = level adjustment active trbl = treble adjustment active bias = bias adjustment active. (Not possible in repro and sync operation). Flashing dot between channel and parameter indication: The display value of the corresponding audio parameter is not stored.	Displays the selected soft jumper and the corresponding function. (For detailed information refer to the Section Soft jumper programming, 2.5.2.) A flashing decimal point between Softjumper status indication: Indicates that the softjumper status (or value) has not yet been stored.

	Normal key function:	Key function in "adj." mode:	Key function in "SHIFT+adj." mode:
[23] SHIFT	Setup key for alternative functions (playback in opposite tape direction, library wind, soft jumper program, backward paging in the soft jumper program, storing the new counter reading) and functions which for safety reasons can only be activated by pressing two keys (tape type or equalization standard, varispeed, tape speed, mono/insert, ready/safe switch for time code, fader ready for recording and tape dump for inverted dump edit mode. If you press the SHIFT key followed by a locator key, the stored address will be displayed for approx. 4 seconds.		
[24] Z-LOC	Zero locator. Positions the tape at the tape address 00.00.00. When this key is pressed in LAP mode [20], the LAP function is switched off and the tape is positioned at the actual zero address of the main timer. The reproduce mode as well as the record mode can be preselected while the tape is positioning. The LEDs of the preselected functions flash.		
[25] LOC 1	<p>Address locator 1. Positions the tape at the address stored with the key combination SET [17] and LOC 1 [25]. The reproduce mode as well as the record mode can be preselected while the tape is positioning; the LEDs of the preselected functions flash. The locator address is displayed for as long as this key is held down, and the two decimal points flash.</p> <p>If this key is pressed in LAP mode [20], the LAP function is switched off and the tape is positioned at the actual LOC 1 address of the main timer. The stored address always relates to the actual tape address i.e. when the tape timer is set to zero with RESET [21], the locator address is automatically converted. When the key combination first SHIFT [23] and after release then LOC 1 [25] is pressed, the stored locator address is displayed briefly without causing the tape to be positioned at the displayed address.</p>		

	Normal key function:	Key function in "adj." mode:	Key function in "SHIFT+adj." mode:
[26] [27]	<p>Softkey The keys [26 and 27] can be assigned to different functions by means of the soft jumpers 9 and 10.</p>		
[26]	<p>LOC-START (Soft jumper position 1 = standard programming). Positions the tape automatically to the address at which the last PLAY or record command was entered (and the tape was standing still). During the positioning process, play or record can be preselected; the corresponding LED above the preselected function key flashes.</p>	<p>down Decrements the value of the active alignment parameter (lvl, trbl, bias) selected with the (param) [18] key of the respective channel chosen by key channel [20].</p>	<p>down Decrements the value of the selected key (channel) [20] or switches off the corresponding function.</p>
[27]	<p>BACKSPACE (Soft jumper position 4 = standard programming). While this key is held down the tape is rewound at approximately 4 times the play speed but the tape is not lifted off the soundhead. PLAY is automatically activated when this key is released.</p> <p>LOOP (Soft jumper 0). In this programming mode, pressing of this key causes a play loop to be performed between the tape address 00.00.00 and the address stored in LOC1. The loop always starts at the lower of the two tape addresses.</p> <p>LOC2/LOC3 (Soft jumper position 2/3). In this programming mode a second address locator (analog) LOC1 is available. When the keys SHIFT [23] and (LOC2/LOC3) [26/27] are pressed, the stored address is briefly displayed without changing it.</p>	<p>up Increments the value of the active alignment parameter (lvl, trbl, bias) selected with the (param) [18] key of the respective channel chosen by key [20].</p>	<p>up Increments the value of the softjumper status selected by key [20] or switches on the corresponding function.</p>

Normal key function:	Key function in "adj." mode:	Key function in "SHIFT+adj." mode:
<p>FADER READY (Softjumper position 9). In the FADER READY setting the key can be used to enable the fader start. This function is acknowledged by the red FAD LED in the display window [22]. If at least one channel is switched to READY [36/62], the machine can be enabled for recording by simultaneously pressing SHIFT [23] and FADER READY [26 or 27] (the yellow LED next to the FADER READY key flashes). When the fader potentiometer is opened, the machine starts immediately in record mode.</p> <p>LIFTER (Soft jumper position 6/7) Cancels the tape lifting in spooling mode. This key can be programmed as a momentary push button (position 6) or as an ON/OFF key (position 7).</p> <p>REHEARSE (Softjumper position 8). Simulation of electronic cutting without record function.</p>		
<p>[28] SHUTTLE Editing mode, the tape tension control is enabled and the audio reproduce channels are open. The tape can be moved forward or backward to the desired position by manually turning the right-hand reel [3]. When the SHUTTLE key [28] is pressed a second time, the editing mode is cancelled.</p>		
<p>[29] SHUTTLE CONTROL Rotary wheel for motor-assisted editing mode with activated SHUTTLE function [28].</p>		
<p>[30] TAPE DUMP Switches the "waste basket mode" on and off. The right-hand spooling motor is disabled. Mode A or B can be selected by changing over the programming switch (jumper JP8) below the cover.</p>	<p>input In models without output selector, the input signal is connected directly to the output for setting the internal audio level.</p>	



Normal key function:	Key function in "adj." mode:	Key function in "SHIFT+adj." mode:
<p>Mode A: The TAPE DUMP [30] key functions as a preselector switch. The "waste basket" mode is activated with the PLAY [33] key. The tape is played but not wound up. The loose tape can be rewound on the left-hand spindle [2] by pressing the < [31] key. In this mode it is possible to play a loose piece of tape without winding the tape onto the reel (described in Section 2.4.25).</p> <p>Mode B: The "waste basket" mode is activated directly with the TAPE DUMP [30] key. The machine stops when this key is pressed a second time. When the SHIFT [23] and tape dump [30] keys are pressed simultaneously, the LED next to the tape dump key starts to flash. The effect will be that the left-hand motor stops and the slack tape is wound on the right-hand reel (also refer to Section 2.4.25).</p>		

- [31] < Key for rewinding of the tape at high speed. The tape is wound on the left-hand reel. Rewinding at reduced speed (library wind) is possible by simultaneously pressing SHIFT [23] and < [31].
- [32] > Key for spooling the tape forward at high speed. The tape is wound on the right-hand reel. Spooling forward at reduced speed is possible by simultaneously pressing SHIFT [23] and > [32].
- [33] PLAY Key for reproducing the tape. This key is pressed together with the REC [35] key for activating the recording mode. REVERSE PLAY is activated by pressing SHIFT [23] and PLAY simultaneously.
If no tape is inserted (tape tension sensor in idle position, light barrier not covered), the capstan motor can be switched on with the PLAY key for cleaning the capstan shaft.
- [34] STOP This key cancels all tape transport functions and all selected operating modes except the preselection of the TAPE DUMP [30] mode A.
- [35] REC Record key. Depending on the programming it may only be effective in conjunction with the PLAY [33] key. Recordings can only be made on the enabled channel(s) (READY [36/62]). If no channel is switched to READY, the record command will be ignored. Mode A or B can be selected by changing over the programming switch (jumper 11) below the cover.
Mode A: Both keys, PLAY [33] and REC [35] must be pressed for activating the record mode. (Jumper in pos. 0).
Mode B: To switch from reproduce to record mode, only the REC [35] key needs to be pressed; but for activating the record function from STOP mode, the PLAY [33] and the REC [35] key have to be pressed. (Jumper 11 in pos. 1).

Internal VU meter panel

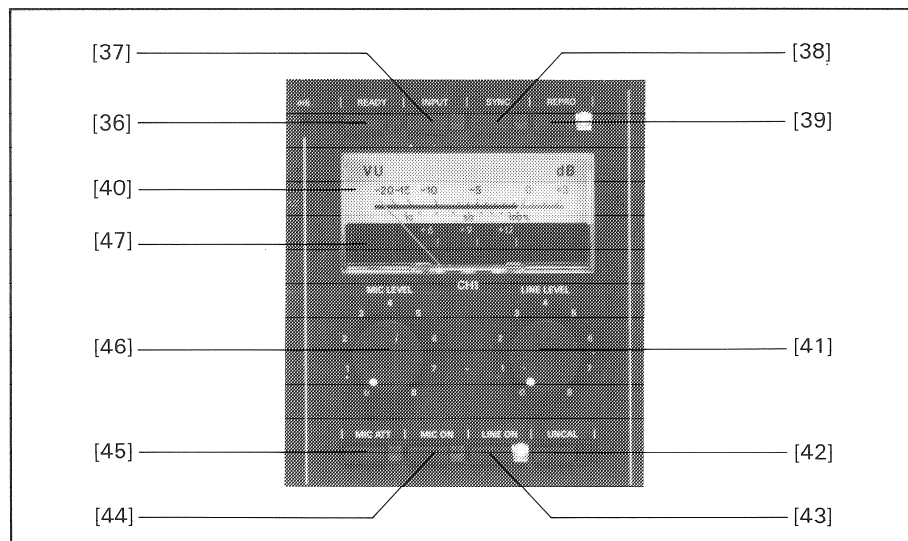

Fig. 2.4.3

In the VU versions, the control panel exists:

- 1 x in MONO units
- 2 x in STEREO units

On STEREO (2-channel) units the left-hand operator panel controls the left-hand channel 1 (CH1), the right-hand operator panel controls the right-hand channel 2 (CH2).

Important: ONLY units with built-in VU meters are equipped with a balanced phantom-supplied microphone input!

External VU meter panel

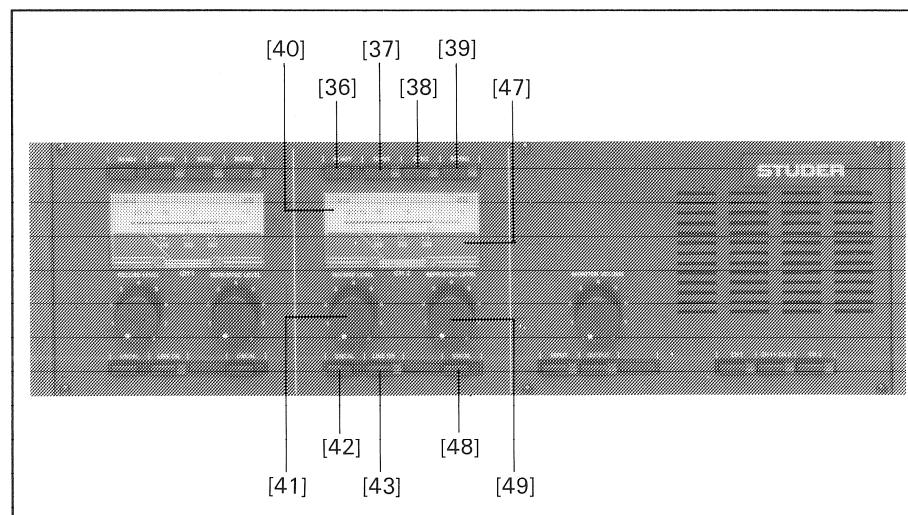

Fig. 2.4.4

In VUK versions, this control panel exists:

- 1 x in MONO units
- 2 x in STEREO units
- 4 x in 4-channel units

On STEREO (2-channel) units the left-hand operator panel controls the left-hand channel 1 (**CH1**), the right-hand operator panel controls the right-hand channel 2 (**CH2**).
On 4-channel units the channels (**CH1 ... CH4**) are arranged from left to right.

- [36] **READY** Enables the channel for standby recording. The red LED next to the key flashes. While a recording is in progress, this LED is continuously lit up.
- [37] **INPUT** switches the input signal to LINE OUT (premonitoring). The level of the input signal is indicated on the VU-meter [40]. This signal can also be heard via the XLR output, the monitor speaker [4], and the headphone connector [61].
- [38] **SYNC** The audio signal is reproduced from the record head with limited frequency response. Synchronous recording of channel 2 to an existing recording on channel 1 (and vice versa) is possible. The VU-meter [40] indicates the level of the SYNC reproduce signal. The SYNC signal can also be heard via the monitor speaker [4], and the headphone connector [61].
- [39] **REPRO** Output selector of the respective channel. The audio signal is reproduced from the reproduce head. The VU-meter [40] indicates the level of the reproduce signal. The REPRO signal can also be monitored via the speaker [4], and the headphone connector [61]. This function can also be activated while a recording is in progress in order to continuously monitor the quality of the recording (tape/source monitoring).
- [40] **VU-METER** Output meter for the respective channel with three peak indicator LEDs for +6, +9, and +12 dB relative to 0 VU.
- [41] **LINE LEVEL RECORD LEVEL** Input level potentiometer for the LINE INPUT. Only enabled when the UNCAL [42] key has been switched over to uncalibrated record mode.
- [42] **UNCAL** Activates the uncalibrated record mode for the respective channel. The record level can be adjusted with the LINE LEVEL [48] potentiometer.
- [43] **LINE ON** Switches the LINE INPUT of the respective channel on and off. When the microphone input is simultaneously activated with the MIC ON [44] key, the two signals will be mixed.
- [44] **MIC ON** Switches the microphone input of the respective channel on and off. When the line input is simultaneously activated with the LINE ON [43] key, the two signals will be mixed.
- [45] **MIC ATT** Microphone attenuator for the respective channel. The input signal on the MIC INPUT socket is attenuated by approx. 28 dB.
- [46] **MIC LEVEL** Input volume potentiometer for the respective channel for adjusting the sensitivity of the microphone input. The potentiometer is active also in not pushing key function.

- [47] **PEAK-LED's** The 3 LEDs +6, +9 and +12 dB are peak LEDs that warn against oversaturation of the tape. In the standard setting the peak values +6, +9 and +12 dB above 0 VU are indicated.
- [48] **REPRO-/SYNC-LEVEL** REPR/SYNC LEVEL. Output level potentiometer for the LINE OUTPUT. The signal to be controlled is selected by the keys INPUT [37]; SYNC [38] or REPRO [39]. Only enabled when the UNCAL [49] key has been changed over to uncalibrated reproduce mode.
- [49] **UNCAL** Activates the selected channel by the uncalibrated reproduce mode. The output level can be adjusted with the REPRO/SYNC LEVEL [48] potentiometer.

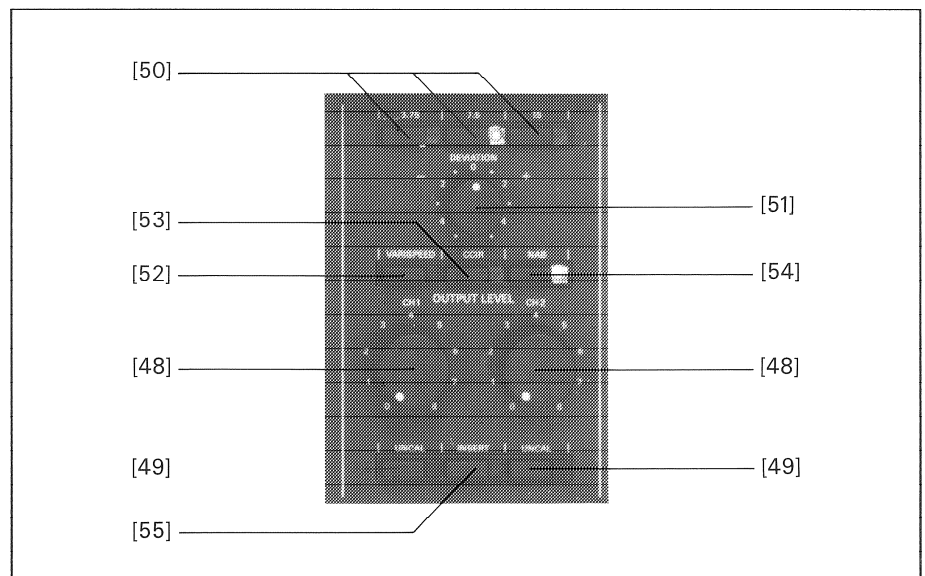
Right control field 1**(standard 1/4" version)****Pull-out page Fig. 2.4.4**

- [50] **15, 7,5, 3,75
30, 15, 7,5** Speed selection keys for selecting the desired nominal tape speed in inches per second. To prevent inadvertent changeover, soft jumper 07 can be set in such a way (see programming instructions below) that a changeover is only possible together with the SHIFT [23] key. (First hold down the SHIFT key and then also press the speed selection key).
- [51] **DEVIATION** Potentiometer for continuously varying the tape speed in "varispeed" mode (VARISPEED [52] key) within the range of ± 7 semitones (-35%, +54%) relative to the selected nominal speed. At 3.75 ips the range is: +7, -1.5 semitones.
- [52] **VARISPEED** Activates the varispeed mode. In this mode the tape speed can be varied with the DEVIATION [51] potentiometer. To prevent unintentional activation, this key is only effective when pressed in conjunction with SHIFT [23] (press and hold SHIFT and also press the VARISPEED key).

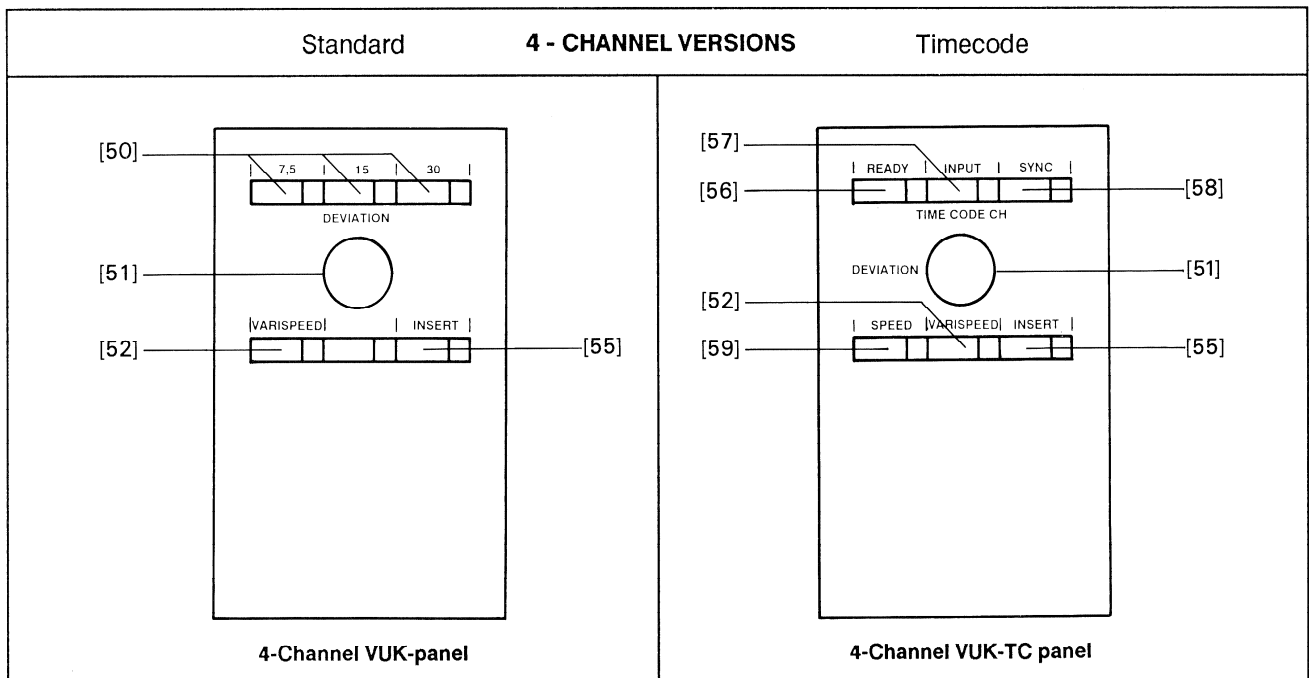
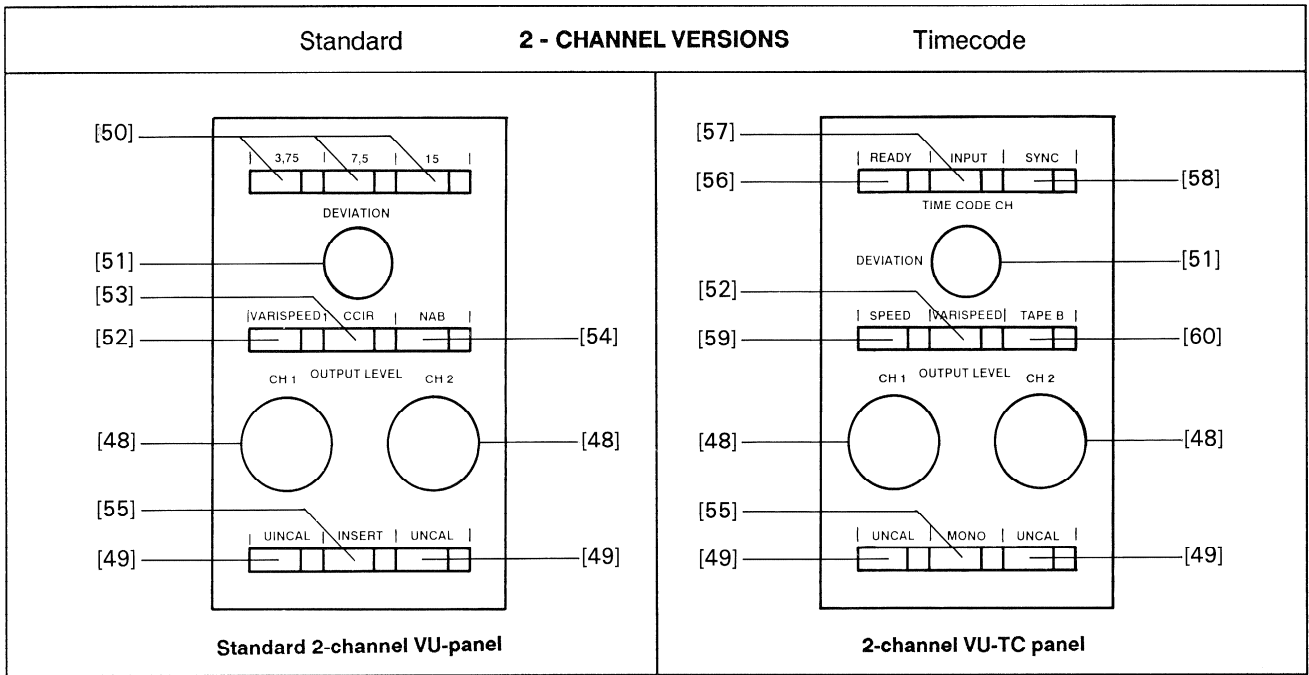

- The right-hand operator panel contains the speed selector, tape type or equalization selector, and a key for activating the MONO or INSERT mode. These two last functions are available as OPTIONS.
- VU versions with built-in VU-meters are additionally equipped with the output level potentiometers [48] and the corresponding enable key (UNCAL [49]).
- TC versions are equipped with the time code selection keys [56-58].
- 1/2" machines are only available in the HS (High Speed) version and with only one equalization standard (either CCIR or NAB). The speed selection keys [50] are correspondingly labelled.

[53] Audio softkeys
[54]

They can be programmed (by means of softjumper 13) to switch between two different tape characteristics:

CCIR/NAB

Selected switch between equalization CCIR/NAB.
 or to switch between the CCIR and NAB standards:

TAPE A/TAPE B

or two different head sets:

HEAD A/HEAD B

- HEAD A = main reproduce head
- HEAD B = 2. reproduce head

The method of programming is described in section 2.5.2

To prevent unintentional activation, this changeover can only be enabled by simultaneously pressing the SHIFT key [23] (press and hold SHIFT key and also press the [53] or [54] key.

[55] MONO/INSERT

This key activates the internal audio insert point.

- On stereo units the OPTIONAL mono/stereo selector switch can be installed with or without test generator. In this case the key [55] is labelled as MONO.
- With the option 20.807.950.00 it is possible to insert an external balanced circuit (e.g. noise reduction system) into the audio input and/or output path. In this case the key [55] is labelled as INSERT (see Fig. 2.3.1, item 11).

To prevent unintentional activation, this changeover can only be enabled by simultaneously pressing the SHIFT key [23] (press and hold SHIFT key and also press the MONO/INSERT key.

If the insert point is unused, this key is disabled by means of jumper JP48 (JP46 for 1/2" versions) located below the cover.

Control field TC-versions

See Page E2/25 "2-channel versions"

[56] READY

Enables the timecode channel for recording. The red LED next to the key flashes. While a recording is in progress, this LED is continuously lit up.
 On/off selection of READY function is only enabled when pressed SHIFT [23] and READY [56] simultaneous.

[57] INPUT

Output selection of the time code channel. The time code input signal is connected directly to the time code output.
 Select the INPUT function by pressing the SYNC [58] key. The function selected last (SYNC or REPRO) with the will be activated.

[58] SYNC/REPRO

Output selection of the time code channel. The time code signal is reproduced via the time code combination head.

- If the yellow LED to the right of the key is dark, the output selection is set to **REPRO**. This means that the Timecode signal coincides with the audio signal on the audio reproduce head.
- If the yellow LED is light, the output selection is set to **SYNC**. This means that the time code signal coincides with the audio signal on the audio reproduce head.
- During a time code recording the TC input signal is automatically applied to the TC output, regardless of the switch setting.

[59] SPEED

This key works as a wraparound function. The desired tape speed can be selected by repeatedly pressing this key. The selected speed is displayed by the LEDs on the left of the display [22].

To prevent unintentional activation of this function, soft jumper 07 (see programming, Section 2.5.2) can be set in such a way that the changeover can only be effected in conjunction with the SHIFT [23] key. Hold down the SHIFT [23] key and also press the SPEED [59] key.

[60] Audio Softkeys

Programmable key for the following functions:

- Tape B** Changeover to the calibration data of a second tape type with corresponding equalization standard.
 - LED on the right of the key is dark = tape type A selected (TAPE A)
- NAB** Changeover to the other equalization standard of soft jumper 13
 - LED on the right of the key is dark = CCIR standard selected
 - LED on the right of the key is light = NAB standard selected
- HEAD B** Changeover to the 2nd reproduce head
 - LED on the right of the key is dark = reproduce head A (main head) is selected.
 - LED on the right of the key is light = reproduce head B (auxiliary head) is selected.

These functions can be programmed (with soft jumper 13). The programming method is described in Section 2.5.2.

To prevent unintentional activation, the changeover is only possible in conjunction with the SHIFT [23] key. (Press and hold the shift key, then press key [60]).

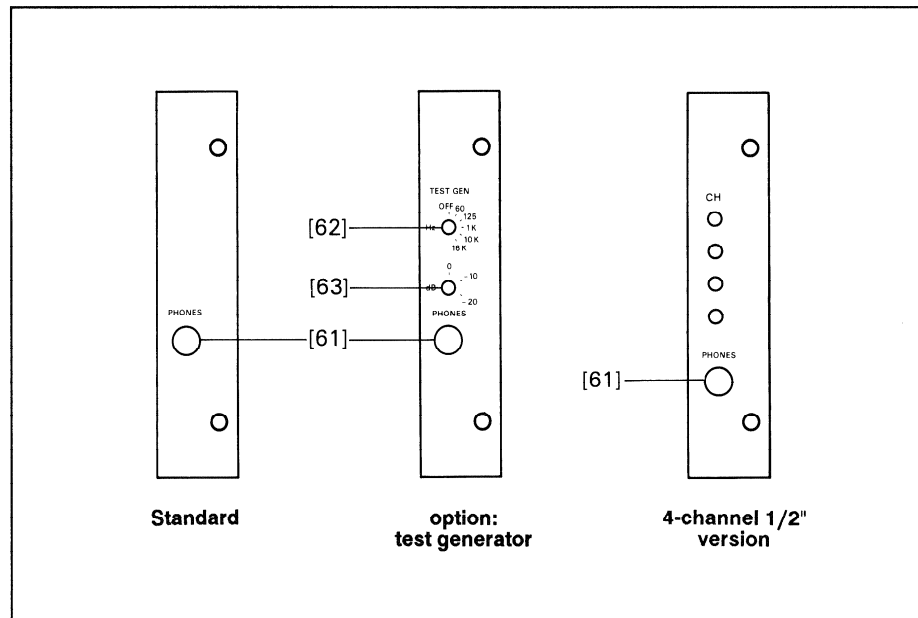

Fig. 2.4.6

[61] PHONES

Headphone socket. The built-in monitor speaker is automatically switched off when the headphones jack is inserted. The Tape/source reproduce level of the headphones can be adjusted with the VOLUME [5] potentiometer.

[62] Hz

Test generator (only on models with the optional TEST GENERATOR). Depending on the switch setting a sine signal (0 VU) with a frequency of 60 Hz, 125 Hz, 1 kHz, 10 kHz or 16 kHz is fed instead of the input signal. In the OFF position the test generator is disabled. To prevent mixing of the test generator signals with the inputs, the functions MIC ON [44] and LINE ON [43] should be switched off.

[63] dB Booster amplifier (only in units with the option: TEST GENERATOR). Depending on the switch setting the test signal is attenuated by -10 or -20 dB and the output signal boosted by +10 or +20 dB.

[64] CH1...CH4 Monitor selection key (see pull-out page Fig. 2.4.5/3).
The selected and engaged keys connect the corresponding output signal(s) to the monitor and headphones amplifier.

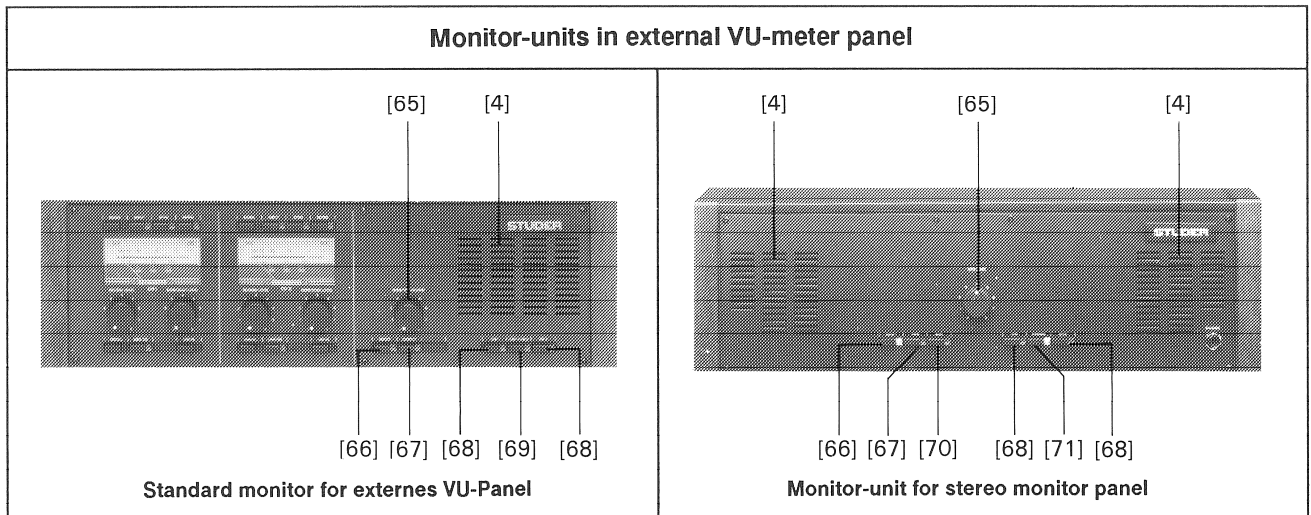

Fig. 2.4.7

Fig. 2.4.8

[65] MONITOR VOLUME Volume control of the monitor amplifier. It influences the monitor volume of the input signals selected with the key [66] or [67].

The volume of the headphones socket PHONES [61] can also be adjusted. The monitor speaker is switched off when the headphones are plugged in.

[66] INPUT Signal selector of the monitor speaker. When you press the INPUT [66] key, the signal available on the input is connected to the monitor speaker (source monitoring).
If the output selector of the VU-meter unit is set to INPUT [37], the monitor always reproduces the input signal in the INPUT [67] or OUTPUT-TAPE [67] settings.

[67] OUTPUT TAPE Signal selector of the monitor speaker. When you press the OUTPUT [67] key, the reproduce or SYNC signal from tape is heard through monitor speaker. Depends on the setting of the output selector [37, 38] of the VU-meter unit.
If the output selector is set to INPUT [37], the input signal is reproduced by the monitor in the OUTPUT-TAPE [67] setting.

[68] CH1 + CH2 Signal selector of the monitor speaker. When you press the OUTPUT key [67], the input signal of the corresponding channel is connected to the monitor speaker. The signal to be monitored is determined with the keys INPUT [66] (source monitoring), OUTPUT TAPE [67], or AUX [70] (auxiliary input).

On the instrument panel stereo monitor the input signal is connected to both speakers in accordance with the channel selection [68].

[69] CH1 + CH2 Selector switch for the monitor
When CH1 + CH2 [69] is pressed, the signals of both channels are added and reproduced in mono mode.

[70] Stereo-auxiliary input With the AUX [70] key you can monitor the signal connected to the AUX Input via the monitor speaker or the headphones (PHONES) socket. This signal has no further connection to the unit. The AUX input is strictly a monitoring channel.

[71] STEREO Both channels are reproduced in stereo mode via the built-in monitor speaker and the PHONE [61] socket when the STEREO [71] key is pressed on the instrument panel stereo monitor.

2.4.2 Power switch [1]

Caution: Before you connect the tape recorder to the AC outlet, check that the setting of line voltage selector agrees with the local mains voltage. The fuse rating must be checked whenever the setting of the line voltage selector has been changed (Section 2.3.1). The power switch [1] is located at the top edge of the tape deck cover.

When the tape recorder is switched on, the operating state that existed when the machine was switched off is automatically reestablished and displayed. The software release date (WW.YY = week. year) is shown on the display [22] for a few seconds. The last timer reading is subsequently displayed.

Exception: Tape transport functions that were active when the machine was switched off are not restarted, and the channels that were set to READY and the varispeed mode are disabled. The tape recorder is always switched to STOP [34]. When a tape is inserted, the yellow LED of the STOP key is continuously light. If there is no tape or if the tape is slack, the LED flashes for approx. 10 seconds and then switches off.

2.4.3 Indications at power on time

After the machine has been switched on, the VU-meters [40] are illuminated and the software date is shown on the display [22].

The following indications are also possible. They signal the current operating state of the tape recorder:

- Display: The last tape address is indicated.
- Locator addresses are saved.
- STOP: The stop function is active. If the LED flashes for approx. 10 s and then switches off, there is no tape inserted or the inserted tape is slack.
- CCIR (TAPE A/REPRO HEAD LEFT) or NAB (TAPE B/REPRO HEAD RIGHT): the selected equalization standard (tape type/reproduce head) is indicated.
- 3.75 7.5 15 or 30: The selected tape speed is indicated next to the display [22] and on the speed selector keys [50].
- Input selector: The selected input is indicated with MIC ATT [45], MIC ON [44], LINE ON [43] or UNCAL [42].
- Output selector: The selected output is indicated with INPUT [37/52], SYNC [38/58], or REPRO [39/58].
- Output level: Uncalibrated output level is indicated by the red LED next to the UNCAL [49] keys.
- MONO/INSERT [57] is indicated if a corresponding option is installed and if it was selected before the machine was switched off.

On models equipped with an VU meter panel the channel selection for the monitor output is also indicated.

2.4.4 Inserting the tape

Adapter for 3-pronged (CINE) reels for DIN AEG hubs and NAB reel adapters are engaged in the spindles.

Three-pronged reel (DIN 45514, 45517)

Mount the full reel on the left-hand spindle, the empty reel on the right-hand spindle. Pull out the three-pronged guide and lock the adapter with a 60° turn.

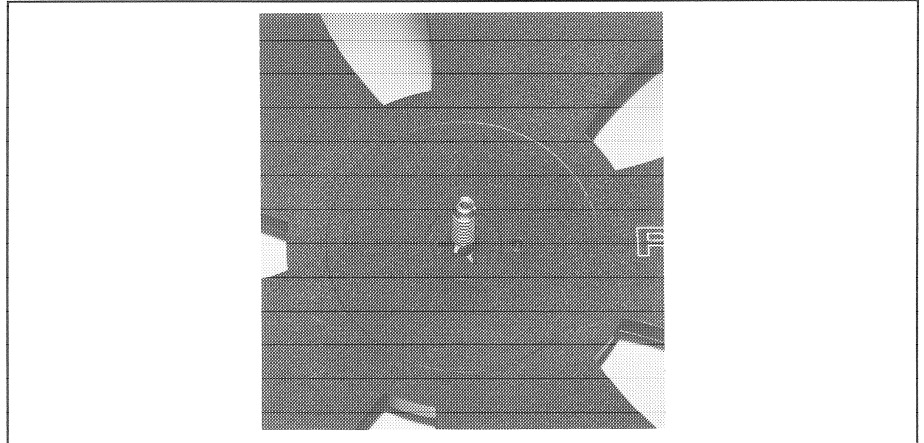

Fig. 2.4.9

DIN adapter and Self-supporting pancake (DIN 45515)

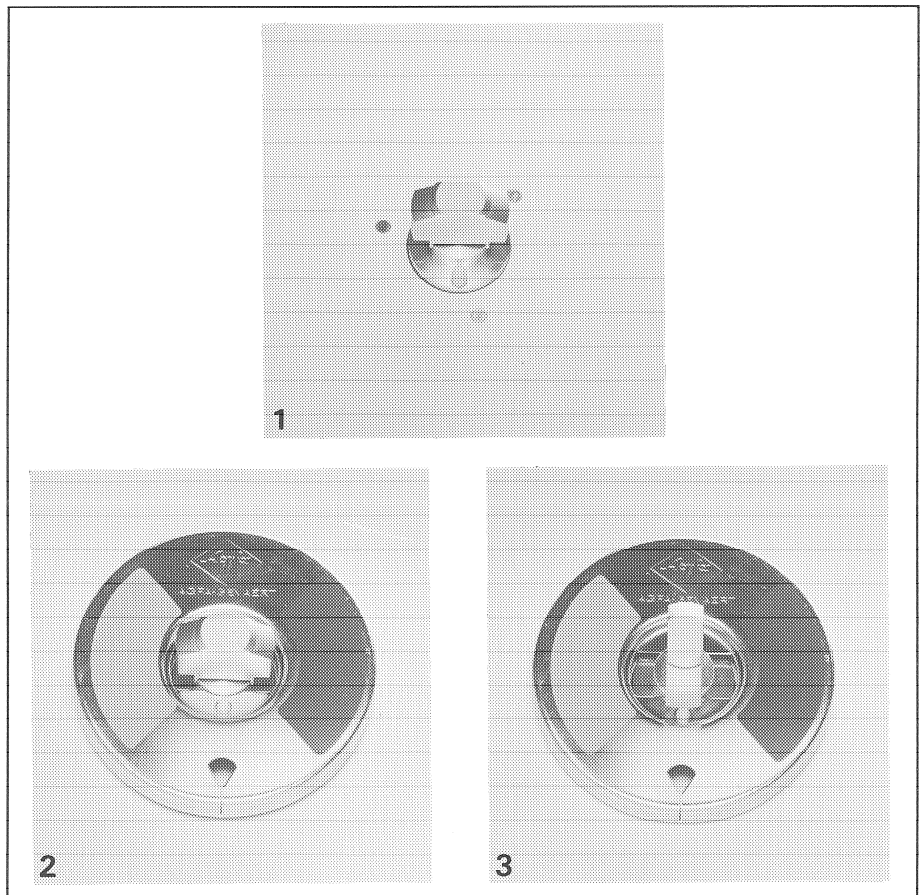

Fig. 2.4.10

1 DIN AEG platter
2 Center of pancake, unlocked

3 Center of pancake, locked

Install the DIN adapter

Mount the spindle on the adapter and engage the driving pin of the reel flange in the holes of the spindle.

Mount the full pancake on the left-hand side. Lift the clip and twist it by 60° until it rests on the guide pins. Mount an empty reel flange and an empty hub on the right-hand side.

NAB reel

Mount the NAB adapters on the two spindles [2/3] and lock them by pulling out the three-pronged guides and giving a 60° turn.

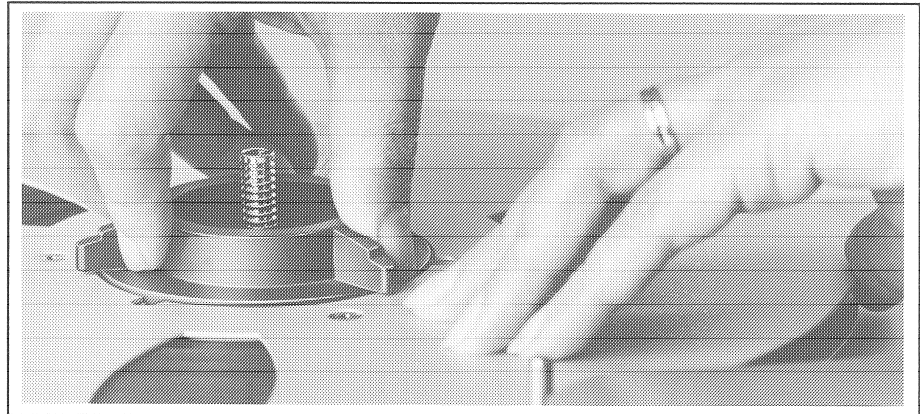

Fig. 2.4.11

Threading the tape

Thread the tape as illustrated. It must be threaded exactly around the tape tension sensor [9], the tacho roller [7], through the light barrier [8], and over the soundheads. Pull the leading end of the tape over the pinch roller [13] (the pinch roller can be moved to the idle position by actuating the tape lifter [6]), and around the right-hand guide roller. Thread the tape on the right-hand reel and secure the tape by giving the right-hand reel a few counterclockwise turns.

If the tape starts with a transparent leader, spool forward by pressing the > [32] key until the oxide coating has passed the light barrier [8]. Set the tape timer [22] to zero by pressing the RESET [21] key. If the tape is always set to zero at the same address, the magnetic tape can be repetitively positioned at any address by means of the real-time tape counter [22]. If necessary, raise the head shield [15] in front of the reproduce head(s).

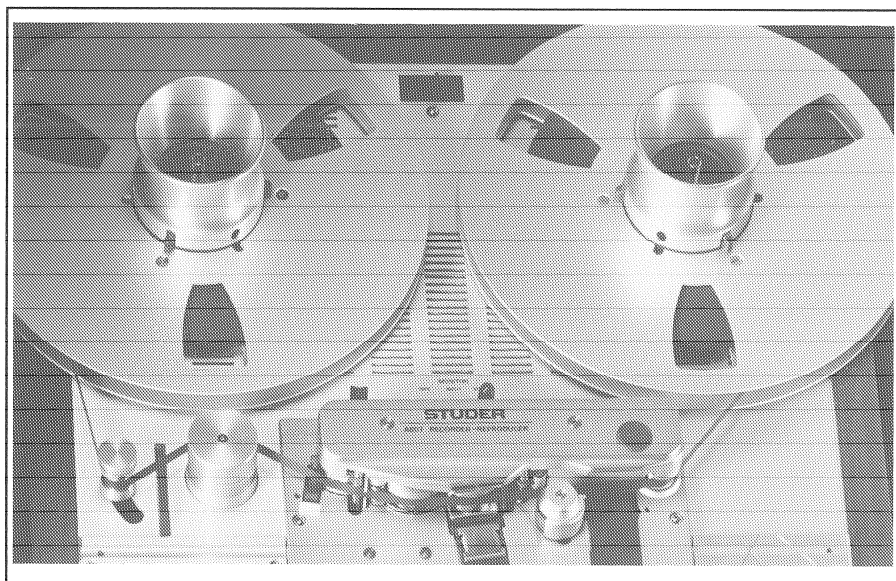

Fig. 2.4.12

2.4.5 Tape speed [50]

Three tape speeds are available. Depending on the model, three out of the following four speeds can be selected: 3.75/7.5/15/30 ips. The speed is selected:

- either by pressing the key [50]. The LED in the key lights up. If correspondingly programmed (soft jumper 07) it may be necessary to hold down the SHIFT [23] key while selecting the speed.
- or by repeatedly operating key [59]. The selected speed is indicated in the display [22] in the left control field generally. Also in this case interlocking with the SHIFT key can be programmed.

2.4.6 Play mode [33]

When the local PLAY key [33], a corresponding remote control button, or a fader start device is actuated (possibly via the FADER READY key), the tape recorder switches to play mode. The yellow LED above the PLAY key lights up.

The play mode can be cancelled by pressing the STOP [34] key or any other tape command key. If the PLAY key is pressed while a recording is in progress (REC), the machine switches to play without interruption and the record mode is cancelled. If the PLAY key is pressed in spooling mode, the magnetic tape is immediately decelerated and the play function is preselected. As soon as the magnetic tape has come to a standstill or achieved the nominal speed in the play direction, the machine switches to play mode.

Any tape transport function can be selected independently of the current operating state of the machine. The microprocessor checks automatically the validity of the command and protects the tape by first decelerating it before the opposite sense of rotation or a slower speed is activated. A SHUTTLE or locator function can also be selected directly.

cleaning the capstan motor When no tape is mounted (tape tension sensor in idle position, light barrier not covered), you can switch on the capstan motor for cleaning the shaft by pressing the PLAY [33] key. The motor rotates for as long as the key is pressed.

2.4.7 Reverse play mode

By simultaneously pressing the SHIFT [23] and PLAY [33] keys, the tape recorder can be switched to REVERSE PLAY for searching a tape location or for achieving special effects. Any tape transport command, including the SHUTTLE and the locator function can be selected directly from reverse play mode.

2.4.8 Varispeed control [52]

In reproduce as well as play mode, the variable tape speed can be selected by simultaneously pressing the two keys SHIFT [23] and VARISPEED [52]; the red LED next to the VARISPEED key flashes. The deviation from the nominal tape speed can be selected with the DEVIATION [51] potentiometer within the range of ± 7 semitones (+7 to -1.5 semitones at 3.75 ips). The tape speed can also be altered by means of an external varispeed control (option). When the external varispeed control is activated, the internal control frequency is automatically disabled.

Notes:

The delay time for the drop-in and drop-out is matched to the corresponding nominal speed; these delays are not adjusted in varispeed mode! The indication of the tape timer no longer corresponds to the true elapsed time but rather to the playing time at nominal speed.

2.4.9 Record mode REC [35]

The information in this Section do not apply to "playback only" models (PBO)!
--

When the REC [35] and the PLAY [33] keys are pressed simultaneously, the tape recorder switches to record mode provided at least one channel has been enabled with the READY [36/56] key and the red LED next to the key flashes. During a recording the LEDs of the REC [35], PLAY [33], and READY [36/56] keys are continuously light.

The setting of soft jumper 11 (for programming details see 2.5.2) can be changed in such a way that the record mode can be activated from play mode by simply pressing the REC [35] key (but PLAY and REC still have to be pressed to enable recording from the STOP condition).

From record mode it is possible to switch directly to fast wind, play or a locator function by pressing the corresponding key. The STOP [34] command immediately interrupts the record mode. Channels that are switched to SYNC reproduction automatically switch to INPUT with the drop in and back to SYNC with the drop out.

Drop-in:

Click-free changeover from SYNC reproduction to record mode is possible. Depending on the soft jumper setting, this is possible by either pressing REC [35] together with PLAY [33] or only the REC [35] key. The record head is switched on with a speed-dependent delay so that the erase head and the record head are enabled at exactly the same tape location.

Drop-out:

Click-free changeover from record mode to SYNC play mode is possible by pressing the PLAY [33] key. The record head is switched off with a speed-dependent delay so that the erase head and the record head are switched off at exactly the same tape location.

Notes: Since the machine interrupts a recording immediately when the STOP [34] key is pressed, the drop-out process can no longer be executed. For joining recording segments without a gap it is necessary to switch from record to PLAY before STOP is activated. For the drop-in we recommend that you first switch to PLAY [33] and then to record (in order to prevent inaccuracies caused by the tape start).

Overlapping drop in: If e.g. an applause is to be faded in with overlap at the end of a recording, the magnetic tape can be lifted off the erase head by means of the tape lifter [6]. The machine is then restarted in record mode and the tape lifter slowly released. The tape first contacts the record head and the applause is added to the existing modulation. When the tape lifter is released, the tape also contacts the erase head. The existing modulation is erased and only the applause is recorded.

2.4.10 SYNC reproduction SYNC [38]

The SYNC [38] key switches the corresponding channel to SYNC reproduction. This means that the output audio signals are not supplied by the reproduce head but by the record head via the reproduce amplifier.

Since there is no time offset between the record and the "reproduce" head in this mode, it is possible to add a synchronous recording to a channel with an existing recording (e.g. vocalization of instrumental music).

Procedure: Synchronous recording to channel 1

- Switch channel 1 to SYNC [38].
- Switch channel 2 to READY [36] and connect MIC to CH2.
- Select MIC ON [44] and adjust the sensitivity with the potentiometer [46]. (Possibly activate the attenuator [45], switch the phantom power on or off).
- Start the machine in record mode
- Monitor the music of channel 1 via the headphones [58] and add the vocal part via the microphone.

For technical reasons, the sync reproduce frequency response is limited to approx. 6 kHz at 3.75 ips, 10 kHz at 7.5 ips, 12 kHz at 15 ips, and 12 kHz at 30 ips. A degradation in quality is, therefore, inevitable with SYNC reproduction.

SYNC preselection: SYNC reproduction can be preselected for a channel that has been readied for record mode. When the SYNC [38] key is pressed during a recording, the corresponding channel is connected to the INPUT. This channel is automatically switched to SYNC reproduction when the drop-out occurs (PLAY, STOP).

2.4.11 Spooling mode < > [31/32]

The < [31] key activates the fast wind in the forward direction, the > [32] key in the rewind direction. The tape will be wound at the maximum spooling speed. The spooling functions are cancelled by STOP [34], PLAY [33], REC+PLAY [35,33], SHUTTLE [28], TAPE DUMP [30], LOC functions and by spooling in the opposite direction. It is admissible to switch from spooling directly to play or record mode. The LED of the preselected function flashes; the magnetic tape is decelerated, and the preselected function is only activated when the tape has come to a stop or reached the nominal speed.

Tape lifting

In spooling mode the tape is automatically lifted off the heads in order to minimize the wear of the tape and the audio heads.

- Automatic cueing:

When the programmable LIFTER [26/27] keys is actuated (different functions can be assigned to the keys [26] and [27] by setting the respective soft jumpers [9 + 10], (see section 2.5.2) the tape lifter is retracted so that the tape makes contact with the audio heads. Depending on the setting of the soft jumpers, the tape lifting is defeated either for as long as the key is pressed or until the key is pressed again.

- Manual cueing:

Cueing in spooling mode is possible by manually pressing the pinch roller [13] against the capstan shaft. The closer the tape is pushed against the reproduce head, the stronger the output signal. For safety reasons it is not possible to press the pinch roller completely against the capstan shaft.

Note:

In order to protect the treble speaker of the monitor boxes from overloads when the cueing function is active in spooling mode, the reproduce level is automatically attenuated by 12 dB.

2.4.12 Producing pancakes at reduced spooling speeds, LIBRARY WIND

The reduced spooling speed is intended for pancakes that are to be saved in a library. The tape is wound more gently and, due to the absence of an air cushion between the individual layers, also more tightly.

The library wind function is activated by pressing and holding down the SHIFT [23] key and simultaneously pressing the spooling key < [31] or > [32]. The library wind function is cancelled as soon as any tape transport function is selected.

To ensure that a smooth pancake can be produced with any type of tape, the reduced spooling speed can be individually adjusted with the trimmer potentiometer SHTL located below the left-hand tape splicing block [10].

2.4.13 Stop mode STOP [34]

The STOP [34] key has the highest priority and cancels all operating states such as play, record, spooling, SHUTTLE, and the LOC functions. The tape is immediately decelerated after this function has been selected. Any new command entered during the deceleration phase of the tape is stored and immediately activated when the tape speed required for this function is achieved.

2.4.14 Locator Z-LOC, LOC1 (LOC2, LOC3, LOC START) [24-27]

Depending how the keys [26] and [27] are programmed, up to three transfer locators and one zero locator are available (for programming refer to Section 2.5.2). All locator addresses refer to the main tape timer. When a locator function is called with activated auxiliary timer (LAP [20]), the machine switches from the auxiliary timer to the main timer before the locator function is executed. The LAP function remains switched off.

LOC: When the Z-LOC [24] key is pressed, the tape is wound forward or backward at high speed until the tape location corresponding to the timer address 00.00.00 is reached.

LOC START: When the LOC START [26/27] key is pressed, the tape is wound forward or backward at high speed until the tape address is reached at which PLAY or REC was activated the last time from STOP mode (prerequisite: standstill of the tape). The machine then switches to STOP mode. The play or record function can be preselected by pressing the corresponding key while the tape is being positioned. The LED of the selected function flashes until the function is performed.

LOC1...LOC3: At least one transfer locator is always available with the LOC1 [25] key. One additional transfer locator each (LOC2, LOC3) can be assigned through corresponding programming of keys [26] and [27]. In this way up to three tape addresses can be stored and automatically searched at high speed by pressing the corresponding key. The locate function can be cancelled by pressing [34], < [31], > [32] or by selecting a different LOC function. As is the case for the LOC START function, the play and record functions can be preselected.

Programming the locator addresses:

- Storing the current tape address:
Position the magnetic tape at the desired tape address, press the SET [17] (the first digit in the display [22] flashes), and then the key of the transfer locator (LOC1...LOC3) in which the tape address is to be stored.
- Storing a known tape address:
The locator address can also be entered via the keyboard without positioning the magnetic tape. Press the SET [17] key; the first digit in the display flashes. With the STEP [19] key you can now alter the value of the digit in single steps. Then press the SEL [18] key to access the next digit and alter it with the STEP [19] key. Repeat these steps until the tape address to be stored is shown on the display.
Store the tape address by pressing one of the locator keys (LOC1...LOC3).

Reading out a LOC address:

- During a LOC process: Press the corresponding LOC key a second time.
- In any other operating mode: Press the SHIFT [23] key and then the corresponding LOC key.
Whenever the display [22] does not indicate the current tape address, the two separating dots between the hours and minutes and between the minutes and the seconds flash.

Note: The locator addresses always relate to the actual tape address and are automatically converted when the tape counter is set to zero (RESET [21] key). When a different tape speed is selected, the current counter content as well as all locator addresses are recomputed and remain stored even when the tape recorder is switched off.

2.4.15 Programmable functions

The programmable keys [26] and [27] (soft jumper 09 and 10) as well as [53] and [54] (soft jumper 13) can be assigned to different function by changing the soft jumper status. The programming method is described in section 2.5.2.

KEY	SOFT JUMPER		STATUS
[26]	09	MODE ASSIGNMENT SOFTKEY 1 (Default status = 1)	0 = LOOP 1 = LOC START 2 = LOC 2 3 = LOC 3 4 = BACKSPACE 5 = FADER READY
[27]	10	MODE ASSIGNMENT SOFTKEY 2 (Default status = 4)	6 = LIFTER AS MOMENTARY KEY 7 = LIFTER FLIP-FLOP KEY 8 = REHAERSE

[53] [54]	13	MODE ASSIGNMENT AUDIO SOFTKEYS	2 CHANNEL VERSION	0 = TAPE A/B CCIR 1 = TAPE A/B NAB * 2 = REPRO HEAD A/B CCIR* 3 = REPRO HEAD A/B NAB 4 = CHANGE EQUILIZATION CCIR/NAB
[60]			TC 1/4" VERSION	0 = TAPE A/B CCIR 1 = TAPE A/B NAB 4 = CHANGE EQUILIZATION CCIR/NAB
WITHOUT			4 KANAL VERSION	0 = CCIR 1 = NAB

* Only when second Head is available (option); not available in Timecode-versions.

LOC: The locator functions are described in Section 2.4.14.

LOOP: This function performs a continuous loop between tape address 00.00.00 and the address stored in LOC1. The lower of the two addresses (timer reading 00.00.00) or a negative address in LOC1 is taken as the starting address. When the LOOP key is pressed the magnetic tape is positioned at the starting address and the play mode is activated until the ending address is reached. At this point the tape is automatically rewound to the starting address and the play mode is reactivated. This procedure is repeated until the LOOP function is cancelled with the input of a new tape deck command.

- BACKSPACE:** While this key is pressed, the tape is rewound at approximately 4 times the nominal play speed (depends on the selected nominal play speed) without lifting the tape from the soundheads. The reproduce path is enabled for monitoring. PLAY is automatically reactivated when you release this key.
- LIFTER:** Depending on the soft jumper programming of the LIFTER function, the tape lifter is defeated either until this key is pressed again (soft jumper [9] or [10] set to status 7) or only for as long as this key is pressed (soft jumper [9], [10] set to status 6).
For a detailed description of the LIFTER function refer to Section 2.4.11 Tape lifter.
- REHEARSE:** Simulates a recording (insert mode)
For channels selected with the READY [36] key, the sync signal is replaced by the input signal after the record command has been entered. However, the erase and record currents are not switched on. The sync/input changeover occurs at the right moment.
When the REHEARSE function is selected, the LEDs of the tape deck keys PLAY or PLAY and REC flash.
- FADER READY:** Four different fader start modes can be selected. They are called mode A, B, C, and D.
Depending on the selected fader start mode (set with soft jumper 12), a FADER READY KEY may be required for enabling or disabling the fader start circuit (such a switch is required for mode B, C, and D).
Rather than with an external switch, this function can also be performed with key [26] or [27]. When the fader start circuit is enabled (FADER READY [26 or 27]), the yellow LED next to the key as well as the FAD LED in the display window [22] are light to signal the fader ready condition. When this key is pressed again, the circuit is disabled, the LEDs switch off, i.e. opening of the fader has no effect on the tape recorder. When the SHIFT [23] key is pressed together with the built-in fader ready key, the tape recorder starts in record mode when the fader is opened, provided at least one channel is switched to READY [36].
- CCIR/NAB:** These keys are used for changing over between CCIR [53] and NAB [54] equalization standard which can be individually calibrated. The method of programming the keys [53/54] is described in Section 2.5.2
- NAB** On timecode units the NAB [60] key changes over between CCIR and NAB equalization standard and vice versa if the soft jumper is correspondingly programmed.
If the yellow LED next to the NAB [60] is light, NAB equalization has been selected.
If the yellow LED next to the NAB [60] key is dark, CCIR equalization is selected.
Different audio calibration parameters can be stored for the NAB and CCIR standard.
- TAPE A / TAPE B:** In this mode the keys [53/54] are used for changing over between two individually calibrated tape types (type A and type B). This is possible with CCIR or NAB equalization selected. The method of programming is described in Section 2.5.2

- TAPE B:** On timecode units the TAPE B [60] key changes over between the two individually calibratable tape types A and B if the soft jumper is correspondingly programmed. If the yellow LED next to the TAPE B [60] key is light, tape type B is selected. If the yellow LED next to the TAPE B [60] key is dark, tape type A is selected.
- HEAD A/HEAD B: *** In this mode the keys [53/54] are used for switching from the standard reproduce head (in REPRO mode) to the optional second reproduce head. This is possible with CCIR or NAB equalization selected. The reproduce level for each reproduce head is individually adjustable. The method of programming is described in Section 2.5.2
- * On time code units this programming is not possible, i.e. when soft jumper 13 is selected, only the states 0, 1 and 4 can be selected.

2.4.16 Fader start

With the fader start circuit, the tape recorder can be started in PLAY mode by means of 5V...24 V DC or AC applied by a remote control unit between pins 11 and 12 of the parallel remote control socket. In the operating modes (FADER B, C, or D), the fader start must be enabled ("FADER START READY") by a switch that interconnects pin 6 (SR-READY signal) and 1 (ground) of the same socket. Direct fader start selection without a ready key is only possible in FADER A mode. The fader can also be enabled with the programmable FADER READY [26] [27] key of the local keypad or on the optional remote control. The function programmed in the tape recorder (FADER B, C, or D) is performed. When they SHIFT [23] key is pressed together with the local fader ready key [26] [27], the machine is started in record mode when the fader is opened, provided at least one channel has been set to READY [36].

Important: When the FADER READY function is switched off or when no READY [36] key is selected, fader start ready is automatically cancelled.

FADER A: Fader start without FADER START READY key. After the fader start the local keypad and the remote control keys are disabled, the built-in monitor speaker is muted (but not the headphones!). When the fader is pulled back (the fader switch opens), the tape recorder stops, but the built-in monitor speaker is only unmuted when the tape has come to a standstill. The machine can now again be operated.

FADER B: Fader start with FADER START READY key. In order to activate the fader start function, the FADER READY key must be selected (FAD LED in the display window [22] is on). After the fader start, the local keypad and the remote control keys are disabled, the built-in monitor speaker is muted (but not the headphones!). When the fader is pulled back (the fader switch opens), the tape recorder stops, but the built-in monitor speaker is only unmuted when the tape has come to a standstill. The machine can now again be operated. If the fader switch is actuated but the fader ready key has not been pressed (FAD LED is dark), the operating state of the tape recorder does not change. Exception: in play mode the built-in monitor speaker is muted when the fader is opened and unmuted when the fader is closed.

FADER C: Fader start with FADER START READY key. After the fader ready key has been pressed, the local keypad and the remote control keys are disabled. The machine can only be started by opening the fader. The built-in monitor speaker is muted (but not the headphones!). If the fader switch is actuated but the fader ready key has not been pressed, the operating state of the tape recorder does not change.

Exception: in play mode the built-in monitor speaker is muted when the fader is opened and unmuted when the fader is closed.

FADER D:

Fader start with FADER START READY key. Regardless of the position of the fader read switch, the local keypad and the remote control keys remain enabled, even after the fader start. The built-in monitor speaker is muted (but not the headphones!). If the fader switch is actuated but the fader ready key has not been pressed, the operating state of the tape recorder does not change.

Exception: in play mode the built-in monitor speaker is muted when the fader is opened and unmuted when the fader is closed.

FADER MODE TRUTH TABLE:				
FADER MODE	A	B	C	D
FADER READY-KEY REQUIRED FADER READY-NOT REQUIRED	▪	▪	▪	▪
INTERNAL MONITOR MUTED	▪	▪	▪	▪
FADER CLOSED TRANSPORT DECK KEYS ENABLED TRANSPORT DECK KEYS DISABLED	▪	▪	▪	▪
FADER OPEN TRANSPORT DECK KEYS ENABLED TRANSPORT DECK KEYS DISABLED	▪	▪	▪	▪
LED Fader ready LED Light = Fader start activ LED off = No fader start possible				

2.4.17 Tape timer [22]

The electronic tape timer always displays the real tape time in hours, minutes, and seconds, relative to the selected nominal tape speed (exception: varispeed mode). The timer has a display range -9 h 59 min 59 s to 99 h 59 min 59 s. The timer can be set to zero (00.00.00) by pressing the RESET [21] key.

When the end of the tape, a torn tape, or the tape leader is detected, the timer stops automatically. In waste basket mode (TAPE DUMP [30]) the timer continuous to run or stops, depending on the setting of the soft jumper 05 (Section 2.5.2).

Tape segments can also be timed (Section 2.4.18 Auxiliary timer).

In "adj" mode (Section 2.5.3) the tape timer display shows the setting of the audio parameters; in soft jumper programming mode (Section 2.5.2) it shows the setting of the selected software switch. When the SHIFT key is pressed followed by a LOC key, the tape timer displays the content of the locator assigned to the corresponding key.

Note: The locator addresses always relate to the actual tape address and are automatically recomputed when the tape timer is set to zero (RESET [21] key).

Setting the tape timer:

Starting with software release 15/90, the tape timer can be set.

If the A807 is parked at the start of a music selection with a known start time, the start time can be read into the time timer if the tape timer reading deviates.

Procedure:

- Press the SET [17] key (first digit of the display flashes). If necessary modify the first digit with the STEP [19] key, otherwise press the STEP [19] key to advance to the next position to be modified, and set this position with the STEP [19] key to the desired starting time according to the list of selections. When you press the SHIFT [23] and SET [17] keys the start time is read into the tape timer and stored. All LOCATOR positions are recalculated so that the stored tape addresses are retained.

Exception:

- The zerolocator no longer parks at the old tape address, it now parks at the new zero position.

2.4.18 Auxiliary timer LAP [20]

The LAP [20] key activates a second (auxiliary) tape timer with a user-selectable reference (zero setting). The auxiliary timer mode is signalled by the LAP LED in the display window. The auxiliary timer can be set to zero (RESET [21] key at any tape address and can thus be used for determining the exact playing time of a selection without influencing the main timer or having to compute the difference between the start and the end time. When the LAP [20] key is pressed a second time, the display switches back to the main timer, the LAP LED switches off.

Note: When the LAP function is active, it is not possible to set a locator address. The locator addresses always relate to the main timer. When a locator key is pressed, the LAP function is automatically cancelled, the main timer is activated, and the tape is positioned at the selected locator address.

2.4.19 MONO/INSERT [55] (not available by 4-channel versions)

On two-channel and stereo models with channel selector buttons, this key is labelled with MONO; on all other models with INSERT. However, the actual function is always the same: the internal insert point of the 0 Ω amplifier is activated in the audio input and output path.

On stereo models the optional MONO/STEREO switch can be connected into the circuit at this point. A noise reduction system (Dolby) or a supplementary circuit of a different type can also be connected here.

The function of the MONO (INSERT) [57] key is enabled by moving the jumper JP48 (for 1/2" versions JP46) on the COMMAND PANEL BOARD 1.727.660.81 to position "B". The Audio control board 1.727.670.82 straps IS3, IS4, IS5 and IS6 on position B must change by setting, so that the audio signals can be looped via the INPUT or the OUTPUT INSERT BOARD (MONO/STEREO SWITCH). With the jumpers JS1 and JS2 on the AUDIO CONTROL BOARD the user can define, whether the signal for the built-in monitor speaker is to be tapped before or after the insert point (Fig. 2.4.7).

To enable this function, the SHIFT [23] key must be pressed and held while the MONO or INSERT [57] key is pressed. When SHIFT and MONO/INSERT are pressed again, the function is switched off.

MONO	The various modes of the MONO/STEREO switch are programmed by changing jumper settings.
Input:	On the input section by setting the jumpers JP1 and JP2 on the M/S INPUT AMPLIFIER 1.727.441.00 / 451.00.
MONO MODE A:	The input signal of channel 1 is recorded simultaneously on channel 1 and channel 2 (JP1 = A, JP2 = B).
MONO MODE B:	The input signals of channel 1 and 2 are added and the aggregate signal recorded simultaneously on both channels (JP1 = A, JP2 = A).
MONO MODE C:	The input signal of channel 2 is simultaneously recorded on channel 1 and channel 2 (JP1 = B, JP2 = A).
Output:	On the output side by changing the jumpers JP1 and JP2 on the M/S OUTPUT AMPLIFIER 1.727.442.00 / 452.00.
MONO MODE A:	The mono reproduce signals of channel 1 and channel 2 are added and reproduced via the output channel 1 (OUTPUT CH1) (JP1 = A, JP2 = B), the output channel 2 (OUTPUT CH2) remains muted.
MONO MODE B:	The signals of both channels are added and the aggregate signal is simultaneously reproduced via both outputs (OUTPUT CH1, CH2) (JP1 = A, JP2 = A).
MONO MODE C:	The mono reproduce signals of channel 1 and channel 2 are added and reproduced via the output channel 2 (OUTPUT CH2) (JP1 = B, JP2 = A), the output channel 1 (OUTPUT CH1) remains muted.

2.4.20 Remote control

The following functions can be remote controlled with the parallel remote control: Play, record, spooling, stop, reset timer, zero loc, loc start, lifter, varispeed on/off and fader (fader ready) indirectly also back space (PLAY + <). Please note that the backspace speed is identical to the one in the rewind function, i.e. no matching to the normally selected tape speed.

The pin assignment of the remote control connector and the connection configuration are described in Section 2.3.3.

2.4.21 External VU-meter panel

Tape recorder versions with VU meter panel (VUK) are equipped with the following operator controls:

- [40] VU-meter(s) for level indication
- [41/48] Potentiometers for decreasing/increasing the output signal level, if
- [42/49] the UNCAL keys are active.
- [37 - 39] Output selector for determining the output signal on the XLR socket (input, SYNC or reproduce signal)
- [36] Ready key to enable recording.
- [4] Monitor speaker. (Automatically muted when the headphones [61] are plugged in)
- [68, 69] Channel selection keys for monitoring the desired channel or both channels.
- [65] Volume control (also influences the volume on the headphones socket [61] of the tape recorder).
- [66, 67] Monitor selection keys. Determine whether the input or output signal are to be monitored (source/tape monitoring).

2.4.22 External stereo monitor panel

An external stereo monitor panel (with or without VU meters) is available as an option. It contains the following controls:

- [66, 67, 70] Monitor selection keys. Select the signal to be monitored.
 - INPUT = Monitor the input signal (source monitoring)
 - OUTPUT = Monitor the output signal (tape monitoring)
 - AUX = Monitor the auxiliary input (input signal from 5-pin XLR connector).
- [65] Volume control (also influences the headphones socket [61] on the tape recorder.
- [68, 71] Channel selection keys
 - If one of the keys [68] is pressed, the audio signal of the corresponding channel is connected to the monitor speaker.
 - If key [71] is pressed, the left-hand speaker processes the signal of channel 1 and the right-hand speaker the signal of channel 2 (stereo mode).

2.4.23 Test generator (option) (only for 2-channel versions)

A test generator can be installed as an option in all 2-channel versions of the A807 MKII. The optional test generator includes the MONO/STEREO switch. If only the test generator is required (without the MONO/STEREO switch), the MONO (INSERT) [57] key can be disabled by changing the position of jumper JP48 on the command panel board 1.727.662.83 (or 1.727.762/63/66.00 in time code units) below the front tape deck cover.

- Jumper JP48 in position H as illustrated = mono/stereo switch disabled.
- Jumper JP48 in position L = mono/stereo switch enabled.

Command panel: 1.727.662.83

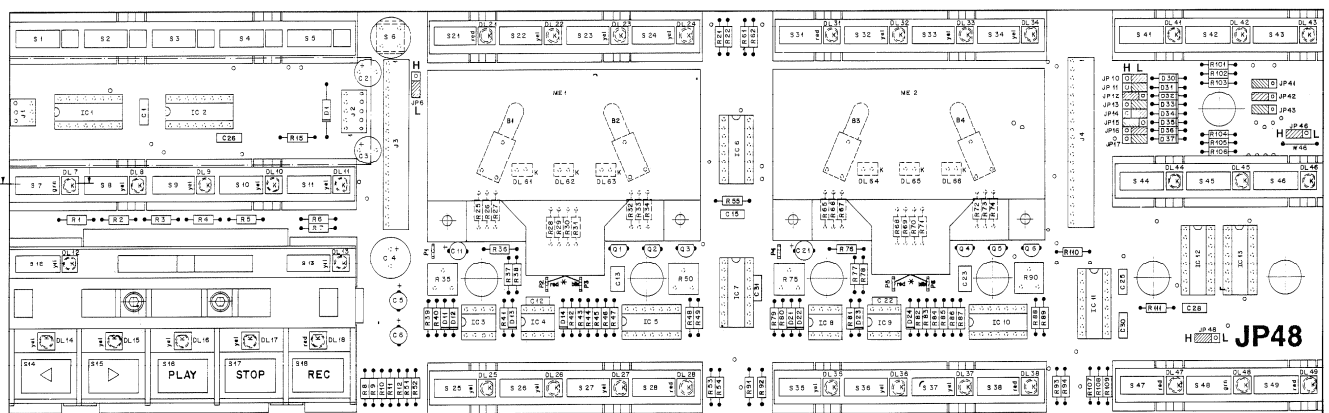

Fig. 2.4.13

The controls of the test generator are accessible from the operator panel and can be adjusted with a screwdriver. The test generator is switched on and the test frequency (60Hz, 125Hz, 1kHz, 10kHz, 16kHz) of the sine wave generator is set with the Hz [62] switch. The test generator is disabled when this switch is in the OFF position.

- Note:** When operating with the test generator, make sure that no signals are available on the inputs (MIC INPUT and LINE INPUT). This signal would be mixed with the generator signal and could lead to measurement errors.
- On models without input selector, the signal cables on the inputs should be detached.
 - On models with input selector the inputs should be switched off (MIC ON [44] and LINE ON [43] in off position).

The booster amplifier is operated with the dB [63] switch. The generator level can be attenuated by 10 or 20dB. At the same time the gain in the reproduce path is automatically increased by 10dB or 20dB; in this way the reference value of the VU-meter is the same as for nominal level. The booster amplifier can also be used when the test generator is switched off, e.g. when playing a reproduce test tape.

2.4.24 Editing, cutting the tape

Searching a tape address with fast wind

Any tape address can be searched by means of fast forward > [32] and rewind < [31] keys. However, additional facilities have been provided that may be more convenient: SHUTTLE [28/29], Z-LOC [24], LOC1 [25], and, depending on the internal programming (Softjumper 09 and 10), the keys [26] and [27] which support the following functions: LOC START, LOC2 LOC3, BACKSPACE.

The locator functions are described in Section 2.4.14, the BACKSPACE function in Section 2.4.15.

SHUTTLE [28/29]

The SHUTTLE [28] key activates the editing mode. The tape is not lifted so that cueing is always possible. Editing under assistance of the spooling motors is possible with the aid of the SHUTTLE CONTROL [29] wheel. When this wheel is turned, the tape is spooled in the corresponding direction. The greater the deflection of the wheel from its home position, the faster the spooling speed. An edit point can thus be conveniently searched and approximately aligned. For fine-positioning of the edit point, the tape can be moved forward or backward by manually turning the right-hand spindle [3]. The tape tension control and the reproduce paths are enabled.

Marking the tape:

The center of the reproduce head (head gap) can be marked on the reverse side of the tape by means of a grease pen or a soft pencil. A tape marker [11] is available as an accessory. A light pressure on the marking lever marks the tape with a stamp exactly at the reproduce head gap.

The tape can subsequently be cut at the marked position.

Cutting the tape:

The tape can be easily lifted off the reproduce head by means of antimagnetic scissors and cut exactly in front of the head gap. If the position of the reproduce head gap has previously been marked, the tape can be transported up to the optional scissors [12] and cut or be inserted manually into the optional cutting block [14] on the head shield or below the head block, and cut with a razor blade.

Splicing the tape:

The two tape sections to be joined are inserted with the reverse (marked) side facing up into the splicing block [10] or the cutting block [14] (only for 1/4" versions). The ends are butted together without overlap and spliced with an adhesive tab that is approx. 20 mm long and 1/4" (1/2") wide.

2.4.25 "Waste basket mode" TAPE DUMP [30]

In "waste basket mode" (TAPE DUMP [30] key) the right-hand spooling motor [3] is disabled. Unwanted tape segments can thus be played into the waste basket. When the TAPE DUMP [30] key is pressed, the machine switches either to play or preselects the "waste basket mode", depending on the programming (see 2.5.2) with the soft jumper 08.

Mode A (soft jumper 08 in position 0):
The TAPE DUMP [30] key functions as a preselector. The "waste basket mode" is activated by pressing the PLAY [33] key. The tape is played but not wound up. The STOP [34] key interrupts the tape feed, but the TAPE DUMP function remains active until it is cancelled by pressing the TAPE DUMP [30] key again. When the "waste basket mode" is active, all tape transport functions except < [31], PLAY [33], and STOP [34] are disabled.

Mode B (soft jumper 08 in position 1):
The "waste basket" mode is activated directly by pressing the TAPE DUMP [30] key. The machine stops when this key is pressed again.

Retraction of a loose tape segment:

(only possible in TAPE DUMP mode A):

If too much tape has been unwound in "waste basket" mode, it is not necessary to rewind it manually. Simply tension the tape with two fingers of your right hand (preferably gloved) and continually hold down the < [31] key. The left-hand spooling motor [2] rotates and slowly takes up the loose tape. (Fig.2.4.8)

This process can be stopped by releasing the < key.

The motor torque is limited and controlled in such a way that the tape can be easily decelerated by hand. As soon as the tape is released, the motor continues to run only very slowly. The motor speed can be increased by a lightly tensioning to the tape segment.

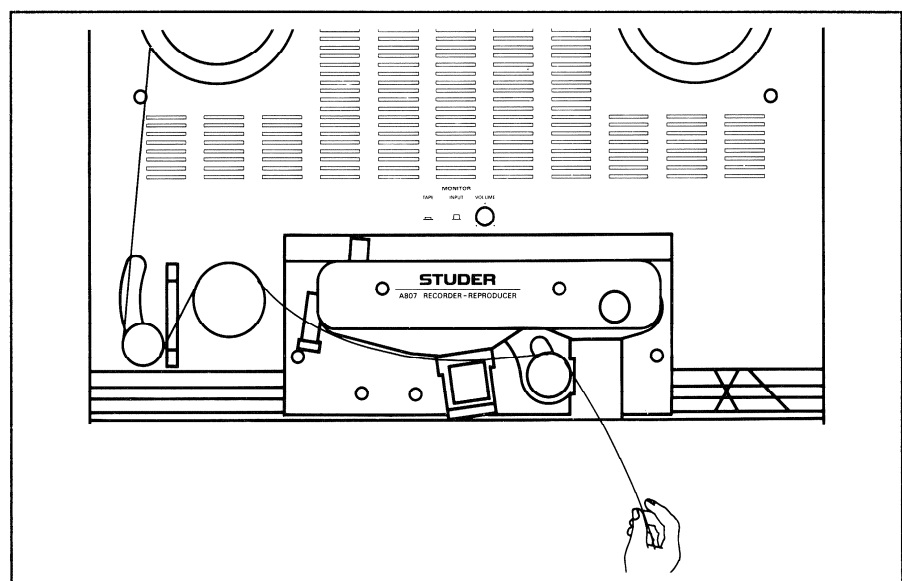

Fig. 2.4.8

For monitoring a recording while a loose tape is being drawn in with the right-hand spooling motor [3], the special dump edit mode can be preselected by pressing the TAPE DUMP and subsequently the SHIFT [23] key (Fig.2.4.15) In this mode the TAPE DUMP LED flashes. You can start this function by pressing the PLAY [33] key. The left-hand spooling motor is disabled and the loose tape is wound up by the right-hand motor. At the same time you can check the recording on the tape at the selected speed via the monitor speaker. Press TOP to terminate this mode.

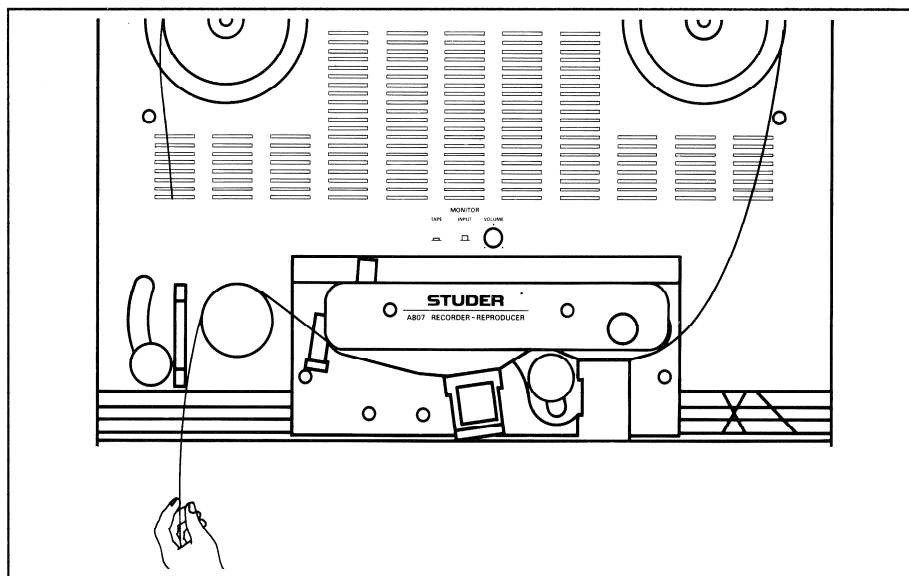

Fig. 2.4.15

If the spliced tape is inserted loosely in the tape path, i.e. if the tape tension sensor is not deflected, you can wind the tape on the right-hand reels in section by pressing the key PLAY [33], < [31], or > [32].

To signal that no tape is inserted or that the tape is inserted only loosely, the LED or STOP key flashes for 10 seconds (i.e. the tape sensor lever is in the home position); subsequently the LED is switched off.

To make sure that no tape is inserted (particularly if the machine is remote controlled and if there is no direct line of sight to the tape recorder), the LED can be restored to the flashing condition for another 10 seconds by briefly pressing the STOP key. If the LED remains dark, the STOP LED (or the stop lamp of the remote control) is defective.

Playing a discarded tape segment

After a long editing session it may happen that many tape sections have been cut and that it is no longer clear as to which piece belongs where and which end of the tape is the beginning or the end.

With the A807 tape recorder you can play cut segments without first joining them and winding them on a reel.

Procedure:

- Thread the tape according to (Fig.2.4.16) and select the TAPE DUMP [30] function.
- With two fingers of your left hand tension the left-hand tape end in such a way that the tape makes contact with the head.
- In TAPE DUMP mode A start the reproduction by pressing the PLAY [33] key. The PLAY function can be cancelled by pressing the STOP [34] key.

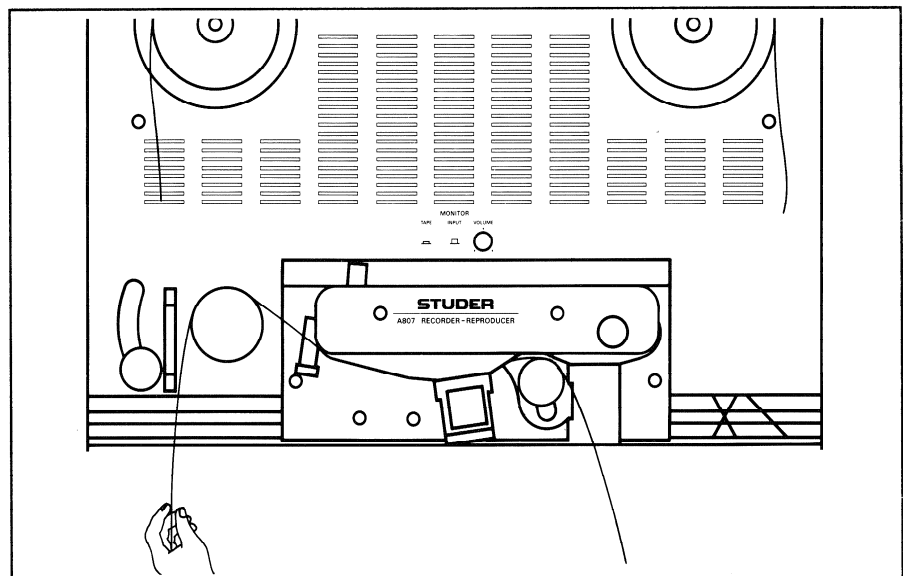

Fig. 2.4.16

2.5 Programming

SW versions 20/92 and up

2.5.1 Hardware jumpers ¼" and ½" versions

Command panels

1.727.660.81–668.81

After the round knobs have been removed by pulling them off and the four fixing screws have been unfastened, the cover of the operator panel can be removed and the jumpers become accessible.

Jumpers 10 to 17 should only be changed if a version has been modified into another one.

Jumper 13

If jumper 13 (ready key version) on tape recorders equipped with ready keys [36] is set to position H (no ready keys), the effect will be that after power up the ready function (ready for recording) is automatically selected.

Jumper 6

With jumper 6 you can prevent unauthorized persons from modifying the audio calibration data in the RAM or the settings of the soft jumpers. For this purpose set jumper 6 to the position "H" (non operable). This disables the push button [16].

Jumper 46/48

Jumper 46 (on 1/2" versions) or 48 (1/4" version) enables the INSERT or (MONO) function [57].

If the mono/stereo selection electronics of the option external insert point is retrofitted, the corresponding jumper must be changed to position "L" (key enabled).

If the optional test generator is installed, the mono/stereo selection electronics is always included. Jumper 46 or 48 determine whether the mono/stereo selection electronics is also to be enabled.

- Jumper 46 or 48 in position "H" = Only the test generator is enabled.
- Jumper 46 or 48 in position "L" = Test generator and mono/stereo switch are enabled.

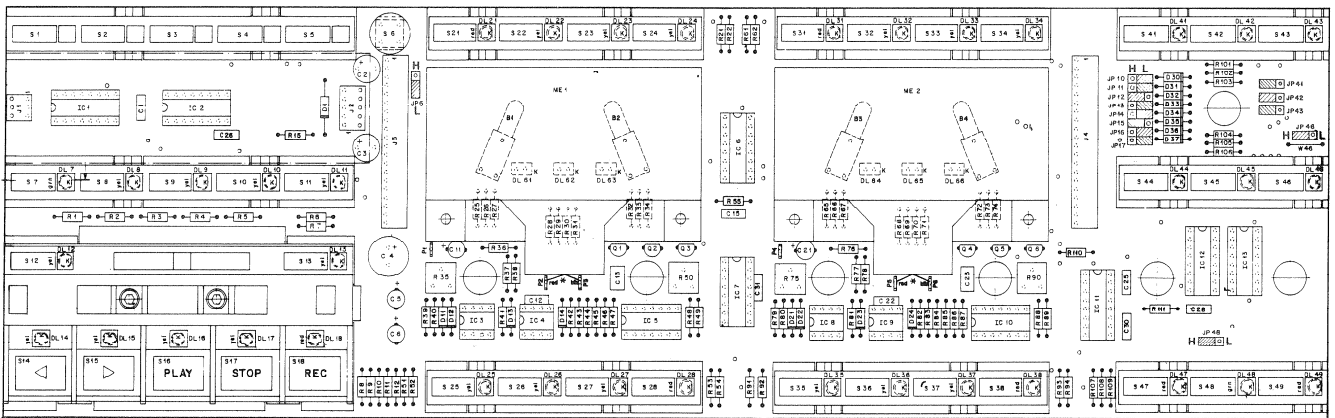

Command panel jumper 1.727.662 and 1.727.760...766











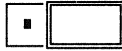



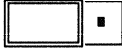



- Jumper 6** **Pos. H:** The programming of the softjumper is locked
Pos. L: The programming of the softjumper is enabled (see D2/56).
- Jumper 10** **Pos. H:** Settings for 4-Channel version
Pos. L: Settings for 2-Channel version
- Jumper 11** **Pos. H:** Settings for the high speed (HS) version 7,5, 15, 30ips.
Pos. L: Settings for standard speed version 3,75, 7,5, 15ips.
- Jumper 12** **Pos. H:** Settings for standard version with Record, Repro facilities
Pos. L: Setting Repro-only version (no Record facilities)
- Jumper 13** **Pos. H:** Version without READY-keys
Pos. L: Version with READY-keys
- Jumper 14** **Pos. H:** For erase heads with inline erasing tracks
Pos. L: For erase heads with staggered erasing tracks
- Jumper 15** **Pos. H:** Audio electronics board version: 1.727.47x.xx
Pos. L: Audio electronics board version: 1.727.46x.xx
- Jumper 16** **Pos. H:** Version with timecode tracks (TC-version)
Pos. L: Version without timecode facilities
- Jumper 17** **Pos. H:** Key-assignment for specific customer
Pos. L: Standard key arrangement
- Jumper 41-43** **Pos. H:** Version without timecode tracks (TC-version)
Pos. L: Version with timecode tracks (TC-version)
- Jumper 46** Only for 4-Channel versions
(Command-Panel) 1.727.666.xx and 1.727.766.xx
Pos. H: The INSERT- resp. MONO-key [S46] is locked.
Pos. L: The INSERT- resp. MONO-key [S46] is enabled.
- Jumper 48** Only for 2-Channel versions
Pos. H: The INSERT- resp. MONO-key [S48] is locked.
Pos. L: The INSERT- resp. MONO-key [S48] is enabled.

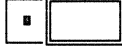

Command panel Hardware jumper

1/4" und 1/2" Versions

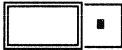

JUMPER		H	L	(H = ON, L = OFF)
06	ADJUST KEY			H = DISABLED L = ENABLED

10	CHANNEL VERSION			H = 4 CHANNEL L = 2 CHANNEL
11	SPEED VERSION			H = 7.5, 15, 30ips L = 3.75, 7.5, 15ips
12	ONLY PLAYBACK VERSION			H = STANDARD (REC/REPRO) L = PLAYBACK ONLYE
13	READY-KEY VERSION			H = WITHOUT READY KEY L = WITH READY KEY
14	ERASE HEAD GAP			H = INLINIE L = STAGGERED
15	VERSION OF AUDIO ELECTRONICS BOARD			H = 1.727.47x.xx L = 1.727.46x.xx
16	TIMECODE VERSION			H = WITH TC CHANNEL L = NO TC VERSION
17	SPECIAL KEY LAYOUT			H = SPECIAL KEY LAYOUT L = STANDARD KEY LAYOUT

Only for 1/2" version available

46	INSERT (MONO) S 46			H = KEY S46 NOT ACTIVE L = KEY S46 ACTIV
----	--------------------	---	---	---

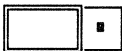
Only for 1/4" version available

48	INSERT KEY S 48			H = KEY S48 NOT ACTIV L = KEY S48 ACTIV
----	-----------------	---	---	--

These hardware jumpers are standard programming for A807 1/4" VUK-version (speed 3.75, 15 and 30ips, without time code)

Audio control PCB 1/4" 1.727.672.00

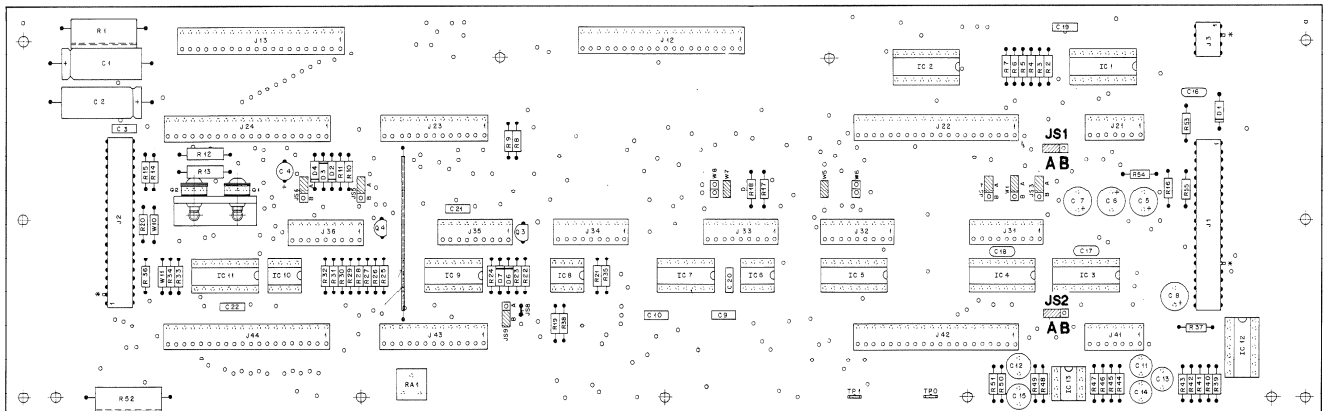

- Jumper JS1 In pos. A =** The input signal of CH1 is tapped before the insert point and fed to the XLR connectors and the monitor output.
- JS1 In pos. B =** The input signal of CH 1 is tapped after the insert point and fed to the XLR connectors and the monitor output.
- JS2 In pos. A + B =** Same as JS1, but applies to CH 2

Audio electronic PCB 1.727.470.00

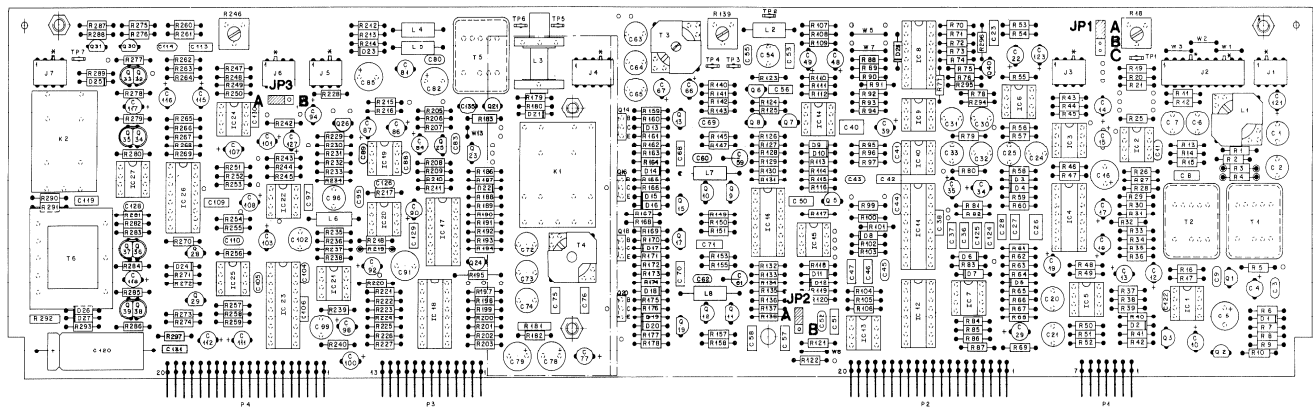

- Jumper JP1 =** Input level sensitivity
- Pos. A =** Input signal -4dB to +12dB (standard)
 - Pos. B =** input signal -17dB to -1dB
 - Pos. C =** Input signal -30dB bis -14dB
- JP2 =** Dolby HX PRO
- Pos. A =** Dolby HX PRO on (standard)
 - Pos. B =** Dolby HX PRO off
- JP3 =** Output level sensitivity
- Pos. A =** -4dB bis +12dB (standard)
 - Pos. B =** -17dB bis -1dB

2.5.2 Soft jumpers

SW versions 20/92 and up

Certain functions can be selected or deselected by means of so-called software jumpers. It is also possible to assign different functions to some of the keys (designated as soft keys).

Selection of the soft jumper program

Most of the operational parameters can be set by "soft jumpers" i. e. programmed by software. Programming is possible by operating keys "adj." [16] and SHIFT [23] together. Press then "channel" [20] repeatedly until the wanted soft jumper appears.

By "up" [26] and "down" [27] the status of the soft jumper can be changed to the required value. By press SHIFT [23] and channel [20] together the last status of soft jumper was aktiv. However the newly updated soft jumper settings become effective immediately. This change is not automatically stored (indicated by flashing decimal point in the display). By activating "store" [19] the new status will be memorized.

Example

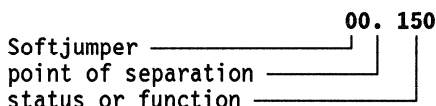

The soft jumper program can be terminated by pressing the adj [16] key again. All settings that have not been stored yet (flashing dot) will be lost. The newly stored soft jumper settings become effective immediately. Those that have not been stored are only effective for as long as the program is not terminated.

Soft jumper

JUMPER		STATUS
00	MUTE TIME FOR EACH SPEED	000 - 950 milliseconds in steps of 50 millisecc.
01	RS 232 BAUD RATE	12 = 1200 BAUD 96 = 9600 BAUD
02	RS 232 ECHO MODE	0 = OFF 1 = ON
03	TAPE STOP WITH TRANSPARENT TAPE	0 = OFF 1 = ON
04	MONO/STEREO CHANGEOVER switched automatically to mono at speed 3.75 and 7.5ips	0 = OFF 1 = ON
05	COUNTER STOP IN DUMP MODE	0 = OFF 1 = ON
06	RETURN OF PINCH ROLLER IN EDIT MODE	0 = OFF 1 = ON
07	SPEED CHANGE	0 = DIREKT SPEED CHANGE 1 = SPEED SHIFT WITH SHIFT ONLY

JUMPER		STATUS	
08	TAPE DUMP MODE	<u>0</u> = KEY "TAPE DUMP" PRESELECTS FUNCTION ACTIVATION WITH PLAY 1 = DIRECT ACTIVATION	
09	MODE ASSIGNMENT SOFTKEY 1 (Default status = 1)	0 = LOOP 1 = LOC START 2 = LOC 2 3 = LOC 3 4 = BACKSPACE 5 = FADER READY 6 = LIFTER AS MOMENTARY KEY 7 = LIFTER FLIP-FLOP KEY 8 = REHEARSE	
10	MODE ASSIGNMENT SOFTKEY (Default status = 4)		
11	RECORD COMMAND DEFINITION	<u>0</u> = KEY "REC AND PLAY" TO BE PRESSED TOGETHER 1 = IF MACHINE IN PLAY, PRESS "REC" ONLY.	
12	FADER START DEFINITION	<u>0</u> = A <u>1</u> = B (see truth table 2 = C on following page) 3 = D	
13	MODE ASSIGNMENT OF AUDIO SOFT KEY	2 CHANNEL VERSION	0 = TAPE A/B CCIR 1 = TAPE A/B NAB 2 = REPRO HEAD A/B CCIR 3 = REPRO HEAD A/B NAB 4 = CHANGE EQUILIZATION CCIR/NAB
		4 CHANNEL VERSION	<u>0</u> = CCIR <u>1</u> = NAB
		TC 1/4" VERSION	0 = TAPE A/B CCIR 1 = TAPE A/B NAB 4 = CHANGE EQUILIZATION CCIR/NAB
14	MODE ASSIGNMENT CHANNEL SELECTION KEY	<u>0</u> = INDIVIDUAL 1 = PARALLEL	
15	AVAILABLE TIMECODE ELECTRONIC	0 = ACTIV 1 = NOT ACTIV	
16	TIMECODE REFERENZ OF ASSIGNMENT REPRO/SYNC * not available in 2-channel	0 = NO REFERENCE 1 = CHANNEL 1 2 = CHANNEL 2 3 = CHANNEL 3 4 = CHANNEL 4	
17	MASTER SAFE	<u>0</u> = SAFE/READY SWITCH ACTIV 1 = MASTER SAFE	
18	TRANSPARENT TAPE COUNTING	<u>0</u> = TIMER STOPS ON CLEAR LEADER-TAPE 1 = TIMER ACTIVE ON CLEAR LEADER-TAPE	
19	CALIBRATED LEVEL	<u>0</u> = NO CALIBRATION 1 = CALIBRATED	

The underlined settings in the status field are the default values.

FADER MODE TABLE

FADER MODE TRUTH TABLE:				
FADER MODE	A	B	C	D
FADER READY KEY REQUIRED		n	n	n
FADER READY KEY NOT REQUIRED	n			
INTERNAL MONITOR MUTED	n	n	n	n
FADER CLOSED: TRANSPORT KEYS ENABLED TRANSPORT KEYS DISABLED	n	n	n	n
FADER OPEN: TRANSPORT DECK KEYS ENABLED TRANSPORT DECK KEY DISABLED	n	n	n	n
LED Fader Ready LED Light =Fader start activ LED off =No fader start possible				

Soft jumper 00

MUTE TIME

With the soft jumper 00, the mute time during the STOP-PLAY transition can be individually entered for each of the three tape speeds within the range of 00 ms to 950 ms in steps of 50 ms.

Soft jumper 01

BAUD RATE

The transmission rate (baud rate) of the serial RS232 interface can be set with the soft jumper 01. Two speeds can be set: 1200 or 9600 baud.

Soft jumper 02

ECHO MODE

Soft jumper 02 switches the echo mode of the serial RS232 interface on and off.

Soft jumper 03

LIGHT BARRIER

Soft jumper 03 switches the light barrier [8] on and off. When the light barrier is enabled, the machine switches to STOP when the transparent tape section is reached (or when a torn tape is detected). The tape recorder responds as follows in the various modes:

- In PLAY mode the machine stops immediately when the transparent tape section is detected. If transparent tape is in front of the light barrier when the machine is in STOP mode, the desired tape transport function (e.g. PLAY) must be pressed until the tape with the oxide coating covers the light barrier.
- In spooling mode (< or >) the tape recorder stops immediately when the transparent tape is reached. If the spooling key is continuously pressed, the transparent tape section will be skipped.
- In fader start mode the tape recorder also stops when the transparent tape is detected. If the transparent tape is in front of the light barrier when the fader is closed, the tape recorder starts in play mode when the fader is opened, and stops when the next transparent tape section is reached.
- Transparent tape sections are ignored in all LOCATE functions (Z-LOC, LOC1, etc.). The tape is positioned directly at the target address.
- Transparent tape sections are ignored in waste basket mode (TAPE DUMP).

- Soft jumper 04** **MONO/STEREO CHANGEOVER**
Soft jumper 04 controls the mono/stereo changeover as a function of the selected tape speed (only active when MONO/STEREO switch is installed). When the changeover is enabled, the MONO priority is automatically activated when the machine is switched on with either 3.75 or 7.5ips. STEREO mode is automatically selected when the machine is started with 15ips or 30ips.
- The selected states can always changed by pressing the SHIFT [23] and MONO [55] keys.
- Soft jumper 05** **COUNTER STOP IN DUMP MODE**
With the soft jumper 05 a counter stop can be set in TAPE DUMP mode. In this case the content of the tape timer is frozen when the TAPE DUMP [30] is selected. It is not updated as long as the "waste basket" mode is active. As soon as this mode is terminated, the tape timer continues to run from the frozen reading.
- Soft jumper 06** **PINCH ROLLER RETRACTION**
With the soft jumper 06 the pinch roller [13] can be retracted to the idle position when an "out-of-tape" condition is detected. An out-of-tape condition is recognized when there is no tape tension (tape tension sensor [9] in the idle position) and if no tape is detected by the light barrier [8] (both conditions exist e.g. during tape editing).
When the STOP [34] function is initiated or when the tape is edited with TAPE DUMP [30], the pinch roller stays in the cueing position.
- Soft jumper 07** **SPEED CHANGE**
To avoid speed changes by hazard, the speed key [50] can be locked and enabled only if the SHIFT key [23] is pressed at the same time.
- Soft jumper 08** **TAPE DUMP MODE**
With the soft jumper 08 you can define whether the dump edit mode is to be activated by pressing only the tape dump key [30] or whether this key is to be used as a setup key for the waste basket mode. In the latter case the tape dump mode is initiated by pressing the play key [33] (refer to Section 2.4.25).
- Soft Jumper 09/10** **MODE ASSIGNMENT SOFTKEY 1 AND 2**
Assignment of the functions for the two soft keys 26 and 27], refer to the functional description in 2.4.1.
- Soft jumper 11** **RECORD COMMAND DEFINITION**
The soft jumper in position "0" defines that the PLAY [33] and REC [35] key must be pressed simultaneously for starting a recording. Position "1" defines that only the REC [35] key must be pressed from PLAY [33] mode in order to start a recording. However, if the tape is stopped, both keys PLAY [33] and REC [35] must be pressed.
- Soft jumper 12** **FADER START DEFINITION**
Soft jumper 12 defines the fader start mode. The individual functions are listed in the table (refer to Section 2.4.16).
- Soft jumper 13** **MODE ASSIGNMNET OF AUDIO SOFT KEY [53 and 54]**
(On time code versions only key [60])
The individual functions are described in Section 2.4.1 (keys 5349/54 and 60).

- Note:**
- For 1/4" timecode versions the positions "2" and "3" are not used because no additional reproduce head can be installed.
 - For 1/2" machines only the equalization can be determined:

Position 0 =	CCIR
Position 1 =	NAB

Soft jumper 14 **CHANNEL SELECTION PARALLEL/INDIVIDUAL**
 Soft jumper 14 defines whether the channel selection keys READY [36], INPUT [37], SYNC [38], REPRO [39] change over both channels simultaneously or whether the channels can be changed over individually (requires software version 15/90 or later).

Soft jumper 15 **TIME CODE TIME COMPENSATION ON/OFF**
 In position "0" the time code signal (input or reproduce signal) is routed via the recalculation circuit so that it can be recorded or reproduced in synchronism with the audio signal.

 In position "1" the time compensation is disabled, i.e. the time code signal is recorded directly on tape or connected from the reproduce head to the output.

Soft jumper 16 **TIME CODE CHANGEOVER SYNC/REPRO**
 The soft jumper 16 defines whether the SYNC/REPRO [58] changeover of the timecode channel can be effected individually or whether the timecode channel automatically assumes the status of a selectable channel.

Example: Jumper Pos.1
 If the audio channel "1" is switched to SYNC [38], the time code channel also switches to SYNC (LED on the right of the SYNC [58] key is light, see Section 2.4.1).

Soft jumper 17 **MASTER SAFE SAFE/READY**
 The soft jumper 17 disables in position "1" the SAFE/READY switch. The machine is on MASTER SAFE.

Soft jumper 18 **TRANSPARENT TAPE COUNTING ON/OFF**
 In position "1" the Tape Timer counts sections with transparent leader tape and stops counting in position "0".

Soft jumper 19 **CALIBRATED LEVELS**
 The soft jumper 19 determines whether the machine is switched to calibrated or uncalibrated level after power-up. Recorders without potentiometers for RECORD level or REPRO/SYNC level have to be set to calibrated level (1).
 0 = No calibration: the input and output levels have to be adjusted with the corresponding potentiometers. The UNCAL LED's are light.
 1 = Calibrated levels: input and output are switched to line level.

2.5.3 Programming the audio parameters

When you press the microswitch adj [16] by means of a pointed tool, the A807 tape recorder is switched to audio alignment mode. In this mode the display [22] of the tape timer no longer shows the current tape address but information concerning the audio parameters. The three red LEDs to the right of the display indicate which parameter is being displayed (functions identified with lower case letters: lvl, trbl, and bias).

In addition the functions of the keys LAP [20], SEL [18], STEP [19], LOC START [26], and BACKSPACE [27] change to the functions specified in yellow lettering below the keys.

LAP	=	channel
SEL	=	parameter
STEP	=	store
LOC START	=	down
BACKSPACE	=	up
TAPE DUMP	=	input (only in models without output signal selector)

In adj mode the machine remains operable so that play and record commands can be entered and different tape speeds can be selected, and for switching over between CCIR/NAB, TAPE A/B, or HEAD A/HEAD B. The tape timer also continues to run internally.

A detailed description concerning the alignment of the audio parameters can be found in Section 4.2 of this manual (calibration). Only the method for entering the parameters is described here.

- Switch the machine to the alignment mode by pressing the adj [16] key.
- Select the desired tape speed, equalization standard, tape type or reproduce head by pressing the appropriate keys.
- Select the desired operating mode (REPRO, SYNC or READY + REC).
- Select the audio channel to be calibrated by pressing the channel [20] key.
- Select the parameter to be adjusted by pressing the param [18] key.

lvl	=	level adjustment
trbl	=	treble correction
bias	=	bias adjustment

- With the down [26] and up [27] key you can modify in the desired direction the decimal value and consequently the level selected with param [18].
- When the setting is correct, save the value by pressing the store [19] key.
- Press the adj [16] key again to quit the alignment mode. All modified values that have not been stored yet (identified by a flashing dot) will be lost. The machine continues to operate with the old data.

Exempel:

The display [22] shows the following information:

A1 .025 LED: M

The letter A in the first position of the display signals the "adj" mode. The digit in the second position of the display specified the audio channel:

1 = CH1 (left)	2 = CH2 (right)
----------------	-----------------

The last three digits of the display specify the decimal value of the setting (min. = 000, max = 255). The dot between the numbers indicates whether or not the value has been stored.

- If the dot is continuously light (■) = the value has been stored.
- If the dot flashes (*) = the value has been entered but not stored.

The program can be terminated by pressing the adj [16] key again. All values that have not been stored yet (flashing dot) will be lost.

The newly stored parameter values become effective immediately. Those that have not been stored are only effective for as long as the program is not terminated.

Function chart

FUNCTION KEY		INDICATION			COMMENT
CENTER FIELD	LEFT FIELD	CH	LED	DISPLAY (* = flashing dot, ■ = permanent dot)	
REPRO or SYNC or READY+ RECORD	adj.	1	lv1	A1 ■025	Programm call, last stored setting
	up			A1 *026	Level up to 026
	up			A1 *027	Level at 027
	:			:	:
	up			A1 *255	Max. level
	down			A1 *254	Level down to 254
	store			A1 ■254	Level value 254 stored for channel 1
	channel up	2	lv1	A2 ■030	Last stored level for channel 2
	:			:	:
	up			A2 *122	Level up to 031
down			A2 *121	Level at 122	
store			A2 ■121	Level down to 121 Level value 121 stored for channel 2	
channel param up	1	trbl	A1 ■254	stored level for channel 1	
store			A1 ■122	stored treble setting for channel 1	
			A1 *123	treble up to 123	
			A1 ■123	setting 123 stored	
channel down	2	trbl	A2 ■153	stored treble setting for channel 2	
store			A2 *152	treble down to 152	
			A2 ■152	setting 152 stored for channel 2	
ONLY in READY+ RECORD	param up	2	bias	A2 ■089	Bias setting for channel 2
	store			A2 *090	Bias up to 090
				A2 ■090	Bias setting 090 stored for channel 2
channel down	1	bias	A1 ■112	Bias setting for channel 1	
store			A1 *111	Bias down to 111	
			A1 ■111	Bias setting 111 stored for channel 1	
	adj.				Quit program

2.6 Serial interface RS232

The STUDER A807 tape recorder is equipped with a serial interface (RS232) for operation with a terminal, a computer, or for remote control of the tape deck functions.

2.6.1 RS 232 Standard interface

The term "RS232" defines a connection between a "terminal" (computer) and a "modem" (A807) for the purpose of exchanging data. In addition this standard defines the:

- Electrical characteristics (level, lines)
- Mechanical characteristics (connector)
- Signal descriptions
- Standard connections.

The interface can operate with a data rate of up to 19.2 k baud (On the A807/A810/A812/A820 up to 9.6 k baud) and cable lengths of up to 15 m. The signal levels are defined as follows:

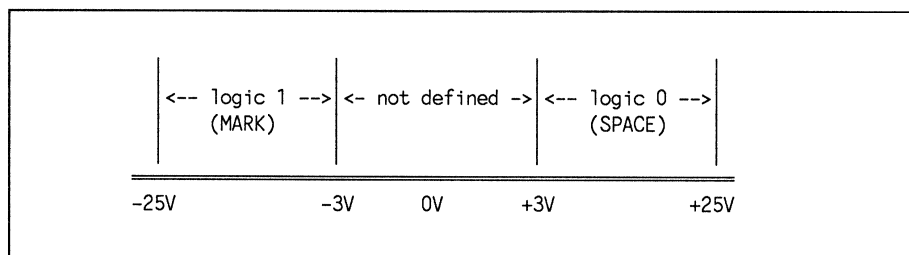

The 25-pin connector defined in this standard supports various interface structures. The full pin assignment is rarely used nowadays. Modern systems frequently use a minimal structure according to 2.5.4 for the terminal-modem or terminal-terminal connection and consequently need only a smaller 9-pin connector.

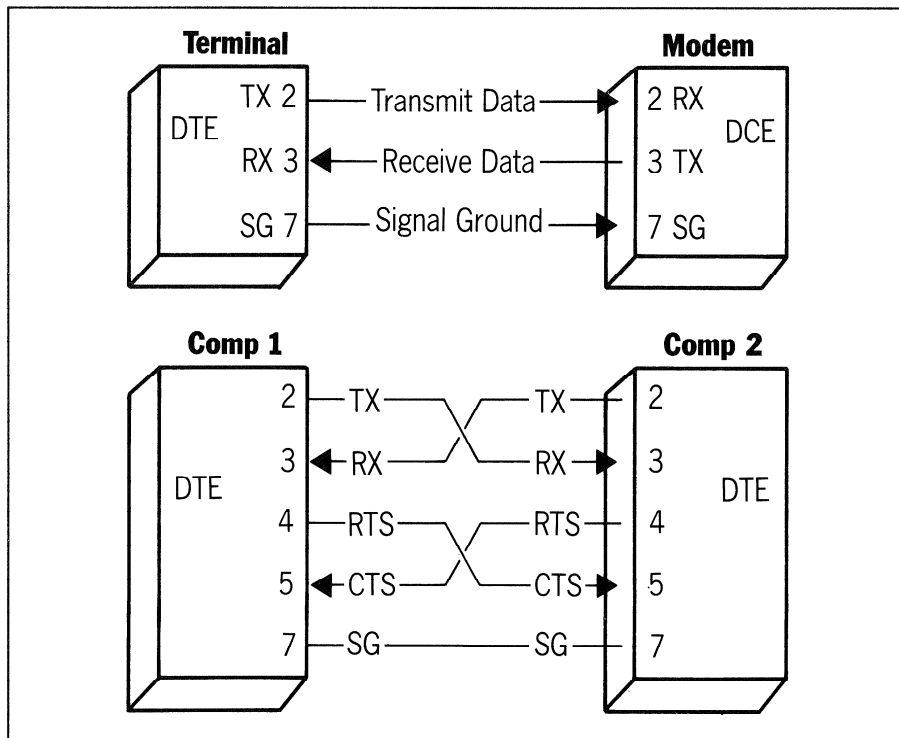

Fig. 2.6.1

All extensions (e.g. baud rate, code, synchronous/asynchronous connections, number of start/stop bits, parity, hardware/software handshake) are defined by the manufacturer.

2.6.2 RS 232 Interface of the A807

A 9-pin connector is used for the serial interface of the A807 tape recorder. With a correspondingly prepared adapter cable it is possible to define whether a unit should function as a terminal or a modem.

Recorder 9-pin plug		Terminal 25-pin plug		Modem 25-pin plug	
Signal	Pin	Signal	Pin	Signal	Pin
SNDATA	2	Trans. Data	2	Trans. Data	3
RCVDATA	8	Record Data	3	Record Data	2
GROUND	9	Signal Ground	7	Signal Ground	7

No additional handshake lines are used. A software handshake (X ON/X OFF protocol) is implemented for all transmission rates, however it is only required for 9.6 k baud.

X ON	= 0001 0001 (ASCII: DC1)	= resume
X OFF	= 0001 0011 (ASCII: DC3)	= interrupt

Upon receipt of an X OFF, the tape recorder still transmits up to 2 characters. After the tape recorder itself has transmitted X OFF, it can still receive five characters without losing a command.

Fixed settings:

1 start bit 1 stop bit 8 data bits No parity bit

The baud rate can be set with the aid of soft jumper 01 (1200 or 9600 baud). Only ASCII characters are admissible as data!

2.6.3 Working with the serial interface RS 232

The computer or the terminal are to be connected to the tape recorder by means of an adapter cable fitted with a 9-pin socket.

The computer or the terminal should be set as follows:

1 start bit, 8 data bits, 1 stop bit, no parity bit, no echo mode, baud rate 1200 or 9600 baud. The handshake lines CTS and RTS are to be connected to "LOW".

After a RESET of the tape recorder (switching the tape recorder off and on again), the following message is displayed on the screen:

A807

The desired commands can now be entered via the terminal keyboard according to the table below. Most commands are not executed until the ENTER or LINE FEED key is pressed.

Important: In addition to the processor for controlling the tape deck and audio electronics, TC versions are equipped with a separate processor for TC signal processing. For exchanging certain information these two processors must communicate with each other across the serial interface. For this purpose the external interface is briefly interrupted (approx. 30 ms) and X OFF is signalled. After the internal data transmission has been completed and X ON transmitted, the external interface functions again in the normal manner.

Command list

Audio commands		
command (_ = blank, / = CR, * = blank or CR)	A807 Response	Remarks
Software update: June 90		
STP*	<CR><LF>	Stop
RWD*	<CR><LF>	Rewind
FWD*	<CR><LF>	Forward
PLY*	<CR><LF>	Play
REC*	<CR><LF>	Record (direct)
WNF <SPEED>	<CR><LF>	Controlled wind forward
WNR <SPEED>		Controlled wind reverse
SSA* ¹	<CR><LF>	3,75 ips (9,5 cm/s)
SSB*	<CR><LF>	7,5 ips (19 cm/s)
SSC*	<CR><LF>	15 ips (38 cm/s)
SSD* ¹	<CR><LF>	30 ips (76 cm/s)
NS?* XX = 00...03	XX<CR><LF>	Nominal speed ? 9,5 cm/s (3.75 ips) to: 76 cm/s (30 ips)
VEN*	<CR><LF>	External varispeed on
VEF*	<CR><LF>	External varispeed off
FEN* ²	<CR><LF>	Fader enable on
FEF* ²	<CR><LF>	Fader enable off
EDT*	<CR><LF>	Lifter mode on
LFT*	<CR><LF>	Lifter mode off (tape not on head)
LOC <adress>	<CR><LF> <hh:mm:ss>	Positioning at the timer: reading hh:mm:ss e. g. : LOC_01:20:15 or: LOC_-1_03_22
LMV <adress>	<CR><LF> <XXXXXX>	Positioning at the number of tacho pulses <XXXXXX > * e. g.: LMV_00AE4F * (* = 3 Byte HEX)
MV? STM <adress>	<CR><LF> XXXXXX <CR><LF> <hh:mm:ss>	Move roll counter ? set counter hh:mm:ss e. g. STM_-0:43:57 or: STM_00_55_12
TM?* <adress>	<CR><LF> <hh:mm:ss,xx>	Read out of the tacho pulse number xx = xx/256 s
Note:	¹ = Only possible if speed change is not interlocked with the SHIFT key by means of the softkey 07. ² = Only feasible in FADER START MODE B, C or D.	

Tape deck commands (cont.)		
DST* ³	<CR><LF> <hh:mm:ss,x>	Continuous indication of the tape deck counter and status (xx=xx/256 seconds, Y=status [2 words HEX])
ST?*	<CR><LF> XX XX = 81 XX = 01 XX = 82 XX = 02 XX = 83 XX = 03 XX = 84 XX = 04 XX = 85 XX = 05 XX = 86 XX = 06 XX = 88 XX = 08 XX = 89 XX = 09 XX = 25 xx = A5 XX = C0 XX = 40 xx = C1 xx = 41 XX = C2 XX = 42 XX = C3 XX = 43 XX = CA XX = 4A XX = CB XX = 4B XX = 59 XX = D9	Tape deck status ? (xx = 1 Byte HEX) Tape out achieved Tape loaded, no tension STOP, tape tension STOP not achieved Rewind achieved Rewind not achieved Fast forward achieved Fast forward not achieved PLAY achieved PLAY Play varispeed achieved Play varispeed PLAY external ref. achieved PLAY external ref. Record achieved Record Reverse play Reverse play achieved SHUTTLE backward achieved SHUTTLE backward SHUTTLE forward achieved SHUTTLE forward Locate rewind achieved Locate rewind Locate forward achieved Locate forward Rewind control achieved Rewind controlled Wind forward controlled achieved Wind forward controlled TAPE DUMP TAPE DUMP achieved
ESY	<CR><LF>	Enable synchronizer
SD?*	DD.WW.YY	Inquiry of software release date ? DD = Day WW = week YY = Year
MT?	aa<CR><LF>	Inquiry of machine type? aa = Machine type number 5 = 807 MKII
Note: 3 = Continuous status indication is terminated with the command "Control X".		

Audio commands		
command (_ = blank, / = CR, * = blank or CR)	A807 Response	Remarks
ION/	<CR><LF>	Insert on (set mono)
IOF/	<CR><LF>	Insert off (set stereo)
SNBA SCRA	<CR><LF> <CR><LF>	Set NAB equalization Set CCIR equalization
STAA STBA	<CR><LF> <CR><LF>	Set tape sort A Set tape sort B
SRH* CRH*	<CR><LF> <CR><LF>	Rehearsel mode on Rehearsel mode off
AA?	<CR><FL> aabbccdd aa: 0 = Safe 1 = Ready/record bb: 0 = Tape 1 = Input cc: 0 = Reproduce 1 = Sync dd: 0 = Demute 1 = Mute	Channel 1...8 status MSB(xx) : channel 8 LSB (xx) : channel 1 xx = aa...dd
REA_i/	<CR><LF>	Set channel i to ready i=1, 2, 3, 4, E, F
SAF_i/	<CR><LF>	Set channel i to safe i = 1, 2, 3, 4, E, F
INP_i/	<CR><LF>	Set channel i to Input i=1, 2, 3, 4, E, F
SYN_i/	<CR><LF>	Set channel i to synch i = 1, 2, 3, 4, E, F
REP_i/	<CR><LF>	Set channel i to repro i = 1, 2, 3, 4, E, F
MTN_i/	<CR><LF>	Set channel i to Mute i = 1, 2, F i = 1, 2, 3, 4, F F = 2 Kanal oder 4 Kanal
MTF_i/	<CR><LF>	Demute channel i i = 1, 2, F i = 1, 2, 3, 4, F F = 2-channel, or 4-channel

- Δ To activate only, if the corresponding function has been selected by soft-jumper (13).
Not possible with 4-ch recorders (blocked).

Audio commands (cont.)		
SAP* <i,j,xx>	<CR><LF>	Set audio parameter and store i = channel 1 or 2 j = D/A converter xx = 1 Byte HEX j: 0 = Level REPRO/SYNC 1 = Treble REPRO/SYNC 4 = Level RECORD 5 = Treble RECORD 6 = Bias RECORD
PAP* <i,j,xx>	<CR><LF>	Set audio parameter without storing i=channel 1 or 2 j= D/A converter xx = 1 Byte HEX j: 0 = Level REPRO/SYNC 1 = Treble REPRO/SYNC 4 = Level RECORD 5 = Treble RECORD 6 = Bias RECORD
AP?* <i,j>	<CR><LF> XX	Inquiry audio parameter XX = 1 Byte HEX i = channel 1 or 2 j = D/A converter j: 0 = Level REPRO/SYNC 1 = Treble REPRO/SYNC 4 = Level RECORD 5 = Treble RECORD 6 = Bias RECORD

Machine and timecode commands		
LCD*	<CR><LF>	Local keyboard disabled
LCE*	<CR><LF>	Local keyboard enabled
TC	<CR><LF> [Y,N]	Timecode present on tape? Y = Yes; N = No
TCN	<CR><LF>	Set timecode delay aktiv
TCF	<CR><LF>	Set timecode delay bypassed

The above list of commands may not necessarily be complete. It will be updated or extended as required.

2.7 Care Instructions

Daily care is limited to cleaning the heads, the capstan shaft, and all elements that come in contact with the tape. Dust and oxide particles of the magnetic coating accumulate principally on heads and the tape guidance elements. This can lead to drop outs.

Cleaning should, therefore, be performed daily, or if contamination is visible, even more frequently.

For proper care of the tape recorder we recommend the STUDER CLEANING KIT (part No. 10.496.010.00). It contains all utensils required for cleaning a tape recorder:

- Head cleaner
- Aluminite cleaner
- Felt sticks
- Cleaning rag

Procedure: Moisten a felt stick or the cleaning rag with a small amount of head cleaner and clean the heads and all elements that come in contact with the tape. Use a second felt stick or a dry section of the cleaning rag to wipe the cleaned parts dry.

Normally, the capstan shaft does not rotate when the recorder is not switched to play mode. For cleaning purposes a special function has been provided: When the magnetic tape is unthreaded (tape tension sensor in idle position, light barrier not covered), the capstan shaft continues to rotate for as long as the PLAY [28] key is pressed. For cleaning aluminum surfaces use the special aluminite cleaner. It removes the dirt and restores the metallic lustre of the aluminum.

Caution: Make sure that neither head cleaner nor aluminite cleaner penetrates into the bearing of the capstan shaft!

The acrylic panels of the VU-meters are not resistant to solvents!

Lubricating the capstan bearing:

Do not apply oil! The capstan motor contains permanently lubricated ball bearings → Damage to the ball bearings may occur!

A sticker-label with the same information is attached to each capstan motor.

Please note: Earlier capstan motors are equipped with sintered sleeve bearings.

The capstan motor and its sintered-sleeve bearing are virtually maintenance-free. To replenish the grease in the bearing, sintered-sleeve capstan bearings should be re-greased annually or after a prolonged idle period.

For relubrication use only the recommended lubricants!

For oil lubricated capstan motors apply one drop of PDP 65 oil every six months. (Order No. 20.020.401.04). This motor version is not marked with any sticker-label.

For **grease lubricated** capstan motors (in production since 1.1.1988; identified by a **label**), only the liquid grease CONSTANT GLY 2100 (Part No. 20.020.401.10) should be used.

Procedure: On grease lubricated capstan motors (red label) lift off the upper plastic bearing cap and apply a few drops of liquid grease into the bearing gap (between the capstan shaft and the bearing).

Note: The bearing seat of capstan shafts is ground to the internal diameter of the pressed in sintered-sleeve bearing within very close tolerances. For this reason it is impossible to replace the bearing shaft in the field if any service is needed. Capstan motors should always be shipped to the national STUDER dealer for overhaul.

All earlier capstan motors returned to STUDER for overhaul will be refurbished to the new ball-bearing version!

RAM Parameter für Glasmetakköpfe

Entzerrungs-Parameter

Für die im RAM abgespeicherten Equalizations-Parameter für Glasmetakköpfe gelten folgende Einstellwerte (Hex Werte) nach Referenzwerten. Sollten die gespeicherten Werte einmal verlorengehen, so ist die Neu-Eingabe nach folgender Tabelle vorzunehmen:

1/4"

	9,5 cm/s 3,75 ips	19 cm/s 7,5 ips	19 cm/s 7,5 ips	38 cm/s 15 ips	38 cm/s 15 ips	76 cm/s 30 ips
	CCIR+NAB	CCIR	NAB	CCIR	NAB	CCIR+NAB
REPRO	AE	82	68	44	68	29
REC	BB	A9	BE	C6	A5	D5
SYNC	00	85	70	44	68	29

1/2"

	19 cm/s 7,5 ips	19 cm/s 7,5 ips	38 cm/s 15 ips	38 cm/s 15 ips	76 cm/s 30 ips
	CCIR	NAB	CCIR	NAB	CCIR+NAB
REPRO	82	61	44	61	26
REC	99	B7	C1	A5	D9
SYNC	90	70	44	61	26