

CT8-58

CHICAGO



transformers

filter reactors

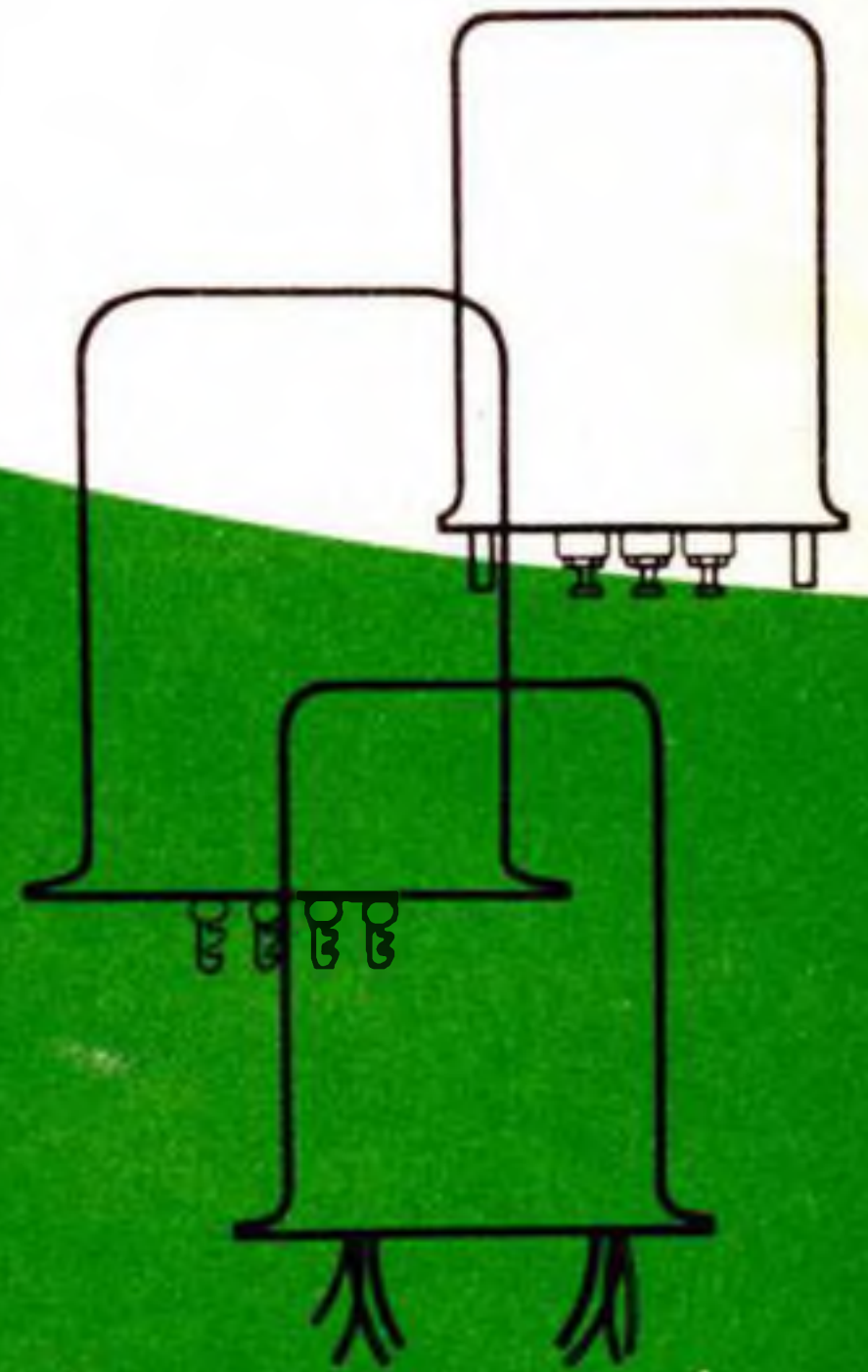

**MIL-T-27A
HERMETICALLY SEALED**

**NEW EQUIPMENT
COMMERCIAL GRADE**

**CONTROL and
POWER CIRCUIT**

a*

b*

c*

**CHICAGO STANDARD TRANSFORMER
CORPORATION**

CHICAGO

HERMETICALLY-SEALED TRANSFORMERS

Designed and built in accordance with
all MIL-T-27A requirements

POWER TRANSFORMERS

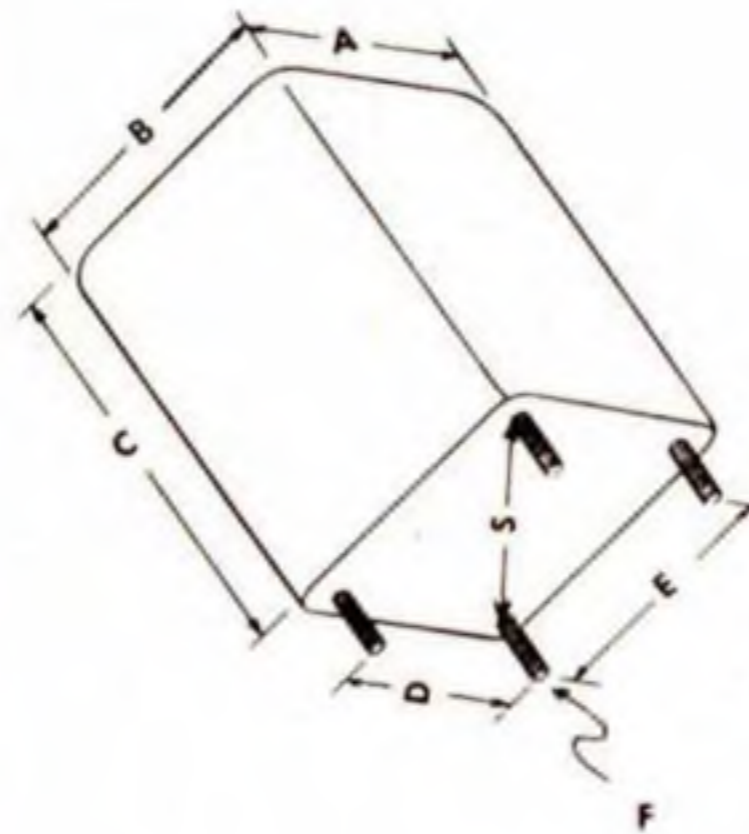
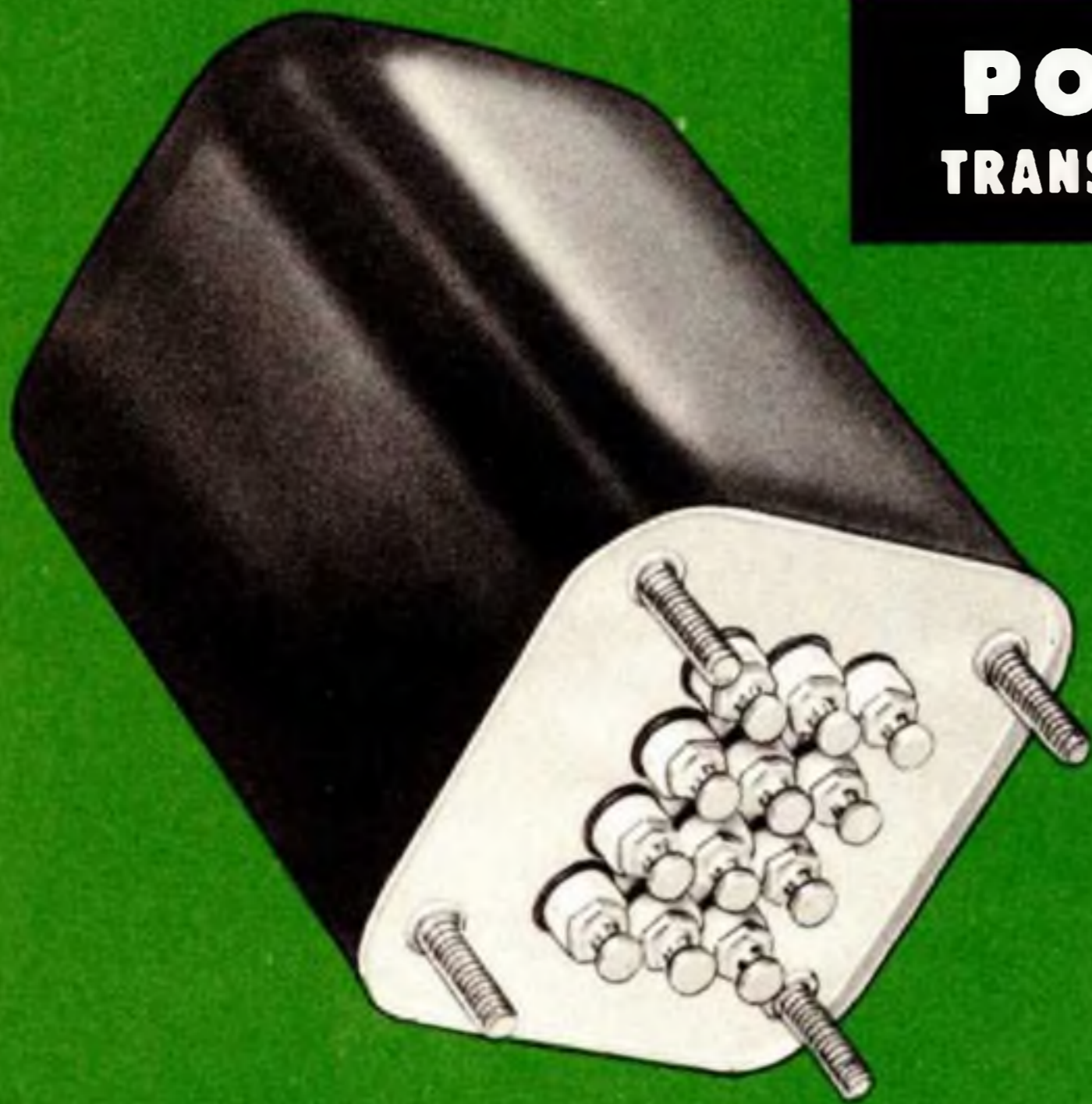

YY ALTERNATE CASE DIMENSIONS

Case Size	A	B	C	D	E	F
8	1.546	1.546	1.955	1.000	1.000	6-32
9	1.546	1.546	2.143	1.000	1.000	6-32
12	2.241	2.101	2.680	1.562	1.375	6-32
13	2.241	2.101	2.930	1.562	1.375	6-32
14	2.521	2.381	3.049	1.812	1.687	6-32
15	2.521	2.381	3.299	1.812	1.687	6-32
16	2.861	2.711	3.492	2.000	1.875	8-32
17	2.861	2.711	3.742	2.000	1.875	8-32
18	3.245	2.979	3.867	2.375	2.125	8-32
19	3.245	2.979	4.242	2.375	2.125	8-32
20	3.667	3.292	4.305	2.625	2.375	10-32
21	3.667	3.292	4.680	2.625	2.375	10-32
22	4.573	4.120	5.318	3.375	3.000	10-32
24	5.323	4.792	6.068	3.375	3.000	12-24

POWER TRANSFORMERS—TF4RXO3YY

Max. operating Altitude 10,000 ft.

FOR CAPACITOR INPUT SYSTEMS—Primary: 117 volts, 50/60 cycles

Catalog No.	High Voltage Secondary			Rectifier		Filament				Case Size	Wt. Lbs.
	A-C Volts	D-C Ma.	D-C V. Output	Volts	Amps	No. 2		No. 3			
PHC-10	250-0-250	10	320	—	—	6.3	0.6	6.3	1.2	14	2
PHC-20	250-0-250	20	300	—	—	6.3	0.6	6.3	1.2	15	2
PHC-40	225-0-225	40	210	5	2	6.3CT	2	—	—	17	3 1/4
PHC-55	270-0-270	55	260	5	2	6.3CT	2	—	—	17	3 1/2
PHC-60	300-0-300	60	285	5	2	6.3CT	3	—	—	19	4 1/2
PHC-70	335-0-335	70	320	5	2	6.3CT	3	—	—	19	4 1/2
PHC-85	330-0-330	85	320	5	2	6.3CT	3	—	—	20	6
PHC-105	345-0-345	105	320	5	2	6.3CT	3.5	—	—	21	6 1/2
PHC-120	375-0-375	120	380	5	3	6.3CT	4	—	—	21	9 1/2
PHC-150	370-0-370	150	390	5	3	6.3CT	4	6.3CT	1	22	11 1/2
PHC-200	385-0-385	200	390	5	3	6.3CT	4.5	6.3CT	1	22	12
PHC-250	400-80-0 -80-400	250	410	5	6	6.3CT	7	5	2	24	15

FOR REGULATED POWER SUPPLIES—Primary: 115 volts, 50/60 cycles

PHC-165	440-0-440	165	430	5	3	6.3 6.3	7.5 0.6	6.3 6.3	3 3	22	12
PHC-200A	450-0-450	200	442	5	2	6.3 6.3	4 4	6.3	0.6	22	12

All secondary A.C. voltages $\pm 3\%$

GENERAL SPECIFICATIONS

CHICAGO hermetically-sealed transformers are designed and built in accordance with MIL-T-27A Grade 4, specifications for Class R operation. Other units are listed for Class S operation. All units fully meet the rigid requirements for guided missile, military airborne and ground communications equipment, marine equipment, and in any field where a maximum of sealing quality construction is important. They are especially useful in research and development applications, pilot runs, and pre-production models.

To indicate the construction characteristics of this CHICAGO transformer line, the MIL-T-27A specifications require that the transformers be:

1. Temperature and Immersion cycled for 5 complete test cycles of five steps each in temperatures varying from (Plus 85°C. for Class R; Plus 108°C. for Class S) to minus 55°C. including a 25°C. saturated salt water immersion step.
2. Moisture resistance tested in temperatures varying from plus 65°C. to minus 10°C. at 90-95% relative humidity for ten 24 hour cycles extending over a ten day period.
3. Tested for insulation resistance in excess of 1000 megohms after being subjected to tests 1 and 2.
4. Tested on each winding at twice the rated A-C voltage and frequency.
5. Operated for 48 hours with 12% overload at rated ambient temperature with no resultant damage either electrically or mechanically.
6. Subjected to severe vibration tests on a shake table for a period of 2 hours in each of three perpendicular planes.
7. Subjected to 10 impact shocks of 50 gravitational units acceleration in each of 3 mutually perpendicular planes.
8. Capable of operation in 65°C. ambient temperature with a temperature rise not exceeding 40°C. except that the special Class S units can operate in an 85°C. ambient with a temperature rise not exceeding 45°C.

FOR REACTOR INPUT SYSTEMS—Primary: 117 volts, 50/60 cycles

Catalog No.	High Voltage Secondary			Rectifier Volts Amps		Filament				Case Size	Wt. Lbs.
	A-C Volts	D-C Ma.	D-C V. Output			No. 2 Volts Amps		No. 3 Volts Amps			
PHR-55	350-0-350	55	260	5	2	6.3CT	2			17	3¼
PHR-70	425-0-425	70	320	5	2	6.3CT	3			19	4½
PHR-85	440-0-440	85	325	5	2	6.3CT	3			20	6
PHR-105	450-0-450	105	320	5	2	6.3CT	3.5			21	6½
PHR-120	500-0-500	120	390	5	3	6.3CT	4			21	9½
PHR-150	510-0-510	150	395	5	3	6.3CT	4	6.3CT	1	22	11½
PHR-200	520-0-520	200	390	5	3	6.3CT	4.5	6.3CT	1	22	12¼
PHR-300	550-370-75-0 -75-370-550	300	420	5	6	6.3CT	5	6.3CT	1	24	17½

BIAS TRANSFORMERS—COMBINATION PLATE AND FILAMENT SUPPLY

Primaries: 115 volts, 50/60 cycles; 230 volts, 50/60 cycles—TF4RX03YY

Catalog No.	Primary Volts	High Voltage Secondary		Rectifier Volts	Filament Amps	Case Size	Wt. Lbs.
		A-C Volts	D-C Ma.				
1BH-150	115	180-160-140-120-0 -120-140-160-180	150	5.0	3.0	19	5

All secondary A.C. voltages ± 3%

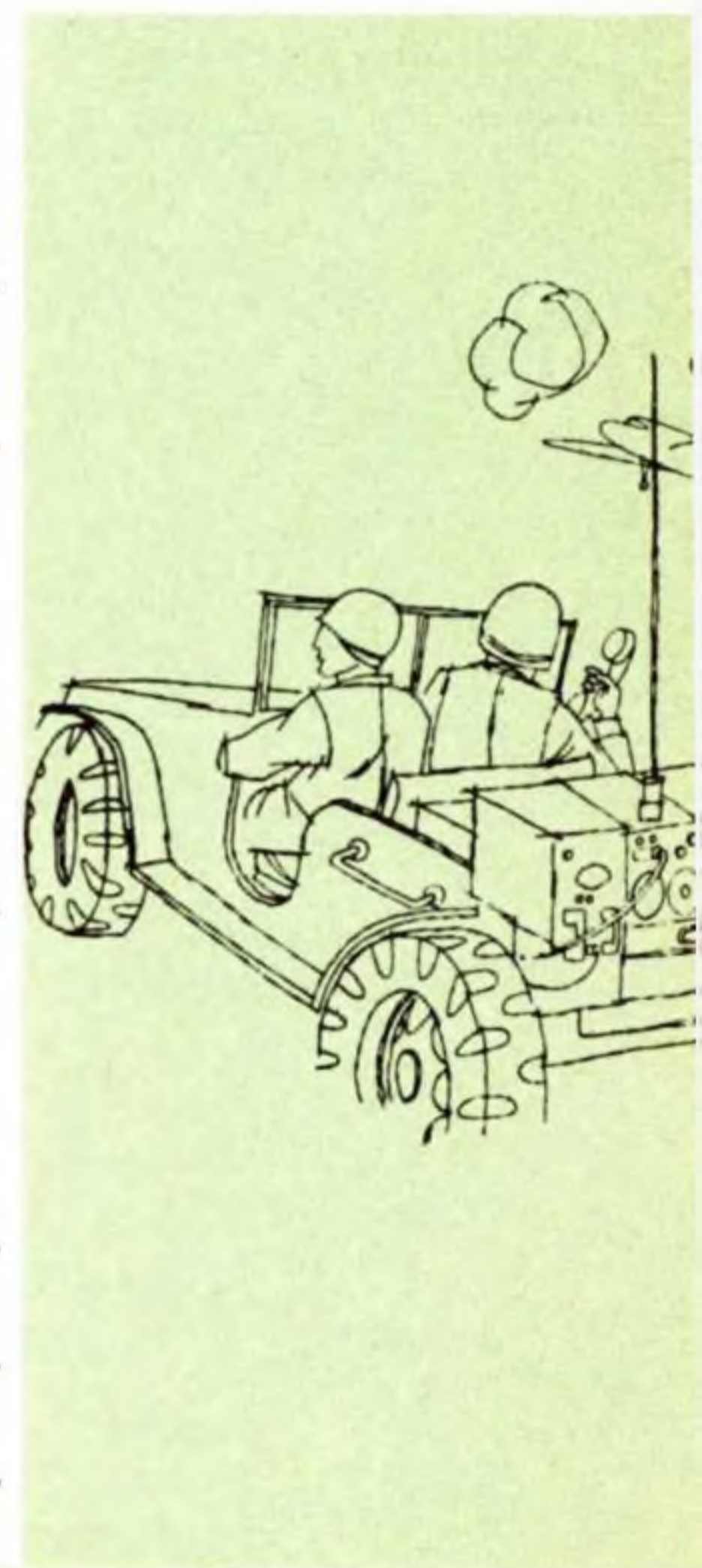

CHICAGO

The world's toughest transformers

PREFERRED FOR EVERY MODERN CIRCUIT REQUIREMENT

FILTER REACTORS

TF4RX04YY



YY ALTERNATE CASE DIMENSIONS

Case Size	A	B	C	D	E	F
8	1.546	1.546	1.955	1.000	1.000	6-32
9	1.546	1.546	2.143	1.000	1.000	6-32
12	2.241	2.101	2.680	1.562	1.375	6-32
13	2.241	2.101	2.930	1.562	1.375	6-32
14	2.521	2.381	3.049	1.812	1.687	6-32
15	2.521	2.381	3.299	1.812	1.687	6-32
16	2.861	2.711	3.492	2.000	1.875	8-32
17	2.861	2.711	3.742	2.000	1.875	8-32
18	3.245	2.979	3.867	2.375	2.125	8-32
19	3.245	2.979	4.242	2.375	2.125	8-32
20	3.667	3.292	4.305	2.625	2.375	10-32
21	3.667	3.292	4.680	2.625	2.375	10-32
22	4.573	4.120	5.318	3.375	3.000	10-32
24	5.323	4.792	6.068	3.375	3.000	12-24

The design of CHICAGO New Equipment filter reactors provides maximum inductance for given current rating in the smallest possible size of unit. Their mountings and current ratings match with those of the power transformers on pages 2 and 3.



FILTER REACTOR CURVES

Actual inductance values of CHICAGO Filter Reactors when operated throughout the specified current range. All measurements made at 10 volts, 60 cycles.

Catalog No.	Inductance Henries	Max. D-C Current, Ma.	D-C Resistance in Ohms	Insulation Test Volts RMS	Case Size	Wt. Lbs.
RH-1510	15	10	680	1000	8	1
RH-1520	15	20	680	1000	8	1
RH-1540	15	40	475	2500	12	1½
RH-1055	10	55	230	2500	13	1¾
RH-1555	15	55	420	2500	13	2
RH-1085	10	85	175	2500	14	2½
RH-1585	15	85	285	2500	14	2¾
RH-8105	8	105	100	2500	17	3¾
RH-12105	12	105	170	2500	17	4
RH-8150	8	150	100	2500	18	5¼
RH-12150	12	150	150	2500	19	5½
RH-8200	8	200	85	2500	20	7
RH-12200	12	200	140	2500	20	7
RH-8250	8	250	90	2500	22	10½
RH-8300	8	300	60	3500	22	12½

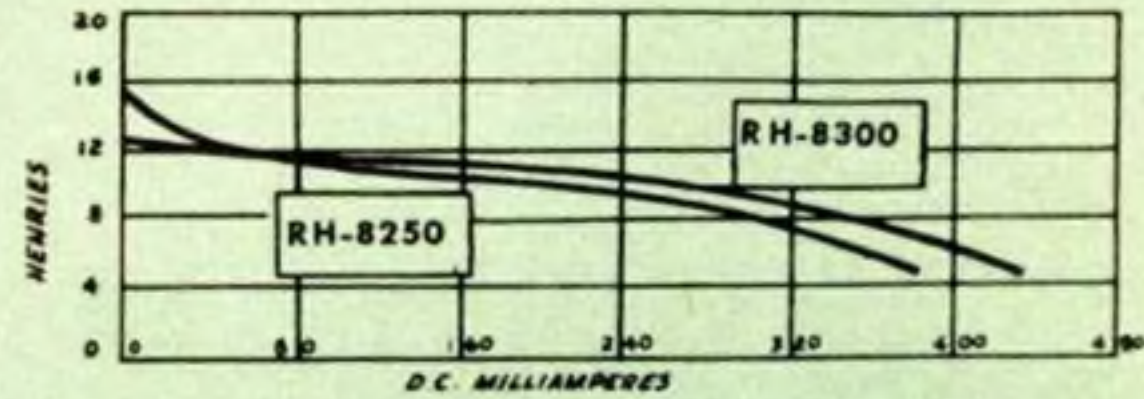
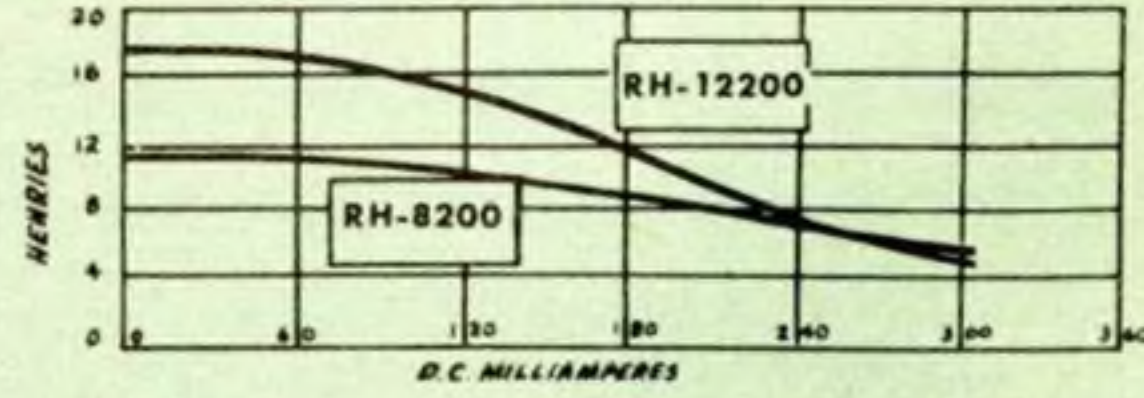
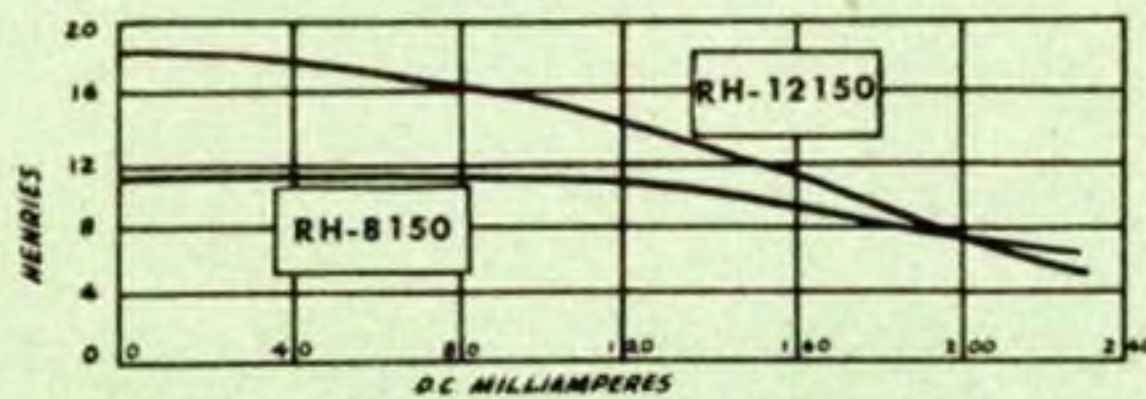
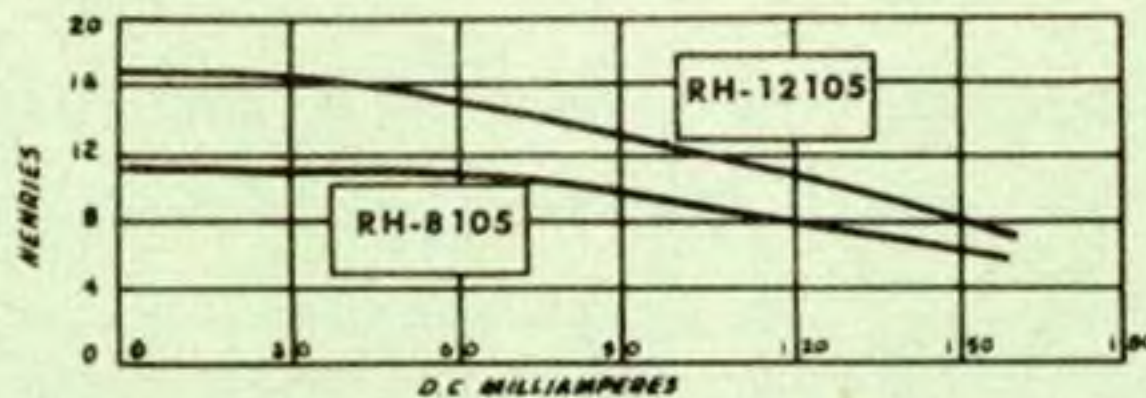
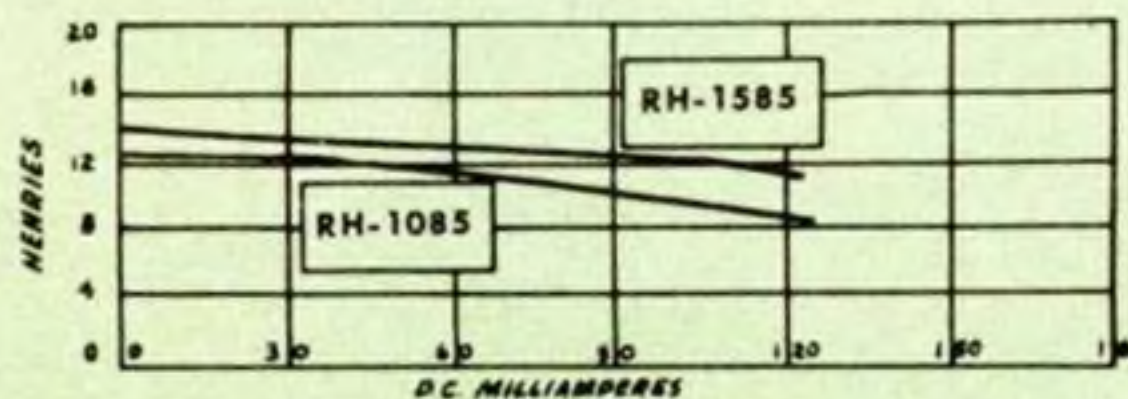
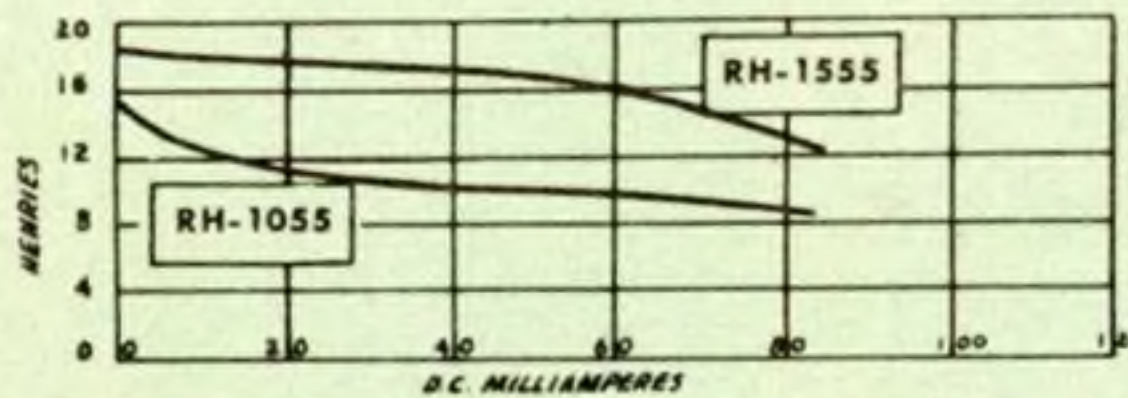
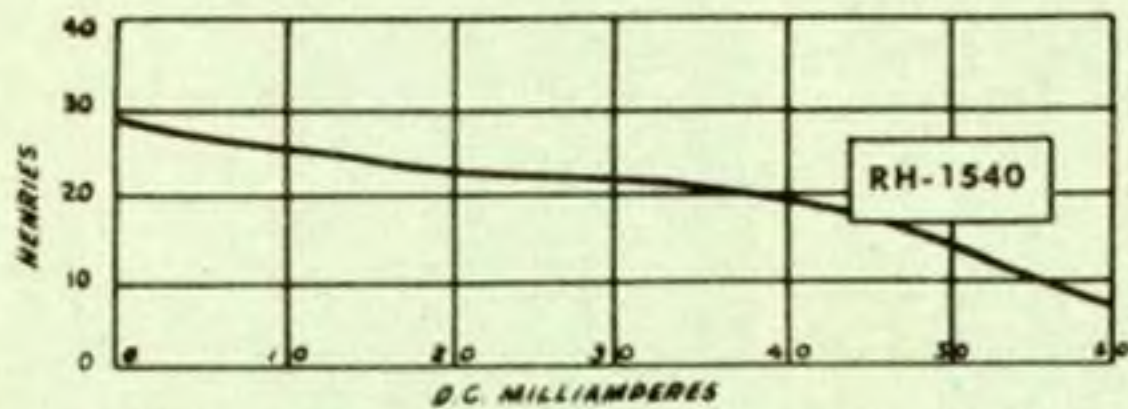

MIL-T-27A HERMETICALLY SEALED TRANSFORMERS AND REACTORS

a

Designed and built in accordance with MIL-T-27A, Grade 4, Class R operating temperature; life expectancy X (10,000 hours minimum). Maximum operating altitude 10,000 feet.

MULTIPLE FILAMENT TRANSFORMERS

MULTIPLE FILAMENT TRANSFORMERS

TF4RX01—†

All Primaries: 105/115/125 volts, 50/60 cycles

Catalog No.	Sec. No. 1	Sec. No. 2	Sec. No. 3	Insul. Test	Case Size†	Wt. Lbs.
FMS-1	5 V. 2A	6.3 V. CT 2.5 A	—	2500 V.	GA	3½
FMS-2	5 V. 2A	12.6V. CT 1.25A	—	2500 V.	GA	3½
FMS-3	5 V. 3A	6.3 V. CT 5A	—	2500 V.	HA	4
FMS-4	5 V. 3A	6.3 V. CT 3A	6.3 V. CT 3A	2500 V.	JB	4¾
		← 12.6 V. CT 3A →				
FMS-5	5 V. 3A	6.3 V. CT 1A	6.3 V. CT 5A	2500 V.	JB	4¾
FMS-6	6.3 V. CT 3A	6.3 V. CT 3A	—	2500 V.	HA	4
	← 12.6 V. CT 3A →					
FMS-7	6.3 V. CT 6A	6.3 V. CT 6A	—	2500 V.	KA	6½
	← 12.6 V. CT 6A →					
FMS-8	5 V. CT 3A	5 V. CT 3A	5 V. CT 6A	5000 V.	KA	7

All secondary A.C. voltages ± 3% †Refer to case size.

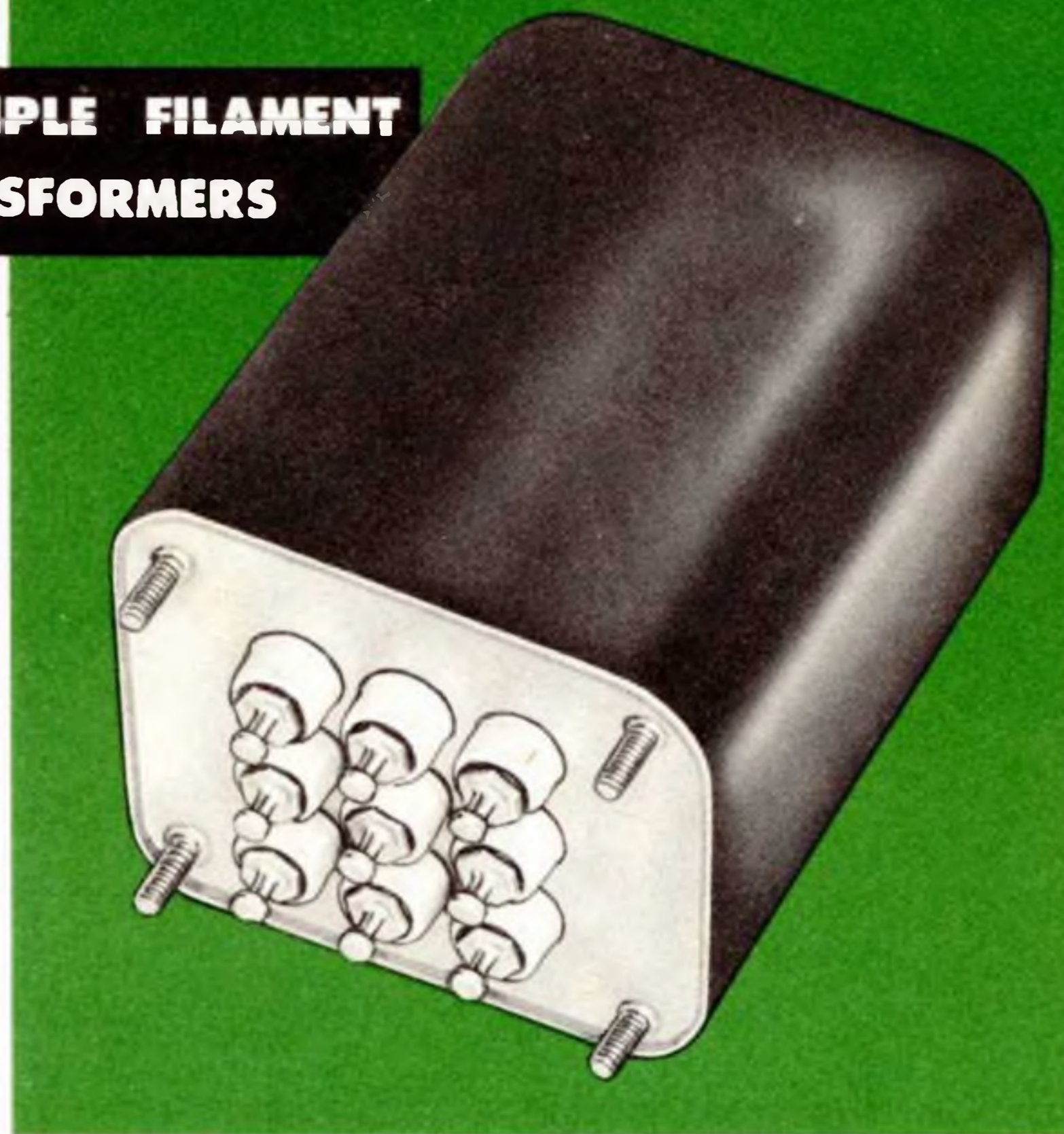

FILAMENT TRANSFORMERS

Ratings of CHICAGO filament transformers provide voltages and currents for heating a wide range of receiving and transmitting tubes. Catalog Nos. FH-210, FH-210H, FH-215H, FH-510H, and FH-520HB are specially designed for high voltage rectifier supplies.

FILAMENT TRANSFORMERS—TF4RX01YY

Primary: 115/230 volts, 50/60 cycles

Catalog No.	Secondary		Insulation Test Volts RMS	Case Size	Wt. Lbs.
	Volts	Amps			
FH-25	2.5 CT	5.25	3500	15	2
FH-210	2.5 CT	10.	5000	15	3
FH-210H	2.5 CT	10.	9000	19	4
FH-215H	2.5 CT	15.	9000	21	5¼
FH-54	5.0 CT	4.	2500	15	2¼
FH-58	5.0 CT	10.	2500	17	3½
FH-510H	5.0 CT	10.	8000	21	6
FH-520HB	5.0 CT	20.	10000	24	13
FH-615	6.3 CT	1.5	2500	12	1
FH-63	6.3 CT	3.	2500	14	2
FH-65	6.3 CT	5.5	2500	16	3
FH-610	6.3 CT	10.	2500	19	5
FH-104	10.0 CT	4.	2500	17	3¼

All secondary A.C. voltages ± 3%

MS CASE DIMENSIONS

Case Size	Dimensions in Inches					
	A	B	C	D	E	F
GA	2¾	2¾	3¼	2¼	1¾	6-32 x ¾
HA	3¼	2¾	4¼	2¼	1¾	8-32 x ¾
JB	3¼	3¼	3¾	2¾	2¼	8-32 x ¾
KA	3¼	3¾	5¼	3	2¾	10-32 x ½
KB	3¼	3¾	4¾	3	2¾	10-32 x ½

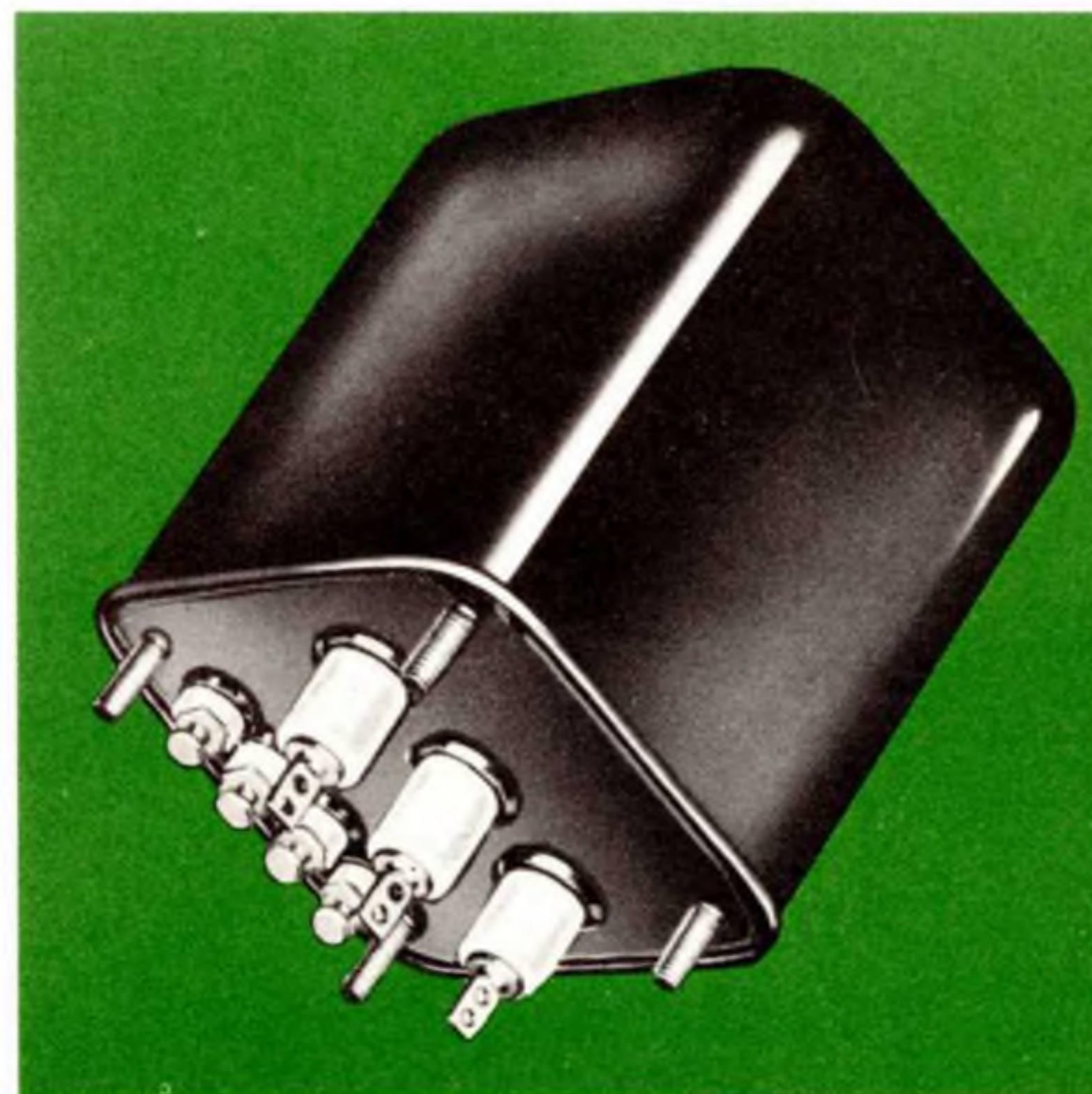

CHICAGO

The world's toughest transformers

PREFERRED FOR EVERY MODERN CIRCUIT REQUIREMENT

YY ALTERNATE CASES

Designed and built in accordance with MIL-T-27A, Grade 4, Class S* operating temperature and life expectancy X (10,000 hours minimum). Maximum operating altitude 10,000 feet.

All 400 cycle transformers contain the famous CHICAGO'S "Sealed-in-Steel" construction: Seamless drawn steel cases and one piece base covers with deep seal soldering.

*High Temperature Operation 85° C. ambient, 45° C. rise.

400 CYCLE TRANSFORMERS

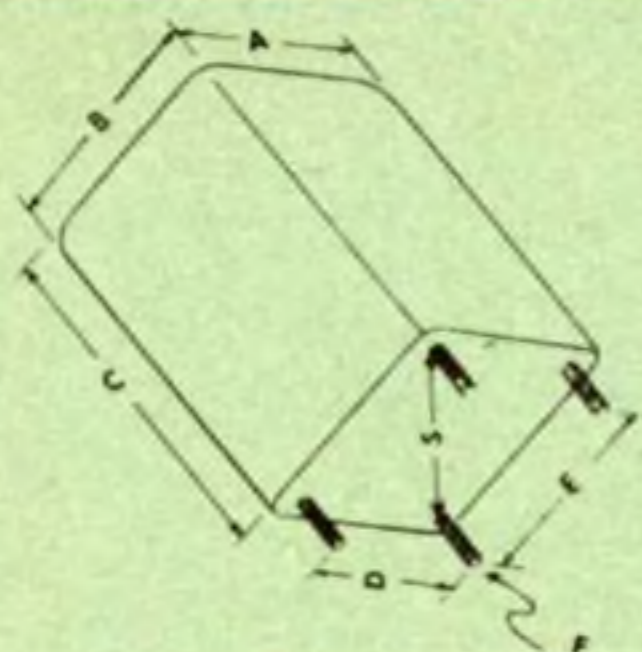

YY ALTERNATE CASE DIMENSIONS

Case Size	Dimension in Inches						
	A	B	C	D	E	S	F
3	1.198	1.198	2.008			1.156	6-32
7	1.361	1.361	2.037			1.312	6-32
10	1.901	1.791	2.205	1.312	1.062		6-32
11	1.901	1.791	2.424	1.312	1.062		6-32
12	2.241	2.101	2.680	1.562	1.375		6-32
13	2.241	2.101	2.930	1.562	1.375		6-32
15	2.521	2.381	3.299	1.812	1.687		6-32
16	2.861	2.711	3.492	2.000	1.875		8-32
17	2.861	2.711	3.742	2.000	1.875		8-32
20	3.667	3.292	4.305	2.625	2.375		10-32
21	3.667	3.292	4.680	2.625	2.375		10-32

POWER TRANSFORMERS—TF4SX03YY

All primaries 105/115/125 V., 380-1000 cycles

Catalog Number	High Voltage Secondary		Rectifier Filament		Other Filaments		Case Size	Terminal Type	Wt. Lbs.
	A.C. Volts	D.C. Ma.	Volts	Amps.	Volts	Amps.			
4PHC-55	270-0-270	55	5.0	2	6.3 CT	2	13	A	1½
4PHC-70	335-0-335	70	5.0	2	6.3 CT	3	13	A	1¾
4PHC-120	375-0-375	120	5.0	3	6.3 CT	4	17	B	2½
4PHC-165	440-0-440	165	5.0	3	6.3 6.3 6.3 6.3	7.5 3 3 0.6	20	B	6
4PHC-200A	450-0-450	200	5.0	2	6.3 6.3 6.3	4 4 0.6	20	B	5¾
4PHR-300	550-370-75-0 75-370-550	300	5.0	6	6.3 CT 6.3 CT	5 1	21	B	6½

FILTER REACTORS—TF4SX04YY

Catalog Number	Inductance (henries)	Maximum D.C. Ma.	D.C. Resistance (ohms)	Insulation Volts RMS	Case Size	Terminal Type	Wt. Lbs.
4RH-255	2.0	55	160	2,500	3	B	¼
4RH-270	2.0	70	165	2,500	7	B	½
4RH-2120	2.0	120	100	2,500	11	B	1
4RH-2165	2.0	165	90	2,500	11	B	1½
4RH-2200	2.0	200	73	2,500	13	B	1¾
4RH-2300	2.0	300	47	2,500	16	B	3¼

FILAMENT TRANSFORMERS—TF4SX01YY

All primaries 105/115/125 V., 380-1000 cycles

Catalog Number	Sec. Volts	Sec. Amps.	Insulation Volts RMS	Case Size	Terminal Type	Wt. Lbs.
4FH-63	6.3 CT	3	2,500	10	B	¾
4FH-65	6.3 CT	5.5	2,500	11	B	1
4FH-610	6.3 CT	10	2,500	13	B	1¾
4FH-620	6.3 CT	20	2,500	15	B & C	2½

STEP-DOWN TRANSFORMER

**THREE-PHASE
400 CYCLES
TFIRX01YY**

Y-Y connected, HP3-140 is identical to CHICAGO Specification No. 9926A in size and construction, but is rated at 140 va. instead of 88 va. Primary is 115 volts per phase, 3-phase, 400 cycles. Designed primarily for aircraft applications.

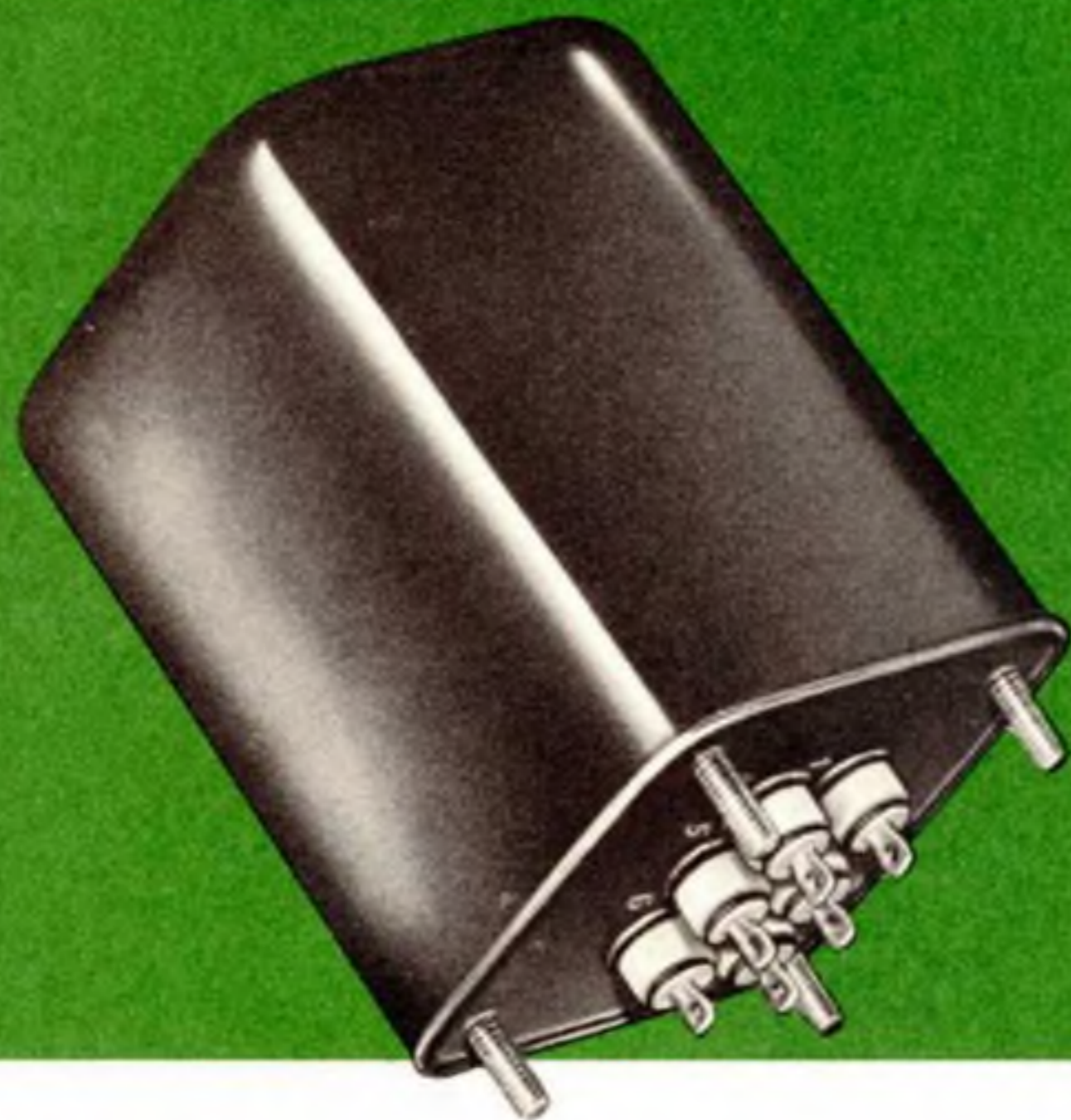

Catalog No.	Secondary		Case Size	Terminal Type	Weight Lbs.
	Volts	Va. Cap.			
HP3-140	28.5	140	17	R	3

All secondary A.C. voltages \pm 3%

MIL-T-27A HERMETICALLY SEALED TRANSFORMERS AND REACTORS

a

MILITARY STANDARD CASES

Designed and built in accordance with MIL-T-27A, Grade 4, Class S* operating temperature and life expectancy X (10,000 hours minimum). Maximum operating altitude 70,000 feet.

The complete line is housed in Chicago's one piece drawn-steel cases. Outside case dimensions and mounting dimensions are within the tolerance of the Military Standard Specifications.

*High Temperature Operation 85° C. ambient, 45° C. rise.

400 CYCLE TRANSFORMERS



POWER TRANSFORMERS—TF4SX03—†

(Capacitor Input Systems)

All primaries 105/115/125 V., 380-1000 cycles

Catalog Number	High Voltage Secondary		Rectifier Filament		Other Filaments		Case† Size	Wt. Lbs.
	A.C. Volts	D.C. Ma.	Volts	Amps.	Volts	Amps.		
4PMS-40	255-0-255	40	5.0	2.0	6.3 CT	2.0	GB	1½
4PMS-55	270-0-270	55	5.0	2	6.3 CT	2	GB	1¾
4PMS-70	335-0-335	70	5.0	2	6.3 CT	3	GB	1¾
4PMS-85	330-0-330	85	5.0	2.0	6.3 CT	3.0	GA	2½
4PMS-105	345-0-345	105	5.0	2.0	6.3 CT	3.5	GA	2¼
4PMS-120	375-0-375	120	5.0	3	6.3 CT	4	GA	3
4PMS-150	370-0-370	150	5.0	3.0	6.3 CT	4.0	JB	4¼
4PMS-165	440-0-440	165	5.0	3	6.3	7.5	KB	6½
					6.3	3		
					6.3	3		
4PMS-200A	450-0-450	200	5.0	2	6.3	0.6	KB	6¼
					6.3	4		
					6.3	4		
					6.3	0.6		
4PMS-300♦§	550-370-75-0	300	5.0	6	6.3 CT	5	KA	7½
	75-370-550				6.3 CT	1		

FILTER REACTORS—TF4SX04—†

Catalog Number	Inductance (henries)	Maximum D.C. Ma.	D.C. Resistance (ohms)	Insulation Volts RMS	Case† Size	Wt. Lbs.
4RMS-240	2.0	40	190	2,500	AH	¼
4RMS-255	2.0	55	160	2,500	AH	¼
4RMS-270	2.0	70	165	2,500	AJ	¾
4RMS-285	2.0	85	125	2,500	AH	¼
4RMS-2105	2.0	105	110	2,500	EB	½
4RMS-2120	2.0	120	100	2,500	EB	1
4RMS-2150	2.0	150	95	2,500	EB	1
4RMS-2165	2.0	165	90	2,500	EB	1
4RMS-2200	2.0	200	73	2,500	FA	2
4RMS-2300§	2.0	300	47	2,500	HA	4

FILAMENT TRANSFORMERS—TF4SX01—†

All primaries 105/115/125 V., 380-1000 cycles

Catalog Number	Sec. Volts	Sec. Amps.	Insulation Volts RMS	Case Size†	Wt. Lbs.
4FMS-63	6.3 CT	3	2,500	EB	1
4FMS-65	6.3 CT	5.5	2,500	EA	1¼
4FMS-610	6.3 CT	10	2,500	FA	2
4FMS-620	6.3 CT	20	2,500	GA	2½

♦Reactor Input All secondary A.C. voltages ± 3%
 †Refer to Case Size
 §Max. operating Alt. 50,000 ft.

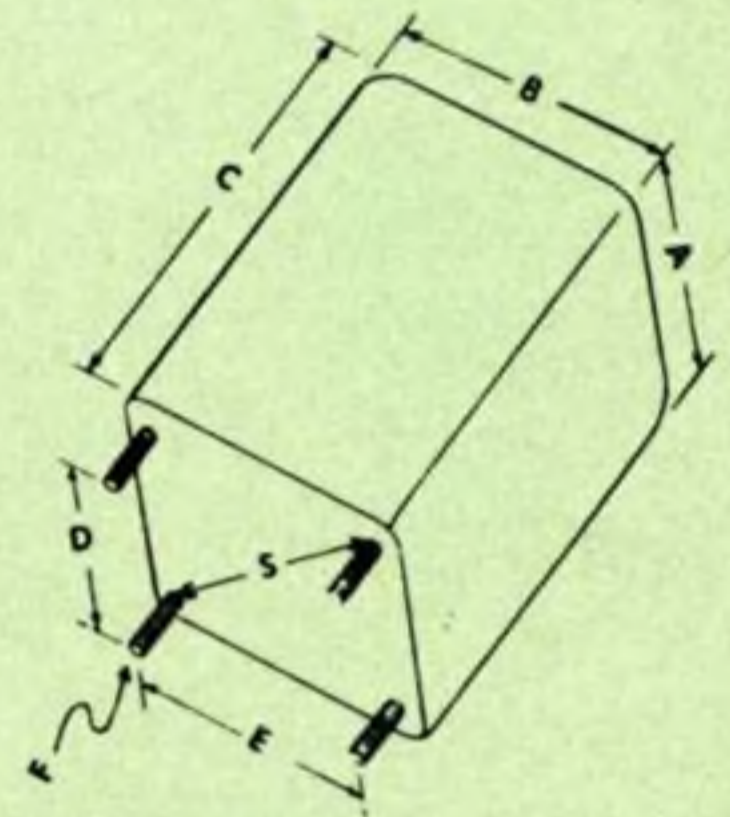

MS CASE DIMENSIONS

Case Size	Dimensions in Inches						
	A	B	C	D	E	S	F
AH	1½	1½	1¾	—	—	1¼	6-32 x ¾
AJ	1¾	1¾	2¾	1¾	1¾	—	6-32 x ¾
EA	1½	1½	2¾	1¾	1¼	—	6-32 x ¾
EB	1½	1½	2¾	1¾	1¼	—	6-32 x ¾
FA	2¾	2¾	3½	1½	1¾	—	6-32 x ¾
GA	2¾	2¾	3½	2½	1¾	—	6-32 x ¾
GB	2¾	2¾	2¾	2½	1¾	—	6-32 x ¾
HA	3½	2¾	4¼	2½	1¾	—	8-32 x ¾
JB	3½	3½	3¾	2½	2½	—	8-32 x ¾
KA	3½	3¾	5¼	3	2¾	—	10-32 x ½
KB	3½	3¾	4¾	3	2¾	—	10-32 x ½

CHICAGO

The world's toughest transformers

PREFERRED FOR EVERY MODERN CIRCUIT REQUIREMENT



**MS
TRANSFORMERS**



MS CASE DIMENSIONS IN INCHES

Case Type	A	B	C	D	E	F
AJ	1 5/8	1 3/8	2 3/8	1 3/16	1 3/16	6-32
EB	1 13/16	1 13/16	2 7/16	1 3/8	1 1/4	6-32
FB	2 5/16	2 1/16	2 1/2	1 11/16	1 7/16	6-32
GB	2 3/4	2 3/8	2 13/16	2 1/8	1 3/4	6-32
HB	3 1/16	2 5/8	3 3/16	2 19/64	1 55/64	8-32
HA	3 1/16	2 5/8	4 1/4	2 19/64	1 55/64	8-32
JR	3 1/16	3 1/16	3 3/8	2 5/8	2 1/8	8-32
KB	3 13/16	3 3/8	4 5/16	3	2 7/16	10-32
LB	4 5/16	3 11/16	4 1/2	3 5/16	2 11/16	10-32
MB	4 11/16	4	4 15/16	3 11/16	3	1/4-20
NB	5 1/16	4 5/16	5 1/2	4 1/16	3 5/16	1/4-20

See Mil-T-27A classification (Column 2) for case size:

MS (MILITARY STANDARD) TRANSFORMERS

All transformers in the MS line are as established jointly by the three armed forces—Army Signal Corps, Navy Bureau of Ships, and Air Force—working through ASES (Armed Services Electronic Standards Agency) and in cooperation with the transformer industry.

Tests have been conducted in the CHICAGO Transformer plant, the results of which indicate that all units will meet the requirements of MIL-T-27A, Grade 4, Class R operating temperature; Life Expectancy X (10,000 hours minimum).

The complete line is housed in Chicago's one-piece drawn-steel cases. Outside case and mounting dimensions are within the tolerances of the Military Standard specification. Terminal arrangements and markings are also in accordance with the same specification.

POWER TRANSFORMERS—REACTOR INPUT SYSTEMS

Maximum Operating Altitude 10,000 ft.

Primary—105/115/125V.—Frequency—54-66 Cycles

Catalog Number	Mil-T-27A Classification	Mil-T-27A Part No.	High Voltage Secondary		D-C, V Output	Rectifier Filament		Filament No. 2		Wt. Lbs.
			A-C Volts	D-C Ma.		Volts	Amps	Volts	Amps	
PMS-70	TF4RX03HA001	MS-90026	200-100-0 100-200	70	156	6.3/5	2	6.3	3	4
PMS-70A	TF4RX03JB002	MS-90027	325-0-325	70	260	6.3/5	2	6.3	4	5
PMS-150	TF4RX03KB006	MS-90028	325-0-325	150	245	6.3	5	5	3	7 1/4
PMS-175	TF4RX03LB003	MS-90029	400-0-400	175	318	5	3	6.3	8	10
PMS-250	TF4RX03MB004	MS-90030	450-0-450	250	345	5	3	6.3	8	13
PMS-350	TF4RX02KB001	MS-90031	350-0-350	250	255	—	—	—	—	7 1/2
PMS-550	TF4RX02LB002	MS-90032	550-0-550	250	419	—	—	—	—	11
PMS-800	TF4RX02NB003	MS-90036	800-0-800	250	640	—	—	—	—	16 1/2

FILAMENT TRANSFORMERS

Maximum Operating Altitude 10,000 ft.

Primary—105/115/125V.—Frequency—54-66 Cycles

Catalog Number	Mil-T-27A Classification No.	Mil-T-27A Part No.	Secondary		Insulation Volts RMS	Wt. Lbs.
			Volts	Amps		
FMS-23	TF4RX01EB002	MS-90016	2.5	3.0	2500	1 1/2
FMS-210	TF4RX01GB003	MS-90017	2.5	10	2500	2 1/2
FMS-53	TF4RX01FB004	MS-90018	5.0	3.0	2500	1 3/4
FMS-510	TF4RX01HB005	MS-90019	5.0	10	2500	4
FMS-62	TF4RX01FB006	MS-90020	6.3	2.0	2500	1 3/4
FMS-65	TF4RX01GB007	MS-90021	6.3	5.0	2500	2 3/4
FMS-610	TF4RX01JB008	MS-90022	6.3	10	2500	5
FMS-620	TF4RX01KB009	MS-90023	6.3	20	2500	8
FMS-210H	TF4RX01JB012	MS-90024	2.5	10	10000	4 3/4
FMS-510H	TF4RX01KB013	MS-90025	5.0	10	10000	7

All secondary A.C. voltages \pm 3%

MIL-T-27A HERMETICALLY SEALED TRANSFORMERS AND REACTORS

a

AUDIO TRANSFORMERS

YY ALTERNATE CASE DIMENSIONS

Case Size	A	B	C	D	E	F
13	2.241	2.101	2.930	1.562	1.375	6-32
14	2.521	2.381	3.049	1.812	1.687	6-32
16	2.861	2.711	3.492	2.000	1.875	8-32
18	3.245	2.979	3.867	2.375	2.125	8-32
20	3.667	3.292	4.305	2.625	2.375	10-32
21	3.667	3.292	4.680	2.625	2.375	10-32
22	4.573	4.120	5.318	3.375	3.000	10-32

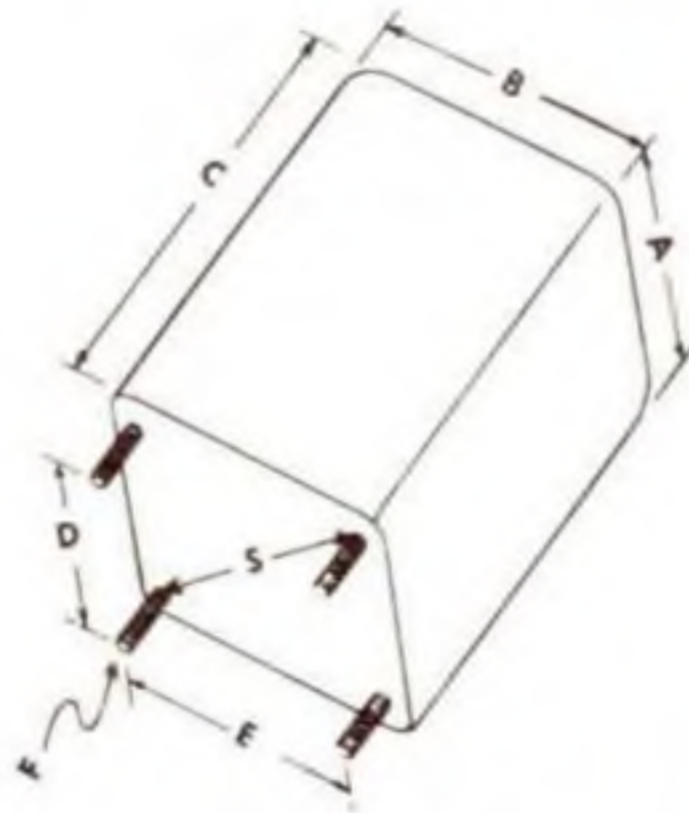

INPUT TRANSFORMERS—TF4RX—YY††

Maximum Operating Altitude 10,000 ft.

Frequency Response, 30 to 15,000 cycles

Catalog No.	Application	Impedance Primary-Secondary	Operating Level§	Hum Reduction	Case Size	††Family	Wt. Lbs.
BIH-1	Line to Single or Push-Pull Grids	*Pri: 600/150 ohms CT *Sec: 50,000 ohms CT	+15 dbm.	-70 dbm.	13	10	1½
BIH-4	Line to Line	Pri: 600/150 ohms CT Sec: 600/150 ohms CT	+15 dbm.	-70 dbm.	13	16	1½
BIH-6	Interstage—P-P Pl. to Sgl. or P-P Grids	*Pri: 20,000 ohms CT *Sec: 50,000 ohms CT	+15 dbm.	-70 dbm.	13	15	1½
BIH-7	Low imped. mike, pickup, or multiple line to grid	Pri: 50/150/250/600 *Sec: 50,000 ohms CT	+15 dbm.	-70 dbm.	13	10	1½
BIH-8	Single Plate to Push-Pull Grids	Pri: 10,000 ohms *Sec: 50,000 ohms CT	+15 dbm.	-70 dbm.	13	10	1½

OUTPUT TRANSFORMERS—TF4RX13YY

Maximum Operating Altitude 10,000 ft.

Frequency Response, 30 to 15,000 cycles

Catalog No.	Application	Impedance Primary-Secondary	Operating Level§	Output Tubes	Case Size	Wt. Lbs.
BOH-1	Single Plate to Line	#Pri: 15,000 ohms *Sec: 600/150 ohms CT	+15 dbm.	6C4's or equiv.	14	2¼
BOH-2	Push-Pull Plates to Line	*Pri: 20,000 ohms CT *Sec: 600/150 ohms CT	+30 dbm.	6C5's or equiv.	16	3
BOH-4	Push-Pull Plates to Line	Pri: 7,500 ohms CT *Sec: 600/150 ohms CT†	+43 dbm.	6L6's or equiv.	20	6
BOH-5	P-P Plates to Line or Voice Coil	*Pri: 10,000 ohms CT *Sec: 600/16/8 ohms CT and 150/4 ohms	+37 dbm.	6V6's or equiv.	18	4
BOH-9	P-P Plates to Line or Voice Coil	*Pri: 5000/3000 ohms CT *Sec: 600/16/8 ohms CT and 150/4 ohms	+42 dbm.	6B4G's or equiv.	20	6

*Split and balanced windings.

‡0 to 10 ma. D-C. §0 dbm. reference level = 1 milliwatt. †Has tertiary winding for 15% inverse feedback.

††Refer to family All secondary A.C. voltages = 3%

MIL-T-27A FULL FREQUENCY RANGE AUDIO TRANSFORMERS

Designed and built in accordance with MIL-T-27A, Grade 4, Class R operating temperature; Life Expectancy X (10,000 hrs. min.).

Frequency response of these input and output transformers is characteristically within ±1db over the full range of 30 to 15,000 cycles.

For Commercial grade "Sealed-in-Steel" transformers identical to this series in performance and construction, See page 24.



CHICAGO

The world's toughest transformers

PREFERRED FOR EVERY MODERN CIRCUIT REQUIREMENT



AUDIO TRANSFORMERS

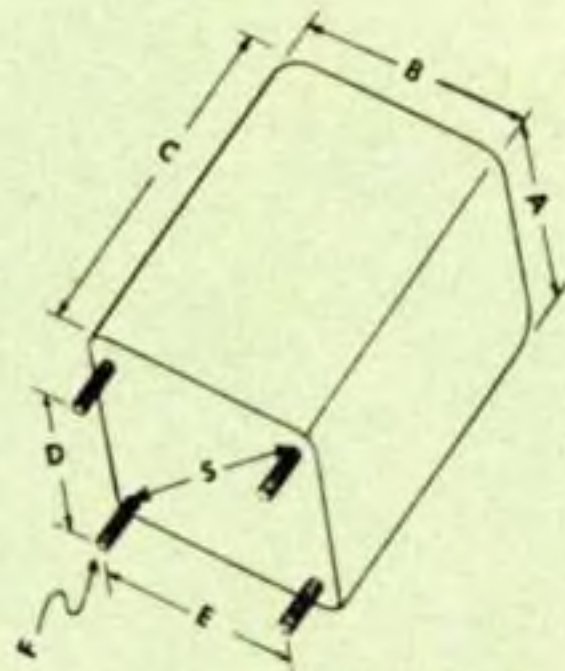

MS CASE DIMENSIONS

Case Size	Dimensions in inches						
	A	B	C	D	E	S	F
AG	1	1	1 3/8	---	---	3/4	4-40 x 3/8
AH	1 5/16	1 5/16	1 3/4	---	---	1 1/4	6-32 x 3/8
AJ	1 5/8	1 5/8	2 3/8	1 3/8	1 3/8	---	6-32 x 3/8
EA	1 5/16	1 13/16	2 3/4	1 3/8	1 1/4	---	6-32 x 3/8
EB	1 5/16	1 13/16	2 7/8	1 3/8	1 1/4	---	6-32 x 3/8
FA	2 3/8	2 1/8	3 1/8	1 11/16	1 7/8	---	6-32 x 3/8

M. S. AUDIO TRANSFORMERS

Maximum Operating Altitude 50,000 ft.
Frequency Response ± 2 db 300—10,000 cps,
 AJ Case Size—Max. Wt. .6 lbs.

Catalog No.	MIL-T-27A Classification	MIL-T-27A Part No.	Application	Impedance	Operating Level	Pri. DCMA
AMS-1	TF1RX15AJ001	MS-90000	P-P Plates to P-P Grids	Pri: 10,000 ohms CT Sec: 90,000 ohms CT 22,500 ohms CT	15 dbm.	10
AMS-2	TF1RX16AJ002	MS-90001	Line to Voice Coil	Pri: 600 ohms CT 150 ohms Sec: 4/8/16 ohms	2W	—
AMS-3	TF1RX10AJ001	MS-90002	Line to P-P Grids	Pri: 600 ohms CT 150 ohms Sec: 135,000 ohms CT	15 dbm.	—
AMS-4	TF1RX16AJ001	MS-90003	Line to Line	Pri: 600 ohms CT 150 ohms Sec: 600 ohms CT 150 ohms	15 dbm.	—
AMS-5	TF1RX13AJ001	MS-90004	Single Plate to Line	Pri: 7600/4800 ohms Sec: 600 ohms CT/150 ohms	2W	40
AMS-6	TF1RX13AJ002	MS-90005	Single Plate to Voice Coil	Pri: 7600/4800 ohms Sec: 4/8/16 ohms	2W	40
AMS-7	TF1RX13AJ003	MS-90006	P-P Plates to Line	Pri: 15,000 ohms CT Sec: 600 ohms CT/150 ohms	2W	10
AMS-8	TF1RX13AJ004	MS-90007	P-P Plates to Line	Pri: 24,000 ohms CT Sec: 600 ohms CT/150 ohms	1W	20
AMS-9	TF1RX13AJ005	MS-90008	P-P Plates to Line	Pri: 60,000 ohms CT Sec: 600 ohms CT/150 ohms	5W	20

TRANSISTOR AUDIO TRANSFORMERS—TF4RX— — — — †

Maximum Operating Altitude 50,000 ft.

Catalog No.	Application	Impedance in Ohms		Max. Pri. D.C. Ma.	DC Res. in Ohms		Power in Watts	Case † Size	Fam-ily †	Wt. Lbs.
		Pri.	Sec.		Pri.	Sec.				
TAMS-1	Input	600 CT	10	20	42	.8	.05	AG	17	2 1/2 oz.
TAMS-2	Interstage	100 CT	10 CT	100	4.3	.8	.25	AH	17	5 oz.
TAMS-3	Interstage	100	1000 CT	100	5.8	45	.25	AJ	17	11 oz.
TAMS-4	Interstage	500 CT	5000 CT	12	37	250	.03	AJ	17	11 oz.
TAMS-5	Driver	1000	200 CT	10	400	115	.05	AG	17	2 oz.
TAMS-6	Driver	2000	200 CT	5	720	115	.05	AG	12	2 oz.
TAMS-7	Driver	100	100 CT	100	12	12	.5	EB	17	1 lb.
TAMS-8	Output	9800	15	2	640	2	.05	AG	12	2 oz.
TAMS-9	Output	1000	4/8/16	10	180	3.5	.2	AG	17	2 1/2 oz.
TAMS-10	Output	2000 CT	4/8/16	—	250	4	.2	AG	12	2 1/2 oz.
TAMS-11	Output	48 CT	8/16	275	5	1.5	5	FA	17	1 1/2 lb.
TAMS-12	Output	20 CT	8	500	.55	.35	10	AJ	17	12 oz.

†Refer to Family and Case Size.

MILITARY STANDARD AUDIO TRANSFORMERS

Designed and built in accordance with MIL-T-27A, Grade 1, Class R operating temperature; Life Expectancy X (10,000 hrs. min.).

TRANSISTOR AUDIO TRANSFORMERS

Designed and built in accordance with MIL-T-27A, Grade 4, Class R operating temperature; Life Expectancy X (10,000 hrs. min.).

The "TAMS Series" of transistor transformers shown at right include a variety of input, interstage, driver, and output types engineered to provide the best efficiency and electrical performance for the electrical power ratings and physical sizes listed.

The impedance ratings and power handling capabilities have been selected to match the most popular and commonly available types of transistors.

Detailed information on applications and circuit constants can be obtained from most booklets of transistor characteristics and applications published by the transistor manufacturers.

MIL-T-27A HERMETICALLY SEALED TRANSFORMERS AND REACTORS

a

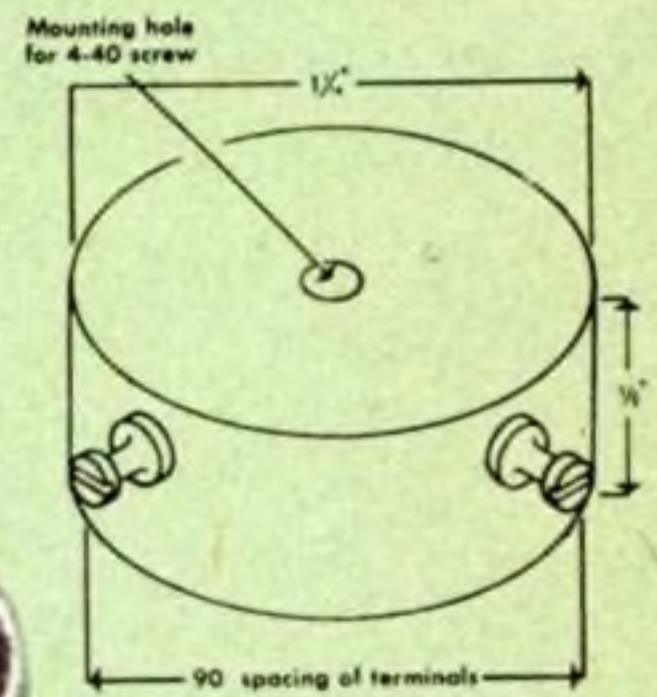
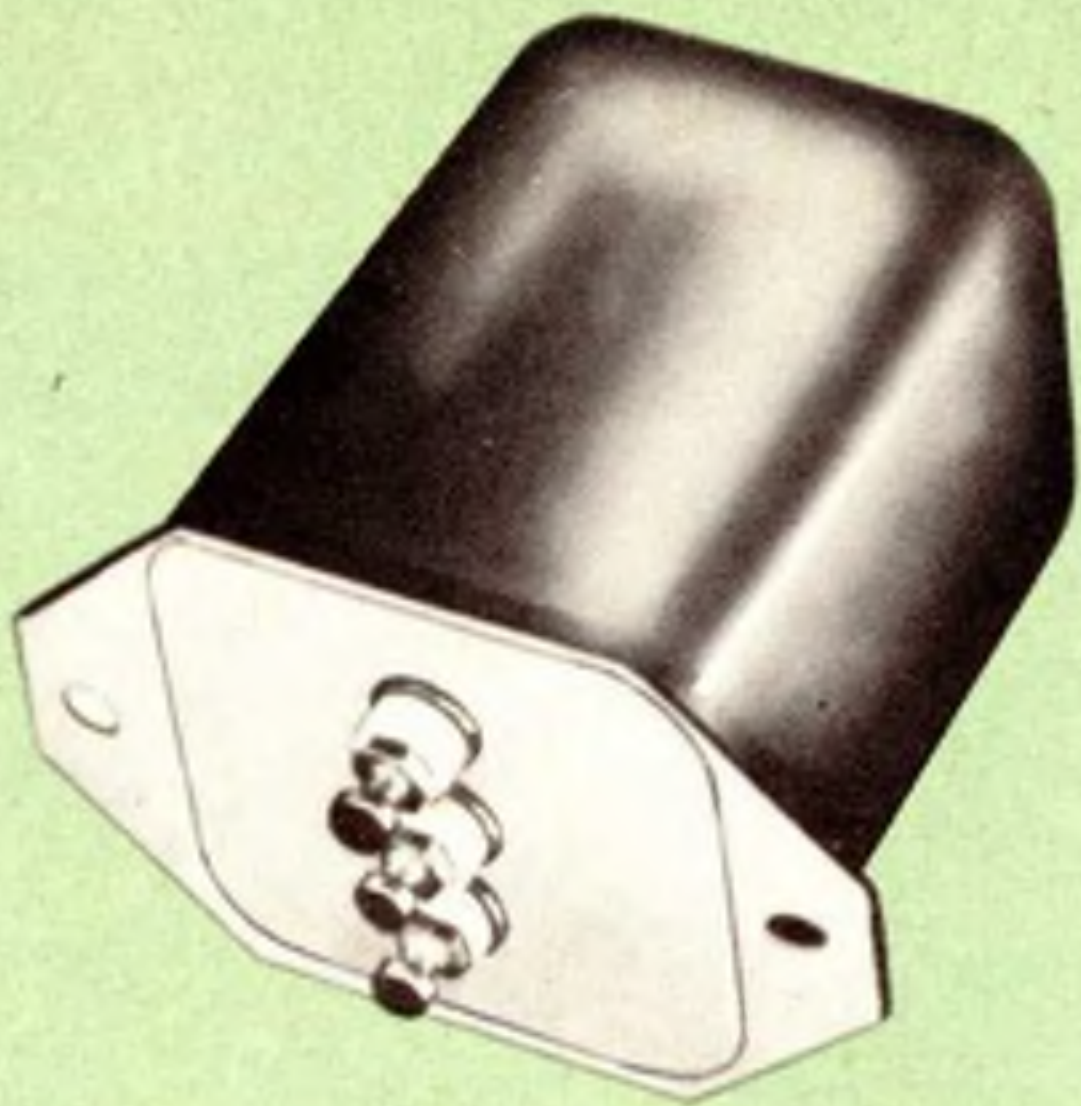

LOW PASS FILTER LPF-2

For attenuating frequencies above 3,000 cycles in low level speech amplifiers.

Originally designed and intended for commercial aircraft communication service, the LPF-2 can be advantageously employed in all types of amateur, police and commercial voice communication equipment.

Electrically, the filter operates out of a source impedance of 50,000 ohms (plate of a 6C4, 6J5 or equivalent) to a 50,000 ohm grid.

The low pass filter will function satisfactorily at input signal levels up to 10 volts RMS. A plate blocking condenser must be used between the input of the filter and the preceding audio amplifier stage, since none is incorporated in the filter proper. The insertion loss of the LPF-2 is relatively low, being in the order of 0.8 db. If greater attenuation than that which can be obtained from a single section is desired or required, two sections can be cascaded. Case size: 9; shipping weight: 8 3/4 oz.

For commercial grade filter, see LPF-1 page 20.

MOLDED TOROIDAL INDUCTORS

CHICAGO toroids, plastic encapsulated in molded cases, are now stocked in standard ratings for immediate delivery. Individual units may be stacked and mounted with a single screw to obtain various combinations of inductance. CHICAGO toroids are wound on high density, high permeability cores of powdered molybdenum permalloy, with utmost attention given to stability, low temperature co-efficients, insulation and ruggedness.

Features:

- High Q over wide frequency ranges
- Minimum pickup from external magnetic fields
- Close tolerance of plus, minus 1%
- High stability over temperature range of -55° to plus 85° centigrade
- Not affected by high humidity
- Resist shock and vibration
- Small sized, uniform, easily stacked

VOLTAGE ATTENUATION CURVE OF LPF-2 FILTER

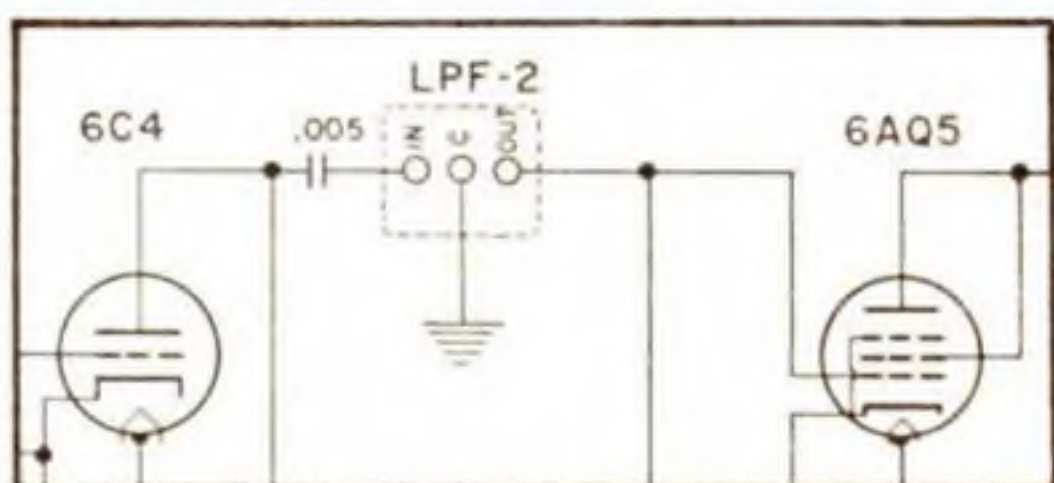
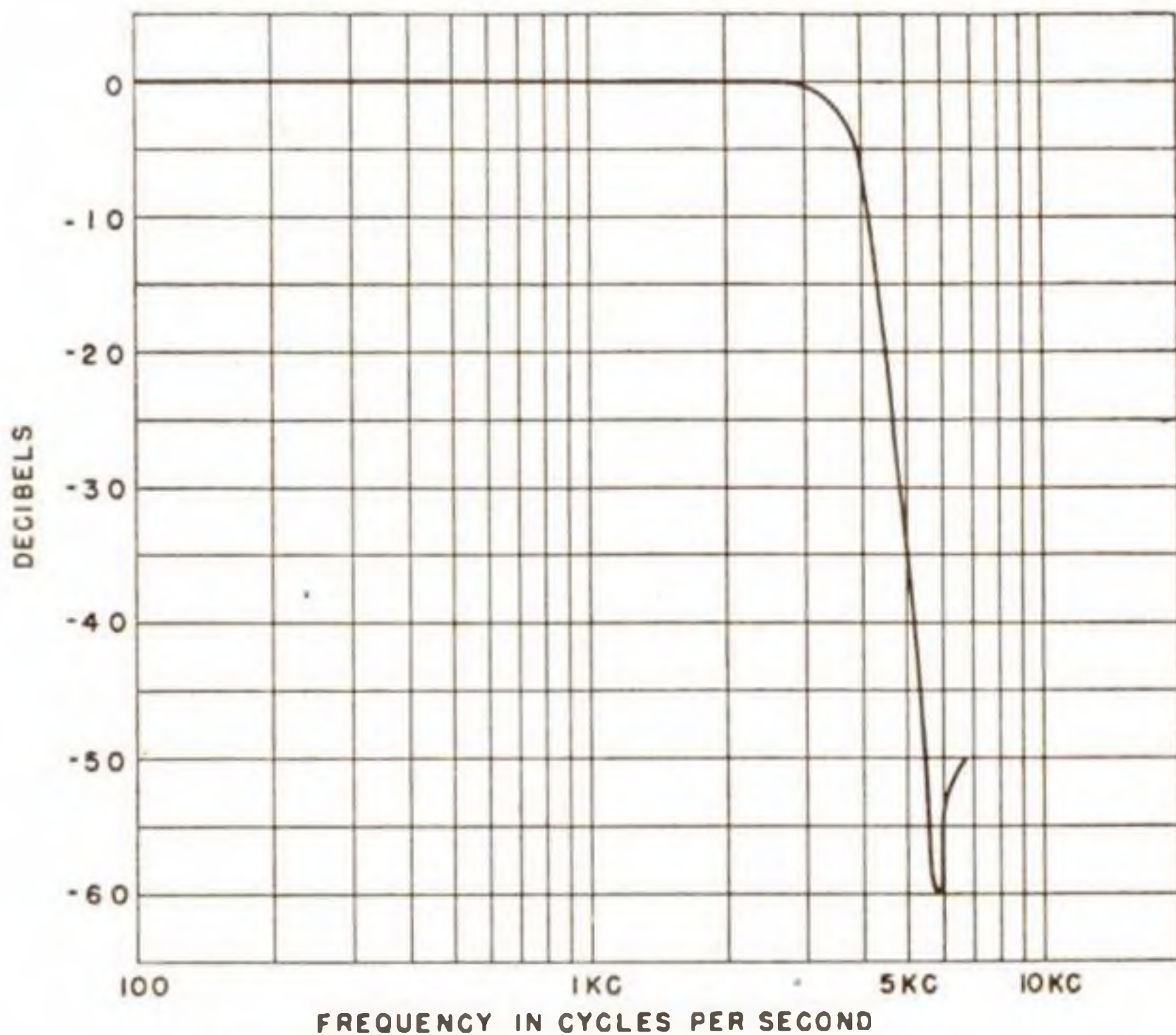

Catalog No.	Inductance (m.h.)	D.C. Res. (ohms)
TM-1 A	1	.32
TM-2 A	2	.72
TM-5 A	5	1.85
TM-8 A	8	2.25
TM-10 A	10	3.25
TM-20 A	20	7.0
TM-50 A	50	18.5
TM-80 A	80	29.5
TM-100 A	100	32.5
TM-200 A	200	71.5
TM-500 A	500	185
TM-800 A	800	300
TM-1000 A	1000	340

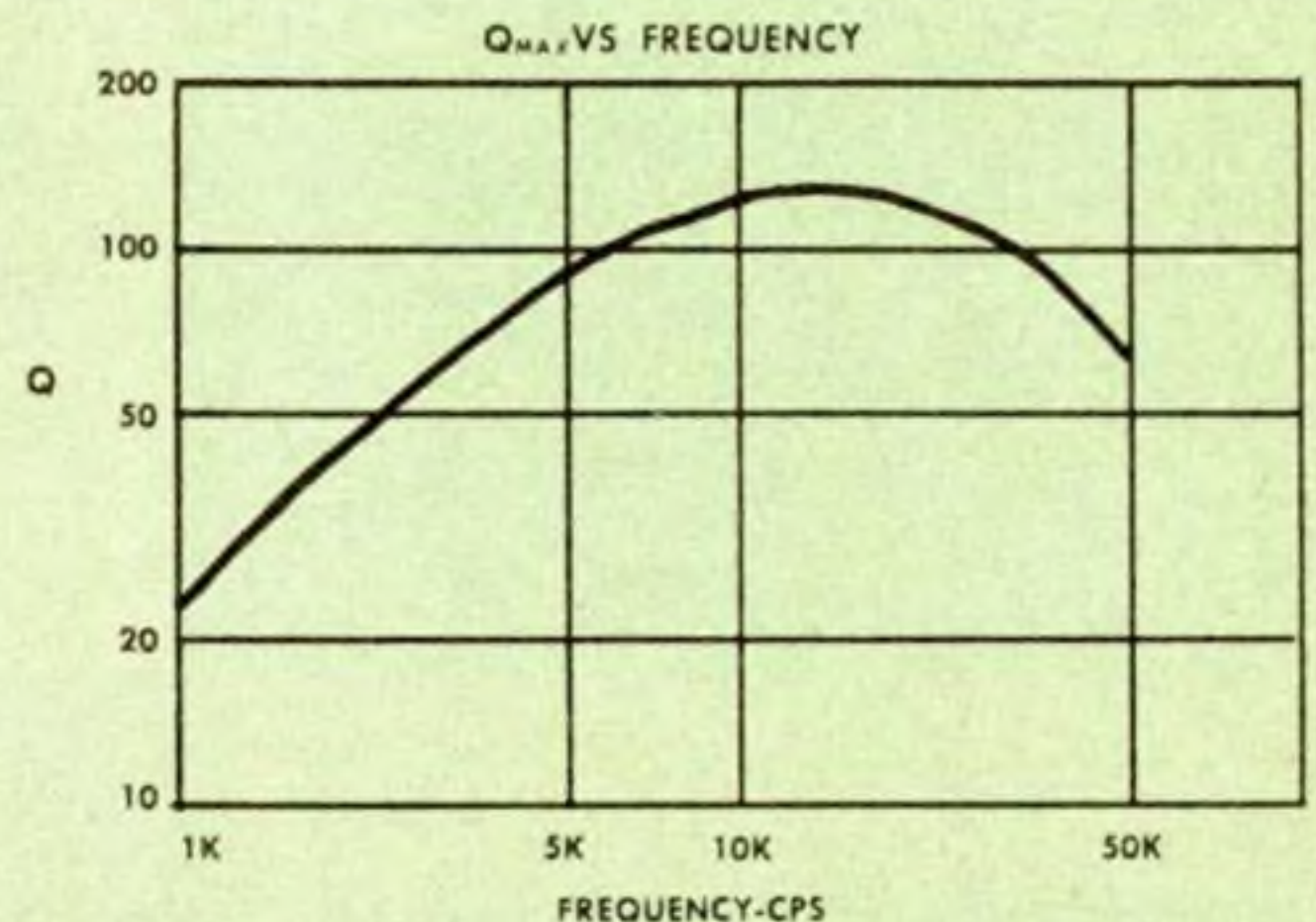

CHICAGO

The world's toughest transformers

PREFERRED FOR EVERY MODERN CIRCUIT REQUIREMENT

MIL-T-27A PUBLIC ADDRESS RANGE AUDIO TRANSFORMERS



Designed and built in accordance with MIL-T-27A; Grade 4, Class R operating temperature; Life expectancy X (10,000 hrs. min.). Maximum operating altitude 10,000 feet. Transformers in this series are electrically the same as those listed on page 22. Their frequency response is within ± 1 db over a frequency range of 50 to 10,000 cycles. Response curves for the three PHO output transformers are identical to those for units with corresponding PSO numbers shown on page 22. Used in military communication and test equipment.

DRIVER TRANSFORMERS—TF4RX12YY

Catalog No.	Typical Driver Tubes	Primary Impedance	Max D-C in Pri.	Power in Watts	Ratio Pri./ $\frac{1}{2}$ Sec.	Case Size	Wt. Lbs.
PHD-10	P-P 6N7's, 6A6's, 6J5's, 6C4's, etc.	20,000 ohms CT	10 ma.	3	3:1	14	2 $\frac{1}{4}$
PHD-25	P-P 6N7's, 6A6's, 6J5's, 6C4's, etc.	20,000 ohms CT	25 ma.	5	3:1	15	2 $\frac{1}{4}$
PHD-100	P-P 6B4G's, 45's, 2A3's, 6L6's, etc.	5,000/10,000 ohms CT	100 ma.	10	5:1	18	4 $\frac{1}{2}$

OUTPUT TRANSFORMERS—TF4RX13YY

Catalog No.	Typical Output Tubes	Class	Impedances Primary—Secondary	Max. D-C In Pri.	Power Level	Case Size	Wt. Lbs.
PHO-80	P-P 6B4G's, 6L6's P-P 6V6's, 6L6's	A1 AB	Pri: 5,000 ohms CT Sec: 600/150/ * 16/8/4 ohms	120 ma.	20 watts	20	6 $\frac{1}{2}$

*Has tertiary winding to provide 10% inverse feedback.

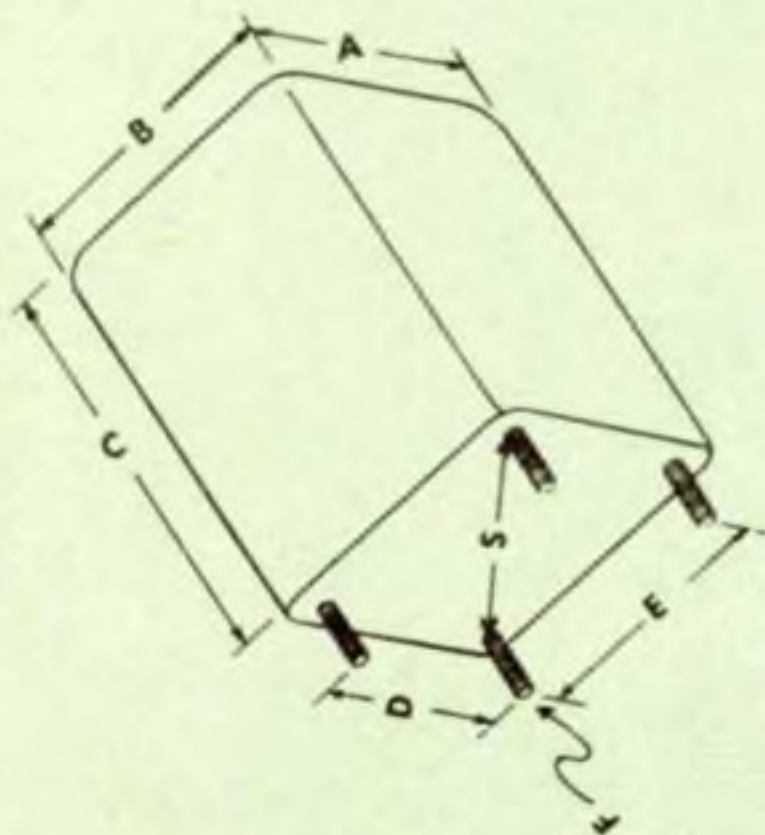

MIL-T-27A COMMUNICATIONS RANGE AUDIO TRANSFORMERS

Designed and built in accordance with MIL-T-27A; Grade 4, Class R operating temperature; Life expectancy X (10,000 hrs. min.). Maximum operating altitude 10,000 feet. The frequency response of these input output transformers is within ± 1 db over range of 200 to 3500 cycles, which makes them well adapted to equipment designed for unattenuated speech reproduction. Built to withstand high humidity, severe shock, or corrosive action.

INPUT TRANSFORMERS—TF4RX—YY††

Catalog No.	Application	Impedances Primary-Secondary	Case Size	Family††	Wt. Lbs.
CIH-1	Low Level Line to Single or P-P Grids	Pri: 600/150 ohms *Sec: 100,000 ohms CT	9	10	$\frac{3}{4}$
CIH-2	Low Level SB or DB Microphone to Sgl. or P-P Grids	Pri: 125/50 ohms, 80 ma. Sec: 125,000 ohms CT	12	11	$\frac{3}{4}$

*Split and balanced windings.

OUTPUT TRANSFORMERS—TF4RX13YY

Single Plate to Line or Voice Coil

Catalog No.	Typical Output Tubes	Class	Impedances Primary-Secondary	Max. D-C in Pri.	Power Level	Case Size	Wt. Lbs.
COH-1	Sgl. 6L6, 6V6, 25A6, etc.	A	Pri: 5,000 ohms Sec: 600/150/ 16/8/4 ohms	55 ma.	5 watts	14	2 $\frac{1}{4}$
COH-2	Sgl. 6F6, 6V6, 6N6, 6K6, 7B5	A	Pri: 8,000 ohms Sec: 600/150/ 16/8/4 ohms.	55 ma.	5 watts	14	2 $\frac{1}{4}$

††Refer to family group.

YY ALTERNATE CASE DIMENSIONS

Case Size	A	B	C	D	E	F
8	1.546	1.546	1.955	1.000	1.000	6-32
9	1.546	1.546	2.143	1.000	1.000	6-32
12	2.241	2.101	2.680	1.562	1.375	6-32
13	2.241	2.101	2.930	1.562	1.375	6-32
14	2.521	2.381	3.049	1.812	1.687	6-32
15	2.521	2.381	3.299	1.812	1.687	6-32
16	2.861	2.711	3.492	2.000	1.875	8-32
17	2.861	2.711	3.742	2.000	1.875	8-32
18	3.245	2.979	3.867	2.375	2.125	8-32
19	3.245	2.979	4.242	2.375	2.125	8-32
20	3.667	3.292	4.305	2.625	2.375	10-32

MIL-T-27A SATURABLE TRANSFORMERS (Magnetic Amplifiers)

Application: For use with 2 phase 115v. 400 cycle Servo-Motors.

SATURABLE TRANSFORMER—TF4RX40YY

All Primaries 115v., 400 cycles;

Maximum Altitude 50,000 ft.

Ratings

Catalog No.	STH-3		STH-5	STH-10	STH-18
Power Output in watts	2.7	3.5	5	10	18
Voltage Output, volts	26	115	115	115	115
Load Resistance in ohms	250	3800	2640	1320	775
Tuning Capacitor, MFD	.28	.19	.4	.6	1.0
Primary Current in amps	.085	.1	.13	.24	.35
Control Current, MA	8	8	8	8	8
Control Coil Res. (Per Coil) in ohms	2900	2900	3100	4200	5600
Control Coil By pass Capacitors, MFD	.1	.1	.1	.1	.1
Base Area, Dimensions, in.	1 ⁵ / ₁₆ x 1 ¹³ / ₁₆		1 ¹ / ₂ x 2 ¹ / ₈	1 ³ / ₄ x 2 ¹ / ₂	2 ¹ / ₈ x 3 ¹ / ₈
Height, in.	2 ⁷ / ₁₆		2 ³ / ₄	2 ³ / ₃₂	3 ³ / ₈
Mfg. Ctrs., in.	3/4 x 1 ¹⁵ / ₁₆		1 x 1 ⁵ / ₈	1 ¹ / ₈ x 1 ⁷ / ₈	1 ¹ / ₂ x 2 ¹ / ₂
Actual Wt., Lbs.	3/4		1	1 ¹ / ₂	2 ¹ / ₂
Typical Servo-Motor Load:					
Kearfott	R-118	R-119-2	R-110-2	R-111-2	R-112-2
G. M. Labs.	—	665-54-19	665-54-47 665-52-48	665-53-40 665-53-41	665-53-44 665-53-45



Saturable Transformers

are designed and built in accordance with MIL-T-27A, Grade 4, Class R operating temperature and life expectancy X (10,000 hrs. minimum).

Typical Magnetic Amplifier Circuit

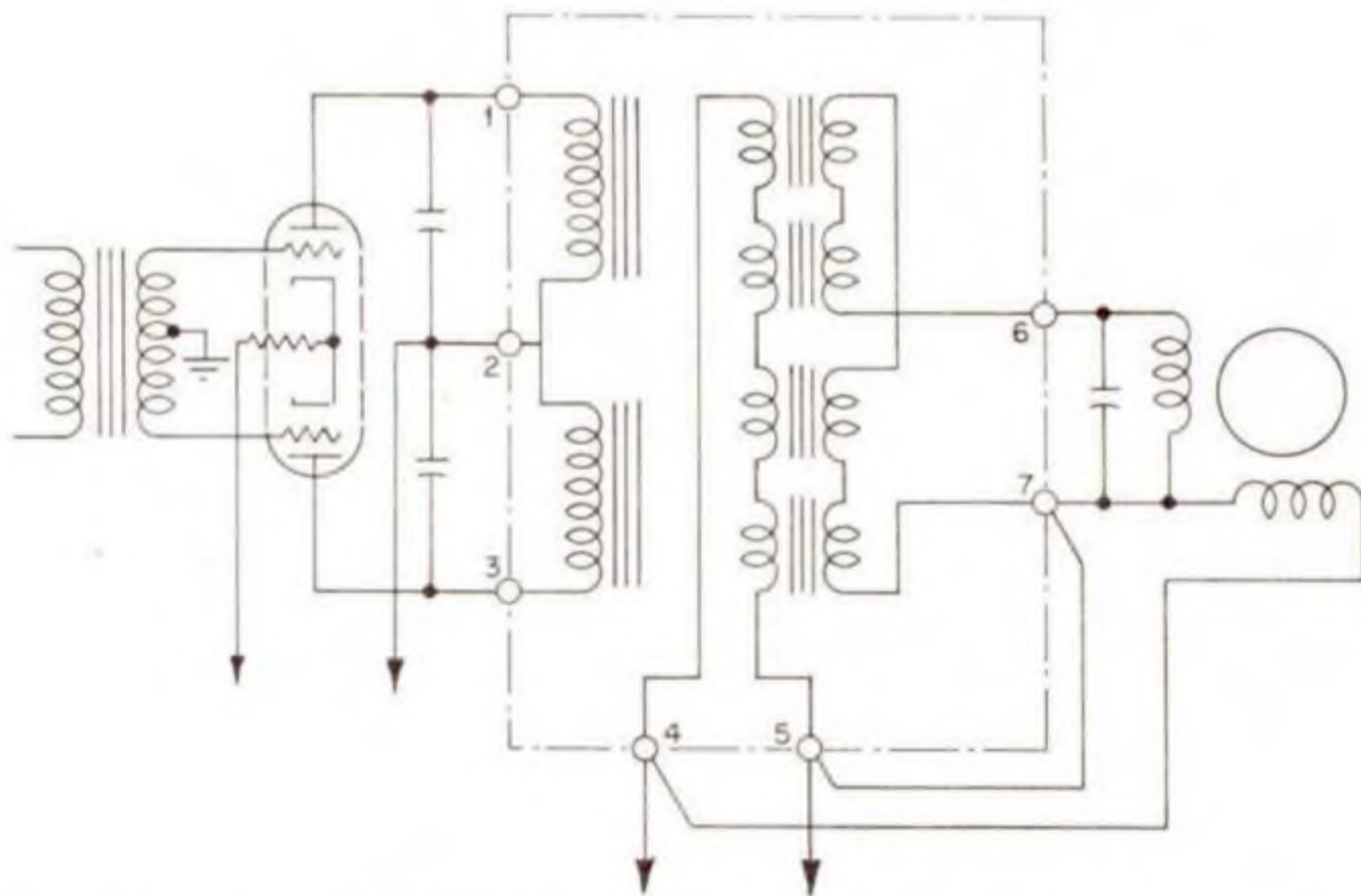

CAT. NO. 10111 PULSE TRANSFORMER

Ratio, 1:1:1. Equivalent of former Utah Nos. X-124T-2 and X-124T-3; for use in blocking oscillator, multivibrator and 'scope circuits—wherever accurate timing and triggering are necessary; unexcelled in circuit applications for generating low power and low voltage pulses; can be used in circuits utilizing repetition rates from 0 to 500 KC, and pulse widths ranging from .3 to .6 microsecond. Completely impregnated and sealed. Dimensions, 1¹/₈" wide, 1¹³/₁₆" long, 9/16" high; 6-32 mounting studs.

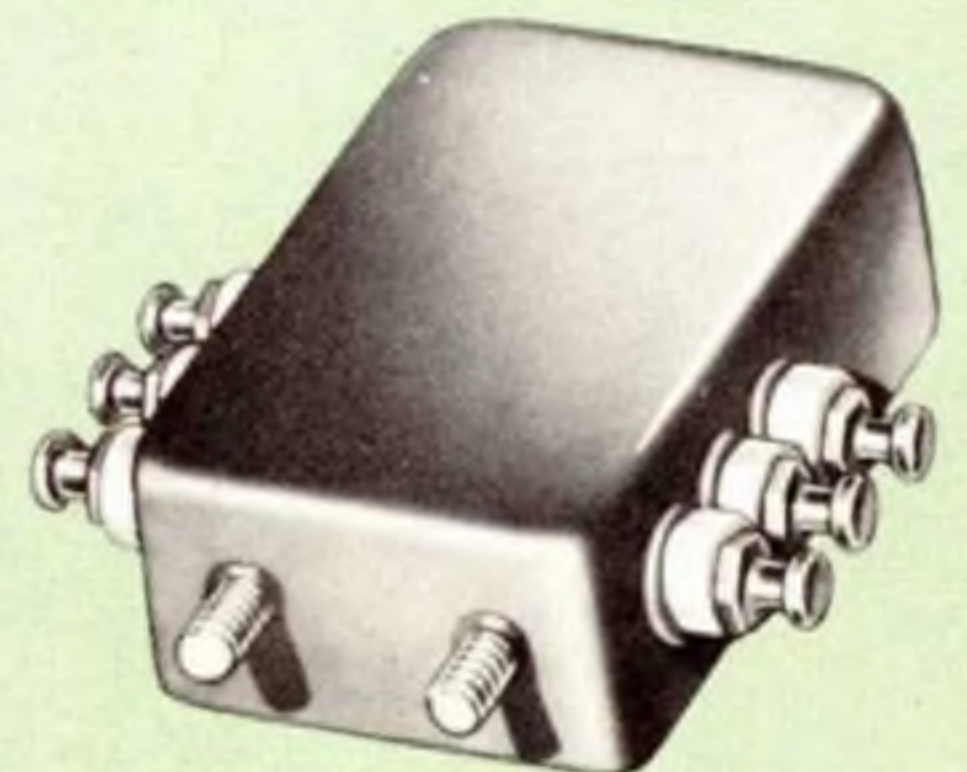

CHICAGO

The world's toughest transformers

PREFERRED FOR EVERY MODERN CIRCUIT REQUIREMENT

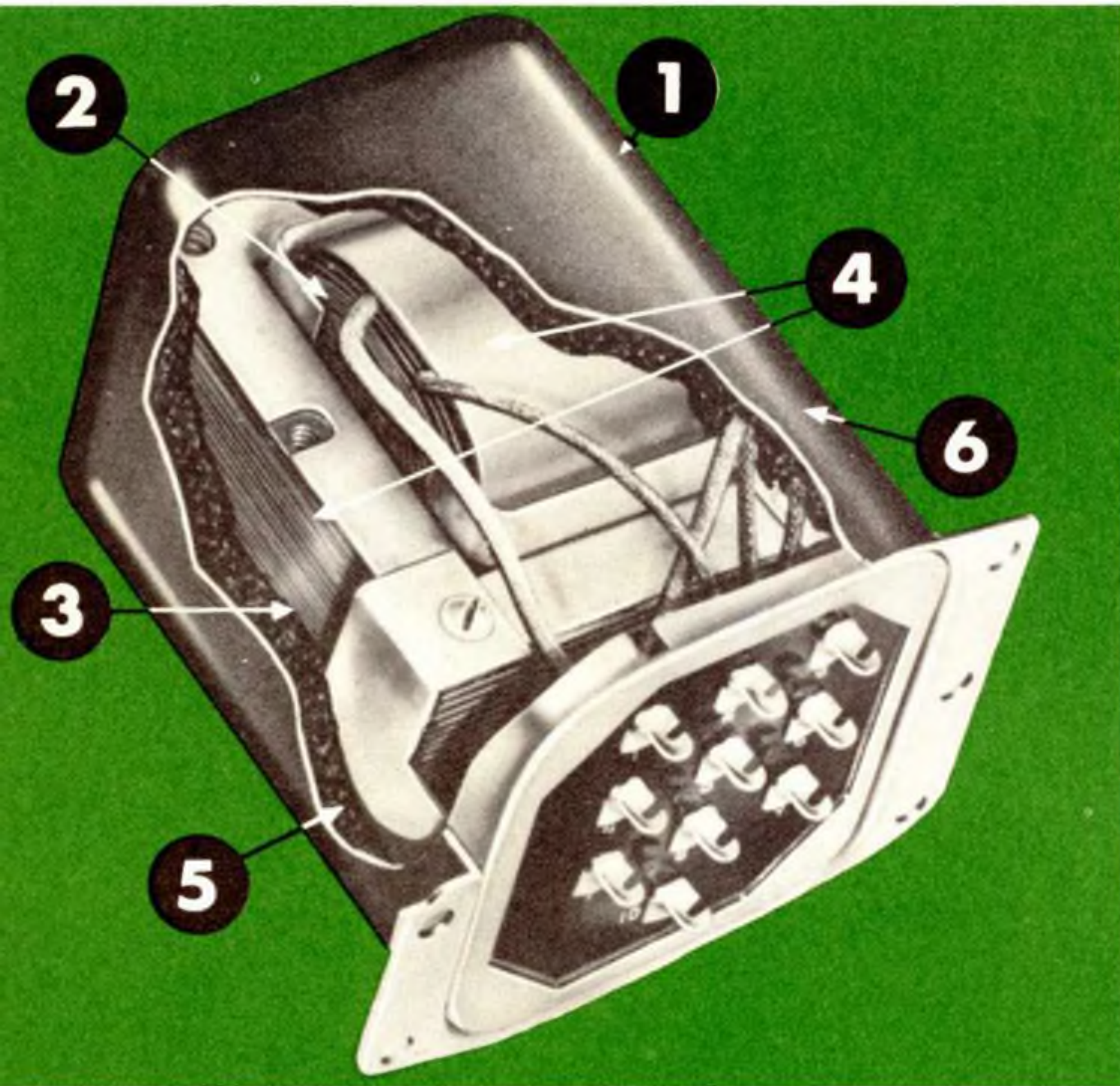

CHICAGO'S FAMOUS "SEALED-IN-STEEL" CONSTRUCTION

- 1** Exclusive one-piece drawn-steel case, unsurpassed for strength, moisture-resistance, better electrostatic and magnetic shielding, mounting ease and streamlined appearance.
- 2** Uniformly-wound precise coil structures—cooler operation and better electrostatic shielding in power units—minimum leakage, optimum coupling in audio units.
- 3** Core of high-grade non-aging silicon steel brought to high efficiency by scientific heat-treating in CHICAGO's own annealing ovens.
- 4** Core and coil vacuum-impregnated with varnish. Final high-temperature baking achieves a perfectly impregnated coil and core locked against vibration.
- 5** All internal free space is filled by special, moisture-resistant compound. Prevents corrosion and helps maintain far cooler operation than in conventional air-surrounded mountings.
- 6** Checked by quality controls at every stage of manufacture, rigidly inspected, "torture-chamber" tested to insure long, dependable life in actual service.

POWER TRANSFORMERS-

Primary: 117 volts, 50/60 cycles

CHICAGO'S power transformers are of the famous "Sealed-in-Steel" construction. They have excellent protection against corrosion by atmospheric moisture, industrial fumes, etc., and, in addition, add greatly to the finished modern appearance of any equipment.

Current ratings of these power transformers and their mountings are perfectly matched in the series of filter reactors on page 15.

FOR CAPACITOR INPUT SYSTEMS

Catalog No.	High Voltage Secondary			Rectifier		Filaments				Mounting		Wt. Lbs.
	A-C Volts	D-C Ma.	D-C V. Output	Volts	Amps.	No. 2		No. 3		Type	Size	
						Volts	Amps.	Volts	Amps.			
PCC-40										C	16	
PSC-40	225-0-225	40	210	5	2	6.3CT	2			S	17	3 1/4
PCC-55										C	16	
PSC-55	270-0-270	55	260	5	2	6.3CT	2			S	17	3 1/2
PCC-60										C	18	
PSC-60	300-0-300	60	285	5	2	6.3CT	3			S	19	4 1/2
PCC-70										C	18	
PSC-70	335-0-335	70	320	5	2	6.3CT	3			S	19	4 1/2
PCC-85										C	20	
PSC-85	330-0-330	85	320	5	2	6.3CT	3			S	20	6
PCC-105										C	20	
PSC-105	345-0-345	105	320	5	2	6.3CT	3.5			S	21	6 1/2
PCC-120										C	22	
PSC-120	375-0-375	120	380	5	3	6.3CT	4			S	22	9 1/2
PCC-150										C	22	
PSC-150	370-0-370	150	390	5	3	6.3CT	4	6.3CT	1	S	22	11 1/2
PCC-200										C	22	
PSC-200	385-0-385	200	390	5	3	6.3CT	4.5	6.3CT	1	S	22	12
PCC-250	400-80-0									C	24	
PSC-250	-80-400	250	410	5	6	6.3CT	7	5.0	2	S	24	15

NEW EQUIPMENT COMMERCIAL GRADE TRANSFORMERS AND REACTORS

b

"New Equipment" Transformer Characteristics:

- Power and audio ratings that precisely fit the requirements of today's most-used tubes.
- Audio transformers with line and voice coil impedances that exactly match the ratings of the currently popular high-fidelity speakers.
- Observance of RETMA Standards for heat rise and lead color coding.
- Streamlined, drawn-steel cases that look well with other modern set components and adds to the handsome appearance of any equipment.

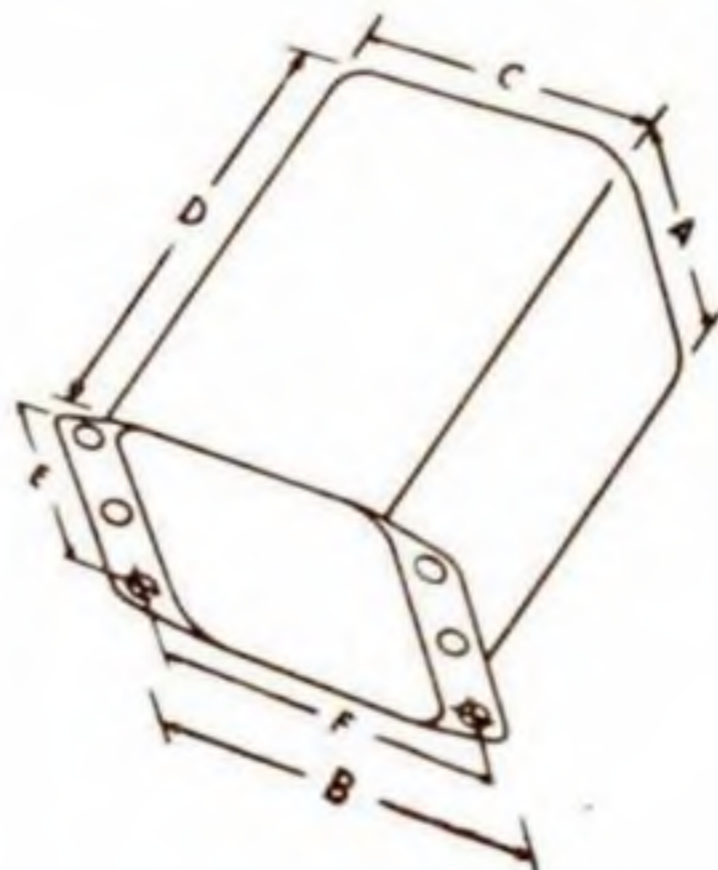

C- AND S-TYPE DIMENSIONS

Case Size	Dimensions in Inches					
	A	B	C	D	E	F
15	2 1/2	3	2 3/8	3 5/16	1 3/4	2 11/16
16	2 7/8	3 1/2	2 11/16	3 1/2	2	3 1/8
17	2 7/8	3 1/2	2 11/16	3 3/4	2	3 1/8
18	3 1/4	4	3	3 7/8	2 1/4	3 1/2
19	3 1/4	4	3	4 1/4	2 1/4	3 1/2
20	3 11/16	4 7/16	3 5/16	4 5/16	2 3/4	3 7/8
21	3 11/16	4 7/16	3 5/16	4 11/16	2 3/4	3 7/8
22	4 9/16	5 1/4	4 1/8	5 5/16	2 1/2	4 3/4
24	5 5/16	5 7/8	4 13/16	6 1/16	3 1/2	5 3/8

FOR REACTOR INPUT SYSTEMS

Catalog No.	High Voltage Secondary			Rectifier Volts	Rectifier Amps	Filaments				Mounting Type	Mounting Size	Wt. Lbs.
	A-C Volts	D-C Ma.	D-CV. Output			No. 2 Volts	No. 2 Amps	No. 3 Volts	No. 3 Amps			
PCR-55	350-0-350	55	260	5	2	6.3CT	2			C	16	3 1/4
PSR-55										S	17	
PCR-70	425-0-425	70	320	5	2	6.3CT	3			C	18	4 1/2
PSR-70										S	19	
PCR-85	440-0-440	85	325	5	2	6.3CT	3			C	20	6
PSR-85										S	20	
PCR-105	450-0-450	105	320	5	2	6.3CT	3.5			C	20	6 1/2
PSR-105										S	21	
PCR-120	500-0-500	120	390	5	3	6.3CT	4			C	22	9 1/2
PSR-120										S	22	
PCR-150	510-0-510	150	395	5	3	6.3CT	4	6.3CT	1	C	22	11 1/2
PSR-150										S	22	
PCR-200	520-0-520	200	390	5	3	6.3CT	4.5	6.3CT	1	C	22	12 1/4
PSR-200										S	22	
PCR-300	550-370-75-0	300	420	5	6	6.3CT	5	6.3CT	1	C	24	17 1/2
PSR-300										S	24	

FOR REGULATED POWER SUPPLIES—CAPACITOR INPUT

PSC-165	440-0-440	165	430	5	3	6.3	7.5	6.3	3	S	22	12
						6.3	0.6	6.3	3			
PSC-205	450-0-450	200	442	5	2	6.3	4	6.3	0.6	S	22	12
						6.3	4					

BIAS TRANSFORMERS — Primary: 50/60 cycles COMBINATION PLATE AND FILAMENT SUPPLY

Catalog No.	Primary Volts	High Voltage Secondary		Rectifier Filament		Mounting		Wt. Lbs.
		A-C Volts	D-C Ma.	Volts	Amps.	Type	Size	
1BC-150	115	180-160-140-120-0	150	5.0	3.0	C	18	5
1BS-150		120-140-160-180				S	19	
2BC-150	230	180-160-140-120-0	150	5.0	3.0	C	18	5
2BS-150		120-140-160-180				S	19	

AVAILABLE IN THREE VERSATILE CONSTRUCTIONS



B-TYPE

Steel base cover soldered into case. Phenolic terminal board with solid steel pin-type terminals. Unit has mounting studs.



C-TYPE

With 10" color-coded leads brought out through fibre board base cover. Lead ends stripped and tinned. Flanged-mounted unit.



S-TYPE

Steel base cover fitted with phenolic terminal board. Convenient numbered solder lug terminals. Flange-mounted unit.

CHICAGO

The world's toughest transformers

PREFERRED FOR EVERY MODERN CIRCUIT REQUIREMENT

FILTER REACTORS



S-TYPE MOUNTING

The design of CHICAGO filter reactors provides maximum inductance for given current rating in the smallest possible size of unit. Their mountings and current rating match with those of the power transformers, pages 14 and 15.

C- AND S-TYPE DIMENSIONS

Case Size	Dimensions in Inches					
	A	B	C	D	E	F
12	2 1/4	2 1/16	2 1/8	2 1/16	1 1/2	2 3/8
13	2 1/4	2 1/16	2 1/8	2 1/16	1 1/2	2 3/8
14	2 1/2	3	2 3/8	3 1/16	1 3/4	2 11/16
15	2 1/2	3	2 3/8	3 1/16	1 3/4	2 11/16
16	2 7/8	3 1/2	2 11/16	3 1/2	2	3 1/8
17	2 7/8	3 1/2	2 11/16	3 1/4	2	3 1/8
18	3 1/4	4	3	3 3/8	2 1/4	3 1/2
19	3 1/4	4	3	4 1/4	2 1/4	3 1/2
20	3 11/16	4 7/16	3 5/16	4 3/16	2 3/4	3 7/8
21	3 11/16	4 7/16	3 5/16	4 1/16	2 3/4	3 7/8
22	4 1/16	5 1/4	4 1/8	5 5/16	2 1/2	4 3/4
24	5 5/16	5 7/8	4 13/16	6 1/16	3 1/2	5 3/8
26	6 1/8	6 1/2	5 1/4	7 1/16	4 1/4	6

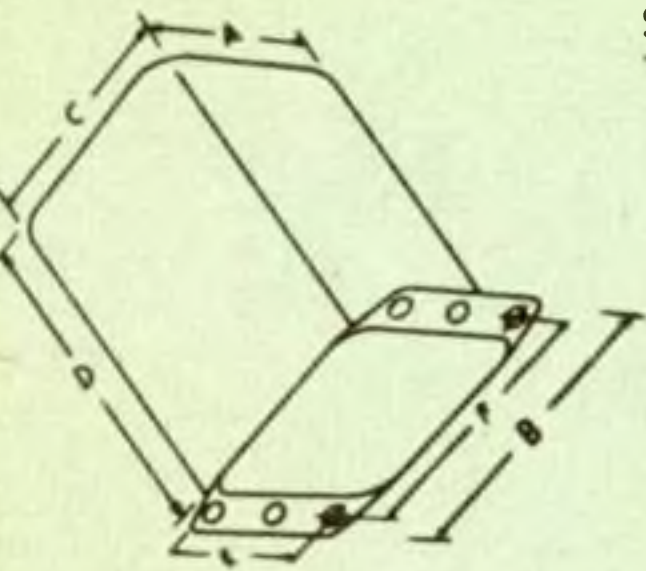

Catalog No.	Inductance, Henries	Max. D-C Current, Ma.	D-C Resistance in Ohms	Insulation Test Volts RMS	Mounting		Wt. Lbs.
					Type	Size	
RC-1540	15	40	475	2500	C	12	1 1/2
RS-1540					S	12	
RC-1055	10	55	230	2500	C	12	1 3/4
RS-1055					S	13	
RC-1555	15	55	420	2500	C	12	2
RS-1555					S	13	
RC-1085	10	85	175	2500	C	14	2 1/2
RS-1085					S	15	
RC-1585	15	85	285	2500	C	14	2 3/4
RS-1585					S	15	
RC-8105	8	105	100	2500	C	16	3 3/4
RS-8105					S	17	
RC-12105	12	105	170	2500	C	16	4
RS-12105					S	17	
RC-8150	8	150	100	2500	C	18	5 1/4
RS-8150					S	19	
RC-12150	12	150	150	2500	C	18	5 1/2
RS-12150					S	19	
RC-8200	8	200	85	2500	C	20	7
RS-8200					S	21	
RC-12200	12	200	140	2500	C	20	7
RS-12200					S	21	
RC-8250	8	250	90	2500	C	22	10 1/2
RS-8250					S	22	
RC-8300	8	300	60	3500	C	22	12 1/2
RS-8300					S	22	

FILTER REACTOR CURVES

Actual inductance values of CHICAGO Filter Reactors when operated throughout the specified current range. All measurements made at 10 volts, 60 cycles.

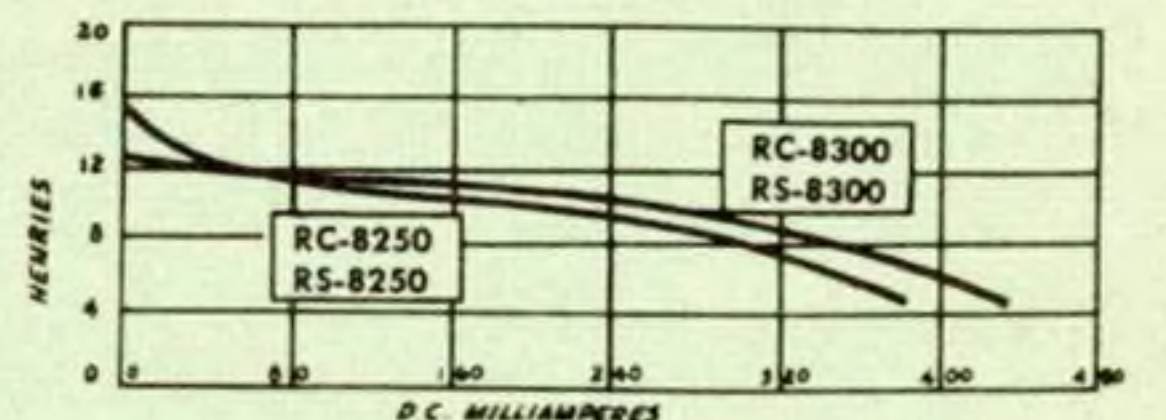
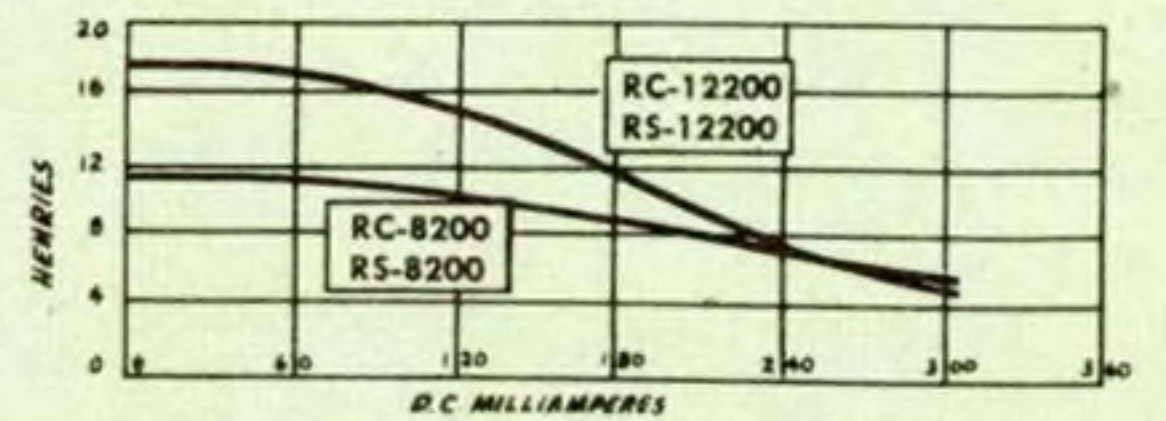
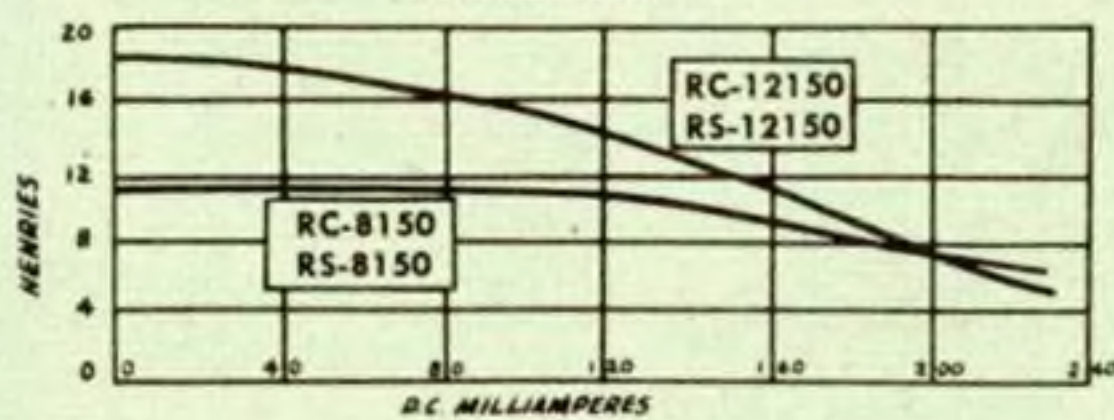
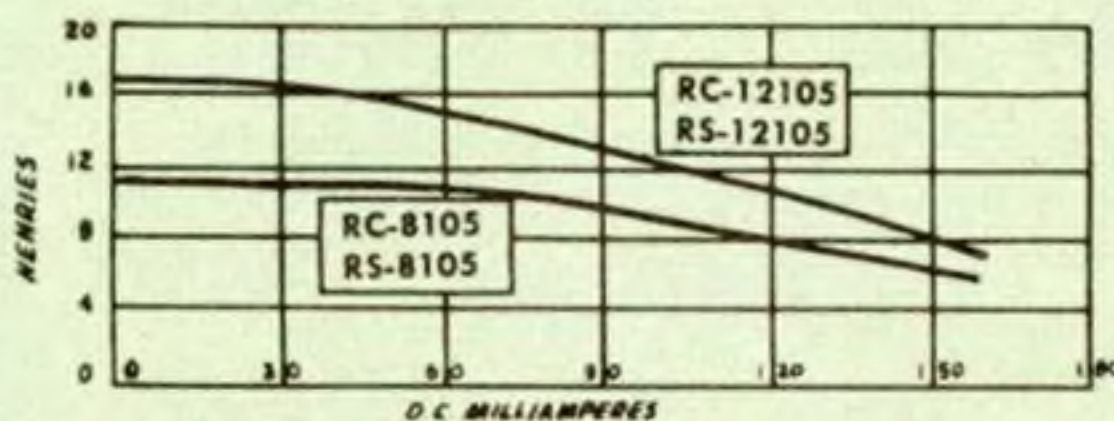
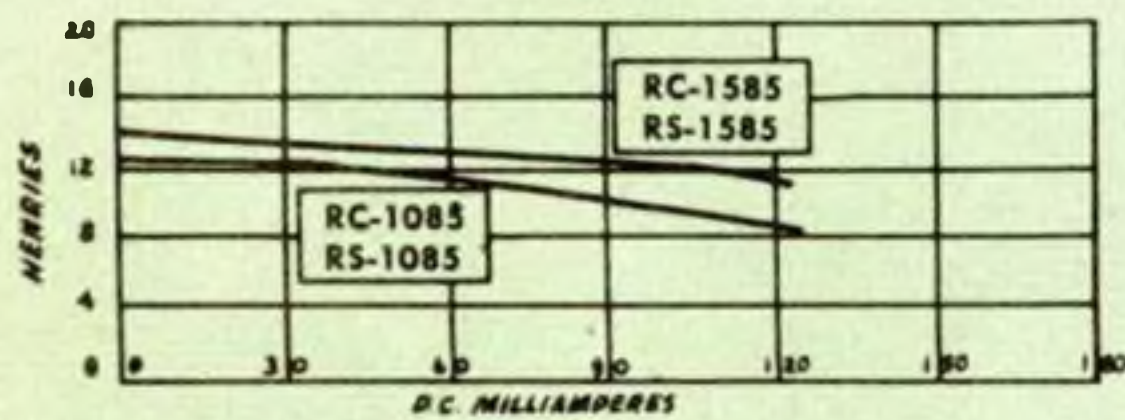
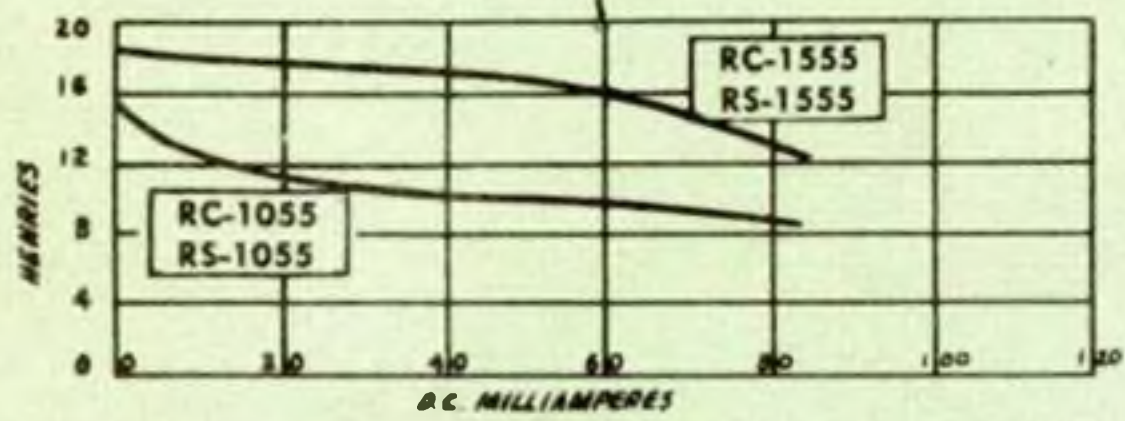
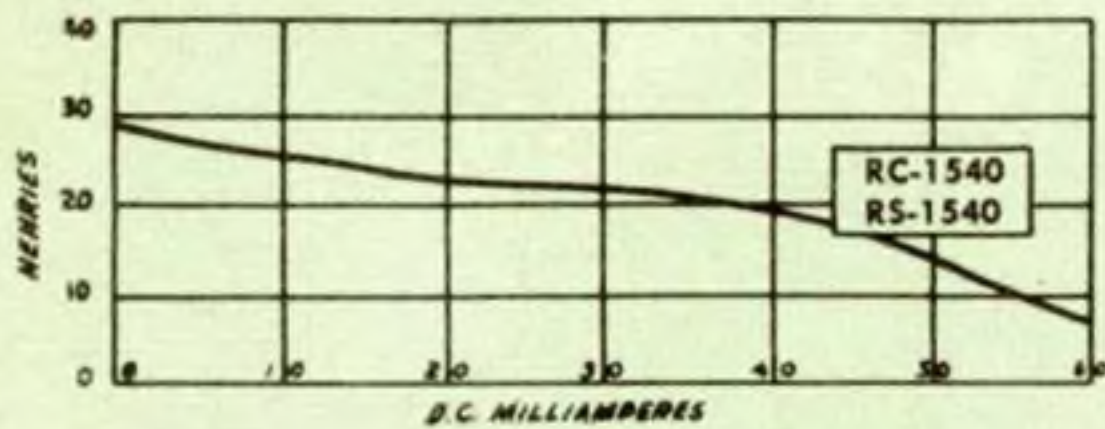

MULTIPLE FILAMENT TRANSFORMERS

For hermetically sealed multiple filament transformers identical in physical size and electrical specifications, see "FMS" types on page 5.

MULTIPLE FILAMENT TRANSFORMERS

All Primaries 105/115/125 Volts, 50-60 Cycles

Catalog No.	Sec. No. 1	Sec. No. 2	Sec. No. 3	Insul. Test	Mounting		Wt. Lbs.
					Type	Size	
F-1	5 V. 2A	6.3 V. CT 2.5A	—	2500 V.	S	15	2¾
F-2	5 V. 2A	12.6 V. CT 1.25A	—	2500 V.	S	15	2¾
F-3	5 V. 3A	6.3 V. CT 5A	—	2500 V.	S	17	3½
F-4	5 V. 3A	6.3 V. CT 3A	6.3 V. CT 3A	2500 V.	S	18	4¾
		← 12.6 V. 3A →					
F-5	5 V. 3A	6.3 V. CT 1A	6.3 V. CT 5A	2500 V.	S	18	4¾
F-6	6.3 V. CT 3A	6.3 V. CT 3A	—	2500 V.	S	17	3½
	← 12.6 V. CT 3A →						
F-7	6.3 V. CT 6A	6.3 V. CT 6A	—	2500 V.	S	21	6½
	← 12.6 V. CT 6A →						
F-8	5 V. CT 3A	5 V. CT 3A	5 V. CT 6A	5000 V.	S	21	7



S-TYPE MOUNTING

FILAMENT TRANSFORMERS

Ratings of CHICAGO filament transformers provide voltages and currents for heating a wide range of receiving and transmitting tubes. Units with secondaries rated for less than 6 amps have solder-lug terminals; those with secondaries rated at more than 6 amps have screw-type terminals. Filament transformers Nos. F-210, F-210H, F-215H, F-510H, and F-520HB are specially for high voltage rectifier supply. They have secondary terminals insulated with ceramic bushings.

FILAMENT TRANSFORMERS

Primaries: 115/230 volts, 50/60 cycles

Catalog No.	Secondary		Insulation Volts RMS	Mounting		Wt. Lbs.
	Volts	Amps.		Type	Size	
F-25	2.5 CT	5.25	3500	S	14	2
F-210	2.5 CT	10.	5000	S	17	3
F-210H	2.5 CT	10.	9000	S	19	4
F-215H	2.5 CT	15.	9000	S	20	6
F-54	5.0 CT	4.0	2500	S	15	2¼
F-58	5.0 CT	10.	2500	S	17	3½
F-510H	5.0 CT	10.	10000	S	21	6
F-516	5.0 CT	20.	2500	S	21	6½
F-520HB	5.0 CT	20.	10000	S	22	13
F-530	5.0 CT	30.	2500	S	22	10½
† F-530BX	5.0 CT	30.	2500	BX*	22	10½
F-615	6.3 CT	1.5	2500	S	12	1
F-63	6.3 CT	3	2500	S	14	2
F-65	6.3 CT	5.5	2500	S	17	3
F-610	6.3 CT	10.	2500	S	19	5
F-712	7.5 CT	12.	2500	S	21	6½
F-725	7.5 CT	25.	2500	S	22	12
F-751	7.75 CT	51.	2500	S	26	29
F-104	10 CT	4.0	2500	S	17	3¼
F-106	10 CT	6.5	2500	S	19	5
F-1010	10 CT	10.	2500	S	21	6½

*See page 21 for illustration †Part number to be deleted from next catalog.



C-TYPE MOUNTING

CHICAGO

The world's toughest transformers

PREFERRED FOR EVERY MODERN CIRCUIT REQUIREMENT

BROADCAST, COMMUNICATIONS AND INDUSTRIAL USE

Plate Transformers and Matching Reactors

The plate voltages and currents of the following CHICAGO Plate transformers fit the requirements of both commercial and ham transmitters and of many industrial applications, including induction heating and electronic control equipment. Both the transformers and the matching filter reactors are con-

servatively designed and have ample insulation throughout. They operate with a temperature rise of 40° to 50°C at full load, 60 cycles, under CCS duty. Under ICAS conditions, the duty cycle is 15 minutes time on and 15 minutes time off, with the same temperature rise applying as under CCS duty.

PLATE TRANSFORMERS

—Primary: 115/230 volts, 50/60 cycles

Catalog No.	Max. Pri. VA	Secondary A-C Load Volts	D-C Volts after filter	DC-Ma.		Mounting		Wt., Lbs.
				CCS	ICAS	Type	Size	
P-45	185	675-575-0 575-675	500 400	250	325	S	22	12
P-67	250	900-735-0 735-900	750 600	250	325	S	22	13½
†P-107	310	1150-870-0 870-1150	1000 750	250	350	FS	60	37
P-1240	360	1425-0-1425* 600-0-600	1250 400	150 200	200 260	S	24	26
P-1512	550	1710-1430-0 1430-1710	1500 1250	300	425	FS	63	43
P-2520	915	2820-2260-0 2260-2820	2500 2000	300	425	FS	70	71
P-2126	1600	2900-2320-0 2320-2900	2600 2100	500	700	FS-1	64	95
†P-3025	1850	3450-2850-0 2850-3450	3000 2500	500	700	FS	81	137
†P-4353	3050	4600-4050-3400 0-3400-4050-4600	4000 3500 3000	600	800	FS	90	150

*Both secondaries may be rectified simultaneously.

FILTER REACTORS

Catalog No.	Inductance In Henries	Max. DC-Ma.	D-C Resistance, Ohms	Insulation Volts RMS	Mounting		Wt., Lbs.
					Type	Size	
R-67	6	700	35	10,000	FS	61	35
R-105	10	500	40	9,000	FS	62	35
R-65	6	500	35	9,000	FS	60	35
R-103	10	300	40	7,500	SX	26	22
R-63	6	300	35	7,500	SX	24	16½

†Part number to be deleted from next catalog.

FS-TYPE MOUNTING

Heavy duty, cast frames and form steel shields are bolted to the core. Shield sections are compound-filled to protect coil windings from corrosion by atmospheric moisture. Screw terminals on the primary side; bushing-insulated terminals on the secondary.

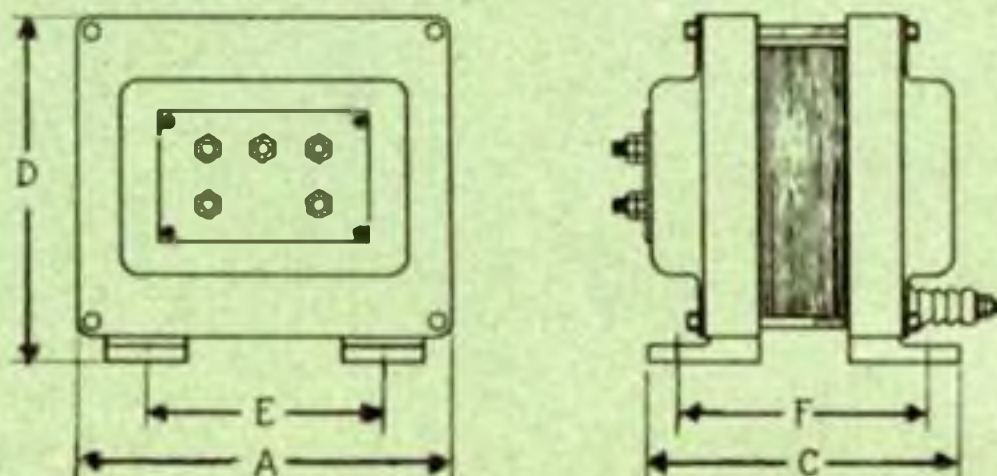

DIMENSION FOR FS & FS-1 MOUNTING

Size	Dimensions in Inches				
	A	C	D	E	F
60	7½	6⅝	7	4¾	5½
61	7½	6⅞	7	4¾	5⅝
62	7½	7⅛	7	4¾	6¼
63	7½	7½	7	4¾	6⅛
64	7¾	9⅛	9	6⅜	7⅛
65	7¾	9¾	9	6⅜	8½
66	7¾	6⅞	9	6⅜	5⅝
70	8⅞	8¼	8½	5½	6
81	11½	10¼	10½	7½	8¼
84	11½	13⅜	10½	7½	11⅜
90	13⅜	10⅞	12¾	9	8⅞



FS-TYPE MOUNTING

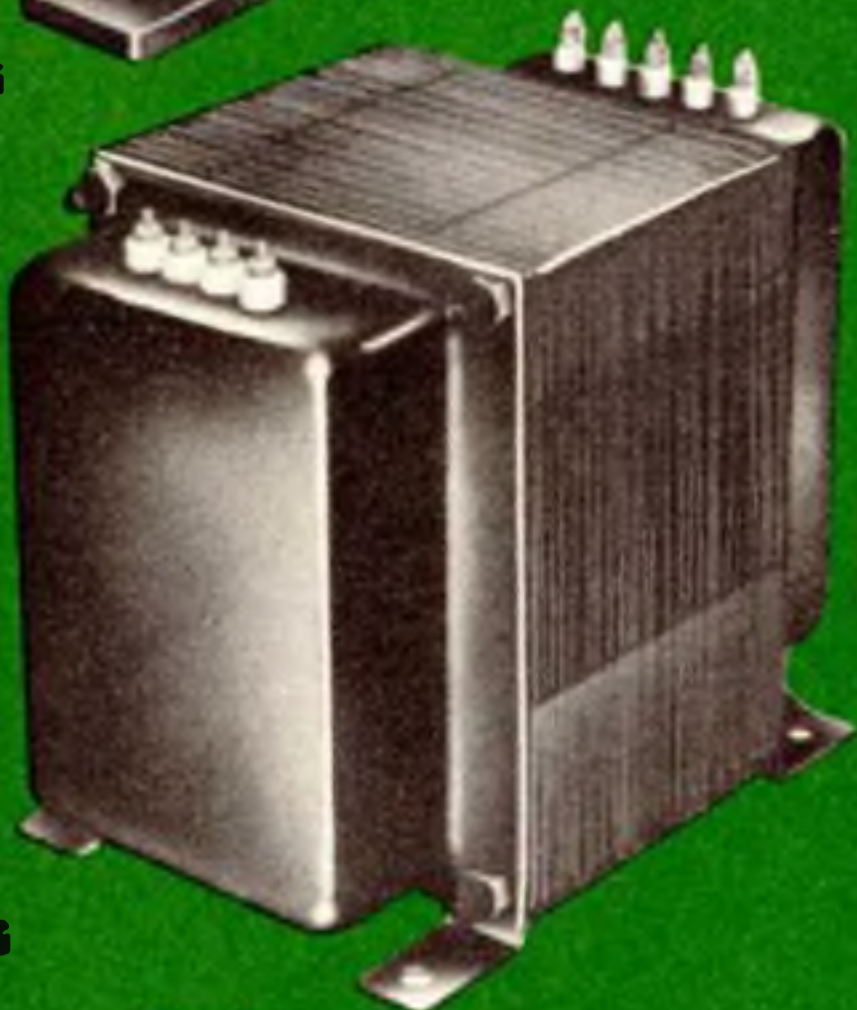

FS-1 MOUNTING



S-TYPE MOUNTING



SX-TYPE MOUNTING

STEP-DOWN AND ISOLATION TRANSFORMERS

STEP-DOWN TRANSFORMERS—Primary: 50/60 cycles

CHICAGO step-down autotransformers solve the problem of operating standard 117-volt radios, amplifiers, and various electrical appliances from 220-volt power sources. They are particularly well adapted to use in Central and South American countries, where 220-

volt lines are frequently found, and where the *Sealed-in Steel* construction protects them against corrosion caused by excessive humidity. Input side is equipped with 8-foot, rubber-covered cord and plug. Output side has standard female receptacle.

Catalog No.	Input Voltage	Output Voltage	Rating, Continuous Duty	Case Size	Wt., Lbs.
SD-50	220-250	110-125	50 watts	16	2 3/4
SD-100	220-250	110-125	100 watts	20	4 1/4
SD-150	220-250	110-125	150 watts	22	7
SD-250	220-250	110-125	250 watts	22	8 3/4
SD-500	220-250	110-125	500 watts	24	14 1/2
SD-1000	220-250	110-125	1000 watts	26	22 1/2

ISOLATION TRANSFORMERS—Primary: 50/60 cycles

A rotary switch on each CHICAGO isolation transformer adjusts to either of three primary voltages, 125/115/105 volts. With the unit operating on a 115-volt line, the three switch positions also provide varying secondary voltages,

105/115/125 volts isolated from line. An electrostatic shield between windings provides true isolation and minimum leakage. Eight-foot, rubber-covered cord and plug on primary, standard female receptacle on secondary.

Catalog No.	Input Voltage	Output Voltage	Rating, Continuous Duty	Case Size	Wt., Lbs.
IS-50	105/115/125	125/115/105*	50 watts	21	5
IS-100	105/115/125	125/115/105*	100 watts	22	8 1/2
IS-150	105/115/125	125/115/105*	150 watts	24	12 1/2
IS-250	105/115/125	125/115/105*	250 watts	24	18 1/4

*With 115-volt primary.

VOLTAGE STABILIZING TRANSFORMERS

Fully automatic magnetic-type AC line voltage stabilizers. For applications requiring accurate voltage stabilization. Output is held constant to within

$\pm 1/2\%$ for line voltage variations from 95 to 130 volts. For 60 cycle operation only. Long life assured by ruggedness of construction. Output voltage: 117 V.A.C.

*New Part Number

Catalog No.	Watts	Base Area	Height	Weight
• VS-250	250	5 1/2 x 11	6 1/4	38 Lbs.
• VS-500	500	6 3/8 x 13 3/4	6 5/8	60 Lbs.

DIMENSIONS FOR S, SX, STEP-DOWN AND ISOLATION TRANSFORMERS

Case Size	Dimensions in Inches					F
	A	B	C	D	E	
16	2 7/8	3 1/2	2 11/16	3 1/2	2	3 1/8
20	3 11/16	4 7/16	3 5/16	4 5/16	2 3/4	3 7/8
21	3 11/16	4 7/16	3 5/16	4 11/16	2 3/4	3 7/8
22	4 7/16	5 1/4	4 1/8	5 5/16	2 1/2	4 3/4
24	5 5/16	5 7/8	4 13/16	6 1/16	3 1/2	5 3/8
26	6 1/8	6 1/2	5 1/4	7 1/16	4 1/4	6

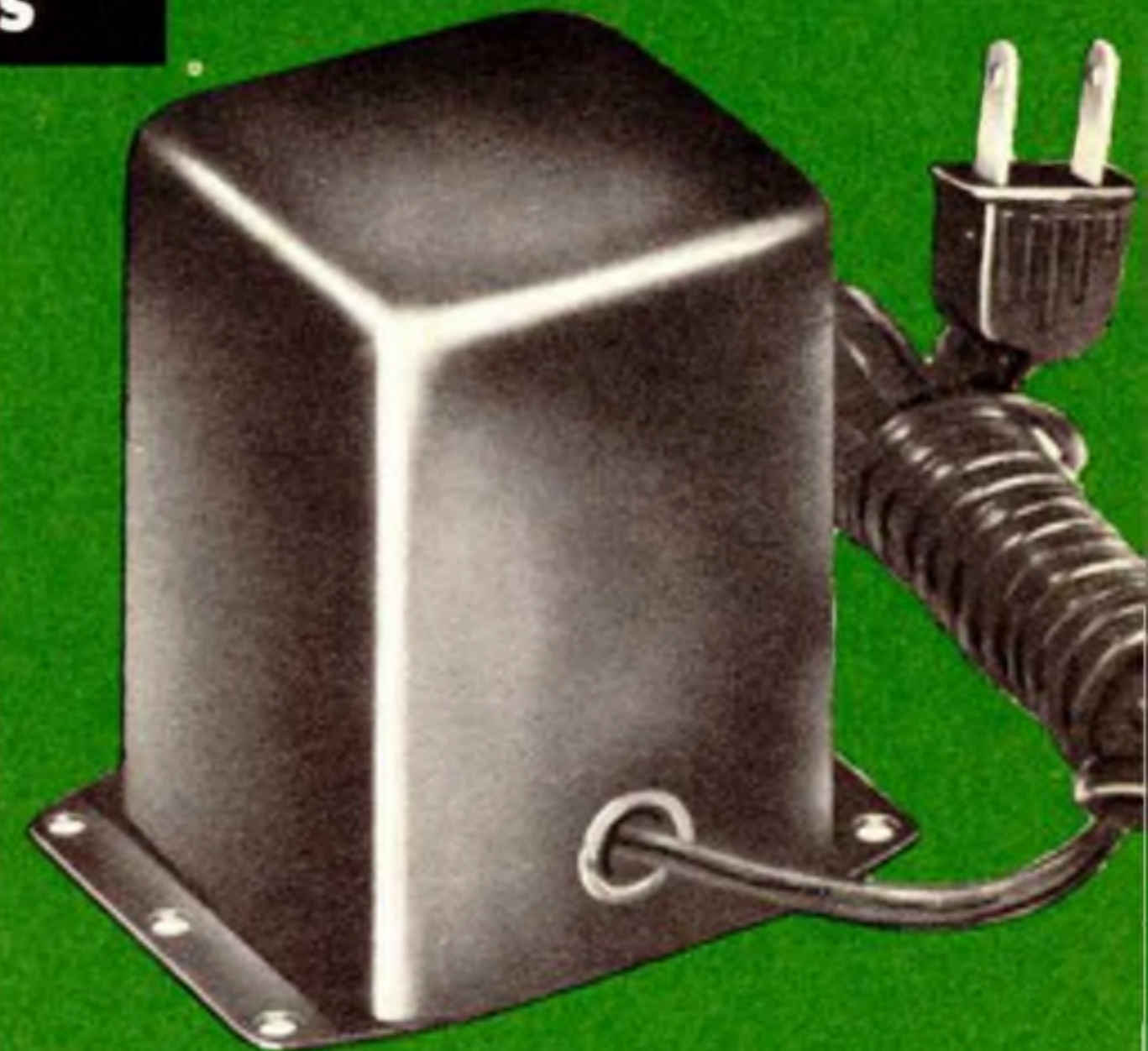
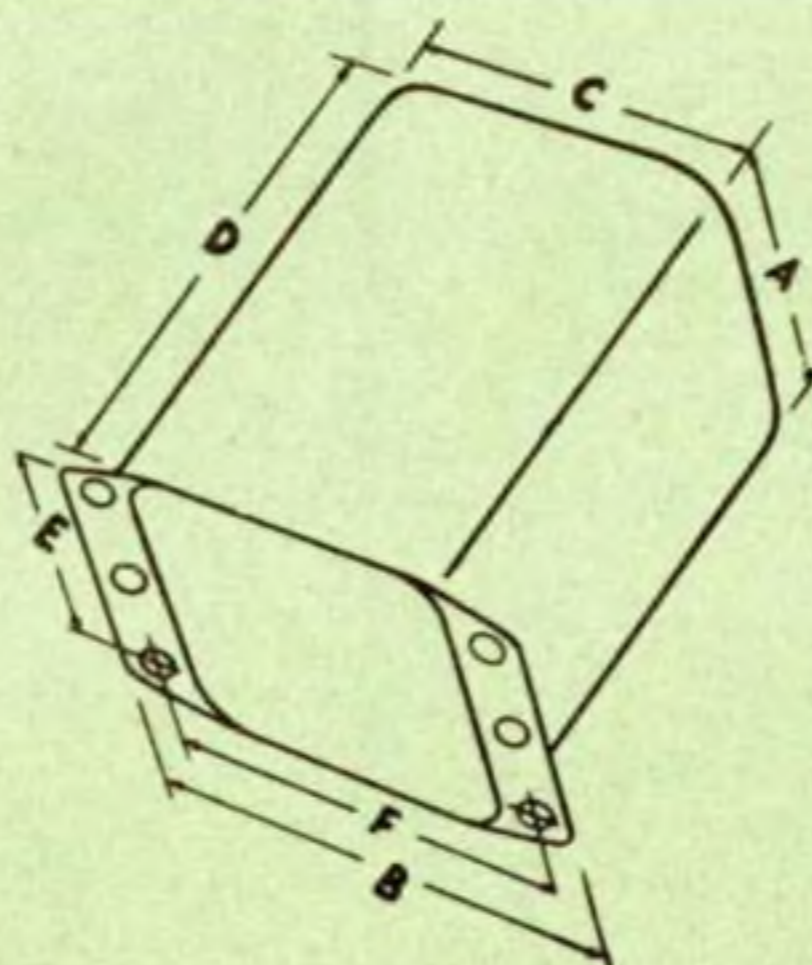

STEP-DOWN TRANSFORMER

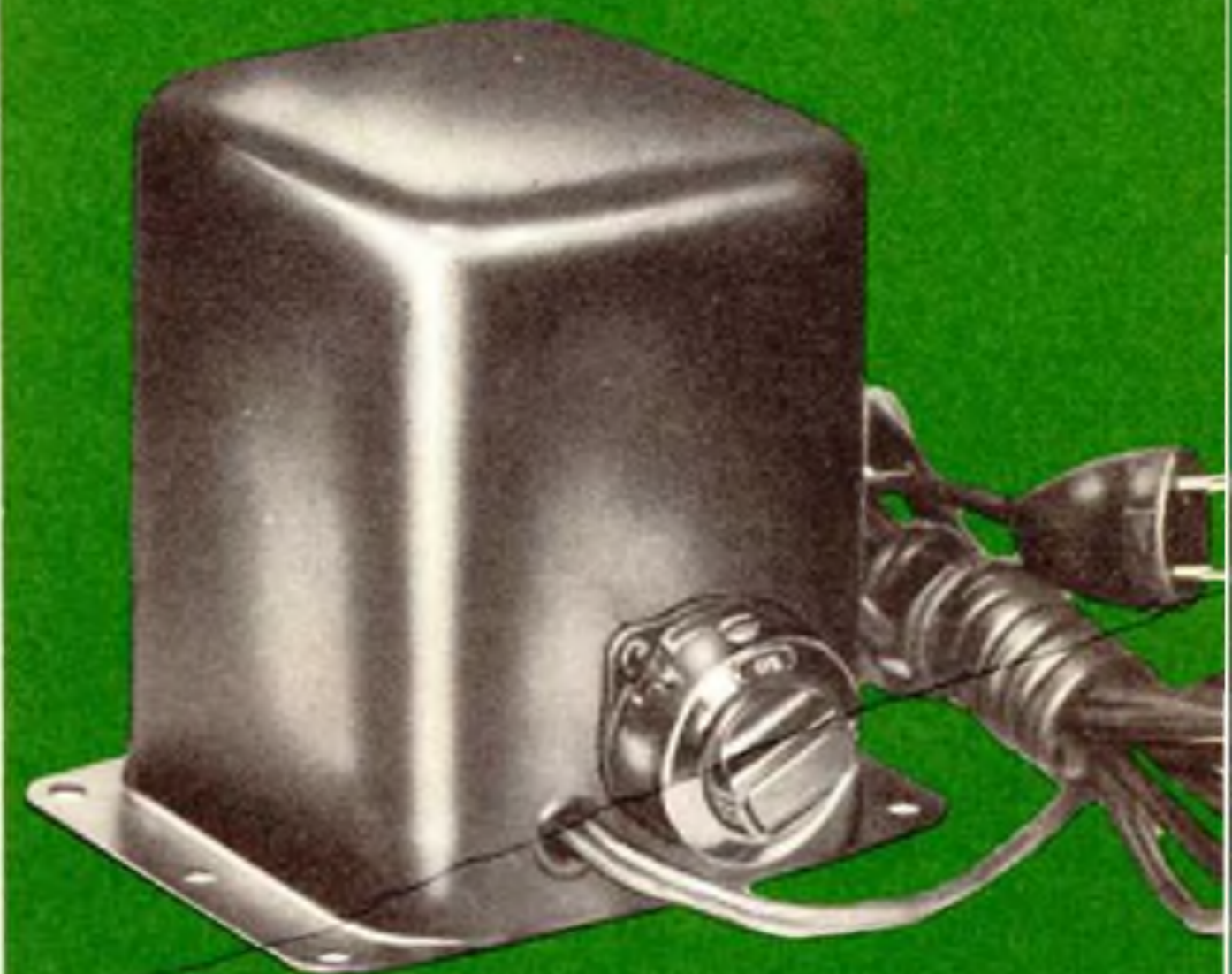

ISOLATION TRANSFORMER

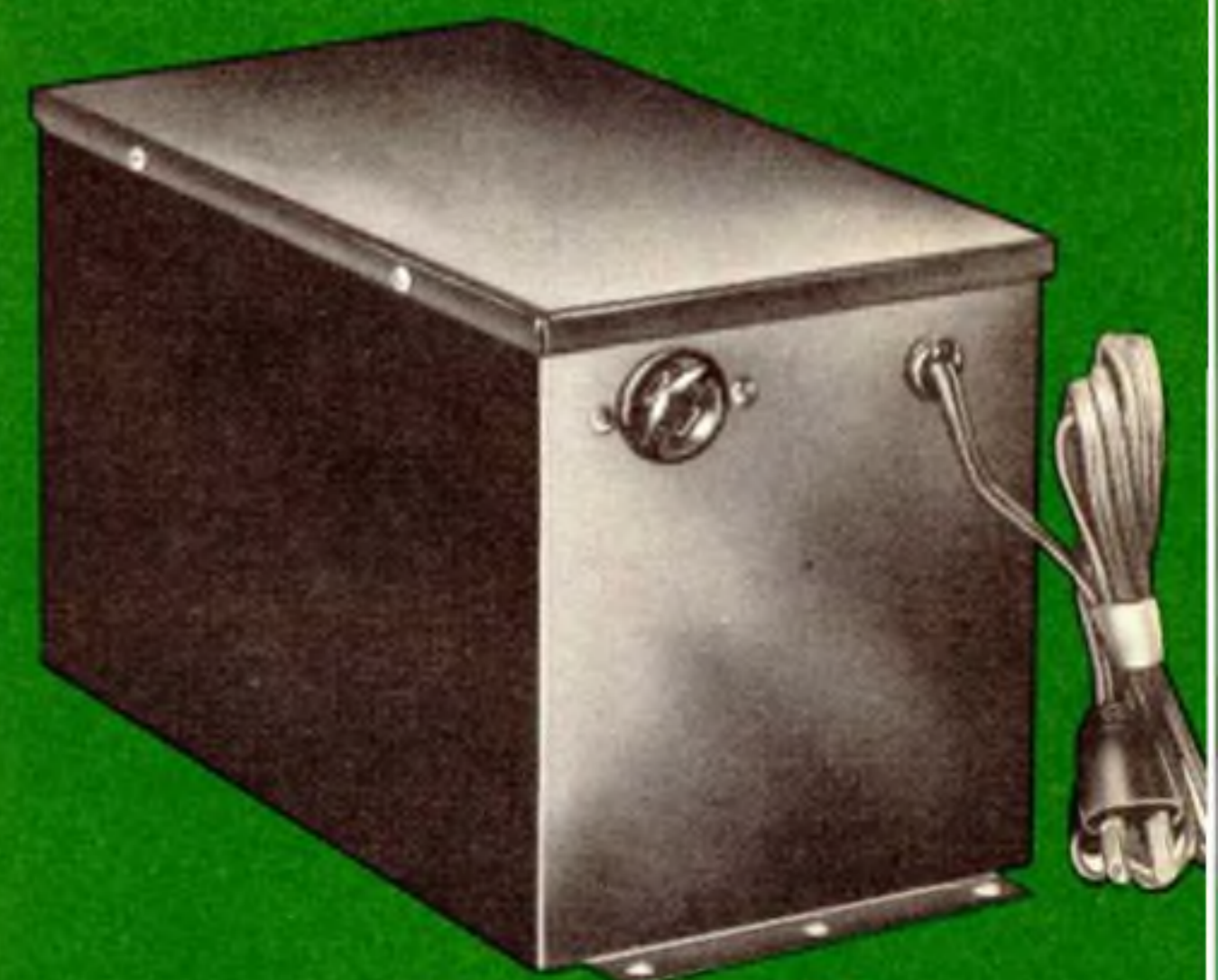

VOLTAGE STABILIZING TRANSFORMER

BX-TYPE MOUNTING



- Eliminate splatter caused by heavy modulation.
- Limit band width to 3,000 cycles.
- Effectively increase "get through" ability of phone signals.
- Prevent negative peak clipping.

S-TYPE MOUNTING



For attenuating frequencies above 3,000 cycles in low level speech amplifiers.

For hermetically sealed Low Pass Filter, see LPF-2, Page 11.

SPLATTER CHOKES

CHICAGO Splatter Chokes, Nos. SR-300 and SR-500, are designed specifically for use in high level "clipper" filters. Windings are tapped to cover an inductance range from .02 to 1.5 henries at relatively constant Q. Their insulation is adequate to withstand the high peak voltages developed during extended periods of extremely heavy modulation.

A high vacuum "clipper" rectifier precedes the filter and provides a proper gating effect, conducting at modulation levels up to 100%. When the modulation level exceeds 100%, the output of the modulator stage swings the instantaneous plate voltage on the final amplifier below zero. The rectifier then stops conducting and negative peak clipping is confined to the rectifier and is not imposed on the modulated amplifier.

The filament transformer for the rectifier must have adequate insulation and should have low capacity between windings and winding to core. Transformer No. FH-210H, p. 5, and F-210H, p. 17, is recommended.

LOW PASS FILTER No. LPF-1

Designed to provide optimum attenuation of the audio frequencies above 3,000 cycles, the LPF-1 fills a long felt need for an economical, yet effective, means of confining a speech signal within narrow frequency limits.

Electrically, the filter operates out of a source impedance of 15,000 ohms, such as presented by the plate of a single 6C5, 6J5, or triode-connected 6J7, into a 100,000 ohm grid. A step-up ratio of 1: 2.63 is obtained when the primary is connected to the 100,000-ohm secondary. A plate blocking condenser is required to prevent D-C from saturating the coils in the filter proper.

The filter operates satisfactorily at signal levels of +10 volts RMS across the 100,000-ohm secondary or of +0.7 volts RMS at 500 ohms. Attenuation characteristics are indicated by the curve at right and the manner in which the filter can be connected is shown by the circuit diagram below.

The filter is constructed in S-type mounting with solder-lug terminals as illustrated. Case size 13; shipping weight, 14 ounces. (Below) Circuit Connections for Low Pass Filter No. LPF-1

Catalog No.	D-C Ma.	Insulation Volts	Inductance in Henries	Mounting Type	Size	Wt., Lbs.
SR-300	300	7,500	.02 to 1.5 Hy	(See Cut)*	22	10
SR-500	500	10,000	.02 to 1.5 Hy	(See Cut)*	24	14½

*See page 21 for dimensions.

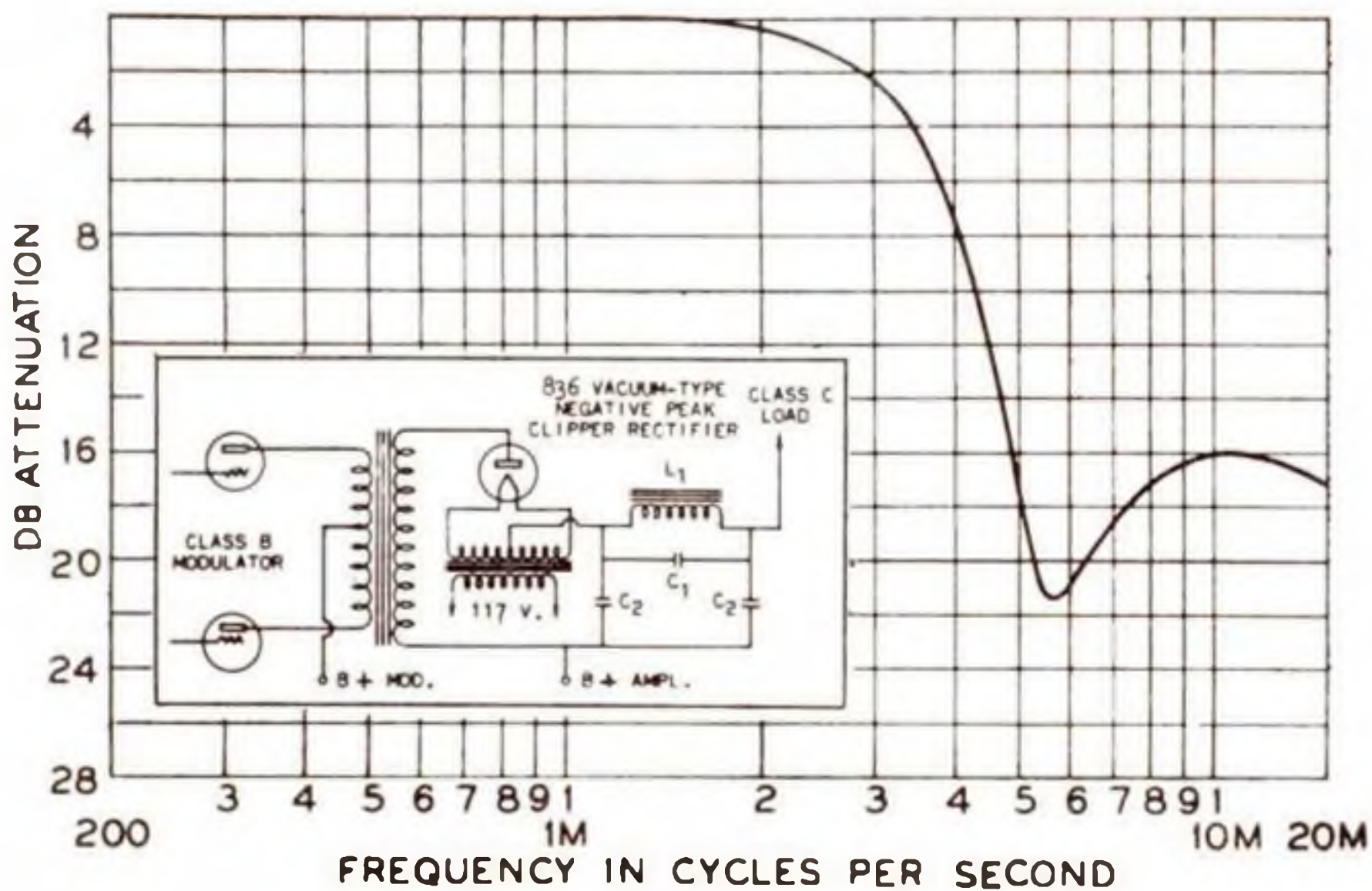

CHARACTERISTICS OF LOW PASS FILTER LPF-1

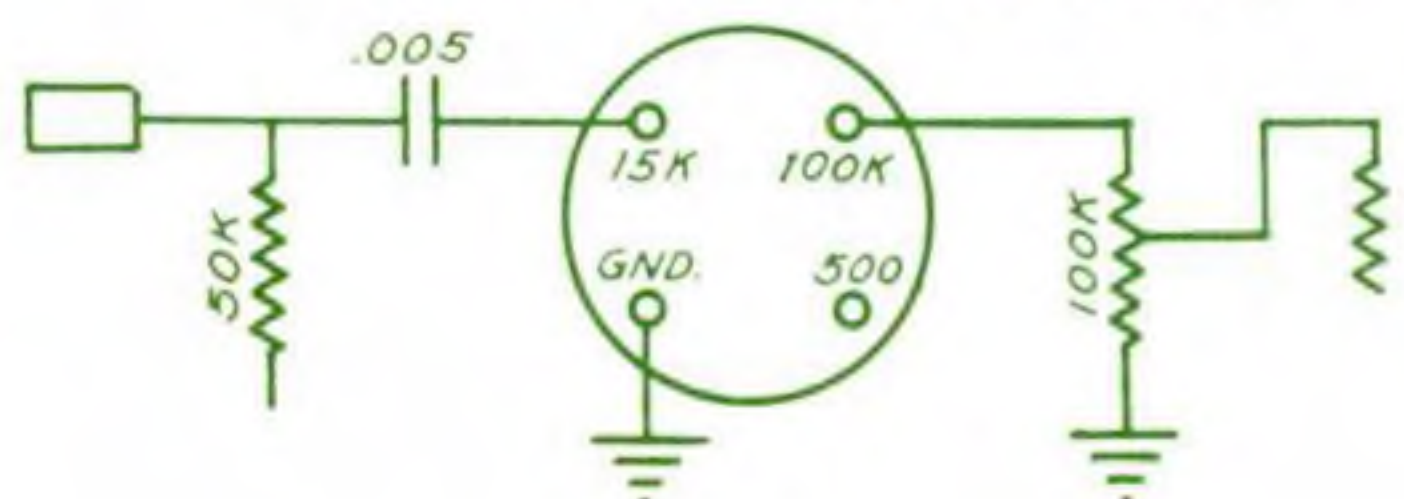
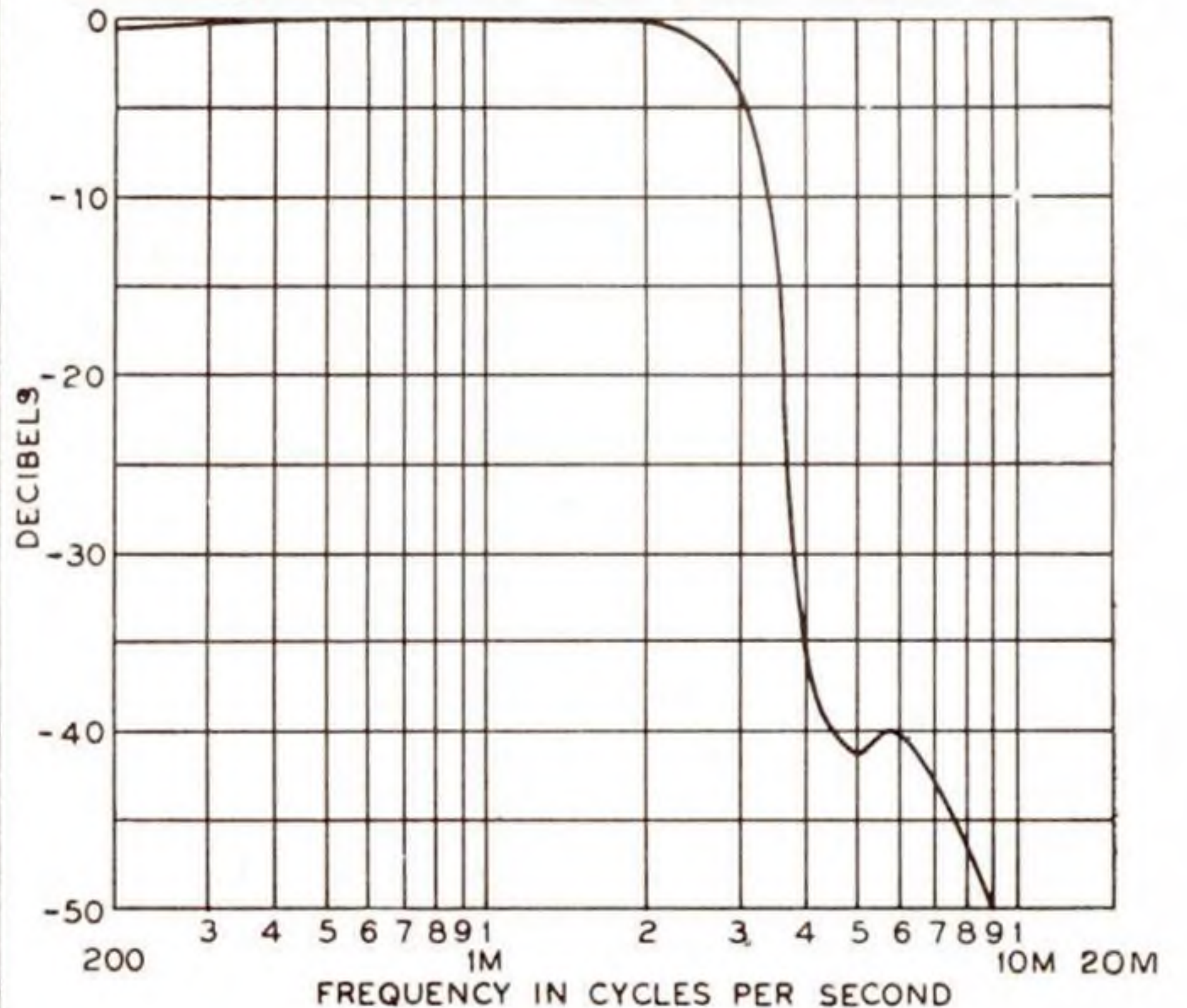

NEW EQUIPMENT COMMERCIAL GRADE TRANSFORMERS AND REACTORS

b

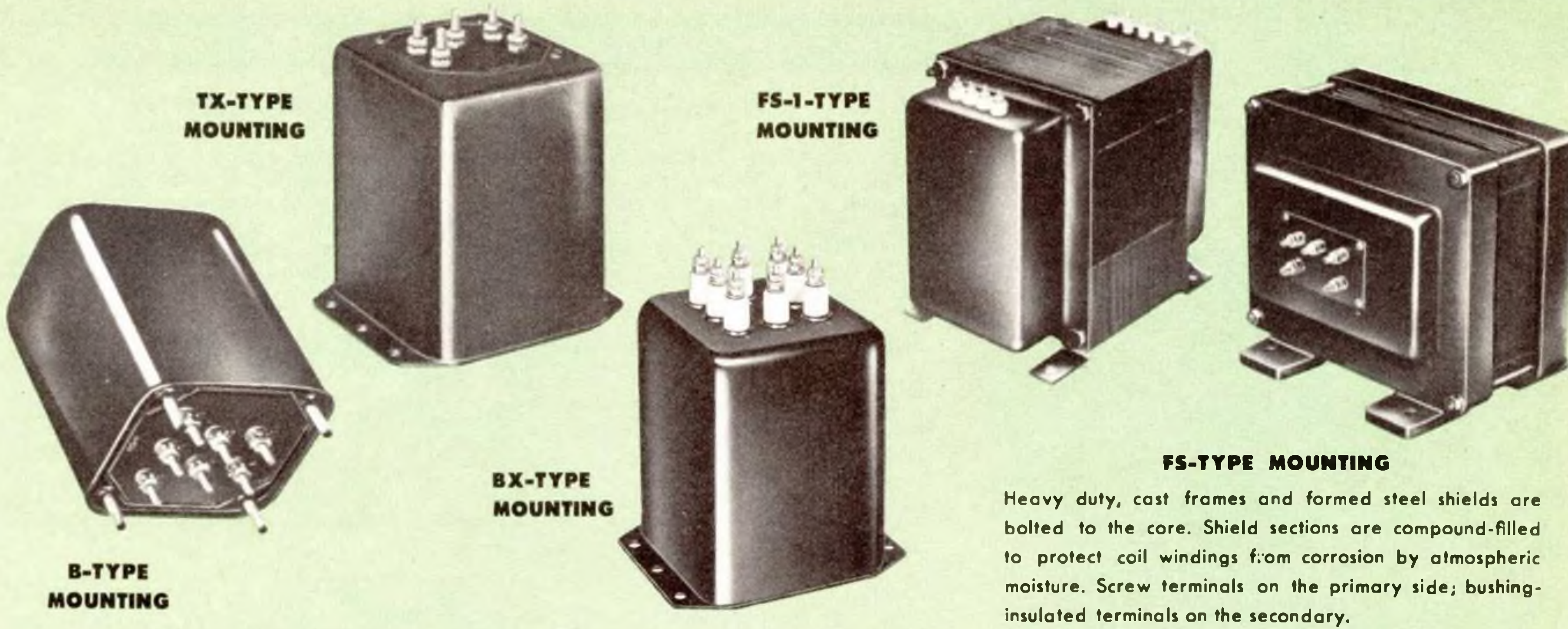

FS-TYPE MOUNTING
Heavy duty, cast frames and formed steel shields are bolted to the core. Shield sections are compound-filled to protect coil windings from corrosion by atmospheric moisture. Screw terminals on the primary side; bushing-insulated terminals on the secondary.

LARGE CAPACITY TRANSFORMERS AND REACTORS

Full Frequency Range Drive and Modulation Transformers

Ideally suited for use by the small-to-medium size, high fidelity broadcast station, the three matched sets of driver and modulation transformers listed below provide frequency response within ± 1 db over the range from 30 to 15,000 cycles.

A uniformly low percentage of distortion has been proven in use. Three specially designed modulation reactors complete the sets.

Conservative design and quality construction assure years of trouble free operation.

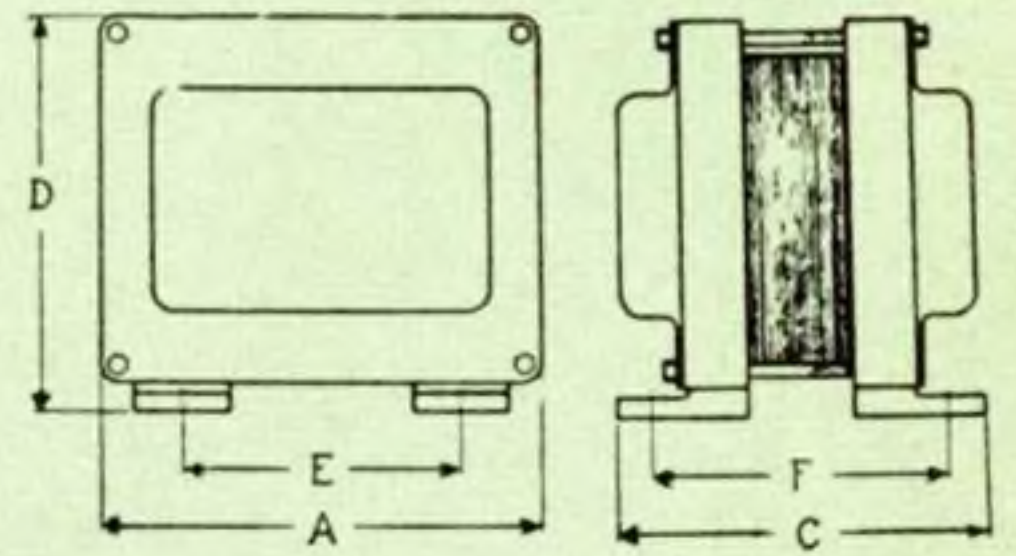

DRIVER TRANSFORMERS

Catalog No.	Recommended Application		Ratio Pri./ $\frac{1}{2}$ Sec.	Mounting		Wt., Lbs.
	In:	Tubes:		Type	Size	
BD-1	250-watt transmitter	From two 2A3's, 6B4's, or similar P-P plates to Class B 838's, 805's, 203A's	3.5:1	B	20	6 $\frac{1}{2}$
†BD-2	1-KW transmitter	From four 2A3's, 6B4's, or similar P-P plates to two 833A's or similar P-P grids	3:1	TX	24	12 $\frac{1}{4}$

DIMENSIONS FOR FS & FS-1 MOUNTING

Size	Dimensions in Inches				
	A	C	D	E	F
65	7 $\frac{3}{16}$	9 $\frac{3}{4}$	9	6 $\frac{3}{8}$	8 $\frac{1}{2}$
66	7 $\frac{3}{16}$	6 $\frac{7}{8}$	9	6 $\frac{3}{8}$	5 $\frac{5}{8}$
81	11 $\frac{1}{2}$	10 $\frac{1}{4}$	10 $\frac{1}{2}$	7 $\frac{1}{2}$	8 $\frac{1}{4}$
84	11 $\frac{1}{2}$	13 $\frac{13}{16}$	10 $\frac{1}{2}$	7 $\frac{1}{2}$	11 $\frac{13}{16}$

MODULATION TRANSFORMERS

Catalog No.	Recommended Application			Impedances (Pri. Plate to Plate) Sec: 5,000 ohms	Mounting		Wt., Lbs.
	In:	With:	Mod. Tubes		Type	Size	
BM-1	250-watt transmitter	Driver Transformer BD-1	203-A, 838, 805, etc.	Pri: 7,500 ohms CT Sec: 5,000 ohms	BX	26	25
†BM-4	500-watt transmitter	Class C Amplifier	833-A, etc.	Pri: 11,000 ohms CT Sec: 5,500 ohms	FS-1	65	105
†BM-2	1-KW transmitter	Driver Transformer BD-2	833-A, etc.	Pri: 9,000 ohms CT Sec: 7,500 ohms	FS	84	175

DIMENSIONS FOR BX, S AND SX, TX-TYPE MOUNTINGS

Case Size	Dimensions in Inches					
	A	B	C	D	E	F
13	2 $\frac{1}{4}$	2 $\frac{11}{16}$	2 $\frac{1}{8}$	2 $\frac{15}{16}$	1 $\frac{1}{2}$	2 $\frac{3}{8}$
20	See Page 2 for B Type Mounting					
22	4 $\frac{9}{16}$	5 $\frac{1}{4}$	4 $\frac{1}{8}$	5 $\frac{5}{16}$	2 $\frac{1}{2}$	4 $\frac{3}{4}$
24	5 $\frac{5}{16}$	5 $\frac{7}{8}$	4 $\frac{13}{16}$	6 $\frac{1}{16}$	3 $\frac{1}{2}$	5 $\frac{3}{8}$
26	6 $\frac{1}{8}$	6 $\frac{1}{2}$	5 $\frac{1}{4}$	7 $\frac{1}{16}$	4 $\frac{1}{4}$	6
28	7 $\frac{1}{16}$	7 $\frac{7}{8}$	6 $\frac{1}{8}$	8 $\frac{1}{16}$	5	7

MODULATION REACTORS

Catalog No.	Recommended Application		Inductance D-C		Mounting		Wt., Lbs.
	In:	With:	Henries	Ma.	Type	Size	
BR-1	250-watt Xmitter	Mod. Transformer BM-1	65	250	BX	28	41
†BR-4	500-watt	Mod. Transformer BM-4	50	400	FS-1	66	73
†BR-2	1-KW transmitter	Mod. Transformer BM-2	100	500	FS	81	165

†Part number to be deleted from next catalog.

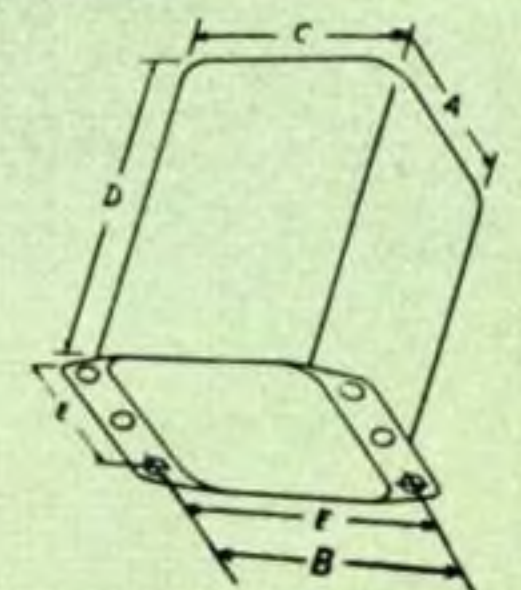

CHICAGO

The world's toughest transformers

PREFERRED FOR EVERY MODERN CIRCUIT REQUIREMENT

PUBLIC ADDRESS RANGE AUDIO TRANSFORMERS

Frequency Response, 50 to 10,000 cycles

As indicated by the representative curves shown below, the frequency response of the transformers in this CHICAGO series is within .5 db from 50 to 10,000 cycles, the maximum range usually required for PA and other types of equipment.

Line and voice impedances used in the output transformers are those recommended as standard by RETMA. The 4, 8, and 16-ohm voice coil impedances can also be used with 3.2, 6, and 20-ohm speakers, without appreciable mismatch.

DRIVER TRANSFORMERS

Catalog No.	Typical Driver Tubes	Primary Impedance	Max. D-C in Pri.	Ratio Pri./½ Sec.	Mounting Type	Size	Wt. Lbs.
†PCD-10 ‡PSD-10	P-P 6N7's, 6A6's, 6J5's, 6C4's, etc.	20,000 ohms CT	10 ma.	3:1	C	14	2 ¼
PCD-25 ‡PSD-25	P-P, 6N7's, 6A6's, 6J5's, 6C4's, etc.	20,000 ohms CT	25 ma.	3:1	C	15	2 ¼

OUTPUT TRANSFORMERS

Catalog No.	Typical Output Tubes	Class	Impedances Primary-Secondary	Max. D-C in Pri.	Power Level	Mounting Type	Size	Wt. Lbs.
PCO-80 ‡PSO-80	P-P 6B4G's, 6L6's P-P 6V6's	A1 AB	Pri: 5,000 ohms CT Sec: 600/150/ * 16/8/4 ohms	120 ma.	20 watts	C S	20 20	6 ½
°PCO-150 ‡PSO-150	P-P 6V6's, 6F6's P-P 6K6's	AB AB1	Pri: 10,000 ohms CT Sec: 600/150/ * 16/8/4 ohms	200 ma.	15 watts	C S	19 19	5
PCO-200 ‡PSO-200	P-P 6L6's P-P Parallel 6V6's	B AB2*	Pri: 6,000 ohms CT Sec: 600/150/ * 16/8/4 ohms	250 ma.	30 watts	C S	22 22	9

*Has tertiary winding to provide 10% inverse feedback. *For low distortion, use fixed bias.

°Also available at same price with 12,000 ohm primary as PCO-150A

‡Part number to be deleted from next catalog.

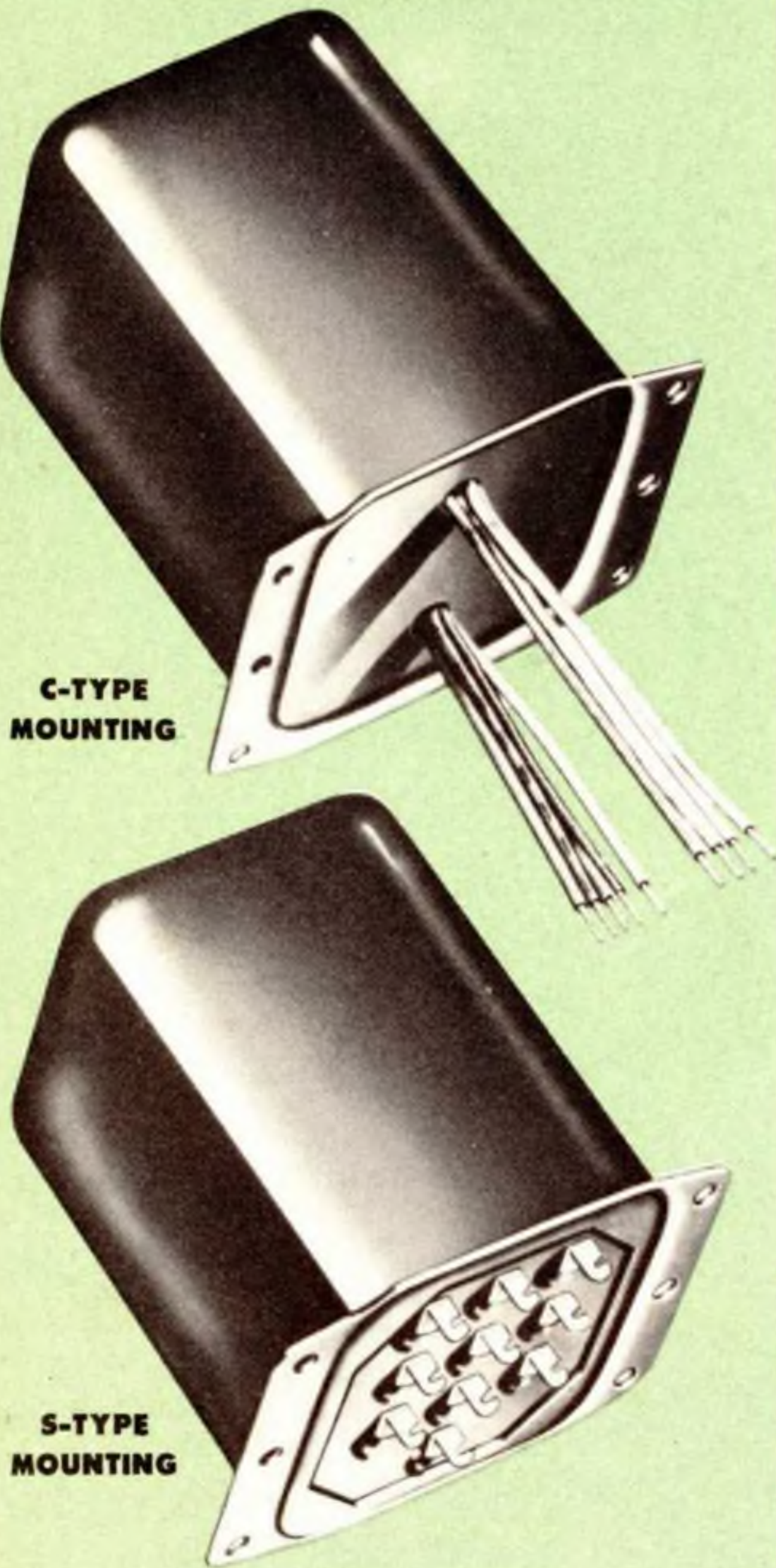

C-TYPE MOUNTING

S-TYPE MOUNTING

DIMENSIONS FOR S- AND C-TYPE MOUNTINGS

Case Size	Dimensions in Inches					
	A	B	C	D	E	F
14	2 ½	3	2 ¾	3 ⅙	1 ¾	2 ⅙
15	2 ½	3	2 ¾	3 ⅙	1 ¾	2 ⅙
18	3 ¼	4	3	3 ⅞	2 ¼	3 ½
19	3 ¼	4	3	4 ¼	2 ¼	3 ½
20	3 ⅙	4 ⅞	3 ⅙	4 ⅙	2 ¾	3 ⅞
22	4 ⅙	5 ¼	4 ⅞	5 ⅙	2 ½	4 ¾

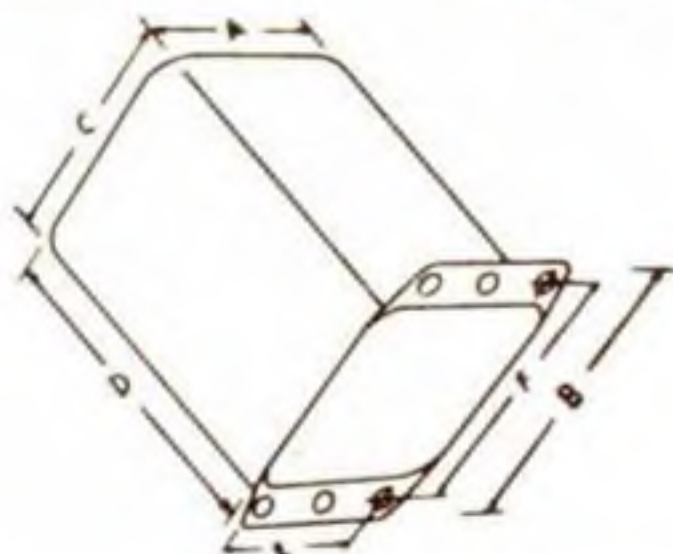

TYPICAL FREQUENCY RESPONSE CURVES

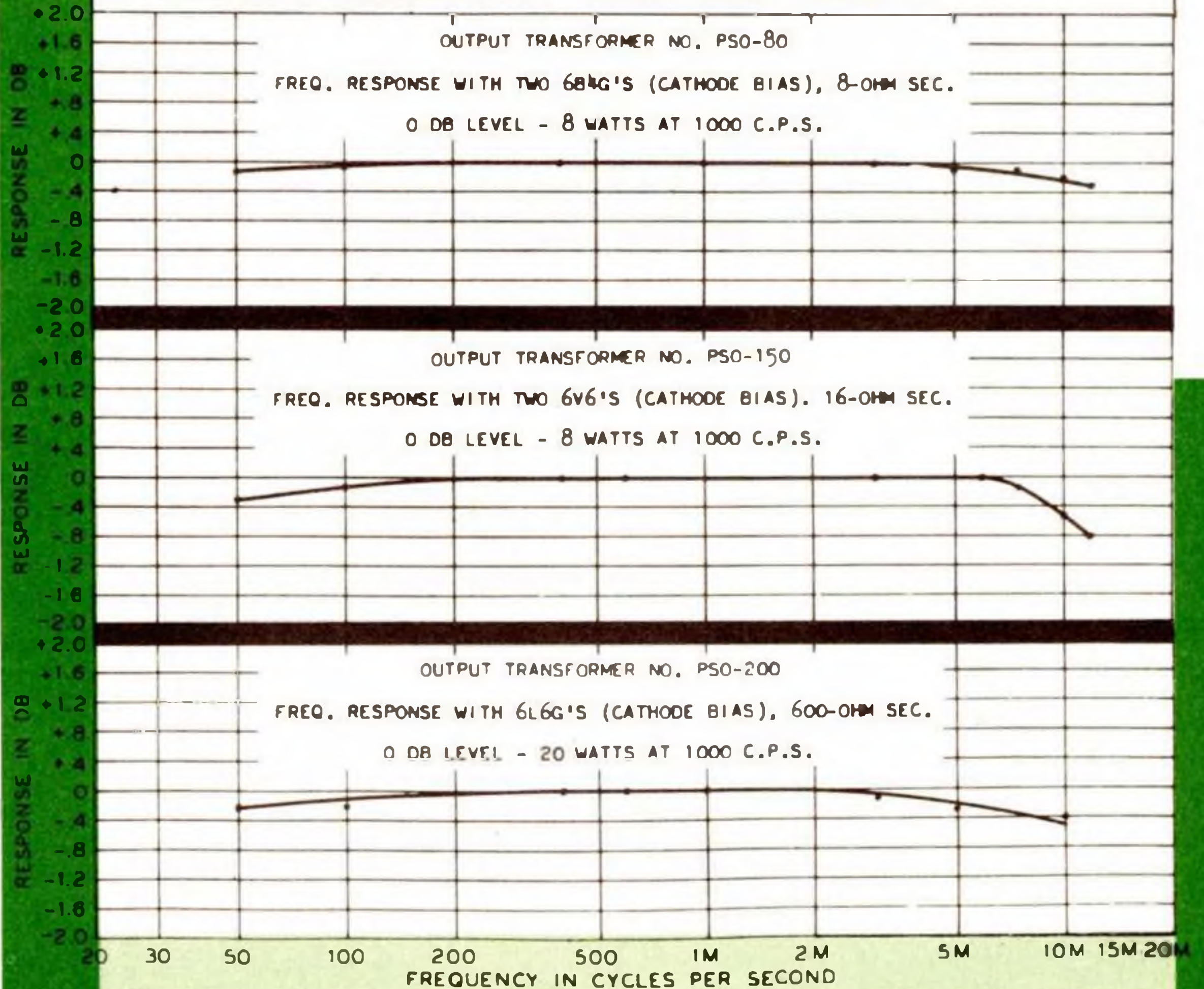

**NEW EQUIPMENT COMMERCIAL GRADE
TRANSFORMERS AND REACTORS**

b

COMMUNICATIONS RANGE AUDIO TRANSFORMERS

Frequency Response, 200 to 3,500 cycles

The transformers and reactors on this page are particularly adapted to use in receiving and transmitting equipment, such as amateur, police, railroad, and aircraft types. Frequency response for the input, output, driver and modulation transformers is within ± 1 db over

the stated voice range. All units, with the exception of Modulation Transformer No. CMS-3, are mounted in drawn steel cases for maximum protection. No. CMS-3 has a heavy duty, frame-and-shield construction.

INPUT TRANSFORMERS

Catalog No.	Application	Impedances Primary-Secondary		Mounting Type Size		Wt., Lbs.
CIC-1	Low Level Line to Single or P-P Grids	Pri: 600/150 ohms CT		C	9	3/4
CIS-1		*Sec: 100,000 ohms CT		S	9	
CIC-2	Low Level SB or DB Microphone to Sgl. or P-P Grids	Pri: 125/50 ohms, 80 ma.		C	9	3/4
CIS-2		Sec: 125,000 ohms CT		S	9	

*Split and balanced windings.

OUTPUT TRANSFORMERS Single Plate to Line or Voice Coil

Catalog No.	Typical Output Tubes	Class	Impedances Primary-Secondary		Max. D-C in Pri.	Power Level	Mounting Type Size		Wt., Lbs.
COC-1 COS-1	Sgl. 6L6, 6V6, 25A6, etc.	A	Pri: 5,000 ohms Sec: 600/150/ 16/8/4 ohms		55 ma.	5 watts	C	14	2 1/4
COC-2 COS-2			Pri: 8,000 ohms Sec: 600/150/ 16/8/4 ohms				C	14	

DRIVER TRANSFORMERS

Catalog No.	Application	Primary Impedance	Max. D-C in Pri.	Ratio Pri./1/2 Sec.	Mounting Type Size		Wt., Lbs.
CDC-1 CDS-1	P-P 2A3's, 6B4G's, 807's to P-P Grids	5,000 ohms CT	100 ma.	3:1	C	17	3 1/2
					S	17	

MODULATION TRANSFORMERS Class B Plates to Class C Load

Catalog No.	Typical Mod. Tubes	Impedances Primary-Secondary		D-C Ma. Pri. Sec.		Power Level	Mounting Type Size		Wt., Lbs.
CMS-1	203A's, 805's, 75TL's, 203Z's	Pri: 9000/6700 ohms CT Sec: 8000/6000/4000 ohms		350	350	250-350 watts	SX	26	22
CMS-3		Pri: 18,000/12,000 ohms CT Sec: 6250 ohms		500	500		500-750 watts	FS	



SX-TYPE MOUNTING (No. CMS-1)

CHICAGO'S No. CMS-1 Modulation Transformer and matching Driver Transformer No. CDS-1, at left, are ideally suited for use in ham and commercial speech transmitters. No. CMS-1 will deliver 250-350 watts of Class B audio power from P-P 203A's, 211's, 805's, 75TL's, etc. to a Class C load with response variations not exceeding ± 1 db. over the stated frequency range. Primary impedances, 9000/6700 ohms ct; secondary, 8000/6000/4000 ohms.

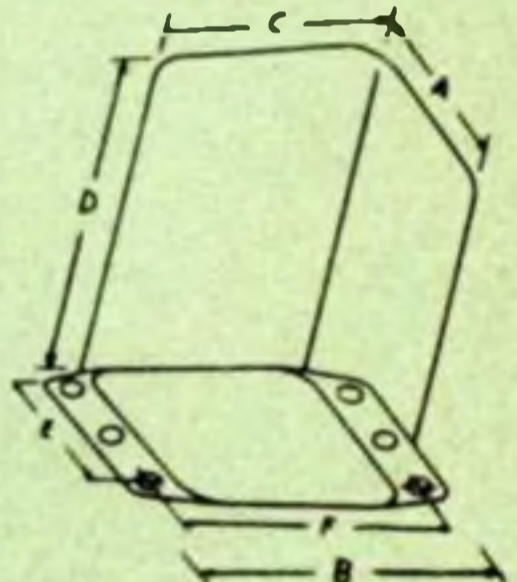

DIMENSIONS FOR C-, S-, AND SX-TYPE MOUNTINGS

Size	Dimensions in Inches					
	A	B	C	D	E	F
9	1 1/2	2 1/4	1 1/2	2 1/8	CHO*	1 1/8
10	1 7/8	2 7/8	1 11/16	2 3/8	CHO*	2 1/8
12	2 1/4	2 11/16	2 1/8	2 11/16	1 1/2	2 3/8
14	2 1/2	3	2 3/8	3 1/8	1 3/4	2 11/16
17	2 7/8	3 1/2	2 11/16	3 3/4	2	3 1/8
26	6 1/8	6 1/2	5 1/4	7 1/8	4 1/4	6

*CHO—Center hole only on each side.

FS-TYPE MOUNTING (Modulation Transformer No. CMS-3)

DIMENSIONS FOR FS-TYPE MOUNTING

Dimensions in Inches					
A	B	C	D	E	F
7 1/2	—	7 13/16	7	4 3/4	6 7/8

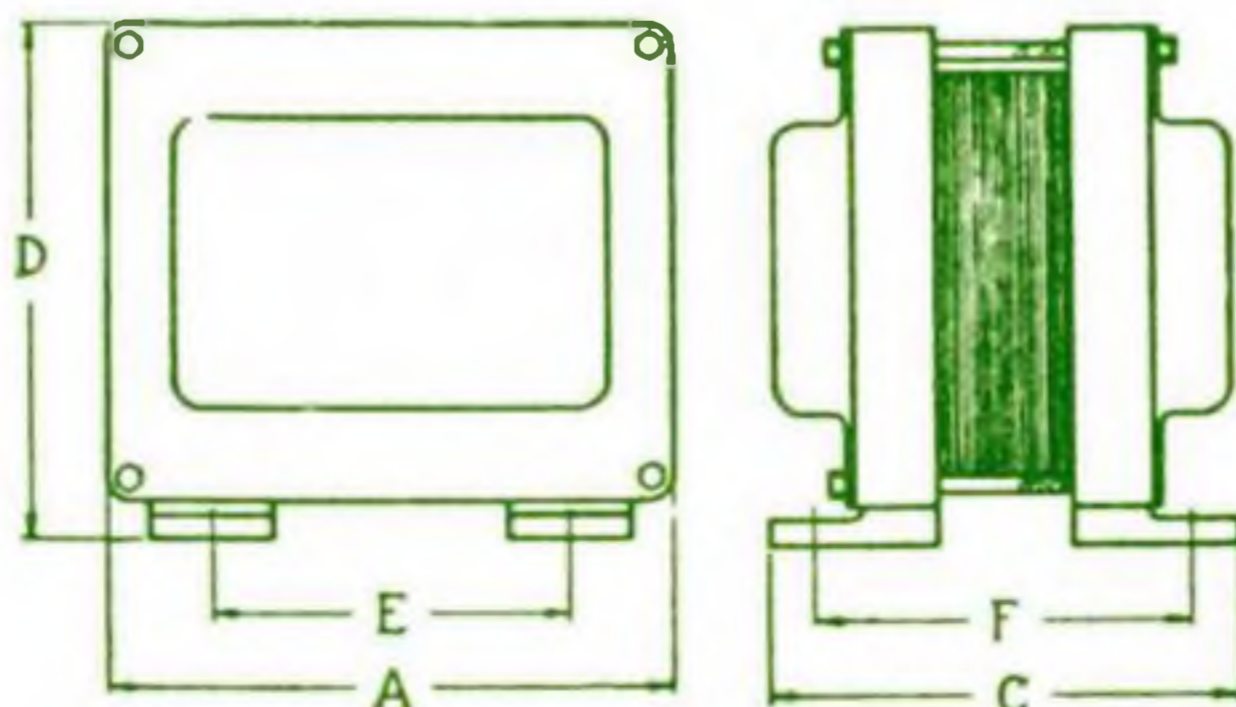



CHICAGO

The world's toughest transformers

PREFERRED FOR EVERY MODERN CIRCUIT REQUIREMENT

B TYPE MOUNTING

Case Size	Dimensions in Inches					Stud Size
	A	C	D	H	K	
13	2 1/4	2 1/8	2 1/16	1 1/16	1 3/8	6-32
14	2 1/2	2 3/8	3 1/16	1 13/16	1 11/16	6-32
16	2 7/8	2 11/16	3 1/2	2	1 7/8	8-32
18	3 1/4	3	3 7/8	2 3/8	2 1/8	8-32
20	3 11/16	3 5/16	4 5/16	2 5/8	2 3/8	10-32
21	3 11/16	3 5/16	4 11/16	2 5/8	2 3/8	10-32
22	4 7/16	4 1/8	5 5/16	3 3/8	3 3/8	10-32
24	See page 16 for C type dimensions.					



CHICAGO Full Frequency Range Input Transformers provide a response within 1 db from 30 to 15,000 cycles. The percentage of distortion is exceptionally low over the full range—at low as well as high frequencies.

All units have hum-bucking coil and core construction to provide maximum neutralization of stray magnetic fields. Internal cases and covers of special alloy give hum shielding of -70 dbm or better.



For uniformly excellent response over the full frequency range, for very low percentage of distortion at all frequencies, and for high grade construction throughout, CHICAGO FF Range output transformers are unsurpassed. Typical frequency response is within 0.5 db from 30 to 20,000 cycles, although maximum deviation from 0 for the respective units varies from 0.2 to about 1.5 db.

Output impedance ratings match perfectly with those recommended as standard by RETMA and used by many leading manufacturers of high fidelity speakers.

A special *Sealed-in-Steel* construction, described under "B-Type Mounting," page 14, protects the coil windings from corrosion by atmospheric moisture. The compactness of this mounting is invaluable in confined chassis spaces.

Driver and modulation transformers for full frequency range transmitters are listed on page 21.

FULL FREQUENCY RANGE INPUT TRANSFORMERS

Catalog No.	Application	Impedances Primary—Secondary	Operating Level ^A	Hum Reduction	Mounting		Wt., Lbs.
					Type	Size	
BI-1	Line to Single or Push-Pull Grids	*Pri: 600/150 ohms CT *Sec: 50,000 ohms CT	+15 dbm.	-70 dbm.	B	13	1 1/2
BI-2	Line to Single or Push-Pull Grids	*Pri: 600/150 ohms CT *Sec: 50,000 ohms CT	+15 dbm.	-90 dbm.	B	13	1 1/2
BI-3	Line bridging to Push-Pull Grids	*Pri: 8000/6000 ohms CT *Sec: 50,000 ohms CT	+15 dbm.	-70 dbm.	B	13	1 1/2
BI-4	Line to Line	Pri: 600/150 ohms CT Sec: 600/150 ohms CT	+15 dbm.	-70 dbm.	B	13	1 1/2
†BI-5	Line to Line	*Pri: 600/150 ohms CT *Sec: 600/150 ohms CT	+30 dbm.	-90 dbm.	B	18	3 1/4
BI-6	Interstage—P-P Pl. to Sgl. or P-P Grids	*Pri: 20,000 ohms CT *Sec: 50,000 ohms CT	+15 dbm.	-70 dbm.	B	13	1 1/2
BI-7	Low imped. mike, pickup, or multiple line to grid	Pri: 50/150/250/600 *Sec: 50,000 ohms CT	+15 dbm.	-70 dbm.	B	13	1 1/2

[†]Split and balanced windings. ^A0 dbm. reference level—1 milliwatt.

FULL FREQUENCY RANGE OUTPUT TRANSFORMERS

Catalog No.	Application	Impedances Primary—Secondary	Operating Level ^A	Output Tubes	Mounting		Wt., Lbs.
					Type	Size	
BO-1	Single plate to Line	‡Pri: 15,000 ohms *Sec: 600/150 ohms CT	+15 dbm. (22 mw)	6C4's to equiv.	B	14	2 1/4
BO-2	Push-Pull Plates to Line	*Pri: 20,000 ohms CT *Sec: 600/150 ohms CT	+30 dbm. (1 watt)	6C5's or equiv.	B	16	3
BO-5	P-P Plates to Line or Voice Coil	*Pri: 10,000 ohms CT *Sec: 600/16/8 ohms CT and 150/4 ohms	+37 dbm. (5 watts)	6V6's or equiv.	B	18	4
BO-6	Push-Pull Plates to Voice Coil	Pri: 7,500 ohms CT Sec: 8/20 ohms	+43 dbm. (20 watts)	6L6's or equiv.	B	20	5 3/4
BO-9	P-P Plates to Line or Voice Coil	*Pri: 5000/3000 ohms CT *Sec: 600/16/8 ohms CT and 150/4 ohms	+42 dbm. (15 watts)	6B4G's or equiv.	B	20	6
BO-10	P-P Low Level Plates to Line	Pri: 20,000 ohms CT *Sec: 600/150 ohms CT	+15 dbm. (22 mw)	6C5's or equiv.	B	13	1 1/2
†BO-11	P-P Plates to Line or Voice Coil	*Pri: 3000/2500 ohms CT *Sec: 600/16/8 ohms CT and 150/4 ohms	+46 dbm. (40 watts)	3C33, 807's, WE300's, 6AR6's	B	22	9 1/2
BO-12	P-P Plates to Line or Voice Coil	Pri: 10,000 ohms CT Sec: 600/16/8 ohms	+40 dbm. (10 watts)	807's	B	22	9
BO-13	P-P Plates to Voice Coil	§Pri: 10,000 ohms Sec: 4/8/16 ohms	+43 dbm. (20 watts)	5881's, 807's	B	21	7
BO-14	Push-Pull Plates to Voice Coil	§Pri: 5000 CT Sec: 8/16 ohms and 70 volt Has cathode feedback winding.	+50 dbm. (100 watts)	6550's	*C	24	21

‡Has tertiary winding for 15% inverse feedback

§Has screen grid taps for extended power.

*Split and balanced windings. †0 to 10 ma. D-C. ^A0 dbm. reference level=1 milliwatt.

†Part number to be deleted from next catalog.

*C type construction with leads. See page 16.

NEW EQUIPMENT COMMERCIAL GRADE TRANSFORMERS AND REACTORS

b

FULL FREQUENCY RANGE AUDIO TRANSFORMERS

HF Series: These units have a wide frequency response of 20 to 20,000 cps with ± 1 db. Correct design reduces harmonic and intermodulation distortion to a negligible amount. Balanced construction minimizes hum pickup. Cases are finished in grey enamel and have four threaded holes at each end for flush mounting. Stud-type terminals are plainly marked for easy identification.

Mountings: HF-1 case; height overall, $3\frac{1}{4}$ ". Base area, $2\frac{9}{16}$ " x $3\frac{1}{16}$ ". Mounting centers, $1\frac{5}{16}$ " x $2\frac{7}{16}$ ". Shipping weight, 3.0 lbs. HF-2 case; height overall, $4\frac{1}{8}$ ". Base area, $3\frac{3}{16}$ " x $4\frac{3}{16}$ ". Mounting centers, $2\frac{11}{16}$ " x $3\frac{11}{16}$ ". Shipping weight, 7.5 lbs. HF-3 case; height overall, $4\frac{11}{16}$ ". Base area, $4\frac{11}{16}$ " x $5\frac{9}{16}$ ". Mounting centers, $4\frac{3}{16}$ " x $5\frac{1}{32}$ ". Shipping weight, 15.0 lbs.

HF SERIES

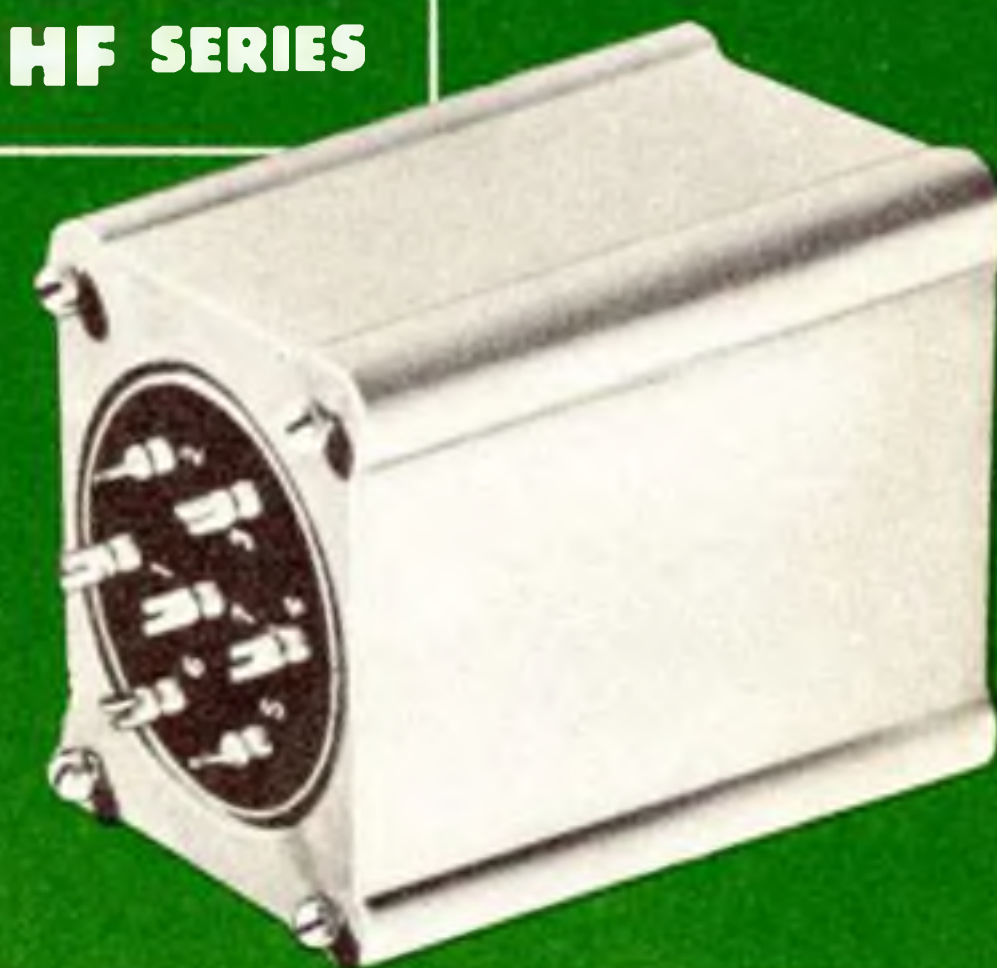

Part No.	Application	Primary Imp/Ohms	Secondary Imp/Ohms	Max. Level	Hum-Pickup Reduction [†]	Mtg.
LOW IMPEDANCE TO GRID						
HF-20	Low Imp. Mic., Pickup, or Line to Grid	50, 125/150, 200, 250, 333, 500/600	60,000 overall, in two sections	15 db	-74 db	HF-1
HF-20X	Low Imp. Mic., Pickup, or Line to Grid	50, 125/150, 200, 250, 333, 500/600	50,000	14 db	-92 db‡	HF-1
HF-22	Low Imp. Mic., Pickup, or Line to P.P. Grids	50, 125/150, 200, 250, 333, 500/600	120,000 overall, in two sections	15 db	-74 db	HF-1
HF-22X	Low Imp. Mic., Pickup, or Line to P.P. Grids	50, 125/150, 200, 250, 333, 500/600	80,000 overall, in two sections	14 db	-92 db‡	HF-1
INTERSTAGE						
HF-29§	Sgl. Pl. to P.P. Grids—Split secondary	15,000	95,000 (turn ratio 2.5:1 overall)	17 db	-50 db	HF-1
HF-31§	Single Plate to P.P. Grids. Split pri. and sec.	15,000	135,000 (Turn ratio 3:1 overall)	14 db	-74 db	HF-1
HF-32	P.P. Plates to P.P. Grids. Split pri. and sec.	30,000 Plate to Plate	80,000 (Turn ratio 1.6:1 overall)	26 db	-50 db	HF-2
MIXING						
HF-40	Low Imp. Mixer, Mic., Pickup, or Line to Line	50, 125/150, 200, 250, 333, 500/600	50, 125/150, 200, 250, 333, 500/600	17 db	-74 db	HF-1
HF-65†	P.P. 2A3's, 6L6's, etc. to Line or Voice Coil	3,000 or 5,000 Plate to Plate	1.2, 2.5, 5, 7.5, 10, 15, 20, 30, 50, 125, 200, 250, 333 or 500	20 watts	HF-2
HF-67†	P.P. 2A3's, 6L6's, etc. to Voice Coil	3,000 or 5,000 Plate to Plate	30, 20, 15, 10, 7.5, 5, 2.5, 1.2	20 watts	HF-2
HF-68†	P.P. Par. 2A3's, 6A5G's, 300A's, 6A3's to Line or Voice Coil	1,500 or 2,500 Plate to Plate	500, 333, 250, 200, 125, 50, 30, 20, 15, 10, 7.5, 5, 2.5, 1.2	40 watts	HF-3

*Response ± 1 db from 25 to 20,000 cps.
§Use shunt plate feed to keep D.C. out of primary winding.

†As compared to standard uncased units.
‡Quadruple alloy magnetic shield.

WF SERIES



WF Series: These units are of the same fine quality as the HF Series above and, with the exception of two units, have a frequency response of 30-20,000 cps. within ± 2 db. The WF-21 and WF-35 have a response within ± 2 db from 50-20,000 cps. WF-21 has multiple alloy shields for extremely low hum pickup. Maximum operating level is $+7$ db. All WF units are cased in the WF-6 type cast case with phenolic terminal board and four tapped holes for flush mounting. Overall dimensions are 2" high with $1\frac{1}{2}$ " x $1\frac{1}{2}$ " base area. Mounting centers are $1\frac{5}{32}$ " x $1\frac{5}{32}$ ". Shipping weight is 0.6 pounds.

Part No.	Application	Primary Imp/Ohms	Secondary Imp/Ohms
INPUT			
WF-20	Low Imp. Mic., Pickup, or Line to Grid	50, 125/150, 200, 250, 333, 500/600	50,000
WF-21	Low Imp. Mic., Pickup, or L to Sgl. or P.P. Grids	50, 200, 500	50,000
WF-22	Low Imp. Mic., Pickup, or Line to P.P. Grids	50, 125/150, 200, 250, 333, 500/600	80,000 overall, in two sections
†WF-24	Dynamic Microphone to 1 or 2 Grids	30	50,000 overall, in two sections
INTERSTAGE			
WF-26§	Single Plate to Single Grid	15,000	60,000 (Turn ratio 2:1)
WF-28§	Sgl. Pl. to 2 Grids. Can use split pri. for P.P. Pl.	15,000	80,000 overall (Turn ratio 2.3:1 overall)
LOW LEVEL OUTPUT			
WF-34§	Single Plate to Line	15,000	50, 125/150, 200, 250, 333, 500/600
WF-36§	P.P. Low Level Plates to Line	30,000 Plate to Plate	50, 125/150, 200, 250, 333, 500/600
WF-35§	Single Plate to Multiple Line	15,000	50, 125/150, 200, 250, 333, 500/600
MIXING			
WF-30	Low Imp. Mixer, Mic., Pickup, or Line to Line	50, 125/150, 200, 250, 333, 500/600	50, 125/150, 200, 250, 333, 500/600

§Use shunt plate feed to keep D.C. out of primary winding.

†Part number to be deleted from next catalog.

CHICAGO

The world's toughest transformers

PREFERRED FOR EVERY MODERN CIRCUIT REQUIREMENT

TRANSISTOR TRANSFORMERS

Here are the smallest iron core audio transformers ever built. They weigh less than 1/10 ounce and are no larger than the transistors they power.

These transformers are designed primarily for transistor audio applications but they can be used wherever low power is involved. Useful range, below 1 mw level. They are constructed of extremely fine wire, wound on molded nylon bobbins, with special nickel alloy steel laminations.

Part No.	Application	Pri. Imp.	Sec. DC Res.	Pri. DC Res.	Sec. DC Res.	Weight
UM-110	Interstage	20,000	1,000	1675	285	0.07
UM-111	Output or matching	1,000	50/60	120	9.0	0.10
UM-112	High imp. mic. input	200,000	1,000	4000	195	0.10
UM-113	Interstage	20,000	1,000	1350	205	0.10
UM-114	Output or matching	500	50/60	70	9.0	0.10

Dimensions* UM-110, 1/4" x 3/8" x 3/8"; UM-111, 112, 113, 114, 3/8" x 3/8" x 3/8". *Dimensions ±.015"

"TINYTRAN" MINIATURE AUDIOS

These miniature units have an exceptional frequency response for transformers of this size: 1 db, 30-15,000 cps. Maximum level 0 db. They are built with nickel steel laminations and have clearly marked stud-type terminals. Tinytrans are cased and potted in 3/8" square, anodized aluminum cans with phenolic terminal boards. Total height, including terminals, is 1 1/4". The case has two 2-56 threaded inserts for easy mounting. The entire transformer weighs only 1.3 ounces.

Part No.	Application	Primary Impedance	Secondary Impedance
TT-11	Mic., pickup or line to single grid	50, 200/250, 500/600	50,000
TT-12	Mic., pickup or line to push-pull grids	50, 200/250, 500/600	50,000
TT-13	Dynamic mic. to single grid	7.5/30	50,000
TT-14	Single plate to single grid	15,000§	60,000

§No DC in primary.

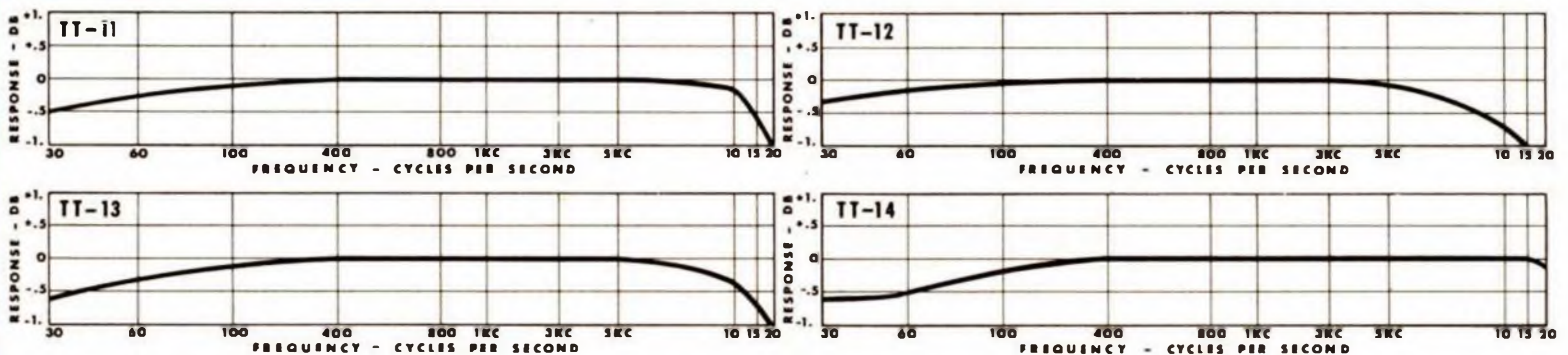

HIGH Q CHOKES

CHICAGO High Q chokes, Nos. NSI-1 and NSI-2, are designed specifically for use in dynamic noise suppressor circuits, but can be used with equal advantage in any tuned circuit requiring the given inductances.

Their inductance values, .8 and 2.4 henrys respectively, are accurate within ±5% with up to 15 ma d-c. The units have a minimum Q of 20.

Catalog No.	Inductance	Wt. Lbs.
NSI-1	.8 henrys	1/2
NSI-2	2.4 henrys	1/2

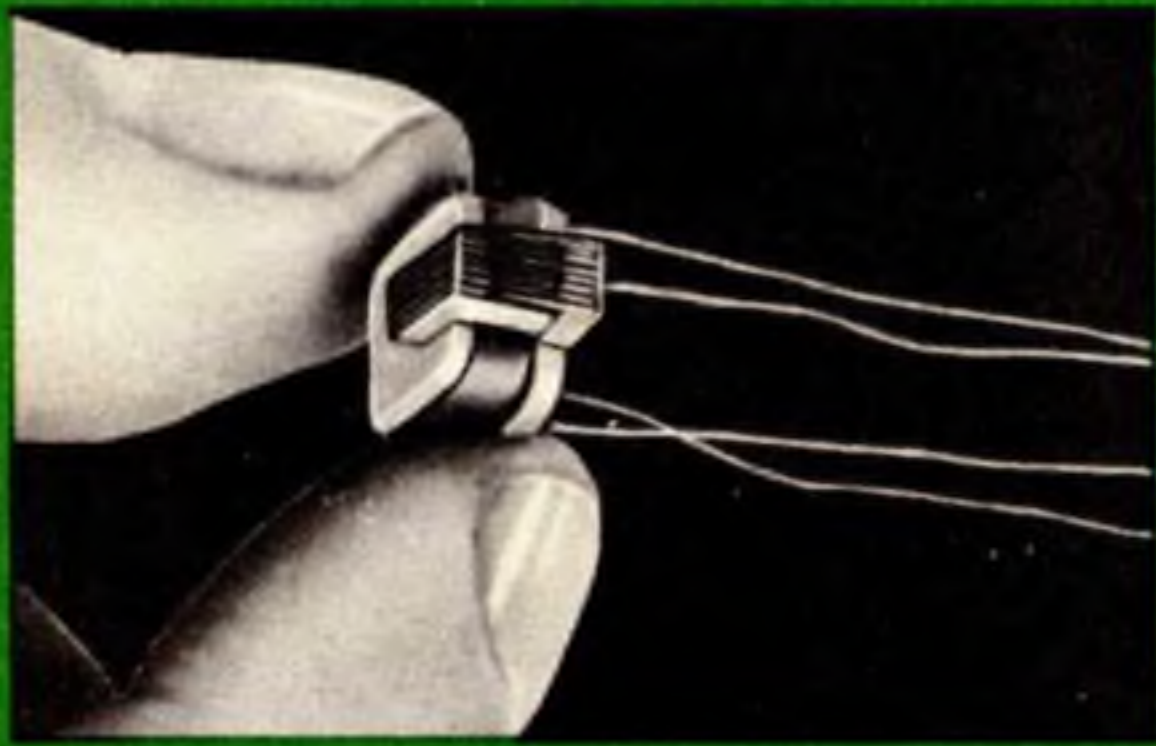
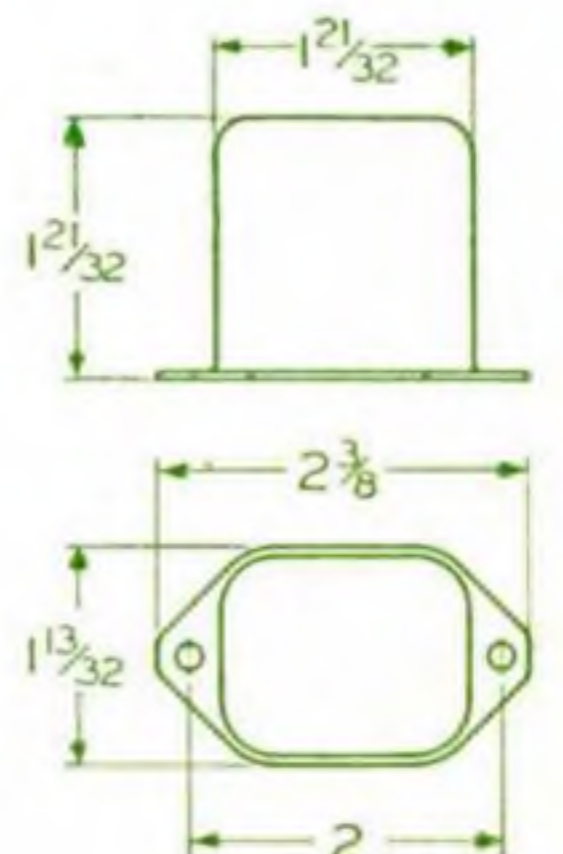

**NEW EQUIPMENT COMMERCIAL GRADE
TRANSFORMERS AND REACTORS**

b

TRANSISTOR TRANSVERTER TRANSFORMERS

These miniature units are used in transistorized circuits for converting battery voltage to plate supply voltage. They are ideally suited for mobile communication applications such as: police radio, amateur radio, commercial or public service vehicles. Write for Bulletin #CT-43 showing circuit diagrams and part lists.

Part No.	Step-Up in Volts D.C.	Case Size	Weight Lbs.
• DCT-1	12 to 275 (a) 125 MADC	10*	7/8
• DCT-2	12 to 250 (a) 275 MADC OR 12 to 500 (a) 165 MADC	12*	1 1/2

*See dimension chart on Pg. 23
•New Part Number

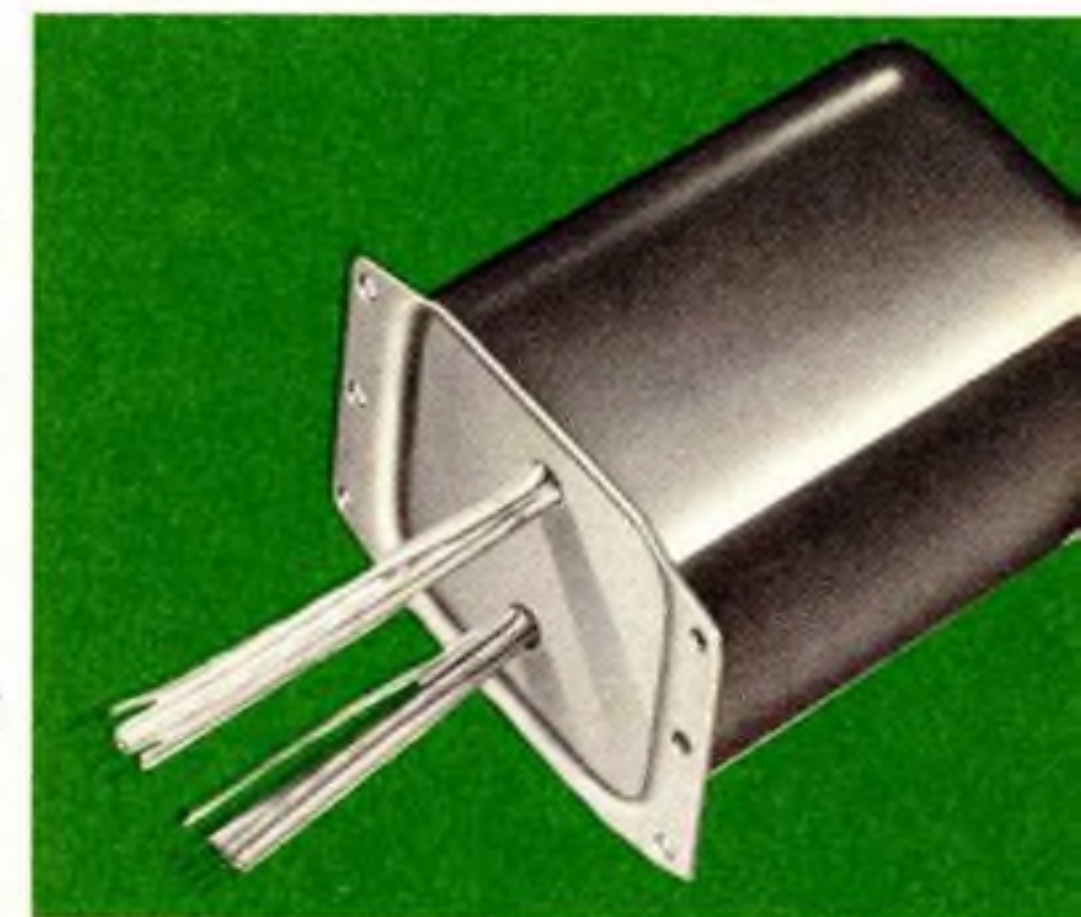

EXACT REPLACEMENTS FOR LINK RADIO EQUIPMENT

Chicago Cat. No.	Type of Unit	Replaces Link Radio Part Numbers	Mtg. Type
†TR-957	Filter Choke	TR-957	L
†TR-1002	Filament Transformer	TR-1002	TX-1
†TR-1014	Filament Transformer	TR-1014	S*
†TR-1016	Output Transformer	TR-1016, 9935	S*
†TR-1028	Plate Transformer	TR-1028	S*
†TR-1034	Vibrator Transformer (6 v.)	TR-1034 and 12534	V
†TR-1035	Vibrator Transformer (12 v.)	TR-1035, 14269	V
†TR-1040	Plate Transformer	TR-1040 and 11862	FS
†TR-1042	Line to Grid Transformer	TR-1042	PV
†TR-1043	Output Transformer	TR-1043	PV
†TR-1045	Impedance Matching	TR-1045	C††
†TR-1050	Vibrator Transformer (6 v.)	TR-1050	V
†TR-1054	Plate Transformer	TR-1054, 11944, 4891	V
†TR-1056	Filter Choke	TR-1056, 0122U	V
†TR-1061	P-P Input Transformer	TR-1061	H*
†TR-1063	Filament Transformer	TR-1063, 11992, 7211	V
†TR-1065	Power Transformer	7650N, TR-1065	S

Chicago Cat. No.	Type of Unit	Replaces Link Radio Part Numbers	Mtg. Type
†TR-1066	Output Transformer	TR-1066	L
†TR-1071	Output Transformer	TR-1071, 6226	L
†TR-1072	Power Transformer	TR-1072, 6248	V
†TR-1073	Vibrator Transformer (6 v.)	TR-1073, 6250, TR-1080	V
†TR-1074	Line to Line Transformer	TR-1074, 6327A	H*
†TR-1075	Low Pass Filter	TR-1075	C††
†TR-1077	Filter Choke	TR-1077, 7282N	BX
†TR-1078	Filament Transformer	TR-1078, 7283A	V††
†TR-1080	Vibrator Transformer (6 v.)	TR-1080	§§
†TR-1081	Output Transformer (Plate to Grid or Line)	TR-1081	S*
†TR-1082	Filament Transformer	TR-1082	TX-1
†TR-1083	Filament Transformer	TR-1083, 8218N	TX
†TR-1088	Power Transformer	TR-1088	V
†TR-1089	Output Transformer	TR-1089, 6132B	B**
†TR-1104	Vibrator Transformer (6 v.)	TR-1104, 14270	V
†TR-7074	Vibrator Transformer (12 v.)	TR-7074	V

*Hermetically sealed with type S terminals. (See page 2). **See page 24.
††See page 22. *Pin type terminals instead solder lugs.
†Part number to be deleted from next catalog.

††Solder lugs instead wire leads. §§Metal case with spade lugs, wire leads.

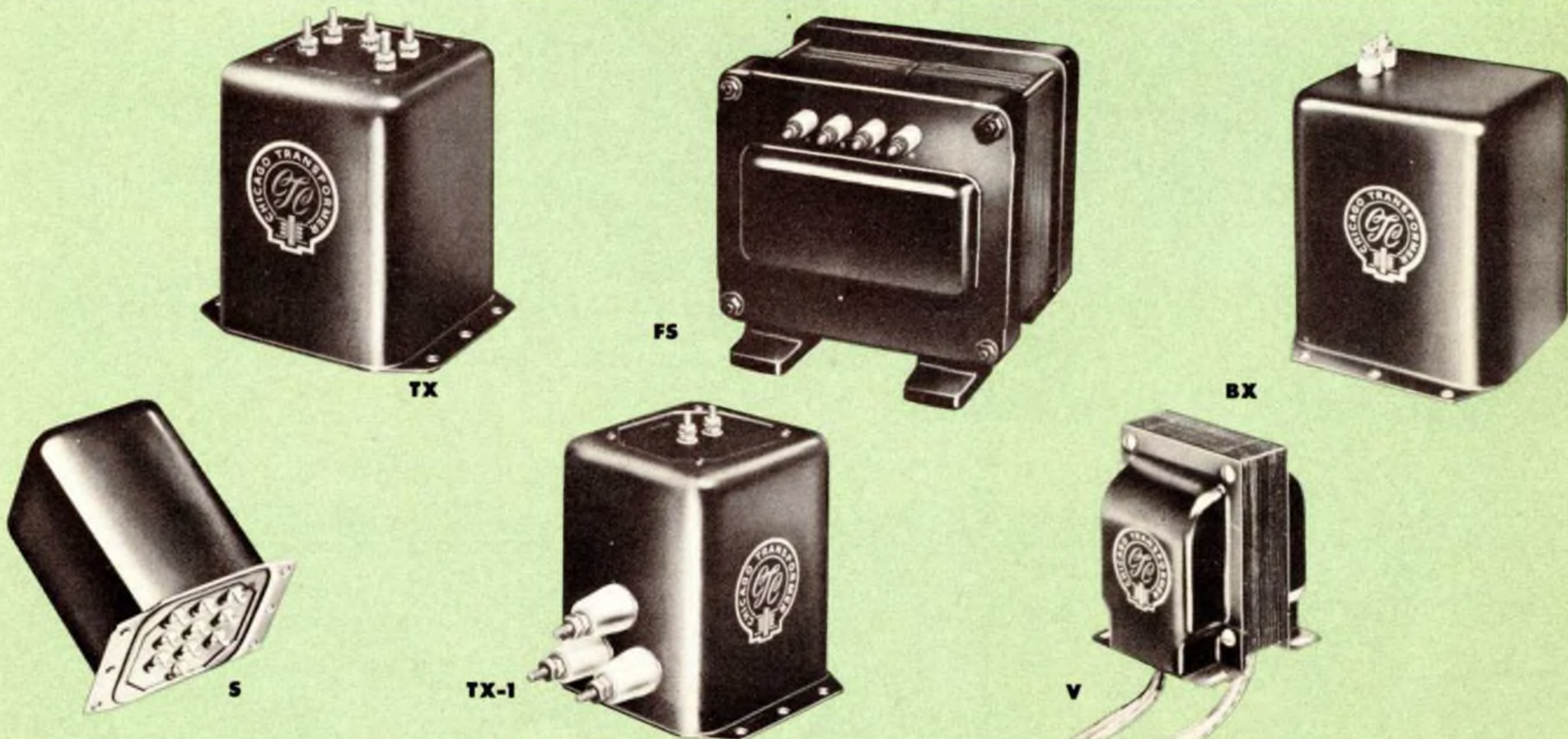

CHICAGO

The world's toughest transformers

PREFERRED FOR EVERY MODERN CIRCUIT REQUIREMENT

POWER CIRCUIT TRANSFORMERS

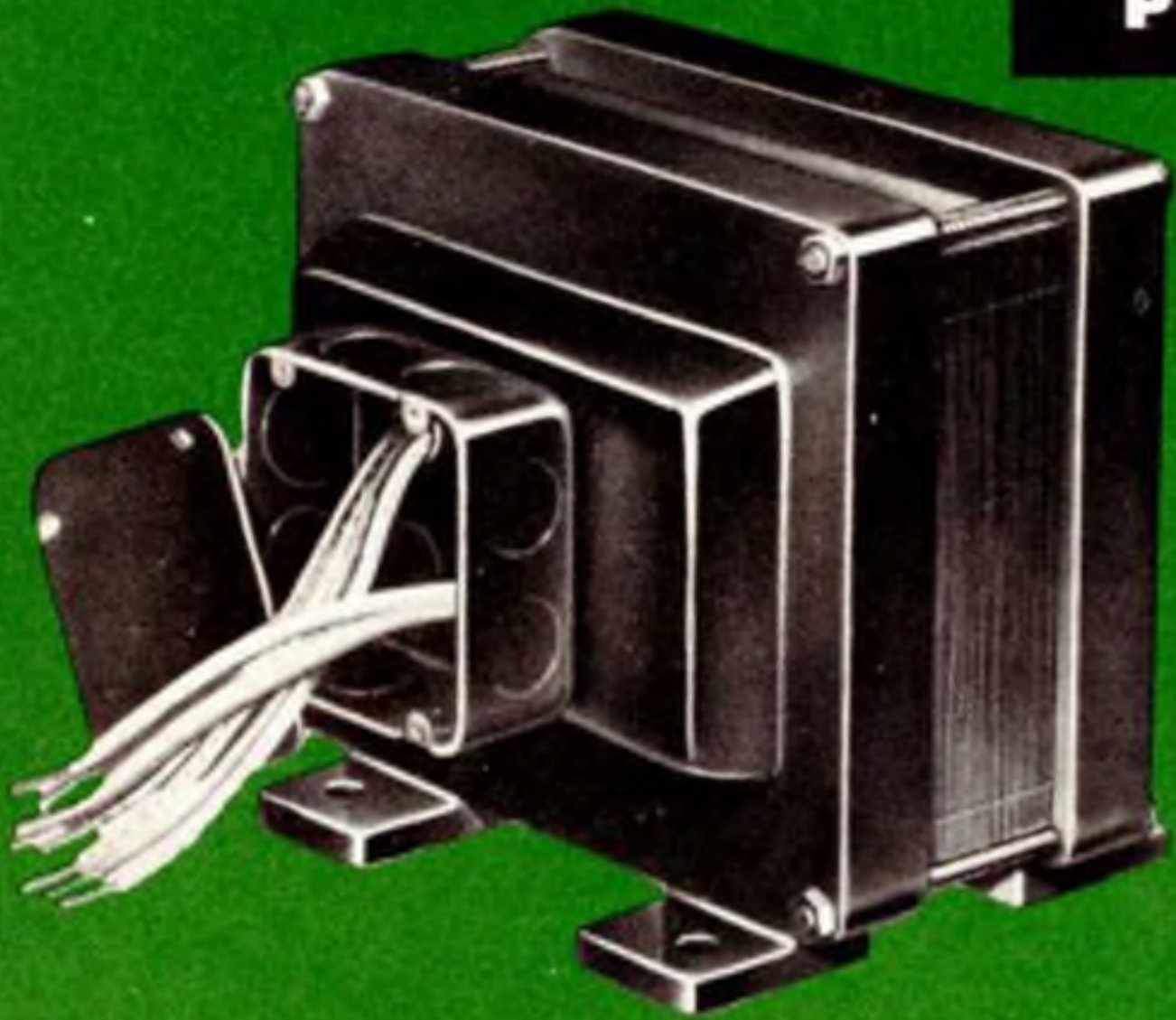

PCB SERIES—Capacities from 1/2 to 10 KVA.

For Use with Conduit Wiring

The larger size of the CHICAGO Power Circuit Transformers in capacities from 1/2 to 10 KVA, as compared to those in the PCF Series, opposite page, makes them more adaptable to installation on overhead structures, posts, or on machines, rather than inside control compartments.

Accordingly, on all units in the PCB Series, the heavily insulated leads are brought out through roomy outlet boxes, which have standard knock-outs for receiving rigid or flexible-conduit, or armored cable. Rugged frames and mounting feet provide strong, rigid support in any mounting position. Coil structure and internal wiring are protected by heavy gauge steel shields.

Ratings of this series supplement those of the PCF units on opposite page and their general application is the same. However, those of 1 KVA capacity and greater provide additional flexibility in use, double secondaries supplying current for 230-volt as well as 115-volt equipment.

PCB SERIES—with Mounting Feet, Outlet Boxes; Primary 50/60 cycles

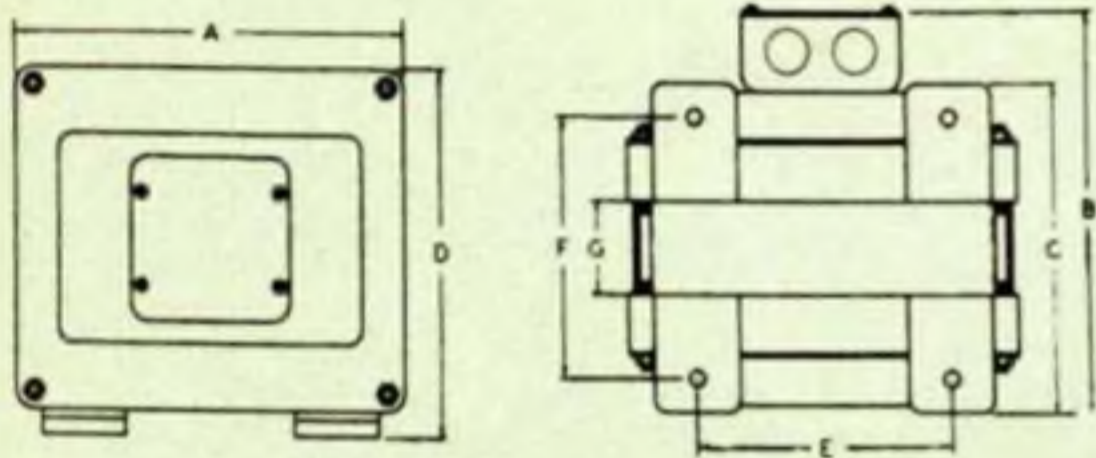

Primary Volts	Secondary Volts	KVA Capacity	Catalog Number	A	Dimensions in Inches						Approx. Weight Lbs.
					B	C	D	E	F	G	
230/460	115	.500	†PCB-24500	7 1/2	8	6 3/8	7	4 3/4	5 1/2	1 3/4	32
230/460	115	.750	†PCB-24750	8 7/8	8 11/16	7 1/8	8 1/2	5 1/2	5 1/2	1 5/8	50
230/460	115/230	1.0	†PCB-241M	8 7/8	9 1/16	7 3/8	8 1/2	5 1/2	6	2 1/8	57
230/460	115/230	2.5	†PCB-242M5	11 1/2	12 1/16	10 1/8	10 1/2	7 1/2	8 1/8	3 3/8	108
230/460	115/230	5.0	†PCB-245M	11 1/2	15 3/4	11 1/16	10 1/2	7 1/2	9 9/16	4 3/8	195
230/460	115/230	7.5	†PCB-247M5	13 13/16	15 7/8	11 1/2	12 3/4	9	10 7/16	4 3/16	245
230/460	115/230	10.0	†PCB-2410M	16 1/8	18	13 3/8	14 9/16	11 3/8	12 3/8	5 1/8	330
230/460	115/230	15.0	†PCB-2415M	14 1/2	21 1/2	17 1/2	12 1/2	12 1/2	11 1/2	8 1/2	500

PCC SERIES—Capacities from 100 to 250 va.

For Mounting on Conduit Boxes

Mounted on rectangular covers that fit standard FS and FD-type conduit boxes, these CHICAGO Power Circuit Transformers offer a handy, economical method of installation at machine tools, welders, and other equipment where step-down from 230 or 460 volts to 115-volts is required. They are widely used in manufacturing plants to operate 115-volt lamps for machine lighting and to supply signalling, heating, and other miscellaneous power loads.

These transformers are equipped with fused secondaries for overload protection. Both primary and secondary leads are brought out through the conduit box covers. Shields and conduit box covers have durable cadmium plated finish.

Unit No. 4100SP in the table below is specially constructed with primary tapped at 10% under and over voltage for the purpose of stabilizing line voltage fluctuations. This feature improves the operation, boosts the performance, and steps up the accuracy of a wide variety of electrical devices.

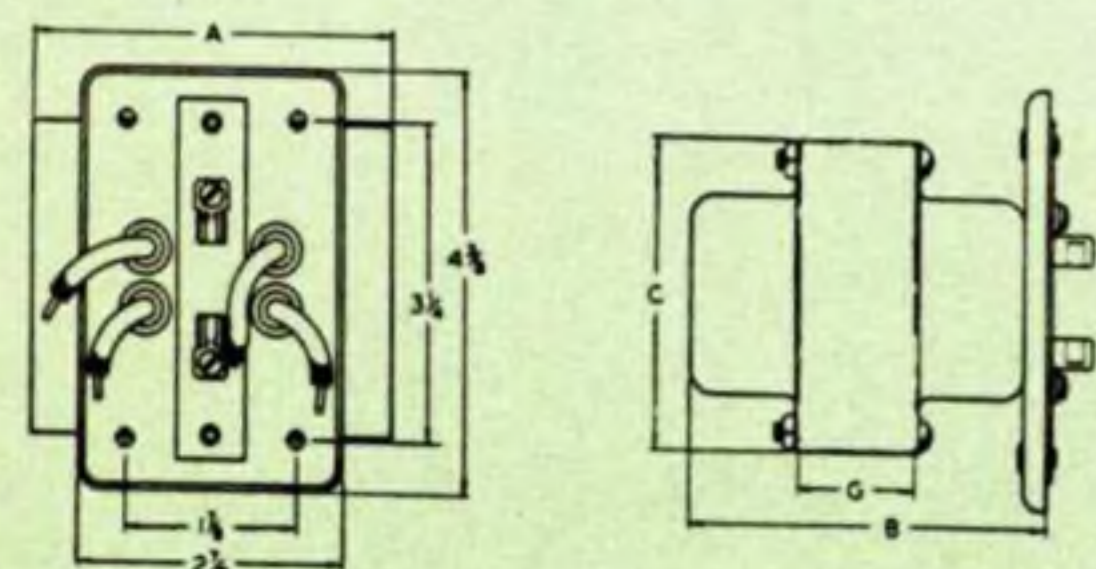
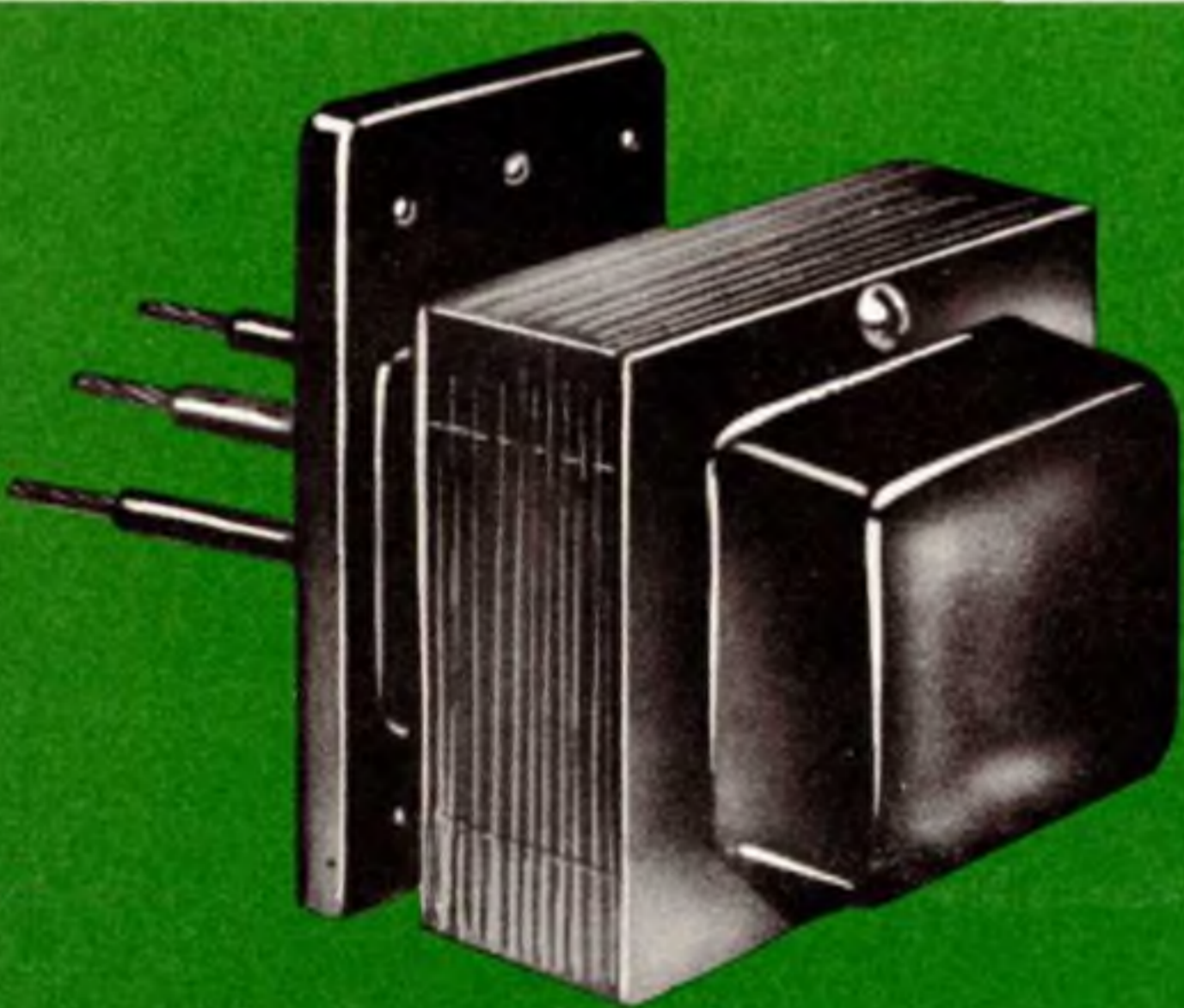

Primary		Secondary Volts	Secondary		Catalog Number	Dimensions in Inches				Approx. Weight Lbs.
Volts	Cycles		Amps.*	V-A Cap.		A	B	C	G	
230/460	50-60	115	.85	100	PCC-24100	3 3/4	4 3/16	3 1/8	1 1/16	5 1/4
460	50-60	115	.85	100	PCC-4100SP	3 3/4	4 3/16	3 1/8	1 1/16	5 1/4
230/460	50-60	115	1.5	150	PCC-24150	4 1/2	4 3/8	3 3/4	1 1/2	7 3/4
230/460	50-60	115	2.2	250	PCC-24250	5 1/4	4 7/8	4 3/16	1 11/16	11 1/2

*Current ratings are for continuous performance.

†Part number to be deleted from next catalog.

POWER CIRCUIT TRANSFORMERS

**PCF SERIES—Capacities from 25 to 250 va.
for IN-Compartment Wiring**

It has become standard practice in most large industrial plants to wire main circuits for single phase, 230, 460, or 575 volts, and to use power circuit transformers for stepping down to lower voltage wherever needed. This method of installation requires only one power service with a single metering and eliminates multiple circuits to each point of use. Valuable savings in copper, conduit, and fittings are thus effected, to say nothing of economies in installation and maintenance.

CHICAGO Power Circuit Transformers are offered in three different series, each of which is made up of units with ratings and types of mountings designed to meet a maximum number of the requirements ordinarily encountered in this field. Their use in industry over a period of many years has proven them to be practical in application and dependable in performance.

The units of all of the three series, described on this and the following page, are normal reactance, dry-type transformers, designed for operation on either 50- or 60-cycle current. Many have double primary windings that can be connected in parallel for 230 volts or in series for 460 volts. All meet the requirements of the Underwriters' Laboratories for air-cooled transformers.

Installations of modern machine tools and other types of production equipment, which operate on one of the service voltages, frequently incorporate supplementary, 115-volt electrical appliances, such as machine lighting, controls, small motor-driven tools, fans, blowers, and heating elements. For operating these 115-volt devices CHICAGO Power Circuit Transformers of the PCF Series are used by nationally-known machine tool manufacturers, who mount the units in the bases of their machines, or in other compartments provided for control equipments.

Transformers in the PCF series are constructed with standard steel shields and mounting feet. Wire leads of approved type are brought out through the shields, primary and secondary leads on opposite sides for ease of wiring.

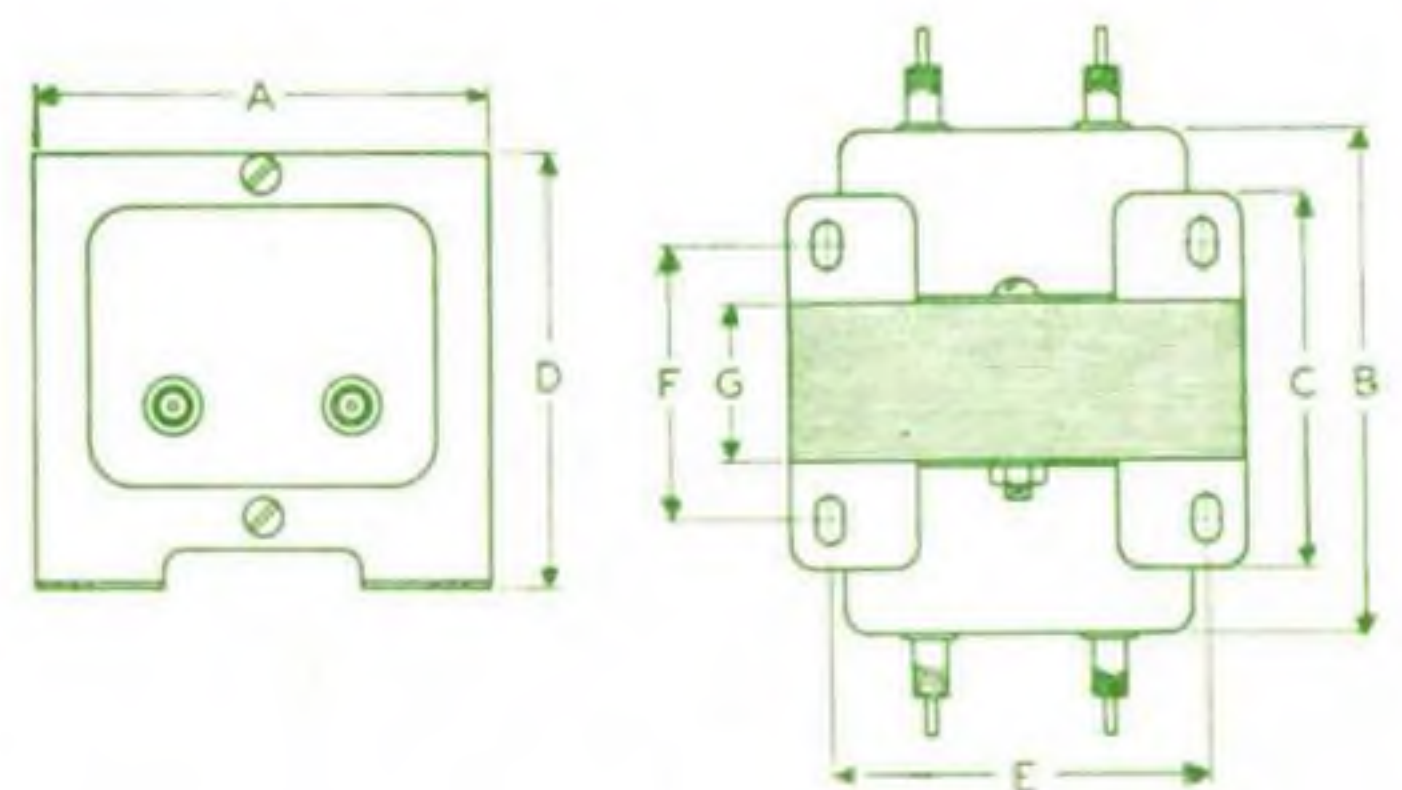
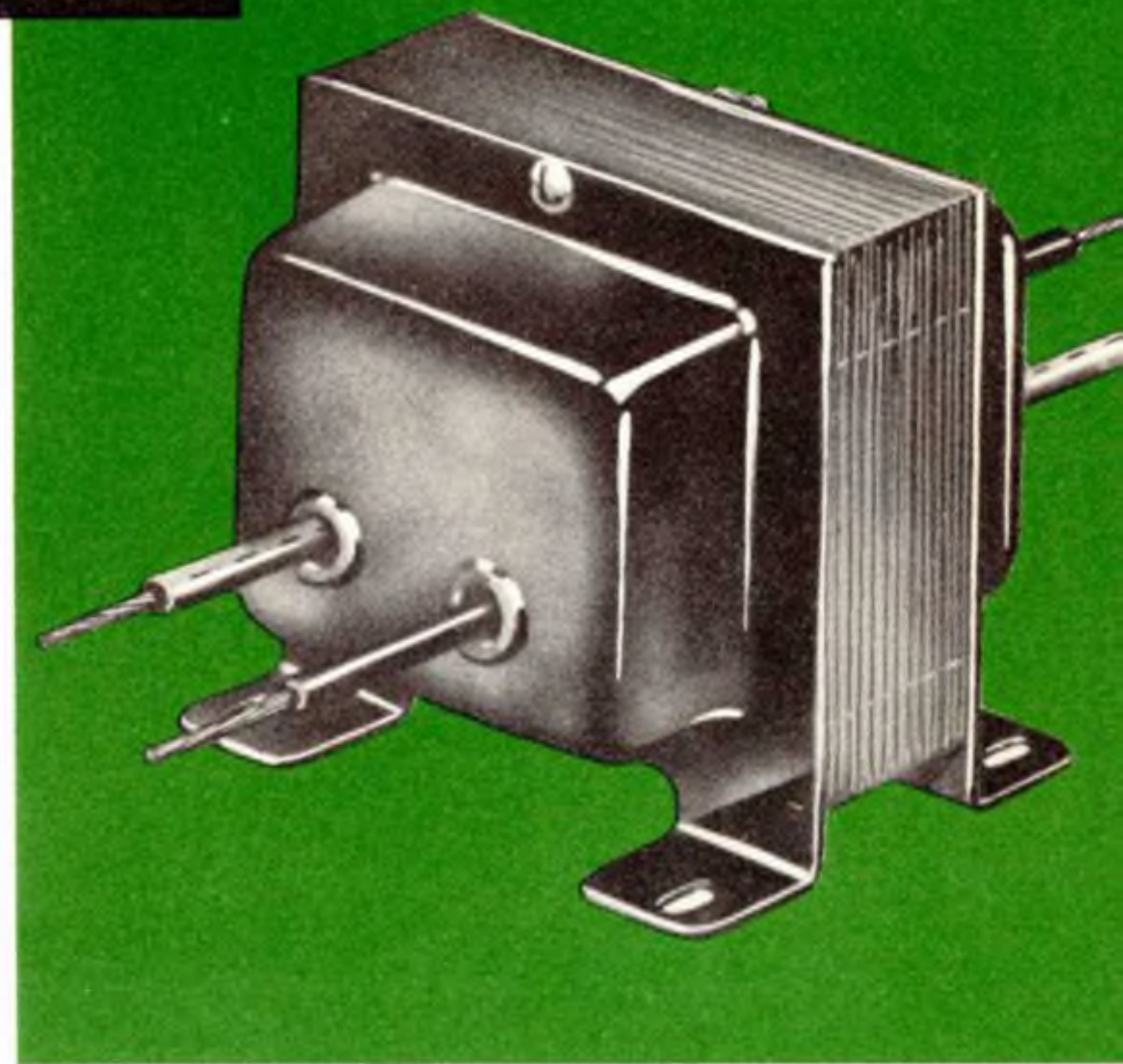

PCF SERIES with Mounting Feet—Primary 50/60 cycles

Primary Volts	Secondary			Catalog Number	Dimensions in Inches							Approx. Weight Lbs.
	Volts	Amps.*	V-A Cap.		A	B	C	D	E	F	G	
230	115	.25	25	PCF-2025	3	3	2 ¹ / ₈	2 ¹³ / ₁₆	2 ³ / ₈	1 ¹ / ₂	3 ¹ / ₄	2
230	115	.45	50	PCF-2050	3	3 ¹ / ₂	2 ⁵ / ₈	2 ¹³ / ₁₆	2 ³ / ₈	2	1 ¹ / ₄	2 ³ / ₄
230/460	115	.65	75	PCF-24075	3 ¹ / ₂	3 ⁵ / ₈	2 ⁷ / ₈	3 ³ / ₁₆	3	2 ¹ / ₄	1 ³ / ₁₆	4 ¹ / ₄
230/460	115	.85	100	PCF-24100	3 ¹⁵ / ₁₆	4 ¹ / ₈	3 ¹³ / ₁₆	3 ¹ / ₂	3 ³ / ₁₆	2 ¹⁵ / ₁₆	1 ¹ / ₁₆	5 ¹ / ₄
230/460	115	1.5	150	PCF-24150	4 ¹ / ₂	4 ¹ / ₈	3 ³ / ₄	4	3 ³ / ₄	3	1 ¹ / ₂	7 ³ / ₄
230/460	115	2.2	250	PCF-24250	5 ¹ / ₄	4 ⁹ / ₁₆	3 ¹⁵ / ₁₆	4 ⁹ / ₁₆	4 ¹ / ₄	3	1 ¹¹ / ₁₆	12

*Current rating for continuous operation.

CONTROL TRANSFORMERS

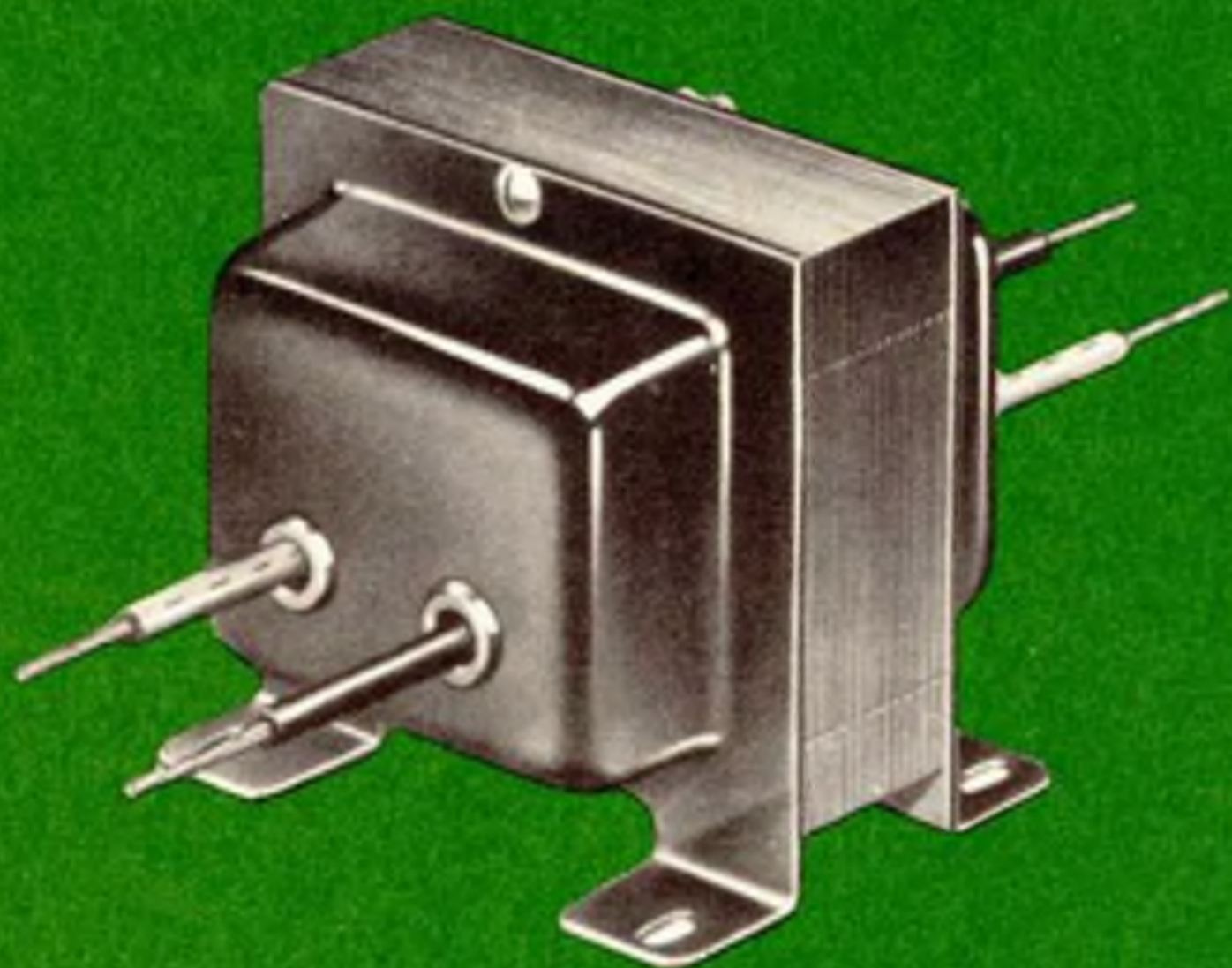

NORMAL REACTANCE TYPE CONTROL TRANSFORMERS

CHICAGO Control Transformers of the normal reactance type are equipped with eight-inch leads of approved type for installations using standard code wiring on both the primary and secondary. For convenience of wiring, primary and secondary leads are brought out through opposite sides of the transformers. They are sturdily constructed with single-piece, steel shield-and-frame units, which have mounting feet with easily accessible slots. All transformers in the normal reactance series meet the requirements of the Underwriters' Laboratories for air-cooled transformers.

Because of their compactness and convenient provisions for mounting and wiring, they are readily adaptable for use with modern machines and appliances, where mounting in machine bases or housings, or in control cabinets, is required.

The National Electrical Code requires closed conduit wiring from the secondary of any normal reactance transformer regardless of voltage. However, when the transformer and low-voltage control devices are installed in a single cabinet, the complete equipment may, under certain conditions, meet code requirements and receive approval from the Underwriters' Laboratories for annunciator-type wiring.

C.T. normal reactance transformers may be operated continuously in ambient temperatures up to 50°C. at the rated capacities shown in the specifications.

Primary: 115 volts, 50/60 cycles

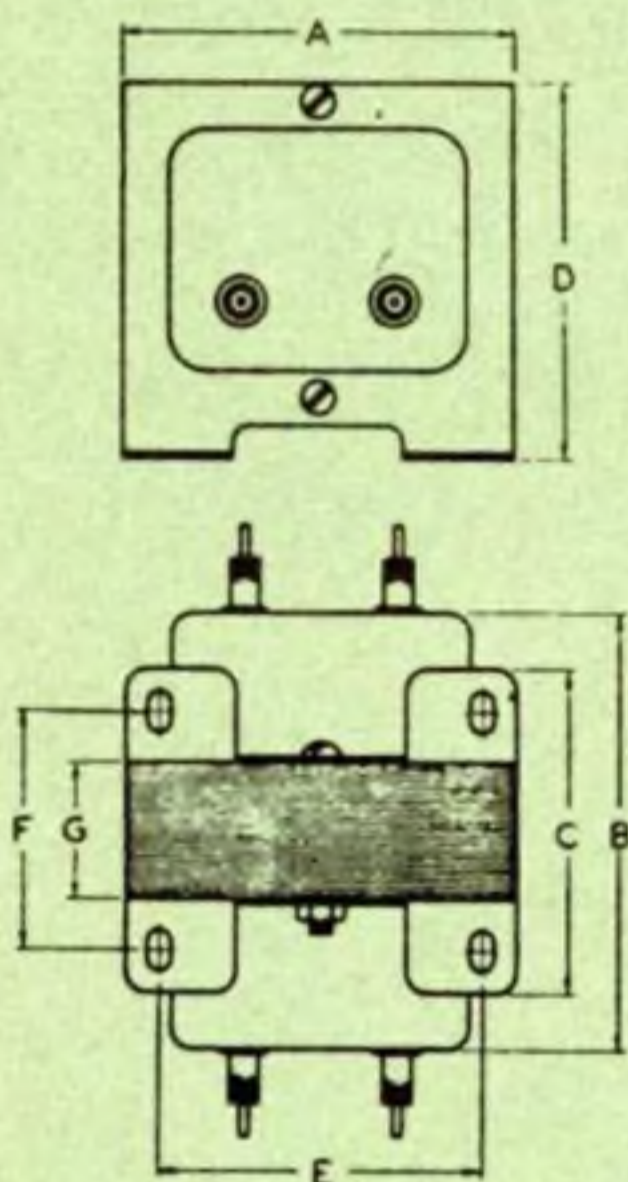

Volts	Secondary		Catalog Number	Dimensions in Inches							Approx. Weight Lbs.
	Amps.*	V-A Cap		A	B	C	D	E	F	G	
16	3.15	50	NCF-1650	3	3 1/2	2 5/8	2 13/16	2 3/8	2	1 1/4	3 1/2
24	1.05	25	NCF-2425	3	3	2 1/8	2 13/16	2 3/8	1 1/2	3/4	2 1/4
24	2.1	50	NCF-2450	3	3 1/2	2 5/8	2 13/16	2 3/8	2	1 1/4	3 1/2
24	3.15	75	NCF-2475	3 1/2	3 5/8	2 7/8	3 3/16	3	2 1/4	1 7/16	4 1/2
24	4.15	100	NCF-24100	3 15/16	4 1/8	3 13/16	3 1/2	3 3/16	2 15/16	1 9/16	5 1/4
24	6.25	150	NCF-24150	4 1/2	3 13/16	3 7/16	4	3 3/4	2 11/16	1 3/16	8 1/2
32	1.55	50	NCF-3250	3	3 1/2	2 5/8	2 13/16	2 3/8	2	1 1/4	3 1/2
32	2.35	75	NCF-3275	3 1/2	3 5/8	2 7/8	3 3/16	3	2 1/4	1 7/16	4 1/2
32	4.7	150	NCF-32150	4 1/2	3 13/16	3 7/16	4	3 3/4	2 11/16	1 3/16	8 1/2
550	(NL)	50	NCF-1550	2 7/8	3	3	3 1/2	2 1/4	2 1/8	1 1/8	3 1/2
775	(NL)	50	NCF-1775	2 7/8	3	3	3 1/2	2 1/4	2 1/8	1 1/8	3 1/2

*Current Rating for continuous operation.

TYPICAL CONTROL TRANSFORMER APPLICATIONS

- Relays
- Solenoids
- Small Motors
- Speed Changers
- Recording Devices
- Pumps
- Electronic Tubes
- Heating Elements
- Elevators
- Door Openers
- Sprinkler Systems
- Automatic Musical Instruments
- Coin-Operated Devices
- Low Voltage Lighting Signal Lamps, Etc.
- Devices Controlled by Thermostats
- Spark Plug Testers
- Control Valves for Fluids and Gases
- Fans and Blowers
- Mechanical and Electrical Signs
- Burglar and Fire Alarms
- Bells, Buzzers, and Annunciators
- and for similar applications

CHICAGO Control Transformers are intended for operation on 115-volt power to supply low voltages to the types of industrial and household equipment listed at left. They are correctly designed and conservatively rated and, because of their proven efficiency and dependability, have been preferred by nationally-known control and machine-tool manufacturers for many years.

Coils are wound of high-grade magnet wire on automatic multiple-coil winding machines. Windings and lead connections are insulated with acid-free and non-corrosive materials of high dielectric strength.

Cores are made of high quality, non-aging silicon steel, the electrical properties of the laminations brought to a high degree of efficiency, after punching, by scientific heat-treating in CHICAGO's own annealing furnaces.



SALES REPRESENTATIVES

CALIFORNIA, Los Angeles		
W. Bert Knight Co.....	10377 W. Pico Blvd.....	BRadshaw 2-0101
CALIFORNIA, San Francisco		
E. L. Berman.....	450 Ninth St.....	UNderhill 3-0317
COLORADO, Denver 3		
Ronald G. Bowen Co.....	721 S. Broadway.....	RAce 2-4641, 4642
DIST. OF COLUMBIA, Washington 10		
S. K. Macdonald, Inc.....	14th and Park Road, N.W.....	COLumbia 5-3938
FLORIDA, Tampa		
Hollingsworth & Still.....	4313 Beachway Dr.....	RE 7-3054
GEORGIA, Atlanta 3		
Hollingsworth & Still.....	508 Whitehead Bldg.....	MUrray 8-5878
ILLINOIS, River Forest		
George Petitt, Inc.....	349 N. Ashland.....	COLumbus 1-0342
LOUISIANA, New Orleans		
Cartwright & Bean, Marion O. Aime.....	821 Pontalba.....	AUdobon 2264
MARYLAND, Baltimore 14		
S. K. Macdonald, Inc.....	2016 Winford Road.....	CLifton 4-9966
MASSACHUSETTS, Wellesley Hills 82		
Michael Scott Co.....	90 Edmunds Road.....	Cedar 5-0102
MICHIGAN, Detroit 21		
Grant Shaffer Co.....	14241 Fenkell Ave.....	BRoadway 3-5390
MINNESOTA, Minneapolis 2		
Nick J. Laub Co.....	3749 W. Broadway.....	Juniper 8-4663
MISSOURI, Kansas City 2		
W. E. Fry & Co.....	406 West 34th St.....	Jefferson 1-5236
MISSOURI, St. Louis 20		
W. E. Fry & Co., Inc.....	6616 W. Florissant Ave.....	Evergreen 2-3500, 01
NEW MEXICO, Albuquerque		
R. G. Bowen, Mr. Carlberg.....	2228-A San Mateo Blvd., N.E.....	Albuquerque 5-4603
NEW YORK, Buffalo 3		
R. W. Mitscher.....	487 Ellicott Sq. Bldg.....	WAShington 2517
NEW YORK, New York		
F. Edwin Schmitt Co.....	136 Liberty St.....	WOrth 2-6550
NORTH CAROLINA, Greensboro		
Hollingsworth & Still, Joe Corn.....	P. O. Box 476.....	CE 5-0806
OHIO, Columbus 15		
William McFadden.....	150 E. Broad St.....	CApitol 1-3363
OKLAHOMA, Tulsa		
Jack F. McKinney Sales Co.....	3503 S. Peoria.....	RF 2-5397
OREGON, Portland 9		
Don H. Burcham Co.....	510 N. 19th Ave.....	Capitol 7-3830, 33
PENNSYLVANIA, Philadelphia 2		
S. K. Macdonald, Inc.....	1531 Spruce Street.....	Kingsley 5-1205
PENNSYLVANIA, Pittsburgh 22		
S. K. Macdonald, Inc.....	415 Beulah Rd.....	Atlantic 1-2253
TENNESSEE, Memphis 4		
Cartwright & Bean.....	1336 Madison Ave.....	Broadway 5-1914
TEXAS, Dallas 7		
Jack F. McKinney Sales Co.....	1330 N. Industrial Blvd.....	Riverside 1-1369
TEXAS, Houston		
Jack F. McKinney Sales Co.....	5951 Southlark.....	Mission 9-1221
WISCONSIN, Milwaukee		
Nick J. Laub Co.....	2333 West Wells St.....	Division 2-3200
WASHINGTON, Seattle 99		
Don H. Burcham Co.....	422 First Ave. W.....	Atwater 4-7297
EXPORT SALES		
Roburn Agencies, Inc.....	431-5 Greenwich Street.....	New York 13, N. Y.
Cable Roburnage		

QUICK REFERENCE INDEX

MIL-T-27A HERMETICALLY SEALED TRANSFORMERS AND REACTORS

	PAGE
Audio.....	9, 10, 12
Bias Transformers.....	3
Chokes.....	4, 6, 7
Driver Transformers.....	12
Filament Transformers.....	5, 8
Filter Reactors.....	4, 6, 7
400 Cycle Transformers.....	6, 7
400 Cycle Reactors.....	6, 7
Input Transformers.....	9, 12
Low Pass Filter.....	11
Magnetic Amplifier Transformers.....	13
Military Standard Transformers.....	8, 10
Multiple Filament Transformers.....	5
Output Transformers.....	9, 12
Plate and Filament Transformers.....	2, 3, 8
Power Transformers.....	2, 3, 8
Pulse Transformers.....	13
Saturable Transformers.....	13
Toroidal Inductors.....	11
Transistor Transformers.....	10

NEW EQUIPMENT COMMERCIAL GRADE TRANSFORMERS AND REACTORS

Audio Filters.....	21, 22, 23, 24, 25, 26
Autotransformers.....	19
Bias Transformers.....	15
Chokes.....	16, 21
Voltage Stabilizing Transformers.....	19
Driver Transformers.....	21, 22, 23
Filament Transformers.....	17
Filter Reactors.....	16, 18
High Fidelity Audios.....	24, 25, 26
High Q Chokes.....	26
Input Transformers.....	23, 24, 25, 26
Isolation Transformers.....	19
Link Radio Replacements.....	27
Low Pass Filter.....	20
Miniature Audio Transformers.....	26
Mixing Transformers.....	25
Modulation Transformers.....	21, 23
Modulation Reactors.....	21
Multiple Filaments.....	17
Output Transformers.....	22, 23, 24, 25, 26
Plate Transformers.....	18
Plate and Filament Transformers.....	14, 15
Power Transformers.....	14, 15
Splatter Chokes.....	20
Step-Down Transformers.....	19
Transistor Transformers.....	26, 27

CONTROL AND POWER CIRCUIT TRANSFORMERS

Control Transformers.....	30
Power Circuit Transformers.....	28, 29
Step-Down Transformers.....	28, 29

CHICAGO

The world's toughest transformers

PREFERRED FOR EVERY MODERN CIRCUIT REQUIREMENT

TRANSFORMERS AND FILTER REACTORS

INDEXED by Catalog Number and Page Number

Catalog No.	Page No.	Catalog No.	Page No.	Catalog No.	Page No.	Catalog No.	Page No.	Catalog No.	Page No.	Catalog No.	Page No.	Catalog No.	Page No.
1BC-150	15	BI-7	24	F-215H	17	NCF-1775	30	PHC-10	2	RC-1055	16	TM-1A	11
1BH-150	3	BIH-1	9	F-510H	17	NCF-2425	30	PHC-20	2	RC-1085	16	TM-2A	11
1BS-150	15	BIH-4	9	F-516	17	NCF-2450	30	PHC-40	2	RC-1540	16	TM-5A	11
2BC-150	15			F-520HB	17	NCF-2475	30	PHC-55	2	RC-1555	16	TM-8A	11
2BS-150	15	BIH-6	9	F-530	17	NCF-24100	30	PHC-60	2	RC-1585	16	TM-10A	11
4FH-63	6	BIH-7	9	†F-530BX	17	NCF-24150	30	PHC-70	2	RC-8105	16	TM-20A	11
4FH-65	6	BIH-8	9	F-610	17	NCF-3250	30	PHC-85	2	RC-8150	16	TM-50A	11
4FH-610	6			F-615	17	NCF-3275	30	PHC-105	2	RC-8200	16	TM-80A	11
4FH-620	6	BM-1	21	F-712	17	NCF-32100	30	PHC-120	2	RC-8250	16	TM-100A	11
4FMS-63	7	†BM-2	21	F-725	17	NCF-32150	30	PHC-150	2	RC-8300	16	TM-200A	11
4FMS-65	7	†BM-4	21	F-751	17			PHC-165	2	RC-12105	16	TM-500A	11
4FMS-610	7	BO-1	24	F-1010	17	NSI-1	26	PHC-200	2	RC-12150	16	TM-800A	11
4FMS-620	7	BO-2	24			NSI-2	26	PHC-200A	2	RC-12200	16	TM-1000A	11
4PHC-55	6	BO-5	24	FH-25	5	P-45	18	PHC-250	2			†TR-957	27
4PHC-70	6	BO-6	24	FH-54	5	P-67	18			RH-1055	4	†TR-1002	27
4PHC-120	6	BO-9	24	FH-58	5	†P-107	18	PHD-10	12	RH-1085	4	†TR-1014	27
4PHC-165	6	BO-10	24	FH-63	5	P-1240	18	PHD-25	12	RH-1510	4	†TR-1016	27
4PHC-200A	6	†BO-11	24	FH-65	5	P-1512	18	PHD-100	12	RH-1520	4	†TR-1028	27
4PHR-300	6	BO-12	24	FH-104	5	P-2126	18	PHO-80	12	RH-1540	4	†TR-1034	27
4PMS-40	7	BO-13	24	FH-210	5	P-2520	18	PHR-55	3	RH-1555	4	†TR-1035	27
4PMS-55	7	BO-14	24	FH-210H	5	†P-3025	18	PHR-70	3	RH-1585	4	†TR-1040	27
4PMS-70	7			FH-215H	5	†P-4353	18	PHR-85	3	RH-8105	4	†TR-1042	27
4PMS-85	7	BOH-1	9	FH-510H	5	†PCB-24500	28	PHR-105	3	RH-8150	4	†TR-1043	27
4PMS-105	7	BOH-2	9	FH-520HB	5	†PCB-24750	28	PHR-120	3	RH-8200	4	†TR-1045	27
4PMS-120	7	BOH-4	9	FH-610	5	†PCB-241M	28	PHR-150	3	RH-8250	4	†TR-1050	27
4PMS-150	7	BOH-5	9	FH-615	5	†PCB-242M5	28	PHR-200	3	RH-8300	4	†TR-1054	27
4PMS-165	7	BOH-9	9			†PCB-245M	28	PHR-300	3	RH-12105	4	†TR-1056	27
4PMS-200A	7			FMS-1	5	†PCB-247M5	28	PMS-70	8	RH-12150	4	†TR-1061	27
4PMS-300	7	BR-1	21	FMS-2	5	†PCB-2410M	28	PMS-70A	8	RH-12200	4	†TR-1063	27
4RH-255	6	†BR-2	21	FMS-3	5	†PCB-2415M	28	PMS-150	8	RS-1055	16	†TR-1065	27
4RH-270	6	†BR-4	21	FMS-4	5	PCC-40	14	PMS-175	8	RS-1085	16	†TR-1066	27
4RH-2120	6	CDC-1	23	FMS-5	5	PCC-55	14	PMS-250	8	RS-1540	16	†TR-1071	27
4RH-2165	6	CDS-1	23	FMS-6	5	PCC-60	14	PMS-350	8	RS-1555	16	†TR-1072	27
4RH-2200	6	CIC-1	23	FMS-7	5	PCC-70	14	PMS-550	8	RS-1585	16	†TR-1073	27
4RH-2300	6	CIC-2	23	FMS-8	5	PCC-85	14	PMS-800	8	RS-8105	16	†TR-1074	27
4RMS-240	7	CIH-1	12	FMS-23	8	PCC-105	14			RS-8150	16	†TR-1075	27
4RMS-255	7	CIH-2	12	FMS-53	8	PCC-120	14	PSC-40	14	RS-8200	16	†TR-1077	27
4RMS-270	7	CIS-1	23	FMS-62	8	PCC-150	14	PSC-55	14	RS-8250	16	†TR-1078	27
4RMS-285	7	CIS-2	23	FMS-65	8	PCC-200	14	PSC-60	14	RS-8300	16	†TR-1080	27
4RMS-2105	7	CMS-1	23	FMS-210	8	PCC-250	14	PSC-70	14	RS-12105	16	†TR-1081	27
4RMS-2120	7	CMS-3	23	FMS-210H	8	PCC-24100	28	PSC-85	14	RS-12150	16	†TR-1082	27
4RMS-2150	7	COC-1	23	FMS-510	8	PCC-24150	28	PSC-105	14	RS-12200	16	†TR-1083	27
4RMS-2165	7	COC-2	23	FMS-510H	8	PCC-24250	28	PSC-120	14	SD-50	19	†TR-1088	27
4RMS-2200	7			FMS-610	8	PCC-4100SP	28	PSC-150	14	SD-100	19	†TR-1089	27
4RMS-2300	7	COH-1	12	FMS-620	8			PSC-165	15	SD-150	19	†TR-1104	27
10111	13	COH-2	12			HF-20	25	†PCD-10	22	SD-250	19	†TR-7074	27
AMS-1	10	COS-1	23			HF-20X	25	PCD-25	22	SD-500	19	TT-11	26
AMS-2	10	COS-2	23			HF-22	25	PCF-2025	29	SD-1000	19	TT-12	26
AMS-3	10	DCT-1	27			HF-22X	25	PCF-2050	29	SR-300	20	TT-13	26
AMS-4	10	DCT-2	27			HF-29	25	PCF-24075	29	SR-500	20	TT-14	26
AMS-5	10	F-1	17			HF-31	25	PCF-24100	29			UM-110	26
AMS-6	10	F-2	17			HF-32	25	PCF-24150	29	PSO-80	22	UM-111	26
AMS-7	10	F-3	17			HF-40	25	PCF-24250	29	PSO-150	22	UM-112	26
AMS-8	10	F-4	17			HF-65	25			PSO-200	22	UM-113	26
AMS-9	10	F-5	17			HF-67	25	PCO-80	22	PSR-55	15	UM-114	26
BD-1	21	F-6	17			HF-68	25	PCO-150	22	PSR-70	15	• VS-250	27
†BD-2	21	F-7	17			HP3-140	6	PCO-150A	22	PSR-85	15	• VS-500	27
BI-1	24	F-8	17					PCO-200	22	PSR-105	15	WF-20	25
BI-2	24	F-25	17			IS-50	19			PSR-120	15	WF-21	25
BI-3	24	F-54	17			IS-100	19	PCR-55	15	PSR-150	15	WF-22	25
BI-4	24	F-58	17			IS-150	19	PCR-70	15	PSR-200	15	†WF-24	25
†BI-5	24	F-63	17			IS-250	19	PCR-85	15	PSR-300	15	WF-26	25
BI-6	24	F-65	17					PCR-105	15	R-63	18	WF-28	25
		F-104	17			LPF-1	20	PCR-120	15	R-65	18	WF-30	25
		F-106	17			LPF-2	11	PCR-150	15	R-67	18	WF-34	25
		F-210	17			NCF-1550	30	PCR-200	15	R-103	18	WF-35	25
		F-210H	17			NCF-1650	30	PCR-300	15	R-105	18	WF-36	25

•New Part Number †Part Number to be deleted from next catalog

CHICAGO STANDARD TRANSFORMER CORPORATION

3501 WEST ADDISON • CHICAGO 18, ILLINOIS • INDEPENDENCE 3-7400

Catalog No. CT-B-58—Printed in U.S.A.

Copyright 1958, Chicago Standard Transformer Corporation

Export Sales Division: Roburn Agencies, Inc.

431-5 Greenwich St., New York City, N.Y.

Cable Address: ROBURNAGE

K4XL's **BAMA**

This manual is provided **FREE OF CHARGE** from the "BoatAnchor Manual Archive" as a service to the Boatanchor community.

It was uploaded by someone who wanted to help you repair and maintain your equipment.

If you paid anyone other than BAMA for this manual, you paid someone who is making a profit from the free labor of others without asking their permission.

You may pass on copies of this manual to anyone who needs it. But do it without charge.

Thousands of files are available without charge from BAMA. Visit us at <http://bama.sbc.edu>