

# COMMUNICATIONS

a merger of  
RADIO ENGINEERING  
...  
COMMUNICATION &  
BROADCAST ENGINEERING  
...  
THE BROADCAST ENGINEER

NOVEMBER  
1937

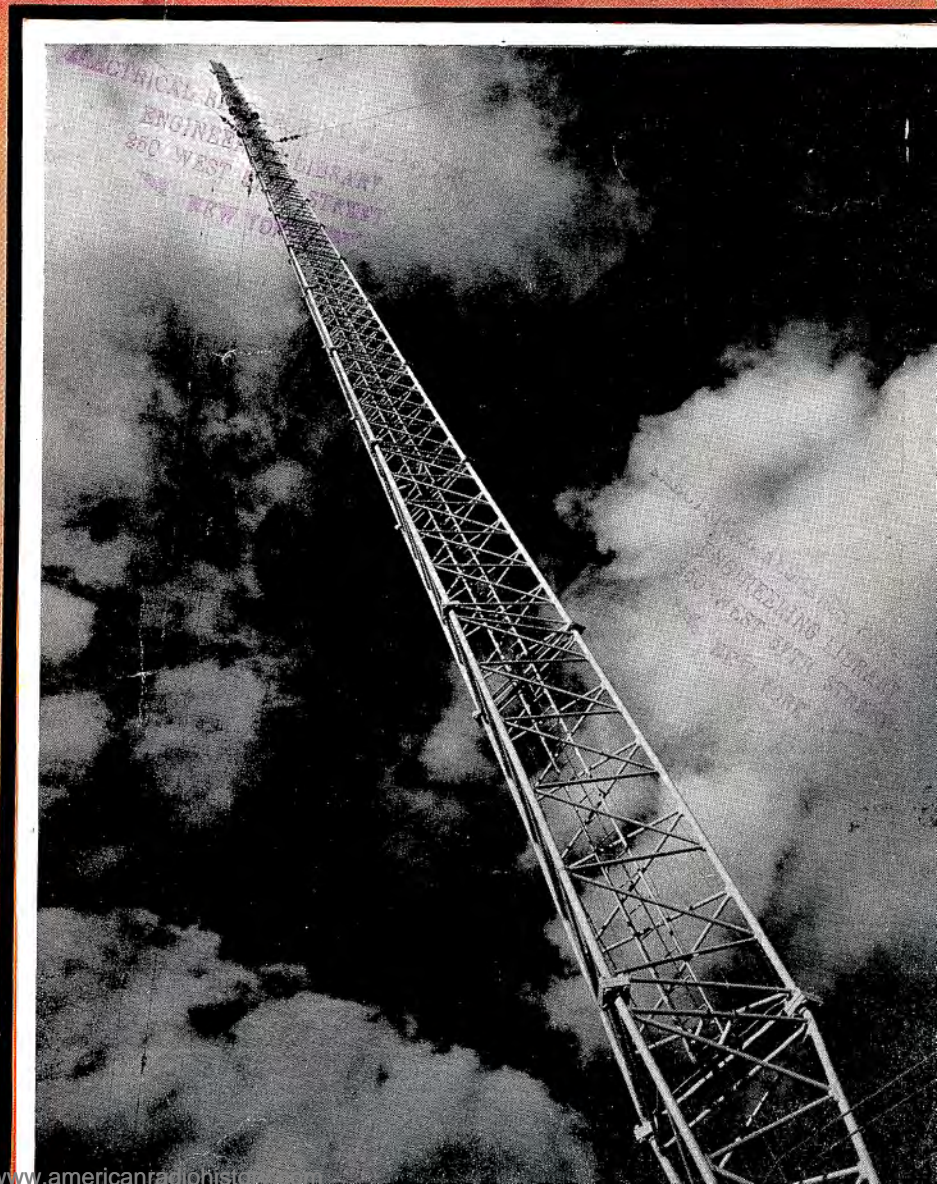

*the New*

**AMPEREX**

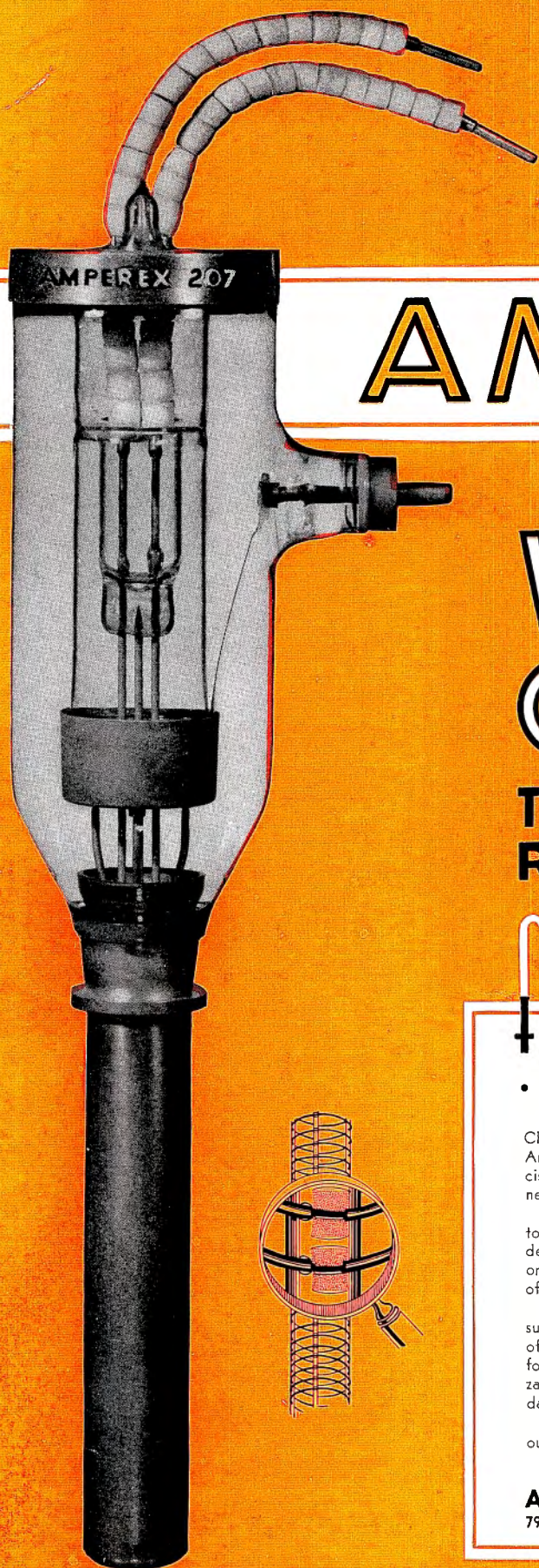

**WATER  
COOLED  
TRANSMITTING and  
RECTIFYING TUBES**

**fine craftsmanship . . .  
. . . expert workmanship**

Characterize every element which enters into the construction of Amperex Water Cooled tubes. The painstaking thoroughness, precision and skill with which these elements are designed and engineered is best illustrated by the grid.

Welding, the customary method of attaching the fine grid wire to the supporting rods, is entirely eliminated. The intense heat developed in this process results in the formation of oxide films on the wires (a source of grid emission) and in the crystallization of grid wire and rod at the point of junction.

For the Amperex grids, a machine was developed which slots the supporting moly rods at accurate intervals determined by the pitch of the grid. The grid wire is securely swaged into these notches, forming a strong rugged grid free from brittleness due to crystallization and free from surface contamination because of any oxidation.

This minute attention to detail is a contributing factor to the outstanding performance of Amperex tubes.

**AMPEREX ELECTRONIC PRODUCTS, INC.**  
79 WASHINGTON STREET                      BROOKLYN, NEW YORK

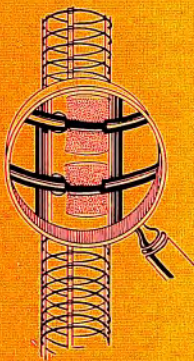

**announcing**

# SVEACOTE

as the solution to your problem of

## **Cost vs. Quality**

### **WRITE AT ONCE FOR DATA SHEETS**

giving interesting, complete and valuable information about this new, rust resisting, fused nickel coated metal.

### **WHAT IT IS —**

SVEA METAL (the purest iron made commercially) fuse-coated with pure nickel by special, effective, approved method to meet all requirements.

### **WHAT IT HAS —**

All the advantages of any material whether nickel, SVEA METAL or cold rolled steel with none of the disadvantages, risks, headaches and losses.

### **WHAT IT DOES —**

Enables you to maintain quality, reduce shrinkage, cut costs and sleep nights.

**NEVER BEFORE HAS THERE BEEN SUCH AN  
OPPORTUNITY FOR TUBE MAKERS TO COMPETE**

for

**HIGHEST HONORS**

**Swedish Iron & Steel Corporation**

17 BATTERY PLACE

NEW YORK, N. Y.

# COMMUNICATIONS

Member of Audit Bureau of Circulations

RAY D. RETTENMEYER • Editors • W. W. WALTZ

## CONTENTS FOR NOVEMBER

Cover Illustration: KDKA's new antenna at Saxonburg, Pennsylvania. This steel structure is 718 feet high and weighs sixty tons. Photo courtesy Westinghouse Electric & Manufacturing Co.

	Page
With the Editors .....	4
Coaxial Cable Television Transmission .....	9
Report of the Rochester Fall Meeting .....	12
Radio Tower Lighting and Marking .....	13
By Arthur R. Nilson	
Motorola Radio Plant Lighting Installation .....	16
By M. R. Matteson	
A Talk-back and Loudspeaker Control System .....	18
By P. S. Gates	
RMA Television Transmission Frequencies and Standards .....	20
By Albert F. Murray	
Disc Recording—Record Processing .....	24
By T. L. Dowey	
The Market Place .....	34
Veteran Wireless Operators Association News .....	42
Over the Tape .....	46
Index of Advertisers .....	48

VOLUME 17

NUMBER 11

BRYAN S. DAVIS  
President

JAMES A. WALKER  
Secretary

Published Monthly by the  
BRYAN DAVIS PUBLISHING CO., INC.

19 East 47th Street  
New York City  
New York Telephone: PLaza 3-0483

SANFORD R. COWAN  
Manager

PAUL S. WEIL  
Advertising Manager

A. B. CARLSEN  
Circulation Manager

Chicago Office—608 S. Dearborn St.  
Telephone: Wabash 1903.



Wellington, New Zealand—Te Aro Book Depot.  
Melbourne, Australia—McGill's Agency.

*Entered as second class matter October 1, 1937, at the Post Office at New York, N. Y., under the act of March 3, 1879. Yearly subscription rate: \$2.00 in the United States and Canada, \$3.00 in foreign countries. Single copies: twenty-five cents in United States and Canada, thirty-five cents in foreign countries.*



## CERAMICS

Enlarged facilities enable improved deliveries, in all types and sizes. Semi-regulating dries are available. The current drain is extremely low, especially important for battery operation. These condensers are very rugged and will stand up under very severe service conditions.

## MAGICORES

This coming year appears to be a "core" year. Current redesigns of receivers are incorporating many new and extremely important magicore applications. Auto sets are almost universally using I-F and antenna cores. Many new materials and shapes have been produced. We would appreciate the opportunity to familiarize you with the engineering possibilities.



## CONDENSERS

Molded. Extruded. Machined.  
Increased production facilities.  
Low loss material.

### CERAMIC CEMENT

Low loss ceramic cement with new possibilities. Why not investigate them?

### LIQUID CROLITE SUPER QUARTZ

An impregnating and covering liquid with losses lower than fused quartz.

**HENRY L. CROWLEY**  
& CO., Inc.  
1 CENTRAL AVE.,  
WEST ORANGE,  
N.J.

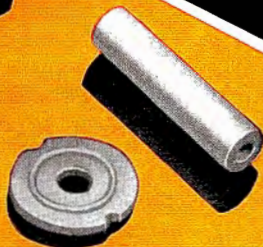

# WITH THE EDITORS

---

## FREQUENCY ALLOCATIONS

THE FEDERAL COMMUNICATIONS COMMISSION have announced their actions with reference to the entire useful radio spectrum which comprises frequencies from 10 to 300,000 kilocycles.

Heretofore the rules of the Commission with respect to the use of radio for practical purposes have been confined to that portion of the radio spectrum from 10 to 25,000 kilocycles. However, as a result of experimentation during the past few years, the hearing of June 1936, and collaboration with the various Government departments, the Commission have decided to allocate frequencies from 25,000 to 300,000 kc. The allocation of the ultra-high frequencies vitally affects television, facsimile, relay, high-frequency and experimental broadcast services. Briefly, the allocations are as follows:

Seven channels between 44,000 and 108,000 kc are now available for assignment to television stations. Television broadcasting has also been assigned twelve channels between 156,000 and 300,000 kc. (Each television channel is 6 megacycles wide.) Television stations will be assigned these channels on an experimental basis with the same requirements as are now imposed. In connection with television allocations, Mr. Murray's article in this issue should be of interest.

In the band 41,020 to 43,980 kc, seventy-five channels are available for assignment to aural broadcast stations. The Commission at an early date will consider the needs and requirements for high-frequency broadcast stations using both conventional and frequency modulation.

Sixteen channels for relay broadcast stations are provided in the 30,830-39,820 kc band. These channels will enable a continuance of the existing stations as well as provide additional facilities for the growth of relay broadcast service.

The allocation of frequencies between 30,000 and 40,000 kc provides twenty-nine frequencies for police service. Of these frequencies twenty-five will be available to mu-

nicipal and county governments and four to state police agencies. The frequencies will be assigned on a shared use basis in accordance with a plan to be announced. It is believed that one group of frequencies will be assigned to fixed stations of relatively large power outputs, and another group to those fixed stations employing lesser powers. A third group will be available exclusively for mobile units.

Concerning aviation, four frequencies have been allocated between 30,000 and 40,000 kilocycles. These are intended primarily for use in instructing student pilots during initial solo flights. The frequency band 129,000-132,000 kc has been set aside for airport traffic control. This band is adjacent to a band allocated to the Government for similar use. Provision has been made for six airport frequency assignments separated by approximately 500 kc. This allocation will permit the use of a separate and distinct frequency for each airport in localities where several airports are in close proximity to each other. It is also interesting to note that in the frequency band 132,000-144,000 kc eleven frequencies have been assigned to aviation service and are designed primarily for radiotelephone service for aircraft in flight.

Various frequency assignments have also been made for fixed, experimental, forestry, mobile press, geophysical, motion picture, coastal and ship harbor, special emergency, marine fire, and other special services.

## ROCHESTER FALL MEETING

ONE OF the biggest and best conventions in the history of the Rochester Fall Meetings has just been concluded. It was the ninth meeting of this group, and was held at the Hotel Sagamore in Rochester, N. Y.

At this convention the results of the recent IRE election were announced. The new officers are as follows: President, Haraden Pratt; Vice-president, E. T. Fisk; directors for 3-year terms, C. M. Jansky, Jr., O. B. Hanson, and F. W. Cunningham.

# Leadership

... AN OBLIGATION

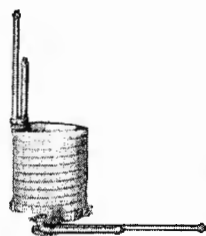

To attain foremost place in its industry, an institution serves its period of apprenticeship. Step by step it builds public confidence by supplying advantages in design, in dependable product, thus meeting in creditable manner the requirements of the field it serves. With accepted leadership comes a new obligation . . . the necessity of forecasting future needs, and of being prepared to satisfy them as rapidly as constant progress in usage may demand.

Such is Lapp's position in radio insulation today. With the growth of radio transmission, amazingly rapid as that has been, Lapp has kept pace to the consistent satisfaction of radio engineers. Lapp still sets the pace . . . an obligation imposed by Lapp's unquestioned leadership. In constant touch with technical progress, Lapp foresees the problems of tomorrow, provides solutions as comprehensively adequate as those already provided for the problems of today.

**BULLETIN 137 TELLS THE STORY OF LAPP WATER COILS  
AND TOWER FOOTING INSULATORS. WRITE FOR YOUR COPY.**

**LAPP**  
LAPP INSULATOR CO., INC. **INSULATORS** LE ROY - N.Y. - U.S.A.

COMMUNICATIONS FOR NOVEMBER 1937 • 5

# Keystone of Your Speech Input Equipment

## ...THE STUDIO AMPLIFIER

*RCA 40-D is a high fidelity, AC operated, de luxe amplifier providing many features...yet available at moderate cost!*

**B**ROADCASTING quality depends upon the studio amplifier. Since all programs usually pass through this unit, it is of fundamental importance to have an amplifier which will assure high fidelity performance at all times.

The RCA 40-D does even more than this. It is a combined high fidelity, AC operated amplifier having uniform frequency response, low distortion and low hum level plus a volume indicator capable of reading either average or peaks. When set for the latter position, its characteristics are similar to those of the modulation monitors required in every station. Thus the operator in the studio control room can adjust gain settings to obtain more nearly the

actual desired modulation percentage than was ever before possible. This "slow return" setting is made possible by the use of a tube type V. I. which also introduces less distortion than the conventional copper oxide type rectifier.

The 40-D offers the maximum in convenience, too. Having a hinged chassis, it is possible to reach every part for inspection without removing the amplifier from the rack. Tubes are accessible from the front. The Volume Indicator uses the latest illuminated type meter. With all of this, the 40-D is not expensive. The nearest district office will be glad to furnish you with full details. Ask for data on the RCA 41-C triple pre-amplifier, too. It's a matching unit.

*Replace weak transmitting and receiving tubes with the tubes preferred by network stations—RCA.*

### SPECIFICATIONS OF THE 40-D AMPLIFIER

Input and output imps. 250/500 ohms  
 Overall gain . . . . . 75 db  
 Normal output level . . . . . 0 db\*  
 Max. usable output . . . +18 db\*  
 V. I. range . . . . -20 db to +18 db  
 Output noise level at normal output (55 db gain) . . . . . -70 db  
 Output noise level at normal output (full gain) . . . . . -60 db

RMS Distortion (400 cycles) at normal output . . . . . 0.3%  
 Frequency response  
 30 - 17,000 cycles  $\pm$  1 db  
 Tubes used . . . two RCA-1603's, two RCA-89's, one RCA-25Z5, one RCA-6A6, one RCA-76, one RCA-84  
 Power input . . . . . 85 watts  
 Panel height . . . . . 13-31/32 in.

\*12-1/2 MW. Zero level



**Broadcast Equipment**

RCA MANUFACTURING COMPANY, INC., CAMDEN, N. J.  
 A SERVICE OF THE RADIO CORPORATION OF AMERICA

New York: 1270 Sixth Ave. • Chicago: 589 E. Illinois St. • Atlanta: 490 Peachtree St., N. E.  
 Dallas: 2211 Commerce St. • San Francisco: 170 Ninth St. • Hollywood: 1016 N. Sycamore Ave.

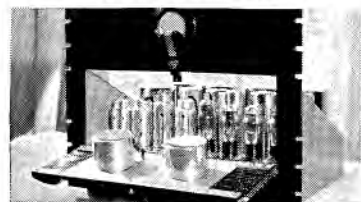
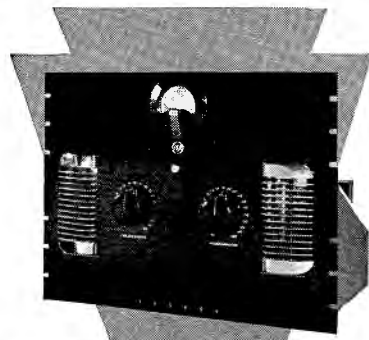

*Tubes accessible from front*

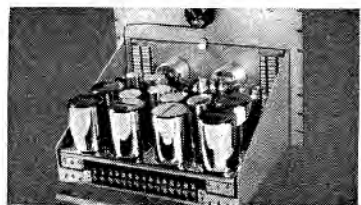

*Heavy, chromium plated shields for components*

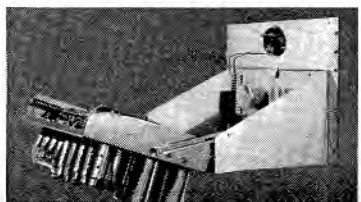

*Every part accessible with hinged chassis*

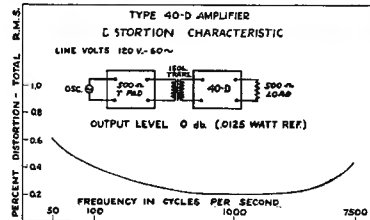

*Low distortion over entire band*

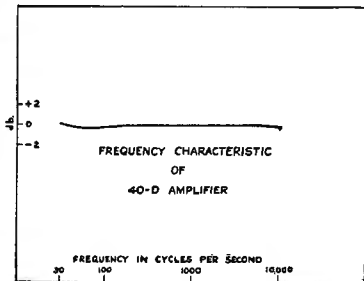

*Uniform frequency response*



Consistent Leadership by

# AMPERITE

achieves another new development . . .  
**THE ACOUSTIC COMPENSATOR** (Pat. Pend.)

An exclusive Amperite feature, available in new Models RBHk (High Impedance) and RBMk (200 ohms)



PUSH UP TO INCREASE HIGHS  
 PUSH DOWN TO INCREASE LOWS



## 3 IMPORTANT USES

1. The Acoustic Compensator enables you to lower or raise the response of the microphone by the mere flip of the finger. Not a volume control—operation is similar in principle to the sliding panels in broadcast studios.
2. Makes the Velocity immediately adjustable to close talking or distant pickup.
3. Immediately adjustable to any room condition . . . or any type of job or occasion.

Increasing the quality, without increasing the price, is the keynote of the Amperite sales policy. In the new Amperite Velocity, with the Acoustic Compensator, the P.A. Industry has the last word in microphone perfection at a competitive price.

**MODELS RBHk, RBMk, with acoustic compensator.** Frequency range 40 to 11,000 CPS. Output, —65 db. Complete with switch, cable connector and 25' of cable. **\$42.00 LIST**

**MODELS RBHn, RBMn, without acoustic compensator** **\$42.00 LIST**

### NEW! AMPERITE CONTACT MICROPHONE

A contact mike without distortion. Ideal for use on all string instruments. Flutters an ordinary fiddle by giving it the volume and depth of a "Strad"; makes a small piano sound like a "Grand". Unusual high output—can be used on radio sets. No string changes, no drilling. Attached without tools. Operates with either high or low gain amplifiers. Frequency response, 40 to 9000 cps. Output, —40 db. 25' of cable.

MODEL KTH (Hi-imp); KTL (200 ohms) . . . . . \$22.00 LIST  
 KTH or KTL with foot-operated volume control . . . \$30.00 LIST

### NEW! AMPERITE "HAND-I-MIKE"

The smallest velocity made . . . but has an output equal to larger types, —68 db. Frequency range 60 to 7500 cps. Excellent for close talking, and can be used as hand, desk, or stand microphone. Unusually rugged. Size of head, 1" x 3/8" x 2 3/8".

MODELS HDH (Hi-imp); HDL (200 oms); with switch, **\$22.00 LIST**

### AN EXCELLENT VELOCITY AT \$22.00 LIST

P.A. Men, you do not have to sacrifice quality on a "low-cost" job. This fine velocity, built to Amperite standards, is excellent for both speech and music. Gives flat response without peaks over entire audible range. Reduces feedback. Frequency range 60 to 7500 cps. Output, —68 db. Unusually rugged, not affected by temperature, pressure or humidity. Triple shielded, fitted with shock absorber and swivel bracket.

MODEL RAH (Hi-imp.) with 12' of cable; MODEL RAL (200 ohms) with 8' of cable. . . . . **ONLY \$22.00 LIST**

### BROADCASTING STUDIOS, please note :

**New Output, —56 db.**

The new Amperite Studio Velocity, model SR80n, has —56 db. output, highest in studio velocities available today. The SR80n is now accepted as the finest microphone for studio and recording: (Two weeks' free trial to established studios). Frequency range 40 to 15000 CPS. Triple shielded, fitted with switch (optional), cable connector, and 25' of cable. MODEL SR80Hn (Hi-imp.); SR80n (200 ohms) . . . . . **\$80.00 LIST**

### SALES AIDS FOR THE P.A. MAN

Amperite offers the following co-operation to P.A. Men

1. FREE: Window Decal advertising your Sound Service. Size 5 1/4 x 9 3/4, finished in 4 striking colors.
  2. FREE: Window Display, 11x17.
  3. Special Sound Equipment Letterheads. Samples and prices on request.
- Write for these valuable sales helps, and new Illustrated Bulletins, today!

**AMPERITE** 6561 BROADWAY, N. Y. U. S. A. CABLE ADDRESS ALKEM, NEW YORK



VELOCITY

# AMPERITE

MICROPHONES

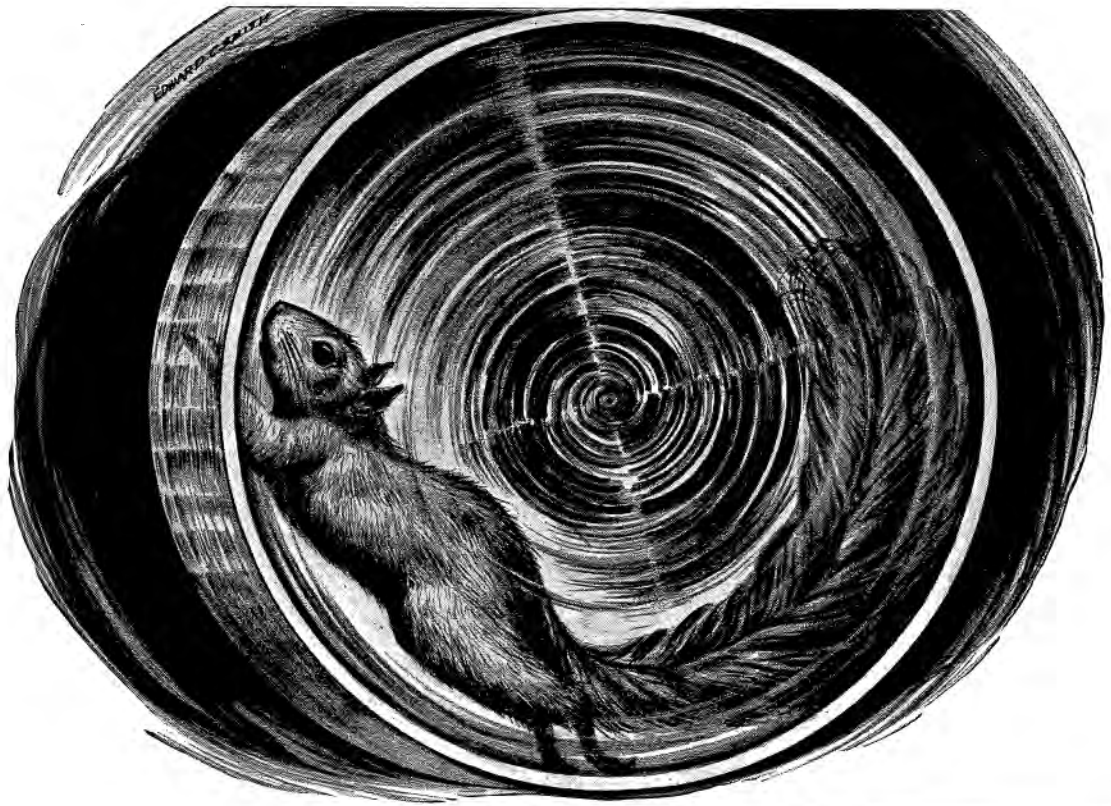

## Plenty of Action but No Progress

If you want to picture plenty of action but no progress, page Mr. Squirrel. With his famous cage he offers a parallel that has become threadbare—threadbare because it is so apt. Apt because every attempt to develop a product or improve an operation has its squirrel-in-a-cage moments.

At such moments Mallory first met most of its valued customers. The Mallory business has been built by helping manufacturers reduce the duration of those "round and 'round" periods.

Mallory accomplishments have touched many fields including the automotive, radio and electrical industries. Mallory developed the electrode material for the new welding technique that made

streamline trains possible. Automobile radio became a practical achievement through Mallory-made vibrators. Mallory produced...

We interrupt this autobiography here because your interest, as well as ours, is not so much in what Mallory has done, but in what Mallory can do for you today—and tomorrow.

To give you a quick, concise picture of our facilities we have listed nine groups of problems in the panel. These are the fields in which we have the technical knowledge and experience to help. We hope you will turn to us when such problems confront you.

You can be assured of an active and sincere interest.

*The business man's encyclopedia of where to go for help....*

**Metal Fabricating Problems** where resistance welding may be used—See Mallory for resistance welding electrodes and advice.

**Contact Problems** involving the making and breaking of an electrical circuit—See Mallory for contacts and engineering assistance (Mallory has served the electrical industry for more than twenty years).

**Non-Ferrous Alloy Problems** where extreme hardness, high conductivity and great tensile strength are necessary—See Mallory for alloys incorporating these characteristics.

**Special Bi-Metal Problems**—See Mallory about bi-metals for thermostats and other requirements.

**Rectification of A/C to D/C Current Problems**—See Mallory for Dry Disc Rectifiers and engineering assistance.

**Condenser Problems** where A/C or D/C Dry Electrolytic Condensers may possibly be used—See Mallory.

**Small and Special Electrical Switches**—See Mallory for Selector, Circuit, Tap and All-Wave types.

**Precision Heavy-Duty and Flexible Resistors—Power Rheostats**—See Mallory.

**Electrical Vibrators**—See Mallory. Whatever the problem—in radio or industry—Mallory probably has the answer and the engineers to solve it.

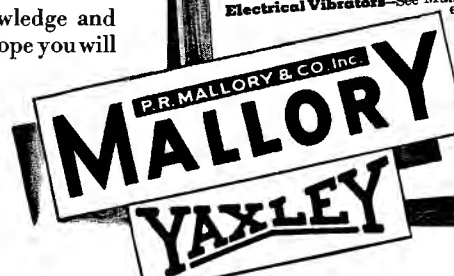

**P. R. MALLORY & CO., Inc., INDIANAPOLIS, INDIANA**

Cable Address—PELMALLO

# COMMUNICATIONS

FOR NOVEMBER, 1937

## COAXIAL CABLE TELEVISION TRANSMISSION

ON NOVEMBER 10 there was an experimental demonstration of motion pictures transmitted over the coaxial cable between New York City and Philadelphia. In the Bell Telephone Laboratories in New York a sound-picture film was run through a transmitter and its two records—sound and scene—were converted into electric currents and transmitted to Philadelphia. There the picture was reproduced large enough for a group of ten people to see easily, while the accompanying sound came from a loudspeaker. The sound picture described, by voice and animated diagrams, the coaxial cable system and explained briefly the operation of the picture transmitter and receiver. Some films typical of the news-reel theatre were also transmitted.

The cable which extends between New York and Philadelphia contains two coaxial conductor units. Each unit is formed by a flexible copper tube and a single wire enclosed by the tube and held at its center by thin disks of hard rubber. Along the route are unattended installations of special amplifying equipment which receive their power over the inner wires of the two coaxials. The cable with its amplifiers and with its terminal equipment is an experimental

installation for the development of broad-band transmission.

Each coaxial conductor unit with its associated one-way amplifiers is capable

of transmitting simultaneously the currents of two hundred and forty different telephone transmitters. Using separate units for transmission in opposite directions, the system provides for two hundred and forty simultaneous conversations. The million-cycle range of each unit is utilized by carrier-current methods. In the present arrangement the transmitters are formed into twenty groups of twelve each. Each transmitter is limited to a frequency band of four kilocycles; and the bands from the twelve transmitters of each group are raised to successive positions between sixty and one hundred and eight kilocycles. Twenty complicated currents are thus obtained. These currents by another modulation are spaced in the range from sixty to one thousand and twenty kilocycles. This system of multi-channel telephony was recently tested over a looped back circuit equivalent to thirty-eight hundred miles; and transmission was satisfactory.

Another question remained: Can the system transmit satisfactorily a single message the frequency components of which occupy its entire range, that is, a current of the kind required in television programs? To study that possibility there were constructed in Bell Tele-

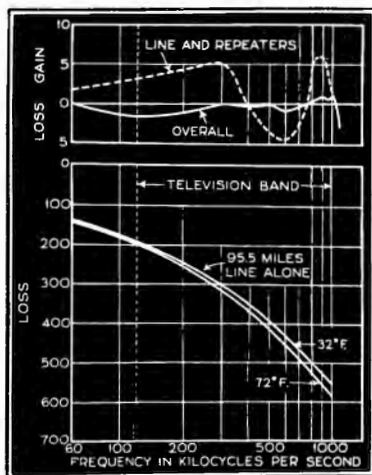

Attenuation of the New York to Philadelphia television circuit.

Left: Receiving cathode-ray tube (center) with power supply (left) and sweep circuit (right).

Right: A close-up view showing wiring at receiving tube.

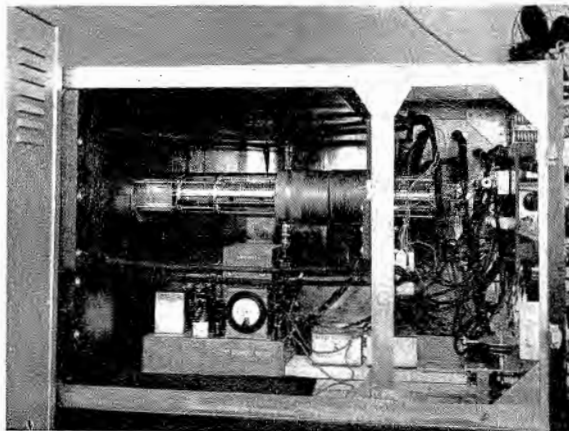
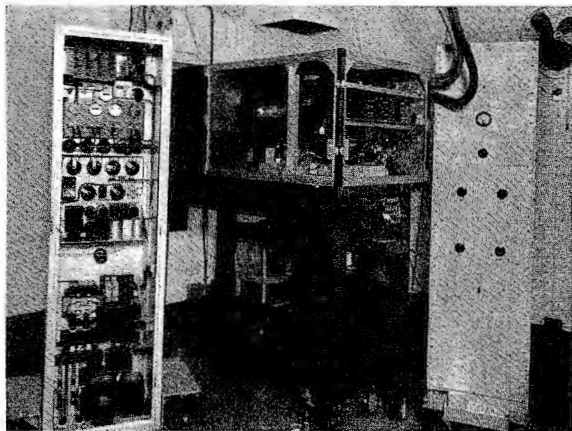

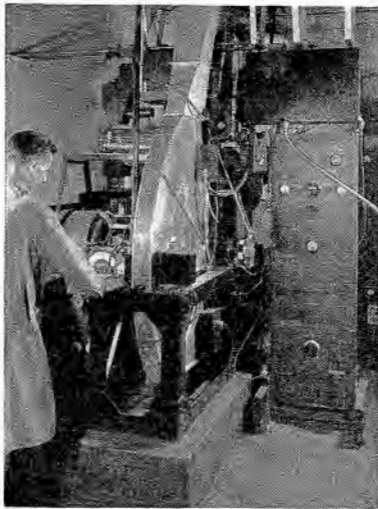

The scanning disc of the experimental motion-picture transmitter in Bell Telephone Laboratories.

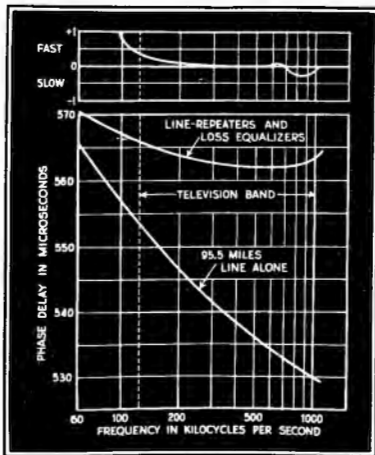

Phase delay of New York—Philadelphia circuit.

The Philadelphia terminal of the coaxial cable showing carrier-current equipment.

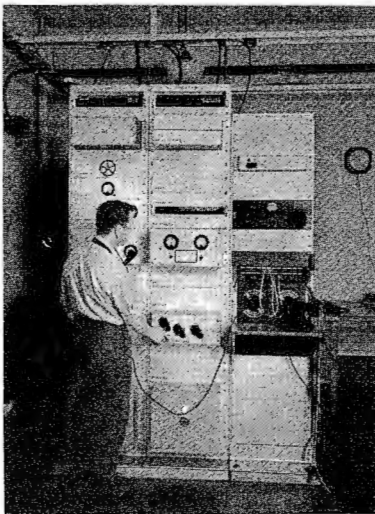

phone Laboratories a transmitter to originate a signal of that range of frequencies and a suitable receiver, both of which utilize some of the present techniques of television.

For a signal which can be repeated over and over a motion picture is used; it moves uniformly past a picture gate where lenses in a large rotating disc sweep across it a light beam three-thousandths of an inch square. The light passing through the film enters an electron multiplier. The resulting current contains frequencies between 0 and 806 kilocycles. Since the coaxial cable is not designed to transmit frequencies below 60 kc, however, the original frequency band from 0 to 806 kc had to be raised by modulations to a higher position in the frequency spectrum.

This is accomplished through a double modulation. The first modulation employs a carrier of 2376 kc and results in a lower sideband from 1570 to 2376 kc and an upper sideband from 2376 to 3182. A filter then removes all of the upper sideband except a small section of its lower frequencies which is passed by the sloping corner of the filter characteristic. A second modulation with a carrier of 2520 results in an upper sideband from 4090 to 4896 kc and a lower sideband from 950 kc to 144 with the addition of a group of somewhat lower frequencies corresponding to the vestigial upper sideband passed by the first filter. A second filter easily removes the upper sideband, and is accurately designed to cut off the vestigial frequencies below 144 kc, so that the frequencies transmitted run from 144 to 950 kc.

In transmission over the cable the lowest frequencies fall behind the highest, taking about twenty millionths of a second longer in travel. In that time the cathode beam can move forty times its width. The effect is the same as if the finer the picture details the more out of synchronism were scanning disc and cathode beam. For the transmission, however, delay equalizers were developed to keep together all the components of the current to a precision corresponding to the motion of the beam for half its width. In the study of such problems of broad-band transmission this picture-transmitting apparatus is a valuable research tool, although the detail which it permits is only that corresponding to the million-cycle range of the amplifying and terminal equipment with which the cable is at present equipped. The frequency limits of transmission are not inherent in the cable itself, but in whatever terminal or intermediate amplifying equipment may be associated with it. Amplifiers designed for a still wider band are under development, which will permit more telephone

channels and more detail in a transmitted scene.

According to a statement issued by Dr. Frank B. Jewett, president, Bell Telephone Laboratories, the demonstration was *not* the first transmission of television image currents for long distances over wires. The first such demonstration was made by the Bell System in 1927 when television image currents were transmitted from Washington to Bell Telephone Laboratories in New York and there reproduced. In that demonstration transmission was over specially conditioned telephone circuits of ordinary construction. The characteristics of such circuits were sufficiently good for the poor grade of television picture then attainable by the equipment for scanning and reproducing (50 lines, corresponding to a frequency bandwidth of approximately 22,500 cycles).

The demonstration was *not* one designed to show an improved television per se. In fact, the images (240 lines) were inferior in grain to those produced by the most modern television equipment (441 lines or better). This was not due to any limitation imposed by the scanning or reproducing apparatus but to the limitations imposed by the experimental terminal and repeater equipment now on the New York-Philadelphia cable. This equipment limits the top frequency of the transmitted current to approximately 1,000,000 cycles so that a 240-line picture is about the finest grain image that can be transmitted.

What the demonstration did show for the first time is the unique and economical utilization for television currents of the frequency band of a long coaxial cable. Instead of transmitting the television currents by the double-sideband method common to radio broadcasting, a method for single-sideband transmission was developed, thus utilizing to the fullest the frequency range for which the cable system was equipped. The double-sideband method has been used in Europe for transmission of 180-line images over coaxial cable. In that transmission each sideband occupied only about one-third of the transmission range of the cable system, amounting to the television use of the available frequency range at only 33 percent efficiency. In the method which has just been demonstrated at Philadelphia a single-sideband is obtained by double modulation and precise filtering; and this sideband is placed to avoid the first 100 kilocycles of the frequency range of the cable system where transmission is unsatisfactory and the various components cannot easily be amplified. There was also introduced compensation for the different velocities of transmission of different frequency

components. The result is the delivery of an essentially perfect replica of the almost infinitely complex current produced at the sending end by the scanning equipment.

These are results never before obtained. As soon as the present experiments are completed the experimental 1,000,000-cycle repeaters on a portion of the cable are to be replaced by experimental 2,000,000-cycle repeaters, as the next orderly step in the development of equipment which will give a coaxial cable system capable of accommodating the maximum number of telephone channels which it is economical to handle on such a cable or the widest band of frequencies which the best television scanning and reproducing apparatus may require.

### CHOOSING CONNECTING LINK BETWEEN CRYSTAL GENERATOR AND AMPLIFIER

BEFORE the announcement of the first commercial crystal microphone in 1931, the radio or electronic engineer had little reason to concern himself with the transmission of electrical energy from relatively high-impedance sources, aside from two possible exceptions, the condenser microphone and the photo cell.

In any case their problems were not entirely similar, and as a great deal has been accomplished since then, it is the purpose of this article to present the existing information in its simplest form.

There has been and continues to be a certain degree of mysticism connected with the name crystal, while actually a piezo crystal is about the simplest form of device for converting electrical to mechanical energy or the reverse. For all practical purposes a crystal when used in a microphone, phonograph pickup, vibration pickup or a similar device, can be considered as a capacitance generator having negligible internal resistance, but high internal capacitive impedance. Since the device is a capacitance and has effectively no series resistance, a capacitance connected in parallel with it will only reduce the voltage output and no frequency distortion will occur since this reduction will be the same for all frequencies.

The expression for computing the voltage loss in db caused by a capacitance load across a crystal-generator device is as follows:  $db \text{ loss} = 20 \log (1 + C_1/C_2)$  when  $C_1$  represents the capacitance in microfarads of the load and  $C_2$  the capacitance in microfarads of the crystal device. Since the impedance of a shielded cable is effectively capacitive reactance, a cable can be considered as a capacitive load on the crys-

tal device. Thus it is a simple matter to compute the loss that can be expected from a length of cable of known capacitance.

Another point that might be considered here is the proper input resistance to use in the amplifier. The input impedance of an amplifier is essentially resistive when connections are made directly to the grid, which is the usual case if crystal generators are being used, and since the internal impedance of crystal generators is capacitive the problem can be considered as similar to that of choosing a grid resistor for a condenser-resistance coupled amplifier. Neglecting tube capacitances, in the latter case, the low-frequency cut-off of the stage is determined by the relationship between the coupling condenser and the grid resistor. The higher the value of the grid resistor, the lower the frequency which the amplifier stage will pass for a given coupling condenser. The same is true of a crystal device, the crystal capacitance represents the coupling condenser. The tube measures the voltage drop in the grid resistor and this is vectorially at right angles to the reactance drop in the crystal generator. The total impedance of the crystal-generator circuit is therefore the vectorial sum of the reactance of the crystal and the grid resistance, i. e., the square root of the sum of the squares of these values. The useful voltage is therefore proportional to the resistance R divided by the impedance, and the loss in decibels for a resistance R is given by

$$db \text{ loss} = 20 \log \frac{\sqrt{R^2 + X^2}}{R}$$

When R = the grid resistance in ohms

$$X = \text{crystal reactance} = \frac{159,000}{fC}$$

C = capacitance of crystal in microfarads

f = frequency in cycles per second.

For example, let us assume we have a grid resistor with a resistance of 500,000 ohms and a crystal device with a capacitance of 0.005 microfarad and we wish to determine the voltage loss at 60

$$\text{Then } X_c = \frac{159,000}{60 \times 0.005} = 530,000 \text{ ohms approx.}$$

$$\text{and } 20 \log \frac{\sqrt{500,000^2 + 530,000^2}}{500,000}$$

$$= 20 \log 1.4572$$

$$= 3.26 \text{ db loss at } 60 \text{ cps.}$$

It should be pointed out here that for a combined parallel capacitive and resistive load, the capacitance to be considered when determining the size of resistor to use is the sum of the crystal capacitance and cable or load capacitance.

C. K. GRAVLEY  
in "Brush Strokes"

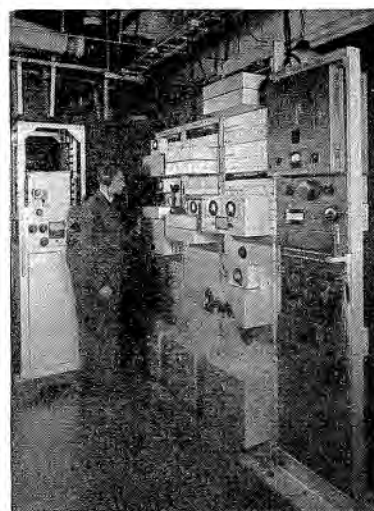

The apparatus which raises the video frequencies to a suitable value for transmission.

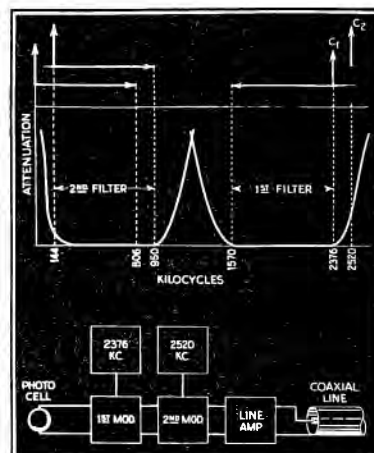

Depicting the action of the filters used to secure single-sideband transmission.

Sending motion pictures from the Bell Telephone Laboratories over the coaxial cable.

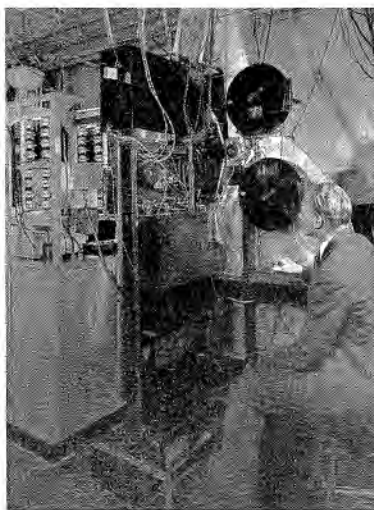

# REPORT OF THE ROCHESTER FALL MEETING

THE 1937 Rochester Fall Meeting of the Institute of Radio Engineers and the Engineering Division of the Radio Manufacturers Association was held at the Hotel Sagamore in Rochester, N. Y., on November 8, 9, and 10. It was one of the largest and most successful gatherings in the history of the meetings, and represented to a large extent a gauge of the progress made in radio and television during the past year.

It is probably significant to note that television received a great deal of attention at the technical sessions. About ten of the twenty papers delivered were either on or closely connected with television.

Of special interest was the paper delivered by William N. Parker, Philco Radio and Television Corporation, on "A Unique Method of Modulation for High-Fidelity Television Transmitters." It is well known that present-day high-definition television requires modulating frequencies from 0 to 3 megacycles, so that tube capacities and other difficulties make the handling of such a wide frequency range difficult when using well-known methods of plate or grid modulation. Further, the attenuation of very broad sidebands, when passed through resonant circuits, is serious. To overcome these a new form of modulation has been developed and is known as "transmission-line modulation." In this system a modulator is placed at the end of a  $\frac{1}{4}$ -wave

transmission line connected at the proper place to the transmission line connecting the antenna and power oscillator. This system is capable of 80% modulation up to 4 megacycles and with good plate efficiency. The simplicity of this modulation system should also make it applicable to high-fidelity ultra-high-frequency sound transmitters.

Another high efficiency system of modulation was described by R. B. Dome of the General Electric Company. According to Mr. Dome, the system is capable of efficiencies comparable to that obtained with the Doherty Amplifier<sup>1</sup>.

Of special interest was C. E. Burnett's description of "The Monoscope," a developmental type of tube designed to produce a video signal of the test picture or pattern enclosed in the tube. According to Mr. Burnett, who hails from the Radiotron Division of the RCA Manufacturing Co., Inc., the high-quality video signal which can be obtained from the Monoscope makes it particularly useful for testing the various units of a television system. Some of these uses are testing receiver circuits, studio circuits, and cathode-ray tubes for television reception.

In presenting his paper on television synchronization, F. J. Bingley, Philco Radio and Television Corporation, pointed out the problems of synchronization in a 441-line interlaced cathode-ray television system. The real test of

a synchronizing system is the ability to maintain perfect interlacing at the receiver. The received synchronizing impulses must provide good synchronization of the horizontal deflecting circuits and give perfect interlacing and vertical synchronization which does not fail. The causes for imperfect interlacing and the several requirements which must be fulfilled by the transmitted synchronizing signals were discussed. A comparison of the various systems used in the U. S. A. and abroad was also given.

The method of color specification of cathode-ray tubes adopted by the International Commission on Illumination in 1931 was discussed by R. M. Bowie and G. A. Fink, Hygrade Sylvania Corporation, in their paper "Specifications of Screen Color of Cathode-Ray Tubes." Three general methods of obtaining data were described and the advantage and disadvantages of each considered.

A. V. Bedford, RCA Manufacturing Co., Inc., in his paper on "Figure of Merit for Television Performance," traced the evolution of a sectionalized test chart for measuring resolution, halftones and deformation of television images. Vertical resolution and horizontal resolution are measured in each of twelve sections of the screen and a formula for converting these readings into an over-all resolution figure of merit was given. The figure obtained was equivalent to the total number of black and white dots which could be put into a screen to be transmitted, with random location relative to the position of the scanning lines, and which could all be separately identified and located in the received picture. The figure of merit may be used as a specification of performance or as a check on developmental progress.

A direct-viewing type cathode-ray tube for large television images was described by I. G. Maloff, RCA Manufacturing Co., Inc. Of special interest in this tube was the uncurved viewing screen which was placed inside the tube, thus eliminating all effect of curvature common in ordinary tubes.

In "Space Charge Limitation on the Focus of Electron Beams," L. B. Headrick and B. J. Thompson, Radiotron Division, RCA Mfg. Co., considered the equations for the envelop of electron beams having either rectangular or cir-

(Continued on page 22)

A Figure of Merit used to determine television performance.

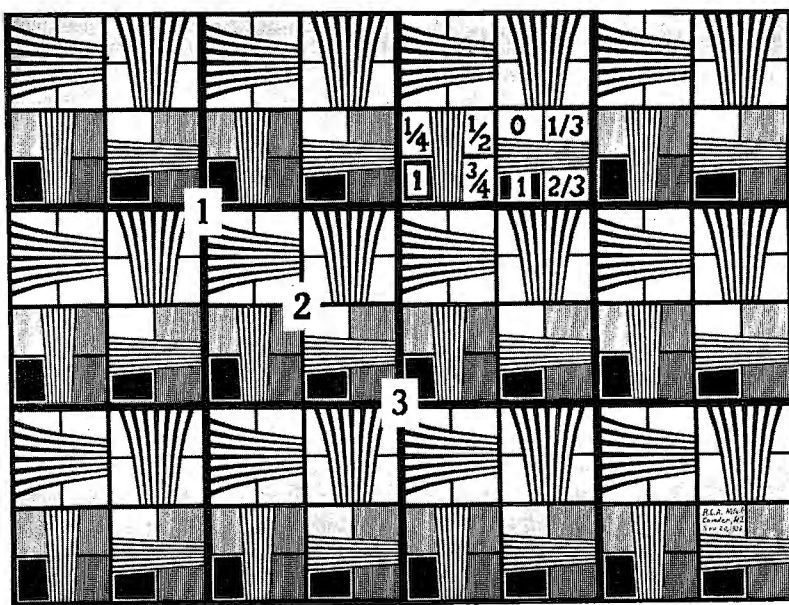

<sup>1</sup>"A New Power Amplifier of High Efficiency", by W. H. Doherty, p. 7, *Communication and Broadcast Engineering*, May, 1936.

# RADIO TOWER LIGHTING AND MARKING

By **ARTHUR R. NILSON\***

THAT NONE of the recent aircraft accidents were caused by collision of the aircraft with a radio tower is a tribute to the regulations governing the markings of these hazards to air navigation, and to the practical design of the lighting systems used on these towers. The need for lighting radio towers at times of darkness was anticipated coincidentally with the need for high radio masts and towers. The machinery for the promulgation of adequate minimum requirements, for rating, and for periodical inspection, as well as the penalizing of operators of so-called "false" lights is lodged in the Bureau of Air Commerce of the Department of Commerce.

## REGULATIONS AND RECOMMENDED STANDARDS

Under the terms of the Air Commerce Act of 1926 radio-tower lights are defined as an air-navigation facility, and as such their installation according to recommended standards is encouraged by the Secretary of Commerce. These standards are based on practical instal-

lations made by the Department of Commerce along Federal Airways.

Two kinds of lights are recognized, namely, true lights and false lights. The law charges the Secretary of Commerce to rate as "true" aeronautical lights all

long-range lights, which in his opinion serve as true aids to aerial navigation. Lights other than true lights which might be confused with the latter will be classed as "false" lights.

Agencies other than the Federal Government may operate four general types of aeronautical lights, as follows:

- (A) Airport Beacons.
- (B) Private Airway Beacons.
- (C) Landmark Beacons.
- (D) Hazard Warning Beacons.

It is quite obvious that radio-tower lights come under the last class. The recommended standards apply to masts or towers 100 feet or more high, provided that such towers are higher than surrounding buildings or terrain. Hence, these recommendations apply to nearly all radio towers.

To obtain an (a) rating on suitability a hazard beacon shall consist of one of the two following types of lights:

(1) A rotating beacon light, equal in effectiveness to the Airways Division 24-inch rotating beacon equipped with a red cover glass, and showing at least six flashes per minute.

(2) A stationary fixed or flashing beacon, equal in effectiveness to the Air-

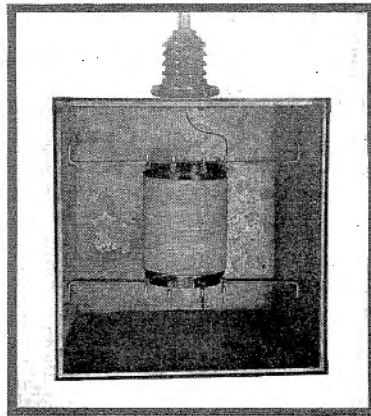
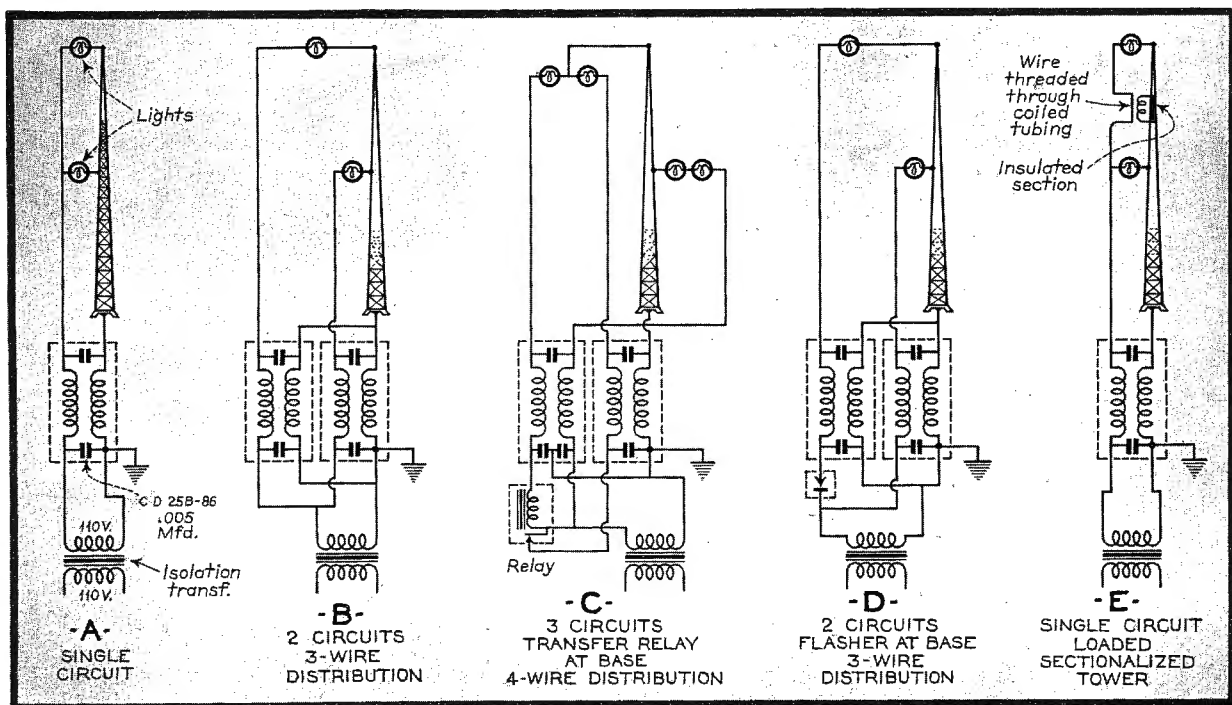

Fig. 2. A typical filter used for supplying power for the warning lights on vertical radiators.

Fig. 3. Showing a number of different methods for connecting chokes.

\*Co-author of *Radio Operating Questions and Answers* and *Practical Radio Communication*, McGraw-Hill Book Company, Inc.



ways Division 300 mm code beacon equipped with a red color screen. If a flashing light is used, at least six flashes per minute shall be shown, and the luminous period shall be at least 35 percent.

In order to prevent duplication within limited areas, the code characteristic selected for use with the beacon light(s) must be approved by the Department of Commerce. Rating of aeronautical hazard lights is made on formal application to the Air Navigation Division of the Bureau of Air Commerce. Applications for the rating of aeronautical hazard lights visible from navigational waters are referred to the Lighthouse Service for investigation and approval in accordance with laws and regulations affecting marine lights. There is always the possibility that aeronautical or marine interests may protest the operation of the light, in which event a rating may not be granted by the Secretary of Commerce.

Ratings are equivalent to a license to operate the light or lights rated, and are issued for a period of one year. Before a rating is renewed the operator must certify that the light(s) has been operated during the part calendar year as proposed in the original application for rating, and that no changes in characteristic or period of operation are contemplated during the ensuing calendar year. If it is proposed to change the manner of operation or characteristic of the light, it will be necessary to submit a new application for rating.

The issuance of a rating certificate for an aeronautical light by the Secretary of Commerce obligates the operator of the light to notify immediately the proper office of the Air Navigation Di-

vision of any extinguishment of the light, the probable period of such extinguishment, and the date on which the light is returned to service. At least three weeks' notice should be given before a light is extinguished in order that warning may be issued to air navigators. The Secretary of Commerce may waive or modify the regulations pertaining to beacon lights as he sees fit.

The Federal Communications Commission, before issuing permits for the erection and operation of commercial radio broadcasting stations, refers each application for an antenna construction permit to the Bureau of Air Commerce for its consideration as to the degree of hazard the antenna will present to air traffic, and for the recommendations of the Bureau as to the proper obstruction marking and lighting to satisfactorily minimize that hazard.

Towers of low height, or those considerably removed from the lanes of air traffic may require no special marking. Others of unusual height, or located near an airport or airway, are required to be painted and lighted in order to obtain the approval of the Bureau of Air Commerce for their erection.

The recommended standards as they apply to radio-antenna towers and poles are divided into three parts: Painting—Lighting—Radio Marker Warning Beacon. These recommendations are as follows:

(a) *Painting*—For maximum visibility, radio towers and poles should be painted throughout their height with alternate horizontal bands of international orange, and white, terminating with orange bands at both top and bottom. The width of the orange bands

should be one seventh of the height of any structure less than 250 feet high, and between 30 and 40 feet for structures over 250 feet high. The width of the white bands should be one-half that of the orange bands, as shown in Fig. 1.

(b) *Lighting*—Towers or poles, the overall height of which do not exceed 125 feet, shall be lighted as follows: At the top of each structure where lighting is required, there shall be installed two 100-watt traffic-signal type lamps. At least one of these lamps shall burn continuously from dusk to dawn. When only one lamp is operated the circuit shall be equipped with a relay for instant switch-over to the other lamp in case of a lamp failure. At both the one-third and two-thirds levels of the structure there shall be installed two 100-watt traffic-signal type lamps at each level on opposite corners of the structure, as shown in Fig. 1. This arrangement must, of course, be modified for triangular towers, but the lights at one-third and two-thirds levels are to be installed in such a manner that at least one lamp at each level shall always be visible. All lamps shall be enclosed in red holophane globes and shall burn from dusk to dawn.

Towers or poles, the overall height of which is between 125 and 200 feet, shall be lighted in a similar manner. Special conditions of terrain and location with respect to airports or airways may require special lighting. If required by reason of such conditions, there shall be installed and maintained a red hazard beacon at the topmost point of the structure, in lieu of the topmost lights and relay. This hazard beacon shall be similar and equal in effectiveness to the standard 300 mm airways electric lantern, equipped with two 200-watt lamps and aviation red color shades. This beacon shall burn flashing. Under special conditions the use of 500-watt lamps instead of 200-watt lamps may be required. Under particularly hazardous conditions, and in areas of heavy air traffic, it may be necessary to add a 24-inch 500- or 1,000-watt red rotating beacon to mark the installation. The beacon may be installed on the roof of the transmitter building provided that point will afford proper visibility, otherwise it may be necessary to install the beacon on a separate tower of proper height.

Towers, the overall height of which is between 200 and 300 feet, shall be lighted by 100-watt traffic-signal type lamps at both the one-third and two-thirds levels on opposite points as shown in Fig. 1. The top of the tower shall be marked by a hazard beacon similar and equal in effectiveness to the standard 300 mm airways electric lantern, equipped with two 200-watt or 500-watt

Fig. 4. A lighting system using a concentric-line feeder system.

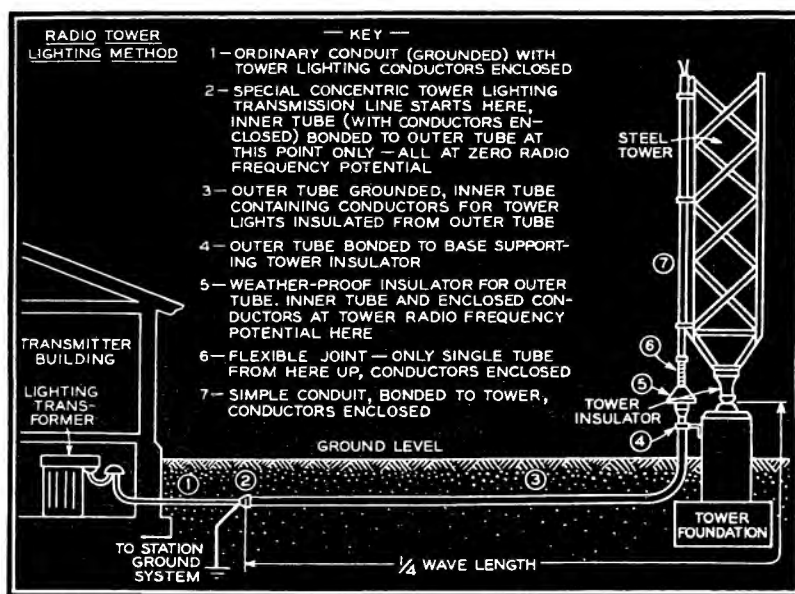



lamps and aviation red color shades. This light shall burn flashing. In certain cases the installation of a standard 24-inch 500- or 1,000-watt red rotating beacon may be required, depending on the degree of hazard presented.

Towers exceeding 300 feet in height shall be lighted by 100-watt traffic-signal type lamps in red holophane globes at the one-third and two-thirds levels as shown in Fig. 1. The top of the tower shall be marked by a hazard beacon similar and equal in effectiveness to the standard 300 mm airways electric lantern, equipped with two 500-watt lamps and aviation red color screens. This light shall burn flashing. In many cases for towers of this height, the installation of a 24-inch red rotating beacon will be required to be installed on the transmitter building, or, if that is not high enough to clear neighboring obstructions, on a separate tower of sufficient height to afford proper visibility. In certain areas the Department of Commerce may require the installation of a radio marker beacon.

[Detailed drawings of a typical two-gang obstruction-light fitting, a typical obstruction-light fitting, a recommended 300 mm airways lantern, and a 24-inch rotating airways beacon are issued as part of these recommendations by the Bureau of Air Commerce.]

(c) *Radio Marker Warning Beacon*—Under specially hazardous conditions the Department of Commerce may require the installation of a radio marker beacon. This type of installation will usually not be required for any except extreme cases, which will be governed by location and other factors as affecting flight conditions, regardless of the height of the structure. When a radio marker beacon is required it shall consist of a transmitter of sufficient power to give ten percent greater strength of signal than that obtained from the nearest radio range station, as measured at a distance of two miles from the proposed structure in the direction of the radio range station. The transmitter shall be crystal controlled and operate on a frequency of 1,200 cycles removed from that of the radio range station. A modulation frequency of 120 cycles and a percentage modulation of 100 percent is recommended. A keying device to transmit alternately - - - - (International Morse "Zero") for approximately 20 seconds and the identification signal of the station for approximately 10 seconds. To obtain the requisite space pattern a conventional "L" type antenna 18 to 25 feet in height and 150 feet in length should be utilized with a 150-foot ground wire buried directly beneath the antenna and connected to suitable ground rods. This type of radio marker beacon will ordinarily not

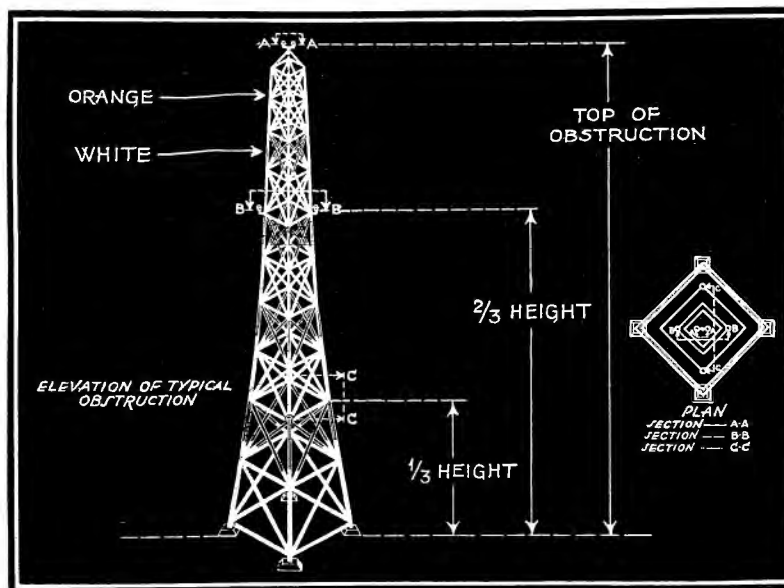

Fig. 1. Showing the recommended standard for painting.

require a power greater than 30 watts.

#### TOWER LIGHTING METHODS

When the problem of tower lighting first presented itself, the towers themselves were, in nearly every installation, insulated from the ground. Under operating conditions, therefore, the tower was at a high potential; and any wire installed to carry lighting power would be at tower potential. It was the practice then to isolate the tower-lighting circuit from the power lines by interposing a motor generator, built to withstand high potential, between the initial source of power and the lighting circuit. This motor generator was carefully insulated from any contact with the ground. Hence, the motor generator acted as a blocking unit to prevent any radio-frequency currents from getting into the power lines.

As soon as radio-frequency chokes capable of handling potentials as high as 10,000 volts were commercially available, these units replaced the more expensive and cumbersome motor generator. A typical filter choke used to supply power for aircraft warning lights on vertical radiators of a broadcast station is shown in Fig. 2. These units are designed to have high impedance at broadcast frequencies, but a low impedance at commercial lighting frequencies. The choke is enclosed in a weatherproof case, and may be mounted to a wall or pole near the base of the antenna. The choke itself consists of two windings, one for each leg of the line. To further increase the effectiveness of the unit a fixed condenser is used at each end of the choke to bypass the radio-frequency currents to ground. The chokes should be rated

with a large safety factor, and be able to carry up to ten amperes continuously, depending on conditions.

A number of different methods of connecting the chokes in the line are shown in Fig. 3. The isolation transformers are shown with one side of the secondary grounded. Where it is possible to ground one side of the power supply the transformer may be omitted. Transformers rated at one or two kva are recommended, depending on load requirements.

An improved lighting method utilizing a concentric-line feeder system, devised by engineers of the Bell Laboratories, is shown in Fig. 4. A more detailed explanation of this system appeared on page 25 of the June-1936 issue of COMMUNICATION AND BROADCAST ENGINEERING, and will not be repeated here. The diagram, however, is shown here for the sake of completeness.

The latest development in radio towers is the shunt-excited antenna, the base of which is grounded. Tower lighting on these radiators is simplicity itself, it being only necessary to run the lighting circuit underground directly to the antenna base, and then vertically up the tower. Filter devices are not required.

The operation of radio tower lights may be controlled by photoelectric means, which are entirely automatic, and which turns on the lights when daylight has decreased to a certain point. Thus, during inclement weather when the sun is entirely obscured, and each day at dusk, the lights come on automatically. Failure of any warning light to burn may be indicated on the control panel in the transmitter control room.

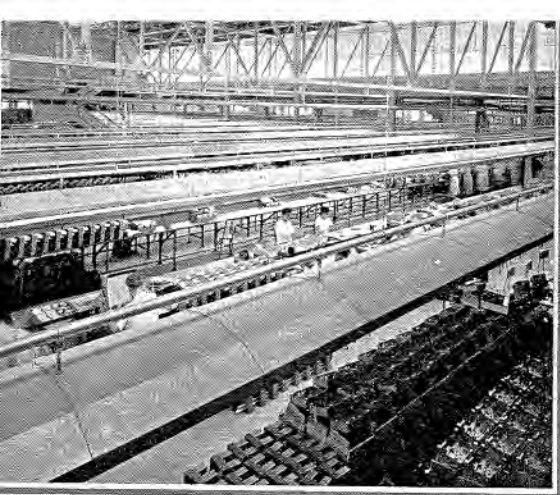

The top part of the lighting fixture is a steel hood designed to provide a reflecting ceiling.

A ONE-HUNDRED-THOUSAND watt installation of indirect industrial lighting has recently been installed at the new Motorola radio plant of the Galvin Manufacturing Company.

Uniformity in lighting is an important factor in modern industry. It speeds up mass production, decreases errors and saves the workers from undue strain which results in slower line work. The Galvin company determined to "light-condition" their new Motorola plant in order to gain these benefits of correct lighting and thereby cut down production costs.

Some 1120 feet of "Light-Hood," a continuous indirect lighting unit especially designed to meet the assembly-line illumination problems, has been installed throughout this plant. Forty foot candles of uniform, glareless, practically shadowless light are now measured on the working surfaces of assembly tables and laboratory benches, while 15 foot candles reach the aisles between the assembly lines—a quantity entirely adequate for movements about the plant.

The "Light-Hood" lines are installed sufficiently high above the tables to eliminate employees' view of the bare lamps; therefore, no one needs to be "temporarily blinded" by the raw light sources, and the workers, performing minute and detail assembly jobs, are able to work through the entire day without eye-strain or fatigue.

The light lines are installed sufficiently high above the tables to eliminate a view of the bare lights.

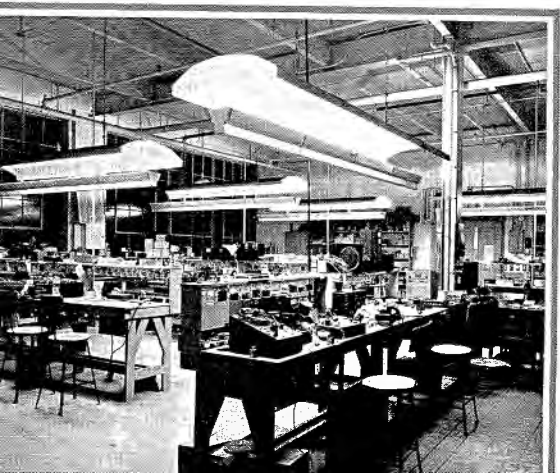

# MOTOROLA RADIO PLANT

By M. R. MATTESON

## THE INDUSTRIAL PROBLEM

The Motorola lighting problem was a real challenge, the demands great and the difficulties many. Four major considerations determined the choice.

(1) Uniform lighting for five 125-foot assembly lines, five 90-foot assembly lines, and five 10-foot laboratory benches. (The width of the working surface is 72 inches and has to receive

ing equipment tested over the assembly lines delivered adequate intensity immediately under the light source, but presented the glare problem and left the aisles under-illuminated. Further, reflected glare from metallic radio parts was annoying and shadows in the chassis units were severe.

An indirect system alone could produce the required quality of illumina-

About 1,120 feet of light-hood has been installed in the Motorola radio plant. Forty foot candles of light are measured on the assembly tables, while 15 foot candles reach the aisles between the assembly lines.

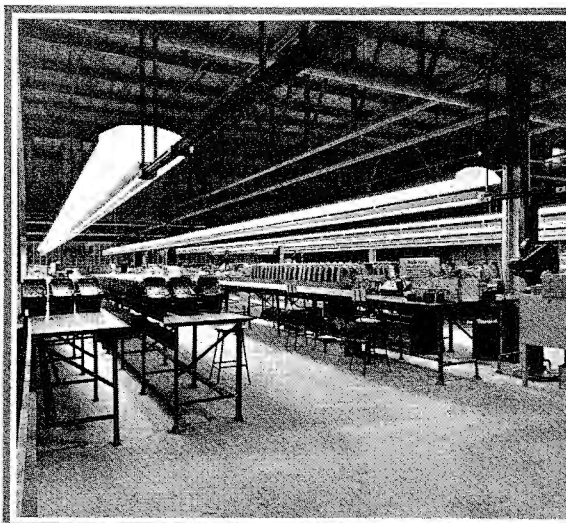

absolutely even light, as well as the whole run of the assembly lines.)

(2) High-intensity lighting, essential to the accuracy and speed of assembling small parts of the radio chassis.

(3) Glareless and shadowless lighting, necessary to insure clear vision and avoid shadowless reflections from the metallic material.

(4) Easy maintenance.

Every available type of industrial lighting unit was tried out on this job. In the old factory, glass and steel diffusers with 300-watt lamps proved fairly satisfactory, but the Galvin Manufacturing Company in completing their new plant, decided an improvement in lighting as timely, necessary and economical.

## LIGHTING EXPERIMENTATION

Early in the tests, gaseous and vaporous combination lights were eliminated. Silver bowls were also tried without satisfaction. Every type of direct light-

tion for the Motorola plant. However, wiring and structure difficulties were great. Individual units were not practical, because each would require conduit runs to the ceiling and conduit drops to the fixture. For necessary control over the successive sections, each unit would have to have a pull switch. The structural obstacles to indirect lighting were even greater. The main ceiling height of the plant is 30 feet, with iron trusses on 30-foot centers running at right angles to the assembly lines across the center of the room. The truss bottoms are only 13 feet from the floor; therefore, over 30 feet of assembly lines the ceiling height was as low as 13 feet.

## THE "INDIRECT" SOLUTION

"Light-Hood" for indirect industrial lighting, fulfilled all quality requirements, overcame wiring and architectural difficulties, and offered a solution

# LIGHTING INSTALLATION

CURTIS LIGHTING, INC.

to the entire Motorola radio plant illumination problem.

The lower part of "Light-Hood" consists of a Lunax aluminum reflecting trough, mounted on CurtiStrip wiring channel. All the wires for each line are carried in this channel, thus, conveniently solving the wiring problem.

The upper part is a steel hood which provides a reflecting ceiling, properly

post near each line. Individual circuits are provided for each of four lights in the line lengths and levolier switches are provided to control each set of four lights in the line. A single master switch is also provided in the panel box to control each entire line.

To carry the circuit lines to the lighting unit, three 1-inch conduits have been dropped from the panel box to the

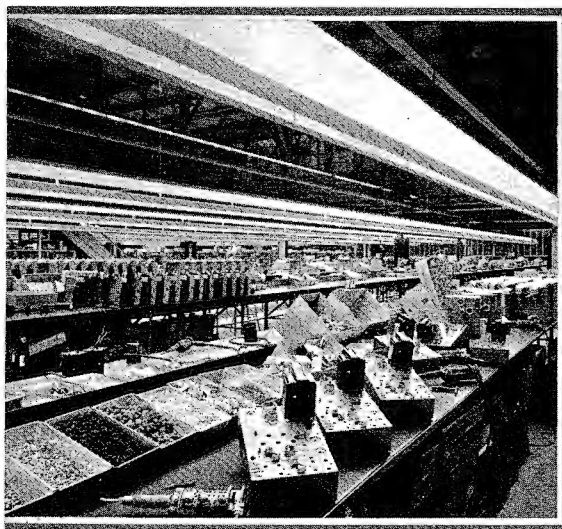

**The lower part of the light-hood consists of an aluminum reflecting trough mounted on a wiring channel. All the wires for each line are carried in this channel. A pipe batten hung from the ceiling furnishes main support.**

shaped and treated to produce the maximum reflectivity. No let-down in intensity occurs between the 150-watt lamps installed on 30-inch centers for the entire length of the trough.

For details regarding this installation, a pipe batten hung from wood beams at the ceiling furnishes the main support. These beams are on 7-foot centers at right angles to the assembly tables. Lockweave chain of 1200 lbs tensile strength were dropped from lag bolts and driven into the sides of every other beam on 14-foot centers with turn buckles provided at lower end and attached to a 1½-inch pipe, from which "Light-Hood" is hung by standard pipe straps on 5-foot centers. The turn buckles enabled an exact leveling of the equipment.

Panel boards with complete control equipment for light-soldering irons and automatic screw drives were placed at convenient levels at each roof support

floor, then run under the table and up to the trough. All overhead conduit runs were thus eliminated effecting a substantial saving in wiring costs for the job.

## NEW YORK INSTALLS RADIO IN FIREBOATS

WITH Mayor F. H. LaGuardia and Fire Chief and Commissioner John J. McElligott officiating, New York City's new two-way radio system for fireboats was formally put in operation October 5. The radio installation now makes possible communication between the City of New York and each of its nine fireboats. The equipment was designed, built, and installed by the General Electric Company.

The system permits constant communication between the boats and headquarters while the boats are tied up or



**No let-down in intensity occurs along the assembly lines. 150-watt lamps are installed on 30-inch centers.**

are in action away from their docks. Heretofore it has been impossible for a boat at the scene of a fire to keep in direct contact with headquarters. Frequently it is necessary for a fireboat to remain away from its dock for 24 hours or more. With the new radio equipment, speedboats may be ordered to remove injured persons to a waiting ambulance, saving valuable time in the prevention of loss of life.

A central control point located in the Fire Alarm Central Office in Central Park is able to talk with any or all boats at any time. Microphones and control equipment are located here, and the main transmitter is installed in the Fire Department Shops Building, Queens Boulevard, Long Island City. This unit is of 500 watts power and operates on a frequency of 1630 kilocycles.

The boat transmitters are of the ultra-short-wave type, operating on 35.6 megacycles with a power of 50 watts. A J-type antenna mast and transmission line, medium-high-frequency receiver, power equipment and microphone and control equipment complete the individual boat installations.

Five pickup receivers, located at strategic land points, permit reception from any of the boats. Thus it is possible to successfully receive messages from any of the boats from any point in New York harbor.

**Another view in the Motorola plant, showing the construction of the indirect lighting system.**

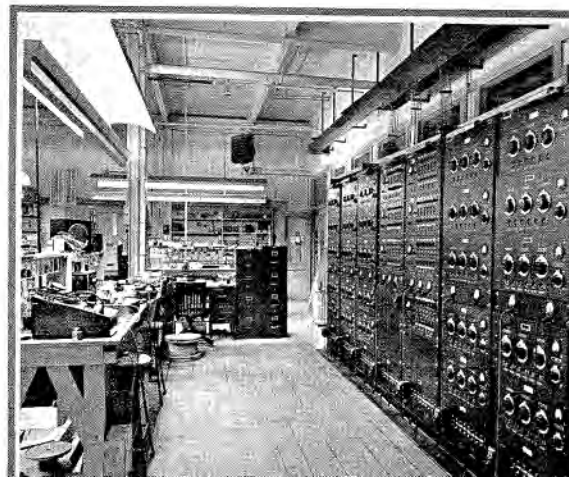

# A TALK-BACK & LOUDSPEAKER CONTROL SYSTEM

By P. S. GATES

GATES RADIO & SUPPLY CO.

THE AVERAGE broadcasting station will use from three to six loudspeakers. These speakers are usually distributed in the control room, the two or three studios, reception room and office. In some cases where audience rooms are provided the loudspeaker is used extensively for either reinforcement, or where the program point is closed from the audience by a transparent drop the speakers are used, of course, for bringing all of the program to the audience.

Multiple speakers in radio broadcasting have long offered a problem of no small consequence. A method must be employed, of course, to cut the speaker out of the circuit that is adjacent to a live microphone, leaving the balance of the speakers in service. This is better known as "talk-back." Furthermore, multiple speakers offer the problem of matching, i.e., the usual monitor or program amplifier output is 500 ohms and high-quality performance cannot be had by operating a half dozen 500-ohm speakers unless series parallel is employed which again offers another problem of inducing complications with "talk-back."

By consulting Fig. 1 we find a circuit diagram of a speaker control system which incorporates talk-back and is designed for use with six or less loudspeakers of any type, either permanent magnet or dynamic. The system is designed for operation from two amplifiers and each speaker is selective into either of the amplifiers. Speakers used should have an input transformer having 3,000 ohms input. The system is so set up that the control operator

may almost instantly place any combination of speakers in operation with the two amplifiers or operate all of the speakers from one amplifier if desired. In addition, provision is made so that any number of the speakers may be cut completely off without causing a mismatch in the output line of either amplifier.

Five of the speakers are arranged for talk-back while the sixth speaker circuit which is usually for the office or reception room and not before a microphone at any point is arranged only for connection to either amplifier and not through the relay system. Switches are provided for each speaker channel, there being six channels in all. These switches are of the four-pole double-throw jack-switch type having a neutral or off position. By again referring to Fig. 1 it will be seen that half of the section of the switch is used for the speaker circuit proper, while the other half is used for matching resistors. When the switch is turned to position No. 1—for connection to what we will call amplifier No. 1—there is automatically placed across the output line of amplifier No. 2 a resistor equal in value to the impedance of the loudspeaker, or 3,000 ohms. The action is the same but reversed when the speaker switch is turned to amplifier No. 2. Thus, it can be seen that we can have five speakers operating on one amplifier and only one speaker on the other amplifier, yet the same load is placed on the amplifier having only one speaker as the amplifier feeding five speakers. This assures not only per-

fect quality by a correct match but no raise in the volume of the single speaker being used or no drop in volume in the circuit where five speakers are used. The foregoing example of one and five speakers will hold true with any combination, such as, two speakers on one circuit, and four on the other, etc.

The relays on the five-speaker circuits employing talk-back are of the make before break type. Each relay operates as a break in one side of the speaker circuit. It will be noticed that circuit break is made in the speaker circuit before the switch so that talk-back will be had on either amplifier set-up. The relay is also provided with a resistor connection equal in value to that of the speaker, or 3,000 ohms. This contact on the relay should make before the speaker circuit breaks so that there will not be a pop each time the speaker breaks out of the circuit. The relays also have an extra pair brought directly off the coil terminals which may be used for connecting studio warning lights, i.e., as each relay operates from contacts on the mixer key and as the relays are so constructed that the speaker breaks out of the circuit when excited, this places a voltage across the relay coil when the speaker is off and if a light is connected to the coil it will illuminate when the speaker is off, consequently operating as a warning or signal light. Fig. 2 illustrates the type of relay contact set-up employed. It was found that small telephone relays were most satisfactory as they were very quiet and required only about one-tenth of an ampere for ex-

Fig. 3. Front view of the completed instrument.

Fig. 4. Rear view, showing arrangement of parts.

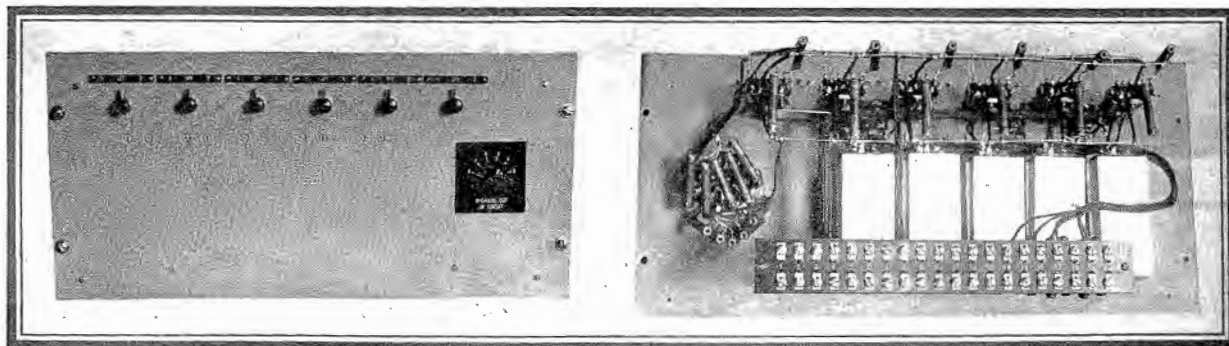

citation. As a result the five relays and five six-volt studio warning lights if all operated at the same time could be supplied by a two ampere rectifier of inexpensive design.

There are conditions where it will be desired to not operate all six of the loudspeakers or some station may only use three or four speakers for their present requirements. In the latter case, it is recommended that the six speaker panel be used such as herein described as future additions will always call for more loudspeakers. For late evening or early morning broadcasts where the studios in general as well as reception rooms, etc., are not used the control operator is using his speaker for monitoring the program with the balance cut off. To take care of this condition where all but one speaker is in use or where only two or three speakers are in use a "speakers out of circuit" switch is provided. This is a six-position double-section selector switch of the non-shorting type giving an off position and five other positions for from one to five speakers out of circuit. The placement of this switch is simply one section across the output of each amplifier circuit. With the example just given the operator would turn this switch to Position 5 as he has five speakers not in use or if he had two speakers in use and four not in use he would turn the switch to Position 4. Resistor values for the various positions based on the use of 3,000-ohm speakers across a 500-ohm line are:

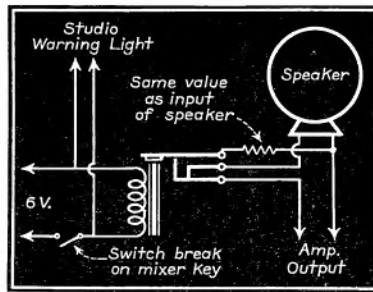

Fig. 2. The type of relay contact set-up employed.

Speakers Out of Circuit	Resistor Value	Switch Position
1	3000 ohms	1
2	1500 ohms	2
3	1000 ohms	3
4	750 ohms	4
5	600 ohms	5
0	000 ohms	0

With the above arrangement any number of speakers may be used either connected or unconnected to the panel but each speaker must be 3,000 ohms input and the amplifier output 500 ohms.

Fig. 3 is the front view of the completed instrument which can be built with space to spare on an 8¾ by 19 inch panel. The rear view in Fig. 4 illustrates the arrangement of parts for convenient wiring. The entire equipment is enclosed by a dust cover for protection to the switch contacts and relays are separately protected by individual dust covers.

## WESTINGHOUSE INCREASES SHORT-WAVE POWER

THE Westinghouse Electric and Manufacturing Company is now making important changes at the W8XK transmitters at Saxonburg, Pennsylvania, which will many times increase the power and which will concentrate radiation on Europe and South America.

The improvements which are being made include the construction of two new directional rhombic antennas one to South America beamed on Buenos Aires and one to Europe beamed on London. The South American beam will greatly improve reception not only in Argentina but also in all of Brazil and the other South American Countries; the European beam will cover England and continental Europe. These antennas replace non-directional vertical doublet antennas and will operate on 6140, 11870 or 15210 kcs. The 21540 channel will continue with a horizontal doublet antenna directed to South America.

The expected power gain on the beam of the rhombic antennas is:

- 25 times at 6140 kc
- 36 times at 11870 kc
- 50 times at 15210 kc

Modernization of the 6140, 11870 and 15210 transmitters will provide a fully modulated carrier of:

- 28 kw on 6140 kc
- 24 kw on 11870 kc
- 18 kw on 15210 kc

The 21540-kc transmitter will not be changed.

Fig. 1. Circuit diagram of the speaker control system described in the accompanying article.

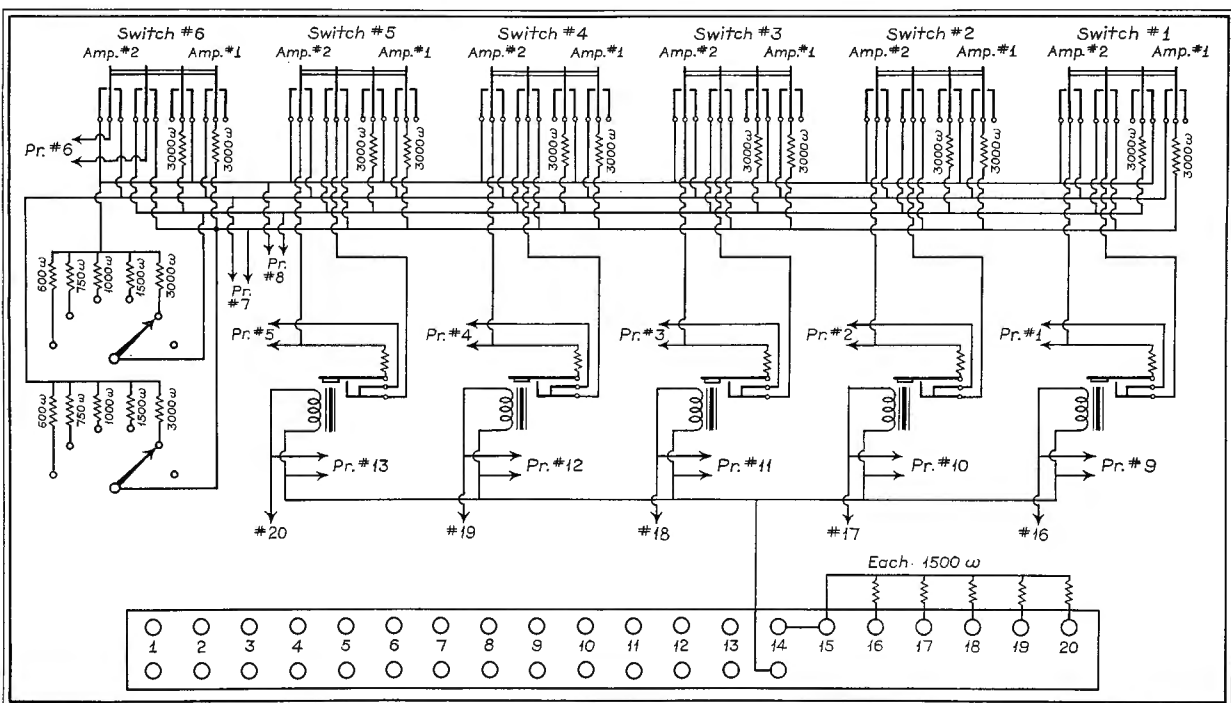

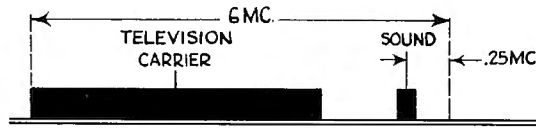

Fig. 1. A typical television channel.

# FREQUENCIES AND STANDARDS

By **ALBERT F. MURRAY**

Acting Chairman  
RMA TELEVISION COMMITTEE

Engineer in Charge of Television  
PHILCO RADIO & TELEVISION CORP.

JUST ABOUT a year ago the author had the pleasure of reporting the progress made by the RMA Television Committee (which reports to Dr. W. R. G. Baker, Director of Engineering) in formulating standards. Let us review these standards, Table I, to see what changes have taken place during 1937.

### REVIEW OF STANDARDS

Skipping for a moment item 1, Frequency Allocation, we come to item 2, Channel Width: 6 mc. Fortunately the FCC has accepted this recommended standard, and all television channels recently assigned are 6-mc wide.

Item 3, Spacing between Television and Sound Carriers: 3.25 mc approximately—no change.

Item 4, Relation of Sound Carrier to

Television Carrier: sound carrier higher in frequency. This standard remains unchanged.

Item 5, Polarity of Transmission: negative. Until a month ago the majority of the television transmitters were using negative modulation. Some are now using positive modulation and there is a possibility of this standard being changed.

Item 6, Number of Lines: 441. It is rather gratifying to find that this seemingly magic number of 441 lines, selected by the RMA Committee, has been echoed in the latest standards adopted in Germany and France.

Item 7, Frame Frequency: 30 per second. This remains unchanged. Field Frequency: 60 per second, interlaced. Unchanged. The choice of interlaced

scanning has been endorsed after a comparative test by the British Broadcasting Corporation and more recently by the German Postoffice.

Item 8, Aspect Ratio: 4:3. Unchanged.

Item 9, Percentage of Television Signal Devoted to Synchronizing Signals: not less than 20 percent. Unchanged.

Item 10, Synchronizing Signal, (a) duration of horizontal and vertical blanking signals: approximately 1/10th of the time to scan one line, 1/10th of the time to scan one field, respectively. Unchanged. (b) Position of synchronizing pulses in regard to blanking signal: at the leading edge, approximately. Unchanged.

To this list of standards the Television Committee has added during the year:

Item 11, Position in the Channel of Sound Carrier:

.25 mc from the upper channel boundary.

*Reason:* To provide a guard band between the sound carrier and the adjacent service.

This is shown in Fig. 1.

This layout of a typical television channel, of course, presupposes double-sideband transmission. Future development may permit the lower sideband to be suppressed. When this is achieved the spacing between the television and sound carriers will then be increased to more than the specified 3.25 mc.

### COMPARISON OF FOREIGN AND AMERICAN STANDARDS

With our brief review of the American standards completed, let us compare them with the standards in use in England, France and Germany.

Let us return to Table 1. For item 5, Polarity of Transmission, we find the English, French and Germans are using positive transmission instead of negative.

For item 6 we have already mentioned that the French and Germans

TABLE I—RECOMMENDED STANDARDS OF RMA COMMITTEE ON TELEVISION

ITEM NO.	RMA RECOMMENDED STANDARD	
1. Frequency Allocation	Lower limit .....	42 mc
	Upper limit .....	90 mc
	An Experimental Band Starting .....	120 mc
2. Channel Width .....	6 mc	
3. Spacing between Television and Sound Carriers .....	3.25 mc	
4. Relation of Sound Carrier to Television Carrier .....	Sound carrier higher in frequency	
5. Polarity of Transmission .....	Negative	
6. Number of Lines .....	441	
7. Frame Frequency .....	30 per second	
	Field Frequency .....	60 per second
8. Aspect Ratio .....	4:3	
9. Percentage of Television Signal Devoted to Synchronizing Signals .....	Not less than 20%	
10. Synchronizing Signal	(a) Duration of Horizontal and Vertical Blanking Signals .....	Approximately 1/10th of the time to scan one line, 1/10th of the time to scan one field respectively
	(b) Position of Synchronizing Impulse in Regard to Blanking Signal .....	At leading edge (Approximately)

have adopted our 441-line standard. The English are using 405 lines.

Item 7—The frame frequency in England and on the Continent is 25, and the field frequency 50 per second, because the frequency of the supply mains is 50 cycles per second.

Item 9—We believe the British are using 30 percent instead of a minimum of 20 percent for synchronizing.

Item 10—Instead of the blanking signals occupying 1/10th of the time to scan one line, i.e., 10%, in Great Britain they occupy 15% of this time. No change otherwise in item 10.

Other important transmission characteristics not listed in this table will be mentioned later. So much for standards of today.

#### THE TREND OF STANDARDIZATION

Now for a look into the future. What will be the trend during 1938? You can draw some conclusions regarding this if I give you some extracts from memory taken at random from the minutes of the RMA Subcommittee on Television Standards, at the meeting in Philadelphia, September 20, 1937. These are some of the topics discussed.

Television transmission can be either horizontally or vertically polarized. The RCA organization submitted data which they have accumulated indicating that less noise was picked up on horizontal receiving antennas, and also there was less signal variation due to indirect path propagation. The committee agreed that standardization on this point was not required for the present.

Philco presented a statement regarding the merits of amplitude selection compared with waveform selection, and advocated the use of the former in connection with the narrow vertical synchronizing signals. It was the opinion of the Committee that standardization on this point be delayed.

Philco reviewed the desirability of attenuating one of the picture sidebands at the transmitter, and mentioned the work underway at W3XE in Philadelphia to accomplish this. The Committee was of the opinion that when this becomes practical the lower sideband is the one that should be attenuated.

RCA presented reasons indicating the desirability of automatic volume control in television receivers. The avc becomes more difficult when a d-c system with positive transmission is used. Some members felt that avc should be a fundamental portion of a television system.

Engineers from CBS, RCA, Hazeltine and Farnsworth had recently returned from Europe, and had many interesting facts to report on the status of television there. The Hazeltine company recommended standards having the principal features of the system used

TABLE II—TELEVISION SYSTEM CHARACTERISTICS AS PROPOSED BY COMMITTEE MEMBERS

COMPANY	TRANSMISSION CHARACTERISTIC (PICTURE BACKGROUND)	POLARITY OF TRANSMISSION	HOR.-VERT. SYNCHRONIZING IMPULSES	QUALIFYING COMMENTS
CBS	d-c	positive	?	if avc available
Farnsworth	d-c or no standard	neg. pref. or positive 2nd choice	unequal	prefer "narrow vertical" synchronizing
GE	d-c	positive	?	if avc available
Hazeltine	d-c	positive	equal	
Philco	d-c	negative or positive	unequal	prefer "narrow vertical" synchronizing
RCA	d-c	positive	equal	if avc available

in England. Some of these standards are in accordance with American standards, others are not. These British standards were discussed, and the advantages of some of them were pointed out. Three principal system characteristics were considered; viz. (1) transmission characteristic or method of transmitting the picture background component, (2) polarity of transmission, and (3) type of vertical synchronizing signals. Tentative recommendations of the various companies concerning these factors are listed in Table II.

A glance indicates that all of the interests represented on the committee favor the d-c method of transmitting picture background. The majority favor positive transmission.

The heading of the third column of Table II may not be clear. It really means this: Should the horizontal and vertical impulses be equal or unequal in amplitude? Naturally, if they are equal in amplitude, wave-shape selection will be required to separate them at the receiver. On the other hand, if the pulses to be transmitted are of unequal height, then the vertical pulses being the higher can be selected at the receiver by amplitude selection. Another way to interpret this would be to ask the question: Do you prefer the serrated type or the narrow vertical type of synchronizing signal? Two companies preferred the latter; they were Farnsworth and Philco. Those companies expressing a preference for the

serrated type of vertical synchronizing signal were Hazeltine and RCA. The question marks following CBS and GE indicate that they have not decided, further tests being necessary.

As to the qualifying comments, we have already mentioned the fact that avc with positive modulation is difficult to accomplish, therefore the following companies, CBS, GE, and RCA indicate that they favor positive modulation only if avc is available, that is, if it is found workable.

What choice has been made abroad regarding the characteristics in this table? In Germany they are using d-c background transmission, the polarity of transmission is positive, and the horizontal and vertical synchronizing impulses are of equal amplitude. The same is true in England.

#### FREQUENCY ASSIGNMENTS

Leaving now the question of television standards, let us find out what progress has been made during the year in solving a very important problem, vitally important to the future of the radio industry, at least that portion that anticipates the manufacture of television receivers. It is the problem of frequency allocation for television.

Refer for a moment to Fig. 2. This figure indicates that last year we had hopes of securing assignments in a continuous band from 42-90 mc. We also wanted an experimental band starting at 120 mc and going upward. This figure illustrates the desirability of having as nearly a continuous band as possible, because this simplifies the tuning of television receivers. What we wanted in frequency assignments is shown in Fig. 3. What we got is illustrated in Fig. 4.

Since the official announcement of the assignment of these bands by the FCC, October 16th, 1937, they have

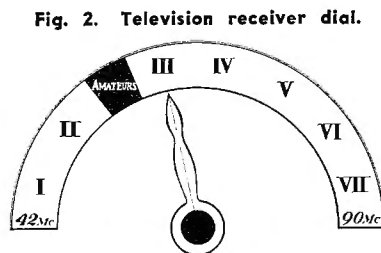

Fig. 2. Television receiver dial.

been the subject of study. We have secured (as requested) for television 7 channels in the lower frequency block. Also there are 12 channels in the higher frequency block, but there are serious breaks in both bands. It must be remembered that the usefulness of frequency assignments above 90 mc for urban television broadcasting today is very doubtful indeed.

At any rate these are the channels that we experimenters are going to use in developing this new art in the United States. They already appear inadequate as to number, if one considers the channels that we are sure are satisfactory. However, it is up to us to make the best of the situation. We should overlook the difficulties and point out the advantages. The main advantages are that the assignment is reassuringly definite, definite as to channel width and channel location. These assignments are more permanent than any previous ones we have had.

Some may ask: How was this frequency assignment arrived at? The steps were these: On June 16, 1936, the RMA presented before a hearing of the FCC in Washington the television needs of the industry. At this hearing the requirements of the Army and Navy and other Government services were presented. These covered a great deal of the territory between 30 and 300 mc. Naturally these requirements conflicted with television needs.

About eight months later a meeting was arranged by Lt. Comdr. Craven (then Chief Engineer of the FCC), attended by a group of representatives of the RMA Television Committee and the Army and Navy and other Government representatives who form the group known as IRAC, that is the Interdepartmental Radio Advisory Committee of the Government. The RMA Committee presented and discussed tele-

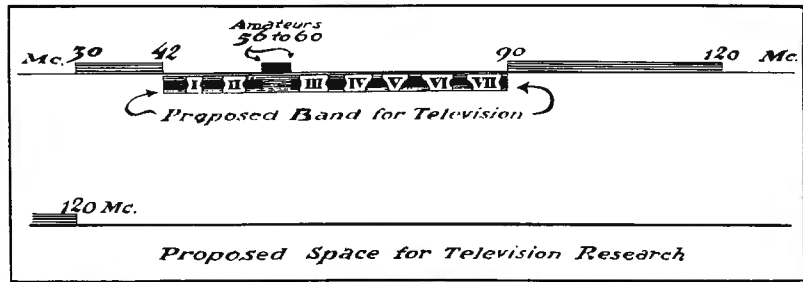

Fig. 3. The proposed television bands.

vision frequency needs. The Army and Navy representatives stated that they needed large bands of ultra-high frequencies for national defense, even in times of peace.

At a later IRAC meeting, at which we had Lt. Comdr. Craven's help and support, the Army and Navy and Government services decided what channels they would give up to television. When these channels were submitted recently to the RMA Television Committee we voted to accept the new assignments for a trial period of one year. These new assignments, to be in force Oct. 13, 1938, are those given in Fig. 4.

In conclusion, official television frequency assignments have been made, so for some time to come this problem is closed.

As for television standards, those formulated by the RMA group, more than a year ago, have been of great value to the companies carrying on television research in the U. S. A., for instance, in crystallizing ideas, in promoting cooperation, and in guiding development work toward commercial television. These early standards have stood the test of time remarkably well. They have always been designated as tentative. They were set up to be changed. Now perhaps the time is approaching, when in view of experience

at home and abroad, they should be changed.

The next step, then, for the RMA Television Committee is to consider carefully modification of the present standards and the addition of new standards.

In view of the technical improvements and developments in process in our various laboratories today we can thank our stars that we, in America, have not yet been completely bound by permanently fixed standards. We should be thankful that we are practical enough and not too proud to profit, where we can, by the commercial field experience of our British and German contemporaries, and by new developments in our own United States of America—the country that must lead the world in technical television development.

#### ROCHESTER FALL MEETING

(Continued from page 12)

cular cross section. An idealized focusing field was assumed in that the initial perpendicular or radial component of electron velocity is assumed to be proportional to the distance of the electrons from the beam axis. The electrostatic force of the electron space charge is the only force considered to oppose the formation of a line or point focus on the beam axis at some distance from the focusing field. The electron density over any cross section of the electron beam is considered to be constant. The axial velocity of beam is assumed to be homogeneous. For the rectangular beam two cases were considered: (1) the electron beam in a field-free space, (2) the electron beam accelerated by a uniform axial potential gradient. The circular beam is assumed to be in a field-free space. The relations between the variables beam current density, voltage, initial angle and the distance between focusing field and the focal point were shown by curves. In cathode-ray tubes made at present for television and oscillographic purposes the space-charge limitation on the focus is not of great importance because other factors contribute largely to the spot size. How-

(Continued on page 33)

Fig. 4. The recent television frequency assignments.

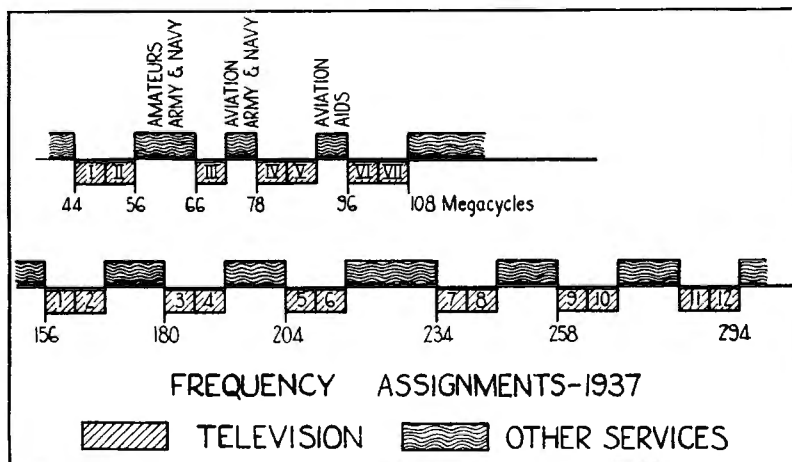



# Brush Crystal Products That Help Solve Your Problems

● The most recent contributions by Brush are:

## High Fidelity Phono-Pickup with features such as:

- Two models, vertical and lateral.
- Sapphire point easily replaced.
- Low stiffness and low moment of inertia, consequently very light.
- Pressure required is under one ounce.
- Response—without further compensation—flat from 30 to 10,000 cycles.

## High Fidelity Crystal Headphone, Type A-1.

This new Brush headphone is similar in appearance to the standard Type "A," but with high fidelity response.

Other than these two instruments, Brush also announces a general purpose, ultra light weight, metal headphone (Type "B") and at the same price as the present Type "A."

The engineer in search of an accessory for the new personal radio set, will find the Brush "Hushatone" (pillow speaker) an attractive sales feature.

Your microphone problem can be solved by one of Brush's many models, ranging in purpose from public address to laboratory standards. Types B-1 and BR2S, two most popular Brush P. A. microphones, recently reduced from \$32.50 to \$26.50 and \$37.50 to \$29.50 respectively.

*Write today for complete details.*

**The BRUSH**  
*Development Company*  
3318 PERKINS AVENUE  
CLEVELAND OHIO

AR26



AR43

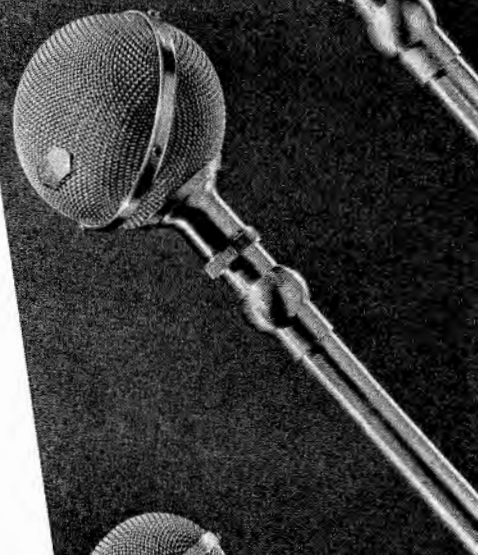

BR2S



B1

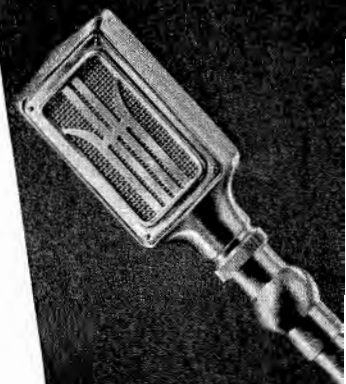

# DISC RECORDING

## Record Processing

By T. L. DOWEY

THE EXACTING REQUIREMENTS of transcription recording with respect to sound quality and surface noise are reflected in the precision and refinement of the processing employed in making the finished records. The speed requirements of transcription work have also led to interesting new developments in this connection. In the last article of this series it was pointed out that the revival of the vertical modulation method for disc recording by the Bell Laboratories was based on fundamental studies intended to effect a consistent all-around improvement in disc recording. In pursuing this program, it was realized that while the advancement of quality by the adoption of better methods of modulation and better recorders and reproducers was one step of fundamental importance, the improvement of the signal-to-noise ratio was equally essential. While boosting of the recording characteristic at the high end permitted some improvement in this respect, as explained in a past article<sup>1</sup>, it was felt that the problem could not be considered satisfactorily solved unless fundamental advances could be made in the processing steps and the record material, corresponding to the progress in recorders and reproducers.

The functions of disc recording processing can be considered in three divisions:

1. To prepare a suitable surface to receive the record engraved by the cutting stylus.
2. To make the recording permanent.
3. To reproduce any number of copies of the original recording in such form as to permit their reproduction.

The second step includes protection of the permanent record against damage or corrosion so that under no circumstances will the original recording be totally lost.

<sup>1</sup>"Disc Recording—Equipment and Its Quality Requirements," by T. L. Dowe, p. 17, COMMUNICATIONS, October, 1937.

This necessitates an intermediate step between the permanent record, or "master," and the production of the final pressing. This intermediate step consists of making a duplicate of the master, called a "stamper," which will take the wear and tear entailed by the stamping process used in making the copies used for reproduction. The master, of course, represents an investment of time and money too great to be exposed to deteriorating influences that can be avoided by any reasonably practical means. The third function includes production of special pressings for specific purposes such as testing and re-recording, and the production of a large number of copies at a minimum cost.

The above functions are similar to those of the commercial processing plants for lateral recording. The developments described below were necessitated by the fact that existing commercial processing methods did not produce results that would meet the quality limits of vertical disc recording. The variations from the commercial procedures for lateral recording described in this article permit the above steps to be carried out without impairing the vertical disc quality.

The description of the process that follows is divided in the same manner that the operations in the plant are divided, for reasons of process function or equipment requirement (Fig. 1).

### WAX FLOWING

Wax flowing is the title of the operation which produces the surface necessary for recording purposes. This operation consists essentially in flowing melted wax over a level surface, producing on a metal plate a wax coating with a surface which is smooth and flat and suitable for recording purposes. The principal reason for using this form of material is to provide a medium

Fig. 2. The cleaning and chromium-plating equipment.

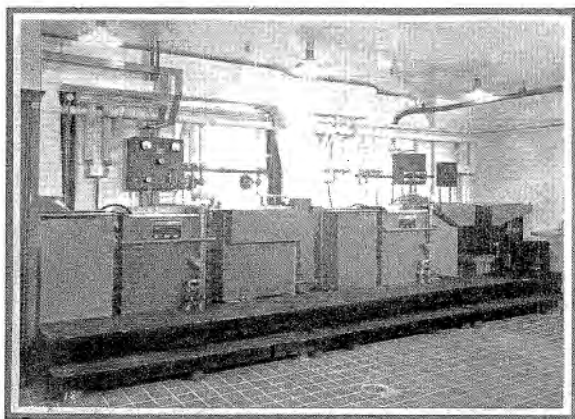
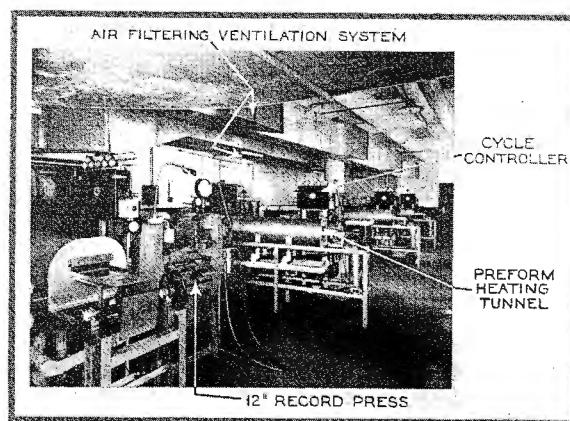
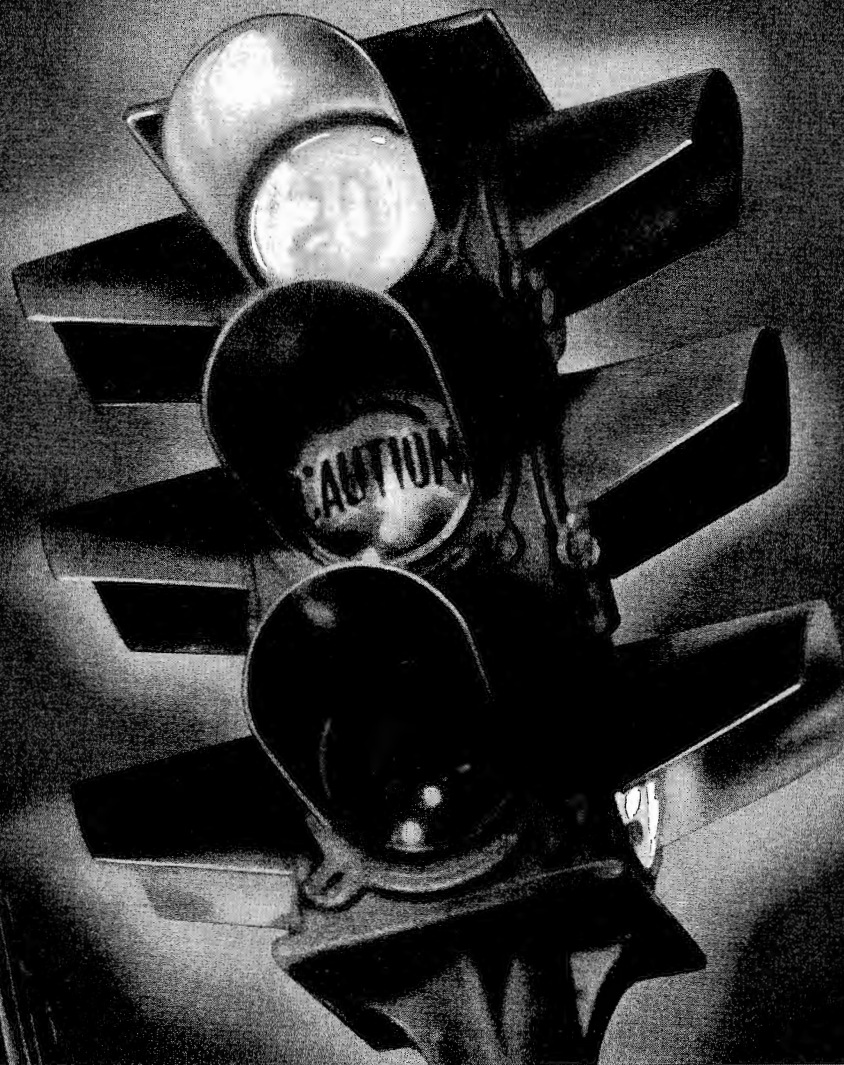
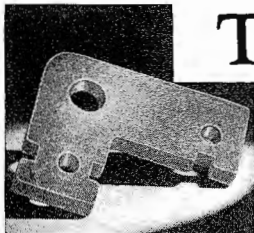

Fig. 3. A press room for molding vertical disc records.





## THIS EYE NEVER SLEEPS



**T**RAFFIC LIGHTS must be dependable because they control the safety of wave after wave of travelers at

cross purposes. That is one reason why *Synthane* Bakelite-laminated is used for insulating traffic light circuits—that plus *Synthane's* combination of mechanical strength, low moisture absorption and

high dielectric strength. *Synthane's* great value lies in its unusually broad combination of physical, electrical, chemical and mechanical properties. *Synthane* is a uniformly dense, solid material. It is tough, strong and light in weight; one of the most effective dielectric materials—combining low power factor, low moisture absorption, high dielectric strength and low dielectric constant. It is chemically inert; corrosion resistant; easy to ma-

chine. The uses for *Synthane* are countless. Just as its combined properties are necessary for insulating traffic lights, so it may be of *material* assistance in the manufacture of your product. *Synthane* is often the most economical material to use. Write for "*Synthane* for Mechanical Applications", telling us in your request your requirements.

**SYNTHANE CORPORATION, OAKS, PENNSYLVANIA**

**SHEETS • RODS • TUBES • FABRICATED PARTS • SILENT STABILIZED GEAR MATERIAL**

**SYNTHANE**  
Bakelite — laminated

which can be engraved by the cutting stylus without undue pressure on the latter, and which has a surface of high polish that is free from residual strains of the type produced by a shaving tool. These strains might distort the groove if they normalized after the engraving. The form of the "recording blank," as the prepared wax surface is called, facilitates safe handling of the recording throughout the process. The master is electroformed on the wax surface of the recording, and on its completion the master and wax are stripped from the metal flowing plate. This leaves a layer of wax on the surface of the master, which affords mechanical protection to

placing it on the flowing platen and melting a sufficient amount of recording wax on its surface to form a liquid film about 0.020-inch thick. This film is allowed to "level" and then it is chilled in such a manner as to preserve the liquid level of the molten wax. It is essential that the flowing table be leveled accurately, that the flowing disc be of uniform thickness and of smooth surface, and that the recording wax have suitable physical characteristics with respect to its solidifying qualities, so as to permit the preservation of the original liquid surface. The wax must be perfectly clean and the air in the flowing room must be completely filtered, as in-

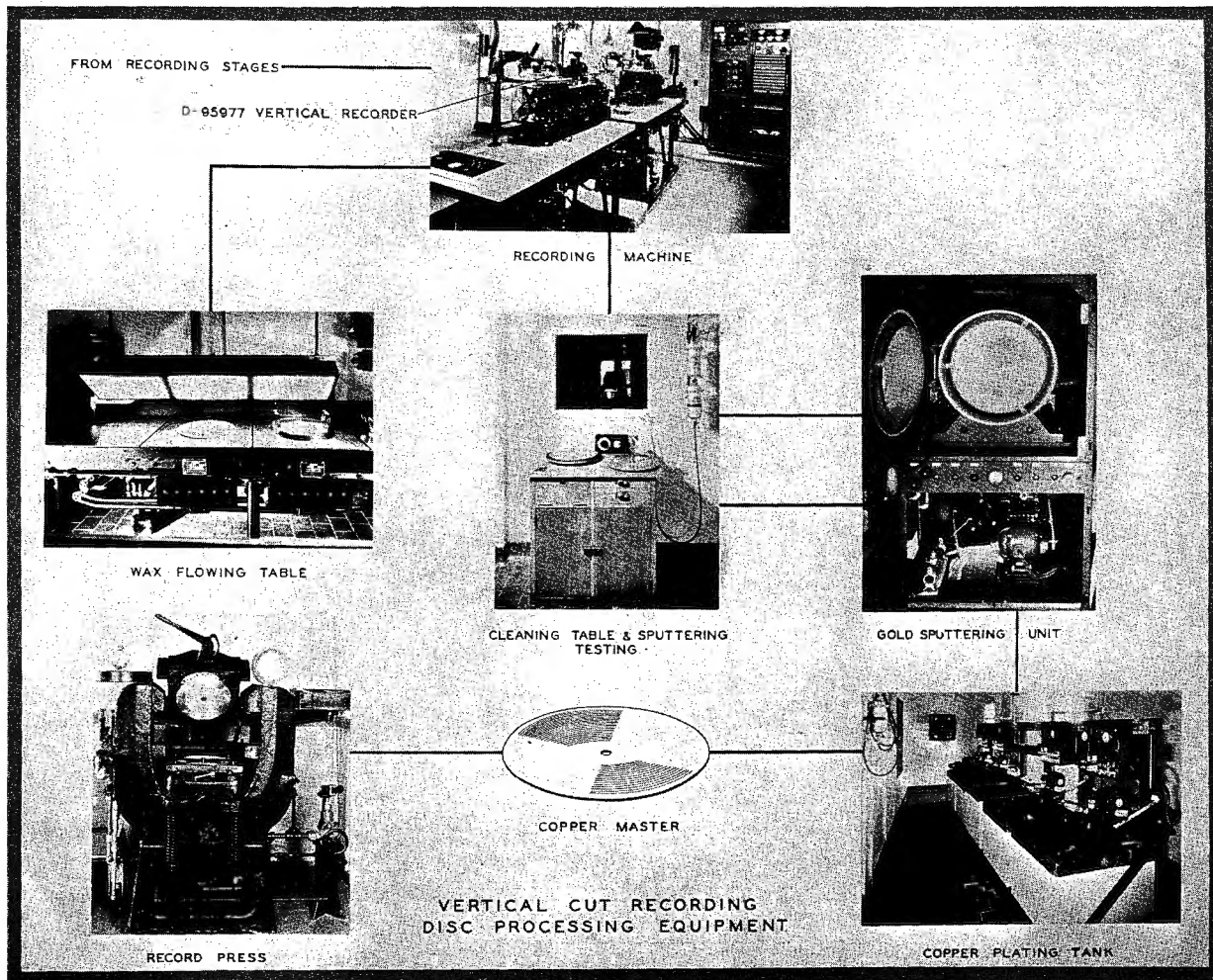

Fig. 1. Vertical cut recording disc processing equipment, showing recording machine, wax-flowing table, cleaning table and sputtering testing, gold sputtering unit, etc.

it for the rest of the process. This wax also prevents contaminating materials from touching the surface and in this manner assists considerably in the ultimate cleaning of the master surface.

The metal plates referred to are flat discs of steel or brass, with a suitable protective finish, and of a diameter somewhat larger than the finished recording. They are thick enough to prevent bending or warping during the processing operation. The flowing operation is carried out on a hot level platen. The platen is heated by steam or electricity under careful temperature control. A corresponding water-cooled platen for chilling the flowed disc, or facilities to chill the flowing platen, are provided. The operation consists of heating the flowing disc by

clusions of foreign matter in the recording blank cannot be tolerated because of the noise introduced. It has been found that both the temperature and the humidity of the air in the flowing room have a definite effect on this operation. It has been found profitable to provide air-conditioning equipment for commercial installations. Although the recording blanks prepared in this manner have a limited storage life and are relatively fragile for shipment, special means have been developed whereby storage and shipment have been carried out satisfactorily on a commercial scale. Upon completion of the process, the discs are cleaned and returned to be flowed again.

Recording with a flowed blank incorporates certain technique which has already been described<sup>1</sup>. Points not

# When Better Transformers Are Made



**WILL MAKE THEM . . .**

It is interesting to note the great number of sensational, new developments advertised by contemporary transformer manufacturers.

Close scrutiny will generally show the new development as an imitation of designs and features originally initiated by UTC.

Examination of the major improvements in transformers over the past few years will readily substantiate this:

**1933**

### HIGH PERMEABILITY CAST SHIELD

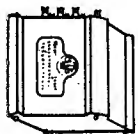

(TOP AND BOTTOM MOUNT)  
Used by UTC since 1933, the high permeability cast shield has been copied extensively by other manufacturers since that time.

**1933**

### HUM BALANCED COIL STRUCTURE

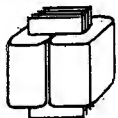

Used by UTC in practically all High Fidelity designs, hum bucking and hum balanced transformers are now accepted as standard practice in the transformer field.

**1934**

### UTC LINEAR STANDARD AUDIO UNITS

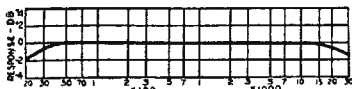

Flat from 30 to 20000 cycles . . . a goal for others to shoot at.

**1934**

### PORTABLE UNITS

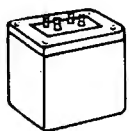

The UTC HIPERM ALLOY group of transformers were brought out to take care of portable high fidelity requirements. Other manufacturers naturally tried to copy these.

**1935**

### ULTRA COMPACT AUDIO UNITS



Developed originally for Aircraft and Hearing Aid Devices. In 1936 an entire series of these units were released for Broadcast Station applications. Ultra compact audios are HUM BALANCED, weigh from 4½ to 5½ oz. and are guaranteed  $\pm 2$ DB from 30 to 20000 cycles.

**1936**

### SEXTUPLE SHIELDING

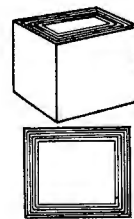

To effect maximum magnetic shielding, UTC developed, in 1936, an arrangement of NESTED CANS which had high shielding effect and was sold under the designation SEXTUPLE SHIELDING. Even the name has been copied! This was improved and evolved into TRI-ALLOY SHIELDING.

**1937**

### TRI-ALLOY SHIELDING

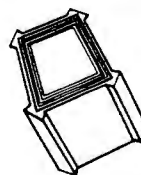

The combination of Linear Standard frequency response and internal TRI-ALLOY magnetic shielding is a difficult one to approach. That is why these units are used by G.E., R.C.A., Philco, Western Electric, Westinghouse, M.G.M., Walt Disney studios, and other discriminating organizations.

**WRITE for the new UTC broadcast bulletin describing transformer, equalizer and amplifier components for every broadcast and recording application.**

*Imitation is the sincerest form of flattery*

**UNITED TRANSFORMER CORP.**

72 SPRING STREET

NEW YORK, N. Y.

EXPORT DIVISION: 100 VARICK STREET, NEW YORK, N. Y. CABLES: "ARLAB"

already indicated are that the temperature of the blank should be controlled carefully by means of temperature-regulated storage cabinets, both before and after recording. After recording, the wax should be forwarded to the next processes with as little handling as possible, so it is preferable to have the recording room and the processing rooms adjacent and, if possible, to have the recording processed to the first protective coating without leaving air-conditioned rooms.

### GOLD SPUTTERING

Gold sputtering identifies the process by which the wax surface of the recording is "metallized" to render it electrically conducting. This permits the recording to be used as a cathode in the ensuing copper electroplating step which forms the master<sup>2</sup>.

The reason for the use of this method of metallizing is that the surface noise obtainable with the other commercial methods is so high that it becomes a limiting factor which restricts the volume range obtainable with vertical disc. It is believed that the surface noise introduced in other methods of metallizing is caused by the use of discrete particles of conducting material, such as bronze powder or graphite dust; there is also a practical disadvantage in that the operation is a manual one, requiring considerable skill in its application. Other methods which involve precipitation of a metal from its salt solution onto the surface of the wax seem to give results comparable with the so-called "graphiting" methods. The film of gold produced on the surface of the wax by cathode sputtering is thin enough to limit the possible variation caused by the metallizing agent to the order of molecular size, rather than the particle size of powdered mediums. It follows that the disturbing modulation of the reproducer stylus due to the metallizing medium is considerably less for gold sputtering than for other methods. Development of the gold-sputtering apparatus to its commercial form has allowed a speed of operation which compares favorably with the usual commercial practices for metallizing. Considerable operation in the commercial field has brought the sputtering technique to a point where the certainty of the results compares with the rest of the process, and gauges have been developed to indicate and control the uniformity of the product.

An additional feature allowed by gold sputtering is that the sputtered gold film adheres to the surface of the copper master as though plated on it, and provides corrosion resistance during the process, until it is replaced by additional protection as described later.

The sputtering-room equipment is shown as the cleaning table and gold-sputtering unit in Fig. 1. On the cleaning table the recording is inspected by the sputtering operator and, when necessary, additional identifications are engraved. The recording is inspected for dirt and chips that may have been left from the recording room and, if found, they are removed. The gold sputtering unit consists of a vacuum chamber mounted in a protective framework, the bottom of which houses vacuum-pumping equipment. An electric circuit to provide voltage to create a gaseous discharge in the vacuum chamber is mounted behind the chamber with a control panel on the front of the cabinet. When the top cabinet door is open the vacuum chamber door may be swung open, as shown. On the door is mounted a gold cathode, and in the chamber is shown a recording mounted on an internal platen arranged parallel to the surface of the gold cathode. An anode is located behind the mounting platen. In operation, the chamber door

is closed with a special seal and the pumps started. When the vacuum gauge indicates a suitable pressure, the voltage is turned on and a gaseous discharge is set up in the chamber. This can be observed through a glass port in the chamber wall.

The gaseous discharge indicates the formation of positive ions in the chamber. Sputtering of the metallic gold is believed to be caused by the bombardment of the surface of the cathode by these positive ions under the influence of the exciting voltage. The bombardment of the ions detaches particles of gold from the cathode, and as the recording is placed between the cathode and the anode in the manner of a target, these gold particles impinge on the wax surface and eventually form a thin coating. Tests seem to indicate that the sputtered film is homogeneous, and structurally forms a continuous metal sheet. The operator gauges the operation of the machine by observing the character of the discharge, and by metering the electric circuit. The quality of the finished product is gauged by a measurement of the electrical resistance of the sputtered film which is carried out on special equipment mounted on the cleaning table.

It is essential to have the sputtering operation carried out in a dust-free atmosphere and it has been considered advisable to provide air-conditioning equipment. The sputtered recording is taken directly to the next step in the process with as little delay as possible.

### PRE-PLATING

Pre-plating describes the operation of covering the sputtered recording with a thin plating of copper to give the surface an immediate though temporary protection with metal of a suitable nature to form a master surface. The commercial load in the recording room varies considerably, and usually the capacity of the recording and sputtering machines exceeds the momentary capacity of the copper equipment. However, as the copper processes can operate continuously on a twenty-four hour basis, it is possible for the recording room to operate at capacity for part of the time if the load can be evened by temporary storage after pre-plating. The immediate protection of the surface insures a minimum of exposure of the sputtered recording to the non-air-conditioned areas in which plating equipment is located. It is possible to remove from the pre-plated recording, dust, dirt, and contaminating substances which might cause serious damage in case they fell on the wax or the gold surface.

Copper deposition for the formation of the master is inherently a dual operation, as the primary deposition must be of a fine-grained structure with strength and hardness characteristics not compatible with the conditions for economically electroforming copper at a fast rate. The presence of a fine-grained pre-plate will stimulate a fine growth of copper in the remainder of the structure, even though the latter is deposited at a high rate. Therefore, the conditions in the pre-plate tanks are controlled for the formation of fine-grained copper at low speed. On the other hand, as described in the following section, the conditions in the copper-forming work are maintained to allow maximum speed of deposition in order to shorten the overall processing time.

The equipment used in pre-plating is identified as "Copper Plating Tank" in Fig. 1. This shows an installation of four pre-plating tanks. Each of these is essentially a rubber-lined steel plating tank, mounted in a rack which supports the auxiliary equipment. This equipment consists of a rheostat for plating current control, a tilting platform holding a motor drive for rotating the cathode, bus-bar connections for the plating current,

<sup>2</sup>"Vertical Sound Records," by H. A. Frederick, *Journal of the S.M.P.E.*, February, 1932.

# Transmitting

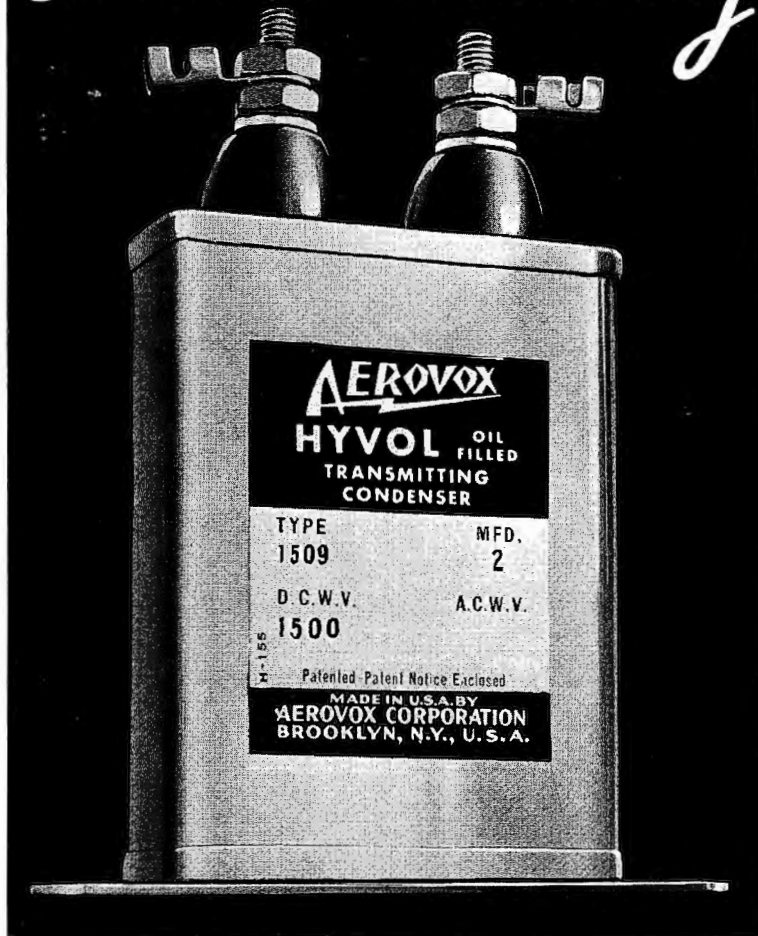

**A**EROVOX prefers to speak in terms of *actual performance* rather than glowing claims. There are millions of AEROVOX condensers or capacitors in daily use. Let those units *you* come across *tell their own story* of dependable, economical, care-free service.

Meanwhile, consider these new HYVOL oil-filled capacitors for transmitting and other high-voltage applications. Using an exclusive super-dielectric oil. Fine linen paper. Selected foil. Properly tensioned windings. High-tension pillar terminals. Heavy welded steel rectangular cases. Quality—at mass-production prices. 600 to 3000 v. D. C. working. .1 to 4 mfd.

## CONDENSERS and RESISTORS

● HYVOL capacitors are also offered in round-can ring-mounted type. Aluminum container. High-tension pillar terminals. 1 to 4 mfd. 1000 to 2000 v. D.C. working.



● Popular inverted - mounting HYVOL unit. Same size as usual electrolytic. Grounded can may be insulated with insulator washer. 600 to 1500 v. D.C. working. .5 to 4 mfd.

● Molded bakelite mica capacitors. Several types to choose from. Screw terminals or soldering lugs. 1000 to 10,000 v. D.C. test. Popular capacities.



● Porcelain - case mica capacitors. Rated in maximum current-carrying capacity at several high frequencies. 2000 to 12,500 v. D.C. test. Popular capacities.

● AEROVOX also offers a line of essential resistors ranging from tiny lacquered carbon and bakelite jacketed carbon resistors, to fixed and adjustable wire-wound vitreous-enameled resistors handling up to 200 watts.



**Write . . .**

Copy of latest catalog covering the most extensive line of capacitors and essential resistors, sent on request. Submit your engineering problems.



# AEROVOX CORPORATION

70 WASHINGTON STREET, BROOKLYN, N. Y.

Sales Offices in All Principal Cities



and acid-proof pipe lines for circulating the electrolyte. Not discernible in the illustration are the anode mountings, which contain the supply of copper being plated and are submerged beneath the electrolyte. The recording is mounted on a supporting spindle which, in turn, is fitted into the rotating mechanism, and thereby suspended while rotating with the recorded surface down in the electrolyte. The action is essentially that of copper electro-plating, the unusual features being means of protecting the recording from possible damage, careful control of electrolyte conditions, and careful cleanliness. The pre-plating operation is normally completed in half an hour, whereupon the pre-plated recording is removed from the tank, washed, dried and placed in cabinets to await its turn in the next step.

### COPPER-FORMING

Copper-forming denotes the step in which the plating is completed to the full thickness of the master by high-speed copper electroforming. It is necessary to form the copper to a thickness of 0.030 to 0.065 inch, depending upon the requirements of the pressing equipment. Practically all commercial work is completed to the heavier weight. The requirement is generally set by the need for a master thick enough to be machined to fit in the record molds in production pressing and to stand the strain of such work without danger of damage. It is essential that the copper be of a proper hardness so that it will not crack or deform in the pressing operation and that its grain structure be uniform throughout. It is also important that the thickness of the copper across the master be uniform. Copper masters have been formed in equipment of the pre-plate type and have been satisfactory in every respect, except that the time required is too long to suit the commercial need. In general, commercial copper-forming requires considerably more than twenty-four hours and, as this was felt to be too long, special equipment was developed to speed up the process.

Generally speaking, commercial copper deposition for recording masters is carried out at around 15 amperes per square foot of cathode surface. References on the subject indicate that, given the proper conditions, this rate of deposition could be increased considerably. In fact, work was done in 1912 to indicate that copper deposition could be carried out at 4000 amperes per square foot given the proper conditions. In analyzing these conditions, it was indicated that an equipment essentially the same as the pre-plate apparatus, as regards fundamental operation, but with considerable increase in the auxiliary services to maintain proper operating conditions, would permit the forming of copper masters at a much higher rate. Machines were built on this basis and their operation to date has given an increased rate in production of masters that has been of considerable value commercially. In designing the machine, it was essential to insure safety for the recording in the event of the failure of any of the auxiliaries, or the machine itself, and to provide means of measuring and controlling the conditions incident to the deposition of the copper. It was also found advisable to provide a deposition thickness gauge in the form of an ampere-hour meter, in order to hold the master within its limits of thickness. The overall operation of the machine has indicated that the power consumption per master is higher, which is to be expected, as the anode-to-cathode voltage is higher at the increased currents. The efficiency of the machine, however, as regards the consumption of copper per master indicates a considerable improvement over former methods used, as it is possible to eliminate considerable waste in finishing the master by

controlling the thickness of the deposit. The quality of the copper in normal operation compares favorably with the results obtained in the more standard types of plating tanks, as it is possible in practically all cases to make a test pressing directly from the formed master without a finishing operation on its back. The close control maintained on operating conditions allows a controlled variation in the characteristics of the copper to meet certain specific requirements of the master finishing and pressing operations.

### MASTER FINISHING

Master finishing covers a number of stripping, machining and finishing operations on the copper master which convert it from a rough copper-plated shell on the flowing disc to a finished master with parallel surfaces and a true center hole and periphery, whose thickness and size fall within predetermined limits. The centering and trimming operations insure that the center hole in the finished pressing will be concentric with the recording. This is accomplished by punching a center hole in the master by means of an optical centering jig that is accurately centered with the concentric groove cut by the recorder at the end of recording. The periphery is cut on an accurate circular shear to be concentric with the center hole. If a test pressing is all that is required from the master, the back is not finished unless there is some unusual irregularity. If there is any irregularity or the master requires back finishing to fit the requirements of the record mold, it is carried out at this stage by means of special sanding or lathe-turning equipments.

### CLEANING AND CHROMIUM-PLATING

Cleaning and chromium-plating identifies the step in which the surface of the finished master is finally cleaned and protected with a surface of deposited chromium. When the wax is removed from the gold surface of the master, by stripping or solvent means, it has been found that residual material is left on the master which will cause interference and surface noise in the resulting pressing. It has been determined that the best cleaning is of the molecular type used to prepare surfaces for electro-plating. This is generally done by a combination of solvent and electro-caustic cleaning methods.

In order to preserve this surface and insure that corroding materials will not harm it, and also to enable it to resist the abrasion of the pressing operation, it has been found advisable to deposit a thin layer of chromium on the surface of the master. The surface-noise requirements in vertical-disc recording are such that the cleaning and chromium-plating operations carried out for this purpose must be under very careful control in order to give a satisfactory result. For this purpose, therefore, special equipment was designed and assembled in a production line, as shown in Fig. 2. The masters are mounted, a pair at a time, in special handling racks, to insure against their surfaces being scratched on the equipment. In the equipment shown, they start at the right-hand end of the line, passing through a solvent and electro-caustic cleaning process across to the chromium-plating tank, which is shown third from the left. Subsequent washing is carried out in remaining tanks and the work is dried in an oven. The conditions surrounding the deposition are controlled carefully to give a chromium deposit of such a character that it will withstand the pressing operation without undue wear or cracking.

Test pressing indicates the production of a pressing as soon after completion of the master as possible, as



Let CLAROSTAT

Solve

YOUR RESISTANCE PROBLEM

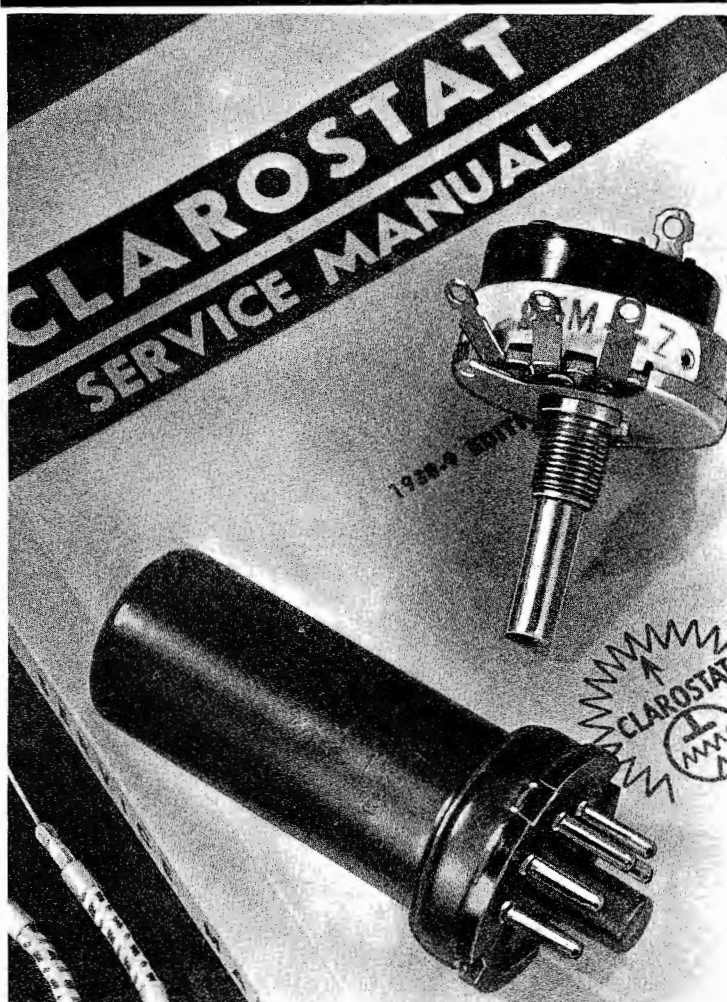

FROM beginning to end, CLAROSTAT will collaborate with you in the solution of your resistance problem. As resistance specialists, working on nothing else but resistors and resistance applications, CLAROSTAT places at your disposal a specialized background second to none.

And whatever the engineering verdict may be, the CLAROSTAT plant stands ready to produce the necessary resistor or resistance device—properly, promptly, economically.

And when your set or assembly is out in the field, in everyday use, CLAROSTAT years later continues to serve you by providing servicemen with exact-duplicate replacement controls and ballasts for servicing. Your good will is thus maintained with trade and public. And at no cost to you.

### Write for DATA . . . . .

Loose-leaf engineering data handbook on resistors and resistance devices is yours for the asking. Likewise the CLAROSTAT Service Manual just issued for servicemen. Meanwhile, submit those problems.



**CLAROSTAT** *Manufacturing Co. Inc.*



285-287 NORTH SIXTH STREET  
BROOKLYN, NEW YORK, U.S.A.

• OFFICES IN PRINCIPAL CITIES •

mentioned at the beginning of this article. The test pressing gives the first positive check on the overall commercial value of the recording, as it indicates what will be the character of the production pressings. A file of test pressings acts as a safeguard, because in the event of damage to the master, a new master can be obtained by re-recording from the test pressing. The chief requirements for test pressing are speed and flexibility. In some cases, also, special requirements regarding the masters or pressings necessitate pressing procedures which could not be carried out in production presses.

The flexibility required for test pressing work necessitates the test press being manually controlled by a skilled operator. A special mold has been developed which permits the insertion of the master with minimum time and mechanical requirements. The material used for the test pressing is Vinylite, the same as used for production pressing, and which will be described in more detail. Equipment of this type is shown as "Record Press" in Fig. 1. This sort of equipment allows production of a test pressing within a few minutes after completion of the master.

The completed test pressing is checked by the recording test man for errors in recording or processing. For this purpose he is equipped with a high-quality reproducing set. He judges the record for quality, surface noise and eccentricity, by listening and visual inspection, and for any detectable errors in recording or processing. If the pressing passes this test, it is forwarded to the customer, for approval of the program as a whole and for instructions as to completion of production pressings.

Stamper is the term given to the duplicate of the master which is made for the purpose of protecting the valuable master by substituting for it in the pressing step. Sometimes additional stampers are made so that several presses may be operated simultaneously to speed up production of a certain record. It has become essential that the process of making a stamper be completed quickly. As mishaps in the pressing operation will at times interrupt production by damaging the stamper in use, a replacement must be made from the master as soon as possible, if schedules are to be met. In some cases, where a large number of pressings are required from the stampers, they will wear so that they are not suitable for further production.

The step involves the production of a positive image of the master (which is a negative of the recording) and is carried out commercially by making an electro-deposited copper duplicate. This process was considered unsuitable, as even with the high-speed forming machines it was too slow. A means of forming a positive replica of the master in a few minutes has therefore been developed. This replica (or "mother") is processed in the manner of a recording. This results in producing a copper duplicate master, or stamper, in about the same time as required for processing a recording to a master.

The process has also the additional advantage that the stampers produced by it afford better sound quality than those made by the slower commercial process. In its final form, the stamper is almost identical in appearance with the master and generally is stamped with an identifying number. The stampers are generally finished to relatively close limits in order to facilitate setting them up in the production pressing molds.

Production pressing is the term applied to the bulk of the pressing work to distinguish it from test pressing. It is carried out on special equipment to insure the production of the volume required, at a rapid rate, with uniform characteristics, and at a minimum cost.

The commercial sales of this type of record vary considerably, and therefore also the number required for each set-up of the master in the press. Speed in setting up the master gives a commercial flexibility that is quite useful. In order to effect this, special molds have been designed to allow quick set-ups.

Special material was adopted for pressing vertical disc records in order to conserve the advantage of the low surface noise inherent in the vertical disc master, to insure reproduction of the full frequency range as originally recorded, to obtain freedom from warping under a wide range of temperature and humidity variations, and to insure wearing characteristics which would give a long life to the record and to the reproducing stylus. The material selected is known commercially as "Vinylite." It is a synthetic resin of the vinyl ester type, polymerized to give certain characteristics, and compounded to give additional characteristics, color, and stability. It is received from the supplier in the form of powder and is used in the form of the unfilled resin.

In order to meet the requirements of vertical disc reproduction in pressing this material, it is necessary to preform the powder and to pre-heat the mold charge. Special presses and oven equipments are provided to accomplish this.

A general view of a press room for molding Vinylite vertical disc records is shown in Fig. 3. The presses are operated by hydraulic pressure and the record molds, which support the stampers, are heated with steam. The temperatures, pressures and timing of the operation are critical for Vinylite record pressing, and it has therefore been found desirable to provide automatic controls for the entire pressing cycle. This controller system incorporates safety devices to prevent damage to the stampers in case the press operator interrupts the normal operation of the cycle.

The press operator gives the record a preliminary visual inspection. Its edge is then trimmed on a special lathe and sent to the test room. The record test man gives it a final check, including reproduction of the sound, and if the record is satisfactory it is sent to the shipping department. There it is checked with the shipping schedules and forwarded to the broadcasting station.

## BELGIUM BROADCASTING CENTER

BELGIUM is to have one of the largest and most modern broadcasting centers in Europe in the new centralized studio buildings constructed by the Belgian Broadcasting Corporation at Brussels. The buildings are completed and the tremendous job of equipping them with all features for up-to-the-minute broad-

casting technique and program control is in progress.

The order for the entire radio and speech-input, and electrical equipment, including the telephone system and the automatic fire-alarm system, has been placed with Bell Telephone Manufac-

turing Company of Antwerp, subsidiary of the International Telephone and Telegraph Corporation. The equipment represents extensive collaboration by the Technical Department of the Belgian Broadcasting Corporation and of the Laboratories of the Bell Telephone Manufacturing Company.

## ROCHESTER FALL MEETING

(Continued from page 22)

ever, as improvements are made in electron focusing systems, the space-charge limitation may account for a large portion of the spot size. Results show that for a circular beam having a given current, voltage, and initial angle, there is a resultant minimum beam diameter at the focal point which can not be reduced by changing the radial component of the focusing field. The value of the minimum beam diameter is nowhere zero and increases rapidly with distance between the focusing field and the focal point. In contrast, for a rectangular beam with one dimension infinite, the minimum beam width depends upon the perpendicular component of velocity supplied by the focusing field. The beam width may be zero up to a given distance from the focusing field and beyond this distance the minimum beam width increases with distance from the focusing field.

The presence and detection of negative ions in the beam of a high-vacuum cathode-ray tube were discussed by C. H. Bachman and C. W. Caranahan, Hygrade Sylvania Corporation, in their paper "Negative Ion Components of the Cathode Ray." Mass spectographic analysis has been applied to separate the negative ion components. Their probable sources and effect on the screen were considered.

A. F. Murray, Philco Radio and Television Corporation, reported on the new television standards that have been added to the list of standards adopted last year by the RMA Television Committee. He also discussed the new television frequencies recently set aside by the Federal Communications Commission.

"Vibrational Tube Analysis" was the title of an interesting paper presented by A. B. Oxley, RCA Victor Company, Ltd. Mr. Oxley pointed out the disadvantages of present methods of testing tubes and described and demonstrated a tube-testing apparatus which consisted essentially of a beat-frequency oscillator, a vibration platform for the tube, and a cathode-ray oscillograph to indicate the effect of the vibration. The apparatus appeared to have considerable merit, especially since its use will show up a number of conditions not indicated by present methods.

The paper entitled "Measurement of Characteristics of Automobile Antennas," and presented by H. Lyman, Philco Radio and Television Corporation, attracted considerable attention. Discussion was contributed by H. C. Forbes, Colonial Radio Corporation; D. E. Foster, RCA License Laboratory,

(Continued on page 40)

# The Gates Studio'er

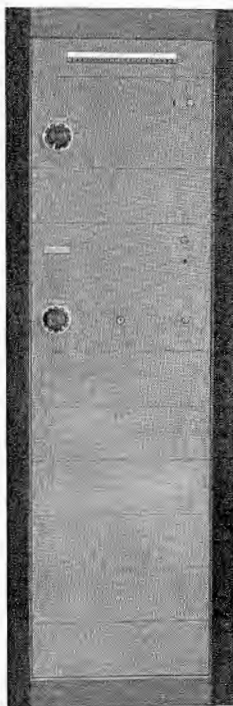

### Main Equipment Cabinet

Contains 20 position interlock patching system, monitor amplifier with self contained power supply, relay talk back and bridging panel, high gain high fidelity line amplifier with self contained power supply, three pre-amplifiers with universal input (room for two additional pre-amplifiers), rectifier for relays and studio warning lights and so constructed that entire equipment may be placed into service after a few minutes time.

Write on your station letterhead for Bulletin 82.

In new speech input equipment an experienced engineer will require (1) excellent quality of all parts, (2) a flat response curve and hum free output, (3) proper segregation of the various departments of the equipment such as line amplifier, monitoring amplifier, etc., and (4) neat modernistic appearance so that his equipment may be placed in that part of the studios that he desires without creating unsightly appearance.

The new Gates Studio'er is built exactly as experienced broadcast engineers want equipment. Loads of features—many exclusive, full size massive design, with plenty of room for use of full sized parts and proper segregation of these parts plus that type of appearance that will immediately take the eye as strikingly beautiful.

We suggest that before you purchase any speech equipment you investigate the Gates Studio'er. You will marvel at such fine equipment at the low price tag attached.

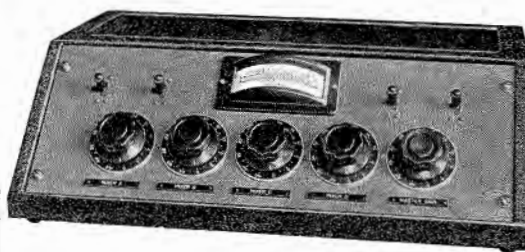

### CONTROL CONSOLE

Has four wiping contact mixing positions, master gain, keys for handling eight input circuits direct as well as talk back and studio warning light system and the new exclusive 5" edgewise V. I. meter. Panel at 45° slope for ease of control.

**GATES RADIO & SUPPLY CO.**  
MANUFACTURING ENGINEERS SINCE 1922  
**QUINCY, ILLINOIS, U.S.A.**  
CABLE ADDRESS (GATESRADIO)

*The Time Proven Line*

# THE MARKET PLACE

NEW PRODUCTS FOR THE COMMUNICATIONS FIELD

## CRYSTAL MICROPHONE

The Turner Company have announced a new crystal microphone, the Model T-9. It features a new shock-proof cartridge. The characteristics of the unit makes it suitable for both voice and music. The output level is -53 db.

Additional information on the Model T-9 may be secured from *The Turner Company*, Cedar Rapids, Iowa.—COMMUNICATIONS.

## MONEL WITH EBONY FINISH

Research engineers of the Huntington works of The International Nickel Company, Inc., have produced "Ebonized" Monel with an ebony finish designed for use where appearance must be maintained under temperatures up to 1,400° F. The material is identical with standard Monel except that a lustrous "blue-black" finish is imparted in a specialized oxidizing operation.

Additional information may be secured from *The International Nickel Company, Inc.*, 67 Wall Street, New York, N. Y.—COMMUNICATIONS.

## MIDGET COMPOSITION-ELEMENT CONTROLS

Starting with scratch, without attempting to boil down or make use of the usual full-sized design, Clarostat engineers have developed a new midget variable control. Known as the Series 37 and 37-S (with switch) controls, these units fit in assemblies where space is at a premium.

Smooth operation is said to characterize these midget controls, due to the contact arm. There is a full 300-degree effective rotation. Both composition element and contact arm provide for quiet operation. Resistance values are permanent. The latest improved technique in carbon coating is said to assure immunity to moisture and climatic conditions.

The tinned terminals are readily soldered. Units are available in linear and tapered resistance ranges from 1,000 to 5 megohms. Total resistance values are held within 20 percent, plus or minus, and closer when required.

Complete engineering specifications may be had by addressing *Clarostat Mfg. Co.*, 285 N. 6th St., Brooklyn, N. Y.—COMMUNICATIONS.

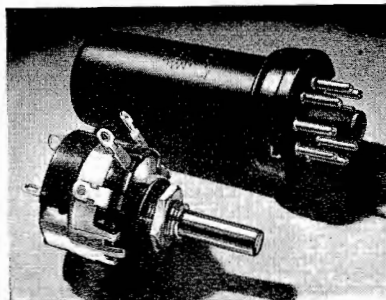

## VIBRATOR POWER SUPPLY

The success of the standard 6-volt series of Mallory Vibrapacks has resulted in a demand for a 12-volt vibrator power supply to be used on airplanes, busses and motor boats for powering radio transmitters, receivers, direction-finding equipment and other scientific apparatus.

To meet this demand the new Vibrapack, Model VP-G556, has been announced. It is designed for operation from a 12-volt storage battery, and delivers a nominal maximum output of 300 volts at 100 milliamperes, with three lower voltage outputs of 275, 250 and 225 volts instantly available at the turn of a switch. A special synchronous or self-rectifying vibrator is employed which provides excellent voltage regulation, long life and high efficiency.

In appearance the Vibrapack VP-G556 is very similar to the equivalent 6-volt Model VP-552, and all installation and operating instructions apply equally to both models, with the exception that the current drain of the VP-G556 is one-half that of the VP-552 because of the higher operating voltage.

An interesting technical data sheet on Mallory Vibrapack, called "Perfect Portable Power" may be obtained without charge from any Mallory-Yaxley distributor, or from *P. R. Mallory and Co., Inc.*, Indianapolis, Indiana.—COMMUNICATIONS.

## DUMMY ANTENNA

Tentative specifications for a new standard dummy antenna for receiver testing have been adopted by the IRE Standards Committee on radio receivers. Previously two dummy antennas were recommended to

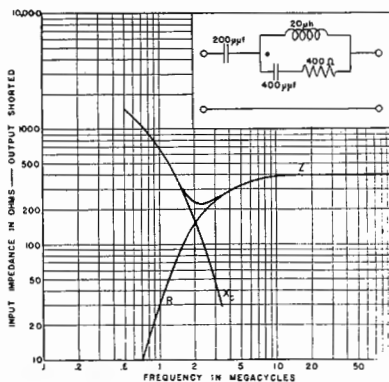

simulate the characteristics of a standard receiving antenna. One of these, intended for use between 540 and 1,600 kc, consisted of a series circuit containing 200 mmfd, 20 mh, and 25 ohms; the other, for use at higher frequencies, was a 400-ohm series resistance.

The standard dummy antenna shown here approximates both these characteristics. Its minimum impedance is 220 ohms, mainly resistive, at 2,200 kc. The impedance approaches 400 ohms resistive at higher frequencies. The circuit constants and impedance characteristics of the antenna are shown on the curve.

Additional information may be secured from the *General Radio Co.*, 30 State Street, Cambridge, Mass.—COMMUNICATIONS.

## CONDENSER BRIDGE AND ANALYZER

Incorporating many new features the new laboratory type Tobe condenser bridge and analyzer makes available a quick and accurate means of testing resistors and of determining the characteristics for paper dielectric and electrolytic condensers.

The a-c bridge circuit, allowing measurement of resistance values between one ohm and one million ohms and capacitance values between ten micromicrofarads and one hundred microfarads, utilizes an electronic eye as a balance indicator. An important feature of the instrument is the provision of a preamplifier stage ahead of the electronic eye and the use of a gain control in the preamplifier stage to allow adjustment of balance sensitivity for maximum speed and ease of operation. Another feature contributing to the facility with which the bridge may be used is the linear graduation of the main control dial. Because this graduation makes the readings absolutely uniform from one end of the dial to the other, the operator is always sure of the accuracy of his readings. Since the control dial of the bridge analyzer has one hundred even divisions and range extension is secured by means of a decade multiplier switch, the operation conforms to standard practices for laboratory bridge operation. All controls of the instrument are direct reading so that it is not necessary for the operator to refer to calibration charts or to make mathematical calculations.

For further data write to *Tobe Deutschmann Corporation*, Canton, Mass.—COMMUNICATIONS.

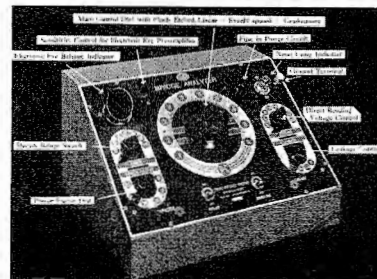

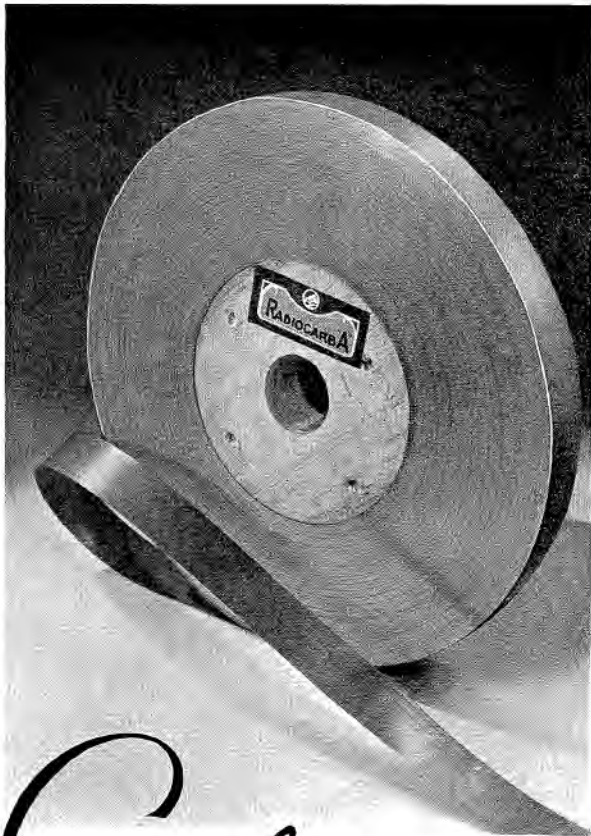

# Carbonized NICKEL



The almost perfect thermal radiator. The favorite material for receiving-tube plates or anodes. Laboratory-controlled RadioCarb A and other W.B.D. carbonized nickels insure:

- Jet black, smooth, adherent, flexible carbon coating that will not peel or dust off in subsequent fabrication.
- Free from loose carbon, slivers, waves, seams, rough edges, hydrocarbons. Minimized sulphur and other impurities.
- Available in all widths up to 6". Thickness from .002 to .020".

**ASK** for samples and quotations. Let us explain how you can save money and produce better tubes with W.B.D. carbonized nickels.

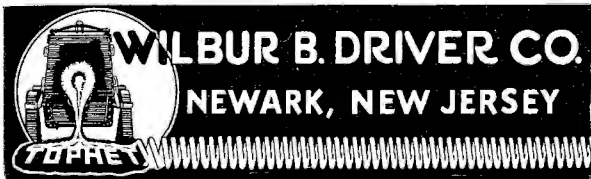

**MR.**  
*Engineer*  
**WE CAN FILL YOUR  
ORDER FROM A  
Blueprint!**

If you are stuck with a "tough one" . . . some particular piece of radio equipment you need, and can't get anywhere, it's dollars to doughnuts **WHOLESALE RADIO SERVICE** has it. But if it isn't in stock, we'll build it for you, exactly to specifications. *Wholesale can do it*—we're doing it every day for radio engineers from Siam to Seattle. Maybe that explains why Wholesale has complete stocks of over 50,000 radio items, why this is the "Largest Radio Supply House in the World."

Our staff of trained technicians *know their blueprints*. Perhaps you have a problem holding up your progress . . . whatever it is consult **WHOLESALE**. Use the services of our highly experienced men. There is no obligation on your part.



**MAIL COUPON FOR THIS  
FREE 180 PAGE CATALOG**

We suggest you send today for the 1938 Wholesale Catalog. It will make your next problem a whole lot simpler, because this catalog is the most complete radio reference book you have ever seen. It's **FREE**. Mail the coupon today!

**WHOLESALE RADIO SERVICE CO. INC.**  
NEW YORK, N.Y. CHICAGO, ILL. ATLANTA, GA.  
100 SIXTH AVENUE 901 W. JACKSON BLVD. 430 W. PEACHTREE ST., N.W.  
BOSTON, MASS. BRONX, N.Y. NEWARK, N.J. JAMAICA, L.I.

**WHOLESALE RADIO SERVICE CO., INC.**  
100 SIXTH AVENUE, NEW YORK, N. Y.

Rush **FREE 1938 Catalog No. 69-72L7**

NAME.....  
ADDRESS.....  
CITY.....STATE.....

PASTE COUPON ON PENNY POST CARD

# Yours FREE

**A TEN DAY TRIAL**  
of the  
**PRESTO WIDE RANGE INSTANTANEOUS RECORDING HEAD**



UNTIL you hear a record made with the Presto 1-B cutting head you won't believe that a frequency range of 50 to 6600 cycles can be played back uniformly from an instantaneous recording. You won't believe that surface noise on a lateral cut recording can be 40 db below the useful sound level.

SO WE SAY—ask for a free trial of the Presto cutting head. Make a record on a Presto Green Seal disc. Listen to it—measure the response. If you are not convinced that it is the finest cutting head you ever used, return it to us and receive full credit.

Take advantage of this exceptional offer today. In ordering specify the impedance required.

The Presto 1-B cutting head may be exchanged, at a special low price, for any cutting head previously furnished with a Presto recorder. It can be adapted to any recorder on the market.

# PRESTO

**RECORDING CORPORATION**

143 W. 19th St., New York, N. Y.  
Export Division (Except Australia and Canada)  
**M. SIMONS & SON CO., INC.**  
25 Warren St., N. Y. Cable: Simontrica, N. Y.  
Australia and New Zealand Agents and Stockists  
**A. M. CLUBB & CO., LTD.**  
76 Clarence St., Sydney, N. S. W., Australia

## TERMINALS

Two new types of terminals embodying several novel and useful features have been made available. These terminals are said

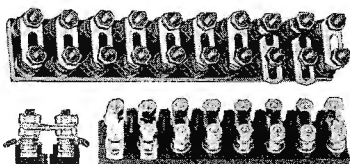

to be desirable for fire-alarm signalling, radio telegraph and telephone, motor-control services, etc.

The terminals are made in two general sizes. Each size comes in strips mounted on bakelite. One strip takes care of eight wires. This strip has sixteen posts and each wire is connected by slidable links for interconnection. Without the slidable links this strip takes care of sixteen wires. The larger size comes in strips for ten wires when used with slidable links, or twenty wires without slidable links.

The unique features of these strips is that they may be cut apart by a hack saw into smaller units, each circuit being provided with individual mounting screw holes so that any number of units desired are made available.

For further data write to *L. S. Brach Mfg. Corp.*, 55 Dickerson St., Newark, N. J.—COMMUNICATIONS.

## SVEACOTE

The Swedish Iron & Steel Corporation, 17 Battery Place, New York, N. Y., is offering a new rust resisting metal for internal vacuum tube use, known as Sveacote. It is Svea metal coated by the fused method with pure nickel in such a way as to result in complete coverage of a very effective nature.

The suppliers of this material claim for it all of the advantages to be obtained from any material offered for internal tube parts with none of the disadvantages resulting from segregations and impurities.

A bulletin, "Sveacote Data," gives detailed information on this metal. Write to the *Swedish Iron & Steel Corp.*, 17 Battery Place, New York City.—COMMUNICATIONS.

## PRECISION RESISTORS

Ohmite has just announced the Riteohm "71" line of vitreous enameled resistors. These one-watt units are said to have an accuracy of one percent and are for use in voltmeter multipliers, laboratory equipment, radio and electrical test sets, etc. Riteohms up to 50,000 ohms are only 1 3/4 by 3/8 inches in size and 7/16 by 2 inches up to 100,000 ohms.

The Riteohm 71 is single-layer wound, with special alloy wire, on a ceramic tube.



The ends of the wire are mechanically locked and brazed to the copper lugs.

For further information write to the *Ohmite Manufacturing Co.*, 4835 W. Flournoy St., Chicago, Ill.—COMMUNICATIONS.

# TELEVISIO

PRESENTS

The VC I Beat Frequency Oscillator



A radical departure in price for a custom-built product featuring

- Essentially flat frequency response.
  - General radio precision German silver control equipment.
  - Hand calibrated over a 3-month period.
  - Solid walnut cabinet.
  - Pure sine wave output at 500 ohms.
  - Finest material and workmanship guarantee satisfaction or refund after ten-day trial.
- The swing to hi-fidelity makes this instrument a necessity for laboratories, production line, and service booth.

COMPLETE WITH MATCHED TUBES \$35 NET LIMITED TIME OFFER

**The Televiso Company**

127 N. Dearborn St., Chicago, Ill.

Engineering manufacturers of allied electronic products

Audio Medical Radio

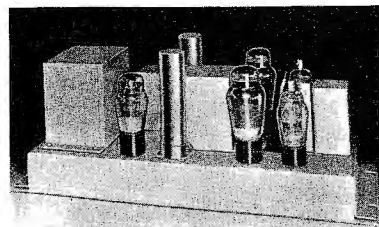

## A-F AMPLIFIERS

Two new audio-frequency amplifiers have been introduced in the broadcast transmitting field for use in operating monitor loudspeakers. Designated as the 94C and the 94D, they provide great flexibility of application and large power output at low cost. They may be used for all general purposes where a gain of approximately 45db (on a 600-ohm input circuit) is ample, except in the lowest level circuits. They also provide amplification suitable for line use.

These units may be used as isolation amplifiers which, bridged across high-quality program circuits, feed other similar units located at monitoring loudspeakers; or for feeding others used for line distribution. One of these devices bridged across a program circuit may feed as many as 100 others without affecting the level or quality of the program supplied to any of the combinations and without appreciably affecting the transmission on the program circuit, it is said.

These amplifiers are products of the *Western Electric Co.*, 195 Broadway, New York City.—COMMUNICATIONS.

**MIKE WITH ACOUSTIC COMPENSATOR**

The new Amperite velocity microphone shown in the accompanying illustration is equipped with an acoustic compensator to

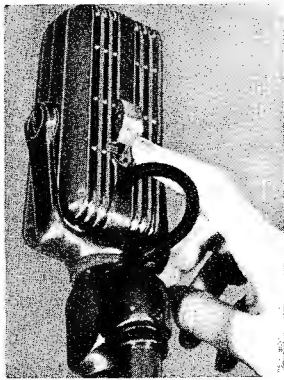

permit the adjusting of the response of the p-a system to the requirements of any particular room or condition. This is accomplished by merely pushing the compensator up or down. By pushing it up the pitch is raised to any degree required—by lowering it the pitch is lowered. This is done by introducing an acoustic baffle to absorb some of the lower frequencies. In this way no peaks or any other undesirable effects are introduced.

For complete information write to *Amperite Co.*, 561 Broadway, New York City.—COMMUNICATIONS.

**SIGNAL GENERATOR WITH DIRECT-READING DIAL**

The Clough-Brengle Model 110 signal generator features a direct-reading dial. This dial, better known as the "meter reading dial," is said to make for ease in operation. As may be seen from the illustration, the dial has unified calibrations, set one beneath the other for all five bands. For example, 200 kc is directly in line and below 2.0 mc and 20 mc. Change of wavelength is attained by turning band-selector

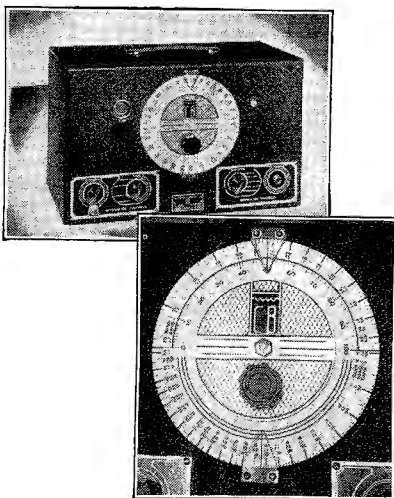

switch. The 110 signal generator operates at 1/2 percent accuracy.

Descriptive literature sent on request by *Clough-Brengle*, 2815 West 19th Street, Chicago, Illinois.—COMMUNICATIONS.

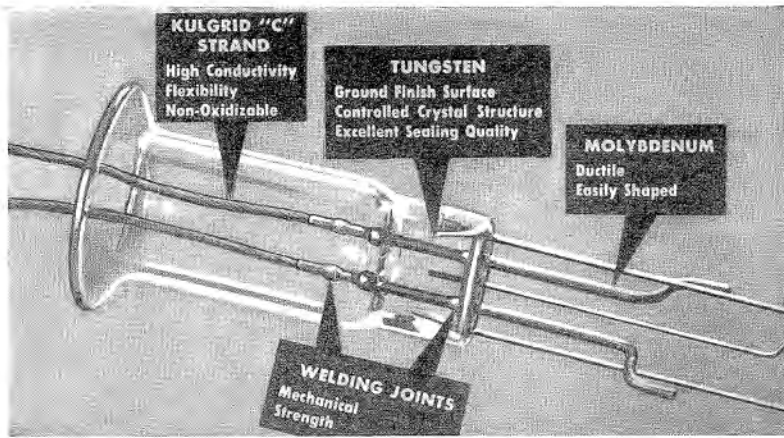

**HARD GLASS STEM  
MADE WITH  
CALLITE LEAD-IN WIRES  
of Tungsten • Molybdenum • Kulgrid**

The TUNGSTEN in Callite Hard Glass Welds is specially processed to give a compact fibrous structure, free from longitudinal cracks and is centerless ground to eliminate surface imperfections.

The KULGRID "C" STRAND has none of the objectionable features of regular copper strand. Kulgrid "C" does not oxidize. Therefore, no oxide flakes off to deposit in the tube press as is the case with copper strand. Kulgrid "C" is flexible and does not become brittle. It welds more readily to tungsten than ordinary copper strand and forms a strong joint. *Accept no inferior substitutes.*

Pure metals of best quality are used for any third component part.

**CALLITE PRODUCTS DIVISION**

EISLER ELECTRIC CORPORATION

542-39th STREET

UNION CITY, N. J.

**From near and far**

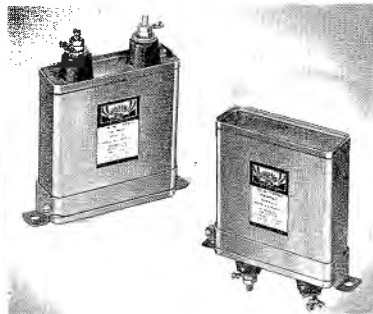

**ENGINEERS ACCLAIM  
CORNELL-DUBILIER  
UNIVERSAL MOUNTING  
DYKANOL CAPACITORS  
Type TJ-U**

Latest, from the research laboratories of Cornell-Dubilier are the Type TJ-U high voltage DYKANOL capacitors with adjustable mounting brackets. The most practical and up-to-date capacitor development. Universal mounting provides the engineer with utmost flexibility of installation and added safety—at no extra cost.

For better results, specify C-D Type TJ-U capacitors with Universal Mounting brackets, the original oil filled and impregnated transmitting capacitor. Available in a complete capacity range from 600 to 25,000 volts. Described in detail in catalog No. 150, free on request.

WORLD'S OLDEST AND LARGEST EXCLUSIVE MANUFACTURER OF CAPACITORS  
MICA • PAPER • DYKANOL • WET & DRY ELECTROLYTICS



**CORNELL-DUBILIER  
ELECTRIC CORPORATION**

1005 Hamilton Boulevard, South Plainfield, New Jersey

# A DYNAMIC PICK-UP for Lateral Reproducing

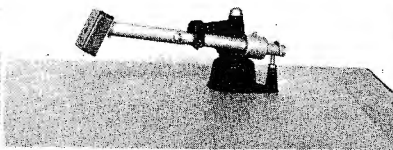
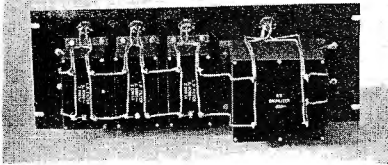

The electro-dynamic principle so successfully applied in the construction of electro-acoustic apparatus such as microphones, loudspeakers, vertical reproducers, is used in our *Dynamic Pick-Up for Lateral Reproduction*.

**THIS MEANS:**

1. **Freedom of Distortion:** There are no non-linear elements involved, as the voltage is exactly proportional to the velocity of the needle point.
2. **Constancy of Impedance:** The impedance is a pure resistance over the whole audio range. This feature allows the use of networks directly from the pick-up and we do not consider a reproducing system flexible and up to date without the employment of equalizers and filters.

**We Are Offering a Complete Reproducing System Consisting of**  
A Neumann Dynamic Pick-Up Head with a precision built pick-up arm.  
A standard rack panel with equalizer and set of low pass filters.

Ask for our latest "Sound Apparatus Bulletin" on Modern Reproducing.

**SOUND APPARATUS COMPANY**

150 WEST 46th STREET

NEW YORK CITY

**TRANSMITTING TRIODE**

The tube shown in the accompanying illustration is a low-power transmitting triode designated as RCA-809. It is in-

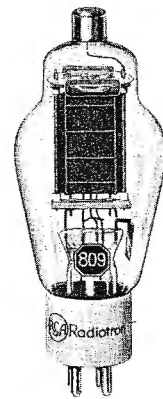

tended for use as an r-f power amplifier, oscillator, and Class B modulator. It can be operated with maximum rated input at frequencies as high as 60 mc, and has been designed to provide high plate efficiency with low driving power. For Class C service, the maximum plate dissipation is 25 watts.

The 809 is constructed in a dome-top bulb of liberal size to insure adequate heat dissipation and freedom of gas evolution from the bulb surface. A large cap on the top of the bulb provides a low-resistance connection for the plate. A ceramic base is employed.

Additional information may be secured from the *RCA Radiotron Division, RCA Manufacturing Co., Inc.*, Harrison, N. J.—COMMUNICATIONS.

**MULTIRANGE METER**

Greater sensitivity is the feature of the Model 350, 5000-ohm-per-volt multirange meter. This new instrument is intended for the radio and electrical appliance trade.

The advantage of increasing the sensitivity of the meter is found in reading voltages at the tube sockets in radio receivers. The small drain of the meter—often less than 50 microamperes—is said to permit accurate determination of voltage.

Ranges are: volts, 3, 15, 150, 600, a-c and d-c; 15 and 150 mils d-c; and 0 to 5,000 to 1,500,000 ohms with self-contained batteries. Resistance to 15 megohms can be read with an external 15-volt battery. Model 350 is supplied in two styles, one

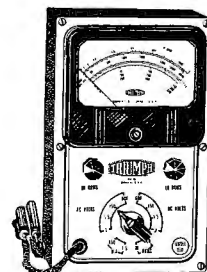

with a 3-inch square meter and the other with a 4½-inch rectangular meter.

Complete information may be secured from the *Triumph Mfg. Co.*, 4017 W. Lake Street, Chicago, Illinois.—COMMUNICATIONS.



**Frequency Measuring Service**



Many stations find this exact measuring service of great value for routine observation of transmitter performance and for accurately calibrating their own monitors.

**MEASUREMENTS WHEN YOU NEED THEM MOST**

*at any hour every day in the year*

**R.C.A. COMMUNICATIONS, Inc.**

*Commercial Dept.*

A RADIO CORPORATION OF AMERICA SERVICE

66 BROAD STREET

NEW YORK, N. Y.

**UNIVERSAL CRYSTAL MICROPHONES**



**\$22.50**  
LIST

Ideal for special events broadcasts, call systems, amateur 'phones, P. A. systems, etc. Rugged. Chrome finish. Furnished in handi-mike or stand model (as shown). Includes 10 ft. cable.

Desk stands extra. \$2.50 for handi model and \$3.50 for stand model. Licensed under patents of Bush Development Co.

*Microphone Division*

**UNIVERSAL MICROPHONE CO., LTD.**

424 Warren Lane

Inglewood, Calif., U. S. A.



### VOLUME CONTROL DEVELOPMENT

Known as the "Silent Spiral Connector," an exclusive development now available on IRC Type C volume controls, does away



with sliding metal-to-metal contact. By means of a spiral spring wire, positive and continuous electrical connection is obtained between the center terminal and the volume adjustment arm. As a result of this replacement of the usual slide-and-friction contact with solid, positive contact, there is no opportunity for noise to develop at this critical point. Combined with the unique IRC metallized resistance element plus the 5-finger "Knee Action" element contact, the silent spiral connector is said to come as triple assurance of a minimum of control noise.

A catalog giving full details has just been issued. Copies are obtainable from the *International Resistance Company*, 401 N. Broad Street, Philadelphia, Penna.—COMMUNICATIONS.

### CODE READER

The American code reader is a new type of tape recorder designed for use with any radio receiver. It employs a chemically-treated tape one-fourth inch in width. Reference to the accompanying illustration will show how the roll is placed upon a reel and threaded through rollers, past the moistener (which contains water) and thence under the metal stylus. Two electrically driven rollers pull the tape over the moistener and under the stylus. The motor is controlled by a simple brake arrangement on the front panel by means of which the motor may be stopped at will or the speed accurately controlled. The interrupted electric currents from the output of the receiver (or from the key and battery as the case may be) are fed to the stylus and the resultant dots and dashes recorded on the

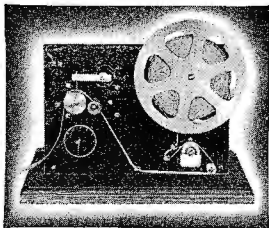

tape are due to an electrolytic action that occurs at the point of stylus contact.

For further information write to the *American Communications Corp.*, 1650 Broadway, New York, N. Y.—COMMUNICATIONS.

# Du Mont type 168

5 inch all-purpose

## OSCILLOGRAPH

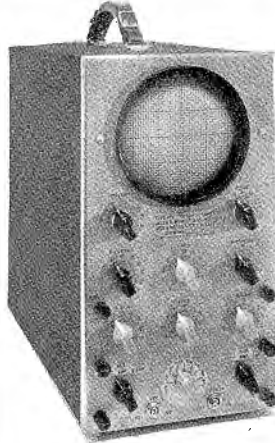

The most precise and convenient method of studying phase relation.

An accurate method of observing the translation of non-electrical phenomena in graphical form.

For studying the limits of vacuum tube characteristics without the danger of long-time overloads.

For Complete Specifications  
— Write —

**ALLEN B. DU MONT LABORATORIES, INC.**  
UPPER MONTCLAIR NEW JERSEY

### INTER-COMMUNICATION SYSTEMS

A complete new line of inter-communication systems is featured by Allied Radio Corporation. These new "Knight" systems include compact two-way units, systems accommodating as many as ten stations, and master call systems for paging in large offices, factories, or institutions.

"Knight" systems are offered exclusively by *Allied Radio Corporation*, 833 West Jackson Blvd., Chicago.—COMMUNICATIONS.

### NEW RCA G-TYPE TUBES

Three new RCA G-type tubes were recently made available to radio equipment manufacturers. These tubes are the RCA-6AC5-G (high- $\mu$  power amplifier triode), the RCA-6U7-G (triple-grid super-control amplifier), and the RCA-6ZY5-G (high-vacuum full-wave rectifier).

The 6AC5-G is intended for use in the output stage of a-c receivers. Two of these tubes when operated as Class B power amplifiers are capable of delivering approximately 8 watts power-output with an input between grids of 950 milliwatts. A single 6AC5-G when operated as a "direct drive" power amplifier with a type 76 tube as driver, can deliver 3.7 watts.

The 6U7-G is similar to the 6D6.

The 6ZY5-G is intended for supplying rectified power to radio equipment having relatively small direct-current requirements.

Further details of the characteristics and ratings of these three types may be secured from the *RCA Radiotron Division, RCA Manufacturing Co., Inc.*, Harrison, N. J.—COMMUNICATIONS.

### LANSING SPEAKER

Lansing Manufacturing Company announces its new Iconic high-quality speaker system. Though it is smaller in size, the Iconic is somewhat similar in design and performance characteristics to the well-known Lansing-Shearer theater horn systems. It includes a new high-frequency unit with constant efficiency up to 10,000 cycles, a new multicellular horn which gives uniform coverage over an angle of 80°, and a new low-frequency unit.

Complete information may be secured from the *Lansing Manufacturing Company*, 6900 S. McKinley Ave., Los Angeles, Calif.—COMMUNICATIONS.

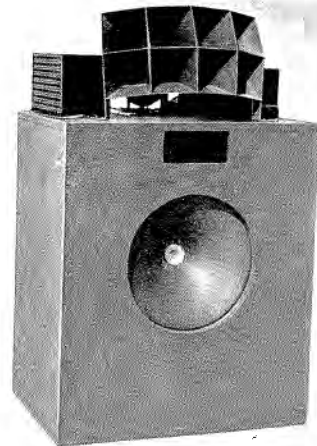

**HIGH AND ULTRA-HIGH  
FREQUENCY PORTABLE  
TRANSMITTER • Type HFM**

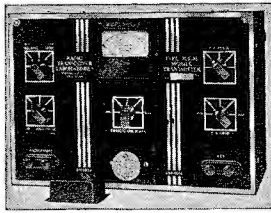

- 10 watts nominal output over entire range.
- 7000 to 60,000 Kc. with single crystal.
- Lower frequencies to order.
- Completely self-contained.
- A1, A2 and A3 emission.
- Operates from 6v. D.C. or 110 A.C. supply. Power equipment available for either.
- Anti-noise microphone for mobile operation.
- Portable receiving equipment to work with above.



**PORTABLE PACK M.O.P.A. UNIT  
TYPE PTR-19-M**

2 WATT TRANSMITTER AND A  
RECEIVER MONITOR

*We have helped many with their portable and mobile communication problems. Write, stating your requirements, and we will advise on available or custom built units.*

Write for Bulletin C-38

**Radio Transceiver Labs.**

8627 - 115th Street  
RICHMOND HILL, NEW YORK

While towers have been insulated for about fifteen years, it is only comparatively recent that the idea of utilizing the tower itself as the antenna has had general acceptance. The first tower footing insulator used under the towers of WJZ in 1925 is shown at the left in the accompanying illustration. A so-called sectionalized type footing insulator is shown at the right. This insulator rests directly on the foundation for the tower. Photo courtesy Lapp Insulator Co., Inc.

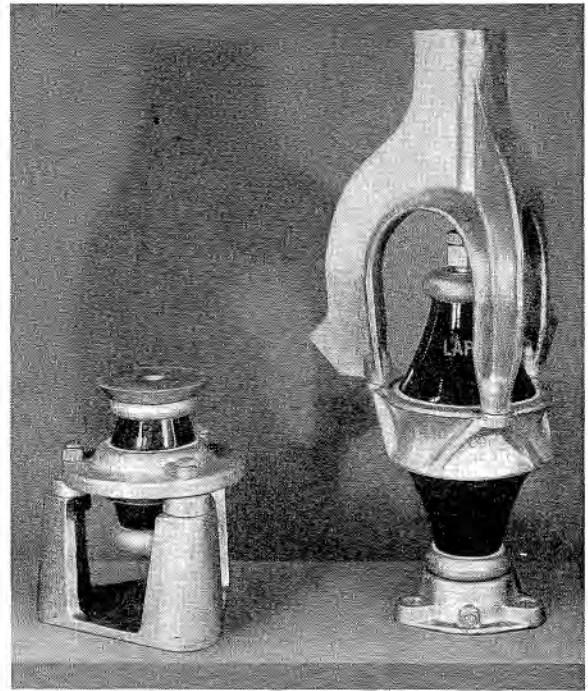

**REPORT OF ROCHESTER FALL MEETING**

(Continued from page 33)

and Malcolm Ferris, Ferris Instrument Corporation. A number of methods are in use at present and little appears to have been done towards standardization. The methods now in use consist of comparing the antenna to be measured to a standard antenna, measuring the voltage presented to the first tube in the receiver, a comparison of the measured field strength with the voltage induced in the antenna, and the like.

The paper "Teledynamic Control by Selective Ionization and the Application to Radio Receivers," by S. W. Seeley, H. B. Deal, and C. W. Kimball, RCA License Laboratory, dealt with a unique remote-control device. The remote-control unit as adapted to a radio receiver consisted of a unit which operated the receiver by the use of power-wire car-

rier currents. An on-off switch, station selector buttons, and volume-control were provided in the remote unit. No power is consumed by the set-up when it is not actually in use. This appears to be one of the outstanding developments in remote control for home radio receivers and we dare say that it will be incorporated in commercial units early next year.

D. B. Sinclair, General Radio Company, presented a paper entitled "Parallel Resonance Methods for Measurement of High Impedances at High Frequencies." The use of the ordinary series-resonance methods enables one to measure the effective resistance of a series tuned circuit. The use of parallel-resonance methods enables one to measure the effective conductance of a parallel tuned circuit with equal ease. The duality existing between series and parallel tuned circuits was pointed out and measuring methods described which are the duals of the usual reactance-variation and resistance-variation methods. By analogy these parallel-resonance methods have been named the "susceptance-variation" and "conductance variation" methods. Errors caused by strong coupling to the high-frequency source and by residual parameters inherent in the standard condenser and circuit wiring are discussed for both series and parallel-resonance systems. A comparison of the ranges, precision and accuracy of the two categories was given.

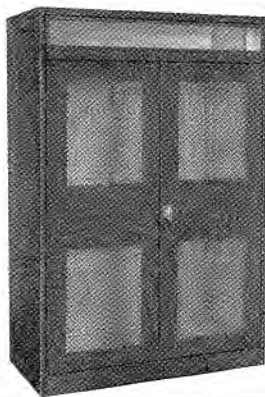

**1938 MODELS  
NOW READY**

TRANSMITTER and RELAY RACK  
CABINETS in MODERN DESIGN,  
and with distinctively improved features that are appreciated by users everywhere. Write today for details and low factory prices.

**LEFEBURE CORPORATION**

Manufacturers  
CEDAR RAPIDS, IOWA, U. S. A.

# SHAKEPROOF

## "HI-HOOK"

*Thread-Cutting*

## SCREWS

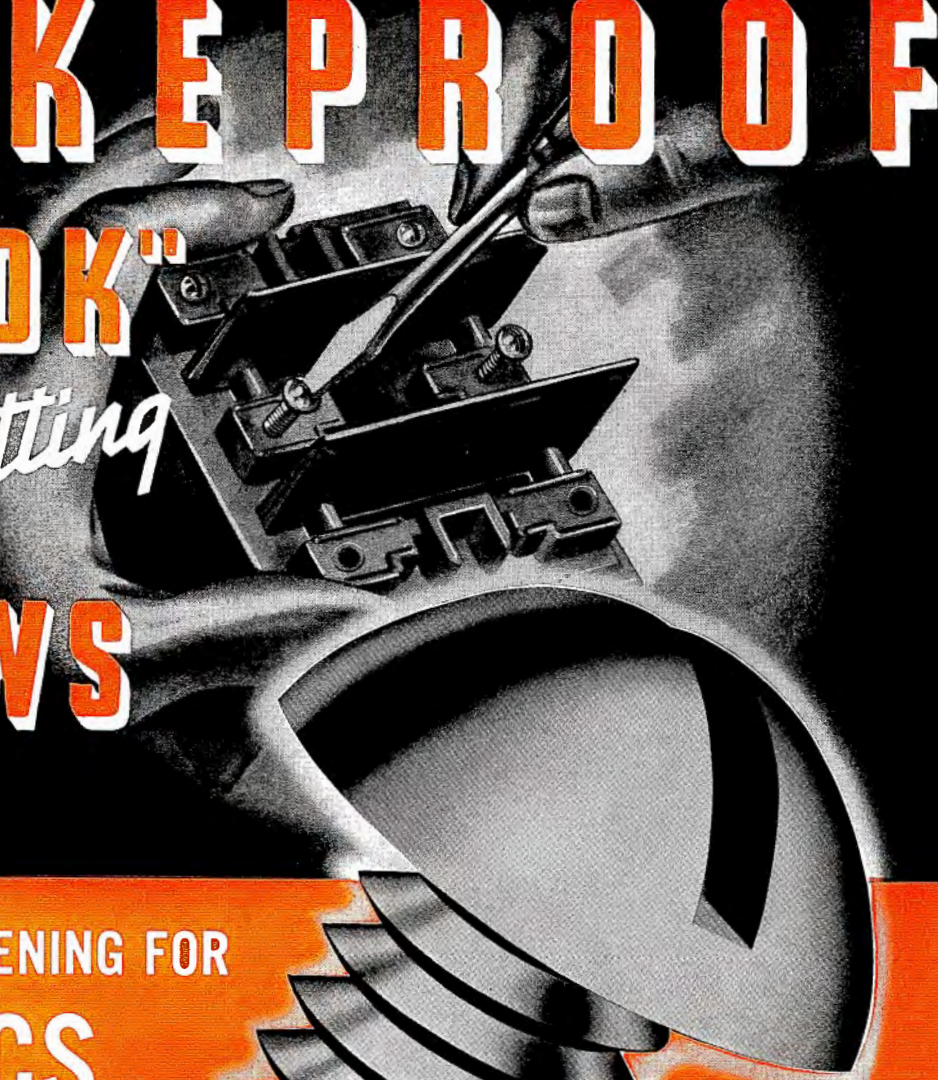

THE PERFECT FASTENING FOR  
ALL PLASTICS

**TAP AND FASTEN**  
*in one operation!*

Shakeproof's new "Hi-Hook" Thread-Cutting Screw solves the problem of making tight and rigid fastenings in plastics at low cost. This amazing screw actually cuts a clean, sharp thread in any plastic material. It drives easily, too, because its double-slot design assures an acute cutting edge. Test Shakeproof's "Hi-Hook" Thread-Cutting Screw on the material you are using—see how it lowers costs and speeds up production. Write for your free demonstration kit, today!

Leading Mill Supply, Hardware and Automotive Parts Jobbers now stock Shakeproof Thread-Cutting Screws and Shakeproof Lock Washers in standard packages. Write for name of nearest jobber!



### SHAKEPROOF LOCK WASHER CO.

Distributor of Shakeproof Products Manufactured by Illinois Tool Works  
2509 North Keeler Avenue Chicago, Illinois  
IN CANADA: Canada Illinois Tools, Ltd., Toronto, Ont.  
Copyright 1937 Illinois Tool Works

The Only Screw that actually cuts its own thread!

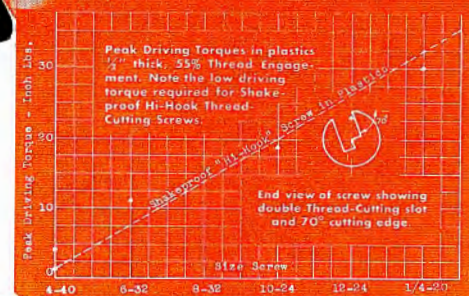

**Double Thread-Cutting Slot  
PRODUCES CLEAN-CUT THREAD  
AND ASSURES EASY DRIVING**

U.S. Pat. Nos. 1,862,486,  
1,909,476, 1,909,477.  
Other Patents. Patents  
Pending. Foreign Patents.

Send For Your Free Demonstration Kit Today!



# VETERAN WIRELESS OPERATORS ASSOCIATION NEWS



W. J. McGonigle, President

RCA Building, 30 Rockefeller Plaza, New York, N. Y.

H. H. Parker, Secretary

## MEETING

THE DECEMBER MEETING of the Veteran Wireless Operators Association will be held on Monday evening, December 6, at 6 p. m., in the Castle Garden Cafe, 62 Pearl Street (just off Broad Street), in New York City\*. The List of nominees for officers and directors of our association will be then announced. Ballots will be mailed to all members in good standing immediately following the December meeting. The ballots should be returned to the Secretary, in an envelope marked "Ballot," and with the signature of the member voting in the upper left-hand corner, before midnight of Sunday, January 2, 1938. If 1938 dues are enclosed we suggest the Ballot be placed in an inner envelope with signature and word "Ballot" on its face. A delicious Chinese or American full-course dinner including a cocktail will be available on this evening for the nominal sum of seventy-five cents.

## THANKSGIVING

ALL GOOD WISHES to our members and friends for a very happy and enjoyable Thanksgiving.

## MARCONI MEMORIAL

IT IS INDEED a pleasure, and it is with a feeling of sincere gratitude, that we acknowledge the generous contributions of G. K. Throckmorton of the RCA Manufacturing Company, W. A. Winterbottom, vice-president of RCA Communications, and C. J. Pannill, president of the Radiomarine Corporation of America. They each added \$250.00 to the Marconi Memorial ever-increasing fund. The list includes:

V. W. O. A. ....	\$100.00
David Sarnoff .....	1,000.00
A. J. McCosker, WOR..	100.00
Lenox Lohr, NBC.....	250.00
Throckmorton, RCAM ..	250.00
Winterbottom, RCAC ..	250.00
C. J. Pannill, RMCA....	250.00

Total to date.....\$2,200.00

\*Article II Section 2, Constitution and By-Laws, V. W. O. A., Inc.

At the December meeting the Board of Directors shall submit a list of nominees for Officers and Board of Directors, of not more than three (3) names for each office, President, Vice-President, Secretary and Treasurer and not more than twenty (20) names for Board of Directors. Printed ballots shall be prepared and mailed to each member eligible to vote. These ballots shall be returned to the Secretary sealed, not later than midnight prior to the January meeting.

Article III Section 1, Nominations and Election of Officers and Board of Directors.

Following the November meeting the Board of Directors will receive petitions in writing, signed by not less than thirty (30) members entitled to vote, setting forth the name of the candidate, and the office for which it is desired he be nominated. These petitions shall be considered by the Board of Directors and shall be included in the final list of nominees when submitted at the December meeting.

We sincerely urge those interested in participating in this "Living Tribute" to a truly great man to communicate with us at the above address.

## ANNUAL CRUISE

REMEMBER THE Thirteenth Annual Cruise of the Veteran Wireless Operators Association will be held simultaneously in cities in which we have chapters formed on the evening of February 11, 1938. We plan on making this the biggest and best in our history. We request the cooperation of all our members and friends by furnishing suggestions and in attendance at their local affair. In each case the subscription fee will be nominal and you may rest assured that a pleasant evening awaits you and yours. We will be glad to furnish persons interested with the address of their local VWOA representative upon their request to the above address. All together—Let's go. February 11, 1938.

## MEMBERSHIP

OUR CONSTANTLY increasing membership continues as a source of encouragement and stimulation to your officers. A method used very successfully by other organizations is about to be tried. We request each and every member to sign up at least one new member from among their friends who are eligible—and, truthfully, how many of us are there who do not have eligibles among our everyday contacts? Doubling our membership, which would be the natural result of the success of this method, would truly be marvelous progress and would not tax any one individual very much. May we hear from you soon regarding your prospective member? Thank you.

## THANKS

THE RESPONSE to our recent appeal for dues is extremely encouraging. There are still a few, however, who have not yet communicated with us and we urge them to do so as soon as possible. We appreciate your cooperation. Thanks, again.

## NEW YORK

AMONG THOSE present at the November meeting of the New York group at the Castle Garden Cafe in New York City: William J. McGonigle, president, New York Telephone Company. . . Fred Muller, vice-president, sales engineer, New York, Collins Radio Company. . . H. H. Parker, secretary, Westchester Lighting Company. . . Wm. C. Simon, treasurer, chief inspector Tropical Radio Telegraph Company, New York. . . C. D. Guthrie, director, radio supervisor in charge of New York office of Maritime Commission. . . A. F. Wallis, director, commercial representative, Mackay Radio and Telegraph Company. . . W. Campbell, business manager of Hearst Radio in New York. . . Geo. P. Smith, who

runs the concessions at Bear Mountain Park during the summer season and is at present engaged in an executive capacity with World's Fair, Inc., in New York working on details for the forthcoming 1939 New York World's Fair. GPS incidentally goes way back in the radio story, having been one of the first Naval Chief Radiomen. . . Thomas S. Baker, chief engineer of Hearst Radio, Inc., not yet a member, but we hope to sign him right soon. . . Arthur H. Lynch, the "Antenna Man," New York, and we believe, Eastern representative for the National Company of Malden, Mass., accompanied by "Bill" Filler, one of the proprietors of Terminal Radio, one of the better equipped "Ham and Engineers" stores in the greater city. . . Wm. J. Gillule, genial member of the marine department of the Mackay Company in New York, attending his first meeting, though he has been a member for some time. . . Henry A. Steinberg, New York representative for the Cornell Dubilier Condenser Corp., who made a special effort to be present. Rather belatedly we express our appreciation to Henry for his whole-hearted cooperation in our most recent Year Book activity and a recent Radio Show sponsored by the Telcol Radio Club. Many Thanks. HAS . . . R. H. Frey, Radio Supervisor, Bull Steamship Lines, the fellow that's getting all those new members. . . R. S. Egolf of RCA Communications, who brought good news of a highlight for a coming meeting. . . R. J. Plaisted from out Ohio way but now connected with NBC in New York working on television. . . D. Warshaw of Mackay Radio whom we haven't seen for some time. . . O. W. Penny of the engineering staff of WMCA in New York and the proud daddy of a big fellow and a little girl. . . V. P. Villandre of Radiomarine and ever-willing Chairman of our Ticket Committee. . . "Steve" Kovacs and Alex Vadas, the "yachting boys" who will be leaving shortly for the South to spend the winter season. "Steve" aboard the yacht *Wild Duck* and Alex aboard the yacht *Mascotte*. Our loss will be Miami Chapter's gain. . . H. T. Hayden, Jr., Ward Leonard Sales Engineer and enthusiastic Chairman of our Membership Committee. . . Frank Orth of the Engineering staff of the Columbia Broadcasting System. . .

Glad to see each and every one at the November meeting and all present were unanimous in their praise of the arrangements. We hope to see them all again at the December meeting. We will then discuss developments in the plans for simultaneous cruises in each of the cities in which we have chapters on February 11, 1938.

## PERSONALS

AMONG THE MEMBERS of the twenty-year  
(Continued on page 45)

## Modest or Pretentious—

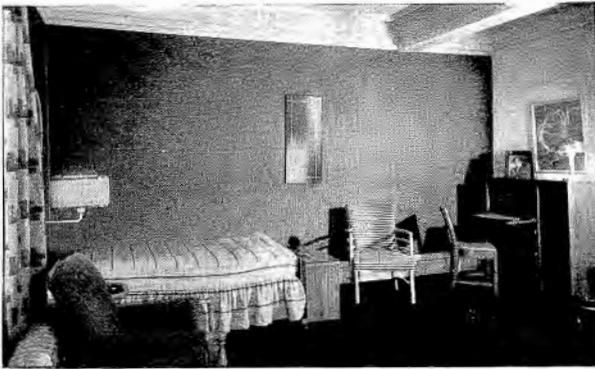

**W**HETHER it be a single room (as above) or an elaborate suite, you will find Hollenden guest rooms modern and up-to-the-minute in decorations, equipment and furnishings. We are completing a modernizing program which make Hollenden guest rooms as fine as any to be found in Cleveland. The location is ideal, the service excellent, the food of the best and the prices moderate. Select the Hollenden on your next trip to Cleveland.

## HOTEL HOLLENDEN

A DeWitt Operated Hotel CLEVELAND R. F. Marsh, Mgr.

### STATEMENT OF THE OWNERSHIP, MANAGEMENT, CIRCULATION, ETC., REQUIRED BY THE ACTS OF CONGRESS OF AUGUST 24, 1912 AND MARCH 3, 1933, OF COMMUNICATIONS

Published monthly at New York, N. Y., for October 1, 1937.

State of New York, } ss:  
County of New York, }

Before me, a Notary Public in and for the State and county aforesaid, personally appeared B. S. Davis, who, having been duly sworn according to law, deposes and says that he is the Business Manager of COMMUNICATIONS, and that the following is, to the best of his knowledge and belief, a true statement of the ownership, management, etc., of the aforesaid publication for the date shown in the above caption, required by the Act of August 24, 1912, as amended by the Act of March 3, 1933, embodied in section 537, Postal Laws and Regulations, to wit: 1. That the names and addresses of the publisher, editor, managing editor, and business manager are: Publisher, Bryan Davis Publishing Co., Inc., 19 East 47th Street, New York. Editors, W. W. Waltz, Tottenville, Staten Island, N. Y., and Ray D. Rettenmeyer, Brooklyn, N. Y. Managing Editor, None. Business Manager, B. S. Davis, Ghent, N. Y. 2. That the owners are: Bryan Davis Pub. Co., Inc.; B. S. Davis, Ghent, N. Y.; J. C. Munn, Union City, Pa.; J. A. Walker, Richmond Hill, N. Y.; A. B. Goodenough, New Rochelle, N. Y. 3. That the known bondholders, mortgagees, and other security holders owning or holding 1% or more of the total amount of bonds, mortgages, or other securities are: None. 4. That the two paragraphs next above, giving the names of the owners, stockholders, and security holders, if any, contain not only the list of stockholders and security holders as they appear upon the books of the company, but also, in cases where a stockholder or security holder appears upon the books of the company as trustee or in any other fiduciary relation, the name of the person or corporation for whom such trustee is acting, is given; also, that the said two paragraphs contain statements embracing affiant's full knowledge and belief as to the circumstances and conditions under which stockholders and security holders who do not appear upon the books of the company as trustees, hold stock and securities in capacity other than that of a bona fide owner; and this affiant has no reason to believe that any other person, association, or corporation has any interest direct or indirect in the said stock, bonds, or other securities than as so stated by him.

(Signed) B. S. DAVIS, Business Manager.

Sworn to and subscribed before me this 5th day of October, 1937.

(Seal) J. A. WALKER, Notary Public.

Queens Co. Clk's No. 2034, Reg. No. 5634.

New York Co. Clk's No. 433, Reg. No. 9-W-299.

Commission expires March 30, 1939.

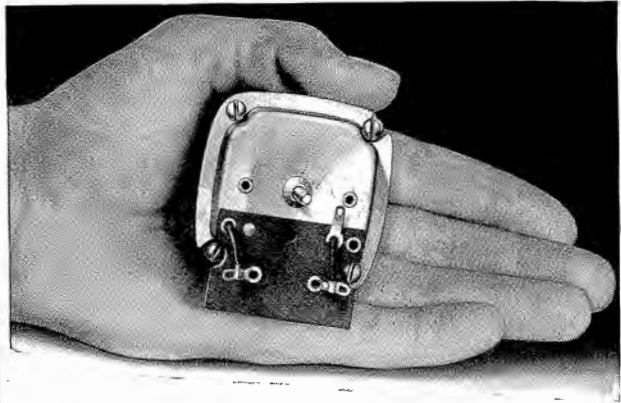

## HERE IT IS . . . A New Fool-proof Motor for "PUSH-BUTTON" Tuning

Here is a new motor, fresh from the Alliance engineering department, specifically designed for use in radio tuning by "push-button" control.

Exclusive safety and dependability features make the Model "R" motor the most rugged and efficient of its kind. Securely mounted, self-aligning, oilless bearings guarantee permanent shaft alignment and noiseless operation. Thermostatic protection against accidental burning out, plus ample heat radiating area provided by the housing, make the Model "R" ideal for concealed positions. Yet the overall dimensions are only 2 1/8" x 2 1/8" x 1 1/2".

The Alliance Model "R" motor can be had now in large quantities at low cost. Mounting and gear assemblies will be supplied to meet your particular demands and specifications.

Write, Wire or Phone for Sample and Complete Details

ALLIANCE MANUFACTURING CO., ALLIANCE, OHIO

# BLILEY CRYSTALS HOLDERS OVENS

QUARTZ  
CRYSTALS  
& MOUNTINGS  
20 Kc - 25 Mc

BROADCAST  
CRYSTALS &  
OVEN MOUNTINGS  
Approved by F.C.C.



Write for

Bulletin G-9

## BLILEY ELECTRIC COMPANY

UNION STATION BUILDING

ERIE, PA.

**A  
One Year  
Subscription**  
(12 issues)

to  
**COMMUNI-  
CATIONS**

**Costs  
Only  
\$1.00**

**E**very qualified radio, electrical, communications and industrial engineer, executive, department head or factory technician can secure a year's subscription to COMMUNICATIONS (twelve issues) for only \$1.00 by using the Group subscription Plan.

Regularly a yearly subscription to COMMUNICATIONS is \$2.00—but in groups of four or more, the subscription rate is only \$1.00 each per year when your occupation is stated.

Use the convenient form printed herewith. Your co-workers will sign up with you at the half-price rate if you tell them about this "G.S.P." All the important news about every phase of radio and communications appears *first* in COMMUNICATIONS. Sign up your group today.

**COMMUNICATIONS:—Enter subscriptions for:**

Name .....  
Address .....  
City-State .....  
Classification .....  
Employed by .....

Name .....  
Address .....  
City-State .....  
Classification .....  
Employed by .....

Name .....  
Address .....  
City-State .....  
Classification .....  
Employed by .....

Name .....  
Address .....  
City-State .....  
Classification .....  
Employed by .....

on  
the "Group  
Subscription  
Plan"

**TEAR OUT  
AND MAIL**

**COMMUNICATIONS: 19 E. 47th ST.,  
NEW YORK, N. Y.**



When mailing a check (or money order) for a group of subscriptions, use this convenient form.

**new!**

**Adjust-A-Volt**  
VARIABLE TRANSFORMER



Type SA-5

**\$10.80** Net Price

**ELECTRICAL SPECIFICATIONS**

Input Voltage	Output Capacity	Output Voltage
115	5 amp.	O-140



provides smooth continuous control of

- A.C. Lines
  - Power
  - Heat
  - Speed
  - Light
- Write for FREE bulletin for details and applications.

**Standard Electrical Products Co.**  
317 Sibley St., St. Paul, Minn.



**New, Astatic MICROPHONE MODEL T-3**

Highly Praised for Flexibility and Performance

Another achievement of Astatic Engineers designed for high class public address, broadcast, recording and amateur use. Tilting mount permits directional or non-directional position to control acoustic feedback. Complete with interchangeable plug and socket connector, cable and spring cable protector. Chrome finish. LIST PRICE, \$25.00.

WRITE FOR LITERATURE



**MICROPHONE LABORATORY, INC.**  
Dept. M-3, Youngstown, Ohio  
Licensed under Brush Development Co. Patents

**VWOA NEWS**

(Continued from page 42)

club reported in QST, periodical of the American Radio Relay League, we find the following members of VWOA—Howard F. McIntosh, Honolulu Chapter Secretary and operator of amateur radio station K6ONM: "Started somewhere between 1911 and 1913 with the usual spark-coil rig for transmitting and coherer, etc., for receiving. Amateur license with call 3SJ in 1916 and 1917. Naval service 1917 to 1919. Marine operating 1919 to 1929. Been ashore with Mackey Radio since 1929; at present connected with their transmitting station at Kailua, Oahu, T. H. Just recently rejoined the amateur game—present call letters, K6ONM, station located at Lanikai, about 15 miles from Honolulu." . . . Thos. W. Braidwood: "Started with a spark coil and single slide tuner, plus a carborundum detector in 1912 at Anglesea, N. J.—used the call letters ZZ—later used a larger spark coil on 110 volts with electrolytic interrupter (this caused all the lights in town to blink)—in 1915 obtained license and call 3UZ—operated station until closed down for World War—resumed operating after war with call 3BA—in meantime obtained commercial license in 1918 and became ship operator" . . . and our good friend W. J. Halligan, now President of Hallcrafters, Inc. "Became interested in 'wireless' around 1915, getting my ham ticket in early 1916. First call 1AEH. Continued until the war, serving in the Naval Reserve, and after war call 1UL was his. In 1924 served as New England Publicity Division Manager for the League, and kept about 10 watts of CW working in my kitchen until moved out of the first district." . . . A. J. Costigan, Chairman of our Board of Directors and traffic manager for Radiomarine, recently returned from an extensive tour of the continent and the British Isles. Welcome home, A. J. . . . If we didn't before, we now express our sincere appreciation and heartfelt thanks to Charles S. Anderson, of RCA Institutes, for his generous cooperation and kind encouragement in the preparation of our 1937 Year Book. The success of all our endeavors is due to just such willing support . . . Pleased to learn in a recent edition of the *Daily News* that Mrs. George Shecklen, wife of our China representative, arrived in Manila safely from war-torn Shanghai. Mr. Shecklen is vice-president of RCA Communications, Inc., with headquarters in Shanghai, China. We trust that he, too, is safe . . . Best wishes to Stanley W. Fenton, recently of the New York office of the Mackay Company, on his recent appointment as marine superintendent of the Mackay Radio and Telegraph Company with headquarters in San Francisco . . . Contact Gil Willets, Stan, also C. I. Stanford at the Presidio, and do your bit for the SF Chapter.

**JEWETT TO SPEAK AT ASA MEETING**

Frank B. Jewett, vice-president, American Telephone and Telegraph Co., and president, Bell Telephone Laboratories, will be guest speaker at the annual meeting of the American Standards Association. This meeting will be held at the Astor Hotel, New York, on Wednesday, December 1st. It will be preceded by a luncheon at one o'clock and will be followed by a meeting of the Board of Directors at 3:30.

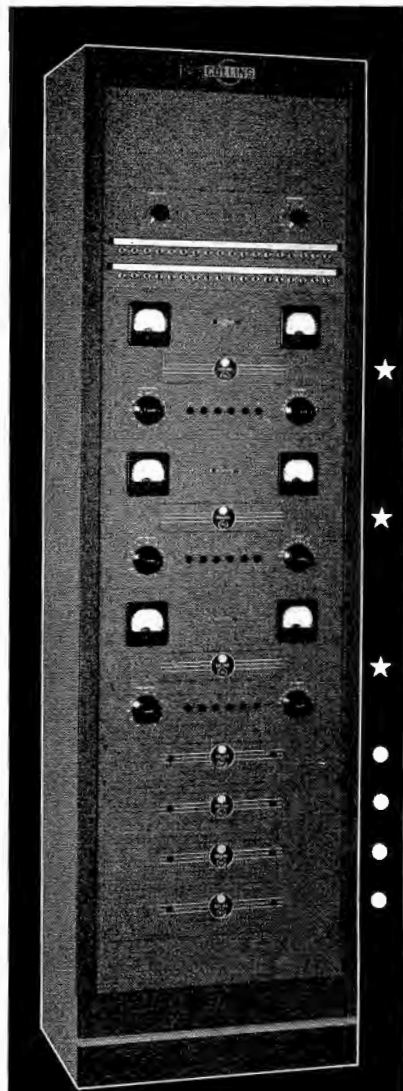

• **6F** PRE-AMPLIFIERS  
AND  
★ **7S** MAIN AMPLIFIERS

are built for stations who use the best equipment obtainable. Their design includes every desirable electrical feature, complete metering, tube access doors, modern styling, easily removable inspection plates.

Technical data sent on request.

**COLLINS**  
RADIO COMPANY

CEDAR RAPIDS IOWA  
NEW YORK, N. Y.: 11 WEST 42 STREET

# OVER THE TAPE . . .

## NEWS OF THE COMMUNICATIONS FIELD

### THROCKMORTON ELECTED PRESIDENT RCA MANUFACTURING CO.

The election of G. K. Throckmorton as president of RCA Manufacturing Company, Camden, N. J., has been announced by David Sarnoff, president of Radio Corporation of America and chairman of the Board of Directors of the RCA Manufacturing Company. Mr. Throckmorton has been executive vice-president of RCA Manufacturing Company and the operating head following the retirement in April of E. T. Cunningham, former president.

### CLAROSTAT ENLARGES LABORATORY

For its routine engineering activities as well as an expanded research program, Clarostat has just provided its engineering department with larger quarters in the Clarostat building. Additional electrical and chemical equipment has been installed, together with more facilities for precision measurements and critical life tests. Headed by George Mucher, chief engineer, Clarostat engineers are engaged in several interesting developments.

### NEW OFFICES FOR FAIRCHILD

The Fairchild Aviation Corporation, Fairchild Aerial Camera Corporation, and Fairchild Aviation, Inc., have announced the removal of their general offices and manufacturing facilities to larger quarters. The new address is 88-06 Van Wyck Boulevard, Jamaica, Long Island, N. Y.

### FREE AUDITING OF FREIGHT BILLS AVAILABLE TO RMA

Substantial savings on freight bills, through the free auditing service of RMA, have been reported recently by several members of the Association. Freight and also express bills will be audited without charge by the RMA Traffic Auditor, Mr. T. P. Scanlan, 1608 Milwaukee Avenue, Chicago. Mr. Scanlan is an experienced traffic man and is the official auditor of the Association, his charges being limited to one-half of any savings actually recovered for Association members after a gratis examination of their transportation accounts. All RMA members are invited to avail themselves of the Association's auditing service by Mr. Scanlan.

### AMPERITE SALES HELPS

The Amperite Co., 561 Broadway, New York, has just announced a new series of sales helps available to the trade. Featured is an attractive window decalcomania in color. Another sales display features the world-famed orchestra leader, Cab Calloway. This display measures 11 x 17 inches, mounted on heavy cardboard, easel backed. A series of three new letterhead designs in two colors to be imprinted with name, address and phone number has found a ready response. For further information please write direct to Amperite Company.

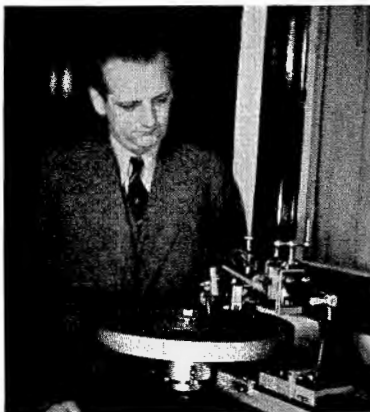

Mr. Georg Neumann.

### NEW OFFICES FOR BENDIX

Bendix Radio Corporation have announced the transfer of their Washington office to 920 East Fort Ave., Baltimore, Maryland.

### LEFEBURE LITERATURE

The Lefebure Corporation, Cedar Rapids, Iowa, have announced literature on their newly designed transmitter cabinet (Type 85-C) and on stock-size relay-rack cabinets. Those interested should write to the above organization.

### ILLUMINATED ADDRESS TO DUBILIER

To commemorate the twenty-fifth anniversary of the foundation of the company, the Dubilier Electric Company, Ltd., of London, presented an illuminated address to William Dubilier in appreciation of his services. This illuminated address is but one of the many expressions of affection and gratitude the English organization has bestowed upon its founder.

William Dubilier.



### NEUMANN VISITS AMERICA

Mr. Georg Neumann, of Georg Neumann & Co., Berlin, Germany, manufacturers of electric-acoustical apparatus well known to sound engineers of this country, was a recent guest of the Sound Apparatus Company, New York City.

Mr. Neumann had opportunity to study Sound Recording and associated branches in the Eastern States. Although he did not find radical innovations in the electric-acoustical field, he found each individual demonstration very interesting. He expresses his appreciation for the friendly reception and willingness to demonstrate wherever he visited and he will be happy to reciprocate the hospitality extended to him in America.

### RESISTANCE DATA BOOKLET

To supplement more than ten thousand copies of the IRC resistance engineering data booklet already distributed on request to design, electrical, radio and electronic engineers throughout the world, a second booklet containing resistance specifications and engineering data complete to September 15, 1937, has just been issued by the International Resistance Company, 401 N. Broad Street, Philadelphia, Penna.

The new supplement is printed in the same size and form as the original booklet so that the two can be bound together for quick, convenient reference. It gives complete specifications and engineering data on a number of new resistor and volume control types.

Copies of the supplement have been mailed to holders of the original guide. Both booklets will be sent on request.

### THORDARSON CATALOG

Thordarson has just made available a catalog covering their line of universal output, driver and audio transformers, chokes, mixers, amplifiers, etc. Write to Thordarson Electric Manufacturing Co., 500 West Huron St., Chicago, for Catalog 400-A.

### NEW ORGANIZATION

A new company by the name of University Laboratories, 191 Canal Street, New York City, has just been organized for the purpose of manufacturing permanent-magnet loudspeaker units of high quality reproduction.

Sidney Levy and Irving Golin are in charge of production and sales respectively. Arthur Blumenfeld has been retained as consulting engineer.

### TAYLOR-WHARTON BULLETIN

The Taylor-Wharton Iron and Steel Company, High Bridge, N. J., have available an interesting 15-page bulletin on the Tisco line of Alnico permanent magnets. The development, production, theory and properties design of Alnico and other alloy steels are covered in considerable detail. A copy of this bulletin may be secured by writing to the above organization.



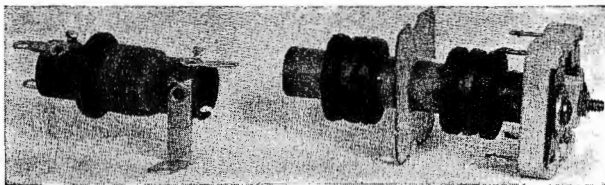

IF-RF WINDINGS—All types, your tolerance—prompt delivery any quantity—send samples or specifications for quotations—Export Division: 100 Varick St., New York City  
**PRECISION INDUCTANCE CORPORATION, 591 BROADWAY, NEW YORK**

**CHAS. EISLER**  
 EQUIPMENT PRODUCED  
**MILLIONS**

RADIO AND ELECTRON TUBES, INCANDESCENT LAMPS, PHOTO CELLS, X-RAY AND CATHODE RAY TUBES, NEON ELECTRODES AND NEON SIGNS, YOU CAN SEE CHAS. EISLER EQUIPMENT IN PRODUCTION EVERYWHERE. RELIABLE FOR OVER 20 YEARS. COMPLETE GLASS WORKING UNIT FOR SCHOOLS, COLLEGES AND GLASS PRODUCT LABORATORIES. WRITE FOR OUR LABORATORY GLASS WORKING

UNIT CATALOG, ELECTRIC WELDERS, VACUUM PUMPS, STEM SEALING, EXHAUST, ETC., ETC., ETC.

**EISLER ENGINEERING CO.**

750 S. 13 ST. (NEAR AVON)

NEWARK, N. J.

**PARAMOUNT PAPER TUBE CO.**

MANUFACTURERS OF SPIRAL WRAPPED TUBING FOR THE ELECTRICAL INDUSTRY  
 SQUARE - RECTANGULAR - ROUND

2035 WEST CHARLESTON STREET

*Chicago, Illinois*

**SPEAKER GRILLE CLOTH**

Complete assortment of patterns.  
 Special colors and patterns made to order.  
 Samples and prices furnished upon request.  
 Shipments made from stock.

**A. G. HINTZE**

300 WEST ADAMS STREET

CHICAGO, ILL.

**RADIO IN ITS ENTIRETY!**



"B-A" serves the trade with every need in radio—complete 160-page catalog of nationally known radio receivers, public address, parts, supplies and equipment. Orders shipped same day received.



**BURSTEIN-APPLEBEE CO.**  
 1012-14 MCGEE ST. -- KANSAS CITY, MO.

**UP-TO-DATE CATALOG AVAILABLE**

PATENTS — TRADEMARKS — COPYRIGHTS

*Correspondence Solicited*

**EUGENE E. STEVENS**

*Registered Patent Lawyer*

Washington Loan and Trust Bldg. - Washington, D. C.

**USED LABORATORY EQUIPMENT**

Weston — G.R. — L&N — G.E., Etc.

Meters — Bridges — Torsion balances — Inductors.  
 Decade boxes — Analytical balances — Oscillographs.  
 Tubular rheostats — Signal generators — Condensers.

*Write for new list*

**Louis J. Winslow**

200 PENNSYLVANIA AVENUE

HILLSIDE, N. J.

**36 years experience**  
 in **PERMANENT MAGNETS**

We make Permanent Magnets for All Purposes — Stamped, Formed and Cast Magnets — Chrome... Tungsten... Cobalt... Alnico (cast only)

**THOMAS & SKINNER**  
**STEEL PRODUCTS CO.**  
 1120 E. 23rd ST. — INDIANAPOLIS

**WRITE FOR PRICES**

LAMINATIONS FOR RADIO TRANSFORMERS  
 TOOLS — DIES — STAMPINGS

**BETTER RESULTS**

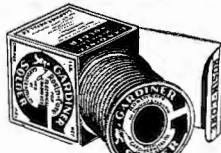

Uniform high quality of Gardiner Rosin-Core Solder permits experienced workers to do faster work... and inexperienced help to do better, neater work. Lowers costs by saving both time and material. Costs less than even ordinary solders... due to modern methods of volume production. Made in various alloys and in gauges as fine as 1/32 of an inch. Bar and solid wire solders, and dipping and casting metals of same dependable quality.

Eastern Sales Office and Warehouse:  
**DAVID M. KASSON & CO.**  
 264 Canal St., New York

In 1, 5 and 20-lb. spools



**PERFECT STELLI**

users include

CJCA	WFIL	WIOD
CJOC	KSTP	WKAR
CJOR	KTRH	WKBW
CKCK	WAAW	WKY
KFAB	WBBM	WLVA
KFKU	WBNS	WLWL
KFNF	WFIL	WMT
KFOR	WFBR	WNBS
KGU	WGBI	WOWO
KLZ	WGL	WRJN
KMBC	WGR	WSYR
KOIL	WHB	WWL
	WHIS	

"ACETATE"  
 RECORDING NEEDLES



Also the MAJOR Networks and many Recording Studios

RUSH ORDERS FILLED PROMPTLY  
 WRITE FOR DETAILS

**RANGERTONE, INC.** 201 VERONA AVENUE  
 NEWARK, N. J.

"THE CRYSTAL SPECIALISTS SINCE 1925"

**PIEZO-ELECTRIC CRYSTALS**

GUARANTEED Accurate to BETTER than .01%

**SCIENTIFIC RADIO SERVICE**

Send for FREE Booklet and Price List!

UNIVERSITY PARK - - - HYATTSVILLE, MD.

**TAYLOR**

**VULCANIZED FIBRE**  
**PHENOL FIBRE**  
**TAYLOR INSULATION**

**TAYLOR FIBRE CO., Norristown, Pa.**

# for Smooth Control of Voltage

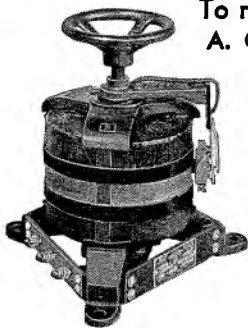

To regulate  
A. C. Lines  
•  
Power  
•  
Speed  
•  
Heat  
•  
Light

## Use TRANSTAT\* REGULATORS

Used for numerous voltage-control applications because of its many advantages over resistive and tap-changing devices. Features are: High efficiency, good regulation, great flexibility. Voltage may be changed gradually, and without interrupting the circuit, from zero to values higher than line voltage. Well suited for large and small voltage-control problems. Equipment available for manual, motor, and automatic control of voltage of any commercial frequency in single-phase or polyphase circuits.

\*Patents 1,993,007 and 2,014,570; other patents pending; Transtat trade-mark registered U. S. Patent Office.



Send  
for  
Bulletin  
1176  
for  
complete  
data

### AMERICAN TRANSFORMER COMPANY

175 EMMET ST. NEWARK, N. J.



## Advertising Index

A	
Aerovox Corp.....	29
Alliance Mfg. Co., The.....	43
American Transformer Co.....	48
Amperex Electronic Products, Inc.	Second Cover
Amperite Corp. ....	7
Astatic Microphone Laboratory, Inc.....	45
B	
Bliley Electric Co.....	43
Brush Development Co., The.....	23
Burstein-Applebee Co.....	47
C	
Callite Products Division.....	37
Cinaudagraph Corp.....	48
Clarostat Mfg. Co., Inc.....	31
Collins Radio Co.....	45
Cornell-Dubilier Corp.....	37
Crowley Co., Inc., H. L.....	3
D	
Driver Co., Wilbur B.....	35
Du Mont Labs., Allen B.....	39
E	
Eisler Engineering Co.....	47
G	
Gardiner Metal Co.....	47
Gates Radio & Supply Co.....	33
General Radio Co.....	Third Cover
H	
Hintze, A. G.....	47
L	
Lapp Insulator Co., Inc.....	5
Lefebure Corp. ....	38
M	
Mallory & Co., Inc., P. R.....	8
P	
Paramount Paper Tube Co.....	47
Precision Inductance Corp.....	47
Presto Recording Corp.....	36
R	
RCA Communications, Inc.....	38
RCA Mfg. Co., Inc.....	6
Radio Transceiver Labs.....	40
Rangertone, Inc.....	47
S	
Scientific Radio Service.....	47
Shakeproof Lock Washer Co.....	41
Solar Mfg. Corp.....	Back Cover
Sound Apparatus Co.....	38
Standard Electrical Products Co.....	45
Stevens, Eugene E.....	47
Swedish Iron & Steel Corp.....	1
Synthane Corp. ....	25
T	
Taylor Fibre Co.....	47
Televiso Co., The.....	36
Thomas & Skinner Steel Prod. Co.....	47
U	
United Transformer Corp.....	27
Universal Microphone Co., Ltd.....	38
W	
Wholesale Radio Service Co., Inc.....	35
Winslow, Louis J.....	47
Z	
Zophar Mills, Inc.....	48

## Waxes Compounds Varnishes

FOR INSULATION  
OF CONDENSERS

Transformers, coils, power packs, pot heads, sockets, wiring devices, wet and dry batteries, etc. Also WAX SATURATORS for braided wire and tape. WAXES for radio parts. Compounds made to your own specifications if you prefer.

### ● ZOPHAR MILLS, INC.

Founded 1846

120—26th Street  
Brooklyn, N. Y.

## CINAUDAGRAPH

# Speaker

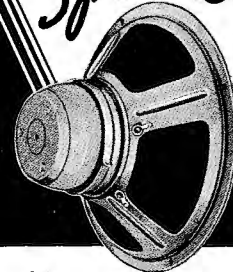

### CINAUDAGRAPH Magic Magnet Speakers

—extensively utilized by all leading radio receiver and P. A. equipment manufacturers—are available in a complete range of sizes from 5½ to 18 inches, to meet your every radio requirement.

If you demand utmost dependability and fidelity of reproduction from your equipment—in-sist on Cinaudagraph P. M. speakers. Carried in stock by all progressive distributors. Free descriptive literature on request.



**CINAUDAGRAPH  
CORPORATION**  
Speaker Division • Stamford, Conn.

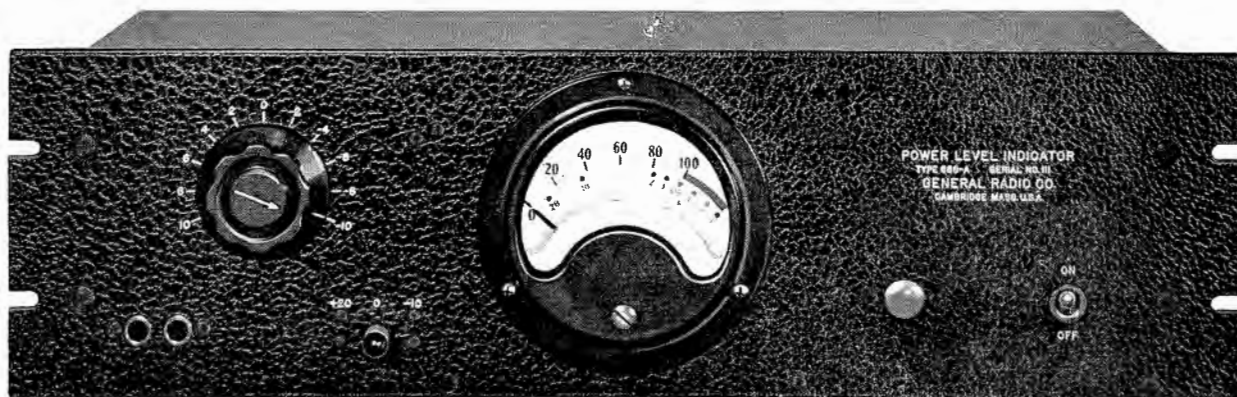

## HERE'S THE NEW G-R POWER LEVEL INDICATOR.

TAKE A LOOK AT THE CIRCUIT. IT HAS EVERYTHING YOU HAVE WANTED IN A VOLUME INDICATOR. IT IS MADE RIGHT AND PRICED RIGHT.



- HIGH-SPEED SLOW-SPEED MICROAMMETER —————→
- VACUUM TUBE VOLTMETER —————→
- DELAY DISCHARGE CIRCUIT —————→
- FULL-WAVE RECTIFIER DIODES —————→
- PHASE DIVIDER —————→
- LINEAR DEGENERATIVE AMPLIFIER —————→
- ACCURATE MULTIPLIER —————→
- DOUBLE SHIELDED INPUT —————→

TYPE 686-A  
POWER LEVEL INDICATOR

**\$195.00**

COMPLETE WITH TUBES

Write for  
Bulletin 202

Address:

**30 State Street  
Cambridge, Mass.**

Branches in LOS ANGELES,  
NEW YORK or SAN  
FRANCISCO

# GENERAL RADIO COMPANY



announces a complete line of

# TRANSMITTING CAPACITORS

## OIL-PAPER

and

## MICA TYPES



### TRANSOIL . . . SOLAREX . . . TRANSMICA

*Write for complete catalog*



**SOLAR MFG. CORP., 599-601 BROADWAY, NEW YORK, N. Y.**

[www.americanradiohistory.com](http://www.americanradiohistory.com)