

COMMUNICATIONS

\$1.00

INCLUDING "RADIO ENGINEERING" AND "TELEVISION ENGINEERING"





For Accurate Alignment of IF Circuits . . .
THE HAR-CAM *Visual Alignment* SIGNAL GENERATOR

This sturdy, compact HAR-CAM unit is designed for the visual alignment of the IF circuits in FM and AM receivers. The performance of the IF circuit is shown visually on an oscilloscope and accurate alignment is swiftly and easily accomplished.

The Model 205 TS HAR-CAM Visual Alignment SIGNAL GENERATOR has a frequency range

from 100 kc to 20 mc . . . Its linear frequency sweep deviation is adjustable from zero to 900 kc peak to peak . . . Stable r-f gain control is independent of frequency . . . Output impedance, 1 ohm to 2500 ohms . . . It has a phone jack for aural monitoring of zero beat calibration of main tuning dial and a panel jack to feed linear sweep voltage to the x-axis

amplifier of the oscilloscope . . . Size, 7" wide, 9½" high, 10½" deep. Weight but 18 pounds.

The HAR-CAM 205 TS is designed and built with stable and proven circuit principles which insure fine, lasting performance. For complete specifications, write for HAR-CAM Visual Alignment SIGNAL GENERATOR Bulletin No. H-40.

HARVEY RADIO LABORATORIES, INC.

442 CONCORD AVENUE • CAMBRIDGE 38, MASSACHUSETTS



Typical HARVEY products: Above left: The HARVEY Marine Radio Telephone Model M-25; center: The HARVEY Regulated Power Supply 106 PA; right: The HAR-CAM Model MFT-25 FM Transmitter. Write for Bulletins.

Both are

FERRANTI

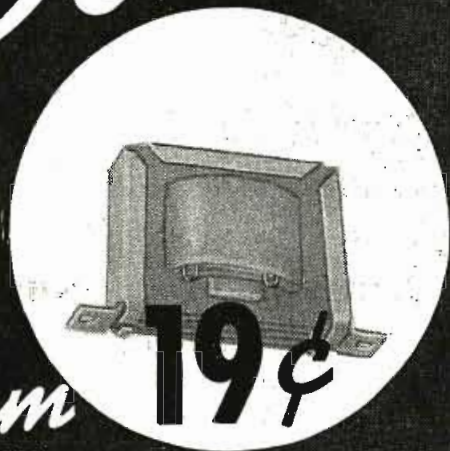

from

THE

**LOWEST PRICED
TRANSFORMER** *to*



\$19.00
**THE HIGHEST
PRICED
TRANSFORMER**

Both backed by

FERRANTI

**HIGH QUALITY
PROMPT SERVICE
RAPID DELIVERY**

and

COMPLETE ENGINEERING SERVICE

Order any Quantity - no matter how small or large



FERRANTI ELECTRIC, INCORPORATED

NEW YORK 20

RCA

NEW YORK

BUILDING

TRANSFORMERS • CHOKES • FILTERS • WIRING AND ASSEMBLIES

We See...

THE RISING INTEREST IN MOBILE AND PORTABLE commercial communications equipment for trains, buses, cabs, trucks, marine-craft, and public service, police and fire vehicles, has initiated many unusual development projects. Because of the variety of problems that prevail in the installation stages and in en-route use, laboratories have begun to develop custom-model systems. For instance, trucks, cabs and buses, operating in mountainous terrain, will receive a transmitter-receiver unit particularly designed for that type of travel. Distances are also a considered factor in this design. Cars operating in crowded tall-building metropolitan areas will receive equipment with features particularly adaptable to that type of service. Vehicles operating in suburban-type communities will receive another type of installation.

Proximity of mineral deposits, water, tunnels, conduits, etc., are also being taken into consideration in this design program. Other factors being studied are types of vehicles, cargoes being carried and space available for installations. For instance, special units are being developed for trucks carrying volatile materials, as well as for the huge freight-carrying trucks, overnight buses and smaller vehicles. These units will be in one, two, or three-section style depending on space availability.

Both communications equipment and vehicle fabricators are cooperating in this effort to provide a communications service that will be fool proof. Good work!

THE RECENT VAPORIZED-ZINC-COATING CAPACITOR German development disclosed by the War Department, introduces a manufacturing procedure that may completely alter many standard concepts.

Developed by the Robert Bosch Company of Stuttgart, Germany, these capacitors heal automatically after quite a few breakdowns. It was possible to operate these capacitors at 20 to 50% higher voltages than paper and foil capacitors, made in the standard fashion. To illustrate, one type capacitor made by the Germans used a single sheet of .4-mil kraft paper and had a maximum working voltage of 250 d-c. Some capacitors used a zinc film only 2 microns thick.

The process covered by U. S. Patent 2,244,090 is in the custody of the Alien Property Custodian. The machinery used to produce these capacitors is expected to arrive in this country some time during the summer when it will be placed on public exhibit.

OCTOBER WILL BE QUITE AN ACTIVE conference and show month. The TBA have scheduled their second television conference for the Waldorf-Astoria Hotel in New York City on Thursday and Friday, October 10th and 11th. NAB expects to hold their conference in Chicago during the later part of October.—L. W.



APRIL, 1946

VOLUME 26

NUMBER 4

COVER ILLUSTRATION

The WOR electrical-transcription control room.

EQUIPMENT DEVELOPMENT

The Measurement of Audio Distortion.....H. H. Scott 23
A Study of Methods Used to Measure Distortion in A-M and F-M Systems.

QUARTZ CRYSTAL DESIGN

Plating Quartz Oscillator Crystals.....K. M. Laing 26
An Analysis of Plating Methods...Cemented, Foil, Film, Firing, Silver-Plating, etc.

BROADCAST ENGINEERING CONFERENCE REVIEW

A Report On the Sixth Annual Conference of Broadcast Engineers
 Lewis Winner 30
Preventive Maintenance for Broadcast Stations (Charles Singer)..... 30
Magnetic Recording (S. J. Begun)..... 31
Tools For the Study of Disk Recording Performance (H. E. Roys)..... 33
Irregular Room Surfaces (K. C. Morrill)..... 35
Circular Antennas (M. W. Scheldorf)..... 36
F-M Broadcast Loops (A. G. Kondoian)..... 38
Super Turnstile Antennas (R. F. Holtz)..... 40
The Clover-Leaf F-M Antenna (P. H. Smith)..... 58
Television Motion-Picture Film (Scott Helt)..... 68
F-M Station Monitor (H. R. Summerhayes, Jr.)..... 68

F-M BROADCASTING

Direct Frequency-Modulation Modulators.....N. Marchand 42
A Discussion of Miscellaneous Types of Direct F-M Modulators.

NOMOGRAM

Nomogram For Computing Inductance of Straight Cylindrical Wires
 J. I. Stephen 48
Chart Can Be Used for the Very High Frequencies.

PRODUCTION DEVELOPMENT

Printed Circuits 78

MONTHLY FEATURES

Editorial (We See)..... 2
 Veteran Wireless Operators' Association News..... 50
 News Briefs of the Month..... 61
 The Industry Offers 69
 Advertising Index 80

Published Monthly by the Bryan Davis Publishing Co., Inc.

BRYAN S. DAVIS, President

F. WALEN, Secretary

PAUL S. WEIL, Vice Pres.-Gen. Mgr.

A. GOEBEL, Circulation Mgr.

Advertising and Editorial offices, 52 Vanderbilt Ave., New York 17, N. Y. Telephone, MUrray Hill 4-0170. Cleveland 6, Ohio: James C. Munn, 10515 Wilbur Ave.; Telephone, SWEetbriar 0052. Pacific Coast Representative: Brand & Brand, 1052 W. Sixth St., Los Angeles 14, Calif.; Telephone, Michigan 1732. Wellington, New Zealand: Te Aro Book Depot. Melbourne, Australia: McGill's Agency. Entire Contents Copyright 1946, Bryan Davis Publishing Co., Inc. Entered as second-class matter Oct. 1, 1937, at the Post Office at New York, N. Y., under the act of March 3, 1879. Yearly subscription rate: \$2.00 in the United States and Canada; \$3.00 in foreign countries. Single copies, twenty-five cents in United States and Canada; thirty-five cents in foreign countries.

SYLVANIA NEWS

CIRCUIT ENGINEERING EDITION

APRIL

Prepared by SYLVANIA ELECTRIC PRODUCTS INC., Emporium, Pa.

1946

ANNOUNCING! EFFICIENT, NEW SYLVANIA R.F. AMPLIFIER TUBE

TYPE 7AG7



TYPICAL OPERATING CONDITIONS

Heater voltage	6.3 volts
Heater current	0.150 ampere
Maximum plate voltage	250.0 volts
Maximum plate dissipation	2.0 watts
Maximum screen grid voltage	250.0 volts
Minimum external negative grid voltage	1.0 volt
Maximum screen grid dissipation	0.75 watts
Maximum heater-cathode voltage	90.0 volts

Here's a new sharp cut-off r-f pentode amplifier designed especially for 6.3 volt and a-c/d-c series service in Television and Frequency Modulation receivers.

The tube may be operated with full plate voltage on the screen grid to produce high input resistance as a result of reduced electron transit

TYPICAL OPERATING CHARACTERISTICS OF TYPE 7AG7 AS A CLASS A1 AMPLIFIER

Plate current	6.0 Ma.
Plate resistance	0.75 megohm
Screen grid current	2.0 Ma.
Mutual conductance	4200 micromhos

Direct Interelectrode Capacitances

Grid to plate	.005 micromicrofarad Max.
Input	7.0 micromicrofarads
Output	6.0 micromicrofarads

time. Identical voltage requirements for plate and screen grid also eliminate the need of screen grid filter resistors and by-pass capacitors in some circuit applications.

Inquiries concerning the new Sylvania Type 7AG7 r-f pentode amplifier tube are invited. Write Sylvania Electric Products Inc., Emporium, Pa.

SYLVANIA ELECTRIC

Emporium, Pa.

MAKERS OF RADIO TUBES; CATHODE RAY TUBES; ELECTRONIC DEVICES; FLUORESCENT LAMPS, FIXTURES, WIRING DEVICES; ELECTRIC LIGHT BULBS

COMMUNICATIONS FOR APRIL 1946 • 3



LABORATORY INSTRUMENTS FOR SPEED AND ACCURACY

A New -hp- AF Oscillator

MODEL 201B

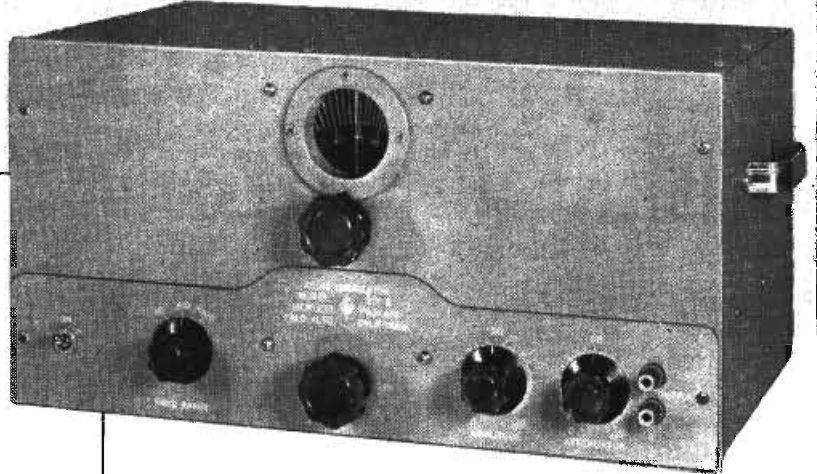

OUTSTANDING NEW FEATURES

3 Watts Output

Distortion Less Than $\frac{1}{2}$ of 1%

Low Hum Level

New Dial With Ball-Bearing Drive

Accurate Expanded Frequency
Calibration

Improved Control of Output Level

In FM and other fields where high fidelity is important, this new -hp- Model 201B Audio Frequency Oscillator will meet every requirement for speed, ease of operation, accuracy and purity of wave form. The product of 6 years of -hp- oscillator development, this new oscillator has many brand new features, in addition to the revolutionary resistance-tuned circuit which has made -hp- a byword in engineering circles.

The 201B has an accurate, convenient method of frequency control. The 6" dial, with smooth ball-bearing action, may be tuned by a directly controlled knob, or for still greater accuracy, may be set by the vernier which has a ratio of 6 to 1 to the main dial. The illuminated main dial is designed so that parallax is eliminated. It is calibrated over 300 degrees with approximately 95 calibration points and has an effective scale length of about 47 inches. The frequency range is 20 cps to 20 kc.

The amplifier delivers up to 3 watts of power into a 600 ohm resistance load, with distortion held to 1%. Thus there is sufficient power available for driving almost any kind of laboratory

or production equipment. Harmonic distortion may be kept to less than $\frac{1}{2}$ of 1%, if the output of the amplifier is limited to 1 watt.

Another important feature of this oscillator is the provision which is made for standardizing each frequency range against a reliable standard, such as -hp's- Model 100B Secondary Frequency Standard. By standardizing the instrument regularly, frequencies can be depended upon to be better than 1% accurate.

A new departure in oscillator design is the dual method for controlling output level. A volume control which is ahead of the amplifier controls the voltage at which the amplifier operates. An output attenuator is provided to attenuate the signal delivered by the amplifier. Attenuation is approximately linear from zero to 40 DB. Both hum level and output voltage are thus attenuated together. As a result, hum level may be kept 60 DB or more below the signal level, a special advantage in cases where small test signals are used.

The impedance looking back into the out circuit is about 50 ohms; thus the voltage regulation for varying loads is extremely good. For measurements where it is desirable to have impedance looking back into the instrument of 600 ohms, as in transmission measurements, the attenuator may be used to give about 6 DB or more of attenuation, making the reflected impedance of the instrument about 600 ohms.

Care has been taken to perfect every detail of this new oscillator. Improved chassis layout and placement of component parts minimizes thermal drift. The voltage on the oscillator is maintained constant with an electronic voltage regulator. The entire instrument is characterized by greater mechanical rigidity; the tuning assembly is mounted on a sturdy cast aluminum frame. The chassis itself is made of aluminum; the oscillator is light in weight and easy to handle. Write today for latest data, prices and delivery information on this versatile, accurate resistance-tuned oscillator.

HEWLETT-PACKARD COMPANY

BOX 1159E • STATION A • PALO ALTO, CALIFORNIA

Audio Frequency Oscillators
Noise and Distortion Analyzers

Signal Generators
Wave Analyzers

Vacuum Tube Voltmeters
Frequency Meters

• Square Wave Generators

Frequency Standards

Attenuators

Electronic Tachometers



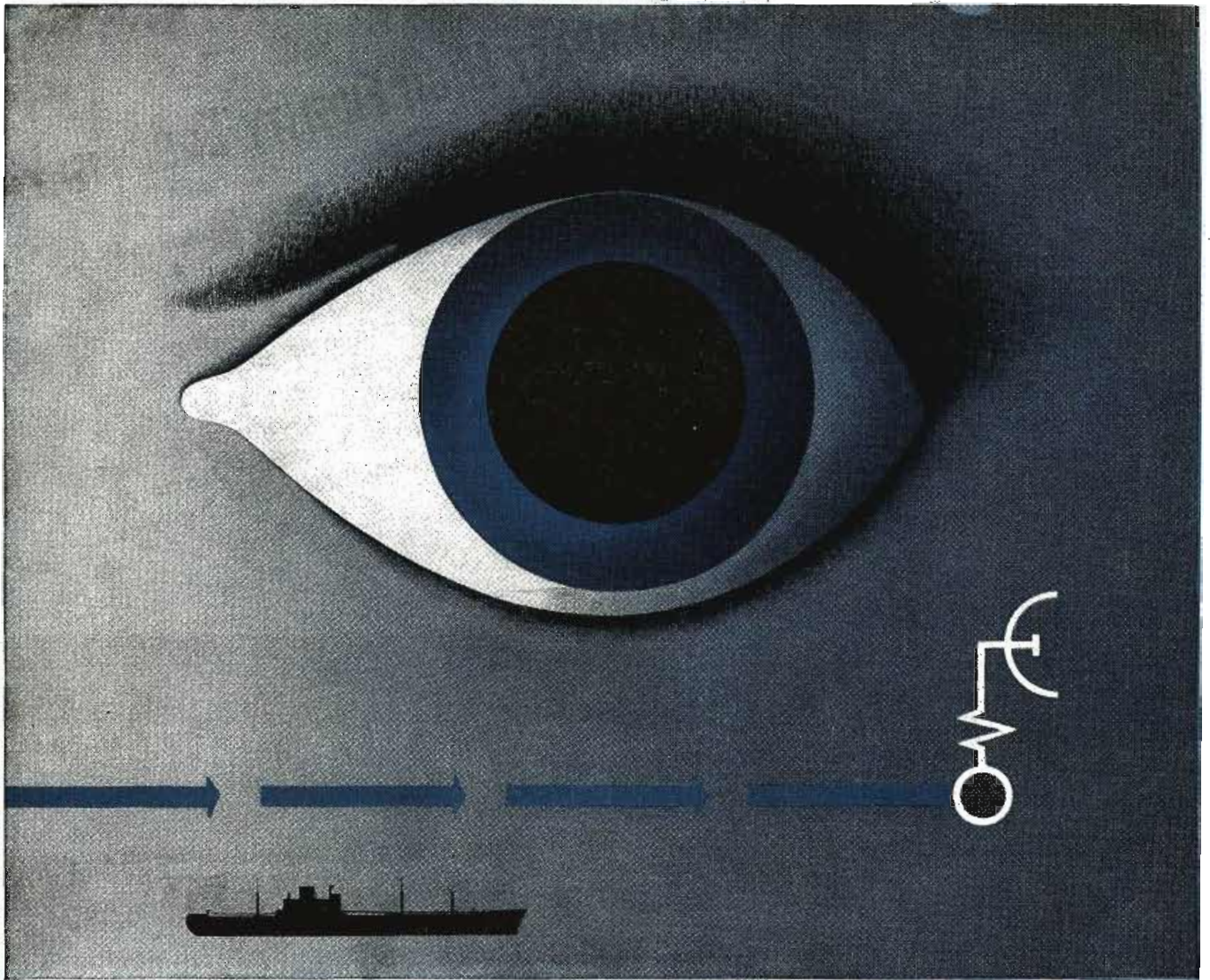

Look ahead ^{to} / _{with} Radar by Sperry

• This year, Sperry Gyroscope Company introduces its new *Radar* equipment for marine use.

Sperry *Radar* has been conceived to function better in this fundamental service: *To enable ships to operate on schedule regardless of visibility...through thick fog, heavy rain, dense smoke, darkness.*

As an aid to navigation it picks up channel markers and buoys; assists in making landfalls with assurance; spots icebergs, floating derelicts and other hazards projecting above surface. It also permits vessels to enter harbors and proceed with

all due safety and caution through fog. Another important feature: Sperry *Radar* provides a Gyro-Compass-controlled image and can be operated by bridge personnel without extensive technical background.

In design and construction, Sperry *Radar* reflects this company's many years of experience in precision manufacture of marine equipment—as well as its outstanding achievements in the field of electronics. In simplicity and dependability, this new *Radar* exemplifies again Sperry's ability to build superior products for merchant ship service.

Sperry Radar Features:

- Designed to meet all Class A specifications of the U. S. Coast Guard.
- Maximum range 30 miles—minimum, 100 yards.
- 10-inch picture on a 12-inch screen.
- Images presented in true or relative relationship at option of operator.
- Gives accurate ranges read from indicator instead of estimated from scope.
- Backed by world-wide service.

SPERRY GYROSCOPE COMPANY, INC. GREAT NECK, N. Y.



Division of the Sperry Corporation

★
LOS ANGELES • SAN FRANCISCO • SEATTLE • NEW ORLEANS
CLEVELAND • BROOKLYN • HONOLULU

GYROSCOPICS • ELECTRONICS • RADAR • AUTOMATIC COMPUTATION • SERVO-MECHANISMS



FOR COMPACT HIGH FIDELITY EQUIPMENT

Ultra compact, lightweight, these UTC audio units are ideal for remote control amplifier and similar small equipment. New design methods provide high fidelity in all individual units, the frequency response being ± 2 DB from 30 to 20,000 cycles. There is no need to resonate one unit in an amplifier to compensate for the drop of another unit. All units, except those carrying DC in Primary, employ a true hum balancing coil structure which, combined with a high conductivity outer case, effects good inductive shielding. Maximum operating level +10 DB. Weight - $5\frac{1}{2}$ ounces. Dimensions - $1\frac{1}{2}$ " wide x $1\frac{1}{2}$ " deep x 2" high.

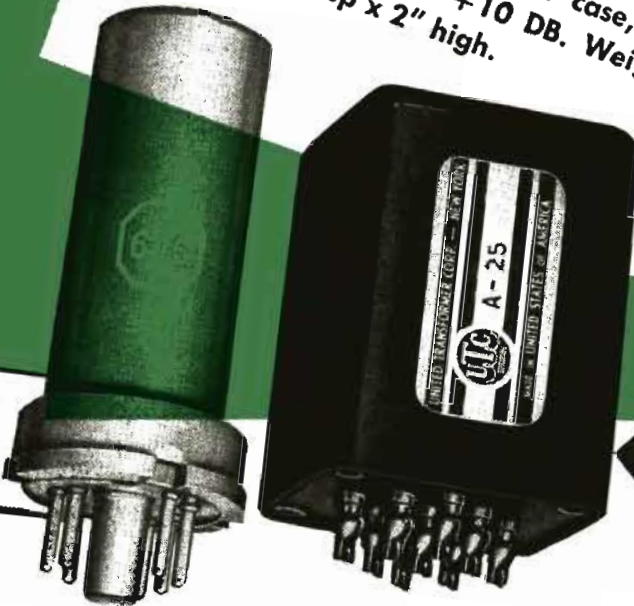

Unit shown is actual size. 6V6 tube shown for comparison only.

FOR IMMEDIATE DELIVERY
From Your Distributor

ULTRA COMPACT HIGH FIDELITY AUDIO UNITS

Type No.	Application	Primary Impedance	Secondary Impedance	± 2 DB from	List Price
A-10	Low impedance mike, pickup, or multiple line to grid	50, 125, 200, 250, 333, 500 ohms	50,000 ohms	30-20,000	\$12.75
A-11	Low impedance mike, pickup, or line to 1 or 2 grids	50, 200, 500 ohms	50,000 ohms	50-10,000 multiple alloy shield for extremely low hum pickup	13.90
A-12	Low impedance mike, pickup, or multiple line to push pull grids	50, 125, 200, 250, 333, 500 ohms	80,000 ohms overall in two sections	30-20,000	12.75
A-18	Single plate to two grids	8,000 to 15,000 ohms	80,000 ohms overall, 2.3:1 turn ratio overall	30-20,000	11.60
A-24	Single plate to multiple line	8,000 to 15,000 ohms	50, 125, 200, 250, 333, 500 ohms	30-20,000	12.75
A-25	Single plate to multiple line 8 MA unbalanced D.C.	8,000 to 15,000 ohms	50, 125, 200, 250, 333, 500 ohms	50-12,000	11.60
A-26	Push pull low level plates to multiple line	8,000 to 15,000 ohms each side	50, 125, 200, 250, 333, 500 ohms	30-20,000	12.75
A-30	Audio choke, 300 henrys @ 2 MA 6000 ohms D.C., 75 henrys @ 4 MA 1500 ohms D.C., inductance with no D.C. 450 henrys				8.70

The above listing includes only a few of the many Ultra Compact Audio Units available . . . write for more details.

United Transformer Corp.
150 VARICK STREET NEW YORK 13, N. Y.
EXPORT DIVISION: 13 EAST 40th STREET, NEW YORK 16, N. Y., CABLES: "ARLAB"



The Answer to Television and
Other High-Voltage Resistor
Applications...

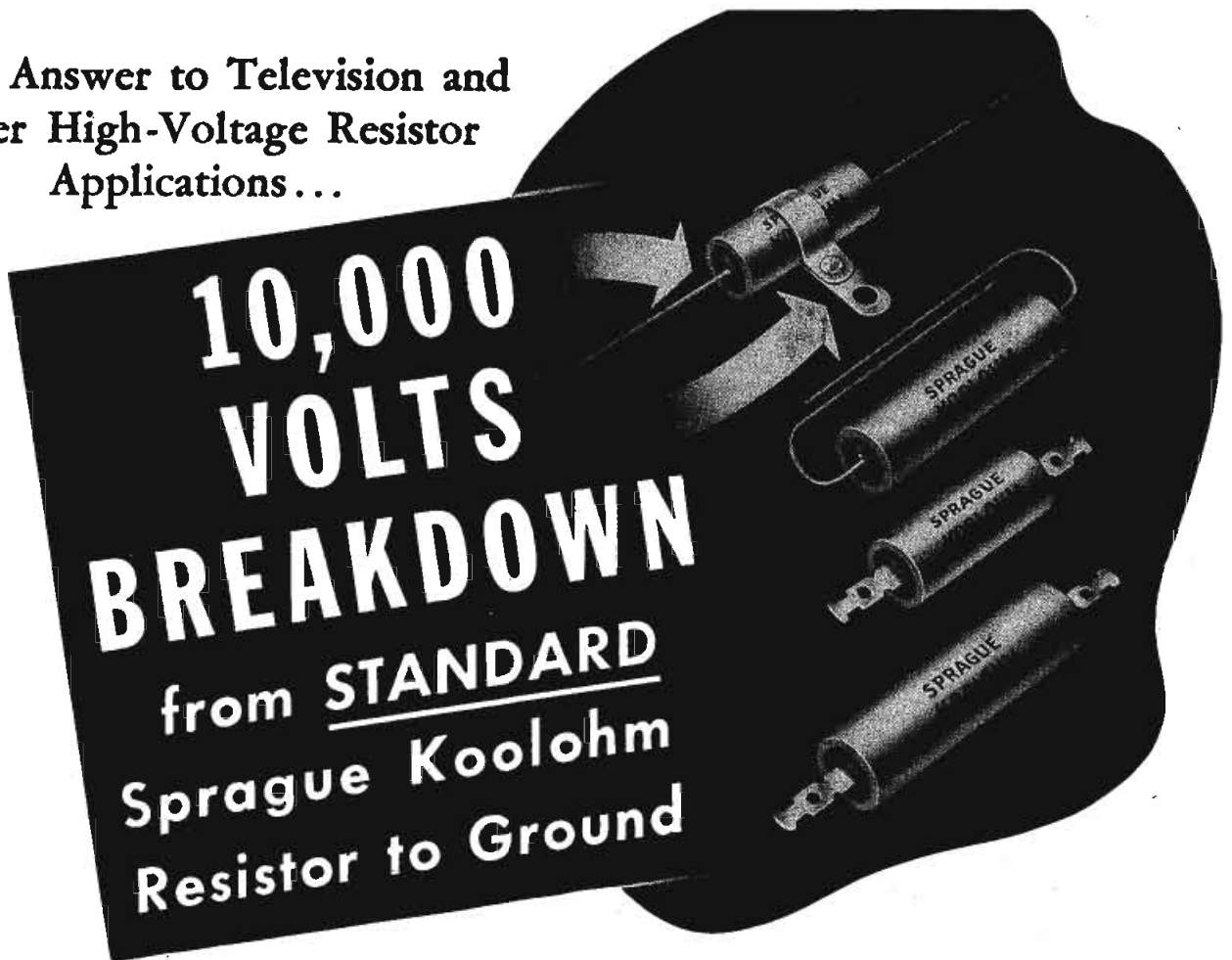

Completely insulated surface

Standard Sprague Koolohm Wire Wound Resistors have the high insulation resistance to ground which you need for television and other applications where high voltages are involved—*10,000 volts from the surface of their sturdy ceramic jackets to their resistance elements.* Mount them anywhere without fear of voltage breakdown!

In addition, Koolohms give you the advantages of higher resistances in smaller physical sizes; easier mounting; use at full wattage ratings; and overall tropicalized protection against the most severely humid conditions. Write for Catalog 10EA.



WOUND WITH
CERAMIC
INSULATED
WIRE

DOUBLY
PROTECTED
by glazed
CERAMIC SHELLS and
MOISTURE-PROOF END SEALS

SPRAGUE ELECTRIC CO., Resistor Division, North Adams, Mass.

SPRAGUE KOOLOHMS

TRADEMARK REGISTERED U.S. PAT. OFF.

The Greatest Wire-Wound Resistor Development in 20 Years

*A value range equal to
its frequency range...*

... A LABORATORY-TYPE SIGNAL GENERATOR FOR SERVICEMEN

We've been designing and producing signal generators for a good many years—each one the best we were able to produce in that year. They have always been pace-setters. Over the years they have become the standard of utility in such instruments for servicemen—distinguished always by that inbuilt Simpson accuracy that stays accurate. Every new model has stepped up the value, dollar for dollar, of the serviceman's investment.

Now this Model 415, with the widest frequency range of them all, tremendously widens the value range as well. Every dollar of its price buys more than a dollar ever bought before, even in a Simpson instrument. We know, for instance, of several

signal generators built for laboratories only, selling *at twice and three times the price* of the Model 415, that will do very little more than this new Simpson Wide Range Signal Generator for AM and FM. And no serviceman's instrument we know of even approaches Model 415 in range, control, constancy of output, completeness of attenuation and degree of utility. Here is another of Simpson's 1946 developments in instruments for radio and television servicemen, the product of long and rewarding research.

We offer Model 415 in the proud knowledge that it is not likely to see its peer for a long time to come.

1. Direct reading dial with continuous coverage from 70 Kilocycles to 130 Megacycles in the following ranges: 75-200; 200-600; 600-1750 Kilocycles and 1.5-4.5; 4-15; 14-30; 29-65; 58-130 Megacycles.
2. Model 415 is practically independent of line voltage fluctuation. Calibration is stable regardless of wide variations in line voltage.
3. RF output is controlled through its entire range, eliminating the necessity of a separate connection for high uncontrolled output as found in other signal generators.
4. RF output voltage is practically constant throughout the entire frequency range.
5. Modulation from 0 to 100% using either the 400 cycle internal sine wave or an external source. A range from 0 to over 20 volts of 400 cycle sine wave is available for external use.
6. High fidelity modulation up to 100% from below 60 cycles per second to over 10 Kilocycles per second.
7. No unwanted frequency modulation present.
8. Each Signal Generator is individually calibrated against a crystal controlled frequency standard.
9. Substantial construction assures maintenance of calibration accuracy indefinitely.

PANEL—Lustrous black anodized aluminum. Dial is encased in a molded bakelite escutcheon with glass covering for protection against damage and dirt. Functional switches and controls are mounted on engraved molded bakelite panels.

CASE—Steel, copper plated for shielding effect and finished in black durable wrinkled enamel. Leather carrying handle.

SHIELDING—In addition to the overall shielding offered by the case and panel, the coils and tuning condenser are individually shielded, then an additional shield is placed over these two assemblies. This series of shields together with other factors reduce leakage to an absolute minimum.

COILS—Low loss RF coils are individually calibrated by means of variable inductance and variable minimum capacitance. These adjustments provide the means for greatest possible accuracy in calibration.

BAND SELECTOR—The rotating turret coil assembly permits the use of shortest possible wiring, resulting in minimum circuit capacitance and permits quick selection of any frequency range.

CONDENSER—A two section tuning condenser using either one section or the other provides for ideal inductance to capacity ratio on all bands. Smooth vernier tuning permits accurate adjustment of the selected frequency.

Price\$115.00

ASK YOUR JOBBER

SIMPSON ELECTRIC COMPANY
5200-5218 W. Kinzie St., Chicago 44, Illinois

Simpson
INSTRUMENTS THAT STAY ACCURATE

**NEW SIMPSON
WIDE RANGE
SIGNAL GENERATOR
FOR AM AND FM**



WATCH FOR NEW SIMPSON DEVELOPMENTS... THEY ARE WORTH WAITING FOR



THE COUNTERSIGN OF DEPENDABILITY IN ANY ELECTRONIC EQUIPMENT

HERE IS A RADICALLY IMPROVED VERSION OF THE EIMAC MULTI-UNIT 304TL TRIODE

NEW NON-EMITTING GRIDS

NEW LOW-TEMPERATURE PLATES

The Eimac Multi-Unit triode 3-300A2 pictured above is a radically improved version of the original 304TL which has been establishing outstanding performance records for a number of years in both civilian and military equipment.

The use of Eimac developed, non-emitting grids, contributes greatly to its already high stability, efficiency and long life, and the new type plates enable it to operate at much lower temperatures.

One of its outstanding characteristics is its ability to handle high current at relatively low voltages. For example: as a class-C amplifier the Eimac 3-300A2 will handle 1200 watts plate input with only 2000 volts on the plate. Under these conditions, the tube will deliver a power output of 900 watts, with a driving power of only 36 watts. The chart at right shows driving power requirements vs. power output. The symbols P_p indicate plate dissipation. Further information will be promptly supplied without cost or obligation.

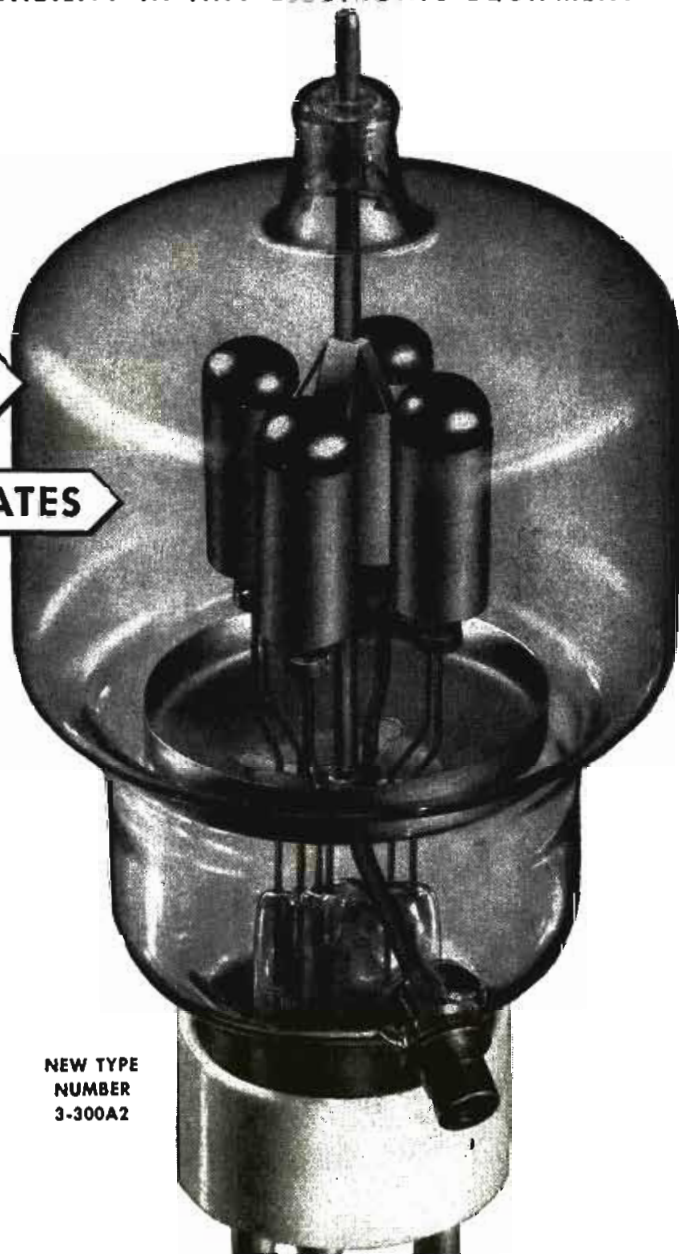

NEW TYPE NUMBER 3-300A2

ELECTRICAL CHARACTERISTICS

Filament: Thoriated tungsten	
Voltage	5.0 or 10.0 volts
Current	25.0 or 12.5 amperes
Amplification Factor (Average)	12
Direct Interelectrode Capacitances (Average)	
Grid-Plate	9.1 uuf
Grid-Filament	8.5 uuf
Plate-Filament	0.6 uuf
Transconductance ($I_b=1.0$ amp., $E_b=3000$, $e_c=-200$)	16,700 umhos

FOLLOW THE LEADERS TO



EITEL-McCULLOUGH, INC., 1176F San Mateo Ave., San Bruno, Calif.

Plants located at: San Bruno, Calif., and Salt Lake City, Utah
Export Agents: Frazer and Hansen, 301 Clay St., San Francisco 11, Calif., U. S. A.

CALL IN AN EIMAC REPRESENTATIVE FOR INFORMATION

ROYAL J. HIGGINS (W9AIO) . . . 600 S. Michigan Ave., Room 818, Chicago 5, Illinois. Phone: Harrison 5948.

V. O. JENSEN, General Sales Co., 2616 Second Ave., Seattle 1, Washington. Phone: Elliott 6871.

M. B. PATTERSON (WSCI) . . . 1124 Irwin-Kessler Bldg., Dallas 1, Texas. Phone: Central 5764.

ADOLPH SCHWARTZ (W2CN) . . . 220 Broadway, Room 2210, New York 7, N. Y. Phone: Cortland 7-0011.

HERB B. BECKER (W6QD) . . . 1406 S. Grand Ave., Los Angeles 15, California. Phone: Richmond 6191.

TIM COAKLEY (W1KKP) . . . 11 Beacon St., Boston 8, Massachusetts. Phone: Capital 0050.

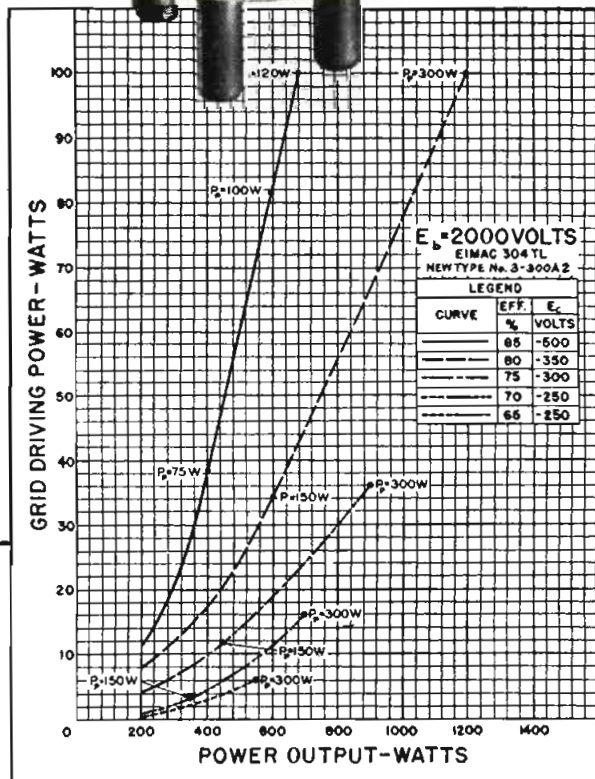

CAUTION! Look for the latest serial numbers on Eimac Tubes. Be sure you get the newest types.

What DOES Make a BETTER Loud Speaker?

WILL the possession of physical facilities and desire create a better product? No, because for all of their importance, these possessions are certainly not unique. All institutions have them to some degree. Is it fanciful claims and fluent use of superlatives in product description that make a product better? Obviously not. Is it the achievement of theoretically perfect performance in the laboratory? No, not that either, for perfection in such respects does not necessarily create the practical ideal.

The simple truth is that no product can be better than know how and the honest application of that know how as the product is created and its virtues described.

What is the yardstick of these ingredients in a product? The record of achievements and the list of contributions to the advancement of science and art is one good measurement. The First PM Speaker, the Bass Reflex Principle, the Hypex Formula are just a few of the advancements contributed to the industry by JENSEN. There is also the endorsement by those users and connoisseurs of Loud Speaker performance whose first and last emphasis is always on superiority. JENSEN Loud Speakers and Reproducers are the overwhelming choice of such people. Finally, and perhaps most important of all, there is the established custom of the manufacturer to make honest statements as to the real ability as well as limitations of the product. Here at JENSEN this has always been a fixed policy, an absolutely essential ingredient in honesty of purpose, even though by some standards it is called "selling down."

And so, a better Loud Speaker is created because of know how, achievement as shown by the record, significant endorsement and integrity of purpose from start to finish. JENSEN Loud Speaker Products, personnel and policy meet these requirements.

For those interested in the proper appraisal, selection, use and operation of Loud Speakers, JENSEN is publishing a series of Technical Monographs—of which five issues are now in print. Note the titles listed below and write for one or all of them.



5 MONOGRAPHS AVAILABLE

1. Loud Speaker Frequency-Response Measurements
2. Impedance Matching and Power Distribution
3. Frequency Range in Music Reproduction
4. The Effective Reproduction of Speech
5. Horn Type Loud Speakers

FREE to the Armed Forces, Colleges,
Technical Schools, Libraries

25c
Each

JENSEN RADIO MANUFACTURING CO.
6603 SO. LARAMIE AVENUE, CHICAGO 38, ILLINOIS
In Canada: Copper Wire Products, Ltd., 137 Oxford Street, Guelph, Ont.

Specialists in Design and Manufacture of Fine Acoustical Equipment

Why

this team is a leader in VHF



1. First voice circuits were single iron wires with ground return. Frequency limitations, noise and high losses soon ruled them out.



2. Big improvement was the all wire circuit—a pair of wires to a message. Later came carrier which stepped up frequency and permitted several messages per circuit.

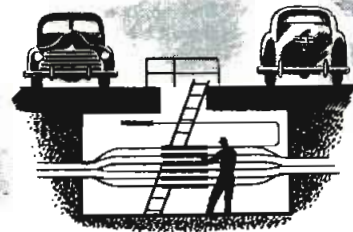

3. Lead covered cable compressed many wire circuits into small space—took wires off city streets. But losses are prohibitive at very high frequencies.



4. Coaxial cable—a single wire strung in a pencil size tube—extended the usable frequency band up to millions of cycles per second and today carries hundreds of messages per circuit, or the wide bands needed for television.

transmission

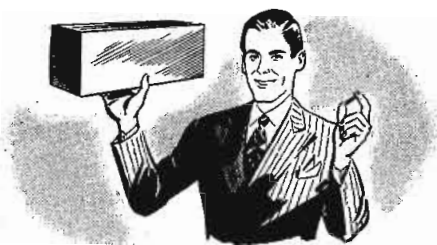

5. Wave guides, fundamentally different in transmission principle, channel energy as radio waves through pipes; vary in size from several inches to under 1 cm.; become smaller as frequency rises.



6. Late model radar wave guides, similar to that used to feed the antenna above, can carry $3\frac{1}{2}$ cm. waves at more than eight billion cps. Experimental guides for still shorter waves are being tested.

Back in 1933, Bell scientists established an historic first when they transmitted very high frequency radio waves for hundreds of feet along hollow pipes called wave guides. For them it was another forward step in their long research to make communication circuits carry higher frequencies, broader bands and more messages per circuit.

Continuing Research showed the way

From the days of the single open wire line—through all-metallic circuits, phantoming, cable, carrier systems and coaxials—up to today's wave guides, every improvement has been the result of continuous fundamental study.

When Bell Laboratories started work on wave guides, there was no immediate application for the microwaves they guided. But the scientists foresaw that *some day* wave guides would be needed—so they kept on working until they had developed the wave guide into a practical device.

With the war came radar—and the problem of conducting microwave frequencies. Bell Laboratories had the answer—wave guides—without which radar at the higher frequencies would have been impractical.

What this means to YOU

Year after year, Bell Laboratories have continued to develop methods for handling higher and higher frequencies. Year after year Western Electric has provided equipment putting these scientific advances to work. This team has become the natural leader in the field.

When your requirement dictates the use of VHF—in mobile communications, broadcasting, or point-to-point radio telephony—depend on Western Electric to supply the latest and best equipment for your needs.



BELL TELEPHONE LABORATORIES

World's largest organization devoted exclusively to research and development in all phases of electrical communication.

Western Electric

Manufacturing unit of the Bell System and nation's largest producer of communications and electronic equipment.

Everything for the Emergency Radio Services!

COMPLETE MATCHED **FM** and **AM** RADIO COMMUNICATION EQUIPMENT

BY *Doolittle*

Mobile Receivers • Station Receivers • Frequency Monitors
Mobile Transmitters • Station Transmitters • Station Control Units
Concentric Transmission Line • Mobile Antennae • Station Antennae

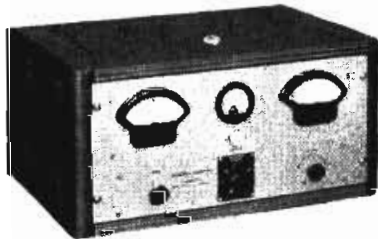

FREQUENCY MONITORS (FM and AM)

Direct reading. No charts or complicated calculations necessary. Model FD-8 — AM Monitor 1600 kc. to 50 mc. operation on one to four frequencies or Model FD-8B one to six frequencies. Model FD-9A FM Monitor 30-44 mc. operation on one or two frequencies. All have 110 V. AC 60 cycle self contained power supply.

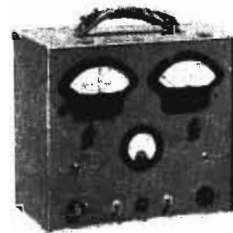

PORTABLE FM MONITOR

Model FD-10A is similar to the FD-9A except operates on 6 Volts D.C. Designed for checking FM Mobile Transmitting Equipment at point of operation. Supplied for operating on one or two frequencies between 30-44 mc.



MOBILE EQUIPMENT (FM and AM)

Models up to 60 watts output. Crystal controlled. Complete with Transmitter, Receiver, Power Supply and all Accessories.



STATION TRANSMITTERS (FM and AM)

18 available models. Power output up to 1000 watts. Assure maximum efficiency, absolute reliability and economical maintenance. Station Receivers, Control Units and Accessories to meet your needs.

Emergency services function with increased speed and effectiveness through FM and AM equipment *completely engineered, built and matched by DOOLITTLE*. Individual units or complete systems . . . standard or special equipment . . . high or low power . . . in MF, HF or VHF . . . for old and new bands.

Outstanding features of DOOLITTLE equipment include: Noise operated squelch. Low power consumption. Maximum coverage. Latest electrical and mechanical design. Compact, easy to install. Very accessible, simple to service. Aluminum construction throughout. Highest quality components.

Equipment engineered and built by DOOLITTLE
years ago still serves efficiently today.

Doolittle
RADIO, INC.

7421 S. LOOMIS BLVD., CHICAGO 16, ILLINOIS

Builders of Precision Radio Communication Equipment
for Police, Fire, Government, Forestry, Railroad, Public
Utility and other emergency services.



*for any type
of application*

BLILEY has the crystals

**Bliley
CRYSTALS**

To name all the engineers who "consult Bliley first" on frequency control problems would make a mighty impressive list.

They know from experience that Bliley engineers are always working in advance of the industry's requirements, and that the right crystal for

their particular application will be available without undue delay.

That is why Bliley acid etched* crystals persistently show up wherever important developments are taking place in the communications field—and go with those developments to all parts of the globe.

Your products, too, will benefit if you make it a habit to "consult Bliley first" on frequency control problems. There's over 15 years of quartz crystal engineering experience at your beck and call.

* Acid etching quartz crystals to frequency is a patented Bliley process.

For complete listing of Bliley crystals now available see Bulletin EM-27

BLILEY ELECTRIC COMPANY • UNION STATION BUILDING, ERIE, PENNSYLVANIA

ANSONIA BUILT A GREAT NEW FLEXIBLE CABLE FOR NAVY RADAR



For use on radar and gunfire control, the Navy needed a specialized high frequency cable. It had to feature:

- (1) flexibility
- (2) extreme low dielectric loss factors
- (3) serviceability under extreme weather conditions.

WANTED—High Frequency Transmission Problems, for M-I-29 . . . a new flexible cable featuring extremely low loss and high conductance. For use where coaxial characteristics are required in a flexible cable.



In cooperation with Navy Engineering, Ansonia helped develop a cable answering these requirements—M-I-29—available now, to you!

To the Navy this cable represented high fidelity radar images and dependable service under severe operating conditions. To you, it may mean clearer television, truer FM radio tone or the solution of a problem in

transmitting ultra high frequency power with low loss, since it approaches coaxial cable in dielectric qualities yet is completely flexible.

Insulated with ANKOSEAL thermoplastic insulation, M-I-29 can be engineered and supplied to meet special dielectric characteristics and operating conditions. "Yankee Ingenuity"

displayed in the creation of this cable is ready now to help make it meet your particular needs.

This is one of a complete line of *job-engineered* cables made by Ansonia. For details on this or other cables, write Dept. AL The Ansonia Electrical Company, Ansonia, Conn.

Why ANKOSEAL solves cable problems

Ankoseal, a thermoplastic insulation, can help solve many electrical engineering problems, now and in the future. *Polyvinyl* Ankoseal possesses notable flame-retarding and oil resisting characteristics; is highly resistant to acids, alkalis, sunlight, moisture, and most solvents. *Polyethylene* Ankoseal is outstanding

for its low dielectric loss in high-frequency transmission. Both have many uses, particularly in the radio and audio fields. Ankoseal cables are the result of extensive laboratory research at Ansonia—the same laboratories apply engineering technique in the solution of cable problems of all types.

THE ANSONIA ELECTRICAL COMPANY



Specializing in "Ankoseal" a Thermoplastic Insulation

ANSONIA CONNECTICUT



A Wholly-Owned Subsidiary of

NOMA ELECTRIC CORPORATION

GENERAL OFFICES • NEW YORK, N. Y.

Makers of the famous Noma Lights—the greatest name in decorative lighting. Manufacturers of fixed mica dielectric capacitors and other radio, radar and electronic equipment.

Just what you've been waiting for!

British-Made

● **RECORD CHANGERS**

May be loaded with 10" and 12" records, intermixed. The MICRO-SONIC arm automatically compensates for the differences in record diameters. One control for start, stop, reject, and repeat.

● **RECORD PLAYERS**

Precision built. Automatic start-and-stop. Crystal or magnetic pick-up—as desired.

● **MOTORS**

A.C. or Universal type. Heavy duty construction, silent, self-lubricating, speed regulated by governor

Micro-Sonic's record changer will be demonstrated at the Congress Hotel, Chicago, during the **Radio Parts and Equipment Show, May 13-16**, inclusive. **BE SURE TO SEE IT!**

You will agree that MICRO-SONIC has the "Rolls Royce" of British-made record-playing equipment.

Be sure to see the MICRO-SONIC line.

"BUILT LIKE A BATTLESHIP . . . WITH THE PRECISION OF A WATCH"

MICRO-SONIC

C O R P O R A T I O N

NEW YORK 11, N. Y.

44 WEST 18th STREET



... of Quality

Centralab RADIOHMS

For ALL Replacement Jobs

For more than two decades servicemen have recognized the "CRL" in the Centralab diamond as a symbol of Quality . . . and so today as in those early pioneer times . . . wise servicemen "always specify Centralab".

Centralab

Division of GLOBE-UNION INC., Milwaukee

PRODUCERS OF



Variable Resistors
Bulletin 697



Selector Switches
Bulletin 722



Tubular Ceramic
Capacitors
Bulletins 630 and 586

Only **FEDERAL** gives you
2 plus values in . . .

FM and TELEVISION LEAD-IN WIRE!

1. Produced by world's largest
manufacturer of high frequency
cable!

2. Engineered in the same laboratories
that have put Federal in the
forefront in FM and Television research!



FEDERAL's high frequency cable is *really engineered* for low-loss signal transmission from antenna to receiver . . . the product of years of experience in FM and Television.

It's a solid, polyethelene insulated type . . . resisting water, acids, alkalis, oils . . . won't embrittle or age in sunlight. It retains flexibility in sub-zero temperatures; and dimensional precision even in hot weather. Elliptical cross section enables it to withstand twisting and abrasion—eliminates any moisture conduction path.

Federal's lead-in cable is available to you now, in various sizes. Write for complete details.

Federal lead-ins have dual, stranded conductors. Characteristic impedance for commercial telecasts is 300 ohms—capacity per foot is 5 mmf.

Other types produced for special applications and experimental work have characteristic impedances of 200 and 100 ohms.

300 ohm
line

200 ohm
line

100 ohm
line

Federal Telephone and Radio Corporation

Export Distributor:
International Standard Electric Corporation

Newark 1, New Jersey



You Have the "Know-How" →

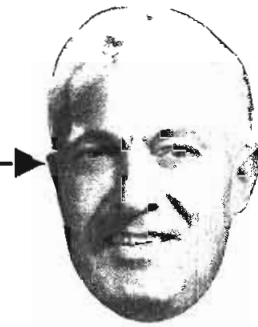

but

have You the "Know Where" →
for business in Aviation?

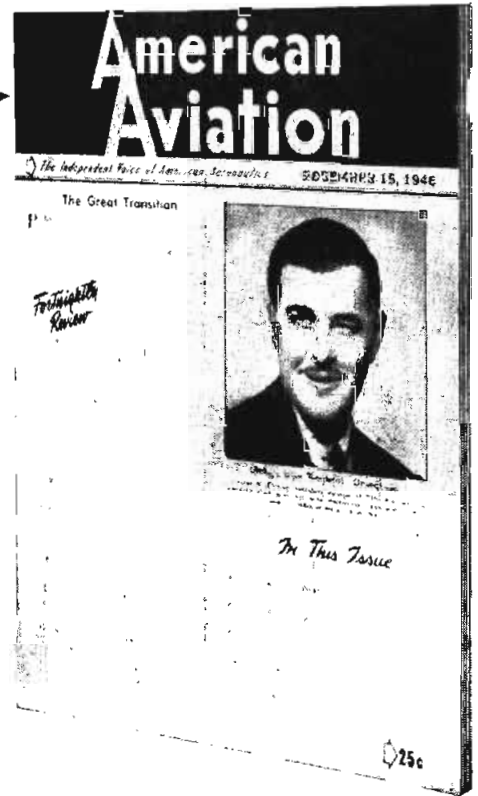

American Aviation, the twice-monthly publication of aviation happenings, will bring you reports of business interest in all phases of this growing industry. You can have the jump on competition with these facts, figures and trends as reported throughout the country by men closely allied with all branches of this expanding business.

Know in advance who plans to open new airlines, build new fields, construct and equip new hangars. Have available the latest information on new aircraft types while still in the design stage. It will give you an early start in selling your equipment for the finished product. Know who is in the market for what you have to sell.

**Other
American Aviation Services**

It's to your advantage to keep your finger on the pulse of the aviation industry. American Aviation Daily does just that for you. Dispatched first class mail every week day, it brings brief, concise, up-to-the-minute news of happenings within the industry. New airlines, routes, equipment purchases, appointments and contracts. Be the first on hand for that new business by reading the Daily. By the month, \$15.00 . . . by the year, \$170.00.

Know who to see in the organization you want to contact. American Aviation Directory provides a listing of 10,000 aviation executives. It covers the personnel and organization of schools, manufacturers, airlines, state and federal agencies cross-indexed five ways.

Published in revised edition twice a year. Single copy, \$5.00

A full Year's Subscription costs only \$4.00

Fill out the coupon for American Aviation and any of our other services you can use. Attach to your letterhead and mail. We'll do the rest.

**American
Aviation Publications**

American Building, Washington 4, D. C.

Start sending me American Aviation today. I'll send a check when you send me the bill, Twenty-six issues for \$4.00.

Name _____

Address _____

City _____ State _____

I'd like to try American Aviation Daily. Here's a check for \$15.00 for a month's trial.

I can use the American Aviation Directory in my business. Here's \$5.00 for the new Spring-Summer Edition.

AMPHENOL

Covers the Spectrum

**WITH CABLES
AND CONNECTORS
FOR EVERY FREQUENCY**

Amphenol serves the electrical and electronic industries with the most complete line of cables, connectors, plugs and fittings for every application. No matter what the need—from high-current, low-voltage cables and connectors such as are used in power lines, to high-voltage, high-frequency components required in the upper regions of the spectrum—there is an Amphenol product for the job. Amphenol cables and connectors are used in Radar, F.M., Television, Standard Broadcast, electronic controls and equipment... and in numerous industrial applications.

Amphenol connectors are engineered and constructed so as to afford the absolute minimum of loss of power, potential or waveform even at the highest frequencies. These components reflect the greatest advancement in all phases of electrically correct design and mechanically correct manufacture. Amphenol makes the most complete line of cables, connectors, plugs and fittings for the most efficient transmission of power at all frequencies.

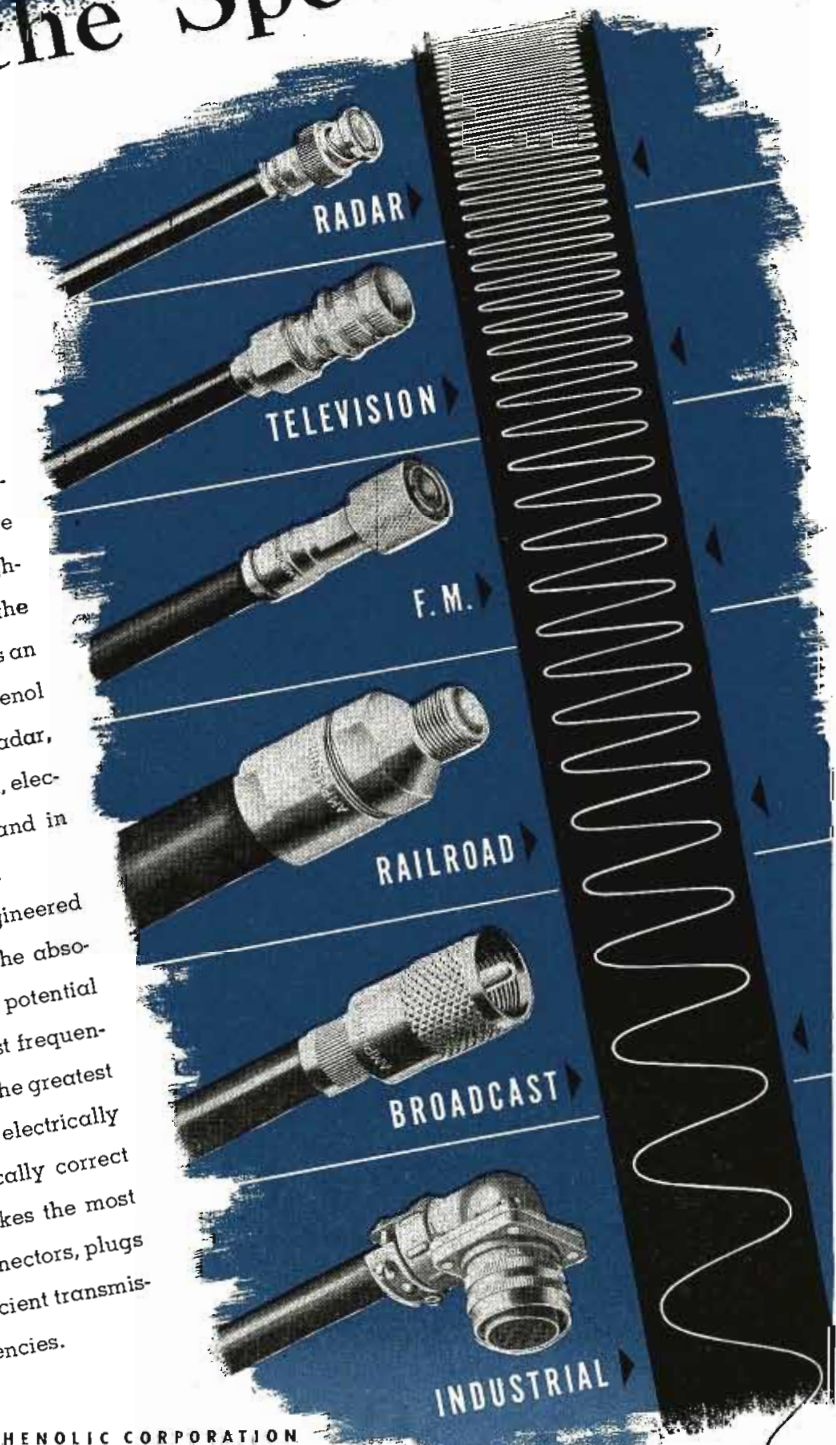

AMERICAN PHENOLIC CORPORATION
CHICAGO 50, ILLINOIS
In Canada • Amphenol Limited • Toronto

COAXIAL CABLES AND CONNECTORS • INDUSTRIAL CONNECTORS, FITTINGS AND CONDUIT • ANTENNAS • RADIO COMPONENTS • PLASTICS FOR ELECTRONICS



FULLY SHIELDED

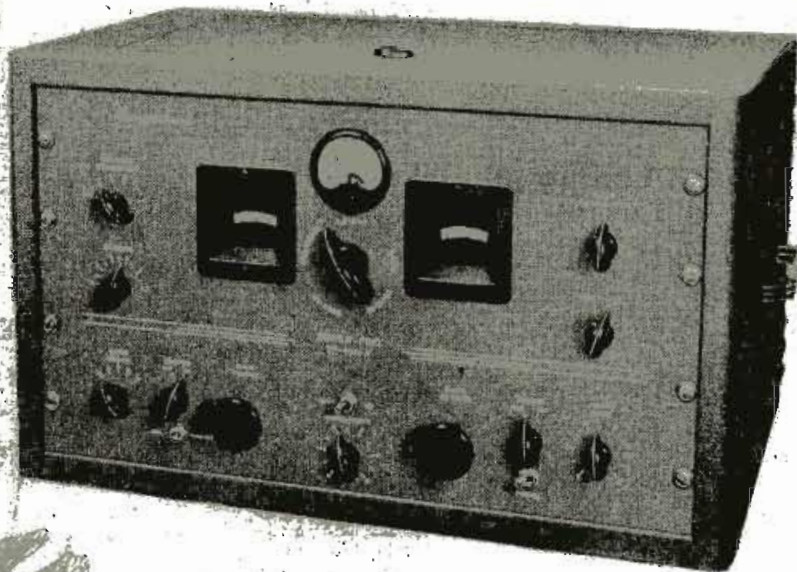

The "Super-Pro's" high-fidelity amplifier provides excellent broadcast quality—fine for use with record players when DX isn't coming through.

"SUPER PRO"

Series 400

.54-30 MC.

If you are troubled with spurious beats and images from powerful stations, you need a "Super-Pro." Complete shielding right up to the antenna terminals is one of the many features of the new Series 400 "Super-Pro."



HAMMARLUND

THE HAMMARLUND MFG. CO., INC., 460 W. 34TH ST., NEW YORK 1, N. Y.
MANUFACTURERS OF PRECISION COMMUNICATIONS EQUIPMENT

COMMUNICATIONS

LEWIS WINNER, Editor

* * * APRIL, 1946 * *

Typical low-distortion (.1%) RC oscillator.
(G.R. 1301-A)

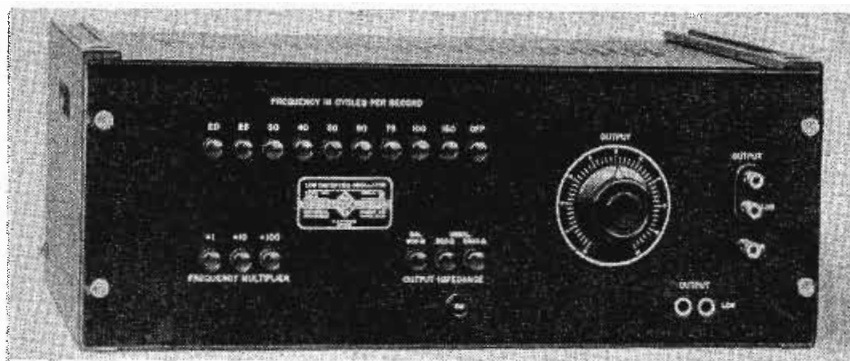

The Measurement of AUDIO DISTORTION

by H. H. SCOTT

Technology Instrument Corporation

A Study of Methods Used to Measure Distortion . . . Non-Linear, Amplitude or Harmonic, Which May Include Components Not Necessarily Harmonically Related to the Signal. Procedures Used for Measurement of Distortion in A-M and F-M Systems Are Also Discussed.

ANY modification of an a-f signal between the point where it reaches the microphone and the point where it is reproduced by a loud-speaker may be considered as *distortion*. In general usage the term as generally used has, however, come to have a more restricted meaning—namely, the introduction of extra components into the signal which were not originally present.

The simplest measurement of non-linear distortion is obtained by applying a single sine-wave signal to a transmission system and measuring the various components in the output of the system with a wave analyzer. At low levels in a good system over 99% of the output voltage will be at the applied fundamental frequency, but there will also exist at a per cent or less of distortion, components corresponding in this case to exact multiples of the fundamental frequency. Of these components, known as harmonics, the

second and third (corresponding to twice and three times the fundamental frequency, respectively) are generally the strongest, but higher-order harmonics may also be present at appreciable amplitudes. There will also exist in the output of the system other spurious components, consisting of the fundamental and harmonics of the power-supply frequency, various noise components resulting from tube hiss and other circuit disturbances, pickup from other circuits, and other extraneous components. Many of these can also be measured on an analyzer or other distortion-measuring device. As the signal level is increased until various parts of the system overload, harmonic distortion may rise to 5%, 10% or even higher values, which in most cases are distinctly noticeable and an-

noying in real high-quality reproduction.

Conventional Measurement Methods

The conventional practice has been to measure non-linear distortion in terms of the harmonic components added to a single frequency test-tone by the system, and various limits have been set, depending upon the requirements of the problem. For instance, distortion as high as 10% is considered tolerable in a single output amplifier stage by many home-type phono and receiver designers. At the other extreme, we have the new FCC requirements for systems, which specify a total distortion between the microphone terminals and the modulated signal, as radiated by the antenna, as low as 2.5% for an entire system, including many amplifiers, transmission lines or other studio-transmitter links, various

This paper was prepared exclusively for COMMUNICATIONS and the NAB Engineers Handbook.

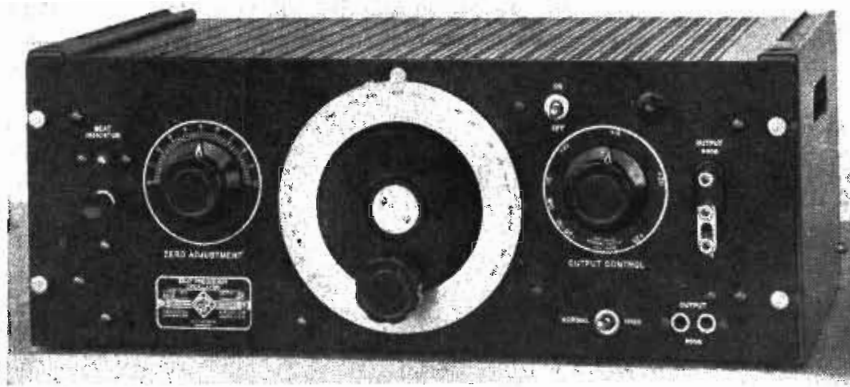

Low distortion (.2%) beat-frequency oscillator.
(G.R. 913-B)

control and amplifier equipment, and the transmitter itself.

In general, for systems of comparable design features which exhibit similar characteristics in regard to the generation of harmonics, a low level of harmonic distortion measured in this manner is an indication of excellence. For systems exhibiting different characteristics, however, and which overload in various manners, it has long been realized that the amount of distortion which is audible to the ear is not necessarily related exactly to the single-frequency harmonic measurements. This is particularly true in the case of home-type receivers or other sound-reproducing equipment which must be built to meet price competition. The reason for this lies in the fact that the distortion characteristics of a non-linear system are far more complicated than can be determined by a simple single-tone measurement.

For instance, if two tones (f_1 and f_2) are applied simultaneously to a non-linear system, the distortion products include not only the harmonics of those two tones but also frequencies equal to the sum and difference of the two tones ($f_1 + f_2$, $f_1 - f_2$) and higher-order intermodulation products (such as $f_1 + 2f_2$, $f_1 - 2f_2$, $2f_1 + f_2$, $2f_1 - f_2$, etc.) which theoretically may include beats between the fundamental and all of the possible harmonics of one tone and the

fundamental and all possible harmonics of the other. It will be observed that it is only by accident that any of these so-called intermodulation components ever coincide with a harmonic of one of the original frequencies. Hence, this intermodulation distortion represents discordant components added to the signal. Since any musical instrument produces tones which contain harmonics as well as the fundamental frequency, it is obvious that a moderate increase in the harmonics themselves need not be annoying. However, the addition of discordant components is distinctly audible, and it is the presence of such intermodulation products which most people call distortion. In any practical system the intermodulation products may become serious under conditions where the actual addition of harmonics themselves is of little consequence. The picture is further complicated by the fact that non-linearity in the amplitude characteristics of a system, which accounts for the distortion, is often a function of frequency, particularly at the lower and higher ends of the frequency range. This is particularly true in systems involving transformers, speakers and other electromechanical transducers, tone control, and filter, push-pull or feedback circuits. The amount of distortion, therefore, is a function not only of amplitude but also of frequency.

In a system producing serious distortion it is almost impossible to simulate by any reasonable measurements the actual results which will be obtained when a signal, such as music from a large orchestra, is impressed upon a system. With each of the thousands of components producing intermodulation with the others, the resulting jumbled noise as heard by the ear is, however, a good indication of what is happening. The problem of distortion measurements is, therefore, to provide the simplest type of measurement which can be correlated with distortion as heard by the ear.

For years the total rms value of the harmonics added to a single tone has been used as a measure of such distortion. Where the total distortion may be kept low and the system is designed in accordance with the best standards of engineering practice without the necessity to cut corners to save cost, this type of measurement is generally satisfactory. In the case of the f-m transmitter, for instance, if the total distortion is below 2.5%, it is not likely that any distortion which may occur will be sufficiently serious to be noticeable. Nevertheless, it is still not impossible. As the quality of the system decreases, it becomes more important to make additional measurements to determine whether or not serious intermodulation takes place. Until further information as a result of experience becomes available, however, it may be assumed that for equipment of the type used in high-quality broadcasting a measure of the single-tone harmonic distortion will generally suffice.

A common fallacy in making harmonic measurements has been to assume that harmonics above the range of hearing were of no importance since they could not be heard. It will be noted, however, that the new FCC requirements for f-m specify harmonic measurements as high as 30,000 cycles, although, admittedly, no one can hear such harmonics themselves. The reason for this is that the presence of such harmonics, whether they are heard or not, indicates that distortion is taking place, and the generation of such harmonics indicates the presence to an indeterminate degree of intermodulation products which may fall within



Amplitude-modulation monitor provided with low-distortion detector circuit for audible monitoring and distortion measurements.
(G.R. 1931-A)

A heterodyne-type wave analyzer.
(G.R. 736-A)

the range of hearing—in fact, within the range where the ear is most sensitive. Thus, these high-frequency harmonic measurements are specified rather than more elaborate intermodulation measurements in an attempt to assure that the intermodulation shall not be serious. For a system of fundamentally high quality and designed in accordance with best engineering practice, this is not an unreasonable assumption.

In terms of what the customer hears on his receiver, distortion measurements are probably the most important measurements to be made on a radio-transmitting system. The maintenance of low-distortion limits insures, in general, clear, natural reproduction of the signals, limited only by the capabilities of the receiving system.

FCC Requirements

The FCC in its Standards of Good Engineering Practice for f-m broadcast stations, requires that the overall harmonic distortion at any modulating frequency between 50 and 15,000 cycles be within the following limits:

Modulating Frequency	Distortion
50 to 100 cycles	3.5%
100 to 7500 cycles	2.5%
7500 to 15,000 cycles	3.0%

Standard test frequencies are 50, 100, 1,000, 5,000, 10,000 and 15,000 cycles.

Such measurements should be made employing the standard 75-microsecond deemphasis in the measuring equipment and the 75-microsecond preemphasis in the transmitting equipment, and should include all harmonics up to 30 kc. Measurements should be made at 25%, 50% and 100% modulation. This latter requirement has introduced certain difficulties, since commercially available analyzers will not tune much above 18 kilocycles, and distortion meters are limited in their sensitivity by the noise in the measured signal. The FCC allows a maximum of -60 db below 100% modulation for the f-m noise level of the entire system in the range from 50 to 15,000 cycles: 100% modulation is equivalent to ± 75 -kc swing.

Since these tolerances include the

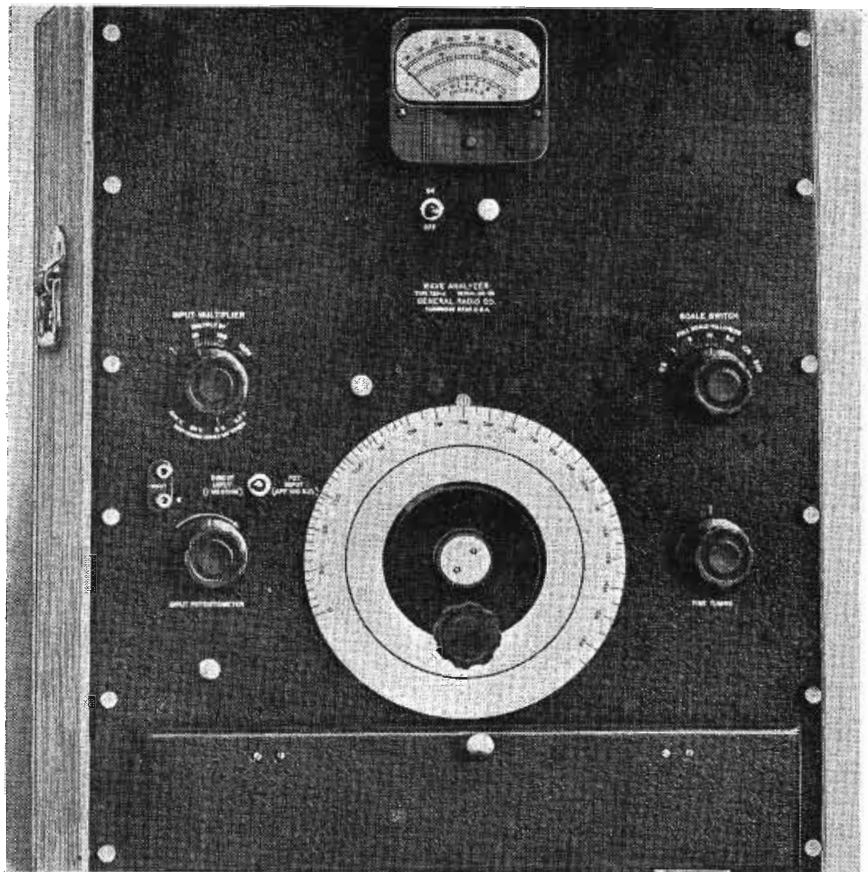

entire transmitting system from the microphone to the antenna, it is obvious that any unit of the system must be better. The FCC recommends that none of the three main divisions of the system (transmitter, studio-to-transmitter circuit, and audio facilities) contribute over one-half of the total distortion.

For television transmitters the performance requirements of the frequency-modulated sound channel are the same as for f-m broadcasting, excepting that 100% modulation is equivalent to ± 25 -kc swing, and the allowable noise level is -55 db.

For a-m broadcast systems the FCC has not established any definite distortion requirements.

Proposed RMA standards for the transmitter alone allow a distortion of 3% for modulation percentages up to 85%, and 5% for modulation percentages between 85% and 95% for a range of fundamentals between 50 and 7500 cycles and including all harmonics up to 24 kilocycles. The allowable noise level is 60 db below 100% modulation. Proposed RMA standards for distortion in the audio facilities have a limit of 2% from 100 to 7500 cycles and 3% from 50 to 100 cycles. All of these distortion measurements are rss values; that is, the amplitudes of the various harmonics are combined by taking the

(Continued on page 52)

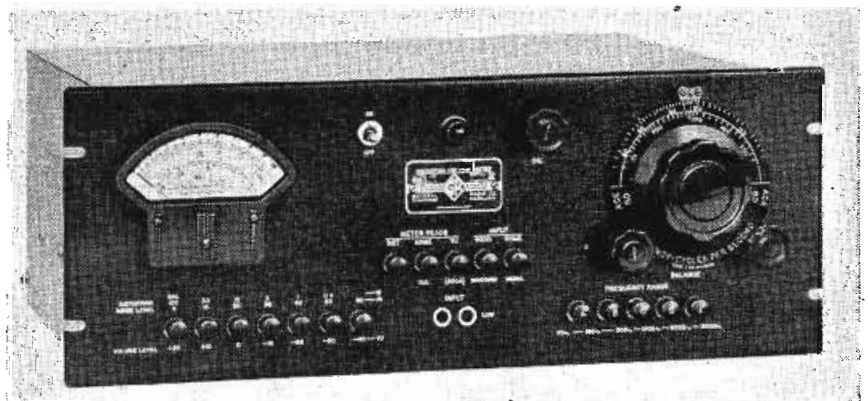

Null-type continuously tunable distortion and noise meter with auxiliary vu scale.
(G.R. 1932-A)

PLATING QUARTZ Oscillator Crystals

by K. M. LAING

North American Philips Company, Inc.

THE oscillating quartz crystal, in common with many other electrically active circuit components, must be supplied with accessory parts to make its properties available in the circuit where it is used. In the case of crystals, the electrically important accessories are electrodes, connecting leads, and contact members. The former must be fitted to the crystal and the latter must fit mating parts which are permanently connected in the circuit. This discussion will be confined primarily to the electrode member.

Many crystals produced in the pre-war period and for military use were assembled between massive metal electrodes. The basic function of these metal pieces, each usually thicker than the crystal itself, is to establish an equi-potential termination for an electrical field in the region near the major faces of the crystal. The electrode is made thick because one of its surfaces must be plane and rigid. If one wished to decrease the electrode thickness to the minimum value required by electrical considerations only, the logical procedure would be to remove the rigidity requirement from the electrode itself, and use the rigidity of the crystal to give the electrode face the required characteristics. The arrangement may be described as a thin metal plating fastened to the crystal.

A factor which differentiates plated crystals from those supplied with massive electrodes arises from changing a self-supporting metal plate to a quartz-supported metal film. In the latter case the metal becomes part of the vibrating mass. For crystals oscillating in the thickness-shear mode, the frequency is primarily dependent upon the thickness of the oscillating body. In the case of a plated crystal, the fre-

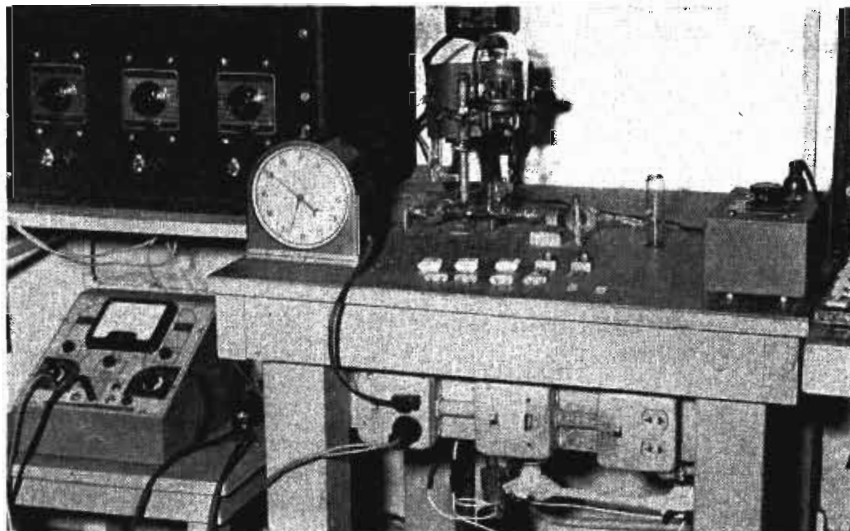

Figure 1
View showing upper section of quartz-crystal plating setup.

quency is thus dependent upon the mass of the metal as well as of the thickness of the quartz. It is evident that the unit may be brought to the required frequency by adjustment of the film as well as by reducing the thickness of the quartz wafer.

Metal Films

Metal films are usually produced from ingots by a rolling process and are referred to as foils. Such foils are applied to the faces of some piezoelectric crystals to act as the electrodes. There are some considerations which limit the usefulness of this method. A bond between metal and quartz must be made with some sort of cement. There is likely to be some damping of the crystal oscillations because of the adherence of the cement, which is usually non-crystalline and viscous in nature, and subject to non-uniform distribution. For this reason, and because of the unstable nature of organic cements, the method is not widely used.

Another way in which thin metal films are formed is by electro-deposition from an electrolyte solution. The method requires a conducting cathode upon which the metal is deposited.

Thus, insofar as quartz surfaces are concerned, the method is not applicable. However, electrolytic plating is used to increase the thickness of thin metal films applied to quartz by other methods. This increase is desired both to decrease the resistance of the film electrode and to adjust the frequency of the unit.

There is another method by which thin films of metal are formed and strongly bonded to non-metallic surfaces. This is the chemical reaction method which is used to form the reflecting surfaces on glass for ordinary mirrors. The process consists of reducing a metal salt in a mixture of solutions in which the surfaces under consideration are immersed. As the metal is precipitated from the mixture, it deposits over all surfaces exposed to the reacting solutions. In common with some of the methods described, this one requires that the surface to be plated be free from oil, grease and wax. If the surface is not scrupulously clean, the adherence of the metal is not adequate.

Firing-On Method

Of a different nature entirely is the plating method called *firing on*. In this, the metal is powdered and suspended in a temporary organic liquid binder. This mixture is applied to the non-metallic surface and subsequently

An Analysis of Plating Methods . . . Cemented Foil, Film Electro-Deposition, Mirror System, Firing, Metallizing, Sputtering and a Silver-Plating Procedure Using Vacuum Pumps Which Affords Control of Electrode Forming and Adjustment of Frequency.

exposed to heat, first to bake the binder, then to burn it away. The metal that has been deposited is fused to the surface by the melting of certain compounds formed at the temperature at which the process is carried out. In some cases the compound to be melted is present in the original suspension. Alternately the metal, in the form of a salt in solution, is applied to the surface and heated to the point at which the salt is decomposed. The result in each case is a firmly adhering metal film. This is the method used to form decorative metallic finishes on china and pottery, as well as in the *metallizing* process used as a basis for solder seals between ceramic and metal parts. This process, used on quartz crystals, is often the basis for subsequent electroplating.

Sputtering

Another method of applying metal films to surfaces is known as *sputtering*. This consists of placing the object to be plated in the vicinity of a piece of metal connected as the anode. A cathode of the metal desired as the film is placed nearby and both are enclosed in a vessel from which the air may be exhausted. A potential of several thousand volts is applied between the electrodes. A vacuum is maintained at a value at which a luminous discharge is produced with the passage of direct current. Some of the cathode metal is then deposited on the object to be plated, as well as on the other exposed surfaces in the vacuum chamber.

The remaining principal process of plating non-conductors is accomplished by evaporating the metal. Subsequently the metal vapor, when it re-solidifies, forms the desired film. All metals can be boiled to produce metal vapor, but the ones which form desirable films do so at high temperatures. The return to the liquid or solid state also takes place at inconveniently high

temperatures. Fortunately these temperatures are dependent on the pressure of the surrounding atmosphere. By reducing this pressure, the boiling point is lowered. Some metals evaporate at usable rates below their melting points in a vacuum.

All metal vapors obey the same laws as other gases. One useful phenomenon is the increase of the distance which a vapor molecule travels before it collides with another molecule. This distance, microscopic at atmospheric pressure, becomes several inches in the vacuum in which evaporation plating takes place. Thus most metal molecules, leaving the hot metal surface, travel the distance to the surface to be plated before suffering a disturbing collision. When the metal molecule strikes a relatively cool surface, it adheres and may be regarded as part of a solid metallic film.

This method is peculiarly important because it is the only one which allows the crystal to be oscillated freely in conventional electronic circuits during the plating process. Of course, a preliminary metal film must be deposited on each side of the crystal so that

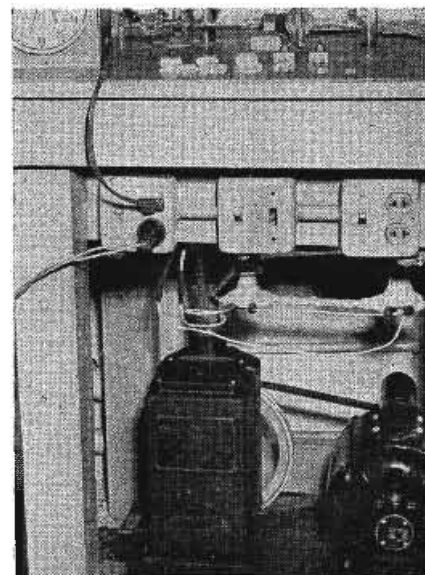
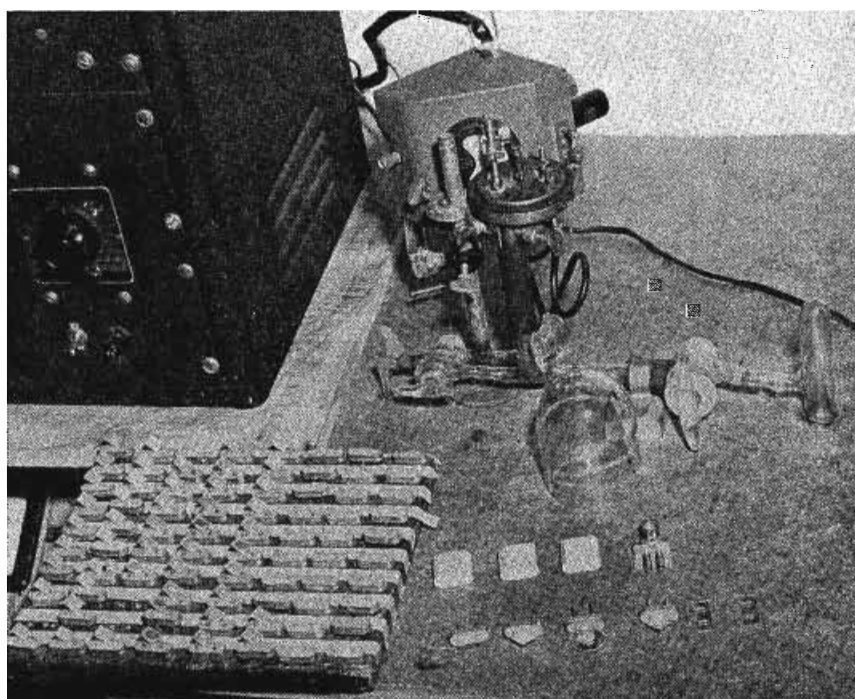

Figure 2
Lower section of plating setup and vacuum pumps.

radio frequency voltage may be applied to the faces to cause oscillation. Thereafter, as plating proceeds, the changing frequency may be observed with suitable equipment. The rate of frequency change may be controlled and stopped when a desired frequency is reached. This enables an accurate, speedy and automatic frequency adjustment to be made, replacing the tedious present methods where the frequency adjusting process must be interrupted so that the

Figure 3
Closeup of plating head, with bell jar removed, and components of crystal holder.



Some of the methods described here are discussed in much greater detail by Strong, John and collaborators in Procedures in Experimental Physics. New York: Prentice Hall, Inc., 1942. Several of the processes are probably in commercial use by crystal manufacturers.

crystal may be oscillated between massive electrodes.

Experimental Method

In an experimental study a two-fold technique of forming the electrode and adjusting the frequency was recently evolved. In this procedure, a vacuum system was used. This consisted of a 3" x 5" jar having the shape of a hollow cylinder closed at one end by a hemisphere; glass was approximately $\frac{1}{8}$ " thick. The edge was ground flat and smooth. It rested on a rubber gasket on a base plate of brass. The base plate, about $\frac{1}{4}$ " thick, carried the supports for the crystal unit and the sources of the metal vapor. These will hereafter be referred to as filaments, for they were electrically heated wires.

Four electrical leads were provided with glass beads which were sealed around the wires. Metal rims sealed around the glass beads were soldered into holes in the base. A hole for evacuating had a pipe soldered into it which led to the vacuum pumping system. It had to be capable of producing and maintaining the requisite low pressure. This pressure was of the order of several thousandths of a millimeter of mercury, or less than one hundred-thousandth of the atmospheric pressure.

The filaments were clamped, by

spring binding posts, in a unit which held them in the proper position. This evaporator unit was fastened to the base plate by a double plug and socket. A shield surrounded the filament on all but one side to minimize plating the inside of the bell jar. The filament was shaped from a composite coil consisting of a core of tungsten or molybdenum wire about 0.012" in diameter. Around this was wound a 0.008" diameter wire of the metal to be deposited on the crystal; in this case, silver. This silver wrap was not close spaced but the turns were separated by a wrap of 0.008" tungsten or molybdenum wire. When the silver melted, large globules could not form because of the remaining spiral of the high melting point metal. The small droplets which resulted were light enough to cling to the filament while evaporation was taking place.

The filaments were heated electrically by means of two of the insulated leads and a common connection to the base plate. With a crystal in place between the two facing filament assemblies, both sides could be plated without a change in position.

The crystal can be mounted on the base portion of the holder which will eventually enclose it, held by the clips that will support it in use. This base is then plugged into a suitable socket mounted on the brass plate. The clips can be connected by means of the re-

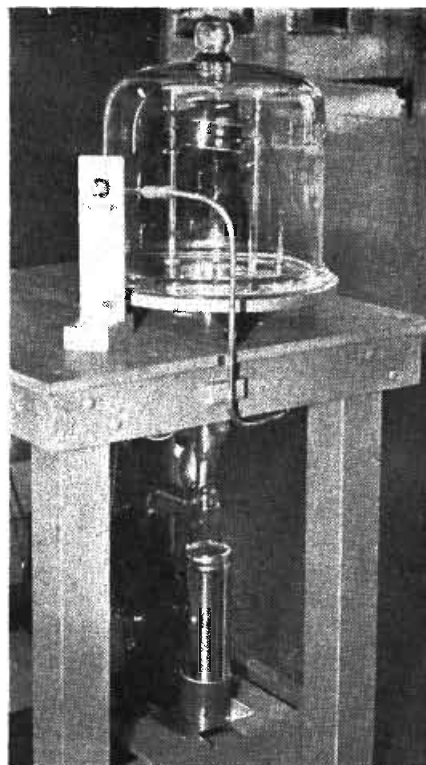

Figure 4
Experimental setup for sputtering quartz crystals. In the large bell are seven wafers for processing.

maintaining two lead-ins to a suitable oscillator.

If a clean bare crystal is put into the clips and the silver deposited on the clip and crystal, no connection is obtained between the clip and the metal film on the crystal face. This is because the clip casts a *shadow* on the crystal, in which no deposit is made. The insulating region resulting prevents contact and subsequent oscillation. To overcome this difficulty the crystal can be moved in the clip after some silver has been deposited on each side, thus shifting the clip to a region already plated. This requires that the vacuum be released and the jar removed temporarily. Vacuum must be re-established before plating may be resumed, to adjust the frequency.

The foregoing procedure may be eliminated by coating that portion of the crystal that will be under the clip with a conductive cement. This consists of a suspension of silver powder in a cellulose base cement. When it has dried, the clips are put on. Enough of the cemented area extends beyond the clips to make connection to the film, as it is established during evaporation. The crystal begins to oscillate.

(Continued on page 56)

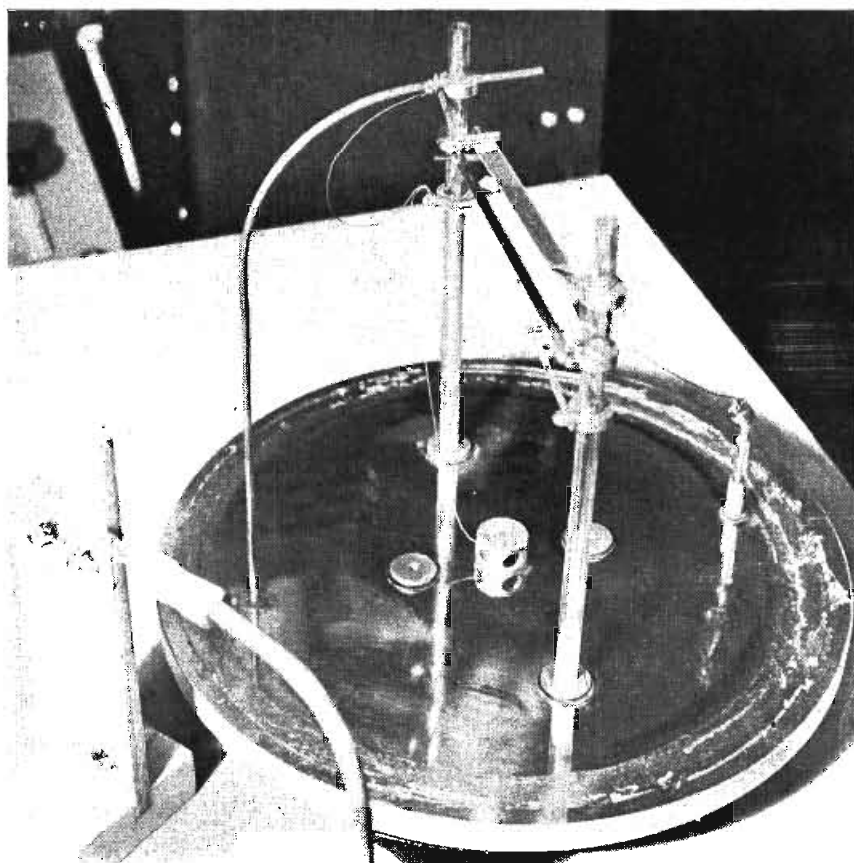

Figure 5
Another view of the experimental setup with the bell jar removed to illustrate how wafers are mounted

THE WILCOX TYPE 255A RECEIVER

A new fixed frequency receiver to meet the present and future requirements of aeronautical ground-air, or point-to-point radio communications.

With increased traffic and new services taxing the already over-crowded 2-20 Mc communication frequencies, the Wilcox Electric Co. Type 255A Receiver has been especially engineered to minimize adjacent channel interference, and to maintain good intelligibility on telephone reception.

The Type 255A occupies only 3½ inches of rack space, making it readily adaptable to the replacement of existing receivers.

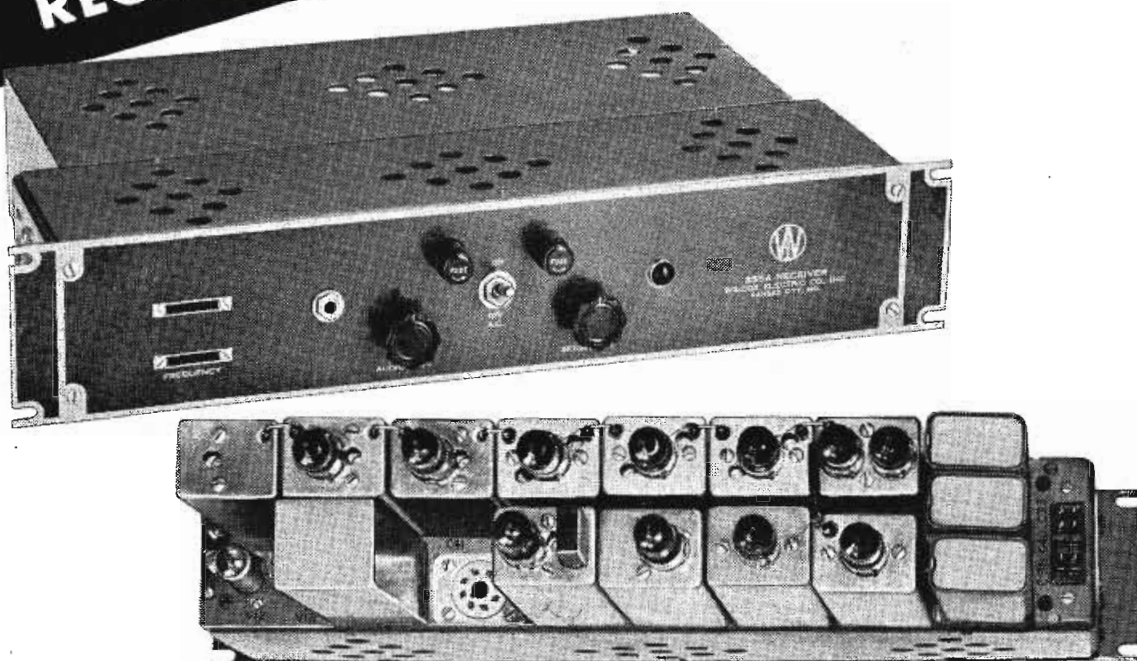

- Input Impedance: 70 ohms.
- Output Impedance: 500 ohms, center-tapped.
- Power. 110 V.A.C., 50-60 cycles, 60 watts.
- Output Power: Choice of 50 milliwatts or 1.25 watts.
- Sensitivity: 1 microvolt at 2/1 SN ratio.
- Spurious Frequency Response: 80 D. B.
- A.V.C.: 3 DB variation from 10 microvolts to 1.5 volts.
- Selectivity: 2X—2 Kc. wide.
10X—4 Kc. wide.
100X—7 Kc. wide.
1000X—11 Kc. wide
- Size: 3½" H. x 19" W. x 11½" D.

Detailed information on request.

Use of miniature tubes permits the building of each stage of the receiver complete within its own shield can, which in turn, plugs into an octal tube socket on the chassis.

Thus, each stage is instantly removable for maintenance, and may be checked in a test set similar to those used for vacuum tubes. Maintenance may then be accomplished on the bench, or a spare stage plugged in, and the stage returned to a maintenance base.

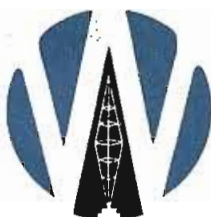

WILCOX ELECTRIC COMPANY, INC.

Manufacturers of Radio Equipment
FOURTEENTH AND CHESTNUT
KANSAS CITY, MISSOURI

A Report on the Sixth Annual Conference of

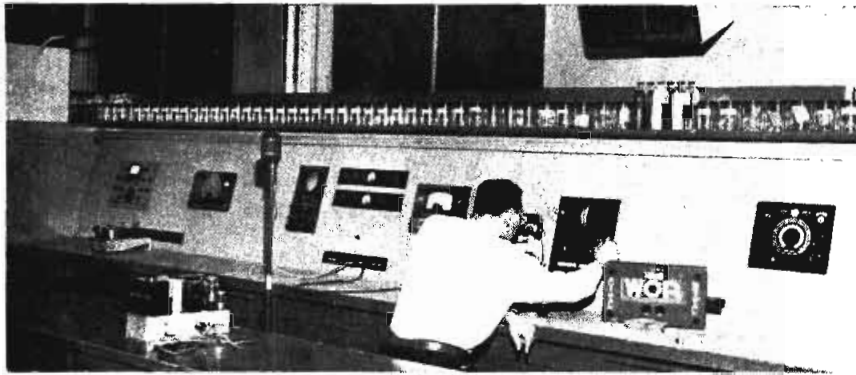

(Singer Paper)
Remote-control-equipment repair room at WOR, where tubes and components are tested.

PREVENTIVE MAINTENANCE FOR BROADCAST STATIONS

Charles Singer
WOR-WBAM

WITHOUT maintenance, the best station in the world will soon become a liability to its operators. The radio station is peculiar among business enterprises in that the commodity which it has to sell is *time*, and once time has been lost, no amount of overtime can retrieve it. The station operator knows that the periodic disassembly, cleaning, lubrication and reassembly of the radio station equipment is done for a definite reason—to keep the radio station in working order—to minimize the chances of its failing when the financial consequences are great. The radio station plant can serve its purpose only if it is operating properly and can be depended upon to provide continuous and quality performance.

One of the most important factors in insuring such service is *preventive maintenance*.

Preventive maintenance may be defined as a systematic series of operations, performed periodically on the equipment.

To appreciate the meaning of the term *preventive maintenance*, it is necessary to distinguish between preventive maintenance, and trouble shooting and repair. The primary function of preventive maintenance is to prevent breakdown, to avoid the necessity of repair. In sharp contrast, the primary function of trouble shooting and repair is to locate and correct existing defects.

Preventive maintenance procedures are designed to: combat the ravages of weather on the equipment; prevent the detrimental effects of dirt, dust, and moisture on the operation of the equipment; keep the equipment in such condition as to insure uninterrupted operation; keep the equipment in condition, so that it will always operate at maximum efficiency; and prolong the useful life and

BROADCAST MAINTENANCE

assure the dependability of the equipment.

In applying a preventive maintenance program, three major technical operations groups must be included . . . transmitter division, studio technical facilities division, and field engineering division.

The transmitting plant is usually located at some distance from the studios. This is necessary in the case of high-powered a-m stations to provide land for a suitable radiating system and to sufficiently remove the transmitter from the population center so as not to encompass too great a population within its blanketing signal contours.

A typical a-m transmitter plant consists of a regular transmitter and sometimes an auxiliary transmitter for emergencies, power switch room, transformer vault, generators for supplying special power needs, gasoline engine generator for emergency power, pump room for circulating cooling water, an audio facilities control room for combining the modulating intelligence with the carrier, and many other associated equipment.

In sharp contrast, the f-m transmitter, because of different propagation characteristics at the higher frequencies, is located in the heart of the population center, preferably at the top of a high

This, the first broadcast engineering conference since 1942, was held at Campbell Hall on the campus of Ohio State University, Columbus, Ohio. Over 450 attended. Next year, the conference is scheduled to be held in Urbana, Illinois, on the grounds of the University of Illinois, where Dr. W. L. Everitt, director of the conference, is now head of the electrical engineering department.



building if the use of tall antenna supporting structures is to be avoided. The area of coverage is also sharply limited by the FCC, a factor which contributes to the reduced power rating of some f-m transmitters. It is therefore apparent that the f-m equipment facilities are not by nature as extensive as those for an a-m transmitter, but no less elaborate.

The studio plant is generally located in the heart of the metropolitan area which it serves. Primarily, this is for the convenience of the artists, performers and business people who deal with the radio station. Typical studio equipment for both a-m and f-m consists of an appropriate speech input console, and a small power room for each group of studios supplying power requirements, various amplifiers and cross connections to master control. In addition to the live talent studios, there are usually one or more electrical-transcription studios where an entire program or a large percentage of the program is produced and put on in the control room by the control room engineer. Of course, no station is complete without its master control room, the central coordinating point for the entire station.

The field engineering division provides the facilities for picking up programs which originate outside of the studio proper. The usual field pick ups are conveniently taken care of by the equipment which is a part of the standard *field cabinet*.

There are seven basic preventive maintenance operations: (1) feel; (2) inspect; (3) tighten; (4) clean; (5) adjust; (6) lubricate; and (7) measure.

Preventive maintenance techniques may be applied to tubes and sockets, capacitors, resistors, fuses and mountings, insulators, relays, switches, motors and generators, transformers and reactors, transmission line, rheostats and potentiometers, terminal boards, cables and connectors, safety wires, chassis and mountings, covers and containers, meters, pilot lights and jacks.

A number of items in the preventive maintenance schedule require work of a special and somewhat delicate nature. These include cleaning and smoothing of relay contacts, cleaning and polishing commutator and collector rings, checking brush spring tension, removing brushes, springs, etc. To do the work properly, special supplies and a few specially constructed tools are needed.

Most of the required materials will be found around the shop, but a few must be improvised. Supplies and tools required, include: carbon tetrachloride, soddard solvent; lint-free cloths; sheets of crocus cloth; sheets of No. 0000 sand-

Members of the round table and question-box session, left to right: Daniel W. Gellerup, Howard Frazier, John Willoughby, E. W. Allen, and R. Morris Pierce.

BROADCAST ENGINEERS

paper; sheets of No. 000 sandpaper; relay contact burnishing tool; non-magnifying lensal mirror; 1" cleaning brush (camels hair); 2" cleaning brush (camels hair); canvas cloth; tube of household cement; small fine cut file; walscolube or vase-line; small pocket knife; airblower; and vacuum cleaner.

Records also play an important role in preventive maintenance. Such records should include data on avoiding trouble; cures; corrections made to equipment; means used to achieve cures, equipment or components used, etc.

An appropriate preventive maintenance program will minimize operating costs and provide a worthy on-the-air record.

(In view of the interest in preventive maintenance, COMMUNICATIONS has arranged to publish Mr. Singer's complete analysis. The data will be presented in several installments, the first to appear in June.)

RECORDING

MAGNETIC RECORDING

Dr. S. J. Begun
Brush Development Company

ALMOST a half-century ago attempts were made to market magnetic-recording equipment. However, the response was poor and it wasn't until 1938 that commercial magnetic recording became substantially successful.

Wartime technological developments improved its commercial potentialities, providing many valuable features which were lacking in earlier equipments.

The magnetic recorder of 1938, such as the Soundmirror, used a tungsten steel tape which required a speed of more than 3' per second to cover a frequency range from about 100 to 4500 cps. Tungsten steel was used in preference to carbon steel since its magnetic properties were slightly better and its corrosion resistance somewhat higher. These tapes were imported from Sweden and it soon became apparent that war conditions would dry up the source. Bell Telephone Laboratories and Western Electric had developed a material, *Vicaloy*, substantially better than tungsten or carbon steel. However, its manufacture in the considerable quantities required for military use offered difficulties.

Certain stainless steels after appropriate heat treatment were found to be satisfactory. Thus wire and tape, in .004" and .006" thickness, were made.

Studies of the system indicated that slow speed operation would provide better recordings. However, the steel wire did not appear to lend itself to this approach. Therefore the National Defense Research Committee initiated a program to develop a magnetic recording material

(Begun Paper)

Unequalized frequency response of different signal carriers with: (a) Magnetic-coated paper; (b) Brush type wire; (c) Stainless steel wire; (d) Carbon steel wire. Carrier velocity, 2' per second. Levels adjusted to equality at 100 cps.

Highlights of Discussions by Singer; Morrill; Begun; Roys; Kandoian; Holtz; Scheldorf; Smith; Helt and Summerhayes, Jr.

by LEWIS WINNER

Editor

which would be superior to the stainless steel materials.

A high coercive force of the magnetic recording material is a prerequisite for satisfactory low speed operation. It is, however, very difficult to obtain a wire or tape from a material with a high coercive force since most commercially available high coercive force materials are brittle; they can be cast or sintered and shaped by grinding, but it is certainly not easy to draw or roll them. It became apparent that an entirely different approach to the problem had to be found. Two methods seemed to be most promising:

(1) The plating of a magnetic alloy on a ductile nonmagnetic metal base.

(2) Suspending magnetic particles in a coating applied to a non-metallic base or dispersing the particles in the base itself.

Both of these methods avoided drawing or rolling of the hard non-ductile magnetic alloys. Recording materials can be provided with a thin magnetic layer.

A thin magnetic layer improved the f -response since the spread of the recording flux within the material is reduced. While it is difficult and expensive to

manufacture a solid wire with a diameter smaller than 0.004", or a solid tape thinner than 0.002", it has been found relatively easy to obtain a thin layer of magnetic material by depositing such material on a non-magnetic base.

When this program was started, relatively little was known about the magnetic properties of plated ferro-magnetic materials or alloys. It was found that the plating process can be made to impart internal strains to the crystalline structure which increases, in many cases, the coercive force in ferro-magnetic materials.

Finally evolved was a process of plating a nickel-cobalt alloy with high corrosion resistance having a coercive force in the order of 200 oersteds or more, and having a remanence in the order of 8,500 gauss.

The stainless steel recording material has a coercive force in the order of 60 to 70 oersteds and a remanence of about 7,000 gauss.

One of the problems in magnetic recording is to obtain for the low frequencies, an output voltage which is at least 30 to 40 db above the voltage which might be generated in the magnetic head due, to

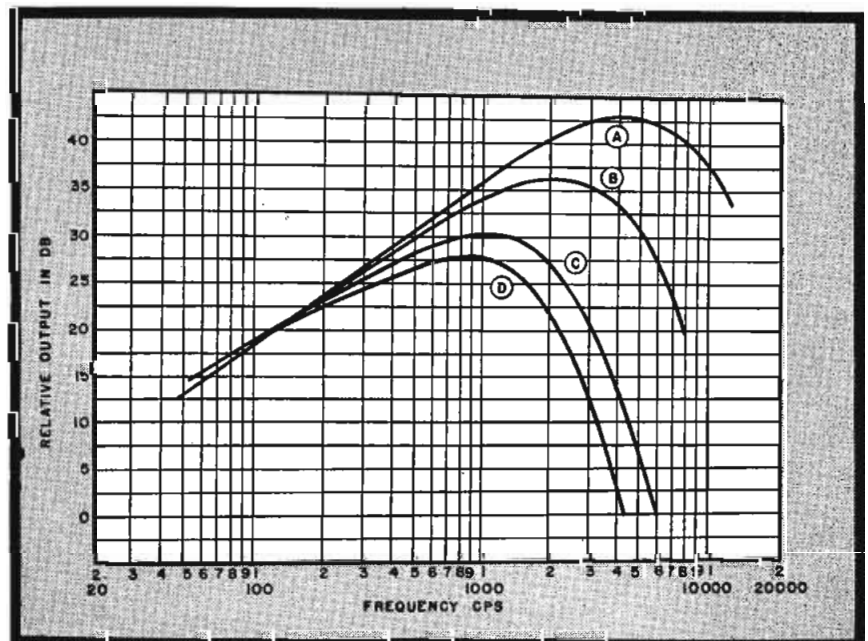



COMMUNICATIONS will cost

you only \$1.00

for the next 12 issues

To the Publisher of
COMMUNICATIONS

52 Vanderbilt Ave., New York 17, N. Y.

Please enter annual subscriptions (12 issues) for each of the undersigned for which payment is enclosed at the rate of \$1.00 each. (This rate applies only on 4 or more subscriptions when classifications are given.)

Name

Address

City-State

Occupation

Employed by

Nature of Business

(State if Manufacturer, Broadcast Station, etc.)

Product

Name

Address

City-State

Occupation

Employed by

Nature of Business

(State if Manufacturer, Broadcast Station, etc.)

Product

Name

Address

City-State

Occupation

Employed by

Nature of Business

(State if Manufacturer, Broadcast Station, etc.)

Product

Name

Address

City-State

Occupation

Employed by

Nature of Business

(State if Manufacturer, Broadcast Station, etc.)

Product

● A subscription to COMMUNICATIONS will provide timely and authoritative articles of decided importance to every engineer and executive in radio, broadcasting, television, facsimile, sound recording and projection, aeronautical, police, railroad, marine and emergency communications.

Leading design, manufacturing and operations engineers keep posted on all new developments in this fast-moving industry by reading COMMUNICATIONS every month. It has helped them. It can help you.

You and your associates can obtain a year's subscription to COMMUNICATIONS (12 issues) for only \$1.00 each by using the Group Subscription Plan. Here's how:

A regular yearly subscription to COMMUNICATIONS costs \$2.00—but, when four or more men sign up at one time, each one is entitled to the half-price rate. (Foreign subscribers only pay \$2.00 each.)

It is easy to get three or more of your associates to subscribe with you. Thousands of leading engineers and executives have subscribed year after year on that basis. Use the convenient form on this page. Fill in the names, tear out and mail today with your check or money-order. Renewals and extensions are acceptable also.

COMMUNICATIONS ● 52 Vanderbilt Ave., New York 17, N. Y.

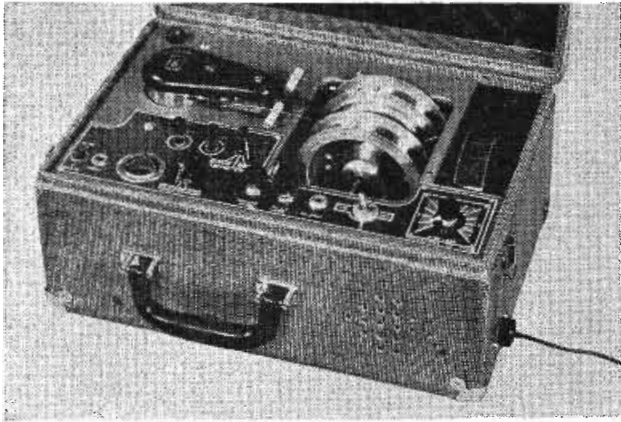

(Brush Paper)
Wire recorder using differential drive unit.

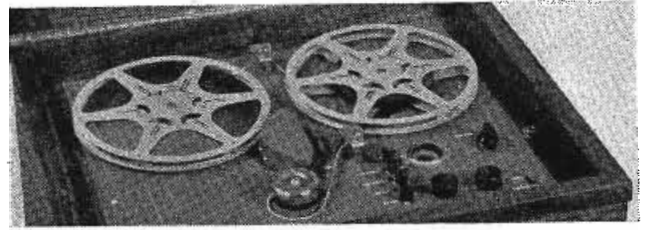

(Brush Paper)
Home-type magnetic recorder using coated paper.

unavoidable spurious leakage fields, such as those generated by the drive motor. While it is possible, within reasonable limits, to control the output voltage from the reproducing head, by providing more turns on the head, or by the use of a suitable transformer the signal-to-noise ratio depends upon the magnetic energy stored in the recording medium, and upon the shielding of the magnetic head, and if a transformer is used, upon magnetic shielding of the transformer. A plating thickness of about 0.003" was found to give the best overall results.

Coated non-magnetic bases can also be used as a magnetic recording medium. The idea of applying a suspension of small particles of permanent magnetic materials in a bonding medium to a non-magnetic base was first suggested in 1928 by Pfeumer in Germany. The A.E.G. in Germany developed a dictating machine in 1934 which used a tape coated with a magnetic powder. An A.E.G. recorder of the 1939 vintage, using such tape, operated with a velocity in the order of 3 feet per second. The signal-to-noise ratio was at best not much more than 20 db.

We began the study of this type tape in 1939. The pace of progress was accelerated by military requirements.

The problem was to find a powder of small particle size with suitable magnetic characteristics. Because of the metallurgical aspects Battelle Memorial Institute was asked to cooperate.

It was soon recognized that for best performance, the particle size should be kept in the order of one micron or less, and that the particle size should be uniform. A magnetic powder was found to meet all of these requirements.

Tapes have been manufactured on a plastic as well as a paper base.

The outstanding advantage of this medium is the low cost of manufacture for a given recording time and a specified frequency band. The cross section of the tape has to be large enough so that the low specific breaking strength of the base material does not interfere with the mechanical operation of the drive mechanism. To obtain sufficient mechanical strength, a tape with a width of 1/4" has been selected. This tape breaks when subjected to longitudinal force exceeding 6 pounds.

The coated type magnetic recording medium is particularly suitable for multi-track recording. The distance between two adjacent tracks depends upon the permissible cross-talk ratio and upon the frequency band which has to be covered.

Since the coated recording medium provides sufficient definition for signals with shorter wavelengths than any other material yet found, a wider frequency spectrum can be reproduced for the same spacing of recording tracks than was heretofore possible. The fact that closely spaced sound tracks can be used makes it possible to design equipment in which a considerable amount of recording time is crowded into a small volume or into limited surface area of the recording medium.

TOOLS FOR THE STUDY OF DISK RECORDING PERFORMANCE

H. E. Roys
R.C.A. Victor

WITHIN the past ten years, a new recording medium, of a cellulose nitrate base, *lacquer*, has been developed. This medium is much harder than the wax compound used for com-

mercial disk recording, so that immediate playback of the recorded disk without appreciable impairment in quality is possible. The lacquer disk has the advantage in that it can also be processed, in a manner similar to the wax blank, so that pressings can be produced for commercial application.

The increased hardness of the lacquer medium over the wax, however, imposes an additional load on the recording head and turntable driving system. Other differences exist, and new equipment has been developed to study the lacquer performance characteristics and determine the requirements of the equipment.

In the design of disk recording equipment, it is helpful to know what forces are attained during cutting, and the variation in these forces due to variations in hardness of the medium, or due to *bounce* (bounce is a form of instability in the action of the recording head while cutting). It was believed that measurements of the forces existing on the tip of the stylus while it is cutting a blank groove would suffice, and that any additional load due to modulation would not be appreciable. Therefore, a simple device was constructed to permit such a measurement. The pole piece and armature assembly of a recording head was used with its axis of rotation at right angles to its normal position. This permitted movement of the armature in a direction tangent to the groove. The stylus, of course, was not rotated. Therefore the cutting surface remained in its normal plane. In operation, a force on the stylus tip deflects the armature by an amount depending upon the stiffness of the center-

(Roys Paper)
Disk cutting force equipment.

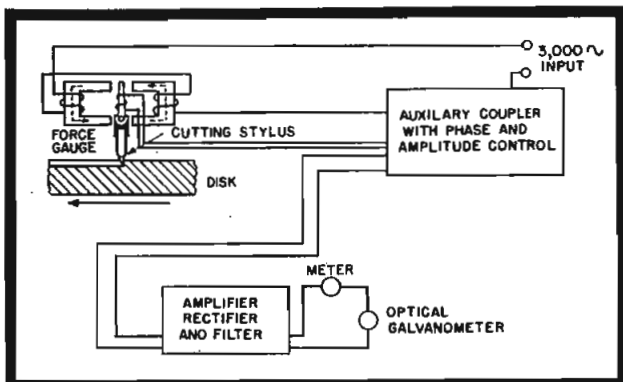

(Roys Paper)
Comparison of measured and calculated results of intermodulation distortion tests with pickups of different tip radii.

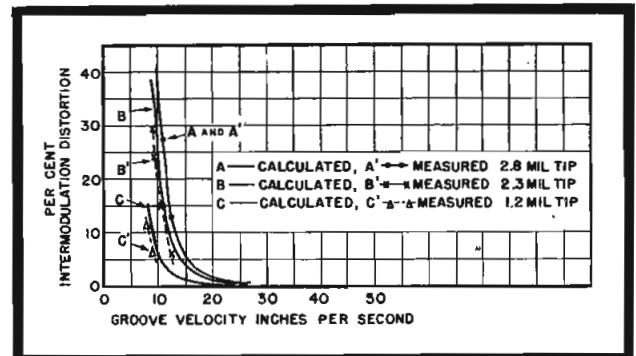

POSITIVE CONTROL

of Varying Power Supply

Raytheon Voltage Stabilizers

DELIVER OUTPUT VOLTAGE CONSTANT TO $\pm 1/2\%$

FLUCTUATION of line voltage need not impair the performance of your electrical equipment. Such variations are easily corrected with magnetic-type, entirely automatic Raytheon Voltage Stabilizers.

Positive control is gained. Power supply is stabilized to $\pm 1/2\%$. Reliability and accuracy of performance are effectively improved, *and at low cost.*

Investigate. Determine how positive control of line voltage can benefit your equipment. Our Bulletin DL-48-537 gives the detailed story. Write for it today.



CASED MODEL

Get These Principal Operating Advantages:

- Control of output voltage to within $\pm 1/2\%$ of 115 or 230 V.
- Stabilization at any load within rated capacities.
- Quick response. Stabilizes varying input voltage within 1/20 second.
- Entirely automatic. No adjustments. No moving parts. No maintenance.



Excellence in Electronics

RAYTHEON MANUFACTURING COMPANY
Industrial Electronics Division, Waltham 54, Mass.

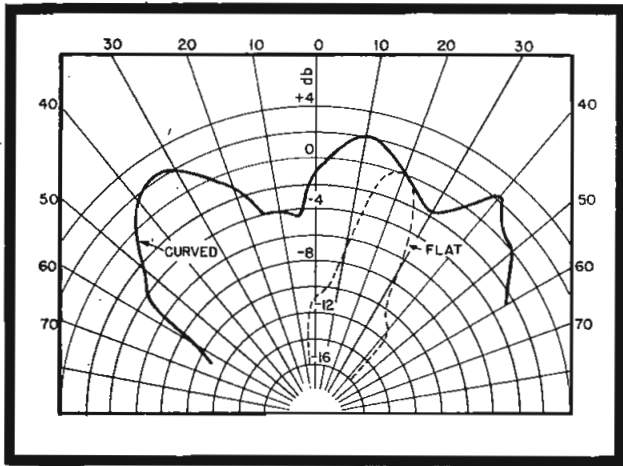

(Morrill Paper)
Polar distribution characteristics of reflected wave for convex and flat panels.

ing spring; in this application this deflection is measured by electrical means.

Measurements were made of the horizontal force at the stylus tip, while it was cutting a groove of normal depth at different groove velocities; that is, at different record diameters and speeds. These measurements were started on the outside of a 16-inch diameter instantaneous playback record blank, and short bands were cut at 78 rpm and 33 $\frac{1}{3}$ rpm.

Measurements also covered the cutting force required for different groove depths. Both steel and sapphire styli were used.

Recording heads of the rochelle salt and electromagnetic type were also tested. The tests disclosed that:

(1) The horizontal force existing on the stylus tip while cutting an unmodulated groove of constant depth is independent of groove velocity.

(2) When operating without the aid of an advance ball, the cutting force tends to remain constant regardless of any hard spots or disk warpage encountered. Constant cutting force imposes an even load on the motor and therefore helps to maintain constant turntable speed.

(3) The inertia of the recording turntable should be sufficient to overcome changes in turntable speed that are due to variations in cutting force because of cutter bounce. Cutting load variations not due to bounce (but due to hard spots and uneven surfaces encountered when using an advance ball), usually occur at such a low rate that turntable inertia has little filtering value. If an advance ball is used, the recommended adjustment is to have the ball barely touch the surface of the disk while recording. Hard spots will then raise the cutter, tending to equalize the cutting load, and therefore help to maintain constant turntable load and speed.

(4) The lateral load imposed upon the cutting

(Morrill Paper)
RCA disk recording studio with polycylindrical wall surfaces.

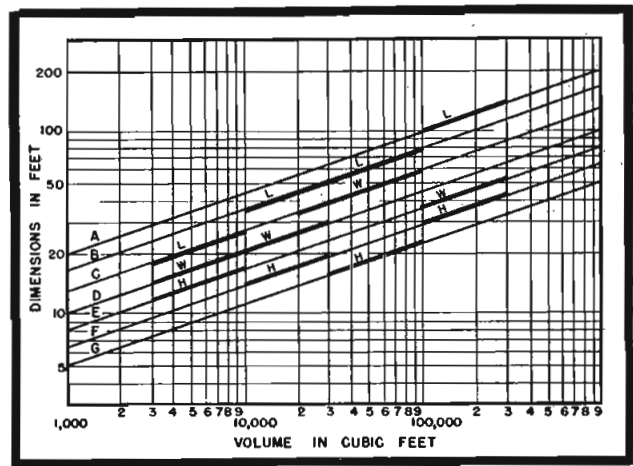
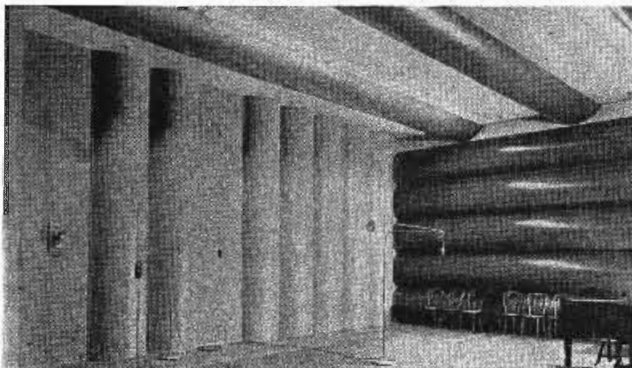

(Morrill Paper)

Preferred room dimensions based on $\sqrt[3]{2}$ ratio, permissible deviation $\pm 5\%$. Volume in cubic feet: small rooms—H:W:L=1:1.25:1.6=E:D:C; average shape rooms—H:W:L=1:1.6:2.5=F:D:B; low ceiling rooms—H:W:L=1:2.5:3.2=G:C:B; long rooms—H:W:L=1:1.25:3.2=F:B:A.

tip while recording on lacquer disks may be of sufficient magnitude to be taken into account during calibration. The load loss depends upon the mechanical impedance of the cutter, and the width of the burnishing edge on the cutting stylus. It will vary with frequency and will be greatest where the mechanical impedance is the lowest.

(5) The intermodulation method of distortion testing appears to offer many advantages in the study of distortion of disk recording and reproducing equipment. Judging by listening tests, it provides a means of measuring distortion that is obnoxious to the ear, but difficult to evaluate by the single-frequency harmonic method.

(6) Reproducing tips which have been worn and are no longer spherical can be detected by the intermodulation distortion method. Distortion resulting from the use of such tips can be measured. The method permits a study of the distortion introduced by processing.

STUDIO DESIGN

IRREGULAR ROOM SURFACES IN STUDIOS

Keron C. Morrill
R.C.A. Victor

THE uniformity of sound within the studio must always depend upon smoothness with which additional reflective components are added to the aggregate sound energy, which in turn must depend upon the placement, configuration or contour, and sound absorption of the room boundaries. This is where classical theory gives way to the modern, and wave acoustics must take over because of the particular relation that the dimensions of the room bear to the wavelength of sound.

Considered as a vibrating system, a room or studio can be studied or analyzed in terms of its normal modes of vibration,

each of which is associated with a normal frequency, and each of which possesses a space pattern or standing wave. In other words, a room is not merely an enclosure which receives sound energy and contains it until it is dissipated, but is rather a musical instrument which is excited to one or more of its normal modes by the introduction of energy.

The vibrating room has normal frequencies, called eigentons, which are very close together, or even coincident, by virtue of the dimensions of the room.

The transient behavior of a room, when the sound is decaying after the source has been cut off, prompts many problems. The assumption of geometrical acoustics that the sound in the room acts as a mass and thus decays logarithmically as a simple oscillator is no longer valid. Instead, for wave acoustics, we must consider that at the moment the source is stopped there is a particular quantity of energy in the room and that the room is now no longer driven at a particular frequency but instead lapses into one or more, usually many, of the eigentons lying near the driving frequency.

The wave patterns associated with these various eigentons in general have different decay rates and therefore the composite decay curve, on a logarithmic scale, will not be straight but instead will drop off rapidly at first as those

(Morrill Paper)
Review room of the photographic science laboratory at the Naval Air Station, Anacostia, D. C., using polycylindrical surfaces.

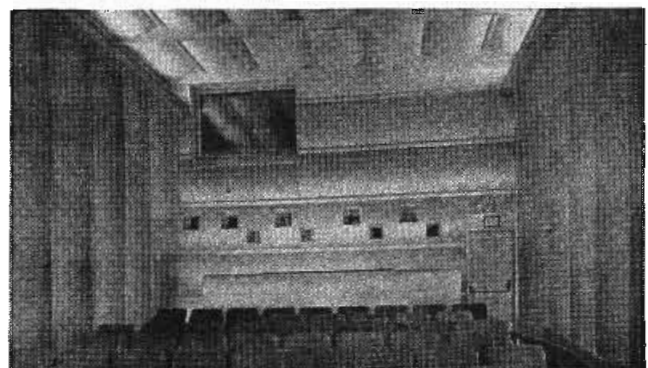



At v-h-f antenna coupling-circuit symposium session, left to right: M. W. Scheldorf, George Sinclair, P. H. Smith, A. G. Kandoian and R. F. Holtz.

patterns having high decay rates disappear, and then more slowly as control is left to patterns having lower decay rates.

A means of obtaining sound diffusion must be provided by roughening the surfaces, but it is not as simple as obtaining optical diffusion because of the old question of the relation of wave-length to room dimensions. Diffusion and dispersion of high frequencies is readily accomplished by small surface irregularities, provided they are well distributed over the boundaries of the studio. To obtain this condition for the middle register of frequencies requires much larger irregularities whose size is commensurate with the wave-length. The low frequencies provide the greatest problem because the size of the boundary irregularities is limited by the physical conditions of the studio.

Serrated, or saw-tooth, surface are one means of breaking up large expanses of area. A reasonable size of section as well as a reasonable amount of depth must be dictated by the size of the studio, the purpose for which the studio is to be used, and the lowest frequency of interest.

In one installation, the size of the serration varied from about $1\frac{1}{2}$ " to 4". Depth of the serration was of the order of 1". The studio was constructed by setting 2 x 4 studs to give the desired contour, placing the computed area of 2" rockwool blanket in the desired space, and then facing over the remainder of the area.

Curved panel diffusers were used in other installations. The first experimental panels were designed entirely on a basis of ease of fabrication by inexperienced mechanics from materials available in any lumber yard. Quarter-inch thick plywood, 4' wide and 8' long, was selected as the skin of the diffuser which was to be circular in shape. This skin was to be

supported on a number of segments which were to be randomly spaced to avoid selective absorption effects. The use of a depth of $11\frac{1}{2}$ " for these segments permitted the use of standard 12" lumber and yet provided irregularities effective down to an octave or more below 1000 cps for which this depth corresponded to a wave-length. These dimensions correspond to a radius of curvature of 22" for the skin and an overall width of 39" for the panel.

Panels similar in construction were used in modernizing an NBC studio in New York. In building this room to the cube root of two criterion for dimensions the ceiling height of the old studio was the governing dimension. This being 15' 8", the resulting floor size was 42' long by 27' 10" wide for the average room. With the exception of the floor, only two materials were used for the studio surfaces: the curved plywood panels and 4" thick rock-wool bats covered with colored burlap.

The axes of the cylinders were mutually perpendicular for pairs of walls. This arrangement was not a live end—dead end affair, but rather what can be called a tapered studio. The design point for reverberation time was somewhat higher than the usually accepted values for studio purposes on the theory that the greater diffusion and consequent more uniform distribution of sound energy would result in a smoother decay curve that would permit a longer time.

A very satisfactory panel was built with 4' x 8' plywood formed over curved segment braces and fitted at the edges with 2" x 3" strips which had been routed and held together with 1" x 3" back braces. The segment braces, spaced at random, had strips of $\frac{1}{2}$ " fiber-board placed between them and the panel to prevent rattling.

Note: Replies to a series of typical queries posed during developmental sessions were offered by Mr. Morrical. These questions covered reverberation, television studio design, insulating doors, etc.

A reverberation question involved the reverberation constant for broadcast studios and the reverberation time versus frequency.

According to Mr. Morrical. The present practice which we have been following has been to use the accepted times published by Morris and Nixon in the case of speech and multiplying these times by a factor of 1.5 in the case of music pick-up. The present trend is toward using a reverberation time versus frequency which is reasonably flat for small studios especially if they are to be used for speech and with a slight rising characteristic at the low end for larger studios which are to be used for music. This latter characteristic abolishes the shape used by MacNair since the acceptable reverberation time for music is so much greater than for speech. The practice of using adjustable attenuators is growing. The means of obtaining this adjustable absorbant is either by heavily folded drapes or reversible panels which have rock wool or other absorption treatment on one side and

convex plywood panels on the opposite side. The television query concerned the additional considerations necessary in television studio design that are not present in conventional small studio design.

Mr. Morrical said, "Television studio design should include consideration of rock wool treatment on all walls and ceiling similar to the practice which has been used on sound movie stages in Hollywood during the past 15 or 20 years. The acceptance required for any practical scene which is being revised should be built into the 'set' rather than in the studio itself."

ANTENNAS

CIRCULAR ANTENNAS

M. W. Scheldorf
General Electric

COMMERCIAL horizontally-polarized antennas employing concentrated current-carrying surfaces have without exception used push-pull input terminals. Often the need for a double transmission line has been overcome by the use of a single coaxial line and a line balance converter or *balun unit*. In reception, the need for simplicity and low cost however has sometimes resulted in the use of a coaxial line without the balun unit. Theoretically this is far from desirable because of currents that result on the outside of this coaxial line due to the impedance imbalance at the terminal end.

An investigation was made to determine the effect of the use of a horizontally-polarized half-wave dipole at the end of a vertical coaxial line with and without the balun unit in this manner. Numerous tests were performed. While the condition without the balun showed a consistent cross-polarization component, there was also a similar consistent component when the balun was used. On the average there was not enough difference to warrant the expense of a balun unit. Consequently we believe that *single-ended* transmission lines should be used with half-wave antennas for reception.

Baluns and their application to f-m broadcasting antennas were also studied. Measurements made on the circular an-

(Scheldorf Paper)
Single bay circular antenna.

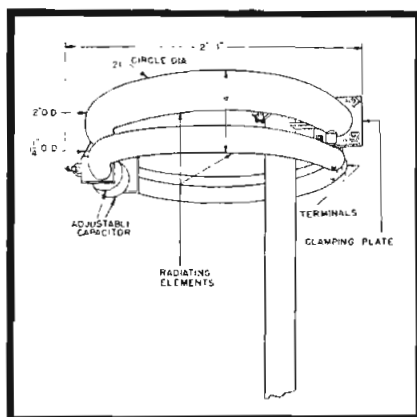

(Scheldorf Paper)
Gain characteristics for multiple bays of circular antenna.

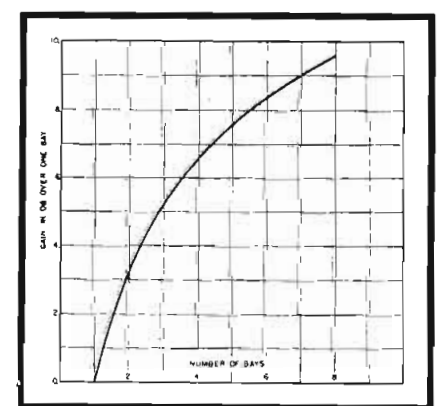



What Do You Want in a Relay?..
CLARE Will "Custom-Build" It
... Exactly

● Clare puts the designer in the driver's seat. Clare Relays permit a flexibility of plan unheard of with ordinary relays.

The secret? There isn't any. It's just that Clare "custom-building" makes it possible for you . . . with the utmost economy . . . to have a relay exactly suited to your specific requirements.

Clare doesn't design and manufacture a new relay for you from the ground up. There would be no economy for you in that. Clare "custom-building" selects the proper combination of Clare features for the job and includes them in a standard basic frame that is ideal for the requirement at hand.

Clare "custom-building" is a method of construction. It permits a wide range of contact ratings . . . five different contact forms or any combination of them . . . either flat or hemispherical contacts which may be of rare metals or special

alloys . . . coil windings to match the circuit and application.

Clare Relays are built for applications where precise performance, long life and dependability are prime requisites. Thousands of users attest to the value of Clare Relays and the Clare "custom-built" principle.

To "custom-build" a relay for you Clare engineers must know all the facts surrounding the requirements. Clare has sales engineers in all principal cities to show you how Clare "Custom-Built" Multiple Contact Relays are the effective answer to modern design problems.

Send for the new Clare Engineering Data Book with its full information on the full line of Clare Relays and allied control apparatus. Address: C. P. Clare & Company, 4719 West Sunnyside Avenue, Chicago 30, Illinois. Cable address: CLARELAY.



Contacts are welded to nickel silver springs by a special process. May be of precious metals or alloys in 12 different standard or special types and sizes.

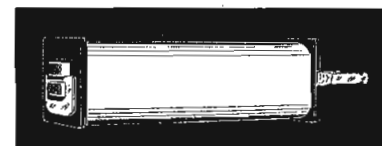

Coil core of a.c. relays is of thin laminations of silicon steel, riveted together. This reduces hysteresis and eddy current losses, gives large amount of power with small heat losses.



High voltage spring pile-up insulators of special heat-treated Bakelite. Have minimum cold flow properties, low moisture absorption content. Permit punching without cracks or checks.

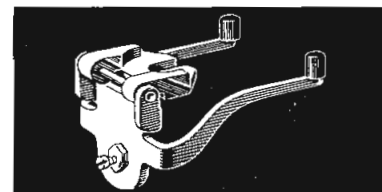

Double arm armature assembly with stainless steel shaft, operating in a marine brass yoke. Heelpiece, core and armature assembly of magnetic metal.

CLARE RELAYS

"Custom-Built" Multiple Contact Relays for Electrical and Industrial Use

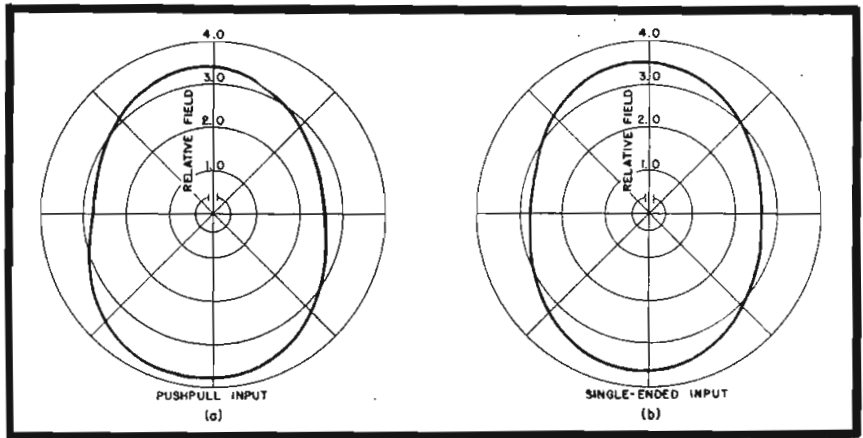
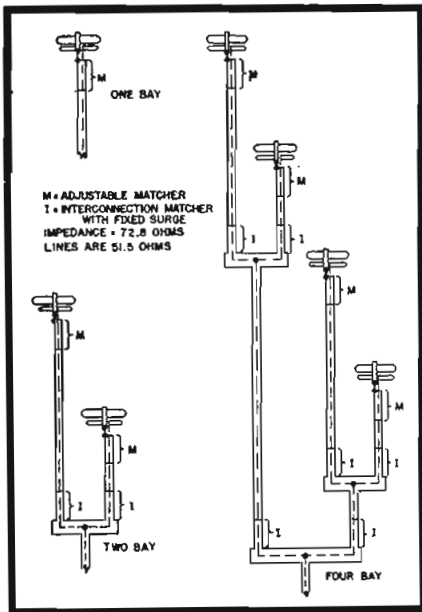

(Scheldorf Paper)
Circular antenna patterns: (a) push-pull input; (b) single-ended input.

Interconnection diagram illustrating how it is possible to connect up an entire system of circular antennas without balun units.

single-bay antenna units may be stacked vertically, spaced at a distance of one wavelength (which is desirable from a feeding standpoint due to phase relationships).

tenna without the balun showed that there is no practical need for including it in the system. Impedance measurements on a representative antenna, with and without a balun indicated an equality of the curves sufficient to remove any doubt about really serious current unbalance and associated impedance change. One set of measurements were made with both input arms of the antenna free from ground and with the slotted section provided with a balun unit so as to excite the antenna properly in a pushpull fashion; another with one input arm of the antenna grounded and with no balun unit associated with the slotted section.

Horizontal pattern measurements showed no evidence of redistribution of the currents in the important radiating elements.

The horizontally-polarized antenna used consisted essentially of a folded dipole with the radiating elements bent to form a

circular shape and having the extreme ends connected by means of an adjustable capacitor. The double current path serves two purposes. First, it permits a transformation of the radiation resistance to a terminal resistance value which has a magnitude of the general order of the nominal surge impedance of coaxial transmission lines used to feed antennas. Second, it permits direct mounting of the radiating system at a point of ground potential so that disturbing capacity effects which normally accompany insulated mountings are eliminated and protection against lightning is secured.

The adjustable capacitor permits tuning of the electrical circuit to resonance at the chosen frequency of operation.

The antenna unit will handle a maximum power input of 12.5 kw, when properly tuned.

When it becomes desirable to have a greater field strength in the horizontal plane, for a given power input, these

F-M BROADCAST LOOPS

A. G. Kandoian
Federal Telecommunication Labs

THEORETICAL studies and practical applications have indicated that coaxially-fed horizontal loops are ideally suited for f-m broadcasting.

Early studies and tests indicated that the loop had one disadvantage; the loop is essentially a balanced system and requires a balanced transmission line, prompting balancing problems.

We thus studied the possibility of loop antennas using only coaxial lines. Experiments disclosed that such an antenna design¹ was entirely practical and effective.

We chose a square-type loop, since it seemed to be the most economical from an experimental and manufacturing view. A 4-element loop was selected in place of the one-two or three type, since it provided for a suitable supporting structure. Design of the loop also provides for a large inside area to allow for rigid structures (2x2). This is particularly important when eight or twelve loops are used.

Inherently the mutual impedance between loops stacked vertically is low enough to be negligible when the separation is near one wavelength. Thus when the feeders of a pair of loops are tied to-

(Kandoian Paper)
Coaxial fed type loop. High or low power is possible with tiers of this type.

(Kandoian Paper)
Measured horizontal pattern of square loop f-m antenna.

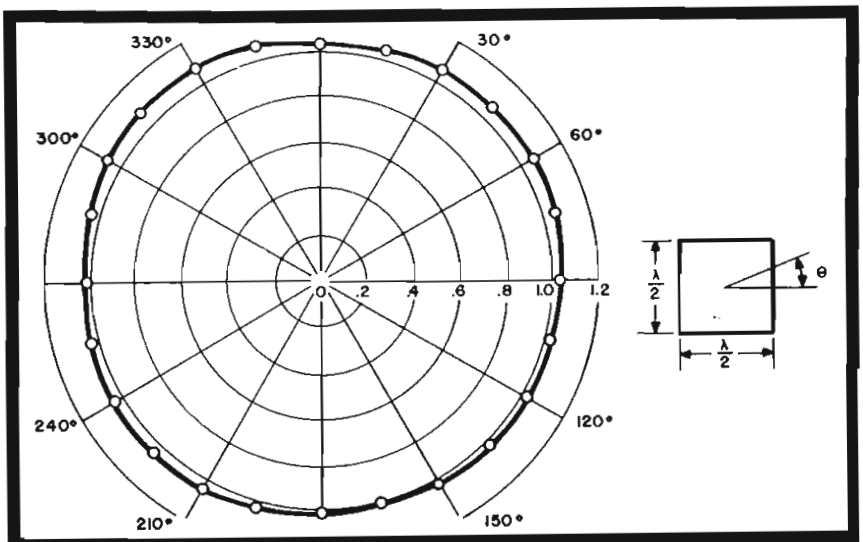
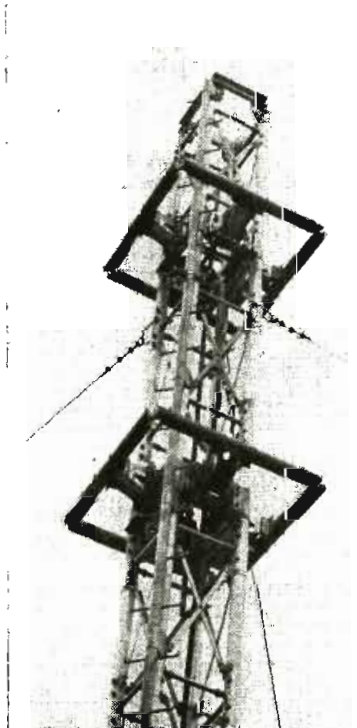



We're coming in...

A static has made a lot of "pick-ups" along the line and here we are ... breezing through the azure blue ... headed for the Show ... and you. It's going to be fun ... shaking hands with the old gang again ... and the new-comers, too. We'll be holding forth at the Stevens, where you'll find Astatic Microphones, Phonograph Pickups and Cartridges ... including many new and improved models ... on display. We'll be seein' you!



Hotel Stevens

CHICAGO, ILL.
Headquarters for
Radio Parts National Trade Show
May 13, 14, 15 and 16

THE

ASTATIC
Astatic

CORPORATION
CONNEAUT, OHIO

In Canada: Canadian Astatic, Ltd., Toronto, Ont.

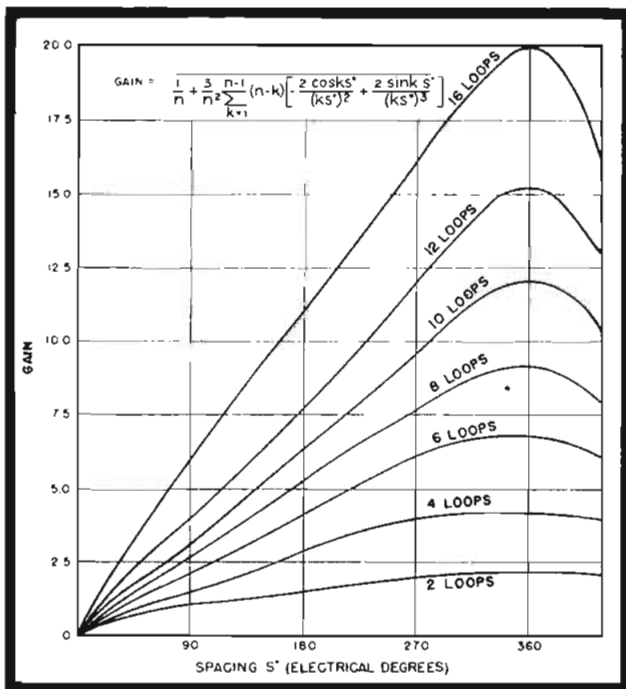

(Kandoian Paper)
Gain of linear array of loops, vertically stacked.

gether the net resulting impedance is one-half that looking into one loop.

Thus any number of loops may be stacked to give a desirable amount of power gain. A sixteen-bay stack with a power gain of approximately 20 appears entirely feasible, assuming the height of the supporting structure is sufficient.

Two alternatives are available for an eight-loop array. If desired, two separate coaxial lines may be used to feed each stack of four loops. In case of damage or breakdown in one portion of the antenna system, it would allow the full use of half of the array.

For a sixteen-bay system, two stacks of a pair of eight-loops may be used.

Stacks may be added without changing radiation characteristics of loop.

Any standard size coaxial feeder cable can be used with the system.

During the war the use of solid dielectrics was advanced, since it minimized maintenance. As a result solid dielectric, such as polyethylene cable was applied

to antennas. The same practice has been applied to this antenna. The only limiting factor is the power, because of the copper loss. These restrictions thus limit the power to 3 kw per loop. However large cables with lower copper losses are now being developed and it may soon be possible to have higher power outputs.

Fundamentally this loop is of the type originally developed and built for aerial navigation and for localized, glide path, radio ranges back in 1939. Theoretical work on this type of antenna has been done by Alford, Foster and others. Practical application of this type of antenna f-m broadcast was described by Hampshire of Federal at the IRE meeting in Detroit in 1940, and later by Scheidori of General Electric.

The loop design provides for the use of any number of radiating elements. The shape of the loop and the cross-section of the radiator can be round, square, rectangular, triangular, etc., without modifying the essential behavior of the loop. And the lines coupling the main feeder to the radiating members may be used as a matching device to obtain any desired input impedance. In addition since the mechanical supports are all metallic, they can be made as large and strong as required without affecting the radiating properties of the antenna.

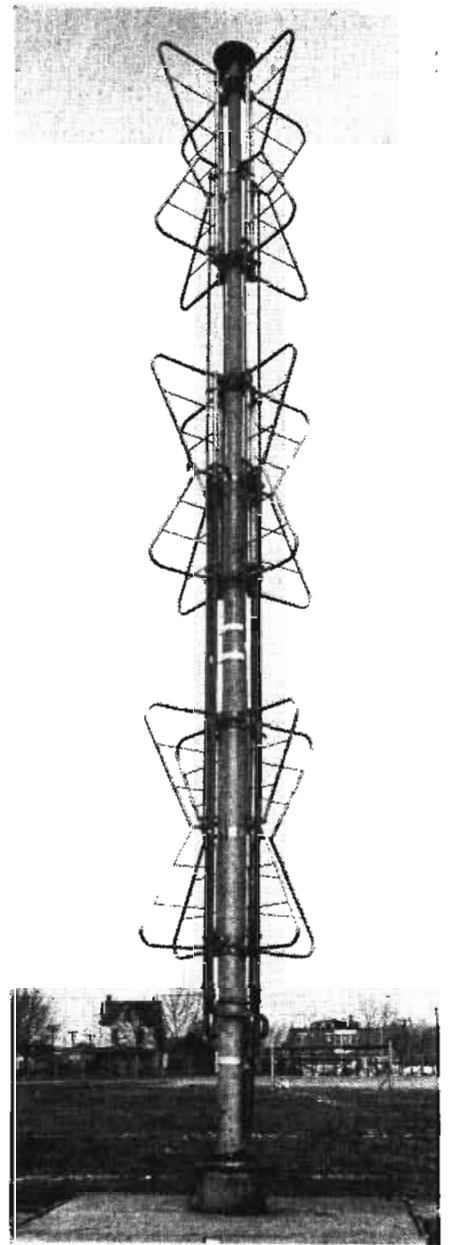

(Holtz Paper)
Super turnstile antenna.

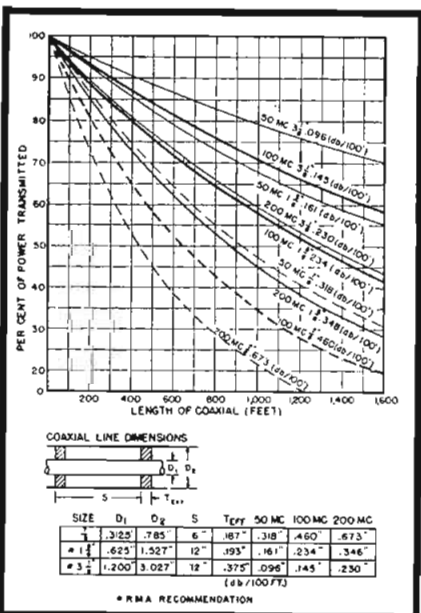

SUPER TURNSTILE ANTENNA

R. F. Holtz
R. C. A. Victor

THIS antenna is essentially a turnstile type with current sheet radiators used in place of the standard cylindrical turnstile radiators. These current sheet radiators are not solid sheets of metal but tubing frame works. This design aids in reducing the wind resistance.

The main advantage of such radiators is that they increase the bandwidth of the antenna to more than adequately cover the entire f-m band, with no field adjustments. The current-sheets are attached to the pole (ground) at top and bottom and are spaced one wavelength between centers in the case of multi-section units. The trans-

(Holtz Paper)
Plot of coaxial line efficiency of turnstile antenna.

mission line outer conductor is attached to one current-sheet, with the inner conductor connected to the pole at feed points.

The r-f currents on the radial members radiate more or less proportionately to the length of the member and to the magnitude of the current in the member. The longer members have a far greater effect in radiation than the shorter ones. Thus the pattern closely approximates that of two simple dipoles spaced one-half wavelength apart.

Turnstile feature permits duplexing more than one carrier on the same antenna. Both audio and video carriers can be fed to the antenna simultaneously, with no cross talk. Carriers of two f-m stations can also be fed to line, thus providing community service in some areas.

Horizontal pattern can be changed from a circle to a figure 8 or any intermediate stage between them.

The power input is 20 kw. However, this can be increased to 50-kw by using larger feed lines.

Normal power gain of a 1-section unit
(Continued on page 58)

Franklin AIRLOOPS

have left the stage of
experiment and investigation!

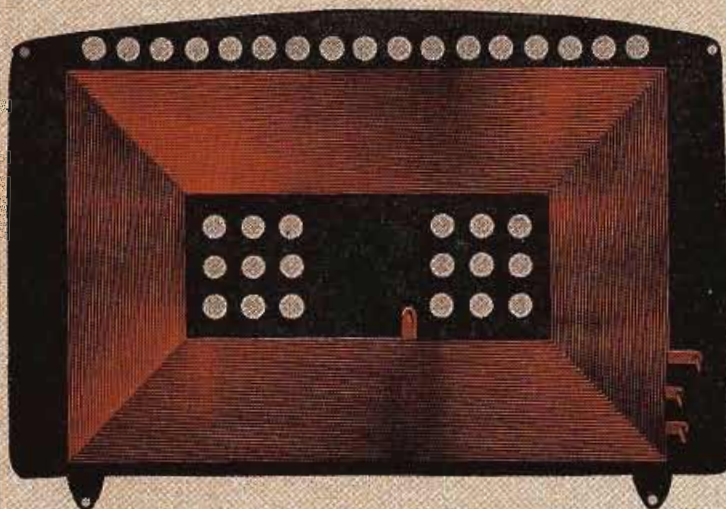

**HUNDREDS OF THOUSANDS
ARE NOW BEING PRODUCED
FOR SOME OF THE LARGEST
MANUFACTURERS OF
RADIO RECEIVERS.**

IF loops are bottlenecking your assembly lines?
you want the best loop for your set?
you are cost conscious?

consult Franklin
for large scale delivery of
AIRLOOPS

A radio engineer's dream come true! The greatest development in loop antenna design and manufacture since 1920! Flat sheets of copper die-stamped into perfect supersensitive loops . . . air dielectric throughout their entire length . . . being rectangular they have 27% more effective area . . . better performance at lower cost . . . no set builder can afford to overlook the significance of the AIRLOOP.

Compare these AIRLOOP values
with conventional loop values and
you too will SPECIFY AIRLOOPS.

- Optimum sensitivity
- High uniform "Q" over entire band
- Inductance to close tolerance without adjustable turn
- Low distributed capacity
- 27% greater effective loop area
- Electrical and mechanical stability
- Backboard and loop in one
- Lower cost
- Elimination of individual loop adjustment on assembly line
- Maximum space utilization
- No haywire

Franklin **AIRLOOP**
175 VARICK ST., NEW YORK 14, N. Y. *corp.*

Figure 1
An ordinary amplifier circuit where the input capacitance is a function of the amplification of the tube.

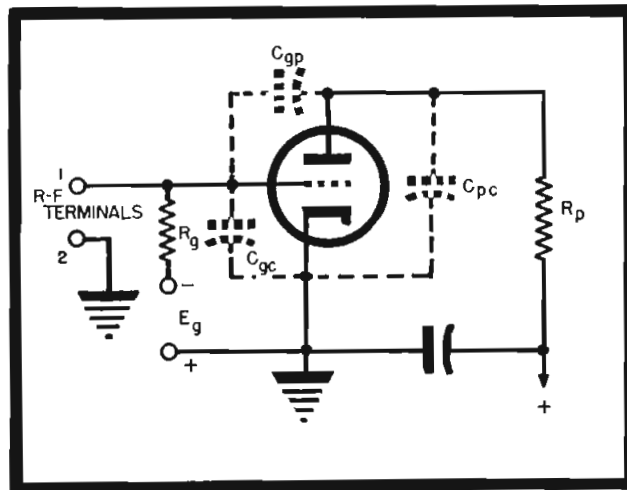

DIRECT Frequency-Modulation MODULATORS

by **N. MARCHAND***
Chief Engineer
Lowenherz Development Company

THERE are many types of reactance-varying circuits that can be used as direct f-m modulators. Any type of circuit that presents a two-terminal impedance which has a reactive component presents a possibility. The other feature required is a means of changing that reactance with the modulating voltage. In other words, for modulating purposes it has to be a reactance that varies with the signal voltage. As in the case of the reactance tube, when this two-terminal impedance is placed across the tank

*Instructor in Graduate Electrical Engineering courses, Columbia University.

In the Previous Paper, Which Appeared in the March Issue, Various Configurations of the Reactance Tube Were Discussed. Miscellaneous Types of Direct F-M Modulators Not Employing the Reactance Tube Are Analyzed in This Installment; Input Capacitance, Transmission Line, RC F-M Oscillator, and Inductively Coupled Types. Design Equations for These Systems Are Also Presented.

circuit of an oscillator, it will cause a variation in frequency of the oscillator with the signal voltage.

Input Capacitance Modulator

In Figure 1 is shown an ordinary amplifier circuit employing a triode tube. A grid resistor, R_g , and a plate resistor, R_p , are shown. The dotted

capacitances are the capacitances that are present across the elements of the tube. C_{gc} is the grid-to-cathode capacitance, C_{gp} is the grid-to-plate capacitance, and C_{pc} is the plate-to-cathode capacitance. These capacitances consist of the internal capacitances of the tube plus any stray capacitances that may exist across the elements. The

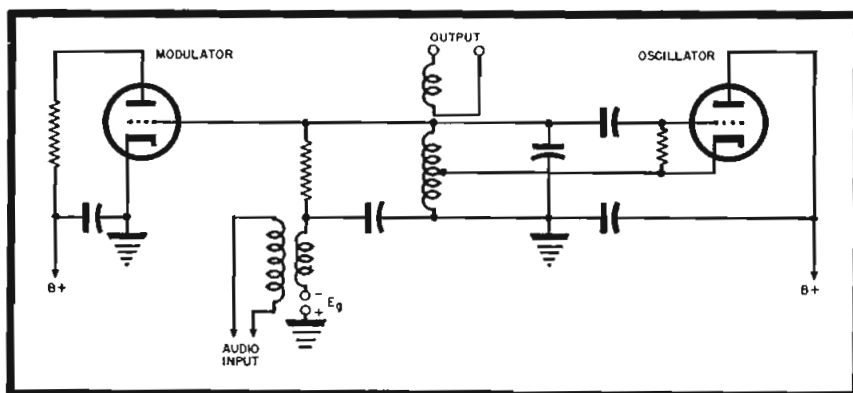
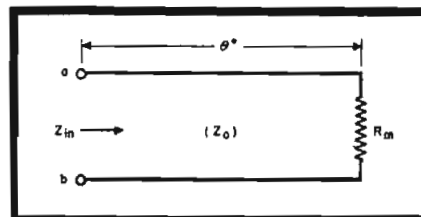
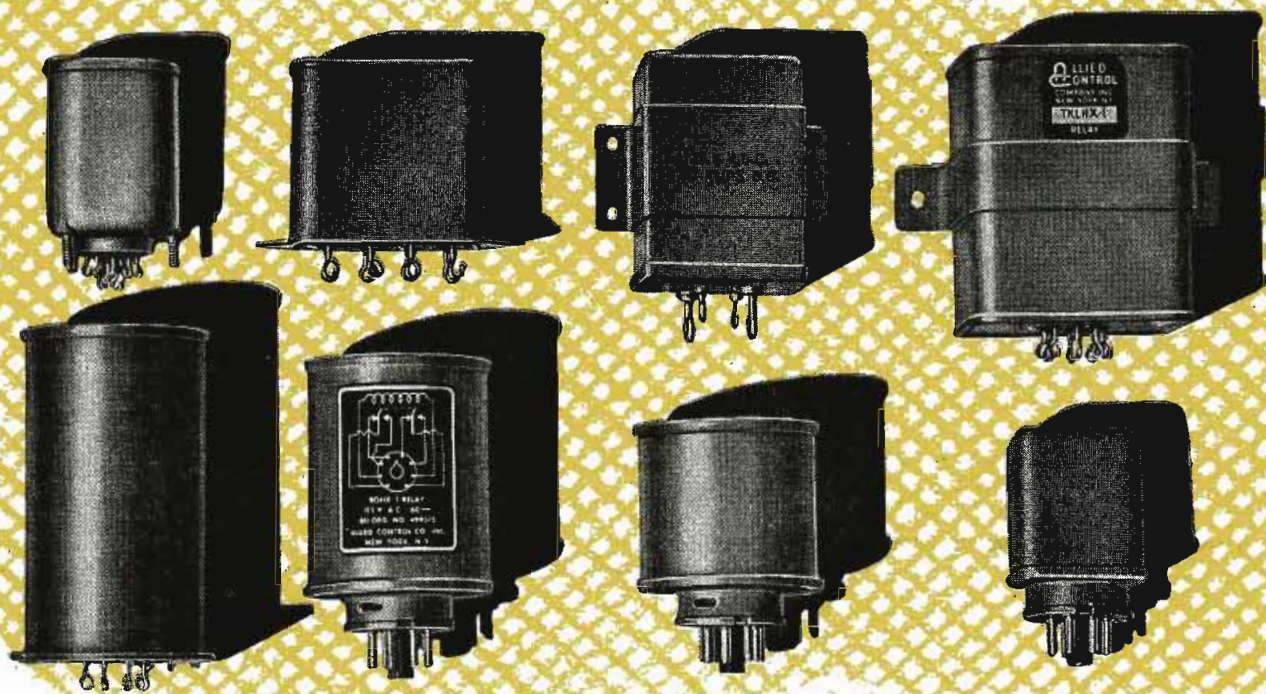

Figure 2 (left)
An f-m generator circuit with the modulator shown in Figure 1.

Figure 3
A length of transmission line θ° long with a characteristic impedance Z_0 that is terminated in a resistance R_m . The input impedance of the lines is Z_{in} .





DIVERSITY OF DESIGN *plus* IN **ALLIED'S** HERMETICALLY-SEALED RELAYS

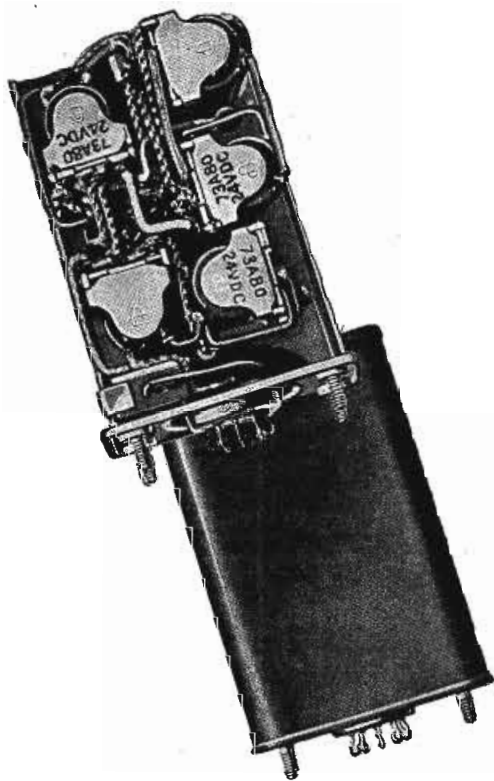

The photo above shows a cut-away view and completed assembly of Allied type TKHX-26 sealed relay with ten soldered terminals individually color marked.

These relays are designed to fit your specific applications and to fill your special requirements completely, but this is not all.

When you specify "Allied" you are sure to get a unit that is completely engineered as a sealed relay — not just equipment built around older types. Moreover these sealed relays are produced completely, from start to finish, in Allied plants, by one organization, under coordinated standards.

These products have back of them a wealth of pioneering experience in the sealing of relays to protect them from dirt, moisture and many foreign substances or to prevent tampering or accidental damage to the working parts. This experience is today expressed in a completely organized sealed-relay division, using the most modern techniques and equipment including a specially designed sealing room where air temperature, humidity and cleanliness are scientifically controlled.

There is wide diversity of design in Allied sealed relays. But of far greater importance are the benefits of experience, complete engineering, and modern manufacturing by one organization. Before you specify be sure to get all the facts about Allied relays.

ALLIED CONTROL COMPANY, INC.



AL-102

GENERAL OFFICES: 2 East End Ave. (at 79th St.) New York 21, N. Y. Factories: New York City (2 East End Ave.) Plantsville, Conn. Chicago—4321 N. Knox Avenue, Chicago 41, Illinois. In California: Allied Control Co. of California, Inc. 1633 South Hope St., Los Angeles 15, Calif.

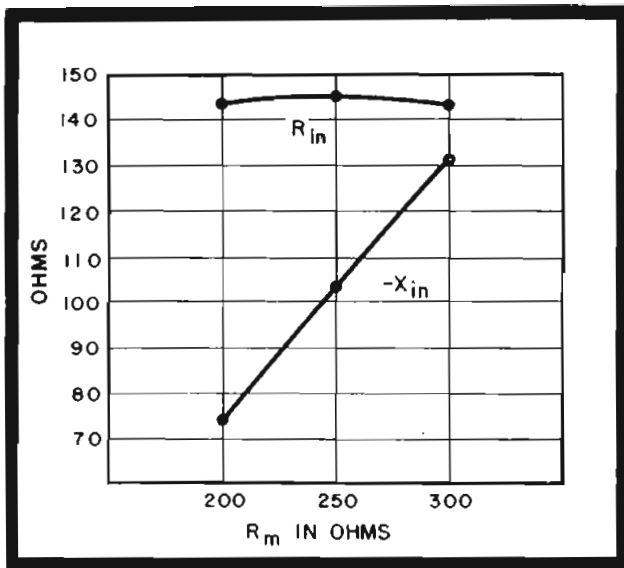

Figure 4
The variation in X_{in} and R_{in} for a transmission line of 100 ohms characteristic impedance and 22° long, when terminated in a R_m that varies.

Figure 5
Circuit of a transmission-line oscillator with a variable-resistance tube as a terminating impedance.

total capacitance presented across terminals 1 and 2, C_{in} , is given by

$$C_{in} = C_{gc} + C_{gp} (1 + G) \quad (1)$$

where G is the gain of the circuit and is equal to the r-f voltage across R_m divided by the r-f voltage across R_g . Let us now consider the impedance presented across terminals 1 and 2 to an r-f signal of frequency f . Calling the impedance across 1 and 2, Z

$$\frac{1}{Z} = \frac{1}{R_g} + j2\pi f C_{in} \quad (2)$$

Thus the input impedance consists of the grid resistor and the input capacitance in parallel. If the grid resistor is made very much larger than the impedance of the input capacitance, it may be neglected and the input impedance becomes equal to the capacitive reactance of C_{in} . Figure 2 shows an f-m generator employing this type of modulating circuit. The bias voltage, E_g , can be used to stabilize the center frequency of the oscillator.

Transmission Line Modulator

A length of transmission line with a variable resistance on the end of it can be used as an f-m modulator. Figure 3 shows a length of transmission line that is θ° long. It has a characteristic impedance of Z_o , and is terminated in a resistor R_m . The input impedance across the terminals a and b is Z_{in} . This impedance is given by

$$Z_{in} = Z_o \frac{R_m \cos \theta + j Z_o \sin \theta}{Z_o \cos \theta + j R_m \sin \theta} \quad (3)$$

Separating the real and the reactive components

$$R_{in} = \frac{Z_o^2 R_m}{Z_o^2 \cos^2 \theta + R_m^2 \sin^2 \theta}$$

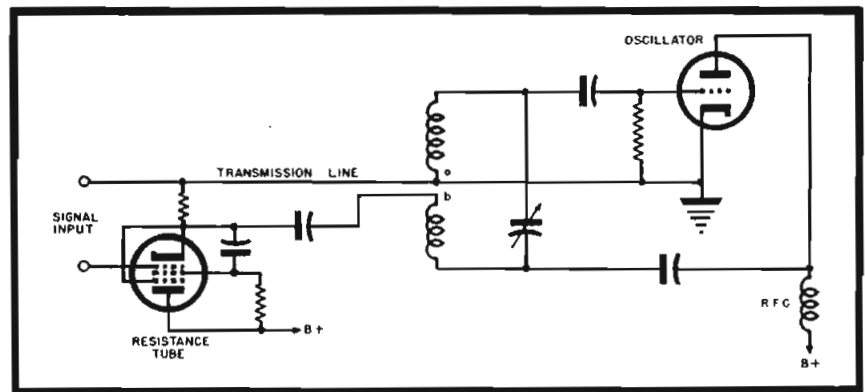

$$R_{in} = \frac{Z_o (Z_o^2 - R_m^2) \cos \theta \sin \theta}{Z_o^2 \cos^2 \theta + R_m^2 \sin^2 \theta} + j \frac{Z_o^2 \cos^2 \theta + R_m^2 \sin^2 \theta}{Z_o^2 \cos^2 \theta + R_m^2 \sin^2 \theta} \quad (4)$$

Now let

$$Z_{in} = R_{in} + j X_{in} \quad (5)$$

where R_{in} is the resistive component of the input impedance and X_{in} is the reactive component of the input impedance. Thus

$$R_{in} = \frac{Z_o^2 R_m}{Z_o^2 \cos^2 \theta + R_m^2 \sin^2 \theta} \quad (6)$$

and

$$X_{in} = \frac{Z_o (Z_o^2 - R_m^2) \cos \theta \sin \theta}{Z_o^2 \cos^2 \theta + R_m^2 \sin^2 \theta} \quad (7)$$

It can be seen from (6) and (7) that both the resistive component and the reactive component will vary with R_m . This means that the frequency of an oscillator will vary with R_m if the two input terminals, a and b , are placed across the tank circuit of the oscillator since the input reactance is varying. However, if the input resistance varies it will cause the amplitude of the oscillator output to vary also. This is detrimental to the operation of an f-m generator. Thus an operating condition should be chosen to give the minimum variation of R_{in} . Since in this circuit

the reactance will be varied by varying R_m , the best operating point for the minimum variation of R_{in} can be obtained by differentiating R_{in} with respect to R_m and equating the differential to zero.

$$\frac{d R_{in}}{d R_m} = \frac{(Z_o^2 \cos^2 \theta + R_m^2 \sin^2 \theta) (Z_o^2) - Z_o^2 R_m (2 R_m \sin^2 \theta)}{(Z_o^2 \cos^2 \theta + R_m^2 \sin^2 \theta)^2} \quad (8)$$

Since in any fraction if the denominator is not equal to zero, the fraction is equal to zero when the numerator is zero, the numerator of (8) is equated to zero

$$Z_o^2 \cos^2 \theta + R_m^2 \sin^2 \theta - 2 R_m^2 Z_o^2 \sin^2 \theta = 0 \quad (9)$$

Simplifying

$$\frac{Z_o^2 \sin^2 \theta}{R_m^2 \cos^2 \theta} = 1 \quad (10)$$

Solving for θ

$$\theta = \pm \tan^{-1} \left(\frac{Z_o}{R_m} \right) \quad (11)$$

Thus for any value of R_m , (11) determines the length of line necessary for the minimum change in R_{in} . At that point, of course, R_{in} does not change at all but it will change a small

More output per dollar input!

The highly efficient output network of the Collins 20K AM broadcast transmitter contributes materially to its high operating economy and reliability. Efficient transfer of power from final amplifier to antenna calls for less power input, and therefore less power dissipation in circuit elements. Lower operating cost, greater dependability, and longer component life are the results of ingenious coordination of circuit design, components, and tubes.

Audio frequency distortion, noise level,

and audio frequency response are within FCC high fidelity requirements. Stabilized feedback constantly safeguards these excellent performance characteristics under widely varying operating conditions.

Complete metering and motor tuning provide control over all circuits. Power change-over from 1000 watts to 500 watts is instantaneous. Write for further information. Collins Radio Company, Cedar Rapids, Iowa; 11 West 42nd Street, New York 18, N. Y.

COLLINS
One Kilowatt
20K
Transmitter



FOR BROADCAST QUALITY, IT'S . . .

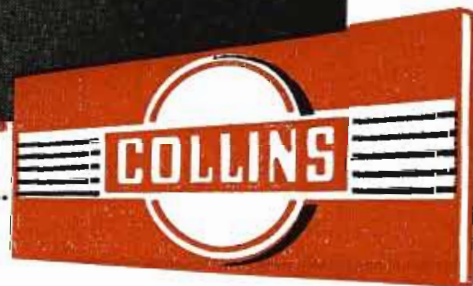

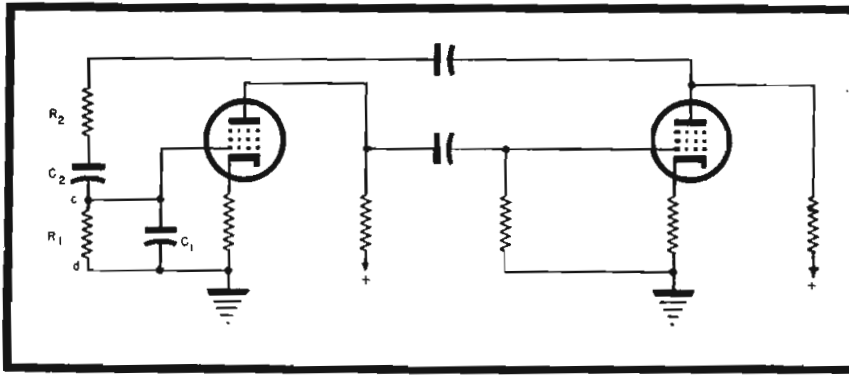

Figure 6
Simplified circuit of an RC oscillator where R_1 , C_1 , R_2 and C_2 are the frequency-determining constants.

should be blocked, of course, with a coupling capacitor.

Resistance-Capacitance F-M Generator

A resistance-capacitance oscillator can be made into an f-m generator by replacing one of the frequency determining resistors by a variable resistance tube whose resistance is determined by the signal used for modulation. In Figure 6 appears a simplified circuit of an RC oscillator where R_1 , C_1 , R_2 , and C_2 are the frequency determining constants. The frequency of oscillation, f , is given by

$$f = \frac{1}{2\pi\sqrt{C_1 R_1 C_2 R_2}} \quad (14)$$

If a variable resistance tube is used instead of R_1 , being connected across the terminals c and d in the figure, the frequency of the oscillator can be made

amount as the swing is increased about that point. The value of R_{1n} at that value of R_m and θ is obtained by substituting (11) into (6). The value of R_{1n} obtained after simplification is

$$R_{1n} = Z_0 \csc 2\theta \quad (12)$$

Similarly the value of X_{1n} obtained by substituting (11) into (7) and by simplifying we have

$$X_{1n} = Z_0 \cot 2\theta \quad (13)$$

Equations (12) and (13) give the val-

and we have a load resistance R_m of nominal value of 250 ohms as a terminating resistor. The length of transmission line to be used as given by (11) should be 22° or about $1/8$ of a wavelength at the frequency being employed. If the terminating resistor is varied from 200 to 300 ohms the variation in R_{1n} and X_{1n} can be calculated immediately from (6) and (7). A curve of the variation in these values is shown in Figure 4.

To employ the transmission line in

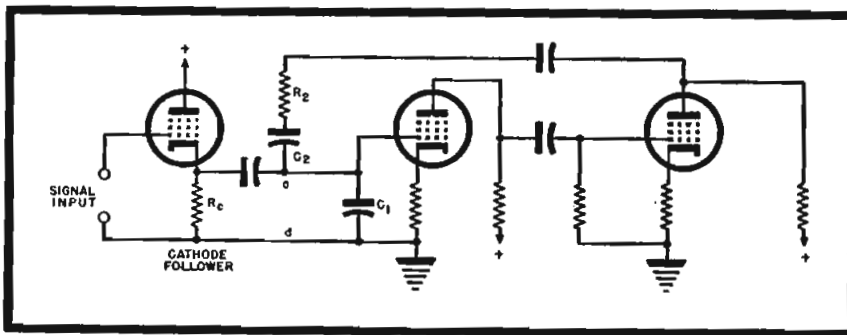

Figure 7
The RC oscillator of Figure 6 with the resistor, R_1 , replaced by a variable resistance tube.

ues of R_{1n} and X_{1n} at the minimum R_{1n} variation. The actual variation in these values is obtained by substituting the values of R_m into (6) and (7).

As an example let us assume that a transmission line which has a characteristic impedance of 100 ohms is used,

an f-m generator, it can be connected in series with the tank circuit of an oscillator as shown in the simplified circuit of Figure 5. If the loading is too great on the tank circuit a shunting resistance can be put across the terminals a and b . The d-c circuit

to vary. In Figure 7 the frequency determining resistor R_1 has been replaced by a variable resistance tube of the cathode-follower type. A cathode resistor, R_c , is used and if the tube has a transconductance of g_m the input resistance R_i across the terminals c and d is given by

$$R_i = \frac{1}{g_m + \frac{1}{R_c}} \quad (15)$$

If the value of R_c is large enough the $1/R_c$ term may be neglected, so that (15) becomes

$$R_i = \frac{1}{g_m} \quad (16)$$

The frequency of the oscillator then becomes

$$f = \frac{\sqrt{g_m}}{2\pi\sqrt{C_1 C_2 R_2}} \quad (17)$$

(Continued on page 57)

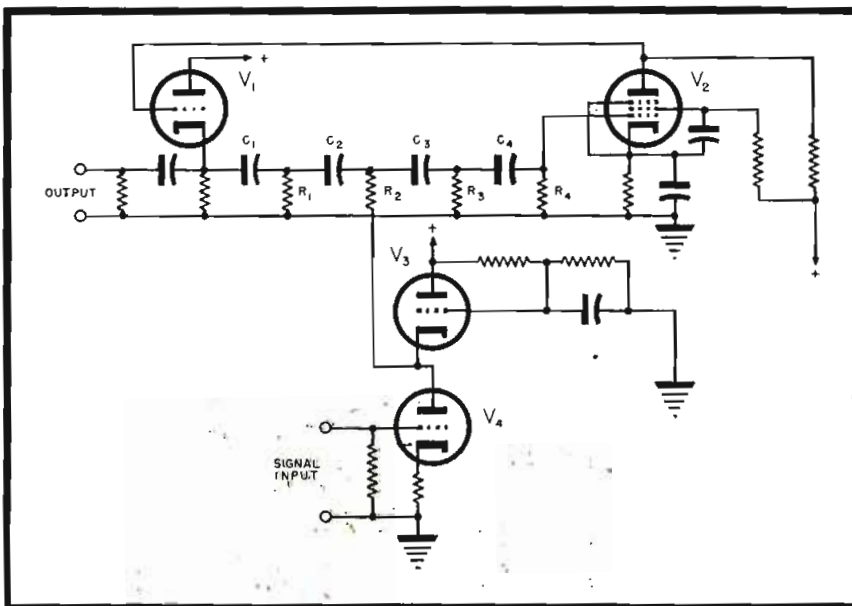

Figure 8
A ladder-network RC oscillator employing a four-step ladder and tubes, V_3 and V_4 , to vary the frequency.

Again...FEDERAL makes NEWS...with the

FIRST TRIODE

EVER DEVELOPED THAT GIVES YOU

600 watts at 600 MC!

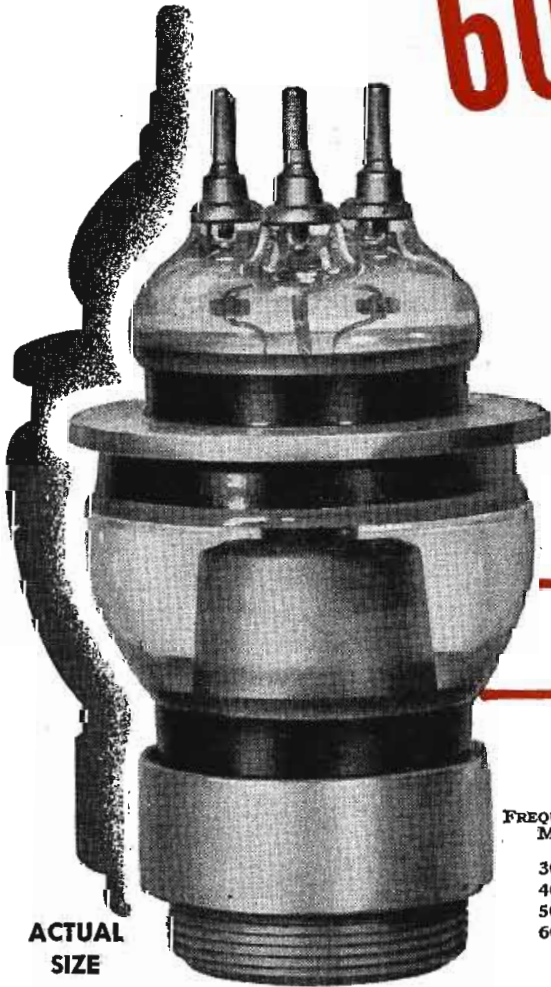

Now being used successfully in the powerful CBS color television transmitter operating at 490 MC carrier frequency with 10 MC bandwidth at 1 KW peak power output.

Federal's 6C22 is the *only* tube of this type ever to operate at this power output at such high frequency. It's the triode to use...as oscillator, amplifier, or frequency multiplier.

Four years of Federal engineering effort were spent in its development for radar equipment. Now it's ready for commercial broadcast use... with features making it especially suitable in the UHF spectrum.

For example, Federal's 6C22 has ring-seal electrode construction which reduces lead inductance... and extremely close interelectrode spacings to lower transit time losses.

And with 37 years of tube-building experience behind all Federal tubes, you'll find "extras" of rugged mechanical design in the 6C22, in addition to trustworthy electrical performance. It has no internal spacers to break down. Built with solid copper anode block, and water cooled, it works at the high power levels with complete safety. Write for complete information.

TENTATIVE MAXIMUM RATINGS AND TYPICAL OPERATION

Key-down conditions without amplitude modulation. Maximum ratings for frequency of 600 MC.

Typical operation— Self-excited oscillator

FREQUENCY MC	PLATE VOLTAGE VOLTS	PLATE CURRENT AMPERES	POWER OUTPUT WATTS
300	2500	0.70	900
400	2500	0.65	800
500	2200	0.70	680
600	2000	0.65	500

DC Plate Voltage... 2500 Volts
DC Plate Current... 0.75 Amperes
DC Grid Current... 0.075 Amperes
Plate Input... 1875 Watts
Plate Dissipation... 1000 Watts

Federal Telephone and Radio Corporation

Export Distributor:
International Standard Electric Corporation

Newark 1, New Jersey



Nomogram for Computing Inductance of

Nomogram May Be Used to Solve Many V-H-F Problems: Estimating Resonant Frequency of a Tube When the External Plate and Grid Terminals Are Connected Together With a Bypass Capacitor of Very Low Reactance; Designing of Wave Filters Using Lumped Elements at Very High Frequencies; Designing of Connecting Leads on Mica Bypass Capacitors so That Bypassing Action Will be Most Effective at Specified Frequency.

by J. I. STEPHEN

IN many high-frequency circuits using lumped constants, the upper limit of the tuning range is determined by the residual inductance of the connecting leads. It is quite important to be able to accurately pre-estimate this inductance. To solve problems of this type and many others encountered in h-f and v-h-f practice, the nomogram shown in Figure 1 has been prepared.

Nomogram Formula

The nomogram is based on the formula: $L = 0.00508 l$

$$\left[2.303 \log_{10} \frac{4l}{d} - 1 + \frac{d}{2l} \right]$$

appearing in the Bureau of Standards circular 74; L is the inductance in microhenries, l is the length of the wire in inches and d is wire diameter in inches. (The formula on which this chart is based is valid only when the wire length is less than a tenth of a wavelength.)

To use the nomogram, it is merely necessary to lay a straight-edge across the two scales corresponding to the known quantities and read the unknown quantity where the straight-edge intersects the third scale.

Examples

Suppose we desire to find the in-

ductance of a straight piece of round copper wire 1" long, having a diameter of 0.005". The ratio of the wire

length to wire diameter is then $\frac{1.000}{.005}$

= 200. Using scale B on the right-hand side of the chart, a straight line is drawn through 200, corresponding

to $\frac{l}{d}$ and through 1.0 of the diagonal,

corresponding to l . The inductance is then read on the left-hand side of the chart and is found to be .028 microhenries.

Now suppose we wish to estimate the resonant frequency of a tube when the external plate and grid terminals are connected together with a bypass capacitor of very low resistance. Obviously, the resonant circuit is composed of the plate-to-grid interelectrode capacity C_{GP} and the inductance of the plate and grid leads, L . The lead inductance, L , is readily found from the nomogram, and using the value of C_{GP} measured at low frequencies, the limiting frequency of the tube is

$$f = \frac{1}{2\pi\sqrt{LC}}$$

Another use of the nomogram is in determining the input resistance re-

¹Terman, *Radio Engineering Handbook*, section 5.

sulting from the inductance of the cathode lead in pentode r-f amplifiers.¹

By determining the cathode inductance and using the chart to determine the neutralizing inductance, the input conductance effects of the tube can be neutralized.

The nomogram is also useful in designing wave filters using lumped elements at very high frequencies. In certain types of low and high pass filters, elements having inductances less than 0.10 microhenries, are required. These values are extremely difficult to realize with solenoidal coils. The simplest and most effective method is to use a piece of straight wire whose length and diameter can be determined by means of the nomogram.

The nomogram can also be used to facilitate the design of the connecting leads on a mica bypass capacitor to assure effective bypassing action at a certain frequency. Since the connecting leads have a definite inductive reactance which combines in series with the capacitive reactance of the capacitor, the network is most effective when it is series resonant and thus has an extremely low reactance from the bypass point to ground. The lead inductance would then be designed equal

to $\frac{1}{(2\pi f)^2 C}$ where C is the capacity

of the capacitor and f is the frequency at which optimum bypass action is desired.

STRAIGHT CYLINDRICAL WIRES

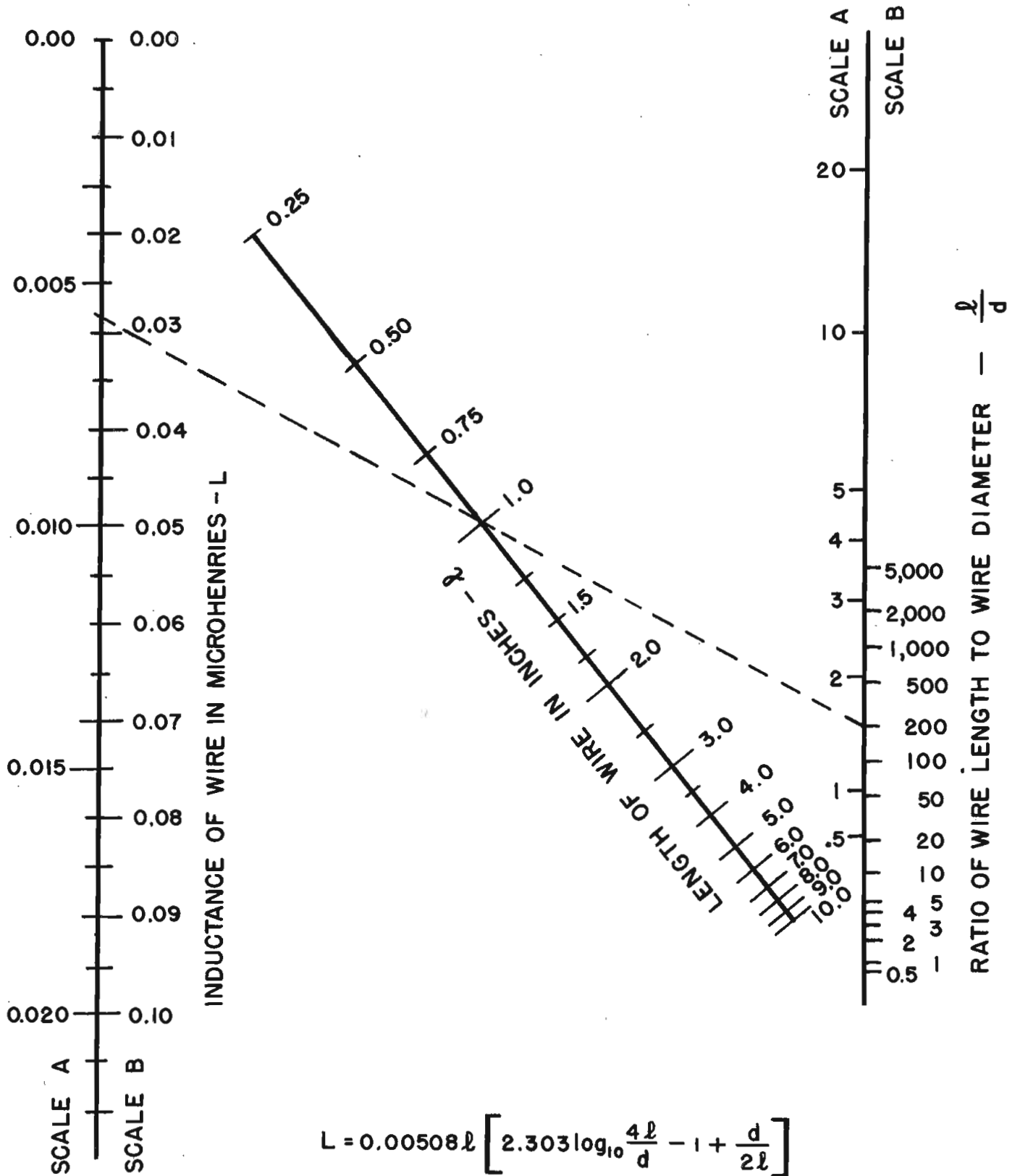



VETERAN WIRELESS OPERATORS ASSOCIATION NEWS

W. J. McGONIGLE, President

RCA BUILDING 30 Rockefeller Plaza, New York, N. Y.

GEORGE H. CLARK, Secretary

George Clark Retires from RCA

ONE of radio's outstanding pioneers, secretary of our association for many, many years . . . George H. Clark . . . has retired from RCA after 20 years of active service . . . quite active!

George, a graduate of MIT, joined RCA in 1919. He organized a show division, which for eight years toured forty-six states with three carloads of apparatus. Since then most of his work has been with patent litigation, publicity and writing. Incidentally in 1908 he was with the Navy as an expert on radio . . . the first in the Navy!

George, known as radio's historian, will continue his collection work. At present, there are five rooms at 66 New Street packed with data collected by George. Three hundred volumes with historical data are already bound. A thousand more will soon be in bindings. He is also writing a treatise on the U. S. Navy and is at present on page 1,000. Five years more should see the completion of that assignment. Yes, George has retired, but he is scheduled to be the most actively retired man we know.

Scores of letters were sent to George

by notables congratulating him on his many contributions to the art.

A letter from Admiral S. C. Hooper (U. S. N., Ret.), with whom George Clark worked closely in the emerging days of Navy radio, when multiple wavelengths (and Clark wave-changers) were being installed in Fleet and shore stations, said:

"When I came into the picture you were the main spring of the cooperation between the industry and the Government. You always saw good in everyone and helped us all.

"In addition to your kind deeds you have left a definite mark on the advance of radio. But for you the basic organization and equipment of Naval communications would not have been so efficient, and you speeded up the art in the right direction. May you have many years of peace and reflection . . . and take it easy!"

Paul A. Porter, former chairman of the FCC, said:

"American communications owes much to the contributions of such radio pioneers as George Clark. The recent VWOA dinner is a fitting tribute to his labors both for the Navy and for industry. It is to such men as George Clark that we are indebted for America's leadership in radio communication."

A letter from E. J. Nally, former president RCA, said:

"Congratulations that you are about to enjoy the full four and many more freedoms which you have so honorably and faithfully won as a reward for your steadfastness, your loyalty, and for the vast contribution you have made to the life around you and to the lives of so many admiring friends."

Major General Frank E. Stoner, Assistant Chief Signal Officer U. S. Army, said:

"The Chief Signal Officer of the Army and the entire corps acknowledge the great contribution made by George Clark in the field of radio communications. His numerous improvements in the art will long be remembered by the nation. He represents the highest tradition in the field of radio communications and will always be loved and respected as a true pioneer and gentleman by those who follow this profession.

"The United States holds its present position of greatness because of men like George Clark. This satisfaction will remain with him forever. The Signal Corps wishes him peace and happiness in his well-earned retirement and sends its 73 to him from the four corners of the earth."

A letter from Lee de Forest, honorary VWOA president, said:

"George Clark and wireless . . . two names inseparable for the past 45 years. There (Continued on page 60)

Below: Photographic review of the life of George H. Clark. This interesting series of illustrations appeared on Christmas cards.



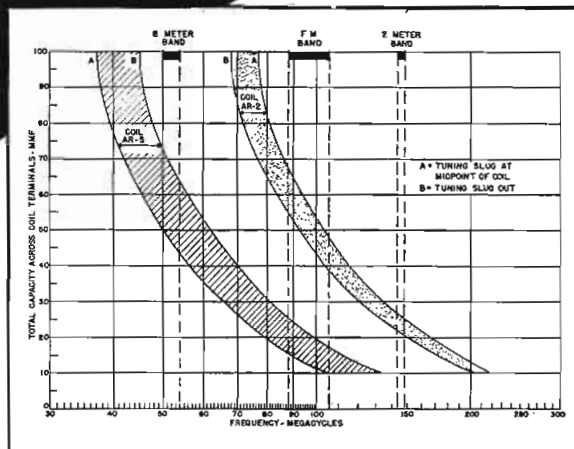
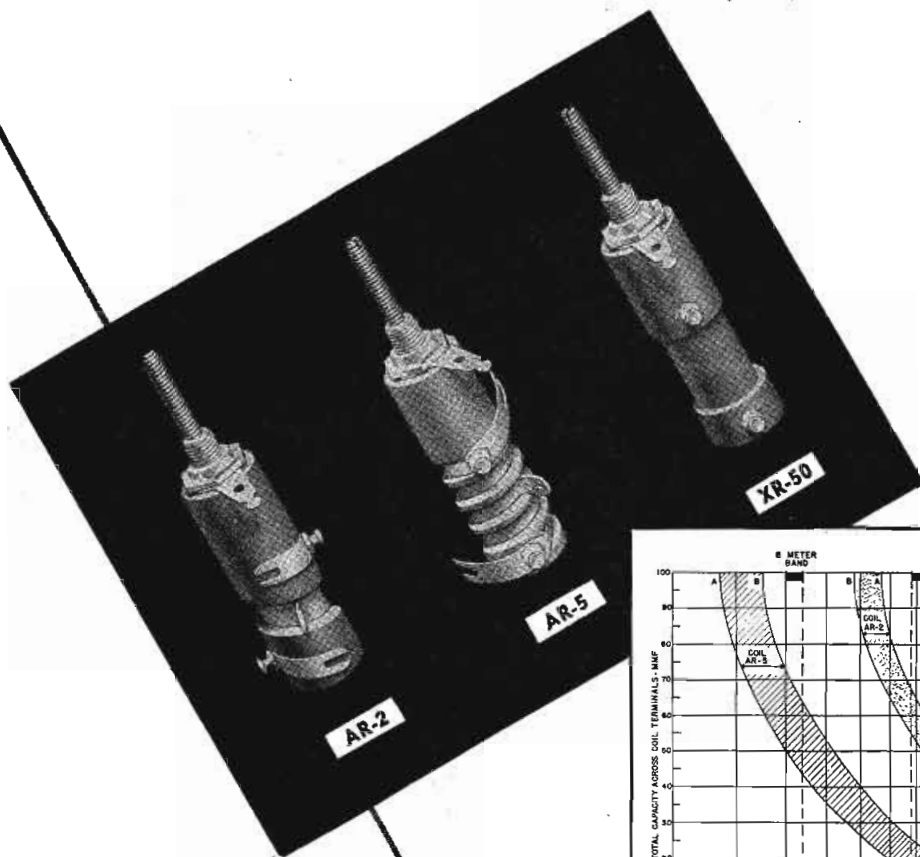

Here are the postwar high frequency coils amateurs will need for work with the micro-waves. Originally designed to meet Navy requirements, these new high-Q units have adjustable inductance and give fine performance as high frequency oscillators, RF stages or frequency multipliers. Two coils are available covering the range from 37 to 220 Mc. A blank form, Type XR-50, may be wound as desired. All three are small and compact, and all are designed for convenient single-hole mounting.



NATIONAL COMPANY, INC., MALDEN, MASS. U.S.A.



A Buy-word for Excellence

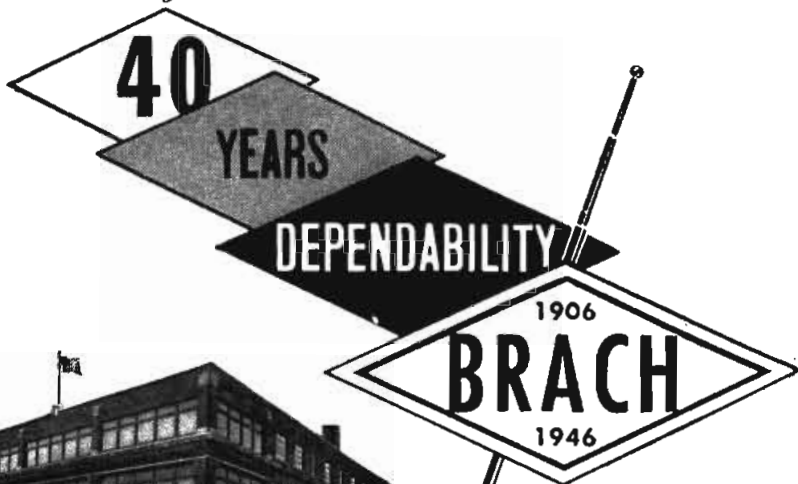

PUR-A-TONE
Reg. Trade Mark

ANTENNAS

ALL TYPES FOR
 • **AUTOS**
 • **HOMES**
 • **MARINE**
A.M. — F.M. — TELEVISION

Make pleased customers and bigger profits . . . ask your distributor for BRACH Puratone ANTENNAS.

Special-purpose transmitting antennas designed for volume production to your own specifications. Collapsible—sectional—direction finding—radar and coaxial type. All sizes, lengths and materials. Consult us on your needs.

L. S. BRACH MFG. CORP.

200 CENTRAL AVENUE NEWARK, N. J.

WORLD'S OLDEST AND LARGEST MANUFACTURERS OF RADIO ANTENNAS AND ACCESSORIES.



AUDIO MEASUREMENT

(Continued from page 25)

square root of the sum of the squares of the individual components.

Signal Sources for Distortion Measurements

The lowest distortion obtained in any type of commercially available oscillator is found in the push-button-operated RC feedback type, in which the distortion is generally better than 0.1% throughout most of the operating range. In this type of oscillator an RC feedback network, usually of the parallel-T type, provides a high degree of

degeneration for all harmonic voltages. The extremely good waveform at low frequencies is made possible by the absence of inductance coils or other non-linear elements. In commercial oscillators of this type the standard push-button frequencies include all of the FCC test frequencies. For highly accurate measurements of distortion such an oscillator is a distinct advantage since the inherent distortion in the test signal will always be small compared to the amount to be measured in the transmitted signal. This is the only commercial type oscillator with a low enough distortion for the FCC *proof-of-performance tests*.

For ordinary maintenance checks on

transmitters other types of oscillators may be used, and if they are to be used also for running response curves, etc., certain of the continuously variable types may be considered more convenient. Continuously variable oscillators are generally either of the beat-frequency type or of the RC type. High-grade units of the beat frequency type may have distortion as low as 0.2% throughout most of the frequency range, but the distortion tends to rise to relatively high values at low frequencies. The continuously tunable RC type, as commercially produced, generally has a somewhat higher distortion through the medium-frequency range than the better grades of beat-frequency oscillators. The most important advantage of the beat-frequency oscillator as a standard test instrument is that the complete a-f range is available on a single dial, which may have a logarithmic or other desired scale shape.

A third type of oscillator, not yet in commercial production and known as the double-beat or multiple-beat, allows the simultaneous application of two test frequencies, thus facilitating measurements of intermodulation distortion. There are considerable theoretical reasons to believe that when such oscillators are generally available two-tone distortion tests will become quite generally used, particularly in cases where high amounts of distortion are encountered, since it is generally agreed that the intermodulation products are considerably more annoying than the spurious harmonics. Of course, intermodulation measurements can always be made using two individual oscillators.

Distortion-Measuring Instruments

The most common form of distortion-measuring instrument is the distortion meter. Various types have been manufactured over a period of years, earlier types being of the fixed-frequency variety. More recent types have been continuously adjustable. One of these has operated by bucking the transmitted signal against the applied signal, which requires careful adjustment of both phase and amplitude and measuring the resulting difference, which is an indication of distortion. The most recent types involve null circuits of the Wien bridge, parallel-T or similar types, which attenuate the fundamental sufficiently so that the remaining signal represents almost entirely the harmonics and noise. Switching the null network out of the circuit allows direct measurement of the noise, which obviously should be considerably lower than the level of the har-

monics if accurate measurements are to be made. This fact limits the usefulness of the distortion meter in some applications. The distortion meter readings, of course, represent the total of all harmonics combined, there being no indication of the relative amplitude of each individual harmonic.

In using a distortion meter, a preliminary check should be made of the noise level in the system under test to be sure that it is not comparable to the magnitude of the distortion to be measured. This is particularly important in circuits having deemphasis, since the standard 75-microsecond deemphasis curve is down approximately 8.2 db at 5000 cycles, 11.4 db at 7500 cycles, 13.6 db at 10,000 cycles and 17 db at 15,000 cycles. For *proof-of-performance tests* on f-m transmitters the FCC has accordingly agreed to require the 50%-and 25%-modulation distortion measurements only for frequencies of 5000 cycles and below. The problem is further complicated in the case of television transmitters, where the allowable noise level is 5 db higher.

One of the earliest, and still one of the best methods for measuring distortion is the wave analyzer. Such devices in present commercial forms are generally of the heterodyne type, having a fixed-frequency filter. In such an analyzer, tuning is accomplished by heterodyning the component being measured up to the filter frequency. The use of a fixed filter allows a very high degree of selectivity. Consequently such measurements are relatively unaffected by noise and other factors, even under conditions where distortion meter measurements may be useless. Present commercial types of wave analyzers, however, do not tune to frequencies above approximately 18 kc, which limits their use for some of the high-frequency distortion measurements now required by the FCC. The great advantage of the analyzer, however, is its versatility. Since it measures each component separately, it may be used equally well for single-tone harmonic measurements or for multi-tone intermodulation measurements.

Another distortion-measuring device is the so-called intermodulation meter, which is intended only for intermodulation measurements. Such a device is quite similar to a modulation meter as used for measuring percentage modulation of a broadcast station, except that the intermodulation meter is an a-f instrument. It measures the depth of modulation produced on one tone, gen-

(Continued on page 54)

**The Difference Between
"We Think So" and
"We KNOW So"**

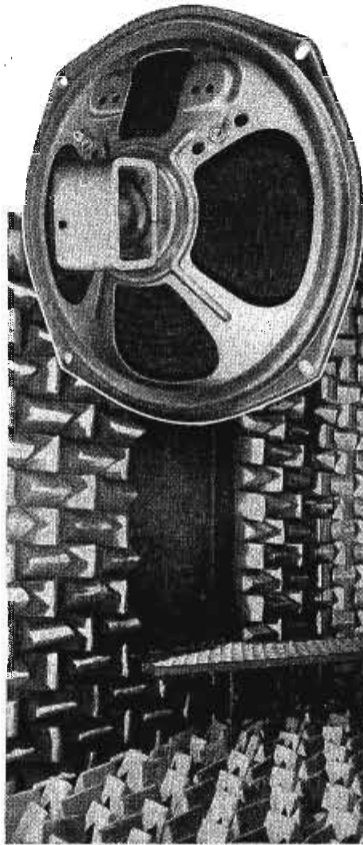

**Permoflux
Speakers**



**...are Engineered for Application in
this Stalactite Acoustical Chamber**

In this completely soundproof room, asymmetrical walls and carefully designed mass-interval baffles effectively reduce troublesome resonant harmonics and reflected sound to an insignificant value. Response curves are plotted which represent true performances so that Permoflux engineers can say "We Know So." Its use at Permoflux is characteristic of the many factors which make it possible to substantiate the fact that Permoflux Speakers provide the finest possible sound reproduction.

SEE US AT THE CHICAGO TRADE SHOW—BOOTH 32

PERMOFLUX
PERMOFLUX CORPORATION
4900 WEST GRAND AVE., CHICAGO 39, ILL.



PIONEER MANUFACTURERS OF PERMANENT MAGNET DYNAMIC TRANSDUCERS

DEPENDABLE PERFORMANCE

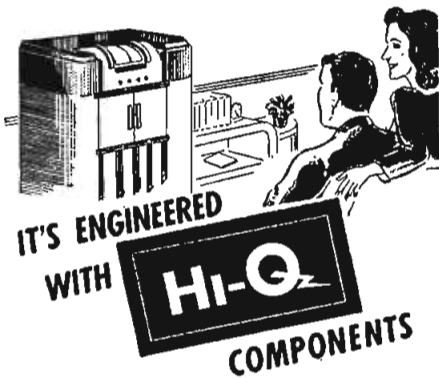

Dependable performance in any electronic equipment is the sum of little things. And when those "little things" are Hi-Q components you can rest assured that performance will be thoroughly dependable. Hi-Q components are available in any desired quantities to your specifications. Send for samples and complete data.



CERAMIC CAPACITORS

CI Type: axial leads

CN Type: parallel leads

Made of titanium dioxide (for temperature compensating types). Tested for physical dimensions, temperature coefficients, power factor and dielectric strength.



WIRE WOUND RESISTORS

Fixed Type

Immediately available in standard ratings or precision built to any tolerance or value.

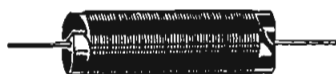

CHOKE COILS

Sturdy construction. Insulated or uninsulated. Quantity production available at once.

ELECTRICAL REACTANCE CORPORATION

FRANKLINVILLE, N. Y.

(Continued from page 53)

erally at a high a-f, by another tone, generally of a low a-f. This type of intermodulation meter is often limited to operation at only a few selected frequencies.

Coupling Test Equipment to Transmitter

Figure 1 shows the conventional means for coupling the test oscillator to a transmitter. Generally this simple arrangement will be found quite satisfactory. The resistance R_s should equal the impedance from which the equipment under test is designed to work. The attenuator, which is of the T type, should be of the impedance from which the equipment under test is designed to work, or a matching pad should be interposed. The connections shown are for unbalanced circuits. If the circuits are balanced an H -type attenuator must be used, and one-half of the re-

sistance, R_s , should be inserted in each input lead. A vu meter is shown for convenience, but any good a-f or vacuum-tube voltmeter may be substituted. For a 600-ohm circuit R_s will equal 600 ohms, and the input level to the equipment will be the reading of the vu meter -6 db minus the setting of the attenuator. The attenuator may be eliminated in cases where the input level is sufficiently high so that it can be read on the vu meter directly.

For measurements on a-f sections of the transmitter the distortion meter or analyzer may be connected directly to the output of the a-f equipment, as shown in Figure 2. The resistance R_L , in parallel with the input impedance of the distortion meter or analyzer should equal the rated load impedance for the equipment.

For measurements of distortion on an a-m carrier the arrangement shown

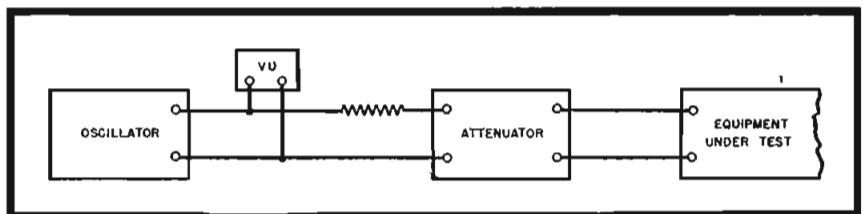

Figure 1

Conventional means of coupling test oscillator to transmitter.

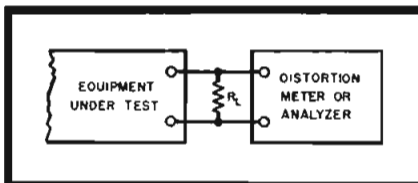

Figure 2

Measuring a-f section of a transmitter, with distortion meter or analyzer connected directly to the a-f output.

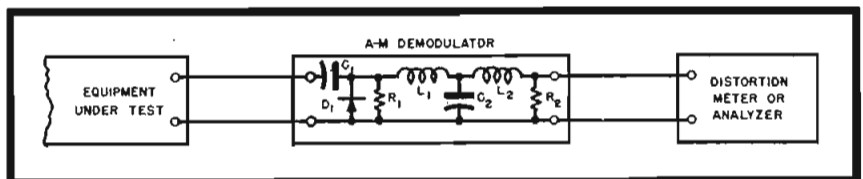

Figure 3

Measurement of distortion on an a-m carrier. $C_1 = 50$ mmfd; $C_2 = 35$ mmfd; $L_1 = L_2 = 25$ millihenries; $R_1 = R_2 = 100,000$ ohms; $D_1 = 6AL5$ or $6H6$.

HOPP Plastic RADIO DIALS

DIAL WINDOWS, NAME PLATES, SCALES, GAUGES, CHARTS, CALCULATORS, ETC.

PLASTIC RADIO DIALS combine the beauty of radiant color with the utility of perfect light transmission. The possibilities of design, size, shape and color combination are limitless.

Whether your problem is dials, or any of hundreds of allied applications, let Hopp artists and engineers "sit in" on your designing problem.

Send us your blueprints or samples for quotation.

ESTABLISHED 1893

THE HOPP PRESS, INC.

460 W. 34th STREET, NEW YORK 1, N. Y.

in Figure 3 may be used. The a-m demodulator is generally included as a part of the monitoring equipment, but the arrangement shown is typical. Suitable values for the circuit are:

- $C_1 = 50$ mmfd
- $C_2 = 35$ mmfd
- $L_1 = L_2 = 25$ millihenries
- $R_1 = R_2 = 100,000$ ohms
- $D_1 = 6AL5$ or $6H6$

The a-f input impedance of the distortion meter or analyzer should be large compared to $\frac{1}{2}R_2$ to avoid distortion at high modulation percentages.

For testing f-m transmitters the same system is used except that a discriminator must be used in place of the a-m demodulator. The requirements for this demodulator are sufficiently strict and the adjustments sufficiently critical so that no simple diagram would be of any use. Generally a suitable discriminator will be included as part of the f-m monitoring equipment utilized with the transmitter.

Before making distortion measurements it is well first to connect the distortion meter or analyzer directly to the output of the oscillator to determine that the distortion in the applied signal is sufficiently low for the tests. This check should be made with the oscillator terminated in the same value impedance as it will be operating into during the tests, but without the equipment to be tested actually connected. When checking the noise level of the system prior to making measurements with a distortion meter, if it is found that hum or other noise components are abnormally high it may be necessary to use an isolating transformer at the output of the oscillator. This is particularly true when working with low-level input circuits. Needless to say, all low-level leads should be well shielded.

Differences Between A-M and F-M Distortion Measurements

On a-m transmitters the distortion measurements are fairly simple because of the relatively high tolerances and the flat frequency response. However, it is characteristic of a-m transmitters that the distortion rises rapidly as 100% modulation is approached. With certain types of a-m transmitters, particularly those employing class B systems, it may also be found that the distortion increases at very low modulation levels. The f-m transmitter, on the other hand, must be capable of swinging to an extent equivalent to 133% modulation, considering a 75-kc swing as 100%. Hence the distortion

(Continued on page 56)



**MODEL
No. 4031**

Curve showing the characteristics at each point of attenuation and equalization in 2 db steps.

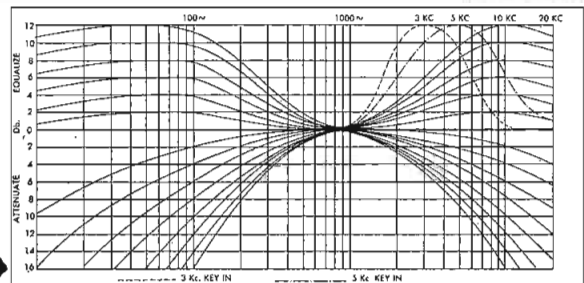

Complete Selectivity on ONE Panel!

Capable of providing variable regulation over a range of 16 db attenuation and 12 db equalization in 2 db steps at both ends of the sound spectrum without wave distortion, the CINEMA Program Equalizer is one of the most advanced units on the market today.

Designed to fit the rapidly expanding needs of motion picture, recording and radio broadcast industry for recording, re-recording and high fidelity sound reproduction, this new equalizer can be cut in or out of the line without changing the overall signal level. Variable peak positions are available at 3, 5, and 10 Kilocycles, selected at will by a key on the panel. Designed with a constant "K" circuit, the impedance remains constant over the entire range.

The illustrated Program Equalizer shown above is an arrangement for a single channel. Multiple channel panels can be supplied to fit your studio requirement.

Now Available Nationally Through:

TURNER & BEALE, 40-08 Corp. Kennedy St., Bayside, Long Island, New York
WRIGHT ENGINEERING CO., 4241 Melbourne Road, Indianapolis, Indiana

MANUFACTURED AND SOLD IN THE WEST BY:



**CINEMA
ENGINEERING COMPANY**

ESTABLISHED, 1935

1510 W. VERDUGO AVE., BURBANK, CALIFORNIA

COMMUNICATIONS FOR APRIL 1946 • 55

BOOST KVA RATING BY FIVE OR MORE



● The new Aerovox Series 1780 water-cooled oil-filled mica capacitors handle exceptional KVA loads for their size. The higher KVA ratings are attained by: (1) Exceptional design—critical arrangement and location of sections; specially-plated parts; large cross-section of conductors, etc., and (2) Use of water-cooling system designed for maximum heat transfer from capacitor section to cooling coils.

All in all, sturdy, hard-working, compact, trouble-free mica capacitors for extra-heavy-duty service. Ratings up to 25,000 v. A.C. Test. Capacitances up to .01 mfd.

● Details on request.



**FOR RADIO-ELECTRONIC AND
INDUSTRIAL APPLICATIONS**

AEROVOX CORP., NEW BEDFORD, MASS., U.S.A.
Export: 13 E. 40th St., New York 18, N.Y. • Cable: 'ARLAB'
In Canada: AEROVOX CANADA LTD., Hamilton, Ont.

AUDIO MEASUREMENT

(Continued from page 55)

of an f-m transmitter should not rise noticeably in the neighborhood of 100% modulation. The television transmitter must be able to swing 40 kc, which is the equivalent of 160% modulation. The lower allowable distortion of the f-m transmitter, plus the fact that a deemphasis circuit which further reduces the amplitude of the high-frequency harmonics is used for the measurements, somewhat complicates the measurement of f-m transmitters, particularly at higher modulation frequencies, and care should be taken to check noise levels to be sure that they are not interfering seriously with the measurements.

For transmitters with sufficiently low distortion to meet the FCC and RMA requirements it is probable that simple single-tone harmonic measurements with a distortion meter or a wave analyzer will provide a satisfactory check on operating performance. In cases where, in spite of low harmonic measurements, however, the quality as judged by the ear appears to be rough or distorted, the source of such difficulty can generally be most easily traced by resorting to two-frequency intermodulation measurements, which may be made with a wave analyzer and either two oscillators or a double-beat oscillator. Such measurements may be particularly valuable in case of high-frequency distortion in f-m transmitters, since the relative sensitivity of harmonic measurements is so greatly reduced by the deemphasis circuit.

Relative Value of Different Types of Distortion Measurements

The choice between various types of distortion measurements is a subject which cannot be easily settled at the present time because of the relatively limited experience with all except the single-frequency type. To meet the FCC *proof-of-performance tests* single-frequency tests are required, and such tests are probably satisfactory for ordinary routine checks on high-grade equipment. In cases, however, where audible distortion exists to a degree considerably higher than the harmonic measurements would indicate, intermodulation measurements are generally desirable. In some instances a simple two-tone check with an intermodulation meter may be sufficient, but in general more complete tests utilizing a wave analyzer and either a double-beat oscillator or two high-quality oscillators are desirable.

JONES 500 SERIES PLUGS and SOCKETS

(Heavy Duty)

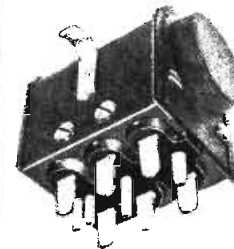

P-506-CE



S-506-DB

Designed for 5000 Volts and 25 amperes per contact. Socket Contacts of phosphor bronze, knife-switch type, silver plated. Plug Contacts are of hard brass, silver plated. Made in 2, 4, 6, 8, 10 and 12 Contacts.

All Plugs and Sockets are Polarized. Long leakage path from Terminal to Terminal and Terminal to ground. Caps and Brackets are of steel, parkerized. Plug and Socket blocks interchangeable in Caps and Brackets. This series is designed for heavy duty electrical work and will withstand severest type of service.

Write for Bulletin No. 500 describing this line of Heavy Duty Plugs and Sockets.

HOWARD B. JONES DIVISION
CINCH MFG. CORP.
2460 W. GEORGE ST. CHICAGO 18

PLATING CRYSTALS

(Continued from page 28)

spontaneously when sufficient silver has been deposited on each side to provide a conductive path for the necessary r-f current.

In most cases, a certain pattern of silver plate is desired on the crystal face. This is usually a central circular patch connected to the clip area by a narrow strip. This pattern is formed by enclosing the crystal in a mask with suitable openings. This may be made of mica sheets or of metal. Some care is necessary in the latter case to avoid short-circuiting. A similar mask or shield is put on the base to eliminate the deposition of silver on the region between the leads. The silver is periodically removed from the masks by dipping them in diluted nitric acid.

The adhesion of a properly applied film to the crystal face is very good. The silver is soft and may be abraded or scratched but it does not peel off.

It has been found that the crystal should be reduced in frequency about 0.25% by the plating on each side to insure good conductivity of the film electrode. Thereafter it may be reduced in frequency, at will, up to a limit of about 3% of the original frequency.

F-M MODULATORS

(Continued from page 46)

where everything remains constant except the g_m of the tube which is dependent on the signal input.

If both R_1 and R_2 are replaced with similar resistance tubes a much greater frequency deviation is possible. If the input resistance of both tubes is inversely proportional to the g_m of the tubes as given by equation (16), the frequency of oscillation becomes

$$f = \frac{g_m}{2\pi\sqrt{C_1 C_2}} \quad (18)$$

Thus with two tubes the frequency of oscillation is directly dependent on the g_m of the tubes.

If television type tubes are used in the circuit the oscillator will work well up to about 4 mc. If it is desired to operate at still higher frequencies compensating circuits should be used. When shunt and series peaking is used in the plate circuits of the two oscillator tubes the circuit works well above 9 mc. However the amplitude of oscillations does not remain constant with frequency and a limiter has to be used to remove the amplitude modulation which is present in the output.

In Figure 8 is illustrated an RC oscillator employing a four-step ladder network for the 180° phase shift. Feed back is accomplished through a pentode amplifier, V_2 , and a cathode follower, V_1 . Tubes, V_3 and V_4 , are used to vary the frequency by varying the resistance between R_2 and ground. In this type of oscillator, which is of the low-frequency type, the frequency can be varied between 2,000 and 4,000 cycles as the resistance between R_2 and ground is varied from zero and infinity. Amplitude modulation can be reduced to a negligible amount by the proper choice of network constants.

Inductively Coupled Variable Reactance

When a capacitance and a variable resistance is placed across the secondary of a transformer, the input reactive component of the impedance can be made to vary as the resistance is varied. In Figure 9 is illustrated a

(Continued on page 59)

Figure 9

An inductively-coupled variable reactance device, employing a variable resistance, R_s .

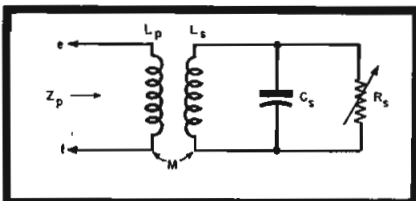

Built like a fine watch.

yet

**RUGGED AS
OLD BIG BEN***

**TURNER MODEL 99
DYNAMIC**

Engineered for discriminating users who want utmost efficiency and dependability, the Turner Model 99 Dynamic is the most rugged microphone in the entire Turner line. Its precision-built dynamic circuit withstands the extremes of climate and temperature to reproduce sharp and clear under difficult operating conditions. Large city police departments, commercial broadcast studios, and leading manufacturers of communications equipment depend on Turner 99 for unfailing performance. Professional case is finished in rich gun metal and equipped with adjustable saddle for semi- or non-directional operation. Range 40-9,000 cycles. Level — 52DB. Available in all standard impedances and complete with 20 ft. removable cable set.

TURNER MODEL 999 BALANCED LINE DYNAMIC

The same professional appearance and rugged construction as Model 99 with voice coil and transformer leads insulated from ground and microphone case. Line is balanced to the ground. Especially recommended for critical applications. Range 40-9,000 cycles. Level — 52DB. In all standard impedances with removable 20 ft. balanced line, low capacity cable set.

Ask your dealer or write for full specifications

*The famous clock of London

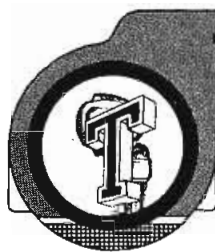

The TURNER Company

TURNER — Pioneers in the Communications Field

907 17th Street N.E., Cedar Rapids, Iowa

Licensed Under U. S. Patents of the American Telephone and Telegraph Company, and Western Electric Company, Incorporated.

"TAB"

That's A Buy



ELECTRONIC VOLT-OHMMETER BRAND NEW U. S. ARMY TYPE 1-107-F PRECISION UNIT. Rugged design housed steel case 6"x5 1/2"x4 1/8" leather carrying handle. Contains Simpson 4" highly damped 400 microamp Alnico meter. Clear visible scale large numerals easily readable at all points. All voltage ranges ten megohms sensitivity; reads 0-3 volts in .05 v steps; 0-10 volts in .2 v steps; 0-30 volts in .5 v steps; 0-100 volts in .2 v steps; 0-300 volts in 5 v steps—OHMS Rx1 from .02 to 1000 ohms; Rx10 from 1 to 1000 Ω ; Rx100 from 20 to 10000 Ω ; Rx1000 from 200 to 1 meg Ω ; Rx 10000 from 2000 to 10 meg Ω (center scale is 10) Unit complete with 3 test leads; batteries and instructions. Cost gov't \$63. "TAB" special \$29.70 Additional V.T.V.M. Loctal tube 1 LE 3/SP Sig C \$1.15.

C'DENSER WE new uprt.mtg. 500MFD-60WV .95
CONDENSER WE oil 16MFD-400V Two for 2.35
CONDENSER KIT 24 midget oil Cornell Dub. 2.40
8 each size 1&2&3 x .05MFD-300WV Gvt. Ins. 1.90
COND. GE pyranol 4MFD-500VDC wkg 2 for 4.25
COND. GE pyranol 2MFD-2000VDC wkg. 2 for 4.25
COND. Wstghse 2MFD-5500VDC wkg (LP575) 12.50
SOCKET Heavy duty 50 watt steelite Ins. 2 for 1.70
SOCKET Amphanol safety UX 77A-4TN 10 for 3.00
SOCKET DIHeptal C-Ray & mtg.ring HF Ins. 1.15
CRYSTAL diode 1N21 & holder Two sets ea. for 1.25
RCA 6AC7-1852 new gvt. Insp.(L.P.\$1.75)... .85
CATHODE Ray Tube new gvt. Insp. 3BP1... 6.95
CATHODE Ray Tube new 5AP1, BP1, BP4... 9.95
RECTIFIER GE 872 new G'Insp. (LP\$7.50)... 4.50
WE 115V60Cpri, 650VCT300ma: 5V3A: 6V5A 5.95
CRYSTAL & HOLDER LO DRIFT cut any freq. 2to9MCS active osc. gtd. @ \$2.49, four for 8.95
CRYSTAL mtd aircraft 1000KC Std .02% accy 7.95
Jennings VC50 air condenser 50NMF-20000V... 3.50
IF transformers 20 mcs. iron core tuned, ea... .97

Complete New W.E. Oscilloscope

5 inch made by Western Electric for U.S. Army type BC412 Cost gov't over \$2000. Contains power supplies 115 V 60 CY. amplifiers and controls for Vertical and Horizontal position. Focus intensity, Sensitivity, Spread, Sweep (fixed freq.) with new tubes 5P4, 879, 5T4, Six 6L8, Two 6SJ7, 6AC7, 6H6. Easily adapted to laboratory Radio service work or television. Completely housed heavy steel case. Exceptional "TAB" price \$65 ship wt. cased 200 lbs. Tested guaranteed new.

Elmas or HK VT 127A with connectors..... 4.95
DAVEN SWITCH 13 circuits 25 amp. cts., 2 for .86
HEINEMAN mag. circuit bkr. 20A or 3A... .97
RELAY sen. sigma 5AH 200 ohm 3.5 ma SPDT 2.25
Relay Sensitive WE. 3500 ohms. SPDT 5A... .97
RELAY 105 Ward L. 115V80CY 20A.Cts..... 1.90
CHOKE G.E. 4HY-1/2A.30 ohm wt.10lbs..... 2.95
TRANSF. 115V60C pri. 5V28A Sec. Hv. Ins. 3.75
DC.VOLTMTR. DW41GE 2000V 1000 ohm 2 1/2" 3.95
DC.VOLTMTR. 301 Weston 4000v 1000 ohms... 10.95
DC.VOLTMTR. 301 Weston 10000V 1000 ohm... 12.95
AC.VOLTMTR. NA33 Wstghse 150V 2 1/2" B.C. 2.95
GE DC DNI miniature 1mA G'Insp. 1 1/2" B.C. 3.25
COND. GE pyranol 3MFD1000VDCWKG 2 for 2.50
CONDOR Aerovox oil 1MFD1000VDC wkg.... 36.00
CO-Axiat 52&72ohm RGG&11u cable 100 ft.... 12.00

Transformer High Voltage

Brand new Kenyon 115v. 60cy. sec. 3200v. 1/2amp. Bargain "TAB" Price \$9.75. Ship. wt. 40 lbs. Two units 8400 v. 1/2amp. C.T. "TAB" priced \$18.



Autosyns Bendix

Brand new gov't sealed and inspected packed in overseas cases, synchro-transmitters AC. 115v. 60 cy. operation. Continuous heavy duty. Precision accuracy made for gun-fire control. Cost gov't \$90 each, 5 lbs. each "TAB" special two for \$18.

\$1 Min. orders FOB, N.Y.C. Add Postage all orders and 25% deposit. Whitehall 3-3537. Send for catalog 300. Don't wait, rush orders as quantities are limited. Buy thru "TAB" and save.

"TAB", Dept. C-5
Six Church Street, New York 6, N. Y.

BROADCAST CONFERENCE

(Continued from page 40)

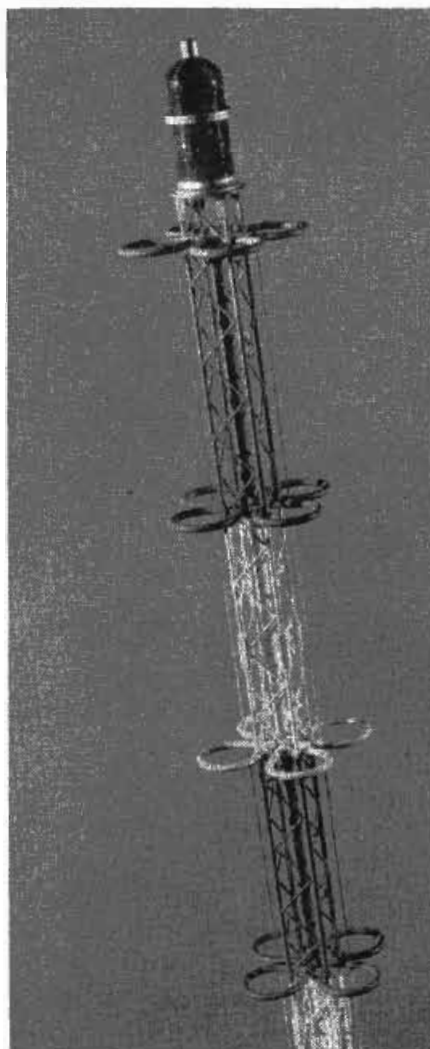

(Smith Paper)

The clover-leaf f-m antenna.

is 1.25; 2-section, 2.50; 3-section, 4.00. Field gain of a 1-section unit is 1.12; 2-section, 1.58; 3-section, 2.00.

The tolerance on the input impedance is such that the voltage standing-wave ratio on a 51.5-ohm line shall be 1.5 or better at any frequency from 88-108 mc.

Horizontal pattern is essentially circular. Under ideal conditions the pattern

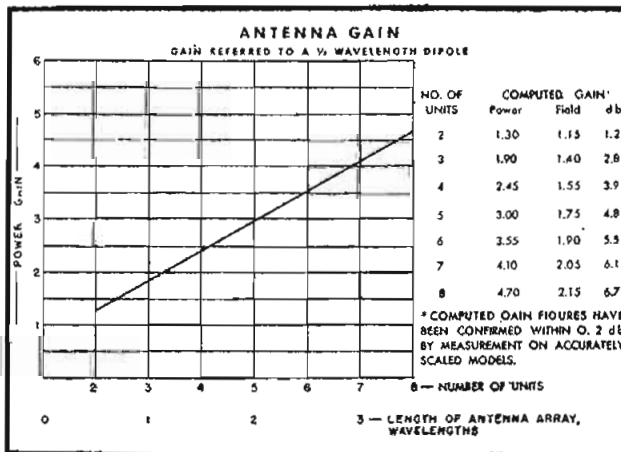

(Smith Paper)

Antenna gain of clover-leaf units.

Permanent MAGNETS By Thomas & Skinner

ALL SHAPES... ALL SIZES
Cobalt • Chrome • Tungsten
Stamped, Formed or Cast.

ALNICO
(Cast or Sintered)

Also: LAMINATIONS for output transformers of highest permeability. Standard stocks in a wide range of sizes for Audio, Choke, Output and Power Transformers. Write for dimension sheet. . . . TOOLS DIES STAMPINGS HEAT TREATING.
44 YEARS' SPECIALIZED EXPERIENCE

Thomas & Skinner

STEEL PRODUCTS CO.
1113 E. 23rd St., Indianapolis 5, Ind.

of the turnstile deviates from round by less than ± 0.5 db.

THE CLOVER-LEAF F-M ANTENNA

Philip H. Smith
Bell Telephone Labs

DESIGNED to radiate horizontally, at power levels up to and including 50 kw, this antenna uses an array of two or more vertically stacked radiating units. Each radiating unit is composed of a cluster of four curved elements.

An r-f voltage applied between the junction of the four elements and their

(Continued on page 60)

F-M MODULATORS

(Continued from page 57)

transformer with a primary inductance of L_p , a secondary inductance of L_s , and a mutual inductance of M . Across the secondary is connected a capacity, C_s , and a variable resistance, R_s . Figure 10 gives the equivalent circuit of the transformer where X_1 and R_1 are the impedances reflected into the primary from the secondary. Z_p is the input impedance across the terminals e and f . Solving for the input impedance, X_1 and R_1 are found to be

$$X_1 = (\omega M)^2 \frac{(\omega L_s) (1/\omega C_s)^2}{+ R_s^2 (\omega L_s - 1/\omega C_s)}$$

$$+ R_s^3 (\omega^2 L_s^2 - 1/\omega^2 C_s^2)^2 \quad (19)$$

and

$$R_1 = (\omega M)^2 \frac{(1/\omega C_s)^2 R_s}{(\omega L_s)^2 (1/\omega C_s)^2 + R_s^2 (\omega^2 L_s^2 - 1/\omega^2 C_s^2)^2} \quad (20)$$

Thus it can be seen that as R_s is varied the reactance across e and f will also vary. This circuit can be used in an f-m generator by using it as the tank circuit of an oscillator and employing a variable resistance tube for R_s .

References

- Maurice Artzt, *Frequency Modulation of Resistance - Capacitance Oscillators*, Proceedings of the IRE; July, 1944.
 A. V. Eastman and E. D. Scott, *Transmission Lines as Frequency Modulators*, Proceedings of the IRE; July, 1934.
 Bruce E. Montgomery, *An Inductively Coupled Frequency Modulator*, Proceedings of the IRE; October, 1941.
 F. E. Terman, *Radio Engineers' Handbook*, McGraw-Hill Book Co.; 1943.

Figure 10

The equivalent circuit of the inductively-coupled variable reactance shown in Figure 9.

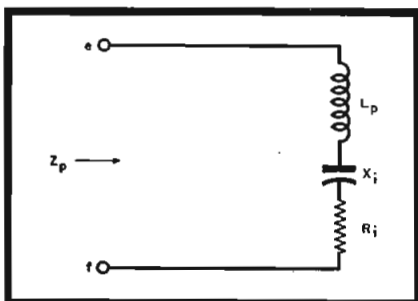

Just a few of the thousands of Radio Parts manufactured by INSULINE

Send for complete catalog describing the full line of I.C.A. Antennas. Or, if convenient pick up a copy when you visit our exhibit at the R.P.E.E. Show, Steven's Hotel, Chicago.

Booth #34

(May 13th to 16th inclusive)

insuline

CORPORATION OF AMERICA

INSULINE BUILDING • LONG ISLAND CITY, N. Y.

More than a quarter-century of Quality production.

BROADCAST CONFERENCE

(Continued from page 58)

ends causes in effect a ring of uniform current which produces a circular radiation pattern about the axis of the ring.

Radiation patterns indicate that the signal intensity is greatest in the direction of the horizon (0°) and is substantially less at higher elevations. With this type, as with all types of directive antennas, the radiation pattern becomes progressively broader and the gain less as the number of radiating units and length of the array is reduced. Conversely, the pattern becomes narrower and the gain higher as the number of units and length of the antenna are increased—all providing that the instantaneous currents in the individual radiating units are established and maintained in their proper relationships.

Maximum gain occurs when the instantaneous currents in all radiating elements are in time phase and of equal amplitude. All radiating elements are connected with clamps at half wavelength intervals to a 3" diameter feed conductor which is centrally located within the tower structure. The tower itself serves as the return or outer conductor of the feed line. The usual phase reversal occurring along such a feed line at half wavelength intervals is compensated for by reversing the mounting position of the radiating elements in adjacent units.

The impedance of the antenna array is matched to the impedance of a coaxial transmission line with a transformer which utilizes the base section of the tower and antenna feed conductor. This transformer can be adjusted over a wide impedance range.

Half wavelength spacing is used. For antennas of equivalent over-all length the sacrifice in antenna gain would be about 6 per cent.

Theoretically and actually more gain is possible with greater antenna lengths and a corresponding increase in number of radiating units. However, a maximum

(Continued on page 68)

VWOA

(Continued from page 50)

lives no man ever associated with the development of radio who knows not George the indefatigable. Early maker and pre-eminently pontifical recorder of radio history, that art and industry owe to him a debt that can never be discharged."

David Sarnoff, RCA president, attending a "farewell?" dinner given by old-time associates from RCA, said it in fewer words when he remarked in the course of an "off the record" speech:

"I hear that George Clark is about to retire. It's a lark! He never could retire; he will work harder than ever."

A letter from Dr. Alfred N. Goldsmith said:

"I have just learned with mingled feelings that my old friend, George Clark, has just retired from active professional work. It comes with a sense of shock to find that a man of his vigorous personality and major capabilities will no longer be 'battling in the radio arena.' But I am satisfied that he will find interesting and productive activities to occupy the many long years which all his friends hope and believe are ahead of him.

"While I realize that George has theoretically 'retired,' I am certain that he will retain that major interest in radio which has carried him forward all these years and which has added substantially to the development of the field. He goes into 'active retirement' with the heartiest good wishes and kindly remembrances of all his friends."

Compact Heater Holder by Crystalab

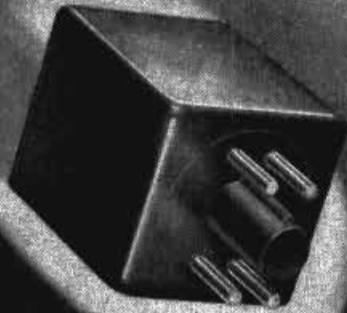

Especially suitable for applications for close frequency tolerance . . . VHF services — police, aircraft, railway communications, etc. . . . works on 6.3v at 1 amp. . . . temp control within $\pm 3^\circ\text{C}$. . . operates at 60°C frequency control of $\pm .005\%$. . . frequency range 3MC to 14MC . . . fits octal socket . . .

TYPICAL CRL — 30 FREQUENCY TEMPERATURE CURVE

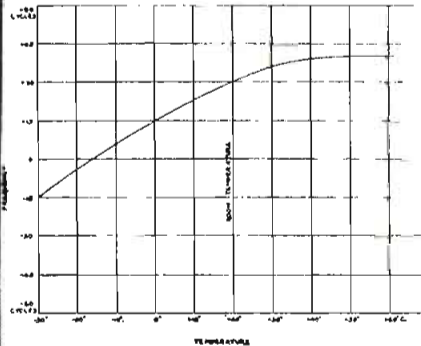

Specialists in
Special Crystals



**CRYSTAL RESEARCH
LABORATORIES INC.**

29 ALLYN ST., HARTFORD, 3, CONN., PHONE 7-3215

BOOKS designed for the ENGINEER

UNDERSTANDING MICROWAVES

by VICTOR J. YOUNG

For those who have not previously considered radio waves shorter than 10 centimeters. Provides foundation for understanding various microwave developments of past five years. To simplify explanations, mathematics are placed in footnotes wherever possible.

CHAPTER HEADS

The Ultra High Frequency Concept • Stationary Charge and its Field • Magnetostatics • Alternating Current and Lumped Constants • Transmission Lines • Poynting's Vector and Maxwell's Equations • Wave-

guides • Resonant Cavities • Antennas • Microwave Oscillators • Radar and Communication • Section Two is devoted to descriptions of Microwave Terms, Ideas and Theorems. Index.

OUT IN MAY — OVER 400 PAGES — PRICE \$6.00

SPEED AND SIMPLICITY

A-C CALCULATION CHARTS

Student engineers will find that this book is invaluable. It simplifies and speeds any work involving AC calculations. The book contains 146 charts. Covers all AC calculations from 10 cycles to 1000 megacycles.

160 PAGES — PRICE \$7.50

ORDER TODAY

JOHN F. RIDER PUBLISHER, INC.

404 FOURTH AVENUE, NEW YORK 16, N.Y.

Export Division: Rocke-International Electric Corp., 13 E. 40th Street, New York 16, N.Y.

NEWS BRIEFS

PREISMAN NOW CREI V-P

Albert Preisman has been elected vice president, in charge of engineering, of the Capitol Radio Engineering Institute, 3324 16th Street, N.W., Washington, D. C.

Mr. Preisman has been associated with the institute for three years, where he has been in charge of radio engineering activities, lesson text revision and development of new lesson material.

* * *

HERRMANN NOW S-M OF WESTINGHOUSE HOME RADIO

Edgar G. Herrmann has been named sales manager of the Westinghouse Home Radio Division, Sunbury, Pa.

Mr. Herrmann was formerly sales manager of the Emerson Radio and Phonograph Corporation.

* * *

MEDAL FOR MERIT TO GEN. SARNOFF

The Medal for Merit was presented recently to Brig. General David Sarnoff, president of RCA.

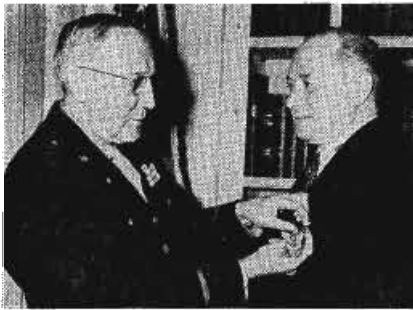

DR. SOUTHWORTH RECEIVES FRANKLIN INSTITUTE LEVY MEDAL

Dr. George Clark Southworth of the Bell Telephone Laboratories has been awarded the 1946 Levy Medal of the Franklin Institute for his discovery that the sun gives off short-wave radiation, similar to that employed in radar.

This discovery, according to Dr. Henry Butler Allen, secretary and director of the Institute, opens the way to an entirely new field of research which it is hoped will yield additional information on the earth's atmosphere, as well as the sun itself.

* * *

ARMSTRONG AND W. E. SIGN F-M AGREEMENT

Major Edwin H. Armstrong has granted a license to Western Electric under his f-m patents for the manufacture of mobile and other communications equipment.

* * *

EBEL APPOINTED WMBD DIRECTOR OF ENGINEERING

A. James Ebel has been named director of engineering for WMBD (Peoria) and WDZ (Tuscola) in Illinois.

Mr. Ebel has been on the University of Illinois. (Continued on page 62)

NOTICE ON HOTEL ACCOMMODATIONS FOR THE PARTS SHOW

In view of the critical housing shortage in Chicago, those planning to attend the show should be sure that they have confirmations of their hotel accommodations.

The housing committee for the show has assigned 1,100 rooms, allotted by Chicago hotels, which include: Stevens, St. Clair, Planters, Webster, Eastgate, Maryland, Harrison, Morrison, Bismark, Chicagoan, Croydon, Brevoort, Atlantic, Parkway and Plaza.

There are still available rooms in some Chicago hotels, since all hotels did not set up an allotment. Persons coming to the show who do not already have a confirmed hotel reservation should try NOW to get accommodations by writing to anyone of the following hotels: Blackstone, Congress, Palmer House, LaSalle, Sherman, Knickerbocker or the Edgewater Beach.

(Show will be held at the Stevens, May 13-16)

Unusual and Vital ELECTRONIC EQUIPMENT

PRODUCED BY

TECH LAB

SUBCONTRACTING DEPT.

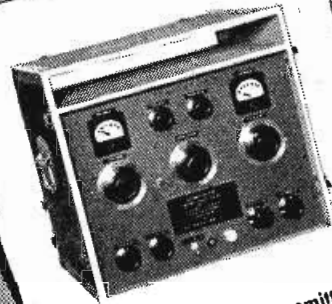

Special Short Wave Transmitter
Range: 1-16 megacycles on
one dial.



Development of special
hearing aid analyzer for
Western Electric Company.

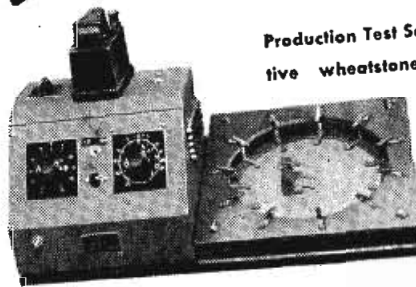

Production Test Set to test varistors. A sensitive wheatstone bridge arranged with switching means for quickly checking a number of varistors in rapid sequence.

Manufacturers have continually called upon the modern facilities of Tech Lab Subcontracting Department to assist them in the production of unusual and vital electronic equipment. Our Engineering Department is ready to assist you with your production problems.



Carbon filling machines for
precision filling of carbon
microphones.



MANUFACTURERS OF PRECISION
ELECTRICAL RESISTANCE INSTRUMENTS

15 LINCOLN STREET, JERSEY CITY 7, N. J.

Will you look like this in 1951?



FIVE YEARS FROM TODAY, will you be in the knee-pants era of radio or will you be "up and on to" every new development? The matter is as pointed as that. True, most receivers cannot reproduce the full range of FM broadcasts yet. But soon they will.

MODERNIZE! Start now to monitor your full FM range with the Altec Lansing Loudspeaker System. Make your improvements — your refinements — now. So when tomorrow comes, you will not just be growing up to standards, you will be setting them. See your dealer.



THE ALTEC LANSING DUPLEX LOUDSPEAKER SYSTEM

Both high and low frequency units are combined in one horn, reproducing the entire FM range, from 50 to 15,000 cycles, without intermodulation effects or distortion.

ALTEC
LANSING CORPORATION

1161 N. Vine St., Hollywood, Cal.
250 W. 57th St., N. Y. 19, N. Y.

NEWS BRIEFS

(Continued from page 61)

nois faculty for the last nine years, serving at present as assistant professor of electrical engineering. He also was technical supervisor for WILL and WIUC at the university in Champaign, Ill.



SECOND NATIONAL ELECTRONIC CONFERENCE IN OCTOBER

The second national electronic conference sponsored by the Illinois Institute of Technology, Northwestern University, and the Chicago sections of AIEE and IRE with the cooperation of the Chicago Technical Societies Council and the University of Illinois, will be held at the Edgewater Beach Hotel in Chicago from October 3rd to 5th inclusive. W. O. Swinyard, 325 West Huron Street, Chicago 10, Illinois, is president of the conference.

PART OF 80-METER BAND GOES BACK TO HAMS

The 3700 to 4000 kc band has been released by the Army and Navy communications staffs and returned to the amateurs on April 1.

The new band is open for code operation; 3900 to 4000 kc will be available for radio-telephone work to holders of class A licenses.

The FCC has also assigned amateurs the 235 to 240 mc band, and privileges on a new channel of 27,185 to 27,455 kc, shared with scientific, industrial, and medical users.

REILLY RESIGNS FROM KLUGE ELECTRONICS

Ray M. Reilly has resigned from Kluge Electronics, Inc., 1031 No. Alvarado Street, Los Angeles, California.

MUSITRON EXPANDS

The Musitron Company, formerly L. M. Sandwick Associates, are expanding their facilities at 223 West Erie Street, Chicago. Leo Frankel is general manager of the company.

Gerald H. Rissman has been named sales manager.

The company produces portable phonographs, transcription playback units, etc.

HALLICRAFTERS TO MAKE REPUBLIC AIRCRAFT TWO-WAY UNITS

The Hallicrafters Company have received from the Republic Aviation Corporation, Farmingdale, Long Island, N. Y., a contract to build two-way radio telephones for Republic's four-passenger all-metal amphibian planes, "Sea-Bees."

WARD LEONARD RELAY BOOKLET

An 8-page booklet describing heavy-duty relays, single-pole single-break and double-break relays, three- and four-pole relays, latching relays, etc., has been published by the Ward Leonard Electric Company, Mount Vernon, New York.

SCHOOL SOUND STANDARDIZATION PROGRAM PREPARED BY RMA

A program for standardizing radio and sound-amplifying equipment in the nation's schools, approved by a joint committee of radio manufacturers and educators, is now being prepared for application by the RMA engineering and sound system sections. Minimum standards

Carter

The Finest
ROTARY POWER SUPPLY



The Carter Super Dynamotor illustrated above is the preferred power supply of leading mobile radio manufacturers, and is operating in over 42 State Police radio networks.

Ideally suited for Police, Marine, Aircraft, Railroad, and other mobile communications, the Super provides unequalled efficiency, reliability, and stamina for mobile transmitters. Write for latest bulletin of Carter Products today!

SALES OFFICES IN PRINCIPAL CITIES



1603 Milwaukee Avenue

Cable Genemotor

for school radio and sound facilities will be arranged to protect the institutions from inadequate equipment and to permit free exchange of radio educational material.

Tentative specifications for the school radio equipment were drawn and approved at a recent meeting in Cleveland of the RMA school equipment committee and representatives of the National Education Association, the Association for Education by Radio and the U. S. Office of Education.

The specifications cover five classifications of school radio and sound amplifying equipment: central program distribution systems, classroom receiving sets, portable transcription players, speech input units and recorders.

DU MONT EXPANDS

Allen B. DuMont Laboratories have purchased the 4-story Doherty Building at 1,000 Main Avenue in Clifton, N. J. The building will be occupied after September 1st for the manufacture of Du Mont oscillographic instruments and television receivers.

WILLIAM S. PALEY RECEIVES MEDAL FOR MERIT

The Medal for Merit was recently awarded to William S. Paley who, as a civilian, was head of radio operations of the Army Psychological Warfare Branch in Europe.

SCHWARTZ JOINS DEE ELECTRONICS

H. H. Schwartz has joined the Dee Electronics, Limited, 455 Craig Street West, Montreal, Canada, as communications engineer.

HORNI SIGNAL REORGANIZED

The Horni Signal Manufacturing Corporation was recently reorganized. All operations have been concentrated in one location at 421 West 54th Street, New York City.

Andrew B. Cruminy, Newark, New Jersey, has been named trustee in the reorganization.

BOUCHERON APPOINTED G-M OF FARNSWORTH BROADCAST DIV.

Captain Pierre Boucheron, U.S.N.R., has been named general manager of the broadcast division of the Farnsworth Television & Radio

Corporation and will be in charge of WGL at Fort Wayne, Ind.

Captain Bouchron recently received the Legion of Honour rank of Chevalier, from the French Government for distinguished service during the liberation of France.



SCOTT, SEARLE AND PACKARD FORM INSTRUMENT CORP.

H. H. Scott, R. W. Searle and L. E. Packard, have formed the Technology Instrument Corporation, 1058 Main Street, Waltham, Massachusetts.

H. H. Scott, who will serve as president, in charge of technical development, was formerly with the General Radio Company as executive engineer.

L. E. Packard, who will serve as treasurer, in charge of sales engineering activities, was also with General Radio as district manager in the New York and Chicago offices.

Raymond W. Searle will be secretary-clerk and production manager of the organization. He was formerly a member of the production department of General Radio in a supervisory capacity.



H. H. Scott



L. E. Packard



(Left): R. W. Searle

CENTRALAB SWITCH BOOKLET

A 32-page booklet describing a variety of single and multiple switches has been released by Centralab, Milwaukee 1, Wis.

SOLAR CATALOG

A 36-page catalog covering capacitors for industrial, amateur and general service applications, has been published by the Solar Capacitor Sales Corporation, 285 Madison Avenue, New York 17, N. Y.

Capacity analyzers are also featured in the catalog.

JAMES G. BIDDLE CO. MOVES

James G. Biddle Company has consolidated its offices and factory at a new location, 1316 Arch Street, Philadelphia 7, Penna.

WARD OF CRYSTAL RESEARCH NAMED TO NAM POST

Samuel I. Ward, president and general manager of Crystal Laboratories, Inc., Hartford, Conn., has been appointed a member of the international economic relations committee of the National Association of Manufacturers.

CBS CONSTRUCTION OPERATION GROUP REORGANIZED

The CBS construction operations group has been divided into four units: construction plans division, estimating division, construction and maintenance operations division, and field installation division.

These units will be under the direction of Clarence R. Jacobs, assistant director.

The construction plans division will consist
(Continued on page 64)

How Many Slices in a Loaf of Bread?

It's unimportant unless there aren't enough to go around. When the loaf isn't large enough to feed everyone who asks for a slice, the problem becomes involved. The size of each slice takes on significance.

We, at Stancor, are confronted with a parallel situation. A day never passes that we don't risk offending valued customers by keeping the slices as thin as feasible... that everyone may have his fair share.

We know how you feel about this. You need transformers, desperately perhaps, and it's been a long time since Stancor has been able to supply all you want. We're certain, however, that you would not condone a sacrifice of quality for quantity. In a sense, then, you dictate Stancor policy.

Because of our insistence on high standards of quality, production and delivery have never stayed apace with Stancor sales. Today there is a greater gap than ever. We feel you understand the reasons for this, since our current problems are also yours.

Soon, we hope to be able to meet your constantly increasing demands. Meanwhile, there can be no change in the Stancor policy of quality. We know you wouldn't want it any other way.

Jerome J. Kahn
PRESIDENT

STANDARD TRANSFORMER CORPORATION
1500 NORTH HALSTED STREET • CHICAGO 22, ILLINOIS

Designed for



Application

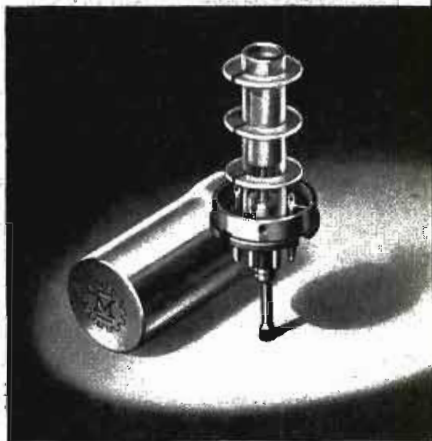

The No. 74001 Tunable Coil Form

Another new Milten "Designed for Application" product is the No. 74001 permeability tuned, shielded plug-in coil form. Standard octal base of low loss mica-filled Bakelite, polystyrene 1/2" diameter coil form, heavy aluminum shield, iron tuning slug of high frequency type, suitable for use up to 35 mc. Adjusting screw protrudes through center hole of standard octal socket. Special extension terminals facilitate connection to base pins.

**JAMES MILLEN
MFG. CO., INC.**

MAIN OFFICE AND FACTORY
**MALDEN
MASSACHUSETTS**



NEWS BRIEFS

(Continued from page 63)

of two units: architectural design, headed by Frederick Semmens, chief designer, and mechanical and technical, under the direction of Kingdon S. Tyler who continues as special assistant to Mr. Jacobs.

Roland J. Young is chief estimator of the estimating division.

Construction and maintenance operations division, with Pier Cherici in charge, will consist of three operating units: architectural and mechanical drafting, repairs and replacements (New York), and air-conditioning operations (New York).

CENTRALAB PROMOTES WOLFF AND ROUP

Robert L. Wolff has been named chief radio and electronics engineer of Centralab. He succeeds H. W. Rubinstein.

Roland R. Roup has succeeded G. Milton Ehlers as chief ceramic engineer.



R. L. Wolff



R. R. Roup

CORNING-GLASS BULLETINS

Three bulletins describing glass components, "vycor" (96% silica glass), and metallized glassware, have been published by the Corning Glass Works, Corning, New York.

BURLINGTON TRANSFORMER DATA

A bulletin covering "donut" transformers has been published by the Burlington Instrument Company, Burlington, Iowa. Application and engineering data are offered.

SMITH NOW HEAD OF RAYTHEON MICROWAVE DEPT.

J. Ernest Smith has been appointed head of the microwave communication engineering department of the Raytheon Manufacturing Company.

Mr. Smith was formerly with Radio Corporation of America, as research division head of RCA Laboratories.



MORHAN COMPANY TO EXPORT FOR MARION

Morhan Exporting Company, 458 Broadway, New York City, has been appointed export representatives for the portable bench-type soldering unit made by the Marion Electrical Instrument Company, Manchester, N. H.

OHMITE RITEOHM RESISTORS BULLETIN

A 4-page bulletin, 126, describing Riteohm 1/2-watt and 1-watt non-inductive, pie-wound, ± 1% precision resistors, has been released by Ohmite Manufacturing Company, 4835 W. Flournoy St., Chicago 44, Illinois.

KRAMER NOW JENSEN TECHNICAL SERVICE ENGINEER

Karl Kramer has been named technical service engineer of the Jensen Radio Manufacturing Company, Chicago, Ill.

Mr. Kramer joined Jensen in 1935 and has served since then as senior development engineer and applications engineer. In this capacity, he has been responsible for direct-radiator loud

PREMAX

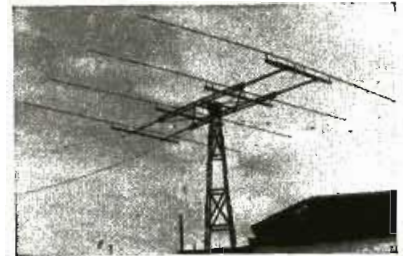

For Commercial or
Amateur Arrays

PREMAX Antennas

Tubular Steel Antennas and Elements are performing just as many important jobs in peace time as they did during the war. If you have an antenna problem, get the special Bulletin 460. Doubtless one of the Standard Premax designs will do the job.

Premax Products

Division Chisholm-Ryder Co., Inc.
4610 Highland Avenue, Niagara Falls, N. Y.

speaker development and for the design and development of enclosures.



DIGEST OF EXPIRING PATENTS PUBLISHED

A weekly 250-page reference book, "Public Domain", containing over 1000 patents due to expire four weeks after date of issue and which will then be in the public domain, has been announced by the Scientific Development Corporation, 614 West 49th Street, New York 19, N. Y. The first issue will appear in May.

NATIONAL CATALOG

Catalog 600, covering variable capacitors for receiving, transmitting, neutralizing; r-f chokes, shaft couplings, coil forms; exciter tanks; plug-in bases and shields; oscillographs; receivers; etc., has been released by the National Company, 61 Sherman Street, Malden, Mass.

CASE NOW HALLICRAFTERS CHIEF ENGINEER

Nelson P. Case, formerly chief engineer of the receiver division of Hallicrafters, has been promoted to chief engineer of all of Hallicrafters activities.

SUN RADIO MOVES

Sun Radio and Electronics Co., Inc., has moved to 122-124 Duane Street, New York City.

A dealer sales department has been established under the supervision of Lou Selonek.

MORTON JOINS INSULINE

A. R. Morton has been named chief engineer of

the electronics division at the Insuline Corporation of America. He was formerly chief engineer of the Ansley Radio Corp.

Lester R. Behrmuth has been appointed sales representative of Insuline. He will service outlets throughout the New York-Eastern Pennsylvania-Virginia area.

COBURN BECOMES PANORAMIC S-M

R. M. Coburn has been appointed sales manager of the Panoramic Radio Corporation, 242 West 55th Street, New York City.

Mr. Coburn was formerly general sales manager of National Union Radio Corporation.



GILLIG PROMOTED BY EMERSON

Phil Gillig has been elected vice president in charge of the home products division of the Emerson Radio and Phonograph Corporation.

CAPT. FINCH WINS LEGION OF MERIT

The Legion of Merit was awarded recently to Capt. W. G. H. Finch, USNR . . . "for exceptionally meritorious conduct in the performance of outstanding service to the Government of the United States as Head of the Countermeasures Design Section, Electronics Division, Bureau of Ships, from December 1, 1941, to September 1, 1945."



BUTLER WINS IRC PROMOTION

Robert Butler, former manager of the IRC customer service department, has been named merchandise division sales engineer of the International Resistance Co., 401 N. Broad St., Phila. 8, Pa. He succeeds Victor Nicholson who has joined the Harry B. Segar Co., manufacturers' representatives, Buffalo, N. Y.

Below: Bob Baggs (center), sales manager of the IRC merchandise division; Robert Butler (left), and Victor Nicholson.



ALEXANDER NOW KEN-RAD MANAGER

L. K. Alexander has been appointed manager of the Ken-Rad division of General Electric's electronics department with headquarters at Owensboro, Kentucky.

POLYTECHNIC RESEARCH OPENS CONSULTING LAB

Polytechnic Research and Development Company, Inc., formerly P. I. B. Products, Inc., 66 Court Street, Brooklyn, N. Y., has opened a consulting engineering laboratory.

The company was established during the war for the manufacture of microwavc test equipment for the armed services.

Dr. H. S. Rogers, president of the Polytechnic Institute of Brooklyn and of the Brooklyn Chamber of Commerce is head of the company. F. J. Gaffney is chief engineer.

Mr. Gaffney was formerly head of the mea-
(Continued on page 66)

BRUSH Crystal HEADPHONES

Specially designed for your special job



Brush Communications Model BJ Crystal Headphone

Designed especially for ease and efficiency in communications work. Extremely light in weight but rugged and durable. Soft rubber housing gives wearing comfort and good ear seal over long hours of constant use. Piezo-Electric crystal drive element insures uniform response and high sensitivity. Comes complete with 5 ft. cord and adjustable headband.

Brush General Purpose Model A Crystal Headphone

Excellent for a wide variety of uses including laboratories, studios, amateur home use, schools, general program listening and many others. As in all Brush crystal products, the Piezo-Electric crystal drive element insures uniform response and high sensitivity. Well suited for multiple installation. Complete with adjustable, lock-type headband and 5 ft. cord.

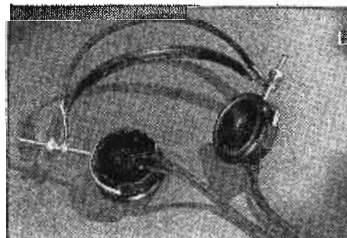

Brush High Fidelity Model A1 Crystal Headphone

For use where high fidelity and extended frequency response are of paramount importance. Does not affect line or circuit characteristics. Ideal for broadcast monitoring, sound measurement, audiometry and other exacting headphone applications. Lightweight, rugged. Complete with 5 ft. cord and adjustable lock-type headband.

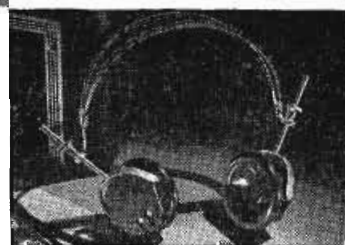

See the complete line of Brush Crystal headphones at your dealer.
For more complete information call or write



THE BRUSH DEVELOPMENT COMPANY

3503 PERKINS AVENUE

CLEVELAND 14, OHIO

Front or Rear Surface

MIRRORS AND REFLECTORS

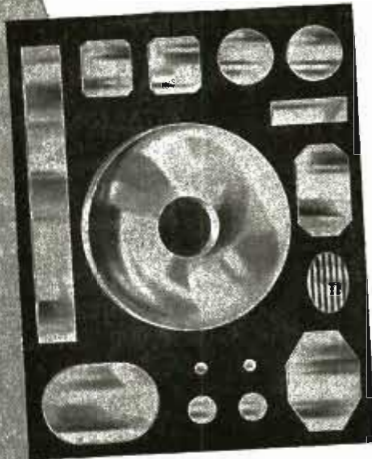

FOR TELEVISION,
ELECTRONIC, OPTICAL,
and SCIENTIFIC APPARATUS

Front or Rear Surface Mirrors and Reflectors made to your specifications.

Closest optical and dimensional tolerances observed.

- EXCEPTIONAL REFLECTIVITY
- WILL NOT TARNISH
- OPAQUE OR SEMI-TRANSPARENT
- HEAT RESISTANT
- PROMPT SERVICE

We invite your inquiries. Samples and quotations will be submitted promptly.

Let Zenith help solve your Mirror and Reflector problems!

ZENITH OPTICAL LABORATORY

SPECIALISTS IN
VACUUM DEPOSITION



123 WEST 64th STREET
NEW YORK 23, N. Y.

STANDARD CRYSTALS

Send for New Catalog

STANDARD PIEZO COMPANY

Established 1936

Quartz Crystals and Frequency Control Equipment

Office and Development Laboratory

SCRANTON, PA.

CARLISLE, PA., P. O. Box 164

CARLISLE, PA.

Representatives

COOPER-DIBLASI

259 WEST 14th STREET, NEW YORK 11, N. Y.

HAL F. CORRY

3522 GILLON AVENUE, DALLAS 5, TEXAS

THE FOSTER COMPANY

409 LUMBER BLDG., MINNEAPOLIS, MINN.

GERBER SALES COMPANY

94 PORTLAND STREET, BOSTON 14, MASS.

A. SIDNEY HARDY

650 BOULEVARD N. E., ATLANTA, GA.

HARRY A. LASURE

2216 WEST 11th STREET, LOS ANGELES 6, CALIF.

L. D. LOWERY

1343 ARCH STREET, PHILADELPHIA, PA.

MANUFACTURERS SALES TERMINAL, Inc.

222 COLUMBIA BLDG., SPOKANE, WASHINGTON

HARRY B. SEGAR & COMPANY

ELLCOTT SQUARE BLDG., BUFFALO, N. Y.

E. J. WALL

1836 EUCLID AVENUE, CLEVELAND 15, OHIO

NEWS BRIEFS

(Continued from page 65)

surement and test equipment group of the MIT Radiation Laboratory.

WISE AND TODD IN NEW BELDEN POSTS

Richard G. Wise has been appointed service manager of the merchandise division of the Belden Manufacturing Company, Chicago. William Todd has been named advertising manager.

ROBINSON BECOMES KINGS ELECTRONICS V-P

J. H. Robinson has been appointed vice president and general sales manager, of Kings Electronics Co., 372 Classon Ave., Brooklyn, N. Y.

Kings Electronics manufacturers coaxial cable connectors, wave traps, wave guides, microphone plugs and jacks.



LOUIS KAHN ELECTED TO AEROVOX CANADA BOARD

Louis Kahn, assistant chief engineer of Aerovox Corporation, New Bedford, Mass., has been elected to the board of directors of its affiliate, Aerovox Canada Ltd., Hamilton, Ont.

DZUS FASTENER BOOKLET

A booklet describing fastener installation procedures has been issued by the Dzus Fastener Co., Inc., Babylon, Long Island, N. Y.

PRESS WIRELESS MANUFACTURING OFFICES MOVED

Executive offices of Press Wireless Manufacturing Corporation have moved from 1475 Broadway, New York to the engineering laboratories at 3801 35th Avenue, Long Island City.

PAUL SELGIN BOOK TO APPEAR SOON

Dr. Paul J. Selgin's book "Electrical Transmission in Steady State" will be released soon by the McGraw-Hill Book Company, Inc.

Dr. Selgin is research engineer for the Farnsworth Television and Radio Corporation. COMMUNICATIONS has presented many of his papers on wave-filter design, equalizer and amplifier circuits, etc.



COOK ELECTRIC RELAY BULLETIN

A 20-page bulletin describing "aerotrol" type relays has been released by the magnetronic division of the Cook Electric Company, Chicago 14, Ill.

AKERROYD RESIGNS FROM RAYTHEON

A. E. Akeroyd has resigned his post as manager of distributor sales of the Raytheon Manufacturing Company, a post he held for 14 years.

An announcement as to future plans is expected soon.

ANDREWS BECOMES PENNSYLVANIA MERCHANDISING MANAGER

Raymond W. Andrews has been appointed mer-

chandising manager in the radio division of Sylvania Electric Products Inc. His office at present is in Williamsport, Pennsylvania.



**REMOTE-CONTROLLED
MOUNTAIN TRANSMITTERS**

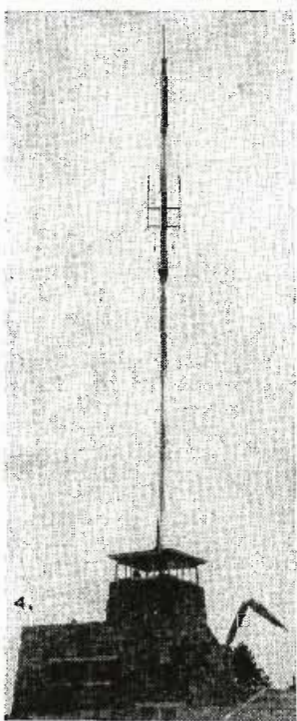

Above and below, antennas for the recently installed mountaintop remote-controlled 250-w f-m State Police system, atop Mount Coolidge and Terry Peak in the Black Hills of South Dakota. Transmitters are said to blanket western half of the State.

Installation above is on Mount Coolidge, 6400' above sea level. The 250-w transmitter antenna is atop. Rapid City h-f link antennas below; at left 81-mc antenna and at right 79-mc antenna. Below appears installation at Rapid City sub-headquarters.

(Courtesy Galvin Mfg. Corp.)

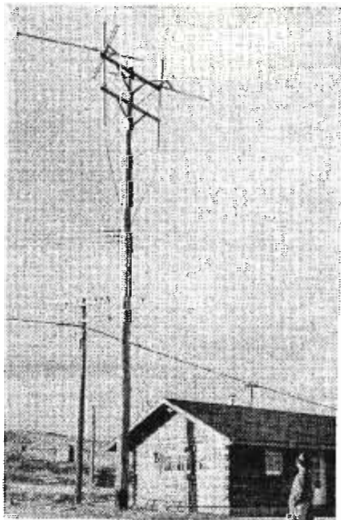

**MODERN
COIL WINDINGS**

*We'll Stick to
Coil Windings*

The pressure of wartime production forced many manufacturers into strange paths . . . we were fortunate that all of our increased facilities could be devoted to coil windings.

Experience has proved to us that superior coil windings result only from continuous attention to their design and production.

We are determined that our reputation for winding of highest quality . . . a reputation earned during 29 years of service to industry . . . shall be maintained.

That's our business and we're going to stick to it.

COTO-COIL CO., INC.

COIL SPECIALISTS SINCE 1917

65 PAVILION AVE.

PROVIDENCE 5, R. I.

AMERICAN CAPACITORS



**For dependable,
unfailing capacitor
performance rely
on "AMERICAN."**



*A hearty welcome awaits
convention visitors at the
AMERICAN BOOTH*

**SPECIFICATION
SHEETS ON
REQUEST**

**ALL STANDARD TYPES • PRECISION
ENGINEERED FOR DEPENDABILITY**

AMERICAN CONDENSER CO.

4410 NO. RAVENSWOOD AVE. • CHICAGO 40, ILL.

BROADCAST CONFERENCE

(Continued from page 60)

of seven to eight units, depending on frequency, was selected as the most practical balance between additional gain and cost. From power-gain studies made, it has been found necessary to double the antenna length to double the gain, i.e., from two to four, four to eight units. Similarly, sixteen units would be required to again double the gain, but increased losses in the much longer feed line, together with a substantially reduced and accordingly more critical radiation beam width, would prohibit full realization of the increase.

A 1½" or larger coaxial line is recommended for all transmitter powers up to 10 kw and 3½" line is recommended for high powers. It is suggested that a characteristic impedance of nominally 51 ohms be used. However, this value is not essential as line impedances between 50 and 100 ohms can be used satisfactorily.

TELEVISION ENGINEERING

TELEVISION MOTION PICTURE FILM

*Scott Helt
Allen B. DuMont Labs*

NOW that the FCC has begun the allocation of channels for commercial television broadcasting, stations will be obliged to operate on a

greatly augmented schedule; it is believed that 28 hours a week will be required.

Because of the considerable rehearsal time necessary for live talent shows, and the great expense in making available such an extended schedule of live talent production it is practical to assume many will televise suitable motion picture films.

The present television stations have used both 16 mm and 35 mm motion pictures.

From the engineering standpoint, it is unfortunate that the standards chosen for television have made it necessary to develop special motion picture projection equipment, or has necessitated the modification or redesign of equipment already available. This is because the frame frequency, as employed in television, is not in agreement with the motion-picture frame frequency.

The present high definition 525-line monochromatic television system is operated at 30 frames per second, each frame being made up of two fields, interlaced. Thus, the field frequency is 60 cycles per second, while the frame frequency standard has been set at 30. Standard sound motion pictures are projected at 24 frames per second. Television engineers found it technically expedient to adopt the frequency of 30 frames per second since 30 is a sub-multiple of 60, and the video equipment is conveniently based upon the standard 60-cycle line frequency. The latter frequency is suitable for use in synchronizing the video transmitter with receivers in the field. Thus, it has been necessary to design or modify existing

equipment to transmit standard motion picture film.

Many optical-mechanical systems have been developed for the frame-frequency transition. One such system provides 60 scanings of the film per second, while the film moves at the speed of 24 frames per second.

In this system one film frame is held in place while it is scanned twice, the succeeding frame being held in place while it is scanned three times, the process being repeated alternately. The scanning beam is so synchronized with the shutter that the image is flashed on the mosaic only during the time between the end of one scanning pattern and the beginning of the succeeding one, while the beam current is biased to cut-off.

In another system the film is passed through the projector at constant speed. An especially designed lens system follows each frame down, keeping it in focus. The series of special lenses is mounted on the periphery of a disc which is made to rotate perpendicularly to the film and the source of illumination. The lenses are placed adjacent to one another about the circumference of the disc, so that one succeeds another in coming into focus. The disc rotates in synchronism with the speed of the film. The only disadvantage of the system lies in the expensive lens system involved.

For average lighting in normal operation, a minimum of at least 25 foot candles are required at the Iconoscope mosaic, though satisfactory illumination is possible with a light level of 1.5 millilumens per square centimeter for average conditions, and 3.5 millilumens per square centimeter for high light conditions. The mosaic of the standard Iconoscope has an area of approximately 100 square centimeters. In one commercial type of modified 35 mm film projector, a 900-watt T-20 projection lamp was found capable of supplying this light demand with at least a 2-1 safety factor.

F-M MONITORS

F-M STATION MONITOR

*H. R. Summerhayes, Jr.
General Electric*

THE f-m station is required to use monitors for indicating frequency, percentage modulation, and modulation peaks. In 1940 such a station monitor was developed. The unit measured and continuously indicated the mean frequency and the percentage modulation of the radiated signal, provided a modulation peak indicator with a warning flasher to show when modulation peaks exceeded some preset value, and it also provided an audio output for use with an external amplifier for program aural monitoring.

When the frequency allocation was raised to the 88-108-mc band, it became necessary to revise the monitor.

The old circuit was essentially a superheterodyne receiver with additional measuring and indicator circuits. The local oscillator signal was derived from a crystal controlled oscillator with appropriate frequency multiplier stages. Some limiting action was achieved by introducing the transmitter signal into the mixer

(Continued on page 74)

THE INDUSTRY OFFERS . . .

SERDEX COAXIAL DIPOLES

Coaxial dipole antennas for the 144-148 mc band have been developed by Serdex, Inc., 91 Cambridge Street, Boston, Massachusetts.

Antenna, model A-144, is 5' high with a tubular mast that is both support and feed line.



AIREON REMOTE UNITS

A remote unit, 1030B, which mounts in the cab or caboose, designed to provide control over mobile v-h-f and induction equipment, has been announced by the railroad division of the Aireon Manufacturing Corp., Kansas City, Kans.

The handset, by Electro-Voice, uses a differential microphone.

Unit mounting space measures roughly 6" wide x 6" deep x 11" high.

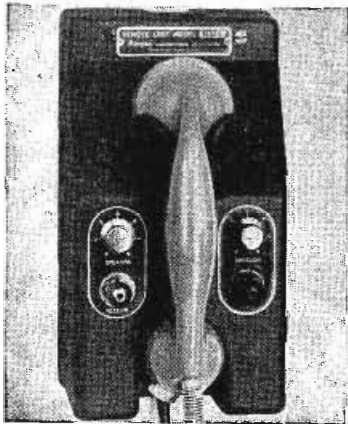

STACKPOLE MOLDED COIL FORMS

Molded bakelite coil forms with anchored "hairpin" wire leads have been announced by the electronic components division of the Stackpole Carbon Company, St. Mary's, Pa. Standard types include forms with coaxial leads each end; single hairpin lead each end; single hairpin lead one end, double hairpin lead the other end; and double hairpin lead each end. Uses are said to range from universal and tapped universal windings to solenoid windings, antenna or coupled windings, iron-cored universal windings, iron-cored i-f transformer or coupled coils and various others.

AEROVOX WATER-COOLED MICA CAPACITORS

Water-cooled mica capacitors, series 1780, for heavy-duty service as in high-power transmitters, have been developed by Aerovox Corporation, New Bedford, Mass.

Available in ratings up to 25,000 volts a-c test, and in capacitances up to .01 mfd.

Higher kva ratings are said to be obtained by

(Continued on page 70)

For FM and TV

NEW ANDREW COAXIAL CABLE WITH

51.5 OHMS IMPEDANCE!

Meets Rigid FM-TV Standards

A new coaxial cable, especially designed for FM and TV use, is now a reality at the Andrew Co. Scheduled for mid-June delivery to the first orders received, these new cables, in 4 sizes, introduce the following important engineering features:

1. Characteristic impedance of 51.5 ohms. (The regular Andrew cables for AM applications have a nominal impedance of 70 ohms.)
2. Connectors and associated fittings have been engineered with special care to avoid reflections and discontinuities. Being completely solderless, these fittings simplify installation and eliminate problems of flux corrosion and pressure leaks.
3. Insulators are spaced 12 inches apart in the 3 large size cables, and 6 inches in the 7/8-inch cable.
4. Improved low loss insulation material is used, having a dielectric constant of 6.0 and a maximum loss factor of .004 at 100 mc.
5. Close tolerances have been established on conductor and insulator dimensions, in order to maintain a constant characteristic impedance.
6. Inner and outer conductors are made of copper having a minimum conductivity of 95% IACS at 25° centigrade.

Your order now is the best assurance of early delivery on this new coaxial cable for your FM or TV installation.

Write or wire the Andrew Co., 363 East 75th Street, Chicago 19, Illinois, for complete information or engineering advice on your particular application.

ATTENUATION CURVE

Attenuation is calculated to provide for conductor and insulator loss, including a 10% derating factor to allow for resistance of fittings and for deterioration with time.

- The new 51.5 ohm air insulated coaxial cable for FM and TV comes in 4 sizes, priced tentatively as follows: 7/8", 42c per ft.; 1 1/8", 90c per ft.; 3 1/8", \$2.15 per ft.; 6 1/8", \$5.20 per ft. Andrew Co. also manufactures a complete line of accessories for coaxial cables.

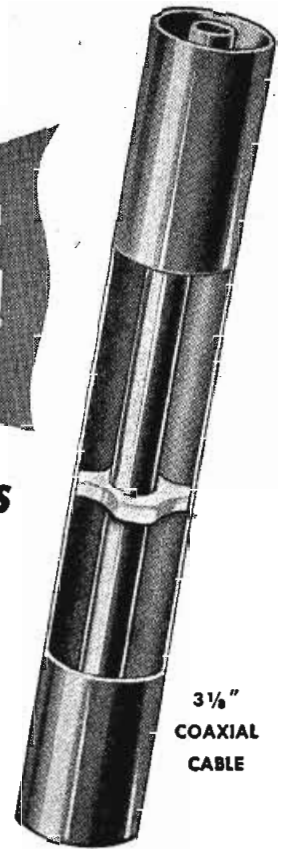
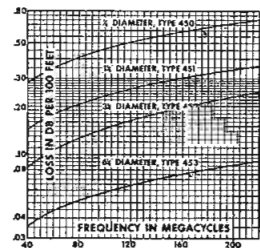

3 1/8" COAXIAL CABLE

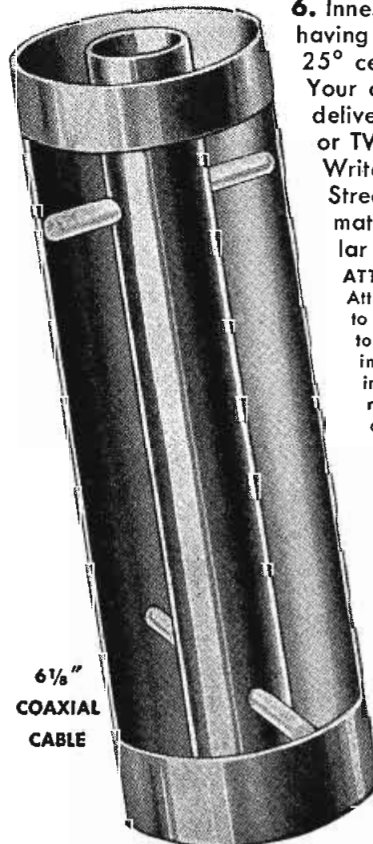

6 1/8" COAXIAL CABLE

ANDREW CO.

363 EAST 75th STREET
CHICAGO 19, ILLINOIS



NEW and Ready for you!

Allied's 1946 CATALOG

of Radio and Electronic Supplies



LARGEST AND MOST COMPLETE STOCKS... Under One Roof

You'll find this new Buying Guide extremely helpful and valuable today! Places over 10,000 items at your finger tips—for research, maintenance and production. Includes parts, tubes, tools, books, test instruments, public address and communications equipment. Concentrates all leading

makes here in one large central stock to give you faster, more efficient, more complete service—saves you time, work and money. Whatever you need... it pays to check with Allied. Write, wire or 'phone Haymarket 6800.

Everything in Radio and Electronics
ALLIED RADIO CORP.
833 W. Jackson Blvd., Dept. 31-D-6, Chicago 7, Illinois

FREE
Send for it
NOW

THE INDUSTRY OFFERS... —

(Continued from page 69)

the use of a water-cooling system that provides maximum heat transfer from capacitor section to cooling coils.

The mica stacks are in an oil bath. Cooling coils in the oil bath provide for transfer of heat. Has a series-parallel mica stack for uniform current distribution; steatite insulator shaped to hold gradients below corona limits; non-ferrous welded metal case, hermetically sealed, and grounded.

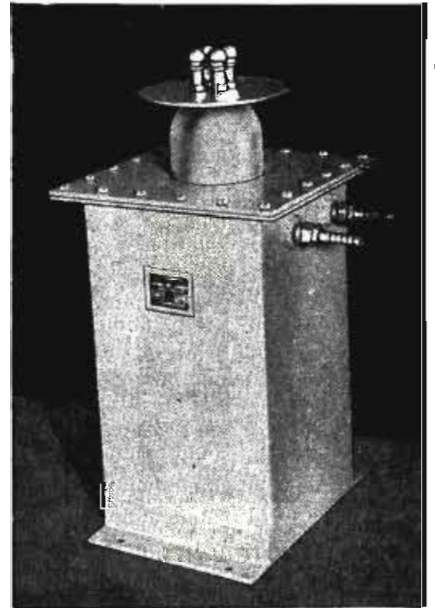

NATIONAL NOISE LIMITER

A double-ended series-valve noise limiter, which is said to clip both the positive and negative peaks off noise pulses, has been developed by the National Radio Company, Malden, Mass. The limiter is used in the HRO communications receiver.

Limiter uses an impedance-matcher connected to a high-impedance circuit.

DU MONT C-R TUBES

A small c-r tube with a 2' neck and diheptal base, 3JP, has been announced by Allen B. Du Mont Laboratories, Inc., Passaic, N. J.

For applications where deflection voltages are under suitable control, the 3JP is directly interchangeable with the 3FP. Equipment using the 3BP may be readily adapted to use the 3JP by providing for connecting the intensifier electrode of the 3JP either to the second anode potential or to a higher potential than the second anode.

The 3JP is said to have a high deflection sensitivity; can be utilized with intensifier potential equal to twice the second anode potential, without reduction in sensitivity as compared with the 3BP operating with the same second anode potential.



SYLVANIA SHARP CUT-OFF R-F AMPLIFIER TUBES

A sharp cut-off r-f pentode amplifier, 7AG7, designed for 6.3 volt and a-c/d-c series service in television and a-m/f-m receivers has been announced by Sylvania Electric Products Inc.,

The **FINEST MICROPHONES**
for P. A. and RECORDING!

AMPERITE VELOCITY MICROPHONE WITH PATENTED ACOUSTIC COMPENSATOR

New P. G. DYNAMIC WITH NEW SUPERIOR ELIPSOID PICK UP PATTERN!

AMPERITE KONTAK MIKES IDEAL FOR AMPLIFYING STRINGED INSTRUMENTS USED WITH ANY AMPLIFIER AND WITH RADIO SETS.

ASK YOUR JOBBER... WRITE FOR FOLDER

AMPERITE

361 BROADWAY NEW YORK

radio tube division, 500 Fifth Avenue, New York 18, New York.

Direct interelectrode capacitances with RMA standard M8-308 shield 1 5/16" in diameter and connected to the cathode are: maximum grid to plate, .005 mmfd; input, 7.0 mmfd; and output, 6.0 mmfd.

Typical operating conditions and characteristics in class A1 amplifier service are: heater voltage, 6.3; heater current, 0.150 ampere; plate voltage, 250; plate current, 6 milliamperes; screen grid voltage, 250; and screen grid current, 2 milliamperes.

Operating in these conditions a cathode-bias resistor value of 250 ohms is indicated. The bias voltage should be approximately 2.0 volts but fixed bias operation is not recommended. Control grid voltage for a plate-current value of 10 microamperes is -10. The suppressor is connected to the cathode at the socket. Plate resistance of the tube is 0.75 megohm and mutual conductance is 4200 micromhos.

The 7AG7 tube may be operated in any position and is supplied in a T-9 bulb with 8-pin lock-in base. Measures 2 25/32" overall and has a maximum diameter of 1 3/16".

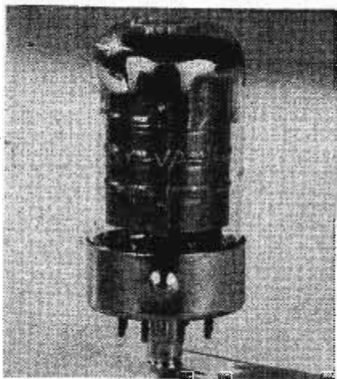

G. E. A-F METER

An audio frequency meter, type YE-5, has been announced by the specialty division of G. E.

The unit has been designed for use in f-m and a-m transmitter monitoring, and in manufacturing processes. Another application for the meter is in telemetering, where a variable control is caused to change a frequency.

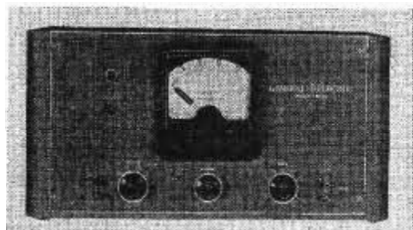

MILLEN 50-WATT TRANSMITTER-EXCITER

A 50-watt transmitter-exciter unit, 90800, for either low-power amateur-band use or as an exciter for higher power p-a stages, has been announced by James Millen Manufacturing Company, Inc., 150 Exchange St., Malden, Mass. Coils furnished are for 10-meter output with 40-meter crystal. Tubes used are 807 and 6L6.

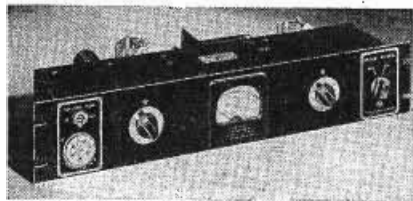

MICRO-SONIC PHONO PRODUCTS

British-made record changers, record players, and phonograph motors are now being distributed by the Micro-Sonic Corporation, 44 West 18th Street, New York City.

The record player provides use of 10" and 12" (Continued on page 72)



MR. RADIOMAN:

Here's How Capitol Radio Can Prepare You Now for a Better Job and a Secure Career in Radio-Electronics . . . !

Add CREI Technical Training to Your Present Experience—Then Get that Better Radio Job You Want—More Money and Security!



CREI home study training in Practical Radio-Electronics Engineering equips you with the ability to go after—and get—a better job in radio-engineering that offers security, advancement and importance.

We are now entering a period where employers can once again afford to be "choosy" in selecting the best-qualified men for the important jobs to be filled.

In our proved course of home study training, you learn not only how . . . but why! Your ability to solve tough problems on paper, and then follow with the necessary mechanical operation, is a true indication that you have the confidence born of knowledge . . . confidence in your ability to get and to hold the type of radio job you want.

CREI courses have been studied by more than 10,000 professional radiomen—so don't say YOU haven't the time. CREI courses are designed to be studied in the most crowded schedules—without interfering with your present work, yet helping you as you progress lesson by lesson.

Now you can read what these typical CREI students have to say. They are men who had the initiative to get started on their own betterment program toward better jobs and more money. You have the same opportunity. It costs you nothing but a moment's time to send for complete details in free book.

"I give CREI full credit for my securing the position as Asst. Chief Engineer. . . ." —W. H. Meiners, 420507

"In the past 7 months I have received 3 increases in salary and a promotion that can be partly credited to CREI. . . ." —C. B. McKnight, 401101

"There are many times where what I am studying in the course works right in with the immediate problems of my job. . . ." —C. I. Carpenter, 411024

CREI Training for Veterans is Approved Under the "G.I." Bill.

JUST OFF THE PRESS!



WRITE FOR FREE 36-PAGE BOOKLET

"Your Opportunity in the New World of Electronics"

If you have had professional or amateur radio experience and want to make more money, let us prove to you we have something you need to qualify for a better radio job. To help us intelligently answer your inquiry—PLEASE STATE BRIEFLY YOUR BACKGROUND OF EXPERIENCE, EDUCATION AND PRESENT POSITION.

CAPITOL RADIO ENGINEERING INSTITUTE

E. H. RIETZKE, President

Dept. CO-4, 16th and Park Road, N. W., Washington 10, D. C.

New York (7): 170 Broadway

Chicago (2): 30 N. LaSalle Street

San Diego (1): 316 C Street

San Francisco (2): 760 Market Street

Member: NATIONAL HOME STUDY COUNCIL • NATIONAL COUNCIL OF TECHNICAL SCHOOLS

FOR VHF

30 TO 200 MC

170-A

**Q
METER**

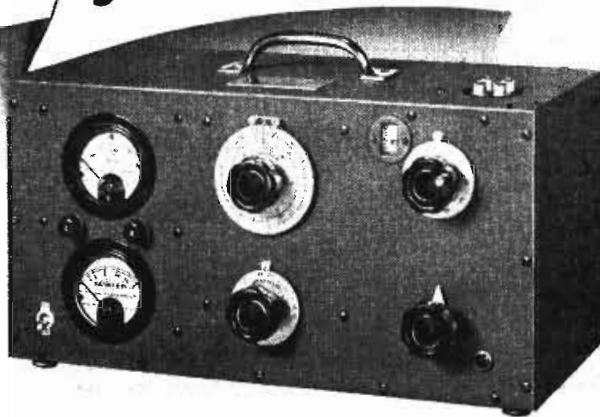

A ruggedly constructed direct reading laboratory instrument specially designed to measure Q, inductance, and capacitance values quickly and accurately. Invaluable in selecting proper low loss components for high frequency applications.

**SPECIFICATIONS:—FREQUENCY RANGE: 30-200 mc, accuracy $\pm 1\%$
RANGE OF Q MEASUREMENT: 80 to 1200
Q CAPACITOR RANGE: 11-60 mmf; accuracy $\pm 1\%$ or 0.5 mmf, whichever is greater**

Write for Catalog C



BOONTON RADIO

BOONTON · N · J · U · S · A



At Long Last!

A FOLDED DIPOLE TURNSTILE

F.M. ANTENNA

By **WINCHARGER**

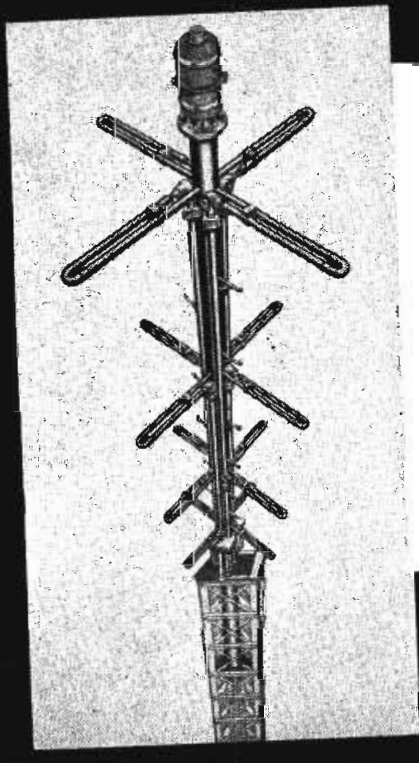

- 1—**VERY BROAD BAND** — incorporates features of ordinary turnstile with vast improvement of FOLDED DIPOLE principle.
- 2—**PROVED** by 4 years actual service in leading 50 K.W. station.
- 3—**FACTORY PRETUNED**—no field adjustment.
- 4—**LARGE SAFETY FACTOR**
- 5—**DESIGNED** by high frequency and Radar antenna engineers of Zenith Radio Corporation.
- 6—**COMPLETE "PACKAGE"** — one company supplies everything — And No Extras to Buy.

Phone, Write or Wire

**Antenna Tower Dept.
WINCHARGER
CORPORATION
SIOUX CITY 6, IOWA**

THE INDUSTRY OFFERS...—

(Continued from page 71)

records for loading and intermixing; tone-arm is said to automatically compensate for differences in diameters.

The Micro-Sonic Corporation is an affiliate of the Micro-Lite Company.

Al Gelardin is president of Micro-Sonic Corporation. Robert Levitt is sales manager.

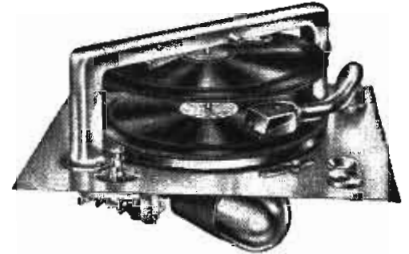

ZENITH ELECTRIC PROGRAM TIME SWITCH

An automatic control for radio and recorded programs application has been announced by Zenith Electric Company, 152 W. Walton St., Chicago 10, Illinois.

Control is embodied in a time switch, type PR-24, which is said to operate automatically to periods as close as five minutes throughout twenty-four hours. It repeats daily.

Unit is enclosed in a steel case 8" wide, 12" high and 4" deep.

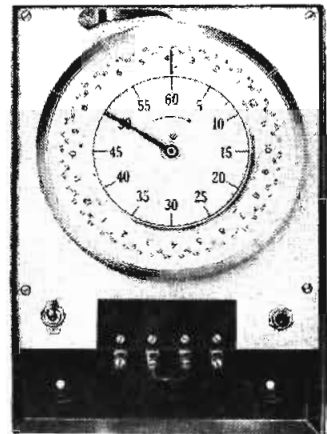

EIMAC TRIODES

Multi-element triodes, type 3-150A, have been announced by Eitel-McCullough, Inc., San Bruno, California. Tube is said to incorporate a new design plate and a non-emitting grid.

Available in high-mu (3-150A3) or low-mu (3-150A2) versions.

Characteristics as a-f power amplifier and modulator, 2-tubes, class B: d-c plate voltage, 1500, 2000, 3000; max.-signal d-c plate current, per tube, 450 ma; plate dissipation, per tube, 150 watts; d-c grid voltage (approx.), -65, -90, -150; peak a-f grid input voltage, 340, 350, 430; zero-signal d-c plate current, 133, 100, 67 ma; max.-signal d-c plate current, 535, 450, 335 ma; max.-signal driving power (approx.), 9, 6, 3 watts; effective load, plate-to-plate, 5700, 9600.

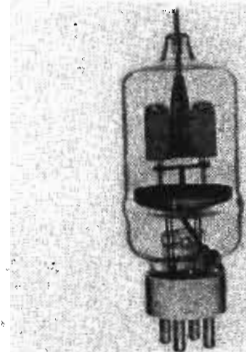

20300 ohms, and max.-signal plate power output, 500, 600, 700 watts. * * *

MASSA SOUND-PRESSURE MEASUREMENT STANDARD

A sound-pressure measurement standard, M-101, for making absolute sound pressure measurements throughout the audible frequency range without appreciably disturbing the sound field, has been announced by Massa Laboratories, Inc., 3868 Carnegie Avenue, Cleveland 15, Ohio. Vibrating system is stiffness-controlled to well beyond 30 kc. Acoustic impedance is said to be 100 times that of a miniature stretched diaphragm.

Size, 5/8" diameter cylinder by 15/16" long. Resonant frequency, above 45 kc. Free field response, non-directional in all planes to 5 kc. Sensitivity, 23 microvolts/dyne/cm² sound pressure.



FINCH FACSIMILE UNITS

Two types of duplex facsimile units, designed for point-to-point, mobile and other commercial communication services, have been announced by Finch Telecommunications, Inc., Passaic, N. J.

One of the models, FRS 141-A, is a high-speed unit which is said to transmit, and receive, at

30,000 words per hour or 2760 square inches of picture copy. The second unit, FRS 140-A, is a medium-speed machine which has a speed of 9600 words per hour or 918 square inches of picture copy. This model operates on any channel which will handle a subcarrier frequency of 1.3 kc.

Each of the models weighs approximately 75 pounds and measures approximately 16" x 16" x 12". Both are designed for either 110-volt 60-cycle or 200-volt 60-cycle a-c; 110-220 volt d-c or battery power.



WARD LEONARD RELAYS

Relays, 130 series, for heavy-duty applications, have been announced by Ward Leonard Electric Co., Mt. Vernon, N. Y.

Contact arrangements are available from one to four poles, normally open or normally closed, single or double throw. Operating voltages for d-c relays are from 6 to 230 and for a-c from 6 to 440.

Relay contact ratings for d-c are 25 amperes, 0-24 volts; 3 amperes, 25-125 volts; 1 ampere, 125-230 volts. Contact ratings for operation on a-c 60-cycle circuits are 25 amperes, 0-250 volts; 15 amperes, 250-440 volts.

RAYTHEON 2-WAY AIRCRAFT UNIT

A 2-way personal plane transmitter/receiver with a fixed tuned v-h-f channel on 75 mc for receiving fan and Z markers, and continuous coverage from 195 to 410 kc and 540 to 1600 kc, has been developed by the Belmont radio division of Raytheon. Weight of the transmitter

(Continued on page 76)

A CORDIAL INVITATION

TO ALL

- Representatives
- Manufacturers
- Servicemen
- Distributors

WELCOME TO

BOOTH 101

RMA

NATIONAL PARTS

SHOW

STEVENS HOTEL

CHICAGO—MAY 13-14-15

See **SUPREME'S**
NEW LINE OF POST-WAR
RADIO, TELEVISION and
ELECTRONIC TEST EQUIPMENT

Supreme Engineers,
Technicians and Sales-
men will be on hand to
show the line and answer
all questions.



SUPREME INSTRUMENTS CORP.
GREENWOOD, MISS.
U. S. A.

Export Department
THE AMERICAN STEEL EXPORT CO., Inc
374 Madison Ave., New York 17, N. Y.

It's a
VERTROD
Product—THE FINEST

VERTROD'S

fourteen models of
ANTENNAE

a model for every purpose — are in production. We are keeping faith with our old customers, and ready to make new friends by producing the finest antenna known to radio, using the same, or better, quality and quantity materials and laboratory tests, on each antenna, without raising our prices above 1941 pre-war prices. Write to Dept. 4515.

During RADIO PARTS SHOW — May 13 to 16 — visit our exhibit at the Congress Hotel, opposite the Stevens.



VERTROD CORP.
60 EAST 42nd ST. NEW YORK 17, N. Y.

New!
Complete!
RADIO CATALOG
Free!



RADIO SETS
AMPLIFIERS
RADIO PARTS
ELECTRONIC EQUIPMENT

Your copy of the complete, new Concord Catalog is ready! It offers you the greatest selection of guaranteed quality RADIO SETS, PHONO-RADIOS, RADIO PARTS, TEST INSTRUMENTS, BOOKS, TOOLS, AMPLIFIERS AND ACCESSORIES, AMATEUR KITS AND SUPPLIES . . . page after page of post-war-engineered equipment and parts you have long been waiting for. All standard, top-quality lines. Thousands of items. Money-saving prices. See the thrilling MULTIAMP *Add-A-Unit* Amplifiers, brand new in the field, with sensational new flexibility, fidelity and power—EXCLUSIVE with CONCORD. Your copy is ready . . . and it's FREE. Rush this coupon today.

CONCORD
RADIO CORPORATION
LAFAYETTE RADIO CORPORATION
CHICAGO 7 ★ **ATLANTA 3**
901 W. JACKSON BLVD. ★ 265 PEACHTREE ST.
Concord Radio Corporation, Dept. R-46
901 W. Jackson Blvd., Chicago 7, Ill.
Yes, rush FREE COPY of the comprehensive new Concord Radio Catalog.

Name.....
Address.....
City..... State.....

BROADCAST CONFERENCE

(Continued from page 68)

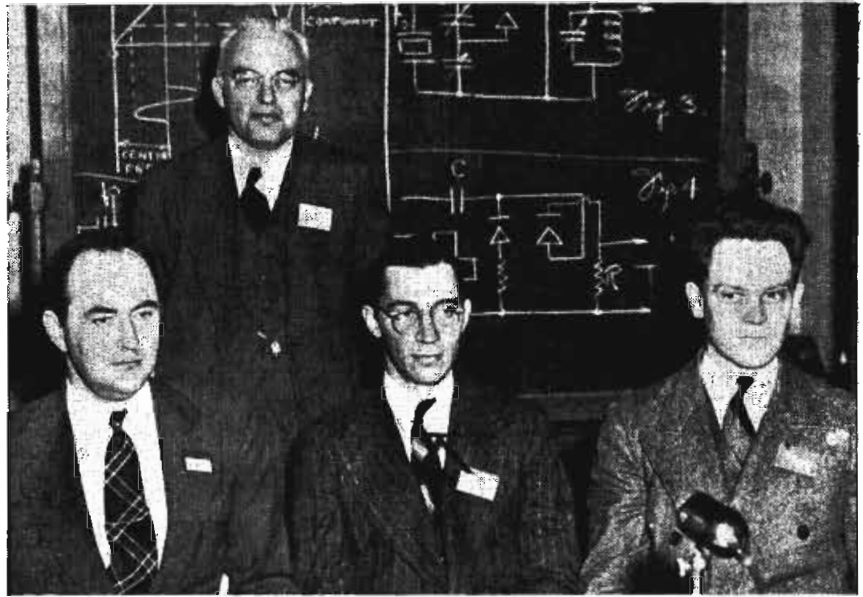

Members of the f-m monitor symposium, left to right: H. H. Summerhayes, Robert C. Higgy, James R. Day, and D. B. Sinclair.

at a saturation level. There was a single very broad band i-f transformer at 5.4 megacycles in the mixer plate circuit. The discriminator amplifier was operated class A to avoid the spurious center frequency change encountered when limiting is used at the discriminator amplifier grid. The discriminator itself was a modification of the commonly used double-tuned circuit with two diodes, each one connected to rectify the sum of the primary voltage and one-half the secondary voltage. However, the structure of the more conventional discriminator was modified in such a way as to facilitate monitoring the frequency directly without d-c amplification.

The increase in operating frequency called for redesign of the frequency multiplier and mixer sections with miniature tubes indicated for the high-frequency stages.

The most difficult requirement was the one calling for extremely low audio distortion and noise level. It is desired to be able to indicate transmitter noise as low as 70 db below 100% modulation and transmitter harmonic distortion less than 1/2%. These considerations led to specifying an inherent noise level for the moni-

tor not to exceed -75 db and a total harmonic distortion not to exceed 1/4%.

The noise specification can be met with the tuned discriminator as far as audio noise due to power supply ripple is concerned.

The specification of 0.25% on allowable total harmonic distortion includes distortion due to non-linearity of the discriminator detection characteristic as well as distortion produced in the audio amplifier. It was decided that 0.15% for the discriminator and 0.1% for the audio amplifier would be satisfactory.

A series of tests with the tuned discriminator proved that it was capable of providing linear frequency modulation detection with a distortion in the order of 0.15% and that the amount of detuning likely to be encountered with the change in capacitance due to changing tubes produced negligible effect on distortion.

(Summerhayes Paper)

Tuned discriminator for the f-m broadcast station monitor.

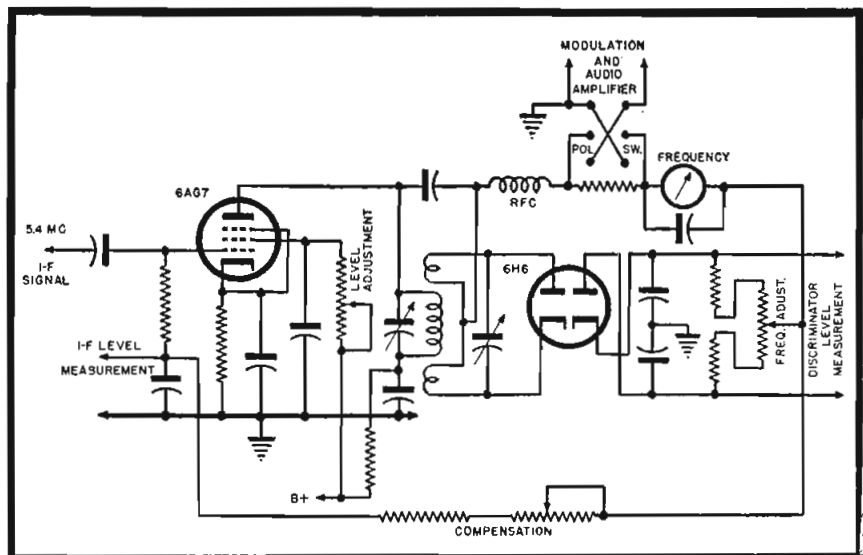

**TUBE INFORMATION
FOR THE
RADIO INDUSTRY**

Call On
**APPLICATION
ENGINEERING
DEPARTMENT**
No Obligation

FOR ANSWERS TO SPECIFIC PROBLEMS

AMPEREX
ELECTRONIC CORPORATION

25 Washington St., Bldg. 1, N. Y. 10111, America
in Canada: Rogers-Mojethe Ltd. Toronto 21

POWER TUBES



SINCE 1925

★
SOME D

REMLER APPOINTED

Agent for
**WAR ASSETS
CORPORATION**

(Under Contract No. 59A-3-48)
... to handle and sell a wide variety of
ELECTRONIC EQUIPMENT

released for civilian use
Write for Bulletin Z-7D

Remler Company, Ltd., 2101 Bryant St., San Francisco 10, Cal.

REMLER SINCE 1918

Radio • Communications • Electronics

ANOTHER NEWARK STORE!

Located at 212 Fulton St., New York 7, N. Y., another big Newark Electric Company store has been opened to serve your radio and electronic needs. Stop in at the new downtown New York store, which is managed by HY Kahu, and you will find the same competent personnel that has made buying at other Newark stores a pleasure.

NEWARK BARGAIN SHEET AVAILABLE

Mail us your name and address and we will send you Newark Electric's famous bargain sheet each month. Write today. Address Dept. C of nearest Newark branch.



CHICAGO
Newark ELECTRIC Company
115-117 W. 45th St. NEW YORK 19
ADOLPH GROSS

NEW YORK
323 W. Madison St. CHICAGO 6
SAM PONCHER

**When is a B-L Rectifier
NOT a Rectifier?**

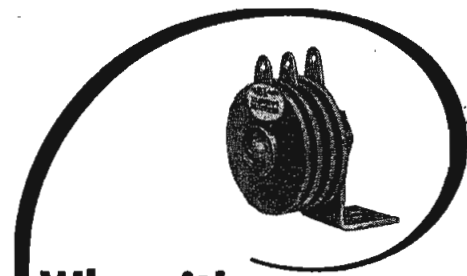

**When it's a
SPARK SUPPRESSOR!**

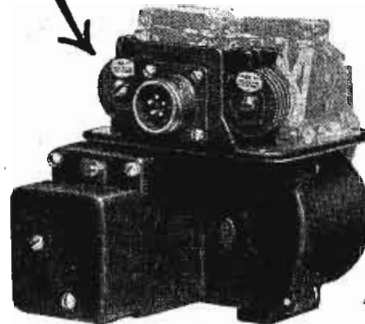

Aircraft Servo Motor manufactured by the White-Rodgers Electric Company, St. Louis. A compact B-L Selenium Rectifier across the rapidly operating relay contacts provides an important safeguard for pilot and plane by eliminating arcing and its resultant radio interference.

Unusual resistance-voltage characteristics make B-L Metallic Rectifiers ideal for overcoming

- RAPID WEAR OF CONTACTS
- RADIO AND TELEPHONE INTERFERENCE
- DAMAGING OSCILLATORY SURGES
- CORROSIVE OXIDATION

The above example is only one of many applications where the unique characteristics of B-L Metallic Rectifiers have offered an ideal solution to an unusual problem.

Whether similar or entirely different problems confront you in the performance or operation of electrical and electronic equipment it will pay to investigate the ability of B-L Rectifiers to meet your needs.

Unusual electrical characteristics plus long life and compact construction make B-L Rectifiers ideal for many applications not ordinarily associated with their name.

SELENIUM



**COPPER
SULPHIDE**

THE BENWOOD-LINZE COMPANY

1815 LOCUST STREET

ST. LOUIS 3, MO.

Long Distance Telephone Central 5830

Designers and Manufacturers of Selenium and Copper Sulphide Metallic Rectifiers, Battery Chargers and DC Power Supplies for practically every requirement.

Laboratory Standards

FM

MODEL 78

SIGNAL GENERATOR

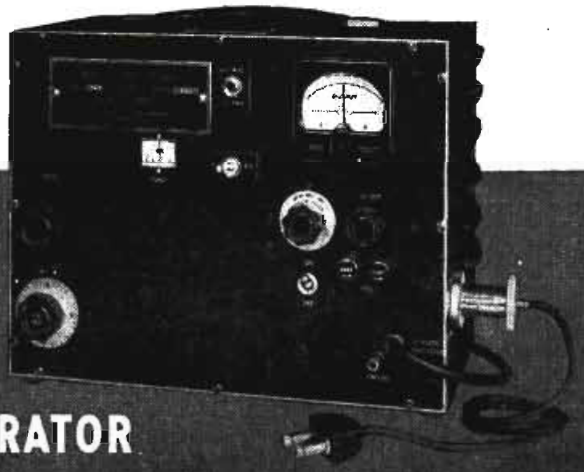

SPECIFICATIONS:

CARRIER FREQUENCY RANGE: 86 to 108 megacycles—individually calibrated dial.

OUTPUT SYSTEM: 1 to 100,000 microvolts with negligible carrier leakage.

OUTPUT IMPEDANCE: Constant at 17 ohms.

MODULATION: 400 cycle internal audio oscillator. Deviation directly calibrated in two ranges: 0 to 30 kc. and 0 to 300 kc.

Can be modulated from external audio source.

Audio fidelity is flat within two db from d.c. to 15,000 cycles.

Distortion is less than 1% at 75 kc. deviation.

PRICE: \$300.00 F.O.B. Boonton, New Jersey

PROMPT DELIVERY

MEASUREMENTS CORPORATION
BOONTON NEW JERSEY



THE INDUSTRY OFFERS...

(Continued from page 73)

and receiver is 14 pounds. Dimensions are: 5" high, 5 1/4" wide, 14 1/4" deep.

A loop antenna may be added to provide radio d-f navigation. Transmitter (14-watts) operation is on the standard private-aircraft frequency of 3105 kc.

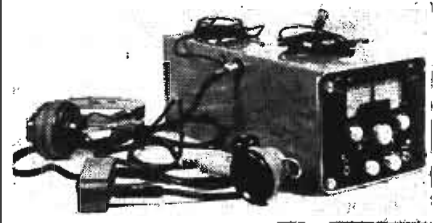

FAIRCHILD TRANSCRIPTION TABLE

A studio-transcription table, 524, featuring a two-speed drive, direct through worm and gear at 33 1/2 rpm, has been announced by the Fairchild Camera and Instrument Corporation, Jamaica, N. Y. A 78-rpm speed is secured through a ball-race mechanism which operates in light oil in a dust-proof housing. Change of speeds is accomplished by pulling up or pushing down a shift pin protruding above the record, from the hollow turntable shaft. This can be done without shutting off the motor.

The drive and 1800-rpm synchronous motor, connected by a rubber coupling, are mounted in a heavy casting in the base of the cabinet. The linkage between the drive and turntable is a hollow shaft with mechanical filters to reduce transmission of vibration from the motor or drive to the turntable.

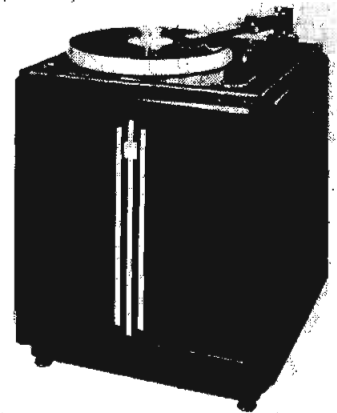

NILSSON PIPE LOCATOR

A transmitter-receiver system, developed by Hugo Wahlquist of the Cathodic Protection Division of Ebaseo Services, for location work, has been announced by the Nilsson Electrical Laboratory, Inc., 103 Lafayette Street, N. Y. 13, N. Y.

Transmitter measures 4" x 5 1/2" x 6" and weighs 4 pounds. Receiver measures 3" x 7" x 8" and also weighs 4 pounds.

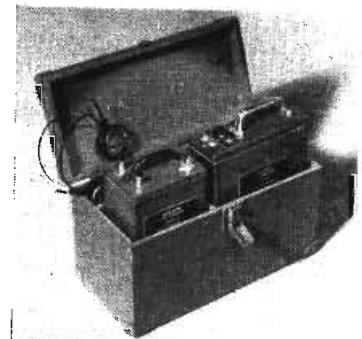

COLLINS AIRCRAFT TRANSMITTER

A 100-watt aircraft transmitter for 3105-kc and 6210-kc voice operation, 17E2, has been produced

CHASSIS • CABINETS • PANELS • RACKS

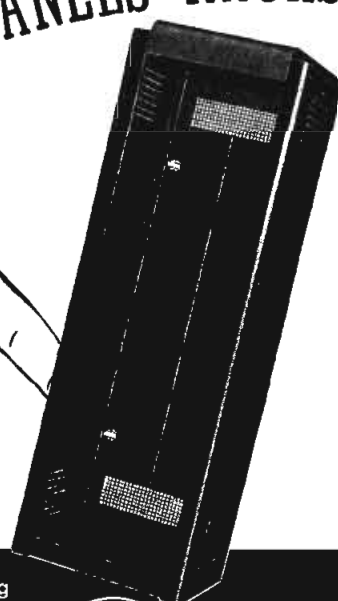

Skill in **METAL**

PAR-METAL . . . a specialized manufacturing plant employing modern high-speed methods. Nevertheless, Par-Metal products have a definite quality of Craftsmanship—a "handmade" quality born of genuine skill and long experience. Write for Catalogue.



Serving the Electronics Field Exclusively

PAR-METAL PRODUCTS CORPORATION

32-62—49th STREET . . . LONG ISLAND CITY, N. Y.

Export Dept.

88 E. 40th St., N. Y. 16, N. Y.

LOOK!



BEAM POWER TUBES



829-B push-pull R-F beam power amplifiers. Exceptionally efficient, with full output at frequencies up to 200 Mc. Max. ratings are: 750 plate volts, 40 watts plate dissipation. While they last...

\$4.95

Stock Number WPS416



R. W. T.

BARGAINS of the MONTH

LOOK!

ACORN TUBES

Government Released. Sensational offer. Normally \$2.85-\$5! Stock No. WPS 422: Type 954. Stock No. WPS 423: Type 954. Stock No. WPS 424: Type 955. Stock No. WPS 425: Type 956. Socket for above. W8464, price 49c



69¢



FREE! Latest Bargain Flyer includes test instruments, record changers, communication receivers, ham transmitting tubes and many other electronic items you need today. Big new catalog coming! Get your name on our list!

**Radio Wire
Television Inc.**

NEW YORK 13 BOSTON 10 NEWARK 2

Originators and Marketers of the Famous **Lafayette Radio**

Cut out coupon, paste on penny post card, mail today.

R. W. T. Dept. TD6
100 AVENUE OF THE AMERICAS, NEW YORK 13

Gentlemen: Send me FREE copy of your Latest Bargain Flyer and put my name on list for your Big New Catalog

NAME _____

ADDRESS _____

CITY _____ ZONE _____ STATE _____

by the Collins Radio Company, Cedar Rapids, Iowa.

Designed for executive type planes. Transmitter is standard 1 ATR size. Weighs 44 pounds.

Circuits are pretuned. A single switch selects the transmitting frequency.

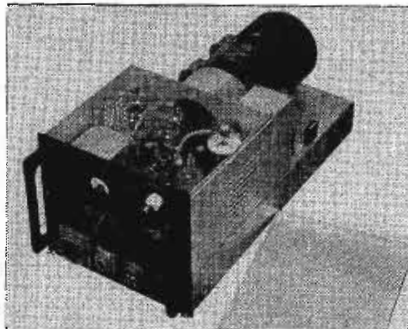

LEWIS HIGH-FREQUENCY BEAM TETRODES

A 150-watt beam tetrode, AT-430, has been announced by Lewis Electronics, Inc., Los Gatos, California, division of Aireon.

Filament voltage is 5; current, 7 amperes. Filament is of heavy thoriated tungsten. Maximum values for class "C" amplifier, not modulated: plate voltage, 4000; plate current, 225 milliamperes. Tube will operate to 120 megacycles at full power.

Has a jumbo 5-pin metal sleeve base and a top plate connection. The plate of the tube is molybdenum, zirconium coated. Overall length of the tube is approximately 6 1/4", diameter approximately 2 3/4".

CANNON LOW-LEVEL SOUND CONNECTORS

Multi-contact connectors, type XL, plug and receptacle, for low level sound uses, have been announced by Cannon Electric Development Co., 3209 Humboldt Street, Los Angeles 31, California.

Size: 2 3/32" overall length, maximum diameter of 5/8". Two-plug types, 0.0792 and 0.0992 pound. Has polarizing means, similar to AN and K aircraft connectors. Three 15-ampere silver-plated brass contacts in phenolic insert to accommodate No. 14 stranded wire.

MERIT TRANSFORMERS

A line of replacement transformers, including audio, power and filter choke models, has been announced by the Merit Coil and Transformer Corporation, Chicago, Ill.

MOTOROLA PRIVATE AIRCRAFT RECEIVER

A 3-band receiver-transmitter for private aircraft has been developed by Donald H. Mitchell, of the Galvin Mfg. Corp., Chicago, Ill.

Features are: Beam reception by push-button; automatic reeling antenna; beacon band (200-400 kc), broadcast band (535-1620 kc), and 75 megacycle marker band, (both Fan and "Z" markers can be heard concurrently with the beam or other signals being received); tear drop loop, statically shielded and remotely controlled with control and azimuth indicator on radio set panel; loudspeaker or headphone reception on all three bands.

Transmitter, 10-watt type; lip microphone attached to head set; remote push-to-talk transmitter button on stick or wheel. Transmitter, receiver and power supply in one unit. Size 4 1/4" x 6" x 9 1/2" deep. Weight 12 pounds. Entire radio equipment weighs 21.34 pounds.

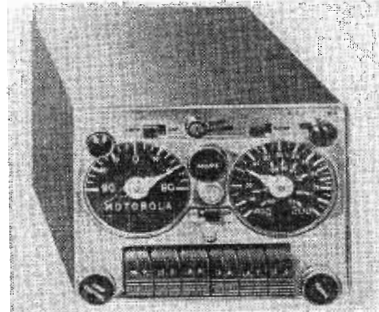

Get your copy NOW!

The Clarostat postwar catalog No. 46 positively lists the outstanding selection of resistors, controls and resistance devices for your equipment building and maintenance jobs, such as:

- ATTENUATORS
- POWER RHEOSTATS
- GLASOHM RESISTORS
- VOLTAGE REGULATORS
- METAL-TUBE RESISTORS
- CONSTANT-IMPEDANCE CONTROLS

- WIRE-WOUND POTENTIOMETERS
- COMPOSITION POTENTIOMETERS
- POWER RESISTOR DECADE BOX
- ETC., ETC.

★ Ask for CATALOG . . .

Ask your jobber for your copy. Order your requirements from him. Or if you prefer, write us for the catalog.



CLAROSTAT MFG. CO., Inc. • 285-7 N. 6th St., Brooklyn, N. Y.

PRINTED ELECTRIC-CIRCUIT PROCESS

THE development of a *printed* electric-circuit process through the use of a silver paste printed or stenciled on steatite ceramic, fired at high temperatures for firm bonding, was recently announced by Centralab. Developed during the war for the radio proximity fuze, the process

provides for the construction of sub-miniature equipment.

The silver paste applied to the steatite is composed of silver oxide or finely divided silver in combination with binders and solvents. Application is completed by means of the silk-screen process. The screen uses a photosensitive emulsion coated onto a fine mesh silk. The screen is stretched tightly on a sturdy wood or steel

frame. The paste is forced through the mesh silk with a neoprene bar. The actual pattern of the screen is produced by preparing an accurate black and white transparency pattern negative.

After application of the silver paste to the ceramic, the plates are placed in a furnace and heated to 1300 to 1500° F. This heat burns off the solvent and binders used to make the silver paste, leaving the pure silver leads or wiring adhering to the steatite with a tensile

Comparison of an amplifier built by the customary method and the printed circuit method.

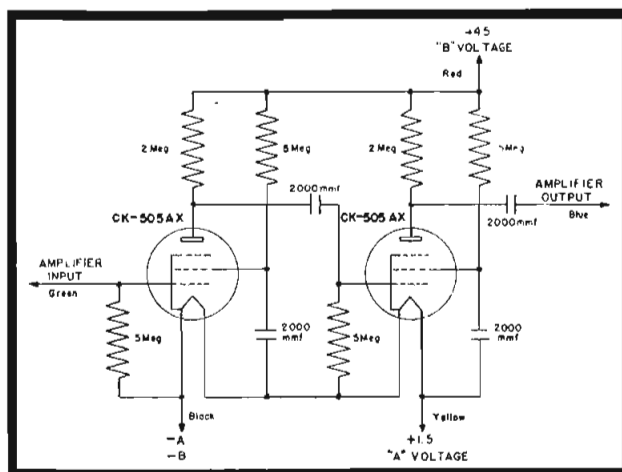
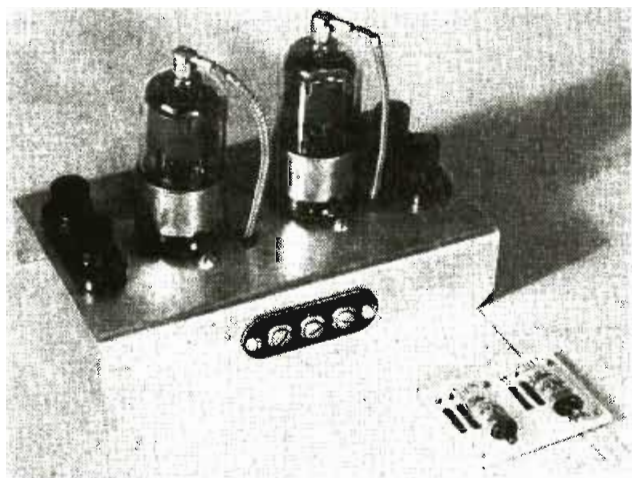

Typical circuit used for printed amplifier.

Electronic Research & Mfg. Corp.

A Service to INDUSTRY

DEVELOPMENT AND CONSTRUCTION OF ELECTRONIC EQUIPMENT FOR ANY APPLICATION

Write or telephone for a discussion of your problem—without obligation.

1420 East 25th Street, Cleveland 14, Ohio
SU. 1958

FREE CATALOG

Radio parts, test equipment, P.A. accessories, amateur supplies, technical books. Send today for your free copy to Dept. C-A.

RADIONIC EQUIPMENT CO.

"Chancellor Radio"

170 NASSAU STREET, NEW YORK 7, N. Y.

Ted McElroy

World's Largest Manufacturer of Wireless Telegraphic Apparatus

COMPLETE CENTRAL OFFICE EQUIPMENT

McElroy Manufacturing Corp.

82 Brookline Avenue • Boston, Massachusetts

18 YEARS IN RADIO

Latest developments in radio and electronic parts and devices, newest "Ham" gear, "Gadgets" to delight the experimenter, bargains in war surplus goods, all in new catalog for you.

BURSTEIN-APPLEBEE CO.,
1012 McGee, Kansas City 6, Mo.
Send me FREE new B-A Catalog. COM

I AM _____
STATE CONNECTION IN INDUSTRY _____
NAME _____
ADDRESS _____
TOWN _____ STATE _____

BIG CATALOG FREE

RADIO INSTRUCTORS

Receiver Servicing Experience. College Degree Preferred. \$3600 a year to start. \$4200 after four months. Work in the heart of the Radio Industry. Write Raleigh G. Dougherty, 158 Market Street, Newark 2, New Jersey, c/o New York Technical Institute of New Jersey.

CRYSTALS EXCLUSIVELY



SINCE 1934

PETERSEN RADIO CO., Council Bluffs, Iowa

Maximum Dependability

Minimum Size

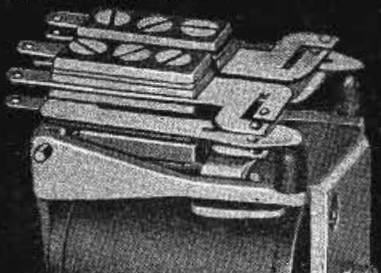

ADVANCE
SERIES 6000
MIDGET TELEPHONE TYPE
A. C. or D. C. Relay

Used in AIRCRAFT REMOTE CONTROL, RADIO and RADAR for maximum dependability and minimum size with these special features:

- **HIGH VIBRATION RESISTANCE** to 12G at 100 milliwatts D.C. in coil.
- **DOUBLE CONTACTS** on each blade, which gives double the assurance of good contact. Platinum silver alloy contact material, rating 1.5 amperes at 115 volts A.C.
- **LOW OPERATING POWER** of 60 milliwatts on D.C. or approx. 1/3 watts A.C. Coil resistance 1 to 10,000 ohms.
- **MIDGET SIZE**, 1" x 1 1/4" x 1 1/4", 2 1/2 oz. (Type 6004, D.P.D.T.)
- **MOISTURE PROTECTION** of coil by cellulose acetate insulation, varnish vacuum impregnation, second varnish dip and baking.
- You Need an Advance Telephone Type Relay for —
- **HIGH UNIT PRESSURE** of small, hemispherical contacts, no waste contact area.
- **POSITIVE MECHANICAL ALIGNMENT** of armature to core, of contact to contact.
- **PIVOT BEARING HINGE** between armature and frame assures minimum of friction—maximum life.
- **SWITCHING CAPACITY** from single pole single throw to 4 pole double throw.
- **OPERATING POWER** moderately low.
- **TRUE ECONOMY OF DESIGN**, correct materials used where needed, excess eliminated, no waste space.

See our display booth #140, RADIO PARTS AND ELECTRONIC EQUIPMENT CONFERENCE AND SHOW, Chicago, Illinois, MAY 1946.

Catalog with complete description and prices will be sent by return Air Mail by —

Advance Relays

ADVANCE
ELECTRIC & RELAY CO.
 1260 West 2nd Street
 Los Angeles 26, Calif., U. S. A.
 Phone Michigan 9331

strength of approximately 3,000 pounds psi.

The resistors are produced by spraying a paint consisting of a conducting material, a filler and a binder, through masks. A resistance range of from 3 ohms to 200 megohms can be obtained.

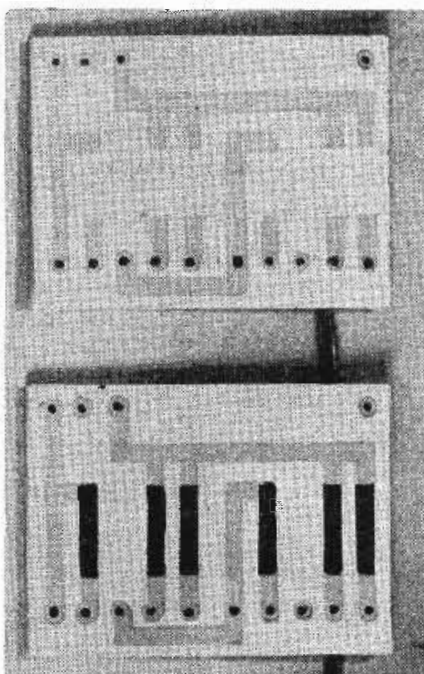

Two steps in the fabrication of the printed circuit amplifier; plates with silver leads screened and resistors added.

Curve of plate-amplifier gain.

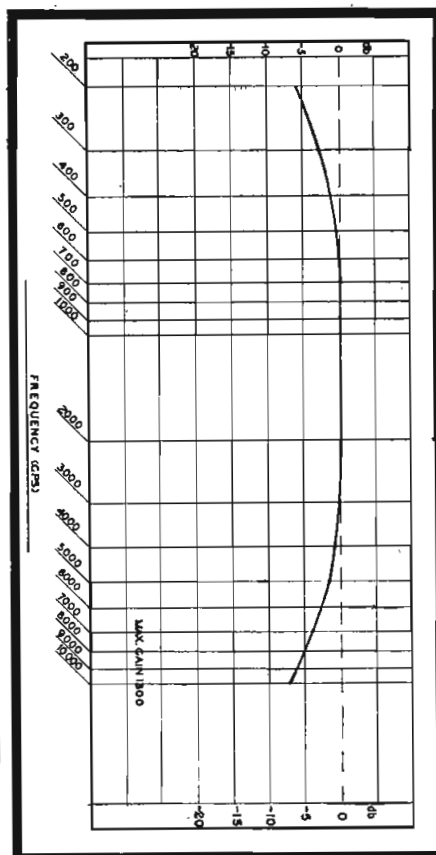

AT LAST!

A Non-algebraic Method for solving Electrical Network Problems

ELECTRICAL NETWORK CALCULATIONS

By DONALD E. RICHARDSON

Senior Physicist, Armour Research Foundation of Illinois Institute of Technology

Electrical network problems can now be solved by simple arithmetic! Here's the book which tells you how. It contains a clear, authoritative exposition, of a new, quick, direct method which reduces greatly the amount of work necessary to obtain the numerical results. Fully-worked examples illustrate every problem-type.

With the aid of ELECTRICAL NETWORK CALCULATIONS, all you need do is tabulate the values of the electrical quantities according to a prescribed form; the solutions are obtained by performing a series of simple arithmetical operations with these tabulated quantities. This method has other advantages, too . . .

It's comprehensive—covering the widest range of electrical problems, for both AC and DC networks.

It's adaptable—suited to pencil-and-paper computation as well as computation with slide rule or machine.

It saves time and effort—by eliminating the use of algebraic, and complex number calculations, and by vastly curtailing the number of arithmetical operations necessary.

It's direct and easy to apply—Hundreds of fully-solved sample problems show every step in the application of this simple, efficient method to both DC and AC networks.

BRIEF OUTLINE of CONTENTS

Kirchhoff's First Law • Kirchhoff's Second Law • Tabular Solution of Algebraic Equations • Tabular Solution of Electrical Networks • Methods for Checking the Accuracy of Reduction • The Zeroes of Initial Tabulation • Solutions Involving the Use of General-path Currents • Changes in the e.m.f.'s of a Network and Mesh-Transfer Conductances • Equivalent Networks • Equivalent Resistance of Resistance Combinations • Point-to-point Voltage Drops, Currents, and Resistances • Problems having K Currents Given • Solutions Proceeding from a List of Branch e.m.f.'s and Resistances • Change in the Resistance of a Single Branch • Tabular Solution of AC Networks • Equivalent Impedance of Impedance Combinations and Equivalent AC Networks • Inductive Coupling • Equivalent Tabulations for Multi-winding Transformer Networks in Terms of Equivalent Short-Circuit Reactances.

Send for your copy NOW!

Use the convenient order form below to obtain your copy of this important new book. Order now!

Durable cloth binding
 5 1/2 x 8 1/2
 About 285 pages
 Illustrated

\$5.75

D. VAN NOSTRAND COMPANY, Inc.
 250 Fourth Ave.
 New York 3, N. Y.

MAIL THIS COUPON

D. VAN NOSTRAND COMPANY, INC.
 250 Fourth Avenue
 New York 3, New York

Gentlemen:

Please send me copies of ELECTRICAL NETWORK CALCULATIONS.

Signed

Address

City..... Zone..... State.....

Com-3-46

KINGS Electronics

**NEW
IMPROVED
MICROPHONE
PLUGS & JACKS ELIMINATE
NOISE • SHORTS • LEAKAGE**



MODEL M-151
Female connector. Solid silver plated contact, coupling can be removed completely for soldering.

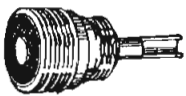

MODEL M-161
Chassis mounting, solid silver plated contact. Milled flat, prevents turning in chassis.

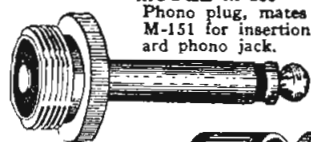

MODEL M-180
Phono plug, mates M-150 or M-151 for insertion in standard phono jack.



MODEL M-192
Solid silver plated contacts double female with coupling nuts.

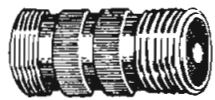

MODEL M-190
Solid silver-plated contacts, double male, mates M-151 or M-150.

STANDARD MICROPHONE JACKS AND PLUGS



MODEL M-170
Mates with Model M-151 and M-150. Standard solder contacts.

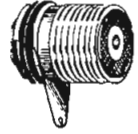

MODEL M-160
Chassis mounting—standard solder contact.

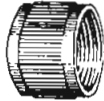

MODEL M-191
Double female coupling mates M-170, M-160-161.



MODEL M-150
Standard solder contact mates with models M-170, M-161, M-160.

**FOR FURTHER DETAILS
CONTACT ROBBY**



KINGS ELECTRONICS CO.
382 CLANSON AVE., BROOKLYN 5, NEW YORK

ADVERTISERS IN THIS ISSUE

COMMUNICATIONS—APRIL, 1946

ADVANCE ELECTRIC & RELAY COMPANY... 79 Agency: Ellsworth A. Sylvester Advertising Agency	HOPP PRESS, INC..... 54 Agency: Gallard Advertising Agency
AEROVOX CORPORATION 56 Agency: Austin C. Lescarboursa & Staff	INSULINE CORPORATION OF AMERICA..... 59 Agency: S. E. Leon & Company
ALLIED CONTROL COMPANY, INC..... 43 Agency: Michel-Cather, Inc.	JENSEN RADIO MANUFACTURING COMPANY 11 Agency: Burton Browne, Advertising
ALLIED RADIO CORPORATION..... 70 Agency: Henry H. Teplitz, Advertising	HOWARD B. JONES DIV. CINCH MFG. CORP. 56 Agency: Merrill Symonds, Advertising
ALTEC-LANSING CORPORATION 62 Agency: Reiss Advertising	KINGS ELECTRONICS COMPANY..... 80 Agency: Sternfeld-Godley, Inc.
AMERICAN AVIATION 20 Agency: Burke Dowling Adams	McELROY MANUFACTURING CORPORATION.. 78 Agency: Shappe-Wilkes Inc.
AMERICAN CONDENSER CO..... 68 Agency: A. L. Adolson	MEASUREMENTS CORPORATION 76 Agency: Frederick Smith
AMERICAN PHENOLIC CORPORATION 21 Agency: Burton Browne, Advertising	MICRO-SONIC CORPORATION 17 Agency: S. E. Leon Company
AMPEREX ELECTRONIC CORPORATION..... 75 Agency: Frank H. Kaufman & Company	JAMES MILLEN MANUFACTURING COMPANY, INC. 64
AMPERITE COMPANY 70 Agency: H. J. Gold Company	NATIONAL COMPANY, INC..... 51 Agency: Graydon Smith, Advertising
ANDREW COMPANY 89 Agency: Burton Browne, Advertising	NEWARK ELECTRIC COMPANY..... 78 Agency: Charles Brunelle
ANSONIA ELECTRICAL COMPANY..... 16 Agency: Albert Frank-Guenther Law, Inc.	NEW YORK TECHNICAL INSTITUTE OF N. J. 78
ASTATIC CORPORATION 39 Agency: Wearstler Advertising, Inc.	PAR-METAL PRODUCTS CORPORATION..... 76 Agency: H. J. Gold Company
BELL TELEPHONE LABORATORIES..... 12, 13 Agency: Newell-Emmett Company, Inc.	PERMOFLUX CORPORATION 53 Agency: Turner Advertising Agency
BENWOOD-LINZE COMPANY 75 Agency: Major Advertising Agency	PETERSEN RADIO COMPANY..... 78
BLILEY ELECTRIC COMPANY 15 Agency: Hardy Advertising	PREMAX PRODUCTS DIV. CHISHOLM-RYDER COMPANY, INC. 64 Agency: Norton Advertising Service
BOONTON RADIO CORPORATION..... 72 Agency: Frederick Smith	RADIONIC EQUIPMENT CO..... 78 Agency: Hirschon-Garfield Co.
L. S. BRACH MANUFACTURING CORPORATION 52 Agency: United Advertising Agency	RADIO WIRE TELEVISION, INC..... 77 Agency: S. T. Seldman & Company
BRUSH DEVELOPMENT COMPANY..... 65 Agency: McCann Erickson, Inc.	RATHEON MANUFACTURING COMPANY.... 34 Agency: J. M. Mathes, Inc.
BURSTEIN-APPLEBEE CO. 78 Agency: Frank E. Whalen Adv. Agency	REMLER COMPANY, LTD..... 75 Agency: Albert A. Brennan
CAPITOL RADIO ENGINEERING INSTITUTE.. 71 Agency: Henry J. Kaufman & Associates	JOHN F. RIDER PUBLISHER, INC. 60 Agency: Lansford P. King
CARTER MOTOR COMPANY..... 62 Agency: Advertising Engineers Corporation	SIMPSON ELECTRIC COMPANY..... 8, 9 Agency: Krelocker & Meloon, Inc.
CENTRALAB DIV. GLOBE-UNION, INC..... 18 Agency: Gustav Marx Advertising Agency	SPERRY GYROSCOPE COMPANY, INC..... 5 Agency: Charles Dallas Itach Company
CINEMA ENGINEERING COMPANY..... 55 Agency: The McCarty Company	SPRAGUE ELECTRIC COMPANY..... 7 Agency: The Harry P. Bridge Company
C. P. CLARE AND COMPANY..... 37 Agency: Hamilton Advertising Agency, Inc.	STANDARD PIEZO COMPANY..... 66 Agency: T. L. Dartnell Advertising Agency
CLAROSTAT MANUFACTURING COMPANY, INC. 77 Agency: Austin C. Lescarboursa & Staff	STANDARD TRANSFORMER CORPORATION.. 63 Agency: Burnet-Kuhn Advertising Company
COLLINS RADIO COMPANY..... 49 Agency: McCann-Erickson, Inc.	SUPREME INSTRUMENTS CORPORATION.... 73 Agency: O'Callaghan Advertising Agency, Inc.
CONCORD RADIO CORPORATION..... 74 Agency: E. H. Brown Advertising Agency	SYLVANIA ELECTRIC PRODUCTS, INC..... 3 Agency: Newell-Emmett Company
COTO-COIL COMPANY 67 Agency: Frank E. Dodge & Co.	TAB 58
CRYSTAL RESEARCH LABORATORIES, INC. 60 Agency: Post & Johnson & Livingston, Inc.	TECH LABORATORIES 61 Agency: Lewis Advertising Agency
DOOLITTLE RADIO, INC..... 14 Agency: Henry H. Teplitz, Advertising	THOMAS & SKINNER STEEL PRODUCTS COMPANY 88 Agency: The Caldwell-Baker Company
EITEL-McCULLOUGH, INC. 10 Agency: L. C. Cole, Advertising	TRANSMITTER EQUIPMENT MANUFACTURING COMPANY, INC..... Back Cover Agency: A. W. Lowin Company, Inc.
ELECTRICAL REACTANCE CORPORATION..... 54 Agency: Scheel Advertising Agency	TURNER COMPANY 57 Agency: The W. D. Lyon Company
ELECTRONIC RESEARCH & MANUFACTURING COMPANY 78	UNITED TRANSFORMER CORPORATION..... 6 Agency: Shappe-Wilkes Inc.
FEDERAL TELEPHONE & RADIO CORPORATION 19, 47 Agency: Rickard & Company	D. VAN NOSTRAND COMPANY..... 79 Agency: J. M. Hickerson, Inc.
FERRANTI ELECTRIC, INC..... 1	VERTROD CORP. 73 Agency: Mitchell Adv. Agency
FRANKLIN AIRLOOP CORPORATION..... 41 Agency: Sam J. Gally	WESTERN ELECTRIC COMPANY..... 12, 13 Agency: Newell-Emmett Company
GENERAL RADIO COMPANY..... Inside Back Cover	WILCOX ELECTRIC COMPANY..... 29 Agency: R. J. Potts-Calkins & Holden
HAMMARLUND MANUFACTURING COMPANY, INC. 22 Agency: Roeding & Arnold, Inc.	WINCHARGER CORPORATION 72 Agency: Critchfield & Company
HARVEY RADIO LABORATORIES, INC. Inside Front Cover Agency: Walter B. Snow & Staff, Inc.	ZENITH OPTICAL LABORATORY..... 66 Agency: H. J. Gold Company
HEWLETT-PACKARD COMPANY 4 Agency: L. C. Cole, Advertising	

**50
CYCLES TO
5
MEGACYCLES**

**DIRECT
READING**

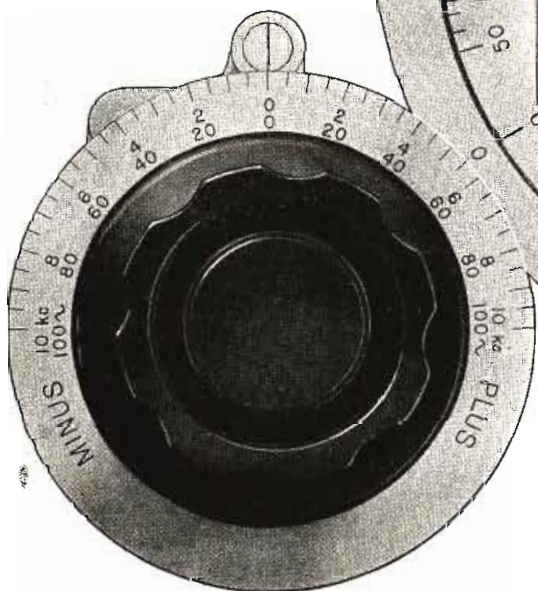

**FREQUENCY CONTROL
AND CALIBRATION**

The main dial is direct reading on two approximately logarithmic scales for 50 cycles to 40 kilocycles and 10 kilocycles to 5 megacycles. The incremental frequency control (above) is calibrated between -100 and +100 cycles and -10 and +10 kilocycles for the two respective ranges. Any frequency change made with this dial is added algebraically to the reading of the main dial.

The calibration may be standardized at any time, by setting the instrument to zero beat with the zero adjustment, to within 5 cycles on the low range and 500 cycles on the high range.

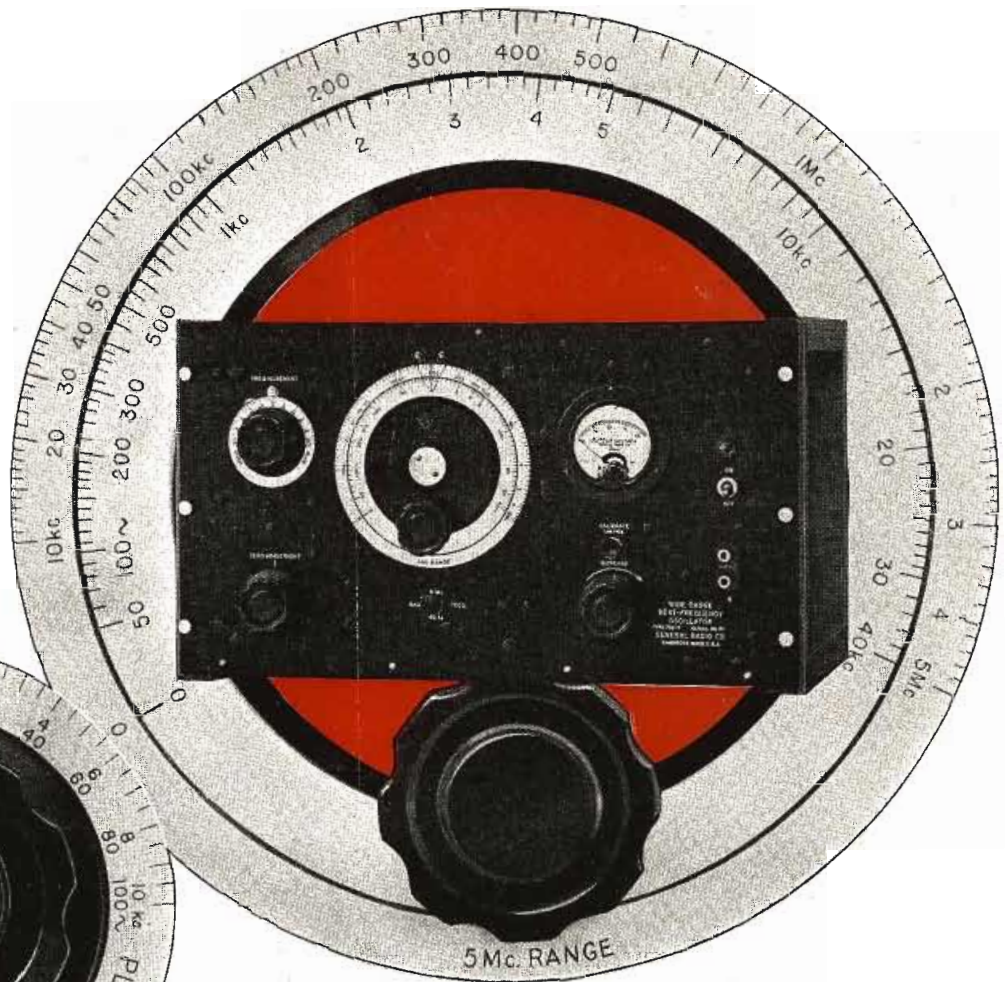

THIS wide-range beat-frequency oscillator has a number of novel circuit arrangements which make it very valuable for use not only as a general-purpose laboratory oscillator but also for testing all sorts of wide-band circuits and systems.

1. The wide ranges are obtained with a single control knob and a two-position range selector switch.
2. The output voltage, by means of an a-v-c circuit, is held constant within ± 1.5 decibels over the entire range.
3. Frequency drift is held to a very small value through carefully designed thermal distribution and ventilation systems.
4. Any small drift remaining may be eliminated by resetting the oscillator to zero beat.
5. A degenerative amplifier minimizes hum and distortion and also equalizes the frequency response.
6. The output voltage is measured by a vacuum-tube voltmeter across the output terminals.
7. One output terminal is grounded.

For taking selectivity curves on tuned circuits over a wide range of frequencies this oscillator is especially useful in that these measurements may be made very rapidly and accurately through its use.

Type 700—A Wide-Range Beat-Frequency Oscillator... \$555

Write for Bulletin 992 for Complete Data



GENERAL RADIO COMPANY

Cambridge 39,
Massachusetts

90 West St., New York 6 920 S. Michigan Ave., Chicago 5 1000 N. Seward St., Los Angeles 38

Need Communication Equipment?

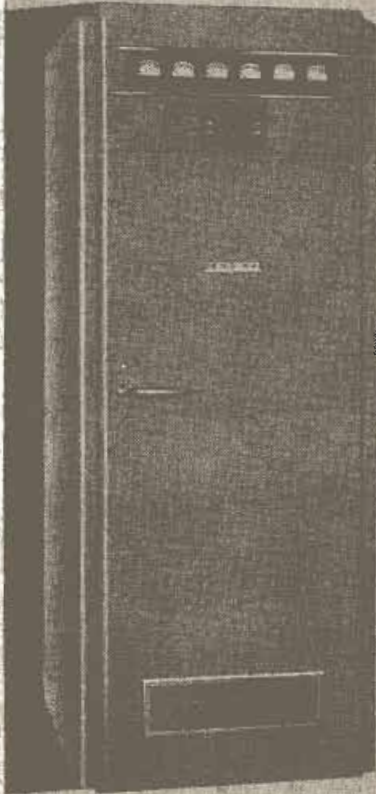

FM and AM Broadcasting

TEMCO will deliver within 30 to 60 days equipment for any of the following services:

- FM and AM BROADCASTING
- AVIATION and MARINE
- POLICE - FIRE - FORESTRY and PUBLIC UTILITY
- POINT - TO - POINT COMMERCIAL
- AMATEUR and CITIZEN

Send us your requirements for IMMEDIATE action

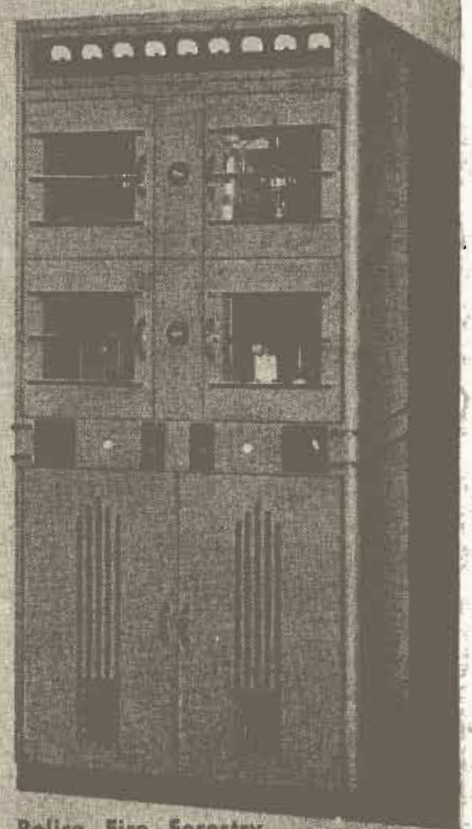

Police - Fire - Forestry and Public Utility

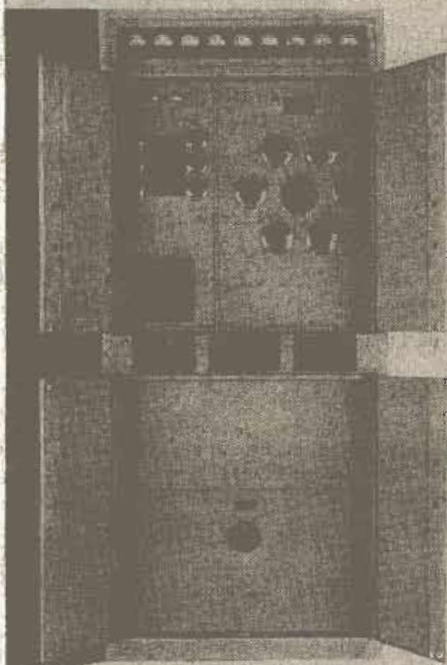

Point-to-Point Commercial

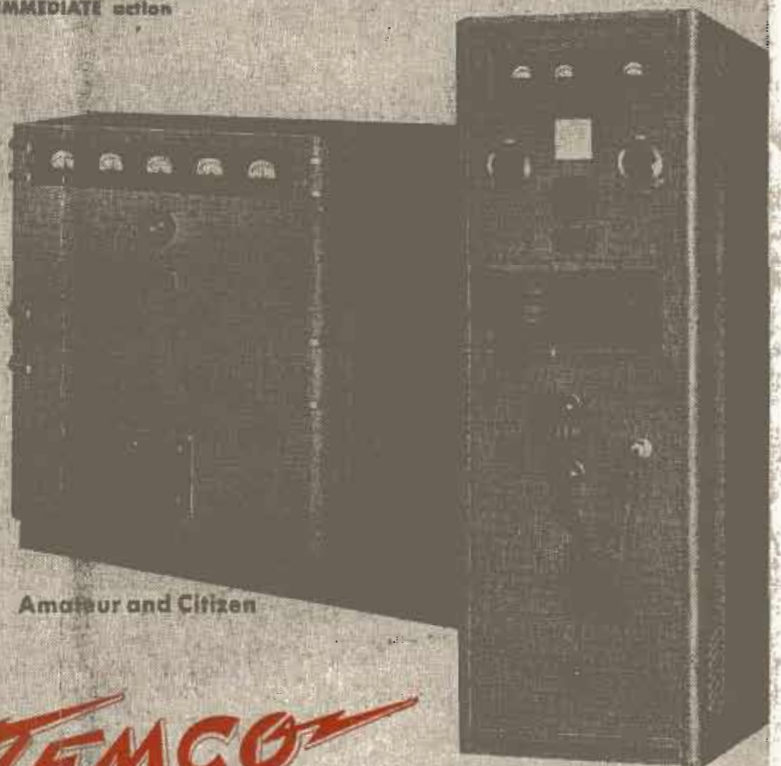

Amateur and Citizen

Aviation and Marine

TEMCO

**RADIO COMMUNICATION EQUIPMENT
TRANSMITTER EQUIPMENT MFG. CO., INC.**

345 Hudson Street, New York 14, N. Y.