

COMMUNICATIONS

INCLUDING "RADIO ENGINEERING" AND "TELEVISION ENGINEERING"



JUNE

★ V-H-F RAIL RADIO SERVICE IN TUNNELS

★ MOBILE 30-44 MC EQUIPMENT

★ MOBILE SERVICE V-H-F PROPAGATION SURVEYS

1947

* UNEXCELLED

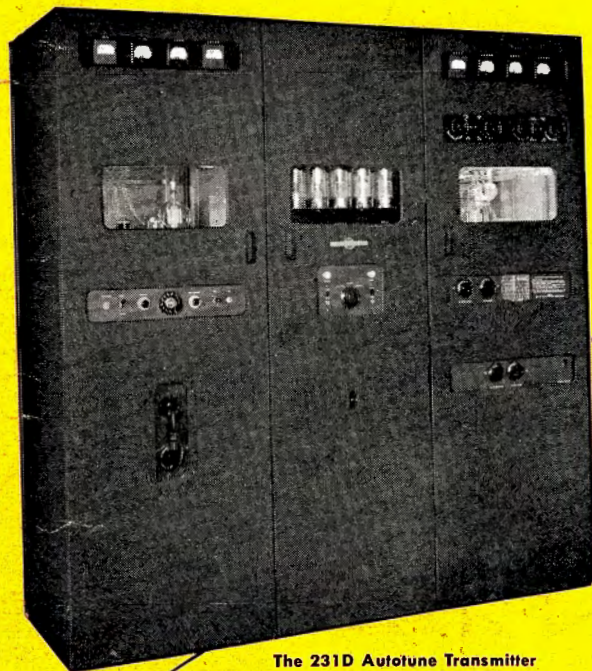

The 231D Autotune Transmitter
3 kw Phone, 5 kw CW

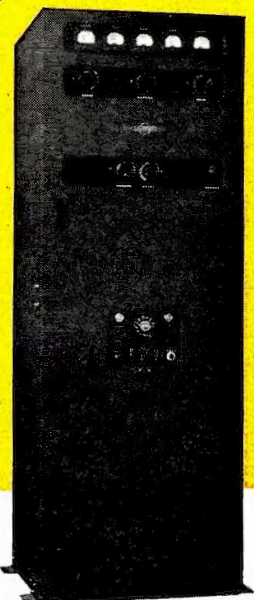

The 16F Autotune Transmitter
300 w Phone, 500 w CW



... for reliable communication

IMMEDIATE DELIVERY

You need a dependable, well engineered transmitter for point-to-point, ship-to-shore, or ground-to-plane commercial radio communication. The Collins 231D or the Collins 16F is the answer. These transmitters have proved themselves thoroughly reliable and efficient in all climates, and under difficult operating conditions.

Any one of eleven frequencies between 2.0 mc and 18.1 mc is available at the flip of a dial, with all circuits tuned and ready to operate. The widely acclaimed Collins Autotune system is utilized to shift the frequency quickly and accurately.

Compressor circuits are incorporated to raise the average modulation level during voice or MCW transmission. CW transmission is also available, with keying speeds of 60 wpm on MCW and 200 wpm on CW. Both transmitters can be adapted for frequency shift keying.

For dependable, trouble-free radio communication use either the 231D or the 16F. They are built for that purpose. Write today for free illustrated bulletins giving detailed information.

IN RADIO COMMUNICATIONS, IT'S ...



COLLINS RADIO COMPANY, Cedar Rapids, Iowa

11 West 42nd Street, New York 18, N. Y.

458 South Spring Street, Los Angeles 13, California

New... **FERRANTI**

ELECTROSTATIC VOLTMETERS

FOR AC AND DC MEASUREMENTS

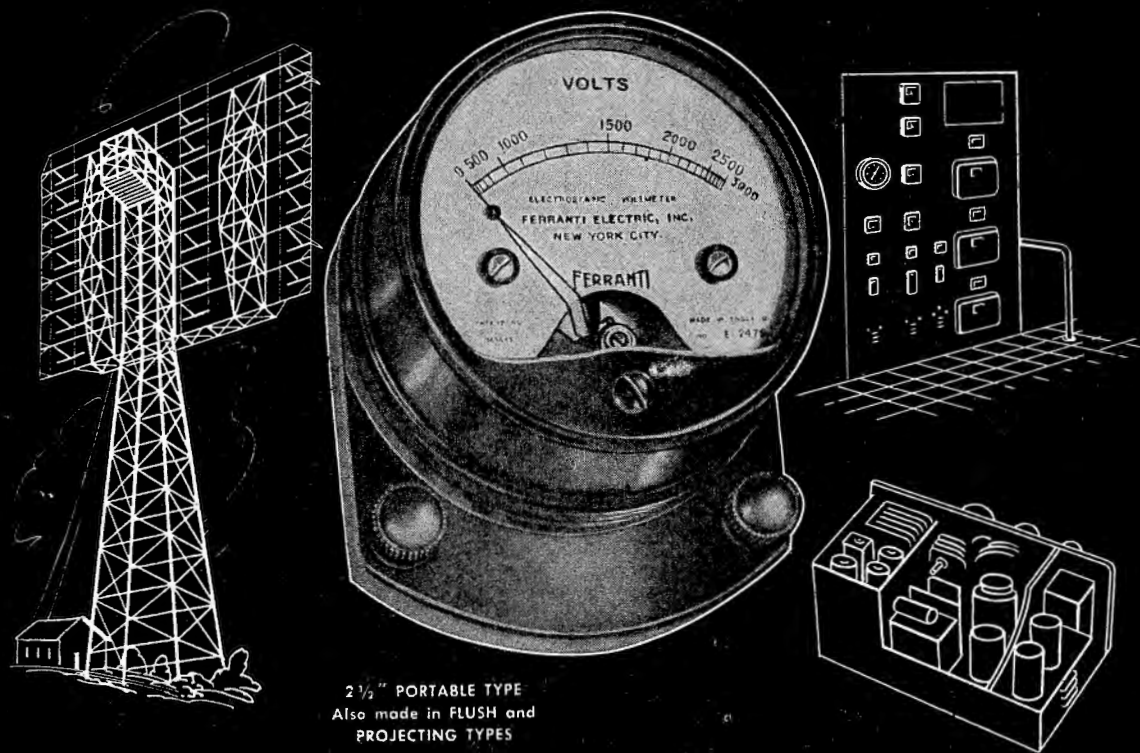

2 1/2" PORTABLE TYPE
Also made in FLUSH and
PROJECTING TYPES

- ZERO CURRENT CONSUMPTION • READING FROM 20 to 25,000 VOLTS • AC OR DC UP TO 3,500 VOLTS
- SELF-CONTAINED • OVER-VOLTAGE PROTECTION •
- 2 1/2 in. DIALS • SINGLE, DUAL AND TRIPLE RANGES
- MAGNETIC DAMPING • PRECISION BUILT, ACCURATE
- THOROUGHLY RELIABLE •

A Product of over 65 years of Ferranti experience

FERRANTI ELECTRIC INC., 30 ROCKEFELLER PLAZA, NEW YORK 20, N. Y.

COMMUNICATIONS

Including Television Engineering, Radio Engineering, Communication & Broadcast Engineering, The Broadcast Engineer. Registered U. S. Patent Office.

LEWIS WINNER

Editor

F. WALEN

Assistant Editor

Bryan S. Davis, President
 Paul S. Weil, Vice Pres.-Gen. Mgr.
 F. Walen, Secretary
 A. Goebel, Circulation Manager

Chicago Representative:
 Lawrence Wehrhelm
 5510 W. Lemoyne Ave., Chicago 51, Ill.
 Telephone MERrimac 7919

Cleveland Representative:
 James C. Munn
 2656 E. 128th St., Cleveland 20, Ohio
 Telephone CEDar 7783

Pacific Coast Representative:
 Brand & Brand
 1052 W. Sixth St., Los Angeles 14, Calif.
 Telephone Michigan 1732
 1085 Monadnock Bldg., San Francisco 5, Calif.
 Telephone Douglas 4475

Wellington, New Zealand: Te Aro Book Depot.
 Melbourne, Australia: McGill's Agency.

Entered as second-class matter, Oct. 1, 1937 at the Post Office at New York, N. Y., under the Act of March 3, 1879. Subscription price: \$2.00 per year in the United States of America and Canada; 25 cents per copy. \$3.00 per year in foreign countries; 35 cents per copy.

COVER ILLUSTRATION

Field testing 152 to 162-mc mobile radiotelephone system.
 (Courtesy Federal Telephone & Radio Corp.)

RAILROAD RADIO

V-H-F Railroad Communications in Tunnels.....J. P. Shanklin 16
Results of Tests in B. & O. Tunnel on 152-162 Mc, Using Directional Antenna, Transmission-Line Feed and Reflecting Wires to Minimize Signal Loss.

MOBILE EMERGENCY COMMUNICATIONS

V-H-F Propagation Surveys for Mobile Services.....Ralph G. Peters 20
Details on Equipment and Methods Used in Typical Surveys Today.
 Mobile F-M Communications Equipment for 30-44 Mc
 R. B. Hoffman and E. W. Markow 28
Small-Sized Radiotelephone Units for 2-Way Police, Fire, Ambulance, Patrol, etc. Services.

AERONAUTICAL COMMUNICATIONS

International Commercial Aviation Radiotelephone System..F. Vinton Long 24
Plan of Network System to Expedite Control of Air Traffic and Transmission of Reservation, Administrative and Airmen Notices.

MEASUREMENT EQUIPMENT

A V-H-F/U-H-F Noise and Field Intensity Meter.....Lewis W. Martin 32
Instrument for 88-400 Mc, Using Butterfly-Circuit Elements, Measures Radiated, Conductive and Inductive Amplitude of Noise, as Well as Field Intensities.

MONTHLY FEATURES

News and Views.....Lewis Winner 15
 Veteran Wireless Operators' Association News..... 30
 The Industry Offers..... 36
 News Briefs of the Month..... 46
 Advertising Index 48

Entire contents Copyright 1947, Bryan Davis Publishing Co., Inc.



Published monthly by Bryan Davis Publishing Co., Inc.
 52 Vanderbilt Avenue, New York 17, N. Y. Telephone MURray Hill 4-0170



EVERY DE MORNAY-BUDD WAVE GUIDE is Electrically Tested, Calibrated and Tagged

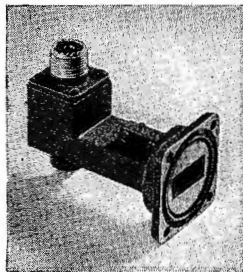

Crystal Mount DB-453

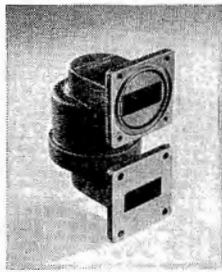

Rotating Joint DB-446



90° Elbow (H Plane) DB-433

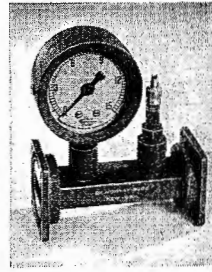

Pressurizing Unit DB-452

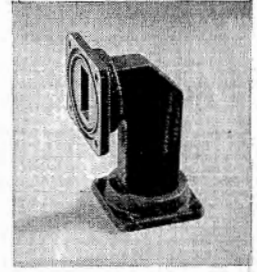

Mitered Elbow (H Plane) DB-439

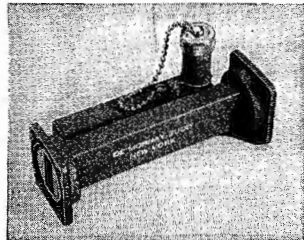

Uni-directional Broad Band Coupler DB-442

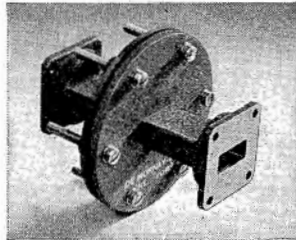

Bulkhead Flange DB-451

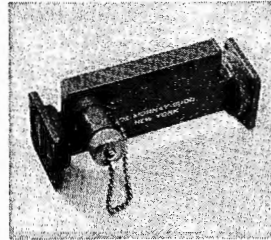

Uni-directional Narrow Band Coupler DB-440

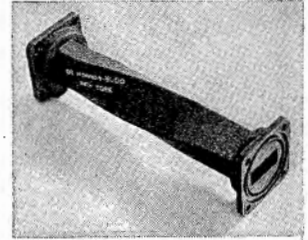

90° Twist DB-435

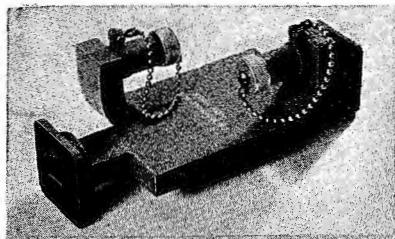

Bi-directional Narrow Band Coupler DB-441

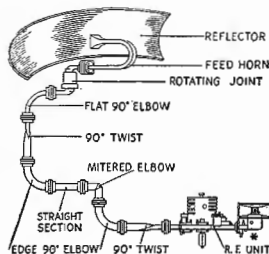

Typical wave guide assembly illustrating use of De Mornay-Budd components available from standard stocks.

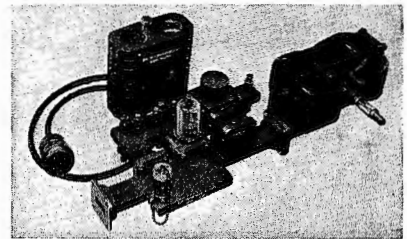

RF Radar Assembly DB-412

When you use any De Mornay-Budd wave guide assembly, you know exactly how each component will function electrically. You avoid possible losses in operating efficiency through impedance mismatches, or breakdown and arcing caused by a high standing wave ratio. (See chart below.)

De Mornay-Budd wave guides are manufactured from special precision tubing, and to the

most stringent mechanical specifications. Rigid inspection and quality control insure optimum performance.

NOTE: Write for complete catalog of De Mornay-Budd Standard Components and Standard Bench Test Equipment. Be sure to have a copy in your reference files. Write for it today.

The curve shows the manner in which the reflected power increases with an increase in the voltage standing wave ratio. The curve is calculated from the following equation:

$$\% \text{ Power Reflected} = \left(\frac{\left(\frac{V_{\max}}{V_{\min}} \right) - 1}{\left(\frac{V_{\max}}{V_{\min}} \right) + 1} \right)^2$$

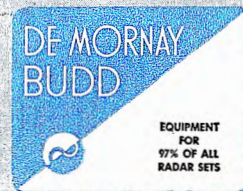
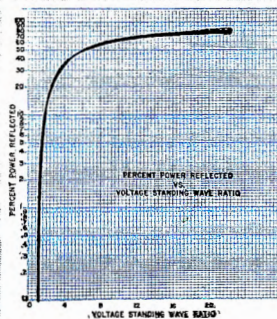

De Mornay-Budd, Inc., 475 Grand Concourse, New York 51, N. Y.

**THIS SPRAGUE
KOOLOHM...**

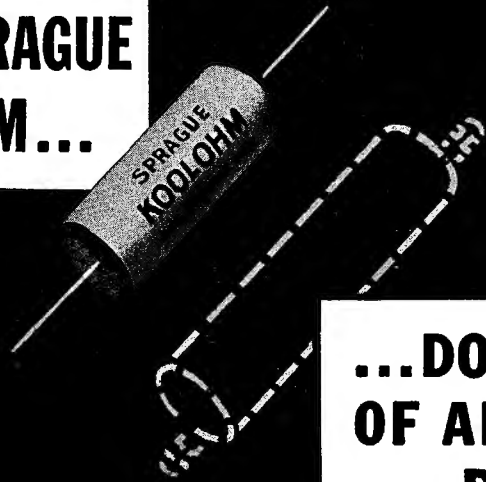

**... DOES THE WORK
OF AN ORDINARY
RESISTOR
THIS SIZE!**

ARE YOU BUYING LARGER RESISTORS THAN YOU ACTUALLY NEED?

The job called for an actual rating of 4.7 watts on a wire-wound resistor to be used in an enclosed space. As usual, the manufacturer planned to use a conventional 10-watt coated resistor—until a Sprague field engineer proved beyond doubt that a 5-watt Koolohm would do the trick with ample safety margin. This instance is typical of savings made possible by Koolohms. Wound with ceramic insulated wire, they dissipate heat faster, they're easier to mount—and can safely be used at full wattage ratings. Write for Catalog 10EA.

Sprague Electric Co., Resistor Division, North Adams, Mass.

**SPRAGUE
KOOLOHM**

Trademark Reg. U. S. Pat. Off.

**MOUNT
THEM
ANY WAY—
ANYWHERE**

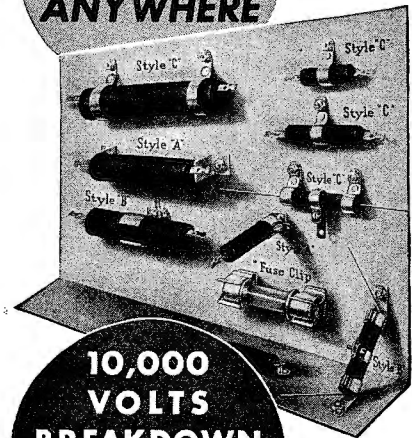

**10,000
VOLTS
BREAKDOWN
INSULATION**

From ceramic
outer shell to
ground

WIRE WOUND RESISTORS

PROFESSIONAL PERFORMANCE—that keeps the original sound alive!

**Stop
WOW!**



—with a positive drive at 33.3 and 78 rpm

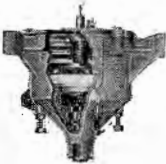

Remember this: When a listener becomes dissatisfied with the quality of your programs, he simply twists a dial. And in doing so, he also tunes out his pocketbook. So why jeopardize what is probably your best source of revenue—*your recorded programs!*

Professional recording and playback should be, and can be, 'WOW'-free. How? With the time-tested Fairchild direct-from-the-center turntable drive, shown above. It eliminates all variations in turntable speed. Evenness of speed is obtained by a carefully calculated loading of the drive mechanism to keep the motor pulling constantly; by careful precision control of all drive alignments that might cause intermittent grab and release; by carefully maintained .0002" tolerances in all critical moving parts.

Further aid to 'WOW'-free performance is provided by a perfectly balanced turntable with extra weight in the rim and a turntable clutch that permits smooth starting, stopping and shifting from 33.3 to 78 rpm in operation.

Fairchild's 'WOW'-free performance is available on professional Transcription Turntables, Studio Recorders and Portable Recorders. For complete information—and prompt delivery—address: 88-06 Van Wyck Blvd., Jamaica 1, New York.



Transcription Turntables
Studio Recorders
Magnetic Cutterheads
Portable Recorders
Lateral Dynamic Pickups
Unitized Amplifier Systems



Fairchild CAMERA
AND INSTRUMENT CORPORATION

SOUND EQUIPMENT



Why this team brings you better ELECTRON TUBES

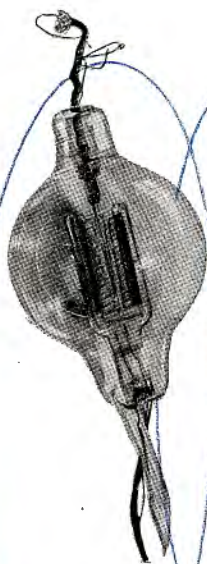

1912. The first effective high-vacuum tube, developed by the Laboratories for long distance telephony, was capable of operation at both audio and radio frequencies, and thus marked the beginning of modern electronics.



1918. This "peanut" tube, the Western Electric 215A, was developed for service in World War I. It was the first commercial tube whose filament was powered by a single dry cell . . . made possible compact, light weight radio equipment.

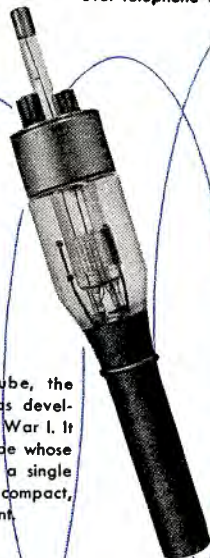

1919. The introduction of the copper-to-glass seal made water cooled tubes practical. The resulting high power tubes were used for broadcasting and for transoceanic radio-telephony.



1940. The beating oscillator, used in the great majority of radar systems. This tube generated a wave in the receiver with which the received microwave was reduced in frequency for amplification.

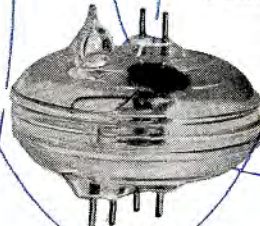

1937. This microwave generator, the 368A, was the first commercial tube to generate frequencies higher than 1500 mc. This type of tube was used by Western Electric in the first absolute altimeter.

1925. This was one of the earliest photoelectric cells. It was made by Western Electric for use in commercial picture transmission over telephone wires.



—QUALITY COUNTS—

1942. This tiny 6AK5, operating in the vicinity of 400 mc, proved itself invaluable as an amplifier in radar receivers. Design specifications were supplied to other manufacturers by Western Electric to speed war production.

1940. Bell Laboratories produced the first American multicavity pulsed magnetron from a British model. The team of Western Electric and Bell Laboratories developed 75 new and improved magnetron designs by extending operation into the 10 cm, 3 cm and finally the 1 cm bands, and produced over 300,000 of these wonder tubes of World War II.

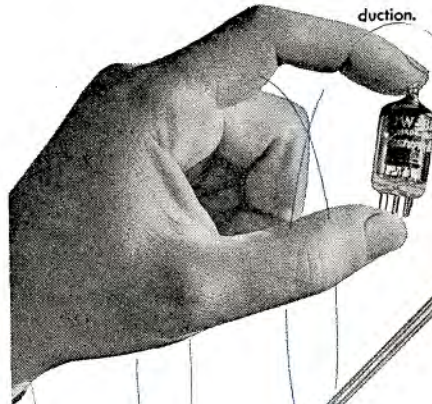

1945. The Bell Laboratories traveling wave tube, still in the research stage, amplifies over a band 40 times wider than present tubes—may be able to amplify dozens of color or black and white television programs, simultaneously.

TODAY. These new forced air cooled FM transmitting triodes are among the latest in the line of tubes designed by Bell Telephone Laboratories and made by Western Electric. Their thoriated tungsten filaments, rugged construction, flexible terminal arrangements and many other features make them tops in performance in the 88 to 108 mc band.

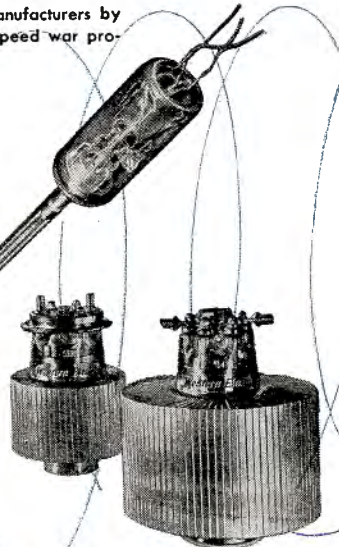
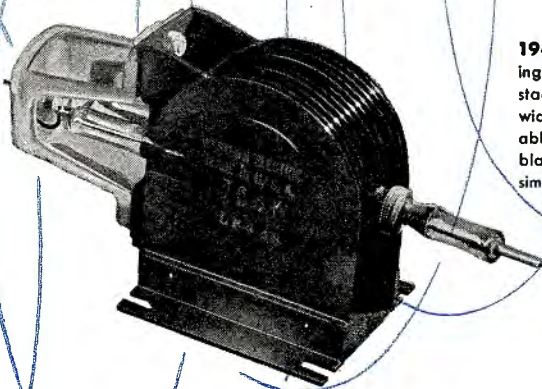

OVER 34 years ago in the laboratories of Western Electric, De Forest's Audion was improved and developed into the high vacuum tube and put to work for the first time amplifying telephone and radio frequency currents. And for over 34 years Western Electric and its research associate Bell Telephone Laboratories have been foremost in designing new and better electron tubes. Every tube shown here and many developments basic to the tube art are examples of that leadership. More than 10 years ago, for instance, Bell Laboratories first used microchemistry to determine what gases were destructive to tube elements, and with Western Electric developed a manufacturing technique to keep these damaging elements out—thus increasing tube life many-fold. Every one of the more than 300 codes of electron tubes now being made by Western Electric from Bell Laboratories' designs has the same unequalled background of research and manufacturing skill.



BELL TELEPHONE LABORATORIES

World's largest organization devoted exclusively to research and development in all phases of electrical communications.

Western Electric

Manufacturing unit of the Bell System and the nation's largest producer of communications equipment.

Listen IT'S A New Jensen SPEAKER

MODEL HNP-51 Coaxial with frequency range control adjusts performance to program quality

For home entertainment, studio, monitoring and moderately high-level sound reinforcement Jensen Model HNP-51 Coaxial has no equal at any price. Actually it is a loud speaker "system" consisting of two loud speakers and a frequency-dividing network. Frequency selector switch permits adjustment to program quality and insures correct frequency response whether operating with "FM," "AM," phonograph records or transcriptions. Cut-away section shows how precision construction and workmanship is combined with the achievement of Jensen engineering traditionally committed to the highest standards in the acoustic industry. The result creates another superlative Jensen product heading the family of Jensen Coaxial speakers ranging in price from \$30.00 to \$125.00.

All Jensen Coaxials are available in a variety of "Bass Reflex" Cabinets to make complete Reproducers. List prices of complete reproducers range from \$84.00 to \$212.00.

Ask for Data Sheet No. 136 and get complete information about Jensen Coaxial Speakers and Reproducers—all are now ready for immediate delivery. A new 24-page Jensen Catalogue also awaits your request.

*Trade mark registered

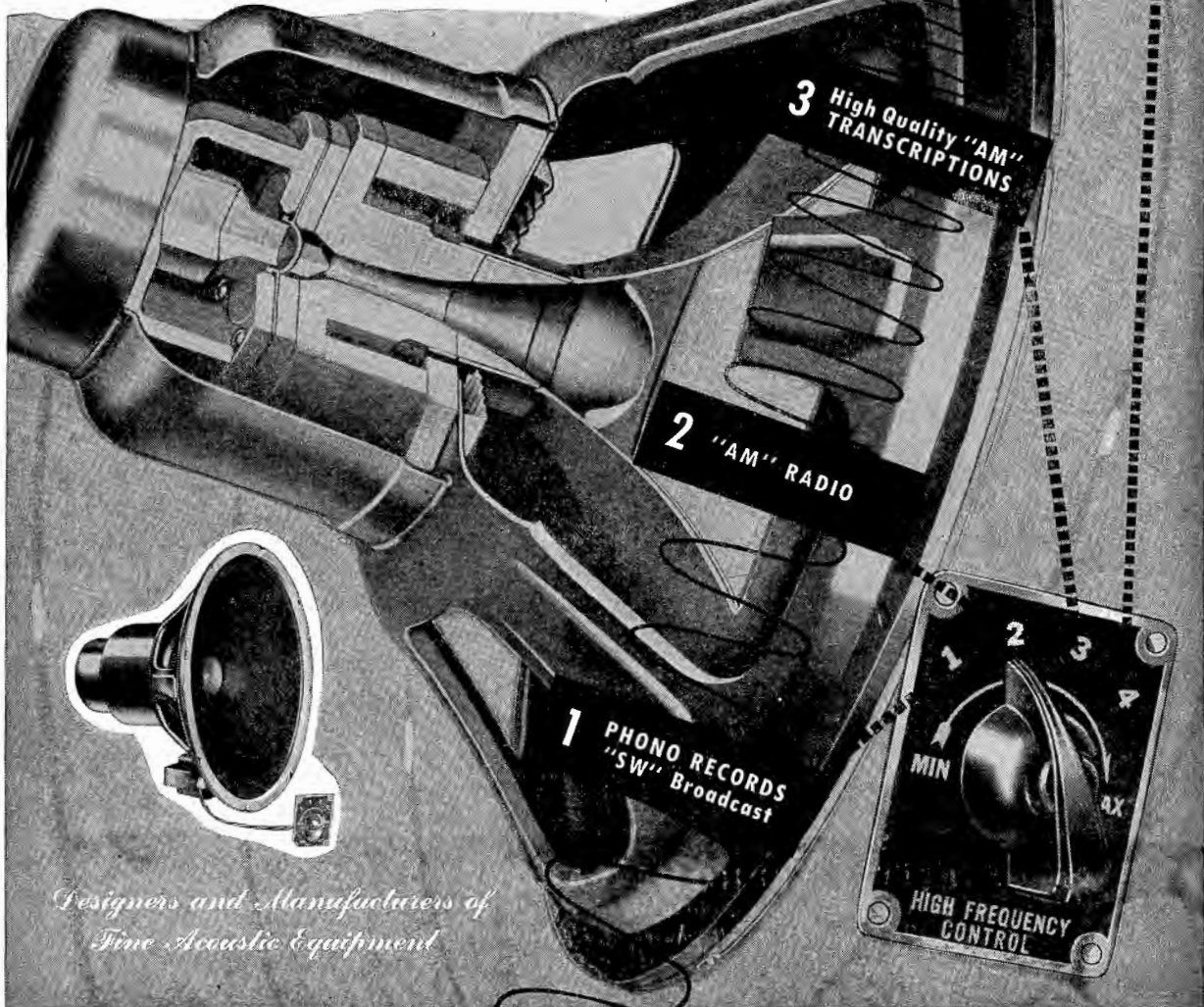

*Designers and Manufacturers of
Fine Acoustic Equipment*

**JENSEN MANUFACTURING CO., 6603 S. LARAMIE AVE., CHICAGO 38, U.S.A.
IN CANADA: J. R. LONGSTAFFE, LTD., 11 KING STREET, TORONTO**

WILCOX 2500 WATT

Transmitter

*Performance
Easy Maintenance
Dependability*

The WILCOX 96C Transmitter is used throughout the world by the Army Air Force Communications System, and by foreign and domestic air-carriers. It has earned the respect of operators and engineers because:

- ✓ **1 SIMULTANEOUS CHANNEL OPERATION** on several frequencies brings new flexibility and operational ease; increases by 3 times the volume of traffic normally handled
- ✓ **2 INSTANTLY REMOVABLE COMPONENTS** make maintenance easy. The transmitter slides from its cabinet like a desk drawer. Plugs, receptacles, and clips make all components easily removable for servicing while adjacent channels continue to operate.
- ✓ **3 RESEARCH AND ENGINEERING** combined with modern production techniques have produced a transmitter capable of sustained operation through all conditions of temperature, humidity, and weather.



Write for Free Catalog...

DEPENDABLE COMMUNICATION

WILCOX ELECTRIC COMPANY, INC. • *Kansas City 1, Missouri*



**FOR COMBINATION
AM-FM BROADCASTING**

This recent installation shows a Blaw-Knox 280 ft. self-supporting insulated Vertical Radiator for AM, topped by an FM antenna.

With Blaw-Knox experience in tower construction dating back to the birth of commercial radio, the broadcasting station had full confidence in the ability of Blaw-Knox to design, build and erect this new type of structure.

**BLAW-KNOX DIVISION
OF BLAW-KNOX COMPANY**

2108 Farmers Bank Building
Pittsburgh, Pa.

BLAW-KNOX ANTENNA TOWERS

★ ANSONIA ★ Ankoseal

will not support Combustion

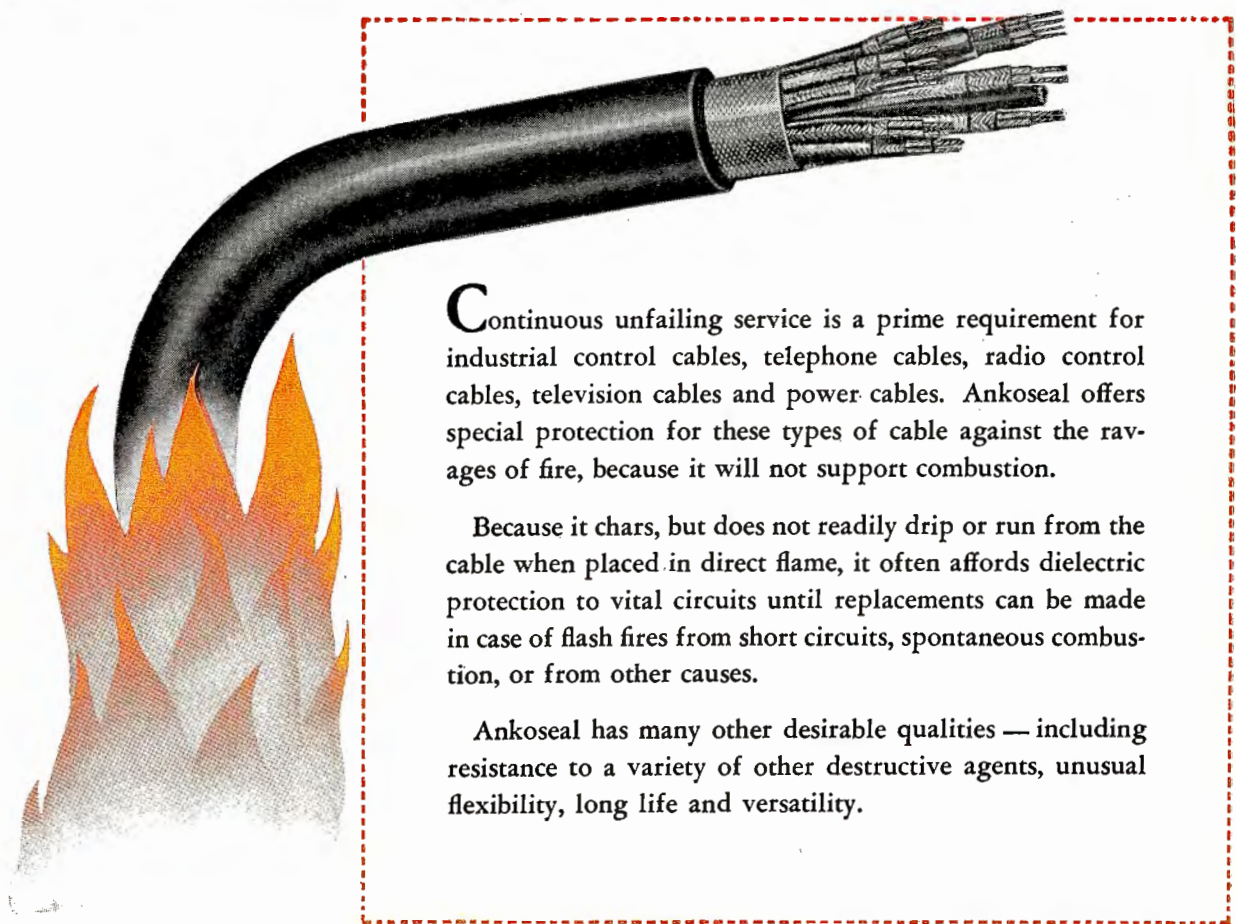

Continuous unfailing service is a prime requirement for industrial control cables, telephone cables, radio control cables, television cables and power cables. Ankoseal offers special protection for these types of cable against the ravages of fire, because it will not support combustion.

Because it chars, but does not readily drip or run from the cable when placed in direct flame, it often affords dielectric protection to vital circuits until replacements can be made in case of flash fires from short circuits, spontaneous combustion, or from other causes.

Ankoseal has many other desirable qualities — including resistance to a variety of other destructive agents, unusual flexibility, long life and versatility.

THE ANSONIA ELECTRICAL DIVISION

ANSONIA, CONNECTICUT *of*

NOMA ELECTRIC CORPORATION

**SEE
YOUR
DISTRIBUTOR**

**for
electronic**

There are still millions of dollars worth of war surplus transmitters, receivers, tubes and various other types of electronic equipment being offered for sale to manufacturers, jobbers and wholesalers.

This may be your once-in-a-lifetime opportunity to take advantage of these bargains. All you do is contact one of War Assets Administrations approved distributors and learn what is available.

For your convenience we are listing the names and addresses of those companies appointed to serve you. They will be happy to quote items, price and delivery. Just call, write, or phone and see how *you* can "Save with Surplus."



OFFICE OF AIRCRAFT AND ELECTRONICS DISPOSAL

WAR ASSETS ADMINISTRATION



Offices located at: Atlanta • Birmingham • Boston • Charlotte • Chicago
Cincinnati • Cleveland • Denver • Detroit • Grand Prairie, Tex. • Helena
Houston • Jacksonville • Kansas City, Mo. • Los Angeles • Louisville • Minneapolis
Nashville • New Orleans • New York • Omaha • Philadelphia • Portland, Ore.
Richmond • St. Louis • Salt Lake City • San Antonio • San Francisco • Seattle • Spokane • Tulsa



equipment

American Condenser Co.
4410 No. Ravenswood Avenue
Chicago 40, Illinois

Automatic Radio Mfg. Co., Inc.
122 Brookline Avenue
Boston 15, Massachusetts

Belmont Radio Corporation
3633 So. Racine Avenue
Chicago 9, Illinois

Carr Industries Inc.
1269 Atlantic Avenue
Brooklyn 16, N. Y.

**Communication Measurements
Laboratory**
120 Greenwich Street
New York 6, New York

Cole Instrument Co.
1320 So. Grand Avenue
Los Angeles 15, California

Electronic Corporation of America
353 West 48th Street
New York 19, N. Y.

Electro-Voice, Inc.
Carroll & Cecil Streets
Buchanan, Michigan

Emerson Radio & Phonograph Corp.
76 Ninth Avenue
New York 11, N. Y.

Essex Wire Corporation
1601 Wall Street
Ft. Wayne 6, Indiana

General Electric Company
Building 267, 1 River Road
Schenectady 5, New York

General Electronics Inc.
1819 Broadway
New York 23, N. Y.

Hammarlund Mfg. Company, Inc.
460 West 34th Street
New York 1, New York

Hoffman Radio Corporation
3761 South Hill Street
Los Angeles 7, California

Hytron Radio & Electronics Corp.
76 Lafayette Street
Salem, Massachusetts

Johanns & Keegan Inc.
62 Pearl Street
New York 4, N. Y.

E. F. Johnson Company
206 Second Avenue, S. W.
Waseca, Minnesota

National Union Radio Corporation
57 State Street
Newark 2, New Jersey

Navigation Instrument Co., Inc.
P. O. Box 7001, Heights Station
Houston, Texas

Newark Electric Co., Inc.
242 West 55th Street
New York 19, New York

Radio Parts Distributing Company
128 W. Olney Road
Norfolk 10, Virginia

Smith-Meeker Engineering Company
125 Barclay Street
New York 7, N. Y.

Southern Electronic Company
611 Boronne Street
New Orleans, Louisiana

Standard Arcturus Corporation
99 Sussex Avenue
Newark 4, New Jersey

Sylvania Electric Products, Inc.
Emporium, Pennsylvania

Technical Apparatus Company
165 Washington Street
Boston 8, Massachusetts

Tobe Deutschmann Corporation
863 Washington Street
Canton, Massachusetts

Tobe Deutschmann Corporation
6919 San Fernando Rd.
Glendale, California

Tung-Sol Lamp Works, Inc.
95 Eighth Avenue
Newark 4, New Jersey



W & H Aviation Corporation
Municipal Airport
Rochester 3, New York

1118

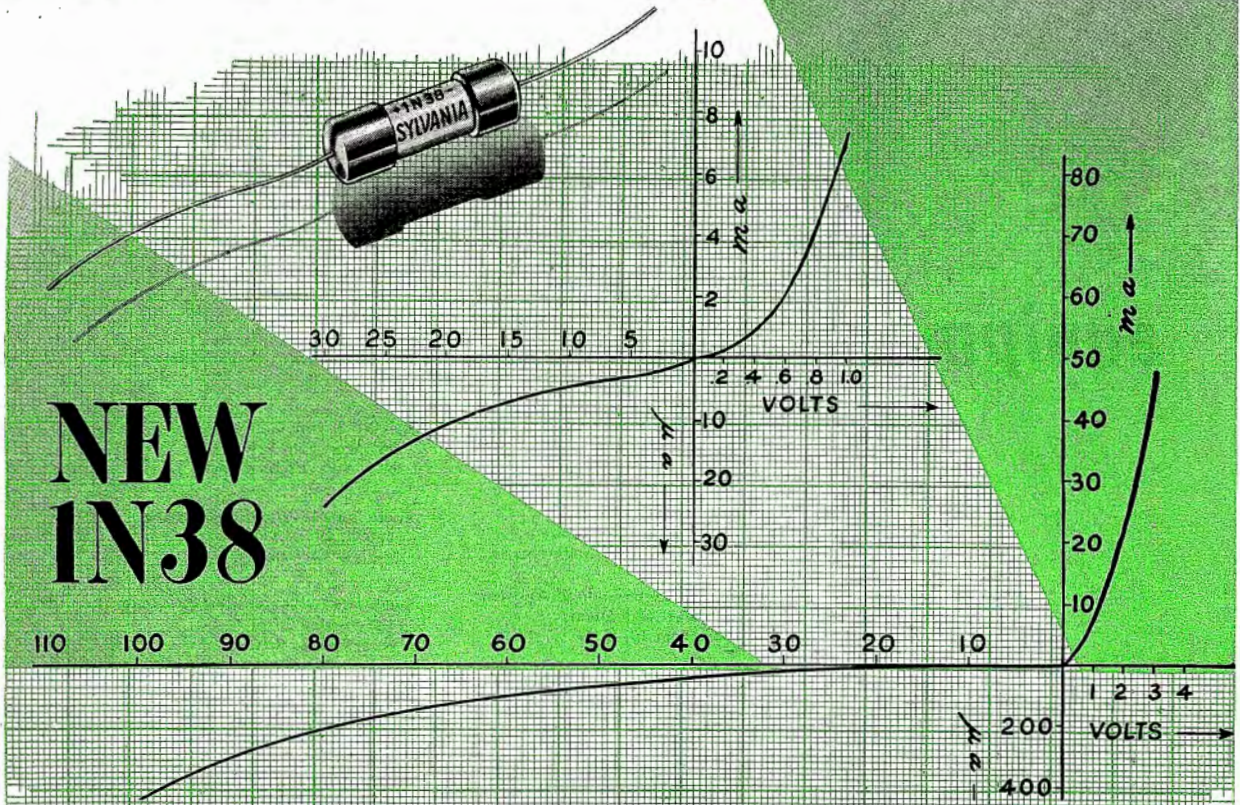
HIGH VOLTAGE FREQUENCY TEMPERATURE CRYSTAL



**NEW
1N38**

-  **HIGH VOLTAGE.** The new Sylvania 1N38 Crystal is designed for a back voltage of 100 volts maximum.
-  **HIGH FREQUENCY.** With its shunt capacitance of only 0.8 to 1.1 μf , the 1N38 is ideal for high frequency use.
-  **HIGH TEMPERATURE.** Rectification efficiency decreases only .0007% per degree temperature rise from 27° to 75° C.

Newest addition to the Sylvania family of Germanium Crystals, the 1N38 is of compact, space-saving design. Pigtail leads permit easy soldering into position.

Back resistance is as high as 2½ megohms.

Minimum life is 5,000 hours at 22.5 ma DC.

Write for full details

Electronics Division, 500 Fifth Avenue, New York 18, N. Y.

SYLVANIA ELECTRIC

COMMUNICATIONS

LEWIS WINNER, Editor

JUNE, 1947

V-H-F AND THE CAA

V-H-F COMMUNICATIONS received quite a tribute from CAA Administrator T. P. Wright recently, who during an address before an airport user's conference, declared that the . . . "biggest CAA news is *v-h-f communications*."

"V-h-f," he said, "will supply a most welcome relief from the aural punishment which pilots have been taking for years."

Stressing the importance of the v-h-f omnidirectional range, he predicted that this method of transmission will change the whole airways picture. For, he said, instead of four legs or courses as now transmitted on the l-f ranges, the v-h-f range will transmit courses in all directions, a course selector being used to select the course to be flown.

Wright said that the v-h-f range will multiply the capacity of our airways for scheduled and non-scheduled flights. The ranges will be placed about 100 miles apart so that their signals will blanket the country and pilots will have a radio course from anywhere to anywhere.

The system will also mean much to the feeder airlines, cited Wright. When all the v-h-f ranges are in, and all operations are shifted from the l-f channels, everybody, including the feeders, he said, will have an airway from everywhere to everywhere.

Wright also emphasized the potential uses of v-h-f distance-measuring equipment; described at the recent IRE meeting in New York City and analyzed in a paper report in the March issue of COMMUNICATIONS. This system provides the pilot with a continuous indication, on a simple dial, of the distance from the point to which he is tuned.

The use of v-h-f and u-h-f for landing guidance in ILS and radar systems will also see wide supplemental application, Wright declared. Airports in Washington, Chicago and New York City have already had radar systems installed and scores of

airports are in line for installations.

The use of airborne radar as an aid in flying the rugged coastal route of Alaska was also reported recently by CAA. Installed in a Grumman amphibian, the radar system has made it possible to fly for miles at less than 1,000 feet on instruments. Pilots have reported that the system would make it quite safe to fly in a dense fog or heavy snow with visibility as low as one-eighth of mile.

CAA airways flight inspector chief Arthur E. Jenks has prepared a book on v-h-f aviation communications that's *must* reading. The book, entitled "Flying the Instrument Landing System," is based on more than 3,000 hours of v-h-f test and diagnostic flying.

Looks like quite a v-h-f year!

THE WHITE BILL

SIGNIFICANT CHANGES IN THE COMMUNICATIONS Act of 1934, proposed in the new White-Wolverston Radio Bill, are being scrutinized carefully by industry and government. There are a few sections, in particular, which are receiving the "fine-tooth-comb treatment" . . . sections 4 and 5. Section 4 takes from the President the authority to name the chairman of the FCC. And section 5 states that the FCC shall select, annually, one of its members as chairman. This section also provides for a sub-division of the commission into *broadcast* and *common carrier* divisions.

It's been indicated that the rotating chairmanship would eliminate the effectiveness of the post. And the sub-division idea has not been received too favorably either, it being felt that the change would cause hearing delays and confusion.

The technical facilities of the FCC, stressed in the bill, receive continued authority to regulate equipment standards and control technical operations of stations.

There'll be rows of hearings and then the roll call and all-important vote decision which may come in the early Summer.

IN THE NEWS THIS MONTH

THE P-A SYSTEM has now come to the aid of the baseball umpire at home plate. A gentleman in Philadelphia has received a patent on a system which provides a microphone under the protective mask and contact to an amplifier through metal plates on the shoes.

There'll be a real roar to the strike and ball calls when this system finds its way into the ball parks.

QUITE A COMPREHENSIVE apartment house tv-antenna agreement has been prepared by the TBA, and accepted by several realty groups in New York City.

The agreement, a three-page legal affair, includes complete details on installation provisions, building codes, accident insurance, site selection, use of antenna by one or more tenants, responsibilities assumed by installer and user, and so on.

Yes, it's quite a document, but it solves an important problem and the TBA antenna groups are to be congratulated on gaining this realty acceptance.

TEN MANUFACTURERS HAVE RECEIVED FCC-standards approvals for their f-m transmitters ranging from 250 watts to 50 kw. Three types of frequency and modulation monitors have also been approved.

Incidentally f-m broadcasters have certainly multiplied during the past months. There are now about 215 stations on the air. And FCC says that it won't be long before 500 different communities in 47 states will be served by f-m.

THE 25TH ANNUAL NAB CONVENTION will be held in Atlantic City, September 15-18, in Convention Hall, with quite an equipment exhibition and series of broadcast engineering clinics. COMMUNICATIONS will publish a complete report on the affair. Watch for it.—L. W.

V-H-F Railroad Communications

THE ATTENUATION OF SPACE RADIO SIGNALS within tunnels presents a problem which is not insurmountable, but quite a challenge from an economic and engineering point of view.

In v-h-f band tunnel-transmission tests, it has been found that the masonry or rock walls of railroad tunnels form poor boundaries; if the tunnel were to be considered as a wave guide, masonry performs as a poor dielectric. Repeated reflections from such surfaces soon absorb the signal.

In preliminary tests in an abandoned brick-lined water tunnel, circular in cross section and 8' in diameter, attenuation of signals in the 156-mc range was found to be 106 db per 200 feet. It was found though that signals could be carried through a tunnel on a transmission line, with the transmission line placed in the crown of the tunnel and arranged so that there would be no coupling into the high-loss tunnel walls, nor an appreciable electrical field within the tunnel. The transmission line had to be designed so that the signal loss was minimized. This was achieved by placing reflector wires above the transmission line in the tunnel crown. Practical means of bringing space radio signals from outside, to trains moving within the tunnel, was achieved by terminating both ends of the transmission line into outside directional antennas.

By the use of such a system, engine-to-caboose communication may be made continuous as the train ap-

proaches and actually passes through the tunnel. For instance, when the engine has entered the tunnel, the signal from the caboose, still being outside, is picked up by the antenna at the tunnel mouth and fed directly into the transmission line within the tunnel, thus reradiating the signal to the locomotive. Tests also proved that after both ends of the train were within the tunnel the transmission line effectively served to link locomotive and caboose by reradiation of the signal. Likewise, the locomotive after it had emerged, fed the signals to the antenna at the opposite end by space propagation.

Preliminary Tests

The preliminary field tests in the abandoned water tunnel were conducted in a portion of the tunnel curved on a 500' radius. A vertically polarized transmitting antenna was mounted just outside the mouth of the water tunnel. A hand-cart using two bicycle wheels was improvised to carry a superheterodyne receiver-type field strength meter. The receiving antenna was a vertical top-loaded quarter-wave type which was worked against a quarter-wave radius rod ground plane. This antenna was mounted on a short mast on the hand-cart which was placed as far away from the operator as possible to minimize the effect of the operator's body on readings. However, due to reflec-

tions and the difficulty of maintaining the cart in a level position on the curved floor, voltage readings were considered to be at least 10% inaccurate. The cart was pushed through the tunnel and readings were taken at 25-foot intervals. Using these voltage readings the attenuation in db per unit length of tunnel was calculated for the various transmission lines which were used in the tests. Figure 1 shows the relative positions of the transmission line under test, also the receiving antenna and equipment which was installed on the cart.

Three different transmission lines were tried and for each test 300' of line was constructed. The physical arrangement of the transmission lines may be seen in Figure 2 (a, b, c). To minimize wall absorption reflecting lines were placed above the transmission line. The arrangement c in Figure 2 was used as a prototype similar to the final installation. A record of signal attenuation appears in Table 1, p. 19. These tests showed that the shielding of the transmission line from the tunnel roof by reflecting wires was of major importance.

It was assumed that the relative field strength received from the transmission line would follow the relations governing the fields around an antenna:

$$E = C I_v \left[\frac{2\pi}{d\lambda} - j \frac{1}{d^2} \right] \quad (1)$$

East portal of the Mt. Airy tunnel showing the radio transmission lines. The double-wire feedline at the upper part of the illustration is connected to the rhombic antenna placed atop of the tunnel.

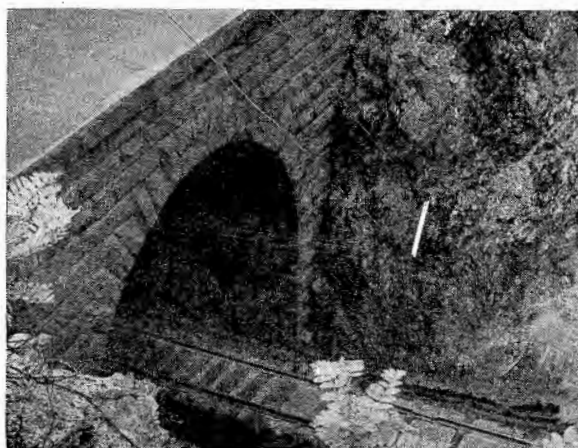

Overhead catenaries or cross wires supporting the v-h-f redistribution antenna, as seen from the west end of the Mt. Airy Tunnel. Wire runs out of the tunnel roughly paralleling the tracks for a short distance.



IN TUNNELS

Tests on 152 to 162 mc, Conducted in Abandoned Water Tunnel and B. & O. Railroad Tunnel at Mt. Airy, Maryland. Signals Fed Into Transmission Lines Via External Directional Antenna. Reflecting Wires Served to Minimize Signal Loss.

by J. P. SHANKLIN

Project Engineer
Bendix Radio, Div. of Bendix Aviation Corp.

where:

E = relative voltage of field

d = distance from the line

λ = wavelength

I_L = line current

C = a constant of proportionality

This equation states that the radiation field, $C I_L \frac{2\pi}{d\lambda}$, varies inversely as distance, and the induction field, $C I_L \frac{1}{d^2}$, varies inversely as the square of distance and is at 90° phase angle

to the radiation field. At $d = \frac{\lambda}{2\pi}$ the two are equal. In the case of the transmission line d was taken to be approximately equal to the distance from a point half way between the high side of the line and the ground plane, and a point at the current center of the antenna. In the case of the top loaded quarter-wave antenna used this would be near the center of the vertical antenna. The constant C will depend on line spacing and was not determined for the water tunnel lines. However, the voltage received was measured at varying distances from the five-wire line C of Figure 2; this

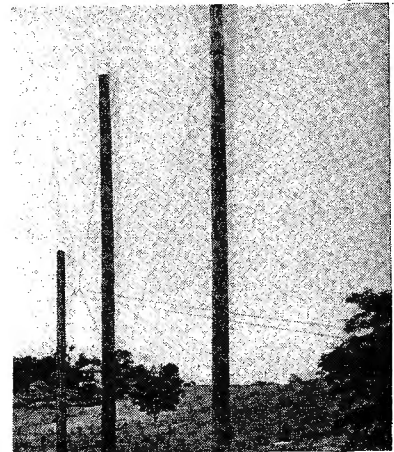

Directional rhombic antenna installed near the east entrance of the Mt. Airy tunnel in Maryland. The diamond shaped antenna may be seen faintly supported on either side of the central pole.

is plotted in Figure 3 and compared with a plot of equation (1).

Railroad Tunnel Used for Final Tests

After these preliminary tests an installation was next made in the Baltimore and Ohio Railroad tunnel at Mt. Airy, Md. This is a double-track brick-lined tunnel 2,760' long. The line (surge impedance of 324 ohms) used in this installation is shown in Figure 4. The line may be considered to have half the surge impedance of a

Figure 2
Physical arrangement of the transmission lines. Arrangement in C was used in final setup.

Figure 1
Relative positions of the transmission line under test; also the receiving antenna and equipment.

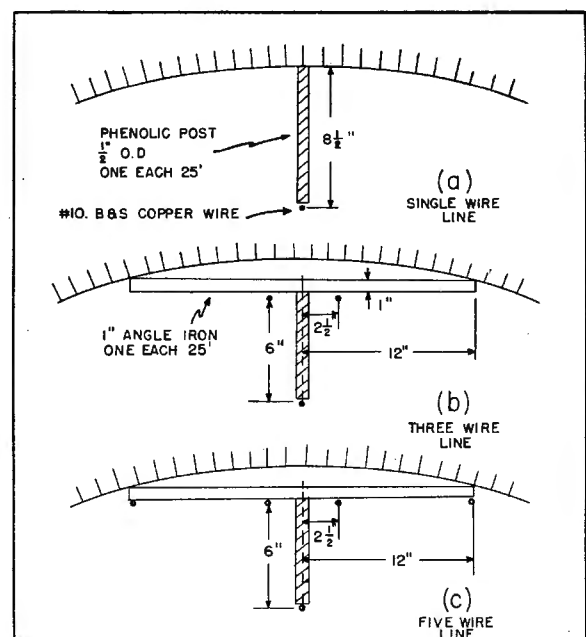
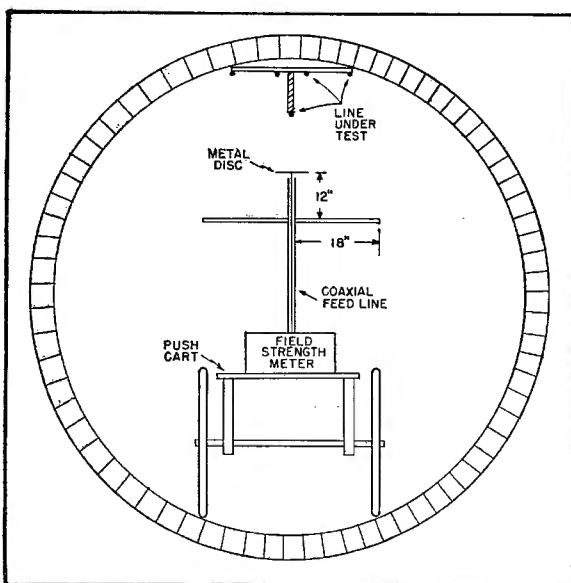

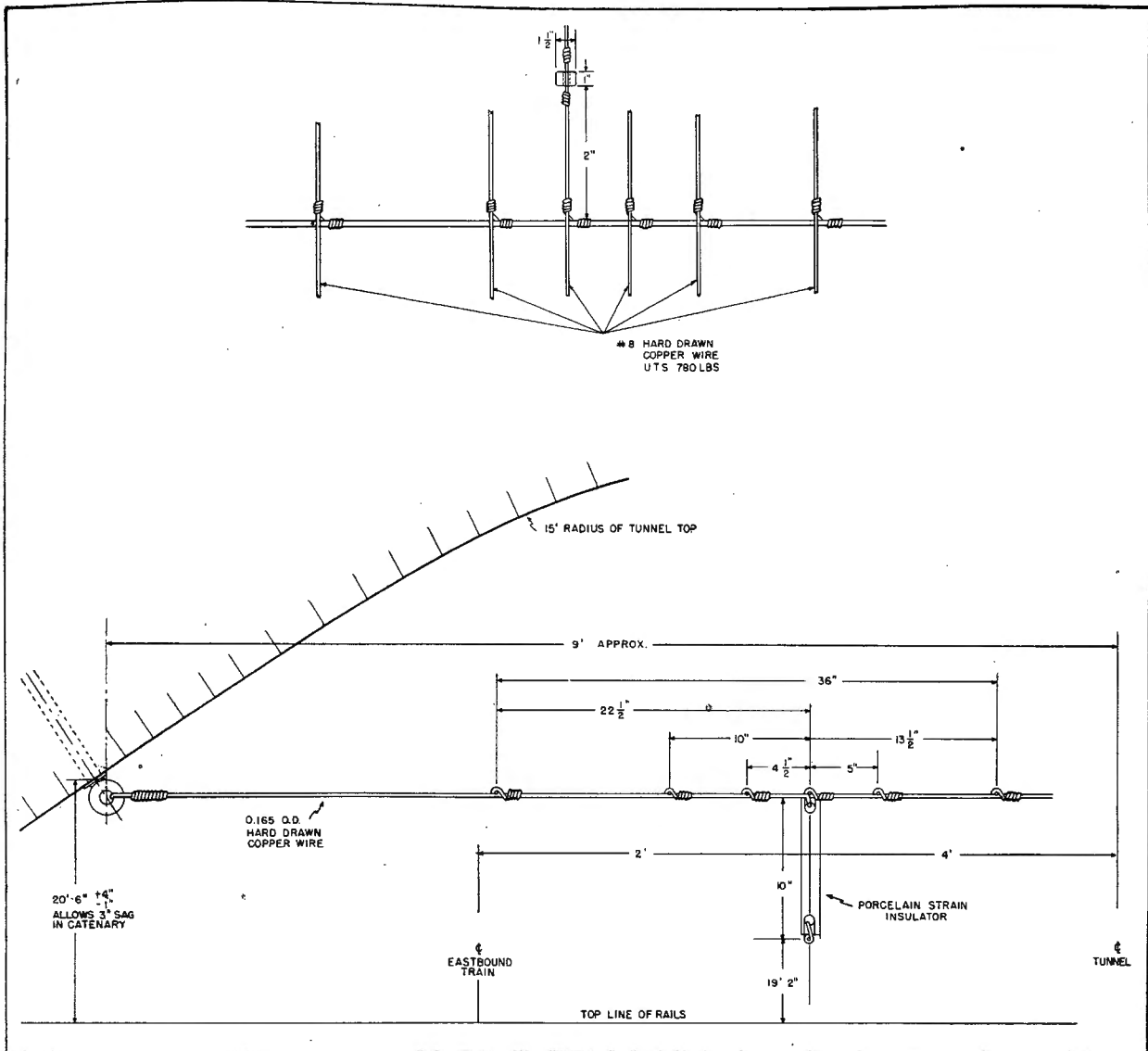

Figure 4
Installation setup in B. & O. tunnel at Mt. Airy, Md.; a double-track-lined tunnel 2,760' long.

balanced line with twice the spacing between the insulated wire and the ground plane, as the ground plane supplants the virtual ground plane which exists through the center plane of a balanced line. This unbalanced line was transferred to a balanced line at the tunnel entrances by drawing the ground plane wires gradually together to a point (Figure 5). The balanced line (575 ohms surge impedance) was then fed into a rhombic antenna located on top of the tunnel out at either tunnel mouth (Figure 5). These rhombics, with a theoretical gain of 15 db, were directed at the track one mile distant from the tunnel.

For test purposes two 10-watt output transmitters were located along the tracks; one .7 mile from the west portal of the tunnel and one 1.2 miles from the east portal of the tunnel. These fed vertical coaxial dipoles

mounted at the same distance above rail tops, as though mounted on a train.

The match between the rhombic antennas and the balanced feed lines, and the feed lines and tunnel line, was investigated by measuring the standing wave on the lines with a probe antenna connected to the field strength meter. To investigate the matches at the east end of the tunnel the west-end transmitter was turned on and then the process was repeated to investigate the match at the west-end. The signal would then be coming out of the tunnel at the end under investigation and standing waves would be created by a mismatch. In no case was the voltage standing-wave ratio

greater than 2 to 1 and as this would result in losses in the order of only 1 db, no artificial matching in was necessary.

The field strength meter was then mounted on a scaffold car which had been used in construction of the tunnel line and readings taken at 100-foot intervals through the tunnel. Only the four center wires of the six-wire ground plane were installed at first. This line showed a total attenuation of 32 db. The two center ground plane wires were then installed and the attenuation dropped to 15.6 db. Of this loss, 3 db was due to a slight curve 1,000' inside the tunnel at the east end. The theoretical loss of the copper line was 1.01 db per 1,000' or 2.8 for 2,760'. The remaining 12.8 db was probably due mostly to tunnel wall absorption. Reflection at the insulators was so

slight that it produced no measureable standing wave.

To meet the clearance requirements demanded by the railroad it was necessary to have a five-foot gap between the trainboard antenna and the lower wire of the tunnel line. This resulted in a 31.3 db drop from the total signal actually present on the transmission line and that picked up on the train.

The space drops in the propagation distances outside the tunnel were the largest involved. These were 85.8 db for the .7 mile at the west-end and 99.1 db for the 1.2 miles at the east-end. Neither path of propagation was line-of-sight. However, had dipole antennas been used instead of the rhombic type, the additional drop would have been approximately 15 db.

Using a 10-watt transmitter and taking 2 vu on a 50-ohm impedance cable as a minimum commercially usable signal, a total drop of 141 db may be tolerated.

The various drops encountered in the railroad tunnel tests were:

- .7 mile of space at west end... 85.8 db
- .5 mile of tunnel line..... 15.6 db
- 4' tunnel line to train..... 31.3 db
- 1.2 mile—total attenuation.... 132.7 db
- 1.2 mile of space at east end.... 99.1 db
- .5 mile of tunnel line..... 15.6 db
- 4' tunnel line to train..... 31.3 db
- 1.7 mile—total attenuation..... 146.0 db

Type of Transmission Line	Attenuation db per 100'
None	35.4
a.....1 wire	26.0
b.....3 wire	4.4
c.....5 wire	Negligible

Table 1
Record of signal attenuation

The above attenuations were measured as a total and as separate drops with substantial agreement between the single total and the sum of the separate drops.

The last total attenuation exceeds the allowable attenuation. However, few freight trains are as much as a 1.7 miles long. Also had the tunnel line been extended some distance down the tracks outside the tunnel the space drop could have been greatly decreased with the addition of a small amount of line attenuation. Such an out-of-the-tunnel line need be only a two-wire balanced line as no shielding from high loss material is necessary outside the tunnel.

The installation as demonstrated in these tests was considered to be satis-

factory from a practical railroading point of view. It was proved that space radio communication can be maintained on trains operating in tunnels.

The tests indicated that a careful selection of wire used for transmission lines is imperative. These tests made use of copper wire for the transmission line. However it is known that few metals will withstand the corrosive stack gases of a steam engine. However, some of the stainless steels have proved useful in tests run by the Baltimore and Ohio Railroad, the wire being virtually unaffected by combustion gases. It is also of interest to note that these steel alloys are not magnetic and while their electrical resistance is about 6.5 times that of a similar copper conductor at v-h-f frequencies, it would still seem to be practical to build a tunnel line of stainless steel. The major part of the 15-db line attenuation in the Mt. Airy tunnel was due to tunnel-wall absorption. If such a line were constructed of stainless steel using No. 0-B&S gauge for the insulated strand and No. 15 B&S gauge for the six-ground plane wires, a line of approximately 30 db total attenuation in the transmission would have resulted.

Figure 3 (Below)
Plot of voltage received at varying distances from the five-wire line of C in Figure 2.

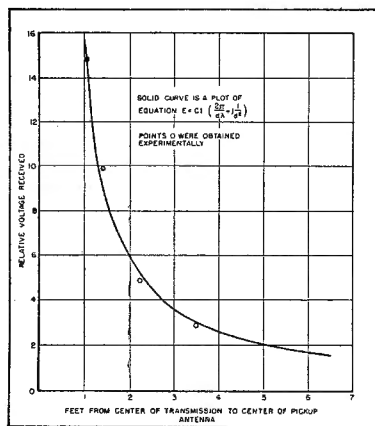
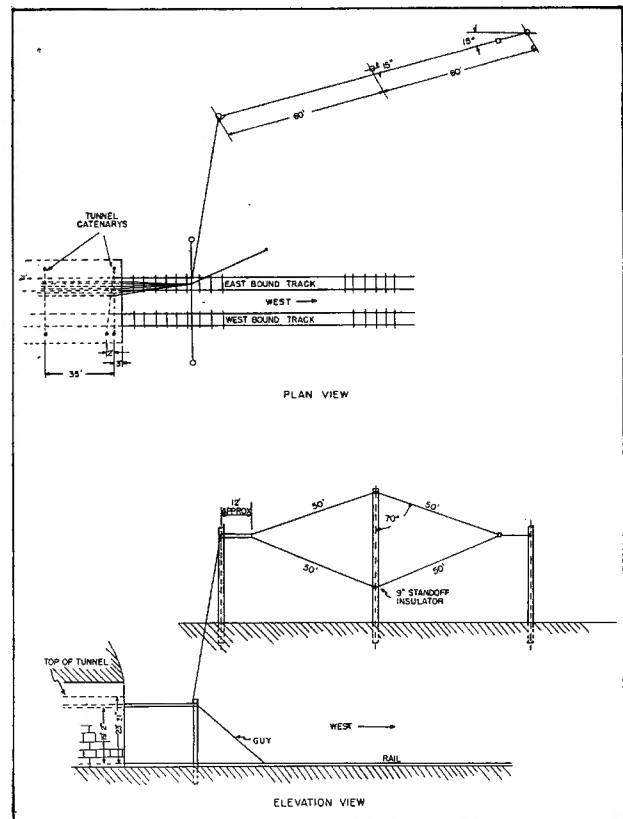

Figure 5
Layout of rhombic-antenna system located on top of the tunnel at either tunnel mouth. Rhombics had a theoretical gain of 15 db.



V-H-F Propagation Surveys FOR MOBILE SERVICES

Location _____ Date _____

Engineer _____ Fixed Station A _____ Mobile Station B _____

Station A Frequency _____ Pwr _____ Ant _____ Ant. Ht. _____

Station B Frequency _____ Pwr _____ Ant _____ Ant. Ht. _____

Elevation Points _____ Road Miles _____ Map Miles _____

Weather _____ Time: A.M. _____ P.M. _____

Special Notes _____

Field test data sheet.

a few pieces of equipment are required. Items include a one- to two-thousand-ohm potentiometer, preferably wire wound or relative high wattage of 2 to 5 watts, one 500-line to 3-ohm voice-coil matching transformer, and one db meter with at least a 20-db range on one scale (or an output meter with minimum scale down 20 db or more from the maximum reading of about 1.75 to 2 volts).

In application, the db meter (or output meter reading volts) is arbitrarily set to zero (or some reference value in case of a different meter) with no carrier and squelch set for maximum noise. When a carrier is received on without modulation the noise will be reduced to some value, about 20 db for best results and 100% intelligibility. The amount of this reduction in noise by an unmodulated carrier is a measure of the usefulness of the system at that point in the field measured, and with the local existing noise level present.

The range or contour map can then be plotted in terms of db ratio of noise, carrier off to carrier on, for no modulation; noise is measured with carrier off and squelch set for full noise, this being used as a zero reference level. The reduction in output noise is then measured with carrier on and no modulation.

If a remote console standard db meter is used the level of full noise would be set at +6 db, so that the noise reduction due to carrier could be read down to -10 and estimated to -15 or so. This means that a reduction of +6 to -15 or -21 db could be easily determined.

An accurate signal-generator is quite handy in these tests, too, providing actual microvolts corresponding to various values of microammeter test readings on meter test positions. Microvolts for a given db noise quieting may be determined.

Checking Optical Path From Geodetic Survey Maps

There are cases where the transmission path is not obvious or where distance is near the critical limit, and it is helpful to plot the elevation contours

A Study¹ of the Various Pieces of Equipment Required for the Tests, and an Analysis of the Methods Applied During the Surveys.

by RALPH G. PETERS

THE SITE OF OPERATION has always been an important factor in communications and in the v-h-f bands it is even more important because of the optical-path requirements. Accordingly it has been necessary to conduct substantial field surveys of the areas, with critical analyses of the propagation characteristics.

Making Field Surveys

The signal plus noise divided by noise ratio at the outer limit of the

range method has been a very practical way of determining useful range and *dead* areas. The greater this ratio, $(S + N)/N$, for a particular combination, the greater the range because a usable percentage of intelligibility is generally limited to about 6 db of equivalent noise ratio, carrier on to carrier off, rather than any value of microvolts per meter.

To conduct a survey in terms of db ratio of equivalent $(S + N)/N$, only

¹Data courtesy Motorola, Chicago.]

Farnsworth

GUARANTEED*
VHF SYSTEMS
NOW AVAILABLE
for immediate installation

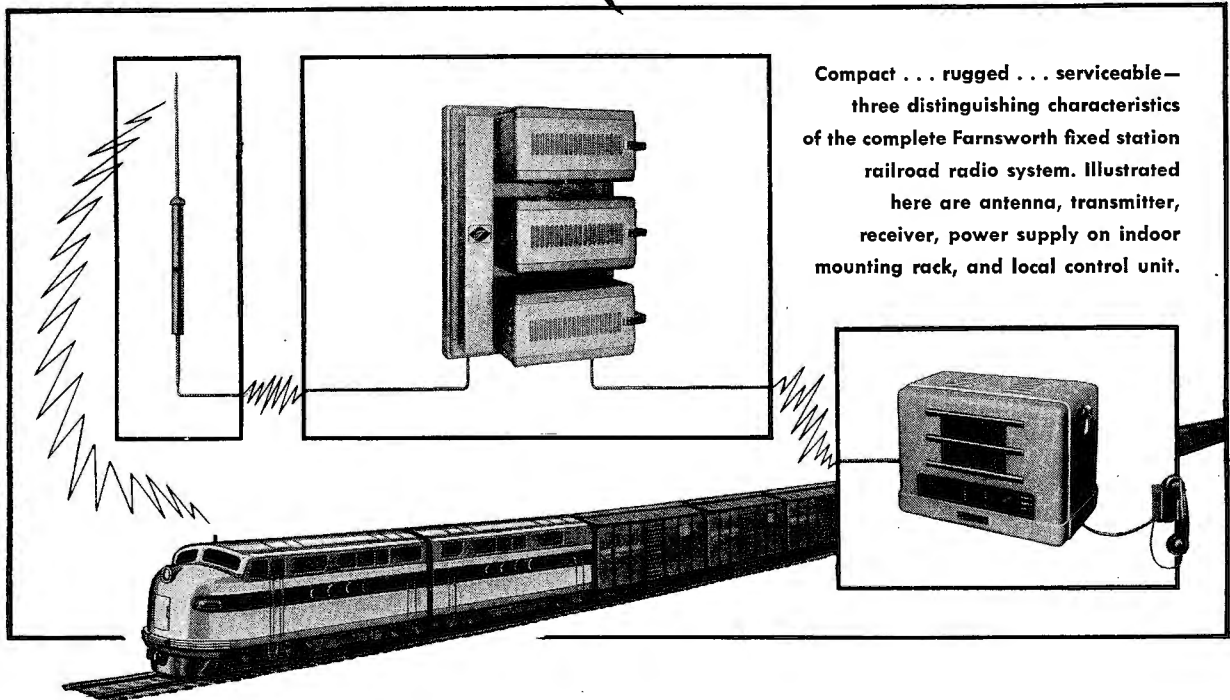

Compact . . . rugged . . . serviceable—
three distinguishing characteristics
of the complete Farnsworth fixed station
railroad radio system. Illustrated
here are antenna, transmitter,
receiver, power supply on indoor
mounting rack, and local control unit.

Progressive railroads have waited many years for railroad radio communications equipment in which they could invest with confidence.

Now Farnsworth engineers and designers—the same men who pioneered the adaptation of radio to rail communications—have developed practical, reliable, *guaranteed** railroad radio communications equipment which merits capital investments.

Farnsworth systems are *thoroughly engineered* to meet the unique and exacting standards of railway operation . . . *carefully designed* to provide maximum usefulness and flexibility . . . *comprehensively planned* to comply with regulations of the FCC and ICC, and the specifications of the AAR . . . *exhaustively field-engineered* over a period of years to guarantee simplified, low-cost maintenance. Developed systematically and without haste in one of the world's great

electronic laboratories, Farnsworth systems represent the best equipment designed and produced for this highly important service.

Write Dept. C-6, Farnsworth Television & Radio Corporation, Fort Wayne 1, Indiana.

* *Farnsworth guarantees this equipment for a period of one year against defective design, material and workmanship, and agrees to remedy any such defect in any railway electronic unit of its manufacture, provided that the unit is returned intact, bearing original serial number with all transportation paid, for Farnsworth's examination at its Fort Wayne, Indiana, factory within one year and thirty days from date of purchase. This warranty does not, however, extend to tubes or moving parts (components which carry the guarantee of the manufacturers thereof).*

Farnsworth
Television • Radio • Phonograph-Radio

Farnsworth Radio and Television Receivers and Transmitters • Aircraft Radio Equipment • Farnsworth Television Tubes • Mobile Communications and Traffic Control Systems for Rail and Highway • The Farnsworth Phonograph-Radio • The Capehart • The Panamuse by Capehart

COMMUNICATIONS FOR JUNE 1947 • 21

STATION..... OPERATOR..... DATE..... PAGE.....														
Time	Test No.	Position, Notes, Landmarks	Readability R	Quieting audio (db)	With carrier Meter— R.F. sensitivity No carrier Position No.	Mileage	Speed	Miles out	Air miles	Microvolts				

Survey log form.

per mile desired. The distance from either station to the particular contour whose elevation is being determined and plotted may be then measured on this chord and transferred up to the elevation arc on a straight line through the center at the point used to strike off 15" earth's surface arc.

Certain factors affecting transmission at the higher frequencies should be noted when endeavoring to determine the best radio path for general or relay transmissions:

- (1) It is obvious that the best path is always optical and for certain safety factors should be somewhat above optical, for relay applications in general.
- (2) Locations near busy highways where ignition or r-f noises may be present should always be avoided.
- (3) Signals will generally be better at a greater distance if the more distant station is always out in the clear and not shadowed by hills, buildings or other obstructions.

(4) If it is necessary that the radio path pass over hills, it is then best that these hills be far from both stations; that is, out near the center of the radio path if possible.

(5) If it is desired to transmit or control different locations with frequencies close together, then it is quite often necessary to use directors or reflectors or directive arrays. Directive arrays may also aid in increasing signal strength at times to get over some hills or other obstructions.

(6) The use of a larger than normal coaxial line for long r-f antenna runs is always helpful where higher towers are required to get over intervening hills.

(7) It is quite important to stay away from large and tall steel framed brick buildings because of their reflecting and absorption properties.

(8) Quite often a lower elevation or lower antenna location off to one side of a hill is appreciably better than a higher one directly in line with some nearby reflecting hill.

(9) Receiving locations should always be placed away from manufacturing plants, welders, motors, diathermy equipment, radio-frequency heaters, etc.

(10) It is best to determine the location where the ground will slope down from the station level towards the other end of the radio link rather than to have rising ground in front of either station. This is especially bad if there is rising ground for several

(Continued on page 41)

between the two radio contact points. From these elevation contours it is much easier to determine whether or not a particular proposed circuit may be feasible.

To conduct those studies geodetic survey maps² of states and territories are quite handy.

In making an elevation contour, the state or territory maps with scales of 8 or 16 miles to the inch should first be secured. These state maps are good for general layout of the transmission paths from point to point. To give closer details, these maps are sectionalized into squares or quadrangles which are coded by numbers on the large scale state map. If the transmission path falls across two or more of the blocks which have been surveyed, it is much easier to secure copies of these particular blocks or rectangles to a more detailed scale of 1 to 2 miles per inch. From the large scale state maps, it can be easily determined where the radio path enters and leaves the sectionalized or rectangular blocks, and a straight line can be drawn across these rectangles, representing the radio path. The contour intervals generally run 25' to 50' per contour line so that the vertical elevations can be read from the more detailed rectangular blocks quite easily at all points along the radio or optical path. From the scale of the map these points can be transferred to the elevation contour drawing being developed.

To develop the contour drawing it is usually most convenient to take a

radius of 15" and draw a heavy arc representing the surface of the earth at sea level. The elevation above this earth surface line should be for the radius used here, exactly 500' per inch. Additional arcs should be drawn above the earth's surface at inch or half-inch intervals, depending upon how accurate the contour is required. For very hilly terrain 500' intervals, an arc at each inch will be sufficient; for terrain which is not hilly these arcs should probably be drawn at one-half and one-quarter inch intervals, always remembering that the vertical scale is 500' to the inch. The two radio points at either end of the path should be drawn in at their respective altitudes above sea level as determined from the contour maps. From the scale given on each map, it is easy to measure the distance from either end of the radio path by the use of a compass or ordinary ruler, so that each contour interval can be measured with respect to its distance from the radio contact station at the end of the circuit and laid off on a line drawn between the ends of the radio circuit. The easiest way to do this, although not strictly accurate, is to find two points on the arc representative of the two ends of the radio circuit to the scale selected for the map. A chord may be drawn between these two points to the scale in inches

²May be secured, generally for 10 cents each, from the Director of U. S. Geological Survey, U. S. Dept. of Interior, Washington, D. C. In Canada, maps may be secured from the Surveyor General, Department of Mines and Resources, Ottawa, Ontario.

Switches OF TOMORROW FOR DESIGNS OF TODAY

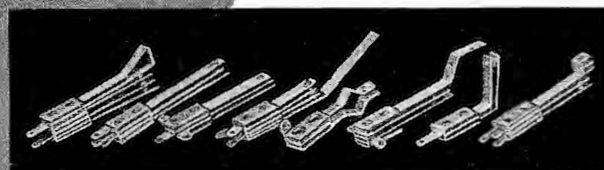
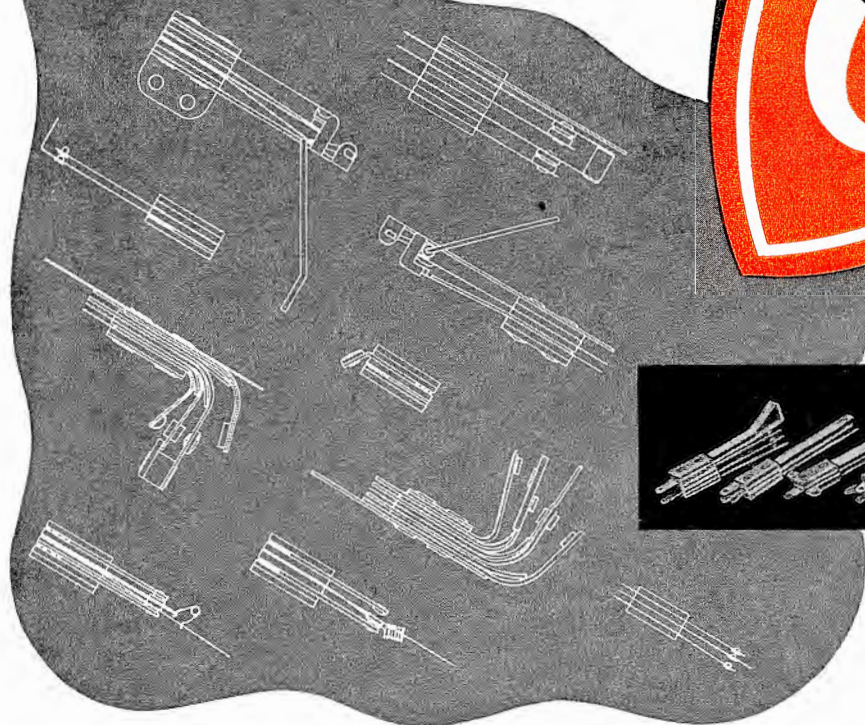

SWITCHES by GUARDIAN for every purpose

Scan the brief pictorial review of Guardian Contact Switch assemblies shown above and you will probably see a switch that is comparable to your needs. Each unit represents a switch so practical, so saving of assembly time, energy, materials and money, as to be worthy of your immediate consideration.

The Guardian Featherub Switch is an example of such true efficiency. It is shown to the lower right of this page. An original Guardian creation, it is actuated mechanically and is adaptable to manual, roll-over or cam action. The Guardian Featherub and all other units shown are standard items. There are hundreds of other types, all of the highest quality. Contact blades are obtainable in phosphor bronze tinned to withstand salt spray test, also in standard Guardian phosphor bronze. All switches are properly insulated. The switch you need is here singly or in combination... one or a million! Try Guardian Switches for performance, price and delivery.

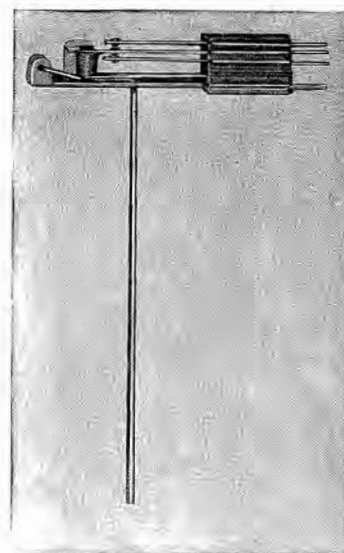

GUARDIAN
FEATHERUB
SWITCH

Your cost-free copy of Guardian's new Catalog 10-A is waiting for you. Write on your business letterhead for it today!

GUARDIAN  **ELECTRIC**
1610-G W. WALNUT STREET CHICAGO 12, ILLINOIS
A COMPLETE LINE OF RELAYS SERVING AMERICAN INDUSTRY

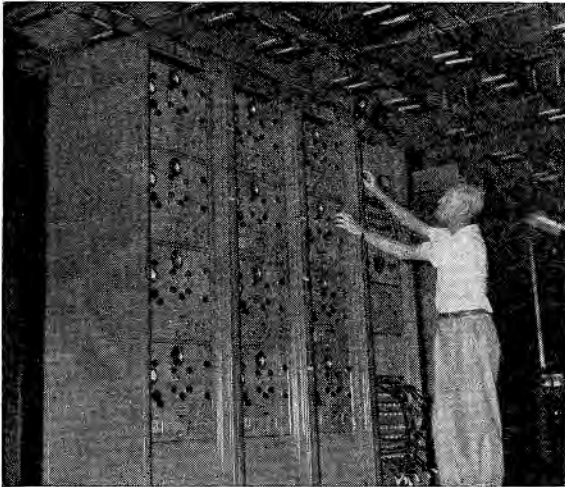

Transmitting frequency-shift keying units with a control bay at a typical international airline station. (Courtesy Press Wireless)

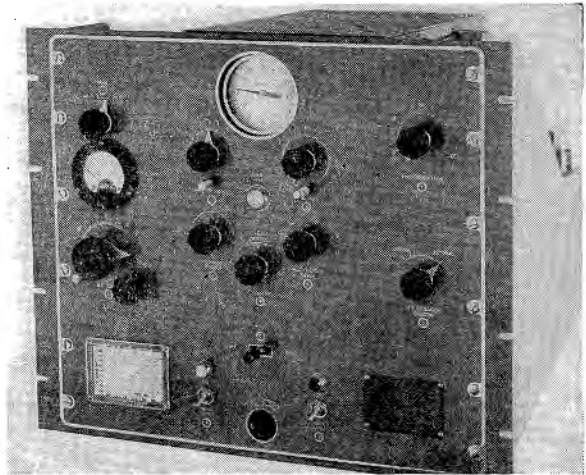

Close-up of high-frequency transmitting frequency-shift keyer. (Courtesy Press Wireless)

International Commercial Aviation RADIOTELETYPE SYSTEMS

THE RADIOTELETYPE SYSTEM of transmission offers many unique advantages. For instance, it is possible to standardize methods of actual transmission and apparatus. Conventional message tapes, punched by perforators, can be interchanged at will between land line (such as CAA weather circuits) and radio transmission circuits. No transcription or changeover process involving two different types of transmission (such as manual radiotelegraph to teleprinter circuits) is required. Ordinarily all material incoming on the circuits is punched on tape by reperforators, and the section containing the required text (such as certain weather collections) is torn off from this tape and transmitted on the radio or landline circuit.

Speed of transmission is another feature. Automatic (in place of keyboard) transmission is used on all modern radioteletype circuits, insuring a speed of from 60 to 100 groups per minute. Long tapes can be inserted in the TD (transmitter-distributor) of the sending equipment and left unattended until transmission is completed. One operator can thus handle several outgoing circuits. (For

this reason, many installations group all transmitting circuits, TD's, together, attended by one or more operators.)

Although radioteletype transmission was used years ago by the CAA and other agencies, and developed extensively by the military during World War II, commercial installations are only now adopting this service for domestic circuits.

Hypothetical Installation

The system also has excellent possibilities for international airways control. To illustrate let us assume that an installation were made in a centrally-located seacoast country like Turkey.

This system could be used for both international and domestic traffic.

Weather traffic, as well as aircraft movement messages, *notams*,² etc., could be handled by Ankara with Cairo, Rome, Athens, Beyrouth, Teheran and all other stations on air routes entering Turkey. It would also be possible to take advantage of already existing facilities, originally in-

²Notices to airmen.

stalled by the AACS and AAF at Payne Field (Cairo), Rome, etc. Inasmuch as typing equipment at Ankara would be identical to those of other ex-military installations, activation of new circuits would be comparatively easy.

Weather would constitute by far the greatest percentage of traffic handled by both the international and domestic systems. It is assumed that Ankara would have continuous schedules with key stations in other countries, and would, on schedule, transmit and receive forecasts, synoptic data, and *notams*.

Broadcast Transmission Method

To save point-to-point circuit time, the broadcast method of transmission could be used wherever possible. For instance, Ankara would receive (simultaneously with several other control stations in other countries) an hourly report of synoptic weather broadcast from Rome. In addition to Ankara, Athens, Budapest and Cairo might simultaneously intercept this broadcast.

The international Ankara weather broadcast would consist of a resume or collection of all reports from its satel-

Analysis of Centralized-Network Systems Which Expedite Control of Air Traffic, and Transmission of Reservation, Administrative and Airmen Notices.

by F. VINTON LONG¹

Communications Consultant
Intercontinent Engineering Corp.

lite stations, plus Ankara local weather. All of these transmissions would take place on one net operating frequency that is common to the eastern division of Turkey. Simultaneously, stations of the western division (airways system arbitrarily divided into eastern and western divisions to lighten the traffic load on each net frequency) would transmit their data to Ankara.

Ankara would record (by cutting tapes) these transmissions by means of typing reperforators. After reception from all satellite stations is completed, Ankara would add its own local weather data (punched out on a manual tape-cutting machine immediately upon receipt from the weather observer) and place the entire collection of cut tape on an international transmitting circuit.

Transmission of the Turkish data collection, plus certain portions of the international circuit data received from abroad, would be broadcast each hour on Ankara's domestic transmitters. During this broadcast, eastern and western division transmitters would be locked together to one TD so that each intercept satellite station would receive the entire collection for both eastern and western points. It should be noted that no receipts are indicated for reception. Blind transmission employed in all instances, is arbitrarily assumed to have been received.

It might appear that the broadcast type of transmission would be unreliable, but experience has proven that speedy dissemination of a large mass of weather information with an average of 90% or better reception is more useful than the slower method of transmitting all weather data point-to-point, with a receipt for each individual message. If urgently required, any unreceived sections could be filled

in (by request) on the regular point-to-point circuits.

It will be noted that each satellite would receive its own weather back from Ankara during the broadcast. Inasmuch as the percentage of this particular portion of the entire resume is small compared to the whole, no great disadvantage would result.

It would seem that the foregoing functions would tie up the radioteletype circuits exclusively for weather transmission. Fortunately, this is not the case on the majority of circuits. On the contrary, weather transmission would require only one-half or less of the total available circuit time, leaving the balance for aircraft movement, operational, passenger reservation, and administrative traffic with priority in the order named. The majority of aircraft departure, arrival and position report messages require less than 30 seconds each, and passenger reservations, if properly coded, about the same. Administrative traffic would be handled during spare circuit time, especially at night.

Although aircraft movement and weather messages customarily have about equal priority, experience has shown that weather should be handled by radioteletype strictly on a schedule basis and routine aircraft movement messages as rapidly thereafter as possible. Emergencies, of course, could be handled via radiotelephone (airway stations), manual radiotelegraph, and also via radioteletype after appropriate warning bell signals have been sent out over the system.

Ankara and possibly other points could combine radioteletype and A-3 (voice) or A-2 (modulated tone)

¹Managing Director, Empresas Ilimitadas, Caracas, Venezuela.

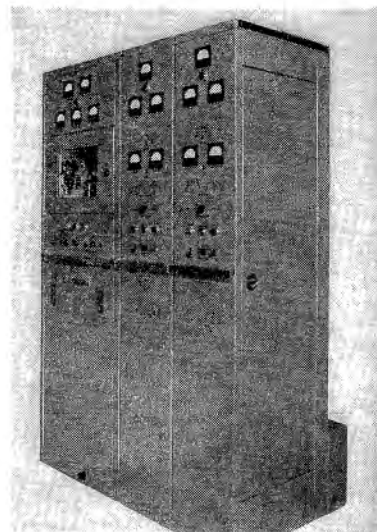

A 3-kw multi-channel h-f a-m transmitter for teletype, telegraph and telephone use.

(Courtesy Westinghouse Electric International Corp.)

broadcasts on the same frequency with the same transmitters by employing frequency shift radioteletype transmission, while modulating the carrier with A-3 or A-2 intelligence. This system is practicable at any location at which the transmitters are assigned clear channels and the carriers stay on continuously.

With this method voice and tone telegraphy can be used to broadcast local weather data, plus condensed portions of the collection available from other points.

The f-s method is somewhat similar to frequency modulation used in broadcasting in that the carrier is *shifted* from one frequency to another by some form of external modulating signal; dissimilarly, however, the amount of shift is relatively very small and is always a fixed, pre-set value. As in f-m, the signal-to-noise ratio is considerably increased with f-s operation but

H-f frequency-shift receiver converter.

(Courtesy Press Wireless)

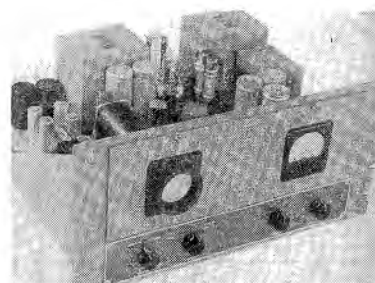

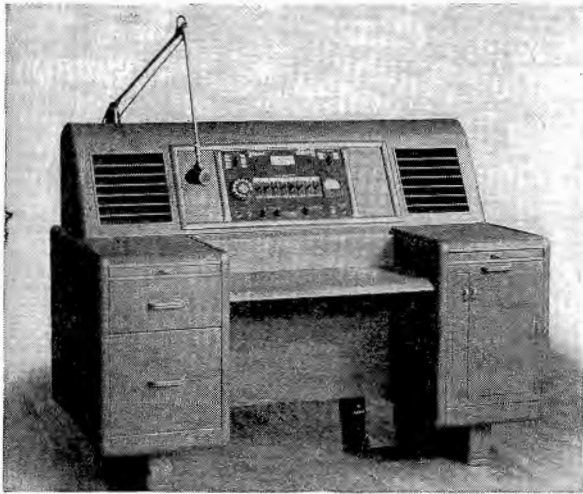

Left: Airways operating console.
(Courtesy Wilcox Electric)



A fixed-frequency crystal controlled h-f receiver.
(Courtesy Wilcox Electric)

since the amount of actual carrier shift is small, the bandwidth required is no greater than that required for moderate speeds of practical make-and-break keying. Further, it has been observed that inherent transients, key clicks, spurious side bands, etc., extend the bandwidth requirements of high-speed amplitude keying considerably beyond those required for frequency-shift transmission at the same keying rate.

The trend of modern communication systems to accelerate keying speeds reaches a point of saturation in amplitude keying under any but the most favorable atmospheric conditions during certain hours of the day and season. As keying speeds increase in make-and-break operation an increment of transient disturbances is encountered with acceleration of the rise and decay of the radiated wave form. Employing f-s circuits, the increment of these transient disturbances is effectively minimized. Further, the reduction of transients permits closer channel spacing. It is, therefore, appar-

ently possible and practical to operate a greater number of high-speed f-s circuits within a given portion of the spectrum than is regularly required for high-speed amplitude keying.

Above 3,000 kc carrier frequency, to transmit mark and space by the f-s method, the amount of carrier shift above and below the hypothetical center frequency is 300 cycles per second, as conveniently employed in some present-day applications for radioteletypewriter and Morse radiotelegraphy. The transmitter, always delivering its full output power to the antenna, usually is adjusted to rest on the space frequency. This, however, is entirely arbitrary and depends on the exact type of mechanical equipment involved.

As an example, a keyed transmitter assigned to 10,000 kilocycles will, by means of carrier shift, successively shift the carrier signal between two frequencies, one at 9,999.7 kc and the other at 10,000.3 kc. The f-s receiving equipment differentiates between these two frequencies by means of dis-

criminating circuits and delivers corresponding mark-and-space pulses to the teleprinter or telegraph recorder and relative black and white signals for facsimile recording.

A near approach to *something for nothing* is effected by the foregoing broadcast plan since no additional frequencies, antenna or transmitters are necessary; merely the addition of modulators to existing f-s transmitters would provide complete weather reception. If desired, A-2 radiotelegraph transmission could be accomplished by using tapes cut into continental-code characters with an automatic wheatstone perforator set. Conventional teletype No. 14 typing reperforators could be used to prepare tape for the radioteletype broadcasts.

Choice of transmitting equipment for any civic airways would result from a compromise between high power and consequent higher installation and maintenance cost, and low power units involving lower cost and easier main-

(Continued on page 42)

Left: A typical frequency shift radioteletypewriter system.
(Courtesy Press Wireless)

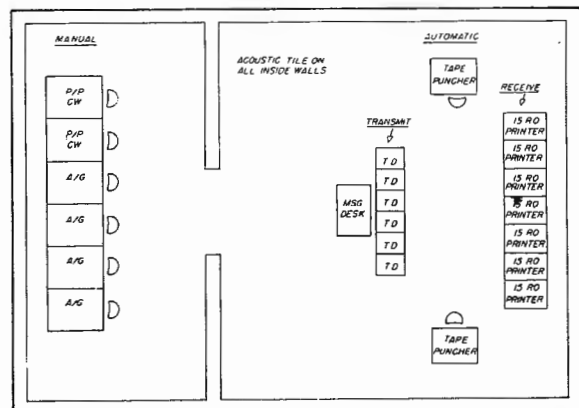
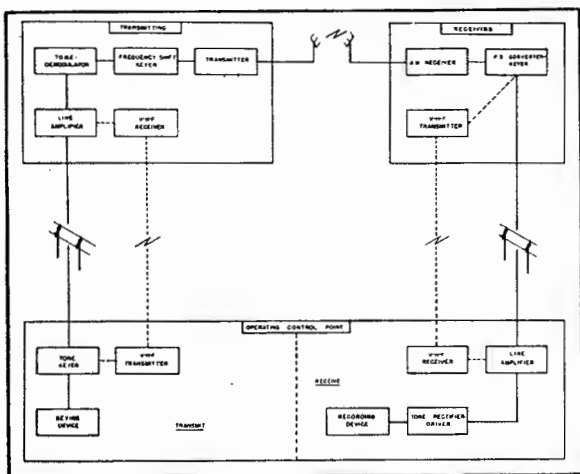

Suggested airways radio operating room; P/P, point-to-point c-w; A/G, air-ground; T.D., transmitter-distribution; and R.O., receiver only.

UHF tetrode



Eimac 4X150A Power Tetrode	
Electrical Characteristics	
Heater voltage	6.0 volts
Heater Current	2.7 amps.
Grid-screen amplification factor (approximate)	4.
Direct interelectrode capacitance (typical)	
Grid-Plate	0.02 μ f
Input	12.0 μ f
Output	4.6 μ f
Maximum Ratings	
DC Plate voltage	1000 volts
DC Plate current	200 ma.
Plate dissipation	150 watts
DC Screen voltage	300 volts

The 4X150A, a new Eimac tetrode, extremely versatile—diminutive in size, will fill the bill in all types of application and at all frequencies up to 500 mc. Performance characteristics include—high transconductance, low plate voltage operation, low grid drive, high plate dissipation, and traditional Eimac-tetrode stability. Physical features include:

- A Low inductance grid lead.
- B Close element spacing for UHF and high transconductance.
- C Screen grid, mounting, and ring connector design effectively isolates input and output circuits.
- D Heater isolated from cathode.
- E Indirectly heated cathode.
- F Low inductance cathode terminals, (four separate paralleled pins).
- G Controlled primary and secondary grid emission, by specially processed grids.
- H New molded glass header, precision pin alignment.
- I Forced air cooled (vertical finned).
- J Simple installation, adaptable to standard octal socket.

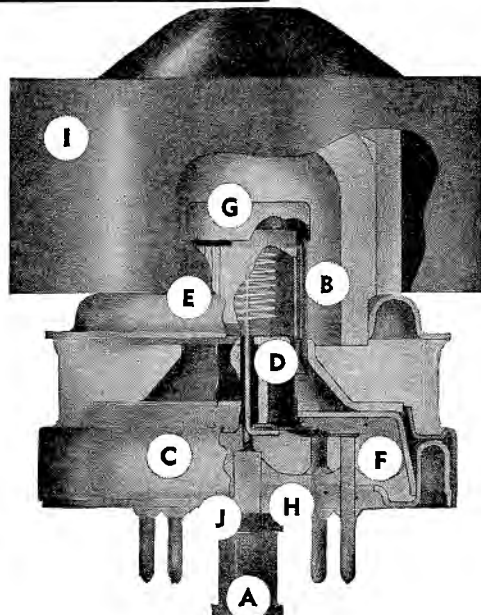

Follow the Leaders to

Eimac
REG. U. S. PAT. OFF.
TUBES

The Power for R-F

PRICE, \$31.00

You will find the 4X150A suited to your requirements, whether for wide-band low-efficiency service such as television video and audio or conventional application. For further information on this new, versatile, Eimac tetrode, type 4X150A, write to:

EITEL-McCULLOUGH, INC.
1455 San Mateo Avenue
San Bruno, California

EXPORT AGENTS: FRAZAR & HANSEN, 301 CLAY ST., SAN FRANCISCO 11, CALIFORNIA, U.S.A.

MOBILE F-M COMMUNICATIONS

Equipment For 30 to 44-mc

WITH THE ADVENT of long-life miniature tubes and highly efficient v-h-f f-m circuits it has become possible to design compact mobile-fixed transmitter-receiver systems with many unique features. For the 30- to 44-mc band, for instance, a small 2-way unit providing selective calling is now available. This *calling* feature permits contacting any one of four groups of mobile stations without energizing any of the others.

The mobile unit, shown in Figure 1, consists of a 25- or 50-watt transmitter,¹ receiver² (both on separate plug-in chassis which are inserted in the housing), control box which is normally mounted on the auto dashboard, loudspeaker, microphone, microphone hook-switch and whip-style antenna.

Operation of equipment is accomplished by lifting microphone off the hook-switch, depressing the microphone switch, which turns on the transmitter, and speaking. Controls provide *carrier*, *monitor* or *selective-calling*.

In the *carrier* position the receiver audio circuit is silenced by a squelch circuit which maintains control until an on-frequency carrier is received. This removes annoying receiver noises during stand-by periods and makes the receiver operative when a call is sent out by a transmitter on the assigned channel. The squelch circuit turns on audio system with signals producing 6 db of noise quieting.

The *monitor* position is used only

Small-Sized Radiotelephone Units, Featuring Selective Calling, and Providing Two-Way Communications, Designed for Police, Fire and Ambulance Departments, Forest Patrols, Taxicab Dispatching, Ferry Services, Construction Projects, Etc.

by R. B. HOFFMAN and E. W. MARKOW

Radio Equipment Division
Federal Telephone and Radio Corp.

for the reception of very weak or fading signals or for checking the operation of the receiver. In this position, the squelch circuit is inoperative, and therefore the operator hears hissing and rushing sounds along with the message. This is characteristic of the impulse and receiver noise characteristics of high-gain receivers in the absence of a signal sufficiently strong to produce quieting.

In the *selective-calling* position a frequency selective decoding circuit is introduced. This renders the receiver audio system operative only in re-

¹Power is derived from standard 6-volt automobile battery; current drain during stand-by periods is 7.12 amperes, and 33.2 amperes or 50.5 amperes during on-call periods, depending upon whether 25- or 50-watt transmitter is used.
²Measured in accordance with RMA procedure.

sponse to the proper calling signal from the central station.

The Receiver

The receiver, Figure 2, is a conventional double-conversion crystal-controlled superheterodyne circuit. Overall receiver sensitivity is such that a 0.5 μ v r-f signal will provide 20 db of thermal noise quieting.³

The first r-f stage uses a 6AK5; mixer, 6BE6; oscillator, 6AK5; 10.7-mc i-f, 6AK5; converter, 6BE6; 1.7-mc l-f, 6AK5; first limiter, 6AK5; second limiter, 6AK5; discriminator, 6AL5; selective-call switch tube, 2D21; decoder amplifier, 6AK5; first audio

Figure 2
Block diagram of the mobile receiver.

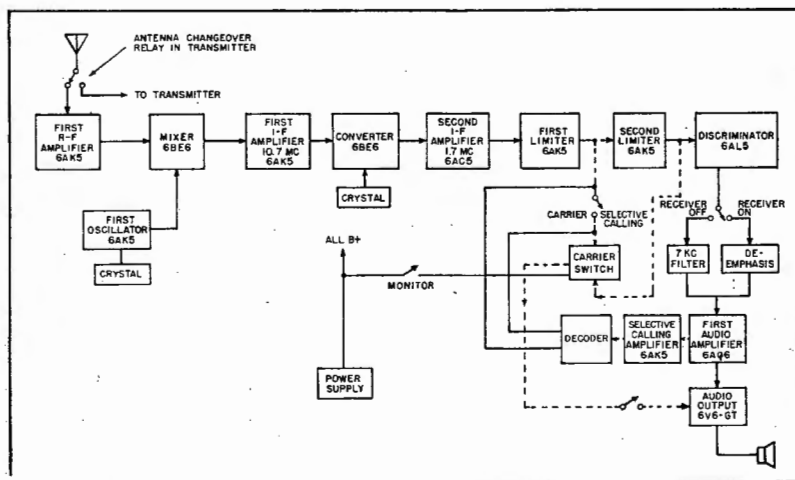
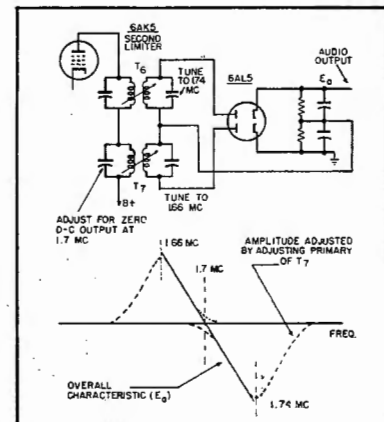

Figure 3
F-m mobile receiver discriminator and plot of discriminator action.



amp, 6AQ6; power amp, 6V6-GT; and power rectifier, OZ4A or 6X5-GT.

The first local oscillator uses a crystal which resonates at the third mode of its fundamental frequency; no fundamental crystal frequency is present in this oscillator.

The discriminator circuit, Figure 3, is a double-tuned dual transformer type. The transformers are tuned 80-kc apart ($1.7 \text{ mc} \pm 40 \text{ kc}$), and the output so phased that the linear portion of the pass-band curve between the transformer peaks can be utilized as an f-m discriminator. (Adjusting T_r adjusts the amplitude of the signal in the secondary winding and permits center frequency zero adjustment.)

The *selective-calling* system makes use of a frequency-selective decoder. The decoder is essentially a spst normally open switch which closes only when an audio signal of suitable frequency is impressed across the driving coil. The receiver circuit is arranged so that when in the *select* position, the audio amplifier stage is inoperative until the decoder contacts close. When the decoder is energized by the proper audio signal, the receiver is *turned on* and the audio system made operative. Once the receiver has been turned on and the r-f carrier *remains* present, the receiver will stay on. If the carrier is removed, the receiver shuts off and cannot be turned on unless the carrier *with proper decoding signal* is again present to turn on the receiver audio circuits. A carrier alone, or a carrier with any other type of modulation, will not turn on the receiver. The operator at the fixed station may call any particular mobile installation by selecting and transmitting the audio tone to which the desired mobile receiver will respond. No other receiver, when in *select* position, and equipped with decoders tuned to any other frequency, will respond.

The audio frequencies to which the decoders are sensitive lie between 150 and 442 cycles. Direct phase modulation of the r-f carrier with frequencies as low as 150 to 440 cycles can be accomplished only with very low deviations, and is therefore not practical. Instead, a sub-carrier system is used in which the low-frequency audio signal amplitude modulates a 7,000-cycle sub-carrier which, in turn, frequency modulates the r-f carrier. In this 7,000-cycle range no frequency-modulation difficulties with respect to deviation are encountered. The station equipment transmits the r-f carrier, frequency modulated by the amplitude-modulated 7,000-cycle sub-carrier, and all receivers in the system receive the signal. The signal is reconverted into an amplitude modu-

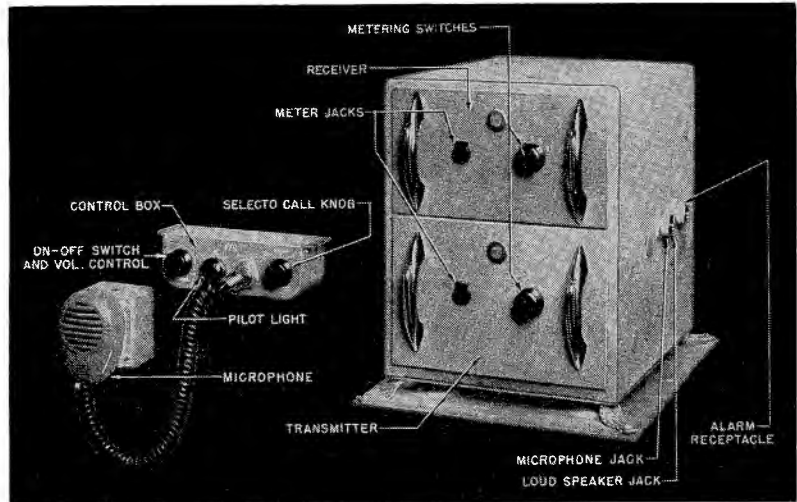

Figure 1
The 30 to 40-mc equipment developed for mobile applications.

lated 7,000-cycle audio signal by the receiver discriminator. The envelope is then high-passed, detected, passed through a low-pass filter network, and the low-frequency 150- to 440-cycle energizing signal impressed on the decoder coil. If the impressed frequency is the same as the decoder-resonant frequency, the decoder contacts will close and turn on the audio circuit. The fixed station equipment is equipped with four low-frequency audio oscillator circuits permitting the selection of four separate groups of receivers.

Briefly the *selective-calling* chain of action is: When calling a mobile unit the station operator chooses the audio channel corresponding to the one with which the mobile unit he desires is provided. The audio signal amplitude-

modulates a 7,000-cycle signal, and the audio-modulated 7,000-cycle signal modulates the r-f carrier. The *select* tone is transmitted at the *beginning* of the fixed-station transmission only. The station equipment automatically provides the proper time duration of about one second by use of a delayed action relay. Reception of the *select call* signal energizes the audit circuit in the mobile receiver which is silenced, when no carrier is present, by the removal of screen voltage from the 6V6 power tube.

Squelch Circuit

In this circuit, Figure 4, a switching relay, which turns the receiver
(Continued on page 40)

Figure 4
Schematic of the squelch and selective-calling circuits of the receiver.

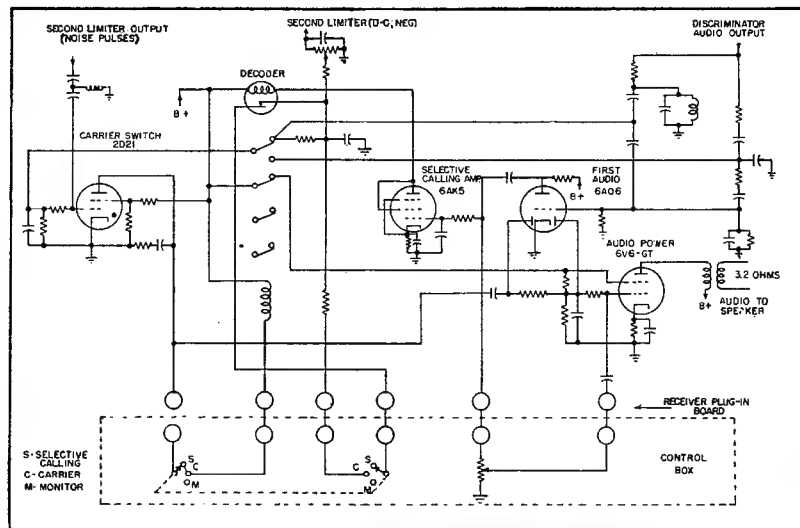



VETERAN WIRELESS OPERATORS ASSOCIATION NEWS

W. J. McGONIGLE, President

RCA BUILDING, 30 Rockefeller Plaza, New York, N. Y.

GEORGE H. CLARK, Secretary

MANY VETERAN VWOA MEMBERS attended the Spring Meeting in New York on June 5th, in the Marine Room of the Fireplace Inn. Among those present were W. J. McGonigle, G. H. Clark, William C. Simon, T. H. Ellis, R. H. Pheysey, R. K. Davis, Eric Bisbee, Roger Lum, Ben Beckerman, J. L. Savick, Sam Schneider, Roy Chipp, H. T. Hayden, W. A. Paul, R. J. Iversen, H. H. Parker and C. D. Guthrie. . . . Life member Iversen revealed that he has just designed two new 1-kw c-w transmitters for the New York Times radio station. The station, WHD, transmits comprehensive news summaries for isolated world outposts twice daily. The daytime broadcast are on 16.72 mc, and nighttime are on 8.36 mc. About 45 minutes of copy at 25 words per minute are transmitted at 1900 gmt and 0500 gmt. Iversen said that he would very much like to have reliability reports from operators hearing the station. The transmitter features automatic electronic keying. Signals are fed into stub-mast one-half wave doublets, located atop the New York Times Building at W. 43rd Street in New York City, 350 feet above the street level. . . . W. A. Paul, now with the Mackay engineering department, revealed that he is doing field engineering on South-American station installations. WAP, who has been in radio since 1926, has sailed many tankers and freighters. From 1926 to 1928, he was with the Independent Wireless Co. In 1928, he joined Tropical Radio and for two years was in the tropics. From 1930 to 1933, he was in New Orleans and in 1933 he went to Miami at WAX. From 1942 to 1945, WAP was in the Navy as a radio electrician, assigned to the Third Fleet in the Aleutians. . . . Rodney Chipp, now a radio-facilities engineer for ABC, told the boys that he is now planning installation of prospective ABC f-m and television stations and a 50 kw a-m transmitter at KGO in San Francisco. RC, who has recently been elected treasurer of the New York Section of the IRE, was quite



VWOA assistant president, George W. Bailey, third from left, at the recent RMA annual spring meeting dinner in Syracuse, N. Y. Left to right: S. P. Taylor, Western Electric, chairman of RMA's transmitter section; F. R. Lack, vice president and manager of Western Electric's radio division; Dr. W. R. G. Baker, vice president of General Electric; George W. Bailey; and J. J. Farrell of the G. E. transmitter department.

active during the war, serving the U. S. Navy as a lieutenant commander. He received the commendation ribbon for his work in radar design. . . . Roger Lum, veteran of the early broadcast days, told the boys that he began pounding brass in 1918. He was with WJZ in 1922 and then went to WRC in 1923. In 1924, he went to WNYC and in 1926 he joined WDAE. In 1931, he was at WGST, and then he decided to enter the business world and join the Chain and Gear Corp., manufacturers of chain drives and flexible couplings. He says that he still yearns to go back into broadcasting and would like to become, believe it or not, a disc jockey. . . . Samuel Schneider revealed that he is now with Oscar Radio, 176 Greenwich Street, N. Y. C., handling radio sales in the marine division. SS was a chief code instructor with the Chamberlain Technical School during the war. He also served with the OWI and was in charge of the radiophoto division. . . . T. H. Ellis reported that he is now actively engaged in aircraft development work and is concentrating on the Lanac system of safety control at the Hazeltine Corp. TE has been in radio since 1925 and served on many ships. In 1931, he was instrumental in establishing radio communications from Belize, British Honduras, which was devastated by a hurricane. He received a commendation for his work from the Governor of

British Honduras and Captain F. Muller. Before joining Hazeltine, Tom served with Tropical Radio for 13 years as a radio operator and radio inspector. During the war, Tom acted as a field engineer for Hazeltine, installing radar and IFF equipment for the U. S. Navy. . . . Robert H. Pheysey, who received the VWOA award in 1930 for his prompt and efficient handling of an SOS, is still quite active with United Fruit Co., with whom he has been associated for 18 years. During this period he has been marine radio operator, inspector and chief of accounting. During World War II, RHP served as a chief operator on an ammunition carrier and transport, making several trips to France and England. . . . R. K. Davis reported that he has returned to his former position as chief inspector at Tropical Radio. . . . Henry T. Hayden is quite active these days on his ham transmitter, W2FO, which operates on 7050 kc. HTH says that he would like to contact other VWOA members. . . . Eric L. Bisbee told the boys at the VWOA dinner that he'll soon become a father-in-law. ELB is with the N. Y. Police Dept., operating the f-m police station, WJII, in Jamaica. The frequency of the station is 39.9 mc. . . . J. L. Savick, now with the N. Y. Telephone Co., automatic dial system division, recalled his early days as a marine operator. JLS began his brass-pounding days in 1919 and for quite a few years served on such ships as the West Lake, Eastern Crown and Allison. JLS is on the air with his ham rig on 7150 kc. His call letters are W2KQE. . . . We learned that Arthur J. Costigan, vice president in charge of traffic of Radiomarine, is down at Atlantic City covering the International Allocations Conference. . . . Harry Cornell, radio supervisor of the Standard Oil Company of N. J. is also covering the Allocations Conference in Atlantic City. . . . We learned, too, that Arthur Lynch is vacationing in Florida and it appears as if he may establish a permanent residence there.

Tolerance is Important...

Especially when it comes to radio parts. That's why National parts are precision-made with tolerances measured as close as .0002".

Operational results justify this close attention to detail for every National precision condenser is mechanically and electrically

interchangeable and can be depended upon to fit the specifications called for. Production flows smoothly when you use National parts because their closely-tooled tolerances and sturdy construction make replacements unnecessary...

Please write to Department
 National Company,
 for further information

Send for your copy of the new National catalog containing over 600 parts today.

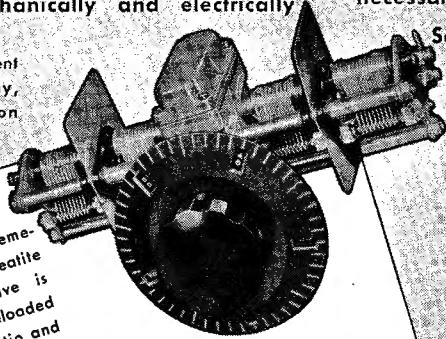

This PW Condenser is of extremely rigid construction with Steatite stator insulation. The drive is through an enclosed preloaded worm gear with 20 to 1 ratio and the rotor shaft is parallel to the panel. Plate shape is straight-line frequency when the frequency range is 2:1.

PW Condensers are available in 2, 3, or 4 sections in either 160 or 225 mmf per section. A single-section PW Condenser with

grounded rotor is supplied in capacities of 150, 200, 350 and 500 mmf, single spaced, and capacities up to 125 mmf, double spaced.

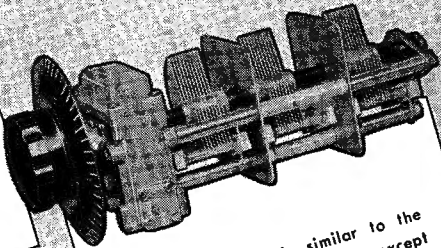

The NPW model is similar to the other PW Condenser models, except that the rotor shaft is perpendicular to the panel. Three sections... each 225 mmf.



NPW-O uses parts similar to the NPW Condenser. Drive shaft perpendicular to panel. One TX-9 coupling supplied.

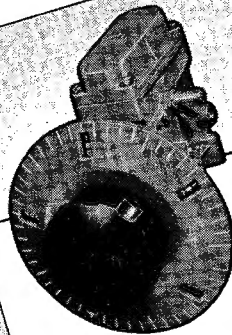

The PW-O uses parts similar to the PW Condenser. Drive shaft parallel to panel. Two TX-9 couplings supplied.

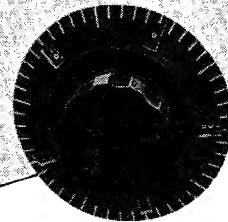

The PW-D micrometer dial can be read direct to one part in 500. It revolves ten times in covering the complete range and fits a $\frac{5}{16}$ " diameter shaft.



**National
 Company, Inc.**
 Malden, Mass.

MAKERS OF LIFETIME RADIO EQUIPMENT

A V-H-F/U-H-F Noise and Field Intensity Meter

Instrument, with 88 to 400-mc Range, Measures Radiated, Conductive and Inductive Amplitude of Noise in Microvolts and Decibels. Unit, Which Also Measures Field Intensities in Microvolts per Meter, Uses Butterfly Circuit Elements.

by LEWIS W. MARTIN

ONE OF THE MOST disturbing elements in transmission and reception is noise. The problem, particularly acute in the v-h-f and u-h-f bands, can be attacked with ultra-sensitive receiving or noise-measuring equipment, such instruments also providing a check on field intensities. With one unit,¹ recently

developed, it has become possible to measure the amplitude of noise and field intensity in microvolts per meter.

In operation, r-f energy or signal is picked up on an adjustable dipole antenna and its location determined by the antenna position. When a close approximation of the source of the

¹Stoddard Aircraft Radio Co. NMA-4 (100 to 400 mc) and NMA-5 (88 to 400 mc).

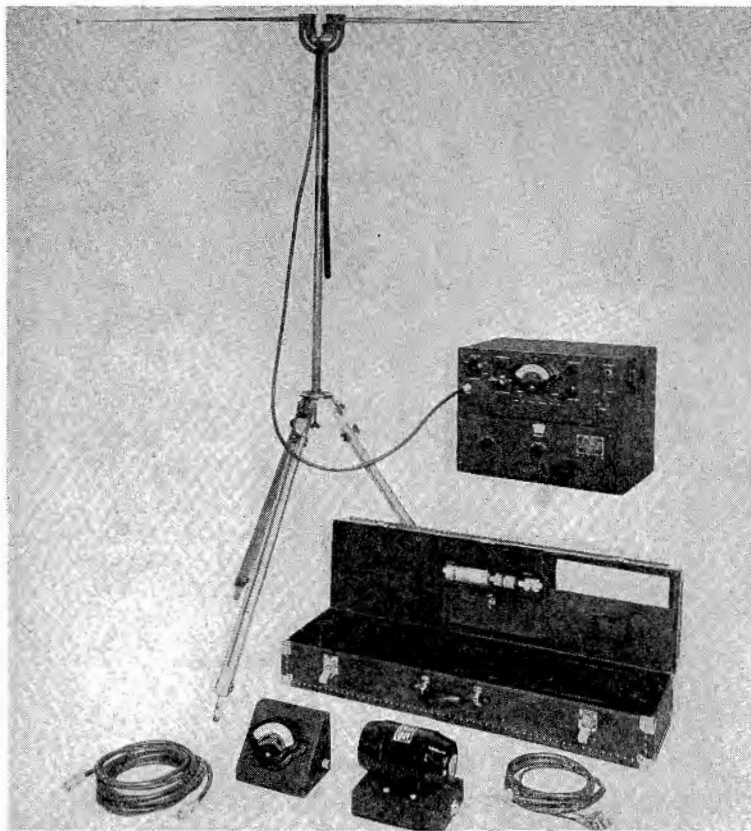

signal has been obtained, the dipole antenna is then replaced with a small loop probe antenna.

The voltage existing across the terminals of the probe antenna is then fed through a 95-ohm balanced transmission line to the input of the instrument.

The voltage can then be attenuated with a resistive-type constant impedance balanced *H* network, which provides for multiplying the indicating meter scale reading by 1, 10, 100, or 1,000.

Voltage at the output of the attenuator is fed through another 95-ohm balanced transmission line to a r-f tuning unit, where it is amplified, selected, and then mixed with the local oscillator to produce an i-f signal. This signal is then fed to an i-f amplifier through a low-capacity coaxial line.

The voltage, after i-f amplification, is then rectified by a diode, the output being fed to an *RC* network which has a voltage charge and discharge timing constant. The resulting voltage is impressed on the input of a vacuum-tube voltmeter. The magnitude of this voltage is proportional to, and is indicated by, a deflection of the pointer of an indicating meter. The indication of the meter is a measure of the voltage existing across the terminals of the antenna.

The instrument features a three-position meter switch marked *field strength*, *quasi-peak noise* and *peak noise*, provides for logarithmic indication of carrier wave *field strength*; logarithmic indication of the *quasi peak* value of radio noise or a modulated carrier wave; and indication, with a linear deflection, of the *peak* value of radio noise.

The logarithmic meter scale indication is produced by means of *avc* voltage applied to the i-f amplifier. In the first position of the switch, the *avc* voltage is proportional to the carrier value of the signal and modulation products are filtered out and the vacuum-tube voltmeter input, in ef-

Noise and field intensity meter equipment, and accessories.

Right: Circuit of the noise-field intensity meter.

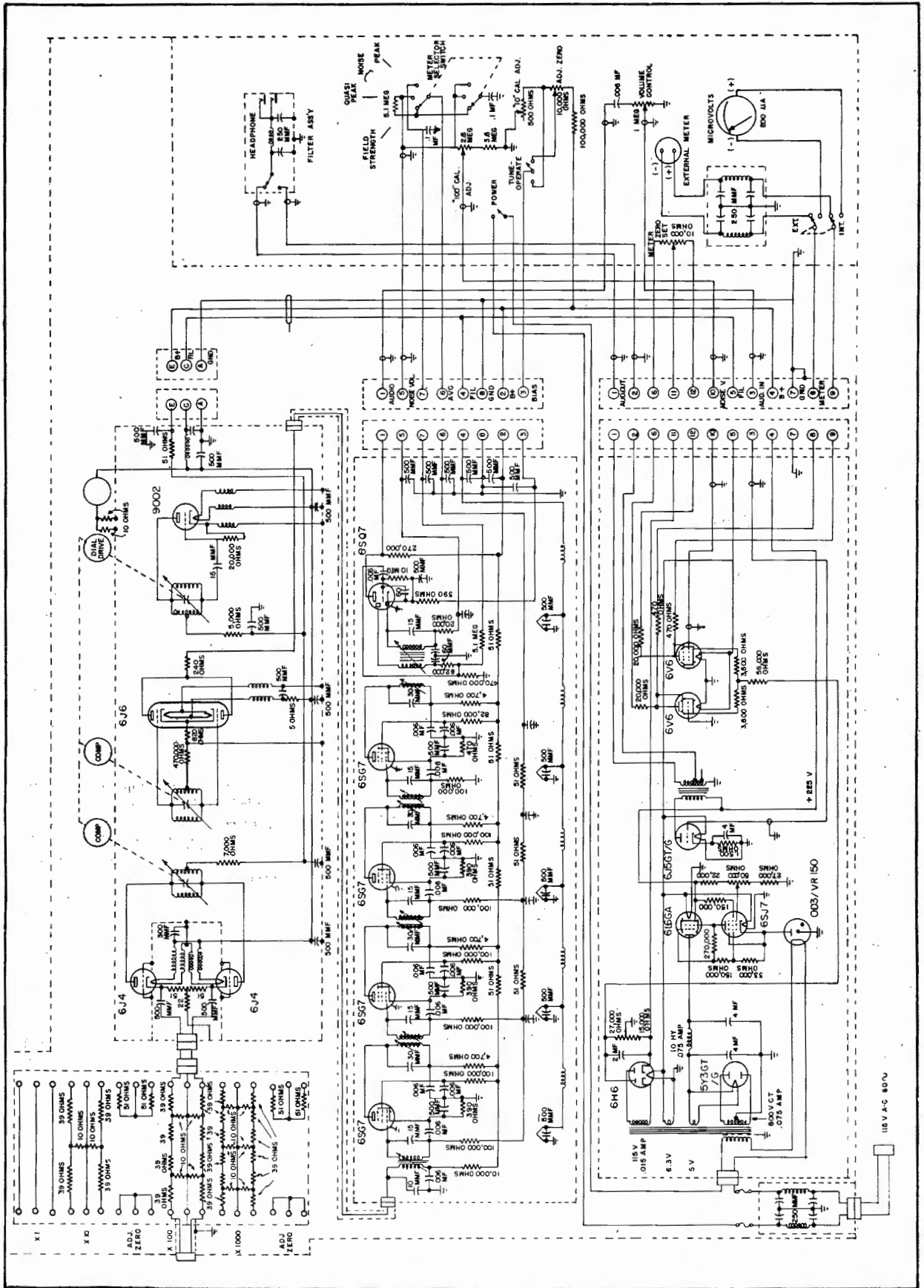

Interior and external views of the r-f amplifier.

Top view of noise-field intensity meter.

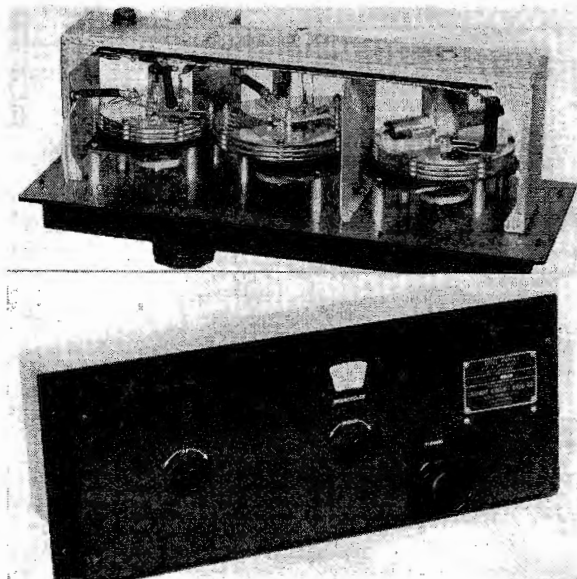
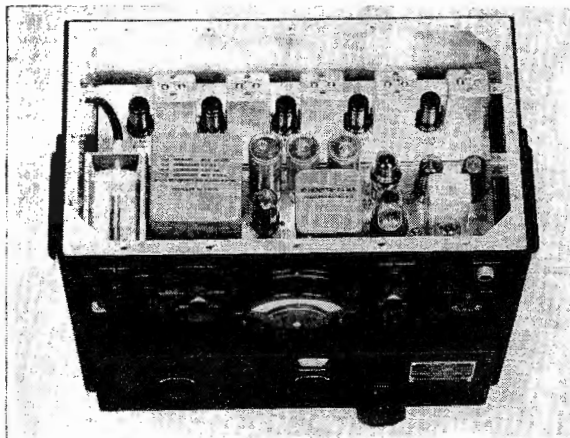

fect, is connected so as to indicate this voltage.

In the second position, the avc voltage is obtained directly from the RC network and is proportional to the *quasi-peak* value of the impressed wave and for steep wave fronts, it rises to values quite high, reducing the i-f gain.

In the third position the avc voltage is obtained from a separate diode rectifier in the i-f amplifier and is filtered by a network having a large and equal charge and discharge time constant so that only the carrier value of the impressed wave is applied as avc voltage. In addition, the vacuum-tube voltmeter is connected to the diode and RC network, thereby indicating the *peak* value of the impressed wave. The indication is thereby substantially linear for noise pulses and equal to their *peak* value because the avc voltage assumes the equivalent carrier to reduce the i-f gain and thereby reduce the indication obtained.

The *peak* position provides for an indication of audio output which may be employed for comparison purposes. For example, the calibration of an audio frequency noise meter may be compared. Incidentally the indicating meter is not calibrated for noise voltages in the *peak* position.

Because the *peak* position provides a linear indication of the *peak* value of an impressed wave, it may be used to also indicate the percentage of modulation of a carrier wave, i.e., doubling the linear angular deflection of the indication is proportional to 100% modulation. This modulation indication is valid only for modulation frequen-

cies approximating 100 cps or pulse lengths not less than .01 second.

Calibration

The instrument is logarithmically calibrated, in terms of microvolts and decibels, by means of an unmodulated sine wave signal obtained from a standard signal generator. The calibration includes the losses in a six-foot length of AN RG-22/U cable (which is negligible) and is made with the meter selector in the *quasi-peak* position.

The stability of calibration is determined by means of the *shot noise* developed in the plate circuit of the r-f amplifier. This *shot noise* is amplified and indicated by a deflection of the indicating meter pointer similar to that which is produced by an impressed signal. The deflection is dependent upon the overall amplification of the instrument and is therefore a direct indication of the stability of the calibration.

This *shot noise* indication is produced each time the instrument is tuned for maximum sensitivity at the desired operating frequency.

Since the *shot noise* acts on the instrument as a signal, provision has been made for balancing out its indication so that the meter reads zero during operation prior to measuring an impressed signal.

The magnitude of *shot noise* varies with the operating frequency and unless balanced out, would effect the avc operating point of the i-f amplifier,

altering the logarithmic calibration of the indicating meter.

Radio-Frequency Tuning Unit

The r-f tuning unit includes an r-f stage, mixer stage and an oscillator; their associated tuned circuits (which are the butterfly type), tuning dial and tuning mechanism.

The r-f amplifier stage is of the grounded grid type and comprises a pair of 6J4 tubes in push-pull for operation with a balanced transmission line input.

Since the input impedance of the grounded grid amplifier is inherently low, direct connection to the transmission line input is possible, and the impedance is so chosen as to provide a precise termination for the line. This eliminates the necessity of employing a coupling coil for terminating the line which causes difficulties when operated over a wide band of frequencies.

The push-pull plates of the grounded grid amplifier are connected to the butterfly-tuned circuit. This type of tuned circuit leads itself to push-pull operation because it is geometrically arranged for balanced connections. It is tunable over a wide range, provides high Q values and produces a substantially constant value of resonant impedance.

The mixer stage consists of a 6J6 dual triode with the grids connected in push-pull and the plates connected in parallel. The grids are connected to another butterfly-tuned circuit and the parallel plates are connected to a

coaxial plug for connection to the i-f amplifier.

The oscillator also employs a butterfly circuit. A 9002 triode is connected in a Colpitts type of circuit wherein the proper feedback voltages are obtained through the inter-electrode capacities. Its operating frequency is 30-mc higher than the r-f or mixer stage.

The r-f butterfly circuit is inductively coupled to the mixer butterfly circuit. The oscillator butterfly circuit is also inductively coupled to the mixer butterfly circuit. These circuits are quite closely coupled so that the oscillator voltage induced in the mixer circuit is many times that of the signal, providing the mixer with good linearity and high conversion gain.

Because the oscillator operates 30 mc higher than the signal frequency, the i-f frequency produced in the plate circuit of the mixer is 30 mc. This difference frequency being relatively high reduces the tendency of pull-in between the mixer and oscillator circuits and provides desirable image rejection. The use of an r-f stage further improves the resulting image rejection ratio.

The r-f, mixer, and oscillator butterfly-tuned circuits are ganged together for single dial operation. The tuning drive comprises a large spur gear train, one gear for each tuned circuit.

I-F Amplifier

Four 30-mc band-pass stages, employing 6SG7s, are used in the i-f. Each stage has relatively low gain to produce good stability.

The first three i-f tubes have avc voltage applied to their grids. It is through the exponential control characteristics of these tubes that the logarithmic scale calibration of the indicating meter is obtained. The fourth i-f stage has fixed bias and functions as an avc amplifier, improving the logarithmic action.

The i-f amplifier is connected through a low-capacity coaxial line to the r-f tuning unit. Each of the i-f stages are individually filtered, including the filament leads. Button type capacitors are used to bypass the output and power leads.

The purpose of this filtering is to provide stability by preventing any regenerative effects occurring in the i-f amplifier. In addition, the filtering prevents any harmonics of the i-f output from being conducted through the external wiring to the input of the r-f tuning unit. This eliminates regeneration from occurring when the

(Continued on page 44)

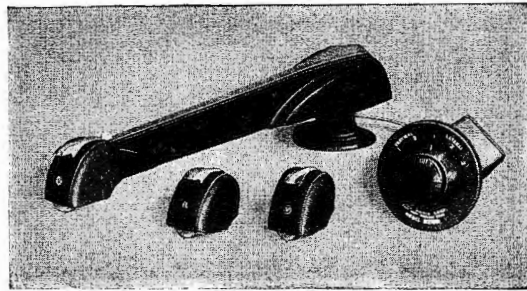

*Universal Reproducer
Lateral Only Reproducer
Vertical Only Reproducer*

*Simplicity ...
Efficiency ...
Quality ...
Durability ...
reasons why*



Federal Telephone and Radio Corporation

offer

PARA-FLUX REPRODUCERS

**AS STANDARD EQUIPMENT
FOR THEIR TRANSCRIPTION CONSOLES**

For FM operation where quality standard will tolerate no compromise, Federal Telephone & Radio Corp. uses PARA-FLUX Vertical Only and Lateral Only Magnetic Reproducers for absolute pick-up accuracy. On AM, too, our Universal Reproducer is widely used to give superior performance where both lateral and vertical reproduction are required from the same unit and likewise for quick cueing operations. All three types assure FM quality, and are interchangeable with the Model A-16 ARM and Model EL-2 EQUALIZER shown above.

Over 1,500 PARA-FLUX REPRODUCERS are now on the air over FM-AM stations.

Available through Authorized Jobbers

Descriptive, illustrated Bulletin PR5, upon request

**RADIO-MUSIC
CORPORATION**
EAST PORT CHESTER, CONN.

The Industry Offers

DUMONT VOLTAGE CALIBRATOR

A voltage calibrator, 264-A, for use with all models of cathode-ray oscillographs has been announced by Allen B. Du Mont Laboratories, Inc., Passaic, N. J. Instrument provides a convenient method for measuring the peak-to-peak voltage of any signal being viewed on the oscillograph screen.

Output of calibrator is essentially a square wave the amplitude of which is continuously variable from 0 to 100 volts. This continuously variable output is obtained from a linear potentiometer with a direct-reading calibrated dial divided into 100 divisions. Connected in parallel with the output potentiometer is a conventional four-step decade output attenuator, providing four ranges of voltage readings, namely, 0-0.1, 0-1, 0-10 and 0-100 volts. Overall accuracy of the output voltage is said to be within $\pm 5\%$ of each range.



FREED VACUUM-TUBE VOLTMETER

A vacuum-tube voltmeter, 1060, which can be used as audio and superionic frequencies, and also as a null detector in d-c bridge measurements, has been developed by Freed Transformer Company, Inc., 72 Spring Street, New York 12, New York.

Input impedance is 50 megohms shunted by 15 mmfd. Voltmeter has a frequency range from 10 cycles to 1.6 mc, with a .5 db variation.

Voltage ranges of .001 to 100 volts in five ranges; .01, .1, 1, 10, 100 volts, full scale. Logarithmic voltage scale calibrated for 1 to 10 and a linear decibel scale calibrated from 0 to 20 db.

SUPERIOR ELECTRIC VOLTAGE REGULATOR

An instantaneous-electronic type voltage regulator, Stabiline type IE series, has been announced by Superior Electric Co., 54 Laurel St., Bristol, Conn.

With the first model in production, type IE5101, the output voltage is said to be held to within ± 0.1 volt of any nominal value in the settable output range between 110 and 120 volts for an input line voltage change from 135 to 95 volts. Although the time for recovery varies, depending upon line voltage, load current, load power factor and other conditions, it usually is in the order of 3 to 6 cycles. Device is said to be independent of any load power factor change from a lagging .5 to a leading .9.

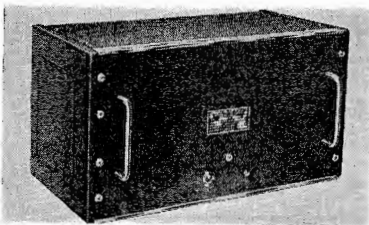

WESTON ELECTRONIC ANALYZER

An electronic analyzer, model 769, has been announced by the Weston Electrical Instrument Corporation, Newark 11, N. J.

Instrument features a h-f vacuum-tube voltmeter for measurements on frequencies up to 300 mc, electronic voltohmmeter, and a 10,000-ohm-per-volt d-c and 1000-ohm-per-volt a-c multimeter. Uses a unity gain d-c amplifier, incorporating both regeneration and degeneration.

The v-t-v-m accuracy is said to be 5% to 150 mc, and 12% from 150 to 300 mc, direct reading; use of a corrective curve reduces this to 8% on 150 to 300 mc. Has a 3/2" and 3/4" diameter r-f probe.

The electronic voltohmmeter covers ranges from 3 to 1200 volts, and 2000 ohms to 2000 megohms full scale. Electronic zero balance is said to be unaffected by zero adjustments to the ohmmeter.

Analyzer section has six 10,000-ohms-per-volt voltage ranges, six rectifier-type a-c voltage ranges to 1200 volts, three ohmmeter ranges to 200,000 ohms, and six d-c ranges to 600 milliamperes.

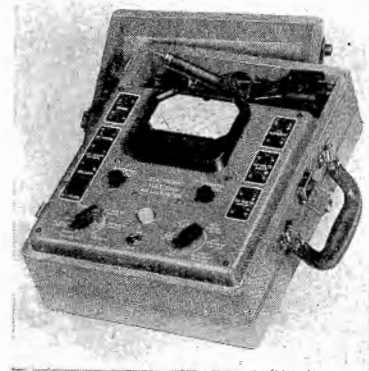

RAYTHEON TETRODE

A 450-watt plate-dissipation tetrode, RK-6D22, has been announced by the power-tube division of the Raytheon Manufacturing Company, Waltham, Mass.

When tetrode-connected, can be used as class C amplifier. When triode-connected (screen grid and control grid tied together) the tube can be used as a zero-bias class B audio amplifier.

Tetrode-connected, tube delivers 1000 watts output with about 22 watts of drive.

As a zero-bias class B triode, a pair of tubes will deliver 2400 watts of audio with 45 watts drive.

Under class C conditions, the tube is rated for a maximum plate voltage of 3500 volts; while as a zero-bias class B triode, it is rated for a maximum of 5000 volts.

GRAY PLAYBACK ARM

A playback arm made to accommodate low-mass highly compliant cartridges has been announced by Gray Research & Development Company, Inc., Elmsford, Westchester County, New York.

Has an adjustable scale for optimum stylus pressure and a self-leveling base.



UNITED ELECTRONICS VACUUM CAPACITOR

A 50-mmfd vacuum capacitor, Cap 50/-60/-30, has been announced by United Electronics Company, Newark, New Jersey.

The capacitance is said to be within a tolerance of $\pm 2\%$ or ± 1 mmfd. Peak potential is 30 kv. Features include large periphery glass-to-copper seals, end caps gold plated to minimize oxidation and maintain low-contact resistance. Overall dimensions, 2 1/4" x 6 1/2".



RCA 5-KW TV TRANSMITTER

A 5-kw tv transmitter, TT-5A, featuring a new power tube, the 8D21, in the aural and visual sections, has been announced by the RCA engineering products department.

Tube, a dual-tetrode, is said to have inherent stability, achieved by built-in neutralization; wide bandwidth at high efficiency, achieved by low output capacity; and minimum current loss to grids and shields, accomplished by electron optics.

The tube is designed in such a way that the screen grid is bypassed to the cathode within the tube, and the small feed through capacitance is essentially reduced to zero by means of small neutralizing tabs within the tube.

By the use of efficient high level modulation, only one stage of broadband r-f has to be tuned—the power amplifier output circuit of the picture transmitter. Low power stages are tuned in the conventional manner.

The two transmitter units, visual and aural, are almost identical. The primary difference is the type and method of modulating the two transmitters. The f-m sound transmitter employs a standard RCA f-m exciter at the head of an r-f chain, while the picture r-f chain begins with a conventional crystal oscillator.

All driver stages employ narrow band circuits and are operated class C with the characteristic high efficiency.

Both the picture and sound sections of the transmitter are operated from power supplies which are entirely isolated from each other.

The video section employs three electronically regulated power supplies.

Dual unit reflectometers in both the sound and the picture output circuits perform three main functions: indication of the power output of the transmitters; measurement of the standing-wave ratio on the transmission line; and

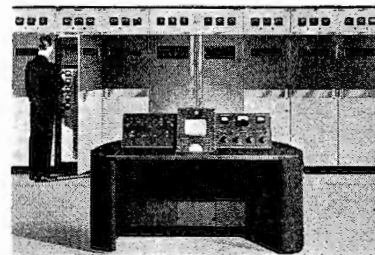

operation as an r-f over-load output, instantly removing plate power, protecting the transmission line against damage from power arc resulting from lightning follow through, in the event of a lightning stroke.

A vestigial side-band filter is said to eliminate the lower side-bands and makes compliance with the FCC regulations positive, by methods independent of operating adjustments. It is constructed of low-loss coaxial transmission lines and is complete assembled and adjusted at the factory for a given assigned channel.

Superturnstile antenna is used with transmitter. Because of the broad-band properties of the antenna, only three antennas of this type (54-66 megacycles, 66-88 megacycles, and 174-216 megacycles) are needed to cover the twelve metropolitan television channels. Antenna gains of 3.8 to 9.3, depending on the channel, are obtained.

The superturnstile can be used for triplex operation. For this purpose, a triplexing unit located in the transmitter building introduces an independent f-m carrier in addition to television picture sight and sound signals. The triplexer enables the same antenna to radiate a television program along with a separate f-m program simultaneously with absolutely no interference from either.

The first production-line model of the transmitter was recently delivered to WNBW, in Washington, D. C., to operate on channel four.

* * *

ST. LOUIS OUTDOOR MICROPHONE

An outdoor type dynamic microphone, which, it is claimed, can be dropped successively without failures, has been announced by The St. Louis Microphone Co., Inc., 2726-28 Brentwood Blvd., St. Louis 17, Missouri.

Range is said to be 40-9,000 cycles. Uses Alnico-V magnet. Variable impedance output adjustable to low, 200, 500 or high.

* * *

FAIRCHILD UNITIZED AMPLIFIER SYSTEM

A unitized amplifier system, featuring a dozen units, has been announced by the Fairchild Camera & Instrument Corp., 88-06 Van Wyck Blvd., Jamaica 1, N. Y.

Thus far, a 35-watt power amplifier (No. 620) and a microphone pre-amplifier (No. 621) have been processed for delivery. Additional units to come out shortly are pre-amplifiers and boosters for pickup and line; output switch panel with volume indicator and monitor take-off; input switch panel; N.A.B. and variable equalizers; mixer; volume indicator panel; bridging device; and auxiliary power supply.

The 620 power amplifier is said to have a frequency response of 30 to 15,000 cycles, ± 1 db; noise level, -40 db maximum. Output impedance is 500 ohms, isolated, and there is a second low-impedance winding for monitoring; 2, 4, 8, 14 and 20 ohms. Input impedance is 600 ohms, isolated.

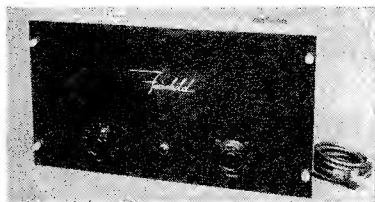

* * *

COLLINS R-F EXCITER UNITS

Three new r-f exciter units for amateurs have been developed by the Collins Radio Company, Cedar Rapids, Iowa.

One, the 310B exciter utilizes a permeability tuned oscillator for its frequency control. Calibration is directly in frequency and accuracy is said to be within .015%. Rated at 15 watts output on all bands under 32 mc.

Another, the 310C, provides all the frequency control advantages of the 310B exciter but is designed as a crystal replacement unit. Has an r-f output of 80 volts rms, and a frequency range of 3.2-4 mc. The output can be plugged into an 80 meter or 40 meter crystal socket. The third, 310C-2, is similar to the 310C-1

(Continued on page 38)

ANDREW UHF ANTENNAS

assure maximum signal strength

Each of these six Andrew Antennas offers a balanced blend of: gain, impedance matching, bandwidth, directional properties and mechanical design as needed for a specific application. As is typical of the complete Andrew line, they do not concentrate on one feature to the exclusion of others. Backed by the experience of the pioneer specialist in antenna manufacture, these models assure maximum signal strength. Write today for complete details.



This is a Dielectric Antenna, with special directional properties for radar.



A "Yagi" array, highly directional with excellent impedance matching & bandwidth.

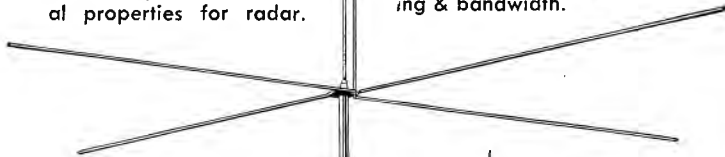

The Andrew Folded Unipole Antenna, ideal for transmitting or receiving, in the frequency range 30 to 174 MC.



A Coaxial Antenna for the amateur 2 meter band.

A Ground Plane Antenna, economical and effective for government, amateur, and emergency communication services.

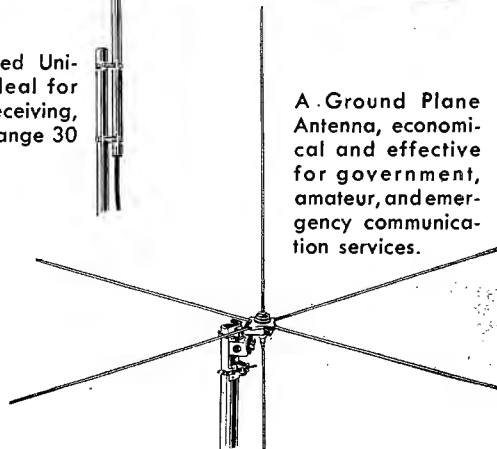

The new Andrew Di-Fan Broad Band Antenna, for improved FM and TV reception.



© 1946

ANDREW

ANDREW CO.

363 E. 75th St. • Chicago 19, Illinois
Pioneer Specialists in the Manufacture
of a Complete Line of Antenna
Equipment

3 WAYS TO BE AHEAD in Buying Test Equipment

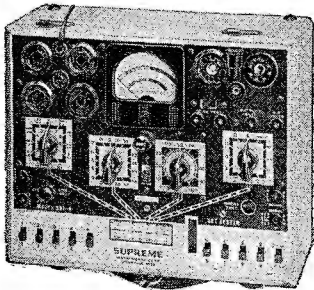

Model 599-A Tube and Set Tester

SPECIFICATIONS
 DC Volts — 5 ranges 0/6/15/150/600/1500 volts, 1000 ohms per volt.
 AC Volts — 3 ranges 0/15/150/600 volts.
 DC Current — 3 ranges 0/6/60/600 milliamps.
 Output Volts — 0/15/150/600 volts.
 Ohmmeter — 4 ranges 0/200/20,000 ohms and 0/2/20 megohms.

Condenser Checker — Ohmmeter provides fast method of checking leakage of both paper and electrolytic condensers.
 Battery Tester — Tests most commonly used dry portable batteries of 1.5/4.5/6.0/45/90 volts. English reading "Replace-Good" scale.



WRITE FOR NEW CATALOG

SUPREME INSTRUMENTS CORP., Greenwood, Miss., U.S.A.

Export Department: THE AMERICAN STEEL EXPORT CO. Inc., 347 Madison Ave., New York 17, N. Y., U.S.A.

- 1 BUY ACCURACY
- 2 BUY DEPENDABILITY
- 3 BUY SUPREME-ACY

Ask your nearest SUPREME jobber for a demonstration of Model 599-A Tube and Set Tester (above), Model 561-AF & RF Oscillator, Model 546-A Oscilloscope, Model 592 Speed Tester. Ask to see the complete line of SUPREME equipment.



Tube Testing — Circuit incorporates proven and modernized emission circuit. Checks for short, leakage, and noise tests between elements.
 Power Supply — 100-133 volts — 50/60 cycles. Special voltages and frequencies on request.

amplifier, tone oscillator and local remote control adapter may be plugged into the rack-mounted control panel.



BROWNING AMATEUR FREQUENCY METER

An amateur frequency meter, MJ-9, designed for checking the frequencies of f-m or a-m amateur transmitters operating in the 3.5 to 148 mc bands has been announced by Browning Laboratories, Inc., Winchester, Mass. Bands covered are 3.5-4 mc, 7-7.3 mc, 14-14.4 mc, 20.5-21.5 mc, 28-29.7 mc, 50-54 mc, and 144-148 mc.

Meter is direct reading for all bands with separate coils for all bands except the 144 to 148-mc range, this being covered by harmonics of the 20.5 to 21.5 mc band. A 500 kc crystal controlled oscillator is used as a reference standard. Overall accuracy of the unit is said to be .05% at all frequencies.

The Industry Offers

(Continued from page 37)

exciter with the added advantage of a self-contained power supply.

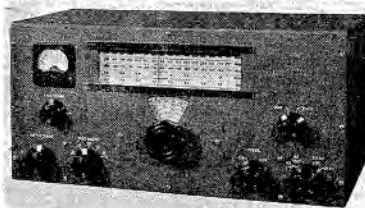

310B exciter

mediate frequency alignment, by fixed frequencies of 456 and 465 kc. Suitable trimmers are provided for recalibrating.

C-D TV CAPACITORS

A series of television receiver capacitors has been announced by the Cornell-Dubilier Electric Corp., South Plainfield, New Jersey. Impregnated and filled with Dykanol and hermetically sealed. Type GC1A00 is shown in illustration.

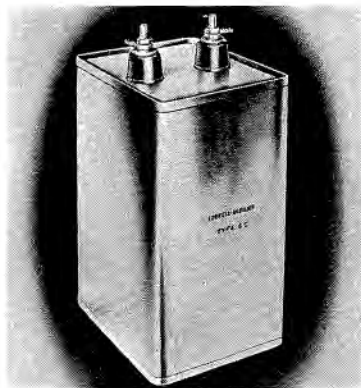

RCP SIGNAL GENERATOR

A pocket-size supplementary signal generator, 710, has been developed by Radio City Products Co., Inc., 127 West 26th Street, New York 1, N. Y.

Broadcast band alignment is provided for by fixed frequencies of 1500 and 550 kc; inter-

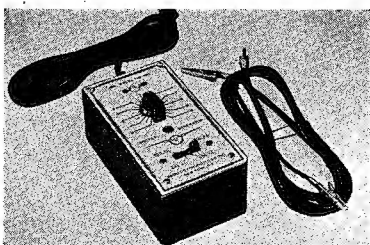

G. E. EMERGENCY COMMUNICATIONS UNITS

A 60-watt f-m transmitter-receiver combination, SC-9, for fixed station use by police, power, forestry and public utility groups, has been developed by the transmitter division of G.E. Incorporating one or two receivers, the combination is designed to permit remote operation over a single-pair telephone line. A pre-



MILLEN ANTENNA-MATCHING PREAMPLIFIER

An impedance-matching device and a broadband preamplifier combined into a single unit, No. 92,101, the result of the engineering efforts of G. E. and James Millen Mfg. Co., has been announced by Millen.

Coils are available for the 6-, 10- and 20-meter bands.

A 6AK5 miniature tube serves as a broadband r-f amplifier to provide an additional gain of about 30 db.

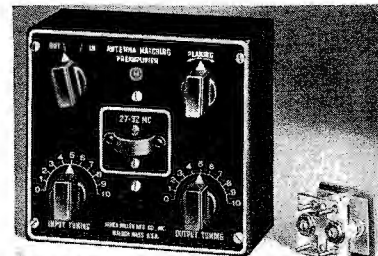

AMPERITE STUDIO RIBBON MICROPHONES

A ribbon microphone, which, it is said, will not become boomy on close talking, has been

announced by the Amperite Company, 561 Broadway, New York 12, N. Y.
 Frequency range is said to be from 40 to 1400 cps; output -56 db.
 Wide pick-up angle of 120° front and back; feedback said to be unusually low since the microphone has no peaks.



PRESTO AMPLIFIER

A portable recording amplifier, 90-A, that is said to contain all the facilities necessary for operation on remote assignments, is available from Presto Recording Corp., 242 W. 55th Street, N. Y. City. Consists of three preamplifiers, mixer, master gain control and recording amplifier:

Selector provides the NAB 33 $\frac{1}{3}$ rpm recording and playback characteristics, 78 rpm recording characteristic and a flat response, 20 to 15,000 cps \pm 1 db. The flat response can be modified by variable bass and treble controls, giving emphasis up to 20 db at 100 and 7,500 cps or 20 db deemphasis at 7,200 cps.

Noise is 60 db below recording level and distortion at maximum output is less than 1 $\frac{1}{2}$ %.

Recording level is monitored by means of a Weston type 30 VU indicator with illuminated scale.

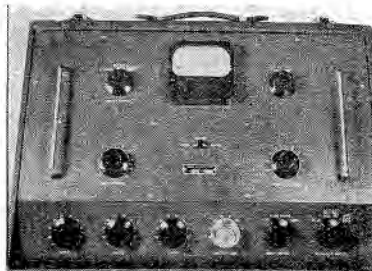

G. E. CALROD MIDGET SOLDERING IRON

A lightweight calrod soldering iron available with $\frac{1}{8}$ " and $\frac{1}{16}$ " diameter tips, has been announced by the industrial heating division of G.E.

Iron is 8" long and weighs 1 $\frac{3}{4}$ ounces without the cord. Rated 25 watts, 6 volts, and is used with a 115/-volt insulating transformer.

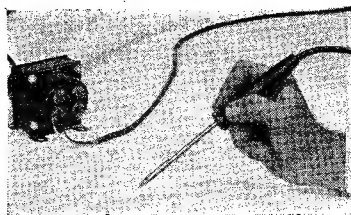

NEW
 TECH-LAB
 DEVELOPMENT

For **RAPID**
MEASUREMENT
 OF
AUDIO FREQUENCY
GAIN or LOSS

TYPE 1A TRANSMISSION MEASURING SET

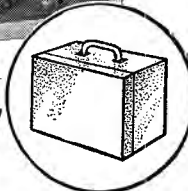

Completely Self-Contained
 PORTABLE • AC OPERATED

With this instrument it is possible to quickly and accurately analyze and service equipment in different locations without fuss in time consuming demounting and transportation of apparatus. It will thus pay for itself in a short time and no modern radio station can afford to be without it. It can also be used to good advantage in factory checking and inspection of audio equipment.

The set combines in a modern efficient manner an accurate vacuum tube voltmeter, an audio oscillator with four fixed frequencies and a precision attenuator all mounted in a handy cabinet easily carried by the operator.

SPECIFICATIONS

- GAIN: Up to 80 db.
- LOSS: 60 db. maximum.
- VACUUM TUBE VOLTMETER:
 Range—40 to +40 db.
 (1 mv. ref. level)
- AUDIO OSCILLATOR:
 Freq. Range: 100 to
 10,000.
- PRECISION ATTENUATOR:
 Flat to 20 KC; 93 db.
 in 1 db. steps.
- DIMENSIONS:
 10 $\frac{1}{4}$ " x 16 $\frac{1}{4}$ " x 8 $\frac{3}{4}$ "
- WEIGHT: 30 lbs.
- INPUT: 115 Volts.
 60 cycles, 70 watts.

TECH
 LABORATORIES, INC.

Manufacturers of Precision Electrical Resistance Instruments
 337 CENTRAL AVE. • JERSEY CITY 7, N. J.



for experienced cooperation "call Cleveland"

2 more

applications of
COSMALITE*

a spirally laminated paper base Phenolic Tube
For coil forms in all standard broadcast receiving sets, specify #96 Cosmalite.
For permeability tuners, specify SLF Cosmalite.
LOWER COSTS . . . Quick Deliveries.
Ask about our spirally wound kraft and fish paper Coil Forms and Condenser Tubes.
*Trade mark registered.



All-Fibre Cans
• Combination Metal and Paper Cans
• Spirally Wound Tubes and Cores for All Purposes
• Plastic and Combination Paper and Plastic Items

The CLEVELAND CONTAINER Co.
6201 BARBERTON AVENUE CLEVELAND 2, OHIO
PRODUCTION PLANTS also at Plymouth, Wisc., Ogdensburg, N. Y., Chicago, Ill., Detroit, Mich., Jamesburg, N. J.
PLASTICS DIVISIONS at Plymouth, Wisc., Ogdensburg, N. Y. • ABRASIVE DIVISION at Cleveland, Ohio
New York Sales Office—1186 Broadway, Room 223
IN CANADA—The Cleveland Container Canada Ltd., Prescott, Ontario

new

**CONCORD
Radio
Catalog**

**RADIO PARTS • RADIO SETS
RECORD CHANGERS • PLAYERS
HAM GEAR • AMPLIFIERS • TESTERS**

It's here—the new 1947 Concord Catalog—a vast, complete selection of everything in Radio and Electronics. See these value-packed pages showing thousands of items available for IMMEDIATE SHIPMENT—hundreds of them now available for the first time—featuring new, latest 1947 prices. See new LOWER prices on finest-quality RADIO SETS, PHONO-RADIOS, RECORD CHANGERS, RECORD PLAYERS, PORTABLES, AMPLIFIERS, COMPLETE SOUND SYSTEMS, TESTERS. See latest ratings of well-known, standard, dependable lines of radio parts and equipment—tubes, condensers, transformers, relays—available for IMMEDIATE SHIPMENT from huge stocks in CHICAGO and ATLANTA. Mail coupon NOW!



free
Mail COUPON TODAY!

CONCORD
RADIO CORPORATION
LAFAYETTE RADIO CORPORATION
CHICAGO 7, ILL. ATLANTA 3, GA.
901 W. Jackson Blvd., 265 Peachtree St.

Concord Radio Corporation, Dept. R-67
901 W. Jackson Blvd., Chicago 7, Ill.
Yes, rush FREE COPY of the comprehensive new Concord Radio Catalog.
Name.....
Address.....
City..... State.....

30-44 MC F-M

(Continued from page 29)

audio on or off, is held closed by the plate current flowing through a 2D21 thyatron when the receiver is in standby condition. The relay will open, energizing the receiver audio system through a set of relay contacts when plate current through the thyatron is stopped. The method of controlling the flow of the thyatron plate current is the key to the entire operation of the squelch circuit. Control grid bias, which controls the flow of plate current, is applied to the thyatron oscillator, from (1), the second limiter grid bias resistor and (2), the output of the second limiter plate. The second limiter grid bias voltage is always saturated on either noise or on-frequency signals and is negative. The voltage from the second limiter plate when no signal is present, on the other hand, consists of continuous noise pulses, the positive peaks of which exceed the steady negative voltage derived from the second limiter grid, changing the instantaneous grid voltage to a positive value and permitting the 2D21 tube to fire, draw plate current, and close the plate relay. The thyatron is extinguished after the first cycle of oscillation, and fires again when another noise pulse is applied to the grid, the random effect keeping the receiver audio off.

Two effects occur, one with on-frequency signals, and the other with near frequency strong signals. When an on-frequency signal is received there is no change in second limiter grid voltage, but the level of the positive peaks of noise is reduced and cannot keep the thyatron in operation. Therefore the plate relay opens and turns on the audio tube.

When an adjacent channel or other signal of sufficient strength is present, the early r-f and i-f stages of the receiver tend to saturate and reduce the noise signal on the limiter grids. With sufficient input signal the second limiter grid bias will go to zero, and at the same time the discriminator output voltage is reduced to zero because of absence of noise signal. The thyatron bias is continuously zero thus permitting the tube to remain fired at all times. In this way the audio stages are caused to remain off. This effect is compensating for all values of adjacent channel or near frequency input signal. However, as in any receiver, interference with an incoming on-frequency signal may be present if the interfering signal is of sufficient strength.

The receiver audio system utilizes a 6V6, driven by a 6AQ6 ampli-

fier. A maximum of $1\frac{1}{2}$ watts output is obtained; about 1 watt with 10% harmonic distortion.

The overall receiver battery drain, when in mobile service, is about 6 amperes when standing by, and 7 amperes when audio is turned on. A power supply, using 6X5-GT rectifier is used for 6-volt d-c operation. This is replaced by a conventional full-wave rectifier using a 5Y3-GT when in fixed station 117-volt a-c use.

[To Be Continued]

V-H-F Survey

(Continued from page 22)

miles in front of each end of the radio lane.

Survey Equipment

In conducting these tests, it is essential that a variety of supplementary equipment and components be available. For instance, an altimeter is a required piece of equipment to determine the characteristics of test-territory terrain.

Quite often results of a test may be interpreted entirely differently if something is known of the terrain character. Careful checks must be made when driving at high speed, with windows open. Altimeters are greatly affected by speed of the car and the resultant windage.

In preparing the antenna setup, it is necessary to provide for support pipe clamps, U bolts, spare fixed-station antenna whips, coaxial coupling materials and appropriate connectors if the antenna does not use copper coaxial. All cabling for mobile units or any special remote setups must be carefully checked. If the cable involves any special features that might be subject to breakage or damage, spares should be included.

Checking Before Tests

Before raising the antenna, it is quite important to check the leakage resistance of the coaxial line from the center conductor to the outer conductor. It is also advisable to check the center conductor continuity from end to end. This may be done by shorting top antenna whip to the outer casing and measuring with an ohmmeter, on a low resistance scale, between the center conductor and outer conductor at the transmitter end of the antenna lead-out cable.

These tests, made just preceding the raising of the antenna, must also be

(Continued on page 45)

CURRENTLY

SORENSEN & COMPANY, INC.
Manufacturers of
VOLTAGE REGULATORS, NOBATRONS & ELECTRONIC APPARATUS

**FROM
SORENSEN
AT
STAMFORD**



POWERFUL NEWS!

SORENSEN SYSTEM NOW APPLIED TO DC VOLTAGE REGULATION

The Sorensen system of AC electronic voltage regulation provides quick, accurate response to even the smallest voltage change with a minimum wave distortion and a regulation accuracy of $\frac{1}{2}$ of 1%.

Arrange now to receive your personal copy of the Sorensen electronics journal "Currently", published bi-monthly.

This same electronic regulation system has been incorporated into the Nobatron, providing a source of regulated DC voltage at currents and stabilities that, in the

past, was available only with batteries.

This new source of stabilized DC voltage is obtainable in six standard models operating on a 95-125 AC source of 50 to 60 cycles.

Among the more important uses for Nobatrons are DC ammeter calibration in experimental and quality control laboratories, testing of components in the automotive and aircraft industries in battery-operated relays and in other applications where it is desirable to replace a battery to guarantee continuous regulated power supply.

GENERAL AC REGULATOR SPECIFICATIONS

Input Voltage Range (-1 model) ..	95-125
	(-2 model) .. 190-250
Output Voltage Range (-1 model) ..	110-120
	(-2 model) .. 220-240
Load Range	25-30,000 V. A.
Regulation Accuracy	$\frac{1}{2}$ of 1%
Harmonic Distortion	5% Max. (2% in "S" Models)
Input Frequency Range	50-70 cycles
Inductive Power Factor Range	Down to 0.7 P.F.

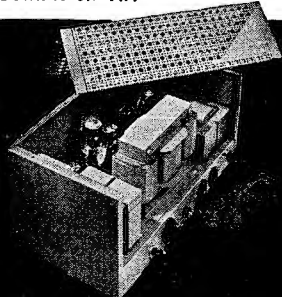

For standard voltage regulation, Sorensen Model 500 is a proven leader in its field—compact, accurate and dependable. This model typifies the Sorensen line of AC and Nobatron all-purpose voltage regulators. Let a Sorensen engineer help you with your next voltage regulation problem.

SORENSEN & COMPANY, INC.

375 FAIRFIELD AVENUE • STAMFORD, CONNECTICUT

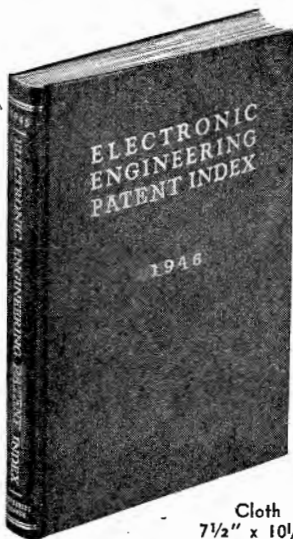

The Patent Guide You Have Been Waiting For!

ELECTRONIC ENGINEERING PATENT INDEX, 1946

A master compilation of over 2000 electronics patents arranged for rapid reference. First book of its kind ever published.

During 1946 the U. S. Patent Office granted over 2000 electronics patents. Here in this single volume is the complete collection reproduced in entirety from the 52 weekly issues of the Patent Office Gazette issued during 1946. Each electronic patent included gives patent title, number, inventor, assignee, illustrations, etc. All patents are conveniently arranged under more than 90 subject headings. Here is a wealth of new information on circuits, components, manufacturing methods, etc.

Cloth
7 1/2" x 10 1/3"
480 Pages

Send for descriptive circular

Order Now, Edition Limited

PRICE \$14.50

ELECTRONICS RESEARCH
PUBLISHING COMPANY

2-4 W. 46th STREET
NEW YORK 19, N. Y.

Now Available. 1946 Supplement To the 1925-1945 Edition of ELECTRONIC ENGINEERING MASTER INDEX

Covering the important one and one-half year period from July 1945 to December 1946, and including over 3000 miscellaneous entries, this supplement contains over 7500 new bibliographical listings arranged under more than 400 subject headings. A special feature is the classified compilation of MANUFACTURERS' CATALOGS.

Order Now, Edition Limited
230 pages.....\$14.50

Send for descriptive literature

Radioteletype Systems

(Continued from page 26)

tenance by unskilled personnel. Above all, flexibility should be paramount in the plan, as the system should stand unlimited expansion without obsolescence of equipment. Standardization of equipment for replacement and maintenance purposes is an important item.

Often transmitting equipment are divided into two categories: 400-500-watt output for domestic circuits, and 3 kw for international use. The smaller transmitters combine radioteletype r-f channels with A-3 voice r-f channels in a common cabinet with common power supply. Two radioteletype r-f channels (for day and night frequencies) and two voice r-f units might constitute one complete transmitter.

Common Frequencies

Common frequencies could be used for satellites within a net. Because the carrier is turned on and off constantly as stations transmit and receive, simultaneous use of A-3 (voice) and f-s keying on the same channel is impractical. Thus satellites would use simplex operation between themselves and full duplex between each individual satellite and the control station. This might be called half-duplex or shared-time duplex operation. Traffic between divisions would be relayed by Ankara. Because the r-f carriers of both eastern and western divisions transmitters at Ankara would stay on continuously, operation of combined A3/A1 and f-s telegraph transmission would be feasible.

Rhombic directional transmitting antennas would be beamed from each satellite towards Ankara, to provide better reception from the low-power transmitters. Ankara on the other hand, would have to transmit in all directions; 3-kw transmitters would be required to give sufficient power to the non-directional antennas.

There would be no distinction between the domestic and international transmitters. Three 3-kw output transmitters of 4 r-f channels each would be arbitrarily set up with frequencies corresponding to the circuits desired. From two to four r-f units could be operated simultaneously on each transmitter, which insures sufficient channels available for all services.

The base station would ordinarily use at least two and occasionally three or four r-f channels (frequencies) simultaneously on both domestic and international weather broadcasts. In fact, for conventional domestic point-to-point transmission, both day and

Crystals for the Critical



IF6 CRYSTAL FILTER WITH HIGHER Q

The "Stabilized" IF6 filter crystal has become standard with many of America's leading receiver manufacturers—and for good reason, too. Our "Stabilizing" process materially raises the Q—permits sharp signal discrimination. The holder has lower capacity and the crystal is free from spurious frequencies within +0 — 10 KC of operating frequency. Normally supplied in 455 KC, but can also be supplied in a wide frequency range.

Catalog on Request or Write Us About
Your Crystal Problems

The JAMES KNIGHTS CO.
SANDWICH, ILLINOIS

HOPP Plastic RADIO DIALS

DIAL WINDOWS, NAME PLATES, GAUGES,
CALCULATORS, SCALES, CHARTS, ETC.

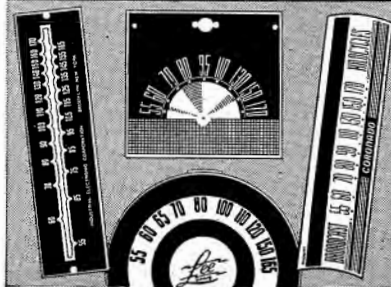

PLASTIC RADIO DIALS have endless possibilities in design, size, shape and color combination. Attractive and durable, our radio dials, windows and scales are preferred by many leading Radio manufacturers.

Not only for dials, but for numerous other electronic and electrical applications, Laminated Plastics are preferable.

Consult with our artists and engineers regarding applications for your particular purpose. Or... send us your blue prints or samples for quotation.

THE HOPP PRESS, INC.
460 W. 34th STREET, NEW YORK 1, N. Y.
ESTABLISHED 1893

night channels would be keyed simultaneously from one TD. This would enable nearby and distant satellites to choose the frequency best received.

Dual-Diversity Uses

Dual-diversity reception would be required for the international circuit and also on the sub-international circuits. Purely domestic short-haul circuits can use non-diversity receiving equipment.

It is hoped that international commercial aviation may some day acquire that degree of standardization of communications so vital to safeguarding our airways.

³Data on frequency-shift principles of operation, courtesy of Press Wireless Manufacturing Corp.

AT TEXAS CITY DISASTER



Harvey Radio 30 to 40-mc band mobile equipment in use during the recent Texas City disaster. Radio equipped car was used inside restricted area as a command post communications unit. A three-way communications setup at the police station provided additional coverage of the disaster area. Equipment had a power output of 40 to 70 watts.

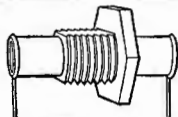
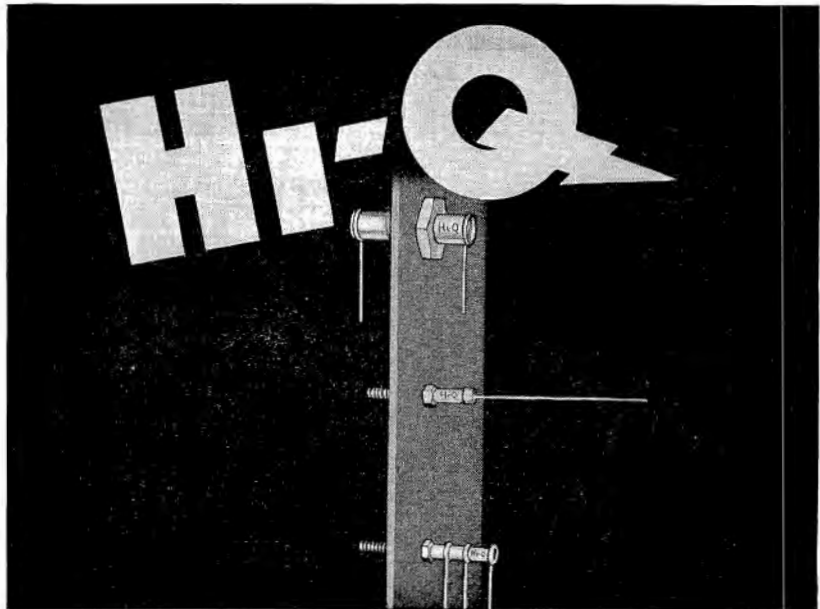

**FEED-THRU
AND**

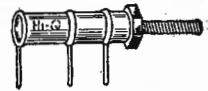

STAND-OFF CERAMIC CAPACITORS

are made to the same high performance standards as conventional CN and CI type Hi-Q capacitors. Engineers who have thoroly investigated Hi-Q capacitor performance are unanimous in their approval. We invite inquiries for samples to meet the exact needs of your applications.

OTHER  COMPONENTS

WIRE WOUND RESISTORS



CERAMIC CAPACITORS



S. I. TYPE
Durez Coated

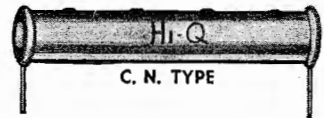

C. N. TYPE



C. I. TYPE

CHOKE COILS

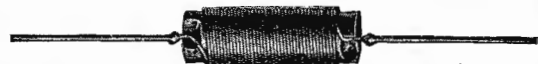

ELECTRICAL REACTANCE

C O R P O R A T I O N

FRANKLINVILLE, N. Y.

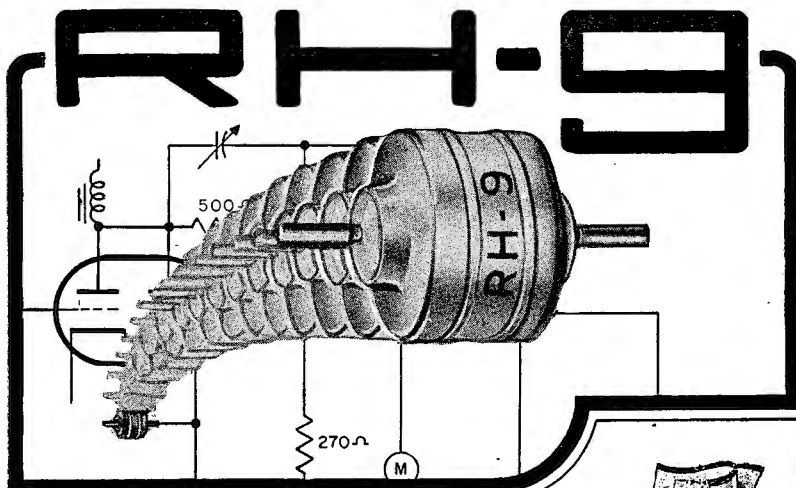

THE LATEST IN VHF HARMONIC MODE CRYSTAL UNITS

With RH-9 in a simple one tube oscillator circuit output X-tal frequencies from 12 to 75 mc, while operating in the 3rd, 5th, or 7th mechanical mode, can be generated. These frequencies can be multiplied to higher frequencies as desired.

- .005% maximum frequency drift from -55°c to +90°c
- Capacity between pins approximately 1 mmfds
- Shock and vibration tested (Ideal for mobile equipment)
- For transmitting, receiving, and filtering circuits
- For FM and TV
- Higher frequencies on special order



For Specifications of Crystal Unit RH-9 write for Catalog RHC-2



REEVES-HOFFMAN CORPORATION

SALES OFFICE: 215 EAST 91 STREET, NEW YORK 28, N. Y.
PLANT: 321 CHERRY STREET, CARLISLE, PA.

PREMAX

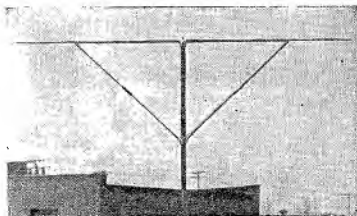

For Both FM and Television

Antennas effective in the 44 to 88 mc. range and in the 174 to 216 mc. range as well as those satisfactory in the 44 to 216 mc. range are now available. This covers, with one antenna, both FM and Television bands. Send for Bulletin No. 4610.

Premax Products

Division Chisholm-Ryder Co., Inc.
4710 Highland Avenue, Niagara Falls, N. Y.

JONES 400 SERIES PLUGS and SOCKETS

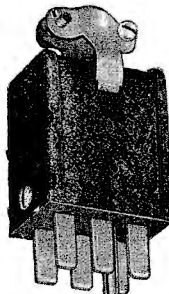

P-406-CCT

A medium size Plug and Socket that fulfills practically every requirement in the public address, radio and kindred fields. Socket contacts are of phosphor bronze, cadmium plated.

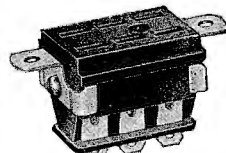

S-406-AB

Plug contacts are of hard brass, silver plated. Insulation is of molded Bakelite. All Plugs and Sockets are Polarized.

Made in 2, 4, 6, 8, 10 and 12 contacts. Caps are of steel with baked black crackle enamel. A quality item at popular prices. Send today for catalog No. 14 listing complete line of Jones Electrical Connecting Devices—Plugs, Sockets and Terminal Strips.

HOWARD B. JONES DIVISION
CINCH MFG. CORP.
2460 W. GEORGE ST. CHICAGO 18

Noise-Field Meter

(Continued from page 35)

operating frequency is harmonically related to the i-f frequency.

Vacuum-Tube Voltmeter

The vacuum-tube voltmeter is a bridge circuit having one triode connected 6V6 or 6V6GT/G in each of the two adjacent bridge arms. The indicating meter is connected across the bridge between the plates of the tubes. The noise output voltage is applied between grid and ground of one voltmeter tube, while the grid of the other voltmeter tube is directly grounded.

With no signal, the plates of the two tubes are at the same potential, and no current flows in the indicating meter circuit. With the d-c component of the noise voltage applied to the grid of its voltmeter tube, the plate resistance of this tube is changed and the bridge is unbalanced, causing a current to flow in the indicating meter. The heaters of the two voltmeter tubes are connected in parallel, so that changes in initial velocity of electron emission occurring because of fluctuations of cathode temperature with line voltage change appears equally in both sides of the bridge circuit, and, because they are balanced out, do not appear on the indicating instrument.

The triode section of a 6SQ7 (located in the i-f amplifier) serves as the first stage of the audio amplifier. A 6J5GT/G tube (located in the power supply) serves as the second audio amplifier stage.

The input signal to the 6J5GT/G is adjusted by means of a potentiometer volume control. The audio output is carried through a tapped output transformer having output impedance of 4,000 and 300 ohms selected by a switch.

A balanced H attenuator of 100 ohms impedance serves to reduce the input signal voltage before application to the r-f amplifier by factors of 1.0, 0.1, 0.01, 0.001, to permit limiting the r-f amplifier drive under conditions of high input signal.

The attenuator assembly consists of four separate attenuators of equal physical dimensions mounted on a turret and successively substituted in the input transmission line to give the desired loss.

Instrument has a bandwidth of approximately 210 kc at 6 db down. At twice the i-f, plus the incoming signal frequency, the attenuation is not less than 60 db over the operating frequency range.

V-H-F Survey

(Continued from page 41)

made immediately after the raising of the antenna. The center-conductor continuity test may be a bit difficult unless the antenna is near enough to some roof or building to permit placement of a bare wire around the antenna whip to the skirt so that the upper end can be shortened.

Connectors

Connectors are an important field-test equipment item. Three or four type u-h-f connectors are usually sufficient. These are used to connect RG-8/U cable sections as may be here required. In some cases, a special connector may be used on the antenna, or it may be necessary to connect from flexible RG-8/U cable to a $\frac{7}{8}$ " coax or a special antenna. It may be found at the test location that additional lengths of antenna cable are required.

Three lengths of RG-8/U flexible r-f cable with connectors, 50', 100', and 200', are also *must* items.

Miscellaneous Items

It is often advisable to have available an assortment of mica capacitors of about 100, 500, 2,000 and 5,000 mmfd, half a dozen mica metal-enclosed toothpick-type capacitors, a few spikes for use in blocking up antennas for fastening guy ropes, zippers if it is necessary to put an antenna into a couple of cars, spare mobile antenna or complement of parts if it is necessary to put an antenna on a car as in the case of the 160-mc equipment, several hanks of sash cord, an extra pair of long-nose pliers and side cutters, extra tuning tools or real small screwdrivers with insulated handles, a small $\frac{1}{4}$ " x 1" neon pilot lamp tube, plenty of solder, a good flashlight, a good soldering iron, etc.

Spare tubes are quite essential, too. They should be very carefully checked for all units.

Dummy loads should always be available at the test location; a small bulb and connector for the mobile units and a larger bulb with short connection or flexible cable for quarter kilowatt units.

A standard 50-microampere test meter kit is also necessary. A voltohmmeter¹ or equivalent should also be available. If data are to be taken on mobile runs a db or noise meter is required for determining noise reduction by carrier.

¹Simpson 260 voltohmmeter.

Now you can
buy all these
CANNON
plugs receptacles
and accessory fittings

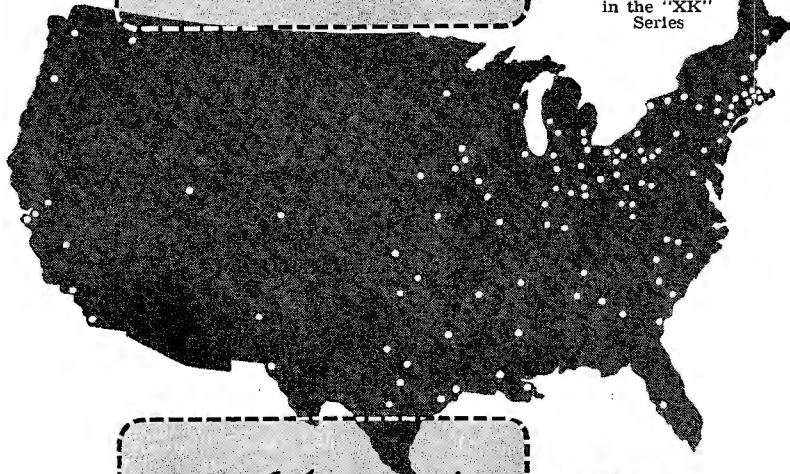

-in 6 type series
from more than
125* distributors

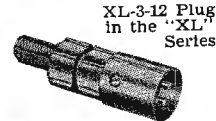

XL-3-12 Plug
in the "XL"
Series

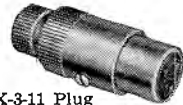

X-3-11 Plug
in the "X"
Series



XK-3-12 Plug
in the "XK"
Series



O3-11
Receptacle
in the "O"
Series



TQ-1-12 Plug
in the "TQ"
Coaxial
Series



P3-CG-12
Plug in the
"P" Series

To make it easier and quicker to obtain fittings in the above illustrated Cannon Electric Type Connector Series, more than 125* radio and electrical distributors can fill your requirements. Many of these distributors carry stock items on their shelves for immediate delivery. They are ready to serve you and discuss your requirements. Contact them first.

These type series are widely used on microphones, sound equipment, in radio and electronic devices. Their quality and performance are assured by Cannon Electric's *thirty-two* years of continuous operation under the same management.

For a complete list of Representatives, Distributors and a Catalog covering these lines, write for Bulletins CED and RJC-1, Address Dept. F-121.

*Additional distributors are being added in certain states.



CANNON ELECTRIC DEVELOPMENT COMPANY

3209 Humboldt Street, Los Angeles 31, California

Canada & British Empire—Cannon Electric Co., Ltd., Toronto, Ontario • World Export Agents (excepting British Empire) Frazer & Hansen, 301 Clay St., San Francisco 11, Calif.

INDUSTRY ACTIVITIES

Ground-breaking ceremonies for the 460-kw f-m transmitter of KMPC were conducted recently at San Gabriel Peak, near Los Angeles. San Gabriel Peak has an altitude of 6,156 feet. Because of its inaccessibility, KMPC will construct an inclined tramway of 1,200 feet, extending from Mt. Wilson Road to the crest of San Gabriel Peak. Living quarters for radio technicians, as well as the transmitter's own electrical power plant of 200,000 watts, will be erected on this site.

Lloyd Sigmon is chief engineer of KMPC-FM.

Motorola, Inc., is the new name of the Galvin Manufacturing Corporation.

The Sound Apparatus Company has opened a plant in Stirling, New Jersey. Research laboratories are in Millington, N. J., Main offices are at 233 Broadway, N. Y. City.

Raytheon Manufacturing Co., Waltham, Mass., has formed a commercial products division, which will consist of the broadcast equipment division, recently transferred from Chicago to Waltham.

Frank S. Hornig has been appointed sales manager of the new division, and **William A. Gray** is assistant sales manager.

David D. Coffin will be chief engineer, and **James N. Nye** will be engineer in charge of broadcast transmitter equipment. **Everett G. Fraim** has been appointed engineer in charge of speech input equipment, microwave applications, and engineering service and installation supervision on broadcast and microwave equipment.

Electro-Voice, Inc., recently held a microphone sales clinic with the sales staff of Newark Electric in Chicago. The clinic was conducted by **Web Soules**, sales manager.

The A. T. & T. have announced that on August 1 it would make intercity video transmitting facilities available to broadcasters on a commercial basis. Tariffs covering rates to become effective on that date have been filed with the FCC.

Intercity video channels for television broadcasts will be provided over both coaxial cable and radio relay facilities. Four thousand miles of coaxial cables have now been placed for use in furnishing telephone service. It is expected that this mileage will grow to 6,500 by the end of 1947 and to more than 9,000 miles by the end of 1948.

Two additional one-way video channels will become available along the New York-Washington route by the middle of 1948.

Experimental radio-relay facilities, with television possibilities, will be available in both directions between New York and Boston in the latter part of 1947. Another radio relay system, to link New York and Chicago, is projected.

For occasional, or part time, service an inter-exchange video channel (a transmission link between cities) will cost \$1.25 per circuit mile for the first hour of use, and one-quarter of that amount for each additional consecutive 15 minutes of use. In addition, there is, for each city, a monthly station connection charge of \$250, plus \$15 for each hour of use.

For monthly service the charge will be \$40 a month per circuit mile for eight consecutive hours daily, plus \$2 a month for each additional consecutive hour. For each station connected on a monthly basis the charge will be \$750 a month for eight consecutive hours daily and \$50 a month for each additional consecutive hour.

News Briefs

The St. Louis Microphone Co. has been incorporated. The company moved into a new building at 2726-28 Brentwood Blvd., St. Louis 17, Missouri.

Capitol Radio Engineering Institute, Washington, D. C., celebrated its 20th anniversary recently. An anniversary dinner was held at Hotel Mayflower, during which CREI president **E. H. Rietzke** was honored for his work as an engineering educator.

The Brush Development Co., Cleveland, exhibited their magnetic type recorders and allied equipment at the recent Mid-America Exposition in the Public Hall, Cleveland, Ohio.

The Sola Electric Company plants have been moved to a new building at 4633 West 16th Street, Chicago 50, Illinois.

Selenium Corporation of America, an affiliate of Vickers Incorporated, manufacturers of selenium rectifiers, and photoelectric cells, have moved to a new plant at 2160 East Imperial Highway, El Segundo, Cal.



The RCA Exhibition Hall, 36 W. 49th St., N. Y. C., was opened recently.

The Exhibition Hall features a television display, where visitors may be televised and simultaneously see their own televised images.

On view are giant models of various tubes containing miniatures of radio and television receivers, transmitters, and other electronic equipment. On exhibition, too, are tv receivers, home receivers and portable and personal radio sets. On-the-spot demonstrations include the vibration pickup and electronic metal-detectors and computing devices.

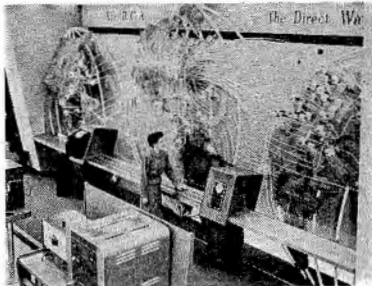

WGN will install a 5-kw G. E. tv transmitter this summer.

The station, to be known as **WGNA**, expects to have a test pattern on the air by late October and to be ready for limited commercial operation by January. **Carl J. Meyers** is director of engineering.

PERSONALS

George L. Beers, assistant director of engineering, RCA Victor, recently received the honorary degree of Doctor of Science from Gettysburg College, Gettysburg, Pa.

Mr. Beers graduated from Gettysburg College in 1921, when he received a B.S. degree in electrical engineering.

D. M. Allgood is now a vice president of the Farnsworth Television & Radio Corporation.

Robert F. Davis has been appointed as a communications field engineer for Motorola, Inc., with headquarters in Denver. His territory will cover the states of Colorado and Kansas.

A. F. Wild has been appointed sales manager of television equipment in the G. E. transmitter division at Syracuse, N. Y.

Jack M. Williams has been named advertising manager of the RCA home instrument department.

Mr. Williams was formerly advertising manager of the RCA Victor record department.

Henry C. L. Johnson, formerly advertising manager of the Sylvania Electric Products, Inc., radio, electronics and international divisions, has been appointed advertising manager of Rheem Manufacturing Company, 570 Lexington Ave., N. Y. City.

James D. McLean, formerly manager of sales of G. E. transmitters, has been appointed commercial manager of Philco tv station WPTZ.

George F. Metcalf, manager of General Electric's Electronics Laboratory at Syracuse, N. Y., was decorated in Washington, D. C., recently by Lord Inverchapel, British Ambassador, for his wartime contributions to airborne radar. Metcalf was appointed an Honorary Officer of the Military Division of the Most Excellent Order of the British Empire, conferred by King George VI.

Metcalf headed the Aircraft Radar Laboratories at Wright Field, Ohio, while he was in the service.

E. J. Pool has been elected vice president and a member of the board of directors of Cinch Manufacturing Corporation, Chicago.

Edward M. Tuft has been appointed director of personnel of the RCA Victor Division.

A. D. Heller has been appointed chief mechanical engineer of the United States Television Manufacturing Corp.

Philip G. Caldwell has been appointed manager of sales of the G. E. transmitter division at Syracuse, N. Y.

Mr. Caldwell formerly was sales manager of television equipment for the division.

... For Dependable Commercial Service

Designed for the rigors of commercial service in all types of radio communication . . . broadcast, mobile, aircraft, police. Precision made for utmost in stability, dependability, trouble-free operation. Calibrated within .005 per cent of specified frequency . . . range 1.5 to 10.5 MC. Temp. coefficient less than 2 cycles per megacycle per degree centigrade. Weighs less than 3/4 ounce. Gasket sealed against contamination and moisture. Meets FCC requirements for all above services. See your jobber—Petersen Radio Company, Inc., 2800 W. Broadway, Council Bluffs, Iowa. (Telephone 2760.)



PR Precision CRYSTALS

Electronic Research & Mfg. Corp.

A Service to INDUSTRY
Development and Construction of
Electronic Equipment for Any Application

1420 E. 25th St., Cleveland 14, O. - Ph.: SU. 1958

WHEN YOU CHANGE YOUR ADDRESS

Be sure to notify the Subscription Department of COMMUNICATIONS, 52 Vanderbilt Avenue, New York 17, N. Y., giving the old as well as the new address, and do this at least four weeks in advance. The Post Office Department does not forward magazines unless you pay additional postage, and we cannot duplicate copies mailed to the old address. We ask your cooperation.

Major General Harry C. Ingles, who served as Chief Signal Officer of the United States Army from July, 1943, to March, 1947, has been elected president and a director of RCA Institutes, Inc.



Gen. H. C. Ingles

James F. White has been appointed assistant sales manager of Andrew Co., Chicago, Illinois.



James F. White

Sidney Karr is now advertising and publicity manager for the Amplifier Corp. of America.

Harry F. Mickel, formerly manager of the communications equipment section of RCA in Camden, N. J., has been appointed engineering sales manager of the radio engineering products division of Raymond Rosen & Company.

Edward F. Weston is now chairman of the board of the Weston Electrical Instrument Corp.; Caxton Brown is chairman of the executive committee; Earl R. Mellen, president; H. Leigh Gerstenberger, vice president in charge of sales; Reginald R. Lambo, vice president in charge of manufacturing; John H. Miller, vice president and chief engineer.

Andrew A. Foley, Walnut Street, Philadelphia, Penn., has been named Astatic representative in the Philadelphia territory.

Walter Carruthers has been named chief engineer in charge of the Don Lee Broadcasting System. Carruthers was formerly director of development and research.

Carl V. Hansen, Jr., has been elected vice president and treasurer of the St. Louis Microphone Company, Inc.

LITERATURE

The Lenx Electric Mfg. Co., 1751 N. Western Avenue, Chicago 47, Ill., have prepared a 16-page bulletin describing and illustrating radio and instrument hook-up wire, radio lead-in and ground wire, shielded cables, shielded jacketed microphone cables, cotton-braided extension cables, crystal microphone cables, phono and musical instrument pickup cordage, tinned copper shielding and bonding braids, and p-a and intercommunications cables.

Two volumes of an index to RCA technical papers has been released by the RCA Laboratories Division, Princeton, N. J. The indexes are available without charge.

The General Radio Experimenter for April describes a wide-frequency-range capacitance bridge, Type 716-C.

Clarostat Mfg. Co., Inc., 130 Clinton St., Brooklyn 2, N. Y., have released a bulletin "Why Cement-Coated Power Resistors?". Simple tests to determine overload capacity, heat-shock immunity, through-coating leakage, corrosion elimination and other advantages of cold-setting cement coating, are illustrated and described.

Cornell-Dubilier Electric Corporation, South Plainfield, New Jersey, have published a 208-page book by W. C. King, sales engineer, entitled "Power Factor in Your Plant."

The book is based on actual experience in answering the questions of maintenance engineers. Book, priced at \$3.00, can be ordered from Cornell-Dubilier.

Rugged! Dependable!

ASTATIC DN-SERIES DYNAMIC MICROPHONES

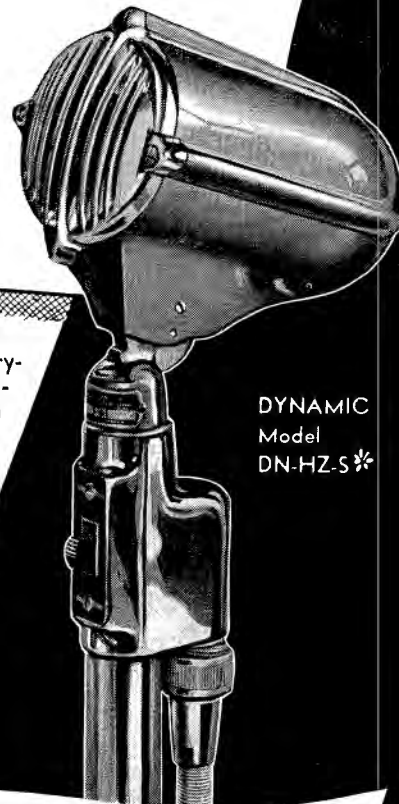

DYNAMIC
Model
DN-HZ-S*

BECAUSE of their resistance to varying temperatures and high relative humidity, sturdy construction and excellent performance under most difficult conditions, Astatic Dynamic Microphones are extensively used and praised. Four models, with different output impedances, are available. Unique tilting head, swivel mount permits directional or non-directional use and supplies a means of effectively controlling acoustic feedback. Rich opalescent gray finish with bright chrome grill.

* High Impedance Model, equipped with Type S On-Off Switch

JT-SERIES

Complete with Handle and Interlocking Base

While relatively inexpensive, Astatic JT-Series Microphones are ideal for amateur, home recording and public address requirements. These microphones are available in choice of voice or wide range models and come equipped with convenient handle, interlocking base and 15 feet of shielded cable. Opalescent Gray and Chrome.

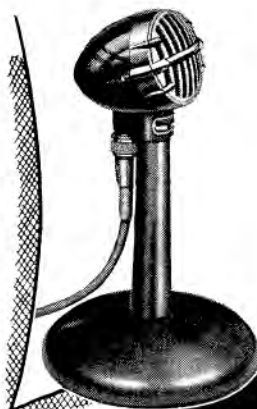

THE
Astatic
CORPORATION
CONNEAUT, OHIO

IN CANADA: CANADIAN ASTATIC LTD. TORONTO, ONTARIO

Astatic Crystal Devices Manufactured
under Brush Development Co. patents

Designed for



Application

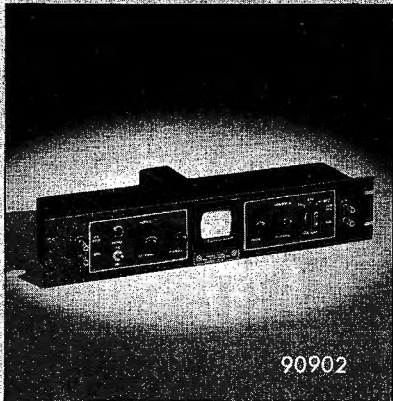

**90900 Series
Cathode Ray Oscilloscopes**

The No. 90902 and No. 90903 Rack Panel (3 1/2") Oscilloscopes, for two and three inch tubes, respectively, are inexpensive basic units comprising power supply, brilliancy and centering controls, safety features, magnetic shielding, switches, etc. As a transmitter monitor, no additional equipment or accessories are required. The well-known trapezoidal monitoring patterns are secured by feeding modulated carrier voltage from a pick up loop directly to vertical plates of the cathode ray tube and audio modulating voltage to horizontal plates. By the addition of such units as sweeps, pulse generators, amplifiers, servo sweeps, etc., all of which can be conveniently and neatly constructed on companion rack panels, the original basic 'scope unit may be expanded to serve any conceivable application.

**JAMES MILLEN
MFG. CO., INC.**

MAIN OFFICE AND FACTORY
- MALDEN
MASSACHUSETTS



ADVERTISERS IN THIS ISSUE

COMMUNICATIONS—JUNE, 1947

ANDREW CO. 37 Agency: Burton Browne, Advertising	THE HOPP PRESS, INC. 42 Agency: Gallard Adv. Agency
THE ANSONIA ELECTRICAL DIV. NOMA ELECTRIC CORP. 11 Agency: Albert Frank Guenther Law, Inc.	JENSEN MFG. CO. 8 Agency: Burton Browne, Advertising
THE ASTATIC CORPORATION 47 Agency: Wearstler Advertising, Inc.	HOWARD B. JONES DIV. CINGH MFG. CORP. 44 Agency: Merrill Symonds, Advertising
BLAW-KNOX DIV. BLAW-KNOX CO. 10 Agency: Al Paul Lefton Co.	THE JAMES KNIGHTS CO. 42 Agency: Rudolph Bartz, Advertising
CANNON ELECTRIC DEVELOPMENT CO. 45 Agency: Dana Jones Co.	JAMES MILLEN MFG. CO., INC. 48
THE CLEVELAND CONTAINER CO. 40 Agency: The Nesbitt Service Co.	NATIONAL CO., INC. 31 Agency: John A. Cairns & Co., Inc.
COLLINS RADIO CO. Inside Front Cover Agency: McCann-Erickson, Inc.	PETERSEN RADIO CO. 46 Agency: Bozell & Jacobs
CONCORD RADIO CORP. 40 Agency: E. H. Brown Adv. Agency	PREMAX PRODUCTS DIV. CHISHOLM-RYDER CO., INC. 46 Agency: Norton Adv. Service
DeMORNAY-BUDD, INC. 3 Agency: Federal Adv. Agency	RADIO-MUSIC CORPORATION 35 Agency: A. J. Stromanson Co.
EITEL-McCULLOUGH, INC. 27 Agency: L. C. Cole, Advertising	REEVES-HOFFMAN CORP. 44
ELECTRICAL REACTANCE CORP. 43 Agency: Sebeel Adv. Agency	SDRENSEN & CO., INC. 41 Agency: Henry A. Stephens, Inc.
ELECTRONIC RESEARCH & MFG. CORP. 46	SPRAGUE ELECTRIC CO. 4 Agency: The Harry P. Bridge Co.
ELECTRONICS RESEARCH & PUBLISHING CO. 42 Agency: Armstrong, Schleiffer & Ripen	SUPREME INSTRUMENTS CORP. 39 Agency: O'Callaghan Adv. Agency, Inc.
FAIRCHILD CAMERA & INSTRUMENT CORP. 5 Agency: G. M. Basford Co.	SYLVANIA ELECTRIC PRODUCTS, INC. 14 Agency: Newell-Emmett Co.
FARNSWORTH TELEVISION & RADID CORP. 21 Agency: N. W. Ayer & Son, Inc.	TECH LABORATORIES, INC. 39 Agency: Lewis Adv. Agency
FEDERAL TELEPHONE & RADIO CORP. Back Cover Agency: Rickard & Co.	WAR ASSETS ADMINISTRATION 12, 13 Agency: Fuller & Smith & Ross, Inc.
FERRANTI ELECTRIC, INC. 1	WESTERN ELECTRIC CO. 6, 7 Agency: Newell-Emmett Co.
GENERAL RADIO CO. Inside Back Cover	WILCOX ELECTRIC CO., INC. 9 Agency: Arthur G. Rippey & Co.
GUARDIAN ELECTRIC CO. 23 Agency: Kennedy & Co.	

for
**VOLTAGE
 MEASUREMENTS**
 to
1,000 Mc!

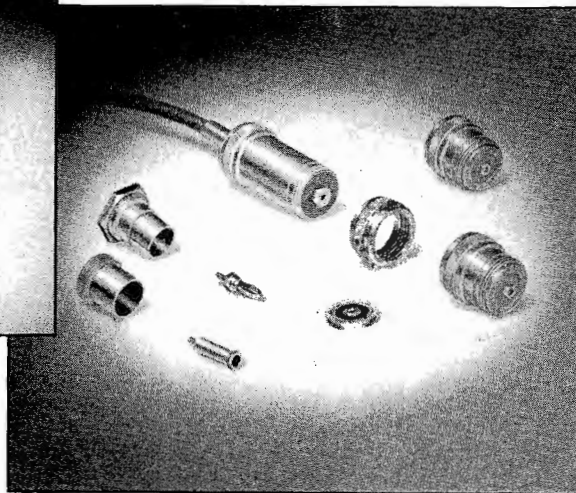
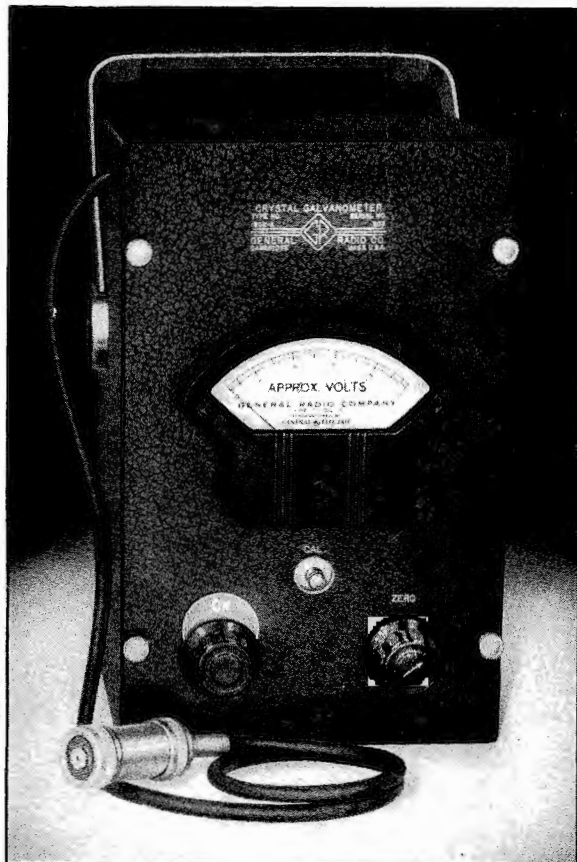

The Type 1802-A Crystal Galvanometer (a "galvanometer" rather than a "voltmeter" because it does not have the high accuracy of most other G-R instruments) measures voltages from 30 to 1,000 Mc, and is useful up to 4,000 Mc. It is direct-reading from 0.1 volt to 100 volts and is finding considerable utility in u-h-f measurements.

Essentially it is very simple — a 1N21B crystal and a d-c amplifier. To obtain the high upper-frequency limit, however, several mechanical and electrical design problems are involved. The crystal rectifier extends the frequency range far above that obtained with the usual tube diode; however, the uniformity of commercially available crystals is below that of the v-t diodes and limits the instruments accuracy to $\pm 5\%$.

The upper frequency limit is dependent upon the design of the pick-up probe. The probe assembly has been designed to minimize inductance by using cylindrical blocking and by-pass condensers. The probe design and the crystal itself result in an average probe resonant frequency of about 1800 Mc. Individual crystals modify this resonant frequency.

The amplifier uses a degenerative cathode-follower circuit arranged as a bridge system. The sensitivity of the meter is essentially independent of zero setting.

Two capacitance voltage dividers are supplied as multipliers extending the voltage ranges to 10 and 100 volts. Fittings for plugging into coaxial connectors are furnished.

TYPE 1802-A Crystal Galvanometer . . . \$210.00

WE HAVE A FEW IN STOCK — Order Now for Probable Immediate Shipment



GENERAL RADIO COMPANY

Cambridge 39,
 Massachusetts

90 West St., New York 6

920 S. Michigan Ave., Chicago 5

950 N. Highland Ave., Los Angeles 38

AMERICA'S FIRST COMMERCIAL 10-KW FM TRANSMITTER

now operating in the new FM band at "WELD", Columbus, Ohio



*Another Achievement for
FM BY FEDERAL!*

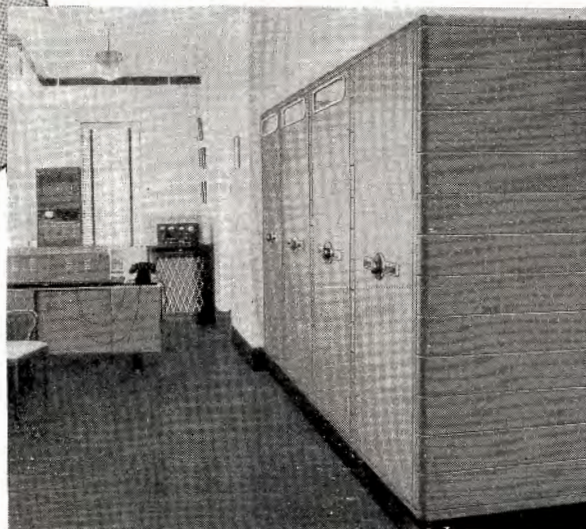

Here's the new transmitter room at Station WELD, showing Federal's 10-KW FM transmitter. Full-length hinged doors give unhampered access from both front and rear—with minimum overall space requirements.

THE 10-KW Federal transmitter, now on the air at Station WELD, marks a new high in FM transmitter capacity—the first new-band commercial transmitter of its power to be installed in this country!

Station WELD wanted the utmost in power—the finest in FM quality. That meant FM by Federal! For the Frequematic* modulator—an exclusive Federal

feature—assures the last word in fidelity and mean carrier stability. Simple all-electronic circuits with standard receiver tubes assure unsurpassed dependability and economy.

If you're considering a new FM station—or improving your present one—Federal's 38 years of research and experience are ready to serve you. For further information, write to Federal, Dept. B410, today.

**Trademark*



Federal Telephone and Radio Corporation

100 KINGSLAND ROAD, CLIFTON, NEW JERSEY

KEEPING FEDERAL YEARS AHEAD... is IT&T's world-wide research and engineering organization, of which the Federal Telecommunication Laboratories, Nutley, N. J., is a unit.

In Canada: — Federal Electric Manufacturing Company, Ltd., Montreal.
Export Distributors: — International Standard Electric Corp., 67 Broad St., N. Y. C.