

Electronic Engineering

AUGUST 1952

**A GOOD SET
DESERVES
A BICC
T/V DOWNLEAD**



80-ohm screened twin cable. T3121



71-ohm solid dielectric coaxial cable. T3022



80-ohm un-screened twin cable. T3066

Use BICC Downleads for all your T/V installations. They're made to close specifications from first grade materials to ensure a long dependable life and precise characteristics. Keep your customers satisfied by giving them the best possible results.

Further information on BICC T/V Downleads is available in Publication No. 244. Write to-day for a free copy.



T/V DOWNLEADS

keep your customers satisfied!

BRITISH INSULATED CALLENDER'S CABLES LIMITED
NORFOLK HOUSE, NORFOLK STREET, LONDON, W.C.2

TWO SHILLINGS

VALVES

**For
SPECIAL
PURPOSES**

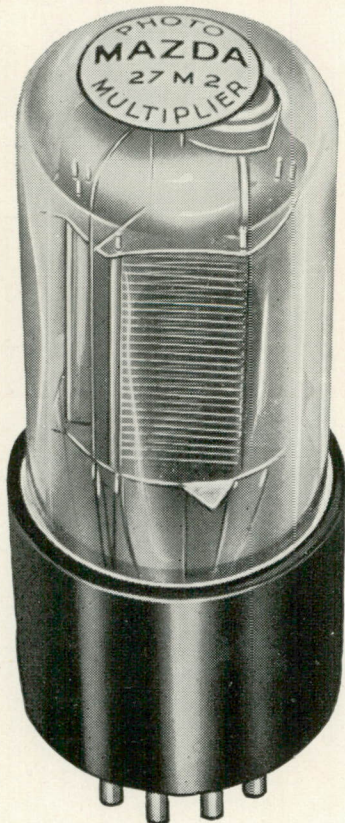

27M2 Nine Stage Photo-Electric Multiplier

The Mazda 27M2 is a high vacuum photo-cell with high response in the visible region. The photo-electric current produced at the cathode is multiplied many times by secondary emission occurring at successive cathodes within the valve.

It is capable of multiplying very small currents produced under weak illumination by an average value of 250,000 times, when operated at 80 volts per stage. When operated at an overall voltage of 600 volts, i.e., 60 volts per stage, followed by a single stage D.C. amplifier, it is suitable for the amplification of changes in cathode current greater than 10^{-14} amperes.

The resultant output current is a linear function of the exciting illumination, under normal operating conditions. Since secondary emission occurs simultaneously, the frequency response is flat up to the frequencies at which transit time becomes a limiting factor.

Because of its sensitivity, low noise level, low dark current and freedom from distortion, the 27M2 may be used for light-operated relays, for film scanning, facsimile transmission, in scientific research involving low light levels, and in many applications where its small size is an advantage.

NOTE.—The 27M2 is similar to the 27M1 except for the wider tolerances on the anode dark current which necessitates a lower anode supply voltage, with a resulting reduction in the current amplification to approximately one quarter of that obtainable from the 27M1.

PRICE £6 0. 0. (provisional)

TYPICAL OPERATION

Overall Voltage 800 v.

*Sensitivity† 2 A/lumen

Spectral Range 3,300—6,500 Å

*The sensitivity is on the basis of a lamp colour temperature of 2700°K and a light spot area of 4 mm. × 20 mm. The tube is adjusted to a position of maximum sensitivity.

DIMENSIONS

Max. Overall Length (mm.) 94.0

„ Bulb Diameter (mm.) 28.5

„ Base Diameter (mm.) 33.4

Light Centre from Seat (mm.) 49.2 ± 2.4

It is recommended that the bleeder current in the potentiometer providing the secondary cathode voltages should be of the order of 10 times the maximum working current output of the tube.

EDISWAN

MAZDA

RADIO VALVES AND CATHODE RAY TUBES

THE EDISON SWAN ELECTRIC CO. LTD., 155 CHARING CROSS ROAD, LONDON, W.C.2

Member of the A.E.I. Group of Companies

RA.181

CLASSIFIED ANNOUNCEMENTS

The charge for these advertisements at the LINE RATE (if under 1" or 12 lines) is : Three lines or under 7/6, each additional line 2/6. (The line averages seven words.) Box number 2/- extra, except in the case of advertisements in "Situations Wanted," when it is added free of charge. At the INCH RATE (if over 1" or 12 lines) the charge is 30/- per inch, single column. Prospectuses and Company's Financial Reports £14.0s.0d. per column. A remittance must accompany the advertisement. Replies to box numbers should be addressed to : "Electronic Engineering," 28, Essex Street, Strand, London, W.C.2. Advertisements must be received before the 14th of the month for insertion in the following issue

OFFICIAL APPOINTMENTS

APPLICATIONS ARE INVITED by the Ministry of Supply for posts in the Experimental Officer class at R.A.F. Signals Experimental Establishments to assist in one of the following: 1 (a) General Experimental work in connexion with design of high power long distance radio telegraph systems or radio communications and radar systems D 171/52A. 1 (b) Aerial and feeder systems D 172/52A. 2. Site selection and installation design of large radio receiving and transmitting stations, radio telegraph terminal offices, or radio airfield approach and landing aids D 173/52A. 3. Experimental and development work associated with small electro-mechanical machines for machine telegraph systems D 174/52A. 4. Development and test of prototype mobile and portable radio and radar installations D 175/52A. 5. Engineering trials and investigations of modern automatic telegraph and line equipment D 176/52A. Post 1 (a) is located at Ruislip. Posts 1 (b), 2, 4, and 5 at Medmenham and Post 3 at Kidbrooke. Candidates should have a minimum Higher School Certificate with a Science subject as principal subject but those over twenty will generally be expected to have a Higher National Certificate or equivalent qualifications in applied physics, radio or electrical engineering. Experience in the duties outlined above is desirable and knowledge of R.A.F. signals equipment would be an advantage. Salary will be assessed according to age, qualifications, experience and location within the following inclusive ranges: Experimental Officer (Minimum age 26) (Posts 1(a), 2, 3, and 4) £597-£786. Assistant Experimental Officer (Posts 1(a), 1(b), 2, 4, and 5) £264 (age 18)-£571. Rates for women somewhat lower. Posts are unestablished. Application forms obtainable from Ministry of Labour and National Service, Technical and Scientific Register (K), Almack House, 26, King Street, S.W.1, quoting appropriate Reference No. Closing date 28th August 1952. W 2850

ASSISTANT (SCIENTIFIC) CLASS: The Civil Service Commissioners give notice that an Open Competition for pensionable appointment to the basic grade will be held during 1952. Interviews will be held throughout the year, but a closing date for the receipt of applications earlier than December, 1952, may eventually be announced either for the competition as a whole or in one or more subjects. Candidates must be at least 17 1/2 and under 26 years of age on 1st January, 1952, with extension for regular service in H.M. Forces, but candidates over 26 with specialised experience may be admitted. All candidates must produce evidence of having reached a prescribed standard of education, particularly in a science subject and of thorough experience in the duties of the class gained by service in a Government Department or other civilian scientific establishment or in technical branches of the Forces, covering a minimum of two years in one of the following groups of scientific subjects: (i) Engineering and physical sciences; (ii) Chemistry, bio-chemistry and metallurgy; (iii) Biological Sciences; (iv) General (including geology, meteorology, general work ranging over two or more groups (i) to (iii) and highly skilled work in laboratory crafts such as glass-blowing). Salary according to age up to 25: £236 at 18 to £363 (men) or £330 (women) at 25 to £500 (men) or £418 (women); somewhat less in the provinces. Opportunities for promotion. Further particulars and application forms from Civil Service Commission, Scientific Branch, Trinidad House, Old Burlington Street, London, W.1., quoting No. S 59/52. Completed application forms should be returned as soon as possible. W 2865

COMMISSIONERS OF NORTHERN LIGHT-HOUSES: Applications are invited for the post of Radio Engineer for duties in connexion with the maintenance and development of radio aids to marine navigation. Good academic qualifications, a sound knowledge of electronics, and practical experience are essential. Salary scale £880 to £1,170 per annum. Superannuation conditions are similar to those in the Civil Service. Applicants should apply in writing to the Secretary, Northern Lighthouse Board, 84, George Street, Edinburgh, stating age, qualifications, experience, and enclosing copies of testimonials. W 2818

LONDON HOSPITAL, Whitechapel, E.1., has vacancy for Electronic Engineer for Technical maintenance and development of E.E.G. equipment. Consideration will be given to part time appointment. Apply in writing to The Secretary. W 2864

TRINITY HOUSE, LONDON. Applications are invited for appointment to the following posts in the Electrical and Electronics Department of the Corporation of Trinity House, London: (a) One Senior Engineer required as Deputy to the Director of this Department and for the preparation and application of light electrical engineering schemes, including development of automatic control mechanism. Some knowledge of electronics would be an advantage. Salary Scale: £970 rising to £1,280 per annum. (b) One Senior Experimental Officer required for the development of radio and automatic remote control systems; a sound knowledge of physics and V.H.F./Centrimetric techniques is required. Salary Scale: £844 rising to £1,075. (c) One Engineer-Designer required for the development of electro-mechanical mechanisms and mechanical design problems associated with radio and electrical equipment. Salary Scale: £844 rising to £1,075. (d) Four Engineers to be engaged in the above work. Salary Scale: £628 rising to £970. (Scale linked to age at entry between 25 and 34 years. Maximum starting pay is as at age 34, viz: £875 per annum). Qualifications required. For the senior posts (a), (b) and (c) Corporate Membership of the Institute of Electrical Engineers, or equivalent, is essential. For the engineering posts (d) applicants must have at least passed the graduate examination of the Institute of Electrical Engineers, or equivalent, and have had at least three years experience. All candidates must be medically fit and of British Nationality. Appointments. A major proportion of those appointed will be placed on the permanent established staff after a satisfactory probationary period of twelve months. Applications. Applications should be made in writing to the Secretary, Trinity House, London, E.C.3, not later than 31st August, 1952, stating age, occupation, qualifications and experience and enclosing copies of recent testimonials. W 2845

SITUATIONS VACANT

The engagement of persons answering these advertisements must be made through a Local Office of the Ministry of Labour or a Scheduled Employment Agency if the applicant is a man aged 18-64 inclusive or a woman aged 18-59 inclusive unless he or she, or the employment, is exempted from the provisions of the Notification of Vacancies Order, 1952.

AERONAUTICAL SERVICE ENGINEER required. Duties will include installation, flight testing and servicing, for which a thorough practical and theoretical knowledge of A.C. and D.C. amplifier systems is required. A knowledge of electro-mechanical servo systems and synchronous transmission systems, would be an advantage. Preferential consideration will be given to applicants with previous electronic experience in possession of H.N. Certificate (or equivalent), or who have served a recognised engineering apprenticeship with subsequent experience in a technical capacity. Must be prepared to travel. Position will be permanent and pensionable after qualifying period. Commencing salary £450 p.a. Apply with full details of age, qualifications and experience to: Personnel Manager, Sperry Gyroscope Co. Ltd., Great West Road, Brentford, Middlesex. W 2826

AN ASSISTANT ENGINEER is required by an engineering laboratory in Godalming, for theoretical and experimental work on magnetic amplifiers and electrical instruments. Applicants should possess a degree in Physics or Electrical Engineering or Higher National Certificate in Electrical Engineering. Previous experience in this type of work would be an advantage. Write, giving full details of qualifications and experience, to Box No. W 1518.

AN ENGINEER AND ASSISTANTS are required urgently by a large firm for work of national importance on the development of

novel projects. Applicants should be thoroughly familiar with medium and high voltage grid controlled rectifiers and associated electronic equipment. Apply, giving full details of qualifications and experience and quoting reference IHG to Box W 2779.

AN EXPERIENCED DRAUGHTSMAN is required in the expanding Valve Development section of the Nelson Research Laboratories, English Electric Co. Ltd., Stafford. Applicants should have Higher National Certificate or better and experience in mercury pool and high vacuum tubes is desirable but not essential. Please write giving full details of age, qualifications and experience quoting reference "English Electric 143A" to Westminster Employment Exchange, Chadwick Street, London, S.W.1. W 2817

ASSISTANT FOREMAN REQUIRED. West London area, for electronic equipment section. Good opening, with prospects, in important company for young engineer with at least O.N.C standard of Electro-Technical training and experience in the construction, assembly and wiring of high grade equipment or instruments. Please write stating age, education, details of Technical training and experience, also salary required. Box No. W 2860.

BELLING & LEE LTD., Cambridge Arterial Road, Enfield Middlesex, require research assistants in connexion with work on electronic components, fuses, interference suppressors and television aerials. Applicants must be graduates of the I.E.E. or possess equivalent qualifications together with similar laboratory experience. Salary will be commensurate with previous experience: five day week, contributory pension scheme. Applications must be detailed and concise, and will be treated as confidential. W 138

BOULTON PAUL AIRCRAFT LTD. invite applications from experienced development engineers or physicists for appointments to their electronic development and instrumentation laboratories for work in a varied and interesting field of applied science including instrumentation and control systems, analogue computing, servomechanisms, etc. Senior applicants should be of Honours Degree standard but there are also vacancies for less qualified candidates. Applications with details of qualifications, age, experience and salary required should be forwarded to the Personnel Manager, Boulton Paul Aircraft Ltd., Wolverhampton, Staffs. W 2833

CATHODE RAY TUBE ENGINEER required to assist in work on design and developments of Teletubes. Physics Degree desirable, with knowledge of Chemistry an asset, but applicants with experience of this work preferred. Excellent facilities for man wishing to specialize in this field. Salary in accordance with qualifications. Apply in writing to the Personnel Officer, Brimar Valve Works, Fooks Cray, Sidcup, Kent. W 2819

DEVELOPMENT ENGINEERS/PHYSICISTS. Senior positions with good prospects in connexion with the development of electronic computing and training equipment, including Flight Simulators. Experience in electronics essential. Good starting salaries, depending upon age, experience and qualifications. Location, near Waterloo station. Apply in writing to: Chief Engineer, Redifon Ltd., Broomhill Road, Wandsworth, S.W.18. W 2802

DEVELOPMENT ENGINEERS. Senior and Junior for Radio, Television and Electronics. Previous experience of circuit development work essential. Write giving full details of qualifications, experience, etc., to: Employment Manager, Ferguson Radio Corporation Ltd., Gt. Cambridge Road, Enfield. W 2857

DRAUGHTSMEN, senior and intermediate required in London W.12 by important company manufacturing light electro-mechanical and electronic equipment. Applicants should have experience in this field including electronic components layout. One post requires some experience super-sonic equipment also knowledge of shipboard practice an advantage. Please write giving details of experience, age and salary required. Good conditions of employment and pension scheme. Box No. W 2861.

SITUATIONS VACANT (Cont'd.)

The engagement of persons answering these advertisements must be made through a Local Office of the Ministry of Labour or a Scheduled Employment Agency if the applicant is a man aged 18-64 inclusive or a woman aged 18-59 inclusive unless he or she, or the employment, is exempted from the provisions of the Notification of Vacancies Order, 1952.

E. K. COLE LTD. (Malmesbury Division) invite applications from Electronic Engineers for permanent posts in Development Laboratories engaged on long-term projects involving the following techniques: 1. Pulse Generation and Transmission. 2. Servo Mechanism. 3. Centimetric and V.H.F. Systems. 4. Video and Feedback Amplifiers. 5. V.H.F. Transmission and Reception. 6. Electronics as applied to Atomic Physics. There are vacancies in the Senior Engineer, Engineers and Junior Grades. Candidates should have at least 3 years' industrial experience in the above types of work, together with educational qualifications equivalent to A.M.I.E.E. examination standard. Commencing salary and status will be commensurate with qualifications and experience. Excellent opportunities for advancement are offered with entry into a Pension Scheme after a period of service. Forms of application may be obtained from Personnel Manager, ECKO Works, Malmesbury, Wilts.

W 2800

ELECTRONIC INSTRUMENT MAKER required. Capable of high standard of wiring and skilled in various mechanical processes encountered in this field. Opportunity for ambitious person to progress in young and rapidly expanding organisation. Good salary. Rivlin Instruments, 7a Maitland Park Villas, N.W.3.

W 2868

ELCONTROL LTD. (manufacturers of industrial electronic controls, have vacancies for the following, all of whom must have some experience of electronic manufacture and assembly: (a) Assistant to Chief Engineer to handle day-to-day problems. (b) Production charge hand. (c) Assembler used to prototypes, able to work from drawings. We are small but growing, and these are ground floor jobs for enthusiasts. Chief Engineer, Elcontrol Ltd., Wilbury Way, Hitchin, Herts. Phone Hitchin 1598.

W 2752

ELCONTROL LTD., manufacturers of industrial electronic controls, have vacancy for tester also able to supervise small assembly group and assist with prototypes and specials. This is a ground floor job in a growing firm but experience of electronic manufacture essential. Elcontrol Ltd., Wilbury Way, Hitchin, Herts. Phone 1598.

W 2832

ELECTRONIC ENGINEER with Higher National Certificate and experience of circuit design required to work with Mathematicians (Honours Graduates) on a new electronic computing project. Outstanding opportunity, with good salary for self-education. Apply, quoting reference S.P.I., to Employment Manager, Vickers-Armstrongs Limited (Aircraft Section), Weybridge, Surrey. Applications, with certain exceptions, are subject to the approval of the Ministry of Labour and National Service.

W 2782

ELECTRONIC ENGINEER with several years research and development experience is invited to apply for a permanent post in rapidly expanding company, engaged on the development of laboratory instruments. Applicants should possess an Honours Degree or the equivalent qualification in Physics or light electrical engineering. The work is of absorbing interest, and offers scope for the exercise of individual initiative. Salary will be commensurate with qualifications and experience. Application should be made to Technical Director, Messrs. Solartron Laboratory Instruments Ltd., 22, High Street, Kingston-on-Thames, Surrey.

W 1516

ELECTRONIC ENGINEER for development and design of gramophone pick-ups. Applicant would also be responsible for the technical supervision of production assembly lines manufacturing gramophone pick-ups and other components of a similar type. Previous experience of acoustical devices essential. State age, qualifications, experience and salary required. Box No. W 2838.

ELECTRONIC ENGINEER required for pre-production liaison duties between development and production units. Applicants must have a comprehensive and thorough knowledge of

electronic circuitry and test procedure and be able to advise on production aspects involved in the early design stages. Application should be made, in writing, giving full details of qualifications, experience, etc., to the Personnel Department, E.M.I. Engineering Development Ltd., Hayes, Middx., quoting ED/82. W 2855

ELECTRONIC ENGINEERS required for development work in the Gloucestershire area. Good academic qualifications and apprenticeship. Experience in one or more of the following desirable: Control systems, D.C. Amplifiers, Computing devices, Video Circuits, Microwave Techniques. Apply with full details of qualifications, age and salary required to Box AC72918, Samson Clarks, 57-61 Mortimer Street, London, W.1. W 2790

ELECTRONIC ENGINEERS for development work with substantial Birmingham Company. Honours Degree in Electrical Engineering or Physics with industrial experience in circuitry and instrument design essential and some practical experience in the application of optics would be an advantage. Five-day week. Staff Pension scheme: excellent working conditions and sound promotion prospects. Initial salary fully commensurate with qualifications and experience. Applications, which will be treated in confidence, should state full particulars of education and experience. Box No. W 2830.

ELECTRONIC ENGINEERING COMPANY, Teddington area, requires electronic engineer with wide knowledge of industrial electronics, including pulse techniques, to take charge of development of new equipments. Well established company. Salary £1,250 plus. Good chance of becoming technical director, as present technical director will be going abroad to start foreign branch. Please state education and experience to Box No. W 1505.

ELECTRO-MECHANICAL Engineers required with good academic qualifications, apprenticeship, theoretical background and knowledge of production methods for development work. Experience in electrical methods of computation, servo theory and instrument design desirable. Apply with full details of age, experience and salary required to the Personnel Manager, Sperry Gyroscope Co., Ltd., Great West Road, Brentford, Middlesex. W 2791

ELECTRONIC RESEARCH and Development Engineers and Physicists. Applications are invited by an old established London firm of repute for: (a) Two senior posts of a highly interesting nature with scope for individual work and advancement, (b) One junior post. (c) One draughtsman with electrical design experience. A first or second class Honours Degree in Physics or Electrical Engineering would be an asset for the posts (a) and (b). Applications will be treated in strict confidence. Write giving details of qualifications, experience and salary required, to Box No. W 1525.

ENGINEERS for the maintenance of Digital Computers are required by the Computer Section of Ferranti Limited. Applications are invited from Engineers experienced in the servicing of large electronic equipments such as radar systems and predictors. Courses of instruction will be given to successful applicants, who will normally be based in Great Britain, although there will be opportunities for tours of duty abroad. Initial salary in accordance with experience and ability in the range £450-£700 per annum. The Company has a Staff Pension Scheme. Application forms from Mr. R. J. Hebert, Staff Manager, Ferranti Limited, Hollinwood, Lancs. Please quote reference D.C. M.E. W 2814

ENGINEERS required for interesting development work on the design of all types of radio transformers. The work includes investigation of the use of new materials to transformer design. Applicants should write, giving full details to: Personnel Department (ED/76), E.M.I. Engineering Development Ltd., Hayes, Middx. W 2828

ENGINEERS required for interesting work on components for Telecommunications and Television Transmission Equipment. Should be capable of undertaking development work without supervision. Scope for men with enterprise and imagination with suitable experience. Degree or equivalent desirable but not essential. Apply Box No. W 2834.

ENGINEERS required for development and maintenance of electronic equipment. National Certificate standard. Previous experience on electronics or radar desirable. Remuneration according to experience and qualifications. Apply: Labour Exchange, Rugby. Ref.: Construction Dept., The British Thomson-Houston Co. Ltd., Rugby. W 2866

ENGLISH ELECTRIC COMPANY LIMITED, Luton, have vacancies for Designers and Draughtsmen for both light electrical and mechanical development work on guided weapons. Technical qualifications such as ordinary National Certificate desirable but not essential. This is an excellent opportunity in a new field. Please write, giving full details and marking your application "English Electric 144G" to Westminster Employment Exchange, Chadwick Street, London, W.1. W 2820

ENGLISH ELECTRIC COMPANY LTD., Luton, invite applications for permanent posts in a department developing and engineering in a wide variety of specialized electronic circuits. Previous experience in such work would be an asset and, for one vacancy, some experience in optics or oscillography would be a recommendation. Salaries will be in accordance with qualifications and experience, up to £625 per annum. The laboratories are new and pleasantly situated. Please write, giving full details and quoting reference 1002, to Central Personnel Services, English Electric Co. Ltd., 24-30, Gillingham Street, London, S.W.1. W 2839

EXPERIENCED COMPONENT ENGINEERS are urgently required by a large firm for work of national importance. Applicants selected will be required to build up a new section specialising in selection and design of electrical and mechanical components for electronic equipment, together with associated light and medium-heavy control gear, transformers and wiring. Applicants should have a full working knowledge of service specifications and type approval procedure, experience of component design and an understanding of ratings. Please write giving full details of experience and qualifications and quoting reference IHF to Box No. W 2780.

EXPERIENCED COMPONENT ENGINEERS are urgently required by the English Electric Co. Ltd. Applicants selected will be required to build up a new section specializing in selection and design of electrical and mechanical components for electronic equipment, together with associated light and medium heavy control gear, transformers and wiring. Applicants should have a full working knowledge of service specifications and type approval procedure, experience of component design and an understanding of ratings. Please write, giving full details of experience and qualifications and quoting reference 986 to Central Personnel Services, English Electric Co. Ltd., 24-30, Gillingham Street, London, S.W.1. W 2835

EXPERIENCED ELECTRONIC ENGINEER required by the English Electric Company Limited, Luton, for investigation into the nature of mechanical vibrations in connexion with guided missiles project. Position of responsibility in a new department is available for a well qualified man. Adaptability and ability to develop electronic measuring techniques required. H.N.C. or equivalent and some experience of vibration work essential. Salary according to qualifications. Please write giving full details of qualifications and experience and quoting reference "850 C" to Central Personnel Services, English Electric Company Ltd., 24-30, Gillingham Street, London, S.W.1. W 2846

EXPERIENCED ENGINEER required by company in North-West England for design and development of television aerials and associated components. Write giving age, experience and salary required to Box No. W 1524.

FERRANTI LIMITED, Edinburgh, require additional staff for their Engineering Division engaged on Electro/Mechanical instruments and radar equipment. Duties involve (a) the engineering and production design of new items to be put into production after the prototype has been evolved in the laboratories and (b) the clearing of technical snags during the various stages of production. Applicants should be fully qualified engineers and preferably have (a) Degree or Corporate Membership of one of the professional institutions (b) several years' experience in production design of instrument or radar equipment, and (c) knowledge of production methods. Opportunity for initiative; good prospects; staff pension scheme. Apply quoting reference "E.D." and give full details of training and experience in chronological order to the Personnel Officer, Ferranti Limited, Ferry Road, Edinburgh. W 145

CLASSIFIED ANNOUNCEMENTS
continued on page 4

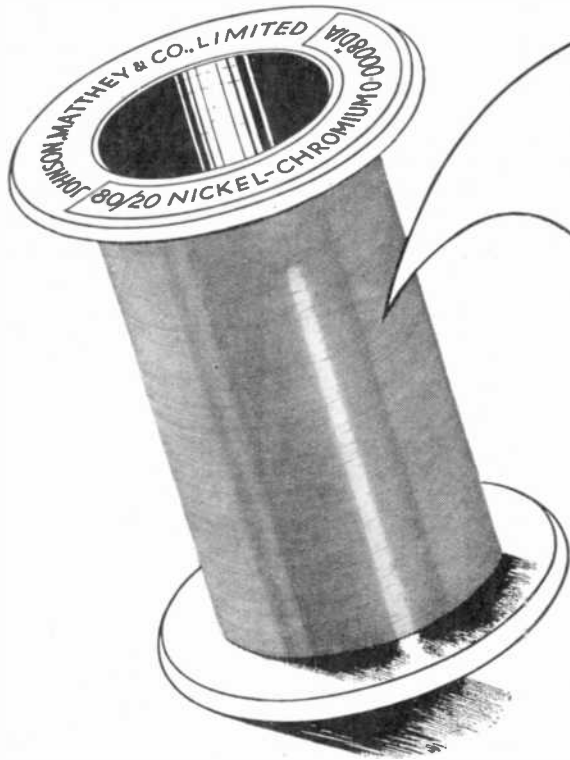

I, sir
will Resist...

... and my value may be relied upon, absolutely, for I am one of the J.M.C. precision resistance wires. I am found in any precision instrument where accurately controlled resistance is of prime importance.

Johnson Matthey precision resistance wires are produced to meet all requirements. Each spool is marked with an accurate resistance value for the wire it contains, a value that is maintained within *precise* tolerances throughout the entire spool. Publication 1440, "Electrical Resistance Materials," giving full technical data, is available on request.

And I will
protect you!



The J.M.C. plastic container ensures complete protection for the wire upon its light alloy spool up to the moment of use.

Specialised Products of

A series of technical data sheets descriptive of our materials and products for instrument manufacture is available on request.

Johnson 
Matthey

JOHNSON, MATTHEY & CO., LIMITED HATTON GARDEN LONDON, E.C.1
Telephone: HOLborn 9277 BIRMINGHAM: Victoria Street, Birmingham 1

SITUATIONS VACANT (Cont'd.)

The engagement of persons answering these advertisements must be made through a Local Office of the Ministry of Labour or a Scheduled Employment Agency if the applicant is a man aged 18-64 inclusive or a woman aged 18-59 inclusive unless he or she, or the employment, is excepted from the provisions of the Notification of Vacancies Order, 1952.

FERRANTI LIMITED. Manchester, have staff vacancies in connexion with long-term development work on an important radio tele-control project at their new laboratories at Wythenshawe, South Manchester. (I) Senior Engineers or Scientists to take charge of research and development sections. Qualifications include a good degree in Physics or Electrical Engineering and extensive past experience in charge of development work. Salary according to qualifications and experience in the range of £1,000-£1,600 per annum. Please quote reference WS. (II) Engineers and Scientists for research and development work in the following fields: Radar, radio and electronic circuits, micro waves, high power centimetric valves, vacuum and/or high voltage techniques, servo control and electro-mechanical devices. Qualifications include a good degree in Physics or Electrical Engineering or Mechanical Science, or equivalent qualifications. Previous experience is an advantage but is not essential. Salary according to qualifications and experience in the range £500-£1,000 per annum. Please quote reference WE. (III) Technical Assistants for experimental work in the fields listed in (II) above. Qualifications required: a Degree or Higher National Certificate in Electrical or Mechanical Engineering or equivalent qualifications. Salary in the range of £400-£600, according to age and experience. Please quote reference WT. (IV) Designers and Draughtsmen. Section leaders, leading draughtsmen, draughtsmen and junior draughtsmen, preferably with experience in any of the fields mentioned above. Salaries based on A.E.S.D. rates: in the range £330-£850 per annum with good allowances for special qualifications and experience. Please quote reference WD. The Company has a Staff Pension Scheme. Application forms from Mr. R. J. Hebbert, Staff Manager, Ferranti, Ltd., Hollinwood, Lancs. Please quote appropriate reference. W 2721

GLASS BLOWER required by Ferranti Ltd (Wythenshawe) for work on experimental microwave valves. Experience is required in normal laboratory glass-blowing and metal-to-glass sealing techniques. Salary according to age and experience in the range £500 to £800 per annum. Company has a Staff Pension Scheme. Application forms from Mr. R. J. Hebbert, Staff Manager, Ferranti Ltd., Hollinwood, Lancs. Please quote reference ROW. W 2762

GUIDED WEAPONS development offers good opportunities for Senior and Junior Electronic, Electrical, Radio and Mechanical Engineers and Draughtsmen, Aerodynamicists, Trials Observers, Technical Authors, and Computers (female); also for skilled and semi-skilled Fitters, Electronic Wiremen, Toolmakers and Machine Tool Operators. Apply quoting reference S.P. and giving particulars, qualifications and experience, to the Employment Manager, Vickers-Armstrongs Limited (Aircraft Section), Weybridge, Surrey. W 2813

HERRING INDUSTRY BOARD require Honours Graduate in Physics or related field to work in Aberdeen on problems of smoking and drying of fish, including investigation of the physical properties of smoke and of the diffusion of water in fish. Successful candidates will be required to design apparatus in measurement and control of variables involved and ultimately to apply results to industry. For terms of employment, apply to Secretary, 1 Glenfinlas Street, Edinburgh, 3. W 2853

HIVAC LIMITED, the rapidly expanding Electronics Division of Automatic Telephone and Electric Co., Ltd., will shortly open new premises at Ruislip, Middlesex, with excellent modern facilities for the development and manufacture of miniature and sub-miniature valves, cold cathode tubes and other electronic devices. Applications are invited from Engineers, Physicists and Chemists with previous experience in the valve industry or in precision engineering for posts in the Development and Production Departments which occur as a result of this expansion. The appointments, a number of which will be for senior positions, will all be pensionable, offer splendid opportunities for advancement, and good salaries. Preference will be given to applicants with a University Degree in Physics, Engineering or

Chemistry, or who are members of an appropriate professional body. Applications, stating age, full details of qualifications and experience, together with an indication of salary expected, should be addressed to The Managing Director, HIVAC Limited, Greenhill Crescent, Harrow-on-the-Hill, Middx. W 2794

IMPERIAL CHEMICAL INDUSTRIES Limited, Metals Division, has a vacancy at one of its Swansea factories for an Assistant Technical Officer to operate a direct reading spectrometer for the control analysis of aluminium alloys. Candidates should be between 24 and 30 years of age, should possess Inter. B.Sc. or equivalent qualification and should preferably have had experience in spectrographic analysis. Knowledge of electronics would be advantageous. Applications, giving full particulars of education, experience, and salary desired, should be addressed to Staff Officer, I.C.I. Metals Division, Witton, Birmingham 6. W 2824

INSTALLER for Communication Equipment required by Mullard Equipment Ltd., Wandsworth. Applicants should have had experience in the installation and testing of carrier telephone and similar equipment and should be willing to travel. Permanent pensionable post. Salary according to experience and qualifications. Apply Personnel Department, Mullard Equipment Ltd., Brathway Road, S.W.18. W 2841

JUNIOR ELECTRONIC ENGINEER required to assist in development and testing of range of high quality electronic instruments. Excellent opportunity for advancement in young and rapidly expanding organisation. Good salary offered. Rivlin Instruments, 7a Maitland Park Villas, N.W.3. W 2869

KELVIN & HUGHES LIMITED, New North Road, Barkinside, Essex, have the following vacancies: Research Engineers, age 25-35. Applicants should be of Degree standard, preferably with Communications training and sound mathematical background. The work is experimental and is concerned with various problems in electronics and acoustics. Applications stating age, salary required and full details of previous experience and technical training should be addressed to the Personnel Dept. W 2858

LABORATORY ENGINEER required for design and development of H.F. testing equipment for coaxial and telephone cables. Engineering or physics Degree essential and approximately 2 years experience desirable. 23 to 26 years of age. £440 to £600 per annum according to qualifications and experience. Write stating qualifications and experience to Personnel Manager, Standard Telephones & Cables Ltd., North Woolwich, E.16. W 2863

MATHEMATICIANS and Physicists with a special interest in theoretical problems are required by the English Electric Co., Ltd., for their Luton Establishment. Applications are invited from Senior men with Honours Degree and Industrial experience, and Graduates (male and female) who have recently left University. Please write, giving full details of qualifications and experience and quoting reference 441H, to Central Personnel Services, 24-30, Gillingham Street, London, S.W.1. W 2825

MURPHY RADIO, LTD., have vacancies in an expanding programme covering the field of domestic equipment and many branches of Electronic development for Engineering and Physics, or similar qualifications. These posts are permanent and pensionable and offer good opportunities for advancement. Applications giving full details of qualifications and experience should be forwarded to the Personnel Manager, Murphy Radio, Ltd., Welwyn Garden City. W 2757

ONE SENIOR AND SEVERAL JUNIOR electronic engineers are urgently required by a large firm for work of national importance. Successful applicants will be required to take over experimental radar and other circuits, and to collaborate with experienced component and mechanical engineers in the development of soundly engineered equipment for quantity production. Applicants should have experience of layouts, allowance in circuit design for component tolerances, and an understanding of production methods. Please write, giving full details of qualifications and experience and quoting ref. IBA, to Box No. W 2781.

POST GRADUATE and Final Year university students in engineering, metallurgy and chemistry are invited to send details of their records to the Staff Manager (Ref. GBLC/S/284) Research Laboratories of The General Electric Co., Ltd., Wembley, Middlesex. A number of openings in interesting experimental research will be available during the coming months for men with outstanding ability and qualifications. W 2836

PHYSICIST with experience of high vacuum techniques and induction heating generators, for laboratory developing new materials for the radio, radar and electronics industries. Initially applicant will be responsible for the development of a new type of electrolytic condenser to pilot plant stage. Promotion to a more responsible position would follow the successful completion of this work. Minimum salary £550 per annum. Box No. W 1521.

PHYSICIST/ELECTRONIC ENGINEER required for research work on the application of radioactive materials to industrial processes. Applicant must have good Honours Degree and several years post graduate experience. Knowledge of radio-active measurement techniques an advantage. Salary £600 to £800 per year. Apply Isotope Developments Limited, Beenhams Grange, Near Reading. W 1529

RADAR HANDBOOKS . . . Engineers required for the preparation and/or editing of technical reports on radar and allied electronic equipment. Applicants must have sound knowledge and practical experience of modern radar equipments and be capable of producing reports in clear, concise and good English. They should also possess a marked critical faculty to enable them to detect errors and omissions. Those earning less than £700 per annum need not apply. Applications should be made, in writing, to Box No. W 2854.

RADIO ENGINEER required for interesting position on the development of Car Radio receivers with a Company in the West London area. The post requires a sound knowledge of radio engineering and involves liaison duties between the design team, production unit and users. The post offers excellent prospects. Application should be made, giving full details, to Box No. W 2856.

RADIO ENGINEER, Design/Development engineer required for valve driven H.F. Heaters. Applicants should have had previous experience of this type of equipment or of medium power transmitting equipment. Apply in writing giving details of experience and salary required to Applied High Frequency Ltd., 52a, Goldhawk Road, London, W 12. W 2859

ROLLS-ROYCE LIMITED, Derby, have vacancies for Electronic Engineers experienced in maintenance and design of Electronic Equipment, to work upon the measurement of vibrations of Engines, etc. (Gas Turbine and Piston Types). Some mechanical knowledge, strength of materials, etc., an advantage. Higher School Certificate (or equivalent) or Higher National Certificate minimum requirement. Salary £400 to £650 p.a. (or higher for very well qualified men, according to experience). Apply to the Employment Manager. W 2766

SALES OFFICE ENGINEER required in Selenium Metal Rectifier Division. Applicants should possess sound technical qualifications together with commercial or contracts/Engineering experience. Write giving age, qualifications and details of experience to Personnel Manager, Standard Telephones and Cables Limited, Warwick Road, Boreham Wood, Herts. W 2831

SENIOR AND JUNIOR development engineers required for responsible work in radio and television development laboratories. Applicants for senior position should be able to undertake development work with minimum supervision. Excellent conditions and salary available for applicants who are accepted. Apply in first case to Chief Engineer, Radio Division, McMichael Radio, Ltd., Wexham Road, Slough, Bucks. W 2731

SENIOR DRAUGHTSMEN experienced in work on Electronic Equipment. Salary according to age and experience. Apply Mullard Equipment Limited, Brathway Road, Wandsworth, S.W.18. W 2843

SENIOR ELECTRONIC ENGINEERS required for interesting development work. Applicants should have a sound theoretical knowledge with a degree or equivalent in physics or engineering and previous experience of the design of prototype electronic equipment. A special knowledge of microwave techniques would be desirable. Applicants should write, giving full details to: Personnel Department (ED/75), E.M.I. Engineering Development Ltd., Hayes, Middx. W 2829

CLASSIFIED ANNOUNCEMENTS
continued on page 6



By Appointment to the Professional Engineer...

ATTENUATORS · FADERS · STUD SWITCHES AND TOGGLE SWITCHES
WIREWOUND POTENTIOMETERS · HIGH STABILITY CARBON RESISTORS
WIREWOUND RESISTORS · PLUGS AND SOCKETS · TERMINALS
KNOBS DIALS AND POINTERS

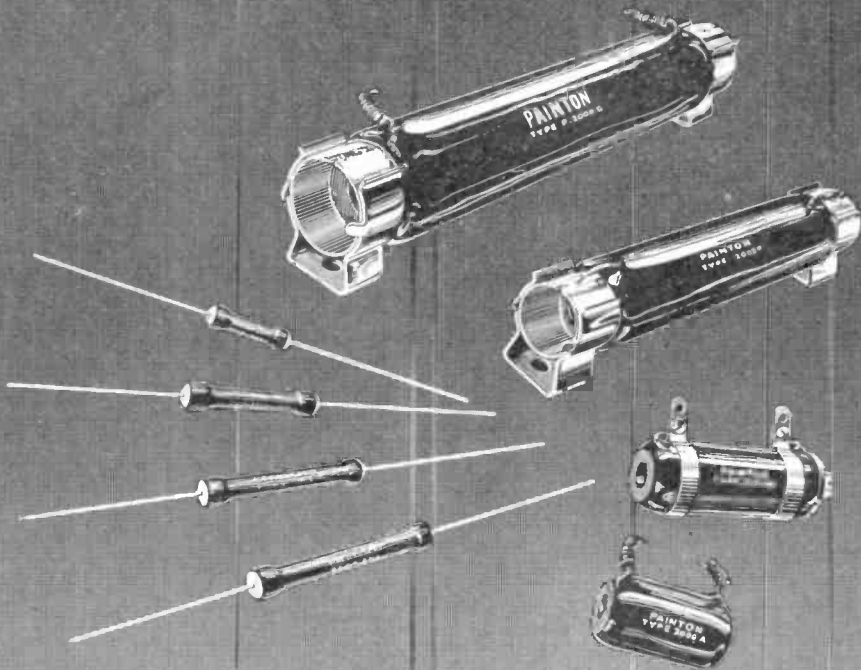

VITREOUS ENAMELLED WIRE WOUND RESISTORS

Range from 5 watts to 200 watts · Resistance tolerance $\pm 1\%$ or $\pm 5\%$ on Resistors
up to 10 watts, $\pm 5\%$ on Resistors above 10 watts · Maximum resistance 100,000 ohms.
Designed to conform to current R.C.S.C. Specifications

PAINTON
Northampton England

SITUATIONS VACANT (Cont'd.)

The engagement of persons answering these advertisements must be made through a Local Office of the Ministry of Labour or a Scheduled Employment Agency if the applicant is a man aged 18-64 inclusive or a woman aged 18-59 inclusive unless he or she, or the employment, is exempted from the provisions of the Notification of Vacancies Order, 1952.

SENIOR ELECTRONIC ENGINEER required. Experience of Helicopter instrumentation and of analogue computers would be an advantage. Apply, stating experience, age, etc., to the Personnel Officer, Saunders-Roe Ltd., Southampton Airport, Eastleigh, Hants. W 2852

SENIOR RADAR or Radio Engineer urgently required for exceptionally interesting work on guided weapons project. Salary according to experience. Apply to L. H. Bedford, Chief Engineer, English Electric Company, Ltd., The Airport, Luton. W 2844

TECHNICAL ASSISTANTS, experienced in dealing with electronic measurement and instrumentation, required for work on Aero Engines and their application. Candidates aged between 25 and 30, possessing Degree or Diploma and willing to deal with problems during flight preferred. Applications stating age, qualifications and details of experience should be addressed to the Divisional Personnel Manager, The Bristol Aeroplane Company Limited, Engine Division, Filton House, Bristol. W 2849

TECHNICAL & RESEARCH PROCESSES LTD. require a Designer-Draftsman with precision mechanical and electronic experience for interesting development projects. Write fully 25, Bickerton Road, Upper Holloway, N.19. W 1522

TECHNICAL WRITER required for expanding Technical Publications Department of large electronics organisation in London. Applicants must have previous experience in general electronics or communications. Pensionable appointment. Full details including age and salary required to Box No. W2840.

TELEPHONE TRANSMISSION ENGINEER required by Mullard Equipment Limited, Wandsworth. Applicants should have had experience in the development or testing of carrier telephone and allied equipment, and should possess a good engineering degree or equivalent. Some knowledge of filter or transformer design would be an advantage. Permanent pensionable post. Salary according to experience and qualifications. Apply Personnel Department, Mullard Equipment Ltd., Brathway Road, S.W.18. W 2842

TELEVISION CAMERAMAN required for employment in Canada with expert handling knowledge of Image Orthicon Camera Equipment. Experience in Studio Lighting, Vision Control, Sound Mixing and Equipment Maintenance desirable. Applicants must be capable of undertaking complete responsibility for the work involved. Adequate salary and good prospects are offered. Write with full particulars of age, education and practical experience to Box No. 1537.

THE BRITISH IRON & STEEL Research Association. Technical Assistant required to work in the Instruments Research Section of the Physics Department of the above Association in their Laboratories at Battersea. Work will be mainly on the development of measuring instruments for use in the Iron and Steel Industry and in Steelmaking research. Good opportunity for anyone interested in Physics, Electrical or Electronic Engineering or Instrument making. Education to Intermediate or Ordinary National Certificate standard essential. Practical experience in experimental physics, light electrical engineering or electronic engineering very desirable. Starting salary in the range £400-£600 p.a. according to age, qualifications and experience. Written applications only quoting "Instruments" to Personnel Officer, B.I.S.R.A., 11, Park Lane, London, W.1. W 2848

THE ENGLISH ELECTRIC Company Limited, Luton, invites applications for permanent posts in a Laboratory engaged in development work involving Radar Techniques. Senior and Junior positions are available to candidates possessing suitable qualifications and a knowledge of one or more of the following: (1) Centimetric systems and measurements, (2) Radar or Television receiver practice, (3) Mechanical layout and design work in connexion with the above. Salaries according to qualifications and experience in range £450 to £1,000. The laboratories

are new and pleasantly situated. The Company also encourages further study in the case of Juniors. Please write, giving full details and quoting reference "English Electric 4561" to Westminster Employment Exchange, Chadwick Street, London, W.1. W 2823

THE ENGLISH ELECTRIC VALVE COMPANY, Chelmsford, Essex, has several attractive vacancies for Graduates to undertake research and development work on vacuum tubes. Applications from Graduates who have recently qualified as well as those with industrial or research experience will be considered. Please write, giving full details, quoting reference 419E to Central Personnel Services, English Electric Co. Limited, 24-30, Gillingham Street, London, S.W.1. W 2847

THE GENERAL ELECTRIC CO., LTD., Browns Lane, Coventry, have vacancies for Development Engineers, Senior Development Engineers, Mechanical and Electronic, for their Development Laboratories on work of National Importance. Fields include Microwave and Pulse Applications. Salary range £400-£1,250 per annum. Vacancies also exist for Specialist Engineers in component design, valve applications, electro-mechanical devices and small mechanisms. The Company's Laboratories provide excellent working conditions with Social and Welfare facilities. Superannuation Scheme. Assistance with housing in special cases. Apply by letter stating age and experience to The Personnel Manager (Ref. CHC). W 2717

THE PLESSEY COMPANY LIMITED has vacancies in its Telecommunications Engineering Department for Senior Engineers and Draughtsmen to work on long term private venture and defence projects. Qualifications for Senior Engineers are a Degree in Physics or Engineering and at least two years experience in electronic, radio or radar development work. Six or more years experience of advanced work in the above field will be accepted as an alternative to a Degree. Qualifications for Draughtsmen are at least two years drawing office experience on electronic, radio or electro-mechanical devices. The positions are permanent and pensionable and very adequate salaries are available for experienced men. Applicants should be of British birth and Nationality and will be required to work either at Ilford or at the company's laboratories near Witham, Essex. Apply in confidence to The Personnel Manager, The Plessey Company Limited, Vicarage Lane, Ilford, quoting reference T.E.D. W 2837

THE PRINTING, PACKAGING and Allied Trades Research Association invites applications from engineers with wide experience in the application of electronic and servo mechanical methods to the control of operations. The person appointed will be expected to make a survey of the operations and machinery used in printing to see what are the possible applications of automatic control and to undertake work on such problems as may be selected. Initial salary will be in one of the following ranges £750-£950 or £1,000-£1,200. Superannuation under F.S.S.U. Applications in writing to Patra House, Randalls Road, Leatherhead, Surrey. W 1531

VALVE DEVELOPMENT ENGINEERS are required by the Nelson Research Laboratories, English Electric Co. Ltd., Stafford, in an expanding section of the Laboratories. Applicants should have Inter. B.Sc. or higher qualifications with development or production experience in the manufacture of mercury vapour or high vacuum tubes. A knowledge of glassworking machines and drawing office routine would be useful though not essential. Please write giving full details and quoting reference "English Electric 308" to Westminster Employment Exchange, Chadwick Street, London, S.W.1. W 2816

WANTED AT ONCE. Design and research manager. Well known firm of optical instrument makers have high level vacancy for manager to take over sole control of design and research department. State salary required and full experience from date of leaving school. Box No. W 1526.

Further "Situations Vacant" advertisements appear on page 54 in displayed style.

SITUATIONS WANTED

GRADUATE of Tech. University of Norway, Elect. Eng., age 31, at present in England, seeks post in television or assoc. Box No. W 15351.

HIGHLY QUALIFIED Electrical Engineer, skilled, lucid and expert Technical Writer, offers help in drafting or revising MSS, Reports, Theses, etc. Box No. W 1504.

INSPECTOR, 28, with third year City and Guilds, seeks the opportunity of becoming representative. Box No. W 1532.

SENIOR COMPUTER ENGINEER B.Sc.(Eng.), A.M.I.E.E., seeks responsible position in charge of development. 2 years experience digital techniques, 15 years varied electronic experience. Housing assistance necessary. Box No. W 1530.

FOR SALE

AMERICA'S famous magazine Audio Engineering, 1 year subscription 28s. 6d.; specimen copies 3s. each. Send for our free booklet quoting all others; Radio Electronics, Radio and Tele. News, etc. Willen Limited (Dept. 9), 101 Fleet Street, London, E.C.4. W 108

MAGSLIPS at 1/10th to 1/20 of list prices. Huge stocks. Please state requirements. K. Logan, Westalloy, Hitchin, Herts. W 116

MAGSLIPS, Selsyns, Ipotis Sine-Cosine Potentiometers and other devices for electrical and mechanical computation, remote control and indication, and servo control applications. Brochure and Prices from: Servotronic Sales Inc., Hopton Radio, 1, Hopton Parade, High Road, London, S.W.16. Tel.: STReatham 6165. W 2851

MINIATURE STEEL BALLS and Ball Bearings, Swiss and German Precision Work. Quick delivery. Distributors: Inley (London) Limited, 119 Oxford Street, London, W.1. Tel.: Gerrard 8104 and 2730. W 143

PANORAMIC Radio Adaptors. B.C.1031 for Receivers with I.F. 450/465c/s Max. sweep 100 + 100c/s 115/230 volts A.C. 50/70c/s. B.C. 1032 Navy Model Max. sweep 500 + 500c/s for Receivers with I.F. 5.5Mc/s. New condition, all with valves and Cathode Ray Tube. Send for special leaflet, "E.E." B.C.221 Frequency Meters 120kc/s to 20Mc/s Accuracy 0.005 per cent battery operated, supplied with all charts. Wavemeters R.C.A. T.E. 149 Accuracy 0.005 per cent 200kc/s to 30Mc/s. Relays. Magnetic Relays type 85, twin coil, large tungsten contacts 5 C/O 1 make and 1 break arranged in bakelite mounting with three fixed Resistors, new, 10 Ω , post 1s. 6d. Send for latest list of Precision Instrument and Test Gear. Leslie Dixon and Co., 214 Queenstown Road, London, S.W.8. W 2793

PURE BERYLLIUM FOIL, 0.005" thick and Beryllium Metal Discs for X-Ray Tube Windows: Elgar Trading Ltd., 240 High Street, London, N.W.10. W 141

QUALITY COMPONENTS - CONDENSERS .001, .01, .1 750v 6d each 5/- doz. Pfs. 5 to 500 6d each 5/- doz, 25 x 25v 50 x 12v 1/6 8 x 350 2/- 8 x 450 3/- 8+8 450v. 4/6 16+16 450v 5/6 Potentiometers-long spindle, all values 2/9, SP. SW. 4/6 DP.SW 5/6. Co-Axial Cable 80 Ω 1/- yd. Slewing 1 mm. 2 1/2 yd. Valve-holders-Efso (ceramic) 10d Mazda Oct. Int. Oct. (amph) 8d. M.O., I.O., Easo (pax.) 5d Nuts and Screws 4 or 6 BA-Screws 6d doz, nuts 6d doz. Tag Strips 3 or 4 way 3d 5 or 7 way 5d Mains Droppers .3a 720 Ω (3 taps) 3/- Grommets Asstd. doz 1/6. All goods new, guaranteed. Our aim—Good quality components at a reasonable price. R. E. Hope (E) 13, Waddon Road, Croydon, Surrey. W 1527

RADIUM SCINTILLOSCOPES (Crooke's Spinthariscopes) showing proof and effect of Radium atoms continuously exploding, by countless powerfully expelled Alpha particles causing ceaseless show of brightly flashing points of light on hitting small zinc sulphide screen, viewed through magnifying lens. Continuous action, lasting a thousand years. Compact nickel instrument 1 1/2 in. long x 3/4 in. diam., takes to pieces for showing parts. Price one guinea, regist. post 1/-. Interesting leaflet, "Radio-activity and Atom Bomb", free. Cefa Instruments, 30, Caxton Street, London, W.12. W 1534

TOROIDAL COILS wound, and latest potted inductors to close limits. Bel Sound Products Co., Marlborough Yard, Archway, N.19. W 139

CLASSIFIED ANNOUNCEMENTS
continued on page 8

PLASTIC MOULDINGS

**FOR THE
ELECTRONIC
AND
ALLIED INDUSTRIES**



- FULLY A.I.D. APPROVED FOR DEFENCE PROGRAMME REQUIREMENTS.
- AMPLE CAPACITY AVAILABLE FOR ALL COMPRESSION MOULDINGS, UP TO 250 TON PRESSES, AND SMALL PRECISION MOULDINGS IN THERMOPLASTICS.
- SPECIAL GRADE MOULDINGS IN MELAMINE AND NYLON-FILLED PHENOL.
- PROMPT ATTENTION TO ALL ENQUIRIES.
- GOOD, RELIABLE DELIVERY, AND FIRST-RATE QUALITY IN PRODUCTION.
- A REPRESENTATIVE WILL CALL, IF DESIRED.

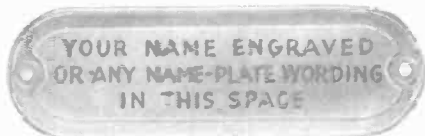

NAME PLATES FROM STANDARD TOOL

Attractive name plates to your own wording at extremely keen prices.

VISCOSE DEVELOPMENT COMPANY LIMITED
WOLDHAM ROAD, BROMLEY, KENT. RAVENSBORNE 2641

FOR SALE (Cont'd.)

WEBB'S 1948 Radio Map of the World, new multi-colour printing with up-to-date call signs and fresh information; on heavy art paper 4s. 6d., post 6d. On linen on rollers 11s. 6d., post 9d. W 102

WIRE RECORDER U.S. Navy type. Runs for 1/4 hour. £2. T. S. Davis, Hensol, Pontyclun, Glam. W 1519

EDUCATIONAL

CITY & GUILDS (Electrical, etc.) on "No Pass—No Fee" terms. Over 95 per cent successes. For full details of modern courses in all branches of Electrical Technology send for our 144-page handbook—Free and post free. B.I.E.T. (Dept 337C), 17 Stratford Place, London, W.1. W 142

THE POLYTECHNIC, 309 Regent Street, W.1., Department of Mathematics and Physics. A course of lectures on Electronics will be held on Thursday evenings from 6 to 7.30, commencing 25th September, 1952. The course is suitable for those who wish to take this subject in the Graduateship examination of the Institute of Physics. Fee for the course—£2. A detailed syllabus of the lectures is available. Application to attend the course should be made as soon as possible to the Head of the Department of Mathematics and Physics. W 2821

FREE. Brochure giving details of courses in Electrical Engineering and Electronics, covering A.M.Brit., I.R.E., City and Guilds, etc. Train with the Postal Training College operated by an Industrial Organisation. Moderate fees. E.M.I. Institutes, Postal Division, Dept. EE29, 43, Grove Park Road, London, W.4. (Associate of H.M.V.). W 2808

SERVICE

CAPACITY available for coil winding. Box No. W 1517.

MACHINING: Capacity available for precision milling centre lathe turning and cutting of spur gears. Quantities 1-500. Also design of electromechanical mechanisms, drawing office facilities and special electronic equipment. Harvey Electronics Ltd., 273, Farnborough Road, Farnborough, Hants. Phone 1120. W 1500

THE ELECTRICAL INSTRUMENT REPAIRERS. All kinds of meters, Volt, Amp, Galvo, recording, Electric Clocks, Aircraft instruments repaired. We are also skilled Horologists. Government Ministry enquiries invited. Ask for estimate. Send your enquiries to: Mr J. R. W. Ridgway, F.B.H.I., J. R. Ridgway & Co., 34, City Road, E.C.1. TERminus 0641. W 1528

TRANSFORMERS up to 20 K.V.A. chokes, solenoids and all types of associated equipment to specifications. Rewinds, repairs and overhauls. Good deliveries and quotations by return. Wilflo Products, 230/254, Brand Street, Glasgow, S.W.1. W 2777

WANTED

WANTED. Copies E.E. Oct '48 and Feb. '49. Also vols. prior to vol. 20. Box No. W 1533.

WANTED. One copy of January, February, March 1949 issue of **ELECTRONIC ENGINEERING** by The Rheostatic Company Limited, Frimley, Aldershot. W 1523

WANTED Ex W.D. Long afterglow electrostatic Cathode Ray Tubes type VCR87 or similar. Room 63 Royal Technical College, Glasgow. W 2827

The TYPE C.F.B. AUDIO TRANSFORMER



Technical information in Data Sheet No. 3

EARLY DELIVERY

Designed to exacting formulae—built to a rigid specification the C.F.B. series is universally acknowledged without rival. Incorporating the latest grain orientated strip wound 'C' cores, the C.F.B.s assure the full audio band width with the absolute minimum distortion. Here are some brief figures: series leakage induct. 10 m.H.; primary shunt induct. 130H. Coupling between primaries:—Leakage induct. for one half, other shorted, 30m.H. D.C. resistance per half primary 88 ohms; Power up to 60 w. from 22 c/s-30 kc/s, distortion less than 1 per cent with no negative feed back.

PARTRIDGE TRANSFORMERS LTD
ROEBUCK ROAD · KINGSTON UPON AVON · GLOUCESTERSHIRE · ENGLAND
TELEPHONE: 42111

AN ULTRASONIC SOLDERING IRON

Can be used for soldering aluminium, and other metals that form refractory oxides

THE problem of soldering metals that form refractory oxides has now been overcome.

A new soldering iron, developed by Mullard Ltd., destroys oxide film by ultrasonic stimulation and provides a "clean" metallic surface.

This means that perfect soldering of aluminium, and other metals, can now be achieved without scraping or brushing molten metals. Standard soft solders can be used. And no flux is needed.

A small electronic amplifier supplies the ultrasonic power. Two controls, a mains and a trigger switch, ensure simplicity of operation. Unskilled workers can use the apparatus without discomfort, since the ultrasonic frequency used is inaudible to the human ear. Full information about the Mullard Ultrasonic Soldering Iron—the only commercial model in the world—is available on request.



The Mullard Ultrasonic Soldering Iron and Amplifier. The unit operates from A.C. mains and is robustly made to suit workshop conditions.

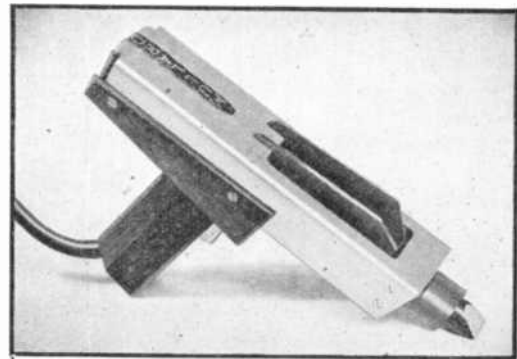

The soldering iron has a nickel silver bit driven by a magnetostriiction transducer. The transducer is arranged to run at its natural resonant frequency by a feed-back system. A conventional low voltage winding heats the soldering bit.

Mullard

CONDUCTIVITY EQUIPMENT · POTENTIOMETRIC TITRATION APPARATUS · ELECTRONIC POLAROGRAPH · TEMPERATURE CONTROLLERS · UNIVERSAL MEASURING BRIDGES · VALVE VOLTMETERS · F.M. SIGNAL GENERATORS · OSCILLOSCOPE

NORTHERN AGENT: F. C. Robinson & Partners, Ltd., 287, Deansgate, Manchester, 3

MIDLAND AGENT: Hadley Sound Equipments Ltd., 72, Cape Hill, Smethwick. Tel.: Smethwick 0977.

SCOTTISH AGENT: Land, Speight & Co. Ltd., 73, Robertson Street, Glasgow, C.2.

Mullard Ltd., Equipment Division, Century House, Shaftesbury Avenue, London, W.C.2. Telephone: GERrard 7777



(M1.340)

When Variety

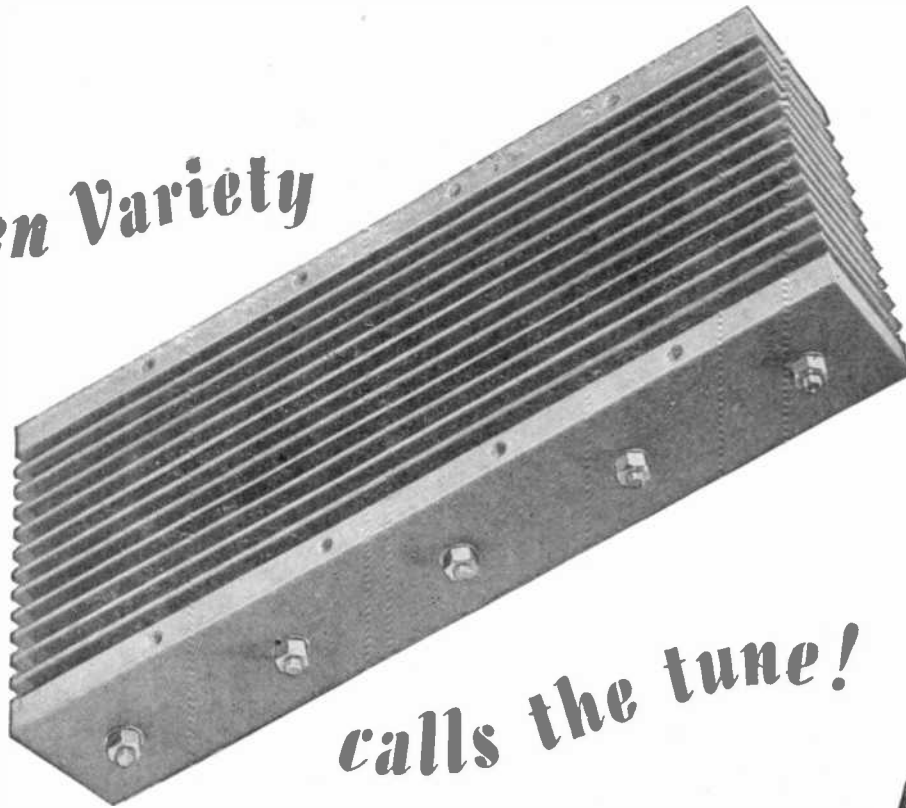

calls the tune!

Playing up to the applause which comes our way from the experts, we present a picture of a lens-drying tray made of Tufnol which according to them more than comes up to scratch! For one thing it *doesn't* scratch, and that's important to optical glass; for another, it is unaffected by chemical action: two qualities not combined elsewhere.

Tufnol is, in fact, quite unlike any other material; yet it shares the virtues of many. The uses to which it can be put are of infinite variety! It is only half the weight of aluminium, yet structurally strong enough to work sympathetically with steel: it machines



Tufnol is easily machinable with ordinary workshop facilities. Photograph shows a Tufnol gear being cut.

easily and accurately without splitting; does not warp; and is resistant to moisture and erosion. Added to these qualities is a high degree of electrical insulation. Supplied in sheets, tubes, rods, bars, angles, channels, or specially moulded shapes, Tufnol's astonishing versatility in use is the secret of its success!

WHAT'S ON YOUR PROGRAMME?



Are you likely to have a new use for Tufnol, any time in the future? Our Technical Staff will be glad to co-operate on any ideas you may have. If there is anything you want to know about what Tufnol has done, we will send you appropriate literature. Why not get in touch with us TODAY!

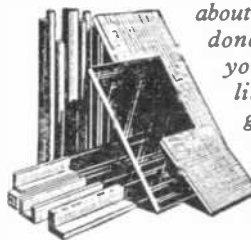

TUFNOL
REGISTERED TRADE MARK
 An **ELLISON** Product

TUFNOL LTD • PERRY BARR • BIRMINGHAM • 22 B

252

Waveguide Impedance Measurement

Unique features of design
give extreme accuracy

Metrovick Standing Wave Detector

TYPE 512

This instrument consists of a waveguide section built up from solid material, and a moving carriage, on which is mounted a tunable crystal detector.

The carriage is of the non-contacting type, and is located directly from the inside surface of the waveguide, thus eliminating any variation in probe penetration along the travel of the carriage.

This unique feature makes possible extreme accuracy in the measurement of waveguide impedances.

It has been designed for operation over the band of wavelengths from 10 cms. to 11 cms. in size 10 standard waveguide and it is fitted with Inter-Service Standard waveguide connectors.

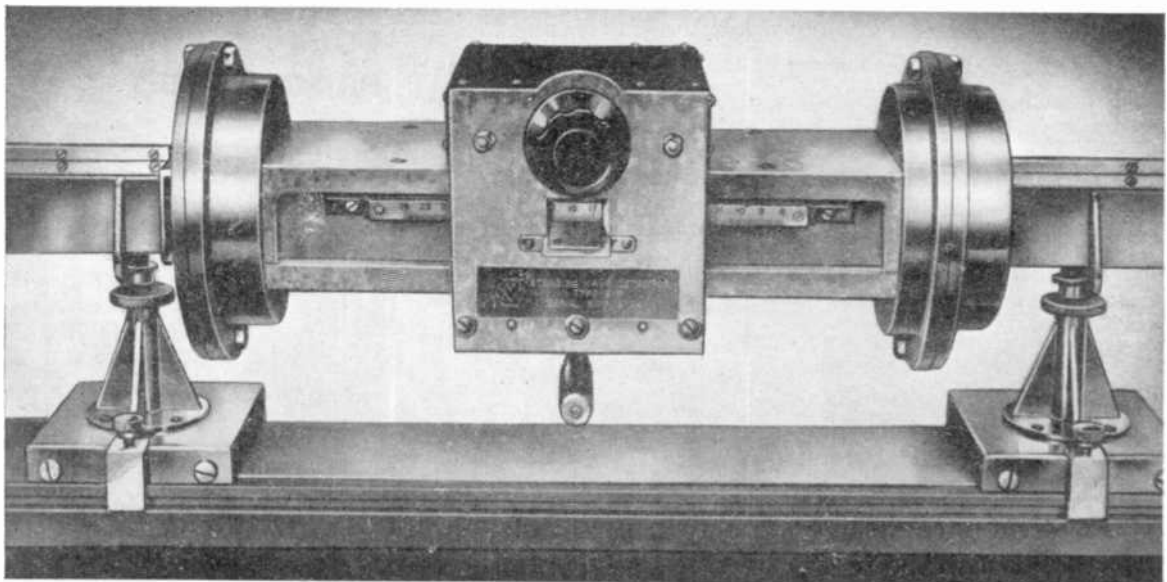

METROPOLITAN-VICKERS ELECTRICAL CO. LTD., TRAFFORD PARK, MANCHESTER 17
Member of the A.E.I. group of companies

METROVICK Test gear for the microwave laboratory

R/E204

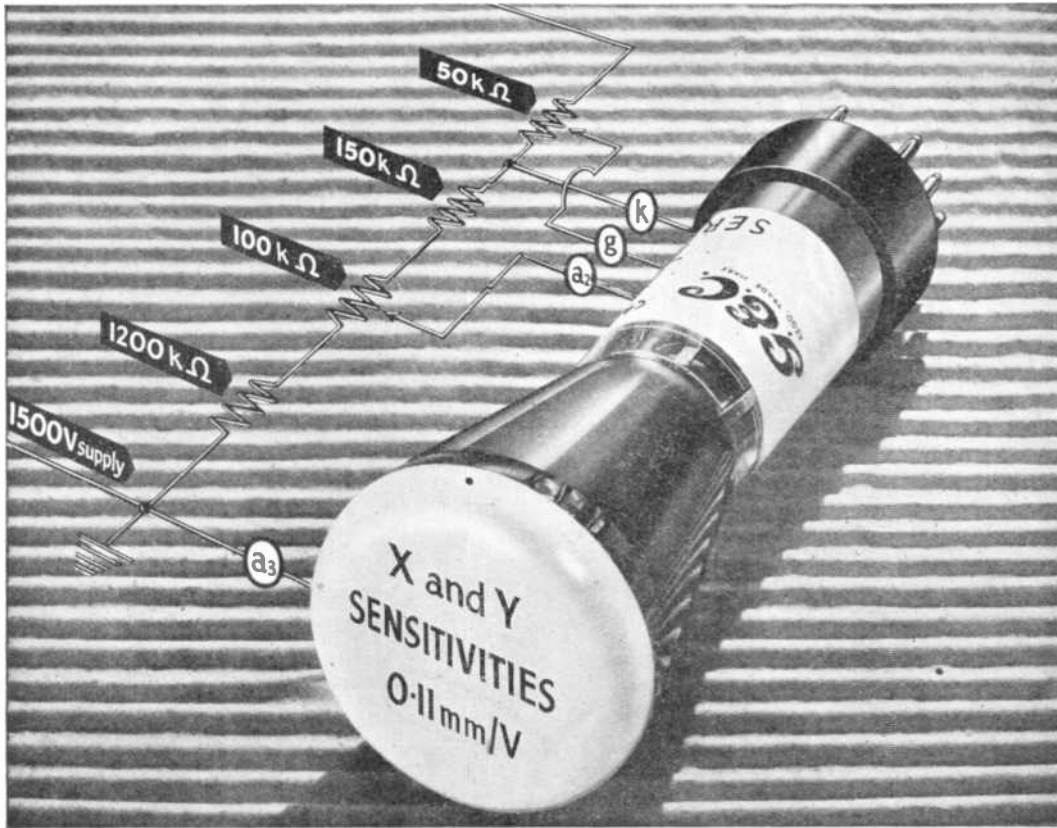

G.E.C. instrument cathode ray tubes

The above illustration shows a typical supply network suitable for the E4205-B-7; the deflection sensitivity increases as V_{a3} is reduced until it is 0.28 mm/V at the minimum of 600V. G.E.C. electrostatic instrument tubes are available in four standard sizes. All have 4V heaters and short-persistence green screens. Brief details are given in the table—for further

Type No.	Bulb dia. (mm)	V_{a3}	Sensitivity (mm/V)		Base
			X	Y	
E4103-B-4	39	600-1000	$\frac{90}{\sqrt{V_{a3}}}$	$\frac{100}{\sqrt{V_{a3}}}$	Brit. 9-Pin
E4205-B-7	70	600-1500	$\frac{170}{\sqrt{V_{a3}}}$	$\frac{170}{\sqrt{V_{a3}}}$	B12B
E4412-B-9	90	600-4000	$\frac{350}{\sqrt{V_{a3}}}$	$\frac{750}{\sqrt{V_{a3}}}$	B12D
E4504-B-16	160	600-5000	$\frac{600}{\sqrt{V_{a3}}}$	$\frac{1100}{\sqrt{V_{a3}}}$	B12D

information apply to the Osram Valve and Electronics Department.

Special screens are available to order.

A range of specialised tubes is available for applications where normal types are unsuitable. Detailed information is available upon receipt of requirements.

THE GENERAL ELECTRIC CO. LTD., MAGNET HOUSE, LONDON, W.C.2

*Ceramic
Switches
by*

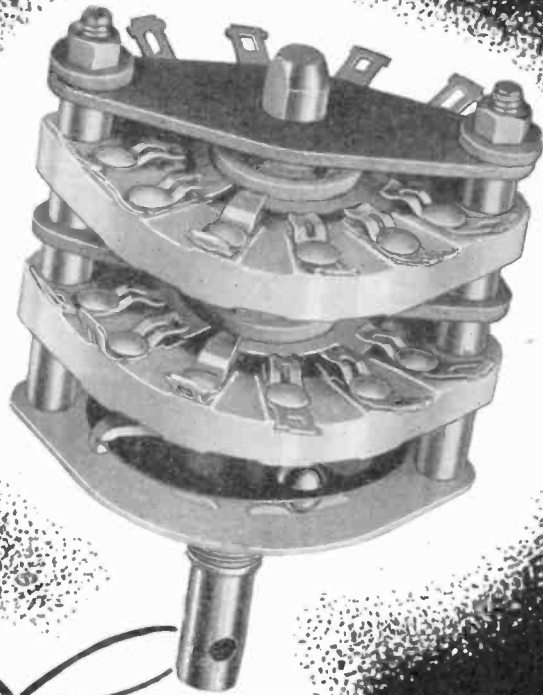

A. B. Metal Products are proud to announce that their famous H Type range of Switches is now available with "CERAMIC" insulation.

Stators and Rotors are manufactured in best quality electrical Porcelain, giving the highest degree of insulation, together with first-class Radio frequency Characteristics.

FULLY INTER-SERVICE TYPE APPROVED TO R.C.L. 151.12.

Early deliveries can be quoted, and we invite your enquiries.

Write for illustrated brochure :—



Metal Products Ltd

16, BERKELEY STREET, LONDON, W.1.

*Phone : Grosvenor 5206/7

A NEW VALVE VOLTMETER



Zero and Calibration Stability under all operating conditions

Rivlin Instruments present their new valve voltmeter, Model VV.1. This instrument is characterised by its accuracy and exceptionally high degree of zero and calibration stability, without which accurate voltage indication is of no value.

Model VV.1 permits measurement of A.C. and D.C. potentials in the following ranges, 1, 2.5, 10, 25, 100 and 250 volts f.s.d.

Accuracy is better than $\pm 2\%$ A.C. and D.C. and calibration remains unaffected by normal mains variation.

For high-frequency measurements a low-capacitance probe is incorporated, which

remains plugged into the front panel when required for low frequency measurement.

Separate terminals are provided for D.C. measurements, either positive or negative, the input impedance being of the high value of 40 megohms.

Construction is to the finest instrument standards. All components are conservatively rated, and only condensers of paper or mica dielectric are used.

The Rivlin Valve Voltmeter, Model VV.1 is supplied in a case for bench use, but if required the panel can be withdrawn from its case and fitted directly to a standard rack without modification.

R

Production has been organised to enable early delivery of the Rivlin Valve Voltmeter, Model VV.1 to be offered. Descriptive leaflet available on request to Dept. 5.

RIVLIN INSTRUMENTS, 7A MAITLAND PARK VILLAS, LONDON, N.W.3
Telephone GULLiver 2960

Hearts and Heterodynes

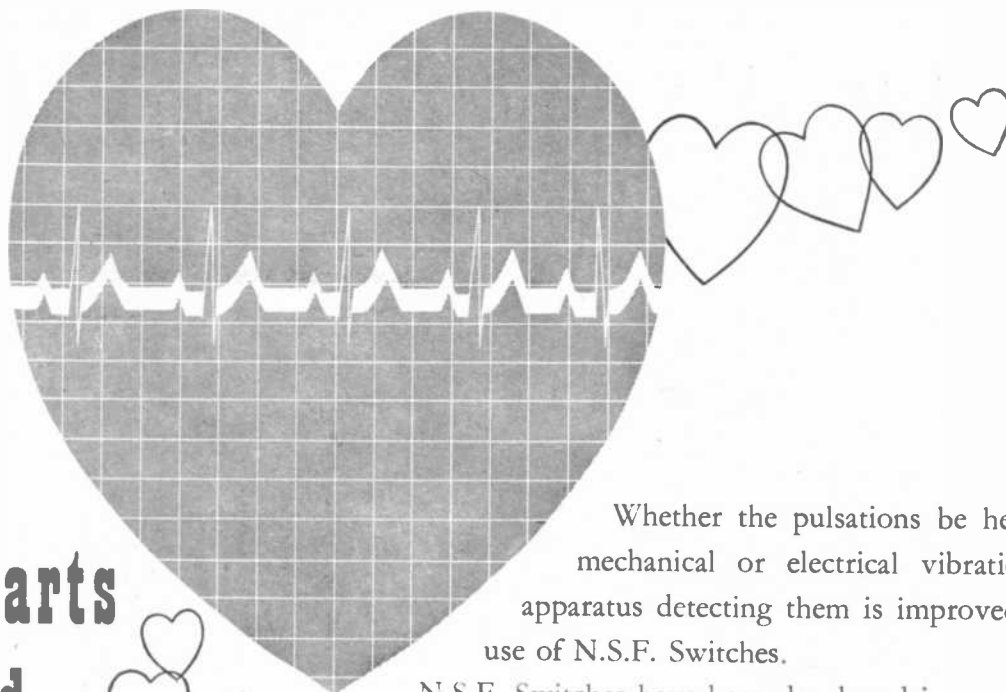

Whether the pulsations be heartbeats, mechanical or electrical vibrations, the apparatus detecting them is improved by the use of N.S.F. Switches.

N.S.F. Switches have been developed in co-operation with the industries which they serve and are in constant use all over the world today. They are available in a wide range of types and ratings to suit every purpose.

N.S.F. Limited are specialists in switch manufacture and can offer an unrivalled advisory and practical service to industry. They are pleased to co-operate with manufacturers on switch problems generally and on special applications in particular.



Switch to N.S.F. for better switching



N.S.F. LIMITED
KEIGHLEY · YORKS

LONDON OFFICE: 9 Stratford Place, W.1. Phone: Mayfair 4234

Phone: Keighley 4221/5
Grams: ENESEF, Keighley

*Sole licensees of Oak Manufacturing Co., Chicago and G. H. Leland Inc., Dayton, U.S.A.
Licensees of Igranic Electric Co. Ltd. for the products of Cutler-Hammer Inc. Milwaukee, U.S.A.*

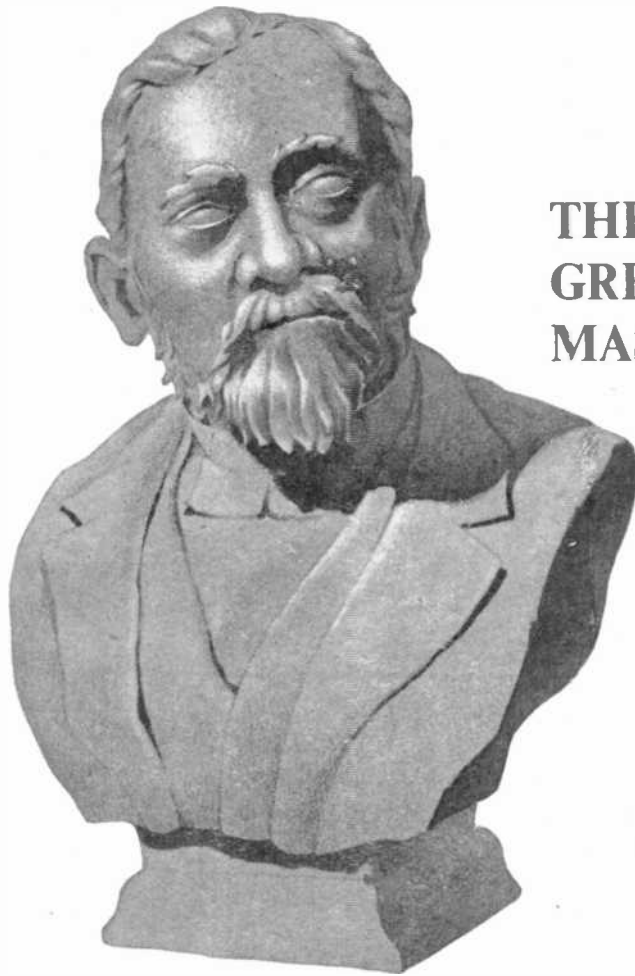

THE GREAT MASTERS



Louis Pasteur (1822-95) the greatest French Chemist of the 19th century invented a method of sterilizing milk, to which his name has become universally applied and is used in common practice the world over, today.

The name "Taylor Tunnicliff" has become synonymous with all manner of high quality ceramics serving the electrical and electronic industries of our own age.

TAYLOR TUNNICLIFF & CO., LTD. Masters of Porcelain Insulation

PORCELAIN INSULATORS & BUSHINGS FOR ALL HIGH VOLTAGE INSULATION · DIE MADE PORCELAINS
LOW LOSS CERAMICS · REFRACTORIES FOR ALL ELECTRICAL HEATING · FISH SPINE BEADS

HEAD OFFICE: EASTWOOD · HANLEY · STAFFS · Stoke-on-Trent 5272/4
LONDON OFFICE: 125 HIGH HOLBORN · W.C.1 · Holborn 1951/2

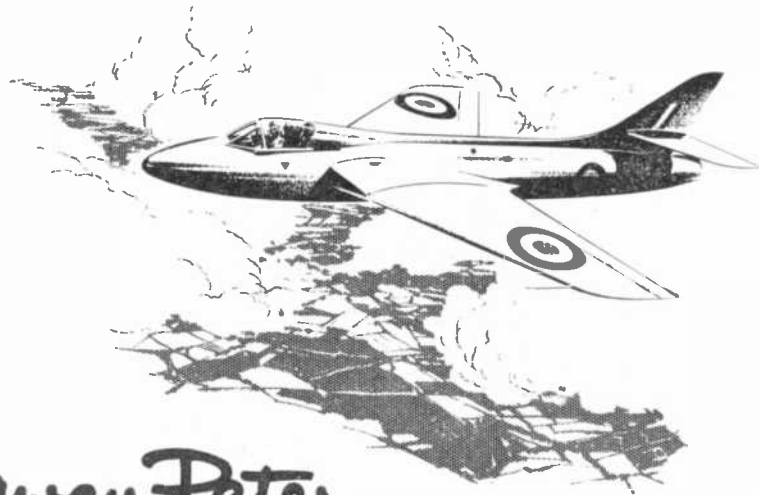
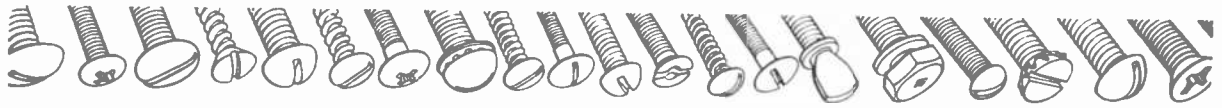

Fly away Peter

As easy as that? Of course not! The idea is born and developed, the plans are made and assembly is prepared. And this is where we come into the picture. We are there although you cannot see us. Bolts and Screws and Rivets are required and they must have a pedigree, just the same as the Hawker Hunter.

The plane is built, it flies. Another fine aircraft has been helped on its way with our products, our knowledge and our resources. This we ensure by laboratory testing all raw materials and observing the closest metallurgical and process controls through every stage of manufacture of every fastener.



We supply all industries requiring small fasteners of the highest quality to hold together the products they manufacture. Our specialists are always at your service to advise and assist you with your own particular problems.

LINREAD LTD. STERLING WORKS COX ST. BIRMINGHAM 3



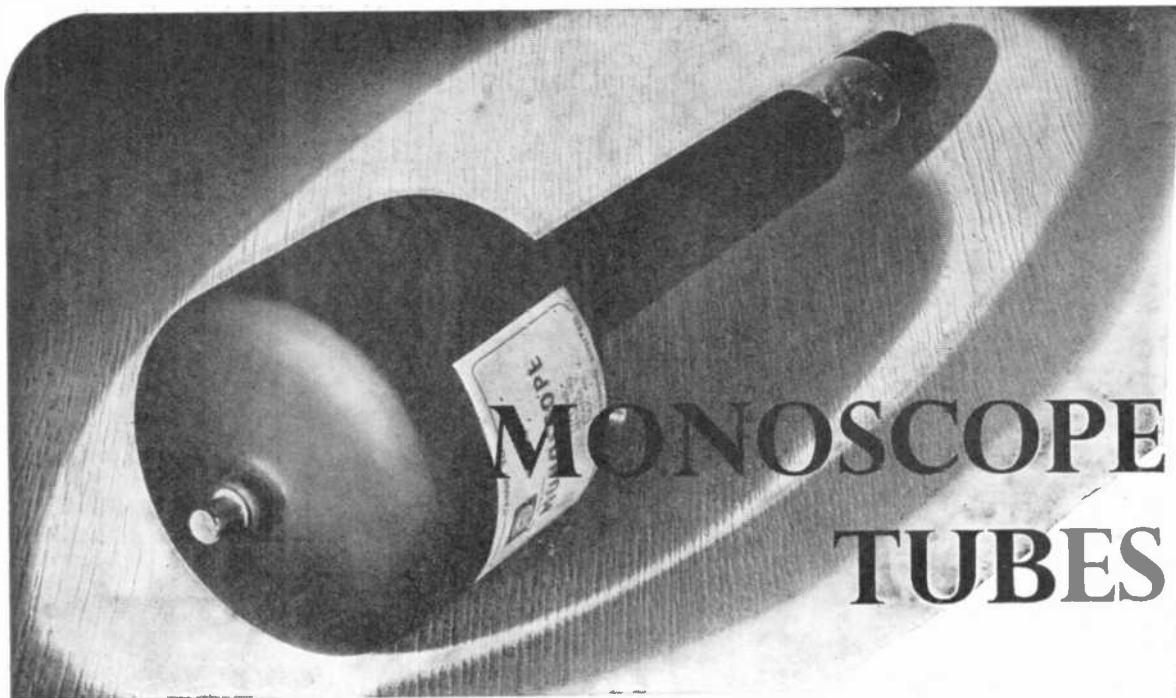

MONOSCOPE TUBES

THE Monoscope is basically a simple caption scanner apparatus capable of providing a video signal derived from a fixed pattern within the tube.

Almost any pattern comprising pure line, halftones or a combination of both can be supplied on receipt of specific requirements, and two standard types are available.

Type J.101 — Test Chart "A"

Type J.201/XI — Test Chart "C"

TYPICAL OPERATING DATA

Deflection	- - -	<i>electromagnetic</i>
Focus	- - -	<i>electrostatic</i>
V _h	- - -	6.3 V
V _g (cut-off)	- - -	-50 V
V _{a1}	- - -	1200 V
V _{a2} (focus)	- - -	850/850 V
V _{a3} (wall)	- - -	1200 V
V target	- - -	1160/1200 V
I target	- - -	5 μA

Resolution better than 500 lines

Video Signal 0.5 μA peak to peak (min)

CINEMA-TELEVISION LIMITED

A Company within the J. Arthur Rank Organisation

WORSLEY BRIDGE ROAD · LONDON · SE 26

Telephone: Hither Green 4600

SALES AND SERVICING AGENTS

F. C. Robinson & Partners Ltd.,
287 Dean-gate, Manchester, 3

Hawnt & Co., Ltd.,
59 Moor St., Birmingham, 4

Atkins, Robertson & Whiteford Ltd.,
100 Torrissdal Street, Glasgow, S.2





On the edge of
Antarctica

...at the
gateway of
Australia

Two Marconi RB.109 Automatic Marine Beacons are being erected in South Georgia, primarily for the use of Antarctic whaling fleets. The stations are designed to operate without attention for three months at temperatures down to 12°F and wind velocities up to 120 m.p.h.

Fully duplicated beacons, Type WB.8, are being installed on Troughton Island, off Western Australia, to aid shipping in the vicinity of the dangerous Penguin shoals. The station will provide high power MF beacon transmission by automatic time control and on "request".

MARCONI marine beacons

MARCONI'S WIRELESS TELEGRAPH COMPANY LTD • CHELMSFORD • ESSEX

ELECTRONIC ENGINEERING

18

AUGUST 1952

For **Audio Frequency** work

We have the tools



Cathode Ray Oscilloscope—1684D/2—a general purpose instrument—7mV/cm from d.c. to 1 Mc/s—servo, audio and T.V. work.

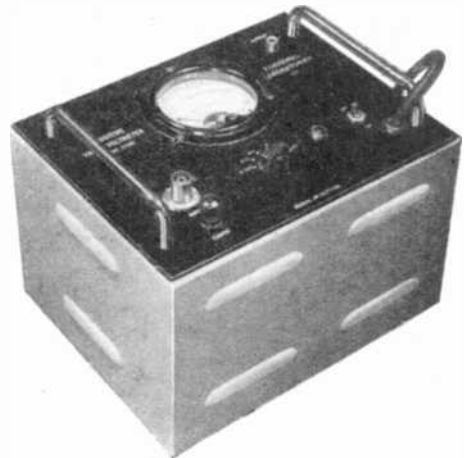

Sensitive Valve Voltmeter—378B/2—1mV to 100V—10 c/s to 500 Kc/s—log voltage and linear dB scale.

THESE five instruments selected from the wide range of Furzehill test equipment provide accurate measurement, observation and calibration facilities in the field of Audio Frequency Engineering.



Diode Voltmeter—281C/2—50 c/s to 250 Mc/s, 0.1V to 150V a.c.—0.2 to 300V d.c.

THE following instruments are also available from current production—

- Oscilloscope Camera
- A.F. Attenuator
- Resistance Box
- Stabilized Power Pack

TECHNICAL specification price and delivery period for all instruments are available on request.



Beat Frequency Oscillator—AF200B—50 c/s to 20 kc/s—2 watts into 600 or 10 ohms—log scale to 1 kc/s.



Frequency Standard—1744—1 kc/s to 80 Mc/s—0.005% accuracy.

Furzehill

LABORATORIES LTD. · BOREHAM WOOD · HERTS · Elstree 3940.

BAKER PLATINUM LIMITED

deoxo

Catalytic Gas Purifier

The Baker 'Deoxo' Gas Purifier provides a highly efficient and trouble-free catalytic method of removing unwanted oxygen from hydrogen. Also the removal of either of these gases from Nitrogen, Argon, Helium, Neon, Carbon Dioxide, and saturated hydro-carbons.

The 'Deoxo' standard Purifier will remove up to 1% oxygen or 2% hydrogen. High purity is consistently produced, the remaining impurity being less than one part per million (.0001%).

OPERATIONAL ADVANTAGES

As catalytic reaction commences at room temperature, this purification system offers the following advantages :—NO auxiliary heating required • NO water cooling required
NO operating expenses • NO maintenance expenses.



A copy of the illustrated publication, giving full details of the 'Deoxo' process, will be forwarded on application. Technical representatives are always available for consultation and advice.

BAKER PLATINUM LIMITED

52 HIGH HOLBORN, LONDON, W.C.1 Telephone: CHAncery 8711.

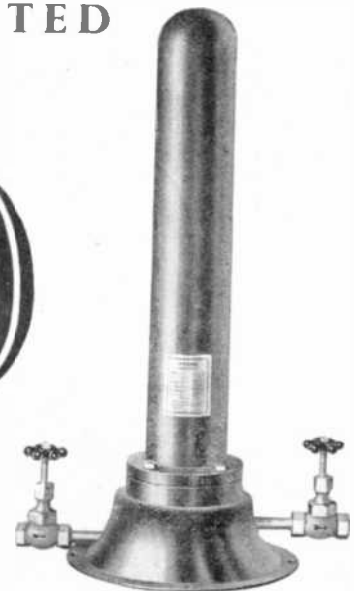

200 cfh Model



5 cfh Model

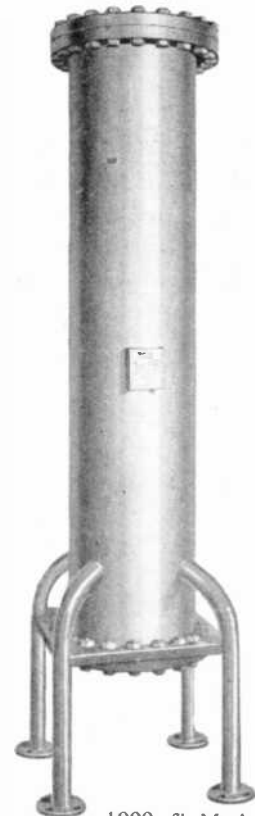

1000 cfh Model



Standard

*valves are the
best insurance
against
valve replacement costs*

*... used exclusively in the submerged repeaters
on the Netherlands-Denmark coaxial
submarine telephone cable link*

Standard Telephones and Cables Limited

Registered Office: Connaught House, Aldwych, London, W.C.2

RADIO DIVISION, OAKLEIGH ROAD, NEW SOUTHGATE, LONDON, N.11



UNIVERSAL UNITS

RESISTANCE • CAPACITANCE • INDUCTANCE

IN education and in industry, these units find a host of applications. There is a physical reality about them which appeals to the elementary student and which is necessarily missing from the more expensive boxes where switches are hidden mysteries and connexions must be taken on trust. This unit form of construction is economical and very convenient, and the moulded containers are sensibly engineered, so that fixing to a panel or to each other is quite simple.



WRITE FOR DESCRIPTIVE LITERATURE

MUIRHEAD & Co., LTD.

PRECISION ELECTRICAL INSTRUMENT MAKERS

BECKENHAM • KENT • ENGLAND

Telephone : BECKenham 0041 Telegrams & Cables: MUIRHEADS ELMERS-END

PRECISION

MUIRHEAD

ELECTRICAL INSTRUMENTS

54K



FERRANTI Transformers and Chokes

The 'H' range transformers and chokes are designed to meet the most stringent requirements for Service and Civil Radar and Radio Equipments. They are hermetically sealed and fully tropicalized, and their compactness is made possible by using 'C' cores of high efficiency. Each unit is individually tested. Components can be supplied to meet individual needs with ratings up to $1\frac{1}{2}$ kVA at 50 cycles and correspondingly higher ratings at higher frequencies.

'H' range
Hermetically sealed. 'C' core construction

FERRANTI LTD. TECHNICAL SALES DEPARTMENT FERRY ROAD EDINBURGH 5



EVERSHED

F.H.P. MOTORS

TYPICAL D.C. SERVO MOTORS FOR ELECTRONIC CONTROL

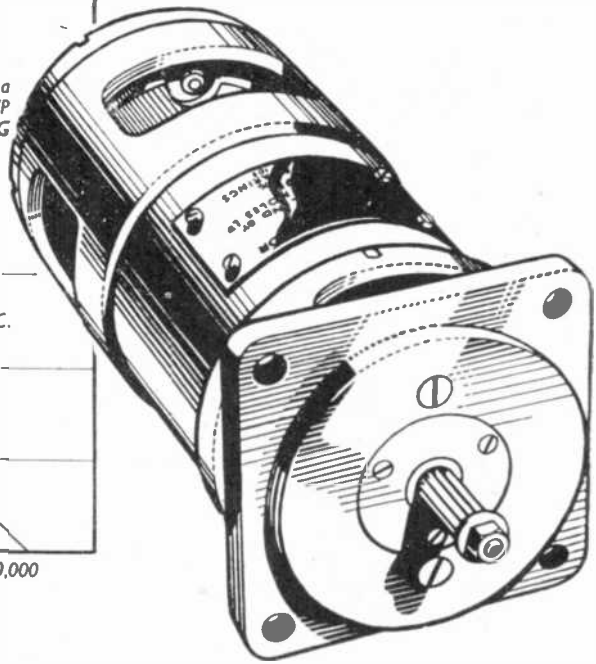
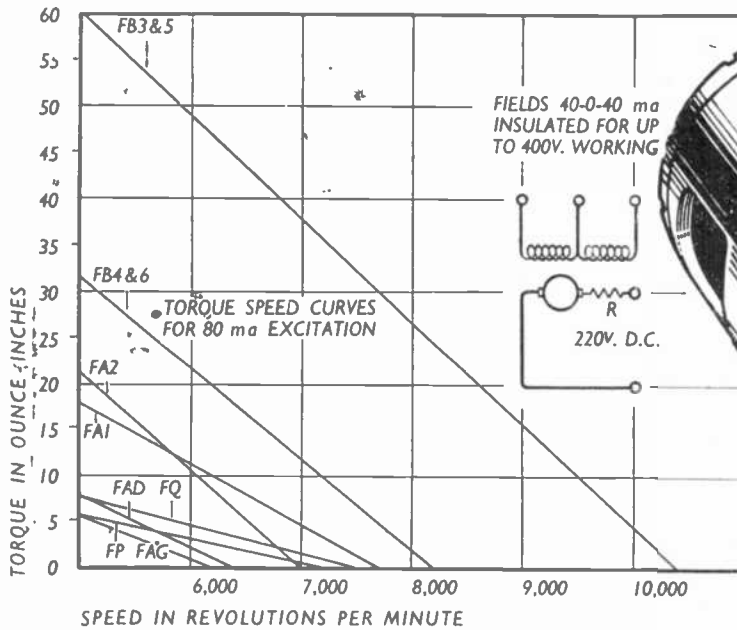

Motors may be supplied with a limited range of alternative Armature and Field Windings.

All motors rated for a standstill temperature rise of 55°C.

Please send for the Evershed Small Motors Data Book E.E.22.

EVERSHED & VIGNOLES LTD

ACTON LANE WORKS
CHISWICK · LONDON · W.4

Telephone: Chiswick 3670

Telegrams: Megger, Chisk, London

Cables: Megger, London

Frame Size	Armature Moment of Inertia oz. ins. ²	Brush and Bearing Friction oz. ins. ²	Generator Output per 1000 r.p.m.
FP	.5	.5	—
FAG	.75	1.2	20
FQ	.75	.5	—
FAD	1.0	1.2	20
FA 1	1.6	.75	—
FA 2	1.9	1.2	20
FB 3	2.0	1.0	—
FB 5	2.0	1.0	—
FB 4	2.0	1.0	—
FB 6	2.0	1.0	—

6/84

The ERIE[★] 531

*for
split-second
assembly*



A push with the finger and it's fixed!—and it's equally simple in design. Comprising only four parts, a combined mounting and earthing terminal, an adjustable inner electrode, a combined outer electrode and terminal and a moulded dielectric, yet it has all the essential requirements of a high frequency trimmer and compares more than favourably with articles of far greater complexity. Its capacitance change from maximum to minimum is practically linear, a feature which greatly assists production line adjustment and, despite its open construction, the 531 Trimmer has high resistance to tropical exposure.

RANGE (MOUNTED)	:	1 to 8 PF and 0.5 to 5 PF
RATED WORKING VOLTAGE	:	500 volts D.C
POWER FACTOR	:	Not greater than 0.12
INSULATION RESISTANCE	:	10,000 megohms minimum
MAX. OPERATING TEMP.	:	75°C

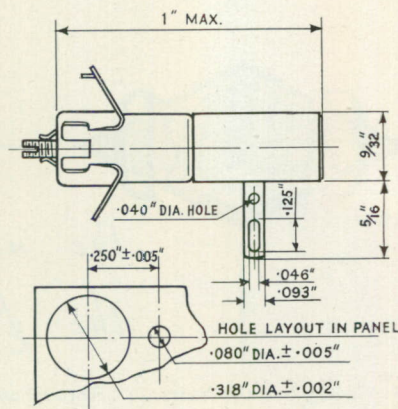

★Registered Trade Marks

ERIE[★] Resistor Ltd

CARLISLE ROAD, THE HYDE, LONDON, N.W.9. Tel.: COLindale 8011. Factories: London and Great Yarmouth; Toronto, Canada; Erie, Pa., U.S.A.

FINE GAUGE—LONG LENGTHS

Nickel Chrome RESISTANCE WIRES

Although the spider may have pioneered the production of a fine gauge strand of continuous length we have added refinements of our own. Our speciality is Resistance Wire manufactured in long lengths to reduce your operational changes. Our normal range covers gauges down to 50 s.w.g. to customers' specifications, but even finer gauges, equally consistent in uniformity and accuracy, are available on application.



LONDON AGENT: Cotsil, Ltd.,
80 Mortimer St., London, W.1.
Telephone: Langham 1071/2.

Cromaloy V

FOR CONSISTENCY

A. C. SCOTT & CO. LTD., CROMALOY HOUSE, CITY RD., MANCHESTER

dm AS 13



*the name which helps to sell
the Best Radio Grams*

Throughout the Years . . . Throughout the World . . .
Garrard has reigned supreme in producing Turntable
Units of unsurpassed quality.

Manufacturers who use Garrard Units in their finest
instruments always mention them by name in their
sales specifications.





Quarter the thickness of a human hair

The average human hair is $\frac{4}{1000}$ of an inch in thickness (.004" diam. if you'd rather be technical) and our finest enamelled copper wire is only $\frac{1}{1000}$ when insulated with five separate coats of enamel; one pound of it would measure 316,000 feet, or some 60 miles. Amazingly fine in every way — it must be of course to bear the name Connolly. Let us know if you'd like further details of this or any of our other winding wires.

The largest manufacturers of fine enamelled wire in the world.



CONNOLLYS (BLACKLEY) LTD., MANCHESTER, 9
Telephone: CHEETHAM HILL 1801 Telegrams: "CONNOLLYS BLACKLEY"

LONDON OFFICE:
34, Norfolk Street.
STRAND W.C.2 TEMple Bar 5506

BIRMINGHAM OFFICE:
19, Bent Avenue,
QUINTON, 32 WOODgate 2212

professional

T.V. SERVICING



COSSOR 'TELE-CHECK' Model 1320

An Alignment Wobbulator for setting up the correct response curves of a T.V. receiver's tuned circuits. In addition the instrument incorporates a generator which produces a pattern of either horizontal or vertical bars on the receiver screen so that linearity of its time-bases can be checked.

A feature of the instrument is that the frequency modulation of the carrier injected into the receiver is carried out electronically, the X-sweep voltage of the oscillograph being used to control this modulation. The response curves of R.F. and I.F. tuned circuits are displayed on the oscillograph producing the sweep voltage, the 7 megacycles bandwidth of the F.M. sweep occupying the entire length of the trace. The carrier of the 'Tele-Check' can be set to any frequency between 7 and 70 megacycles.

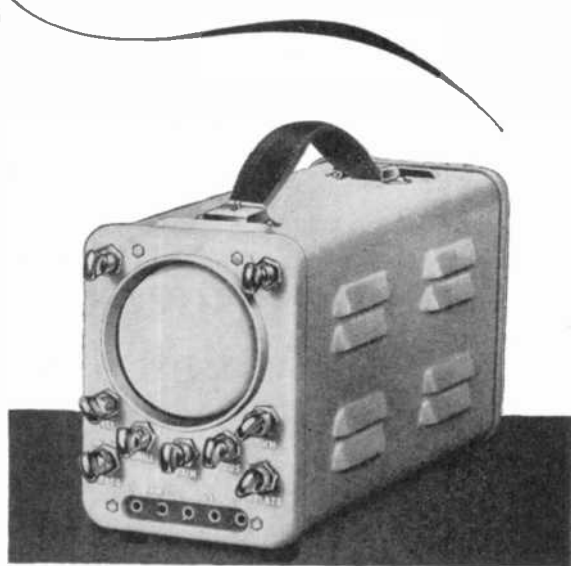

COSSOR Model 1039
PORTABLE OSCILLOGRAPH

Although a miniature instrument and weighing only 9½ lbs. the oscillograph is fitted with a tube of 2½" diameter and provides screen of adequate size for most displays. Its single-stage Amplifier covers a frequency range of 25 cycles to 3.5 megacycles (30% down) at a gain of 10 or from 25 cycles to 150 kilocycles (30% down) at a gain of 60. The switching provides the following facilities: D.C. to Y plate; A.C. to Y plate high gain at low bandwidth; low gain at high bandwidth.

The free-running Hard Valve time-base provides symmetric deflection to the X plates with repetition frequencies of 10 c.p.s. to better than 50 kilocycles and can be fed from the X terminal on the front panel to control the modulation of the Coscor 'Tele-Check'.

ELECTRONIC **COSSOR** INSTRUMENTS

Write for descriptive leaflets to your usual wholesaler, or direct to

A. C. COSSOR LTD., INSTRUMENT DIVISION, DEPT. NO. 2, Highbury, London, N.5



Use COSSOR Valves and Tubes



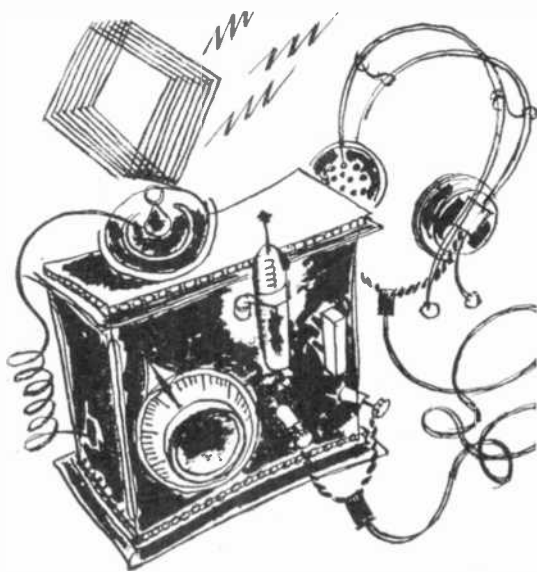

The Cat's Whisker!

It certainly was the cat's whiskers to those who gazed into the crystal and saw a great radio industry. In those early days of 210 men had little more than faith - and an idea. Parmeko, young then, have also grown great in their own small way, in their specialized way - with transformers; helping with compact efficiency, radio and those other industries where electronic and electrical equipment must be efficient or cannot 'be'.

PARMEKO of LEICESTER

Makers of Transformers for the Electronic and Electrical Industries

Electronic Engineering

Incorporating *ELECTRONICS, TELEVISION and SHORT WAVE WORLD*
 Managing Editor, H. G. Foster, M.Sc., M.I.E.E.

Vol. XXIV

AUGUST 1952

No. 294

Contents

Commentary	347
The Engineering of Radar Equipments	348
By G. W. A. Dummer, M.B.E., M.I.E.E.	
A System of Pulse Code Modulation	356
By S. Fedida, B.Sc., A.C.G.I., A.M.I.E.E.	
Franco-British Joint Television Programme	361
Pulse Brightening Discrimination	362
By A. L. Whitwell, A.M.Brit.I.R.E.	
Peak Signal Monitor Circuits	365
A Stable, High Quality, Power Amplifier	366
By E. J. Miller, B.Sc.(Eng.)	
The Analysis and Automatic Recognition of Speech Sounds	368
By Caldwell P. Smith	
The Design of Wire Wound Resistors	372
By K. L. Selig, A.M.I.E.E.	
An A.G.C. Amplifier with Constant Output	374
By A. B. Shone, B.Eng., A.M.I.E.E.	
An Add-on Counter	376
Chart for Determining Acceleration	377
By A. E. Maine	
Television I.F. Characteristics	378
By C. Evans	
An Electronic Time-Base and Stimulator Unit	380
By W. T. Catton, M.Sc.	
University Lectures on Nuclear Reactors	381
Book Reviews	382
Letters to the Editor	385
Electronic Equipment	386
Notes from the Industry	388
Publications Received	388

Published Monthly on the last Friday of the preceding month at
 28 Essex Street, Strand, London, W.C.2.

Phone: CENTRAL 6565. Grams: 'LECTRONING, ESTRAND, LONDON'

Subscription Rate:
 (Home or Abroad) Post Paid 12 months 26s. or \$3.75 (U.S.)

Classified Advertisements, Page 1
 Index to ADVERTISERS, 58

A Range of Thyratrons for Static and Mobile Applications

The Mullard range of thyratrons now includes types suitable for use in both static and mobile applications.

For static power and motor control applications a group of mercury-vapour valves is available, with anode current ratings ranging from 0.5 to 6.4 amperes.

For switching, servo mechanisms and motor control applications in aircraft, ships and mobile industrial equipments, there is a series of xenon-filled thyratrons available, with anode current ratings ranging from 0.1 to 6.4 amperes. On account of the small variations-with-temperatures of xenon, these tubes are specially suitable for use in equipments operating over a large ambient temperature range.

For special applications where extremely rapid rates of current rise are required, as, for example, in the modulation of radar transmitting systems, there is also a hydrogen-filled thyratron, the ME1503. This valve, characterised by its very low ionisation and de-ionisation time, is the first of a group of hydrogen thyratrons now being developed.

Brief technical details of the Mullard range of thyratrons are given below. More comprehensive information will be gladly supplied on request.

TYPE	DESCRIPTION	BASE	V_a (pk) max. (KV)	PIV max. (KV)	I_a (pk) max. (A)	I_a (av) max. (A)
MERCURY-VAPOUR	MT17	4-pin UX	2.5	5.0	2.0	0.5
	MT57	4-pin UX	1.0	1.0	15	2.5
	MT105	B4D	2.5	2.5	40	6.4
XENON-FILLED	2D21	B7G	0.65	1.3	0.5	0.1
	MT5544*	B4D	1.5	1.5	40	3.2
	MT5545*	B4D	1.5	1.5	80	6.4
HYDROGEN-FILLED	ME1503	B4D	8.0	8.0	60	0.015

* Supplies temporarily restricted to Government Contractors only.

Mullard

MULLARD LTD., COMMUNICATIONS & INDUSTRIAL VALVE DEPT., CENTURY HOUSE, SHAFESBURY AVENUE, W.C.2
MVT 113



Electronic Engineering

Vol. XXIV.

AUGUST 1952

No. 294.

Commentary

ELSEWHERE in this issue is a short description of the technical arrangements whereby television viewers in this country were able to receive some seventeen programmes from Paris during the period July 8th to July 14th.

Although these transmissions break little new ground from the technical point of view and the distance between London and Paris is short compared with the great American coast-to-coast network, they represent nevertheless a very solid achievement, and the future possibilities in the way of international exchange of television programmes are enormous.

This Franco-British week of television is the result of many weeks of co-operative effort on the part of the B.B.C. and the *Radiodiffusion-Télévision Française*, and a number of problems had to be solved before the two countries could be linked together by this new medium.

In the first place it will be recalled that when the C.C.I.R. conference in London last year failed to arrive at a uniform standard for television in Europe it was thought that the international exchange of television programmes would be ruled out and that countries would be confined to their own frontiers. However, the development of a convertor device, due mainly to the Research Department of the B.B.C. opened up a new approach and the obvious step was an exchange between this country and France.

This time last year, programmes originating in Calais were transmitted across the Channel but this was not an exchange of programme in the strict sense as French viewers did not share the programme. It was essentially an extension of an O.B.—one of the longest made at that time by the B.B.C.—and it provided a good deal of useful information, particularly on the difficulties of cross-Channel propagation.

The true international exchange entails the simultaneous transmission of a single programme in two countries, each with its own system; and if for no other reason, the Franco-British week will go down in history as the first time this desirable result has been achieved.

Secondly, an added complication arises from the fact that the French have two systems operating in Paris—the old 441 line system and the high definition 819 line—and since the French television receivers are not made to operate on both, the normal programme time has to be divided between the two systems, reminiscent of the old Baird-E.M.I. days in this country. The other transmitting centre is at Lille, operating on 819 lines, and it is only by the recent installation of a temporary radio link that these two cities have been joined. When a 441 line programme from Paris has to be transmitted to Lille recourse is made to a convertor. Thus by this means the R.T.F. have been able to convey their programmes to Lille where another temporary radio link carried them to Cassel for conversion by the B.B.C. to our own 405 line system.

We have already commented on the excellent spirit of co-operation existing between the R.T.F. and the B.B.C., and it is perhaps symbolic that the actual building at Cassel where the R.T.F. handed over to the B.B.C. was the scene of earlier Anglo-French co-operation born, unfortunately, of a grimmer necessity. It was in fact General Plumer's Second Army Headquarters of the first World War.

We confess that we have not been able to appreciate all the programmes we have received but we have remained in no doubt about the high technical standard achieved, and the engineers and producers of the R.T.F. and B.B.C. are to be congratulated on their efforts. Prior to the actual week we were able to inspect the mobile equipment, the sites of some of the actual broadcasts and the methods by which the programmes reached us, all of which was very much in our minds when later we sat before our screens. Making due allowances for the newness of the experiment and the initial vagaries of the weather there can be no doubt that international television has arrived and that further linking of the European countries is now only a matter of time.

It is expected that Paris will very shortly be linked with Holland, Switzerland and Italy, and when one of the world's greatest traditional ceremonies takes place next year—namely our own Coronation—it will be televised across Europe.

The Engineering of Radar Equipments

Designed for the R.A.F.

By G. W. A. Dummer,* M.B.E., M.I.E.E.

During the last war little time was available to "engineer" radar equipments. Operational necessity demanded that equipment, often still in the experimental stage, should be flown and operated on a "crash" programme basis. Experience in the European and Pacific theatres of war showed that the engineering design of radar equipment was unsatisfactory when the equipment was used under arduous service conditions and extremes of climate. Since the war much thought has been given to improved engineering of radar equipments.

The many factors which affect the engineering design of radar equipments are discussed. Among these are: sealing of equipments, pressurizing of airborne equipments; heat dissipation in sealed containers; weight reduction; accessibility for servicing; simplicity of controls; corrosion problems; and packaging and transport risks. Faults due to components in equipments and to the mechanical design of equipments are discussed. Suggestions are given for some essential engineering design requirements based on post-war pan-climatic testing and operational experience, and some trends in future engineering design are given.

Historical

AIRBORNE RADAR

THE first airborne radar equipments were designed in small individual boxes consisting of a display box (fitting two cathode-ray tubes side by side), a modulator and transmitter box, a receiver box and an aerial system, connected by multi-way cables and junction boxes. All these boxes were mounted on trays fitted with anti-vibration mountings. This assembly of boxes provided the flexibility which was so necessary at the time when experimental equipment was being flown, but resulted in a complexity of connecting leads and numerous servicing difficulties. With the introduction of the first centimetre airborne radar, the engineering difficulties were greatly increased by the addition of a scanner with high revolving speeds and considerable balancing problems.

About 1942 a standard box chassis (size 9in. by 8in. by 18in.) was introduced, based on the then existing electrostatic cathode-ray tube displays and this was adopted for the majority of radar equipment circuits with the exception of transmitter/modulator and aerial system. The chassis were interconnected by means of cables with large multi-pin plugs and appropriate junction boxes. As the number of radar equipments in the aircraft increased—with the introduction of Gee, H₂S, Oboe, Babs, Rebecca, etc.—the complexity of the aircraft installation became considerable.

Owing to the necessity for pressurizing the transmitter and modulator, cylindrical construction had been adopted for these units so that the installation difficulties in an aircraft were, and still are, extremely difficult. In small fighter aircraft it may be necessary to "tailor make" the radar equipment to the particular aircraft, or even *vice-versa*, while in large bombers the radar circuit boxes are mounted on shelves, with the scanner, navigator's displays and control units individually positioned.

GROUND RADAR

The first early warning radar equipment (CH) was constructed on standard Post Office type panels and fitted into racks. The weight of each panel was held by front panel screws and it was extremely difficult to remove the heavy panels for servicing. In the early CHL and CCI

ground radar equipments, panel racks were provided on which the heavy panels could slide when being removed. The P.O. or B.B.C. type of rack in which the chassis panels are mounted vertically was also adopted and a number of experimental console systems were developed in which the chassis were built round a central cathode-ray tube display.

Several designs for maximum accessibility have been evolved since the war, such as the flat plate construction in the Gee transmitters and the drawer system as used in Airfield Control Radar (ACR).

Engineering Design Requirements

From experience gained in testing equipments in the laboratory under simulated pan-climatic conditions and from post-war operational experience gained in the field, it is considered that design requirements should include those detailed in the list below. These requirements should all be considered at the early design stage of the radar equipment. Only by this attitude towards engineering design will reliable world-wide operation be obtained. While there are obviously many conflicting factors, the following suggestions are given in approximate order of priority as essential requirements for future design.

- (a) Adequate performance.
- (b) Reliability.
- (c) Capability of operation in any part of the world. (This includes ruggedness, mechanical strength, adequate heat dissipation, etc.).
- (d) Ease of servicing and maintenance (until the stage of continuous fault-free life is reached).
- (e) Lightweight.
- (f) Simplicity of controls.
- (g) Adequate packaging.

It is obvious that the equipment must give a certain standard of performance, naturally required to be as high as possible. It may, however, be well worthwhile to sacrifice some of the performance in the interests of the remaining requirements to ensure, for instance, the utmost reliability in operation.



The constructional methods which have been attempted in order to achieve these aims have been numerous and there is no one system which can achieve simply and easily

* Ministry of Supply.

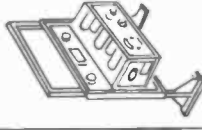
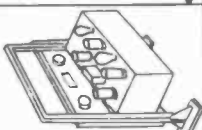
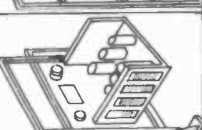
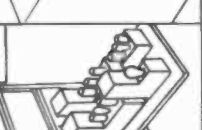
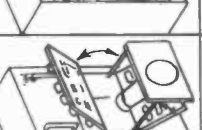
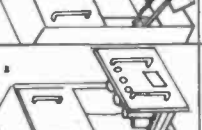
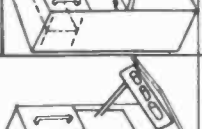
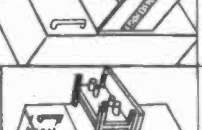
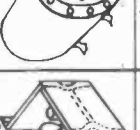
GROUND EQUIPMENT

	FLAT PLATE	OPEN P.O. or BBC TYPE	OPEN RADIO TYPE	IMPROVED RADIO PLUG-IN SUBUNIT TYPE	OPEN PLUG-IN SUBUNIT TYPE	SPLIT RECTANGULAR	FILING CABINET (INVERTED)	FILING CABINET WITH REMOVABLE SERVICING TRAY	EXTRUDED "H" CHASSIS	FULLY SEALED
TYPE OF CONSTRUCTION										
ENGINEERING DESIGN REQUIREMENTS	EXCELLENT	MEDIUM	GOOD	EXCELLENT	MEDIUM	MEDIUM	MEDIUM	MEDIUM	MEDIUM	POOR
HEAT DISSIPATION	EXCELLENT	POOR	POOR	EXCELLENT	POOR	POOR	POOR	POOR	POOR	EXCELLENT
CLIMATE PROTECTION	EXCELLENT	EXCELLENT	EXCELLENT	EXCELLENT	EXCELLENT	GOOD	GOOD	EXCELLENT	GOOD	MEDIUM
ACCESSIBILITY	EXCELLENT	EXCELLENT	EXCELLENT	EXCELLENT	EXCELLENT	GOOD	GOOD	GOOD	EXCELLENT	MEDIUM
RUGGEDNESS	GOOD	GOOD	GOOD	GOOD	MEDIUM	MEDIUM	MEDIUM	MEDIUM	MEDIUM	MEDIUM
WEIGHT	MEDIUM	MEDIUM	MEDIUM	MEDIUM	MEDIUM	MEDIUM	MEDIUM	MEDIUM	MEDIUM	MEDIUM

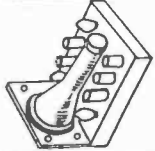
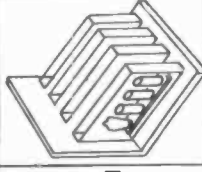
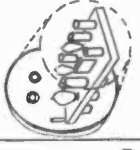
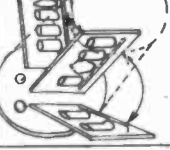
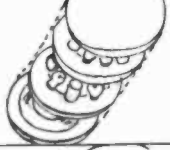
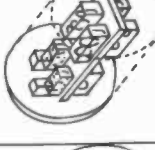
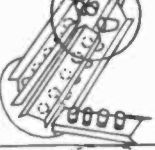
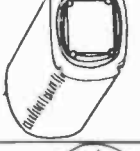
AIRBORNE EQUIPMENT

	OPEN TYPE	OPEN PLUG-IN STRIP UNITS	PRESSURIZED CYLINDRICAL	PRESSURIZED CYLINDRICAL (SPLIT CHASSIS)	PRESSURIZED CYLINDRICAL (DISK CHASSIS)	PRESSURIZED PLUG-IN SUB-ASSEMBLIES	PRESSURIZED HEXAGONAL HINGED SEMI-SUB-UNITS	PRESSURIZED ELIPTICAL	SEALED BREATHING
TYPE OF CONSTRUCTION									
ENGINEERING DESIGN REQUIREMENTS	MEDIUM	MEDIUM	POOR	EXCELLENT	EXCELLENT	POOR	POOR	POOR	POOR
HEAT DISSIPATION	POOR	POOR	EXCELLENT	EXCELLENT	EXCELLENT	EXCELLENT	EXCELLENT	EXCELLENT	MEDIUM
CLIMATE PROTECTION	POOR	EXCELLENT	EXCELLENT	EXCELLENT	EXCELLENT	EXCELLENT	EXCELLENT	EXCELLENT	MEDIUM
ACCESSIBILITY	POOR	EXCELLENT	MEDIUM	MEDIUM	MEDIUM	POOR	POOR	EXCELLENT	MEDIUM
RUGGEDNESS	MEDIUM	MEDIUM	MEDIUM	MEDIUM	MEDIUM	POOR	POOR	EXCELLENT	MEDIUM
WEIGHT	MEDIUM	MEDIUM	MEDIUM	MEDIUM	MEDIUM	GOOD	GOOD	GOOD	MEDIUM

EXPERIMENTAL CONSTRUCTIONS

	OPEN TYPE POTTED SUB-UNITS	PRINTED WIRING ON GLASS OR CERAMIC PLATES	PRINTED WIRING CERAMIC TUBE STAGES	PRINTED WIRING PLASTIC PLATES	SEALED GAS-FILLED SUB-UNITS	PRESSURIZED DOUBLE ENDED
TYPE OF CONSTRUCTION						
ENGINEERING DESIGN REQUIREMENTS	EXCELLENT	EXCELLENT	GOOD	GOOD	GOOD	POOR
HEAT DISSIPATION	EXCELLENT	EXCELLENT	MEDIUM	POOR	EXCELLENT	EXCELLENT
CLIMATE PROTECTION	EXCELLENT	EXCELLENT	POOR	EXCELLENT	EXCELLENT	EXCELLENT
ACCESSIBILITY	EXCELLENT	EXCELLENT	POOR	MEDIUM	MEDIUM	GOOD
RUGGEDNESS	GOOD	POOR	MEDIUM	GOOD	MEDIUM	MEDIUM
WEIGHT	POOR	MEDIUM	GOOD	GOOD	MEDIUM	MEDIUM

Fig. 1. Methods of construction for radar equipment

all these requirements. A summary of the main radar equipment constructions (both ground and airborne) is given in Fig. 1 together with an attempt to summarize the main qualities of each type of construction.

Pan-Climatic Operation of Equipments

It became obvious towards the end of the war that radar equipments must be designed *ab initio* to operate under Service conditions in any part of the world. Equipment inside an aircraft on a desert airstrip may reach a temperature of +50 to +60°C; on taking off the craft can climb in ten minutes to 30000ft, where the air temperature is -40°C. There is thus an external temperature difference of 100°C in ten minutes. With present high speeds an aircraft may, within a few hours, fly from arctic to tropical regions or *vice versa*. An Inter-Service testing schedule specifying the tests which should be made on all prototype equipments was drawn up in 1946 and many equipments have now been tested to this specification (K.114)¹ which includes high and low temperature tests, humidity, mechanical shock and vibration tests. These tests have been of the greatest value in improving the engineering of equipments by predetermining, in the laboratory, mechani-

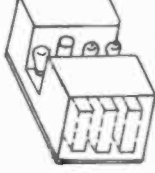
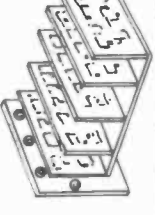
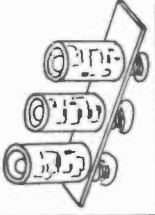
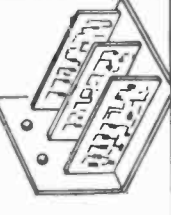
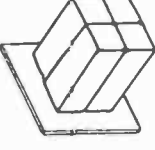
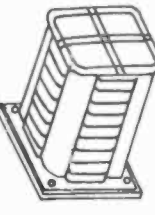
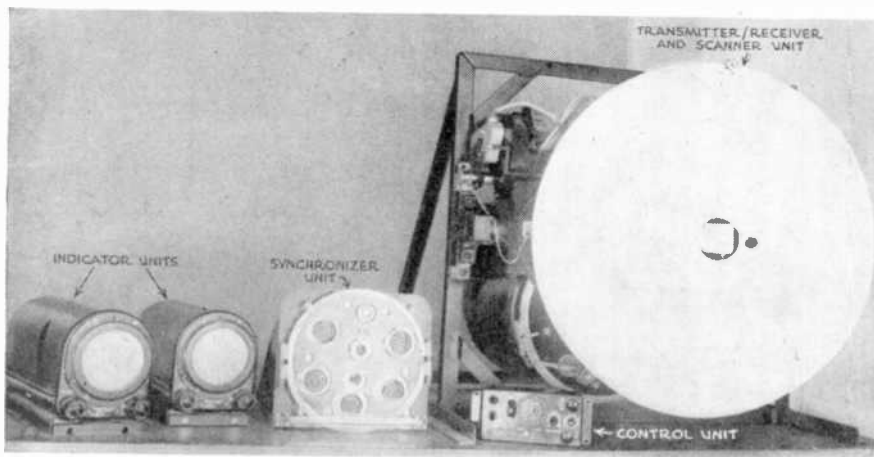

Fig. 2. A typical airborne radar system which has successfully passed K.114/J mandatory tests (Table 1)

cal and electrical faults which would otherwise have occurred in service. It is essential that early prototype models be tested to this schedule, so that modifications suggested by failures in the tests can be incorporated before final tooling is started. A typical airborne radar equipment which has successfully passed the K.114/J mandatory tests (Table 1) is shown in Fig. 2.

The Reliability of Radar Equipments

Good "reliability design" may be defined as the prevention of faults in the operational life of an equipment by the use of stable circuits, sound engineering techniques, high quality components, and a high standard of workmanship and inspection.

Since the war, the development of miniature components has enabled the size and weight of equipments to be decreased, but problems of heat dissipation arise and components are not as easily accessible as before unless special precautions are taken. To fulfil new operational requirements, so many more components and valves are being used in radar equipments that the reliability of each individual component and valve must be of an extremely high standard.

In unsealed radar equipments most faults are due to component failures and in sealed equipment most are due to mechanical failures. — Many faults have occurred in

equipments tested to the K.114 specification during the post-war years, some due to component design and manufacture and some to the mechanical design of equipment. It will be of value to discuss the faults which have occurred in these tests.

5. (a) FAULTS DUE TO COMPONENTS IN EQUIPMENTS

The component faults which occur in any electronic equipment can be divided into three classes:—

- Class 1 Faults due to poor manufacture or the use of unsuitable materials.
- Class 2 Faults due to bad design, such as electrical or thermal overloading of components and valves.
- Class 3 Fundamental faults, into the cause of which research is needed.

A rough analysis has shown that about 60 per cent of the total faults are in the first class, 35 per cent in the second class and 5 per cent in the third class.

The first class, theoretically, need rarely occur. By sound valve and component design and with careful testing of materials and finished components it is possible to bring faults in this class to a very small proportion. Unfortunately, process control and control of materials used in components is subject to the necessity for keeping the cost

of the finished components competitive. This is necessary in the radio industry as a whole where price is a vital factor in the marketing of television and radio sets. The service requirements are in a different category, and reliability, not cost, should be the vital factor.

Examples of weaknesses in component manufacture which have been revealed in K114 tests are: the pulling tight of sealed transformer terminal leads before soldering, resulting in breaking of the wires under vibration; mechanically poor end connexions on fine wire potentiometers, resulting in fracture; and the use of corrosive steels for switch parts resulting in rusting and inability to operate the switch. The penetration of moisture, as is well known, has been one of the most prevalent causes of compo-

nent failure. Dry joints due to bad soldering have occurred, but are only a small proportion of total faults.

The introduction of sealed components has improved reliability and high quality components are being produced by the radio industry in many cases under Service development contracts. Reliable valves are being produced in small quantities; these quantities should increase as more experience is gained by the valve manufacturers. Undoubtedly the importance of the project cannot be overstressed.

The occurrence of Class 2 faults depends on the skill of the equipment designers, both at Government Establishments and in the radio industry. The increasing part taken by the radio industry in the design and development of radar equipments for the Services stresses the importance of training and using skilled designers, technicians and engineers. It is important that the designers should be informed of faults in design arising as a result of trials, tests, etc., so that they are not repeated in later designs.

The third class represent a fundamental problem which is obviously more difficult to solve. Included in this category are the generation of unwanted pulses by capacitors, the failure of metal type rectifiers at temperatures reached in some sealed equipments and the development of special components.

The use of new materials, such as polytetrafluorethylene, acenaphthylene, silicones, high permittivity ceramics, ferrite

magnetic materials, etc., is profoundly influencing the design of future components.

All new materials must have a trial period for the assessment of advantages and disadvantages before coming into general use, and these materials are at present going through this stage. In the next few years, major advances will undoubtedly be made in the design of smaller, more efficient and more reliable components.

FAULTS DUE TO THE MECHANICAL DESIGN OF EQUIPMENTS

The vibration testing of the K.114 schedule has proved most useful in revealing weaknesses in designs.

In the resonance test, the equipment is clamped rigidly to the vibration table and the frequency of vibration is slowly varied over the range 10 to 100c/s at an amplitude varying between 0.010 inches and 0.001 inches. Any resonance occurring in chassis members, group boards or large components can be immediately detected by means of a stroboscopic lamp, firing at a frequency slightly different from that of the vibration frequency, so that the movement of the components, etc., is seen in slow motion.

The importance of detecting these resonances cannot be overstressed. The cure in some cases may be quite simple—possibly the movement of a supporting strut or the addition of small bracket—but the effect on the general mechanical strength of the assembly is considerable.

Where the cure for a resonance is likely to be expensive, for instance, the re-design of a casting, then the resonant part is given a fatigue test of fifteen million cycles at its resonant frequency.

An aim of radar designers and manufacturers is to achieve a high strength to weight ratio and the equipment must be made as light as possible. Modern design practice is to make the first equipment with little or no safety factor in its structural strength, to subject it to vibration, shock and load tests and then to strengthen the parts which are shown by these tests to be weak. In the past it has been usual to design equipments with a large but unknown safety factor, but by the modern method the safety factor can be improved where it is shown to be necessary with little increase of weight.

Another test is being used to great advantage to determine the amount of packaging or shock absorbing material needed to pack radar equipments for transport. An equipment is placed on a drop testing machine and drops 4ft 6in. with a resilient pad, which on impact decelerates it at a known rate. This rate of deceleration has been termed the "impact load factor". An equipment has an impact load factor of n if it can stand, for short periods, a deceleration of ng before breaking (g is the acceleration due to gravity). Impact load factors up to 75 have been obtained with modern compact radar equipments. Tests on this machine make possible considerable improvement in the mechanical structure. A further test which is being developed for radar equipment used in high speed fighters is a centrifuge "steady g " test in which any steady acceleration up to 12g will be produced. These tests will ensure that relays, etc., do not operate during turns at high speed and that there will be no structural failures due to operational manoeuvres. All these tests will improve the mechanical strength and reliability of future equipments.

Corrosion Problems

Experience has shown that heavy corrosion of metal parts has taken place in open type equipment in high humidity and at high temperature. Switches, relays, meters and rotating parts have been seriously corroded. While many components, such as relays, meters, etc., are now hermetically sealed to prevent moisture penetration, the problem is still present on materials used in the mechanical construction. Aluminium alloys are being used more and more for airborne chassis, but steel is still used for many chassis for open type ground equipment. Various protections have been used for steel—zinc-plating, passivated zinc-plating and cadmium plating being reasonably common. Good cadmium plated steel (0.002in.) has proved satisfactory on tests, but the other two have not, although an experimental tin-zinc plating process has been remarkably successful in resisting corrosion. Recent tests on a large number of protected steel samples have shown that high purity (99.5 per cent) aluminium metal spray finishes have also been extremely successful in resisting corrosion. Fig. 3

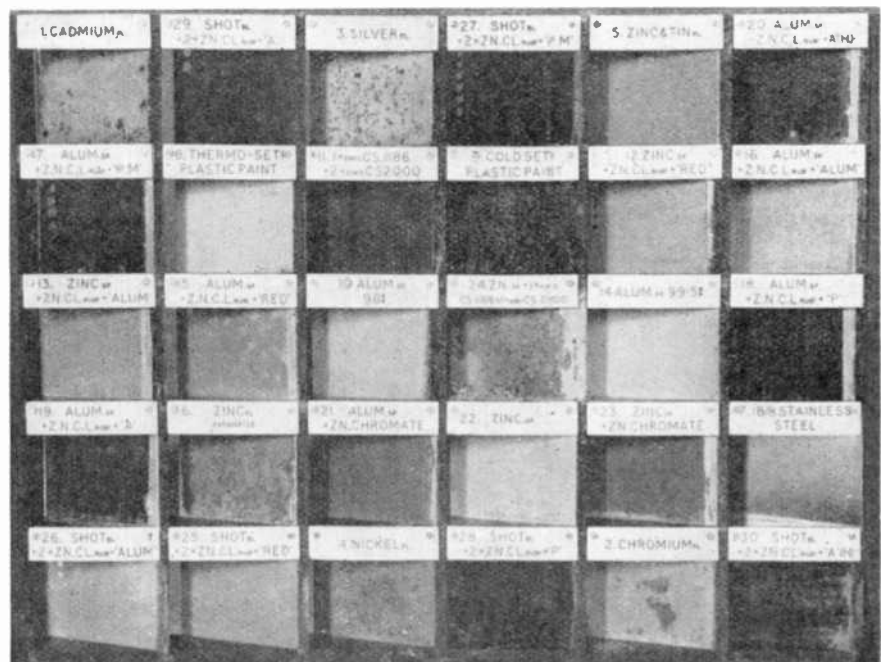

Fig. 3. Metal finishes after one year's exposure to high humidity and temperature

shows the appearance of 30 steel samples with various protective finishes after one year's exposure to high temperature and high humidity in a laboratory test chamber.

Each component (or mounting strip holding a component to the chassis) may be made of a different metal; electrolytic corrosion takes place, due to the difference in potential between them in high humidity. The types of metallic finishes which are commonly used in radar equipments are:—

- (a) *Chassis*—Zinc-, silver or cadmium-plated steel (being replaced by aluminium alloys whenever possible).
- (b) *Valveholders*—Silver or cadmium plated steel.
- (c) *Potentiometer mounting, etc.*—Nickel-plated brass.
- (d) *Electrolytic capacitor cases*—Deep drawn aluminium.
- (e) *Capacity clips*—Zinc-plated steel.
- (f) *Soldering tags*—Tin-plated brass.
- (g) *Valve screens*—Deep drawn aluminium (or silver- or cadmium-plated steel or brass).
- (h) *Nuts and bolts*—Cadmium-plated and nickel-plated steel.

In order to overcome this corrosion, high purity aluminum alloys are being used for chassis, and tests have shown that under humidity and even salt spray conditions, satisfactory results can be obtained; but corrosion of outer cases of components and of mounting clips, etc., presents a problem. This means that unless a similar light alloy is used throughout the radar equipment (which in turn demands that all component covers, mounting clips, nuts and bolts, etc., must either be of the same material or protected by insulation) corrosion will be present. Stainless steel nuts and bolts have been successful in resisting corrosion when in contact with most of the metals and finishes used in radio chassis.

Accessibility for Servicing

Until the reliability of components has reached the stage where no servicing is required during the effective life of the equipment, the layout of the individual components on the chassis to provide maximum accessibility is of extreme importance. Fig. 4

shows the normal type of component tag-board layout used during the war and also shows an improved layout in which the space on the valve side of the chassis is used, thus releasing space for accessibility on the component side of the chassis. The best shape for accessibility is a flat plate construction and printed wiring techniques have much to offer in this respect. The installation of chassis inside an aircraft is a difficult problem, as withdrawal of any unit means that an equivalent volume of space must be left for withdrawing the unit from its rack or mounting. The size and shape of units varies with the type of aircraft and with the degree of complication of the radar equipment itself.

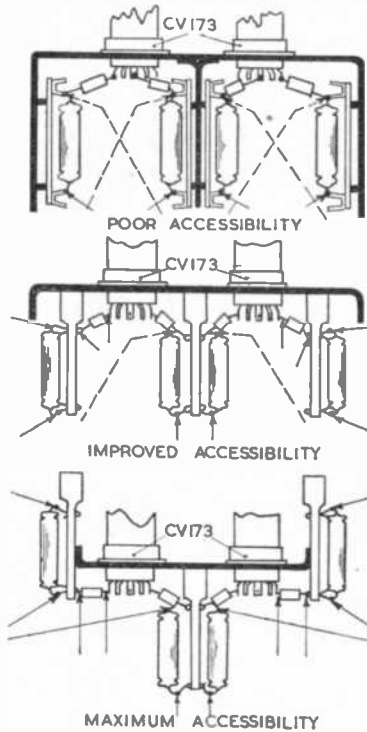

Fig. 4. Accessibility of components on tag-boards

The advantages and disadvantages of sub-unit construction have been discussed for many years. Miniaturization is making the use of sub-units desirable—for example, a modern miniature I.F. strip has to be treated as a complete sub-unit; it cannot easily be repaired in the field.

A great deal of work on sub-units is being done at the radar research establishments and by industry. Experimental equipments have been constructed of replaceable stages, with each stage hermetically sealed, and the valve wired in as part of the stage. A further development is the use of casting resins to enclose sub-units; Fig. 5 shows experimental sub-units in which this process has been used. The components are placed tightly together in a jig and inserted in a mould; the casting liquid is then poured round the components; it sets at room temperature and holds them together. This construction also protects against climatic conditions, although the degree of protection has not yet been established. The valves are not included in the component assembly, so that the heat from the valves can

be conducted away readily without affecting the components. It should be possible to replace valves or groups of components separately without having to throw away complete units. Printed wiring techniques, which are in early experimental stage, also lend themselves to the sealed sub-unit construction. Experimental radar units are being constructed, consisting basically of flat plate construction, utilizing as sub-units large components which are fully sealed, e.g., transformers, chokes, potentiometers, capacitors, etc., and casting in resin blocks all the small unsealed components. All valves are placed in a central "chimney"; the flat construction dissipates heat effectively and provides maximum accessibility and the aim is to provide effective sealing of components, without the attendant problem of adequate cooling.

Sealing of Equipments

The increase in reliability of radar equipments by sealing has been considerable. Tests carried out to the full K.114

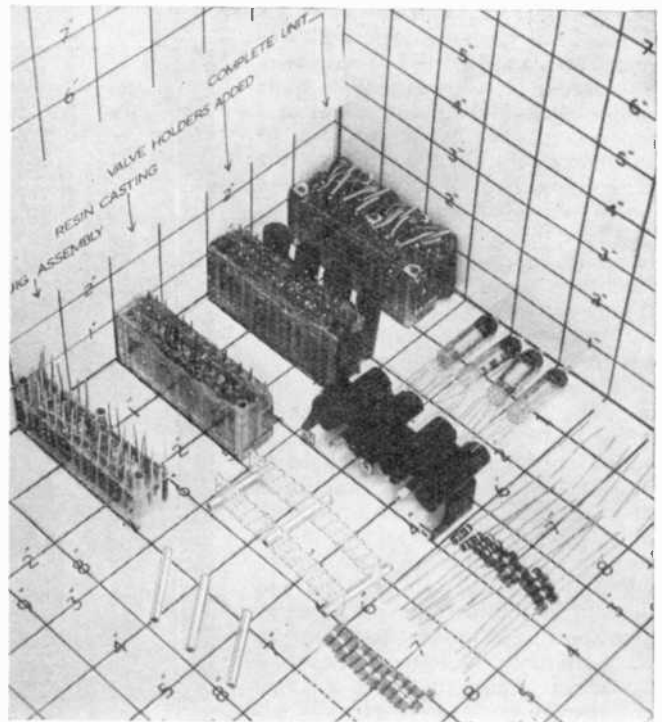

Fig. 5. Casting resin techniques applied to circuits

specification on a number of equipments have shown that component failures on sealed equipments have been negligible. Failures in operation under test on the sealed units have been mainly due to mechanical faults, such as broken wires, loosened rivets and nuts, broken brackets and fractured chassis, all occurring in the vibration tests.

It is obvious that sealing an equipment will prevent damage due to the penetration of dust, or deterioration due to the penetration of moisture, and therefore sealing must be expected to improve the reliability of the components inside.

On the other hand, the dissipation of heat in a sealed and confined space becomes a problem and, in addition, it is not always easy to make components accessible. However, the gain in reliability is enough to confirm the present practice of sealing all radar equipment for operation in the air. Some recent airborne radar equipments use a "breathing" system in which a differential pressure of 2lb or so is maintained between the interior and exterior of the equipment. When the aircraft rises, air leaks out through a suitable

release valve; when it descends air is taken through a similar non-return valve through a silica gel container, which absorbs the moisture from the air. The system avoids the mechanical difficulties of designing the container to withstand differential pressure of 15lb/sq.in. or more, but difficulty is being experienced in cooling at altitude due to the reduction of air density within the unit.

One of the problems which is raised by sealing equipments is whether to develop special light-weight high temperature unsealed components for use only in sealed equipments. If such components were developed, it would be essential to use fully sealed packaging (such as heat-sealed polythene envelopes) to preserve spares until they were fitted into a sealed equipment. Three classes of humidity tests are now included in component type approval tests:—

Class H1—84 days humidity cycling.

Class H2—14 days humidity cycling.

Class H3— 7 days humidity cycling (with a drying out period before test).

It has been considered that class H3 would be suitable for use in sealed equipments, 7 days being allowed for equipments to be left open in the tropics before servicing.

The subject of components for sealed equipments is extremely controversial. There are two approaches—one is always to use the fully tropical (class H1) component, as a safety factor in obtaining reliability, the other is to reduce weight, size and cost by using class H3 components.

Pressurizing of Airborne Equipment

To avoid corona and flashover at high altitudes with miniature construction, it is necessary to pressurize the box containing the high voltage supplies for the radar transmitter and modulator. The modulator voltage of a magnetron is of the order of 13-20kV and with pressurization the equipment can be designed to operate with distances between high voltage points equivalent to those at sea level pressures. Fig. 6 shows a pressurized modulator capable of operation at 60kW up to 40000 feet with a 1μsec pulse at a repetition frequency of 500c/s. With present sealing techniques there is always slight leakage, and in order to ensure that any leakage is outwards, the units are usually pressurized to approximately 5lb/sq.in. above atmospheric pressure.

Working pressures of 15-20lb/sq.in. are allowed for in design. If a sealed box at a sea level pressure of 14.7lb/sq.in. is flown to a height of 40000ft where the external air pressure is 2.7lb/sq.in. there is a pressure of 12lb/sq.in. (or 17lb/sq.in. if initially pressurized to 5lb) tending to burst the box. The container must either be strong enough mechanically to withstand this pressure or some scheme of controlled pressure relief must be used. In general, a cylindrical construction is used for modern airborne pressurized units, as a near approach to the ideal sphere, although recently special square units have been developed. The cylindrical units have proved satisfactory in practice, although awkward to instal in an aircraft. Seals are of various types of rubber under pressure, and release systems include multiple quick release winged nuts and sectional "V" clamps. The difficulties of sealing increase with the increase of area to be sealed and with the large diameters sometimes used (up to 15in.) the problems of holding pressure without undue leakage are considerable.

An important point when considering the use of pressurized units is the detection of air leaks when they do occur. It is important to know not only that there is a leak (this can be detected by normal pressure indicators)

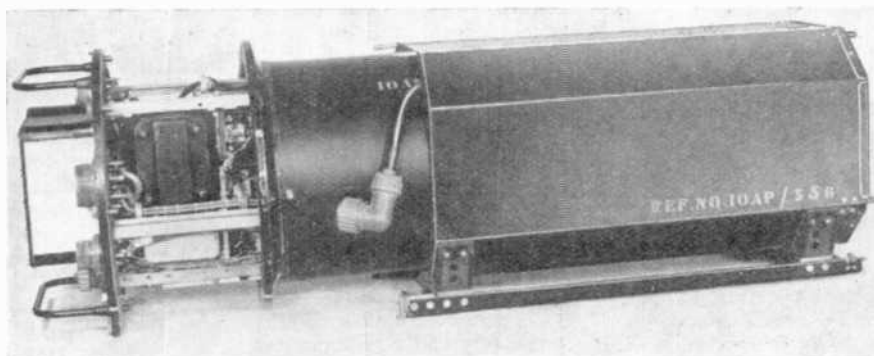

Fig. 6. An airborne pressurized modulator

but where the leak is, so that it can be eliminated. The use of a halogen-compound gas detector has been tried successfully. In testing, 1 per cent by volume of carbon tetrachloride is injected into the pressurized unit via the Shrader valve and a halogen sensitive probe detector is then passed over the place where leaks are suspected. The instrument is remarkably sensitive and very minute leakages can be readily detected.

The use of rechargeable dry CO₂ capsules containing a small tracer of halogen compound is being investigated. Pressure of 3lb/sq.in. can be obtained merely by pressing the capsule through a key on to the Schraeder valve. Two capsules will give 6lb/sq.in. This ensures that dry air or gas is used and obviates the necessity for pumps when pressurizing equipments.

The Dissipation of Heat in Sealed Containers

The necessity for pressurising airborne transmitters and modulators and the sealing of airborne equipments has accentuated the problem of heat dissipation in sealed containers. The best way of transferring heat is by direct conduction, but this is difficult where a normal radar chassis of considerable length and variable conduction is used. Therefore, to avoid hot spots, both radiation and convection cooling have to be used—radiation, by increasing the area and emissivity of the hot surfaces; where this is insufficient, convection, using air streams for forced convection cooling. In general, forced convection cooling systems are used in airborne equipment; an internal fan giving an air flow of about 100cu.ft/min is used to prevent local hot spots, and an external forced draught of about 150cu.ft/min is blown through corrugations between the sealed inner container and the outer cover.

The calculations for heat transfer in sealed radar units are extremely complicated and it is difficult to include the many factors which should be taken into account in any such calculations, e.g. the positioning of components, the conduction through materials, the thermal contacts, the rate of air flow, whether natural or forced convection, etc. As a rough guide, for approximately 6 cubic inches per watt a blower system is not necessary, natural convection cooling by suitable placing of hot components being sufficient. Between 1 and 2 cubic inches per watt, an external blower is necessary and below 1 cubic inch per watt both internal and external blowing are essential. It is emphasized that these figures are a rough approximation only and can be modified considerably by individual features.

The maximum allowable rise of temperature is governed mainly by the safe operating temperatures of the components and materials used in the equipment. Three temperature categories of components exist at the moment, Class A for 100°C working, Class B for 85°C and Class C for 70°C. There are insufficient Class A components available for all to be of this type. Where forced convection cooling is used, the internal temperature is uniform and if it is necessary to use some Class C components, the

temperature rise of the whole assembly has to be restricted to 30°C (assuming the allowable external ambient temperature is 40°C).

Where it is possible to use natural convection cooling (for approximately 6 cubic inches per watt), components of different categories can be used provided there is some form of thermal insulation. A temperature gradient can be maintained in such a closed system by the use of metals and plastics as heat conductors or insulators. Fig. 7 shows a cylindrical container in which this system has been used experimentally.

There is a strong tendency to design components for higher operating temperatures, but although components can be miniaturized, the "watt" cannot. Valves run at operating temperatures of approximately 150°C, silicone oil transformers run up to 180°C, vitreous type resistors to 200°C, glass or ceramic insulation to 200°C and some work has been done on fused glass dielectric capacitors which operate at 150°C.

Heat exchangers can be satisfactorily used in ground equipments, but are bulky and weighty for use in the air. Ideally some form of temperature control of radar equip-

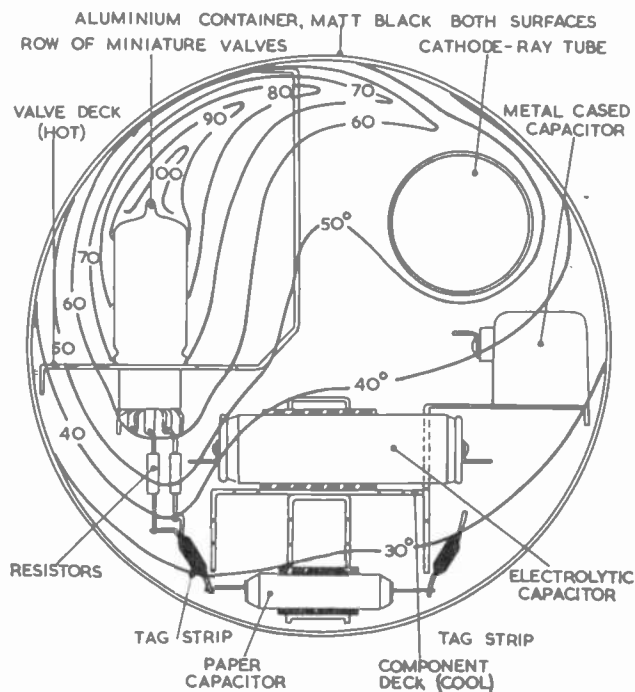

Fig. 7. The application of natural convection cooling to a component assembly in a sealed container 6 inches in diameter

ment would be an advantage, so that the temperature coefficients of components would not affect the high precision computers now being used in airborne radar systems, but the difficulties and complexities of suitable miniature refrigerator systems seem too great.

As the operational height of aircraft increases, the cooling of the radar equipment becomes more difficult because the efficiency of the cooling fan drops considerably as the density of the air is reduced. A modern radar equipment may dissipate up to 1½kW and a forced convection cooling system efficient at medium heights becomes ineffective at heights of the order of 50 000 feet. Although the air temperature outside the aircraft at these heights may be down to -95°C (at 60 000 feet over the tropics) the use of ram or external air is not favoured by the aircraft designer at the high speeds at which modern aircraft fly, although it is being used in some systems. The use of waste air from the pressurized cabin is being considered; also in jet aircraft there is the possibility of bleeding air from the engine compressor through the refrigerator, but there seems no easy solution to this problem.

Weight Reduction

The use of light alloys for chassis, etc., is essential in modern airborne equipment, and much experimental work has been done on the fabrication of aluminium alloy chassis and scanner parts. The problem of "earthing" to an aluminium chassis is usually evolved by using solder tags bolted to the chassis. Numerous aluminium soldering fluxes and solders have been tried, but it is difficult to find a solder which will withstand humidity and salt spray corrosion.

Weight can best be saved in modern airborne radar equipment by careful design of the heavy components. In transformers², weight can be saved in three ways:—

1. By using grain-oriented silicon iron instead of ordinary transformer iron.
2. By using high temperature dielectric materials (silicone oil and polytetrafluorethylene insulation), instead of transformer oil, paper, etc.
3. By improved mechanical structure of the container.

The use of light alloy waveguides in place of the normal silver-plated brass or copper results in considerable weight-saving. Even with short runs worthwhile reduction is possible with fabricated light alloy guides, end flanges and T.R. boxes, but the fabrication of precision light alloy waveguides still remains a difficult production problem. Careful circuit design can again be a factor in weight-saving by the avoidance of heavy current valves and circuits which contain large and heavy capacitors.

For ground equipment, the use of miniature components is becoming prevalent; the difficulties of transport and handling of large equipments are considerable, as shown

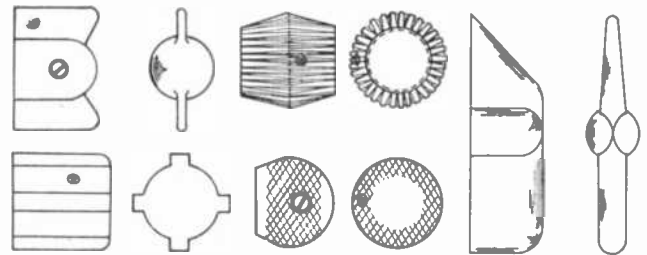

Fig. 8. Control knobs for operation by feel in night flying

by experience in the Far East fighting. Where possible the weight of individual units for ground equipment is limited to 60lb for ease of handling and for air transportation.

Simplicity of Controls

Owing to the necessity of designing equipment which is capable of operation under extreme climatic conditions, there are many difficulties in positioning controls. The problem particularly arises if equipment is to be operated at very low temperatures (e.g. in Arctic or Antarctic regions). Thick gloves are a necessity and the spacing between control knobs, even on miniature equipments must be sufficient for satisfactory operation. High flying aircraft (unless using pressurized cabins) also present difficulties and crowded cockpits require that any pilot's radar controls should be kept to a minimum. In addition, under adverse climatic conditions, the efficiency of the operator is lowered.

The necessity for pre-set controls is being overcome by the introduction of improved components—e.g., accurate and stable resistors—and with these improvements and with advances in circuit techniques, the pre-set control may possibly be eliminated.

A great deal can be done in design to reduce the necessity for controls, but it will still be necessary for some control knobs to be used by the operator and a great deal of thought has been given to the design of suitable knobs, capable of being used on miniature equipment with gloved hands. Fig. 8 shows a range of knobs which have been developed by the R.A.E. in conjunction with the Institute of Aviation Medicine for operation by feel in the low

illumination in a cockpit during night flying. The number of controls may be reduced by circuits designed for automatic operation, but the increase in complexity of the circuits may outweigh the advantages gained. Any reduction in the reliability of the complete equipment by the introduction of complicated circuits to reduce the number of controls is a heavy price to pay and the designer is often faced with this difficult choice.

Packing and Transport

It has been authoritatively stated that during the Pacific War up to 60 per cent of equipment shipped to the Far East arrived damaged. This was due to two main defects:

Failure to provide an adequate moisture-vapour proof barrier.

Insufficient shock and crush absorption.

The hazards which are placed on comparatively delicate radio and radar equipment by the requirement of transportation under war conditions to any part of the world means that packed equipment should survive:—

- Crushing in the holds of ships by stacking,
- High temperatures in the holds of ships in the tropics and low temperatures in the arctic,
- Loading and unloading shocks on docksides,
- Rough transport over bumpy ground,
- Possible immersion in water and mud,
- Long periods of storage in the tropics,
- Long periods of storage in the arctic,
- Vibration when transported by air.

A series of war-time metal containers were designed to withstand these hazards. Known colloquially as "tropicals", they have been extremely successful in transporting equipment to all parts of the world. They are fully sealed, extremely strong, with top-hat sections for absorbing shock and crushing and have no end joints. They are fitted with internal spring cushions and are capable of repeated use in the field.

The packaging of components and spares is also of considerable importance. During the Pacific War it was not uncommon for components and spares in overseas stores to be unfit for use when needed, due to penetration of moisture. A programme of repacking components into wax-dipped cartons was initiated at the end of the war, but tests have shown that these are not entirely suitable due to loss of identification with melting of the wax. A method of polythene packaging has been devised in which the component is sealed in a polythene envelope by heat sealing. The moisture penetration of polythene is far lower than that of other plastics and the component is readily identified through the transparency.

The Trend of Future Engineering Design AIRBORNE EQUIPMENT

The increasing complexity of airborne equipments has become a major problem in designing these equipments for maximum reliability. The break-up of complicated systems into units and sub-units seems to be logical, but there is considerable work to be done in determining the economic size of the sub-units and the methods of inter sub-unit connexion. It would appear that division of the sub-units according to circuit function is preferable. Sealed or "breathing" equipments for airborne radar systems are now in general use and the major effort in improving these equipments must be given to their mechanical design. Scanners carried in the big bombers are large in order to give greater definition and considerable experimental work is being done on engineering constructions using new lightweight metals and magnesium alloys with varying forms of protection against corrosion.

The present sealed, miniaturized airborne equipments are a tremendous improvement in engineering over the unsealed heavy equipment of the last war and the major steps now necessary are the improvement in reliability of miniature valves and components and improvement in the mechanical design of the assemblies.

The limit of packing with miniature components has been almost reached and it must be left to the new techniques (at present in the experimental stage) to provide the next steps in meeting these stringent requirements. Printed wiring techniques may offer many advantages in rapid, reliable, cheap and foolproof construction, and the new plastic potting compounds also offer advantages in protecting sub-units, especially if new lightweight sealing compounds can be developed.

GROUND EQUIPMENT

There are three main classes of ground radar equipment:—

- (1) Fixed permanent ground installations.
- (2) Mobile radar stations.
- (3) Air transportable radar stations.

The trend in the first class is to air-condition the building containing the equipment which will be rack-mounted with drawer type chassis; it will contain built-in test gear and be completely self-contained.

A system which is being developed for Airfield Control Radar uses a removable single plate chassis. These chassis are housed in frameworks in a sealed cabinet in which the bottom framework contains a heat exchanger. This is a true closed air circulating system.

The trend in design for mobile equipments is to air-condition or semi-seal the complete radar equipment in the vehicle. The new Precision Approach Radar (formerly

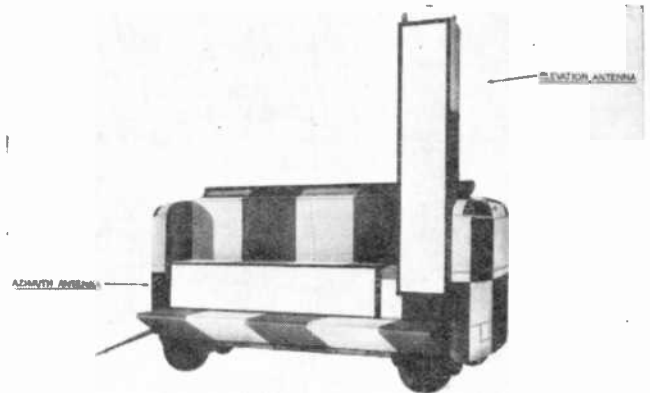

Fig. 9. Precision approach radar vehicle

Ground Controlled Approach) system is shown in Fig. 9; it is being developed with extruded "H" type chassis construction inside the vehicle, which has a system for circulating dry air by raising the air temperature above the dew point, so that condensation is prevented.

The trend in the third class is to use sealed units similar to the airborne radar units. These will be fully paniclimatic, will stand rough handling and can be readily assembled on site. Lightweight folding aerial systems will be used.

The engineering problems associated with aerial systems which it is expected will be used in the future will be increased due to the requirement of obtaining higher aerial resolving powers, which will necessitate much larger aerals than those used at present.

Many of the techniques being developed for airborne equipment may be used in future ground equipments, and the development of printed circuits, potted sub-units, etc., will in the course of time affect the engineering development of future radar systems.

Acknowledgment

Acknowledgment is made to the Chief Scientist, Ministry of Supply, for permission to publish this article.

REFERENCES

1. Inter-Service Specification K.114 : Climatic and Durability Testing of Service Telecommunication Equipment.
2. MORRIS, A. LANGLEY. Small Power Transformers for Aircraft Electrical Equipments. Issue 2. *J.I.E.E.* 96, 3, (1950).

A System of Pulse Code Modulation Using Circulated Pulses

By S. Fedida*, B.Sc., A.C.G.I., A.M.I.E.E.

This article describes a new method' of converting sample pulses representing a certain intelligence into sequences of five on/off pulses which when interpreted as digits in a binary system of units reproduce the original amplitudes of the samples pulses are also outlined.

Two possible methods of solving the reverse problem, i.e., the conversion of sequences of five or more on/off pulses into the original sample within a prescribed tolerance.

THE object of this system, as of all systems of pulse code modulation, is to transform a given varying signal, representing a certain intelligence, into a series of equi-spaced sequences of constant amplitude pulses, conveying the same amount of information within a prescribed tolerance. Each pulse sequence may contain up to a fixed number of pulses, one or more of which may be absent.

These pulses, when interpreted as digits of numbers expressed in the binary system of units, reproduce the original information.

In essence, therefore, a pulse code modulation system comprises at the transmitter end, a sampler followed by a coder and, at the receiving end, a decoder followed by a low-pass filter.

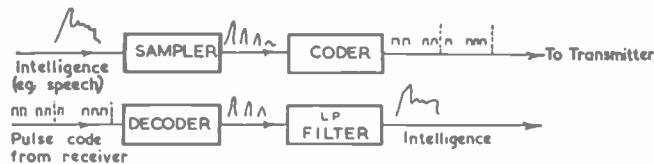

Fig. 1. Block diagram representing the essential parts of a pulse code modulation system

The Sampler

The function of the sampler is to examine the varying signal conveying the intelligence and to send out, at regular intervals of time, a single pulse, the amplitude of which is equal to the amplitude of the varying signal at the moment of sampling. It is known that provided the sampling frequency is equal to or greater than twice the maximum frequency present in the input signal, no information is lost in the process.

The Coder

The samples are supplied to the coder, the function of which is to supply a sequence of constant amplitude pulses for every sample it receives. An incidental but most important function of many coders is that of quantizing. Since the samples received vary in amplitude over an infinite range of values, between a maximum and a minimum, it is necessary to specify a tolerance, which is always greater than the difference between the coded sample and the amplitude of the signal it is meant to represent. In other words, only a finite range of amplitude values can be coded. The greater the range, the faster and more accurate the coder has to be. In this system, the coder as built, can cope with 32 amplitude levels, the lowest level of which is about 1 volt.

* Marconi's Wireless Telegraph Co., Ltd.

In order to represent 32 amplitude levels in a binary system, it is necessary to use sequences of up to five pulses. The amplitude each pulse represents depends on its position with respect to the beginning, or the end, of the sequence.

In this system the first of a sequence of pulses represents an amplitude level of 16, the second an amplitude level of 8, the third 4, the fourth 2 and the fifth 1. It is therefore possible to represent any level from 0 to 31, by choosing the right sequence. Most coders about which published information is available are of one of the following three types:

- (1) Scanning type³
- (2) Subtracting type³
- (3) Counting type.

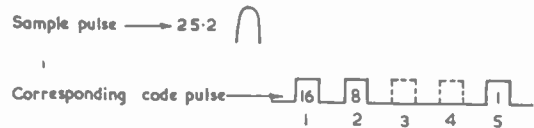

Fig. 2. Pulse sequence corresponding to a sample of amplitude 25.2 units

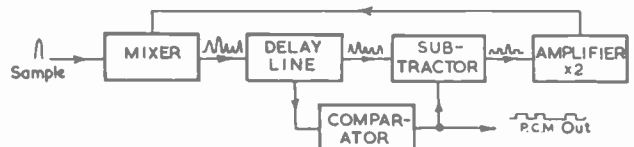

Fig. 3. Block diagram of coder using circulated pulses

This classification corresponds roughly to their respective speeds. Since this coder uses a subtracting method it is necessary to examine what this process involves.

Operation of Subtracting Type of Coder

As soon as a sample pulse is received by the coder, its amplitude is compared to a set level, which represents 16 units. If the sample amplitude is over 16, the coder sends pulse 1 in the sequence, and simultaneously, or very soon afterwards, subtracts 16 units from the sample. If, however, the sample amplitude is under 16, pulse 1 in the sequence is not sent out and no subtraction takes place.

At the end of an interval of time equal to the spacing between two consecutive pulses in a sequence, the sample amplitude, or the remainder of the subtraction of 16 units from it, is compared to another set level, this time representing 8 units. If the pulse is over 8 the coder sends pulse 2 in the sequence and subtracts 8 units, and if the pulse is under 8, pulse 2 in the sequence is not sent out and no subtraction takes place.

This comparison and subtraction process takes place five

times in all, and up to five sequence pulses may be sent for every sample pulse received.

Fig. 2 shows the pulse sequence corresponding to a sample pulse of amplitude 25.2.

The sequence of operations for a sample pulse of level 25.2 is as follows:

Compare 25.2 to 16.	Subtract 16.	Obtain 9.2.
Compare 9.2 to 8.	Subtract 8.	Obtain 1.2.
Compare 1.2 to 4.	No subtraction.	Obtain 1.2.
Compare 1.2 to 2.	No subtraction.	Obtain 1.2.
Compare 1.2 to 1.	Subtract 1.	Obtain 0.2.

The cycle of operations just described, involves the comparison of a pulse amplitude with five different levels, the subtraction of up to five different amplitude values, and, of course, the storage of a pulse between successive inter-rations.

The system to be described simplifies the necessary operations to a very large extent, through the use of only one comparison level and one subtraction level. Storage is replaced by retardation through a delay line.

Operation of Subtracting Coder Using Circulated Pulses

A block diagram of such a coder is shown in Fig. 3. Incoming samples are fed into a mixer and thence to a delay line, the delay of which is approximately equal to the spacing between two sequence pulses.

A tap, about half-way down the delay line, leads the

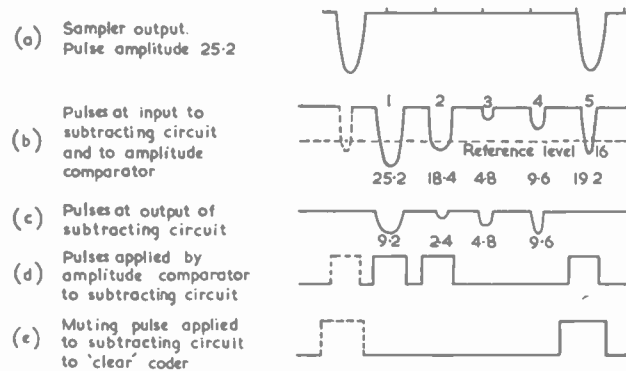

Fig. 4. Sequence of events in various parts of coder

sample to an amplitude comparator, the object of which is to indicate whether the amplitude of the pulse, travelling down the delay line, is larger or smaller than level 16. The indication of the amplitude comparator takes the form of a pulse, which allows the subtractor to subtract an amplitude of 16 from the pulse, emerging out of the delay line. In the absence of a pulse from the comparator, the subtractor has no effect on the delay line output.

The sample pulse, or the result of the subtraction of 16 from it, is fed from the subtractor to an amplifier, with a gain of 2, and thence back to the mixer and the delay line for the above operations to be repeated.

The cycle is at an end when the sample pulse, or one of its residues, arrives at the end of the delay line for the fifth time. At this moment, or preferably a little earlier, a closing or muting pulse is fed to the subtractor, with the object of interrupting the feedback loop until just before the arrival of the next sample.

The complete cycle of operation, when a sample pulse of amplitude 25.2 is fed into the coder, is as follows.

Compare 25.2 to 16.	Subtract 16.	Obtain 9.2.	Multiply by 2.
		Obtain 18.4.	Feedback 18.4.
Compare 18.4 to 16.	Subtract 16.	Obtain 2.4.	Multiply by 2.
		Obtain 4.8.	Feedback 4.8
Compare 4.8 to 16.	No subtraction.	Obtain 4.8.	Multiply by 2.
		Obtain 9.6.	Feedback 9.6
Compare 9.6 to 16.	No subtraction.	Obtain 9.6.	Multiply by 2.
		Obtain 19.2.	Feedback 19.2.
Compare 19.2 to 16.	Subtract 16.	Obtain 3.2.	Interrupt loop.
		Obtain 0.0.	Feedback 0.0.

It is clear that the subtracting pulse, fed by the comparator to the subtractor, coincides with the corresponding sequence pulse and can be supplied to the transmitter through an integrator. Fig. 4 shows the sequence of events, in various parts of the coder, when the latter is analysing sample pulses of amplitude 25.2.

Physical Realization of Coder

It is convenient, for the purpose of synchronization, to

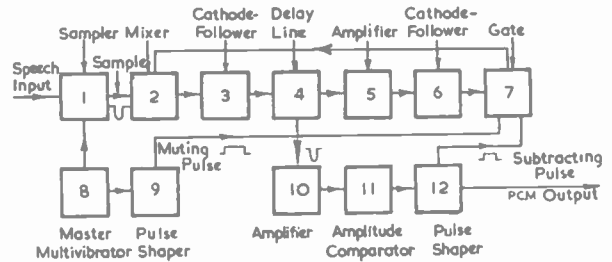

Fig. 5. Detailed block diagram of coder and sampler

incorporate the sampler into the coder and to regulate the whole sequence of events from a common master oscillator or multivibrator.

The block diagram of Fig. 5 includes these two units and shows, in detail, the way in which the basic parts of the coder are interconnected.

A multivibrator (8), the repetition frequency of which is twice the highest frequency present in the input intelligence, feeds the sampler (1) and, at the same time, sends out a muting pulse to gate (7), this causing all residues present at this gate to be shorted out. The sample travels, towards delay line (4), through a mixer and cathode-follower. A tap along the delay line feeds the sample to an amplifier (10), followed by the amplitude comparator (11). This device sends a pulse, through pulse shaper (12), to the gate (7), thus setting it to pass or subtract, as the case may be, before the arrival of the sample. The latter comes out of the delay line and after amplification, by amplifier (5), is applied to gate (7) through a cathode-follower (6). The output of gate (7) is fed back to the mixer and the sample pulse or its residue travels, once again, to the gate and so on, until another muting pulse, originating from (8), through (9), resets the circuit for the reception of the next sample.

The way in which the basic functions of the coder are performed will now be explained in detail.

Subtracting and Muting Circuits

The subtracting, and muting circuits and incidentally the sampler, are variations of a simple diode switch (Fig. 6), the operation of which is as follows:

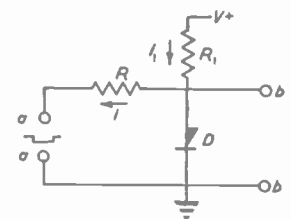

Fig. 6. Basic circuit of diode switch

(a) SHORTING STATE

Let i_1 be the current flowing from the positive potential source V to earth through resistance R_1 and diode D .

$$i_1 = \frac{V}{R_1 + R_f} = V/R_1 \text{ if } R_1 \gg R_f$$

Where R_f is the forward resistance of the diode. The current i_1 , due to a negative pulse voltage v applied at terminals aa , is

$$i_1 \approx v/R \text{ if } R \gg R_f \text{ and } i < i_1$$

Under these circumstances the pulse voltage, appearing at terminals bb , is $v' = vR_f/R$.

This arrangement (Fig. 5) operates as a shorting switch

for pulse voltages less than $V/R/R_1$, at which value diode D cuts off, since $i_1 = i$.

As a shorting switch, the attenuation obtainable is equal to R/R_f (40db for $R = 10k\Omega$, $R_f = 100\Omega$).

(b) NON-SHORTING SWITCH

This switch can be made non-shortening by reducing the positive potential V to zero, in which case the ratio of output to input pulse voltage is

$$\frac{V_b}{V_a} = \frac{R_1 R_2 / (R_1 + R_2)}{R + R_1 R_2 / (R_1 + R_2)} = K.$$

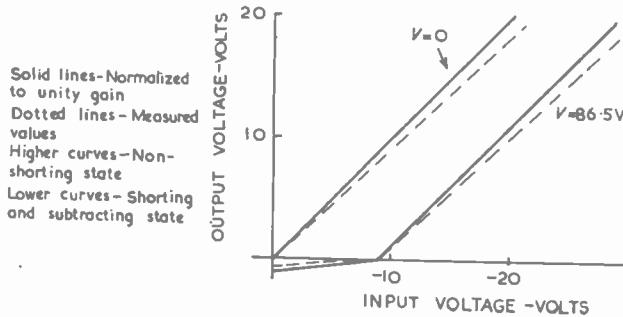

Fig. 7. Static characteristic of diode switch

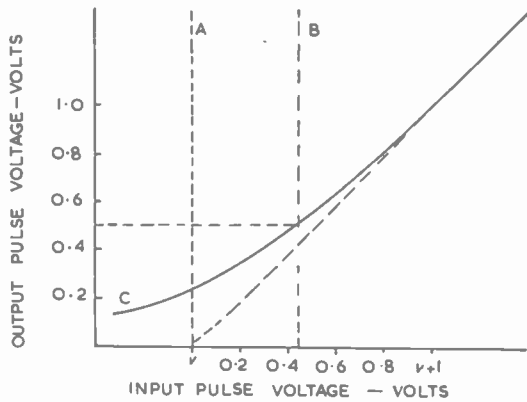

Fig. 8. Dynamic characteristic of diode switch near the cut-off point when set for subtracting

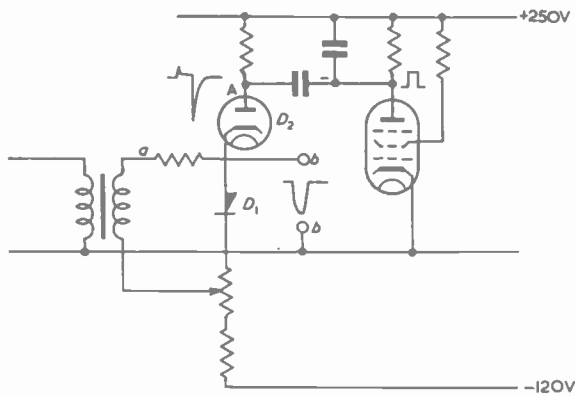

Fig. 9. Circuit diagram of sampler

Where R_2 is the reverse resistance of the diode, usually of the order of $250k\Omega$ for some germanium diodes. It is desirable to make R_1 small compared to R_2 in order to minimize changes in the minimum value of attenuation, with changes in diode reverse resistance.

It is possible, by using a vacuum diode, to make R_2 very large, however, the additional capacitance thus introduced limits the amount of attenuation, when the device is used as a shorting switch, for fast pulses.

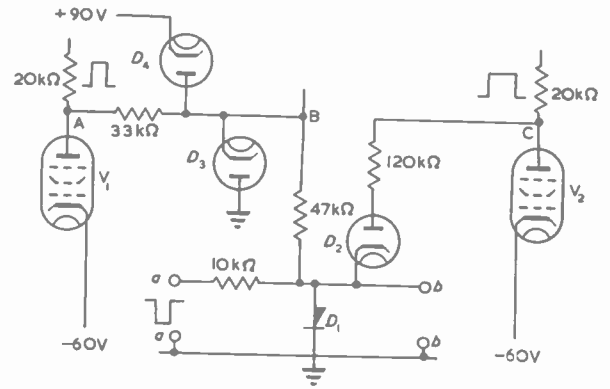

Fig. 10. Circuit diagram of combined subtracting and muting switch

(c) SUBTRACTING SWITCH

If the amplitude v_a of the pulse voltage is increased beyond the value v_0 , at which the diode cuts off, the output voltage v_b is $v_b = (v_a - v_0)K$. The switch is thus able to subtract. It is now evident that it is possible to use this device as a shorting or subtracting switch by setting the positive potential V to a suitable level.

The relation between input and output voltages (D.C.) in the non-shortening, shorting and subtracting conditions is shown in Fig. 7.

The dynamic characteristic of the switch when in the subtracting condition is shown in Fig. 8.

In a coder, where the "quantum" voltage is 1 volt, it is desirable that, for an input voltage of v_0 (v_0 being the reference level), the output of the subtracting circuit should not exceed 0.5 volt and, for an input voltage of $v_0 + 1$, the output voltage should be between 1 and 1.5 volts. It follows that, on the input voltage scale, v_0 should fall between lines A and B. The position of curve C, relative to the input voltage scale, is a function of VR/R_1 ; it is therefore possible to select the correct operating condition by altering the value of VR/R_1 with a tolerance, referred to the input voltage, of approximately 0.4 volt.

Realization of Switch Circuits

(a) SAMPLER (Fig. 9)

This is a normally shorting switch, which becomes non-shortening, at a rate equal to twice the highest modulation frequency and for a duration approximately equal to 0.1 of the repetition period. It follows that voltage V of Fig. 5 is normally high and it is reduced to zero at regular intervals. The positive switching pulse, supplied by the

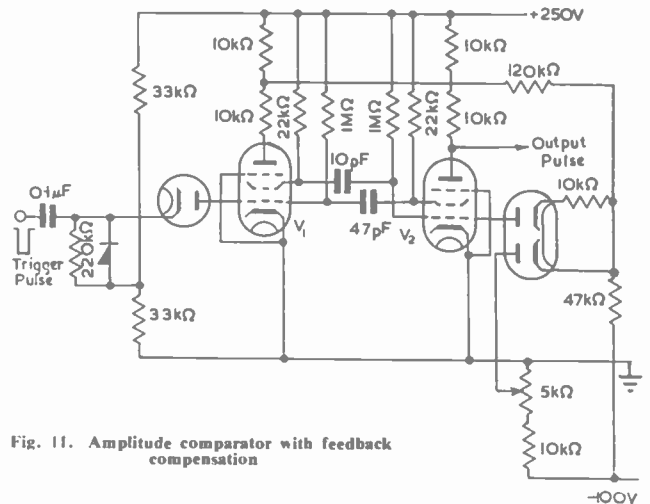

Fig. 11. Amplitude comparator with feedback compensation

pulse generator, is differentiated before reaching point A. The negative swing cuts off diode D_2 and the switch, between a and b, becomes non-shorting. The pulse output, at bb, is proportional to the voltage appearing at "a". The main function of diode D_2 is to prevent a negative "pedestal" voltage from appearing at "b". The positive pedestal voltage is shorted out by diode D_1 . A variable bias can be applied to "a" in order to set the peak of the applied signal to zero level.

(b) SUBTRACTING AND MUTING SWITCH (Fig. 10)

V_1 in Fig. 9 supplies the subtracting pulse to switch D_1 . In the absence of a subtracting pulse, the anode of V_1 is

diode D_2 is cut off and it effectively isolates the source of muting pulse from the subtracting switch.

When the muting pulse occurs, at the end of every coding sequence, diode D_2 conducts and moves the subtracting level of switch D_1 to some value above 31 volts, thus shorting all residues.

The Amplitude Comparator

The function of the amplitude comparator is to compare a signal pulse with a preset level, and to give an indication of whether the signal pulse is larger or smaller than the preset level.

It is also necessary, at least in this coder, that the

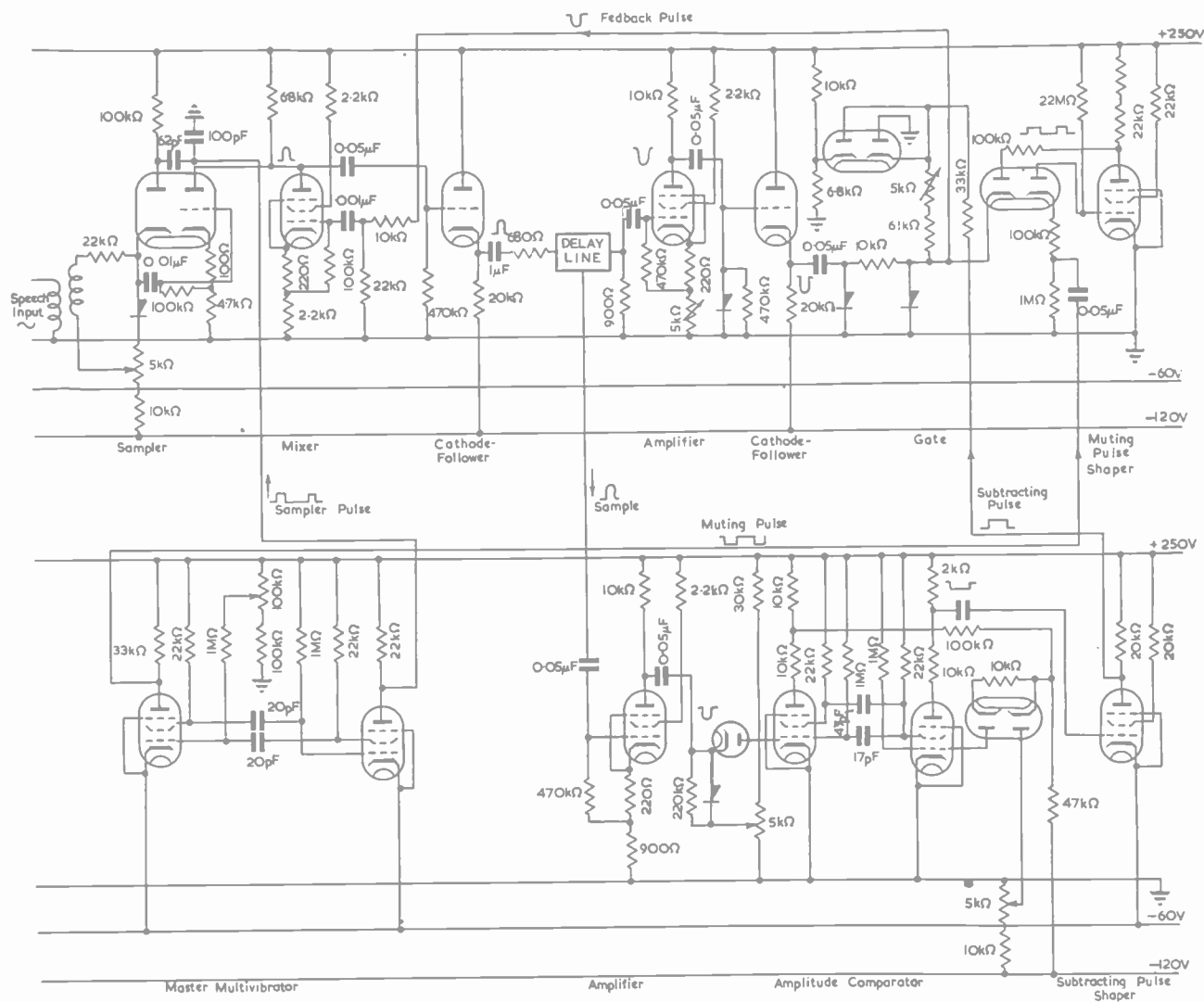

Fig. 12. Circuit diagram of sampler and coder.

below earth potential and point B is kept at earth potential by clamping diode D_3 . The subtracting pulse is positive going at A, and when it occurs the potential of B rises to 90 volts positive, at which point any further rise is prevented by clamping diode D_4 . The switch is now accurately set to the desired subtracting level.

In the present coder the subtracting pulse may occur up to five times in every coding sequence.

The residue of the last subtraction is shorted out by a muting pulse supplied by valve V_2 , the anode C of which is normally at some negative potential. In this condition

indication given by the amplitude comparator shall take the form of a pulse capable of setting the switch, described above, to a subtracting state. It must therefore be of fairly large and constant amplitude, of constant duration and constant delay with respect to the signal pulse. The characteristics of the latter, i.e. its amplitude, width and repetition frequency (when above level 16), are all variable, as can be seen in Fig. 4(b).

The circuit, developed to meet these conditions, is shown in Fig. 11. It consists of a triggered multivibrator, with feedback compensation.

The Delay Line

The function of this part of the circuit is to delay the signal pulse, or the residues, by an interval of time equal to the spacing between two consecutive sequence pulses. In order to keep the size of the line down to reasonable limits, the sample pulse is suitably shaped. The nominal cut-off of the line can be made no greater than five times the fundamental frequency of the sample pulse without producing appreciable ringing and consequent amplitude distortion. Since the sample pulse narrows down at every subtraction it is necessary to raise this cut-off frequency by a considerable amount to avoid coding errors.

Practical Adjustment of Coder

The complete circuit diagram of the coder is given in Fig. 12. For correct operation it is necessary to carry out the following four adjustments.

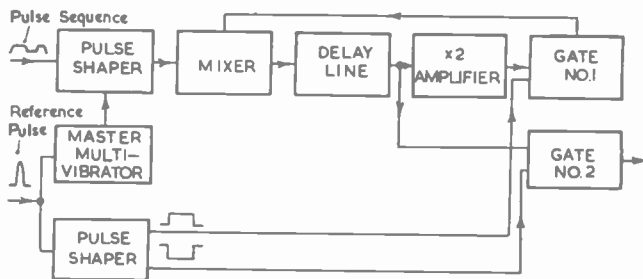

Fig. 13. Block diagram of decoder using circulated pulses.

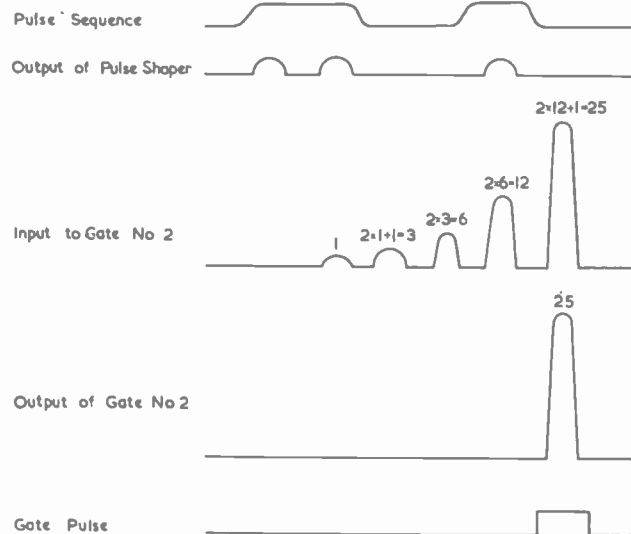

Fig. 14. Pulse waveform in decoder using circulated pulses when reading a pulse sequence representing level 25.

1. SETTING THE TIMING OF MUTING PULSES

If the delay line length is correct the muting pulse cannot help but occur at the right time. However, it is possible to correct for some little error in total delay by an adjustment in the frequency of the master multivibrator. This is set so that the muting pulse falls astride the fifth circulating pulse appearing at the input to the gate.

2. SETTING THE X2 AMPLIFIER

The X2 amplifier has to provide more than 6db of gain as the feedback loop contains some attenuation. To set the amplifier, adjust the bias on the sampler to the equivalent of unit amplitude. When this condition applies, no subtraction takes place except at the end of a sequence. The gain of the amplifier is now adjusted, so that the

pulses, occurring at the input to the gate, are in the ratio of 1 : 2 : 4 : 8 : 16.

3. SETTING THE AMPLITUDE COMPARATOR

Adjust the bias on the sampler so that the first pulse of a sequence appearing at the input to the gate is 16 volts. Set the level control on the comparator so that a subtracting pulse is just produced.

4. SETTING THE SUBTRACTING LEVEL

With the sampler bias at an arbitrary setting, the bias on the subtractor is adjusted to obtain the correct residues after subtraction.

To check the correct operation of the coder, vary the bias on the sampler continuously, when 31 different sequences of five pulses should be obtained at the output.

Decoder

The function of the decoder is to transform a sequence

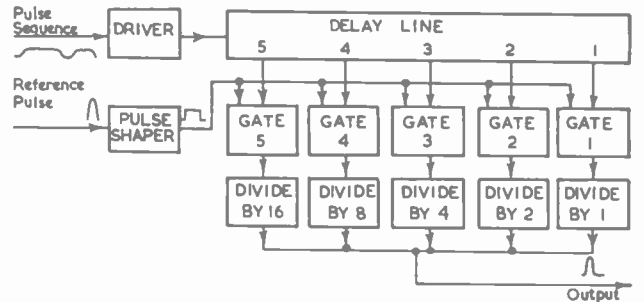

Fig. 15. Block diagram of alternative decoder

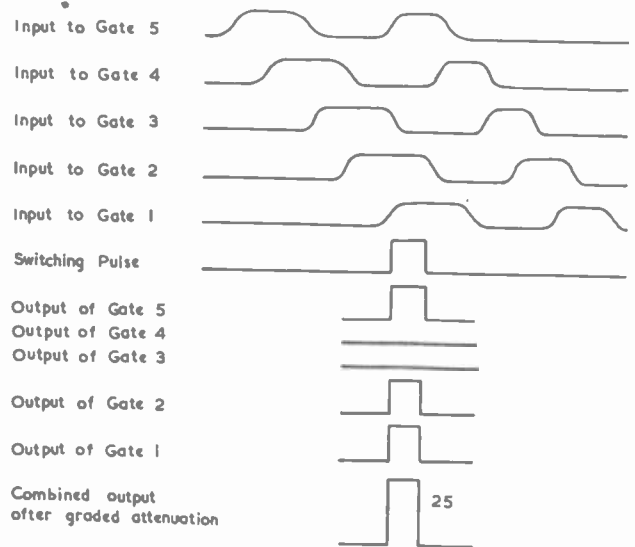

Fig. 16. Waveforms at various parts of alternative decoder when reading a pulse sequence representing 25 units.

of five pulses into the original sample pulse within a prescribed tolerance.

It is possible to operate a decoder on the same principle as the coder in the following way.

The pulse sequence is fed to a pulse shaper, the output of which consists of a single pulse for every pulse in the sequence. The pulse shaper is driven by a master multivibrator, which is itself synchronized by a received reference pulse, which sets the time origin.

The output of the pulse shaper is fed through a mixer to a delay line, the delay of which is equal to the interval between two consecutive sequence pulses. The delay line output is fed to a X2 amplifier, and back to the mixer

through gate (1) and through gate (2) to the output low-pass filter (see block diagram in Fig. 13).

Gate (1) is normally conducting, except for a short interval of time when the reference pulse sets it to a non-conducting state. Gate (2), on the other hand, is normally non-conducting, except for a short interval of time, when the reference pulse sets it to a conducting state.

It can be seen that the first pulse of a sequence goes four times through the X2 amplifier, the second pulse three times, the third twice, the fourth once and the fifth not at all. This process is equivalent to interpreting the pulse sequence in the binary system of units.

Alternative Form of Decoder

Another way of reading the pulse sequence is exemplified by the block diagram of Fig. 15 and the waveforms of Fig. 16. Here the pulse sequence is applied through a driver stage to a delay line, the total delay of which is equal to the time interval between two consecutive sequences. Five outputs are taken from the delay line, the length of time between two adjacent output points being equivalent to

the time interval between two consecutive pulses in a sequence.

When the first sequence pulse arrives at output (1), the second sequence pulse is at output (2) and so on. At this moment the reference pulse is applied through a pulse shaper to gates (1) to (5) simultaneously.

Each gate is such that it supplies a pulse if, and only if, a switching pulse and a sequence pulse are simultaneously applied to it. The gate output pulse is of constant amplitude and duration, since it is a replica of the switching pulse. If all the gate pulses are added together through the graded attenuators shown in the diagram the combined output is a reproduction of the sample pulse.

Acknowledgment

The writer wishes to thank the Chief of Research, Marconi's Wireless Telegraph Co. Ltd., Chelmsford, for permission to publish this paper.

REFERENCES

1. British Patent Application No. 16950 50.
2. MEACHAM, L. A. and PETERSON, E. An Experimental Multi-channel Pulse Code Modulation System of Toll Quality. *B.S.T.J.* (January, 1948).
3. GOODALL, W. M. Telephony by Pulse Code Modulation. *B.S.T.J.* (July, 1947).

Franco-British Joint Television Programme

DURING the period July 8th to July 14th, some seventeen programmes were televised from Paris to London and there distributed over the B.B.C.'s normal network.

This transmission represents the first exchange of programmes between capital cities of Europe and short technical details of the method of transmission are given in the following notes.

PARIS

From the O.B. points in Paris vision signals were conveyed to a receiving point at the Eiffel Tower by radio link. Three 9000Mc/s radio link units were used, manufactured by the Compagnie des Compteurs. The programmes were simultaneously broadcast to French viewers in the Paris Region from the two Radiodiffusion et Télévision Françaises transmitters in Paris, one operating on the 819-line system and the other on the 441-line system (the old French standard). The Radiodiffusion et Télévision Française convertor developed by the French firm Radio Industries was used to convert the 819-line pictures to the 441-line standard.

PARIS-LILLE (136 miles)

The 819-line vision signals were carried by a Radiodiffusion et Télévision Française experimental radio link with intermediate stations at Villers-Cotterets (44 miles north-east of Paris) and Sailly-Saillesel near Peronne (50 miles from Villers-Cotterets and 42 miles from Lille). This radio link works on a frequency of 900Mc/s approximately and was manufactured by Compagnie Française Thomson-Houston. This link is used by Radiodiffusion et Télévision Française to supply programmes to the Lille television transmitter until the permanent radio link now being installed by the French Post Office is ready.

LILLE

The programmes were broadcast from the Radiodiffusion et Télévision Française transmitter at Lille (819 lines) for viewers in that area.

CASSEL

The Lille transmissions on 180Mc/s approximately were picked up at Cassel by a special receiver manufactured by Société Desmet. Radiodiffusion et Télévision Française also installed a temporary radio link working on 9000Mc/s approximately, manufactured by Compagnie des Compteurs. The signals thus received were then fed to the Convertor developed by the BBC Research Department, for changing pictures from French standards to British standards (819-405 lines).

To ensure that the waveform generators at Cassel and Alesbom were synchronized with the British Electricity Supply, a standard 50c/s "tone" derived from the British Grid system was transmitted to France over a Post Office cross channel

telephone circuit and used to synchronize the British equipment. From Cassel onwards, British microwave equipment of a type similar to that used on the Calais relay last year was used.

Work on the installation and testing of the convertor at Cassel and of the temporary links between Cassel and London started on June 19, and this work continued up to the date of the first programme transmission.

Technical responsibility for the camera equipment and for the picking up of programmes in Paris was in the hands of Radiodiffusion et Télévision Française. At various times during the week July 8-14, four different types of camera equipment were used, namely: Pye, Limited—Image Orthicon. Radio Industrie—Image Orthicon and Image Iconoscope. Compagnie Française Thomson-Houston—Photicon.

A more detailed technical description of the equipment will be included in the September issue.



Pulse Brightening Discrimination

By A. L. Whitwell*, A.M.Brit.I.R.E.

A COMMON difficulty experienced in connexion with the use of bridge operated electro-mechanical pick-ups supplied with alternating current is that of detecting or separating the modulation component, which represents the intelligence to be transmitted, from the carrier wave. Initially, two separate modes of operation of the bridge pick-up are possible.

(a) The bridge may be given an initial unbalance, when the variations in output amplitude will correspond to the intelligence to be transmitted and are exactly equivalent to the normal method of amplitude modulation employed in radio transmissions, etc., or

(b) The bridge may be initially balanced to give zero or a minimum output. In this case intelligence corre-

ferred when designing a system for the amplification, detection and oscillographic presentation of the output from carrier operated bridge pick-ups. These are briefly enumerated below:—

(1) For a given carrier peak amplitude, at least twice the modulation amplitude can be accommodated within the operational limits of voltage amplifiers, etc., compared with the initial balance method.

(2) Better definition of the reference zero of the modulation envelope is available.

(3) The effects of amplifier drift, H.T. variations, etc., appear proportional to the strain signal only.

Demodulation

If normal demodulation methods are applied to the signal of method (a) or, by the addition of a fixed reference signal at the demodulator, to method (b), several difficulties present themselves.

Diode detection will be assumed, as this is normally subject to the least degree of distortion in comparison with grid leak, square law, or anode bend detectors. In general,

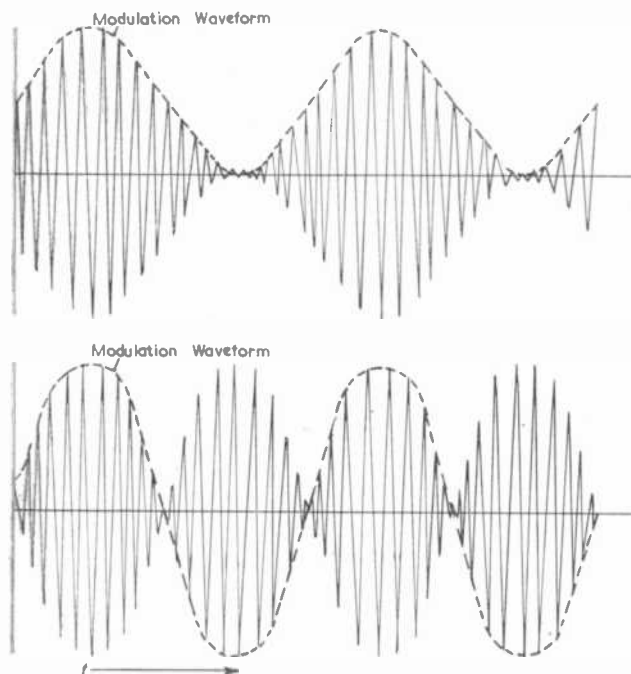

Fig. 1. The two modes of operation of bridge pick-ups

sponding to a positive or negative mechanical disturbance of arbitrary amplitude and sign can only be "translated" accurately as regards sign if the relative phase of the carrier wave can be determined.

The above two methods are illustrated in Fig. 1.

In both the cases shown, the carrier wave is assumed to be modulated by a sine wave having a period T . It will be noticed that the envelope of the waveform shown in Fig. 1(b) is very similar to that of a normal carrier wave, 100 per cent modulated with a sine wave of period $T/2$, and if the modulation were complex it would be impossible to determine the modulation waveform. An example to illustrate this point is given in Fig. 2 which shows very clearly the necessity for phase discrimination in analysing the output from initially balanced bridge pick-ups.

There are several reasons why method (b) is to be pre-

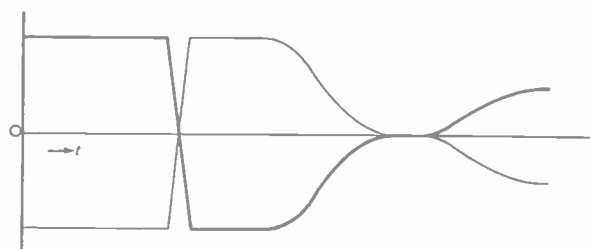

Fig. 2. Illustrating the necessity for phase discrimination

if a sufficiently large input is available the steady state amplitude distortion will be small, even for deeply modulated signals, but in the limit when the modulation approaches 100 per cent some considerable distortion does occur, as would be expected from the fact that 100 per cent modulation entails the periodic reduction of the input voltage to zero and the charge on the capacitor provided with a resistive leak path, necessary for the operation of detecting, reaches zero after only an infinite time. In addition, diode detectors can be a source of distortion if transients are present in the modulated component. At best, the incorporation of a detector in a transducer amplifier-recorder system can only lead to an increase in the amplitude, frequency and phase errors of the whole system, and at worst, when transient disturbances are exceptionally pronounced, the detected output can be seriously unlike the original modulation. The same is also true, of course, of the output from an RC coupled valve amplifier, but it is a comparatively simple matter to apply negative feedback to reduce the transient component of the gain function in this case.

Phase Discrimination

The meaning of the term "discrimination" applied to the oscillographic recording of an amplitude modulated carrier can be defined as the operation of marking, by

* Boulton Paul Aircraft, Ltd.

visual means, the relative phase of the alternate half-cycles of the carrier frequency.

In the absence of a detector, the modulated output of a bridge operated transducer can be amplified and applied to the indicating element of the recording system, with the limitation that the indicator must be able to respond faithfully to the highest frequency component existing in the applied signal. Vibration galvanometers having a uniform frequency response up to one or two kilocycles per second can be used for this purpose, but the system of phase discrimination to be described can only be conveniently applied to the cathode-ray oscillograph, and the following discussion will be confined to this device.

The brightness of the cathode-ray tube trace may be adjusted by variation of the control grid potential; therefore, a convenient method of discrimination is to derive a brightening pulse from one half cycle of the supply to the bridge transducer. This pulse can be made to have any convenient phase relationship to the bridge supply voltage and can be conveniently shaped and modified electronically to have the required duration and amplitude.

In order to achieve simple phase discrimination, the actual phase relationship between the discriminating pulse and the supply waveform is of little importance, provided that it lies within the positive or negative regions of the supply waveform, but a more detailed examination of the application of the pulse discriminating technique points to several advantages which can be obtained by a slight increase in the complexity of the discriminating circuits to provide pulses of very short duration and continuous variation of relative phase. The necessary extensions to the technique are discussed later, but it is convenient at this stage to summarize the chief advantages of phase discrimination with respect to normal demodulation methods, with particular regard to multi-channel recorders.

(a) As already mentioned, a more accurate recording can be obtained.

(b) The elements of the recording system proper are reduced to pick-up, amplifier and indicator, each of which can be designed for very high accuracy and which represent the bare essentials of a recorder.

(c) One discriminator can serve any number of individual recording channels, so that a considerable saving in components is possible. For highest recording accuracy each channel should have the same transmission characteristics, as will be seen later, but for normal purposes a transmission time delay difference between channels of less than a quarter period of the supply frequency can be tolerated. The time delay includes the characteristic lag of the electrical components of the transducer. The permitted tolerance is quite large and proves a comparatively simple condition to meet.

Film Recordings

A very large group of measurements with recorders having several operating channels are made in the low frequency region. Vibration and stress measurements on structures, electro-medical measurements, cyclic machine movements, etc., are all examples of this type of work where the maximum frequency which it is desired to record may not exceed one or two hundred cycles per second, and it is within this region that bridge operated pick-ups and pulse brightening discrimination have their chief use. Bridge operated pick-ups are employed because of their virtually uniform response from zero frequency and hence their ability to reproduce accurately unvarying or static load conditions. At higher operating frequencies self-energized pick-ups can sometimes be used without the necessity of sign discrimination.

While frequency components of the order of 200c/s may exist in the modulation waveform of certain pick-up applications, in very many cases the variations in modulation

frequency occur from zero to perhaps a few tens of cycles per second only; relatively slow film speeds are used for this type of work and the photographic record appears as a modulated band with the component cycles of the carrier indistinguishable from each other. In this case, the discriminating bright spots on the trace appear as a continuous dark line (illustrated in Fig. 3). A relatively high frequency carrier is desirable in order to allow the recording of as wide a frequency band as possible.

If the discriminating pulse amplitude is increased and the general brightness of the trace level is reduced, the record appears identical with that from a normally demodulated carrier-amplifier system, but it is better in practice to use the smallest practicable amount of contrast in order to retain the advantages of peak-to-peak measurements.

It should be noted that at zero force level the record trace amplitude still has a finite value due to the diameter of the cathode-ray tube spot. In order to obtain the maximum accuracy in analysis, a correction to the measured trace amplitude should be made to allow for the spot diameter; this will commonly improve the accuracy of the analysis.

Harmonic Distortion in Bridge Operated Transducers

So far, in this discussion, idealized transducers have

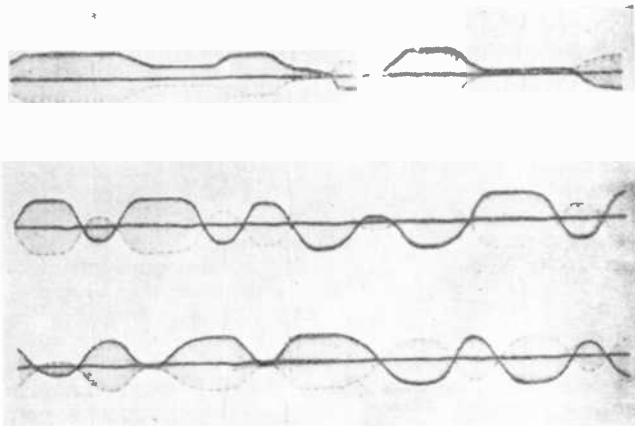

Fig. 3. Typical photographic records

been assumed and the possibility of perfect zero balancing has been implied. In practice, however, it is rarely possible to balance a transducer bridge circuit completely, due to the presence of stray capacitance and inductance, etc. It is a common experience to have a residual composed of quadrature fundamental and second and third harmonics, although it is often possible to eliminate the quadrature fundamental component by attention to the transducer design.

The relative magnitude of the total residuals is of first importance, and it is common practice to reduce it to a level at which it may be neglected in comparison with the maximum range of the transducer, and to include any error in output due to this cause in the specified accuracy of the transducer. In many cases, therefore, transducers are inherently capable of a higher degree of precision than is commonly assumed. Even harmonics supply equal error components at each half cycle of the fundamental frequency, so that peak-to-peak measurements of the carrier wave amplitude eliminate even harmonic errors, provided that the fundamental component is relatively larger than the sum of the even harmonic components. Odd harmonic components of the residual can produce errors in the peak-to-peak measurement, no matter how large the fundamental amplitude may be, although, of

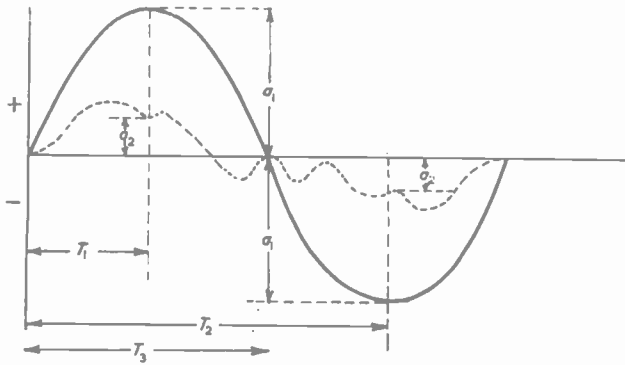

Fig. 4. The effects of harmonic distortion

course, the importance of the error depends on the relative magnitude of the two components. In either case we may assume that it is no longer convenient or sufficiently accurate to make peak-to-peak measurements of the recorded trace when the residuals are large.

Consider the curves shown in Fig. 4. The full line curve represents the fundamental component and the dotted curve the sum of various arbitrary odd harmonic components. T_1 and T_2 represent the instants at which the peak values of the fundamental occur.

It is assumed that pulse discrimination is applied to brighten the trace at time T_1 . When the amplitude of the fundamental component is a_1 , the total amplitude of the combined fundamental and harmonic components at the time T_1 will be equal to $(a_1 \pm a_2)$ in the positive direction and $-(a_1 \pm a_2)$ when the phase of the fundamental is reversed. In other words, the effect of the residual is to move the zero of the trace at the points T_1 and T_2 through the distance a_2 which remains constant.

In order to obtain accurate relative measurements of the fundamental amplitude it is therefore necessary to make a correction for the apparent zero shift represented by a_2 . This can be done with reference to the edge of the recording paper or film by taking a record at zero force level and correcting the trace accordingly, but a more convenient method is to make use of a second discriminating pulse which is arranged to occur at a time T_3 when the amplitude of the composite wave is zero. The transducer circuit can then be adjusted to have an initial unbalance sufficient to offset the zero shift due to the presence of odd harmonic components.

The Discriminator

A schematic diagram, Fig. 5 indicates in block form the application of the foregoing principles to a multi-channel

Fig. 5. Block diagram of six-channel recorder

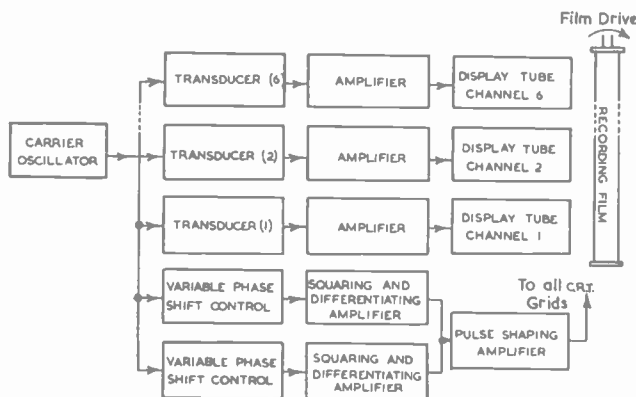

system employing an amplitude modulated carrier wave and cathode-ray oscilloscope displays.

Each channel consists simply of a modulator or transducer, followed by an amplifier and the display tube. Thus, assuming distortionless operation of the various components of the system, the displayed trace on each channel varies with time in exactly the same manner as the output of the modulator.

The discriminator operates in the following manner:

A carrier frequency oscillator which supplies the transducer circuits also feeds to the discriminator unit and by means of pulse shaping and phase adjusting circuits the output of the discriminator is made to consist of a series of pulses of short duration. Two pulses are produced during each period of the carrier waveform. The first pulse can commence after a time delay corresponding to $\frac{1}{4}$ period of the carrier frequency and the second pulse can be generated after a delay of $\frac{1}{2}$ period of the carrier frequency. Variable controls permit the timing of both pulses to be adjusted over a considerable range.

The two pulses from the discriminator are applied to the grids of the display tubes so that the display is brightened momentarily as each pulse arrives.

During each successive carrier frequency oscillation, the

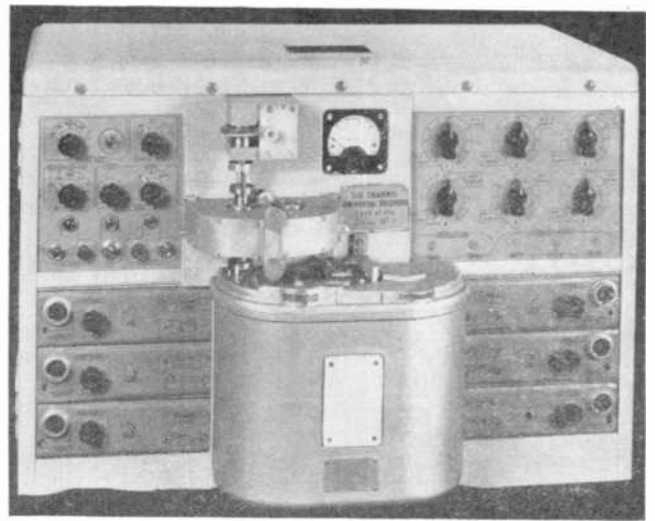

Fig. 6. The six-channel recorder

first pulse (Pulse A) will be reproduced at a controllable time interval with respect to the carrier. Assume the modulator output to be distortion-free in the first instance; it is then obvious that the arrival of Pulse A at the display tube grid can be made to coincide with the peak of the carrier wave and hence a series of bright points will trace out the modulation envelope on one side of the modulated carrier display. As the time delay between Pulses A and B is also variable, this can be arranged to be equivalent to $\frac{1}{4}$ of the carrier frequency period: i.e., pulse B occurs at a time when the carrier amplitude is zero. Hence a second series of bright points on the display occur at zero signal level. As previously explained, however, the latter facility is chiefly useful when unwanted harmonic components are present in the transducer output.

Application

It is necessary to make some reservations regarding the use of the pulse discrimination technique. When various different types of transducer are being used simultaneously with a multi-channel recorder, the relative transmission characteristics will almost certainly differ. In other words, due to the reactive components of the transducer elements,

there will be a phase shift relative to the carrier waveform which may be of noticeable magnitude if the effective output impedance of the transducer is not small compared with the input resistance of the amplifiers. This means that, while there is no difficulty in obtaining sign discrimination with almost any combination of transducers, discrimination against harmonic components will necessitate a more careful choice of transducers. In general it is advisable whenever possible to make use of transducers having the same basic elements, i.e., resistance or inductance, if the full potentialities of the discriminator are to be realized. Alternatively it would be necessary to provide each channel with a separate phase controlling network.

Six-Channel Recorder

A six-channel Recorder incorporating the discriminating technique described above has been developed, and a photograph of the equipment is shown in Fig. 6. The six display channels are self-contained units in trays which accommodate reactive and resistive transducer balance controls; amplifier, cathode-ray display tube, and camera lens. The

units are normally intended for use with 2000c/s carrier type transducers, but alternative designs can be provided if self-generator or D.C. operated transducers are required for special purposes. The display units can be withdrawn rearwards from the Recorder frame for examination or replacement by an alternative unit. Calibration signal levels are selected by controls on the oscillator unit panel and provision is made to allow these reference signals to be injected periodically onto the film recording, or by manual control, before and after a recording sequence.

An electronically derived time marker is available, or the timing marks can be provided by an external source such as a mechanical timing contactor, which may usefully be employed to synchronize the continuous trace Recorder with the operation of an auxiliary control or intermittent recorder, such as the "Automatic Observer" used in aircraft flight data recording.

Acknowledgments

In conclusion the author wishes to tender his acknowledgments to Boulton Paul Aircraft Limited for whom the work described has been carried out.

Peak Signal Monitor Circuits*

In transmitters it is desirable to be able to observe peak signal potentials and for this purpose there is usually provided a simple monitoring circuit having the essential form of a peak voltmeter. A circuit of this type is shown diagrammatically in Fig. 1 and the valve V_1 is a diode rectifier and has a load circuit formed by the load resistor R and shunt capacitor C . Rectified potentials appear across the load resistor and by choosing the time-constant CR to be sufficiently long a practically steady difference of potential is maintained across the rectifier load circuit. This difference of potential is applied between the control grid and cathode of the valve V_2 , which is arranged to operate as a cathode-follower and

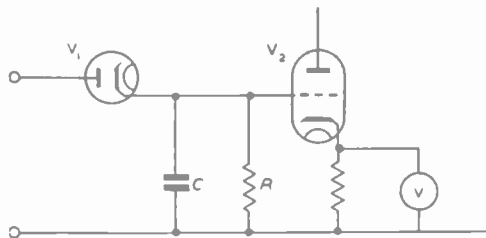

Fig. 1. Basic monitoring circuit

thus repeat substantially unchanged across the meter V , the difference of potential appearing across the load resistor.

When intervals between signal peaks are long the time-constant CR requires to be made correspondingly long, but in some transmitters, such as may be used for pulse radar purposes and for television, it may be found that when an appropriately great value of load circuit time-constant is employed the value of the capacitor C is so great that this capacitor does not become fully charged in the brief period when a signal peak is incident. The difference of potential built up across the resistor R then

falls short of the peak signal amplitude and in consequence the reading of the monitor V is in error.

This difficulty may be overcome by employing two or more peak rectifying circuits in cascade. The first peak rectifying circuit is arranged to have a large time-constant but not so great that the load circuit capacitor cannot be fully charged during the incidence of a signal peak. The fact that the difference of potential across the load resistor of the first rectifier will then decay appreciably before the arrival of the next signal peak is not, however, of consequence on account of the presence of the immediately following peak rectifying circuit. This rectifying circuit,

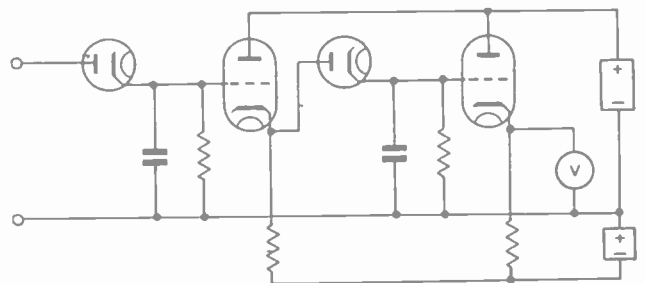

Fig. 2. Practical arrangement of two rectifier circuits in cascade

as will be realized, has fed to it peak signals of relatively long duration and there is accordingly considerable time available for the load circuit capacitor of this rectifier to become fully charged. In many circumstances this capacitor can, therefore, be made adequately large so as to provide a load circuit time-constant that will ensure the maintenance of a practically steady potential across the rectifier load resistor. If, however, the interval between signal peaks is so great that this cannot be achieved then a further rectifier stage (or stages) may be employed.

Fig. 2 shows diagrammatically a practical arrangement in which two rectifier circuits are cascaded, the first rectifier circuit feeding the second rectifier via a cathode-follower stage.

* Communication from E.M.I. Ltd.

A Stable, High Quality, Power Amplifier

By E. J. Miller*, B.Sc.(Eng.)

IT is now well known that for a negative feedback amplifier to be stable, the gain of the amplifier and its feedback loop, or loops, must be controlled far outside the working band of frequencies that the amplifier will encounter.

In many cases, difficulty in designing power amplifiers has been experienced due to the fact that it is far from easy to control the frequency characteristic of an amplifier at frequencies where transformer parameters are the governing factors in the amplifier response.

Requirements for Stability

The requirements for stability in feedback amplifiers have been stated elsewhere¹⁻⁵, but it may be useful to summarize these requirements before proceeding further.

In an amplifier such as Fig. 1, having a single feedback loop, the gain modulus of the amplifier without feedback is μ and the phase shift is θ . The feedback loop has a gain modulus of β and a phase shift ψ . At the point where $\theta + \psi = 360^\circ$, $\mu\beta$ when plotted in the Nyquist diagram must not enclose the point (1,0).

Measuring phase shift is often complicated and it is usual to utilize the relationship between phase shift and attenuation characteristic of networks for design purposes, the attenuation characteristic being somewhat easier to measure. Thus if the product $\mu\beta$ is plotted against frequency a curve results which should have certain definite features if it is to be stable, due allowance being made for manufacturing tolerances and component variation. These features are:

- (i) In the region where $\mu\beta = +9\text{db}$ and $\mu\beta = -9\text{db}$ the rate of attenuation should not exceed 10db/octave (controlled section).
- (ii) After -9db the rate of attenuation can be as rapid as desired, usually determined by the transformer parameters (uncontrolled section).
- (iii) At -9db , the value of $\mu\beta$ should remain constant for a section, the length of which is determined by the rates of attenuation in the controlled and uncontrolled sections (constant gain section).

An ideal cut-off curve for an amplifier at the high frequency end is shown in Curve A Fig. 2. The frequency range of the constant gain section is given by:

$$\frac{f_1}{f_2} = \frac{\text{Slope of controlled section}}{\text{Slope of uncontrolled section}} \dots \dots \dots (1)$$

A similar cut-off curve is to be desired at the bass end but is usually somewhat easier to obtain.

Obtaining the Required Cut-Off Curve

At first sight, it would appear that the output transformer is the limiting factor. However, this is not necessarily true, as will become apparent later. The cut-off rate which is difficult to control is that caused by the leakage reactance and self capacitance of the transformer. In order to make this take effect as high up the frequency band as possible, a high quality transformer having a Mumetal core was tried. This gave results, with β provided by a simple resistive potentiometer, as shown in curve B of Fig. 2.

It will be seen that the response of the amplifier without feedback drops steadily to about 60kc/s, due to the effect

of the valve and other stray capacitances. At this point it experiences a sudden dip, followed by a peak, and then a rapid cut-off. This is caused by the self resonance of the transformer.

The effect of substituting a transformer with a normal Stalloy core is shown in Curve C of Fig. 2. Here the larger core loss effectively damps the peaks in the transformer resonance, while the rapid cut-off is somewhat lowered in the frequency scale by the increased leakage inductance.

Supposing a figure of $+20\text{db}$ is fixed on as the value of $\mu\beta$ in the pass band, this being a typical figure for a push-pull amplifier and the value chosen for the ideal characteristic, then if a pass band extending to 20kc/s is required, a further approximately two octaves will be necessary in

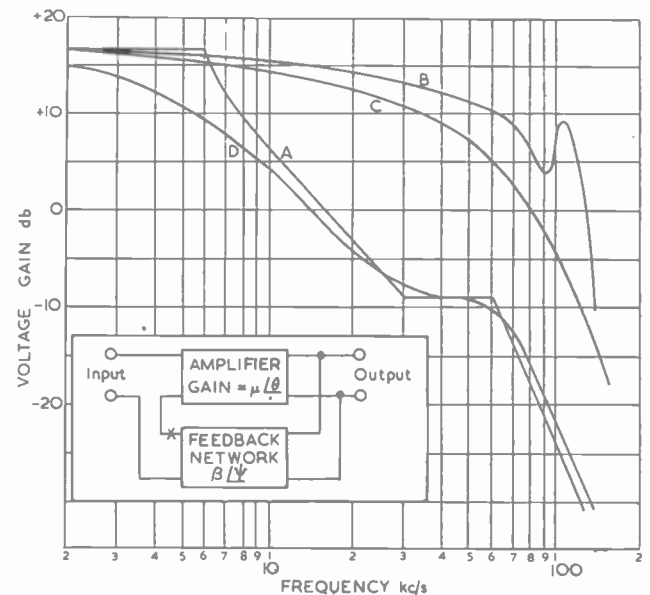

Fig. 1 (Inset). The basic amplifier
Fig. 2. $\mu\beta$ characteristics
A—ideal curve, B—amplifier with mumetal cored output transformer, C—with stalloy core, D—final amplifier.

which to reduce the value of $\mu\beta$ from $+9\text{db}$ to -9db at 10db/octave. This means that the constant gain section cannot begin until about 80kc/s, and then from Equation (1) this section must extend up to about 150kc/s before the uncontrolled section can begin, assuming that the ultimate slope in the uncontrolled section is about 15db/octave. Clearly then, this is a formidable requirement.

Amplifiers have been built which are stable using full feedback over the pass band required. The technique is to use large transformers, well sectioned, and then the response in the $\mu\beta = 0$ region can be held within the 12db/octave slope actually required for stability, omit the constant gain section and hope that the ultimate slope determined by the transformer will not cause the amplifier to be unstable.

It is frequently overlooked that the ultimate slope well below $\mu\beta = 0$ affects the phase shift at $\mu\beta = 0$.

Often this technique is successful, often it is not, and careful manufacture of the output transformer becomes essential. The stability margin is so small that component

* P. O. Research Station.

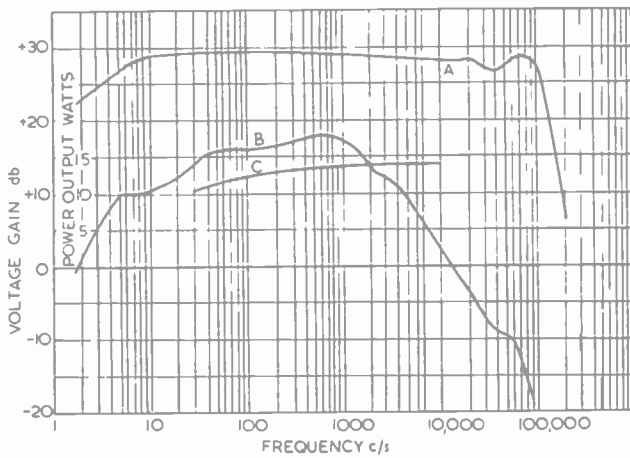

Fig. 3. Amplifier response curves
A—complete amplifier with feedback, B— $\mu\beta$ characteristics, C—power output for 5 per cent total harmonic production.

tolerances, layout variations, and even changes in working signal level, are sufficient to cause instability. As the amplifier in this particular instance was required for quantity production, a rather different technique was adopted.

The Amplifier (Fig. 4)

HIGH FREQUENCY END

As no particular advantage is to be obtained from using an expensive output transformer, a Stalloy cored transformer was used. The technique used here was to reduce the forward gain of the amplifier μ substantially within the pass band, but maintain β constant as a resistance pad only. It will be seen from Curve B of Fig. 3 that $\mu\beta$ is 8db down at 5kc/s compared with the 1kc/s value, and it continues to drop steadily, at no time exceeding 10db/octave, until 30kc/s, where a slight step extends to 60kc/s, after which point the transformer takes control and the ultimate slope is 18db/octave.

This is probably the nearest approximation to the ideal curve which can be obtained with simple circuits. Two resistance capacitance circuits, one across the anode load of the first valve and the other in the grid circuit of the

phase inverting stage, control the cut-off. Their action is complete at 30kc/s, and the capacitor across the bias resistor of the first valve gives the required step.

LOW FREQUENCY

The same technique should be applied at the low frequency end as that used at the high frequency end. However, it was found that at no point did the falling response of the $\mu\beta$ characteristic exceed 6db/octave as far down as was measured, namely 1c/s. There is the possibility that the odd output transformer, or bad out-of-balance of the output valves might maintain the response down to a very low frequency and then provide a rapid cut-off with the attendant instability. To meet this possibility a resistance capacitance network was inserted in each of the grid circuits of the output valves. This reduces the response to 0db by 1c/s.

Results Obtained

It will be seen from Curve A of Fig. 3, when feedback is connected the amplifier has a frequency response that lies within ± 1 db from 10c/s to 20kc/s and within ± 3 db from 4c/s to 100kc/s.

The disadvantage of restricting the forward gain at the high frequency end is that harmonic distortion and output source impedance do not have the beneficial effects that a

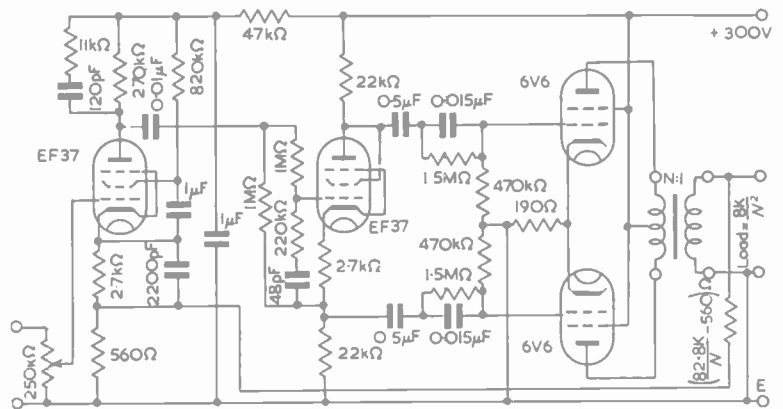

Fig. 4. The complete amplifier

large value of $\mu\beta$ bestows. However, as is evident from the distortion curve, Curve C of Fig. 3, little degradation is suffered in harmonic distortion at the upper frequencies, and full feedback is available at the low frequencies to cope with loudspeaker resonances.

This performance was obtained with a modest output transformer having a Stalloy core $3\frac{1}{2}$ in. by $3\frac{1}{2}$ in. by $1\frac{1}{2}$ in. The transformer is relatively non-critical, since it plays little part in the $\mu\beta$ characteristic until about 60kc/s, and with the large stability margin almost any push-pull output transformer of standard design could be used with confidence. A suitable design for a 15 ohm termination is shown in Fig. 5.

In the amplifier as shown, the calculated phase shift at 15kc/s is where $\mu\beta = 0$ is 125° relative to the pass band. Thus more than 50° phase margin is available at this frequency.

One important constructional point is that the 0.5 μ F coupling capacitor from the anode of the phase inverter stage to grid circuit of the output valve must be of high quality, since any leakage will alter the working point of the output valve.

REFERENCES

1. NYQUIST, H. Regeneration Theorv. *Bell Sys. Tech. J.* 11, 126 (1932).
2. BODE, H. W. Relations between Attenuation and Phase in Feedback Amplifier Design. *Bell Sys. Tech. J.* 19, 421 (1940).
3. TERMAN, F. E. Network Theory, Filters and Equalizers. II, *Proc. I.R.E.* 31, 235 (1943).
4. BLACK, H. S. Stabilised Feedback Amplifiers. *Elect. Eng.* 53, 114, (1934).
5. DUERDOTH, W. T. Some Considerations in the Design of Negative Feedback Amplifiers. *Proc. I.E.E.* 97, III, 138 (1950).

Fig. 5. Winding details of output transformer (15 Ω termination).
Winding 1—1310 turns 34 s.w.g. } enamel and
Winding 2—114 turns 20 s.w.g. } single cupronium
Winding 3—1310 turns 34 s.w.g. } insulation
(The winding in each slot is the same but wound in the opposite direction).

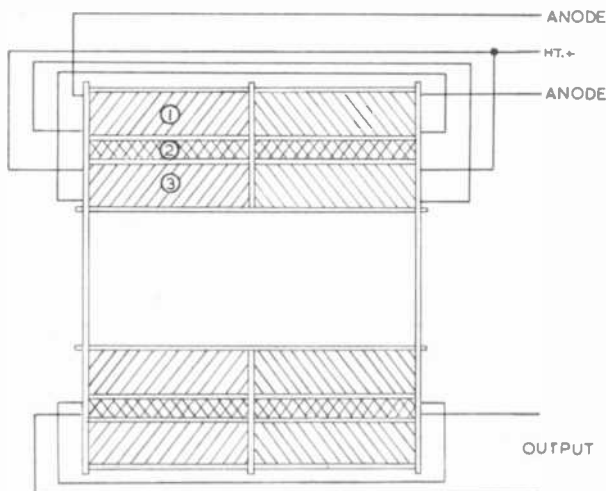

The Analysis and Automatic Recognition of Speech Sounds

By Caldwell P. Smith

ONE of the basic problems in designing a speech analyser system lies in choosing the units of quantity. If the analyser is to dissect the speech signal into the minimum number of elements necessary to indicate the essential meaning of the speech sounds, a possible criterion for designing the structure of the analyser lies in resolving the phonemic structure of speech. An analyser of this type would classify the speech sounds in terms of a catalogue of phonemes*, and ambiguities inherent in phonetic notation, such as the identity of "one" and "won" would offer no particular difficulty as long as the context was sufficient to clarify the true meaning, just as the listener has no difficulty in separating these two meanings in ordinary conversation.

An analyser composed of these phoneme detectors would ideally distinguish all of the features of the speech signal that served to characterize the phonemic structure, and ignore second-order variations that were peculiar to the speaker's age, sex, emotional stress, and other secondary data except as it was necessary or desirable to ascertain these additional facts about the speaker to add to our knowledge of the meaning of what was said. The exact number of phonemes which would suffice to characterize spoken English is open to question; it has been estimated that forty-eight phonemes will serve to categorize most American speech, while thirty-two might adequately describe the primary phonemes as spoken in Chicago.

Something of an enigma is presented when one attempts to construct a set of phoneme detectors, since many of the second-order features of human speech involve greater variations in the acoustical structure of the speech signal than those containing the primary language content. For example, when a child and an adult utter the same words, they generate quite different formant frequencies and fundamental pitch frequencies, making it impossible to set up any universal specification of their speech sounds in terms of absolute frequency spectra of the speech signals.

Many of the speech sounds of a single speaker can be accurately related to the associated frequency spectra, and with sufficient analysis of his voice identities can be established between the phonemes and frequency distributions of his speech signal. A speech analyser was constructed for the purpose of verifying this assumption, and some of its features and results that were obtained will be presented in the subsequent paragraphs. As to the greater problem of devising a machine to accurately classify the speech sounds of any talker in a specified language, regardless of age, sex, emotional stress, and other secondary features, there is evidence to indicate that this may be achieved in a future analyser designed to measure the relative frequency distribution of the speech sounds, automatically adjusting the measure in terms of the length of the speaker's vocal tract. Perhaps such analysers will ultimately serve to type out printed transcriptions as words are spoken into a microphone, leaving stenographers free for more pleasant occupations.

The speech analyser was built around a set of thirty-two filters which served to perform a running frequency analysis of the speech signal. The filters were constructed

of simple single-tuned parallel resonant tuned circuits arranged in contiguous bands from 100 to 7000c/s. In order to achieve precise control of the bandwidth of each selective circuit, the resonant circuits were shunted with variable negative-resistance circuit elements, using the structure illustrated in Fig. 1.

An optimum filter configuration is a primary requisite in the design of an effective speech analyser, and insight into the processes by which speech sounds are generated is helpful in arriving at effective values for the centre frequencies, bandwidths, and number of filters required. The speech generating organs can be likened to an electrical transmission line having changing parameters, excited by an input signal and terminating in a varying load. Using this analogue as a guide, it is convenient to consider the excitation signal and the transmission network separately; the excitation signal is generated by the vibrating vocal chords interrupting the passage of air during phonation,

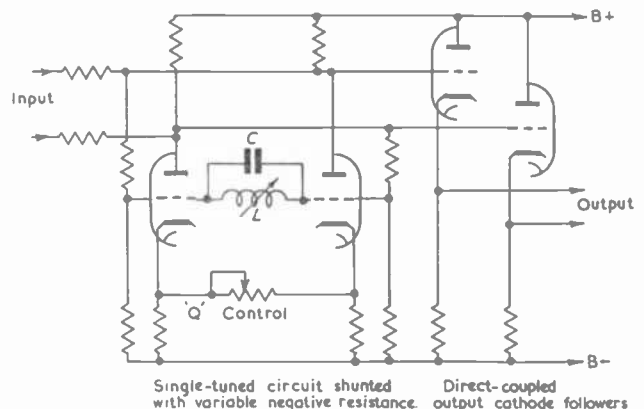

Fig. 1. Variable-Q audio filter

generating the characteristic "buzz" of voiced sounds with the sawtoothed pressure wave caused by the rapid opening and closing of the vocal flaps. This richly harmonic signal acts as an input to the vocal tract during voiced sounds; during unvoiced sounds, the excitation signal is created by a turbulent flow of air through the partially opened vocal flaps, generating a noise-like spectrum having a broad frequency distribution.

The vocal tract cavities are similar to sections of cylindrical resonators, having resonant frequencies and bandwidths determined by the length of the sections, softness of the cavity walls, coupling between sections, input and output terminations, and so on. The peaks of the transmission curve are the resonant frequencies, and generate formants, which have been defined as the frequencies of energy concentration of the speech signal. The broad spectrum generated by the vibrating vocal chords, or larynx, is thus modified to a few frequencies of energy concentration by the resonances of the vocal tract, and these resonances move about in the frequency plane as a result of the speaker altering the parameters of his vocal cavities while talking. Further modification of the sound transmission is imposed by the lips and tongue, which act

* Phoneme: a minimum unit of distinctive sound-feature.

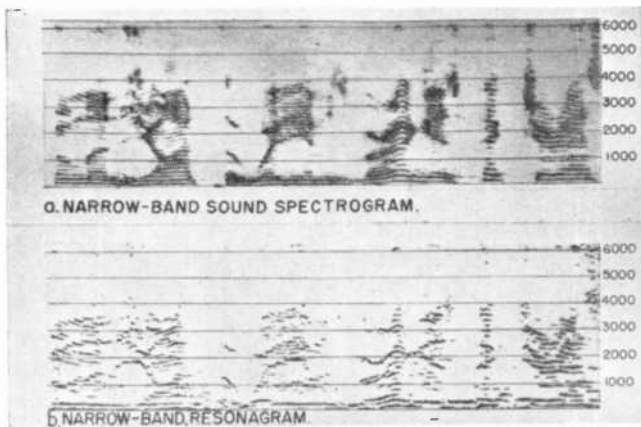

Fig. 2. Comparison of narrow-band spectrogram and resonogram of connected speech

to alter the dimensions, coupling, and termination of the resonant sections.

It is convenient for the purpose of analysis to separate these two functions by which speech is generated, one measurement technique serving to isolate and identify the excitation signal, and another isolating the vocal resonances, or formants, and measuring the frequencies and durations of energy concentrations; these two measures can then be correlated with the particular phonemes that were uttered.

The concept of the complex frequency plane, which has been so successfully applied to studies of network theory by Bode and others, is helpful in arriving at optimum techniques. From this point of view, the speech signal is the composite effect of all of the "poles" and "zeros" of both the excitation signal and the vocal cavities; the principal difference between the two sets is one of decrement. The periodic excitation characterizing the voiced sounds is equivalent to a set of low-decrement poles along the real-frequency axis, while the formant poles lie above the real-frequency axis due to their greater decrement. When a single-tuned filter is used to analyse the speech signal, it is equivalent to introducing another pole in the complex frequency plane, and the output from the filter is proportional to its proximity to the other poles in the system. In order to provide filters which will primarily serve to distinguish formant positions, the set of filters should have the same average decrement, or Q , as the formants. Higher Q (lower decrement) filters which are more selective than this will actually prove a disadvantage, since this is equivalent to moving the filter "poles" closer to the real-frequency axis and thus will tend to resolve the individual

Fig. 3. Comparison of wide-band spectrogram and resonogram of some speech sample as Fig. 2

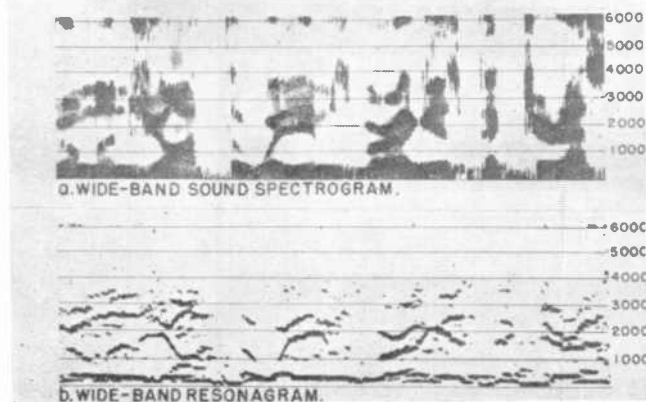

harmonics of the excitation and mask the precise location of the formant centre-frequencies. These considerations are illustrated in Figs. 2 and 3, which demonstrate the analysis obtained with different band-widths of analysing filters.

The formant-analysing filters were adjusted to have bandwidths of approximately 100c/s between 100 and 1000c/s which corresponds to the average bandwidth of formants in this frequency range. Above 1000c/s the filters increase in bandwidth on a logarithmic scale from 1000 to 7000c/s; this arrangement, known as the Koenig scale, is an approximation to frequency intervals containing equal contributions to articulation, and in this sense the speech "information" is on the average nearly evenly distributed among the analysing filters.

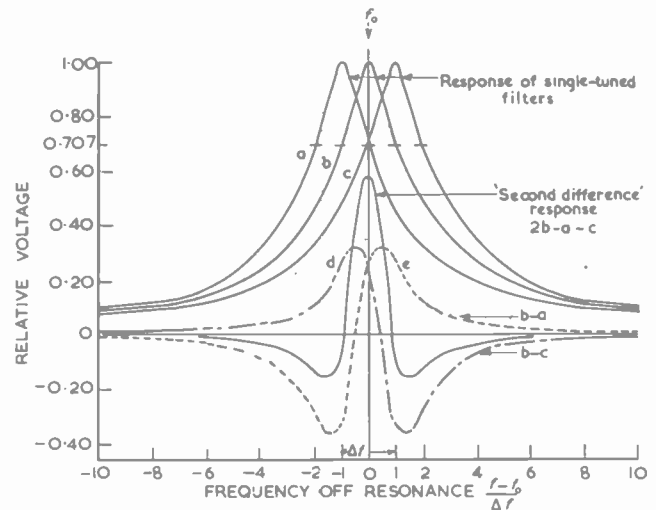

Fig. 4. Frequency characteristic of live or "differencing" filters

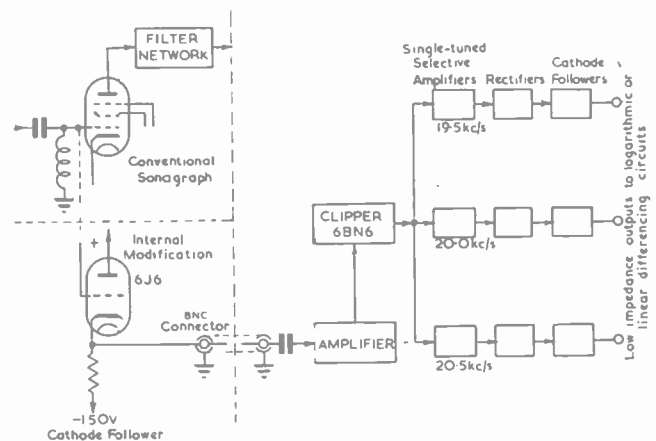

Fig. 5. Resonograph modification of sound spectrograph

Since the filters are single-tuned circuits having relatively low Q 's, this filter configuration would not provide adequate selectivity to resolve formants differing by small frequency increments. In order to improve the selectivity while preserving the benefits of this filter arrangement, a process of differencing is used: the rectified, smoothed outputs from adjacent filters are combined to obtain a signal proportional to the difference between signal levels in adjacent bands. This process is repeated in a second network, in tandem with the first, to produce a signal proportional to the second-difference, which generates the frequency response characteristic illustrated in Fig. 4. This filter arrangement tends to respond to the curvature of the spec-

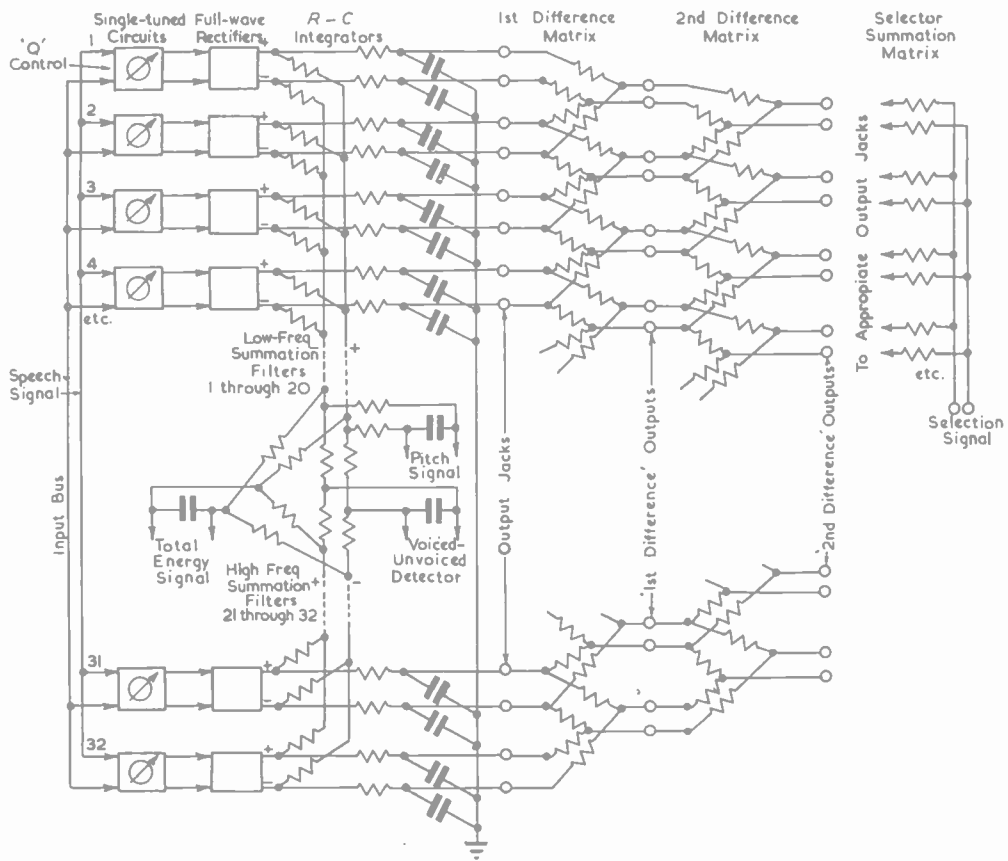
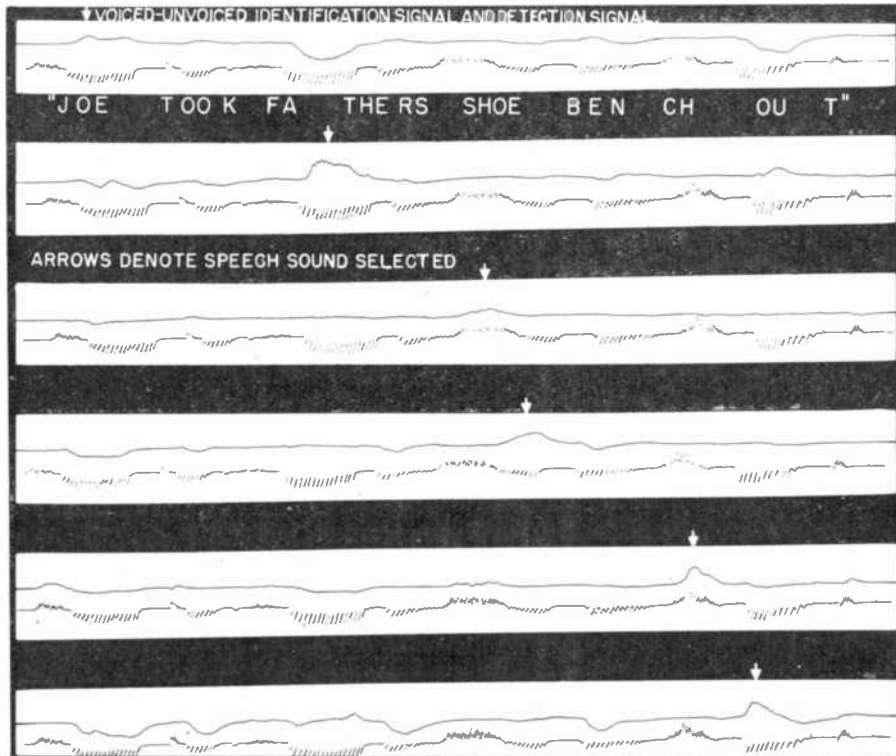

Fig. 6. Speech analyser and detector

Fig. 7. Oscillograms of phoneme detection signals and voiced—unvoiced identification signals. The upper oscillogram of each pair demonstrates phoneme detection by the magnitude of upward deflexion



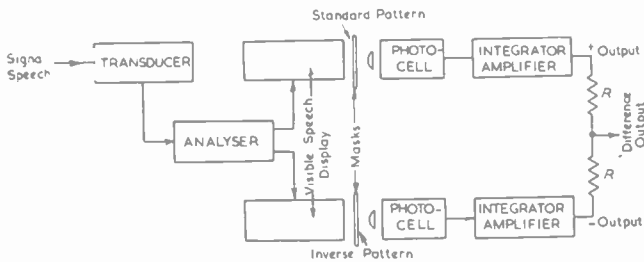

Fig. 8. Device for identifying a visible speech pattern

trum of the input signal over the frequency interval established by the three single-tuned circuits, and hence tends to discriminate against noise and noise-like signals. These considerations, the greater selectivity and the lessened response to noise-like signals makes this arrangement particularly useful for measuring formant frequencies in vowels and vowel-like speech sounds.

This technique of difference filtering was explored by substituting this filter arrangement for the conventional filter arrangement in a sound spectrograph. The details of the modification are illustrated in Fig. 5. Since this method of filtering tends to pick out resonances, the device has been named a Resonagraph and the resulting patterns Resonagrams, some of which are illustrated in Figs. 2 and 3.

The speech analyser system in its entirety is illustrated in Fig. 6. The incoming speech signal is separated into thirty-two signals, proportional to the amount of energy in each of the thirty-two frequency bands. Each filter is followed by full-wave rectifiers, producing separate positive and negative polarity signals of equal amplitude; the differencing consists of simple addition of the positive polarity signal from one filter output to the negative polarity signal from the adjacent filter, in a simple resistance network. Additional resistance networks in tandem with the first generate second-difference signals in the same manner. Differences in time response of the individual filters, due to differences in bandwidths, are equalized in resistance-capacitance smoothing circuits which precede the differencing networks.

Outputs from the full-wave rectifiers are tapped off ahead of the smoothing circuits in two summations, one proportional to the total energy in the low-frequency filters, and the other the total energy in the high frequency filters. These summations serve to identify the excitation signal, that is, to identify the sound as voiced or unvoiced, and extract from the composite speech signal a voltage representing the fundamental pitch of the voiced sounds. The summation of the low-frequency set of filters includes the filter bands below 3000c/s since in general the energy concentrations characterizing the vowel sounds lie below this frequency, while those characterizing the consonant sounds are above this frequency. This is a tentative choice of cross-over frequency based on studies of speech spectrograms, and later experience may provide an optimum crossover frequency.

The voltage generated by the low-frequency summation rises quickly and decays exponentially in synchronism with the fundamental pitch of the speaker's voice. The fundamental pitch signal thus established is independent of the

presence of components of the original speech signal in the frequency range 70 to 300c/s; this is in contrast with conventional techniques for measuring the fundamental pitch, which use a low-pass filter having an upper cut-off frequency between 200 and 300c/s in order to separate the pitch component from the speech signal.

Determination of the voiced or unvoiced character of speech sounds is made by combining the low and high summations with opposite polarity to produce a signal proportional to the difference between energy levels in the upper and lower frequency summation signals. The new signal which is generated in this manner serves to indicate whether the speech signal is voiced or unvoiced by its profile as a function of time: voiced sounds produce characteristic sawtooth-like fluctuation, while unvoiced sounds produce the ragged, irregular fluctuations characteristic of noise. These features are illustrated in the oscillograms of Fig. 7.

An analogue to the process by which particular phonemes are detected is illustrated in Fig. 8. The analogue system again represents a process of differencing, but in this case a reference has been incorporated in the process to serve as a standard with which the incoming signal is compared. Here the degree of similarity between the unknown incoming signal and a standard of reference, which is based on *a priori* knowledge of the statistics of the speaker's voice, is measured by a process of electronic comparison of the image produced by the incoming speech signal, and a reference standard image. The standard-image appears in two forms: a mask or template interposed between the unknown image and a photocell, and an "inverse" mask or template with a photocell. The difference between outputs from the two photocells is measured, and the magnitude and polarity of this signal indicate the degree to which the incoming signal corresponds with the reference pattern. For example, if the incoming signal were a perfect match, one photocell receives full illumination and the other zero illumination; the polarity of the output signal would indicate in this case a "yes" fit, and the magnitude of the signal would indicate "excellent" degree of similarity. A dissimilar phoneme would produce an output signal having polarity and amplitude depending on the degree to which it matched the reference pattern.

In the analogue system, which compares time-frequency-

Fig. 9. The speech analyser and auxiliary equipment

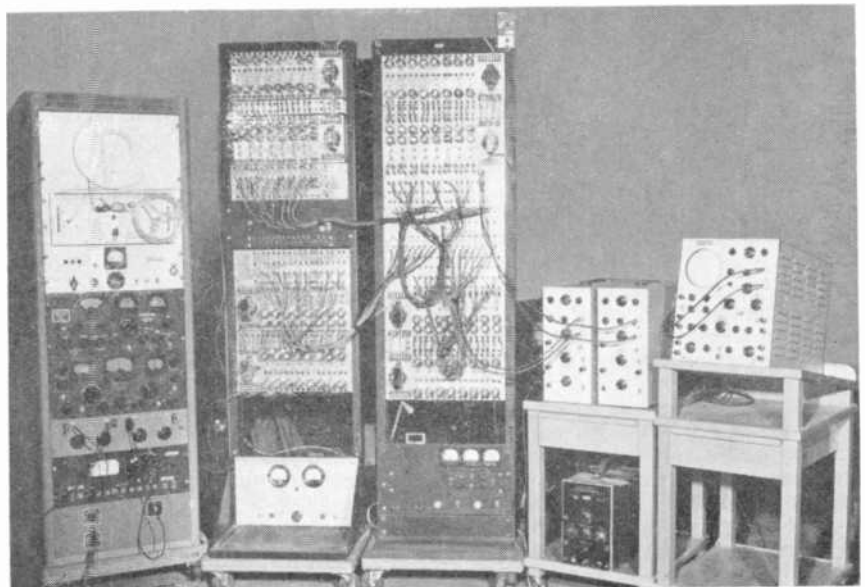

intensity patterns of speech sounds, the machine must decide at what instant in time the comparison shall be made. As an additional complexity, it must normalize the time dimension: the reference pattern must be capable of expansion or contraction along the time axis by some automatic process to compensate for differences in lengths of the spoken sounds. Due to the large variation encountered in lengths of speech sounds, the system which has been presented as an analogue is completely impractical; however, it serves to illustrate the technique actually used in the analyser: standard patterns of reference are established in the form of resistance matrices which sum the output signals from the filter set in various combinations, each combination serving to distinguish a particular phoneme. Each detection matrix performs a comparison of the energy levels in a few critical energy bands, the comparisons having been selected to "detect" the particular distributions of energy among the various filter bands which characterize the various phonemes.

Difficulties caused by variations in length of the various speech sounds are avoided in the present system by the D.C. coupling used in the system of matrices. If a phoneme is sustained, the output voltage is maintained by the corresponding matrix until the sound changes or ceases. The limitation here is one of speed, since the matrices must be capable of detecting the most rapidly spoken phonemes; this limitation in the present analyser is that of the smoothing circuits, which have time-constants of 1/50th second.

In order to automatically recognize words and sentences a set of higher-order matrices are required which are energized from the phoneme matrices, but have the distinction of being time-selective: the sequence as well as the phoneme structure determine selection. An optimum design of matrices for detection of words and sentences would be based on the conditional probabilities involved; circuit-wise this problem is not as difficult as it might seem, since the necessary elements are available in the form of simple resistors, capacitors, and crystal diodes. However, no attempt was made to perform speech recognition at this level in the present analyser system.

The success with which speech sounds were detected from connected speech is illustrated in the oscillograms of Fig. 7. Studies with the experimental analyser were conducted with a single detection matrix controlled with toggle switches for flexibility in selecting and changing the reference patterns. Recognition of the consonant sounds poses greater difficulties than the recognition of

vowels, since the energy concentrations are not as well-defined, and some consonants having similar spectra differ only in duration. In order to provide detection of a complete catalogue of consonant sounds a technique sensitive to duration as well as frequency distribution is required; however, many of the consonants can be detected by the same process as the vowels, by merely shifting the summation to frequency bands in the frequency range between 3000 and 7000c/s. With the large number of output signals available from the present analyser, and the resulting large number of potential permutations and combinations, the system has a resolving power much greater than that necessary to classify ordinary speech; the major limitation is lack of extensive statistical knowledge as to the nature of speech, which would provide a basis for establishing the optimum number and choice of summation matrices.

BIBLIOGRAPHY

- BLOOMFIELD, L. *Language*. (Henry Holt & Co., N.Y.C., 1933.)
 KOENIG, W., DUNN, H. K. and LACY, L. Y. *Sound Spectrograph*. *J. Acous. Soc. Am.* 18, 19 (1946).
 POTTER, R. K., KOPP, G. A. and GREEN, H. C. *Visible Speech*. (D. Van Nostrand Co., N.Y., 1947).
 STEINBERG, J. C. and FRENCH, N. R. *Portrayal of Visible Speech*. *J. Acous. Soc. Am.* 18, 4 (1947).
 CHANG, S. H. *Portrayal of Some Elementary Statistics of Speech Sounds*. *J. Acous. Soc. Am.* 22, 768 (1950).
 STEVENS, K. N. *Autocorrelation Analysis of Speech Sounds*. *J. Acous. Soc. Am.* 22, 769 (1950).
 KRAFT, L. G. *Correlation Function Analysis*. *J. Acous. Soc. Am.* 22, 762 (1950).
 COOPER, F. S. *Spectrum Analysis*. *J. Acous. Soc. Am.* 22, 761 (1950).
 VILBIG, F. *An Apparatus for Speech Compression and Expansion and for Replaying Visible Speech Records*. *J. Acous. Soc. Am.* 22, 754 (1950).
 HALSEY, R. J. and SWAFFIELD, J. *Analysis-Synthesis Telephony with Special Reference to the Vocoder*. *J.I.E.E.*, 95, 391 (1948).
 DUDLEY, H. *The Carrier Nature of Speech*. *B.S.T.J.* XIX, 495 (1940).
 HUGGINS, W. H. *System-Function Analysis of Speech Sounds*. *J. Acous. Soc. Am.* 22, 765 (1950).
 DUNN, H. K. *The Calculation of Vowel Resonances, and an Electrical Vocal Tract*. *J. Acous. Soc. Am.* 22, 740 (1950).
 HUGGINS, W. H. *The Natural Behaviour of Broadband Circuits*. *E.R.L. Report E5013A, U.S.A.F. Cambridge Research Labs.* (Nov., 1948).
 HUGGINS, W. H. *Conjectures Concerning the Analysis and Synthesis of Speech*. *U.S.A.F. Cambridge Research Labs.* (Nov., 1948).
 FANO, R. *The Transmission of Information*. *Tech. Rpt. No. 149, R.L.E., Mass. Inst. of Technology* (Feb., 1950).
 POTTER, R. K. and PETERSON, G. E. *Representation of Vowels and their Movements*. *J. Acous. Soc. Am.* 20, 528 (1948).
 POTTER, R. K. and STEINBERG, J. C. *Towards the Specification of Speech*. *J. Acous. Soc. Am.* 22, 807 (1950).
 FRENCH, N. R. and STEINBERG, J. C. *Factors Affecting the Intelligibility of Speech Sounds*. *J. Acous. Soc. Am.* 19, 90 (1947).
 PANT, G. *On the Normalization of Formant Data, presented at meeting of Acoustical Soc. of Am.* (May, 1951.)

The Design of Wire Wound Resistors

By K. I. Selig, B.Sc., A.M.I.E.E.

THE design of wire wound resistors, though in no way difficult, nevertheless tends to be rather tedious. If large numbers of such resistors have to be designed, it will be worth while to reduce the labour by adopting some simplified design procedure. Krammer¹ recently suggested such a method which goes a long way in reducing the time and effort involved. His method can be further developed so that the design of a wire wound resistor reduces to the reading of a comparatively simple nomogram.

The design is based on the use of cylindrical formers. Table 1 shows all the quantities involved together with their dimensions and representative symbols. Resistors

are designed to have a given power dissipation (p) and a required resistance. The resistance is the product of the resistance per unit length of the wire material and the total length of the wire. For cylindrical formers:

$$L = \frac{\pi Dn}{36} = \pi/36 \times D/d \times l \text{ (yards)} \dots \dots \dots (1)$$

since $n = l/d$ for closely coiled windings.

Hence the total resistance:

$$R = L \times r = \frac{\pi Dlr}{36d} = D \times l \times \left[\frac{\pi r}{36d} \right] \text{ (ohms)} \dots (2)$$

It is seen that the quantity in square brackets, Equation

TABLE 1—SYMBOLS

QUANTITY	SYMBOL	UNITS
Diameter of cylindrical former	<i>D</i>	Inches
Length of former	<i>l</i>	Inches
Power dissipation of former	<i>p</i>	Watts per sq. in.
Diameter of wire	<i>d</i>	Inches
Total length of wire	<i>L</i>	Yards
Number of turns (closely coiled)	<i>n</i>	—
Resistance of wire per unit length	<i>r</i>	Ohms per yard
Resistivity constant	<i>k</i>	Ohms per sq. in.
Total resistance of resistor	<i>R</i>	Ohms
Current through resistor	<i>I</i>	Amperes

TABLE 2—ABBREVIATED WIRE TABLE FOR EUREKA WIRE

S.W.G.	DIAMETER (Inches)	RESISTANCE (Ω/yd.)	RESISTIVITY CONSTANT (<i>k</i>) (Ω/sq. in.)
20	0.036	0.682	1.656
21	0.032	0.863	2.357
22	0.028	1.13	3.527
23	0.024	1.53	5.572
24	0.022	1.83	7.270
25	0.020	2.21	4.658
26	0.018	2.73	13.26
27	0.0164	3.29	17.53
28	0.0148	4.04	23.86
29	0.0136	4.78	30.72
30	0.0124	5.75	40.53
31	0.0116	6.57	49.50
32	0.0108	7.58	61.34
33	0.0100	8.84	77.26
34	0.0092	10.4	98.80
35	0.0084	12.5	130.1
36	0.0076	15.3	176.0
37	0.0068	19.1	245.5
38	0.0060	24.6	358.3
39	0.0052	32.7	549.6
40	0.0048	38.4	699.2

(2), is a characteristic of the wire material varying only with the wire gauge. A constant:

$$k = \frac{\pi r}{36d} \text{ (ohms/sq.in.)} \dots\dots\dots (3)$$

can therefore be added as an additional column in standard wire tables, as shown in Table 2 for Eureka*.

The resistance of a wire closely wound on a cylindrical

former then becomes simply:

$$R = D \times l \times k \text{ (ohms)} \dots\dots\dots (4)$$

The power to be dissipated in the resistor must be equal to (or less than) the permissible wattage loading of the former material multiplied by the surface area of the former. Therefore:

$$p \times \pi D l = I^2 R \text{ (watts) and thus from Equations (3) and (4)}$$

$$k = \pi I^2 / l^2 = R / D l = \pi r / 36 d \dots\dots\dots (5)$$

From these expressions a nomogram can be constructed giving the gauge of wire of a certain resistance material and the $D \times l$ product of the corresponding former to give the required resistance R , provided the current through the resistor I and the permissible wattage loading of the former material are known.

Example

Design a resistor of 750 ohms to carry a current of 1 amp. The power dissipation of the former is to be 50 watts/sq.in.

First draw a line from 50 on the p -scale (extreme left) to the I -scale at 1 amp. This line meets the k -scale (extreme right) at $k = 155$. From this value of k draw a line passing through a value of $R = 750$ ohms on the resistance scales which will intersect the $D \times l$ -scale at a value of 5.7 square inches. In practice it will, of course, be advisable to begin the second line not from the point where the first line intersects the k -scale, but from the nearest point to it corresponding to a convenient wire gauge.

The nomogram can be used for formers of square or indeed arbitrary cross-section if the equivalent diameter of a cylindrical former giving the same length per turn is first calculated,

$$i.e., D = l / \pi \times (\text{length of turn in inches}) \text{ (6)}$$

The resulting product $D \times l$ will give the required length of the former arbitrary cross-section if it is divided by the equivalent diameter D .

REFERENCE

1. KRAMMER, K. *Siemens-Austria Zeitschrift*, 2, 33 (1950).

Chart for the design of wire wound resistors

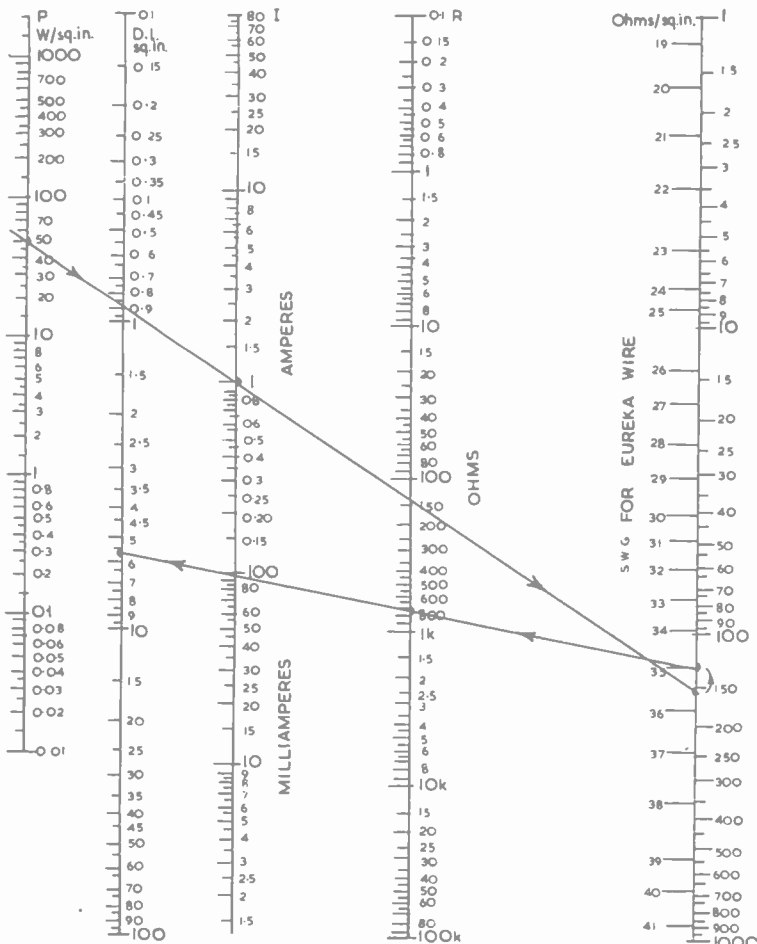

An A.G.C. Amplifier With Constant Output

By A. B. Shone*, B.Eng., A.M.I.E.E.

THE article describes an A.G.C. amplifier which differs from the conventional A.G.C. arrangement in that the delay diode is put before the control amplifier instead of after it. The effect of this alteration is to give a much more rigid control of output level (about ± 0.2 db for change of input of 40db). The normal application of the amplifier is in telegraph work, but in addition it is very suitable for public address and house broadcasting systems, where it is desirable to feed the loudspeakers at a reasonably constant level, irrespective of the wide variations in level of microphone input between different speakers. It can similarly be used to control the modulation depth of communication transmitters.

The general form of a telegraph signal is shown in Fig. 1. These signals are normally sent to line in the form of a

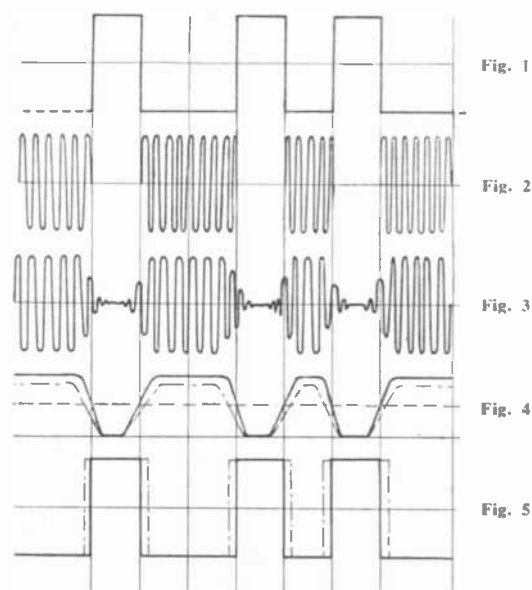

Figs. 1-5. Telegraph converter waveforms

modulated tone as in Fig. 2. In some systems the mark is represented by tone, and the space by no tone. From the point of view of A.G.C. the more convenient system is the one where the mark signal is represented by tone, which is sent to line during quiescent periods, because the level is then automatically correct whenever a signal is sent. In the opposite system there is an inevitable time-lag on the receipt of the first signal while the A.G.C. adjusts itself, which must result in distortion. The amplifier described is therefore for use with "tone-mark" systems.

In order to economize in lines it is usually desirable to limit the frequency band of a telegraph circuit as much as possible; the width used by most systems varies from ± 80 cycles to ± 200 cycles. The higher frequencies of the envelope are therefore removed and the resulting signals received

are as in Fig. 3. When these are detected the envelope will be as in Fig. 4 and if this envelope is fed into a suitable relay biased at the point indicated by the dotted line in Fig. 4 the signals will be correct as shown in Fig. 5. If, however, the peak amplitude of the envelope in Fig. 3 which is passed to the relay is not twice the bias of the relay but is, for instance, as indicated by the chain dotted curve, then the signals out of the relay will be distorted as shown chain dotted in Fig. 5. It is clear therefore that to obtain a high degree of accuracy in a telegraph system where the signals are transmitted over narrow channels it is most desirable that the signal level as supplied to the relay shall be constant and of the correct value. This can be accomplished by regular adjustments of level throughout the system or by the use of a suitable amplifier to keep the

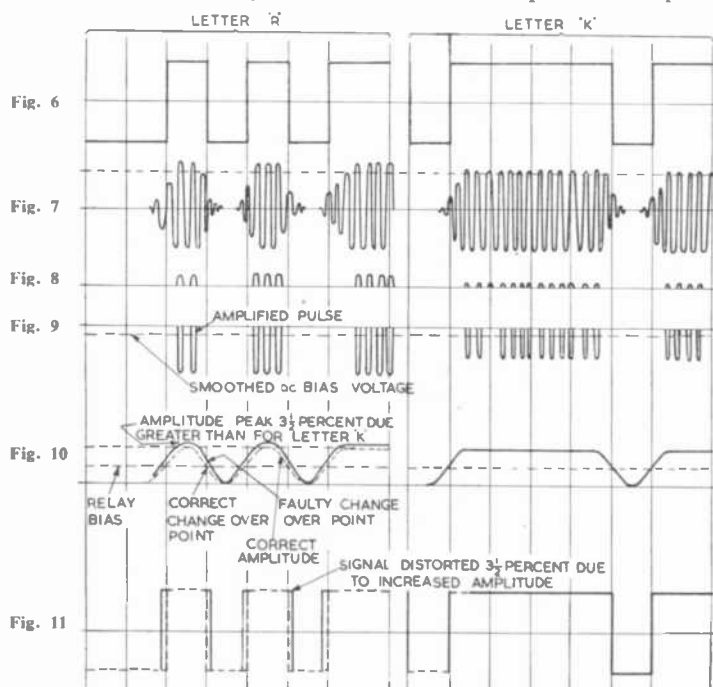

Figs. 6-11. Telegraph converter waveforms

signal to the desired degree of constancy.

The detection of the telegraph signal and the relay output are not described in this article since they follow conventional practice and introduce negligible distortion when, as in this case, the amplifier accurately controls the level. It is however worth noting in passing that by using the same voltage source to supply the D.C. clamp voltage in the amplifier as provides the D.C. bias to the detector relay (dotted line Fig. 4) the conditions for accurate conversion of the telegraph signal set out above are maintained regardless of voltage changes due to mains fluctuations.

For the above purpose the amplifier described below was developed. This amplifier maintains the peak output constant to within ± 0.2 db.

While the amplifier was designed primarily for use in telegraph circuits with time-constants chosen for that pur-

* B.B.C. Engineering Division.

pose, it has nevertheless been found very useful for a number of other purposes. It can, for instance, be used to control speech level. It would, of course, never be used for this purpose in conjunction with broadcast or high quality speech transmission. It can, however, be used in control circuits or talk-back circuits and in this application the distortion introduced is less than might be expected from the circuit. It may be used in talk-back circuits between a film or television studio where the producer due to excitability or remoteness from the microphone may produce microphone outputs of widely varying levels; in such a case the function of the variable gain of the amplifier is to adjust the level until all the speech peaks have a constant value. These may then be fed into the loudspeakers or headphones associated with the talk-back equipment without risk of damaging the former or causing distress to the listeners using the latter. Similarly the amplifier can be used in house broadcast systems where it is desirable to have a reasonably constant level into the power amplifier system in spite of inevitably wide variations in level due to different announcers using the system. In a further application it has been put into service in speech communication transmitters, where it is desirable to maintain the highest possible level of modulation consistent with clarity. In these three latter applications the audible distortion introduced is slight and is more than offset by the freedom from distortion due to blasting of loudspeakers, overloading of amplifiers and over-modulation of transmitters.

Description of Amplifier

The circuit diagram of the amplifier used in the telegraph application and, with slight alteration of time-constants in the subsidiary applications given above, is as shown in Fig. 12. V_1 is the variable gain valve through which the signal passes in the normal way, the signal input being on the grid and the output from the anode. In addition to the signal output which is fed into a transformer of suitable ratio to load the valve, the anode also feeds the first diode of V_2 , which is put in a high impedance circuit in order that it may place a negligible load on V_1 , the cathode of this diode being held at a constant positive potential relative to its anode. The diode conducts only if the peak a.c. voltage supplied to the cathode exceeds the d.c. bias. During the periods that the diode is conducting the difference between these two voltages is fed to the control amplifier valve V_3 , which, after amplification, feeds the signal to the second diode of V_2 , which rectifies it and passes the d.c. component back to V_1 , in the form of a bias which is approximately equal to the gain of the control amplifier multiplied by the difference between the peak signal voltage at the output of the variable gain valve and the clamp bias. By way of illustration suppose that the clamp bias is set to 10 volts and that the gain of V_3 is 100, and suppose the gain of V_1 varies from 100 at 5 volts bias to unity at 40 volts bias. Then it will be seen that the amplifier is working in a position having 5 volts bias when the peaks of signal fed to the grid of V_3 are approximately 0.05 volts, which occurs when the signal out of V_1 is 10.05 volts peak. In this condition the gain of V_1 , being 100 it is clear that the input voltage is 0.1005 volts, and the output voltage 10.05 volts. In the second condition when the V_1 is operating with a bias of 40 volts the voltage peaks into V_3 must be approximately 0.4 of a volt, and therefore the signal peaks

on the output of V_1 must be 10.4 volts. In this case V_1 has unity gain so its input will also be 10.4 volts. It is seen therefore that the input has varied over a range of 40db for a change in output of only 0.35db.

It is clear that the level to which the output is held is controlled by the clamping voltage fed to the cathode of the first diode, and this can be adjusted to any desired value by means of a potentiometer; the accuracy, however, to which the output is held to this preset value is a function only of the gain of the control valve V_3 , which could if necessary be more than one valve, though for normal applications the gain of one valve is quite adequate.

The direction in which the first diode conducts is on negative peaks in the circuit shown in Fig. 12 but could equally well be on positive peaks if the bias voltage were fed to the anode instead of the cathode. On telegraph signals there is a slight advantage gained by amplifying the negative peaks. The time-constants in Fig. 12 have also been designed for optimum performance as a telegraph amplifier, i.e., the bias builds up very quickly on any incoming peak of signal which exceeds the clamp voltage but has a relatively long decay.

Although the amplifier holds the output much more

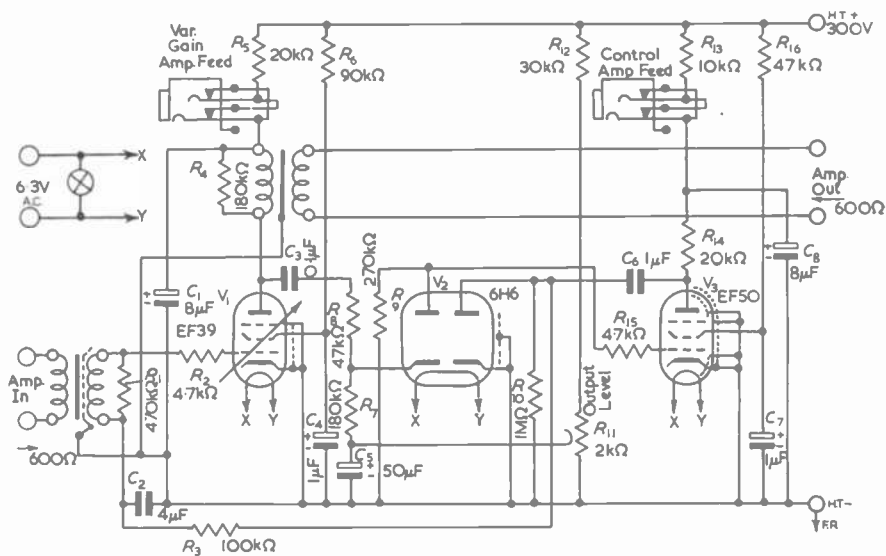

Fig. 12. Auto gain amplifier

constant than the usual A.G.C. circuits, its output level must nevertheless vary very slightly with the type of signal being amplified. If the d.c. and tone envelopes of two typical letters are as in Figs. 6 and 7, the voltage which "splashes over" the voltage clamp to the control amplifier will be as in Fig. 8 (the two letters depicted are "R" and "K"). After amplification and rectification these voltage peaks charge up the capacitor which supplies the bias to the amplifier. Clearly the charge supplied to the capacitor will be slightly different in the two cases, for the letter "K" splashes over more often than the letter "R", which must therefore be greater in amplitude than the letter "K" in order that the total charge flowing to the capacitor will be the same in both cases. This is shown in Figs. 8 and 9. It will be seen from these figures that the change in output level due to the various types of letter being amplified will become increasingly small as the gain of the A.G.C. amplifier is increased. It could in fact be made virtually negligible by having infinite gain in the A.G.C. amplifier. In practice we limit the gain of the A.G.C. amplifier to the maximum gain of one valve, e.g., about 50db, in which case the variation in output level due to the two extreme types of signal should not exceed 0.1db when the signal incoming

level is low. When the incoming signal level is high there is, of course, a very high bias on the amplifier, of the order of 20V, and the charge therefore supplied to the capacitor by the A.G.C. amplifier is a maximum so that the errors due to various types of signal are also at a maximum. However, even then the error due to this cause should not exceed 0.3db between the extreme types of signal. There is therefore no justification for increasing the gain of the control amplifier beyond the maximum obtainable with one valve. This represents a variation of levels supplied to the detector by approximately $3\frac{1}{2}$ per cent which, as will be seen on Figs. 10 and 11, will cause a maximum error of $3\frac{1}{2}$ per cent in the converted signal. This is an extreme case, and in practice the distortion should be well below this figure. In any case this is very much less than other telegraph amplifiers known to the author when working under comparable conditions.

For use in speech circuits such as public address systems and the like, the time-constants can be adjusted to different values where desirable, but in many applications the time-constants shown seem quite suitable. It will be appreciated that it is difficult to test the amplifiers performance on speech. If fed with tone the action of the circuit always to maintain constant output, and therefore the overall characteristic when tested merely exhibits the characteristic of the output transformer. Furthermore, as the action of the circuit is such that it always endeavours to obtain a constant output voltage irrespective of the impedance into which the transformer is working, it gives rise to the apparent effect of having zero output impedance. This is of course fallacious, and in fact the amplifying valve must be correctly loaded to obtain the optimum results. If it is desired to measure the characteristic of the circuit, this must be done either by

replacing the automatic bias by a fixed bias, or alternatively by inserting two tones, one of greater amplitude which effectively clamps the gain of the amplifier and one of lesser amplitude which is measured at the output by means of a selective detector and varied in frequency thus giving the true frequency characteristic of the amplifier. Measurements such as these under steady tone conditions do not give very much information concerning the action of the amplifier under the transient conditions of speech. The only method of obtaining a clear picture under these conditions is by means of oscillograms. These are particularly difficult to interpret, and in practice the best method is to judge the circuit under practical conditions when the improvement resulting from its ability to control output peaks at a constant level often far outweighs the relatively slight harmonic distortion introduced.

Conclusions

Several of these amplifiers have been working satisfactorily in telegraph circuits over a period of twelve months. When the amplifiers were introduced the system in which they are incorporated was changed from "tone-space" to "tone-mark". There has been a consequent reduction in distortion and at the same time a considerable saving in the man hours previously spent in checking telegraph levels throughout the system.

In addition a form of this amplifier has been used in producers talk-back systems very successfully. The circuit has only recently been incorporated as a modulation control in a communication transmitter, but it would appear to have considerable scope in this role particularly in service equipment operated by non-skilled personnel.

An Add-on Counter

At this year's Physical Society Exhibition a commercial Add-on Counter was demonstrated making use of the new Dekatron tubes. The counter is illustrated in Fig. 1 and makes use of cold cathode tubes throughout. It consists of a combined supply and input unit, and up to five plug-in decade units which may be added, if required. The power unit takes only 20mA from the mains and provides various voltages for the decade units. A push button enables all the dekatrons to re-set to "0". The connections to the first counter tube are wired through sockets into which is plugged a small network unit which provides the

GTE175M, and a dekatron counter GC10B, with the associated resistors and capacitors, and a multi-way output socket. A simple catch locks the unit solidly together.

The operation of the device follows the approved lines of using decade dekatron scalars. The output pulse from the preceding dekatron tube triggers the cold cathode tetrode which is used in a self-quenching drive circuit to impulse the associated dekatron tube.

With the power supply shown the capacity is five units, but with a suitably larger power supply there is no limit

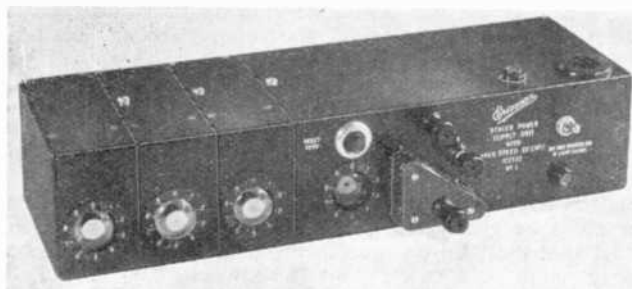

Fig. 1. The Add-on counter

necessary delayed pulse. Networks are available for 60V sine waves and 100V negative rectangular pulses which can have a recurrence rate from 0 to 2000p.p.s. In addition a 100V negative supply terminal is provided for use when counting the closures of contacts.

The Add-on unit with its cover removed is shown in Fig. 2. It consists of a multi-way input plug, a trigger tube

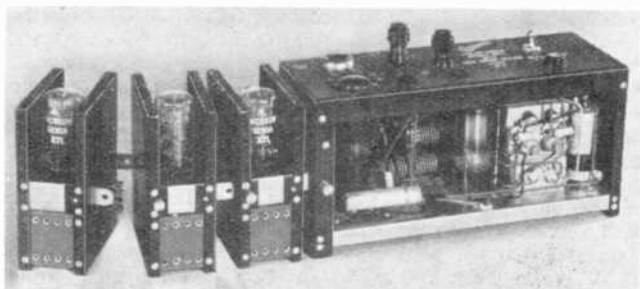

Fig. 2. The Add-on counter with cover removed

to the number of decade units which can be used. The indication of count is by a spot of bright orange light which can be viewed over a wide range.

This unit, which was shown with a number of other devices, such as an Atomic Energy scaler, interval timer, etc., is now being marketed by Ericsson Telephones, Limited, Beeston.

Chart for Determining Acceleration from Vibrational Frequency and Amplitude

By A. E. Maine

The chart is arranged so that the acceleration in g or in./sec² units appropriate to a given frequency and amplitude of vibration may be readily found. In order to cover the frequency range up to 10kc/s without employing scale factors, the basic nomogram is duplicated about a common central line carrying two scales. The right-hand side of the chart is used in the range 1.0 to 100c/s, and the left-hand side for frequencies between 100c/s and 10kc/s.

In use, it is only necessary to lay a straightedge between the desired frequency on the central scale, and the amplitude point on the appropriate outer scale, and then read off the value of acceleration at the intersection with the "mid-way" scale.

Example: (1)

A turbine blade vibrates with a peak amplitude of .001in. at 1.5kc/s, what is its acceleration?

Using the left-hand side of the chart, the answer appears on the left-hand "mid-way" scale at the intersection with the straightedge, viz., 230g or 8.9×10^4 in./sec².

Example: (2)

A part of a mechanism vibrates at 22c/s with an amplitude of 0.1in. what is its acceleration?

Using the right-hand side of the chart, the value is 4.9g or 1.9×10^3 in./sec².

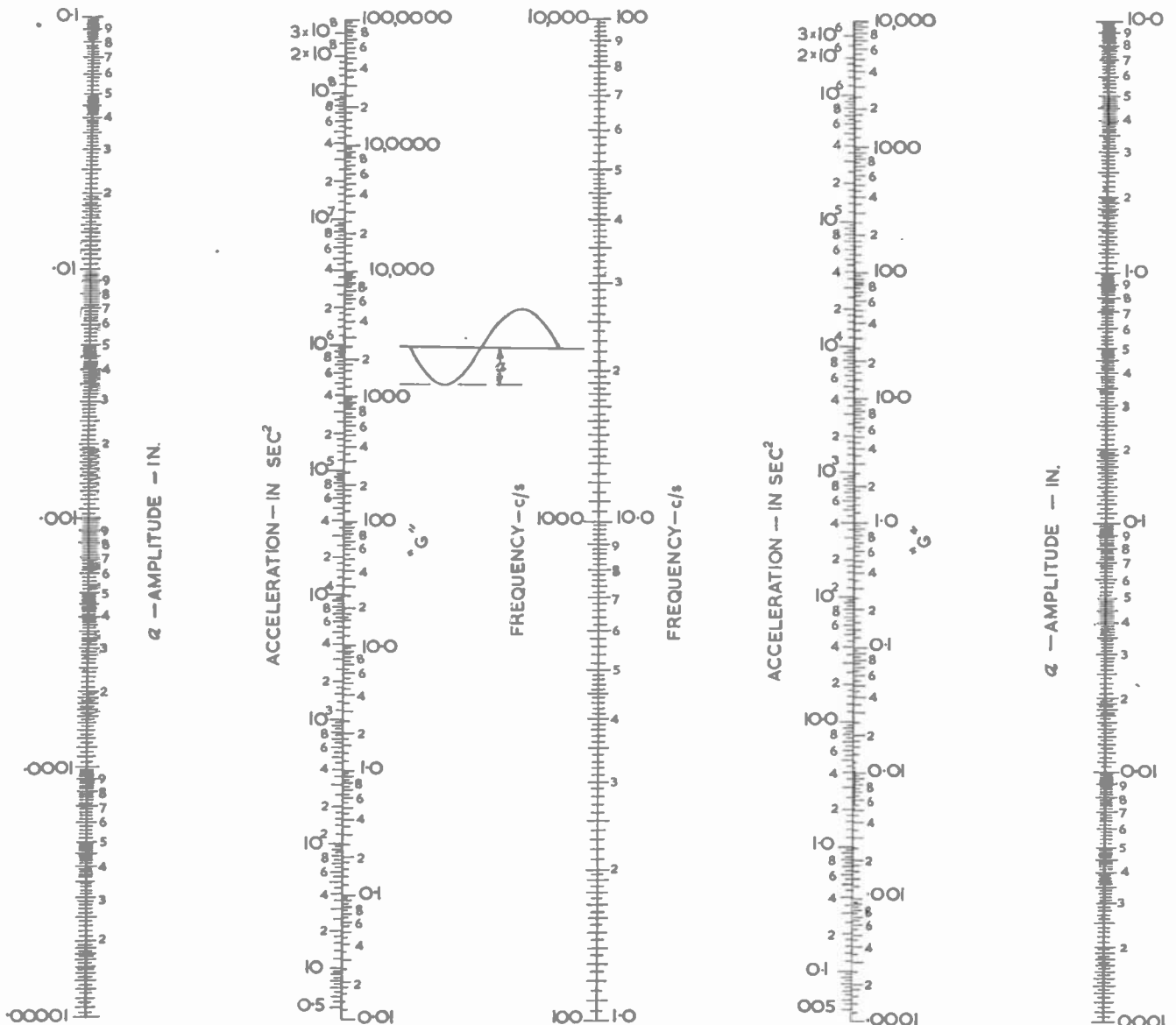

Television I.F. Characteristics

Their Effect on Pulse Response

By C. Evans*

RECENT experience of pulse testing television sets in quantity have clearly shown the effect of the I.F. characteristics on the pulse response and the critical effect of even small deviations from the optimum curve shape.

Pulse testing of television receivers has the advantage that an estimate of picture definition and distortion can be made in the early stages of production and that variable video compensating circuits can be easily adjusted. It is also useful in indicating the nature of the fault in those sets having a bad pulse response.

The pulse test consists of injecting a square wave modulated R.F. into the aerial and viewing the detected video wave form on a C.R.O. either before or after the video stage.

The square pulse appearing at the vision detector will have transient distortions of a nature dependent on the shape of the I.F. characteristics and which may be minimized by a suitable choice of I.F. curve. The distorted pulse consists of an exponentially rising wave-front with superimposed oscillations that can vary in frequency, magnitude and decrement, and the distortion will appear

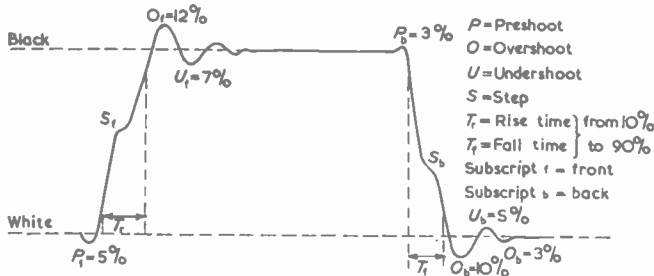

Fig. 1. An exaggerated pulse showing some distortions that can occur and giving pulse rotation

on the picture tube as a loss of definition and the addition of bright and dark shadow lines. The distorted pulse of Fig. 1 represents a black bar on a white background. The overshoots beyond the white line will appear as highlights and the back undershoot will create a dark shadow. The front overshoot extending below the black line may interfere with the synchronizing pulses.

The greatest part of transient distortion is due to the I.F. curve having a sharp attenuation on either side, at sound channel 3.5Mc/s above carrier and at the adjacent sound channel 1.5Mc/s below carrier. Both these frequencies should be about 35db below carrier frequency. For reasonable picture definition the response at carrier +2.5Mc/s should not be much below the carrier response.

Various frequency characteristics to meet these requirements have been investigated, several of which are shown in Fig. 2, together with their video or added sideband response and their distortion of a pulse viewed at the vision detector.

Given the I.F. characteristic it is possible to calculate its effect on a pulse, but it is more convenient to estimate the effect quickly, if approximately, and some general rules may be summarized briefly as follows.

The magnitude of the ringing produced is a function of the slope of the curve at carrier plus about 2.8Mc/s that is, where it starts its steep cut-off. It is largely independent

of the shape of the curve at other frequencies, but will depend to some extent on the total bandwidth of the circuits. The frequency of ringing is usually between 2.5Mc/s and 3.5Mc/s, and is roughly equal to the high frequency peak, or where there is no peak, the start of the high frequency cut-off, plus about 0.5Mc/s. A sharp change in the sideband response will produce a step in the rise of the pulse and approximately, for a definite change in sideband response,

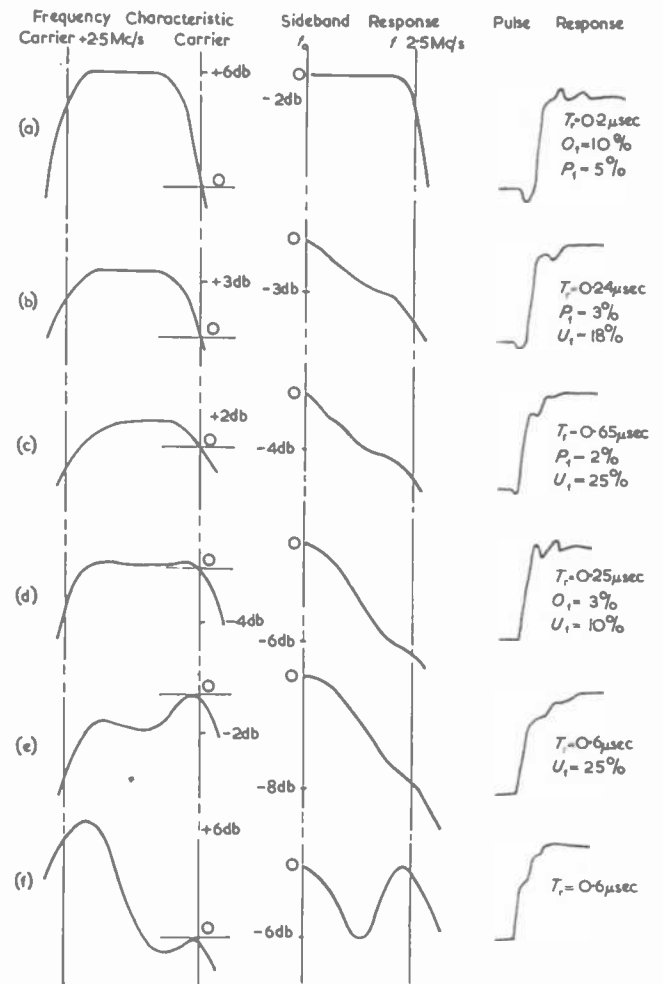

Fig. 2. Various frequency characteristics and their video response

$$\text{step height (db below top of pulse)} = \frac{\text{change level (db below zero)}}{2.5}$$

A second step if present will occur t_n after the first, where $1/t_n = f_n$ = the peak in the sideband response.

When the carrier is asymmetric to the lower peak of the frequency response as may be the case with single sideband reception, then a preshoot will be produced caused by the excessive phase lag of the low frequency components of the pulse causing an envelope delay. The

* Formerly E. K. Cole Ltd.

amount of preshoot is dependent on the slope of the curve at carrier frequency. As most of the pulse energy is contained in frequencies quite close to the carrier, the degree of symmetry required to prevent preshoot is small, about $\pm 0.25\text{Mc/s}$, requiring the carrier to be situated either at a peak or at a flat part of the characteristic. The rise time, of course, is dependent on the high frequency response. Irregularities in the i.f. characteristic and video response produce related irregularities in the pulse response and hence all curves should be as smooth as possible.

Curve (a) of Fig. 2 is designed to give a video response

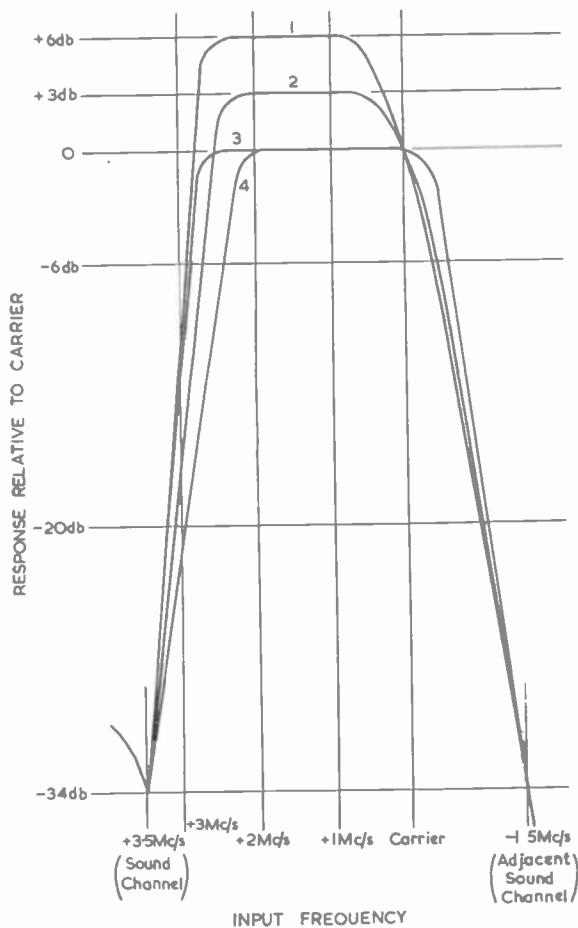

Fig. 3. Response Curves worth practical consideration

1. Good definition but some high frequency ringing.
2. Optimum compromise between 1 and 3.
3. Very little distortion but rise time not so good.
4. Curve for fringe area working.

flat up to at least 2Mc/s , falling smoothly away at higher frequencies. The rather large asymmetry of the carrier, however, produces a noticeable preshoot. It is preferable to avoid large preshoots as they are practically impossible to compensate in the video stage and might, in certain circumstances, interfere with the synchronizing pulses. Preshoot is reduced in (b) and the ringing is less because of the reduced high frequency slope. Rise time, however, is increased. Both preshoot and ringing are small in (c) but the step in the sideband response curve produces a step in the pulse. In the remaining characteristics the carrier crosses at a peak and there is no preshoot. Lack of high frequency response causes a long rise time in (d) and (e), and in (f), which has a good response at 2.5Mc/s , an awkward step is caused in the pulse.

Steps produced by the i.f. circuits are difficult to compensate simply and critical adjustment of the video stage is required. Given this condition, however, curve (f) has

been used very satisfactorily, but it has the disadvantage of being difficult to produce, especially with generator alignment.

In general, however, peaky response curves should be avoided because they are much more liable to variation than a flat response and their variations are much more noticeable on pulse response.

The curves worth practical consideration are shown in Fig. 3. Within the limitations of the required characteristics it is practically impossible to obtain a distortion-

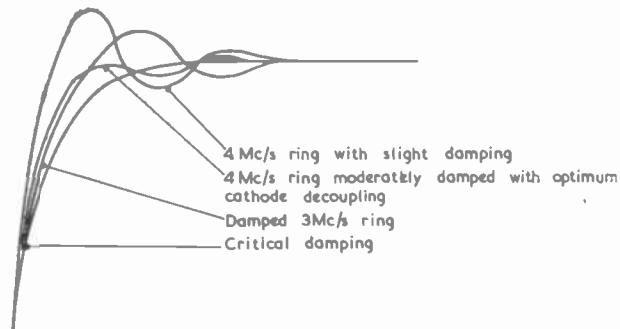

Fig. 4. Wave-front distortions produced by simple video stage

less pulse, but one has at least a choice of distortions. It is seen that the final choice is very much a matter of opinion and depends upon the capabilities of the video stage.

The most satisfactory characteristic is probably (2) of Fig. 3. It is easy to produce and to compensate, it has insufficient preshoot to be troublesome and has a moderately good rise time. For consistent results the curve shape should not vary by more than $\pm \frac{1}{2}\text{db}$ from that specified.

It might be said that a good pulse response of the i.f. circuits is of importance only because it leads to simplification of the video stage. The variable factors of the video stage are the ringing of the anode circuits and the feedback to the cathode, and they may be adjusted to produce wave-fronts as in Fig. 4. The video response should be roughly complementary to that of the i.f. circuits. Thus a high frequency ring with moderate damping would compensate a stepped pulse while critical damping would compensate for a large overshoot.

If the pulsed R.F. input to the set is of such recurrence and polarity that a black vertical band appears on the picture tube, then a direct and useful comparison may be made between pulse shape and resultant picture. A practical procedure is to use a fixed video anode circuit designed to give best results with the specified i.f. characteristic and a variable cathode by-pass capacitor which is adjusted on each set to give minimum overall ringing with rapid rise time. Some overshoot is desirable to sharpen fine picture detail, but it becomes too noticeable when it exceeds 8 per cent. A second overshoot is more noticeable and should not be more than 4 per cent. Undershoot, which is more easily seen, should be less than 3 per cent. In fringe areas where it is desirable to cut the high frequency response to avoid noise, additional overshoot in the video stage is useful to sharpen the picture detail. Fig. 5 shows a typical compensated pulse viewed at the cathode of the picture tube.

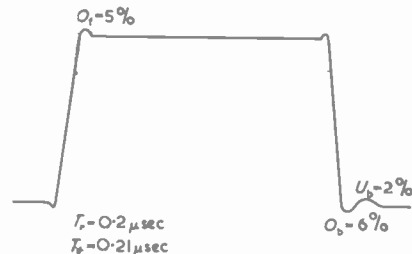

Fig. 5. A typical correctly compensated pulse as seen at the cathode of the C.R.T.

An Electronic Time-Base and Stimulator Unit

and an Electro-mechanical Beam Switching Unit for use in

Physiological Demonstrations

By W. T. Catton,* M.Sc.

THE units described are used in conjunction with an amplifier and cathode-ray oscilloscope, for class demonstrations of muscle and nerve action potentials synchronized with the time-base. The object of the design was to achieve maximum facilities with the simplest circuits and construction. Each unit is enclosed in a sheet metal box 12in \times 8in \times 8in and is easily portable.

The external power supplies required are:—

- Approximately 450V 50mA unregulated H.T.
- Approximately 300V 30mV regulated H.T.
- 6V 5A L.T.

The Time-base Stimulator Unit

This provides a nearly linear push-pull time-base, con-

of 100k Ω are essential. The negative-going sawtooth on the anode of V_1 is differentiated to give positive pulses coincident with the start of each sweep; a by-pass diode is not necessary as very little negative swing is developed by the relatively slow descent of the sawtooth. These positive-pulses trigger two flip-flop oscillators each having a variable pulse-width control. The anode output of each flip-flop is differentiated, the positive-going pulses being by-passed by a diode in each case, and the negative-going pulses being passed to the output amplifiers (6SN7). The flip-flop pulse-width controls, R_3, R_4 , act as independent pulse delay controls. The amplifier input grid potentiometers, R_5, R_6 , provide independent pulse amplitude controls. The outputs from the final

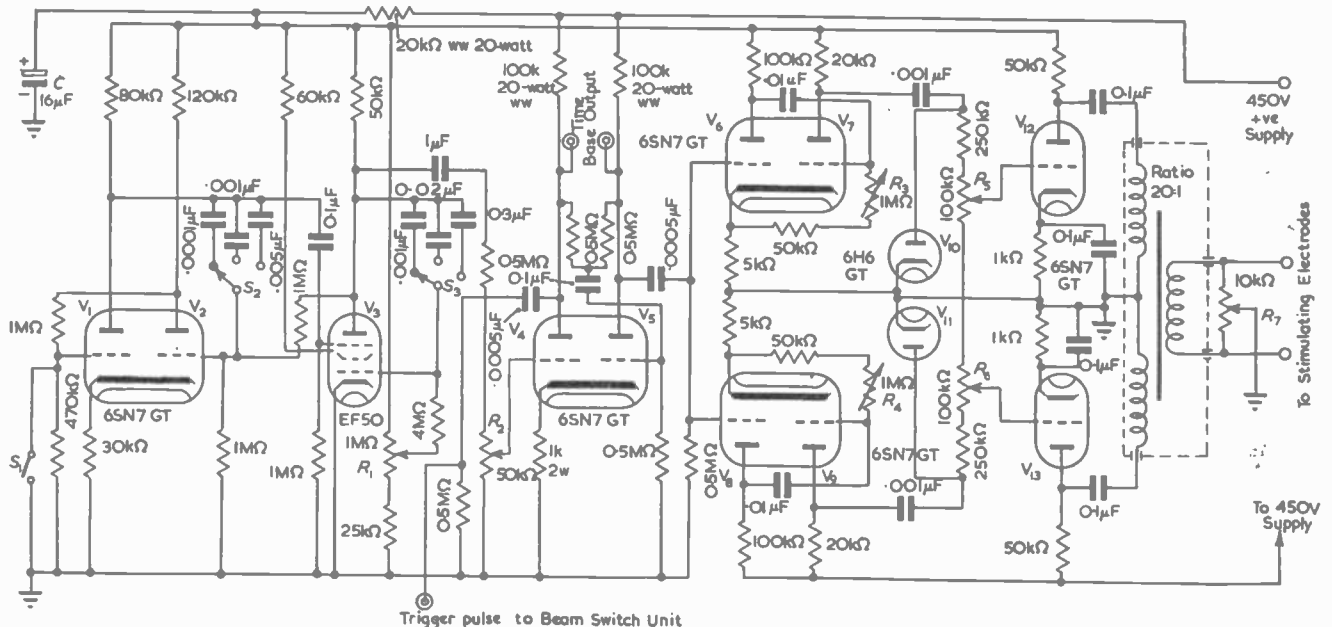

Fig. 1. Time-base and stimulator unit

trollable in velocity and amplitude, and one or optionally two stimulating pulses, locked to the time-base, independently controllable for amplitude and delay, and with an output balanced to earth. The pulse duration is fixed (0.25msec) and the amplitude is variable from 0 to 80 volts. The circuit (Fig. 1) employs the time-base due to Dickinson¹, which gives a nearly linear negative-going sawtooth output. Of the three switched frequency ranges, only the highest (12c/s to 300c/s) is normally used in the demonstration of nerve and muscle action potentials. The fine frequency control R_1 is directly calibrated in terms of time-base repetition rate. The phase-splitter (paraphase type) is fed by about 1/10th of the time-base voltage and the input potentiometer R_2 controls the time-base amplitude. The 6SN7 operated from the 450V H.T. line gives sufficient output to fill a 12 in. electrostatic tube, with a slight loss of linearity. Wire-wound anode loads

double triode are commoned by parallel feeding into two primary windings, L_1, L_2 , of a small iron-cored transformer. Across the secondary winding is a potentiometer, R_7 , whose slider is earthed, providing an output balance control.

The Beam Switching and Time Marker Unit (Fig. 2).

This unit employs two double triodes, one an Eccles-Jordan Trigger (V_{3a}, V_{3b}) which is triggered by sweep-derived pulses from the time-base unit, and one multi-vibrator (V_{1a}, V_{2a}) providing convenient time-marking signals. The triggering pulses (negative-going) are derived by differentiation of the anode waveform of one phase-splitter valve (V_4 , Fig. 1) so that each is coincident with the start of a sweep. The pulses are fed to both anodes of the trigger through diodes, and the triggering is satisfactory when the values of resistors shown in the diagram are used. Each-anode produces a square wave

* Physiology Dept., Medical School, King's College, Newcastle-on-Tyne.

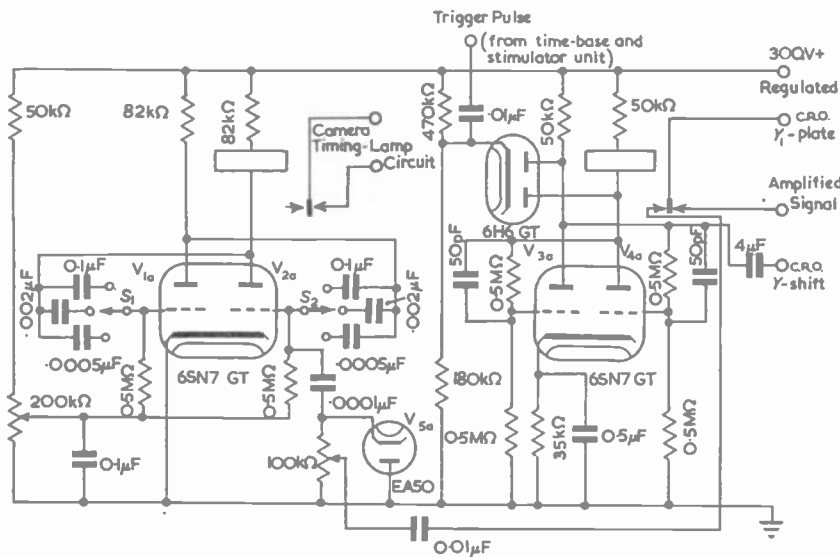

Fig. 2. Beam switching and time-marker unit

of time-duration equal to a time-base sweep, the waves being at any instant of opposite phase. The beam-shift potential is taken from the anode of V_{3a} via a $4\mu\text{F}$ capacitor to the C.R.O. Y_2 plate. In conjunction with the 1 megohm resistor between this plate and earth the time-constant is 4 seconds. Since the longest duration of sweep employed is $1/12^{\text{th}}$ second the square-wave is only slightly differentiated, and in fact both traces appear straight and horizontal.

The input to the C.R.O. Y_1 plate is switched by a relay (Siemen's High Speed Type, 3400Ω) in the anode circuit of V_{1a} , with the connexions so arranged that the time marks appear on the lower beam, and the signal trace on the upper beam. The setting of the contacts is a little critical, but once set and locked the relay appears to maintain its setting over long periods. There is a little loss of time-base due to the relay transit time at rates in excess of 200 per second, so that the signal trace or time-trace

may commence a short distance from the left of the tube at these speeds. This could be overcome by the use of a polarized relay designed to have a minimum transit time, but the simple arrangement described proves adequate for most purposes.

The multivibrator is conventional the output being differentiated to give narrow time pulses; the negative pulses are by-passed by the diode V_{3a} . The two higher frequency ranges give intervals from 1 millisecond to $\frac{1}{4}$ millisecond and from 4 milliseconds to 1 millisecond. The lowest range gives rates of 5 to 10 per second, which may be used to operate a flashing light source where a moving-film camera is being used. The relay (Siemen's High Speed Type) in the anode circuit of V_2 is then made to interrupt the power supply to a small filament lamp. At the higher ranges an extra pair of contacts (not shown) on the Yaxley switch (S_1, S_2) short circuits the relay coil.

The operation of the circuits is summarized in the waveform diagram (Fig. 3).

REFERENCE.

1. Dickinson, C. J. A Simple Slow Running Time-base. *Electronic Engg.* 22, 505 (1950).

University Lectures on Nuclear Reactors

ATOMIC scientists from the Ministry of Supply Research Establishment at Harwell are to be the lecturers in a London University Course devoted entirely to Nuclear Reactors.

The Course will consist of thirty lectures and will be given in the City and Guilds College during the 1952-3 session which starts in October. Permission for the lectures to be given has been granted by Sir John Cockcroft, Director of the Atomic Energy Research Establishment. They will make use of all the latest declassified information on reactors, neutron theory, heat transfer and associate subjects.

The first group of twelve lectures will be concerned with slow neutron natural uranium reactors concluding with a detailed description of the large pile at Harwell (BEPO). They will start with the elementary nuclear physics appropriate to slow reactors and the application of such knowledge to the design and control of a simple-graphite-moderated reactor.

Another group of six lectures will deal with particular aspects of reactors of various types. Information will be given on the various possible systems and the problems involved in metallurgy, chemistry, engineering, heat transfer and physics will be included.

A group of three specialized courses will include five lectures for mathematicians on more advanced slow and fast neutron theory; five lectures for engineers on heat transfer and reactor design; and a lecture for physicists on the experimental use of a reactor followed by the opportunity to take part in experiments involving neutron diffusion and the measurement of a neutron flux.

At the end of the Course it is hoped to arrange a visit to inspect the Harwell piles and give an opportunity for informal discussion with the various lecturers.

All the lectures are open. They are free to students of the College and Inter-Collegiate Students, but for others a fee of ten guineas will be charged for the whole Course with reductions for those who wish to attend only a selected part of the Course.

Fig. 3. Waveforms

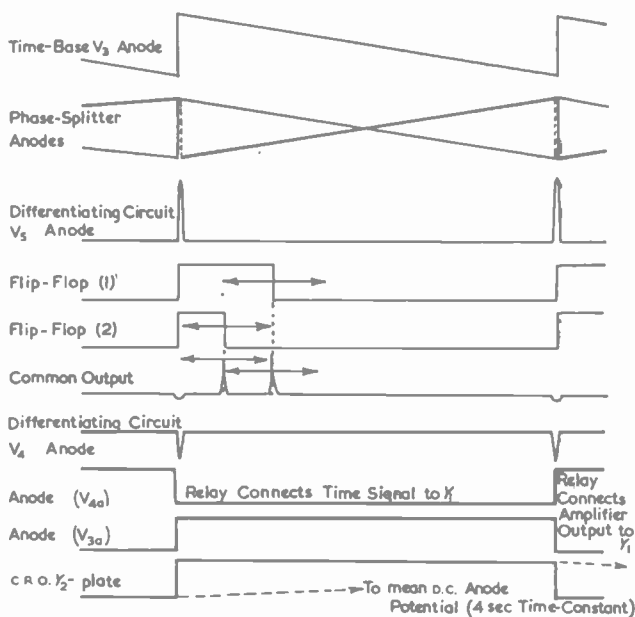

Servomechanisms (Selected Government Research Reports, Vol. V)

293 pp. Her Majesty's Stationery Office for D.S.I.R. February, 1952. Price £3 3s. 0d.

THIS book, as stated in a preface note, contains reports selected from work carried out under the direction of the Ministries of Supply and Aircraft Production. The work reported upon was, of course, carried out during the last war, or very shortly afterwards. The reports may, therefore, be regarded as somewhat out of date, but they may be useful nevertheless in view of the present urge for rearmament in presenting the solution of some problems of wartime technique to the new generation of research and development engineers engaged on servo and allied subjects.

Seventeen reports are collected together, they are diverse in character, and are not related to each other, but some of them at least will appeal to most engineers or designers.

There are three reports on general servo theory: one on harmonic response diagrams, another on Laplace operator methods and a third on servos which are required to respond to low frequency inputs only. These, in the main, retread what is now regarded as well trodden ground. Two more describe techniques for the solution of the high order equations which frequently occur in servo loop analysis. Another contains a description of an electro-mechanical differential analyser, employing velodynes, and gives details of construction, setting up, and tests. A further report describes the application of punched tapes and uniselectors to the computation of serial correlations, and part of it deals with the mathematical theory and the interpretation of the correlograms.

The remaining reports include: one on the velodyne; a scale of ten counting circuit, which is based on the scale of two; several dealing with aided laying, smoothing of input data, and with hydraulics as applied to aircraft controls. There is also one report on a special type of magslip receiver and some factors affecting the linearity of response with speed of d.c. tachogenerators.

The development of the magslip receiver described arose out of the use (or misuse) of magslips for recording data in the testing of predictors.

In the early work, a group of magslip indicators were photographed at frequent intervals during the operation of a predictor following a target, and the positions of the pointers were taken as an instantaneous indication of the output of the predictor. This, as indicated in the report, is not precise, since with an unsmoothed output such as may be produced from the predictor (especially one of the mechanical type), the Magslip Receiver Mk II, which has a natural period of 3-4 cycles per second, will tend to oscillate.

The photographic method of recording does not take a mean of such oscillations as would a human gun-layer. The magslip transmission as described in the report, is applied to a cathode-ray tube either with magnetic or electrostatic deflexion, and the indication of the transmitted angle is therefore precise, since the indicating means has no mechanical inertia. This application is somewhat similar to the present application of mag-

BOOK REVIEWS

slips to some types of radar display tubes.

The book is not a text book or like one of the well known Radiation Laboratory series, and may therefore not be particularly attractive to engineers or students of servomechanisms as an addition to their personal collection, the contents are too arbitrary and specialized. It should be useful, however, in the library of those firms and institutions engaged on servomechanism development and research, and especially for such bodies as may again be engaged on work of a military character.

J. BELL.

Structural Adhesives

203 pp., 175 photographs and diagrams. Lange, Maxwell & Springer, Ltd. January, 1952. Price 21s.

THIS volume, dealing with the theory and practice of gluing with synthetic resins, contains the collected lectures given in Cambridge at the Summer School recently held by Aero Research Ltd., Duxford, Cambridge.

The School was organized as two separate courses, one for woodworkers and the other for members of the engineering, electrical manufacturing and allied industries, but certain introductory lectures were common to both. The book is divided into three parts, and the first eight chapters, consisting of the introductory lectures, describe in an extremely lucid manner some basic rules of adhesion, the properties and chemistry of some synthetic resins and the applications of these products as adhesives. The strength of glued joints and various methods of testing glues are also discussed.

The lectures in the second part of the book are intended for woodworkers and describe the uses of synthetic resin adhesives in the manufacture of plywood and in veneering, etc. Electrical engineers may be interested, however, in the three chapters dealing in considerable detail with the principles and applications of radio frequency heating and strip heating.

Chapters in the final part of the book are devoted to the applications of synthetic resin adhesives in aircraft structures and for the bonding of friction linings. There is also an admirable section on adhesives in the electrical industry. The use of adhesives for bonding mica, ceramics, laminations, rubber and in magnetic cores are described in detail, and considerable information is given concerning the methods of employing these materials together with the results of several practical tests. Of particular interest is the table which appears in the chapter reviewing recent developments in ethoxyline resins. This summarizes the mechanical and electrical properties of these products and directly compares them with those of other casting resins.

R. F. Archer, of Metropolitan-Vickers Electrical Co., Ltd., concludes his chapter

on "Adhesives in the Electrical Industry" with the words "There is now available to the electrical engineer a considerable extension to the range of design possibilities. These new adhesives cannot be classed or dismissed as mere stickers; they are engineering materials . . . in the electrical industry the field of possible applications of true adhesives is not only wide but can be exploited to great advantage."

"Structural Adhesives", a well-produced work, illustrated with many photographs, diagrams, graphs and tables, can be recommended to users and potential users of synthetic resin adhesives as well as to students as a reference book of practical value.

P. A. DUNN

Power System Analysis

By J. R. Morlock and M. W. Humphrey Davies. xv + 384 pp. Chapman and Hall Ltd., London. January 1952. Price 45s.

MANY readers of ELECTRONIC ENGINEERING will expect from this book a "peep over the fence", since it deals in megawatts and cycles per second rather than in megacycles per second and watts (or microwatts). At first glance the landscape next door seems very like our own, for the book starts with two chapters on circuit theory which in the main will seem very ordinary to the communication or electronic engineer, except that there is no mention of M.K.S. units which are now the official internationally agreed system for electrotechnics. (Units in this book are frequently in specialized form, such as cable capacitance in microfarads per mile, but any formulae in basic theoretical form are given in c.g.s. units). But these preliminary chapters should not be skipped, since they detail the symbols and notation to be used later, and also introduce the method of symmetrical components (of positive, negative and zero phase sequence) for 3-phase systems. The idea of a negative-phase-sequence impedance, which for a machine may differ in value from the positive-phase-sequence impedance, is the only substantial difference between the principles of power system analysis and other branches of circuit analysis. A useful item in these chapters is a pair of tables for converting between polar ($Ze^{j\theta}$) and Cartesian ($R + jX$) forms of vectors.

The book is based on the work of a vacation school which was held in the Electrical Engineering Department of Imperial College, and probably this is why it contains a number of worked examples such as a lecturer might demonstrate during his discourse, but no problems for the student to tackle by himself. Moreover, one feels that while the first six chapters give a well organized treatment of the theory of circuit analysis and the characteristics of underground cables and of overhead lines, some of the remaining nine chapters are more in the

nature of brilliant essays which illumine the topic in question but cannot within the available space exhaust their subjects.

It is interesting to note that electronics is not the only branch of electrical engineering in which precise calculations are sometimes prohibited by the uncertainties of secondary effects: in discussing the impedances of overhead lines the authors say that "Values so calculated do not necessarily agree with actual measured values, since the latter are affected by stray effects which are not taken into account in the calculations. . . .". The communication engineer will also be interested to hear that the use of carrier signalling over power lines for protective purposes allows of a more rapid detection and clearing of faults than would be possible in the absence of a signalling channel between the two ends of a power transmission line. But the details of the fascinating subject of protection are outside the scope of this book, which is concerned with the *analysis* of power systems. It is desirable in a vacation school to have lectures summarizing the necessary information on related topics, but debatable whether one should include in a book on systems a chapter on the characteristics of synchronous machines and so short a chapter (5 pages) on the characteristics of loads. One would not query this in a book at student-text level, but this book is aimed at experts and teachers in this field who may be expected to have access to other sources of information.

The discussion of matrices is well balanced, and brings out a point which your reviewer discovered the hard way in his first exploration of matrix methods of circuit analysis: it is the inversion of a matrix in algebraic form which is laborious, and limits the utility of matrix methods to the really complicated types of network or to numerical examples. It is interesting to find also an appendix on Southwell's relaxation method, but it is doubtful whether any justice can be done to this topic in four pages. Other important topics covered are stability of a.c. power systems; control of watts, vars and voltage; network analysers, and system design.

It may appear that this review is unduly critical of a book which reaches a very high standard and possibly contains more information on power systems than any other single book. But the point is that this book is neither a text from which the whole subject can be "swotted up" nor an encyclopaedic reference book, but a review of the field and an inspiration to further study. Indeed, what greater service can one render to the student of any age and degree of experience than to inspire him to further study?

D. A. BELL

Prism and Lens Making

By F. Twyman, F.R.S. Second edition. 629 pp., 260 figs. Hilger and Watts, Ltd., Hilger Division, January, 1952. Price 58s.

THIS book is a unique compendium of the art and science of the optical working of glass for the production of mirrors, lenses and prisms. It is a tribute to the energy and skill of Mr. Twyman who has spent a lifetime working in the

field and who has himself made enormous contributions to it. The main body of the book is dotted with tidbits of practical information culled from the experiences of the men who work on the job, while a number of the more specialized sections are written by those of Mr. Twyman's associates who are directly concerned with the processes described.

The present (second) edition of the book has an even wider appeal than the very successful first edition because it has been enlarged, not only by accounts of important recent developments in optical workshop practice, but also by a considerable widening of its scope. There is, for example, a detailed discussion of the production of Schmidt plates which are of importance in television projection systems, and another chapter on the large mirrors used in modern astronomical telescopes. New also are the chapters on spectacle lenses, on non-spherical surfaces, on the production of synthetic crystals for optical components, and on the techniques of "blooming" and other surface treatments. The interferometric control of high quality optical work, which Mr. Twyman has been largely responsible for introducing is, of course, given the important place it deserves. Finally a welcome diminution in the "secrecy of the trade" has enabled him to collect together information from a wide variety of optical firms and so to make the book more representative of general practice.

W. C. PRICE

Printed Circuit Techniques: An Adhesive Tape-Resistor System

By B. L. Davis. 83 pp., 67 figs., 2 tables. National Bureau of Standards Circular 530. February, 1952. Prices 30 cents, postage 10 cents.

FOR several years the U.S. Navy Bureau of Aeronautics has sponsored a programme of printed-circuit evaluation and development at the National Bureau of Standards for the purpose of improving techniques for printing electronic circuits and sub-assemblies for airborne use. The production of individual resistors to close tolerance is difficult, and the reduced probability of producing a number of resistors on the same base to reasonable tolerances greatly affects the yield of acceptable assemblies. This publication presents a complete description of N.B.S. development work on an adhesive tape-resistor permitting close control of resistance values.

The tape-resistor, a carbon-film resistor in the form of an adhesive tape, covers a range of 10 ohms to 10 megohms. The use of asbestos paper tape and silicone resin binder results in a resistor capable of operation up to 200°C. Because the curing temperature is high, 300°C for several hours, the tape is applicable at present only to glass or ceramic base materials.

The circular gives detailed information on production of the resistors and on equipment and materials needed. It describes the ovens, switching equipment, and recorder for making load-life tests. Appendices include data on each of the carbons studied and supply sources are listed for all uncommon materials and equipment used.

CHAPMAN & HALL

ANTENNAS THEORY AND PRACTICE

by

S. A. Schelkunoff

(Member of the Technical Staff
Bell Telephone Laboratories, U.S.A.)

and

Harold T. Friis

(Director of Radio Research
Bell Telephone Laboratories, U.S.A.)

629 pages 348 figures 80s. net

ADVANCED ANTENNA THEORY

by

S. A. Schelkunoff

216 pages 56 figures 52s. net

37 ESSEX STREET, LONDON, W.C.2

The latest
"Electronic Engineering"
monograph

RESISTANCE STRAIN GAUGES

By J. Yarnell, B.Sc., A.Inst.P.

Price 12/6

This book deals in a practical manner with the construction and application of resistance gauges and with the most commonly used circuits and apparatus. The strain-gauge rosette, which is finding ever wider application, is treated comprehensively, and is introduced by a short exposition of the theory of stress and strain in a surface.

Order your copy through
your bookseller or direct from

Electronic Engineering

28 ESSEX STREET, STRAND,
LONDON, W.C.2.

BOOK REVIEWS (Continued)

Introduction to Electronic Circuits

By R. Feinberg. 163 pp. Longmans, Green and Co. Ltd. January, 1952. Price 18s.

THE author offers this book as an introduction to the subject for university students and others who are familiar with elementary ideas of atomic structure and electron emission. The reader should, in addition, be capable of using complex algebra, Taylor's theorem, Fourier series, and second order differential equations of the first degree. Rationalized M.K.S. units are used for the magnitudes of physical quantities. Treatment of the performance of electronic circuits at V.H.F. and U.H.F. is deliberately omitted.

The first chapter introduces the diode, its application as a half wave and full wave rectifier, and the triode. The tetrode, pentode, simple magnetron, cathode-ray tube and a few simple applications of the latter are the subject matter of the second chapter. Then follows a chapter on alternating current amplification, which deals with voltage and power amplifiers, push-pull circuits, Miller effect, the cathode follower and negative feedback. In the next chapter the author has very judiciously collected many of the non-linearity effects of valves, and has explained the uses to which many of them are put.

Sinusoidal oscillators are dealt with next. Here it is rather a pity that grid current bias is not mentioned, and also that crystal oscillators are treated only sketchily. Under the heading of "Amplitude Modulation" a great deal is left to the imagination of the reader as to how this is effected with an oscillator. The chapter includes, however, an excellent analysis of resistance-capacitance phase-shift oscillators. Mention is also made of the danger of instability in amplifiers. This chapter is followed by a treatment of relaxation oscillators including a two-valve electronic switch, the Puckle time-base, and the multivibrator, the latter being analysed in some detail. The value of this chapter could have been increased by the inclusion of some relaxation oscillators which have become very popular in recent years, such as the blocking oscillator, and the transitron.

The penultimate chapter encompasses the various types of gas-filled valves together with some of their numerous applications. The characteristics of argon, neon, and mercury vapour filled valves are discussed, including the special precautions to be taken when using mercury vapour valves, and the penalties incurred by ignoring them. Grid controlled rectifier circuits with and without a smoothing inductor are well explained together with a mathematical analysis. The chapter concludes with a discussion on inverter circuits. The final chapter deals with cold cathode, photo-, and mercury pool valves. A simple voltage stabilizing circuit using a cold cathode diode is analysed, and a trigger-relay circuit using a cold cathode triode is also

shown. The two electrode and the more sensitive secondary emission photocell are both dealt with, and a simple circuit using a photocell to control the gain of a triode amplifier is included. The author gives a short elementary treatment of the mercury pool triode and the ignitron.

Most sections of each chapter include a description of one or more experiments on the subject matter of the section to be performed by the reader. Each chapter concludes with a number of numerical problems, and most valuable, the answers to them. These are followed by a selection of literature for further reading. Although these bibliographies are a little short, the reader should have no difficulty in finding further references in the recommended articles.

All the diagrams in the book are very clear, and although an unconventional symbol is used for the cathode of a valve it does not produce any ambiguity.

The mathematics used, although sufficiently thorough for the purpose of the book, are by no means difficult. The book seems to be singularly free from both author's and printers' errors. It is well bound, but in the review copy quite a number of pages were not separated from each other at the outer edge.

Although some of the more elaborate circuits are not included, as previously mentioned, the book deals very thoroughly with the fundamentals of electronic circuits, and should serve well those to whom it is addressed as an introduction to the subject.

H. STIBBÉ

Fundamentals of Technical Electricity

By H. G. Mitchell. 543 pp. Methuen & Co. Ltd. March, 1952. Price 18s.

IT is most refreshing to read a really new book on such a general subject. The emphasis of the book is on fundamentals and about 90 per cent of the book deals with basic principles which are the foundation of all electrical science. Although only the last two of 29 chapters deal specifically with electronics and radio, and with electricity, matter and energy, respectively, nearly all the remainder is necessary groundwork for students of electronics. The treatment is most commendable in that correct modern terminology and symbols are used. Resistors, inductors and capacitors are quoted as the physical entities having the respective properties of resistance, inductance and capacitance. Although such terminology, being generally agreed through BS205, etc., should always be taught and used it is rare to find a textbook on fundamentals so treated. Any serious student of electrical engineering or physics, whatever branch he may specialize in later, can learn the fundamentals from this book. The qualifying term "serious" is used since simple calculus is employed in

places, as in $e = -L di/dt$. But this is essential and the mathematics should be within the scope of such students. Vector notation and the operator j are thoroughly covered in one chapter, and another on units is most comprehensive, dealing the E.M. and E.S. units, international and the now official absolute units with their corresponding values, and finally a discussion on the C.G.S. and M.K.S. systems, the latter in both the unrationalized and the rationalized forms. This chapter on units might possibly be better placed earlier in the book. This is one of many chapters that are really up to date.

Under "Electronics and Radio" are covered the principles of the thermionic valve, cathode-ray tube, C.R.O., diode rectifiers, gas-filled valves, the valve as an amplifier and as an oscillator, radio transmission and reception principles, and television and radar in two pages, but with the earlier groundwork specialized books on these subjects can be better followed.

In the small proportion of the book that can be devoted to applications a few points were noted which, partly by compression and omission may give a wrong idea. The modern tungsten incandescent lamp is referred to here as a "half-watt" lamp, which term was dropped by the lamp industry twenty odd years ago, the 100-watt gas-filled lamp having an efficiency of about one watt per candle power, although preferably expressed as 12.7 lumens per watt. In the measuring instrument section there is no reference to the induction watt-hour meter, which is used in this country for about 99 per cent of all A.C. supplies. The Thomson motor meter is described here, giving a wrong impression. The tangent galvanometer is rightly included, as it illustrates a principle, and it is well quoted as not now used. The same note might be added to the descriptions of the Kelvin balance, the Siemens' dynamometer, etc. Incidentally some instruments described are not given their names strictly in accordance with BS89. The term "ohmmeter" is applied to the case of the milliammeter calibrated in ohms with a battery, but strictly this is not an ohmmeter, which is that described under the title of "Megger", which is part of a trade name.

Finally, the book can be thoroughly recommended both to lecturers and to students.

E. H. W. BANNER

Wireless and Electrical Trader Year-book 1952

264 pp. 23rd edition. Trader Publishing Co., Ltd. April, 1952. Price 10s. 6d.

IN the 1952 edition data of practical use to dealers in the new television areas and general reference and technical information have been carefully selected. Features include condensed specifications of current 1952 commercial television receivers and information on valve and C.R.T. base connexions, with over 200 valve base diagrams.

A new feature is a comprehensive list of the I.F. values of commercial radio receivers which have been marketed during the past five years.



High permeability magnetic alloys

by *Standard*

have steadily been improved and extended in range over many years and are produced by a Company which has the unique advantage of being large scale users of these materials.

As a result of this, much direct experience of the requirements and the applications of magnetic alloys is available, thus giving a full appreciation of the desirable characteristics and the actual conditions of use.

V-PERMEENDUR for high permeability with unusually high flux density. Specially applied to high quality diaphragms and pole pieces.

PERMALLOY C for highest initial permeability. Useful for wide frequency band transformers, current transformers, chokes, relays and magnetic shielding.

PERMALLOY B for higher flux densities than Permalloy C and high incremental permeability. Suitable for low power and intervalve transformers.

PERMALLOY D for very high resistivity without undue lowering of maximum flux density or of Curie point. Small variation of permeability with frequency. Ideal for H.F. applications.

Standard Telephones and Cables Limited

Registered Office: Cannongate House, Aldwych, London, W.C.2

TELEPHONE LINE DIVISION North Woolwich, London, E.16 · ALBERT Dock 1401

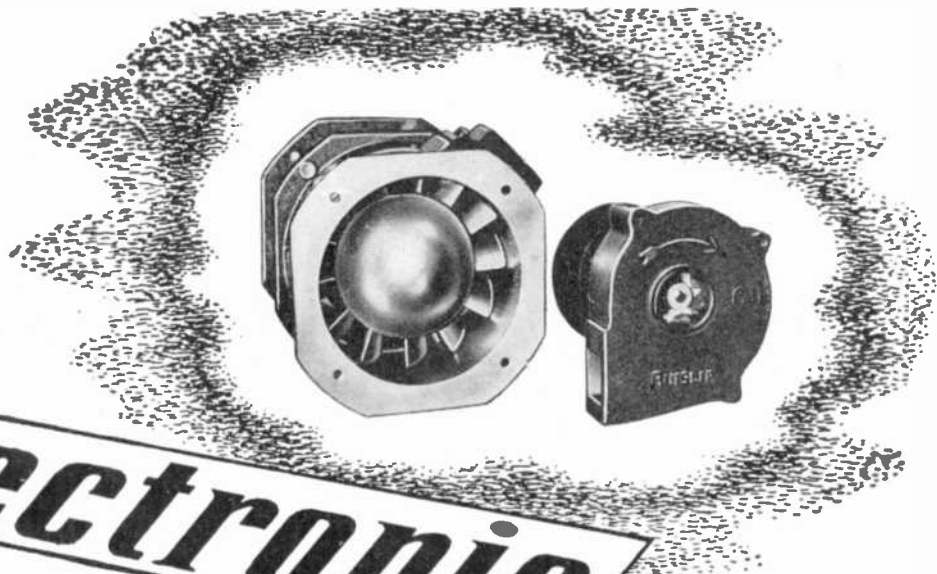

electronic COOLING

The wide range of blowers for force-cooling of valves and maintenance of desired temperature levels in electronic and general electrical apparatus is typical of the progress maintained by **ACI**. The illustration shows the smallest of the blowers (4" Axial Flow type and 2½" Centrifugal type), but our range covers duties from 5 c.f.m. up to many thousands of c.f.m. at pressures up to 45 or more inches w.g. These blowers are used in MARINE & AERODROME RADAR INSTALLATIONS, AIRCRAFT AUTOMATIC PILOTS, COMMUNICATION AND BROADCASTING STATIONS, R.F. HEATING EQUIPMENT, Etc. Let us know your application—we shall be pleased to put forward our proposals.



Complete
Air Treatment
Plant

AIR CONTROL INSTALLATIONS LTD.

Manchester

RUISLIP, MIDDX.

Glasgow

Telephone: Ruislip 4066 (8 lines)

Telegrams: Controlair, Ruislip

THE REPUTATION enjoyed by Marconi Instruments for precision engineering and skilful design is jealously guarded. At all stages of manufacture, and especially in the final testing, the greatest attention is paid to detail. In the future, as in the past, the Company will maintain its policy of producing an unrivalled range of equipment "that is just that little bit better," serving communications and industry, medicine and research, in the precise Marconi manner.

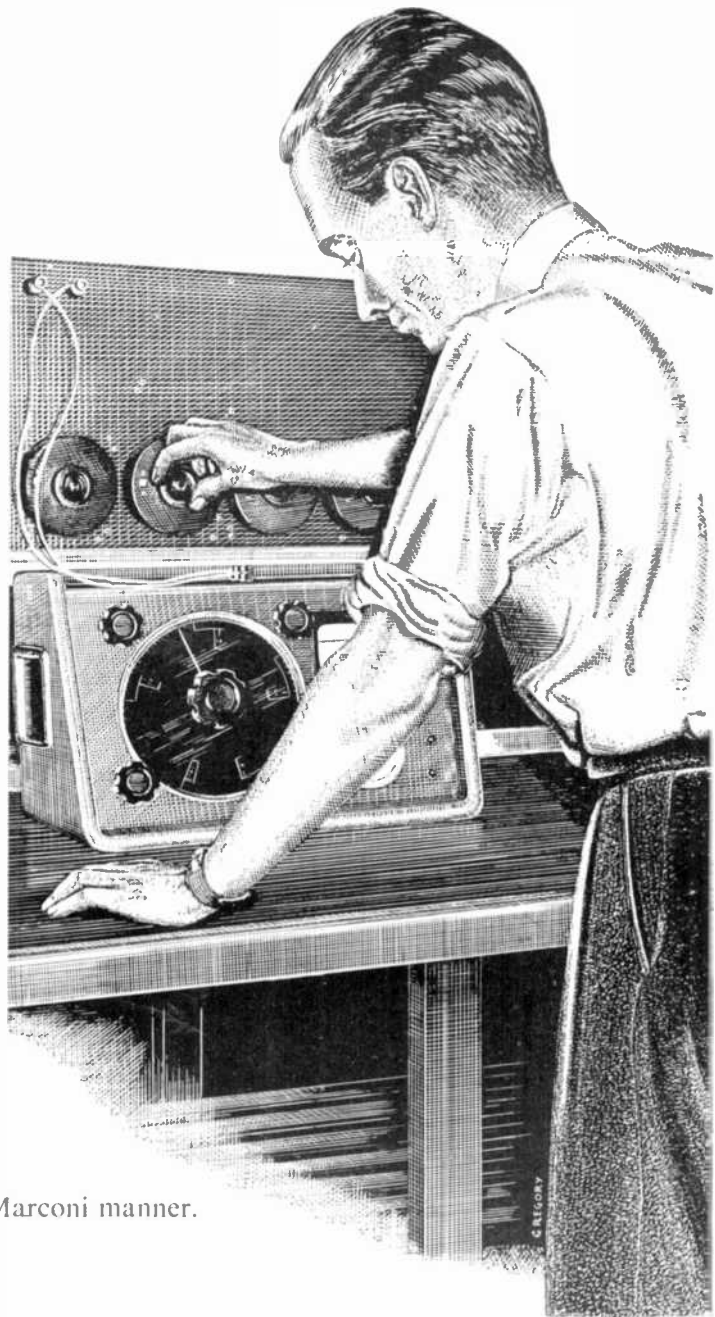

MARCONI instruments

SIGNAL GENERATORS · BRIDGES · VALVE VOLTMETERS · Q METERS · FREQUENCY STANDARDS
OUTPUT METERS · WAVE METERS · WAVE ANALYSERS · BEAT FREQUENCY OSCILLATORS
MARCONI INSTRUMENTS LTD · ST. ALBANS · HERTS · Phone: St. Albans 6161/3

Midland Office: 19 The Parade, Leamington Spa. Northern Office: 30 Albion Street, Hull. Export Office: Marconi House, Strand, London, W.C.2.

The "Belling-Lee" page for Engineers

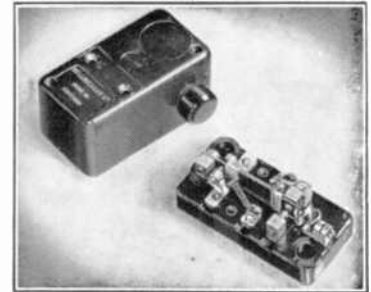
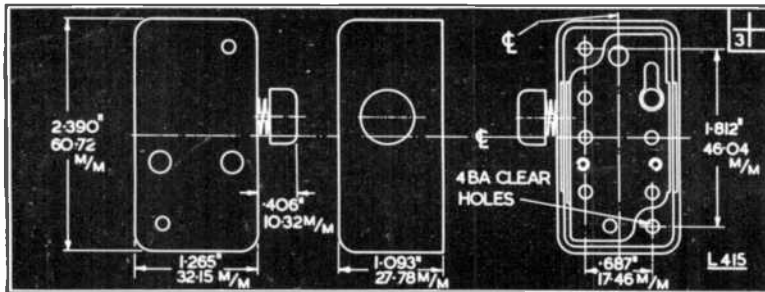

THERMAL DELAY SWITCHES

LIST NUMBERS

L.413 L.415

OTHER TYPES
AVAILABLE

Thermal delay switches for use with motor drives, electrical tools, etc.; also for application to non-critical process timing. The type illustrated above (List Number L.415) is a manual resetting switch.

Where a self-resetting type is required, these are available under List Number L.413 (illustrated below).

Apart from the resetting mechanisms, the general arrangement and electrical characteristics of the two types are similar. Each is fitted with Standard instrument contacts which will break a maximum current of 4 amps. at 250 volts A.C., or 2 amps. at 50 volts D.C.

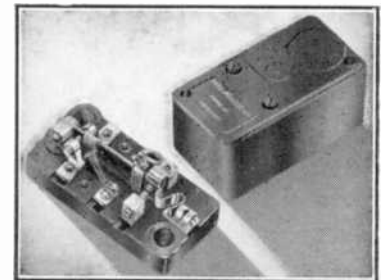
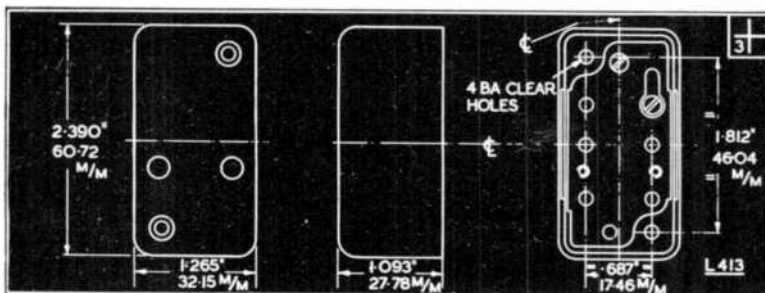

FURTHER DETAILS ON APPLICATION

They can also be supplied to special orders, to break up to 20 amps. at 250 volts A.C. or 5 amps. at 100 volts D.C.

The maximum continuous rating is 10 amps.; normal heater loading for continuous operation, 3-4 watts at any voltage up to 50 volts A.C. or D.C.

For occasional short duration functions, a heater loading up to 25 watts is permissible. The heater may be in series with the main contacts, or independent, being insulated for 250 volts A.C. working potential to bi-metal.

Please write for illustrated pamphlet Ref. P.377,EE

BELLING & LEE LTD
CAMBRIDGE ARTERIAL RD., ENFIELD, MIDDX., ENGLAND

ATE/TMC

**OPEN WIRE AND CABLE
LINE TRANSMISSION EQUIPMENT**

Accessibility...

All wiring is in one plane on the front of the 12-channel carrier line amplifier panel. With the panel swung forward the components are immediately accessible. Panels are quickly removed by cutting the straps linking the tagblock on the panel to the bay tagblock.

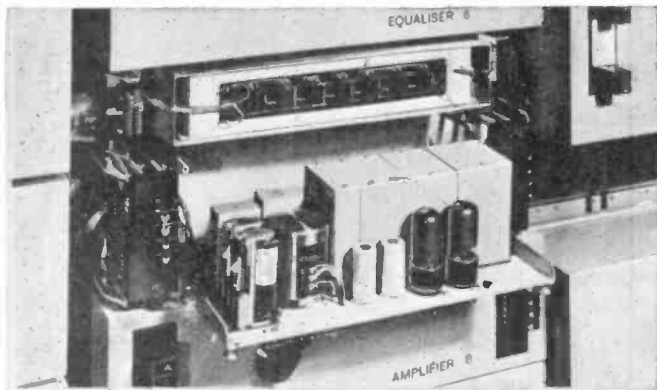

*Above: Group amplifier
Right: Amplifier equipment bay*

AUTOMATIC TELEPHONE & ELECTRIC CO. LTD.

*Radio and Transmission Division: STROWGER HOUSE, ARUNDEL STREET, LONDON, W.C.2
Telephone: TEMple Bar 9262 Cablegrams: Strowgerex, London*



Manufacturers:

AUTOMATIC TELEPHONE & ELECTRIC CO. LTD. - - - - - Liverpool and London
TELEPHONE MANUFACTURING CO. LTD. - - - - - St. Mary Cray, Kent

AT.8471-B105

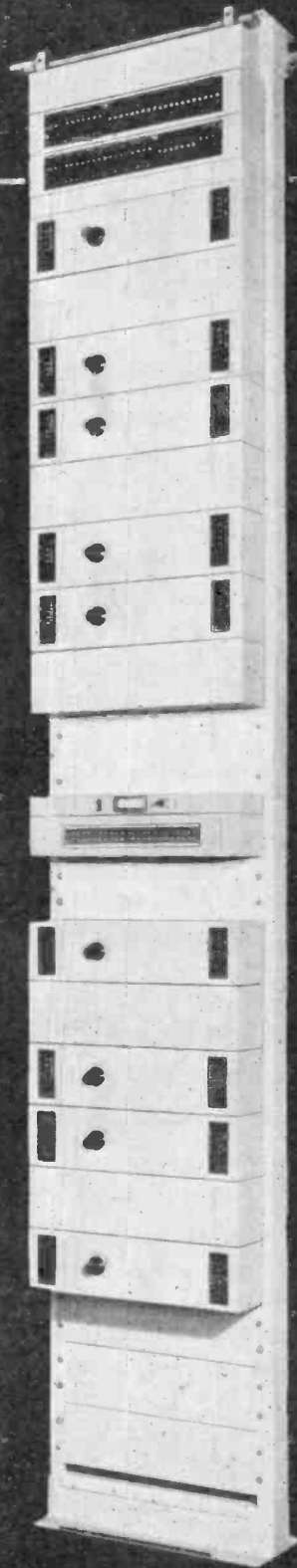

AIRMEC

VALVE VOLTMETERS



Valve Voltmeter Type 712 (Illustrated above)

- ★ Frequency range from 30 c/s to 200 Mc/s
- ★ Balanced, unbalanced and differential inputs
- ★ Measures both positive and negative D.C. voltages
- ★ Six resistance ranges reading up to 100 megohms
- ★ Balanced circuitry ensures exceptional stability
- ★ Very low probe input capacity
- ★ Quick delivery

Millivoltmeter Type 784 (illustrated)

*(Wide-band Amplifier and
Oscilloscope Pre-amplifier)*

- ★ Frequency range—30 c/s to 10 Mc/s
- ★ Voltage ranges 0-10, 0-100, 0-1000 millivolts
- ★ Cathode follower probe
- ★ Can be used as an amplifier up to 15 Mc/s
- ★ Quick delivery



Full details of these or any other Airmec instruments will be forwarded gladly upon request

AIRMEC LABORATORIES **LIMITED**

HIGH WYCOMBE • BUCKINGHAMSHIRE • ENGLAND

TEL : HIGH WYCOMBE 2060

CABLES : AIRMEC HIGH WYCOMBE

What is **V.F.*** costing you?

If your plant or process depends on an absolutely constant mains voltage, then "V.F."* (Voltage Fluctuation) may be costing you much more than you realise. Every \pm variation results in loss of efficiency, and increases operating costs. That is why BERCO and BPT voltage control and regulating equipment plays an important part in well planned industries all over the world — keeping voltage under control!

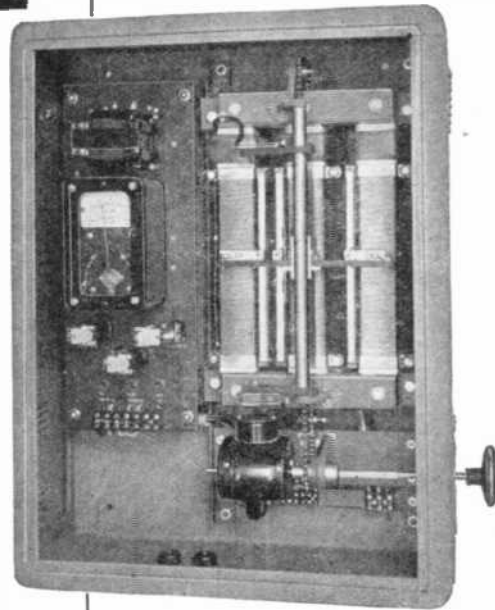

3-phase, air cooled, wallmounting model. Input 440V. \pm 10%, output 440V. \pm 1% 7½ amps.

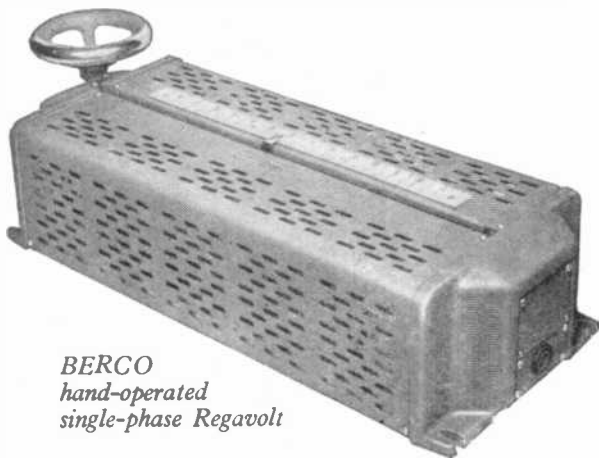

*BERCO
hand-operated
single-phase Regavolt*

For constant voltage use a model from the wide range of Automatic Stabilizers made by British Power Transformer Co. Ltd., for single and three phase supplies.

For variable voltage select a "Regavolt" from the wide range of models made by The British Electric Resistance Co. Ltd. Interesting information and full performance details given in booklet No. C1021.

**THE BRITISH ELECTRIC RESISTANCE CO. LTD.
BRITISH POWER TRANSFORMER CO. LTD.**
Queensway · Ponders End · Middlesex

Telephone : HOWard 1492

Telegrams : "Vitrohm Enfield"

BR/HP 1021T



HIGH QUALITY REPRODUCTION

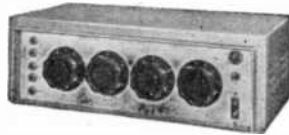

FOUR-WAY ELECTRONIC MIXER

This unit has 4 built-in balanced and screened microphone transformers, normally of 15-30 ohms impedance. It has 5 valves and selenium rectifier supplied by its own built-in screened power pack, consumption 20 watts. Suitable for recording and dubbing, or large P.A. installations since it will drive up to six of our 50 watts amplifiers whose base dimensions it matches. The standard model has an output impedance of 20,000 ohms or less, any impedance can be supplied to order.

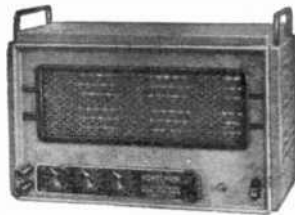

OTHER MODELS IN OUR
RANGE OF AMPLIFIERS ARE—
"SUPER-FIFTY WATT." "THIRTY WATT."
"10-15 WATT RECORD REPRODUCER."

These are fitted in well-ventilated steel cases with recessed controls as illustrated.

Full details on request

EXPORT ENQUIRIES INVITED

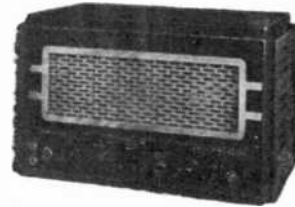

"FIFTY and THIRTY WATT" CINEMA AMPLIFIERS

as illustrated for single or double P.E.C. input with separate adjustable bias. Full range of tone controls to suit all needs with built-in Exciter-Supply if required.



TYPE C.P. 20A AMPLIFIER for A.C. Mains and 12 volt working giving 15 watts output, has switch change-over from AC to DC and "Stand-by" positions. Consumes only $5\frac{1}{2}$ amperes from 12 volt battery. Fitted with mu-metal shielded microphone transformer for 15 ohm microphone, provision for crystal or moving iron pick-up with tone control for bass and top. Outputs for 7.5 and 15 ohms. Complete in steel case with valves.

VORTEXION LIMITED

257-261 THE BROADWAY, WIMBLEDON, LONDON, S.W.19

Telephones: LIB 2814 and 6242-3,

Telegrams: "Vortexion Wimble, London"

FERROXCUBE

FERROMAGNETIC FERRITE

FOR TELEVISION

THE improvement in television components, with their smaller size and greater efficiency, is largely due to Ferroxcube, the new Mullard magnetic core material. The uses of Mullard Ferroxcube in the production of TV components fall into these three main groups:

LINE OUTPUT TRANSFORMER CORES

Since the advent of wide-angle television tubes, with the accompanying demand for increased E.H.T. supplies, the need for line output transformers of the highest possible efficiency has been greater than ever. Mullard Ferroxcube, with its low iron losses, completely fulfils this need — also facilitating the assembly of small, compact transformer units by means of solid, non-laminated U-shape cores.

DEFLECTION COIL YOKES

Mullard Ferroxcube cores in ring form are ideal for producing the magnetic circuit around deflection coils. Used in this way, Mullard Ferroxcube makes possible the construction of efficient deflector coils with a high Q factor. In order to simplify assembly problems, these ring cores are supplied either in the form of a complete circle, as two semi-circles, or as castellated yokes.

LINEARITY AND PICTURE WIDTH CONTROLS

Mullard Ferroxcube can very conveniently be extruded into rods and tubes. In this form it is ideal for use in linearity and picture width controls, providing a smooth control in a compact assembly.

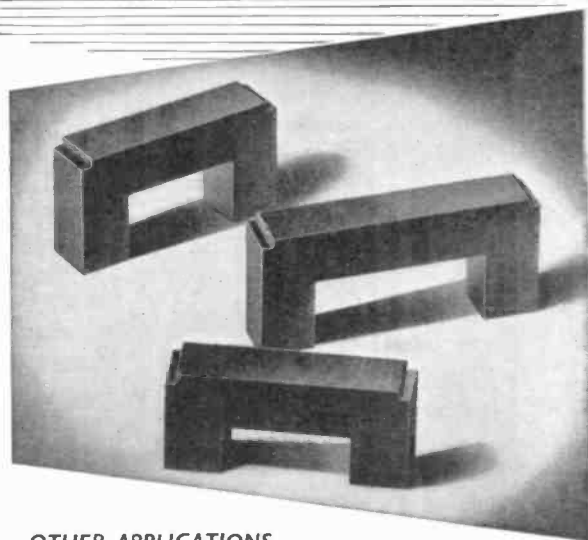

OTHER APPLICATIONS

In addition to its uses in television receivers, Mullard Ferroxcube is also being widely employed in line communications, radar, and other specialised electronic equipments. The purposes for which it is already being most successfully applied in such equipments include filter networks, wide band transformers, magnetic amplifiers, and pulse transformers.

PLEASE WRITE FOR FULL DETAILS



Mullard FERROXCUBE

FERROMAGNETIC FERRITE

MULLARD LIMITED · CENTURY HOUSE · SHAFESBURY AVENUE · LONDON · W.C.2
(MF376)



NAGARD HIGH GAIN D.C. AMPLIFIERS

MULTI CHANNEL AMPLIFIERS can be built up from units into rack or case mounted assemblies of any required number of channels.

UNIT AMPLIFIERS of small dimensions, three will go in standard 19 in. rack panels, and can provide any of the following ranges:

RESPONSE	MAX. GAIN
0-10 Kc/s	200,000
0-100 Kc/s	100,000
0-1 Mc/s	20,000
0-10 Mc/s	250

IMPROVED STABILITY AND LOWER NOISE LEVEL with **LOW GRID CURRENT** and **HIGH INPUT RESISTANCES** are provided by new input converter stage with carrier frequency amplification. **VOLTAGE CALIBRATION** of each channel independently of gain.

NAGARD LTD

18, AVENUE RD., BELMONT, SURREY.

Telephone No. : Vigilant 0345.

ENQUIRIES INVITED for specific applications in **PHYSIOLOGY, STRAIN GAUGE AND COMPUTER** work.

Delco Power for AIRCRAFT

The Delco range of British-made motors, generators, rotary transformers etc. for aircraft is designed to provide power for a wide variety of ancillary equipment including electronic control gear and radio.

Design approval is held from the Ministry of Supply Director of Instrument Research and Development, for D.C. Aircraft Electric Motors.

Available motors include totally enclosed, fan ventilated flame-proof and immersed types built to meet users' requirements and the relevant M.O.S. specifications. All motors achieve maximum output with minimum weight and many variations of standard designs are regularly manufactured to meet individual demands.

DELCO AIRCRAFT MOTORS

MADE BY FRIGIDAIRE DIVISION OF GENERAL MOTORS LIMITED
STAG LANE · KINGSBURY · LONDON N.W.9 · Colindale 6541

some typical applications . . .

- ★ SERVO DEVICES
- ★ FUEL PUMPS
- ★ GUN TURRET MECHANISM
- ★ BLOWERS
- ★ SCANNER DRIVES
- ★ DE-ICING EQUIPMENT
- ★ FOLLOWER DEVICES
- ★ HYDRAULIC PUMP DRIVES
- ★ VENTILATING FANS
- ★ CAMERA DRIVES
- ★ FLAP OPERATORS
- ★ RADIATOR SHUTTERS
- ★ BOMB SIGHT

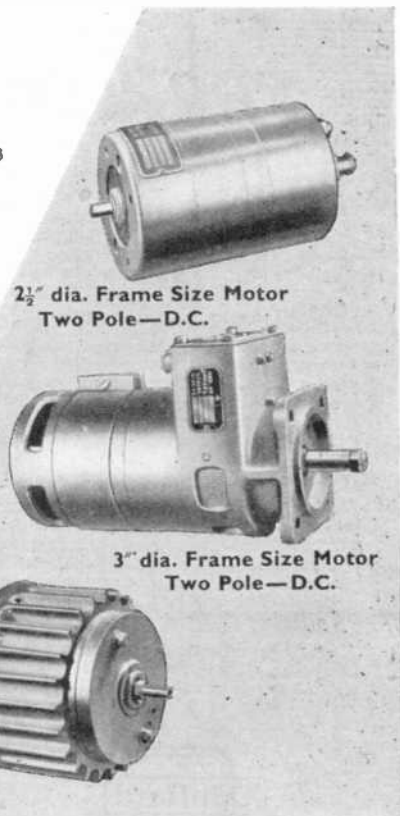

R&G FLUID MEASURES

use **MUREX Sintered Permanent Magnets**

A Murex Sintered Alcomax III Permanent Magnet operates the pointer through the solid body of the contents gauge, ensuring complete isolation of the dial from the liquid. A high degree of magnetic efficiency is required for this application, and as in many other applications, Murex Sintered Magnets continue to give accurate and reliable service.

Photographs by courtesy of Bayham Ltd., (Engineers).

MUREX LIMITED · (Powder Metallurgy Division) · RAINHAM · ESSEX Tel.: Rainham, Essex 3322
LONDON SALES OFFICE: CENTRAL HOUSE, UPPER WOBURN PLACE, W.C.1. Tel.: EUSton 8265

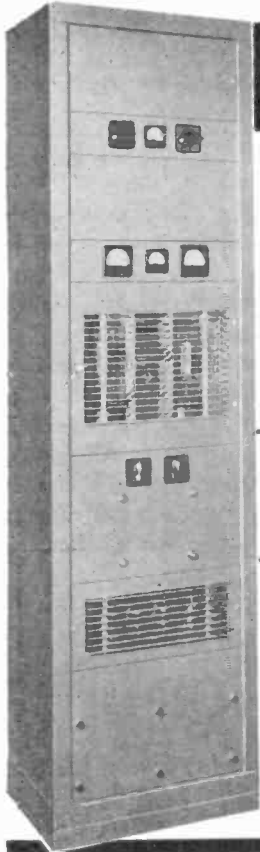

POWER AT AUDIO FREQUENCY FOR INDUSTRY & RESEARCH

THE SAVAGE MARK II KILOWATT AMPLIFIER

FACTS TO IMPRESS:

- The Savage Amplifier was used recently for echo-sounding to the bed of the deepest ocean.
- Used by aircraft manufacturers as a source of power for vibration tests.
- Used as variable frequency power source for machine tools.
- This Amplifier may have a direct application to your problems. Ask us for full details.
- Amplifiers used in Broadcast Relay networks throughout the country each feed several thousand loudspeakers.
- Invaluable for instrument calibration, transformer testing, transmitter modulation, etc.

FEATURES

NEGATIVE FEEDBACK OVER 3-STAGES
NO ELECTROLYTIC CONDENSERS ARE USED
ALL VALVES ACCESSIBLE FROM FRONT OF RACK
UNIQUE CONSTRUCTION ENSURES QUICK ACCESS TO ALL WIRING

SPECIFICATION

OUTPUT: 1,000 watts, A/F
DISTORTION: 0.6% at 1,000 c/s
NOISE LEVEL: -70 dB
OUTPUT REGULATION: 9.0% (0.8 dB)
SENSITIVITY: 0.9 V at 600 ohms

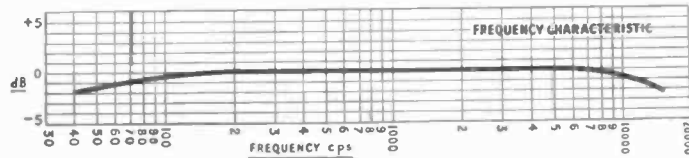

W. BRYAN SAVAGE LIMITED

WESTMORELAND RD., LONDON, N.W. 9 · COLINDALE 7131 · GRAMS: DECIBEL, PHONE, LONDON

Ceramic stand-off Insulators

by

U.I.C.

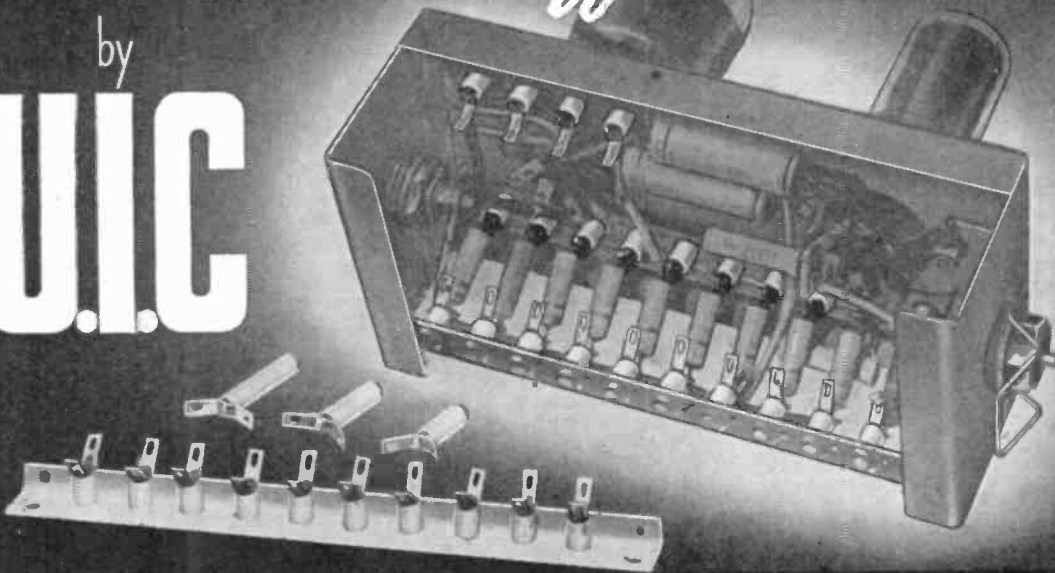

UNITED INSULATOR CO. LTD. OAKCROFT RD. TOLWORTH · SURBITON · SURREY
TELEPHONE: ELMBRIDGE 5241 CABLES: @ALANEL, SURBITON

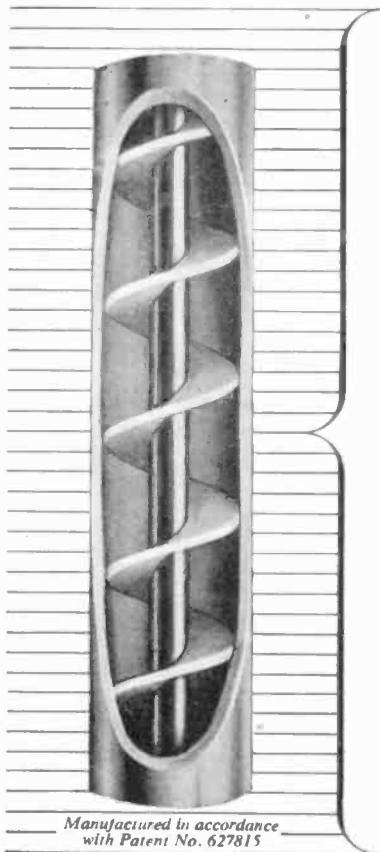

Manufactured in accordance
with Patent No. 627815

HELICAL MEMBRANE COAXIAL CABLES

The Helical Membrane cable was developed primarily for radio-frequency applications to provide a highly efficient construction which would not have the same frequency limitations as disc-spaced cables. The insulation is comprised of a thin Telcothene* tape spirally wound edge-on around the inner conductor. A practical method of achieving this basic form of the insulation was sought unsuccessfully for many years until Telcon succeeded in overcoming the difficulties involved. In the practical form which has been realised, the effective permittivity is as low as that of any commercial form of disc-spaced cable whilst tests indicate that an extremely high degree of uniformity has been achieved. In combination with an aluminium sheath as an outer conductor and a watertight covering, it has electrical characteristics closely approaching the optimum and yet is mechanically robust and reliable.

Full electrical and mechanical data of types available on request.

**Telcothene (Regd.) is polythene processed by Telcon to provide specific characteristics.*

TELCON **RF** cables



THE TELEGRAPH CONSTRUCTION & MAINTENANCE CO. LTD
Head Office: 22 Old Broad St., London, E.C.2. Tel: LONDON Wall 7104
Enquiries to: Telcon Works, Greenwich, S.E.10. Tel: GREENWICH 3291

LOW-INERTIA INTEGRATING MOTORS

Low-Inertia Integrating Motors are permanent magnet D.C. motors in which practically all factors likely to affect the linearity of the voltage/speed curve have been eliminated, e.g., friction, iron losses, brush-contact voltage drop. The resulting accuracy is such that they can be used to integrate minute voltages on a time basis. By using a suitable transducer, temperature difference, or any other quantity, can be converted into a voltage signal, which then enables the motor to integrate this figure over time.

Low-Inertia Integrating Motors can be used in instrument-type servo-mechanisms for driving light loads, for operating mechanical counters performing integration, or as a small power generator. The sensitivity of the motor is such that it will operate directly off a photo-cell or thermo-couple.

Available in 4 types: nominal voltages 1.5 V; 6 V; 12 V; 24 V. Larger models, having outputs of 10 watts and 100 watts, will shortly be available.

Comprehensive technical data forwarded on request

ELECTRO METHODS LTD. (Division M8), THE VALE, LONDON, N.W.11
Telephone: GLADSTONE 6611

MANUFACTURERS OF RELAYS, THERMOSTATS, EARTH PROTECTION EQUIPMENT AND SCIENTIFIC INSTRUMENTS

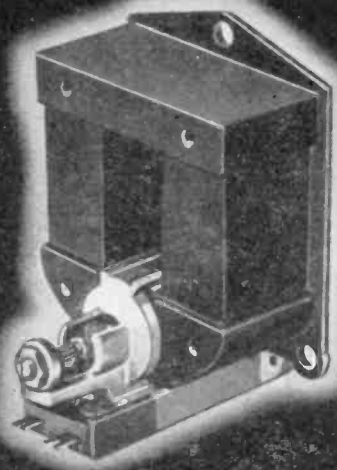



Glass-to-metal Seals

The present abnormal conditions of supply have placed increased emphasis on the correct choice of constructional materials. As an example, the Nilo range of nickel-iron alloys provides a range of compositions each having distinctive characteristics and developed to meet a specific requirement.

We believe that our revised publication, which includes tabular data on the properties of the various grades of alloy, together with examples of their industrial use, will prove a useful guide to the selection of the correct grade of material.

May we send you a copy?

HENRY WIGGIN & COMPANY LIMITED

Wiggin Street, Birmingham 16

36/11/5

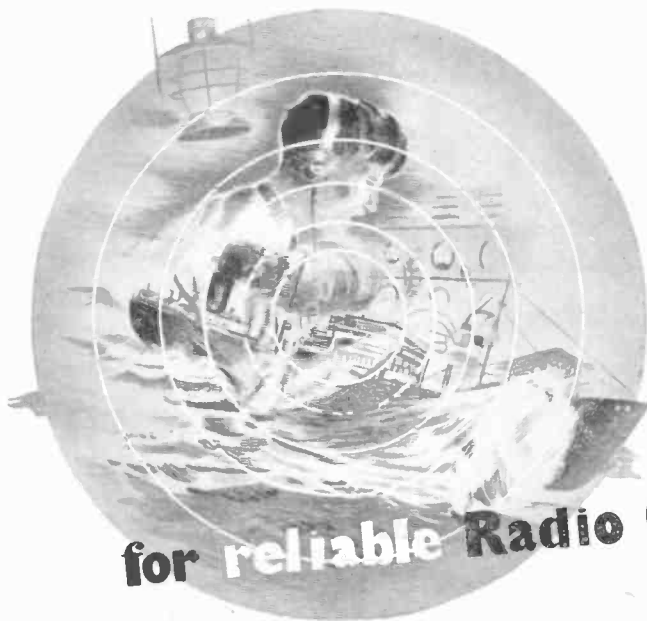

for reliable Radio Communications

YOU CAN'T BUY BETTER!

A COMPREHENSIVE RANGE OF UNITS
IS AVAILABLE COVERING ALL COMMUNICATION
REQUIREMENTS. ASK FOR LEAFLET Q.C. 5012 (R).

Be sure that the Quartz Crystal Units in your radio equipment are the best obtainable
for they are the most critical components!

SALFORD ELECTRICAL INSTRUMENTS LTD · SALFORD 3 · LANCs

A SUBSIDIARY OF THE GENERAL ELECTRIC CO. LTD. OF ENGLAND

Redifon . . .

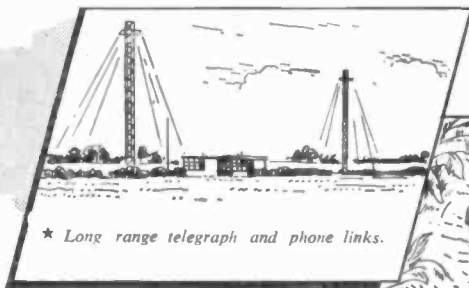

★ Long range telegraph and phone links.



★ Colonial Services.
Fixed and mobile stations.

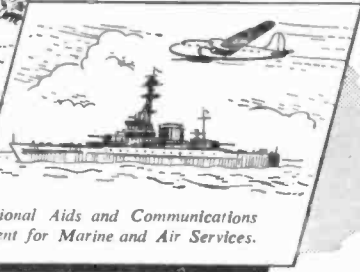

★ Navigational Aids and Communications
Equipment for Marine and Air Services.

spans the world

REDIFON LIMITED, Broomhill Road, London, S.W.18.

Designers & Manufacturers of Radio Communications & Industrial Electronic Equipment. Phone: VANdyke 7281.

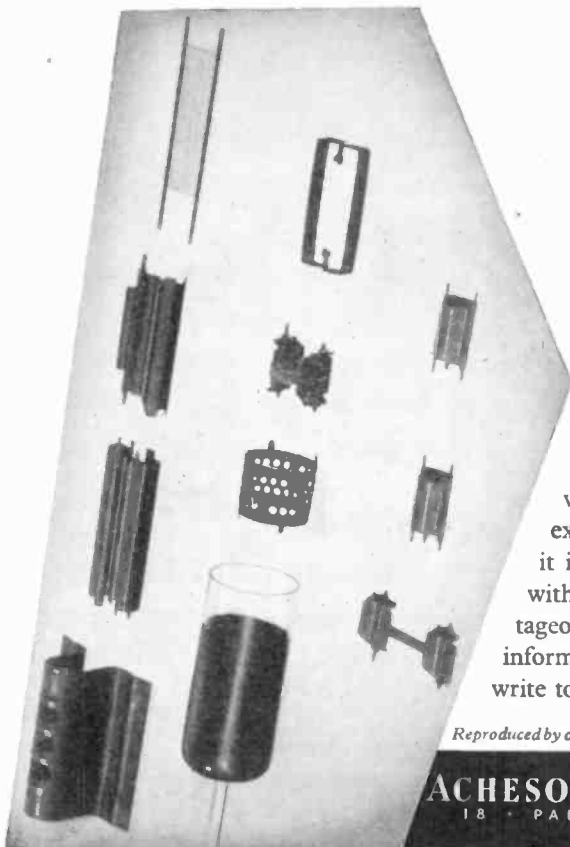

Secondary emission – and temperature – REDUCED

The film formed by 'dag' colloidal graphite is inert to electron bombardment and minimises secondary emission. These properties have led to the extensive use of 'dag' colloidal graphite for the treatment of valve grids and envelopes. The smooth graphite functions excellently as a 'black body'; therefore the substrate on which it is deposited is kept at a lower temperature than is the case with an untreated surface. The treatment is particularly advantageous when used on anodes. For full information on these and other applications write to Dept. D.18.

Reproduced by courtesy of The Edison Swan Electric Company Limited

ACHESON COLLOIDS LIMITED
18 · PALL MALL · LONDON · S.W.1



TAS/AC 6

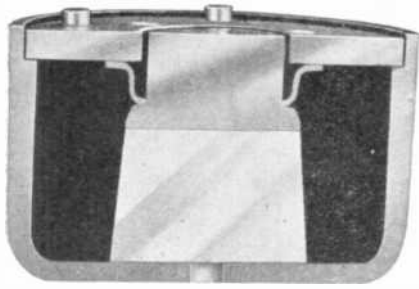

The most efficient method of using the high energy Permanent Magnet materials in the manufacture of Loud Speakers is shown in this illustration.

PERMANENT MAGNETS

A COMPLETE SERVICE —
ADVISORY AND SUPPLY —
FOR SPECIALISED INDUSTRIES



DARWINS LTD

TINSLEY · SHEFFIELD · 9

D27/A.

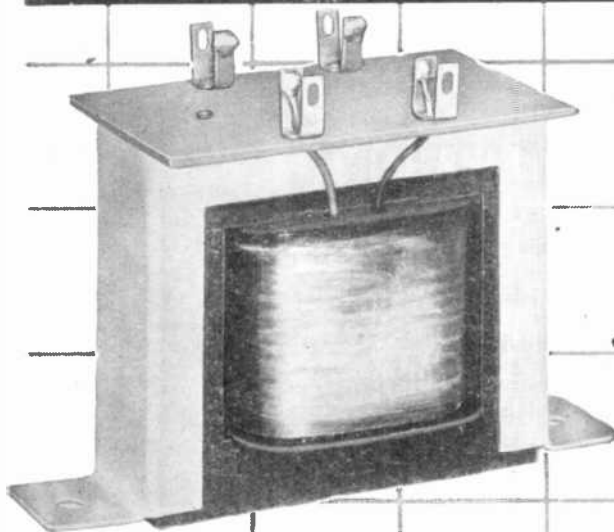

**Are you using a
transformer this size?**



**when this size might
do the job**



Miniaturization can simplify your production problems. Maybe it can widen your market too, by enabling selling costs to be reduced. If you are interested in Input, Output or Interval Transformers, or L.F. Chokes, between the sizes indicated, write for a copy of our comprehensive Brochure—Free and Post Free. Small or large quantities supplied at competitive prices.

Manufacturers of Miniaturized Electronic Instruments
JOHN BELL & CROYDEN

117 HIGH STREET, OXFORD

Telephone: Oxford 48362 & 47072

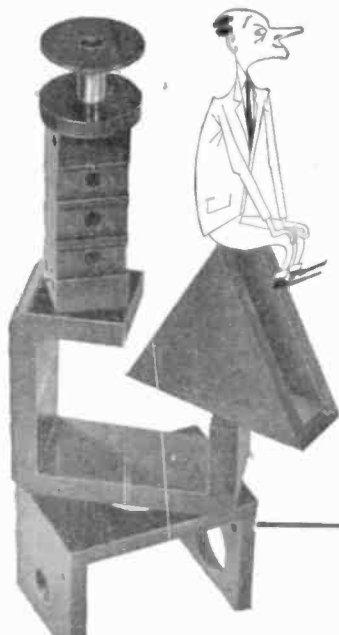

"We've built ourselves a high reputation

as manufacturers of Precision components in all types of Plastics".

Our advanced methods of

- MOULDING ● LAMINATING
- MACHINING ● FABRICATING

ensure a high degree of accuracy, economical prices and quick delivery.

Send us your plastic problems—our technical staff can offer valuable advice and assistance.



RESINOID & MICA PRODUCTS LTD

28 QUEEN ANNE'S GATE, WESTMINSTER, LONDON, S.W.1.

Telephone : WHITEHALL 8892

COLONIAL WORKS, MARY STREET, BALSALL HEATH, BIRMINGHAM, 12

Telephone : CALTHORPE 1303

WESTERN HOUSE, MIDLAND ROAD, BRISTOL, 2

Telephone : BRISTOL 22906

3226 V

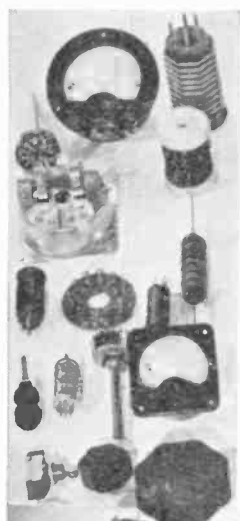

WEBB'S Radio

for

INDUSTRIAL ELECTRONIC SUPPLIES

'PHONE GERRARD 2089 for our "SAME DAY" Service

appreciated for 25 years by

Government Departments, Commercial Laboratories,
Research Establishments, Hospitals, etc.

Unrivalled Stocks of Components and Complete Apparatus

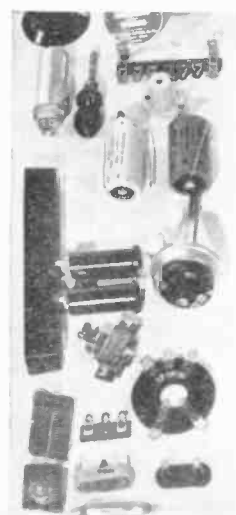

WEBB'S Radio

Telephone. GERRARD 2089

14, SOHO STREET, OXFORD STREET, LONDON W.1

Shop hours: 9-5.30. Sats: 9-1

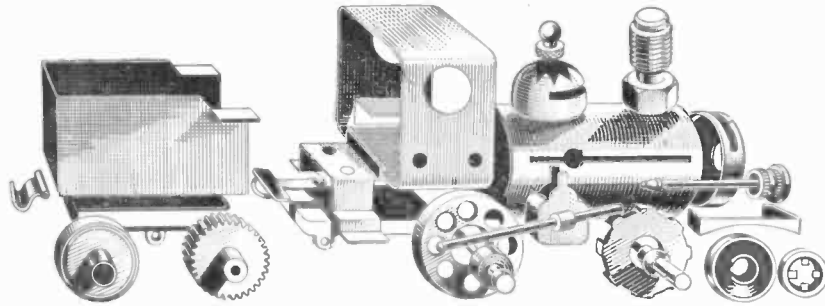

HIGH SPEED AUTOMATICS

Modern machinery and mass production methods give you top quality capstan and automatic work and sheet pressings at a price you are sure to like—and on time.

GRIFFITHS, GILBART, LLOYD & CO., LTD.,

EMPIRE WORKS

PARK ROAD

BIRMINGHAM 18

Tel.: NORthern 2132/4.





Manufacturers of Ammeters, Voltmeters, Ohmmeters, Wattmeters and frequency meters for switchboard or portable use.

MULTI-RANGE TEST SET SERIES 100

The universal testing set for Service Engineers. Sensitivity—10,000 ohms per volt. Strong metal case with carrying handle, complete with leads having detachable bulldog clips and test prods. Size 9 x 5½ x 4 ins.

MEASURING INSTRUMENTS (PULLIN) LTD.
 Electrin Works, Winchester St., Lcncon, W.3
 Tel.: ACOrn 4651/3 & 4395.



RANGES

AC/DC VOLTS: 10, 25, 100, 250, 500, 1,000.

DC MILLIAMPS: 2.5, 10, 25, 100, 500.

AC/DC MICROAMPS: 100 Microamps 10v range.

RESISTANCE RANGES: 0/1 Meg (13,500 ohms mid-scale) 0/10,000 ohms (135 ohms mid-scale).

ALL-POWER

REGULATED POWER SUPPLIES

Semi-standard designs are available covering output voltages from 0.1 to 2,000 volts and output currents from 1mA to 10 amps.

Special Units can be made to any Specification, and although the demand for our products is continually increasing we can still offer reasonably prompt delivery.



ALL-POWER TRANSFORMERS LTD.
CHERTSEY ROAD, BYFLEET, SURREY.

TEL: BYFLEET 3224.

REDUCE YOUR PRESS TOOL COSTS

THE HUNTON UNIVERSAL BOLSTER OUTFIT FOR SHEET METAL PIERCING AND BLANKING ON FLY PRESSES

Bolster Frame with 2 adjustable gauges and insertable steel Holders for Dies $\frac{1}{2}$ in. to $3\frac{1}{2}$ in. bore diameter.

Two Punch Holders with detachable positive-action Strippers take the complete range of Punches $\frac{1}{2}$ in. to $3\frac{1}{2}$ in. diameter.

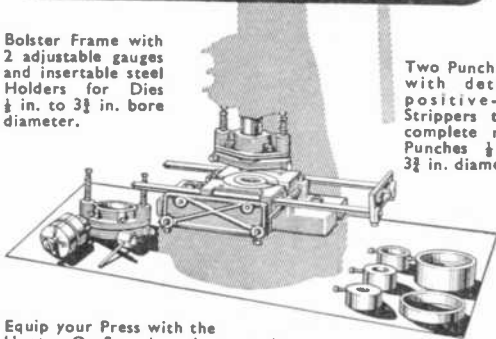

Equip your Press with the Hunton Outfit and use inexpensive standardised Punches and Dies $\frac{1}{2}$ in. to $3\frac{1}{2}$ in. diameter obtainable from stock—in $\frac{1}{8}$ in. sizes—when you need them. Standardised Tools also available at short notice for Square, Oblong and other shapes, Louvre Forming (up to 8 in. long), Corner Notching, Corner Radiusing, Angle Iron Notching and Piercing, etc. Get the Outfit now—Buy Punches, Dies and tools as you need them

Descriptive brochure and prices on request.

HUNTON LIMITED

Phoenix Works, 114-116, Euston Road, London, N.W.1
Telephone: Euston 1477 Telegrams: Untonexh, London

Dept. E.E.

18 TOTTENHAM COURT ROAD, LONDON, W.1.

Tel.: MUSEum 2453/4539

Business Hours: Monday-Friday 9—5.30

Saturday 9—1

RELAYS

D.C. COIL RESISTANCE

3,000 TYPES: 1.9Ω to $80,000\Omega$
600 TYPES: 0.4Ω to $9,200\Omega$.

ALSO LARGE STOCKS OF DOUBLE & TRIPLEWOUND AND SLUGGED COILS.

CONTACTS

3,000 TYPES: up to 8 sets.
600 TYPES: up to 4 sets.
3,000 TYPES: Make (M), Break (B), in Twin-silver, Twin-platinum, Dome-silver (2 amp.), Tungsten (5 amp.), and Flat-silver (8 amp.), Change-Over (C), in all but Tungsten: Make-Before-Break (K), in Twin-silver and Twin-platinum.

600 TYPES: (M), (B) and (C), in Twin-silver and Twin-platinum.

SPECIAL High resistance slugged coils (up to 10,000 OHMS with 1" slug) now available.

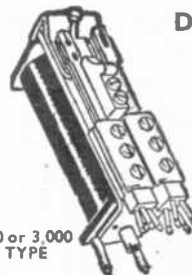

600 or 3,000 TYPE

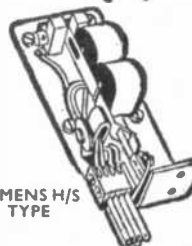

SIEMENS H/S TYPE

ALWAYS "FIT"



SUSPENSION DRAWER SLIDES, SUN and PLANET FRICTION ELIMINATORS and SHEAVES.

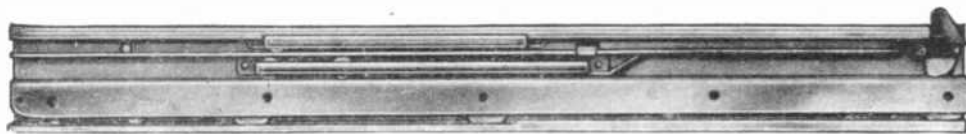

Type A Slides as above supplied in 15 $\frac{1}{8}$ ", 17 $\frac{1}{8}$ ", 21", 23 $\frac{1}{8}$ ", 25 $\frac{1}{4}$ " and 27 $\frac{1}{4}$ " lengths. Heavy type A Slides supplied in lengths 23 $\frac{1}{8}$ ", 28 $\frac{1}{4}$ ", 32" and 37". Type A series case strips may be drilled and countersunk or provided with ears or lugs.



Two arm Type B Slides supplied in 23 $\frac{1}{8}$ " lengths down to 9" lengths. 13 gauge Heavy Type B Slides in lengths up to 30".

We also supply heavy duty castors up to 30 tons capacity each, including twin pneumatic wheeled types up to 44" diameter.

OVER 7,000 TYPES AVAILABLE

Ask for Brochure.

Engineers, Patentees and Sole Manufacturers

AUTOSSET (PRODUCTION) LTD., DEPT. O, Stour St., Birmingham, 18.

Phone : EDG 1143/4.

Est. over 30 years.

Please mention "Electronic Engineering."

AT 3

Two outstanding advantages . .



• This bridge not only measures balanced or unbalanced impedances with equal facility, but also has the merit of extremely low impedances looking back into the terminals and from the terminals to ground. It provides, at radio frequencies, the range, flexibility and stability of an audio-frequency impedance bridge and, having a neutral terminal available, it permits the measurement of three-terminal networks. A high degree of accuracy is maintained throughout the full frequency range.

RADIO FREQUENCY BRIDGE B 601

Capacity: 0.01 pf. to 20,000 pf. in five ranges.
Resistance: 10 ohms to 10 megohms—6 ranges.
Inductance values which will resonate the above capacities between 15 Kc/s and 5 Mc/s.
Direct reading accuracy is constant to within 1% up to 3 Mc/s and may fall to 2% at 5 Mc/s.

Wayne  Kerr

THE WAYNE KERR LABORATORIES LIMITED, NEW MALDEN, SURREY · MALDEN 2202

**WE DESIGN
AND MAKE
ELECTRONIC
INSTRUMENT
HOUSINGS**

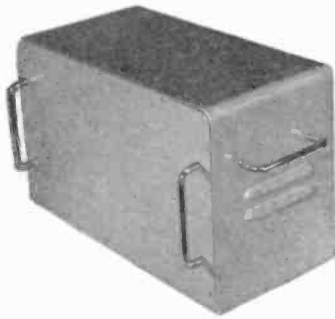

We are the leading independent manufacturers of cabinets for all types of electronic equipment. We specialize in prototypes and bulk production and also manufacture a comprehensive range of standard cases and racks, available from stock. Write for illustrated catalogue to

IMHOF'S

ALFRED IMHOF LTD., 112-116 New Oxford St., London, W.C.1

Telephone: MUSEUM 7878.

A Practical Test

A cold advertisement with its printed claims is all very well as an introduction to a product, but how much better a practical test of a manufactured characteristic.

Over 3,000 people passed through our demonstration room at the recent Northern Radio Show held in Manchester. At the end of each demonstration period we received a round of spontaneous applause denoting the obvious pleasure that good quality reproduction can afford to the receptive ear.

It is not often that the general public is given the opportunity of such a demonstration, and indeed seldom that a printed claim can be adequately proved to the entire satisfaction of all concerned.

At this year's 'Radio Earls Court' we of the House of Goodmans once again have the pleasure of presenting for your enjoyment a practical demonstration of our High Fidelity Reproducers.

The reproducers demonstrated will include the well-known Axiom series in modified form and, of recent design, two special high fidelity 8" units—Axiom 101 and 102.

We look forward to the pleasure of your company. Remember—Demonstration Room No. D.7 and Stand 41, Earls Court, August 26 to September 6, 1952.

AXIOM is a registered trade mark and denotes our High Fidelity Range of reproducers.

AUDIOM is the registered trade mark that is applied to our good quality commercial reproducers.

GOODMANS is the registered trade mark of all the Company's products

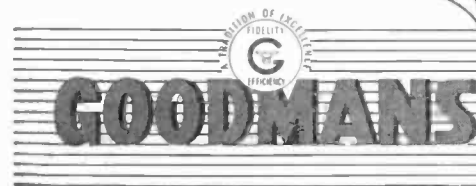

GOODMANS INDUSTRIES LIMITED

Axiom Works, Wembley, Middlesex

Telephone: WEMbley 1200 (8 lines)

VACUUM COATING *for* ELECTRONIC DEVICES

- METAL RECTIFIERS
- RADIATION DETECTORS
- PRECISION RESISTORS
- BARRIER LAYER PHOTO-CELLS
- ALUMINISING C.R. TUBES
- FREQUENCY ADJUSTMENT OF H.F. CRYSTALS
- METALLISED CONDENSER PAPERS
- RADAR ATTENUATORS • DIAPHRAGMS

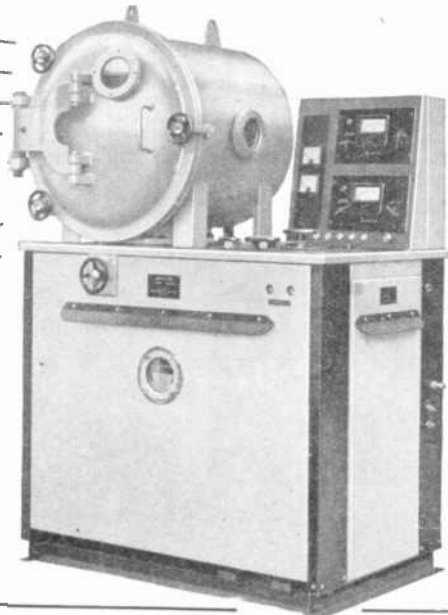

The development of vacuum coating technique has revealed tremendous possibilities in manufacturing methods and in the development of new products.

Many delicate electronic devices, vital today but considered impossible only a few years ago, are now being manufactured and prepared by routine coating methods.

MAY WE ADVISE YOU?

for better vacuum service

W. EDWARDS

& CO. (LONDON) LTD., LONDON, S.E.26

(8 lines) Grams: Edcohvav, Souphone, London

Pretoria Automatic COIL WINDING MACHINE

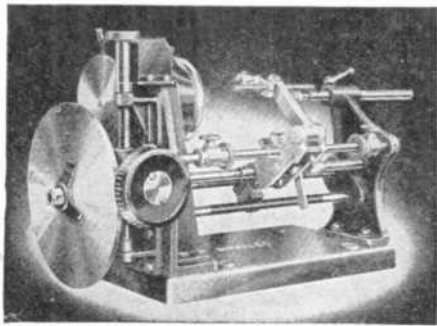

THE PRETORIA is the ideal motor-driven machine for maintenance departments and repair workshops. It winds various types of coils from $\frac{1}{8}$ " to 6" in length and up to a maximum diameter of 5" with wires ranging from 22 to 48 S.W.G.

Many refinements are embodied previously obtainable on only elaborate machines.

NEVILLE'S (LIVERPOOL) LTD.

A Subsidiary of Aeronautical and General Instruments Ltd,
PURLEY WAY, CROYDON, ENGLAND.
Phone: THOrnton 3211. Cables: "Instradio, Croydon"



ABOVE ALL OTHERS

■ POTTED AND COMPOUND FILLED TRANSFORMERS AND CHOKES

made by Woden are the answer when the call is for transformers to operate under exacting industrial conditions, coupled with adverse climatic conditions.

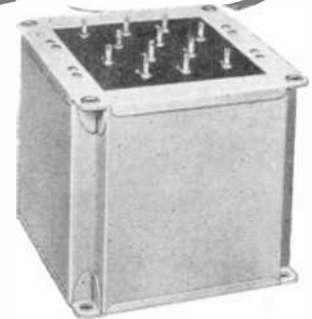

Every transformer leaving our factory is subjected to a rigid inspection, and is fully impregnated with moisture proof filling compound by the latest vacuum and pressure process. The fact that "WODEN" are the choice of many leading radio and television manufacturers is proof enough of the quality of our products.

Please send for latest Catalogue.

WODEN TRANSFORMER CO LTD

MOXLEY ROAD, BILSTON, STAFFS.

TELEPHONE: BILSTON 41959

Precision Pressings

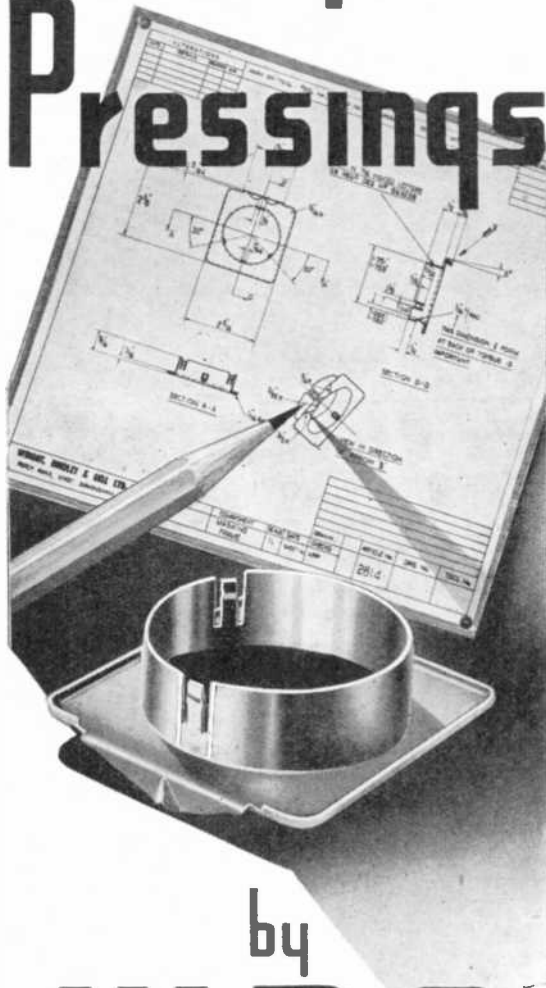

by
W-B-G

IN ALL METALS FOR ALL INDUSTRIES

WRIGHT, BINDLEY & GELL LIMITED
GREET
BIRMINGHAM, II
TELEPHONE VICTORIA 2295(6/7) lines
TELEGRAMS BINDLEY, B'HAM, II

TOGGLE SWITCHES OF SUPREME QUALITY

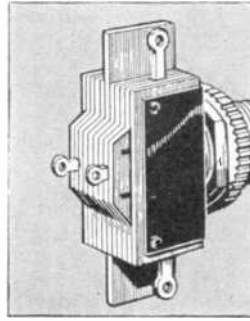

Our miniature "Q.M.B." Toggle Switches have sold literally in millions over the past 30 years. The satisfaction which these switches are giving in regular service is the reason for the continued demand. Other patterns of switches are also offered—the best of their respective types. Prices are very reasonable and delivery can be made promptly. Send now for our 12-page catalogue S-48.

CLAUDE LYONS LTD

ELECTRICAL & RADIO LABORATORY APPARATUS
180 Tottenham Court Road, London, W.1. Tel: MUS 3025



STOCKISTS OF

BX

POLYSTYRENE

A first-class rigid insulating material, supplied in sheets and rods in a range of thicknesses and diameters ex stock.

Information and guidance on manipulation, machining and cementing available on request.

MILTOID LTD.

34/36 Royal College Street, London, N.W.1.
'Phone : EUSton 6467. 'Grams : Celudol, Norwest, London



*Pioneers and specialists
in Small Valves*

SUBMINIATURES
MINIATURES
MIDGETS
GAS TRIODES
ELECTROMETERS
COLD CATHODE
TUBES

HIVAC LTD

GREENHILL CRESCENT, HARROW-ON-THE-HILL,
MIDDLESEX.

Telephone: HARrow 2655

**DONOVAN
ACCESSORIES**
for the
**ELECTRONIC
APPARATUS
MANUFACTURER**

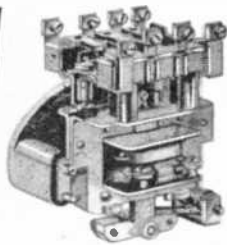

Type A.11 A.C. POWER
RELAY—4-pole with N.O.
or N.C. contacts.

TYPE J.96 TERMINAL BLOCKS

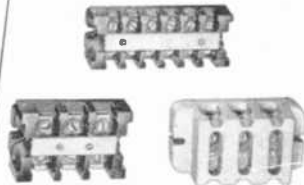

Made in 15, 30 and
60 amp. sizes.



Type C.30 PUSH BUTTON UNIT
arranged for mounting on
customers' own cover plate.

THE DONOVAN ELECTRICAL CO. LTD.
Safuse Works · Stechford · Birmingham, 9.

EGEN

first and foremost!

Egen Potentiometers are recognised everywhere for their dependability and are constantly being specified by radio and electronic engineers. A specialised carbon deposition guarantees perfect electrical stability. Note these features:—

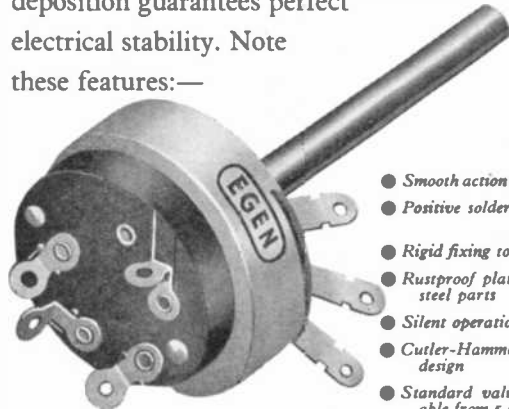

- Smooth action movement
- Positive solder tag location
- Rigid fixing to chassis
- Rustproof plating of all steel parts
- Silent operation
- Cutler-Hammer switch design
- Standard values available from 5,000 ohms. to 2 megohms.

Egen Potentiometers are also available with single pole or double pole switch and without switch. Switches only supplied separately if required.

PRE-SET RESISTORS.
A wire-wound pre-set resistor for panel or chassis mounting; Multi-unit banks available to special order.

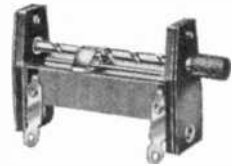

SUB MINIATURE VOLUME CONTROL
For use in Deaf Aids and other miniature electronic apparatus.

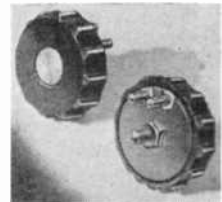

Overall diameter less than 1"

Export enquiries welcomed



EGEN ELECTRIC LTD

Charfleet Industrial Estate, Canvey Island, Essex. 'Phone: Canvey 691 & 2

GUIDED WEAPON RESEARCH

DE HAVILLAND PROPELLERS LTD. require technicians for a Research Laboratory now being set up. The project is one which offers exceptional opportunities to physicists and to electronic, servo and instrument engineers and is unique in type and variety of research work involved. Senior and junior posts are available all offering good security and excellent conditions of employment.

- A Senior Physicists with a wide range of interests for employment as group leaders in a team of research workers. Applicants should possess a good honours degree and should have some industrial experience.
- B Physicists with a good degree as research workers for field and laboratory tests.
- C Servo engineers with previous practical experience of servo mechanisms.
- D Electronic engineers for circuit development and for exploitation of miniature and sub-miniature techniques, and for work on magnetic amplifiers and associated equipment.
- E Instrument engineers having experience of electro-mechanical instruments, i.e., gyros, small specialised motors, relays, etc.
- F Laboratory assistants, City and Guilds, N.H.C., etc. for work in various capacities.

Application, giving age, education, academic qualifications, experience and quoting reference of position sought should be addressed to ;—

The Personnel Manager
DE HAVILLAND PROPELLERS LTD.
Manor Road, Hatfield, Herts.
or call at any Labour Exchange

REQUIRED IMMEDIATELY FOR HIGHLY IMPORTANT GUIDED WEAPON RESEARCH AND DEVELOPMENT

- G B.Sc. standard personnel for work on Supersonic Aerodynamics, Servomechanism Theory and Trajectory Prediction.
- H Technical Assistants of Higher National or Inter. B.Sc. standard for work on same subjects.
- J Computers—Matriculation or General School Certificate standard with aptitude for mathematics.

Applications for these interesting permanent and progressive posts should be addressed to :—

The Personnel Manager
DE HAVILLAND PROPELLERS LTD.
Manor Road, Hatfield, Herts.
or apply to any Labour Exchange
Please quote reference of position sought

GUIDED WEAPONS DEVELOPMENT ENGINEERS

Applications are invited from young men keen to join a rapidly expanding organization. There are vacancies concerned with structures, electro-hydraulic accessories and hydraulics. Appointments are permanent and progressive.

Applicants should preferably be of degree standard or have some experience in the above work.

Please write full details of age, education, academic qualifications and experience, quoting "DE" to :—

The Personnel Manager
DE HAVILLAND PROPELLERS LTD.
Manor Road, Hatfield, Herts.
or apply to any Employment Exchange



Graham Gear Co Ltd

SPURS
SPIRALS
BEVELS
8-100 D.P.

**STATION ROAD
BROOKMANS PARK, HERTS.
Tel:- HATFIELD 3130**



*... It's surprising
where you find them*

The list of "Castle" Components knows no limit. Whatever your needs may be — in Repetition work in all Metals — we can meet them exactly. Machining and Light Assemblies, too. *Send for brochure.*



**THE
CASTLE ENGINEERING
COMPANY (NOTTINGHAM) LIMITED**

HASLAM STREET · CASTLE BOULEVARD · NOTTINGHAM

6133B

POWER Transformers



10VA to 100kVA Open,
Enclosed, Oil Cooled,
D.W. and Auto

For Industrial Engineering,
Furnaces, Electronics, Phase
Conversion, etc.

THE TRANSFORMER & ELECTRICAL CO. LTD.

Eastern Works, Walthamstow, London, E.17

Phone: KEYstone 5031/2



HIFI LTD., 150, HIGH STREET, LYE,
STOURBRIDGE, WORCS. Telephone: LYE 2el

BRADMATIC LTD.

MAGNETIC TAPE RECORDING EQUIPMENT

Bradmaster Model 5 Tape Desk

- Built to professional standards.
- Two speeds—3½ and 7½ inches per second.
- Easily adjusted for single or twin track recordings.
- Fast wind and rewind—full reel rewound in 1½ minutes.
- Heavy alloy flywheel Freedom from "wow" and "flutter."
- Double servo brakes on each hub.
- Push Button control.
- Three heavy duty motors.
- Three shielded Bradmatic heads.
- Size: 13½ in. x 15½ in. x 6½ in. deep.

Price **£41** (fitted with 5 R.P. heads)
or with 6 R.P. heads **£42**

PORTABLE RECORDERS

In rexine covered case, fitted with model 5 Tape Desk (6RP heads) and C.J.R. Type D.1 amplifier with monitoring. Provision for external loudspeaker. Complete with microphone and leads.

PRICE: £114

High Fidelity Sound Heads:—

Type 5RP (record/play), ££3 5 0.

Type 5E (erase) £3 5 0.

Type 6RP (super fidelity), £15 0.

Oscillator Coils, Screening Cans, E.M.I., Scotch Boy and G.E.C. tape, amplifiers and microphones.

Trade supplied. Send for lists.

BRADMATIC LIMITED

STATION ROAD · ASTON · BIRMINGHAM 6

Phone: EAST 0574. Grams: Bradmatic, Birmingham.

now available!

THE BPL UNIVERSAL TEST SET

20,000 Ohms/Volt

- * Leather carrying handle
- * Mirror Scale
- * 20,000 ohms per volt for D.C. and A.C.
- * Two ohms ranges operated from large internal battery.

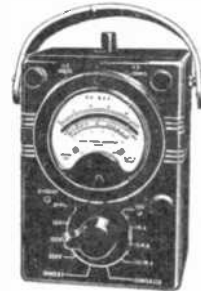

- * Captive head terminal connectors for all ranges.
- * Easy to read 2 colour dial
- * Rotary switch selects ranges clearly marked.
- * Solid bakelite moulded case

FOR ACCURATE LOW RESISTANCE MEASUREMENT

Primarily designed for the easy servicing of all electronic and electrical appliances, radio sets and motor cars. The electrician and the radio engineer will appreciate the provision of two ohms ranges enabling accurate measurement of low resistance as experienced in testing electric fires, motors, windings of transformers, switches, fuses, electric irons, radio tuning coils, etc.

LIST PRICE
£11 10/0 including test leads.
Subject to Trade Discount.

Also Supplied:
B.P.L. Super Rangers and
O.C. Test sets

LONDON STOCKIST:

M.R. SUPPLIES LTD., 68 New Oxford Street, W.C.1.

BRITISH PHYSICAL LABORATORIES

HOUSEBOAT WORKS · RADLETT · HERTS

Telephone: RADLETT 5674-5-6

ELECTRONIC ENGINEERING

Consult us on all cooling problems associated with Electronic Developments.

We are specialists in direct and indirect cooling with high pressure fans and blowers.

GAMACK BROWNE LTD. — ENGINEERS
140 - PARK LANE - LONDON, W.1.

Telephone: MAYfair 4374/5.

TECHNICAL BOOKS

H. K. LEWIS & Co. Ltd., invite inspection of their stock of books on all branches of Radio and Electrical Engineering. Catalogue on request.

LENDING LIBRARY : Technical and Scientific.
Annual Subscription from TWENTY-FIVE SHILLINGS

Prospectus Post Free on Request.

THE LIBRARY CATALOGUE revised to December 1949, containing a classified Index of Authors and Subjects. To subscribers, 17s. 6d. net. To non-subscribers 35s. net. Postage 1s. 3d.

LONDON: H. K. LEWIS & Co. Ltd., 136 Gower St., W.C.1
Telephone: EUSton 4282 (7 lines)

MULTIPLE OBSERVATION

of

Electrical Phenomena on a Conventional Single Beam Oscilloscope.

By using switch unit type 2 up to 4 different electrical waveforms can be observed simultaneously.

No distortion. D.C. response.

Independent shift and gain controls available as additional facilities.

Various models from £10 10s. 0d.

ALEXANDER EQUIPMENT LTD.
1-5, Childs Place, Earls Court, London, S.W.5.
Telephone: FRObisher 6762

SUCCESS?

The demand for qualified technicians to fill well-paid industrial posts grows daily. An E.M.I. course of training is your quickest way to a key position. Our Home Study courses cover all the subjects listed below. As part of the great E.M.I. Group ("H.M.V.", Marconiphone, etc.), we have first-hand knowledge of the technical training required in modern industry. No other college can offer you such a practical background of industrial experience.

POST THIS COUPON NOW—

E.M.I. INSTITUTES, Postal Division, Dept. 11, 43, Grove Park Rd., Chiswick, London, W.4. Please send, without obligation, your FREE BROCHURE. I have marked the subjects which interest me.

Mech. Eng. Elect. Eng. Draughtsmanship Radio Television
 Production Eng. Auto. Eng. Aeronautical Eng. Civil Service
 General Cert. of Education (Matric). Also Courses for A.M.I. Mech.E., A.M.I.C.E., A.M.Brit.I.R.E. A.F.R.Ae.S., CITY and GUILDS EXAMS. in Mech. Eng., Elect. Eng., Telecommunications, etc.

NAME _____
ADDRESS _____

E.M.I. INSTITUTES — The College backed by an Industry I.C.S.

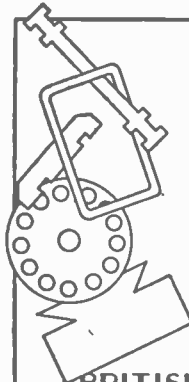

MICA

DISCS
DIAPHRAGMS
ELEMENT STRIPS
CONDENSER PLATES
SPECIAL SHAPES
RAW MICA
WASHERS
etc

BRITISH MICA CO LTD - BEDFORD.

WE TALK YOUR LANGUAGE
when it comes to TRANSFORMERS

- * designed for standard & special applications.
- * built for reliability.
- * engineered for trouble-free operation.



TRANSFORMERS BY *Amos of Exeter* A.I.D. APPROVED
AMOS OF EXETER LTD WORKS COMICK STREET, EXETER.

POWER LIGHT-SENSITIVE CELLS

Selenium on gold-alloy, non-polarised, super-sensitive, gasfilled, permanent, operate any inexpensive robust moving-iron Relay on exposure to Light, direct without a Valve Amplifier. They are working off A.C. or D.C. in several important Industries and have many as yet unexplored commercial possibilities.

Illustrated descriptive List free

CEFA INSTRUMENTS
30 CAXTON ROAD, SHEPHERDS BUSH, LONDON, W.12.

LAMALAC INSULATION

SYNTHETIC RESIN LAMINATED MATERIALS

Sheet, Rod and Tube in all dimensions, Bobbins & Coil Formers to any specification

MICA AND MICANITE SHEET AND MANUFACTURED PARTS

MICA & MICANITE SUPPLIES LTD.,
BARNSBURY SQUARE, LONDON, N.1.

Phone: NORth 3032/5 Grams: MICASULIM, LONDON

**BRASS, COPPER, BRONZE,
ALUMINIUM, LIGHT ALLOYS**
IN [ROD, BAR, SHEET TUBE, STRIP, WIRE

3000 STANDARD STOCK SIZES

H. ROLLET & CO., LTD.

6, CHESHAM PLACE, LONDON, S.W.1.

SLOane 3463

WORKS:

36, ROSEBERY AVENUE, LONDON, E.C.1.

"No Quantity too Small"

also at

Liverpool • Manchester • Birmingham • Leeds

L. WILKINSON WHOLESALE AND EXPORT
19, LANSDOWNE ROAD, CROYDON

Phone: CRO 0839

Telegram: "WILCO" CROYDON

AVAILABLE FROM STOCK

500 Aircraft Compasses, P.10
470 Contactors, American
30,000 Glass Cartridge Fuses,
5 amp., 5C/515
4,800 Glass Insulators, Dome
Type 10B/8093
80,000 Breeze Plugs and Sockets
150 Portable Electric Blowers,
230 V., 220W.
80,000 yds. UNICEL 4
77,000 yds. UNICEL 19
30,000 yds. TRICEL 4
12,000 yds. QUINCEL 7

8,000 Selenium Rectifiers
60,000 Pye Co-Axial Sockets
1,000 Snydlok Fuses, 100 amp.
80,000 Telephone Jack Sockets
42,000 ft. Capillary Tubing.
44 Signal Generators 20/88
M/cs.
1,000 Thermo-couple units,
Type 8, 10AB/4604
100 Klaxon geared Induction
Motors, 220/240 volts. 175 r.p.m.,
torque 15 lbs. ins.No. 1K5SB3.W7
£10 each

The above are a few items from our stocks. We can also supply P.O. Relays, type 3000, built up to your requirements, Snydlok Fuses, Key Switches, Uniselector Switches, Santon, Arrow, "Diamond H" Switches, Oak, etc., in many types. P.O. Standard 19 in. Racks, Tanny 50 watt Rack-mounted Amplifiers, etc., etc. Lists now available.

**'Radiospares'
Quality Parts**

*The
Service Engineer's
First Choice*

SINE-COSINE POTENTIOMETERS—10,000 ohms centre tapped, rectangular card type, direct drive to card, 60 : 1 reduction drive to sine and cosine outputs. Oil immersed for long life. A precision instrument of the highest accuracy at a fraction of current price. New, in makers cartons £3.10.0 each.

WE ALSO HAVE LARGE STOCKS OF MAGSLIPS, SELSYNS, IPOTS, BALL AND PLATE INTEGRATORS, SERVO MOTORS AND OTHER TYPES OF EQUIPMENT FOR COMPUTATION REMOTE INDICATION, REMOTE POWER CONTROL AND SERVO CONTROL PURPOSES.

Write for copies of our current brochure and price lists.

24v Klaxon Motors, 1/20 h.p. 2,500 r.p.m., shunt wound, continuous rating new, 35/- each.

Electrolytic Capacitors, 32uF 450v. wkg., rectangular metal can 3/6 each. £4.15.0 per case of 30 capacitors.

Potentiometers, 5 ohm, 10 watt 4/- each.

Wire wound Resistors, 10,000 ohm 5 watt, 1/6 each.

SERVOTRONIC SALES

INCORPORATING HOPTON RADIO

1, HOPTON PARADE, HIGH ROAD, STREATHAM,
LONDON, S.W.16 STReatham 616S.



**RELAYS
AND
KEY SWITCHES**

LARGEST EX-GOVT. STOCK IN GT. BRITAIN

Types 600-3000 Relays — Siemens High Speed
Also A.C. 250 volts 50 cycles

Uniselector Switches, Telephone Switchboards, Telephone Components,
Plugs, Jacks, Handsets — Government Contractors.

JACK DAVIS (RELAYS) LTD. (Dept. E.E.)

36 PERCY STREET, LONDON, W.1

Phones: MUSeum 7960, LANgham 4821

"SPEARETTE"

MINIATURE VALVE.



WIRING JIGS

SPEAR ENGINEERING CO. LTD.
TITAN WORKS, WARLINGHAM, SURREY.

Telephone: Upper Warlingham 2774.

**THE LATEST in
AIR DIELECTRIC TRIMMERS**

Encased in acetate container for extra protection

Width: 16.5 m/m. Length:
22 m/m. Height: 1.5 to 8pF—
7.5 m/m. 1.5 to 20pF—10
m/m. 2 to 26pF—11 m/m. 2
to 32pF—12 m/m. Low:
Straight line capacity. Power
Factor: Less than .001. Insu-
lation: over 2000 megohms.
Voltage: 500 D.

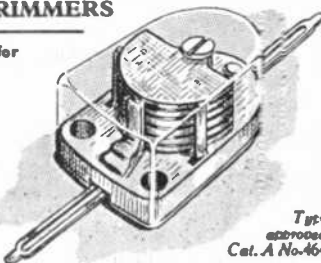

Type approved
Cat. A No.464

OXLEY DEVELOPMENTS CO. LTD.

ULVERSTON, NORTH LANCs. TEL: ULVERSTON 3306



POTENTIOMETERS

Wire-wound and Composition types. Single, Ganged, Tandem Units. Characteristics: linear, log., semi-log., non-inductive, etc. Full details on request.

RELIANCE
RELIANCE MNFG., CO. (SOUTHWARK), LTD.,
SUTHERLAND ROAD, HIGHAM HILL, WALTHAMSTOW, E.17.

Telephone: Lark:wood 3245

INDEX TO ADVERTISERS

A.B. Metal Products Ltd.	12	Edwards & Co. (London), Ltd., W.	51	Nagard Ltd.	39
Acheson Colloids Ltd.	44	Egen Electric Ltd.	53	Neville's (Liverpool) Ltd.	51
Air Control Installation Ltd.	32	Electro-Alloys Ltd.	58	N.S.F. Ltd.	14
Airmec Laboratories Ltd.	36	Electro-Methods Ltd.	42	Oxley Developments Ltd.	57
Alexander Equipment Ltd.	56	Electronic Engineering Monographs	383	Painton & Co., Ltd.	5
All-Power Transformers Ltd.	48	E.M.I. Institutes Ltd.	56	Parmeko Ltd.	29
Amos of Exeter	56	Erie Resistor Ltd.	25	Partridge Transformers Ltd.	8
Automatic Telephone & Electric Co., Ltd.	35	Evershed & Vignoles Ltd.	24	Radiospares Ltd.	57
Autoset (Production) Ltd.	49	Ferranti Ltd.	23	Redifon Ltd.	44
Baker Platinum Ltd.	20	Frigidaire Division of General Motors Ltd.	40	Reliance Mfg. (Southwark) Ltd.	57
Bell & Croyden, John	45	Furzehill Laboratories Ltd.	19	Resinoid & Mica Products Ltd.	46
Belling & Lee Ltd.	34	Garrard Engineering & Mfg. Co., Ltd., The	26	Rivlin Instruments	13
Bradmatic Ltd.	55	General Electric Co., Ltd., The	11	Rollet & Co., Ltd.	57
Bray & Co. Ltd., George	58	Goodmans Industries Ltd.	50	Salford Electrical Instruments Ltd.	43
British Electric Resistance Co., Ltd.	37	Graham Gear Co., Ltd.	54	Savage Ltd., W. Bryan	41
British Insulated Callenders Cables Ltd.	Cover i	Griffiths, Gilbert, Lloyd & Co., Ltd.	47	Scott & Co., Ltd., A. C.	26
British Manufactured Bearings Co., Ltd.	Cover iii	Hifi Ltd.	55	Servotronic Sales	57
British Mica Co., Ltd.	56	Hivac Ltd.	53	Spear Engineering Co., Ltd.	57
British Physical Laboratories Ltd.	55	Hunton & Co., Ltd.	48	Standard Telephones & Cables Ltd. 21 and 31	
Camack Browne Ltd.	56	Imhof Ltd., Alfred	50	Taylor Tunncliffe (Refractories Ltd.)	15
Castle Engineering Co. (Nottingham) Ltd.	55	Johnson, Matthey & Co., Ltd.	3	Telegraph Construction & Maintenance Co., Ltd., The	42
Cefa Instruments	56	Lewis & Co., Ltd., H. K.	56	Transformer & Electrical Co., Ltd., The	55
Chapman & Hall Ltd.	383	Linread Ltd.	16	Tufnol Ltd.	9
Cinema-Television Ltd.	17	Lyons Ltd., Claude	52	United Insulator Ltd.	41
Connolly's (Blackley) Ltd.	27	Marconi Instruments Ltd.	33	Viscose Development Co., Ltd.	7
Cossor Ltd., A. C.	28	Marconi's Wireless Telegraph Co., Ltd.	18	Vortexion Ltd.	38
Darwin's Ltd.	45	Measuring Instruments (Pullin) Ltd.	47	Wayne-Kerr Laboratories Ltd.	49
Davis Supplies Ltd., Alec	48	Metropolitan-Vickers Electrical Co., Ltd.	10	Webb's Radio	46
Davis (Relays) Ltd., Jack	57	Mica & Micanite Supplies Ltd.	56	Wiggin & Co., Ltd., Henry	43
De Havilland Aircraft Co., Ltd., The	54	Miltoid Ltd.	52	Wilkinson, L.	57
Donovan Electrical Co., Ltd.	53	Muirhead & Co., Ltd.	22	Woden Transformer Co., Ltd.	51
Edison-Swan Electric Co., Ltd., The	Cover ii and Cover iv	Mullard Ltd.	8, 30 and 39	Wright, Bindley & Gell Ltd.	52
		Murex Ltd.	40		



Quantity production of small automatically made pieces in Stentite, Porcelain, and Rutile materials for electric cooking and heating equipment, and telecommunication apparatus.

BRAY



GEO. BRAY & CO. LTD., Leicester Place, Leeds 2.
Tel.: 20981/8. Grams.: "Bray, Leeds 2"

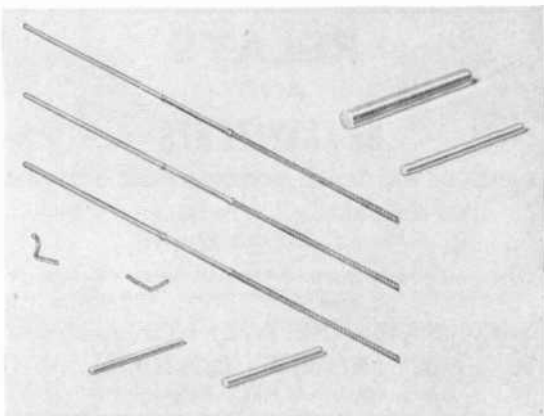

TUNGSTEN RODS & THREE PIECE LEAD WIRES FOR TUNGSTEN TO GLASS SEALS

X-RAY TARGETS WITH OR WITHOUT CAST-ON COPPER BODY. ROTATING ANODES. MOLYBDENUM TUBES & OTHER MOLYBDENUM COMPONENTS.

TUNGSTEN WELDING ELECTRODES FOR INERT GAS ARC WELDING. TUNGSTEN CONTACT RIVETS & SCREWS.



ELECTRO-ALLOYS Ltd.

12, BRUNEL RD., LONDON, W.3.

Makers of TUNGSTEN and MOLYBDENUM Products

GRADING

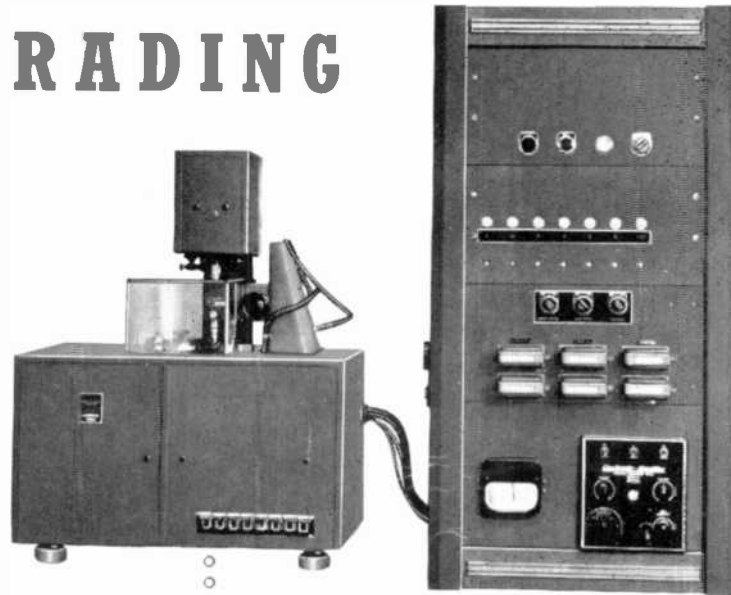

to 500,000th of an inch ...

and counted in any quantity with unflinching accuracy by this electronic grading machine.

British Manufactured Bearings Co. Ltd., now supply steel balls graded to half-a-millionth of an inch; these balls are also components in their micro ball bearings. B.M.B. steel balls and bearings are used in a wide range of industries and are vital components in nearly all precision instruments.



BRITISH MANUFACTURED BEARINGS CO. LTD
CRAWLEY, SUSSEX **CHARLWOOD, SURREY**

B·M·B (Sales) Ltd. (Sole Selling Agents)

2 BALFOUR PLACE · MOUNT STREET · LONDON · W.1

Phone: GROsvenor 3155. Grams: Britmanbea, Audley, London. Cables: Britmanbea, London

All B.M.B. Products are entirely of British manufacture and are fully A.I.D. approved.

**For better
component service**

EDISWAN

CLIX

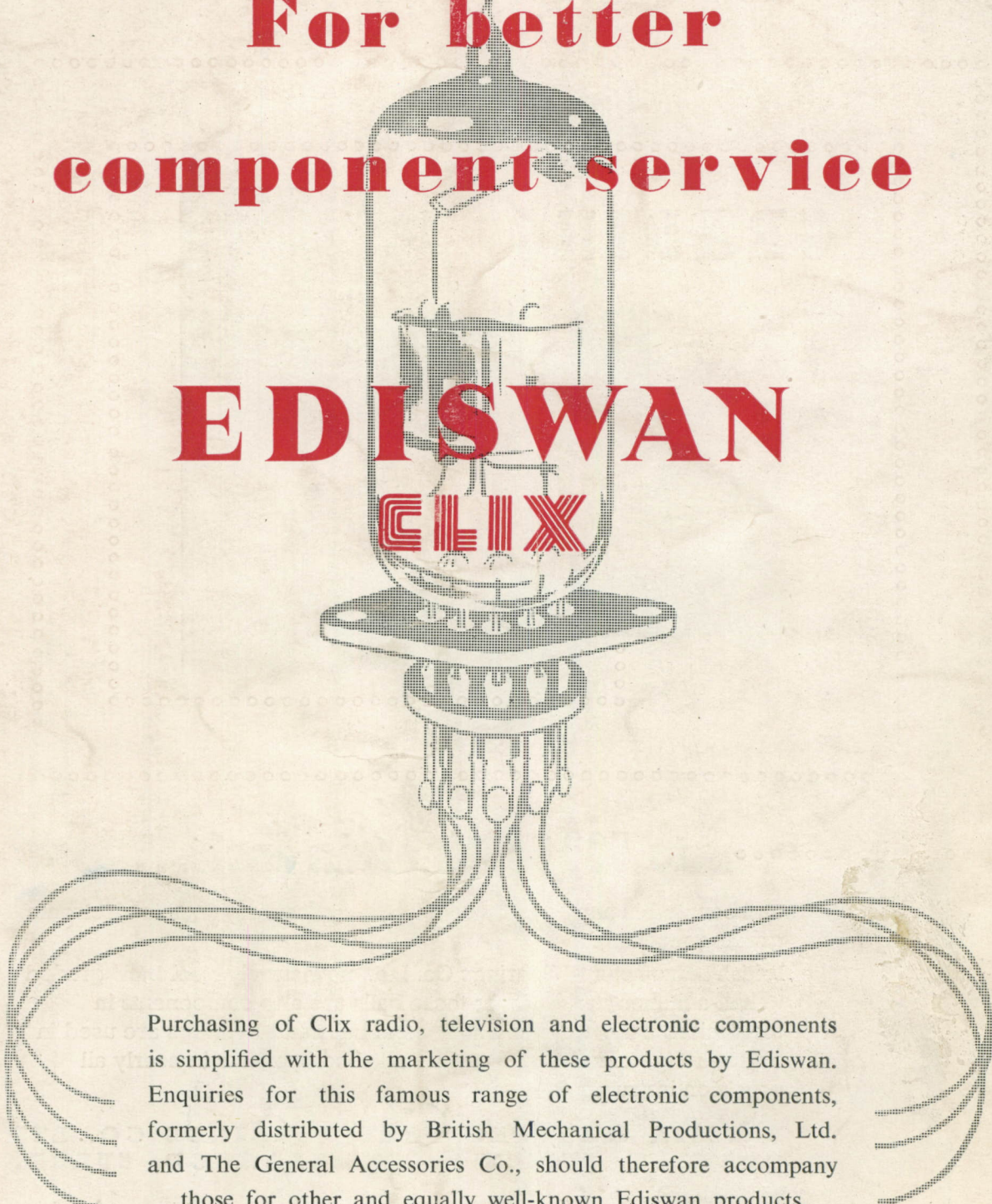

Purchasing of Clix radio, television and electronic components is simplified with the marketing of these products by Ediswan. Enquiries for this famous range of electronic components, formerly distributed by British Mechanical Productions, Ltd. and The General Accessories Co., should therefore accompany those for other and equally well-known Ediswan products.

THE EDISON SWAN ELECTRIC COMPANY LIMITED
155 Charing Cross Road, London, W.C.2, and branches

Member of the A.E.I. Group of Companies

ER7