

the
CORNELL-DUBILIER
Capacitor

Subsidiary
The Radiart Corp.
 Cleveland, Ohio

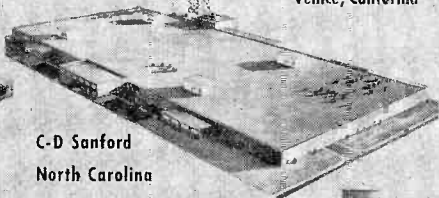

C-D
 Venice, California



C-D Sanford
 North Carolina

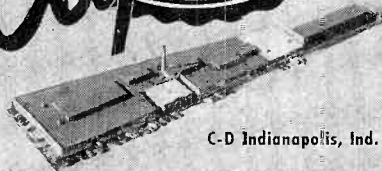

C-D Indianapolis, Ind.



C-D Hope Valley, R.I.



C-D
 Providence, R.I.



C-D Fuquay Springs, N.C.

C-D South Plainfield, N.J.

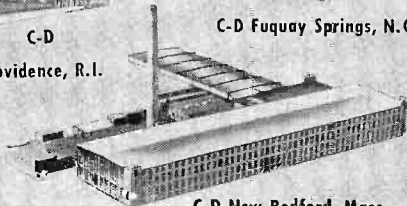

C-D New Bedford, Mass.



C-D Worcester, Mass.



C-D Cambridge, Mass.

Vol. 24

NOVEMBER - DECEMBER, 1959

No. 6

CORNELL-DUBILIER ELECTRIC CORP.
 Hamilton Boulevard, South Plainfield, N. J.

POSTMASTER: If undeliverable for any reason,
 notify stating reason, on Form 3547 postage for
 which is guaranteed.

Sec. 34.66 P.L.&R.
 U. S. POSTAGE
PAID
 So. Plainfield, N. J.
 Permit No. 1

MR. MARSHALL W. COLE
 R. R. 1, BOX 257
 FORTVILLE, IND.

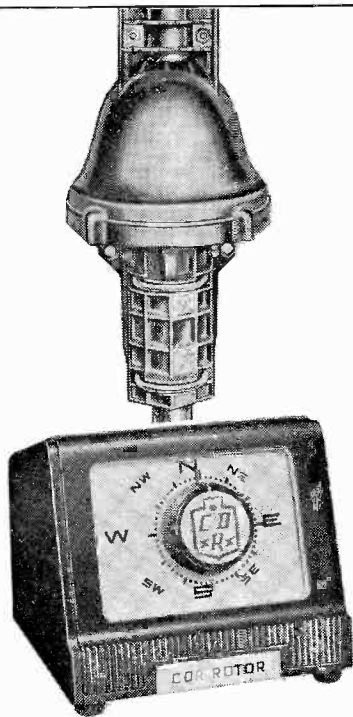

FOR TV

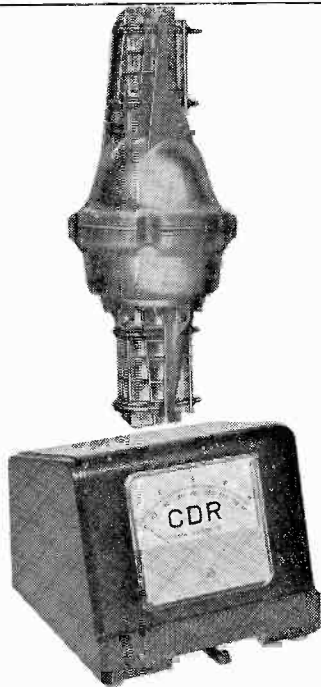

FOR HAMS

CDR ROTORS

The same superlative engineering standards set for CD capacitors are followed in the manufacture of our CDR Rotors. Wherever you use or install a CDR TV Rotor—you'll like the immediate improvement in picture strength and clarity. But don't use a TV Rotor if you're a Ham. You need the extra heavy-duty model "HAM-M"—designed especially for Hams by HAMS. See these and other CDR Rotors at your Cornell-Dubilier distributor.



CORNELL-DUBILIER ROTORS

TRANSISTORIZED FREQUENCY STANDARD

The obvious advantages of transistor circuitry in certain types of test instruments have been listed many times in this journal and in other places and need no repetition here. One instrument which is particularly aided by transistorization is the portable secondary frequency standard.

Earlier constructional articles have described transistorized frequency standards but these instruments usually have contained only an oscillator stage. The utility of a frequency divider in conjunction with the oscillator is well known to users of frequency standards, and its absence from many transistorized circuits is critical. The instrument described in this article accord-

ingly provides a 10-kc multivibrator in addition to a 100-kc crystal oscillator.

This instrument circuit has been chosen for simplicity, fewest components, low d-c power drain, operation from inexpensive batteries, and use of inexpensive transistors. Whereas the volume of the instrument is the same as that of a standard volt-ohm-milliammeter, no attempt was made to miniaturize the layout. Undoubtedly, however, the instrument can be built smaller, if the reader so desires. The completely self-contained frequency standard measures 7" long, 5" high, and 3" deep, and weighs 1½ pound. Its total current drain is approximately 6 milliamperes dc from two 1½-volt,

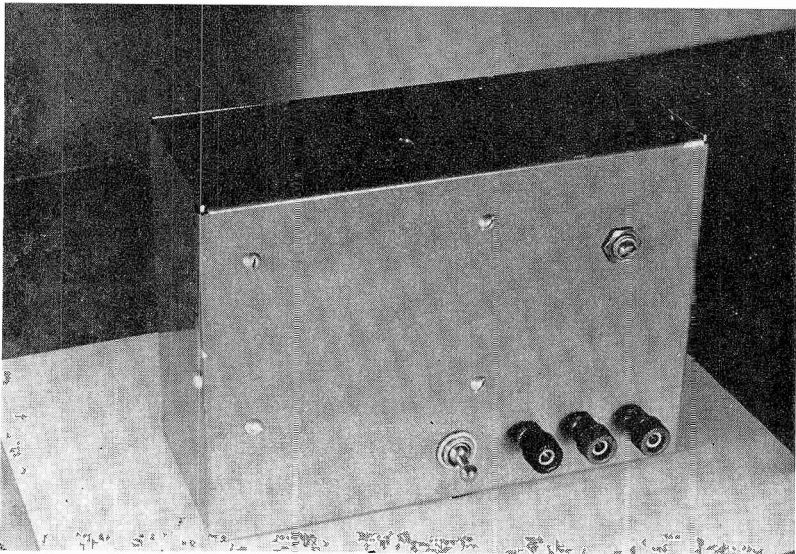

Fig. 1. Completed Frequency Standard. Measuring only 7" x 5" x 3", this transistorized instrument weighs 1½ lb. and operates from two self-contained flashlight cells. See Fig. 8 for identification of components.

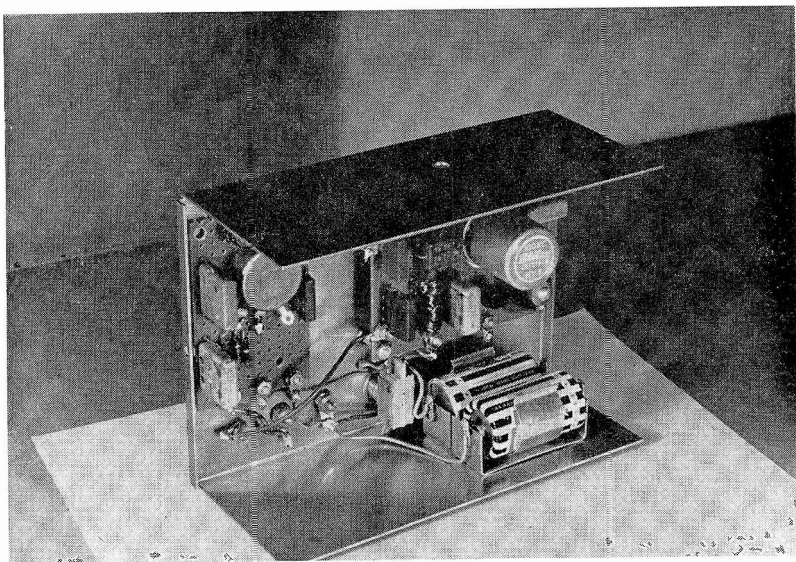

Fig. 2. Inside the Instrument.

Size-C flashlight cells connected in series.

Figure 1 shows the external appearance of the finished instrument. Binding posts are provided for 10- and 100-kc output. (See lower right-hand edge of the front panel.) A hole is provided in the top of the case for insertion of a screwdriver or alignment tool to set the oscillator frequency when standardizing against WWV broadcasts. A screwdriver-adjusted potentiometer in the upper right-hand area of the front panel is provided for setting the multivibrator frequency. Figure 2 shows the inside of the completed instrument.

Instrument Circuit

Figure 3 shows the complete circuit schematic. The oscillator is based upon a miniature 100-kc crystal (Bliley

KV3) and is tuned by adjusting the slug screw of the collector inductor, L. The latter has an adjustment range of 4 to 30 millihenries and is set to approximately 13 mh for 100-kc resonance. The exact inductance setting required depends upon the actual capacitance of C_2 . However, this is not an extremely critical adjustment, since tuning is rather broad. Fine adjustment of the slug permits zero beating with standard frequency radio signals. 100-kc output is provided at terminal T_1 by capacitance coupling through C_4 . Similar output for synchronization of the multivibrator is supplied via capacitance coupling through C_6 . The base resistor, R_1 , may require some alteration in value for particular transistors. The single oscillator transistor, Q_1 , is a 2N107.

The multivibrator employs a con-

ventional cross-coupled circuit utilizing two 2N107 transistors, Q_2 and Q_3 . In this circuit, R_2 and R_3 should be matched in resistance. These two resistances might require some alteration with individual transistors, to obtain exact 10-kc operation. Also, C_6 and C_7 should be matched in capacitance. One base resistance, R_4 , is made

will contain 10-kc markers as well, as a result of inherent coupling within the circuit. Generally, this is no disadvantage, since the space between any two successive 100-kc points will thus be divided automatically into ten equal spaces by the nine intervening 10-kc points. However, should the reader desire to disable the multi-

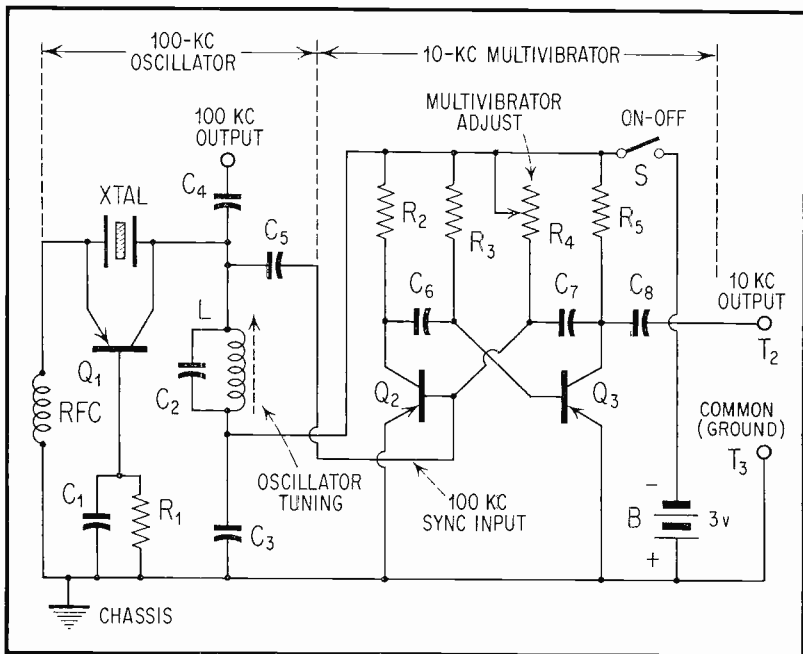

Fig. 3. Complete Circuit of the Frequency Standard.

variable for adjustment of the multivibrator frequency. 10-kc output is provided at Terminal T_2 by capacitance coupling through C_8 . 100-kc energy for synchronization of the multivibrator is injected into the base of Transistor Q_2 , through Capacitor C_6 .

The 100-kc output of the instrument

ibrator, this can be done by means of a separate spst switch. Connect one terminal of this switch to B-minus and connect the B-minus ends of R_2, R_3, R_4 , and R_5 to the other terminal of the switch instead of to Switch S. When this additional "10 KC" switch is opened, the multivibrator will be

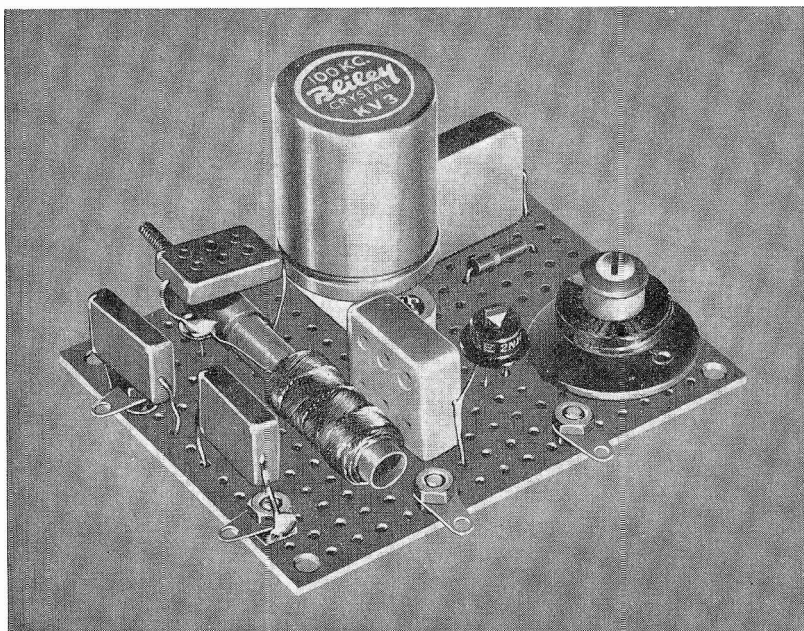

Fig. 4. Oscillator Circuit Board. See Fig. 5 for identification of components.

switched off. Switch S will still be connected to the lower end of Inductor L, as shown in Figure 3, and will become the separate "100 KC" switch. To switch the entire instrument off, both switches then would have to be thrown to their open position.

An examination of Figure 3 shows that the configuration of this circuit does not differ materially from that of the comparable tube circuit. The main difference, of course, is in the size of the instrument and its power supply and in generated heat. The transistor circuit is cool in operation and requires no warmup period; it is ready for instant operation. Moreover, it is not troubled by microphonics and internally-generated hum. A technician

familiar with the tube version of this frequency standard will have no trouble in shifting to use of the transistorized instrument.

Mechanical Construction

Figures 1, 2, 4, 5, 6, 7, and 8 show constructional details of the frequency standard.

The aluminum box (LMB No. 145) which houses the instrument is 7" long, 5" high, and 3" deep. There is ample "breathing space" inside the case, and considerable miniaturization is possible if such is required. Figures 1 and 8 show details of the front panel and its few components.

Both the oscillator and multivibrator are assembled on small panels of 1/16"

thick perforated phenolic stock. The pigtails of the capacitors, resistors, and transistors are passed through the tiny holes in the panels and are connected together underneath. This arrangement provides some of the compactness of the printed circuit without the complexity of the latter's manufacture. The Editors employed separate circuit boards for the oscillator and multivibrator. But there is nothing sacred about this arrangement; an individual builder may use a single board for both circuits if he is so inclined.

The oscillator circuit board is shown in Figures 4 and 5. This board is $3\frac{1}{2}$ " x 3" in size. The crystal socket is fastened to the board with a pair

of 4-40 screws, the neck of Inductor L is gripped by a miniature fuse holder fastened to the board with a 6-32 screw, and the r-f choke is mounted with a single 6-32 screw. Solder lugs along two edges of the board are provided for 100-kc output, sync output to the multivibrator, and for connection to B-minus and ground. The oscillator circuit board is held to the front panel by four $1\frac{1}{2}$ "-long 6-32 screws. These allow the board to be moved back for clearance, so as to prevent panel-grounding of the wiring under the board. A $5/16$ -inch clearance hole is drilled in the top of the case (visible in Figure 1) just above the slug screw of Inductor L. This per-

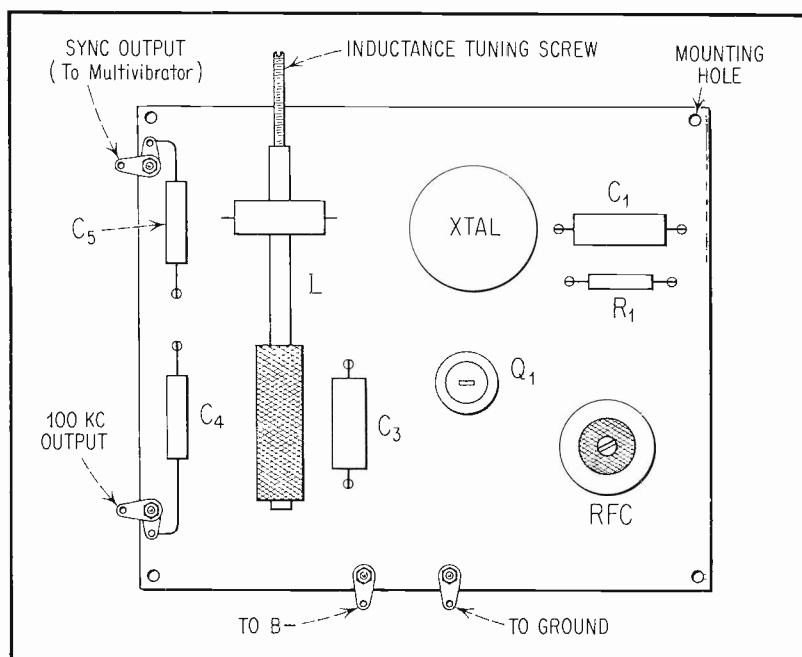

Fig. 5. Layout of Oscillator Circuit Board.

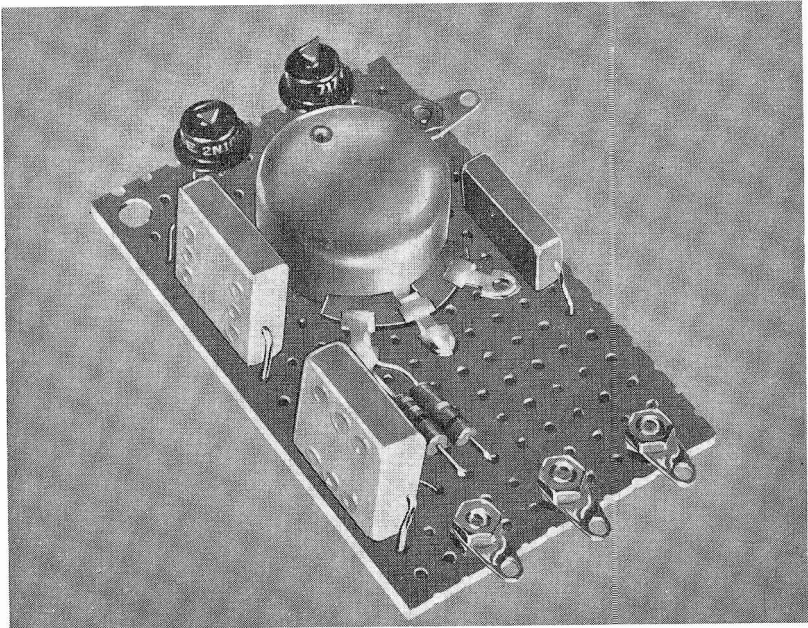

Fig. 6. Multivibrator Circuit Board. See Fig. 7 for identification of components.

mits insertion of a screwdriver or alignment tool to trim the inductance.

The multivibrator circuit board is shown in Figures 6 and 7. This board is 2" by 3" in size. The potentiometer, R_4 , is mounted through a clearance hole in the board and serves to hold the multivibrator circuit board to the front panel, but far enough behind the latter to prevent short-circuiting of the wiring under the board. The potentiometer has a slotted shaft for screwdriver adjustment, since this control is not often operated and a knob or dial might be accidentally twisted. A shaft lock on this potentiometer will protect it from tampering. Solder lugs along two sides of the multivibrator circuit board are provided for 10-kc output, sync input from the oscillator,

and for connection to B-minus and ground.

Terminals T_1 , T_2 , and T_3 are insulated binding posts. Coaxial or concentric connectors employing output cables, while neat in appearance, are not recommended, since cable capacitance tends to bypass many of the desired harmonics in the output signals.

Figure 2 shows the internal construction and interwiring of the instrument. The circuit boards are clearly visible in this photograph, as are also the ON-OFF switch, output terminals, and battery. The two small cells of the battery are clipped into a battery holder (Keystone 174) mounted on the floor of the instrument box.

The parts must be mounted as solidly as possible. Use plastic-covered,

flexible hookup wire for the connections. Keep all signal leads well away from the metal panel to reduce capacitance effects, and do not use shielded wire, since the capacitance of such wire will bypass useful harmonics of 10 and 100 kc. An example of a signal lead "in the clear" is seen in Figure 2. Here, the 100-kc lead from the output binding post to the oscillator circuit board lug is seen pulled well away from the panel, in the lower left section of the photograph.

Initial Adjustment

After construction is completed and all wiring has been checked, insert the crystal into its socket and the cells into the battery holder. Then, proceed to adjust the instrument in the following manner.

- (1) Using a reliable all-wave radio receiver, tune-in WWV standard frequency transmissions on 2500 or 5000 kc.
- (2) Connect the instrument to the receiver; Terminal T_1 to the antenna terminal of the receiver, and Terminal T_2 to the receiver ground terminal.
- (3) Set Switch S to its ON position.
- (4) Adjust the slug of Inductor L for exact zero beat with WWV. Do this during an unmodulated interval of the WWV signal.
- (5) Next, disconnect the receiver antenna, so that no stations will be picked up, but leave the frequency standard connected to the antenna and ground terminals as before. Switch the receiver to the standard broadcast band and place it into oscillation (BFO switched on).
- (6) Near the low end of the band, locate two successive 100-kc signals from the frequency standard,

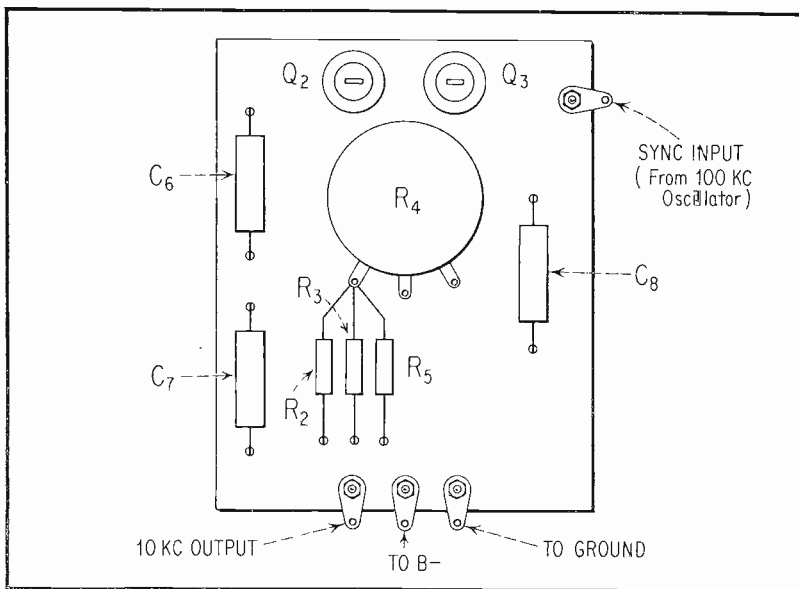

Fig. 7. Layout of Multivibrator Circuit Board.

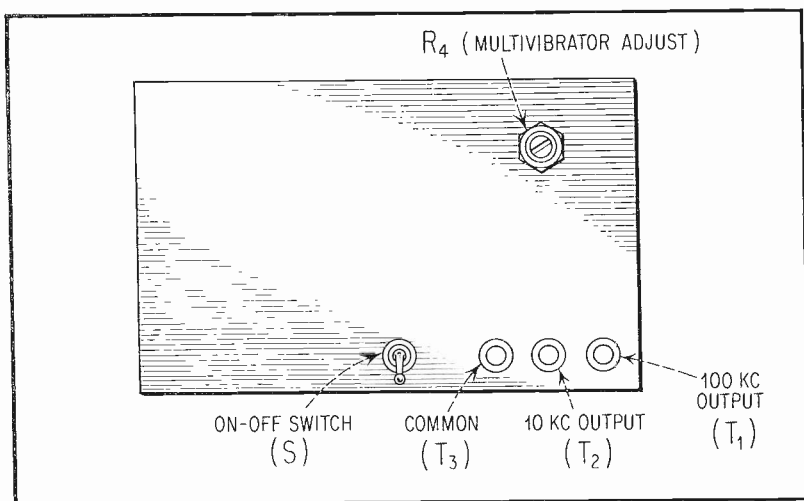

Fig. 8. Front Panel Layout.

and note the corresponding points on the receiver dial. (7) Tuning the receiver slowly, count the number of weaker spot signals (due to the multivibrator) between these two points. (8) Adjust Potentiometer R_4 in the multivibrator until exactly nine intermediate signals appear between the adjacent 100-kc points. When this is done, the multivibrator frequency is set exactly to 10 kilocycles.

Routine Operation

The transistorized frequency standard is used in the normal manner in all applications to which a tube-type instrument commonly is applied.

The instrument should be checked occasionally against WWV. The multivibrator frequency may be checked either with a receiver, as explained in the preceding Section, or with an electronic audio frequency meter connected to Terminals T_2 and T_3 .

Parts List for Figure 3.

- B—3-volt battery (2 Size-C flashlight cells connected in series)
- C_1, C_3, C_5 —0.01 ufd mica — (C-D 1D5S1)
- C_2 —200 ufd mica — (C-D 22R5T2)
- C_4, C_6, C_8 —27 ufd mica — (C-D 22R5Q27)
- C_7, C_9 —0.003 ufd mica — (C-D 1W5D3)
- L—4.30 mh tunable inductor — (Miller 6315)
- Q_1, Q_2, Q_3 —PNP transistors — (General Electric 2N107)
- R_1 —0.75 megohm $\frac{1}{2}$ watt
- R_2 —1000 ohms $\frac{1}{2}$ watt
- R_3 —0.22 megohm $\frac{1}{2}$ watt
- R_4 —25,000-ohm potentiometer with slotted shaft
- R_5 —1000 ohms $\frac{1}{2}$ watt
- RFC—2 $\frac{1}{2}$ mh radio-frequency choke — (Miller 853)
- S—Spst toggle switch
- T_1, T_2, T_3, T_4 —Output terminals (binding posts, insulated)
- XTAL—100-kc quartz crystal — (Biley KV3)

**to do
the
best job
use
the best***



* C-D twist-prong electrolytics, for instance . . . and, to be always ready for the job, stock C-D "Preferred" Twist-Prongs (marked with a★).



CORNELL - DUBILIER
CAPACITORS

★ look for the star on the label.

Old Hands at Dependability



This CORNELL-DUBILIER Advertising Service is FREE to "Capacitor" readers. If there is anything of general interest or appeal in the line of electronic equipment or service that you want to BUY — SELL — or SWAP . . . if you want a job or need help, these columns are at your service.

Please PRINT or TYPE your Ad clearly and limit it to 40 words including your name and address. Because of space limitations — only one Ad at a time — please.

Ads are published in the order received and as space permits.

CORNELL-DUBILIER ELECTRIC CORP. reserves the right to edit your Ad to conform to its policies and is the final judge of its suitability for publication. We do not assume any liability or responsibility for any transaction that results. Make your deal direct with the advertiser listed in the Ad.

If you have a "CHANGE OF ADDRESS" — give both your OLD and NEW and mark your request "For C-D Capacitor Mailing List."

IF YOU ARE RECEIVING DUPLICATE COPIES FOR WHICH YOU HAVE NO USE, PLEASE ADVISE YOUR LETTER CARRIER STATING — "DUPLICATE — NOT WANTED".

WANTED — Old-fashioned xtal set and dual button mike & Astatic D-104 mike. Sway or sell CREI Radio Engineering course and 2 batt. portable radios. James Lowe, 1521 Scenic Dr., Pasadena, Calif.

TRADE — Surplus Equipt. & parts, for late mdl. tube tester. A/2C/ J. Araujo, Box 2011, Electronics Hobby Shop, James Connally AFB, Tex.

FOR SALE — Knight comm. rcvr. with S-meter and xtal calibrator, \$110. plus freight. Murray Ruben 136-48 71 Rd., Flushing 67, N.Y.

FOR SALE — 24" TV chassis, needs CRT \$10, 17" 630 TV chassis \$25, Norelco 630 projection TV with mah. cabinet \$75, Westinghouse 12" and Magnavox 10" table models, \$20 each. J. Eastwood, 868 Center Dr., Franklin Sq., N. Y.

SELL OR TRADE — Elements of Radio Servicing, Marcus and Levy, Basic TV Principles and Servicing, Grob; Radio Physics Course, Ghirardi; VTVM; VOM. Want tubes for Hallicrafter S-40. Richard W. Freligh, Barnesville, Ohio.

FOR SALE — Radio and TV sales and service business — purchased for inventory on hand — building can be purchased or leased. Lloyd E. Apple, 1453 No. Main St., Sidney, Ohio.

SELL OR TRADE — SX42 receiver, in very good condition, \$120. W. C. Woods, 43 Richardson Road, Lynn, Mass.

WANTED — Harvey-Wells VFO to fit TBS 50C transmitter. State price and cond. B. C. Grant, 16 Saco St., Dorchester, Mass.

WANTED — Lampkin 105-B freq meter and 205A FM modulation meter. D. B. Fritz, 3608 St. Lawrence Ave., Reading, Pa.

FOR SALE — Hammond Novachord in good working order, \$100 FOB. Carl Paulson, 339 Blauvelt Rd., Pearl River, N. Y.

WANT — Gonset III for six meter band, in good condition for cash. C. T. Fernandez, 81 Warren St., Rox 19, Mass.

SELL — 14" stack of electronics books, magazines, diagrams, \$5; 7" Admiral; 17" RCA; 21" Motorola built-in UHF. Make offer or swap. Need QST for Dec. '58. J. Leach, Box 336, Milton, Del.

FOR SALE — Golday 599 metal locator, \$100; Heath SC8, \$18. J. Sadey, 2684 West 25th St., Cleveland 13, Ohio.

WANTED — 3" Pilot TV set. State price and condition. S. Terchany'n's 394 Stone St., Johnstown, Pa.

TRADE — Geiger counter, complete with tubes, batteries, and phones. What have you? G. E. Stowers, 2020 East 48th Terr., Kansas City, Mo.

FOR SALE — Ultra-sensitive DC microammeter, RCA type WV-84A, 6 ranges from .01 to 1000 microamps, full scale, like new, \$70. C. Abraham, 378 4th Ave., San Francisco 18, Calif.

SELL OR TRADE — World's finest scope, Tektronix 545 with 53/54C preamp, 30 Mc. bandwidth, all accessories, like new, \$1100, or Ampex tape recorder. Bob Fleischer, 2642 Bentley Ave., Los Angeles 64, Calif.

WANTED — AC voltmeter, 0-15 volts, and 0-150 volts; battery charging full wave dry disc rectifier, about 10 volts, 10 amps, or 15-20 volts, 10 amps. L. Andrews, 957 E. 3rd St., Erie, 3, Pa.

FOR SALE — Lafayette pocket test meter, \$4.50 postpaid in U.S. Details on request. John A. Fels, 801 Silver Spring Ave., Silver Spring, Md.

FOR SALE — 315 deluxe Eico sig. gen., factory wired; Sylvania 140 tube tester, up to date chart. Both in good cond., first \$50 gets them. Joe Billingsley, Box 153, Hardy, Ark.

TRADE — Viking II, Viking VFO, and Hallicrafter SX-71, for small enclosed foreign car. No Austins. G. Walton, 3469 Major Dr., Wantagh, N. Y.

SELL OR TRADE — For professional disc recorder, like new V.M. tape recorder. Sell like new 35 mm German color camera, 2.8 lens. A. V. Larson, 822 4th St., Madison, Minn.

SELL OR SWAP — Queen E-3108 Wheatstone bridge, \$125; Siemens & Halske DC volt-ammeter, 3-15-150 v., 15-1.5-15 amps., \$50; Roller-Smith wattmeter, 0-1000 watts, \$10. D. Levine, 203-09 104th Ave., Hollis 23, L. I., N. Y.

FOR SALE — 2 meter transceiver, 9 tubes, 10 w. xtal control xmt., 13 x 7 x 3 in. Receiver needs slight tuneup, \$17. E. J. Wolitzer, 2143 82nd St., Brooklyn 14, N. Y.

SELL OR TRADE — Tape Oscillator with 10 tubes. Want 35mm camera, used 8BP4 tube. V. R. Valley, 1312 Frankel Ave., Metairie, La.

FOR SALE — 6 mtr. transceiver, 10 w. xmt., xtal controlled, rcvr., three tubes, less power supply, \$15. E. J. Wolitzer, 2143 82nd St., Brooklyn 14, N. Y.

FOR SALE — Collins 32V2, best cash offer over \$320; A-54 mobile transmitter, \$60; Hallicrafters S-38D, \$32.50; tubes, meters, chokes, relays. Want Collins 32V3 factory model. Send for list. Nelson Stover, Box 722, York, Pa.

FOR SALE — Hallicrafters SX-99, \$125, SX-71, \$160; Heathkit Q Multiplier QF-1, \$9; Millen transmitter 90800, full set of coils, \$20. Ronald Szanczyk, 220 Westview Ave., Palisade, N. J.

SWAP — Rhythm and Blues records: sixteen 33 $\frac{1}{3}$ rpm LP's and thirty 78 rpm's, plus albums, wooden carrying cases included. Want cartoned TV tubes in good cond. NYC vicinity only. Victor Smith, 167-22-108th Dr., Jamaica 33, L. I., N. Y.

FOR SALE — Heath CRT checker, \$20; tape oscillator with 10 tapes, \$15; 5" x 7" view camera complete, \$20. V. R. Valley, 1312 Frankel Ave., Metairie, La.

FOR SALE — Simpson GenScope and sweep generator, 3" scope, marker gen., all in one. Very good cond., \$275 FOB. Tanrath - Suburban TV, 211Q Broadway, Rockford, Ill.

WANTED — Radio batt. type, Freshman Masterpiece 3 dial control, xtal set and Loop Antenna — send sketch in reply; Radio News magazine and radio parts catalog up to 1925. John Diaz, 7411 W. Wamimont Ave., Milwaukee 20, Wis.

FOR SALE — Riders TV 1-12, Radio 1-21; Supreme 563 Audio Osc., 562 Audolyzer, 666 Signal Gen; Hickok 650 Vidimeter; Simpson 276 Calibrator; Galvanix Rect. Tester; Capacitesters CT 355 and CD BF 50. Harolds Radio TV Sound, 1750 South Park Ave., Buffalo 20, N. Y.

WANTED — Record cutter to cut excellent records, either 45 or 78. Give lowest asking price. Rev. Stanley Spires, Box 51, Marion, Ohio.

WANTED — Standard signal gen., Measurements Corp. 65B or 80. Ferris or General Radio models considered. L. J. Schnedorf, 610 Monroe Ave., River Forest, Ill.

WANTED — good used SW (S40B or better) rcvr. (value \$100) Sell 30w Bogan ampl. #30 with boom stand and mike plus all cords. Lee M. Singleterry, Sr., 1914 Ballinger Rd., Seattle, Wash.

SELL — 630 chassis with 17" pic. tube, needs align., \$30. And RCA 630 in cab. 10" tube, operating, \$25. Both \$50 or best offer. Irv Chaimowitz, 10 Sandy Court, Massapequa, L. I., N. Y.

FOR SALE — Eico 315 signal gen., \$25. John McCullen, 3050 Bainbridge Ave., Bronx 67, N. Y.

SELL — Radio test equipt., Radios, Cameras, Electric Trains and Parts, 6V Batt. Charger, NRI transmitter, etc. Edward J. Graf, PO Box 3930, Cleveland 20. O.

FOR SALE — SX71 Hallicrafter receiver, Globe 680-A trans. with PB-1 power booster. Want 11 meter band Citizens transceiver, home brew or? John Arnold, Wilson St., Bluffs 3, Ill.

WANTED — 15 element 2 meter Telrex beams; also tower about 70 feet. H. W. Kasper, 96 Maplewood Dr., Laurelton, N. J.

SELL OR SWAP — Stromberg-Carlson rcvr from early 1920's complete with power supply and speaker. Howard Lester, 150 Chittenden Ave., Yonkers, N. Y.

WANTED — Class D Citizen Band equipt Bob Hartman, Dakota, Ill.

WANTED — Johnson navigator. Paul Curtis, 1919 W. King's Hwy., San Antonio 1, Texas.

FOR SALE — Complete 6v mobile xmitter, rcvr, noise limiter, converter plus cables for trunk mounting, \$45. Dan J. Umholtz 392 Armstrong Ave., Jersey City 5, N. J.

FOR SALE — Mobile two-band transmitter and vibrator power supply; 30w modulator; XEC VFO. F. D. Bornman, 19491 Lowell Dr., Detroit 3, Mich.

FOR SALE — National rcvr NC-98 complete with National speaker, new condition, \$100. A. Magistro, 1629-81st St., Brooklyn 14, N. Y.

FOR SALE — Sams Photofact sets, one thru 270 in binders. Never used. Make offer. John F. Zolnik, 126 Hicks St., Meriden, Conn.

WANTED — Echophone. Also BC-348 or BC-312 in any condition. Leon Recht, 430 E. 67th St., New York 21, N. Y.

FOR SALE — Eico 666 tube & transistor check, \$47.50 plus post; Bell & Howell TDC-730 Sterofone Tape Rec. Incl. phones & mike, \$225 pre-paid. G. E. Saunders, 15229 Center Ave., Harvey, Ill.

SELL — To highest offer: Collins 32V2 trans — Central Electronics 10ASSB unit never used. Leo T. Meister, 321 River Rd., Nutley 10, N. J.

FOR SALE — NRI Radio & TV course in binders with multiester, \$25 and NRI Appliance course., \$15. Both plus post. John Latlie, 6146 S. Kenneth Av., Chicago 29, Ill.

WANTED — All types of rcvrs, xmitters & testing equipt. not in working order, also partially or improperly wired kits. Stan Zuchora, 2743 Meade St., Detroit 12, Mich.

FOR SALE — 6v windcharger gen complete with prop., \$8. Fred Kloepper, 649 W. 23rd St., Lawrence, Kan.

FOR SALE — Heathkit 0-12 scope with all probes and test leads, used only a few hours, \$80. Jack Fives, 2916 Rockrose Av., Baltimore 15, Md.

FOR SALE — Precision E-200-C with output cable and copy of "Servicing by Signal Substitution", \$40 cash. Ernest Michailoff, 32 Plymouth Av., Johnstown, Pa.

FOR SALE — RCA ATJ TV camera \$99; TRIO Communications Rcvr & Spkr \$75; BC-455-B rcvr, \$12; Blonder-Tongue CA-1 TV line amp, \$20. Bob Schill, Box 412, Hinsdale, N. H.

FOR SALE — Eico 220 VTYM, \$17; Philco TV 10" Stan. coil tuner, \$20; Delco 6v push button auto radio tube & set tester precision 920, \$25, Hickok VOM, \$20. Prefer local. John Bechtler, 23-79 206th St., Bayside 60, N. Y.

FOR SALE — Eico 488 Electronic sw, Heath VC-3 volt. calibrator. Best offer. Michael Bilgrei, 146 Hewes St., Brooklyn 11, N.Y.

WANTED — Complete schem. for good A-B & C batt. eliminator for old batt. radios & literature on Edison cylinder phono's. Cash waiting. George Weseli, 4445 No. 49 St., Milwaukee 18, Wis.

SELL OR TRADE — 80-40 meter phone-CW xmitter 60w using 2 ARC-5's, \$30; University 25w driver 16 ohm 20" horn \$20. Len Svidor, 3786 Muirfield Rd., Los Angeles 16, Calif.

FOR SALE — 2-12" 9762 Norelco spkrs, \$30 each; bass reflex cabinet \$25. Robert Strasser, 463 Pelham Rd., New Rochelle, N. Y.

SURPLUS SALE — Stancor 52B049 (10P36) heavy duty multi-tilament transformers \$4; Vibro-plex and Lionel keys \$6; J44 keys 50 cents; R-30-U headphones 75 cents; complete shockmounts for BC-653-652 \$3 and plugs \$1. Postage extra. Ed Block, Granview, Texas.

- SELL OR TRADE** — Books: Elements of Radio by Marcus & Horton; Practical Math. for Home Study by Palmer & Bibb; Math. for Electricians and Radiomen by Cooke. Alexander Podstepny, 1652 Doun-ton St., Philadelphia 40, Pa.
- WANTED** — Cabinets for the following portable radios: GE 650 and Westing-house H-479P4. Please state price. Sterling Tucker, 1502 Conoga St., Nor-folk 6, Va.
- PAY CASH OR TRADE** — Equivalent value of tubes, ham parts, etc., for 41-42-52-56-58 copy of ARRL Handbook to com-plete 20 year library. Ham gear for sale. William Toben, 1244 Schafer Dr., Tucson, Ariz.
- SELL OR TRADE** — Two Electro-Voice and 1 Granco TV converters. What have you? A. P. Queen, 100 S.W. 20th Road, Miami, Fla.
- FOR SALE** — Heath sig. gen. SG-8, very good condition, \$15; hearing aid, \$10; spkrs; tuning capacitors; output, power, RF & IF transformers, coils and chokes; radio and TV books. E. Coriell, A-39, 300 West Bluff, East Peoria, Ill.
- SELL OR TRADE** — Two BC-375E trans-mitters, complete with all coils and dyn; Hallicrafters S-36 and S-37 receivers; search radars. Want BC-669 transcvr, 110 v. AC or 12 v. DC power supply. William Hansen, 165 Silverbrook Ave., Niles, Mich.
- FOR SALE** — HQ-160 receiver; pair 813's in parallel, grounded; grid amplifier and power supply. All for \$400. H. M. Kingsland, 1 Jackson Pl., Hewlett, L. I., N. Y.
- FOR SALE** — RCA Senior voltohmyst WV-98A, very good condition, \$59. Paul Richter, 4235 Wickham Ave., Bronx 66, N. Y.
- WANTED** — Electrical Fundamentals of Communication — Albert. Have books for sale. Sidney Gross, 31 Marwood Rd. North, Port Washington, L. I., N. Y.
- WANTED** — Sams Photofact folder set nos. 1 to 114. State price. Joe Fasanella, 319 Beethoven Ave., Sarasota, Fla.
- FOR SALE** — 1500. radio, TV, electronic magazines 1925-1951. Send for list, stamp appreciated. John Landa, Clayton, R. 2, Ga.
- FOR SALE** — BC-639 receiver, tunable 100-156 mc. with RA-42 power supply, \$35; pair of EE-8 field telephones, \$10; 120P7A cathode picture tube; micro-switches. Ted Kempisty, 500 Scarboro Drive, Syracuse 4, N. Y.
- SELL** — Best reasonable offer; C-D 6 v. DC to 110 v. AC automobile power inverter, 150 w. constant, 175 int., top quality unit; Rek-O-Kut lathes and turn-able and cutting amplifier. Yale Hi-Fi, 2732 Florida Ave., Tampa 2, Fla.
- FOR SALE** — Millen R-9'er preamplifier; broad band converter 27-32 mc; 8, 10, 12" PM speakers; portable phonograph; Sylvania tube tester; tubes; CRT 7BP7; National 1" CRM scope. Charles Horn, 325 E. 163rd St., New York 51, N. Y.
- FOR SALE** — Hallicrafters S-53A receiver, Lettine 242 GM 45W transmitter, both very good condition. Best offer. Steven M. Baer, 53 Somerville St., Rochelle Park, N. J.
- FOR SALE** — T4FRC Army Airways trans-mitter, VFO or xtal ending up with PP 810S, with tubes and set of coils, \$75. J. G. Cisek, 241 Myrtle Ave., Irvington 11, N. J.
- WANTED** — Heathkit signal tracer and CRT checker, Central of Chicago type. Will trade VOM or tubes. J. Kosma, 12450 N.W. 5th Ave., Miami 68, Fla.
- FOR SALE** — Citizens Band transceiver 110 v, complete with crystals for channel 17, also desk type crystal microphone, \$75. J. Pains, 314 Bay 14th St., Brooklyn, N. Y.
- FOR SALE** — Weston: Model 1, \$75, 433 \$50, 301 \$5; Dumont scopes: 3" \$75, 5" \$100; HP oscillators \$100; patching equip-ment and jack panels. Emil Backstrom, Jr., 303 Hornidge Rd., Mamaroneck, N. Y.
- WANTED** — Rider TV manuals 11 and 13 thru 16. Grant P. Smith, P.O. Box 523, Mill Valley, Calif.
- FOR SALE** — Like new Heathkit TC-2 tube checker; with pic-tube adaptor and new roll chart. Kenneth Walker, 11937 1/2 Allin St., Culver City, Calif.
- FOR SALE** — 500 watt transmitter con-sisting of power supply and Millen 90881 RF power amplifier, \$250 FOB. Scott Heffner, 1269 Lititz Pike, Lancaster, Pa.

FOR SALE — Sams Photofact folders 17 thru 112, \$15. Belnett's Radio and TV, R.D. 2, Liverpool, Pa.

TRADE OR SELL — Hallicrafter S-40 four-mand rcvr, for automatic slide projector 35mm camera outfit, or \$35. E. A. Sawyer, Box 146, Marshall, N. C.

FOR SALE — Latest complete NRI Radio and TV Servicing course, with radio and electronic multitester. Best offer. Sal Isgro, 118 Gamewell St., Hackensack, N. J.

FOR SALE — Riders TV 4, 5, 6, 7, \$7 each, \$25 for lot; Hickok 620 linearity generator, \$30; Eboco picture tube checker and rejuvenator, \$8. All FOB. Ace TV, 5341 Cordelia Ave., Baltimore 15, Md.

FOR SALE — Heathkit V7-A VTVM, \$17.50 and CT-1 in-circuit capaci-tester, \$5, assembled, manuals included. Girardot Electronic Organ Service, 2308 N. Park Ave., No. 20, Indianapolis 5, Ind.

FOR SALE — SSB CE 20-A, like new with QT-1 and VFO, \$175; Heathkit DX-40, \$55; VF-1, \$15, very good cond.; Heath Balun coils, \$7; RCA magnetic wire recorder, \$17. Joe Martocci, 149 Garibaldi Ave., Roseto, Pa.

FOR SALE — Hickok: tube tester, 610A generator, Microvolt generator, Navy gen., 0-300 mc. Al's TV, Rt. 1, Monmouth Junction, N. J.

FOR SALE — Large selection radio-TV test equip., parts, technical books, TV home study courses, etc. Write for list and prices. C. W. Cooley, 319 Haines St., Kane, Pa.

WILL SWAP — First bound volume of GE Ham News (1946 thru 1950 issues) for copy of second bound volume of the same (1951 thru 1955). F. Bodine, Rt. 1, Box 87, Upper Marlboro, Md.

TRADE — Meissner preselector, SX25; BC-312; Mackay AC/DC rcvr 15-550KC; Hickok 3" scope; drafting table; vibroplex and case. Percy Ott, 507 Juniper St., Quakertown, Pa.

FOR SALE — Viking Adventurer, SM-90 modulator, Heathkit VFO with separate power supply manuals plus extras. Best offer takes all. J. P. Feren, 4913 W. 57 St., Mission, Kan.

WANTED TO BUY — 6 or 8 tube xmitter, tape rec. (new or used), and any type TV servicing course. Edwin Herman, 2479 Shirley Ave., Baltimore 15, Md.

FOR SALE — Pentron tape rec. with 7 tapes A1 con., \$100; Superior TV-II tube checker, \$35. Frank Bou, 47 Oswego Ave., Audubon 6, N. J.

SELL OR SWAP — Sylvania 500 sweep generator, A-1 con. Need good field strength meter. Mike Cory, 4164 Harrison St., Bellaire, Ohio.

SALE OR TRADE — Mod. 82 Rapid tube tester, like new, \$29.50; Knight sweep gen. wired and 4.5 xtal like new, \$45. Need Century FC-2 in good condition. Sensor leakage checker and Sams. Walter Koehler, 131 Stratford Dr., Houghton Lake 12, Mich.

FOR SALE — Central Electronics 20A exciter with QT-1 and 458 VFO (CE version) \$175; Zenith Royal 500 7 transistor portable radio, leather case, hearing aid attachment, batts., \$50. T. L. Rozier, Box 123, Quitman, Ga.

FOR SALE — Knight 100KC calibrator (xtal), \$8. Charles Lustick, 5924 Hasbrook Ave., Philadelphia 20, Pa.

TRADE OR SELL — Johnson Viking 50w Adventurer xmitter in fine con., professionally wired. Want SCR-211 or LM freq. meter in equally good cond. or, \$42. R. Wilton, 4 Liana St., Woburn, Mass.

FOR SALE — Hallicrafters Sky Buddy rcvr. with sideband adapter \$15; W2EWL sideband xmitter 75 and 20 meters, 160w, complete with 2 power supplies, RF output indicator, audio oscillator \$115. W. J. Kelly, 37 Temple St., Williston Park, New York.

FOR SALE — Books on all subjects, Radio, etc., tubes, spkrs, projector, records. Want camera, bookmarks, Sams sets. H. Kuell, 138 Clinton Ave., Newark, N. J.

FOR SALE — Harvey-Wells TBS-50 phone & CW xmitter 80-2 meters. Modified to TBS-50D, like new cond., \$55 postpaid, with APS-50 power supply, \$70. R. A. Batty, 106 Smithfield Dr., Endicott, N. Y.

SWAP — BC-458-A, unmodified for Command rcvr or best offer. R. Feigenbaum, 5 Park St., Spring Valley, N. Y.

SELL — Heathkits: A-7C 6w Hi-Fi Amp., \$15; T-3 sig. tracer \$20; AV-2 Audio VTVM \$15; 150w modulator Eldico AM-150, \$35; 20A Variac 115v, \$25; 6v coax relay, \$4. S. Martin, 469 Galloping Hill Rd., Roselle Park, N. J.

WANTED — Complete Inst. manual on RA-07 or RA-09 Navy com. rcvr 45 KC to 30 MC. State price. John Hazuka, 10616 Nassau, Sunland, Calif.

FOR SALE — Gonset G50, \$285; G66-G77 cables & power supplies, \$450; Hi-Fi 10w linear amp., \$17.50; Regulated power supply for PMR7 on 110v AC, \$15; Power former 1080 — 1080 @ 125ma choke conds, \$19.50. Robert Schmauss, 3903 3903 Swann Ave., Tampa 9, Fla.

FOR SALE — TV test Equipt. caddy parts, sets, radio-phono, amateur radio parts. Very cheap, send stamp for list. Roka, 5341 Cordelia Ave., Baltimore 15, Md.

WANTED — Tektronix 'scope in good or repair. cond. State mdl., cond., and price. John Hicks, 1136 Margray, Pittsburgh 7, Pa.

TRADE — Bud deluxe cabinet Rack, Fits 8 $\frac{3}{4}$ x 19 panel for used tube caddy, Heath SG-8 sig. gen. or Hickok 203 VTVM in good cond. M. Kikkebusch, 404 North Yale Ave., Villa Park, Ill.

WANTED — Condenser tester. State type, condition, price. J. Leo Phelan, White Ave., Middlebury, Conn.

WANTED — for cash Heath C-3 Condenser checker, reasonable and good cond. Kodak Bantam Special with case, f 2.0 lens, compur rapid shutter, Kalert flash gun. Make cash offer. N. Liemberger, 193 Windermere Blvd., Buffalo 26, N. Y.

FOR SALE — S-38-C Hallicrafter rcvr., \$25, incl. maint. manual. Louis Cane 212 Rogers Ave., Endicott, N. Y.

SWAP — Columbia 570 tape rec., Stereo-Monaural with dual spkrs. in cabs., like new. Want good ham rcvr. H. Jerguson, Box 3592, West End Station, B'ham, Alabama.

SELL — HRO coils: 1.7-4 MC, 3.5-7.3 MC, 14-30 MC. All three \$15. Want mobile gear. Carl Stone, Crossfield, Alberta, Canada.

FOR SALE — Selling out TV servicing equipt., parts, tubes, books, and Photo-facts. Will send list or make real deal for entire lot. A. L. Harmon, 37541 Lorie Blvd., Avon, Ohio.

WANTED — Schem. for Sarkes-Tarzian TV tuner used by TV Assembly Co. around 1948 — uses 6C4 osc., 6AK5 mixer, 6AK6 RF. Price no object. Wm. Gieckel, 22-43 35th St., Astoria 5, L. I., N. Y.

FOR SALE — Test equipt.; ham gear 2 thru 80 meters, both mobile and fixed. A. E. Florczak, R 1, Lawrence, Mich.

WANTED — Used community TV system boosters such as Blonder-Tongue CA-1. TV Signal Service, Center, Neb.

WANTED — Hickok 28EX or Hallicrafters SX42 rcvr. Sell or trade 4 x 5 condenser enlarger. V. L. Wardein, 144 Park Ridge Ave., Buffalo 15, N. Y.

WANTED — Experienced Radio-TV Technician. Top pay or service-sales percentage plan for one capable of handling varied service problems. Tomalinos' Radio & TV, Glendive, Mont.

WANTED — Schem. diagram and insts. for Meissner Radio kit in Sprayberry Radio Course. R. V. Nelson, 4325 Yates St., Denver 12, Colo.

WANTED — Old-mdl. 427 Satchell Carlson radio chassis with or without loop, sprk., etc., also models 437 and 463 and a 458 RD intercom. Will buy or swap. Robert Jones, 33A Huntres St., Portland, Maine.

WANTED — National School Automotive Mechanics course, less tools. for cash or trade Radio TV course. Ted Solarz, 3033 S. Pulaski Rd., Chicago 23, Ill.

SELL OR TRADE — Supreme 599-A tube tester, with manual and schem. for, \$30 or good sig. gen. Bill Park, 631 Copley Rd., Upper Darby, Pa.

FOR SALE — Pentron ultra-high fidelity Stereophonic Tape Rec. with xtal mike and 7 tapes \$100. George H. Bou, 47 Oswego Ave., Audubon 6, N. J.

WANTED — Hickok 156 Indicating Traceometer. Geo. Crego, 204 Keith Ave., Waukegan, Ill.

SELL OR TRADE — Robot "35" camera — elec. strobe flash with extension lite, storage batts., and charger. Want test equipt., Heath audio gen., distortion mtr., scope 0-10 or later, VTVM. A. Consiglio, 49 Wallace Pl, White Plains, New York.

FOR SALE — RCA ATJ/CRV59 TV camera converted for 115v operation incl. power supply, tripod and top mounted 5" monitor also ATJ/CRV52 companion TV xmitter, all for \$175. Carl Alsheimer TV Labs., 111 Main St., Waterville, N. Y.

SELL OR SWAP — Riders 4-5-12-15-20, new cond., \$125; McMurdo-Silver sweep gen., \$30; Eico 221 VTUM, \$25; 100 amp. portable batt. charger, \$40. Control TV Service, 123 Ave. U, Brooklyn 23, N. Y.

WANTED — Transcriptions or tape dubbings of Walter Preston's Community Singers, Senor Clemente etc.; Tandberg 5 recorder, Stereo equipt., new Scotch recording tape, etc.; West. Elec. 9-A transcription group. V. Mayher, 168 Williams Ave., Hasbrouck Heights, N. J.

SELL OR TRADE — duplicates of Sams Photolacts. A. T. Weiss, 352 Orion Ave., Metairie, La.

FOR SALE — CBS 17" table mdl., \$35; 24" console, \$130; Videola 17" table mdl., \$35; RCA CT100 color set, \$40; 21" table model, \$90; Hoffman 21" color console, \$300. Don Furman, Box 230, Port Washington, L. I., N. Y.

WANTED — AM FM table radio, also FM tuner. State mdl. number, cond. & price. Mercury Radio Service, 433 S. Wabash Ave., Chicago 5, Ill.

SELL OR TRADE — Rectifier RA-62C; Rider Chanalyst; Eico sig. gen.; sweep gen., and 5" scope; SCR 522 xmitter/rcvr. Interested in mdl. 15 or 21A teletype machine. Henry A. Galbraith, 1214 So. Alford Blvd., Evansville 14, Ind.

FOR SALE — Heath VFO and AT-1 with built-in grid modulator and antenna tuner. Best offer over \$60 for both, FOB. James Lichter, Box 367, Loras College, Dubuque, Iowa.

WANTED — For Heathkit, 3" scope with assembly and operating Manual, good operating Cond. Prof. M. Rotnem, c/o Amateur Radio K8GRA, Kent State University, Kent, Ohio.

FOR SALE — Broadcast equipt.: Gray and RMC phono equalizers, Gates pre-amps, Sarkes DC control amp. with relays, Simpson 305 and Jackson 636 tube testers, EMC 600 scope. Paul Bateman, station KBLR, Goodland, Kan.

FOR SALE — Gonset 2 meter and Tri-Band converter, \$15 each. Thomas Penney, 26 Fairfax St., Burlington, Mass.

SELL OR SWAP — For ham gear. Seco flyback FB-4, Heath SG-1 gen., TS-4A sweep/marker, T-3 trace, Philco 7051 checker, B & K M-400 & M-40, Sams. Owen Murray, 9 Iroquois St., Staten Island, N. Y.

WANTED — Good low resonant frequency woofers suitable for large infinite Baffle with crossover of 700 to 1250 cycles. Also interested in tweeters with 2000-18000 cycles range. Walter Ray, 929 Fairview, Shreveport, La.

FOR SALE — 500 assorted Ferrule power Resistors, Various wattages, \$7.50; 1000 assorted Ceramicons, \$7.50; General Radio Wave filter type 830 C and D, \$7.50 ea. S. S. Brody, 212-12 73rd Ave., Flushing 64, N. Y.

FOR SALE — GE type P-3 wattmeter, single-phase, 10 amps, 100-125v, 1000w, portable, walnut case, high accuracy, precision built, durable, bargain, \$100. Criss Kidder, 220 Maple Lane, No. Syracuse, N. Y.

FOR SALE — Riders Radio Manuals 1 to 23, 800 Resistors, Hickok 155 Traceometer, Clough-Brengle CRA-R Oscillograph, 111-R Frequency Modulator, 110-R sig. gen., 575 Supreme Decade Box instructions for all. S. P. Gruitt, Marshalls Creek, Pa.

FOR SALE — RCA WF-12A geiger counter probe \$45; Powermaster 200 autoformer 2A/12v, \$3. Sp 4 Frank Witmer, Hq. USATCA, Ft. Knox, Ky.

FOR SALE — Precision E-200-C sig. gen., \$65; Heathkits V-4A VTVM/HV probe, \$40; TC-1 Tube Checker, \$30; 0-7 modified scope/VC-2 Voltage Calibrator and probes \$70. E. L. Chapman, 912½ Front St., Olean, N. Y.

FOR SALE — Audio Gen. 20 cycles to 1 mc 10v output, Heathkit AG-8, \$20; Eico VTVM \$18. D. Roberts, 178 Pinckney Rd., Little Silver, N. J.

WANTED — VHF TV boosters, tunable cascade types. Roy Hale Radio & TV, Middlesboro, Ky.

FOR SALE — Arm & Cartridge from Seeburg juke box 720 C. Best offer. Selcraft, Box 394, Spring Valley, N. Y.

TRADE — Elements of Electronics by Hickey & Villines; Basic Electronics by Bernard Grob; Multimeter 20,000 ohm/volt and Sig. gen.; RCA Institute kits, used very few times. Interested in Sams Photofacts. Harry G. Calder, 6819 N. Bouvier St., Philadelphia 26, Pa.

FOR SALE — National NC-188, with original literature including diagrams, \$100. Gordon Beadles, Box 94, Tumwater, Washington.

SELL OR TRADE — RCA 3BX671 seven-band Portable, Industrial TV 1I105RB UHF/VHF TV field strength meter, Hickok 532 tube tester, RME DB-20 Preselector. Want good Color TV set, Air Conditioner, Citizens-Band equip., transistor portable. W. Wallace Cashwell, 213 S. Woodlyne Ave., Tampa, Fla.

FOR SALE — Sams Photofacts, Vols. 1 thru 4, like new \$10 each plus postage. Want cash or U.S. coins. Harold Garrett, 711 South N. Y., Sedalia, Mo.

WANTED — Unconverted Broadcast band command rcvr in top cond. State price. Walter Edwards, Jr., 1801 Windsor Ave., S. W., Roanoke, Va.

FOR SALE — Early batt. rcvrs., govt. surplus TBY xceiver, model railroad HO gauge engines, cars, turntable, magazines. David McKenzie, 406 Main, Leon, Iowa.

WANTED — Two walkie-talkies with diagrams; xmtr for 6-meters; 3" TV. For sale SX-18, CIRE course and Eicor tape rec. Larson, Box 134, Grand Island, Neb.

MAGAZINES — Wanted: proc. IRE 1958, July 1944, June, July, Aug., Sept., 1942; Radio 1935, Dec. 1936, Nov. 1943, April, July, Oct., Nov., 1944, Dec. 1945. Buy, or trade Electronics or QST in 30s. W. Cox, R. 2, Box 106, Georgetown, Ind.

WANTED — Super V Crosley tuner drum only #157282 VHF; and VHF fine tuning knob. State price. Bob Rinker Radio-TV Service, Box 122, Jenks, Okla.

FOR SALE — Master mobile whip, coil, flex r spring, bumper mount, \$15; PE-101 dynamotor 12v input 400v 200 ma output, \$5; Gonset Super Six Converter 6 or 12v input, manual, \$35; AF67, \$125. A. Bogart, 451 Oak St., Emporium, Pa.

FOR SALE — UHF tuner (channels 13 thru 80) Philco type UT-21-D, custom fits 1954 Philco "B" line TV rcvrs., complete with installation instrucs, very good cond., \$750 FOB. William Thomas, 139 S. Delmar Ave., Dayton 3, Ohio.

WANTED — Old batt. operated radios of 1920's, horn type spkrs., homemade variometer variocoupler sets, honeycomb coil sets. Need not operate but should have tubes. F. A. Nichols, 720 E. Eldorado St., Appleton, Wis.

WANTED — Books, magazines, and radio parts you might donate, or sell cheap, for use of boy scout group interested in electronics and amateur radio. Shipping charges gladly furnished. Arthur McGee, 415 S. Tower, Nevada, Mo.

FOR SALE — ATR batt. Eliminator, 610C-RLIF, \$20; Sprague Tel-Ohmike TO-5 Capacitor Analyzer. Both in like new cond. Eastside TV Electronics, Hwy. 52 East, Alexandria, Minn.

SELL OR TRADE — Heath TS-4 align. gen. complete with cables, instrs. and xtal, all in good operating cond., complete with tubes VHF tuner GE part RJX-109. John Prezioso, 423 Fifth St., Niles, Ohio.

FOR SALE — Heath imp bridge 1B-2, \$45; Sun Electric tachometer, 12v, 8cyl, \$20. A. P. Smith, 113 E. Central Lombard, Illinois.

SELL OR SWAP — Triplett 3441 scope like new, \$125; Solar CE capacitor analyzer, \$25; McMurdo-Silver, Heath, others, also tubes & parts. Will trade for firearms. Carl T. Petersen, 2430 E. 20th St., Oakland 1, Calif.

FOR SALE — O-1 MA meter, 4 1/2" square bakelite case, knife-edge pointer. 50 ohms internal resistance, VOM scale. Ship postpaid for \$5. L. Wienreb, 151-09-34th Ave., Flushing 54, N. Y.

FOR SALE — Precise 111 EM-GM tube tester wired, calibrated, in very good cond., \$80 FOB or consider trading for tape rec. Paul Landrum, 356 Patten Chapel Rd., Chattanooga 9, Tenn.

FOR SALE — Hammarlund SP-400-X rcvr. with power supply, \$210; Hallcrafters S-20-R rcvr., \$50. Both recently aligned and in very good cond. Richard Norton, 143 Merrick Rd., Lynbrook, L. I., N. Y.

SELL OR SWAP — Viking tape rec., demonstrator, 75SR 3-head stereo deck, RP61 record-playback amp. in Viking case plus 2 PB60 stereo playback preamps in cabinet, mike, etc. Swap for Exacta VXIIA or make offer. Prefer local. Stewart Gibson, Box 324 Waltham 54, Massachusetts.

WANTED — Used RF Induction heater, or tubes capable of 5-10 KW output. State price and cond. Roger Larson, 4900 Neptune Lane, Dayton 24, Ohio.

FOR SALE — Wilcox-Gay 4F portable tape rec., push button controls, 2 speeds, tape timer, push-pull amp., \$65; Nortronics SK-100 stereo converter \$10; RJ F-15-M mahogany sprk. cabinet \$15. New condition, FOB. Jack Atkins, 1375 27th St., Ogden, Utah.

FOR SALE — Supreme 565 VTVM \$19; Simpson 485 crosshatch gen., \$39; Simpson 488 field strength meter, \$59; Triplet 2400 7" VOM with extra AC current ranges .5 amp to 10 amps, \$39. Glenn Seaton, 10023 Madison Ave., Cleveland 2, Ohio.

FOR SALE — 30 - 50 mc. transmitter, 30 w. FM Motorola incl., power supply Vibrapak, complete package, \$25. H. Sinclair, 706 Hawthorne, Elmhurst, Ill.

FOR SALE — Schematics 50 cents each, name it and will send same day. Supreme Radio Service, 40 Ackerson Ave., Pequannock, N. J.

SELL — Hallcrafters S40A receiver, very good condition, \$49.50. B. Nastoff, 320 West 56th Pl., Gary, Ind.

FOR SALE — BC-342-M receiver 1500 - 18 mc., direct S meter, 100 kc. spotter, Gonset 10-11 converter, VR pwr. supply, spare RA-20 supply, very good cond., professional alignment. Will trade in on communication receiver. G. E. Howarth, 216 1st Avenue East, Oskaloosa, Iowa.

WANTED — Hickok 209A or equal in good condition, also Ferroglyph 8 1/4 hub-lock reels. M. Kennedy, 315 West 4th St., New York 14, N. Y.

SELL OR SWAP — National HFS receiver, Millen 90810 xmtr., 813 linear band-switching pi-net final, 2500/3000 v., 1 kw. power supply with regulated screen, bias included, choice exciters, Collins 310-B, Central 20A. Marion W. Cole, 3202 Avenham Ave. SW, Roanoke 14, Va.

FOR SALE — RCA ATJ/CRV59 TV camera, \$99; ATJ companion TV xmtr., \$35; TR10 comm. rcvr. and spkr., \$75; BC-455 rcvr., \$10; pair of Eimac 4-400A's, \$49; pair of 4X250B's, \$49. Bob Schill, P.O. Box 412, Hinsdale, N. H.

WANT TO BUY — Batt. elim., Hickok test equip., Heath ignition scope. Have Sams for sale. J. Moser, R. 1, Lewisburg, Pa.

SELL OR TRADE — Hickok 203 VTVM-condenser checker in very good cond., recently calibrated, leads and manual, \$30; little used Shure 566-S microphone with connector and cable, \$45. Le Roy Singer, 4 Atwood Rd., Plainview, N. Y.

FOR SALE — Vocaline radio transceivers (2), model JRC-425 special, complete, stainless steel mikes, push-button control, earphone jack, AC and DC line cords, plug-in antennas, operates on Citizens Radio band, \$175 or best offer. R. L. Edwards, Jr., Melbourne Avenue, Deale, Md.

FOR SALE — Hickok 600A mutual conductance tube checker, with adapter to check picture tube, \$100 plus shipping; Coyne Servicing books: Radio, TV, Appl. and Electrical, for \$3.00 plus shipping. John D'Alessandro, 239 Barclay Road, Upper Darby, Pa.

FOR SALE — Heath WA-P2 Hi-Fi preamp., Knight 25 w. ultra-linear basic amp., Heath BC-1A AM and FM-3A FM tuners. All units two years old, very good cond., all for \$100 FOB. B. A. Sichelstiel, 8611 Midi Ave., Baltimore 14, Md.

FOR SALE — Eico 625 tube tester, factory assembled, \$35; also McGraw-Hill book, Television and Radio Repairing by John Markus, \$5. T. E. Pritchard, 26 Platt Ave., Saddle Brook, N. J.

FOR SALE — Table model radios, motors, books, 16 sound films, 35 mm sound films; Victor model 40 sound projector, 16 mm, 2" lens, 750 w. lamp, 2000' capacity, \$135. P. J. Calderaro, 652 Main, Wakefield, Mass.

WANTED — Reconditioned ready to go Heathkit DX-40 phone and CW transmitter, for \$20 or less, and Gotham all-band vertical antenna for \$5 or less. S. W. Gehret, 331 West Greenwich St., Reading, Pa.

WANTED — Radio 3 dial control, mfg. or sold in mid-20's by W. C. Braun Co., Chicago; schematic for Atwater-Kent mod. 20, sounder and key, rheostats 3, 50 w., 3500 ohms. John E. Wosniac, 7419 W. Warming Ave., Milwaukee 20, Wis.

SWAP OR SELL — Heathkit grid-dip meter, \$15, and 17 w. Masco public address system, \$25. Want FM-AM tuner, old crystal set, small transmitter and rcvr suitable for mountain cabin use. James Lowe, 1521 Scenic Dr., Pasadena, Calif.

SELL OR TRADE — National HRO-50T receiver, all coils, speaker and Heath Q multiplier. Want VHF aircraft transceiver or ? ? L. Block, 3828 W. Jefferson, Los Angeles 16, Calif.

WANTED — Electronic test equip. of lab. grade for cash or swap electronic equip. of equal quality. W. C. Pendergast, 9777 E. Hasket Lane, Dayton 24, Ohio.

WANTED — Good late make generator at bargain for cash; also resistor and capacitor decade boxes. Will trade RCA 160-B 5' scope for Philco or Simpson genoscope and cash if necessary. McKinley's Radio and TV Service, Zebulon, Ga.

WANT — Electroplating equip., rectifiers, anodes, chemicals, resistance decade boxes, bridges, pyrometers and scientific equip. Al Aaron, 6010 Jamestown Road, Hyattsville, Md.

FOR SALE — Rider radio man. 5 x 12 Zenith Vol. 1 and 2, in one cover, \$5 COD plus postage; Heathkit tube checker TC-1 in good working order. Stephen Barniak, 2426 Perot St., Philadelphia 30, Pa.

FOR SALE — Webcor 2130 tape recorder, records and plays back in both directions, \$60 or swap for Revere 8 mm movie projector. A. J. Kinge, 235 - 73rd St., Brooklyn 9, N. Y.

FOR SALE — Hickok 691 marker adder, never used, best offer over \$50. Donald Hardy, Route 3, Massena, N. Y.

WANTED — Mod. xformer Universal type, approx. 30 w. Have Chicago P67 1000 v. AC, 300 ma CT plate xformer, Kenyon 300 ma T-510 G-19H choke, T-164 11H 300 ma choke. A. Sylvia, Nantucket, Mass.

WANTED — 100 w. all-band transmitter, comm. or home brew, or 100 w. 10-15-20 rig. Trade for TV test equip.; also want receiver, usable on 10 meters. J. C. Stevens, 700 71st Ave., Seat Pleasant, Md.

WANTED — Instruction booklet and schematic diagram on McMurdo-Silver 906 signal generator. C. G. Jenkin, 237 Main Ave., Clinton, Iowa.

WANTED — Technical manual TM-11-625 for radio sets SCR-543-A-B-C, state price and condition. H. W. Lingenfelter, 21352 Kenwood Ave., Rocky River 16, Ohio.

FOR SALE — HT9 trans. 150 w. phone and CW all coils, \$90; old model HRO rcvr, all coils, \$60; dual high voltage supplies for 813 PP final, \$70; BC-458 trans. (no cover), \$4. John Kakstys, 18 Hillcrest Terr., Linden, N. J.

BEST OFFER — The C-D Capacitor from Jan. 1950 to Oct. 1959, good clean cond., 106 copies. T. C. Coughlin, 441 - 42nd St., Brooklyn 32, N. Y.

FOR SALE — 84 issues Radio TV News, Jan. '51 to Nov. '54, Feb. '56 to Dec. '58, complete, plus others; 42 issues Radio Electronics, '52-'53, complete plus others. Bill Praetz, 203 Covert St., Brooklyn 7, N. Y.

FOR SALE — Sylvania 500 sweep gen.; 216 sig. gen.; 145 audio sig. gen.; Hickok 610A sig. gen.; 650 TV videometer; Kay Mega marker, Jr. and piper; 2 WO-56A RCA scope; 2 Philco 7053 CRT tester. Vito Daidone, 882 South Orange Ave., Newark 6, N. J.

FOR SALE — Decca P-905 45 rpm portable record player, \$4; Solar CC-1-60 capacitor analyzer, needs tubes, \$3; 670-A super-meter, like new, with manual, needs battery, \$10. Virgil Kramer, Route 3, Burwell, Neb.

FOR SALE — Simpson VTVM with leads, purchased in 1956, good cond., cash or money order, \$35. Clarence R. Putnam, Box 228, South Roxana, Ill.

FOR SALE — 6 volt battery eliminator, \$15; 17" RCA TV in working order, \$40. P. Shavel, 332 Mauver St., Brooklyn 6, N. Y.

HAVE — Test equip., TV sets, tape recorders, antique radios, classic record collection, magazines. Want Lincoln pennies, 1909 SYDB and 1955 double-struck. S. Roszewski, 22 Ellington Ave., Rockville, Conn.

SELL OR TRADE — Eimac 4x150A in sealed bag, won at hamfest, \$15, or trade for multimeter or ham gear. Paul Van Nostrand, 1810 Ziegler Rd., Orlando, Fla.

FOR SALE — Heathkit AR-3 rcvr with cab., \$25; Heathkit QF-1 Q multiplier, \$7; WAL Globe Chief 90 xmitter, \$40; Knight V44 VFO, \$25; DPTD coax relay, \$10. All fine cond., with manuals, prepaid. Geo. Snyder, 900 E. Arcadia Dr., Pittsburgh 37, Pa.

FOR SALE — BC-221 AH freq. meter with reg. AC power supply, orig. calibration book, \$70; extra good PE-103 dynamotor, \$15; DB-23 RME preselector in fine cond., \$35. Jim Stueber, 8410 Flower Place, N.E., Albuquerque, N. Mex.

SELL OR SWAP — Heath O-10 scope with leads, demod. probe, schematic, \$50 or ham comm. xmt. Bill Blanton, 115 Duncan Cir., West Monroe, La.

FOR SALE — Deluxe 35" cabinet rack, \$10; Knight in-circuit condenser checker, \$10; 1000-750 v. power supply, UTC, etc., \$15; 50 w. home brewed CW 20 mtr. xmitter, \$10. J. Farrier, 222 Johnston Circle, Sidney, N. Y.

FOR SALE — 2 RCA transcription pickups, \$1.50 each; also switches, relays, transformers, condensers, and thermistors. Eric Scholer, 209 Glengary Rd., Schenectady 4, N. Y.

WANTED — Chassis and knobs for Sentinel Treasure Chest portable radio, model 286 PR. State price. Wilbur Remley, R. 6, Box 370, Decatur, Ill.

SELL OR SWAP — Stereo tape player, Livingston-Pentron, stag. heads, built-in preamps, working order, with 3 classic recorded tapes, \$50, or swap for LP Hi-Fi classic monaural records. D. G. Brower, R. 1, Box 84, Zion, Ill.

WANTED — Home for Scott 27 tube all-band Hi-Fi radio receiver with 4 speed VM changer in massive wood cabinet, \$80 FOB. W. Greenbaum, 17 Poplar St., Elmsford, N. Y.

FOR SALE — RCA WV-97A Senior Volt-ohmyst with WG-289 high voltage probe, WG-264 crystal diode probe. All in orig. cartons, \$50 cash. Walter Hunneschagen, Box 396, Rochester, Ind.

SELL OR TRADE — Collins-built Navy TCSS and TCS12 transmitter, receiver and 117 v. AC power supply; 40, 80, 160 meters, 125 w. output, TVI'd, perfect, with manual, \$125 cash, or trade toward Hallicrafter SX-100. Meet halfway, save shipping. Phil Wood, Bangor, Mich.

FOR SALE — Complete electronic and TV commercial shop equip., from estate. Make offer. Voightlander camera with flashgun, 3/4 x 4/4, \$60. M. Mangold, 11723 - 2nd Ave., Lynwood, Calif.

FOR SALE — Allied Ocean Hopper rcvr., complete with coils and cabinet, wired and ready for use, unaligned, \$10. G. Howard, 405 Queensway Dr., Lexington, Ky.

WANTED — Instruction manual for Wilcox electric type 96N transmitter. G. Merriman, 2093 Constitution Blvd., Boston, McKeesport, Pa.

WANTED — Hallicrafters SX-42 speaker. J. L. Matthews, Box 2004, East Gadsden, Ala.

FOR SALE — Triplett 666H VOM, \$9.50; Heath V7 with HV probe, \$17.50; Pacc G30PC RF sig. gen., factory wired and calibrated to 1% accuracy, \$30. E. Giroux, 735 Park Ave., Hoboken, N. J.

FOR SALE — Ammeters reading 20 amps below and above zero for cars with 12 v. system, surplus still sealed in containers, \$2 each plus shipping. Martin Goffe, 1011 - 44th St., Brooklyn 19, N. Y.

FOR SALE — 130 watt AM-CW, rack-mounted, xmt., in steel cabinet, 4 panels, with back door; Heath VFO; radio magazines; Pop. Electronics Mark II speaker baffle. Want compact, commercial xmt., power no object, and/or light weight beam rotator. Stephen Swerling, 132 Bloomingdale St., Chelsea 50, Mass.

Consistently Dependable
Cornell-Dubilier
 mica capacitors



**They don't just meet ratings:
 they exceed them!**

Other capacitors may look like C-D micas. But there the resemblance ends. Because only C-D's have the built-in extras that are the result of over 50 years of capacitor leadership.

See your classified telephone directory for nearest C-D jobber.

C-D WAS "FIRST" WITH HIGH VOLTAGE TRANSMITTING MICAS, "POSTAGE-STAMP" MICAS, "SILVERED" MICAS, BAKELITE MOLDED MICAS.

THERE ARE MORE C-D CAPACITORS IN USE TODAY THAN ANY OTHER MAKE

CORNELL DUBILIER *Capacitors*

Plants in South Plainfield, N. J.; New Bedford and Cambridge, Mass.; Providence and Hope Valley, R. I.; Indianapolis, Ind.; Sanford, Varina and Fuquay Springs, N. C.; Venice, Calif.; and subsidiary, The Radiart Corporation, Cleveland, Ohio.

They May Look Alike...

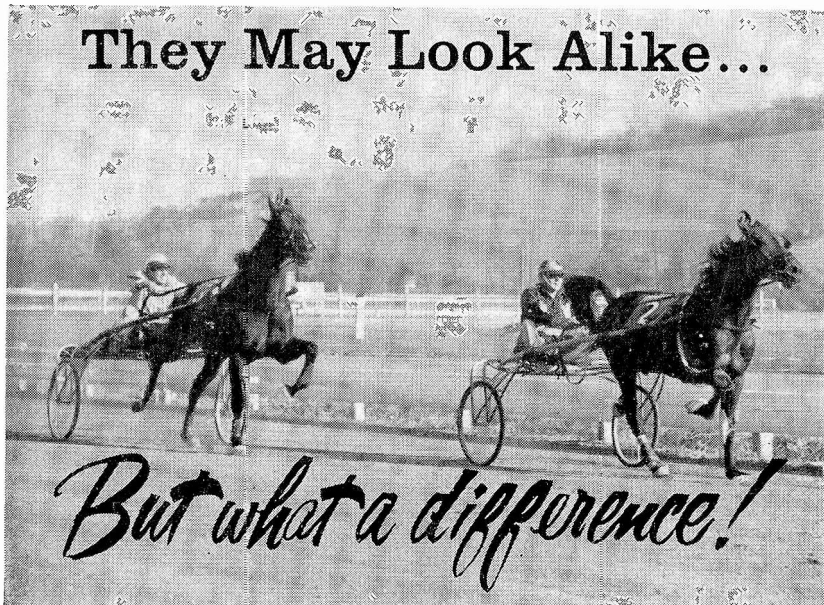

But what a difference!



It's the same with capacitors. Others may look like C-D tubulars, but only C-D's have the built-in extras that are the result of 50 years of capacitor leadership. Next time you buy capacitors, insist on performance. Insist on C-D...*by name!*

TYPE TWMA (DEMICON)

Hermetically sealed with glass-to-metal seal terminals, this miniature metal-cased Mylar* tubular is built to give long-lasting performance.

insist on them by name



CORNELL-DUBILIER CAPACITORS

*Du Pont Reg. T.M.