

Electronic Engineering

DECEMBER 1951

Seasonal Greetings

from
Vortexion
LIMITED

MAKERS OF HIGH QUALITY AMPLIFIERS

257-261 THE BROADWAY,
WIMBLEDON, S.W.19

Telephones: LIBerty 2814 and 6242-3 Telegrams: "VORTEXION, WIMBLE, LONDON"

TWO SHILLINGS

The core of the Motor is the Electrical Stamping



SANKEYS...
ARE THE LARGEST
MANUFACTURERS
OF ELECTRICAL
STAMPINGS IN
EUROPE

SANKEYS
"STALLOY" &
"LOHYS"
Electrical Sheets
are Rolled at
The **MANOR WORKS**

JOSEPH SANKEY & SONS LTD.

ESTABLISHED 1854

BANKFIELD WORKS, BILSTON STAFFS, ENG.

TELEGRAMS SANKEY · BILSTON

LONDON OFFICES ULSTER CHAMBERS 168 REGENT STREET W

CLASSIFIED ANNOUNCEMENTS

The charge for these advertisements at the LINE RATE (if under 1" or 12 lines) is: Three lines or under 7/6, each additional line 2/6. (The line averages seven words.) Box number 2/- extra, except in the case of advertisements in "Situations Wanted," when it is added free of charge. At the INCH RATE (if over 1" or 12 lines) the charge is 30/- per inch, single column. Prospectuses and Company's Financial Reports £14 0s. 0d. per column. A remittance must accompany the advertisement. Replies to box numbers should be addressed to: "Electronic Engineering," 28, Essex Street, Strand, London, W.C.2. Advertisements must be received before the 14th of the month for insertion in the following issue.

OFFICIAL APPOINTMENTS

ADMIRALTY. Applications are invited from Engineering, Electrical and Ship Draughtsmen for temporary service in Admiralty Departments at Bath. Candidates must be British subjects of 21 years of age and upwards, who have had practical Workshop and Drawing Office experience. Salary will be assessed according to age, qualifications and experience within the range £320-£545 per annum. Applications giving age and details of technical qualifications, apprenticeship (or equivalents) Workshop and Drawing Office experience, should be sent to Admiralty (C.E.11, Room 88), Empire Hotel, Bath. Candidates required for interview will be advised within two weeks of receipt of application. W 137

ADMIRALTY. Vacancies exist for Electrical and/or Mechanical Engineering Draughtsmen in Admiralty Research and Development Establishments located in the vicinity of Weymouth, Portsmouth, Teddington (Middlesex) and Baldock, Herts. Draughtsmen experienced in light current, electro-mechanical, precision mechanical and electronic equipment are particularly needed. Candidates must be British subjects of 21 years of age and upwards, who have had practical workshop experience (preferably an apprenticeship) together with Drawing Office experience. Appointments will be in an unestablished capacity, but opportunities may occur for qualified staff to compete for established posts. The salaries offered depending on age, experience, ability and place of duty will be within the range £320-£560 p.a. Hostel accommodation is available at some Establishments. Applications, stating age and details of technical qualifications, apprenticeship (or equivalents) Workshop and Drawing Office experience, should be sent to Admiralty (C.E.11, Room 88) Empire Hotel, Bath, quoting DM/R.D. Original testimonials should not be forwarded with application. Candidates required for interview (at London or Bath whichever is nearer) will be advised within two weeks of receipt of application. W 2111

ADMIRALTY. Temporary Assistant Overseers experienced in all electrical engineering techniques are required for temporary service in the Overseeing service of the Electrical Engineering Department, Admiralty. Vacancies exist at London, Belfast, Birmingham, Birkenhead, Barrow, Bishop Auckland, Hull, Leeds, Liverpool, Manchester, Newcastle and Sheffield. Candidates must be British subjects of 21 years of age and upwards who have served an apprenticeship or had equivalent practical workshop experience and possess some technical qualifications. Salary will be assessed according to age, qualifications and experience on a range with a London maximum of £675 p.a. For candidates of 30 years of age salary will normally be related directly to age, i.e., £570 p.a. (London) and for younger candidates will be approximately £20 p.a. less than the age 30 rate for each year of age they are under 30. The London rates are reduced from £10 to £15 p.a. at Belfast, Birmingham, Birkenhead, Hull, Leeds, Liverpool, Manchester, Newcastle and Sheffield, and by from £20 to £30 p.a. at other towns in the provinces. Applications, stating age, details of technical qualifications and apprenticeship (or equivalent) and workshop experience, should be sent to the Admiralty, Empire Hotel, (C.E.11, Room 83), Bath. Candidates will be interviewed locally as soon as possible after receipt of their applications. W 2272

APPLICATIONS are invited by the Ministry of Supply from Physicists and Electrical Engineers for the following posts in the Scientific Officer Class at a Research Establishment South East of London. 1. Electrical Engineer with a sound knowledge of physical principles and electronic applications to physics problems. (D 490/51-A). 2. Physicist or Electrical Engineer with experience in radio communications. (A 337/51-A). 3. Physicist with experience in electronic circuitry problems for measurement of high speed transients. (A 337/51-A). 4. Electrical Engineer for research and development in V.H.F. and U.H.F. transmission and reception. Previous experience in leading a team of scientists in the execution of field trials would be

of value. (D 490/51-A). 5. Electrical Engineer for design and development work in a wide field of electronic instruments. Experience in the design of radio receivers and transmitters and/or in the handling of high speed transients would be of value. (D 490/51-A). Candidates should possess a 1st or 2nd class Honours Degree in Physics or Electrical Engineering or equivalent qualifications, and for the senior posts at least 3 years post-graduate research experience. For Post 1 candidates should have served an apprenticeship. Salary will be determined on age, qualifications and experience within ranges £380 to £1 295. Rates for women somewhat lower. Posts are unestablished but carry benefits under F.S.S.U. Application Forms obtainable from Ministry of Labour and National Service, Technical and Scientific Register (K), Almack House, 26 King Street, S.W.1, quoting appropriate reference No. W 2298

APPLICATIONS are invited by the Ministry of Supply from Electrical and Mechanical Engineers and Physicists for posts in the Experimental Officer Class at the Royal Aircraft Establishment, Farnborough. Candidates should have experience in at least one of the following: (1) Generation and distribution of electrical power in aircraft. (2) General electronics, communications or radar. (3) Aircraft structure and associated mechanical problems. (4) Servo mechanisms and automatic actuators. Acceptable qualifications include, as a minimum, Higher School Certificate with Physics and Mathematics as principal subjects, but other qualifications such as Higher National Certificate in Electrical or Mechanical Engineering or a Degree in Physics would be an advantage for some of the posts. Salary will be assessed according to age, qualifications and experience within the ranges: Senior Experimental Officer (minimum age 35), £742-£960, Experimental Officer (minimum age normally 28), £545-£695. Rates for women somewhat lower. The posts are unestablished. Application forms obtainable from Ministry of Labour and National Service, Technical and Scientific Register (K), Almack House, 26 King Street, S.W.1, quoting D 483/51-A. Closing date 14 December, 1951. W 2289

APPLICATIONS are invited by the Ministry of Supply for vacancies in the Experimental Officer Class at the Atomic Energy Research Establishment, Harwell, Berks., for work in the following fields: Physics, Electronics and Scientific Computing (Ref. A 309/51/ABG), and Chemistry (other than Organic Chemistry), Chemical Engineering and Metallurgy (Ref. F 777/51/ABG). These posts offer a wide variety of experimental work in connexion with the development of atomic energy and the opportunity for a career in an increasingly important branch of science. Candidates should possess at least Higher School Certificate or Higher National Certificate in a relevant scientific subject or mathematics or equivalent qualifications. Higher qualifications will be an advantage. Appointments will be made according to qualifications, experience and age within the following salary ranges: Experimental Officer (male) £545-£695 per annum. Assistant Experimental Officer (male) £240 (at age 18), £505 per annum. Rate for women somewhat lower. Application forms obtainable from Ministry of Labour and National Service, Technical and Scientific Register, Almack House, 26 King Street, London, S.W.1, quoting the appropriate Ref. No. W 2249

ASSISTANT (SCIENTIFIC) CLASS: The Civil Service Commissioners give notice that an Open Competition for pensionable appointment to the basic grade will be held during 1951. Interviews will be held throughout the year. Successful candidates may expect early appointments. Candidates must be at least 17 and under 26 years of age on 1st January, 1951, with extension for regular service in H.M. Forces, but other candidates over 26 years with specialised experience may be admitted. All candidates must produce evidence of having reached a prescribed standard of education, particularly in a science subject and of thorough experience in the duties of the class gained by service in a Government Department or other civilian scientific establishment or in technical branches of the Forces, covering a minimum of two years in one of the following groups of scientific subjects:

(i) Engineering and physical sciences. (ii) Chemistry, bio-chemistry and metallurgy. (iii) Biological Sciences. (iv) General (including geology, meteorology, general work ranging over two or more groups (i) and (iii) and highly skilled work in laboratory crafts such as glass-blowing). Salary according to age up to 25—Men £215 (at 18) to £330 (at 25)—£455; rather less in the provinces and for women. Opportunities for promotion. Further particulars and application forms from Civil Service Commission, Scientific Branch, Trinidad House, Old Burlington Street, London, W.1, quoting No. S 59/51. Completed application forms should be returned as soon as possible, and not later than 31st December, 1951. W 2297

B.B.C. requires electronic engineers for Operations and Maintenance Department (Television) in London. Duties involve detailed investigation of performance and design of television equipment at audio, video and radio frequencies and compilation of reports. Engineering Degree or equivalent and experience in television practice essential. Salary £655 (may be higher if qualifications exceptional) rising by 5 annual increments to £840 maximum. Apply Engineering Establishment Officer, Broadcasting House, London, W.1, within 7 days. W 2306

B.B.C. requires Instructor in Engineering Training Department at Evesham, Worcester. Candidates should have Degree or equivalent qualification in Physics or Electrical Engineering. Knowledge of any branch of radio or broadcast engineering (sound or television) and teaching experience are desirable. Salary £655 (may be higher if qualifications exceptional) rising by 5 annual increments to £840 p.a. maximum. Applications to reach Engineering Establishment Officer, Broadcasting House, London, W.1, within 7 days. W 2264

CROWN AGENTS for the Colonies. Electrical Engineer (Electronic) required for the headquarters staff at the London office. Salary scale £750 a year, rising to £1,000. Extra duty allowance of 8% of annual salary also payable at present. A substantially increased scale is in prospect, however, and when introduced will become effective from date of appointment. Engagement will be on un-established terms with a prospect, after satisfactory service and as vacancies occur, of appointment to the established and pensionable staff and promotion to a higher grade. Candidates should preferably hold an Honours Degree in Electrical Engineering (Telecommunications and Electronics) or should be corporate Members of the Institution of Electrical Engineers. They should have served an apprenticeship with a firm of Electrical Engineers manufacturing radio or associated equipment and have had subsequent experience on the manufacturing and technical side of the industry. The appointment will, in the first instance be to the Inspection Department and candidates should be capable of dealing with the problems arising from the inspection of a wide variety of electronic equipment by a staff of Inspecting Engineers operating locally in various parts of the United Kingdom. Apply at once by letter, stating age, full names in block letters, and full particulars of qualifications and experience, and mentioning this paper to the Crown Agents for the Colonies, 4 Millbank, London, S.W.1, quoting on letter M.28544.B. The Crown Agents cannot undertake to acknowledge all applications and will communicate only with applicants selected for further consideration. W 2324

ELECTRICAL ENGINEERS and Physicists are invited by the Ministry of Supply to apply for the following appointments in the Scientific Officer Class at a Research and Development Establishment near London. Senior Scientific Officer 1. Electrical Engineers (2) with special qualifications in radio communications and experience in the engineering of development prototypes. (D 390/51-A). 2. Physicist with experience in electronic circuitry for research into the measurement of high speed transients. (A 245/51-A). 3. Physicist with experience of optical and electronic techniques, and with an interest in fluid mechanics, for work on aerodynamics problems including wind tunnel investigations. (A 246/51-A). Scientific Officer 4. Electrical Engineer or Physicist with interest in the application of electronic methods to optical

OFFICIAL APPOINTMENTS (Cont'd.)

instrumentation techniques. (D 392/51-A.) 5. Electrical Engineer or Physicist for work on high speed electronic calculating machine. (D 391/51-A.) Candidates should possess a 1st or 2nd class honours Degree in Physics or Electrical Engineering or equivalent qualification. For the senior grade the minimum age is 26 and at least 3 years' post-graduate research experience is required. For post 1 an engineering apprenticeship or industrial experience would be an advantage. Salary will be determined on age and on an assessment of the successful candidates' qualifications and experience within the ranges: Senior Scientific Officer—£720 to £910, Scientific Officer—£380 to £620. Rates for women somewhat lower. Posts are unestablished but carry benefits under F.S.S.U. Application forms obtainable from Ministry of Labour and National Service, Technical and Scientific Register (K), Almack House, 26 King Street, S.W.1, quoting appropriate reference number. W 2288

ELECTRONIC PHYSICISTS and Engineers are required by the Ministry of Supply for the following posts, in the Experimental Officer Class, at a Research Establishment South East of London. 1. Electrical Engineer with experience of aircraft radar installation and maintenance. Candidates must be prepared to do experimental flying. (D.491/51-A.) 2. Physicist with experience in the generation and reception of signals in the V.H.F./U.H.F. Region, or in the production and handling of short duration pulses. (A 336/51-A.) Candidates must be at least 28 years of age. Minimum qualification is Higher School Certificate but higher qualifications will be an advantage. Salary will be assessed according to age, qualifications and experience within ranges £545 to £960. Rates for women somewhat lower. The posts are unestablished. Application forms obtainable from Ministry of Labour and National Service, Technical and Scientific Register (K), Almack House, 26 King Street, S.W.1, quoting appropriate Ref. No. Closing date 14 December, 1951. W 2301

ENGINEERS required by Ministry of Supply at Hayes, Middlesex and Manchester. Qualifications: British, or British parentage; regular engineering apprenticeship and either be corporate members of one of the Institutions of Civil, Mechanical or Electrical Engineers or have exempting qualifications. Possess sound knowledge of electronic theory and practice; be familiar with modern techniques connected with radio, radar and electronics. Duties: Technical direction and supervision of inspection of mass produced miniature electronic devices. Salary: Within the Range £600-£900 p.a., slightly less for Manchester. Unestablished, periodical competitions for established pensionable posts. Application forms from Ministry of Labour and National Service, Technical and Scientific Register (K), Almack House, 26-28 King Street, S.W.1, quoting D492/51-A. Closing date 14 December, 1951. W 2300

ENGINEER required by Ministry of Supply Establishment at Malvern, Worcestershire. Qualifications: British, of British parentage; regular engineering apprenticeship and either be corporate member of one of the Institutions of Civil, Mechanical or Electrical Engineers or hold exempting qualifications and have workshop or drawing office experience; specialised experience in one or more of the following is desirable: (a) Electronic Engineering; (b) Servo Mechanisms; (c) Fine Mechanisms, including hydraulic devices. Duties: To take charge of a team of Engineers investigating engineering and design problems, working with scientific staff on development of ground radar equipment. Salary: Within the range £1,177-£1,370 p.a. Unestablished, periodical competitions for established pensionable posts. Application forms from Ministry of Labour and National Service, Technical and Scientific Register (K), 'Almack House,' 26 King Street, S.W.1, Quoting Reference No. D.482/51-A. Closing date 14 December, 1951. W 2287

MINISTRY OF SUPPLY require Technical Grade III in Sevenoaks, Kent. Qualifications: British, of British parentage, regular engineering apprenticeship or equivalent training in Services or industry. At least three years' experience in construction, assembly, fault finding and testing of electronic instruments or equipment essential. Possession of Ordinary National Certificate or City and Guilds Certificate or equivalent qualification an advantage. Duties: responsible for maintenance, fault finding, repair and calibration of electronic instruments and apparatus. Salary: £437 (at age 26)-£545 p.a. Unestablished. opportunities for establishment may arise. Written applications, giving date of birth

and education, full details of qualifications and experience of posts held (including dates) should be addressed to the Appointments Officer, Ministry of Labour and National Service, 1-6 Tavistock Square, W.C.1, quoting reference K1.366 within ten days of the appearance of this advertisement. In no circumstances should original testimonials be forwarded. Only candidates selected for interview will be advised.

MINISTRY OF SUPPLY requires, at Research and other Establishments in various parts of the country, skilled Mechanics for precision light engineering work connected with the setting up, maintenance, and repair of instruments (Mechanical, Electrical and Electronic). 5 day week of 44 hours. Rates of pay and other conditions of service on application. Write in the first instance, giving age, particulars of apprenticeship, training (including Forces' training), qualifications and experience, also stating whether preference for a particular district, to the Secretary, Ministry of Supply, Room 263, Shell Mex House, Strand, London, W.C.2. Applications from skilled fitters and machinists would also be welcomed. W 2299

PHYSICIST OR ENGINEER (Radar) Dominion Physical Laboratory, New Zealand. Applications are invited from suitably qualified persons to fill the vacancy for a Physicist or Engineer in the Radar Laboratory, Lower Hutt, New Zealand. Commencing salary, according to qualifications and experience, will be up to £860 N.Z. per annum plus 15% General Wage Increase. Applicants should possess first or second class Honours in Physics or Engineering. The appointee will be required to work on decimetre-wave apparatus in the field or radar laboratory. Previous experience in this type of work is desirable. Application forms and conditions of appointment may be obtained from: The High Commissioner for New Zealand, 415 Strand, London, W.C.2, mentioning this paper and quoting reference No. A.3/64/107. Completed applications should be lodged not later than 8th December, 1951. W 2258

PROFESSIONAL ENGINEERS in Government Departments. The Civil Service Commissioners announce an Open Competition for permanent appointments of Professional Engineers, General Service Class (Main and Senior grades). The vacancies at present announced are in the Admiralty (not less than 5 in the Main Grade and one in the Senior Grade). The duties in the Admiralty cover the production of mechanical, electrical and electronic equipment for H.M. Ships and include design for production, correlation of manufacturing requirements and capacity advice on production methods, preparation of estimates and, in certain cases, material inspection and functional testing. Candidates must be at least 30 years of age on 1st January, 1951. Minimum Qualifications. Generally Corporate Membership of the Institutions of Mechanical Engineers, or Electrical Engineers is required, together with evidence of apprenticeship or pupillage and subsequent engineering experience. Exceptionally, candidates of high professional attainments without some or all of these qualifications may be admitted. Salary scales: Main Grade. Men—£900-£1,200. Women—£650-£850 (London). Men—£860-£1,140. Women—£620-£810 (Provinces). Senior Grade. Men—£1,250-£1,450. Women—£900-£1,100 (London). Men—£1,177-£1,370. Women—£860-£1,040 (Provinces). The rates for women are at present under review. Further particulars and application forms from Secretary, Civil Service Commission, Trinidad House, Old Burlington Street, London, W.1, quoting No. S86/51. Applications will be accepted at any time but not later than 31st December, 1951, and selected candidates will be interviewed as soon as possible after receipt of their Application Forms. Candidates are advised to apply as early as possible as a closing date earlier than 31st December may eventually be announced. W 2268

PROFESSIONAL ENGINEERS IN GOVERNMENT DEPARTMENTS. The Civil Service Commissioners announce an Open Competition to be held during 1951 for permanent appointments in many Departments of the Civil Service for a wide variety of engineering duties. Applications will be accepted at any time but not later than 31st December, 1951, and selected candidates will be interviewed as soon as possible after the receipt of their Application Forms. Candidates are advised to apply as early as possible. Age Limits: Candidates must be under 35 on 30th November, 1951, with extension for regular service in H.M. Forces and for established Civil Service. For appointments in the Post Office they must be 21 or over, in the Ministry of Supply, 23, and in all other Departments 25 or over on that date. Minimum

Qualifications vary for different posts. Generally a University Degree in Engineering or Corporate Membership of the Institutions of Mechanical Engineers, Electrical Engineers or Civil Engineers, or passes in or exemption from Sections A and B of the corresponding Associate Membership examinations, or evidence of exceptionally high professional attainment are required. For certain posts, Corporate Membership of the Institute of Fuel by examination or the Institution of Chemical Engineers, or Graduate Membership of the Institution of Chemical Engineers, or Associate Fellowship of the Royal Aeronautical Society or an Honours degree in Physics will be accepted instead. The salary on appointment will be fixed according to age. The salary for men aged 25 in London is £575 rising by annual increments of £25 to £750, and by £30 to £900. Salaries for women and for posts outside London are lower. There are prospects of promotion to higher grades on scales for men in London of £900-£1,200, £1,250-£1,450 and above. Further particulars and applications forms from Secretary, Civil Service Commission, Trinidad House, Old Burlington Street, London, W.1, quoting No. S85/51. W 2250

RADAR AND ELECTRONIC technicians are required for repair and maintenance of Radar and Electronic Control and computing equipment in the Glasgow and Edinburgh areas. Applicants should have had experience comparable with the standard of Armament Artificer (REME) or hold National Certificate in Electrical Engineering, or equivalent qualifications. Salary in Scale £437 (at 26) by £20 to £545. Applications should be addressed to: A.D.M.E., H.Q. 3 A.A. Group, Riccarton House, Currie, Midlothian, giving details of experience, qualifications and age. W 2234

SENIOR PRINCIPAL PRODUCTION ENGINEER. Admiralty Production Pool—The Civil Service Commissioners invite applications from men for one or two permanent appointments as Senior Principal Production Engineer. Candidates must have been born on or before 1st January, 1920. Candidates must be Corporate Members of the Institution of Mechanical Engineers and/or the Institution of Electrical Engineers or show evidence of exceptionally high professional attainment. They must have had a wide general engineering background, including apprenticeship, and have had extensive experience in the Engineering Production Field. Salary £1,500-£1,750. Exceptionally a starting salary above the minimum may be granted according to qualifications and experience. Further particulars and application forms from the Civil Service Commission, Scientific Branch, Trinidad House, Old Burlington Street, London, W.1, quoting No. S.4098/51. Completed application forms must be returned by 13th December, 1951. W 2280

SITUATIONS VACANT

A LABORATORY ASSISTANT required capable of taking charge of electrical and electronic equipment for a Guided Missiles Project. Duties will include calibration and minor repairs of instruments. Applicants with the necessary experience will also control Sub-standard Room and undertake design of laboratory equipment. Full particulars to Box No. W 2190.

ALWYN ISHERWOOD LIMITED, require T.V. engineers for bench and field service. If you want good pay with prospects under ideal operating conditions, and you are master of your craft, contact the Service Manager, Alwyn Isherwood Limited, 91/95 Westgate, Wakefield. Tel. 3196/7. Expenses will be paid for all applicants selected for interview. W 1373

A NEW DEFENCE PROJECT of National Importance being undertaken by a well known Aircraft Company located in the Northern Outskirts of London, offers highly paid and interesting posts for suitably qualified applicants. Vacancies exist in Senior (salaried grades) and for Junior Engineers in various categories: (a) Physicists with experience in electronic problems. (b) Physicists with experience in optical work. (c) Electronic Engineers with Servo-Mechanism experience. (d) Electronic Engineers with experience of low frequency work and measuring systems. (e) Electrical Engineers with experience in small motor design and development. Applicants for Senior posts should possess a good University Degree and preferably should have some

CLASSIFIED ANNOUNCEMENTS
continued on page 4



QUALITY

ACCURACY

RELIABILITY

By Appointment to the Professional Engineer...

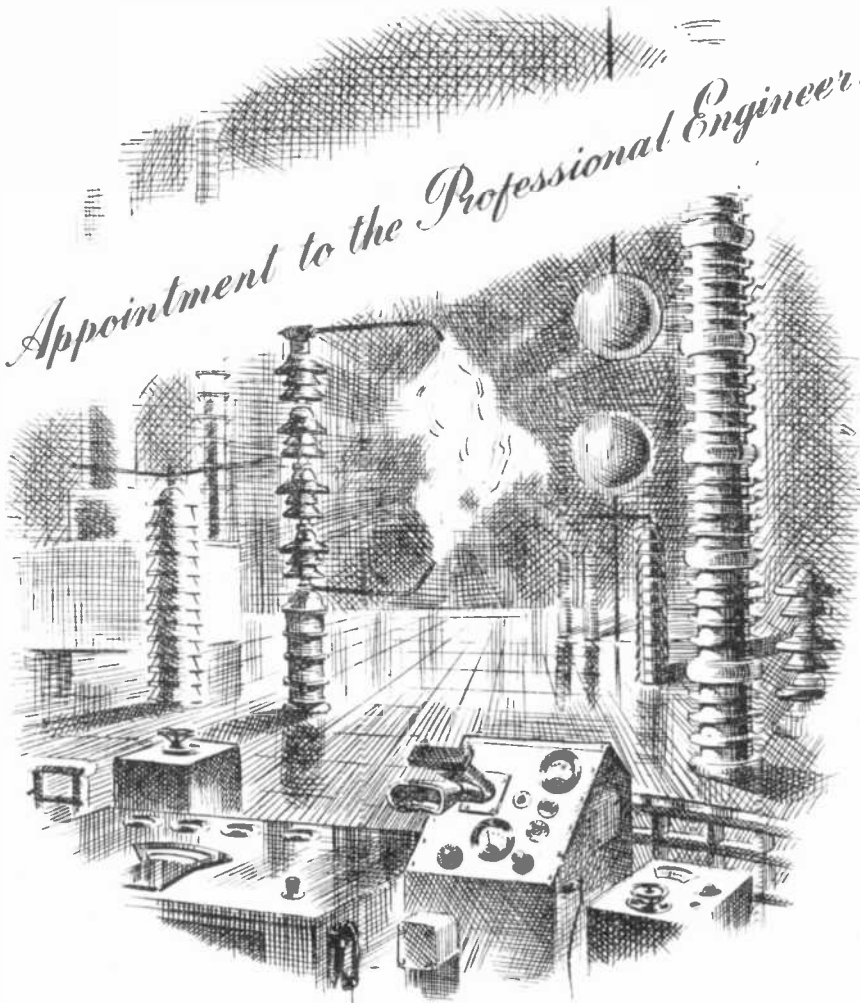

ATTENUATORS · FADERS · SWITCHES · WIREWOUND POTENTIOMETERS · PLUGS
AND SOCKETS · WIREWOUND RESISTORS · HIGH STABILITY CARBON RESISTORS
KNOBS DIALS AND POINTERS · TERMINALS

PAINTON

Northampton England

SITUATIONS VACANT (Cont'd.)

industrial experience. Applicants for Junior posts should have a good industrial experience. be qualified either by City & Guilds certificate or by Inter. B.Sc. Write full details, qualifications, experience, age, salary sought to Box A.C. 65489 Samson Clarks, 57-61 Mortimer Street, W.1. W 2136

A NUMBER of Senior and Junior vacancies for Radio, Radar, Electronic, Television, etc., Development, Service Engineers, Draughtsmen, Wiremen, Testers, Inspectors, etc. Urgent required, 30 Television Service Engineers. Write in confidence: Technical Employment Agency, 179 Clapham Road, London, S.W.9. (BR1) 3487. W 113

A NEW DEFENCE project of National Importance being undertaken by a well-known Aircraft Company located in the northern outskirts of London, offers highly paid and interesting posts for suitably qualified applicants. Vacancies exist in Senior (salaried grades) and for Junior Engineers in various categories:- (a) Physicists with experience in electronic problems. (b) Physicists with experience in optical work. (c) Electronic Engineers with Servo-mechanism experience. (d) Electronic Engineers with experience of low frequency work and measuring systems. (e) Electrical Engineers with experience in small motor design and development. Applicants for Senior posts should possess a good University Degree and preferably should have some industrial experience. Applicants for Junior posts should have good industrial experience and be qualified either by City and Guilds certificate or by Inter. B.Sc. Please apply in writing giving full details to Box A.C. 66670. Samson Clarks, 57-61 Mortimer Street, London, W.1. W 2232

A NUMBER of vacancies exist for Electro-Mechanical Designers with a good Degree in mechanical and electrical engineering, or similar qualification, and several years' experience in a Laboratory or Factory design department. Successful candidates will be expected to work in laboratory teams or in laboratory factory teams on interesting and varied projects, and to be responsible for the mechanical design of equipment. The posts are permanent and pensionable. Salary according to qualifications and experience and consistent with present day levels. Application form from Personnel Officer, Mullard Research Laboratory, Cross Oak Lane, Salfords, near Redhill, Surrey. W 2116

AN ELECTRONIC ENGINEER is required by firm in the Guildford area, for development work on aircraft instruments and electronic equipment. Applicants should possess a University Degree, Higher National Certificate or equivalent qualifications, and preferably have had laboratory experience in Physics, Electrical Engineering or Instrument Technology. They should apply, giving details of qualifications, experience and required salary to Box No. W 1364.

AN EXPERIENCED electrical engineer or physicist is required by the Research Laboratories of The General Electric Co. Limited, at their Stanmore Laboratories to take responsibility for the work of a number of men engaged on research and development on circuits for the generation and handling of nonsinusoidal waveforms such as are used in timebases, differential analysers and digital and analogue computers. Applicants preferably between 28-35 should have good Honours Degrees and should be able to produce evidence of ability for original work and inventiveness in the form of published work or patents. The appointment is in connexion with a major guided weapon project for defence, and offers good prospects and starting salary. Applications should be sent to the Staff Manager, (Ref. GBLC/195) G.E.C. Research Laboratories, East Lane, North Wembley, Middlesex. W 2253

AN INDUSTRIAL GROUP in Trafford Park invites application for a vacancy in its Research Department for research and development work connected with electrical insulation. Applicants should be of Degree or H.N.C. standard in physics, electrical engineering or mechanical engineering, with experience of experimental techniques. The salary will be according to accepted standards for scientific staff. W 2212

APPLICATIONS ENGINEER, required by "Applied High Frequency Ltd." Previous experience in Induction Heating essential and some knowledge of metallurgy an advantage. Good salary to right man. Phone SHE. 1151. W 2265

APPLICATIONS are invited to fill the following vacancies: Two Senior Design Draughtsmen for work in connexion with the development of existing and design of special purpose machinery. Applicants must have served a general engineering apprenticeship and hold a National Certificate or equivalent. Must be able to work on own initiative and possess original ideas. Senior Tool Design Draughtsman for interesting and varied work. Applicants must have served a toolroom apprenticeship and possess National Certificate or equivalent. Salary approximately £500 per annum but in accordance with experience and qualifications. Apply Standard Telephones and Cables, Ltd., Corporation Road, Newport, Mon. W 2242

APPLICATIONS are invited for the post of Chief Inspector to the Cheltenham Research Laboratories of Furzehill Laboratories Limited. Applicants should have a thorough experience of electrical and electronic work and be fully conversant with the general requirements of A.I.D. and A.R.B. procedure. Engineering qualifications should preferably be to Degree standard. Housing accommodation available to the selected applicant if required. Write stating age, qualifications and salary required to Chief Engineer, Furzehill Laboratories Limited, Shenley Road, Borehamwood, Herts. W 2309

APPLICATIONS ARE INVITED for the responsible position of flight engineer for Guided Missiles. Applicant should be of Degree standard and have practical experience of mechanical and electrical installation. Knowledge of telemetry and servo mechanisms is desirable, though not essential. North London district. Write full details, qualifications, experience, age, salary sought to Box A.C. 65692 Samson Clarks, 57-61 Mortimer Street, W.1. W 2155

ASSISTANT DEVELOPMENT ENGINEER required by well-known Midland Company, preferably with Honours Degree in mechanical or electrical engineering and with practical experience in instrument manufacture or precision engineering. Age 28/35. Salary in the order of £800 p.a. depending upon qualifications and experience. Box No. W 2209.

ASSISTANT DEVELOPMENT ENGINEER, age 20-26, required for circuit design of electronic measuring instruments. Experience in this type of work or suitable technical qualifications essential. Commencing salary according to age and experience. Write giving full details of qualifications and experience to Dawe Instruments Limited, 130 Uxbridge Road, Hanwell, W.7. W 2319

A SENIOR ENGINEER is required by the Industrial Electronics Dept. of the English Electric Co. Ltd., for design and circuit work on valve type HF heating generators. Applicants should have good experience in this type of work or on radio transmitters. A University Degree is desirable but not essential. Please write giving full details and quoting ref. 357B to Central Personnel Services, English Electric Co. Limited, 24-30 Gillingham Street, London, S.W.1. W 2294

A WELL-KNOWN Midland Company requires an R.F. Heater Applications Engineer for test work on samples and the design of applicators. Men with metallurgical knowledge and at least H.N.C. should apply giving full details of qualifications and experience quoting ref. HFH to Box No. W 2295.

BEILING & LEE LTD., Cambridge Arterial Road, Enfield, Middlesex, require research assistants in connexion with work on electronic components, fuses, interference suppressors and television aerials. Applicants must be graduates of the I.E.E. or possess equivalent qualifications together with similar laboratory experience. Salary will be commensurate with previous experience. Applications must be detailed and concise, and will be treated as confidential. W 138

CHIEF ELECTRICAL INSPECTOR (35-45) required. Essential qualifications include experience both in planning and progressing inspection of telecommunication and light electrical equipment and control of labour. Preference will be given to applicants with knowledge of audio-frequency and electrical measurements and who are A.I.D. approved. Write full details of qualifications, career and salaries earned to Personnel Manager, The Phoenix Telephone and Electric Works Ltd., The Hyde, N.W.9. W 2311

CHEMIST OR METALLURGIST required for Works Laboratory of new factory in Northamptonshire manufacturing new materials for the radio, radar and electronic industries. Science Degree desirable and 5-10 years' previous in-

dustrial experience essential. Applicant will be required to work for the first year or two on the development of processes for the production of various types of iron cores. Promotion to a more responsible position would follow the successful completion of this work. Minimum salary £650 per annum. Box No. W 2266.

COMMERCIAL opportunity for Scientific or Engineering Graduate to pioneer application of new processes developed by leading industrial organisation. Wide experience of manufacturing methods desirable; also some electrical or electronic knowledge. Previous sales experience not essential. Exceptional opportunity for man capable of growing with business. Full particulars and salary required in confidence to Box No. W 2311.

COMMUNICATION ENGINEER required for senior commercial appointment in London office of Company of international repute. Applicants must have an engineering or scientific Degree or equivalent, and thorough experience in the radio communication or radar field. Commercial experience, especially export, would be an advantage. Exceptional opportunity in expanding business. Write in confidence giving full particulars of education, experience and salary required to Box No. W 2313.

COMMUNICATIONS ENGINEER familiar with circuit design, is required for work on H/F quartz crystal circuits. Candidates should preferably have a University Degree and 2-3 years experience in experimental work. Applications should be sent to the Staff Manager (Ref. GBLC(O)/176) Research Laboratories of The General Electric Co. Ltd., Wembley, Middlesex, stating age and record. W 2252

BUSH RADIO LIMITED require a number of Engineers and Physicists for new Research and Development Laboratories which are being formed at Plymouth. (a) A Qualified Senior Engineer for a responsible position. The applicant should have a University Degree in Physics or Electrical Engineering, or have passed the graduation examination of the I.E.E. He will be required to make preliminary theoretical investigations to initiate experimental work and to direct assistants. (b) A Senior Engineer—preferably with a good theoretical background. A successful applicant will be required to carry through to the production stage, design and development of radar and similar equipment. (c) A Transformer Designer—the applicant should be experienced in the design of small power transformers (less than kVA), chokes, audio-transformers, and pulse transformers, and will be expected to carry through to the production stage the design of power supplies and other associated equipment. Experience of servo-motors and generators would be useful, but is not essential. (d) A Research Physicist or Engineer—the applicant should have a University Degree in Physics or Electrical Engineering. Ability to apply mathematics to electrical problems is required as well as a flair for experimental work in the field of electronics. Previous experience is not essential. Candidates for the posts (a) and (b) above should have had at least five years' experience in the design of electronic equipment especially in the following fields:—Pulse techniques, C.R.T. displays, telemetering equipment, microwave equipment and aerials, servo mechanisms. The Laboratory is situated in pleasant surroundings on the outskirts of Plymouth and there is a pension scheme in operation. Candidates should write giving full details and salary required to the Chief Engineer, Bush Radio Limited, Power Road, Chiswick, W.4. W 2170

CROMPTON PARKINSON LIMITED invite applications from graduate Physicists with good Honours Degree to work in their Lamp Development Laboratory on general lamp problems. Applicants with or without experience will be considered. Good prospects for man wishing to make a career in industry. Send full particulars of training and practical experience, if any, to Ref. GLD, Crompton Parkinson Limited, Guisley, Nr. Leeds, Yorkshire. W 2262

DESIGN AND DEVELOPMENT Section of a large Engineering Company of National repute situated in the West Country has vacancies for:- (1) Senior Design Draughtsman with specialized experience of design of special purpose Automatic process machines and Hopper and Feed mechanisms for small components. (2) Design Draughtsman with experience of design and development of Radio components. (3) De-

CLASSIFIED ANNOUNCEMENTS
continued on page 6

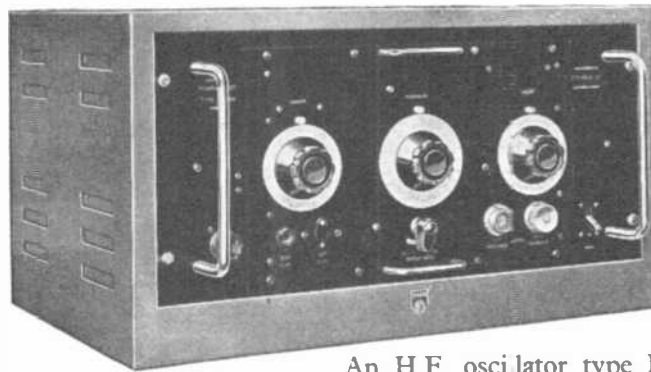

EKCO power unit 1033A

An H.F. oscillator type Power Unit designed in conjunction with the A.E.R.E. to energise all types of counters, including proportional and scintillation counters. Ripple and spurious pulses are reduced to such a level that external filters are not normally required. Output voltage is continuously variable from 500 to 3,000 volts and is virtually unaffected by mains variations up to $\pm 10\%$. This Unit may be used with confidence wherever a highly stable voltage is needed.

Please write for complete Catalogue giving specifications and prices of the range of Ekco equipment for the Radiochemical Laboratory.

EKCO electronics

E. K. COLE LTD. (Electronics Division) 5 VIGO STREET, LONDON, W.1

THOSE WHO KNOW can appreciate the significance of

FULL INTERSERVICE TYPE APPROVAL CATEGORY "A," CLASS H.I

To Specification R.C.S. 132



FOR the first time this formidable specification relating to Moulded, Silvered Mica Condensers has been conquered in every particular. We are proud to announce the introduction of this remarkable condenser (hitherto devoted to Service requirements) to the commercial market.

A few salient points: Full working voltage at 100° C. - Full proof against humidity at 71°C and tested to 3 months' tropical exposure - Moisture repelling moulded case - Freedom from scintillation effect - Withstands "freezing" at minus 40° C. - Extraordinary stability (they are often used as sub-standards) - Low temperature coefficient (well within limits laid down by above specification) - Very high insulation resistance - Every specimen undergoes 15 minutes' immersion in boiling water before despatch.

In short . . . THE ONLY CAPACITOR WITH FULL TYPE APPROVAL AS ABOVE

Write for explanatory leaflet to:—

ALSTON CAPACITORS - HALESWORTH - SUFFOLK

SITUATIONS VACANT (Cont'd.)

velopment Engineer for pre-production Laboratory development of Radio components and small mechanisms. These appointments are of a permanent and progressive nature. Pension scheme in operation. Salaries according to qualification and experience. Please write stating age and experience to Box No. W 2284.

DESIGN ENGINEERS. (Ref. 862A) required by The English Electric Company Limited, Luton, for work on flight simulators in connexion with guided weapon development. Degree or H.N.C. essential and previous experience of electromechanical and electronic analogue computing desirable. Applications stating age, technical qualifications and experience to Central Personnel Services, 24 Gillingham Street, London, S.W.1, quoting reference. W 2263

DEVELOPMENT ENGINEER required for well-known firm of electrical instrument makers situated in North London. Man with good technical and mechanical knowledge for experimental work. Apply Box No. W 2211.

DEVELOPMENT ENGINEER required by A.H.F. Ltd., Shepherds Bush. Preference given to man with experience of high frequency induction heating equipment. Good salary to right man. Phone 1151. W 2233

DEVELOPMENT ENGINEERS required by firm in N.W. London manufacturing an extensive range of industrial instruments and controls. Candidates should have a good theoretical background, preferably with a Degree or equivalent in physics or electrical engineering and should have some experience of the development or testing of process control instruments. The starting salary will be according to the experience of the applicant ranging from £400 per annum for Junior Engineers to £650 per annum for specially qualified applicants. Write Box No. W 2285.

ELECTRICAL ENGINEER. The National Research Council, Ottawa, Canada, requires immediately a young University graduate with research outlook to join a team working on aircraft de-icing. The work is mainly in the electrical and electronic field with some observational flying. Some experience with aircraft electrical power systems is desirable. Initial salary up to \$3,900, depending on age, qualifications and experience. Apply by letter giving full details to the Employment Officer, National Research Council, Sussex Street, Ottawa, Ontario, Canada. W 1360

ELECTRICAL ENGINEER 22/25 H.N.C. standard. Applicants should have some experience of electronics, test and calibration work. Good prospects. 5-day week. Apply Muirhead and Co. Limited, Elmers End, Beckenham. W 2326

ELECTRICAL ENGINEER, preferably with radio transmission experience and training to associate membership of the I.E.E. or Higher National, required as sales engineer for important National Manufacturer. Position involves working from Headquarters in London, but applicant would be required to cover the whole country. Write, giving full details of education, training, experience and salary required sending a photograph if possible which will be returned, to Box No. W 2286.

ELECTRONIC ENGINEERS required in the Weybridge district. Experienced in installation, inspection and testing of electronic equipment to Ministry standard. Write stating age, experience, qualifications and salary required to Box P.812, Willings, 362 Gray's Inn Road, London, W.C.1. W 2256

ELECTRONIC ENGINEER required to join a team of research workers investigating a new field in the use of electronic equipment. Qualifications include an Honours Degree in Physics or Engineering which, if in the computing and pulse circuit fields, would be considered an asset. Salary would be according to qualifications and experience, ranging up to £1,000 per annum. Contributory pension scheme. Box No. W 2100.

ELECTRONIC ENGINEER, with good theoretical background to Higher National Certificate standard and with practical experience in use of valves in audio and radio frequency circuits, is required in the Valve Life Testing Laboratory at the G.E.C. Research Laboratories, Wembley, Middlesex. Apply to the Staff Manager (Ref. GBLC/0/262) stating age and record. W 2282

ELECTRONIC ENGINEER WANTED to take charge of department in large London factory using High Frequency heating equipment. Previous experience preferable, but applicant with good general qualifications in electronic engineering and intending to specialize in High Frequency would be considered. The position offers excellent opportunities, good salary and scope to a man with initiative interested in this branch of industry. Box No. W 1370.

ELECTRONIC ENGINEERS—Attractive positions are available in the organization of a large manufacturing company located in south-west Lancashire. Three Engineers are required with scientific and fundamental knowledge of Electronic component parts and their functional circuits with application to storage principles and binary system. Three other engineers wanted with knowledge and experience of Electronics which will enable them to reduce to practice developments resulting from research carried out by first three Engineers, to provide signalling storing and transmitting systems for Telecommunicating purposes. The positions carry full technical staff status, with superannuation scheme, and five-day week and are backed by the organization's wide experience and facilities in the telecommunication field. The range of work ahead is interesting and of permanent, progressive and expanding character. Applicants should reply, stating age, experience and approximate salary required to Box No. 324, Dorland Advertising Limited, 18/20 Regent Street, London, S.W.1. W 2283

ELECTRONIC ENGINEERS REQUIRED for development work in Gloucestershire area. Good academic qualifications and apprenticeship. Experience in one or more of the following desirable: Control systems, D.C. Amplifiers, Computing devices, Video Circuits, Microwave Techniques. Apply with full details of qualifications, age, and salary required to Box No. A.C. 67297, Samson Clarks, 57-61 Mortimer Street, London, W.1. W 2291

ELECTRONIC AND RADIO ENGINEERS. Applications are invited for the position of Field Trials Engineer to lead a team engaged in the usage and application of V.H.F. Radio-Link Systems. Practical experience desirable, but not essential. Salary according to qualifications. Write giving full details and quoting ref. DHG to Box No. W 2165.

ELECTRONIC OR RADIO ENGINEER required to supervise a laboratory testing radio components including electrolytic and ceramic condensers, volume controls, and magnetic materials, etc. Applicants should be familiar with the properties of these components. Previous experience of testing desirable. Apply in writing to The Plessey Company Limited, 186 Watling St. East, Towcester, Northants. W 2192

E.M.I. ENGINEERING DEVELOPMENT LIMITED offer interesting and progressive positions connected with the development of: (a) Small electric motors and their application to gramophone equipment. (b) Radio transformers and other components. (c) Stabilized power packs for airborne equipment. Qualifications: Age 23-28, training in physics or engineering, experience in the above field an advantage. Salary according to age and qualification. Applications should be sent to: Personnel Department (ED/53), E.M.I. Engineering Development Limited, Hayes, Middlesex. W 2259

E.M.I. ENGINEERING DEVELOPMENT LIMITED have a number of vacancies for engineers and senior engineers on interesting development work in various electronic engineering projects. The posts are for permanent pensionable staff and offer good prospects. Qualifications: a Degree in Physics or Engineering or equivalent, together with several years design or specialized experience in the following fields: (a) L.F. Equipment. (b) Television Equipment. (c) Microwave Techniques. (d) Pulse Techniques. (e) Servo Techniques. (f) Test Gear Designs. (g) Inspection. Applicants should write giving full details of experience and type of work required and quote ED/33, to Personnel Department, E.M.I. Engineering Development Limited, Hayes, Middlesex. W 2235

E.M.I. ENGINEERING DEVELOPMENT LIMITED require experienced electronic engineers, including team leaders for the development and design of radar equipment. Applicants should have a sound technical training with a Degree or equivalent qualification, and several years experience in this field, a thorough knowledge of microwave technique and ability to originate circuitry is essential. The appointments are for permanent pensionable staff and carry a good salary and excellent prospects.

Applicants should write quoting ED/34 and give full details to Personnel Department, E.M.I. Engineering Development Limited, Hayes, Middlesex. W 2240

ENGINEER desires private tuition in specific branches of mathematics particularly use of Laplace transformations. Tutor with Communications background would be preferred. S. London area. Box No. W 2243.

ENGINEERS required for interesting work on the development of radio transformers and similar components. The work involves investigation of the application of new magnetic materials to transformer design. Applicants should write giving full details of experience, etc., and salary required, to the Personnel Department (ED/50), E.M.I. Engineering Development Limited, Hayes, Middlesex. W 2237

ENGINEERS required for liaison between development team and users of special electronic equipment. Applicants should have a Degree or similar qualification with a sound general experience in the field of electronics. Application should be made giving full details of experience, etc., and quoting ED/52, to the Personnel Department, E.M.I. Engineering Development Limited, Hayes, Middlesex. W 2244

ENGINEERS required for development, servicing and instruction on electronic equipment. National Certificate standard, previous experience on electronics or radar desirable. Remuneration according to experience and qualifications. Apply Construction Department, British Thomson-Houston Co. Limited, Rugby. W 2316

ENGLISH ELECTRIC VALVE CO. LTD., Chelmsford, require an engineer for testing and development work on micro-wave klystrons. Applicants must have Degree or equivalent qualification but previous experience is not essential. Write giving full details of qualifications and experience, mentioning ref. 419D, to Central Personnel Services, English Electric Co. Limited, 24-30 Gillingham Street, London, S.W.1. W 2307

EXPERIENCED ENGINEERS required to fill the following vacancies in the Electronics Laboratories of a Company situated near London. 1. Deputy Section Leader of Microwave and R.F. Laboratory. Applicants should hold an Honours Degree or equivalent in either Physics or Maths plus some industrial experience. 2. Deputy Section Leader of Circuits Laboratory. Applicants should hold an Honours Degree or equivalent and have extensive experience of Electronics generally and Pulse techniques in particular. 3. Designer Draughtsmen to work on light mechanical devices associated with electronics generally. Applicants should hold a Higher National Certificate or equivalent, preferably in Mechanical Engineering. These posts qualify for the Company's pension scheme. The work is both novel and interesting and involves the development of new techniques but not original research. Successful applicants will after a probationary period, be expected to carry the full design responsibility of a particular project. Apply giving details of age, experience and salary required to: Personnel Department, Kelvin and Hughes Limited, New North Road, Barking, Essex. W 2228

EXPERIENCED ESTIMATORS are invited to apply for employment with a large Electro-Mechanical firm in the West Country. A knowledge of this type of work, including radio components, would be a great advantage though not necessarily essential. Good staff conditions operate and the post offers excellent prospects of advancement. Full details of experience and qualifications should be sent to Box No. W 2275.

FERRANTI, LIMITED, Moston Works, Manchester, have staff vacancies in connexion with special electronic valve development and manufacture in association with an important Radio Tele-Control project. (1) Senior Valve Engineers to take charge of Research and development work. Qualifications include a good Degree in Physics or Electrical Engineering and extensive experience in charge of development work. Salary according to qualifications and experience in the range of £1,100-£1,600 per annum. Please quote Ref. S.V.E. The company has a Staff Pension Scheme, and will give housing assistance in

CLASSIFIED ANNOUNCEMENTS
continued on page 8

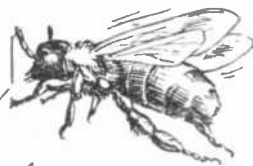
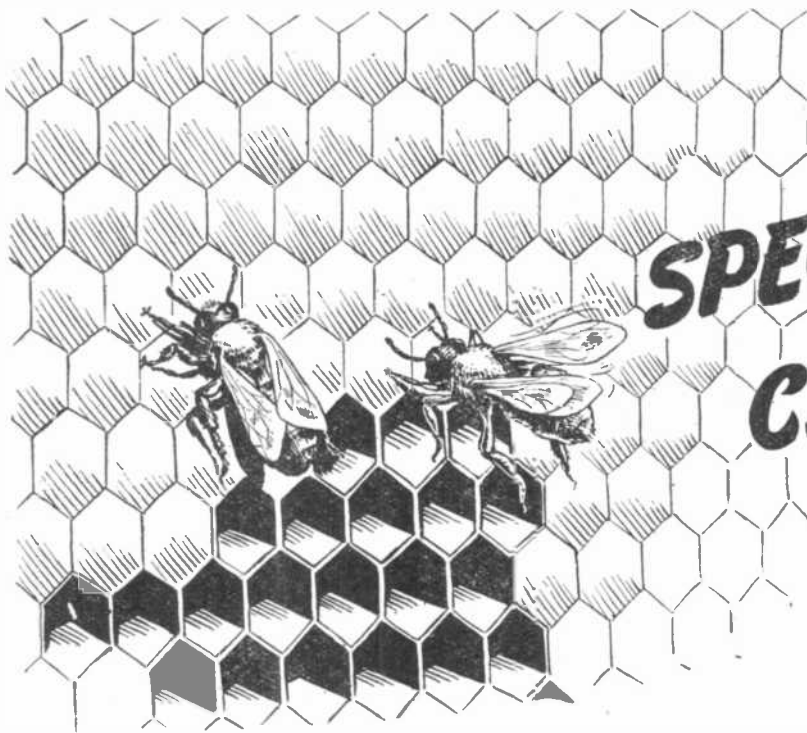

SPECIAL CELLS

FOR SPECIAL PURPOSES

Included in the wide range of "CINTEL" photo-electric cells you will probably find the very one suited to your own particular requirement; but if your problem calls for a cell of special properties, then we are prepared to make it for you.

With over 70 different types in our range, and equivalents for most other manufacturers' cells, we are in a position to solve your photo-cell problem.

Full technical information is available on application to:—

TYPE VA 39
FOR
ACCURATE
PHOTO-
METRIC
WORK

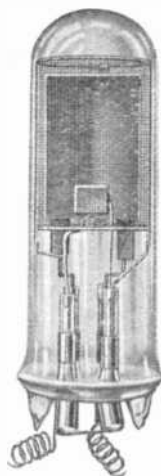
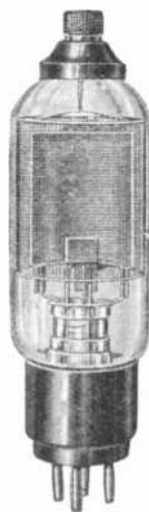

TYPE QVA 39
QUARTZ
ENVELOPE
SENSITIVE
DOWN TO
1900 AU.

CINEMA-TELEVISION LIMITED

A Company within the J. Arthur Rank Organisation

WORSLEY BRIDGE ROAD · LONDON · S E 2 6

Telephone: HITher Green 4600

SALES AND SERVICING AGENTS

F. C. Robinson & Partners Ltd., H. Hawnt & Co., Ltd., Atkins, Robertson & Whiteford Ltd.,
287, Deansgate, Manchester, 3 59, Moor St., Birmingham, 4 100, Torrisdale Street, Glasgow, S.2



REGISTERED TRADE MARK

SITUATIONS VACANT (Cont'd.)

special cases. Application forms from Mr. R. J. Hebbert, Staff Manager, Ferranti, Limited, Hollinwood, Lancs. W 2044

FIELD TRIALS ASSISTANTS. Applications invited, interesting appointments connected with trials of new project. Successful applicants required to travel (London and West Wales). Experience in small electronic, electro-mechanical or hydraulic devices necessary. General experience in the field essential. Ex-service Artificer grades with suitable experience would be considered. Write stating age, experience and salary required to: The Personnel Manager, Sperry Gyroscope Co. Ltd., Great West Road, Brentford, Middlesex. W 2304

FIRST CLASS ELECTRONIC ENGINEERS of British Nationality are invited to join a company located in country surroundings to the South West of—but close to—London. The company's operations which are on a considerable scale are solely concerned with pure research and development work in the Fields of Electronics, Electricity and intricate mechanisms. The working conditions are ideal and the scientific equipment is plentiful and of high quality. The positions offered are permanent, the salary will be generous and there is a pension scheme. Applications in the first place will be seen by the Managing Director only and there need be no apprehension in the mind of any intending applicant of any breach of confidence. Applications should contain full personal particulars, details of education and all positions held subsequently and should be addressed to the Box number given and marked "Managing Director." W 2296

G.E.C. require electrical engineering graduates for work on the design of turbo-mechanisms and associated light airborne equipment. Candidates should have had preferably not less than three years experience and have some knowledge of magnetic amplifiers and pneumatic and hydraulic systems. Appointments will be for work at Stanmore and applications should be sent to the Staff Manager (Ref. GBLC/144), Research Laboratories, of The General Electric Co. Limited, East Lane, North Wembley, Middlesex, giving age, qualifications and experience. W 2230

GRADUATE PHYSICIST aged up to 27 required by Central Research Department of The Morgan Crucible Co. Ltd. Successful applicant will be required to work initially on development of high voltage test equipment and should have an interest in Electronics and the electrical properties of matter. Position is interesting, pensionable and permanent. Write giving details of age, experience, qualifications and salary required to the Staff Manager (Ub), Battersea Church Road, S.W.11. W 2267

INSTALLATIONS SUPERVISOR required. Applications are invited from men with experience of maintenance and test of small electronic and electro-mechanical devices. Additional mechanical knowledge an advantage. Qualifications—H.N.C. standard. Write stating age, experience and salary required to: Personnel Manager, Sperry Gyroscope Company Ltd., Great West Road, Brentford, Middlesex. W 2305

INSTRUMENT ASSEMBLERS with some electrical knowledge required, also test room assistants, for well-known instrument Company situated in North London. Good working conditions and canteen. Apply Box No. W 2210.

JUNIOR ENGINEER required to assist with small batch production planning and engineering of light electro-mechanical and audio equipment. London area. Applicants should be at least Ordinary National standard with good practical training. General knowledge of electronics and some experience with test gear an asset. State age, details of education, technical training, experience and salary required. Box No. W 2318.

JUNIOR ENGINEERS interested in radio or radar are required in special English Electric Laboratory working on guided weapons project. Good prospects. Salaries between £350 and £600 per annum according to qualifications and experience. Write giving full details and quoting ref. 815D to Central Personnel Services, English Electric Co. Limited, 24-30 Gillingham Street, London, S.W.1. W 2279

JUNIOR ELECTRONIC ENGINEER wanted, of City and Guilds or National Certificate standard. Write giving full resume of experience together with wage required to Box M.3039, Haddons, Salisbury Square, E.C.4. W 2277

LABORATORY ASSISTANT with experience in electronics and/or electrical instrument calibration required for work of an interesting and varied nature in connexion with instrumentation for aircraft engine flight development and allied projects. Apply giving details of experience, salary required, etc., quoting reference G.11, to Box No. W 2278.

LABORATORY ASSISTANTS required for development laboratories engaged on the design of experimental and prototype electronic equipment. Applicants should have a wide experience of maintenance and installation of radio, television and radar and should write giving full details to Personnel Department (ED/51), E.M.I. Engineering Development Limited, Hayes, Middlesex. W 2238

LABORATORY TECHNICIAN Male (min. age 25 years) required for the Electron Microscopy Laboratory, Biophysics Department, National Institute for Medical Research, The Ridgeway, Mill Hill, N.W.7. Experience in Electronics desirable. Salary according to age and experience. Permanent superannuated post after probationary period. 3-4 weeks holiday per year. Apply in writing to Administrative Officer at above address. W 2276

MANUFACTURERS of domestic radio and television in London W. have two laboratory vacancies:- (a) Qualified electrical or radio engineer (B.Sc.(Eng.) preferred). Experience not essential. (b) Laboratory assistant. Some experience required. An evening class student could leave early once or twice a week. Both these will be supervised by an experienced engineer. The laboratory carries out design, development and testing work and other miscellaneous duties. Versatility, manual dexterity and some small knowledge of draughtsmanship are an advantage to applicants. Write stating qualifications, experience, and salary required to Box No. W 1371.

MARCONI'S WIRELESS TELEGRAPH Co. Ltd., Chelmsford, have staff vacancies for Technical Assistants in their Test Division to work in all branches of electronic engineering. Candidates with suitable qualifications and good electronic experience will be considered. Good salaries paid to suitable applicants. The Company operates a pension scheme. Please apply quoting reference 809A and giving full details to Central Personnel Services, English Electric Co. Limited, 24-30 Gillingham Street, London, S.W.1. W 2251

MARCONI'S WIRELESS TELEGRAPH Co. Ltd., require Engineers for their Marine Development Group for work on radar and echo-sounding equipment. Applicants should have good academic qualifications and preferably have had experience on one of the above or kindred subjects. A short period of training will be given if necessary. Five day week. Good pension scheme. Please apply quoting Ref. no. 848A to Central Personnel Services, English Electric Co. Limited, 24-30 Gillingham Street, London, S.W.1. W 2229

MECHANICAL AND ELECTRONIC engineers required for interesting work on new project in expanding development unit, Manchester district. Engineering Degree or equivalent with 4 years' experience in modern electronics (broad band amplifiers and tape recorders), or light mechanical systems required. Salary commensurate with responsibility and guaranteed rising scales. Posts are permanent and pensionable. A few senior posts are available. Write in confidence stating experience and qualifications to Box No. W 2302.

MITCHAM WORKS LIMITED require a Senior Mechanical Designer. Applications are invited from men with Higher National Certificate or equivalent qualifications with workshop plus several years design experience in the mass production of electronic test equipment to commercial and service requirements. The man required for this position must be capable of taking full responsibility for the projects assigned to him. Salary not less than £650 per annum to the right man. Apply to Personnel Officer, Mitcham Works Limited, New Road, Mitcham Junction, Surrey. W 2241

MURPHY RADIO LTD., have vacancies for senior mechanical designers in their electronics division. A full and varied programme ensures opportunity of widening experience with excellent prospects. Application giving particulars of training and experience should be made immediately to Personnel Dept., Murphy Radio Ltd., Welwyn Garden City. W 2131

PHYSICIST or Electronics Engineer required to take charge of a group engaged on long-term project of great national importance. Candidates should be British born, should have an

Honours Degree and at least five years' experience in an electronics or communication engineering research unit, exclusive of any service experience. The post is permanent and pensionable and offers good prospects of advancement to a man prepared for hard work. Apply stating full details and quoting Ref. A.A. to Box No. W 2327.

PHYSICIST required for development work on electronic components in laboratory of large company situated in country area of Essex. Suitable applicant should have Degree in physics and should be interested in development work—previous experience being an advantage. Accommodation will be made available to the selected applicant. Kindly state fullest details to Box No. W 2257.

PHYSICIST with experience in the electronic field required to aid in the direction of a team of research workers investigating a new field in the use of electronic equipment. Only first class men with an Honours Degree in Physics need apply. The salary will be in conformity with the successful applicant's ability and experience, but will not be less than £1,000 per annum. Contributory pension scheme. Box No. W 2099.

PHYSICISTS required for interesting work in the following fields:- (1) Applications of new materials to electronic engineering. (2) Cathode Ray Tube development. (3) Properties of magnetic materials and applications to magnetic tape recording. (4) Electronic Engineering problems including microwave applications. The posts are for permanent pensionable staff and carry good salary and prospects. Applicants should have a sound theoretical training with a Degree or equivalent and experience in one of these fields and should write giving full details and quoting ED/35, to Personnel Department, E.M.I. Engineering Development Limited, Hayes, Middlesex. W 2236

PHYSICISTS AND ELECTRONIC ENGINEERS required for laboratory in Northamptonshire to carry out design of radio and electronic components from new ceramic and magnetic materials. Previous experience desirable. Salary £450-£650 according to qualifications and experience. Box No. W 2052.

RADIO MECHANICS required for work on centimetre equipments at Stanmore. Previous experience essential. Progressive staff positions. Five-day week. Write giving full details of age, experience and qualifications to the Staff Manager (Ref. GBLC/G/44), Research Laboratories of the General Electric Co. Limited, North Wembley, Middlesex. W 2180

RADIO AND RADAR Design Draughtsmen (experienced) required. Apply stating age, experience and salary required to the Personnel Department, Kelvin & Hughes Limited, New North Road, Barking, Ilford, Essex. W 2227

REQUIRED by an old established firm at their Research Laboratories, Borehamwood. Senior Draughtsmen for design of specialized Electronic Equipment or Mechanical and Electrical precision devices. Sound general engineering and practical experience. Higher National Certificate standard preferred. Must be capable of undertaking design work calling for originality and initiative. Salary up to £625. Five-day week of 39½ hours. Apply Box No. W 140.

SALARIES up to £1,000 p.a. offered to really good senior electronic engineers for work on aircraft and industrial instruments. The factory is near the coast and pension scheme is in operation. Full experience and qualifications to Box 200 CRC, 29 Hertford Street, London, W.1. W 2315

SALES MANAGER required for expanding business in telecommunications and industrial electronics. Appointment in London in well known Company. Essential qualifications and experience: (a) experience as a successful sales executive; (b) ability to deal with diverse applications of electronics; (c) engineering or scientific Degree or corporate membership of professional institution; in addition candidate should preferably: (d) have export experience; (e) have experience of radio or line telecommunications or industrial electronics; (f) have earned not less than £1,500 per annum. Applications will be dealt with at Director level

CLASSIFIED ANNOUNCEMENTS
continued on page 10

- Finger-tip selection
- Positive segregation
- Carries complete range in minimum of space

700 LABpak'd RESISTORS

10 ohms — 10 megohms
in a Space 12" × 4" × 4"



The LABpak (card)
carries the resistors
The FREE unit stores
the cards

THE **LAB** TESTED STORAGE UNIT

is designed to provide a comprehensive range of resistors for research and experimental laboratories and small production units. It is supplied free with an initial purchase of

180 Type R Resistors (Order LSUC $\frac{1}{2}$)
or 240 Type T Resistors (Order LSUC $\frac{1}{4}$)

Alternatively you may specify your own Ohmic values from the preferred range. Thereafter replacements and additions, ready carded, are always available from stock.

Your local radio wholesaler will handle your needs, but more detailed information can be obtained from

THE RADIO RESISTOR COMPANY LTD.
50, Abbey Gardens, London, N.W.8. Tel. : Malda Vale 5522

RESISTOR SPECIFICATION					
Ref.	Type	Loading	Max. Volts	Range	Dimensions
T	$\frac{1}{2}$ -watt	$\frac{1}{2}$ -watt	250	10 ohms to	$8'' \times \frac{1}{32}''$
R	$\frac{1}{2}$ -watt	1-watt	500	10 megohms	$8'' \times \frac{1}{16}''$

Tolerance available $\pm 20\%$, $\pm 10\%$ $\pm 5\%$

SITUATIONS VACANT (Cont'd.)

in strict confidence; they should include salary required and full chronological particulars of education, qualifications and experience to Box No. W 2314.

SCIENTIST or Engineer required for important commercial post in Electronic Division of well-known firm in London area. Degree in science or engineering and ability to conceive and carry through novel applications of electronics to industrial processes. Commercial or industrial experience desirable. Appointment offers exceptional prospects in large organisation pioneering new fields, and having extensive research and technical backing. Particulars of education, experience and salary required, in confidence to Box No. W 2312.

SENIOR AND JUNIOR DEVELOPMENT Engineers required in the Components Laboratory of the Plessey Co. Ltd. The vacancies are in connexion with the design and development of components mainly for radio and television. For the senior positions a Degree in engineering or physics or equivalent qualification is required and for the Junior positions Inter B.Sc. or Higher National Certificate. Salary will be in accordance with qualifications and industrial experience. Applicants should state fullest details of experience to Personnel Manager, The Plessey Co. Limited, Ilford, Essex. W 2247

SENIOR CIRCUIT ENGINEER is required by the English Electric Co., for employment in the London area. Experience of designing time bases, stabilized power packs and cathode ray monitoring circuits is essential, a Degree and an interest in production development is desirable. A good salary will be paid to the right man for this responsible position. Write giving full details, quoting ref. 921 to Central Personnel Services, English Electric Co. Limited, 24-30 Gillingham Street, London, S.W.1. W 2248

SENIOR DRAUGHTSMEN: Metropolitan-Vickers Electrical Co. Ltd., require for their Trafford Park works, a number of senior draughtsmen preferably with experience in Radio and Radar equipment. For qualified men these jobs are permanent, five-day week under good conditions. Apply in writing stating age, experience, qualifications, salary required, etc., marking envelopes "Radio D.O." to Personnel Manager, Metropolitan-Vickers Electrical Co. Limited, Trafford Park, Manchester 17. W 2140

SENIOR ENGINEER required to undertake development work on low frequency iron cored components. Previous experience in this subject is essential, and a Degree or equivalent would be an advantage. The salary will be in accordance with qualifications and experience. Apply in writing to Advance Components Limited, Back Road, Sernall Street, Walthamstow, E.17. W 2269

SENIOR LABORATORY Engineer with experience for television development all circuit design work of high national importance. Excellent prospects and conditions. Write, call or phone Personnel Manager, Peto Scott Electrical Instruments Limited, Weybridge Trading Estate, Weybridge. 4271. W 2226

SERVO DESIGNER, aged 30-40 required, salary £1,000-£1,500 according to experience. First or Second Class Honours Degree in Mathematics, Mechanical or Electrical engineering required but applicant should be well versed in all three branches. Considerable experience required in the design of servo systems preferably for aircraft. The applicant, who will be interviewed in London, will be responsible for the control of development projects comprising electrical and hydraulic servo flying controls. W 2255

SEVERAL DRAUGHTSMEN are required for work on electronic engineering projects. Some of the vacancies are for senior men of at least HNC standard who have spent a number of years in a Laboratory or Factory design department and are capable of original layout work. Other posts are for detailing draughtsmen capable of producing Workshop drawings from such layouts. Salaries will be at current levels according to qualifications and experience. Prospects of promotion are good and the posts fall within the Company's Pension Scheme. Application form from the Personnel Officer, Mullard Research Laboratory, Cross Oak Lane, Salfords, near Redhill, Surrey. W 2117

SEVERAL ELECTRONIC ENGINEERS or Physicists are required, who have graduated in Physics or Telecommunications and have two or three years radar experience, to take charge of the development of particular sections of a project involving radar. The work includes design of pulse generators, timing wave form

oscillators, electronic computers, V.H.F. transmitters and receivers and servo systems. In addition Technical Assistants are needed with H.N.C. or equivalent qualifications. All the positions available are for work of high interest in a new and expanding field. Applications, which will receive prompt attention should give the fullest details of education and professional experience with appropriate dates. Apply Employment Manager, Vickers-Armstrongs Limited (Aircraft Section), Weybridge, Surrey. W 2271

SPERRY GYROSCOPE CO. LTD., Great West Road, Brentford, Middlesex, require Electronic Engineers with good academic qualifications and apprenticeship required for development work. Experience in one or more of the following desirable:—Control systems, D.C. amplifiers, computing devices, video circuits, microwave techniques. Apply with full details of age, experience and salary required to the Personnel Manager. W 2220

SPERRY GYROSCOPE CO. LTD., Great West Road, Brentford, Middlesex, require Electro-Mechanical Engineers with good academic qualifications, apprenticeship, theoretical background and knowledge of production methods, for development work. Experience in electrical methods of computation, servo theory and instrument design desirable. Apply with full details of age, experience and salary required to the Personnel Manager. W 2221

TECHNICAL ASSISTANT required for work in Materials Application Division. Qualifications: Inter B.Sc. or equivalent with interest in metallurgy. Apply giving age and fullest details of experience to: Personnel Department (ED/55), E.M.I. Engineering Development Limited, Hayes, Middlesex. W 2273

TECHNICAL ASSISTANT. Opportunity occurs in established progressive business covering development on electronic equipment applied to photography. South London. Industrial experience in measurements and circuitry an advantage. Qualifications H.N.C. or Inter B.Sc. Salary approx. £500 depending on experience. Apply Box No. W 1780.

TECHNICAL ASSISTANTS required for interesting Laboratory and Field work connected with Guided Missiles Project. Applicants to be between 20 and 35 years of age with, at least, National Certificate (Electrical) or equivalent. Experience of R.F. technique up to 500 mc. would be an advantage. Full particulars to Box No. W 2191.

TECHNICAL LABORATORY Assistants with experience in the fields of radio and electronics are required for work in the Stanmore area. Apply in writing giving full details of age, qualifications and experience to the staff Manager (Ref. GBLC/G/820). Research Laboratories of The General Electric Co. Limited, North Wembley, Middlesex. W 2139

TECHNICAL WRITERS (Male or Female) required to prepare and edit reports and handbooks for publication. Qualifications: a good general training in electronics with wide practical experience of electronic equipment, marked critical faculty (form and content) and ability to write clear English. Applicants should write giving full details to: Personnel Department, ED/42, E.M.I. Engineering Development Limited, Hayes, Middlesex. W 2239

TECHNICIAN aged 24 to 30 years, required for the construction and maintenance of laboratory and process control electronic instruments. Experience in electronics, radio or radar is essential and applicants should preferably be capable of assisting in the design of new instruments. Applications marked "Confidential" giving full details of experience and present salary to the Personnel Supervisor, The Yorkshire Copper Works Limited, Leeds, 10. W 2231

THE FOLLOWING vacancies exist in the Design Department of a Company operating a large number of Wire Broadcasting Systems:—1. Senior Engineer to take charge of Radio Frequency Section. Must have a Degree and have had at least three years' practical experience of Television design. Salary: £800 to £1,000 per annum, according to experience. 2. Junior Engineers, age 20 to 25, with Degree or graduateship of I.E.E. or I.R.E. Salary £400 to £500 per annum. 3. Laboratory Assistants capable of wiring and testing radio equipment under supervision. Salary: £8 per week. Please send full particulars to Box No. W 2178.

THE GENERAL ELECTRIC CO. LTD., Brown's Lane, Coventry, have vacancies for Development Engineers, Senior Development Engineers, Mechanical and Electronic, for their Development Laboratories on work of National Importance. Fields include Microwave and Pulse Applications. Salary range £400-£1,200

per annum. Vacancies also exist for specialist Engineers in Component design, valve applications, electro-mechanical devices and small mechanisms. The Company's Laboratories provide excellent working conditions with Social and Welfare facilities, Superannuation Scheme, Assistance with housing in special cases. Apply by letter stating age and experience to The Personnel Manager (Ref. CHC). W 2254

THE PLESSEY CO. LIMITED, Vicarage Lane, Ilford, have an immediate vacancy for a Graduate Engineer between the ages of 25 and 35 with an interest in light electro-mechanical devices and another for an electronic circuit designer. Applicants must be British born and should preferably have had some experience in design work in these fields. The posts are progressive and pensionable and are in a newly formed division of the Company. Salaries will be in accordance with age and experience. Application should be made in writing to the Personnel Manager, quoting reference G.C. W 2246

THE TELECOMMUNICATIONS DIVISION of The Plessey Company, requires for work in its laboratories at Ilford, a limited number of experienced Electronic Engineers. The vacancies are for work on long term projects in connexion with important defence and other contracts in the radio communication field. The successful applicants will be required to take charge of portions of major projects under the direction of the Principal Project Engineers. Age is not important but the minimum qualifications are either a Degree in Physics or engineering or at least six years' experience of advanced development work in radio communication. Applicants should be of British birth. The posts are permanent and pensionable and very adequate salaries are available for the right men. Write in confidence to the Personnel Manager, The Plessey Co. Ltd., Ilford, Essex, marking letter " " for the attention of the Chief Engineer—Telecommunications Engineering Laboratories. W 2245

TUBULAR CAPACITORS. Manufacturer requires services of Trade Representatives to introduce a new line. Applications invited only from those with extensive technical capabilities and with connexions with Radio and Electronics industry. Good salary assured to successful applicant. Box A.C. 67452. Samson Clarks, 57-61 Mortimer Street, W.1. W 2317

TWO PHYSICISTS or Electrical/Mechanical Engineers required for the development of automatic control installations and general process instrument work in the chemical industry in the Merseyside area. Candidates should have a First or Second Class Honours Degree and preferably some practical experience in industry or in the Armed Services. Successful candidates will be appointed to the permanent staff with membership of the Pension Fund. Excellent prospects exist for properly qualified individuals. Apply, giving full particulars to Staff Manager, Imperial Chemical Industries Limited, General Chemicals Division, Cunard Building, Liverpool, 3. W 2270

VACUUM PHYSICS LABORATORY requires engineers or physicists experienced in development of special valves for radar applications at microwave frequencies particularly magnetrons, TR cells or Klystrons. Openings include senior positions for suitable applicants offering good opportunities for advancement. Apply quoting "VPL" and give full details of training, qualifications and experience and salary expected to the Personnel Officer, Ferranti Ltd., Ferry Road, Edinburgh. W 2303

WANTED PHYSICIST or Electronic Engineer experienced in the design of high pressure mercury arc tubes. Please apply giving full details to Box 129, Scientific Publicity Limited, Clifford Inn, London, E.C.4. W 2293

WELL-KNOWN RESEARCH LABORATORIES on the outskirts of London have the following vacancies for Mechanical Engineers: (1) Intermediate post, aged 28-35 starting salary £800-£1,250 according to age and qualifications. (2) Junior post, aged 23-27 starting salary £500-£700 according to age and qualifications. No special experience is required but the work on which successful candidates will be employed is likely to include advanced problems in Servo Mechanisms including the development of small mechanisms and structures. All posts will be permanent and a superannuation scheme to which the firm contributes will be available to those successful candidates who wish to join. Applications must be made in writing by 31st

CLASSIFIED ANNOUNCEMENTS
continued on page 12

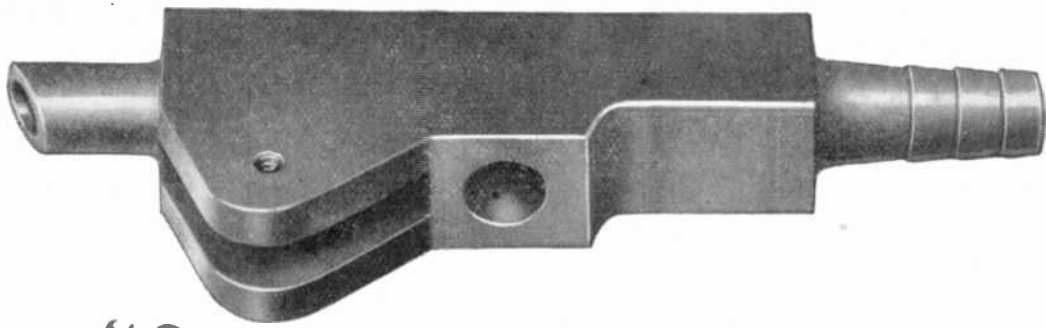

“CHOOSE YOUR WEAPONS”

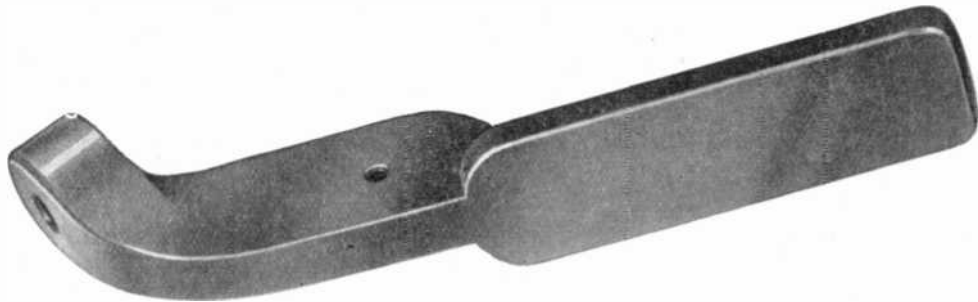

How serious is the challenge of your rivals in industry? In the great drive to maintain and increase the export trade in highly competitive world markets, production costs and efficiency are all-important. The fitness-for-purpose of the smallest machine-part is of vital concern to the industrialist of today; and Tufnol is helping his engineers to make constant improvements in plant and equipment—for Tufnol is the material of enterprise and efficiency! The hand-controlled nozzle for discharging dilute acids pictured above has the advantage of Tufnol's extreme lightness in weight and its resistance to chemical action—but these are only two of its unique combination of properties: it resists

moisture and corrosion; withstands extremes of climate; can be lubricated with water; has good tensile, shear and compression strength; will not split or crack or warp; and is an excellent electrical insulator. Where other materials show certain deficiencies in action, it is often found that Tufnol gives a greatly improved performance—and will enable you to hit an even higher production target.

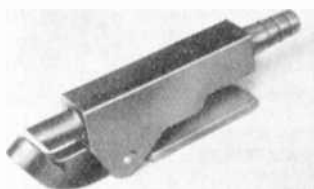

Illustration shows the nozzle hand control here assembled for use.

TUFNOL CHALLENGES YOU!

The way in which Tufnol could help you may be found in the informative literature which contains detailed information. If you have any problems of plant or equipment where Tufnol may help, let us know.



Normally it is supplied in sheets, tubes, rods, bars, channels and angles—but shapes can be specially made to order. We shall be glad to supply you with any other information.



TUFNOL
REGISTERED TRADE MARK
 An **ELLISON** Product

TUFNOL LTD · PERRY BARR · BIRMINGHAM · 22 B

259

SITUATIONS VACANT (Cont'd.)

December, 1951. Before appointment, candidates will be expected to attend an interview in the vicinity of London. Reasonable travelling expenses will be paid. Apply Box No. W 2274.

SITUATIONS WANTED

ELECTRONIC ENGINEER. Fluent German, reasonable French. Age 44. General knowledge of modern practice. Requires progressive well paid position within reach of W. London. Box No. W 1374.

SALES MANAGER of well known components manufacturers desires change offering greater scope. Well known at High level throughout set makers and Ministry departments. Good technical knowledge, able negotiator with excellent sales record. Box No. W 1375.

YOUNG EXECUTIVE, A.M.I.E.E., 12 years' industrial experience, 4 years' supervising development teams, seeks responsible post in electronics industry. Box No. W 1372.

FOR SALE

AMERICA'S famous magazine *Audio Engineering*, 1 year subscription 28s. 6d.; specimen copies 3s. each. Send for our free booklet quoting all others; Radio Electronics, Radio and Tele. News, etc. Willen Limited (Dept. 9), 101 Fleet Street, London, E.C.4. W 108

DECCA HAN GRAMOPHONE. 200-250 volts A.C. with amplifier and loudspeaker. Fitted with stroboscope and output jack. An excellent high quality gramophone for the musical nomad. £20 or offer. Bath 5633. W 1378

MAGSLIPS at 1/10th to 1/20 of list prices. Huge stocks. Please state requirements. K. Logan, Westalley, Hitchin, Herts. W 116

MERCURY SWITCHES are made by Hall Drysdale & Co. Ltd., of 58 Commerce Road, Wood Green, London, N.22. Phone BOWes Park 7221-2. W 107

MINIATURE STEEL Balls and Ball Bearings Swiss and German Precision Work. Quick

delivery. Distributors: Inley (London) Limited, 119 Oxford Street, London, W.1. Tel.: Gersard 8104 and 2730. W 2290

PURE BERYLLIUM FOIL 0.005-in. thick: Elgar Trading Limited, 240 High Street, London, N.W.10. W 141

TOROIDAL COILS, manually wound to one per cent. Bel Sound Products Co., Marlborough Yard, Archway, N.19. ARC. 5078. W 139

WEBB'S 1948 Radio Map of the World, new multi-colour printing with up-to-date call signs and fresh information; on heavy art paper, 4s. 6d., post 6d. On linen on rollers, 11s. 6d., post 9d. W 102

SERVICE

FIRST-CLASS Maintenance Service of electronic and electro-mechanical apparatus. Greater London area. Sub-contracts undertaken. Phone Brixton 6745. W 1358

GLASSBLOWING repetition and scientific, by Hall Drysdale & Co. Ltd., of 58 Commerce Road, Wood Green, London, N.22. Phone BOWes Park 7221-2. W 109



'Radiospares'
Quality Parts

The
Service Engineer's
First Choice



Partridge News

TRANSFORMERS
from 5VA to 100kVA
(POWER OR A.F.)
available for
EARLY DELIVERY

★

Facilities are now available for prompt delivery of "standard" or "to specification" models. Each type is backed by a specialist design and production service of nearly twenty years' standing. Insist on 'PARTRIDGE'—and be sure.

As supplied to

B.E.A. ● National Coal Board
● British Railways ● Royal Aircraft Establishment ● and other Government Departments.

PARTRIDGE
TRANSFORMERS LTD

ROEBUCK ROAD, KINGSTON - BY - PASS
TOLWORTH, SURREY
-Telephone- ELMbridge 6737

W.B.G. Continuous Production of Pressings & Stampings.



Quantity Pressings and Stampings in Continuous Production, including drawn work in Brass and other Copper Alloys, Aluminium and Steel, to manufacturers' requirements.

Capstan and Automatic Machined Brass Parts up to 1½" bar diameter.

Hot Brass Pressings up to 1½ lbs. each.

Chrome and Nickel Plating, Polishing, Bronzing, Coppering, and all metal finishing.

Rolled Brass and Aluminium Strip in coils or in leng-hs.

WRIGHT, BINDLEY & GELL LIMITED
PERCY ROAD, GREET
BIRMINGHAM, II.

TELEPHONE VICTORIA 2295/6/7(P.B.X) TELEGRAMS: BINDLEY B'HAM.II.

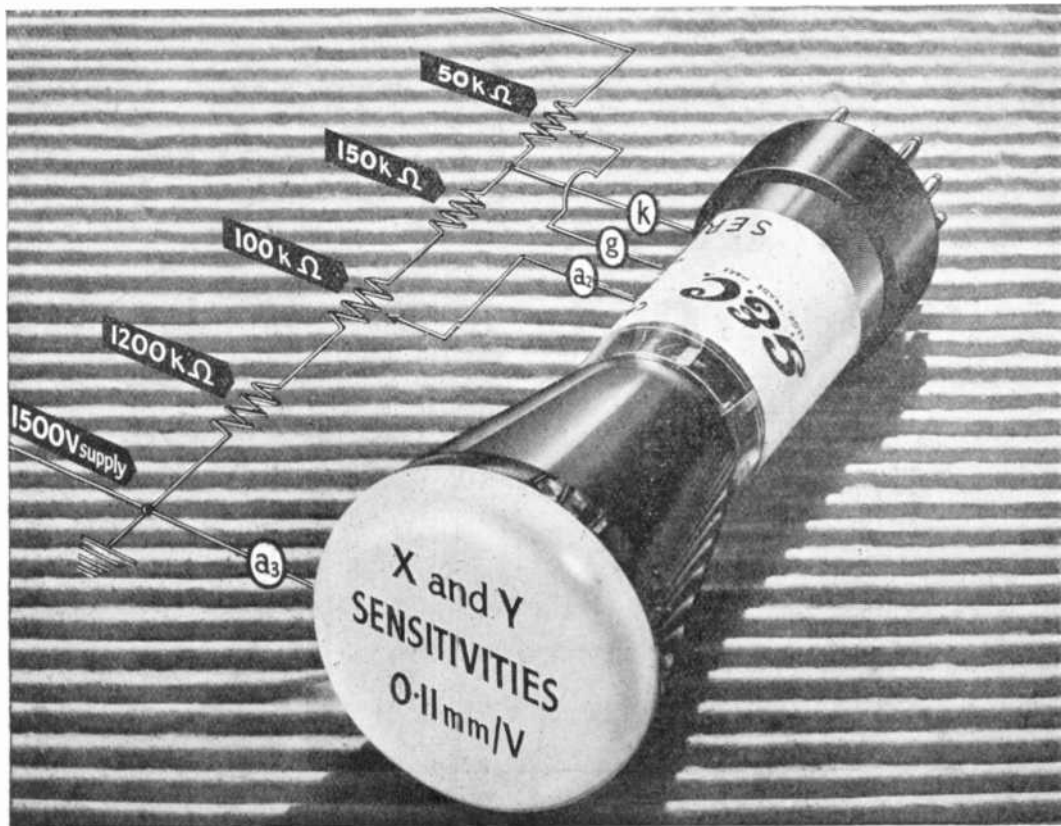

G.E.C. instrument cathode ray tubes

The above illustration shows a typical supply network suitable for the E4205-B-7; the deflection sensitivity increases as V_{a3} is reduced until it is 0.28 mm/V at the minimum of 600V. G.E.C. electrostatic instrument tubes are available in four standard sizes. All have 4V heaters and short-persistence green screens. Brief details are given in the table—for further

Type No.	Bulb dia. (mm)	V_{a3}	Sensitivity (mm/V)		Base
			X	Y	
E4103-B-4	39	600-1000	$\frac{90}{V_{a3}}$	$\frac{100}{V_{a3}}$	B9
E4205-B-7	70	600-1500	$\frac{170}{V_{a3}}$	$\frac{170}{V_{a3}}$	B12B
E4412-B-9	90	600-4000	$\frac{350}{V_{a3}}$	$\frac{750}{V_{a3}}$	B12D
E4504-B-16	160	600-5000	$\frac{600}{V_{a3}}$	$\frac{1100}{V_{a3}}$	B12D

information apply to the Osram Valve and Electronics Department.

Special screens are available to order.

A range of specialised tubes is available for applications where normal types are unsuitable. Detailed information is available upon receipt of requirements.

THE GENERAL ELECTRIC CO. LTD., MAGNET HOUSE, LONDON, W.C.2

EVERSHED

**SPECIAL DUTY
F.H.P. MOTORS**

**TYPICAL
A.C. MOTORS**

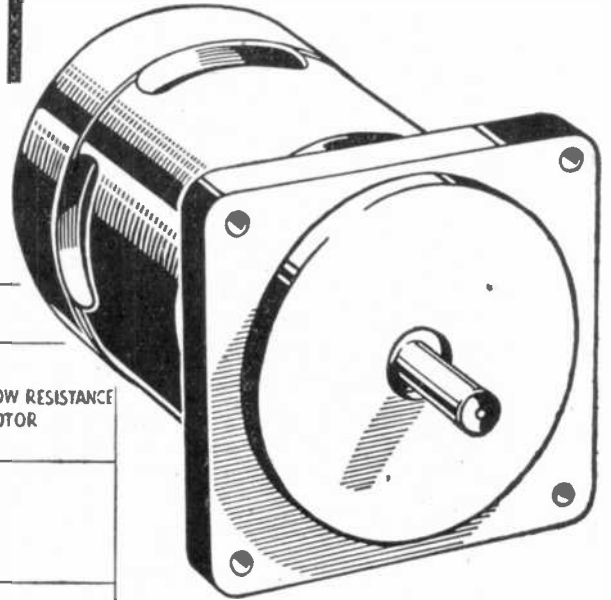

CHARACTERISTIC CURVES FOR
ASYNCHRONOUS MOTORS

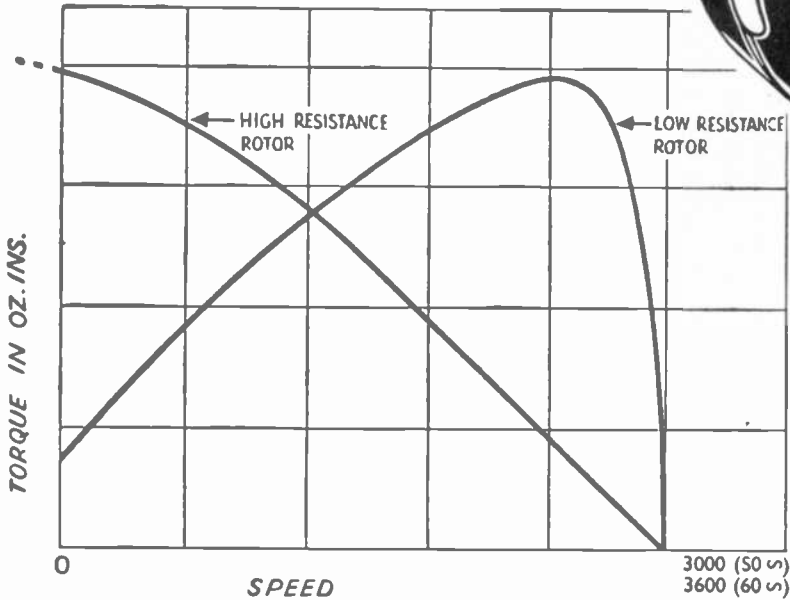

- 1) The motors may be supplied wound for 60 C.P.S. and other voltages.
- 2) The asynchronous motors can be supplied with high resistance rotors giving high starting torques.

Frame Size and Symbol	Type	Voltage	Phase	Frequency C.P.S.	No Load Speed r.p.m.	Torque	
						Starting oz. ins.	Running oz. ins.
FC1/O	Asynchronous	230	1	50	2900	2.5	2
FC10/O	Synchronous	230	1	50	3000	0.75	0.75
FE16/C	Synchronous	230	1	50	3000	6	6
FE17/A	Asynchronous	50	3	50	3000	30	9
FE18/C	Asynchronous	230	1	50	2950	11.5	10

*Send for the
Evershed Small Motors'
Data Book EE 22*

EVERSHED AND VIGNOLES LIMITED

ACTON LANE WORKS · CHISWICK · LONDON · W.4

Telephone: Chiswick 3670

Telegrams: Megger, Chisk, London

Cables: Megger, London

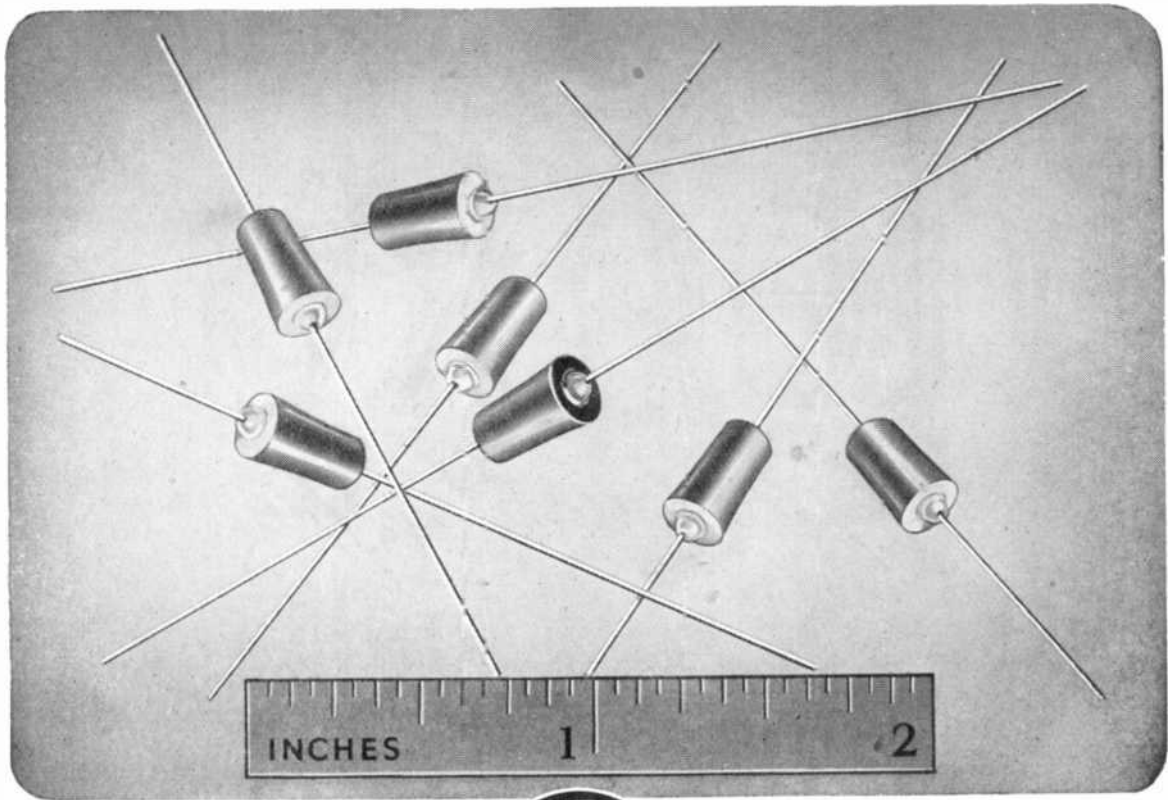

Germanium
CRYSTAL RECTIFIERS

for
Radio & Television Receivers

The ideal replacement for a thermionic diode; needs
neither heater supply nor valveholder

Small in size · Long life · Light weight · Low price

THE
BRITISH THOMSON-HOUSTON
COMPANY LIMITED, RUGBY, ENGLAND

A 253

Member of the AEI group of companies

BAKER PLATINUM LIMITED

deoxo

Catalytic Gas Purifier

The Baker 'Deoxo' Gas Purifier provides a highly efficient and trouble-free catalytic method of removing unwanted oxygen from hydrogen. Also the removal of either of these gases from Nitrogen, Argon, Helium, Neon, Carbon Dioxide, and saturated hydro-carbons.

The 'Deoxo' standard Purifier will remove up to 1% oxygen or 2% hydrogen. High purity is consistently produced, the remaining impurity being less than one part per million (.0001%).

OPERATIONAL ADVANTAGES

As catalytic reaction commences at room temperature, this purification system offers the following advantages:—

NO auxiliary heating required • NO water cooling required • NO operating expenses • NO maintenance expenses.



A copy of the illustrated publication, giving full details of the 'Deoxo' process, will be forwarded on application.

Technical representatives are always available for consultation and advice.

BAKER PLATINUM LIMITED
52 HIGH HOLBORN, LONDON, W.C.1

Telephone: CHAncery 8714

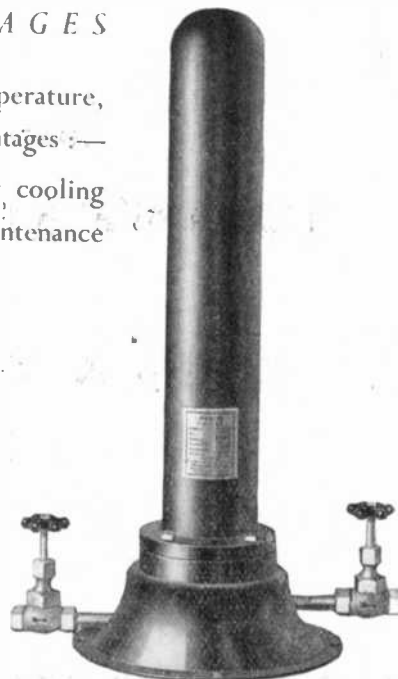

'Deoxo' 200-50 Model

Condenser leadership -from the inside!

Unique wire and cyelet assembly ensuring complete mechanical and electrical connection.

Robust outer aluminium casing.

Synthetic rubber bungs giving full hermetic seal.

Heavy gauge aluminium wire secured to the foils.

Pure aluminium foil and paper element.

"All-aluminium" non-corrosive internal construction.

Viscous electrolyte.



T.C.C. "Picopacks" feature a unique yet simple construction which alone makes possible the manufacture of these miniature electrolytic condensers. In keeping with the famous T.C.C. "Micropack" and "Lectropack" ranges, they embody the "ALL-ALUMINIUM" technique using specially developed viscous electrolytes giving good characteristics at high and low temperatures. A range covering working voltages from 6 to 350 D.C. has been standardised, having numerous applications in such small assemblies as are found in car radios, mobile transmitters, hearing aids, etc.



'PICOPACK' ELECTROLYTIC CONDENSERS

(REGD.)

THE TELEGRAPH CONDENSER CO. LTD. · RADIO DIVISION · LONDON · W.3 · Tel: Acorn 0061 (9 lines)

'ENGLISH ELECTRIC'

electronic insulation tester



Designed for industrial electrical testing

it provides for the first time **10-kV D.C.** in a truly portable equipment having the following outstanding features :

Non-lethal output adjustable from 500 to 10,000-volts.

**High accuracy on comparative tests.
Rejection of surface leakage current.**

Measurement up to 250,000 megohms.

Aural indication of ionisation.

Price **£55** · Size : 15" × 10" × 6" · Weight : 23 lbs.

The ENGLISH ELECTRIC Company Limited

QUEENS HOUSE, KINGSWAY, LONDON, W.C.2

Industrial Electronics Dept. Stafford

Works : STAFFORD · PRESTON · RUGBY · BRADFORD · LIVERPOOL

EN. I.

G.E.C.

QUARTZ CRYSTAL ACTIVITY TEST SET

UNSURPASSED AS A SIMPLE & ACCURATE INSTRUMENT
FOR THE MEASUREMENT OF CRYSTAL PERFORMANCE



The G.E.C. Quartz Crystal Activity Test Set measures the equivalent parallel resistance of a quartz crystal when oscillating in a circuit having an input capacity of either 20 pF, 30 pF or 50 pF, the alternative capacities being selected by a switch.

The dial is calibrated and has a range of 4 kilohms to 130 kilohms and is direct reading. No calculation is necessary. Measurements can be made at any convenient amplitude of oscillation up to 10V. R.M.S. at the crystal terminals for crystals of normal activity.

The accuracy of the loss dial calibration is $\pm 2\%$.

WRITE FOR DESCRIPTIVE LEAFLET—

SALFORD ELECTRICAL INSTRUMENTS LTD.
PEEL WORKS : SILK STREET : SALFORD : LANCS.
Subsidiary of THE GENERAL ELECTRIC CO. LTD. OF ENGLAND

Can this Instrument solve a problem for YOU?

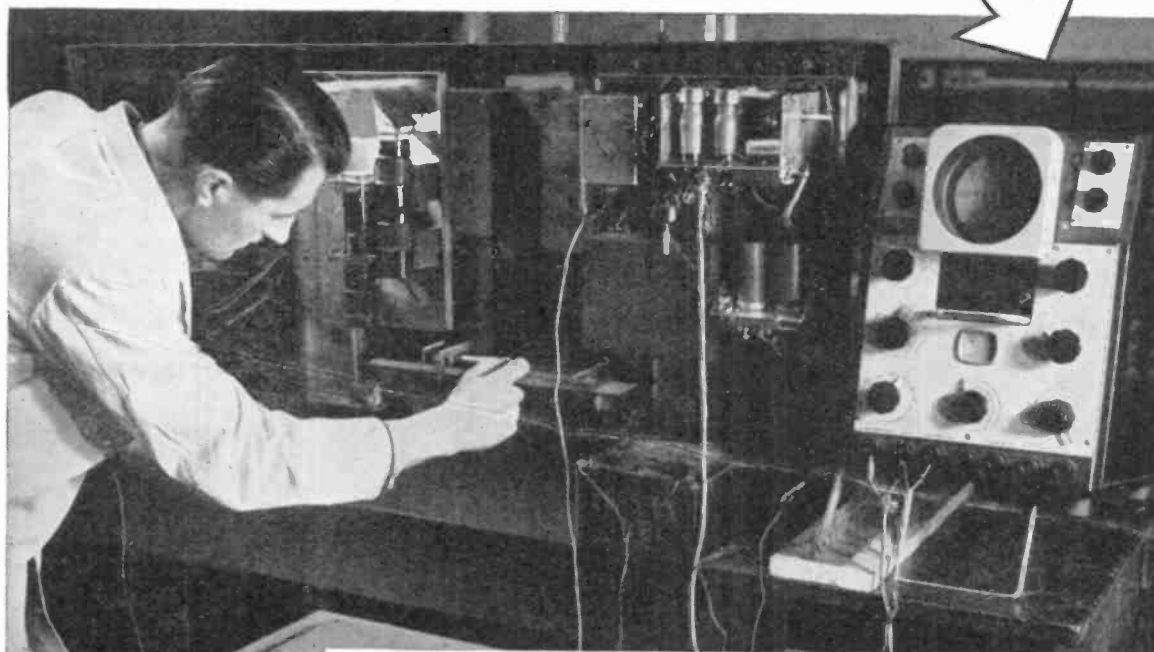

Here, in the Physics Laboratory of the British Iron and Steel Research Association, is a COSSOR Double Beam Oscillograph in use. Many other industries, ranging from nylon spinning to the manufacture of jet engines, now use this versatile instrument. Typical everyday applications are the tracing of noise, strain and vibration; and the answer to long-standing industrial problems is often provided. Our technical advisory staff will quickly let you know whether the Oscillograph can help with *your* problems.

Here are some details: The Double Beam Tube presents two simultaneous independent traces over the full diameter of a 90 mm. screen, and provision is made for the measurement of both input voltage and time upon the calibrated dials. Permanent photographic records may be made using the Cossor Model 1428 Camera.

COSSOR

***Double Beam* OSCILLOGRAPHS**

Please address enquiries to:—

A. C. COSSOR LTD., INSTRUMENT DIVISION • (Dept. No.2) Highbury Grove • London, N.5

The Metrovick

MAGNETIC AMPLIFIER/THYRATRON CONTROL SCHEME

The magnetic amplifier thyatron combination is a semi-electronic equipment designed for industrial applications requiring good accuracy of control with wide range of speed or torque regulation, and may be used in many cases where hitherto only fully electronic equipment has been available. The reduction in the number of consumable components and high impedance circuits increases reliability and simplifies servicing. Speed ranges of 20 : 1 or more with accuracy to about 2% of maximum speed are obtainable. The equipment may also be used in fully automatic schemes, for example tension control in reeling and speed relationship between individual motors on continuous strip processes etc.

The illustration shows a standard equipment for up to 1 hp rating, used for machine tool drives, or tension control in rubber and plastic industries.

Write for descriptive leaflets Nos. 98/1-1 and 98/2-1 which give further details of speed and torque control systems.

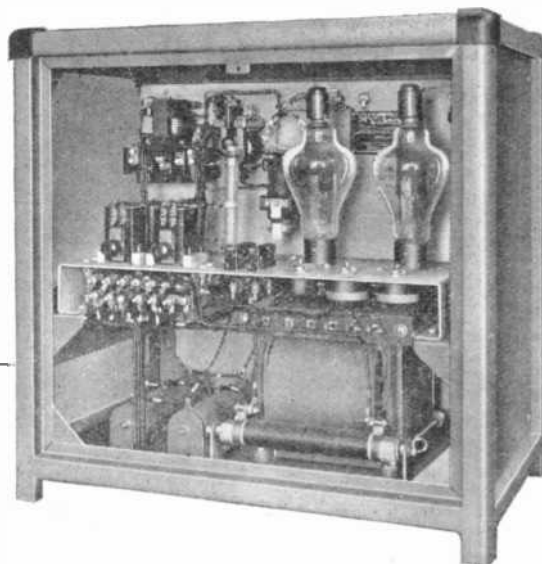

METROPOLITAN-VICKERS ELECTRICAL COMPANY LIMITED, TRAFFORD PARK, MANCHESTER, 17
Member of the A.E.I. group of companies

METROVICK for simplification in electronics

H.T. Supplies

The Ediswan ESU150 half wave mercury vapour rectifier is very suitable for use in the H.T. supply circuit for a medium power transmitter, modulator or R.F. heating equipment calling for a high voltage, high current D.C. supply.

Supplies of this reliable, long life valve are at present available ex stock.

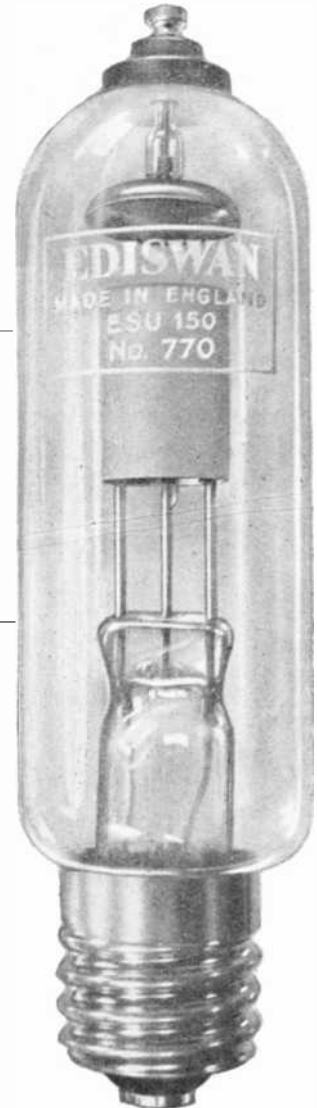

RATINGS

Filament Voltage (volts) V_f	4.0
Filament Current (amps) I_f	10
Maximum Peak Inverse Anode Voltage (volts) P.I.V.(max)	10,000
Maximum Peak Anode Current (amps) $I_a(pk)(max)$	2.0
Maximum Average Anode Current (mA) $I_a(av)$	500
Ambient Temperature Range	10°-50° C
Cathode Heating Delay Time (secs)	60

DIMENSIONS

Maximum Overall Length (mm)	216
Maximum Diameter (mm)	57
Approximate Nett Weight (ozs)	4
Approximate Packed Weight (ozs)	5
Approximate Packed Export Weight (lbs)	3½

BASING

Base	G.E.S.	Filament
Top Cap		Anode

THREE PHASE FULL WAVE RECTIFICATION EMPLOYING SIX ESU150 VALVES

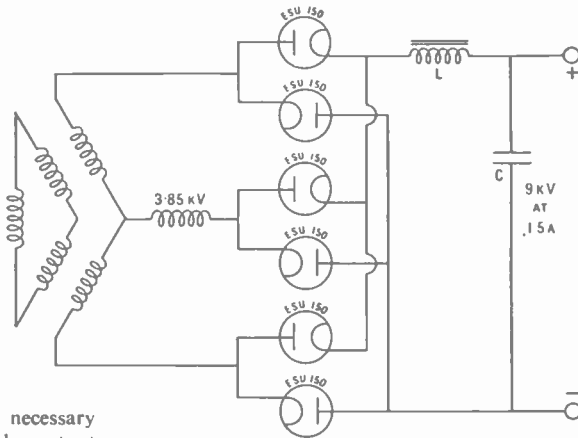

NOTE-
L. C. Filter only necessary when ripple in the d.c. output must be less than 4%.

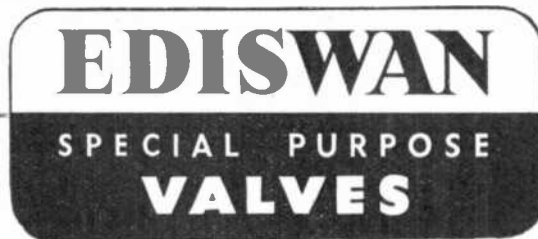

THE EDISON SWAN ELECTRIC CO. LTD., 155 CHARING CROSS ROAD, LONDON, W.C.2
Member of the A.E.I. Group of Companies

EV72

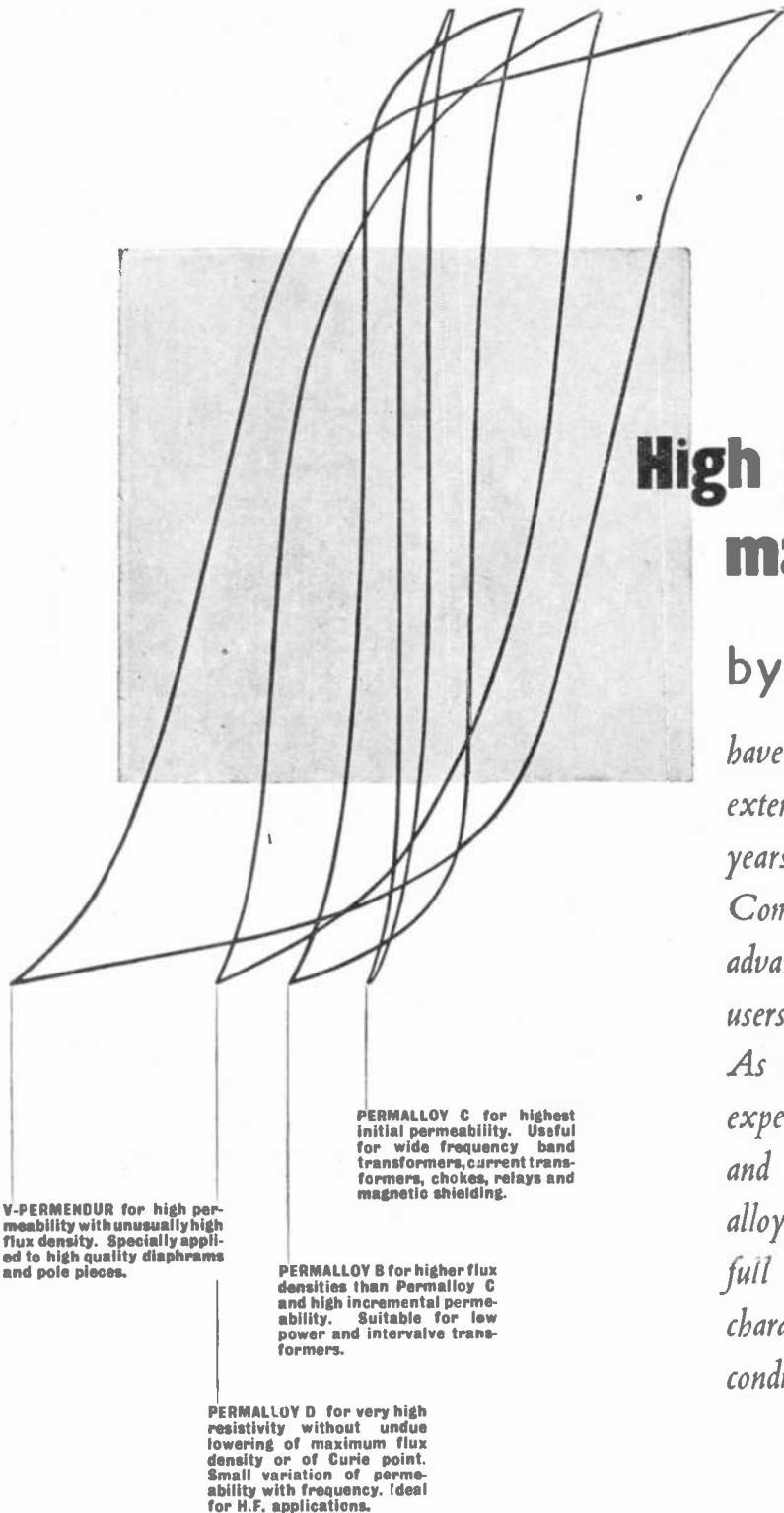

High permeability magnetic alloys by *Standard*

have steadily been improved and extended in range over many years and are produced by a Company which has the unique advantage of being large scale users of these materials.

As a result of this, much direct experience of the requirements and the applications of magnetic alloys is available, thus giving a full appreciation of the desirable characteristics and the actual conditions of use.

V-PERMEADUR for high permeability with unusually high flux density. Specially applied to high quality diaphragms and pole pieces.

PERMALLOY C for highest initial permeability. Useful for wide frequency band transformers, current transformers, chokes, relays and magnetic shielding.

PERMALLOY B for higher flux densities than Permalloy C and high incremental permeability. Suitable for low power and intervalve transformers.

PERMALLOY D for very high resistivity without undue lowering of maximum flux density or of Curie point. Small variation of permeability with frequency. Ideal for H.F. applications.

Standard Telephones and Cables Limited

Registered Office: Connaught House, Aldwych, London, W.C.2

TELEPHONE LINE DIVISION North Woolwich, London, E.16 · ALBERT DOCK 1401



ON 12TH DECEMBER 1901 Marconi did what many distinguished scientists said was impossible. He transmitted a wireless signal across 2,000 miles of ocean, from Poldhu in Cornwall to St. John's in Newfoundland. In a prophetic report *The Times* called this an event "the importance of which it is impossible to over-value".

MARCONI serves mankind

MARCONI'S WIRELESS TELEGRAPH COMPANY LTD · CHELMSFORD · ESSEX



* The first range of Transformers to be granted INTER-SERVICE TYPE APPROVAL (under RCS 214)

The tremendous reception accorded Parmeko's Neptune Series since their introduction has confirmed the belief that one of the major needs of the Electronic Industry was for a smaller, lighter, and more efficient transformer. The Neptune series now supplies that need.

PARMEKO OF LEICESTER

Makers of Transformers for the Electronic and Electrical Industries.

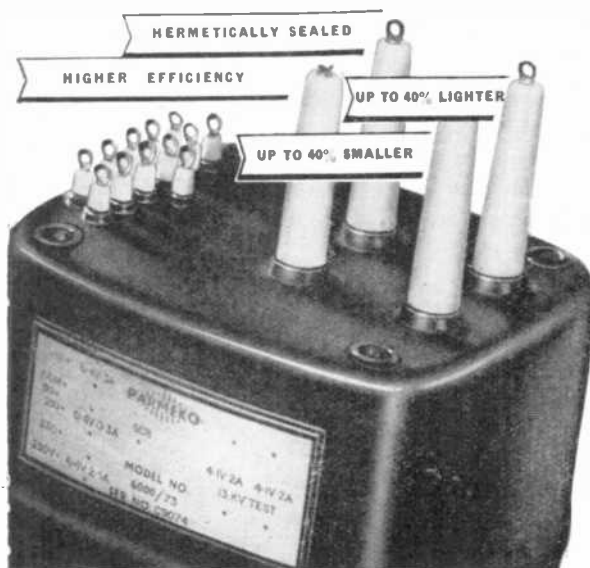
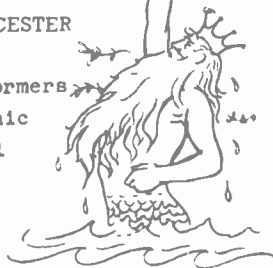

Electronic Engineering

Incorporating *ELECTRONICS*, *TELEVISION* and *SHORT WAVE WORLD*
 Managing Editor, H. G. Foster, M.Sc., M.I.E.E.

Vol. XXIII

DECEMBER 1951

No. 286

In This Issue

Commentary	457
Feedback Logical Computers	458
By D. M. McCallum, B.Sc., A.M.I.E.E. and J. B. Smith, M.A., B.Sc., A.M.I.E.E., A.Inst.P.	
Equipment for Acoustic Measurements (Part 4)	462
By C. G. Mayo, M.A., B.Sc., M.I.E.E. and D. G. Beadle, B.Sc., A.C.G.I., A.M.I.E.E.	
Slotted Line Techniques	466
By E. G. Hamer, B.Sc., A.M.I.E.E.	
Television in Germany	470
When W/T First Spanned the Atlantic	471
Picture Storage Tubes	472
By R. E. B. Hickman	
The Decca Flight Log	475
Television on Wheels	475
Developments in the Design of Airborne Equipment	476
An Electronic Ultramicrometer	479
By W. Alexander, M.Sc., M.I.E.E.	
Jet Navigation	480
A Linear Staircase Generator	481
By A. M. Spooner, B.Sc. and F. W. Nicholls	
Premiums for Technical Writing	482
The Prediction of A.F. Response No. 2 (Part 1)	483
By N. H. Crowhurst, A.M.I.E.E.	
The Loading Error in Linear Potentiometers	489
By G. M. Parker	
Letters to the Editor	490
Electronic Equipment	492
Book Reviews	494
Notes from the Industry	497
Meetings this Month	498

Published Monthly on the last Friday of the preceding month at
 28 Essex Street, Strand, London, W.C.2.

Phone: CENTRAL 6565. Grams: 'ELECTRONING, ESTRAND, LONDON'

Subscription Rate:
 (Home or Abroad) Post Paid 12 months 26s. or \$3.75 (U.S.)

Classified Advertisements, Page 1
 Index to ADVERTISERS, Page 50

HIGH EFFICIENCY AT V.H.F. with this new MULLARD DOUBLE TETRODE

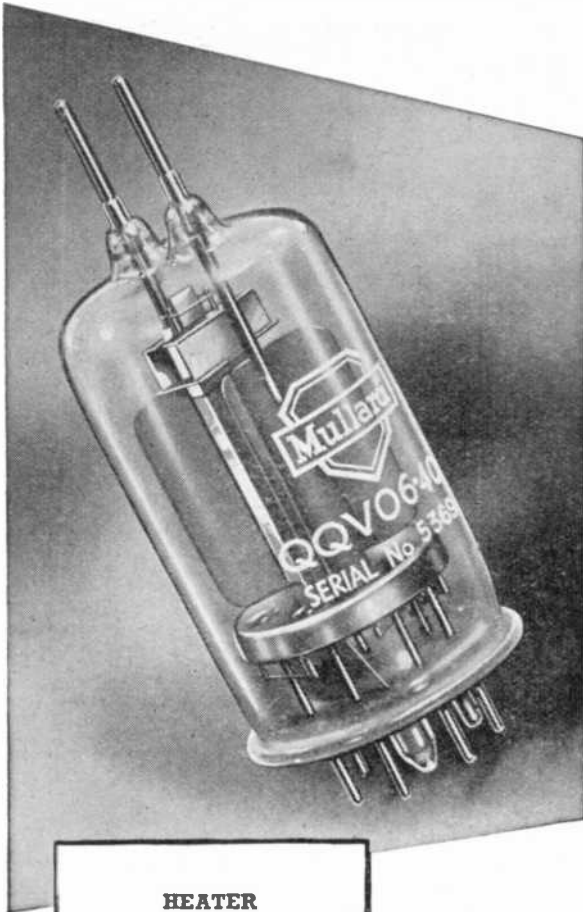

HEATER

	Series	Parallel
V_h	- 12.6	6.3 V
I_h	- 0.9	1.8 A

CAPACITANCES

Each section

C_{g1-all}	-	10.5 $\mu\mu\text{F}$
C_{a-all}	-	3.2 $\mu\mu\text{F}$
C_{a-g1}	-	<0.08 $\mu\mu\text{F}$

Two sections in
push-pull

C_{out}	-	2.1 $\mu\mu\text{F}$
C_{in}	-	6.7 $\mu\mu\text{F}$

LIMITING VALUES

V_a max.	-	600 V
P_a max.	-	2 x 20 W
V_{g2} max.	-	250 V
P_{g2} max.	-	2 x 3 W
V_{g1} max.	-	-175 V
P_{g1} max.	-	2 x 1 W
I_k max.	-	2 x 120 mA
f max. (at reduced ratings)	-	486 Mc/s

BASE: B7A

The new Mullard double-tetrode, QQV06-40, is designed for wide-band operation as an R.F. Amplifier, Modulator, or Frequency Doubler and Tripler.

An improved version of the American 829B, the QQV06-40 has the outstanding advantage of very small output capacitances which permit its use at frequencies up to 500 Mc/s. In addition, the comparatively low inter-electrode inductance of this valve, obtained by the use of

a common box screen grid, enables it to operate at V.H.F. with a higher stability than has yet been attained by valves in this class.

When used in tuned-anode, tuned-grid transmitters, the stability of this double-tetrode is increased even further by the use of internal neutralizing condensers.

Other important design features are:—

1. Direct and short connections between pins and electrodes, causing lower inductance and resistance.
2. No insulating parts (mica or ceramics) between anodes, resulting in lower losses at V.H.F.
3. Screened micas, preventing possible losses due to contaminated mica.

Brief technical information on the QQV06-40 is given here. Full information on this and other valves in the Mullard range will be supplied on request to the address below.

Mullard



MULLARD LTD . COMMUNICATIONS AND INDUSTRIAL VALVE DEPARTMENT
CENTURY HOUSE . SHAFTESBURY AVENUE . LONDON . WC2

MVT 110

Electronic Engineering

Vol. XXIII.

DECEMBER 1951

No. 286.

Commentary

AFTER announcing preliminary measures to meet the present emergencies, the new Government is proposing a long Christmas recess to enable its Ministers to study at close quarters the many and urgent problems with which it is now faced.

Topics on which we have occasion to comment are therefore held in abeyance and we find ourselves in a somewhat similar position to the French lady, who wrote to her husband: "*J'écris parce que je n'ai rien à faire et je finis parce que je n'ai rien à dire*".

As is well known, the charter of the B.B.C. expires at the end of the year, but it is unlikely that the Government will have much time to devote to the forming of a new one. Nothing more drastic than "The mixture as before" can be expected and it is unfortunate that the many recommendations put forward by the Beveridge Committee must be shelved for the time being. While we dislike the idea of sponsored television programmes, the new Government is likely to take a more sympathetic view of this controversial subject than did the late Government, but the major issues of the Beveridge Report, such as v.h.f. broadcasting, must await a more favourable state of the country's affairs.

At the present moment the Government has more urgent affairs to attend to, and the radio industry, with the rearmament programme under way, is showing no desire to embark on a new manufacturing programme. Nor has there been any clamour on the part of the general public to invest in v.h.f. receivers. But in the meantime what of Wrotham?

* * *

Elsewhere in this month's issue is published the official statement of the Radio Industry Council relating to a scheme just launched for the encouragement of technical writing.

Briefly, the scheme is designed to promote the writing and publication of articles dealing with technical progress and development of radio and electronics in this country and up to six premiums of 25 guineas each will be awarded annually to those authors who, in the opinion of the judges, most successfully satisfy the specified requirements.

This project is the result of discussions which have been taking place for some months past and while there are still a few details which need clarification, we are sure that it will receive the full support of the industry. It is not clear at this stage into what categories the premiums will be divided and we should like to see at least one premium made available to an author for his first paper. But the object of the scheme is perfectly straightforward and it is well that the scope has been left as wide as possible.

There are one or two features which might give rise to adverse criticism. One is that the professional writer is ineligible and another is that papers or articles published

in the trade journals and journals of learned societies and professional institutions cannot be considered. We are not aware of the reasons which led the R.I.C. to make these decisions, but we assume they are based on considerations of the criteria which have been laid down. It is obvious, however, that the lack of the kind of article or paper which the R.I.C. deplures, is not due to any shortcomings on the part of the professional writer, but to the inability or unwillingness on the part of the scientific worker himself.

Trade journals, as their name implies, deal largely with trade matters and have a closed circulation among radio dealers and wholesalers. Such articles as do appear in them are therefore considered beyond the scope of the scheme. It is true that papers appearing in the journals of the learned societies and professional institutions could qualify for awards since they are of the requisite standard as regards originality and presentation, but again there are probably very good reasons why they have been excluded.

As a general rule, when an author is considering a paper for publication, his choice of journal lies between those of the learned societies and those of the several technical publishers who specialize in this type of publication. The different requirements of each in the way of length, technical standard, and so on, usually enable the selection to be made without difficulty, but there is quite naturally some amount of overlap and certain papers or articles could be equally well presented to either.

It is an unfortunate aspect of the postwar years particularly, that technological progress and development in this country has not been adequately represented, and the impression is being gained abroad that we are lagging behind. It is difficult without generalizing to attribute this to any one cause or without making the usual excuses.

As far as fundamental research itself is concerned, we believe this country is second to none and in the universities and research organizations where so much of this work is carried out, active encouragement is given for the results to be published in the form of a report for restricted circulation or a paper to a learned society. But in industry, which is largely concerned with development rather than fundamental research, this happy state of affairs does not exist except in the more enlightened establishments, and too often an item of research or development is regarded as a secret to be guarded at all costs from competitors. Even where the broader view is taken, official permission to publish does not end the prospective author's difficulties. Time is not always available for the preparation of his manuscript, and typing and drawing office facilities are not readily forthcoming.

The awakening of the Radio Industry Council to the dangers of such a state of affairs within the industry is therefore most timely.

Feedback Logical Computers

By

D. M. McCallum,* B.Sc., A.M.I.E.E. and J. B. Smith,* M.A., B.Sc., A.M.I.E.E., A.Inst.P.

In a previous article a description was given of a simple Logical Computer.¹ This Computer was of the "scanning" type; that is to say, it dealt with a problem containing N two-state logical variables by investigation in a pre-determined order of all the 2^N possible combinations of the states of these variables. It was pointed out that under certain conditions a feedback method of operation is advantageous.

The present article outlines some of the theoretical principles of operation of a feedback computer, describes a small demonstration model which has been constructed and assesses the merits of the method when applied to problems of different types.

IN order to assess the relative performance of different modes of operation it is necessary to establish a measurable quantity as a standard of comparison.

The way in which this may be done will be illustrated by an example. Suppose for simplicity that a computer is considered with only three "variables." These give rise to 2^3 , i.e. eight possible combinations, which may be arranged in a convenient diagram as in Fig. 1(a).

The non-feedback or scanning type of computer investigates these combinations in a pre-determined sequence which includes every combination once and only once, and which is the same for every problem. Such a sequence may be defined by joining the combinations by directed

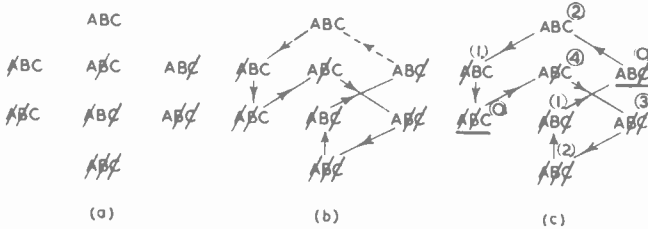

Fig. 1. Transition diagrams

arrows, as in Fig. 1(b). The sequence may be scanned from the same point each time; alternatively, if the closing arrow (shown dotted) is drawn in, it may be begun at any point. A diagram such as Fig. 1(b) will be referred to as a *transition diagram*, and the change indicated by any arrow as a *transition*.

It is evident that the desirable object in a logical computer is that it should proceed from any arbitrary initial combination to a combination which is a solution of the problem in a number of transitions which is on the average as low as possible.

For any given problem, the average number of transitions required will depend on the number of solutions and on their position in the scanning sequence. Referring again to Fig. 1(b), suppose that $A̅BC$ and ABC are the solutions of some problem. Then we may write against every combination in the diagram the number of transitions required to proceed from that combination to a solution. This has been done in Fig. 1(c). The average number of transitions for *this* scanning sequence is therefore

$$E = \frac{1}{8} (2 + 1 + 0 + 4 + 3 + 2 + 1 + 0) = 1.625$$

The reader will verify, however, that this scanning sequence happens to be well suited to this particular problem, and that different scanning sequences would produce different values, mostly higher, for the average number of transitions. To obtain a general result it is desirable to average also over all possible scanning

sequences. When this is done, a result is obtained which depends only upon the total number of combinations n (eight in the example, 2^N for the general case with N variables) and upon the number of solutions s . This gives the average number of transitions required to obtain a solution from an arbitrary starting point with an arbitrary scanning sequence as

$$E_0 = \frac{n - s}{s + 1}$$

Values of E_0 for varying values of n and s are given in Table I. E_0 is a measure of the time taken by a computer of the scanning type to obtain a single solution to a problem, and will be used as a standard of comparison for alternative methods. The value of E_0 for the example given above is 2.

Table I
Values of $E_0 = \frac{n-s}{s+1}$

	$s=1$	2	3	4	5	6
$n = 2$	0.50	—	—	—	—	—
4	1.50	0.66	0.25	—	—	—
8	3.50	2.00	1.25	0.80	0.50	0.29
16	7.50	4.66	3.25	2.40	1.83	1.43
32	15.50	10.00	7.25	5.60	4.50	3.71
64	31.50	20.66	15.25	12.00	9.83	8.29
128	63.50	42.00	31.25	24.80	20.50	17.43

A Mechanism to replace the Scanning Sequence

It has been noted above that a scanning sequence which is peculiarly suited to a given problem may give a lower value of the quantity E than the average value E_0 defined above. It therefore follows that the average time taken to solve a problem could be reduced if it were possible to choose in every case a scanning sequence peculiarly suited to the problem. This is an illuminating concept which helps to explain the superiority of the feedback method.

An example will again be used for illustration. Suppose that a problem has three variables, A, B, C, and two "rules"

A if and only if B (satisfied by AB, $A̅B̅$)

A or else C (satisfied by $A̅C$, AC)

There are clearly two solutions, ABC , and $A̅B̅C$; these are the same as were used in the previous example.

Now, starting from Fig. 1(a) again, it is possible to draw a transition diagram. This time there is no rigid scanning sequence; instead, the principle is applied that a variable may change its state if and only if one of the rules containing it is unsatisfied. To avoid complicating the diagram it is also assumed that all transitions will be "single," i.e. will involve a change of only one variable; this is however, not essential to the main line of argument. The result is shown in Fig. 2(a).

* Ferranti, Ltd., Edin'burgh

Fig. 2(a) differs markedly from Fig. 1(b) in several respects. Firstly, from any given combination, several transitions are in general possible. Secondly, there are some combinations from which no transition is possible; these are of course the solutions. Thirdly, there are some combinations to which no transition is possible, e.g. ABC; unless this happens to be the starting point, no possible sequence can ever include it. Fourthly, closed loops occur which do not pass through any solution, e.g. the loop formed by the transition from ABC to $\bar{A}\bar{B}\bar{C}$ and back to ABC.

It is clear from Fig. 2(a) that in any such system, whatever the starting point, successive transitions can only lead to one of two results; either a solution will be reached, or else a situation will be set up in which a series of transitions round some closed loop is continuously repeated. The latter situation is obviously undesirable; whether or not it can actually arise will depend upon the mechanism which makes the selection between the possible transitions at any given point. If this mechanism is "deterministic" in the sense that it always operates in the same way under the same set of circumstances, then the possibility of this instability will be present (although not necessarily realized in every problem).

The only way to ensure freedom from periodic behaviour is to introduce an element of randomness into the sequence, so that the various transitions from any point have definite probabilities of occurrence, but are not otherwise controlled. This changes the sequence into what is known

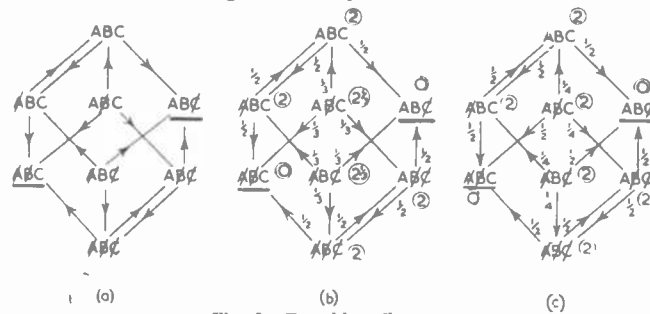

Fig. 2. Transition diagrams

mathematically as a "stochastic process" of a special type, the "discrete Markoff process."

The simplest assignment of probabilities is obviously that which makes the possible transitions from any point equiprobable. Once probabilities have been assigned, it is possible to calculate again the quantity described above, viz. the average number of transitions from an arbitrary starting-point to a solution. This will be done with reference to Fig. 2(a).

The two solution points obviously receive the value 0. Consider next points ABC, $\bar{A}\bar{B}\bar{C}$ and let x, y be the values to be given to them. There are two possible transitions from ABC, one to a solution and one to $\bar{A}\bar{B}\bar{C}$. Hence, if each transition has probability $\frac{1}{2}$, there is a chance of $\frac{1}{2}$ that a solution will be reached from ABC in one transition, and a chance of $\frac{1}{2}$ that the first transition will be to $\bar{A}\bar{B}\bar{C}$, after which a further y transitions will (on average) be required. Hence,

$$x = \frac{1}{2} \cdot 1 + \frac{1}{2}(1 + y) = 1 + \frac{1}{2}y$$

By similar reasoning, beginning with $\bar{A}\bar{B}\bar{C}$

$$y = 1 + \frac{1}{2}x$$

whence $x = y = 2$

From the symmetry of the diagram it is clear that the points $\bar{A}B\bar{C}$, $A\bar{B}\bar{C}$ receive the value 2 also. Finally, the points ABC, $\bar{A}\bar{B}\bar{C}$ receive the value z given by

$$z = \frac{1}{2} \cdot 1 + \frac{1}{2}(1 + 2) + \frac{1}{2}(1 + 2) = 2\frac{1}{2}$$

These values are shown in Fig. 2(b), which also shows the probabilities assigned to the various possible transitions from each point.

Hence the average transition-value for all points is

$$E = \frac{1}{8}(0 + 0 + 2 + 2 + 2 + 2 + 2\frac{1}{2} + 2\frac{1}{2}) = 1.58$$

Hence this system is, on average, more rapid than the particular scanning system in Fig. 1(c), even although the latter was well above average for a scanning system.

There is no reason to suppose that the assumption of equiprobable transitions is the best obtainable. It would, for example, be possible to assign the probabilities so that each transition had a probability weighted in accordance with the number of rules violated by the variable concerned. Consider the point ABC in Fig. 2(a); here A is involved in two unsatisfied rules, B and C in one only, so that the weighting of the three transitions from this point would be $\frac{1}{2}, \frac{1}{4}, \frac{1}{4}$. The previous calculation then gives $x = 2, y = 2, z = 2$ (Fig. 2(c)). Hence, $E = 1.5$, a further improvement.

It is clear that within the broad framework of the principles here described there is scope for investigation of variations in detail of the procedure. In addition to the assignment of transition probabilities, the question also arises as to whether "double transitions" (simultaneous change of two or more variables) should be permitted, and if so, with what probabilities. Moreover, the known

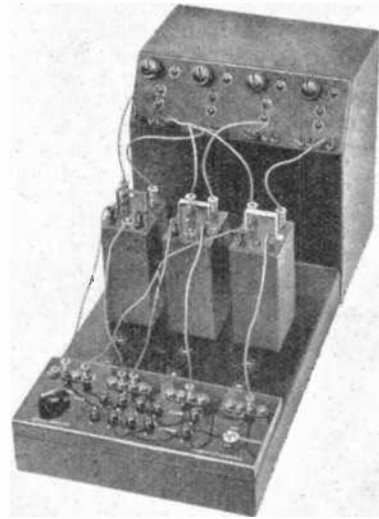

Fig. 3. A general view of the demonstration model

difficulty of producing true randomness in an actual working model prompts the question as to whether some "pseudo-randomness" may not perhaps suffice for practical purposes. Complete answers to these questions are not yet known.

The Demonstration Model

A general view of the machine is shown in Fig. 3. Only four two-state variables are provided. The indicating lamps and output sockets are on the rear panel, a red lamp indicating the state in which the sockets are connected to earth and a green lamp that in which the sockets are live (at +24 volts). The centre section of the machine carries the supply sockets for the connective boxes; the front section carries the control switches (which are described later) and "feedback sockets" for each variable.

The connective or rule boxes are the same as those in the earlier computer and problems are set up in a similar fashion. The output from the final box in any rule is taken to feedback sockets of all variables involved in the rule. Fig. 3 shows the wiring of a problem described in a later section.

Instead of the self-oscillating relay circuit described earlier it was found desirable to use a bistable relay circuit which is changed from either state to the other state by

applying an earth to the control lead. In Fig. 4 the circuit consists of relays $A\beta/3$ and $A\gamma/3$, and the triggering line is indicated by an X. Starting with the relays in the positions shown, when an earth is applied to the line at X, $A\beta$ operates but $A\gamma$ does not, as the fluxes produced by the two windings are equal and opposite. When the earth is removed, $A\beta$ remains operated through $A\beta_1$, and $A\gamma$ operates, as one winding is still energized through $A\beta_3$. When an earth is again applied to X, $A\beta$ is released, as $A\gamma_3$ causes $A\beta$ to be short-circuited. $A\delta$ remains operated through its second winding until the earth is removed from X, when it releases and the original circuit conditions are restored. Contacts $A\gamma_1$ and $A\gamma_2$ ensure that the polarity of the circuit in the second winding is correct at the different points in the cycle.

This circuit is the basic block in the computer and the different modes of operation are obtained by triggering the four two-state variable circuits of this type in different ways. There are four modes of operation called Simultaneous Auto, Simultaneous Manual, Manual, Auto, any of which may be selected by the multi-position switch at the left of the front panel. The two manual modes correspond to the auto modes and the latter will be described. In the Simultaneous Auto mode all variables which cause rules to be unsatisfied are triggered simultaneously from one oscillator, while in the Auto mode separate oscillators running at different frequencies are used to trigger the different variables and thus introduce randomness. Each oscillator is of the type shown in Fig. 4 as $A\alpha$; its frequency is controlled by the $1k\Omega$ variable resistor.

As Auto operation is mechanically simpler it is described first. Referring to the block diagram of Fig. 5(a), it will be seen that the leads from the feedback sockets are broken

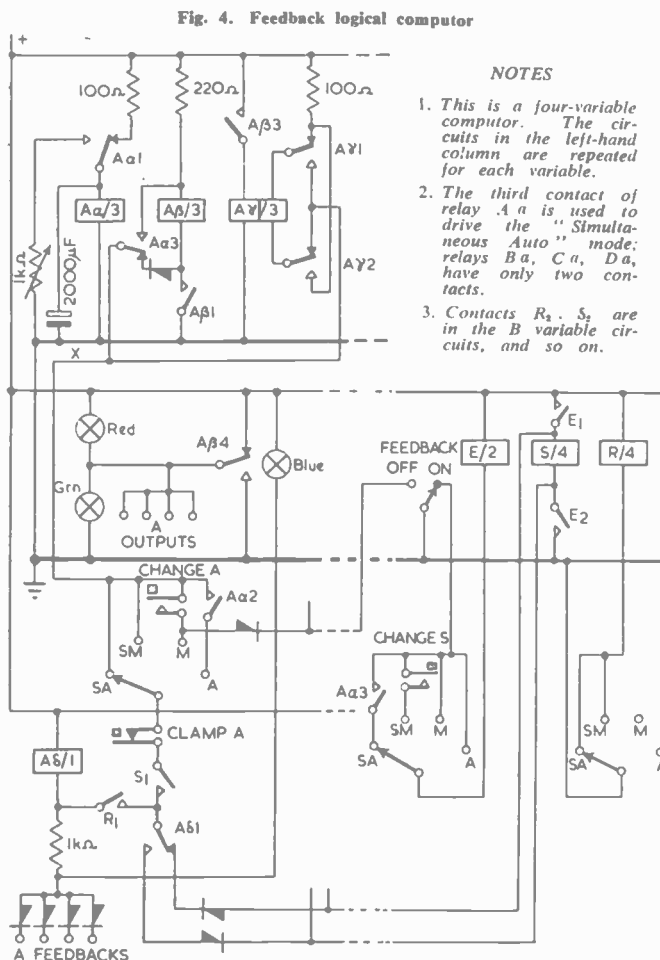

Fig. 4. Feedback logical computer

NOTES

1. This is a four-variable computer. The circuits in the left-hand column are repeated for each variable.
2. The third contact of relay $A\alpha$ is used to drive the "Simultaneous Auto" mode; relays $B\alpha$, $C\alpha$, $D\alpha$, have only two contacts.
3. Contacts R_1 , S_2 are in the B variable circuits, and so on.

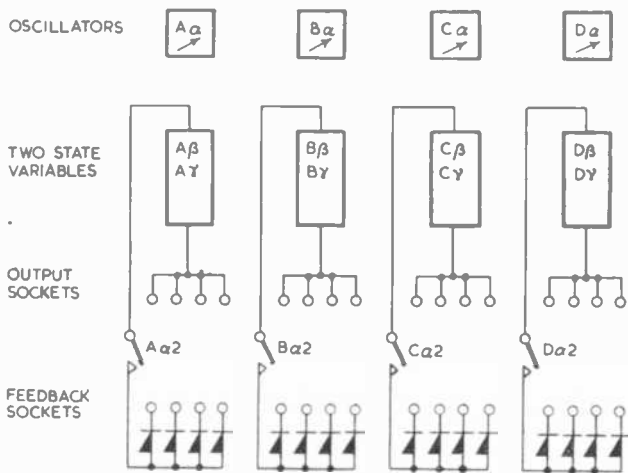

Fig. 5(a). Block diagram for "Auto" mode

by the normally open contacts $A\alpha_2$, $\beta\alpha_2$, etc., so that earths from the feedback sockets are only fed back to the triggering points while the relays are made. The frequencies of the oscillators may be continuously varied over a large range, so that if for instance an earth is simultaneously applied to the A and B feedback sockets, it is largely a matter of chance which variable changes first.

In the Simultaneous Auto case, which is provided so that a certain type of instability may be demonstrated, it is desired that at any time an earth is connected to two or more feedback sockets the associated variables will change simultaneously. The A oscillator is used as the master and drives the slave relays E and S. The latter makes and breaks the four lines from the feedback sockets to the triggering points simultaneously (Fig. 5(b)). As difficulty was experienced in equalizing the operating times of the two-state variable circuits, memory relays $A\delta$, etc., are inserted in association with each variable to remember the presence or absence of an earth on the feedback sockets. When relay E is operated by the $A\alpha$ relay, contacts E1 and E2 hold the relays $A\delta$, $B\delta$, etc., in the positions they had prior to E making, as well as operating relay S. Thus the more rapid changing of one of the variables cannot act through the connective boxes to alter the feedback conditions until all the variables have changed; the time for which E is made is long enough to ensure that the changes are complete before it releases.

The two manual positions correspond to the auto positions, five push buttons being provided, one for each variable and one common button to change all variables simultaneously. A feedback On-Off switch in series with the E relay keeps the feedback loops open until it is desired to set the computer in action, and allows the variables to be set to any initial condition by pressing the associated manual buttons. An additional stabilizing facility consists of four clamp buttons which enable any feedback line to be broken. Pressing the clamp button on a variable which is continuously oscillating will usually cause the machine to reach a solution. The blue lamp beside each pair of variable lamps lights when any unsatisfied rule involves that variable.

Example of the Operation of the Computer

The problem which is set up in Fig. 3 has the following rules:—

- A or else B
- If B then C
- A if and only if D

This problem has been discussed in the earlier article and the transition diagram for it is shown in Fig. 6. The following are examples of the behaviour of the computer

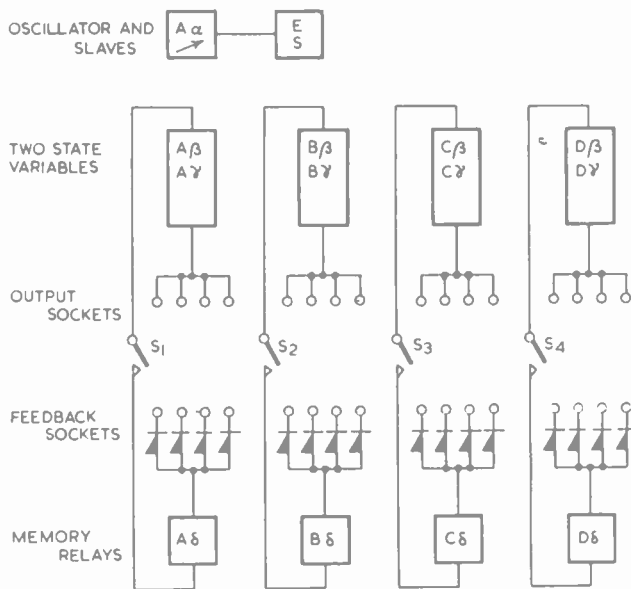

Fig. 5(b). Block diagram for "Simultaneous Auto" mode

with initial conditions which are an arbitrarily chosen "equidistant set."

(a) "AUTO" MODE

A B C D	<u>A</u> B C D	A B C D	A B C D
A B C D		<u>A</u> B C D	<u>A</u> B C D
A B C D			
A B C D			
A B C D			
A B C D			
A B C D			
A B C D			
A B C D			
<u>A</u> B C D	<u>A</u> B C D	A B C D	A B C D
A B C D		A B C D	A B C D
<u>A</u> B C D		A B C D	<u>A</u> B C D
		A B C D	
		<u>A</u> B C D	
		<u>A</u> B C D	

(b) "SIMULTANEOUS AUTO" MODE

A B C D	<u>A</u> B C D	A B C D	A B C D
A B C D		A B C D	A B C D
A B C D		(these two combinations recur)	A B C D
A B C D			(last two combinations recur)
(last two combinations recur)			

Problems best suited to Feedback Computers

The question naturally arises as to whether there is any class of problem for which the superiority of the feedback type of computer is most marked. It is found that when the rules each contain relatively few variables and do not overlap to any great extent (i.e. each variable appears only in one or a few rules) the advantage of the feedback method is very great; on the other hand, when one rule contains all the variables, or when each variable appears in many rules, the feedback method is not advantageous. To take an extreme example, a four-variable problem with a single answer (say ~~A~~B~~C~~D) has a standard average-transition value $E_0 = 7.5$. If the same problem is set up in a feedback computer with four independent rules such as

- Not A
- B
- Not C
- D

then (assuming "single" equiprobable transitions only) the average-transition figure is $E = 2$. On the other hand, if

it is set up with a single rule which includes all the variables, e.g.

$$(B \text{ and } D) \text{ and not } \{(A \text{ or } C)\}$$

Then the average-transition figure is $E = 17.16$. Any set of rules intermediate in character will give a value of E between these two extremes.

The region in which the use of a feedback computer appears likely to be most fruitful is that in which the number of variables is large. It is therefore of interest to examine the behaviour of these limiting values of E for a large number (N) of variables.

Taking the most unfavourable case first (a single rule including all variables), it is found that for a single-solution N -variable problem on the same assumption of single equiprobable transitions, the value of E is given by a rather complicated expression which can be shown for large N to approximate to 2^{N+1} . This means that the feedback computer will have "looked at" all possible combinations "about twice" on the average, before finding the solution.

For a scanning type computer the average number of transitions E_0 is given by the formula previously given, with $s = 1$, i.e.

$$E_0 = \frac{n-1}{2} = 2^{N-1} \text{ approximately.}$$

So at the worst, the feedback computer takes about four times as long as the scanning computer.

The most favourable case (single-variable non-overlapping rules) has a value of E which can be simply expressed

$$E = \frac{1}{2}(N - \log_2 s)$$

and with $s = 1$ this gives $E = \frac{N}{2}$

It is clear that the advantage here is of quite a different order, and that the feedback computer is vastly superior. For $N = 20$, for examples, the two values are

$$E_0 = 524,288 \quad E = 10$$

so that the feedback computer is in this case more than 50,000 times more rapid than the scanning one. Although a problem in which the rules were of this optimum nature would be trivial, it is found that in most many-variable

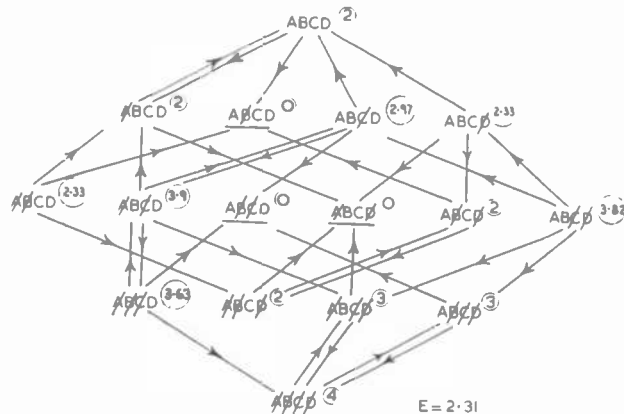

Fig. 6. Transition diagram (A or else B, A if only D, if B then C)

problems arising in practice the rules are in fact numerous rather than complex, so that much of this potential advantage may actually be realized.

It is of interest to note that the type of problem solved quickly by a feedback computer tends to be precisely that which is solved quickly by a human brain.

Acknowledgment

The authors wish to thank Messrs, Ferranti, Ltd., for permission to publish this article.

REFERENCES

MCCALLUM, D. M. AND SMITH, J. B., Mechanized Reasoning, *Elec. Engng.*, XXIII, 126 (1951).

Equipment for Acoustic Measurements

(Part 4)

The Direct Measurement of Reverberation Time

by

C. G. Mayo,* M.A., B.Sc., M.I.E.E. and D. G. Beadle,* B.Sc.(Eng.), A.C.G.I., A.M.I.E.E.

It is necessary when building a studio or hall for broadcasting to keep the reverberation time within close limits over the audio frequency spectrum. Reverberation is the persistence of sound in a room due to repeated reflexions after the original sound has ceased, and it can be shown that in conditions of complete diffusion the reverberant sound decays according to the law

$$I = I_0 e^{-kt} \dots\dots\dots (1)$$

where I is the intensity of sound after a time t , I_0 is the steady state intensity and k a constant depending upon the volume and sound absorption in the room. In practice, conditions are seldom completely diffuse and the decay fluctuates about this curve. The reverberation time was defined by Sabine as the time taken for the sound to decay to inaudibility from a steady state intensity 60db higher. For measurement purposes it is usual to obtain a curve over the decay period showing sound intensity in decibels against time, which, from equation (1), should be a straight line whose slope is inversely proportional to the reverberation time. In the past a high speed level recorder has been used to trace the sound intensity on a decibel scale against time, but now the triggered time-base oscilloscope, described in the previous article,¹ has been adapted to display the decay curve logarithmically. This is done by replacing the linear Y plate amplifier with an amplifier whose output is proportional to the logarithm of the input voltage.

In order that the reverberation times may be read directly off a special scale on the front of the cathode-ray tube, the time-base of the oscilloscope has to be calibrated. This is most conveniently achieved by passing a damped wave-train of known decrement through the logarithmic amplifier and adjusting the time-base so that the resultant trace is at a predetermined angle to the Y axis of the tube. The method of adjustment also has the advantage of checking the performance of the logarithmic amplifier as any departure of the trace from linearity is easily discernible. The apparatus for producing the damped wave-train has been called a decay calibrator and in order to save space is combined with a noise generator in a single carrying case. The noise generator is used for reverberation measurements when it is desired to excite a wider band of frequencies than is contained in the more usual warble tone.

The Logarithmic Amplifier

The logarithmic amplifier is designed to operate from signals at microphone level and convert them into a direct voltage proportional to the logarithm of the amplitude of the input signal. The direct voltage is applied to the directly coupled push-pull Y-plate amplifier of the triggered time-base oscilloscope and, in conjunction with the linear time-base, displays the decay curve of a studio on a logarithmic scale against time.

The logarithmic law is obtained, over a range of some

35db, by suitable use of the $I_a - V_g$ characteristic of a variable-mu valve, and by using two such stages in cascade a range of 70db has been obtained with a maximum deviation of ± 1 db from a logarithmic law.

The circuit diagram of the logarithmic amplifier is shown in Fig. 1. The microphone amplifier, consisting of valves V_1 and V_2 , has a maximum undistorted output of +13db relative to one milliwatt into 600 ohms and has a voltage gain of 53db. Negative feedback is used to keep distortion low and the output impedance has to be increased by the addition of R_{11} and R_{12} in order to present 600 ohms to the load. The transformer T_3 operates from 600 ohms to the push-pull grids of the first variable-mu stage. The step down to 600 ohms in the output of the microphone amplifier is to permit the insertion of a standard band-pass octave filter to eliminate extraneous noises and ensure that only the wanted frequency band reaches the amplifier. Push-pull is used for the variable gain stages to eliminate instability which would otherwise be caused by the push-pull components introduced by the operation of the bias voltage.

The output of the push-pull stages is rectified by a full wave rectifier W_1, W_2 biased by the delay voltage developed across the common cathode resistance R_{33} of valves V_6 and V_8 . This delay voltage determines the level at the output of the transformer T_5 and, by maintaining this level at a constant value, the gain of the variable-mu stages must follow the variations of input level. Thus, if the input is decaying exponentially the gain of the variable-mu stages must increase exponentially in order to maintain a constant output and, since the characteristics of a variable-mu valve are approximately exponential it follows that a linear decrease of bias voltage will maintain the required constant output. Furthermore the delay voltage biases V_8 beyond cut-off so that when the peak a.c. signal applied to the rectifiers exceeds the cut-off bias the signal will be amplified before being passed on to the voltage doubler V_7 . This is similar in effect to amplified a.v.c. and gives a better control. The gain of V_8 is determined by the feedback resistances R_{38}, R_{39} and is limited to prevent instability. V_8 acts as a voltage regulator for determining the cathode potential of V_{10} . In the absence of V_8 the unsmoothed signal from the rectifiers W_1, W_2 would, if applied to the grid of V_{10} , cause variations in the cathode current and hence in the biasing voltage. But with the grid of V_8 held at a positive potential by the voltage divider R_{21} and R_{14} , the cathode potential will remain constant by cathode-follower action despite variations in the cathode current of V_{10} . The voltage doubler V_7 charges negatively the $0.1\mu F$ capacitor C_8 , and the charging resistor R_{37} prevents the mean potential from being unduly disturbed by sharp-peaked transients. The resulting negative bias is applied directly to the grids of V_5 and V_6 and after further decoupling by R_{22}, R_{23} and C_7 to the grids of V_3 and V_4 . The discharge time-constant of C_8 is variable in three steps by resistors R_{34-36} and hence the maximum operating speed can be controlled. The values of R_{34-36} and C_8 were

* Research Department, B.B.C. Engineering Division.

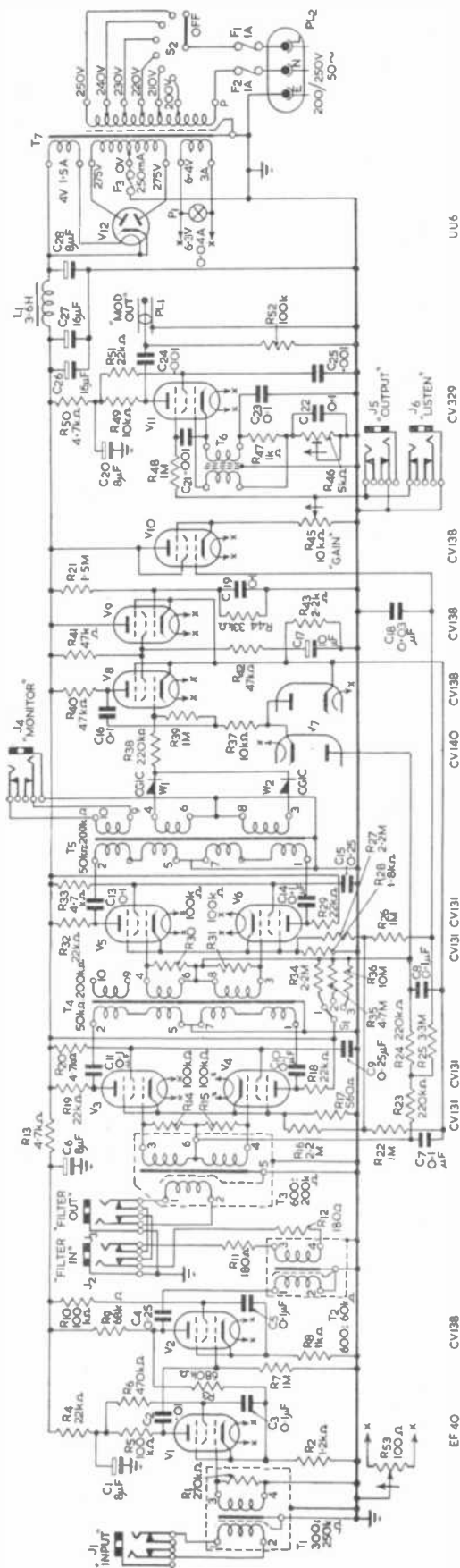

Fig. 1. The logarithmic amplifier

chosen to give maximum operating speeds of approximately 300, 600 and 1,200db/sec respectively corresponding to minimum reverberation times of 0.2, 0.1 and 0.05 seconds. In practice reverberation times of less than 0.2 seconds are seldom found, so that the instrument is capable of meeting all requirements for room acoustics.

The direct voltage corresponding to the logarithm of the input voltage is obtained by adding, through resistances R_{16} , R_{27} , R_{26} and R_{25} , a voltage proportional to the mean cathode current to the mean grid bias of both pairs of variable- μ valves. The resulting voltage is smoothed by the capacitor C_{18} and applied as a negative voltage to the grid of a cathode-follower V_{10} , the output voltage of which is displayed on the triggered time-base oscilloscope. The operating point of the cathode-follower is set by connecting its grid through R_{21} and R_{22} to the point of fixed positive potential as determined by the cathode current of V_8 and V_9 .

Fig 2 shows the individual curves for (a) cathode current and (b) bias voltage for a given input signal as well as (c) the composite curve. It will be seen that the deviation of the latter from the dotted line representing a true logarithmic curve is less than ± 1 db.

V_{11} has been included so that the sound decay can be

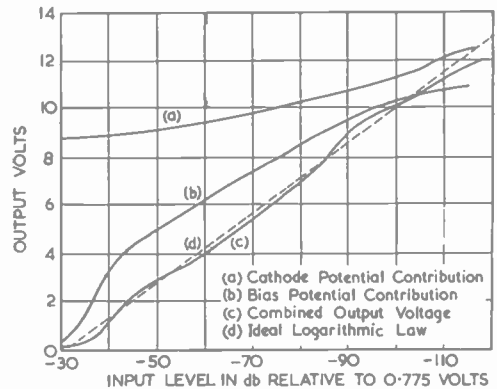

Fig. 2. Input/Output characteristic of logarithmic amplifier

displayed as an intensity modulation on the oscilloscope trace. The valve operates as a megacycle oscillator with the amplitude of oscillation controlled on the suppressor grid by the direct voltage output of the logarithmic amplifier. The signal is passed through a small capacitor of suitable working voltage and after rectification the resultant direct voltage is applied to the grid of the cathode-ray tube, thus modulating the brightness. This method of display is comparatively new and few results have so far been obtained.

A further piece of apparatus is being designed to provide timing pulses at known intervals after the tone has been cut off in the studio. These pulses will be used to brighten the cathode-ray trace and give the delayed frequency response of the studio in a somewhat similar manner to that already used for displaying loudspeaker transient response curves.²

The Decay Calibrator and Noise Generator

The circuit diagram of the decay calibrator and noise generator is shown in Fig. 3, in which it will be seen that V_3 and V_4 form the decay calibrator, V_2 is the noise generator and V_5 , V_6 and V_7 are an audio frequency amplifier. All three units together with a power supply unit are contained in a carrying case measuring 17in. \times 6in. \times 10in. with a total weight of 17lb.

The decay calibrator is designed to give a wave-train of known decrement, which when rectified by the logarithmic amplifier gives a straight line trace on the oscilloscope. The time-base speed of the oscilloscope may then be adjusted until the slope of the line corresponds to the

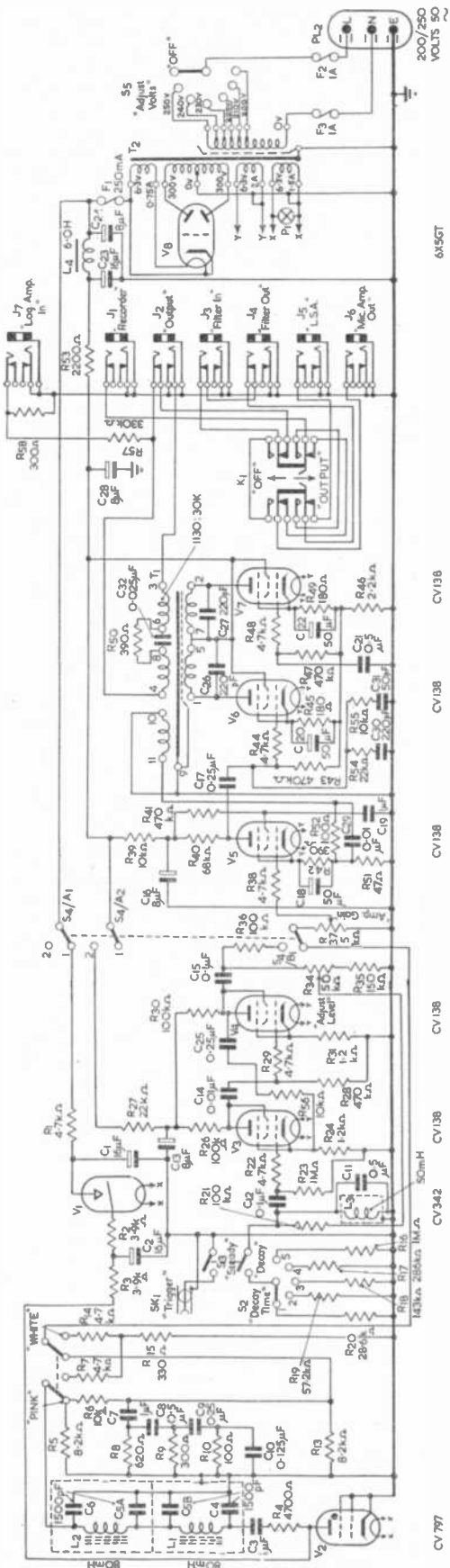

Fig. 3. Decay calibrator and noise generator

appropriate time on the reverberation scale. The unit consists of a circuit $L_3 C_{11}$ tuned to 1,000c/s which is made to oscillate by positive feedback over the two stage amplifier $V_3 V_1$. The forward gain of the amplifier is stabilized by negative feedback so that the setting of the oscillation control R_{31} is critical and the tuned circuit behaves as a pure L and C . The decay is then determined by introducing damping across the tuned circuit by the resistors $R_{16} - R_{20}$ which have values to produce decay times of 7, 2, 1, 0.4 and 0.2 seconds respectively. The last four decays are used for calibration, while the 7 second position is used as a sensitive test to determine the correct adjustment of the oscillation control.

The differential equation expressing the instantaneous voltage across a parallel tuned circuit is

$$LC \frac{d^2 E}{dt^2} + \frac{L}{R} \frac{dE}{dt} + E = 0 \dots\dots (2)$$

where L , C and R are respectively, the inductance, capacitance and resistance and E is the voltage.

The transient solution of equation (2) is given by

$$E = E_0 \exp\left(\frac{-t}{2RC}\right) \cos\left[\sqrt{\frac{1}{LC} - \frac{1}{4R^2 C^2}} \times t + \phi\right] \dots (3)$$

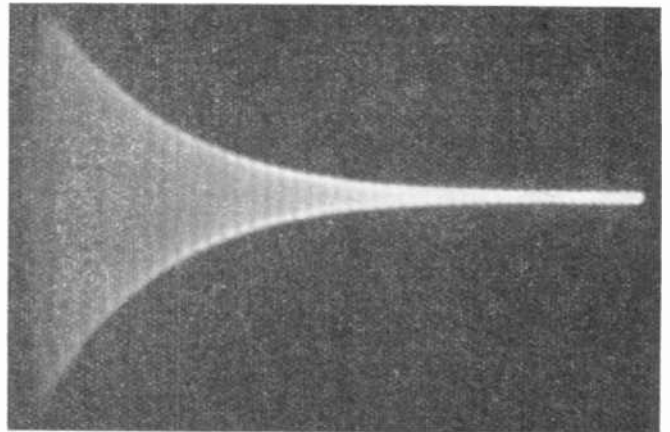

Fig. 4. Decay calibrator output waveform

where E_0 and ϕ are constants. This represents an oscillation of frequency

$$\frac{1}{2\pi} \sqrt{\frac{1}{LC} - \frac{1}{4R^2 C^2}}$$

the amplitude of which is decaying exponentially.

The decay time T is defined as the time taken for E to fall by 60db and will be given by

$$T = 2RC \log_e 10^6 = 13.82RC \text{ seconds} \dots\dots (4)$$

Hence it will be seen that the decay time is directly proportional to the damping resistor provided that the maintaining amplifier is strictly linear.

The output from the decay calibrator is taken from the anode of V_1 through the blocking capacitor C_{15} and the isolating resistor R_{16} to the input of the audio frequency amplifier which has already been described in detail.³

Before using the decay calibrator, the oscillation control R_{31} is adjusted with the decay time switch S_2 set to 7 seconds and the "Steady-Decay" switch S_3 at Decay so that oscillations do not quite build up. Then, on opening S_3 , oscillations build up until limited by the maintaining amplifier. Since the amplifier has considerable negative feedback this limiting point is well defined and the amplifier will be linear up to this point. The "Decay Time" switch S_2 is then set to the desired decay time and S_3 closed to start the decay. A second contact on S_3 is used to trigger the time-base of the oscilloscope concurrently with the

onset of the decay of the oscillation. Fig. 4 shows a photograph of the decay obtained from the decay calibrator.

The noise generator V_2 is of the type described by Shorter and Harwood.⁴ A 3db/octave filter consisting of $C_7 - C_{10}$ and $R_8 - R_{10}$ can be inserted as necessary into the output circuit of the noise generator to convert the energy distribution of the noise from equal energy per cycle of the "white noise" generated into "pink noise" or equal energy per octave. The attenuator R_7, R_{14} and R_{15} is inserted so that the total noise output remains constant for either case.

The key K_1 in the output circuit of the audio frequency amplifier is used when making reverberation measurements. In the "output" position "white" or "pink" noise is fed through an octave band-pass filter connected between J_3 and J_4 to a loudspeaker amplifier connected to J_5 . The noise from the speaker in the studio is picked up on a microphone, amplified, and the output of the amplifier connected to J_6 and thence via the key to the input of the logarithmic amplifier and triggered time-base oscilloscope attached to J_1 . On throwing the key the noise is cut from the studio and the filter transposed between the output of the microphone amplifier and the logarithmic amplifier input to prevent rumbles and other extraneous noises from giving a false decay curve.

A photograph of the decay calibrator, noise generator, logarithmic amplifier, octave band-pass filter and triggered time-base oscilloscope with reverberation scale is shown in Fig. 5.

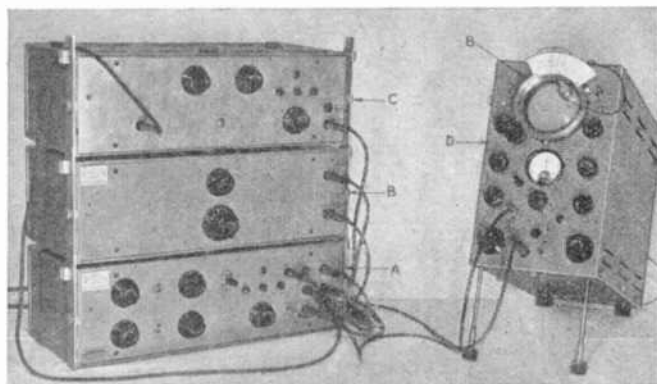

Fig. 5. Equipment for reverberation measurements

- (A) Decay calibrator and noise generator (B) Octave band-pass filter
(C) Logarithmic amplifier (D) Triggered time-base oscilloscope
(E) Reverberation scale

The Reverberation Scale

The special scale developed for reading reverberation times directly off the face of the oscilloscope is shown in Fig. 6. It consists of an outer brass ring (A) which has a bayonet fixing to the oscilloscope housing. An inner ring (B) is carried on three polytetrafluoroethylene bearings (C) and can be rotated with respect to the outer ring by a friction drive (D). A perspex graticule (E) is fastened to the inside of the ring and has several parallel lines engraved upon it to assist in the alignment of the graticule and the decay curve. These lines are illuminated by indirect lighting from a flash lamp bulb in the housing (F) on the graticule. The inner ring also carries the reverberation scale (G) which is divided into three ranges 0.2 to 0.8, 0.4 to 1.6 and 1.0 to 4.0 seconds. The index (H) for the scale is carried on a lamp housing (K) on the outer ring—the lamp being used to back light the scale. The lamp housing can be adjusted on the outer ring so that the index corresponds to "∞" on the reverberation scale when the graticule lies along the time-base axis. This allows for variations in the position of the bayonet fastening and also for misalignment of the cathode-ray tube.

Application to Studio Testing

The apparatus described has been in use for some time for taking reverberation measurements, and has proved to be very satisfactory when using either warble tone or white noise as the source of sound.

The time-base of the triggered time-base oscilloscope is first calibrated by setting the graticule of the reverberation scale to a value corresponding to one of the decay times of the decay calibrator and adjusting the speed control until the slope of the decay curve corresponds to the slope of the graticule.

The source of sound is used in conjunction with the tone pulser¹ so that pulses of sound are reproduced in the room being measured at intervals rather longer than the reverberation time. The sound in the room is picked up on a microphone and amplified by the first two stages of the logarithmic amplifier. The signal is then passed through a band-pass filter to eliminate unwanted noises and afterwards converted into a direct voltage corresponding to the logarithm of the input voltage. The resulting direct voltage after further amplification is applied to the vertical deflexion plates of the cathode-ray oscilloscope to give the decay curve the slope of which is measured. The graticule

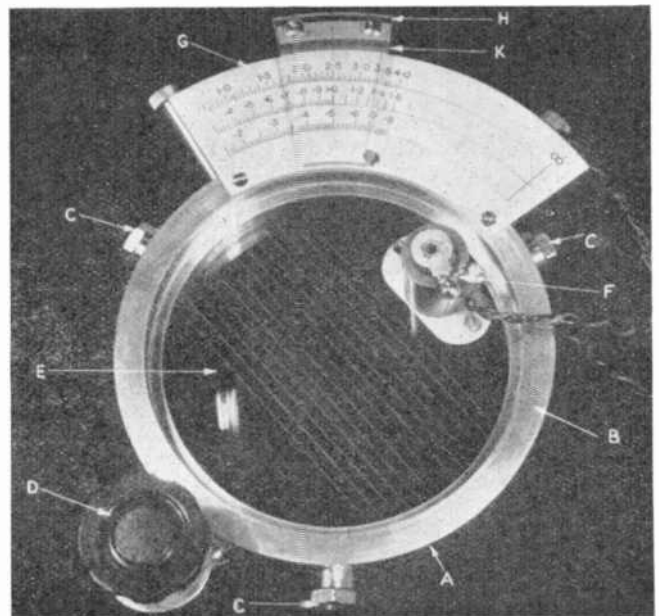

Fig. 6. The reverberation scale

- (A) Outer ring (B) Inner ring (C) P.T.F.E. bearings
(D) Friction drive (E) Cursor (F) Cursor lamp housing
(G) Reverberation time scale (H) Index (K) Scale lamp housing

of the reverberation scale is then set to the mean value of several successive decays.

Further results using the apparatus were discussed in a paper read at the Building Research Congress from September 11-20, 1951.

Acknowledgments

In conclusion the authors wish to thank their colleagues of the B.B.C. Engineering Research Department for help in the development of these units and they are also indebted to the Chief Engineer of the B.B.C. for permission to publish this article.

REFERENCES

- MAYO, C. G., BEADLE, D. G., AND WHARTON, W., Acoustic Pulse Measurements, *Electronic Engineering*, XXIII 424 (1951).
- SHORTER, D. E. L., Loudspeaker Transient Response—Its Measurement and Graphical Representation, *B.B.C. Quarterly*, I, No. 3, (1946).
- SHORTER, D. E. L., AND BEADLE, D. G., A Portable Microphone to Line Amplifier, *Electronic Engineering*, XXIII, 326 (1951).
- HARWOOD, H. D., AND SHORTER, D. E. L., A High-Level Noise Source for the Audio Frequency Band, *J. Sci. Inst.*, 27, No. 9 (1950).

Slotted Line Techniques

By E. G. Hamer,* B.Sc.(Eng.), A.M.I.E.E.

AT V.H.F. nearly all connexions between circuits are made by co-axial cables, and in many cases one requires to know either the electrical characteristics of these connecting cables, or the impedance, or other characteristics of the point of connexion. Bridge and other similar networks are capable of giving a high accuracy of measurement over a wide range of impedances at the lower frequencies but at V.H.F. the leads used to connect the bridge to the circuit under test, and stray capacitances have an appreciable effect, and have to be allowed for as far as possible. It is often easier to measure directly the voltage or current distribution along the connecting cable, as from these results the properties of the cable itself, or the circuit connected to the cable may be fairly easily deduced. This can be done by inserting at a suitable place in the connecting cable a section of coaxial line which has a longitudinal slot along it. The voltage or current distribution along the slotted section of the line may be investigated by means of a probe, the probe being of the electrostatic type to measure the voltage, or a small loop to measure the current. Usually an electrostatic probe is used as, if a loop is used, it is very difficult to avoid mixed electrostatic and magnetic pick-up, and both voltage and current will be measured simultaneously. For mechanical reasons the slotted line section is usually much larger in diameter than the connecting cable, and care must be taken that inserting it into the circuit under test does not cause any errors due to mismatch and discontinuities. When a voltage is applied to one end of a transmission line a voltage and current wave travel along the line building up electrostatic and electromagnetic fields. These waves travel down the line at a finite speed dependent on the materials from which the line is constructed, the principal factor determining the velocity of propagation on lines used for V.H.F. being the dielectric constant of the insulating material used. At any discontinuity some of this energy will be reflected back and the resultant voltage wave along the line will be altered. If the applied voltage is sinusoidal the incident and reflected travelling waves will combine at all points along the line to give a stationary wave. The peak magnitude of the stationary or standing-wave varies along the line in a cyclic manner, as well as varying sinusoidally with time. It is important to distinguish between the incident and reflected waves, and the stationary "Standing-Wave" which is a combination of the two. In a loss-less line an observer measuring the instantaneous voltage at any point would be unable to detect between a single incident travelling-wave, and a combination of incident and reflected waves giving a resultant standing-wave. If the observation point was moved the voltage would vary in phase but not in peak amplitude, (in the case of the single travelling-wave), but the voltage of the standing-wave would vary in phase and peak magnitude. The ratio of the reflected voltage or current wave to the incident voltage or current wave at any point in the line is known as the "Reflexion Coefficient", and is a vector quantity as it takes account of the phase angle between the incident and reflected waves. The ratio of the maximum value to the minimum value of the resultant standing-wave (if any) is termed "The Standing-Wave Ratio" and is a scalar quantity being a measure of magnitude only. Simple relationships exist between these two quantities, and usually the easiest one

to measure is the standing-wave ratio. In a section of loss-free line the standing-wave ratio will be constant along the line, as will also be the magnitude of the reflexion coefficient; but the phase angle of the reflexion coefficient will vary along the line at a rate twice that at which the electrical angle of the travelling-waves is varying.

One of the most important properties of a transmission line is its characteristic impedance, and this is determined by the construction of the line; it is the impedance which would be measured at the input of an infinitely long length of the line. In most lines used for V.H.F. where the losses are small it has a purely resistive value, and if a short length of line is terminated by a resistance of this value the line will behave in the same manner as an infinite line (i.e., there will be no reflected wave); but if the line is terminated by any other impedance, resistive, reactive, or a combination of resistance and reactance there will be a reflected and hence a standing-wave. A reflected wave will also be caused if an impedance is shunted across the line, or placed in series with the line at any point.

- If E_I and I_I are the incident voltage and current.
- E_R and I_R are the reflected voltage and current.
- Z_o = Characteristic Impedance of the line.
- Z = Terminating Impedance.
- K = Reflexion Coefficient = $E_R/E_I = -I_R/I_I = k\angle\phi$.
- S.W.R. = Standing Wave Ratio

Then

$$K = \frac{Z - Z_o}{Z + Z_o} \quad (\text{Vector Quantity})$$

$$\text{S.W.R.} = |Z|/|Z_o| \text{ or } |Z_o/Z| \quad (\text{Scalar Quantity})$$

$$|K| = k = \frac{\text{S.W.R.} - 1}{\text{S.W.R.} + 1} \quad (\text{Scalar Quantity})$$

$$\text{S.W.R.} = \frac{1 + k}{1 - k} \quad (\text{Scalar Quantity})$$

$$\dot{Z} = \dot{Z}_o \frac{1 + K}{1 - K} \quad (\text{Vector Quantity})$$

The Power flowing along line = $E_{\max} \times E_{\min} \times R_o$
where E_{\max} and E_{\min} are R.M.S. values.

\therefore Power along line is proportional to $e_{\max} \times e_{\min}$
where e_{\max} and e_{\min} are maximum and minimum values of the standing-wave voltages.

Line Construction

It is important that the section of the measuring line introduced into the cable or circuit under test should introduce no discontinuities or other errors due to itself. Any such discontinuities or errors may be due to:

- (a) The junction between the cable and the line itself.
- (b) Any irregularities in the measuring line due to eccentricity, or variation of sizes of elements.
- (c) The mechanical supports for the inner conductor.
- (d) The effects of the slot in the line.
- (e) Energy absorbed by the measuring probe.

Effects (b) (c) and (d) may be easily made negligibly small compared with irregularities in the cable under test; (a) is made negligible by careful mechanical design, and use of suitable matching sections; and (e) is made small by using a small probe penetration and sensitive detectors.

To minimize the effects of (a) the ends of the line are usually tapered, the taper being such as to gradually reduce

* Research Laboratories of The General Electric Co., Ltd., Wembley, England.

the size to that convenient for incorporation of an integral cable junction. Both the inner and outer conductor of the line are tapered so that the characteristic impedance remains constant all the way along the tapered section, and the longer and more gradual the taper the less are any small discontinuities.¹

When all these effects have been minimized errors in reading the actual voltage distribution along the slotted line may also occur due to:

- (a) Oscillator harmonics and oscillator instability.
- (b) Instability of detector and probe circuits.
- (c) Errors in reading.
- (d) Coupling between the line and probe varying.

Careful oscillator design, using buffer circuits and output filters make errors due to (a) negligible.

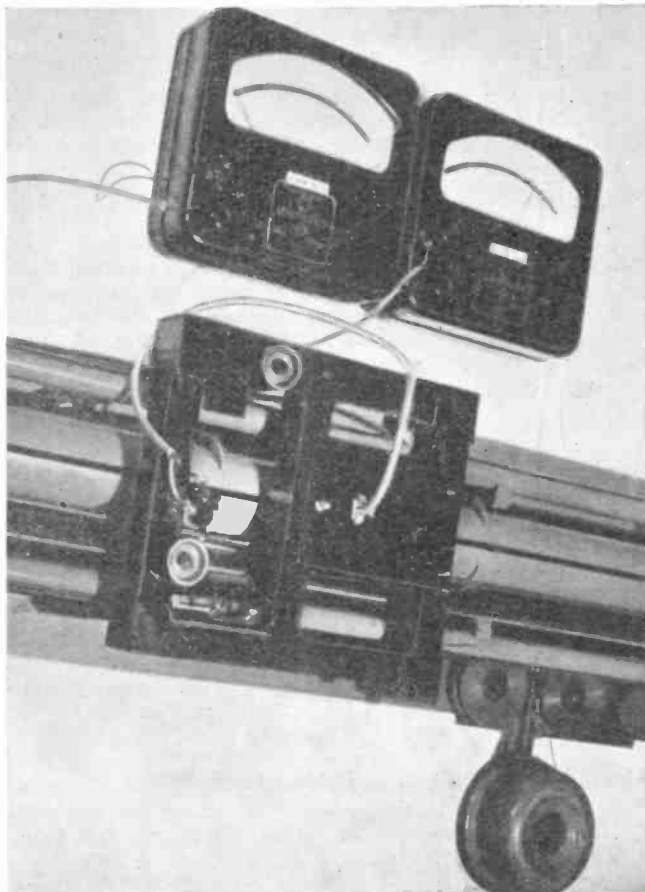

Fig. 1. Typical slotted line and carriage

If a silicon crystal detector is used and the current is kept below 60 microamps no appreciable change of calibration is likely to occur due to effect (b). Provided good galvanometers are used the reading error (c) should be low especially if two ranges are used say 0-6 and 0-60 microamps.

Probe coupling (d) is the largest source of error, and careful mechanical design is required to minimize variations of probe penetration into the line, and the effects of eccentricity of the inner conductor. A rigid inner conductor is required mounted on the minimum of spacers, and a precision moving carriage. Even after the most careful construction errors will still be present, but if the whole line is rigidly mounted, and the construction of the carriage is such that any error is repeatable, the line itself

may be calibrated to allow for these defects and accurate and consistent readings obtained. It is important that the amount of material used for the spacers should be reduced to the minimum consistent with mechanical rigidity.²

Fig. 1 shows a photograph of a typical slotted line, and Fig. 2 shows an enlarged view of the probe section. The outer of the line is rigidly mounted in Vee blocks which are themselves fastened to an angle iron frame, the carriage runs on guide rails bolted to the Vee blocks, and has spring loaded wheels. The cursor consists of a perspex sheet with a scribed line in close proximity to a steel scale, oblique lighting being used to show up the cursor line. It will be noted that the whole of the probe assembly is insulated from the carriage, the probe itself being a small disk inserted through the slot in the line. A silicon crystal is connected to the top of the probe, and the earth return of the crystal and by-pass decoupling circuits are made by means of silver plated contacts to the sides of the slot. It is essential that the probe earth return should not be made via the carriage otherwise, particularly at high frequencies, external circulating currents may be set up in the carriage framework, and along the outside of the line.

Fig. 3 shows a drawing of the probe assembly, it will be

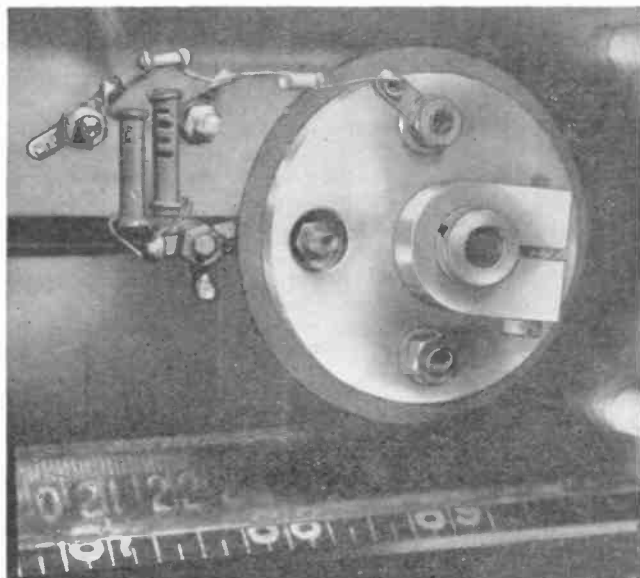

Fig. 2. Probe assembly

seen that the crystal mounting also forms a by-pass capacitor, and that the earth return is via symmetrical earth contacts alongside the probe. The probe depth can be varied easily, and the coaxial type of silicon crystal easily removed. The complete assembly is mounted on a sheet of distrene and is insulated from the carriage.

Calibration of the Line

For most measurements it is not necessary to know the actual R.F. voltage along the line, but only its relative magnitude compared to some other measured value. In this case the line can be easily calibrated by taking a series of readings of crystal current with the line open circuited. With the line open-circuited a large standing-wave ratio will occur, and the input power from the oscillator is adjusted so that at a voltage maximum the high range galvanometer is at full scale reading. A series of measurements are made of crystal current at regular intervals along the line, these intervals being more closely spaced when the low range galvanometer is in use. The positions of the minima are determined as accurately as possible, and in some cases it may be desirable to plot the readings against the distance along the line, on both sides of a

minimum so as to locate the position of the minimum accurately. Under these open-circuit conditions the voltage distribution along the line will be sinusoidal, and in one-half period a change of electrical angle from 0 to π will occur when the probe travels the distance between successive minima. The probe circuit only measures the amplitude of the resultant wave and takes no account of

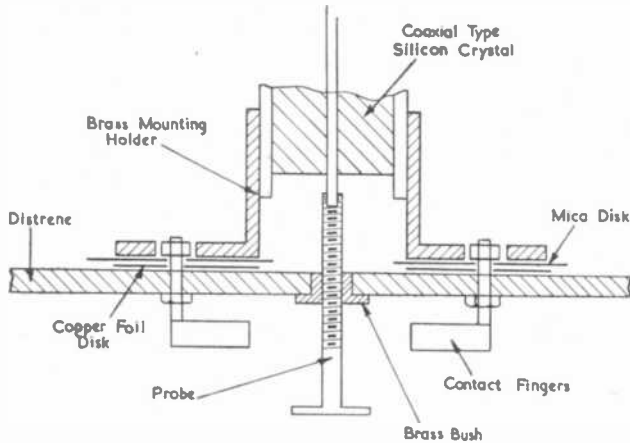

Fig. 3. The probe assembly

the phase. If the minimum occur at distances d_1 and d_2 along the line, and if the maximum reading corresponds to a relative voltage of 1, then the relative voltage at any distance d between d_1 and d_2 and is:

$$\text{Relative volts} = \text{Sin} \left[\pi \frac{d - d_1}{d_2 - d_1} \right]$$

where only the positive values are used. The galvanometer readings at these points may be plotted against the calculated relative voltages.

This work is considerably eased if a calculating machine is available as $\pi/(d_2 - d_1)$ may be set up, and multiples of this value added successively corresponding to distances $d - d_1$ along the line; the values of the sine function being read from suitable tables for each operation.

If it is desired to calibrate both the voltage probe, and the line itself to allow for any other errors such as variation of probe depth, then a much more elaborate procedure is required.² Such a calibration is only required when trying to make measurements of very low standing-wave ratios (1.05/1), or if bad irregularities exist in the line due to faulty construction.

It is necessary to calibrate the line for each band of frequencies used as the calibration varies with frequency, mainly due to changes of performance of probe circuit components. Once made the calibrations remain constant for a considerable time provided that excessive current is not passed through the silicon crystal.

Measurement of Impedances

Nearly all line measurements are made by the determination of the reflexion coefficient at the end of the measuring line and from this the impedance at this or any other position may be evaluated.

Now

$$|K| = k = \frac{\text{S.W.R.} - 1}{\text{S.W.R.} + 1}$$

so that a measurement of the standing-wave ratio immediately enables the magnitude of the reflexion coefficient to be determined. Now if at the end of the line

$$E_R = KE_I = k \angle \phi E_I$$

where $K \equiv k \angle \phi$

and at a point θ electrical degrees from the end of the line when moving towards the generator.

$$\text{Incident Voltage} = E_I \angle +\theta$$

$$\text{Reflected Voltage} = E_R \angle -\theta$$

$$\begin{aligned} \therefore \text{The Resultant Wave} &= E_I \angle +\phi + E_R \angle -\theta \\ &= E_I \angle +\theta + kE_I \angle \phi - \theta \end{aligned}$$

and this will have a maximum value when

$$\theta = \phi - \theta$$

$$\therefore \phi = 2\theta$$

hence the distance of the first voltage maximum from the end of the line enables the argument of the complex reflexion coefficient to be obtained. In practice it is preferable to measure a minimum position as this may be more accurately located,

then

$$\theta - (\phi - \theta) = n\pi$$

$$\therefore \phi = 2\theta - n\pi$$

also it is easier to measure the minimum from some arbitrary position such as that when the line is open circuited, rather than determine the exact electrical distance from the end of the line. On open circuit

$$K = 1 \angle 0$$

$$\therefore \theta_{00} = +n\pi/2$$

hence by measuring the shift of a minimum position from that obtained on open circuit to that with the circuit under test connected to the line the argument of the reflexion coefficient may be accurately determined (see Fig. 4). This may be used to obtain the value of the impedance by solving

$$\dot{Z} = \dot{Z}_0 \frac{1 + K}{1 - K}$$

or alternatively the use of "Smith" charts enables an easy graphical solution to be made.³

If the point of observation is moved towards the load the value of the argument of the reflexion coefficient will increase positively; but when measuring the shift of a minimum position after the load has been connected, a shift of the minimum towards the load corresponds to a negative value of the reflexion coefficient argument and vice-versa. These rules must be carefully observed when using "Smith" charts to calculate the change of impedance along a line, or the impedance connected to the end of an open circuited line.

Measurement of Co-axial Cable Characteristics

In many cases it is necessary to know the electrical length of a cable at the frequency under test, this being

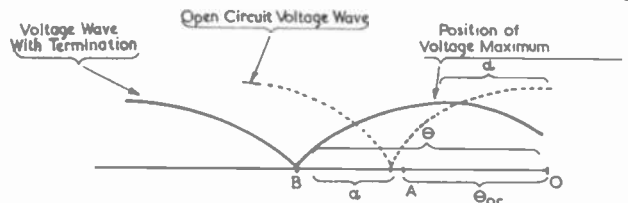

Fig. 4. Reflexion coefficient

- A = Probe minimum on open circuit
- B = Probe minimum when load placed on end of line
- AB = α = electric angle probe has moved
- AO = θ_{oc}
- BO = θ

$$\therefore \theta = \alpha + \theta_{oc} = \alpha + n\pi/2$$

$$\therefore \theta = 2\alpha$$

rarely equal to the mechanical length. This is easily determined as, if a minimum position with the air spaced measuring line open-circuited is found, and then the open-

circuited test cable be added, the distance the minimum moves towards the load end of the line will be the electrical length of the cable. If a long piece of cable is under test a whole number of half wavelengths may have to be added to the distance the probe moves, the distance corresponding to a half wavelength being conveniently and accurately determined by the distance apart of the minimums along the slotted line. If the piece of cable under test has a characteristic impedance very different from that of the measuring line, or is a high-loss length, it is more accurate to slightly adjust the test frequency, or length of cable under test so that the minimum position does not apparently move. This is to avoid any errors due to the change of reflexion coefficient angle at the junction of the measuring line and test cable.

If now the electrical length, mechanical length, and hence velocity ratio are known, the characteristic impedance may be evaluated by measuring the total low frequency capacitance of the cable under test. The frequency at which the capacitance is measured should be sufficiently low for the cable to behave completely as a lumped and not a distributed network.

Now

$$Z_0 = 138/\sqrt{\epsilon} \log_{10} D/d$$

when ϵ = dielectric constant of the insulating material, also the velocity of propagation in cable is proportional to $1/\sqrt{\epsilon}$.

$$\therefore \text{Velocity Ratio} = \frac{\text{mechanical length}}{\text{electrical length}} = 1/\sqrt{\epsilon}$$

Now the capacitance of a concentric cable

$$C = \frac{24.11\epsilon}{\log_{10}(D/d)} \text{ pF per metre.}$$

$$\therefore Z_0 = \frac{3350\sqrt{\epsilon}}{C} = \frac{3350 \times \text{Electrical length}}{C \times \text{Mechanical length}}$$

$$\therefore Z_0 = \frac{3350 \times \text{Electrical length of cable in metres}}{\text{Total capacitance in pF}}$$

When making a measurement of the characteristic impedance the length of cable should be approximately 5 to 10 wavelengths long. If short lengths of cables are used errors may be caused by the capacitances of the plugs and sockets used, and the end effects of the cable. If long lengths of cable are used, the standing-wave ratio is reduced and the position of the minimum cannot be accurately determined; also there may be some ambiguity in determining the approximate number of half wavelengths and hence the electrical length of the cable unless the velocity ratio has been accurately determined from tests on a short length.

Another important parameter of the cable is the attenuation at the test frequency and if

$$n = \text{voltage attenuation along cable} = \frac{\text{sending end voltage}}{\text{receiving end voltage}}$$

then at the receiving end

$$k_R = \frac{|E_R|}{|E_1|}$$

$$\text{at the sending end } k_S = \frac{|E_R|}{|E_1|} \quad \text{when} \quad \frac{|E_R|}{|E_1|} = \frac{|E_R|}{n|E_1|}$$

$$\therefore k_S = k_R/n^2$$

Now if the receiving end is open-circuited and $k_R = 1$

$$\therefore k_S = 1/n^2$$

$$\text{but } k_S = \frac{S.W.R. - 1}{S.W.R. + 1} = 1/n^2$$

$$\therefore n = \sqrt{\frac{S.W.R. + 1}{S.W.R. - 1}}$$

$$\text{Attenuation in db} = 20 \log_{10} \sqrt{\frac{S.W.R. + 1}{S.W.R. - 1}}$$

where S.W.R. is the standing-wave ratio measured when the test cable is open-circuited.

In many cases it is desired to measure the standing-wave ratio caused by connecting a piece of equipment (say an aerial) to a cable, and in such cases the attenuation of the cable connecting the equipment under test to the measuring line must be allowed for. The measured standing-wave ratio will be less than the true standing-wave ratio at the point where the equipment is connected to the cable. If k_T is the true magnitude of the reflexion coefficient at the equipment junction and k_m is the measured magnitude of the reflexion coefficient at the measuring line junction then $k_m = k_T/n^2$

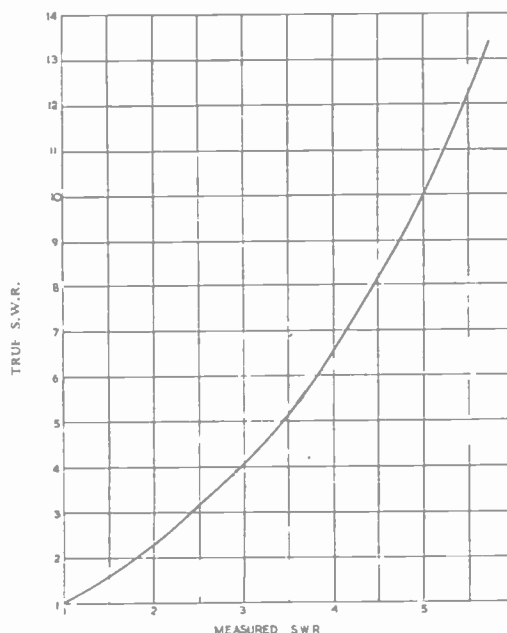

Fig. 5. S.W.R. correction for aerial cable length 14.3 metres

The true standing wave ratio =

$$S.W.R._T = \frac{1 + k_T}{1 - k_T} = \frac{1 + n^2 k_m}{1 - n^2 k_m}$$

$$\text{but } k_m = \frac{S.W.R._m - 1}{S.W.R._m + 1}$$

$$\therefore S.W.R._T = \frac{S.W.R._m \left[\frac{n^2 + 1}{n^2 - 1} \right] - 1}{\left[\frac{n^2 + 1}{n^2 - 1} \right] - S.W.R._m}$$

but with the test cable on open circuit

$$n^2 = \frac{S.W.R._m + 1}{S.W.R._oc - 1}$$

$$\therefore S.W.R._oc = \frac{n^2 + 1}{n^2 - 1}$$

$$\therefore S.W.R._T = \frac{S.W.R._m \times S.W.R._oc - 1}{S.W.R._oc - S.W.R._m}$$

Fig. 5 shows a graph of the correction curve for a typical aerial test cable, it will be seen that at low standing-wave ratios the correction required is negligible; but at the higher values the required correction is very large.

Measurement of Aerial Characteristics

The measurement of the impedance at the base of an aerial is made by using a combination of the methods

described. The electrical properties of the cable connecting the aerial to the line are measured, the aerial is then connected and the impedance at the junction of the connecting cable and measuring line then determined. From Smith's charts or by calculation the impedance at the junction of the connecting cable and the aerial is then determined. In calculating the impedance at the base of the aerial, the true reflexion coefficient has the same magnitude as that measured at the end of the line, but the reflexion coefficient angle will have changed by an amount twice the electrical angular length of the connecting cable if losses are neglected. A standing-wave ratio measurement may be made over the frequency band required corrections being applied to allow for the attenuation of the connecting cable.

One of the major requirements in connexion with aerial work is to determine the gain of the aerial under test against another aerial or against the equivalent omnidirectional source. An accurate and simple method is to feed the aeriels under test through the measuring line, the power being adjusted in all cases to give the same signal strength at the receiving station. The power flowing into the aerial is then proportional to the product of the maximum and minimum values of the standing-wave pattern. This is a true measure of the power flowing through the line to the load irrespective of the value of the aerial impedance, or characteristic impedance of the connecting cables.

The polar diagram of an aerial may be taken in the same way and by applying "Rousseau's" construction to the polar diagram, the mean radiated power in the plane under test may be evaluated and hence the gain over the omnidirectional source in the same plane. By repeating the polar diagram in various planes the mean spherical radiated power may be determined, and the gain of the aerial in any direction over a true omnidirectional source determined.

Many other types of measurements may be made by using combinations of the techniques described; and provided that care has been taken in the setting up and calibration of the measuring line and that care is exercised in making the measurements, repeatable results accurate to within less than 5 per cent can be obtained. If the construction of the line is sufficiently good these measurements may be made at frequencies up to 500Mc/s. At the super high frequencies many of the concepts of impedances, and characteristic impedance no longer hold, but similar techniques may be employed using slotted wave-guides to take the place of the slotted co-axial line.

REFERENCES

- ¹ OLIVER, M. H., Discontinuities in Concentric-Line Impedance: Measuring Apparatus. *Proc. I.E.E.*, 97, Pt. III, 29-38 (1950).
- ² MEDHURST, R. G. AND POOL, S. D., Correction Factors for Slotted Measuring Lines at V.H.F. *Proc. I.E.E.*, 97, Pt. III 223-230 (1950).
- ³ SMITH, P. H., An Improved Transmission Line. *Electronics*, xvii, 130 (1944).

Television in Germany

After the war the German broadcasting system was split up and Western Germany and the Western Sectors of Berlin were covered by a number of organisations, as follows:—

Nordwestdeutscher Rundfunk (NWDR—Hamburg)	(FORMER BRITISH ZONE)
Berliner Rundfunk (an NWDR unit)	BERLIN (British Sector)
Radio in the American Sector (RIAS)	BERLIN (American Sector)
Hessischer Rundfunk (Frankfurt)	} FORMER AMERICAN ZONE
Sueddeutscher Rundfunk (Stuttgart)	
Bayerischer Rundfunk (Munich)	FORMER AMERICAN ZONE
Radio Bremen	FORMER BREMEN ENCLAVE (American)
Suedwestfunk (Freiburg)	FORMER FRENCH ZONE

There was a temporary stop to work on television until 1948 when NWDR was able to take it up again in co-operation with a few commercial firms. By 1950, NWDR had set up in Hamburg an experimental apparatus including a film scanner, a diapositive scanner and a studio camera. Since then this equipment has been increased by one film scanner and two studio cameras, and for some months has been making experimental public transmissions of 625 line pictures with negative modulation. All the cameras and scanners are made by Fernseh GmbH of Darmstadt which is owned by the Bosch concern. This apparatus modulates a 0.1kW vision and a 0.06kW sound transmitter (made by Siemens) which at present operates in the region of 100M/cs, soon to be changed over to the final band of 200M/cs, in conformity with the decision to adopt the European standards agreed at Geneva in 1950. There are also two waveform generators made by Lorenz.

The NWDR television plans are much more advanced than those of the other broadcasting systems in the Federal Republic, which apart from RIAS, have got no further than discussion how they might share in NWDR's service.

Television in Eastern Germany

Many reports have been received about progress alleged to have been made in Eastern Germany and there is no doubt that some progress has been made in installation of television. There is believed to be only one factory in Eastern Germany manufacturing television receivers. The one model which is produced is identical with the small television set manufactured in the U.S.S.R. The German factory produces sets (without valves, which are installed in Russia) with Soviet markings, which are exclusively for delivery to Russia. There is no production of television receivers in Eastern Germany for domestic consumption. The East German production of television receiver sets is on a relatively small scale.

NWDR's Plans

NWDR has decided to push ahead first of all with the establishment of a proper service in the Former British Zone and the British sector of Berlin. Its immediate plans are for the establishment of two 10kW transmitters in Hamburg and Langenberg (near Dusseldorf), and three 1kW ones in Hanover, Cologne and Berlin (British sector).

It is hoped that the five transmitters will be ready to be put into service by the summer of 1952, and would be capable of reaching 12 million people. Links on decimetre wavelengths between the transmitter stations are being set up by the German post office with early extensions planned to Frankfurt (am Main), and subsequently to Baden-Baden and Munich.

Production of Television Receivers

As far as receivers are concerned a number of firms have started, or are planning to start, production of sets. Blaupunkt and Phillips are two of the first in the field. The initial price of a receiver will probably be DM1,000 (i.e., more than £83) until large-scale production can be started.

When W/T First Spanned the Atlantic

DECEMBER 12, 1951, marks the fiftieth anniversary of the historic day when Marconi's faith in the possibility of long distance signalling by "telegraphy without wires" was dramatically vindicated.

Marconi had come to this country only four years previously to demonstrate his first crude apparatus. There was admittedly little of originality in its component elements. But in his grasp of the potentialities of these products of the scientists' laboratory and the means by which the emission of Hertzian Waves could be applied to the transmission of intelligence with range of action measured in miles instead of feet, he stood alone.

His first patent—the world's first patent—on telegraphy without wires was filed on June 2, 1896. The young man soon drew around him the interest of men of science, the support of men of business, the friendship and advice of men of influence and Marconi's Wireless Telegraph and Signal Company, as it was at first named, was formed the following year.

From the results so far achieved in the long series of investigations and trials on which he was still engaged he had formed the unshakeable opinion that, carried out on a sufficiently large scale, his transmissions would be capable of reception across the Atlantic. Of proof there was none save that of achievement. To that end a transmitter of 25kW input—a hundred times more powerful than anything before attempted—was planned.

The coastline of West Cornwall was an obvious choice of position for the great experiment.

Building work at Poldhu commenced in October 1900. By January of the following year the plant was installed and ready for preliminary tests. Professor J. A. Fleming, F.R.S., of University College, London (Sir Ambrose Fleming who later devised the forerunner of all thermionic valves), had been appointed Scientific Adviser to the company and, knowing his wide experience in dealing with extra high tension alternating currents on a large scale, Marconi had entrusted to him many aspects of the design problems involved.

The aerial system which it was proposed to use for the Trans-Atlantic test was to be in the form of an inverted cone of wires supported by a circle of twenty masts, 200ft in diameter, each mast being 200ft high. The transmitter buildings were situated in the middle of the circle of masts.

Readiness for the attempt was approaching when on September 17, 1901 the mast structure was wrecked by a heavy gale and it became necessary quickly to construct another aerial. Time was vital and a simpler fan shaped array suspended from a triatic between two 170ft masts was constructed and used in the actual trans-Atlantic experiment.

All was now ready at Poldhu and on November 27, 1901 Marconi and his two assistants Kemp and Paget left England, arriving in Newfoundland on December 5.

A room for use as a receiving station and store was placed at their disposal in the disused hospital on Signal Hill at St. Johns.

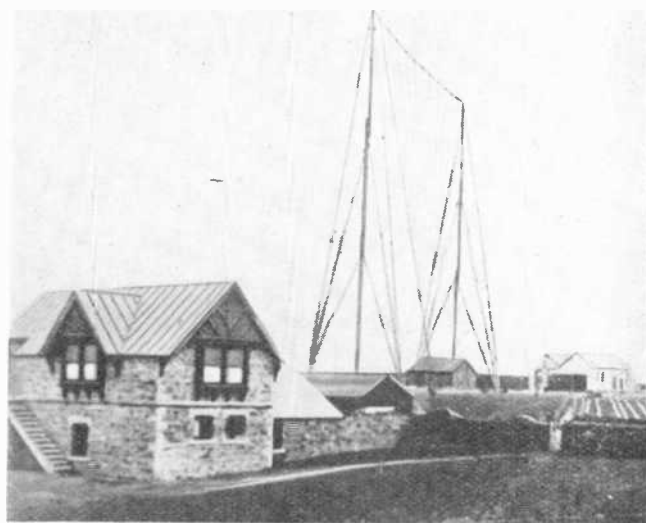

The transmitting station at Poldhu.

To elevate the long aerial required in those days the party had brought balloons and large kites. By December 9 they were ready and a telegram was despatched to the waiting engineers at Poldhu instructing them to commence on December 11 the prearranged programme. This required the transmission of repetitions of the Morse letter "S" (three dots) from 3 p.m. to 6 p.m. Greenwich time daily.

The next day was spent in experiments with kites and one was successfully flown to raise 600ft of wire. Difficulty was found in using any of the syntonic apparatus which had been brought owing to the continual variation in the capacitance of the aerial caused by the rise and fall of the kite in the boisterous wind and Marconi decided to use the next best means of reception available. This was a simple circuit embodying a sensitive self-restoring coherer which had been designed for use in the Italian Navy. It was arranged for aural reception with a telephone earpiece so that the weakest signals could be detected.

On the following day the wind increased in force and a balloon which had been inflated was carried away on its first ascent and lost. In the weather prevailing it was decided that the kites would stand a better chance.

On the next day, Thursday, December 12, the gale was unabated. The first kite flown, carrying an aerial wire 500ft long, was lost in a vicious squall within an hour. A second kite rose. It held.

At half-past twelve Marconi, who had been listening silently, handed the earphone to Kemp, quietly asking him whether he could hear anything. Through the intermittent crash of atmospherics Kemp heard faintly but distinctly that unmistakable sequence of three dots repeated again and again. Only then did Marconi say that he himself had heard but had wanted that confirmation. A recognizable signal had been received from across the Atlantic, undeterred by the curvature of the earth, generated by a few kilowatts only of radiated power and launched from aerials only 150ft high. Whatever the theory, the question was answered.

Marconi, who unfortunately for the historian was no diarist, made the laconic entry in his pocket notebook under December 12, 1901: "Sigs. at 12.30, 1.10 and 2.20."

Today an Empire broadcast, a telephone conversation with a friend in mid-ocean and television itself fail to raise a single eyebrow. But our thoughts go back at this time to that day just fifty years ago, to a cold bare room on Signal Hill where two men waited tensely as the gale whistled under the eaves—waited to prove an idea which meant so much to the world.

Picture Storage Tubes

By R. E. B. Hickman *

IN ordinary broadcast television, any time lag of the cathode-ray tube image due to afterglow of the tube screen, or any other reason, is regarded as a serious defect to a proper presentation of the picture, and hence something to be eliminated. Long persistence phosphors, however, find many applications in cathode-ray oscillography, particularly in the investigation of non-recurrent phenomena. In Teleran, the television-radar-air-navigation system¹ it is required to be able to transmit a composite television picture of a radar pattern, a ground map and other information, such as meteorological data. Special tubes have been evolved to meet this need.

Long Persistence Screen Tubes

Since the generation of a single complete radar P.P.I. (plan position indicator) pattern may take many seconds, a tube which could store information for this length of time was required. A first attempt to solve the problem made use of the long afterglow properties of certain phosphors, to produce a composite picture. This relatively dim afterglow was then picked up by a very sensitive image orthicon camera tube.

Conventional oscillograph or television tubes with the types of phosphor known as P1 and P4 are very efficient as converters of electron excitation into visible light, but the images have very short persistence, the peak brightness decaying in 60 milliseconds to less than one per cent. A high efficiency phosphor of much longer decay period was developed to meet the special requirements of P.P.I. display, the resultant P7 cathode-ray tube screen is a two-layer screen, consisting of a yellow-phosphorescing zinc cadmium sulphate layer applied directly to the tube face and a blue-fluorescing zinc sulphide layer on top of this. In operation, the zinc sulphide layer is excited to blue fluorescence by the electron beam. During this time the yellow layer absorbs and stores the blue light energy so that when the exciting beam is removed, the blue fluorescence ceases immediately, but the yellow layer releases its energy as a relatively intense afterglow, so that the image traced by the electron beam is stored on the screen for some time after the signal itself has ceased. Using screens of this type, it is possible to obtain decay curves such that the screen brightness is still at 50 per cent of its peak brightness after 2 seconds and not less than 10 per cent after approximately 8 seconds. The storage property of this screen is cumulative. Thus, if the second scan of the screen commences before the image due to the first scan has totally decayed, the newly acquired energy will add to that already possessed by the screen and will result in a higher phosphorescent level than would have occurred if excitation had started from zero energy level. The phosphorescent level will continue to rise with each subsequent scan until an equilibrium condition is reached.

However, due to the pressure of war-time research another and more elegant solution of the picture storage problem has been developed. This employs a storage orthicon tube² to pick up the initial bright flash of a high intensity cathode-ray tube with no afterglow, the picture being retained as a charge on a very high capacitance

target. A scanning beam of very small current is used which necessitates many scans to erase any given picture charge, thus providing the desired picture storage.

Requirements of Teleran System

So as to underline the characteristics that a suitable pick-up tube should possess, it may be helpful to give a brief description of the Teleran system as a whole. In brief, a ground search radar explores the air space and displays the information on several P.P.I. display tubes, each tube corresponding to a certain altitude layer. This division of the air space into layers enables a large amount of information to be displayed simultaneously. Since the television pictures are sent out from one transmitter only, the information relating to any one altitude layer is transmitted for only a portion of the total transmitting time: for $1/n^{\text{th}}$ of the time if there are n layers. A pilot thus has access to information about altitude layers other than his own should it be required. A plane equipped with the Teleran system carries a transmitter which is triggered by a

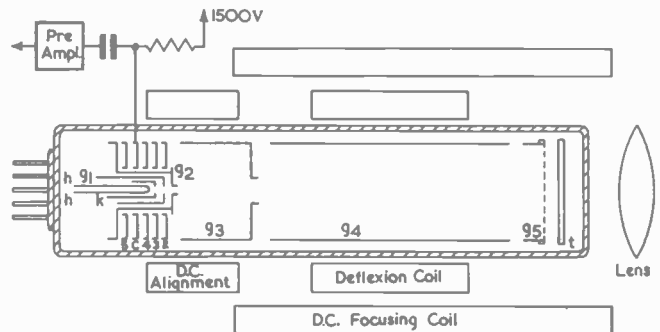

Fig. 1. Storage Orthicon

coded signal corresponding to its altitude. The radar information received at the ground station is applied to the appropriate P.P.I. display tube by means of an altitude decoder in the receiver.

Aeroplanes show up on the pilot's Teleran screen as bright pips, the pip corresponding to his own plane having a radial line drawn through it. Because of the storage elements in the system at least three pips, corresponding to three scans of the radar antenna, are visible simultaneously. This gives a method of determining the direction of motion of any particular plane since the weaker pips denote previous positions of the plane. For an antenna rotating at, say, 6 R.P.M., three pips corresponds to a delay of 30 seconds, and with the time sharing referred to above, a storage time of $30n$ seconds is required, which corresponds to many hundred television scans.

Storage Orthicon

The construction of the storage orthicon is, apart from the high capacitance target, very similar to that of the well-known image orthicon tube³. Fig. 1 shows a diagrammatic cross section of a storage orthicon.

In operation a fine beam of electrons leaves the electron gun at about 200V velocity and passes through a D.C.

* RCA Photophone, L.L.

alignment field where it is accurately aligned with the magnetic field of the focusing coil. It is then magnetically deflected horizontally and vertically so as to scan the target t in a rectilinear pattern. In the region between the decelerator screen g_2 and the target t the beam velocity is reduced practically to zero. Electrons at such low velocities striking the target knock out on the average less than one secondary electron per incident primary, so that the target surface potential is discharged down to cathode potential. At this potential the beam can no longer land on the target surface. Thus in the absence of light on the target, the beam closely approaches the target, is then reflected back upon itself and returns to the electron multiplier section of the tube. This is the condition giving maximum D.C. output and zero signal current.

If, however, any part of the target is illuminated by light which passes through the semi-transparent backing plate and the dielectric, photo-emission occurs from the scanned photo-sensitive side of the target, producing a positive charge on that part of the target. The field in front of the target is sufficiently strong to saturate this photo-emission. When the scanning beam passes over the lighted parts of the target, a number of electrons will land each scan driving these parts of the target to a potential which is dependent on the magnitude of the beam current. This action will be discussed in greater detail later.

The return beam is thus modulated according to the charge pattern left on the target. It has a maximum value

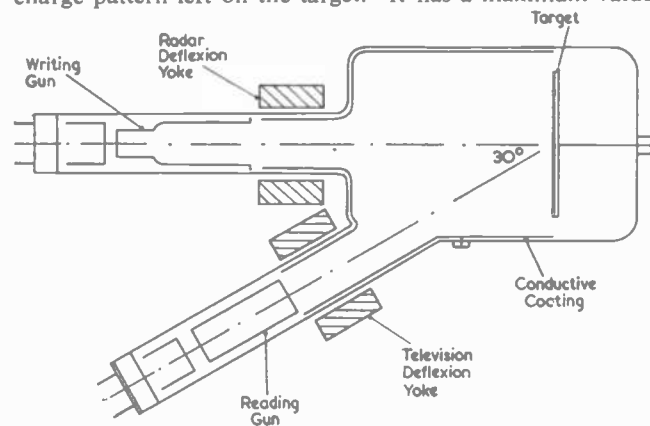

Fig. 2. Single sided target Graphecon

for regions of no light and a minimum for high light regions. In normal operation the potential swing of the target is of the order 2 or 3 volts. The modulated beam returns to g_2 , the first of the five multiplier stages incorporated in the tube. This stage is also the end of the electron gun. The secondary electrons from the last multiplier stage 5 are collected by a collector screen c , the current to which forms the video signal.

THE STORAGE ORTHICON TARGET

In an image orthicon used for normal television pick-up, the scanning beam current is adjusted so that the picture charge at any point on the target is neutralized by a single scan. In the storage orthicon tube, however, removal of the picture charge is only required after several hundred scans. This is accomplished by decreasing the beam current and by increasing the target capacitance. Merely decreasing the beam current, however, increases the signal-to-noise ratio. The high capacitance target consists of a very thin glass dielectric, with a semi-transparent conducting backing plate on the side which is exposed to the light. A conventional photo-sensitive layer is formed on the scanned side of the target. The storage time of such a target is many times greater than the usual mica targets of conventional orthicon tubes. The whole target has a very high resistivity.

PERFORMANCE CHARACTERISTICS

In operation, it has been found that the signal-to-noise ratio discrimination of the storage orthicon is of a high order. Signals which cannot be separated visually from a noise background can be picked up by the storage tube and successfully resolved. Picture resolutions of greater than one thousand lines, have been obtained in laboratory tests. Picture storage and continuous reproduction of the signal for tens of seconds has been obtained.

The Graphecon

It will be appreciated that the system described above, requires, in addition to the storage orthicon tube itself a high screen brightness cathode-ray tube and an optical system, both of which are unnecessary in principle, since the light acts merely as a link between two electrical signals. In order to obtain an all-electronic conversion scheme, a completely new tube called a Graphecon (graphe—to write, and echo—to keep or to hold) was designed and built.⁴

The tube may be regarded as a television picture tube and an iconoscope mounted in a single envelope. The fluorescent screen of the picture tube and the mosaic of the iconoscope are both replaced by a single storage target. This 3in. square metal target coated with a thin film of insulating material is the heart of the tube and its development and design are the result of recent work which has shown that under certain circumstances some materials, such as pure quartz or magnesium fluoride, may be used both as insulators and conductors of electricity. Unlike the fluorescent screen of the cathode-ray tube, the mosaic

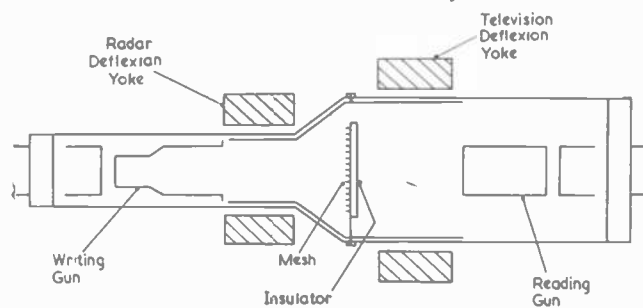

Fig. 3. Double sided target Graphecon

of the iconoscope or the target of the storage orthicon, the target of the graphecon is sensitive not to light, but to electric charge. The picture tube portion of the graphecon forms the *writing gun* accepting the radar signal and writing it on the target, while the iconoscope portion forms the *reading gun* generating the required television signal and gradually removing the stored signal from the target.

CONSTRUCTION OF THE TUBE

Two possible arrangements of the graphecon are shown. Fig. 2 shows a magnetic deflexion type tube using a single sided target. The writing gun is mounted perpendicular to the target, thereby avoiding the necessity of applying somewhat involved keystone correction to the radial deflexion pattern of the radar signals. The reading gun is mounted at the same angle to the target, as is used in standard television pick-up iconoscopes so that the normal and fairly simple keystone corrections as used in such tubes can be applied. Fig. 3 shows a magnetic deflexion in-line version of the tube with a two-sided target which avoids any need for keystone connection. The target construction is modified to permit the writing beam to penetrate the target. A third variant with all electro-static focus and deflexion has been built with a single sided target. Such a tube can be made smaller and lighter than the magnetic deflexion types but necessarily suffers from the lower resolution limits of the electrostatic deflexion system.

Standard 12-in. television picture tube electrode assemblies are used for the writing gun and operate at 6,000 to 10,000

volts. The reading gun assembly is a standard iconoscope assembly operating at normal potentials of 800 to 1,000 volts. The target consists of a metal plate, thick enough to be self supporting, on to which is deposited by evaporation, a film of one of the insulators mentioned above. The film thickness is of the order 6,000 Angstrom units. For in-line versions of the tube the metal backing of the target must be made transparent to electrons. This is achieved by using a 500-per-inch mesh on to which is evaporated a thin layer of aluminium, on to which in turn is evaporated the

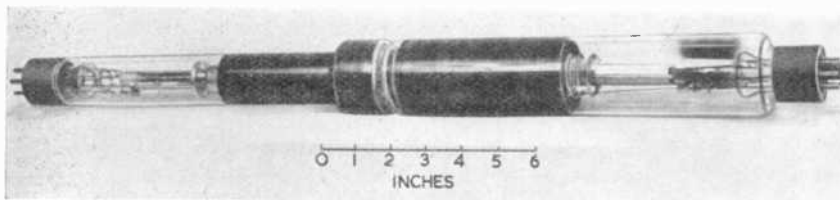

Straight through type Graphecon

insulating layer. This size mesh is sufficiently fine not to limit the resolving power of the tube.⁵

PRINCIPLES OF OPERATION

The reading beam, operating at 800 to 1,000 volts, has a secondary emission ratio greater than unity, and hence as it scans uniformly over the insulator surface, the potential of this surface is brought to approximately that of the collector wall coating of the tube. The insulator may be regarded as the dielectric of a capacitor, one plate of which is the metal backing of the target and the other is the surface scanned by the electron beam. Since one plate of this capacitor is also an insulator it is possible to discharge any part of it without affecting the remainder. Such discharging may occur in any pattern, as, for example, a P.P.I. pattern.

It has recently been shown⁶ that in films thin enough to be penetrated by an electron beam, currents can flow through the film in the direction of the potential gradient and that the insulation recovers on removal of the beam. An insulating film may be chosen of such a thickness that the 1,000 volt reading beam will not penetrate it while the 10,000 volt writing beam fully penetrates it. Thus the low velocity reading beam may be used to charge up the dielectric and the high velocity writing beam to discharge it.

To generate the television signal the target surface is first uniformly charged with the target metal at 50 volts negative. Where the writing beam strikes and drives the surface negative, secondary emission occurs and a charge is removed each time the reading beam scans these areas. This removal of charge from one plate of a capacitor causes an equal charge to flow on to the other, which is the signal plate. The signal current produces a voltage across a load resistor which is then amplified and applied to a viewing tube, which may be a normal television picture tube.

OUTPUT SIGNAL

The signal output increases as the target surface potential decreases, but the curve eventually levels off because the secondary emission collection saturates at relatively weak fields. The saturated secondary emission is proportional to beam current so that reducing the beam current reduces the amount of charge removed from the target each scan and provides a means of obtaining many television pictures of the writing pattern. Decreasing the beam current, however, reduces the signal output and consequently the increase in viewing time which can be so obtained is limited by the amplifier noise level. A viewing time of up to 5 minutes has been obtained, with 2 or 3 minutes as a normal value. This means that several thousand television scans are possible in the period during which a readable signal can be obtained. With the reading beam switched off, the storage time is required only by the leakage resist-

ance of the target insulating film. In laboratory tests a storage time of 10 days has been obtained.

THE TARGET

The target charging time, or viewing time, is proportional to the total area of the target. Any reduction in tube size will therefore result in a proportional reduction in the maximum viewing time. The thickness of the target film determines the capacitance of the target. There is an optimum writing beam voltage for each film thickness such that the maximum amount of beam energy is absorbed in the insulator. The film thickness also determines the degree of half tone reproduction. Half tones are obtained on that part of the output signal curve where the output varies with the target surface potential. In the saturated portion of the curve a black and white picture results, since the signal is either at a maximum value or not present at all.

Applications of the Graphecon

Secondary applications of the graphecon include use as a D.C. or single trace oscillograph to provide a bright picture of the complete trace for variable times. The graphecon may also be operated as an oscillograph-iconoscope combination in conjunction with a projection type of television set to provide a large screen oscillograph for demonstrations or experiments to be viewed by large audiences. Photography of short duration transient phenomena is simplified by using the graphecon, which can be made very sensitive to the reading beam, to record the trace and photographing the long persistence image on an oscillograph tube.

The principle application of the tube is, of course, providing a means of viewing radar P.P.I. patterns. A system using the graphecon for such purpose has many advantages over systems using tubes with long persistence phosphors or storage orthicons. For instance, the signal brightness decay curve shows a considerable improvement over the exponential decay of long persistence phosphor tubes. The brightness level of the viewing screen can be made such that

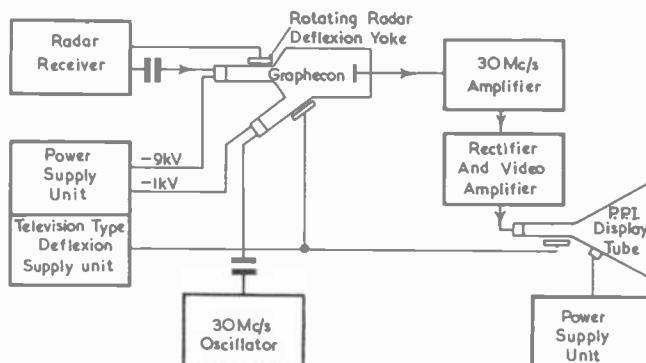

Fig. 4. Block diagram showing use of Graphecon to view P.P.I. display

the ambient light level is not a limiting factor. The final picture size can be magnified to the limits of projection technique. The viewing time of the picture can be varied over a range from a few seconds to several minutes. The high writing speed makes it possible to trigger the writing gun from the received signal so that the writing gun need not operate continuously in order that the reading gun may produce a steady picture. This feature is made use of in the time sharing method of transmission referred to previously and enables a continuous picture to be produced from radar signals, normally received at a repetition rate too slow for flickerless viewing.

The signal-to-noise ratio of the system can be consider-

ably improved by the integration method of superposing successive radar patterns. The true signals will occur repeatedly in the same part of the target, and the effect is additive. Noise, however, which is a random signal, does not repeat itself to such an extent and hence the general effect is not additive. A further discrimination against noise arises from the fact that the target is not completely discharged by small writing beam currents, such as may be formed by noise pulses. The viewing time of these noise pulses is thus shorter than for strong signal pulses

and the noise disappears quickly, leaving behind the strong radar pips.
A block diagram of a system using a graphecon to view P.P.I. radar presentations is given in Fig. 4.

REFERENCES

- ¹ D. H. EWING & R. W. K. SMITH, *RCA Review*, VII, 4.
- ² A. ROSE, P. K. WEIMER & H. B. LAW—*Proc. I.R.E.*, 34, 7
- ³ S. FORGUE, *RCA Review*, VIII, 4.
- ⁴ L. PENSAC, *RCA Review*, X, 1.
- ⁵ H. B. LAW, *Rev. Scientific Instr.*, Dec. (1948)
- ⁶ L. PENSAC, *Physical Review*, Feb. 1, (1949)

The Decca Flight Log

THE Decca Flight Log is a British development of the Decca Marine Navigator System. The Decca manufacturer to fix his position at any moment of their products under all conditions. This is done possible components are now transmitted by three Decca moisture; transmitters, which consist of two cans and filled with ceramic capacitors. The leads are ceramic cans with a moisture-proofing material. Navigator enables a pilot to take the readings of two stations simultaneously receive radio signals from two stations sited on the ground at which the two very then finding the point on the ground at which the two accurately indicated position fixing is done of position fixing is done altogether satisfactory for fast flying aircraft.

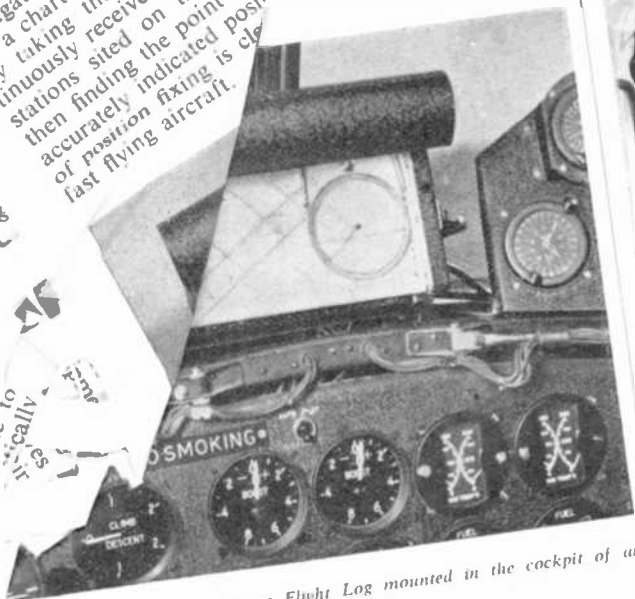

The display head of the Decca Flight Log mounted in the cockpit of an aircraft.

The Decca Flight Log, however, provides at any moment a pictorial presentation of the aircraft's exact position in relation to the surrounding country and the track the pilot wishes to fly, and records the track already flown. This is done by amplifying the torque of the Decca movements and using one to move a chart through a viewing aperture measuring 10 by 4 inches which is continuously within the pilot's view, and the other to traverse an automatic plotter requiring no human intervention. Charts of differing scales can be made up into rolls and stored in the display head. Should the aircraft cross the boundary of one chart on to another of a different scale, the pushing of a button brings the new scale into effect. The results of tests so far carried out suggest that the Decca system and Flight Log may be able to provide European air routes with a better navigational service than any at present in use or contemplated, and at a much lower cost than for any comparable system.

Television on Wheels

PART of the large contract to provide a complete television system for Canada (won by Marconi's Wireless Telegraph Co., Ltd. some months ago) was for two special vehicles which are now ready for delivery. The design and manufacture of these "Television Stations on wheels" constitutes a great advance in television outside broadcasting technique for each is a self-contained 3-camera station, with its own production and transmission equipment.



An interior view of one of the television outside broadcasting vehicles. Left to right (foreground), store cupboards, power regulating unit (main desk broadcast distribution box, three camera control monitors, master control monitor and mixing vision receiver. (Above) sound receiver and "on the air" producer's desk. (Extreme right) producer's desk.

The only external requirement of these units is connexion to electrical mains and telephone. The Marconi Company can even eliminate those requirements by using a trailer generator power supply and microwave sound channel to replace the telephone lines. The vision microwave link, on the Canadian vehicles, is stowed permanently on the roof. Access is by an internal ladder which an engineer can mount to the roof, where he can erect and orientate the parabola. Each of the three cameras is carried in fitted cupboards, together with electronic viewfinders and sets of lenses. The cable is on reels at the rear of the vehicles and the receiving aerial is mounted on outriggers. The facilities provided allow all crew members to hear in their earphones, both programme and instructions. Camera-operators can speak to camera control personnel and producer: the producer and technical director can speak to all the crew.

ELECTRONIC ENGINEERING

DECEMBER 1951

New Tec
The us of
along ma
designer.
units consi
cylindrical
usually of
slightly dom

inside
the latter were
aluminium with one end
other end was left open and this was

the maximum
the maximum temperature at which
component will operate satisfactorily
of working voltages and power dissipa-
tion figures must be adopted or component life will be
very short. As an example, a capacitor rated for 350
volts at 70°C can only be used at 250 volts at 85°C and at

DECEMBER 1951

ELECTRONIC ENGINEERING

Developments in the Design of Airborne Radio and Radar Equipment

REFORE ..

only 200 volts at 100°C. Similarly, a carbon resistor rated for 1 watt dissipation at 70°C falls off to $\frac{1}{2}$ watt at 100°C. Thus, if very high working temperatures are allowed, the physical size of components for a given rating must be greatly increased.

In a sealed unit there is no free air ventilation and even the air inside tends to become relatively static with the result that serious hot-spots quickly build up and components become over-run. One method which has been used to deal with this problem is for a small fan to be mounted inside the sealed unit so that all the air is continuously and thoroughly stirred up; in this way as much as possible of the internal heat is transferred to the walls of the container. A secondary blower mounted externally on the unit now circulates cool air over the outside surface of the container, thus removing the heat as rapidly as possible. This system requires a multiplicity of small blowers in a radio installation involving several separate units, and this individual internal and external blowing arrangement is cumbersome and wasteful of space. It is suggested that some form of integrated cooling system for a complete radio or radar installation of several units might be practicable. It is envisaged that all the units could be connected together by means of flexible air ducts which also connect to an additional unit containing a blower and heat radiator. The internal air would thus be in a closed system and could be kept dry by means of a dessicator.

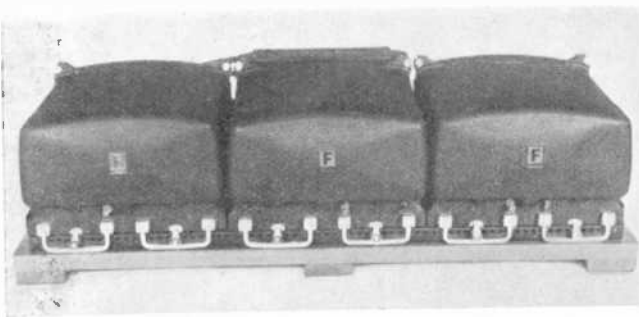

Rectangular sealed radar units of very recent design. This is the Distance Measuring Equipment, reproduced here by courtesy of Messrs. Ferranti, Ltd.

The circulating air would pass through the radiator and be cooled before re-circulation, and some external fan or blower would be needed to remove the heat from the radiator surfaces. In this scheme the radiator and air circulation unit might become a piece of standard equipment as is the case of motor generators, alternators, etc.

Operating Sealed Equipment

There is obviously no necessity for aircraft units to be installed in the pressure cabin of an aircraft since they are completely unaffected by change in pressure or other climatic conditions. Any indicating units, however, (cathode-ray tubes, meters, etc.) would be mounted on a control panel in the pressurized aircraft cabin together with all the necessary control knobs and switches. These control knobs have to operate variable components inside the remotely stowed sealed units, e.g., wavechange switches could be operated remotely by means of small motors and gear trains mounted internally. In fact, various small actuators and switch rotators are now becoming available commercially to the electronic equipment designer: in using them it is merely necessary to provide electrical connexions from the control panel to the sealed units concerned. It is possible for switch and other component shafts to be brought out through the front panels of sealed units but special neoprene seals and packings are required to avoid serious air leakage. They must, however, always form sources of potential air leakage and, in any case,

their advantages are questionable because, during flight, there would be no personnel to operate them outside the pressure cabin of the aircraft.

Cable entry into sealed units offers relatively little difficulty and a range of sealed plugs and sockets for this purpose is available. The plugs and sockets may be of the "screw-on" type, or they may be so mounted on the backs of the units that they automatically mate up with the connectors when the complete units are pushed into their mounting racks in the aircraft.

Miniaturization

In view of the tremendous increase in quantity and in complexity of aircraft electronic equipment, every possible saving in weight and size has to be made. Miniaturization is thus an absolute necessity and with this in mind radio valve manufacturers have produced complete ranges of miniature (and even sub-miniature) valves. Likewise, miniaturized components generally are becoming more and more readily available and more and more reliable. The use of miniature techniques affords a very great saving in weight and size but, naturally, the difficulty and hence the cost of manufacture of miniature units is high. Perhaps the most serious consequence of the introduction of miniature technique is the difficulty of servicing the equipment. The intricacy of the wiring of a group of miniature valves is quite alarming and if it is necessary to change components, extreme care must be taken to avoid damage to neighbouring components by application of a soldering iron. The servicing of equipment in the field thus becomes an extremely risky undertaking and it can only be done by really first rate and highly experienced mechanics.

One way in which this difficulty may be overcome to some extent is by designing the miniaturized, hermetically sealed units in such a way that each contains one or more of plug-in or readily detachable sub-units. These sub-units would be made to service these except in the field workshops, and if a fault did occur, the sub-unit would merely be replaced by a new one. This method would be returned to a base depot for repair. It would be more economical to scrap it than to send it to a base depot for repair.

In addition to the requirements of the present day, the introduction of manoeuvrable aircraft has necessitated a great increase in the mechanical strength of electronic equipment, including the electronic components themselves. These must be capable of withstanding sustained accelerations of up to 12g and must withstand momentary accelerations of up to 25g. This means that the equipment must be able to withstand distortion under extreme conditions. It can well be imagined that, say, a transformer weighing a pound or more, could do very severe damage in an aircraft if it broke away from its anchorage.

From the foregoing remarks concerning the present trends of electronic equipment design, it will be seen that the design of the electronic circuits is only one aspect of the design of a successful piece of apparatus. The days have passed when the manufacture of electronic gear consisted merely of wiring up a lot of valves and components on a folded sheet-metal chassis and putting the whole assembly in a light dust cover. Sound mechanical design is now just as important as sound electronic circuitry and the manufacturer must have at his disposal engineering design and production facilities which will enable him to produce mechanical parts of the highest precision. The day when the guillotine and bending machine were the only tools required has gone and the radio manufacturer must now be a master of machining, casting, drawing, welding and all the other processes formerly associated only with precision mechanical engineering.

DECEMBER 1951

the voltage on g_1 relative to that on g_2 , depend on the frequency to which L_2C_2 is tuned, but so also will the magnitude of this influence voltage. Keeping the frequency of the Hartley oscillator steady at f_1 , and with the magnitude of the oscillatory voltage E_1 on g_1 constant, varying the tuning of the circuit L_2C_2 so that its frequency f_2 varies from below f_1 through equality to above f_1 will cause a change to occur in the magnitude of the voltage E_2 appearing by influence effect on g_2 . It will vary in the manner shown in Fig. 3(a). Also, the angular separation between E_2 and E_1 during the same frequency change varies between -180° , through -90° at equality of f_2 and f_1 , to zero degrees. A more instructive curve than angular difference is, as we shall shortly see, a plot of the cosine of the angular separation between E_2 and E_1 , as f_2 is varied. This is shown in Fig. 3(b).

The anode current of this type of valve is given by $SE_2 \cos \phi$, since the beat frequency in the anode current under the present conditions is zero and the voltages E_1 and E_2 having the same frequency. In the above expression S is the conversion conductance which includes E_1 and, since the latter is constant, S itself is constant. $\cos \phi$ is the cosine of the angle of phase difference between E_2 and E_1 . As the resonant frequency of L_2C_2 is varied

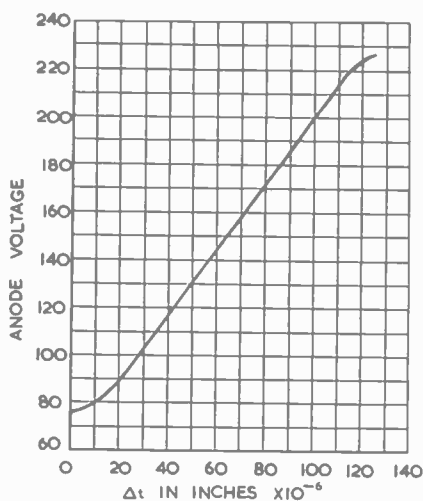

Fig. 4. Characteristic curve of the octode circuit when adapted for use as a micrometer

through f_1 , the anode current at any frequency can be deduced from the ordinates of Figs. 3(a) and 3(b), and will consequently have the form shown in 3(c).

Application as Valve Micrometer

Basically, the circuit described translates changes in capacitance of the capacitor C_2 into proportionate changes of current or voltage at the anode of the valve. Thus, by employing the above circuit, any physical phenomenon which can be translated into a change of capacitance can be measured in terms of an equivalent change in anode voltage. The total extent of the change in anode voltage can be effected by a change in capacitance of as small as 2 picofarads, depending on the fundamental frequency chosen for the Hartley oscillator. At about 20Mc/s the rate of change of anode voltage to capacitance is of the order of 90 volts per picofarad, giving a total change of about 180 volts, for a change of 2 picofarads over the central linear portion of the characteristic.

For the measurement of small changes in length an auxiliary capacitor, having circular plates of 2cm diameter and a separation distance of about .01in. was used. This unit was screened from external fields, and constructed with a guard-ring to give a uniform field between

the plates. The change of length measured was applied to the moveable plate of this capacitor unit. The initial distance of separation of the plates was set so that the total movement, due to the change of length being measured, would not be much greater than 1 per cent of the former. Accordingly, the change in capacitance was assumed to be directly proportional to the change in length. This is a reasonable assumption, and gives an acceptable degree of accuracy under the above conditions. An overall calibration curve for the equipment is shown in Fig. 4, giving the change in anode voltage against the change in separation distance of the plates of the auxiliary capacitor unit. The latter was measured by a combined optical lever mechanism which gave an accuracy of some 2 per cent over the length of 1.2×10^{-4} in. measured. The sensitivity of the circuit is seen to be 1.4 volts per 10^{-6} in., and is linear over a length of 90×10^{-6} in.

In building the equipment adequate screening between the two oscillatory circuits was found to be essential, the reason being that it requires only a small capacitance coupling of two or three picofarads externally between g_1 and g_2 , to neutralize the whole effect of the influence charge on the latter. Although comprehensive tests have not yet been made to check the stability of the circuit, or the accuracy of its calibration once made, rough tests show quite a promising consistency. It is hoped to cover such points as these in tests which are contemplated to obtain more complete information on the optimum working conditions, and the possibilities of further applications of this circuit.

The equipment shows capabilities of being used not only for measuring uni-directional changes in length, as at present, but also for pressure measurements, or again, it could be applied to the measurement and observation of the waveform of minute vibrations of a transient or repetitive nature, over a range of frequencies from zero upwards.

REFERENCES

- Measurement of Magnetostriction. M.Sc. Thesis (London), May, 1939.
- LUKACS, E. Frequency changing with the Octode. *Wireless World*, March 17th, 1938.
- JAMES, E. G., B.Sc., Ph.D. Frequency-changer Valves. *Wireless World* March 30th, 1939.

Jet Navigation

The ever-increasing speeds of modern aircraft—particularly since the advent of jet propulsion—necessitates complementary advances in many other aeronautical techniques and services. One of the earliest problems to arise, as speeds rapidly increased, was the liaison between ground and aircraft for navigational purposes and, in particular, positioning.

Over three years ago this problem was dealt with by Marconi's Wireless Telegraph Co., Ltd., who set about designing and building a modern D.F. installation which would allow ground operators to read off bearings instantaneously to the pilot of a high-speed aircraft. Many more points were taken into consideration.

The equipment had to be compact enough to be unobtrusive in control towers, the main transmitters-receivers would have to be sited somewhere else and remotely controlled from the tower. Instantaneous reading of bearings called for visual presentation. If large meters were used for this purpose, then a duplication service could be incorporated allowing people in other rooms and offices to follow the bearings on repeater meters.

All these things were, incorporated into the design of the Marconi AD.200 V.H.F. D/F installation.

Nearly two years ago an AD.200 was installed in the control tower at Hatfield and has been in constant use ever since.

ably improved by the integration method of superposing successive radar patterns. The true signals will occur repeatedly in the same part of the target, and the effect is additive. Noise, however, which is a random signal, does not repeat itself to such an extent and hence the general effect is not additive. A further discrimination against noise arises from the fact that the target is not completely discharged by small writing beam currents, such as may be formed by noise pulses. The viewing time of these noise pulses is thus shorter than for strong signal pulses

and the noise disappears quickly, leaving behind the strong radar pips.

A block diagram of a system using a graphecon to view P.P.I. radar presentations is given in Fig. 4.

REFERENCES

- ¹ D. H. EWING & R. W. K. SMITH, *RCA Review*, VII, 4.
- ² A. ROSE, P. K. WEIMER & H. B. LAW—*Proc. I.R.E.* 34, 7
- ³ S. FORGUE, *RCA Review*, VIII, 4.
- ⁴ L. PENSAK, *RCA Review*, X, 1.
- ⁵ H. B. LAW, *Rev. Scientific Inst.*, Dec. (1948)
- ⁶ L. PENSAK, *Physical Review*, Feb. 1, (1949)

The Decca Flight Log

THE Decca Flight Log is a British development of the Decca Air and Marine Navigator System. The Decca Navigator enables a pilot to fix his position at any moment on a chart overprinted with a special lattice. This is done by taking the readings of two Decometers, which continuously receive radio signals transmitted by three Decca stations sited on the ground some 60 miles apart, and then finding the point on the chart at which the two very accurately indicated position lines intersect. This method of position fixing is clearly not altogether satisfactory for fast flying aircraft.

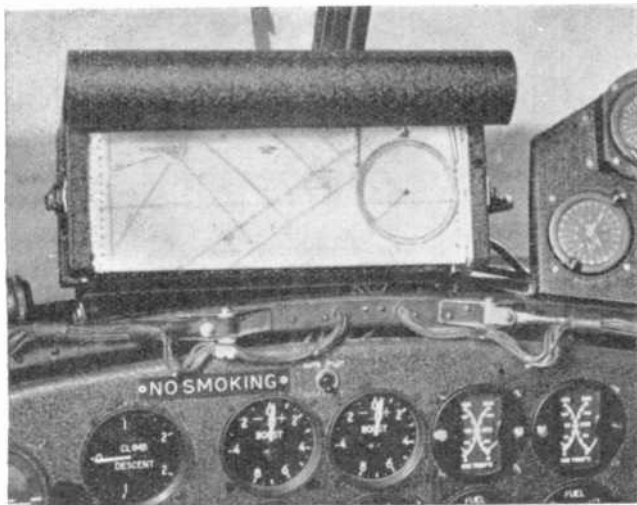

The display head of the Decca Flight Log mounted in the cockpit of an aircraft.

The Decca Flight Log, however, provides at any moment a pictorial presentation of the aircraft's exact position in relation to the surrounding country and the track the pilot wishes to fly, and records the track already flown. This is done by amplifying the torque of the Decometer movements and using one to move a chart through a viewing aperture measuring 10 by 4 inches which is continuously within the pilot's view, and the other to traverse a stylus laterally across the chart, thus achieving a fully automatic plotter requiring no human intervention. Charts of differing scales can be made up into rolls and stored in the display head. Should the aircraft cross the boundary of one chart on to another of a different scale, the pushing of a button brings the new scale into effect.

The results of tests so far carried out suggest that the Decca system and Flight Log may be able to provide European air routes with a better navigational service than any at present in use or contemplated, and at a much lower cost than for any comparable system.

Television on Wheels

PART of the large contract to provide a complete television system for Canada (won by Marconi's Wireless Telegraph Co., Ltd. some months ago) was for two special vehicles which are now ready for delivery.

The design and manufacture of these "Television Stations on wheels" constitutes a great advance in television outside broadcasting technique for each is a self-contained 3-camera station, with its own production and transmission equipment.



An interior view of one of the television outside broadcasting vehicles. Left to right (foreground), store cupboards, power regulating unit (main desk broadcast distribution box, three camera control monitors, master control monitor and mixing. (Above) sound receiver and "on the air" vision receiver. (Extreme right) producer's desk.

The only external requirement of these units is connexion to electrical mains and telephone. The Marconi Company can even eliminate those requirements by using a trailer generator power supply and microwave sound channel to replace the telephone lines. The vision microwave link, on the Canadian vehicles, is stowed permanently on the roof. Access is by an internal ladder which an engineer can mount to the roof, where he can erect and orientate the parabola. Each of the three cameras is carried in fitted cupboards, together with electronic viewfinders and sets of lenses. The cable is on reels at the rear of the vehicles and the receiving aerial is mounted on outriggers.

The facilities provided allow all crew members to hear, in their earphones, both programme and instructions. Camera-operators can speak to camera control personnel and producer; the producer and technical director can speak to all the crew.

Developments in the Design of Airborne Radio and Radar Equipment

BEFORE the war the type of radio equipment fitted into aircraft was very similar to that in use in ordinary broadcast receivers; admittedly the various assemblies, chassis, etc., were rather more carefully and lavishly constructed but, in general, the components used were those which were being manufactured for domestic radio receivers. In those days aircraft radio was a useful device but by no means a vital part of the aircraft and if the serviceability was not very good the consequences were relatively unimportant. The war years changed the whole conception of the use of airborne radio: it immediately became a vital instrument which had to be fully serviceable at all times, flying had to be undertaken under weather conditions which made contact with ground stations absolutely essential. The complexity of the equipment increased and more and more radio had to be crammed into already heavily laden aircraft. Then radar of various types, including radar navigational aids, had to be installed to enable bombers to find their targets and return home; to enable fighters to locate their enemies; and to enable reconnaissance aircraft to plot their positions and find their targets. The actual physical installation of all this delicate electronic apparatus was difficult enough, but keeping it serviceable and in good condition was indeed a formidable task.

The post-war years have seen the introduction of aircraft capable of flying at phenomenal speeds at previously unheard-of heights and over extreme distances. Radio and radar have become integral and vital parts of every aircraft's design, whether it be for military or for civil purposes. This means that the reliability of the electronic equipment must be of the very highest order; failure of a single component may be as disastrous, when weather conditions are bad, as losing an engine. Not only must the apparatus remain in good condition when actually installed in aircraft, but it must be designed to withstand prolonged storage under the worst possible conditions and it must be capable of withstanding exposure to tropical and arctic conditions and yet be immediately serviceable when required.

The techniques for producing reliable, fully pan-climatic radio and radar units for aircraft are now crystallizing; no longer is it necessary to adopt improvised methods for combating the enemies of electronic equipment, makeshift palliatives need no longer to be used, but before discussing the newest techniques a review of the problems is useful.

The Reasons for Component Failure

The primary reason for failure of a piece of electronic apparatus is breakdown of one or more of the components, e.g., a valve, a capacitor, a resistor, a transformer or some other unit. Breakdown of components may usually be attributed to an overload, either application of a voltage or a current in excess of that for which they are designed; obviously the equipment designer is careful to select components which are rated to withstand something in excess of normal operating conditions but it is not possible to select components which will withstand accidental overloads of unknown magnitude. The chief cause of component overloading is electrical breakdown of insulating materials and this is very greatly aggravated

if the insulating material is damp. Moisture, then, is Enemy No. 1. If a piece of insulating material, used between points of fairly great potential difference, becomes damp, an electrical discharge may well take place across the surface of the insulator. This produces local heating and perhaps charring, the discharge becomes worse and in a very short time the insulator catches fire and considerable damage is done. Even if actual fire does not start, breakdown of the insulator invariably causes short-circuits which overload components of one type or another and the result is more or less rapid failure of the equipment.

Moisture also operates in various more insidious ways. It can, and does, find ingress into capacitors, transformers and other components with the result that their insulation resistance gradually becomes lower and lower; in some cases this may cause only mal-functioning of the whole equipment, but generally it will cause premature component failure.

If two dissimilar metals are in contact with one another a small potential is set up between them and if moisture is present, rapid corrosion may take place with the consequent alteration of the electrical contact resistance. If this resistance is included in some part of the circuit, e.g., earth bonding, the equipment may soon cease to operate satisfactorily.

Moisture may find its way into equipment either by directly falling drops or spray, by condensation, or by gradual absorption as would be the case if the equipment were stored in a damp place.

Until recently practically all radio and radar units were constructed in such a way that ventilation of the valves and components was accomplished by means of air circulation through holes and louvres in the dust cover. The units were thus virtually open to the atmosphere and in order to minimize the effects of moisture on the chassis and components inside, various treatments such as spraying the whole unit with varnish, painting vulnerable points with varnish and arranging for the unit to be warmed up before application of high voltage supplies have been used, but obviously, such treatments are only makeshift.

Many of the circuits, particularly those associated with radar, employ exceedingly high voltages, e.g., the voltages developed in a radar transmitter may be anything up to 10,000 volts or even more. At normal atmospheric pressure the air-gap necessary to prevent electrical breakdown between adjacent points carrying high voltage is quite small but, as the pressure decreases, the necessary air-gap increases and at pressures corresponding to an altitude of, say, 50,000 feet, it becomes prohibitively large if the overall physical size of the units is not to become unreasonable. Even before an actual spark breakdown occurs between high voltage points, a brush discharge takes place and this can be quite dangerous; it can rapidly destroy insulating materials and cause fire in the equipment.

Various components are also adversely affected by constant change of atmospheric pressure and their eventual electrical failure is very greatly accelerated. The rarified atmosphere at high altitudes causes the cooling of equipment to be less efficient and may give rise to the develop-

ment of hot-spots which sooner or later cause component failure.

Sealing of Components

During the latter part of the war and throughout the post-war period very considerable efforts have been made by component manufacturers to improve the serviceability of their products under all climatic conditions. Wherever possible components are now sealed against ingress of moisture; transformers are hermetically sealed in metal cans and filled with oil or other insulating material and the leads are brought through the cans by means of sealed ceramic or glass terminals; capacitors are made in metal cans with neoprene seals round the lead-out wires; special mounting boards with long leakage paths have been devised for component mounting. Great care is exercised in avoiding moisture traps of one form or another and metals in contact are always chosen so that their contact potentials are as nearly equal as possible.

While attention to all these details of design led to the production of better and better equipments, the improvements were hardly able to keep pace with the ever increasing stringency of the operating conditions. The real

closed on assembly of the complete unit by fitting an aluminium plate casting with a neoprene gasket, the whole being tightly clamped together to ensure no leakage of air. The radio chassis was integral with the cast front panel and all electrical connexions were brought out through sealed plugs. It was usual for a removable desiccator to be attached to the front panel, together with an air valve through which the unit could be "pressurized" by means of an ordinary tyre pump.

This cylindrical design is mechanically strong enough to withstand pressures above normal atmospheric inside, while operating almost in vacuo outside; it also provides a high degree of electrical screening but it has the disadvantage that its shape is such that it does not lend itself to compact rack mounting in an aircraft installation. The use of several cylindrical units each about 10 inches in diameter, mounted side by side is obviously wasteful of overall space. In addition there is some difficulty in using the cylindrical volume inside to the best advantage. It seems probable, therefore, that radar and radio units will have to revert to the accepted rectangular shapes, the necessary strength in the sealed boxes being achieved by the use of tough material with stiffening members on the



An early type of radar unit. This is the GEE Mk. II Indicator which went into production in 1942 and which has continued in service up to the present time. Reproduced by courtesy of Messrs. A. C. Cossor, Ltd.

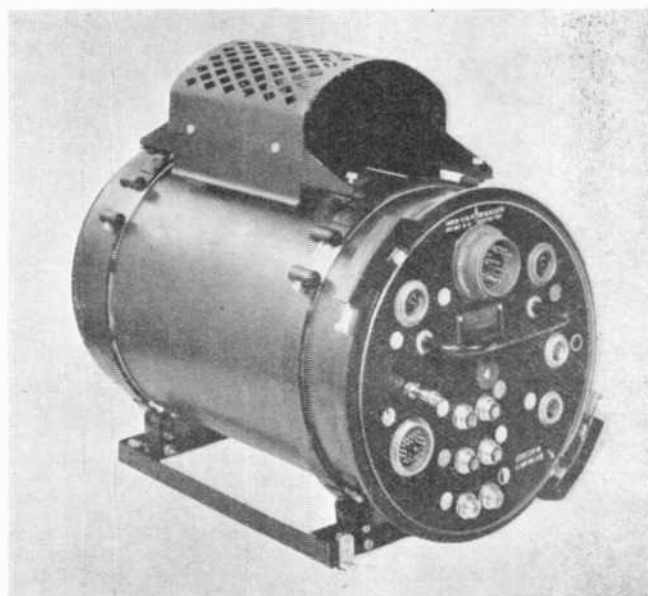

The cylindrical type of sealed radar unit, one of the first of its kind to be developed. This is part of Rebecca Mk IV, reproduced by courtesy of Messrs. E.M.I. Factories, Ltd.

answer to all the basic problems came with the introduction of complete units, hermetically sealed. The assemblies of valves, components, etc., are made very much as before, using the accepted techniques, and then the whole unit is placed in an airtight cover which is usually pumped up to a pressure a few pounds per square inch in excess of atmospheric. The sealing is sufficiently good for the pressure to hold for several days no matter under what conditions of external pressure, temperature or humidity the unit operates. A desiccator is built into the unit so that the internal air is perfectly dry at all times.

New Techniques

The use of hermetically sealed units naturally brings along many attendant difficulties for the equipment designer. The early designs of sealed, or pressurized, units consisted of radio or radar chassis mounted inside cylindrical pressure-tight dust covers. The latter were usually of spun or drawn aluminium with one end slightly domed; the other end was left open and this was

sides, top, bottom and back. The various faces would of course be slightly bowed outwards to enhance the strength. Moulded neoprene gaskets would be necessary in channels running round the front edges of the boxes in order to ensure perfectly airtight seals when the front faces are clamped down. It will be appreciated that rectangular boxes are much more easily packed and stored than cylindrical ones, although they are considerably more expensive to manufacture.

When a hermetically sealed unit is used, special arrangements for dissipating the internal heat have to be made since there is no free circulation of air. The maximum ambient temperature in which the unit may have to operate is 55°C and at present the maximum temperature at which the highest grade of component will operate satisfactorily is 100°C; even with specially designed components, considerable de-rating of working voltages and power dissipation figures must be adopted or component life will be very short. As an example, a capacitor rated for 350 volts at 70°C can only be used at 250 volts at 85°C and at

only 200 volts at 100°C. Similarly, a carbon resistor rated for 1 watt dissipation at 70°C falls off to $\frac{1}{2}$ watt at 100°C. Thus, if very high working temperatures are allowed, the physical size of components for a given rating must be greatly increased.

In a sealed unit there is no free air ventilation and even the air inside tends to become relatively static with the result that serious hot-spots quickly build up and components become over-run. One method which has been used to deal with this problem is for a small fan to be mounted inside the sealed unit so that all the air is continuously and thoroughly stirred up: in this way as much as possible of the internal heat is transferred to the walls of the container. A secondary blower mounted externally on the unit now circulates cool air over the outside surface of the container, thus removing the heat as rapidly as possible. This system requires a multiplicity of small blowers in a radio installation involving several separate units, and this individual internal and external blowing arrangement is cumbersome and wasteful of space. It is suggested that some form of integrated cooling system for a complete radio or radar installation of several units might be practicable. It is envisaged that all the units could be connected together by means of flexible air ducts which also connect to an additional unit containing a blower and heat radiator. The internal air would thus be in a closed system and could be kept dry by means of a dessicator.

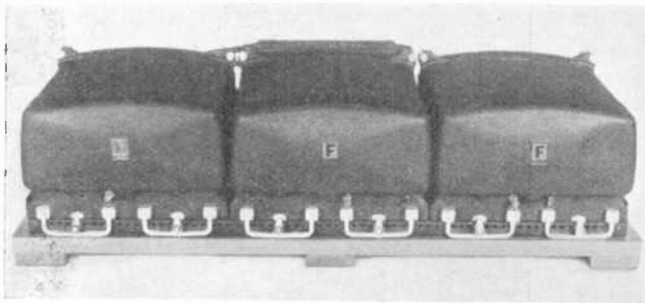

Rectangular sealed radar units of very recent design. This is the Distance Measuring Equipment, reproduced here by courtesy of Messrs. Ferranti, Ltd.

The circulating air would pass through the radiator and be cooled before re-circulation, and some external fan or blower would be needed to remove the heat from the radiator surfaces. In this scheme the radiator and air circulation unit might become a piece of standard equipment as is the case of motor generators, alternators, etc.

Operating Sealed Equipment

There is obviously no necessity for sealed electronic units to be installed in the pressure cabin of an aircraft since they are completely unaffected by change in pressure or other climatic conditions. Any indicating units, however, (cathode-ray tubes, meters, etc.) would be mounted on a control panel in the pressurized aircraft cabin together with all the necessary control knobs and switches. These control knobs have to operate variable components inside the remotely stowed sealed units, e.g., wavechange switches could be operated remotely by means of small motors and gear trains mounted internally. In fact, various small actuators and switch rotators are now becoming available commercially to the electronic equipment designer: in using them it is merely necessary to provide electrical connexions from the control panel to the sealed units concerned. It is possible for switch and other component shafts to be brought out through the front panels of sealed units but special neoprene seals and packings are required to avoid serious air leakage. They must, however, always form sources of potential air leakage and, in any case,

their advantages are questionable because, during flight, there would be no personnel to operate them outside the pressure cabin of the aircraft.

Cable entry into sealed units offers relatively little difficulty and a range of sealed plugs and sockets for this purpose is available. The plugs and sockets may be of the "screw-on" type, or they may be so mounted on the backs of the units that they automatically mate up with the connectors when the complete units are pushed into their mounting racks in the aircraft.

Miniaturization

In view of the tremendous increase in quantity and in complexity of aircraft electronic equipment, every possible saving in weight and size has to be made. Miniaturization is thus an absolute necessity and with this in mind radio valve manufacturers have produced complete ranges of miniature (and even sub-miniature) valves. Likewise, miniaturized components generally are becoming more and more readily available and more and more reliable. The use of miniature techniques affords a very great saving in weight and size but, naturally, the difficulty and hence the cost of manufacture of miniature units is high. Perhaps the most serious consequence of the introduction of miniature technique is the difficulty of servicing the equipment. The intricacy of the wiring of a group of miniature valves is quite alarming and if it is necessary to change components, extreme care must be taken to avoid damage to neighbouring components by application of a soldering iron. The servicing of equipment in the field thus becomes an extremely risky undertaking and it can only be done by really first rate and highly experienced mechanics.

One way in which this difficulty may be overcome to some extent is by designing the miniaturized, hermetically sealed units in such a way that each contains a number of plug-in or readily detachable sub-units. No attempt would be made to service these except in fully equipped workshops, and if a fault did occur, the affected sub-unit would merely be replaced by a new one and the original returned to a base depot for repair. If serious damage were diagnosed on the unit, it would almost certainly be more economical to scrap it than to attempt to salvage it by repair.

In addition to the requirements of pan-climatization and miniaturization, the introduction of very high speed, highly manoeuvrable aircraft has necessitated a corresponding increase in the mechanical strength of the ancillary equipment, including the electronic apparatus. The equipment must be capable of withstanding sustained accelerations of 12g and must withstand momentary accelerations of up to 25g, this means that all components must be very firmly secured, and the actual chassis themselves must be strong enough to prevent distortion under extreme conditions. It can well be imagined that, say, a transformer weighing a pound or more, could do very severe damage in an aircraft if it broke away from its anchorage.

From the foregoing remarks concerning the present trends of electronic equipment design, it will be seen that design of the electronic circuits is only one aspect of the design of a successful piece of apparatus. The days have passed when the manufacture of electronic gear consisted merely of wiring up a lot of valves and components on folded sheet-metal chassis and putting the whole assembly in a light dust cover. Sound mechanical design is now just as important as sound electronic circuitry and the manufacturer must have at his disposal engineering design and production facilities which will enable him to produce mechanical parts of the highest precision. The day when the guillotine and bending machine were the only tools required has gone and the radio manufacturer must now be a master of machining, casting, drawing, welding and all the other processes formerly associated only with precision mechanical engineering.

the voltage on g_1 relative to that on g_2 depend on the frequency to which L_2C_2 is tuned, but so also will the magnitude of this influence voltage. Keeping the frequency of the Hartley oscillator steady at f_1 , and with the magnitude of the oscillatory voltage E_1 on g_1 constant, varying the tuning of the circuit L_2C_2 so that its frequency f_2 varies from below f_1 through equality to above f_1 will cause a change to occur in the magnitude of the voltage E_2 appearing by influence effect on g_2 . It will vary in the manner shown in Fig. 3(a). Also, the angular separation between E_2 and E_1 during the same frequency change varies between -180° , through -90° at equality of f_2 and f_1 , to zero degrees. A more instructive curve than angular difference is, as we shall shortly see, a plot of the cosine of the angular separation between E_2 and E_1 as f_2 is varied. This is shown in Fig. 3(b).

The anode current of this type of valve is given by $SE_2 \cos \phi$, since the beat frequency in the anode current under the present conditions is zero and the voltages E_1 and E_2 having the same frequency. In the above expression S is the conversion conductance which includes E_1 and, since the latter is constant, S itself is constant. $\cos \phi$ is the cosine of the angle of phase difference between E_2 and E_1 . As the resonant frequency of L_2C_2 is varied

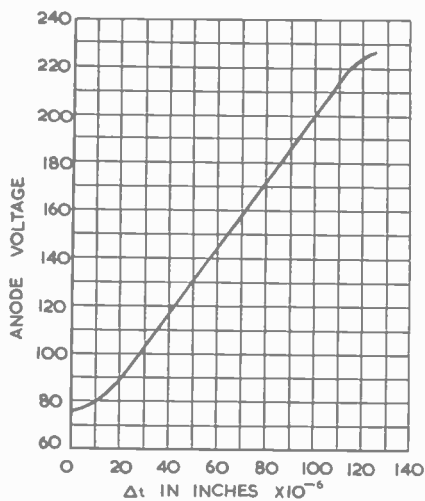

Fig. 4. Characteristic curve of the octode circuit when adapted for use as a micrometer

through f_1 , the anode current at any frequency can be deduced from the ordinates of Figs. 3(a) and 3(b), and will consequently have the form shown in 3(c).

Application as Valve Micrometer

Basically, the circuit described translates changes in capacitance of the capacitor C_2 into proportionate changes of current or voltage at the anode of the valve. Thus, by employing the above circuit, any physical phenomenon which can be translated into a change of capacitance can be measured in terms of an equivalent change in anode voltage. The total extent of the change in anode voltage can be effected by a change in capacitance of as small as 2 picofarads, depending on the fundamental frequency chosen for the Hartley oscillator. At about 20Mc/s the rate of change of anode voltage to capacitance is of the order of 90 volts per picofarad, giving a total change of about 180 volts, for a change of 2 picofarads over the central linear portion of the characteristic.

For the measurement of small changes in length an auxiliary capacitor, having circular plates of 2cm diameter and a separation distance of about .01in. was used. This unit was screened from external fields, and constructed with a guard-ring to give a uniform field between

the plates. The change of length measured was applied to the moveable plate of this capacitor unit. The initial distance of separation of the plates was set so that the total movement, due to the change of length being measured, would not be much greater than 1 per cent of the former. Accordingly, the change in capacitance was assumed to be directly proportional to the change in length. This is a reasonable assumption, and gives an acceptable degree of accuracy under the above conditions. An overall calibration curve for the equipment is shown in Fig. 4, giving the change in anode voltage against the change in separation distance of the plates of the auxiliary capacitor unit. The latter was measured by a combined optical lever mechanism which gave an accuracy of some 2 per cent over the length of 1.2×10^{-4} in. measured. The sensitivity of the circuit is seen to be 1.4 volts per 10^{-6} in., and is linear over a length of 90×10^{-6} in.

In building the equipment adequate screening between the two oscillatory circuits was found to be essential, the reason being that it requires only a small capacitance coupling of two or three picofarads externally between g_1 and g_2 , to neutralize the whole effect of the influence charge on the latter. Although comprehensive tests have not yet been made to check the stability of the circuit, or the accuracy of its calibration once made, rough tests show quite a promising consistency. It is hoped to cover such points as these in tests which are contemplated to obtain more complete information on the optimum working conditions, and the possibilities of further applications of this circuit.

The equipment shows capabilities of being used not only for measuring uni-directional changes in length, as at present, but also for pressure measurements, or again, it could be applied to the measurement and observation of the waveform of minute vibrations of a transient or repetitive nature, over a range of frequencies from zero upwards.

REFERENCES

- Measurement of Magnetostriction. M.Sc. Thesis (London), May, 1939.
- LUKACS, E. Frequency changing with the Octode. *Wireless World*, March 17th, 1938.
- JAMES, E. G., B.Sc., Ph.D. Frequency-changer Valves. *Wireless World* March 30th, 1939.

Jet Navigation

The ever-increasing speeds of modern aircraft—particularly since the advent of jet propulsion—necessitates complementary advances in many other aeronautical techniques and services. One of the earliest problems to arise, as speeds rapidly increased, was the liaison between ground and aircraft for navigational purposes and, in particular, positioning.

Over three years ago this problem was dealt with by Marconi's Wireless Telegraph Co., Ltd., who set about designing and building a modern D.F. installation which would allow ground operators to read off bearings instantaneously to the pilot of a high-speed aircraft. Many more points were taken into consideration.

The equipment had to be compact enough to be unobtrusive in control towers, the main transmitters-receivers would have to be sited somewhere else and remotely controlled from the tower. Instantaneous reading of bearings called for visual presentation. If large meters were used for this purpose, then a duplication service could be incorporated allowing people in other rooms and offices to follow the bearings on repeater meters.

All these things were, incorporated into the design of the Marconi AD.200 V.H.F. D/F installation.

Nearly two years ago an AD.200 was installed in the control tower at Hatfield and has been in constant use ever since.

Linear Staircase Generator for Television Use

By A. M. Spooner,* B.Sc., and F. W. Nicholls.*

FOR measuring the linearity of response of television circuits with amplitude of signal, a linear sawtooth is a convenient test waveform, and is usually suitable. For some applications, however, a staircase waveform in which the amplitude changes in a number of equal steps, is more useful.

The circuit herein described (Fig. 1) produces a linear staircase of amplitude adjustable between 0 and 1 volt D.A.P. at line frequency with a number of steps variable between five and thirty. Fig. 2 shows the output with six steps present. An important use of this waveform is for

as the input to an amplitude window circuit, and the number of steps varied, with the total amplitude maintained constant, the fraction of the amplitude of the input wave selected is obtained as the reciprocal of the number of steps when one step only is visible in the output.

The staircase generator is normally used in conjunction with a television waveform generator from which line suppression pulses are taken to trigger the staircase generator. The output is then fed back into the waveform generator and appears at the output with suppression and synchronizing signals added. Fig. 3 shows the appearance

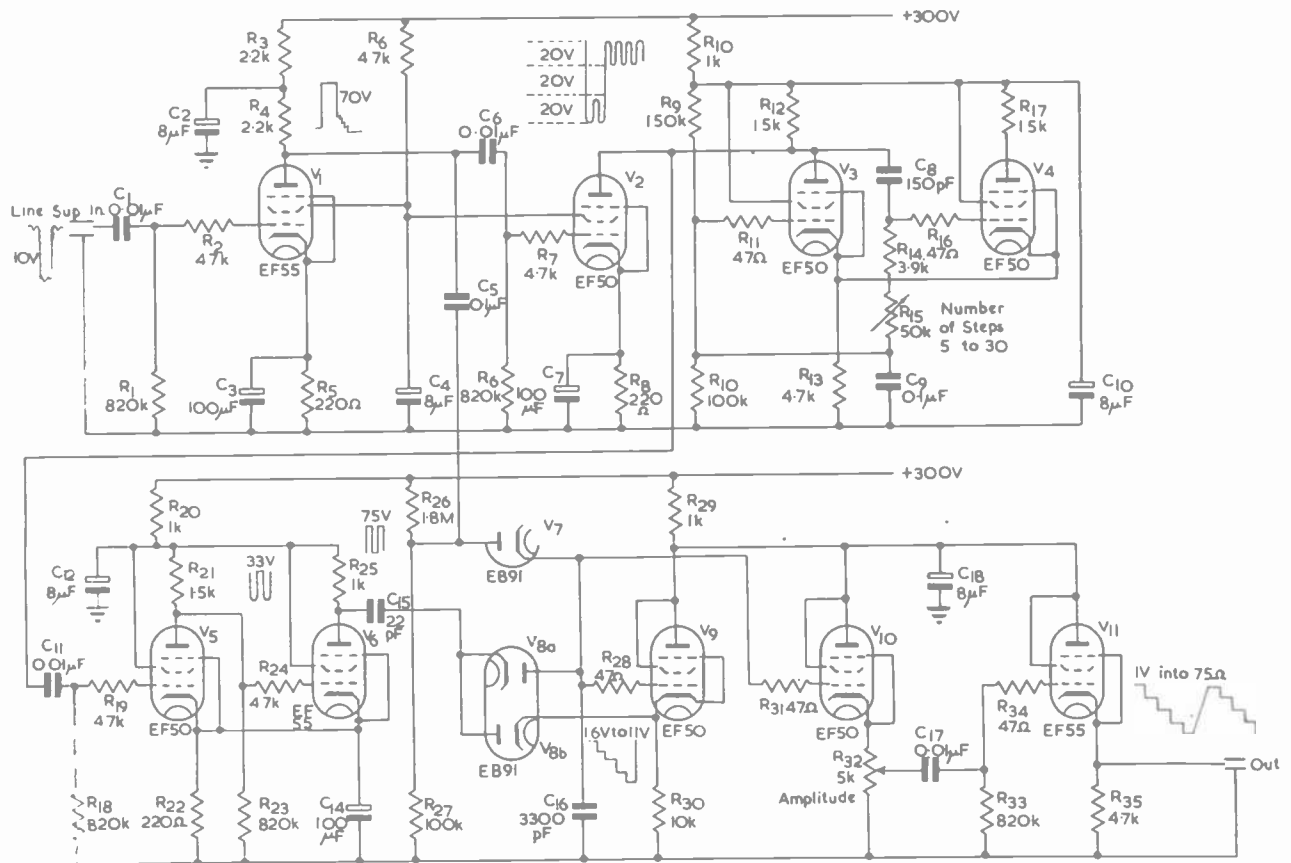

Fig. 1. The linear staircase generator

measuring the response of telefilm recording apparatus, by modulating the cathode-ray tube with the staircase, and measuring the response of telefilm recording apparatus, by densitometer. A sawtooth would not be suitable as the test signal, as the density of the film image would then change continuously, and the area examined by the densitometer would not be of constant density.

Another use of the staircase generator is in testing "amplitude window" circuits. Such circuits are used when it is desired to select only that part of a waveform lying between certain levels. If the staircase waveform is used

of six steps, and Fig. 4 twenty steps, after the addition of suppression and synchronization signals.

The principle of operation is as follows: an astable multivibrator is synchronized by line frequency pulses at a multiple of line frequency and its output is applied to a diode counter circuit which generates the staircase.

V₁ is an amplifier-cleaner which accepts negative line suppression pulses and feeds the amplified pulses to the grid of V₂, another amplifier-cleaner. The anode of V₂ is connected to the anode of V₃, V₃ and V₄ forming a cathode-coupled multivibrator which operates between 50kc/s and 300kc/s, with unity mark-space ratio. When the line suppression pulse arrives at the input, the anode

* Design Dept. of B.B.C. Engineering Division.

of V_3 is carried about 40 volts negative, carrying the grid of V_4 with it. At the end of line suppression the grid of V_4 rises in potential and the multivibrator executes a train of relaxation oscillations which are controlled in number between five and thirty by adjustment of the coupling time constant between V_3 anode and V_4 grid. The first pulse so generated always starts at the back edge of line suppression. V_5 and V_6 square the train of pulses and ensure that

on C_{15} by a small amount, producing a negative-going staircase waveform across C_{16} . When the train of pulses ends, another positive line suppression pulse is applied via V_7 to C_{16} , recharging it to its initial potential.

If the cathode of V_{8b} were connected to a fixed D.C. potential the output would not be linear, since as pulses discharge C_{16} its potential falls, and the negative bias across V_{8a} would increase. This would cause each step to be

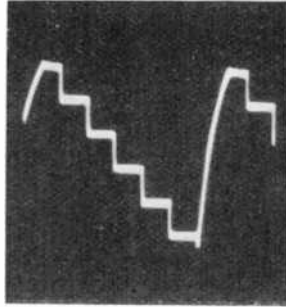

Fig. 2. Six steps

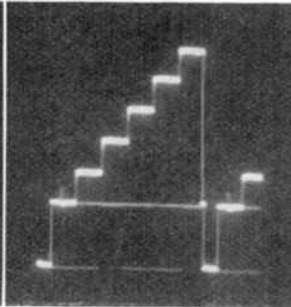

Fig. 3. Six steps with suppression and synchronization signals added

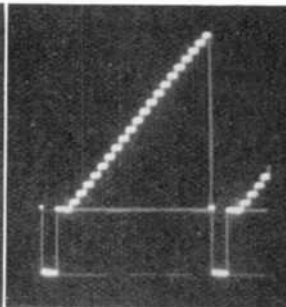

Fig. 4. Twenty steps

their amplitude is constant whatever the number. The diodes V_{8a} , V_{8b} , V_7 and the capacitors C_{15} and C_{16} generate the staircase waveform. V_7 is normally cut off, but during line suppression its anode is carried positive, charging C_{16} to a definite value. At the instant the charging pulse ends, a train of pulses arrives at C_{15} . These pulses pass through C_{15} , are D.C. restored by V_{8b} to the potential of its cathode, and the charge is shared between C_{15} and C_{16} . Each pulse therefore reduces the potential

slightly less than the one before it, producing a curved staircase waveform. To minimize this effect the non-earthly side of C_{16} is connected to the grid of a cathode-follower, and the cathode of V_{8b} is joined to that of the cathode-follower. The bias potential of V_{8a} is thus maintained practically constant.

V_{10} and V_{11} provide for varying the amplitude of the staircase and for feeding the output to a 75 ohm cable.

Premiums for Technical Writing

An Announcement by the Radio Industry Council

TO encourage the writing and publication of articles reporting technical progress and development in radio and electronics in Great Britain, the Radio Industry Council announces that from 1 January, 1952, it will award premiums of 25 guineas each, up to an average of six a year, to the writers of published articles which, in the opinion of a panel of judges, deserve to be commended by the industry. It is hoped in this way gradually to increase the number and standard of articles available to editors.

Eligibility of Writers

Any non-professional writer will be eligible—and by this is meant anyone not paid a salary mainly or wholly for writing and not earning 25 per cent or more of his income from fees for articles or from book royalties.

Eligibility of Articles

The awards will be made for articles published at home or abroad in papers or periodicals which can be bought by the public on the bookstalls or by subscription. Articles in the following classes of journals will not be eligible: Journals circulating exclusively to members of a trade or manufacturers' journals; the privately published journals of professional institutions or learned societies. Writers and editors will be invited to submit published articles to the Secretary, Radio Industry Council, 59 Russell Square, London, W.C.1 (if possible five copies of the journal, proofs or reprints) for consideration, but the judges will consider also unsubmitted published articles.

Criteria

The judges are to be given the greatest possible freedom in choosing articles for awards, but they will be asked broadly to take into consideration:

- Value of the article in making known British achievement in radio and electronics
- Originality of subject
- Technical interest
- Presentation and clarity.

Judges

The judges will be:

One elected member of the Technical Directive Board of the Radio Industry Council (Mr. E. M. Lee, B.Sc., M.I.E.E., the present chairman of the Board).

One elected member of the Public Relations Committee of the R.I.C. (Mr. W. M. York, the present chairman of the Committee).

Mr. T. E. Goldup, M.I.E.E., a member of the Technical Directive Board.

The Director, R.I.C. (Vice-Admiral J. W. S. Dorling, C.B., M.I.E.E.).

Professor Willis Jackson, D.Sc., D.Phil., M.I.E.E., F.Inst.P., Professor of Electrical Engineering, Imperial College of Science and Technology, University of London.

The panel will have power to co-opt specialists and will have the advice of the Editors of "Wireless World" and "Electronic Engineering."

The Prediction of Audio-Frequency Response

No. 2—Circuits with Two Reactance Elements (Part 1)

By N. H. Crowhurst, A.M.I.E.E.

THIS data sheet will deal with circuits reducible to the fundamental configurations shown in Figs. 1 and 2 for high and low frequency cut-off forms respectively. The reason for reversing the position of r and R in (a) and (b) arrangements of these figures is that it enables the same design formulæ to be used. In each case the network can be viewed as a type of resonant circuit in which r is series resistance damping and R is shunt resistance damping, regardless of which is source or load resistance from the viewpoint of the operation of the circuit.

In many practical coupling networks L_s of Fig. 1 will be a leakage inductance between windings of a coupling transformer. In the case of step-up transformers the secondary circuit capacitance will have the greatest effect, and will be the principal component to tune with leakage inductance. All capacitances effectively across the secondary must be included in this value. The circuit of Fig. 1(a) is applicable, provided the primary capacitance does not contribute appreciably to the shape of the response characteristic. Any interwinding capacitance must also be taken into account, but these charts are not applicable to such cases unless the

fed consists of a valve with anode coupling resistance, the source resistance will be the equivalent parallel resistance of the anode coupling resistor and the valve a.c. resistance.

Parallel fed transformer coupling may be treated for low frequency cut-off characteristic by means of the network at Fig. 2(a). Fig. 2(b) is suitable for application to choke coupled output. When choke coupling is employed, the self-capacitance of the choke should not be overlooked in considering the high frequency end of the response characteristic. If choke and transformer coupling is employed in a parallel fed arrangement neither of these networks can be employed with a high order of accuracy, although when the primary inductance of the transformer is high compared to the choke inductance, and the referred load resistance is smaller than the source resistance, a reasonable approximation may be possible by ignoring the primary inductance, that is by assuming it to be infinite.

In addition to the simple networks shown at Figs. 1 and 2, this data sheet can be applied to the approximate determination of response for coupled tuned circuits, where both circuits are tuned to identical frequency, producing band-

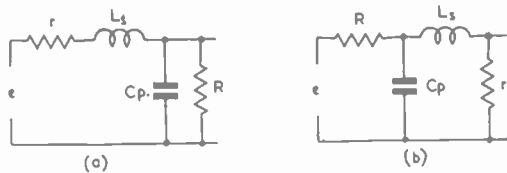

Fig. 1. Alternative networks for high frequency cut-off using two reactances

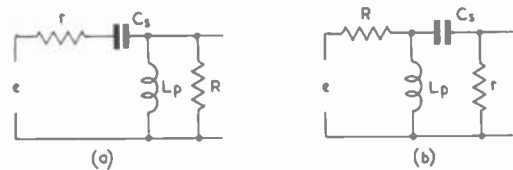

Fig. 2. Alternative networks for low frequency cut-off using two reactances

leakage inductance between sections where interwinding capacitance occurs is negligible compared to leakage inductance between the whole windings. Otherwise the transformer must be treated as a far more complex network, with corresponding possibility of complexity in response characteristic.

If primary capacitance does present a reactance to the circuit that is comparable with other circuit values within the frequency range considered, then the circuit is best treated as a three reactance network, for which a later data sheet is intended. However, for many applications, a sufficiently accurate prediction can be obtained by treating the primary source resistance and capacitance as a single reactance network, combining it with a two reactance network as at Fig. 1(a) consisting of the primary source resistance, the secondary shunt resistance (including core losses), leakage inductance and secondary capacitance.

Step-down transformers can be regarded as step-up transformers operated in reverse. The important capacitance becomes the primary circuit and winding capacitance, and the appropriate network is that of Fig. 1(b). The remarks concerning the circuit capacitances given in the previous paragraphs apply. Another important point to remember when treating transformer coupling is that all impedances should be referred to the same winding of the transformer. Naturally, when the source from which a transformer is

pass effect, and the frequency deviation from resonance is always relatively small.

Three Possible Forms of Amplitude Response

For any of the networks in Figs. 1 and 2, the response produced will fall into one of three possible cases, based upon the shape of the amplitude characteristic. The form of the phase transfer characteristic is similar for all cases, the constants of the network changing the rate of transition from zero phase shift to reversal, through the 90° intermediate, about which the characteristic is symmetrical when plotted to a logarithmic frequency scale.

The frequency discriminating component of the attenuation coefficient for the high frequency cut-off networks of Fig. 1 is:

$$A = 1 - \frac{\omega^2 L_s C_p}{1 + r/R} - j\omega \left[\frac{L_s}{r + R} + \frac{C_p r R}{r + R} \right] \quad (1)$$

and for the low frequency cut-off networks of Fig. 2:

$$A = 1 - \frac{1}{\omega^2 L_p C_s (1 + r/R)} + 1/j\omega \left[\frac{1}{C_s (r + R)} + \frac{r R}{L_p (r + R)} \right] \quad (2)$$

Differentiating the modulus of these expressions, and equating to zero to find the frequency at which a stationary point or peak occurs, the solutions for the high frequency cut-off networks are $\omega_0 = 0$ and

$$\omega_0^2 = \frac{1}{L_s C_p} \left[1 - \frac{L_s}{2C_p R^2} - \frac{C_p r^2}{2L_s} \right] \dots \dots \dots (3)$$

Substituting $E = 1 - \frac{L_s}{2C_p R^2} - \frac{C_p r^2}{2L_s} \dots \dots \dots (4)$

Equation (3) can be written, $\omega_0^2 = \frac{E}{L_s C_p} \dots \dots \dots (3a)$

For low frequency cut-off networks the solutions are $\omega_0 = \infty$ and

$$1/\omega_0^2 = L_p C_s \left[1 - \frac{r^2 C_s}{2L_p} - \frac{L_p}{2R^2 C_s} \right] \dots \dots \dots (5)$$

Substituting a similar expression,

$$E = 1 - \frac{r^2 C_s}{2L_p} - \frac{L_p}{2R^2 C_s} \dots \dots \dots (6)$$

Equation (5) can be written,

$$1/\omega_0^2 = E \cdot L_p C_s \dots \dots \dots (5a)$$

The value of E in expressions (4) and (6) determines which case applies for the values under consideration. Its value may lie between plus one and minus infinity. The three cases are identified as:

1. When E lies between zero and plus one, the amplitude response manifests a peak. Cases in this group are considered in this first part of the data sheet.

2. When E lies between zero and minus infinity, the peak frequency, given by (3a) or (5a), becomes imaginary. The numerical value obtained represents a transition frequency from a characteristic reaching an ultimate slope of 6db/octave to one reaching an ultimate slope of 12db/octave. Cases in this group, as well as the phase response for both cases are given in the second part of the data sheet.

3. When E is zero, the amplitude response becomes a simple transition from level to a 12db/octave slope, the attenuation at the cut-off frequency being 3db. This case cannot be treated under either of the previous headings because the reference frequency given by (3a) or (5a) becomes zero or infinity. This single case, corresponding to critical coupling in band-pass circuits, is treated in the third part of this data sheet.

Peaking Case

To obtain the response in cases where E is positive, the value of E given by (4) or (6) is substituted in the modulus of the attenuation coefficient, and to render the response characteristic dimensionless, x is written for ω/ω_0 in high frequency cut-off characteristics, and for ω_0/ω in low frequency cut-off characteristics. This produces a general form, giving the amplitude response in decibels referred to mid-band of

$$\text{db loss} = 10 \log_{10} \left[1 + \left(\frac{E}{1 + r/R} \right)^2 (x^4 - 2x^2) \right] \dots \dots (7)$$

Substituting $x = 1$ gives the height of the peak in db.

$$\text{db peak} = 10 \log_{10} \left[1 - \left(\frac{E}{1 + r/R} \right)^2 \right] \dots \dots \dots (8)$$

An additional point of interest is that at which $x^2 = 2$, where the curve crosses the zero reference line. For high frequency cut-off networks this occurs at $\sqrt{2}$ times the peak frequency, while for low frequency cut-off networks, it is at the peak frequency divided by $\sqrt{2}$.

Phase Response

The tangent of the phase transfer angle is given by the ratio of the imaginary part to the real part of the attenua-

tion coefficient. A convenient reference frequency for plotting the phase response is that at which the angle is 90° , that is where the real part of the attenuation coefficient

vanishes. Writing $1 - \frac{\omega \phi^2 L_s C_p}{1 + r/R} = 0$, and substituting Equation (3a) gives for the ratio of the two reference frequencies.

$$\omega \phi^2 / \omega_0^2 = f \phi^2 / f_0^2 = \frac{1 + r/R}{E} \dots \dots \dots (9)$$

This applies to high frequency cut-off networks. For low frequency cut-off networks, using a similar substitution, the ratio of the two reference frequencies is given by

$$\omega_0^2 / \omega \phi^2 = f_0^2 / f \phi^2 = \frac{1 + r/R}{E} \dots \dots \dots (10)$$

Writing $y = \omega/\omega \phi$ for high frequency cut-off networks, or $y = \omega \phi/\omega$ for low frequency cut-off networks, the phase transfer angle may be expressed:

$$\phi_t = \tan^{-1} \frac{y}{1 - y^2} \sqrt{2 \left[1 - \frac{E}{1 + r/R} \right]} \dots \dots (11)$$

the angle being positive or lagging for high frequency cut-off networks, and negative or leading for low frequency cut-off networks.

It will be noted that Equations (7) to (11) all contain a term $\frac{E}{1 + r/R}$, its power or reciprocal, showing that the net-

work constants represented in this expression wholly determine the shape of the frequency response, both in amplitude and phase. It will be realized that the relation $f \phi/f_0$ or $f_0/f \phi$ and the shape of the phase response curve given by Equation (11) is fixed for each value of db peak, given by Equation (8).

As the numerical value of expressions (9) and (10) is always greater than unity, it is evident that the frequency at which phase transfer angle is 90° is always further from the centre of the band-pass than the peak frequency. It can be shown that the 90° phase reference frequency corresponds with the point on the amplitude characteristic where the slope is 6db/octave.

Coupled Tuned Circuits

To apply the same formulæ and these charts to the prediction of response of identically tuned band-pass circuits, it is assumed that the two circuits are tuned to a carrier frequency f_c ; that the circuits have Q values of Q_1 and Q_2 , and a coupling coefficient of k . For simplicity in the final formulæ, take Q as the mean value of Q_1 and Q_2 , such that $Q_1 = nQ$ and $Q_2 = Q/n$. Then, writing

$$m = \frac{1}{2}(n^2 + 1/n^2) \dots \dots \dots (12)$$

the peak frequency differs from the carrier frequency on either side by:

$$f_0 = f_c / 2Q \sqrt{k^2 Q^2 - m} \dots \dots \dots (13)$$

and the height of the peak referred to the response at mid-tune frequency is:

$$\text{db peak} = -10 \log_{10} \left[1 - \left(\frac{k^2 Q^2 - m}{k^2 Q^2 + 1} \right)^2 \right] \dots (14)$$

Where the damping of both circuits is identical so that they both have the same value of Q, n and m become unity in the above expressions. Where they are other than identical, n varies from unity, with the result that m becomes greater than unity.

Use of Charts 1—4

CHART 1

Chart 1 is used, having calculated the value E by Equation (4) or (6) (this is given on the chart as $\omega_0^2 L_s C_p$ for the high frequency cut-off networks, and as $\frac{1}{\omega_0^2 L_p C_s}$ for low

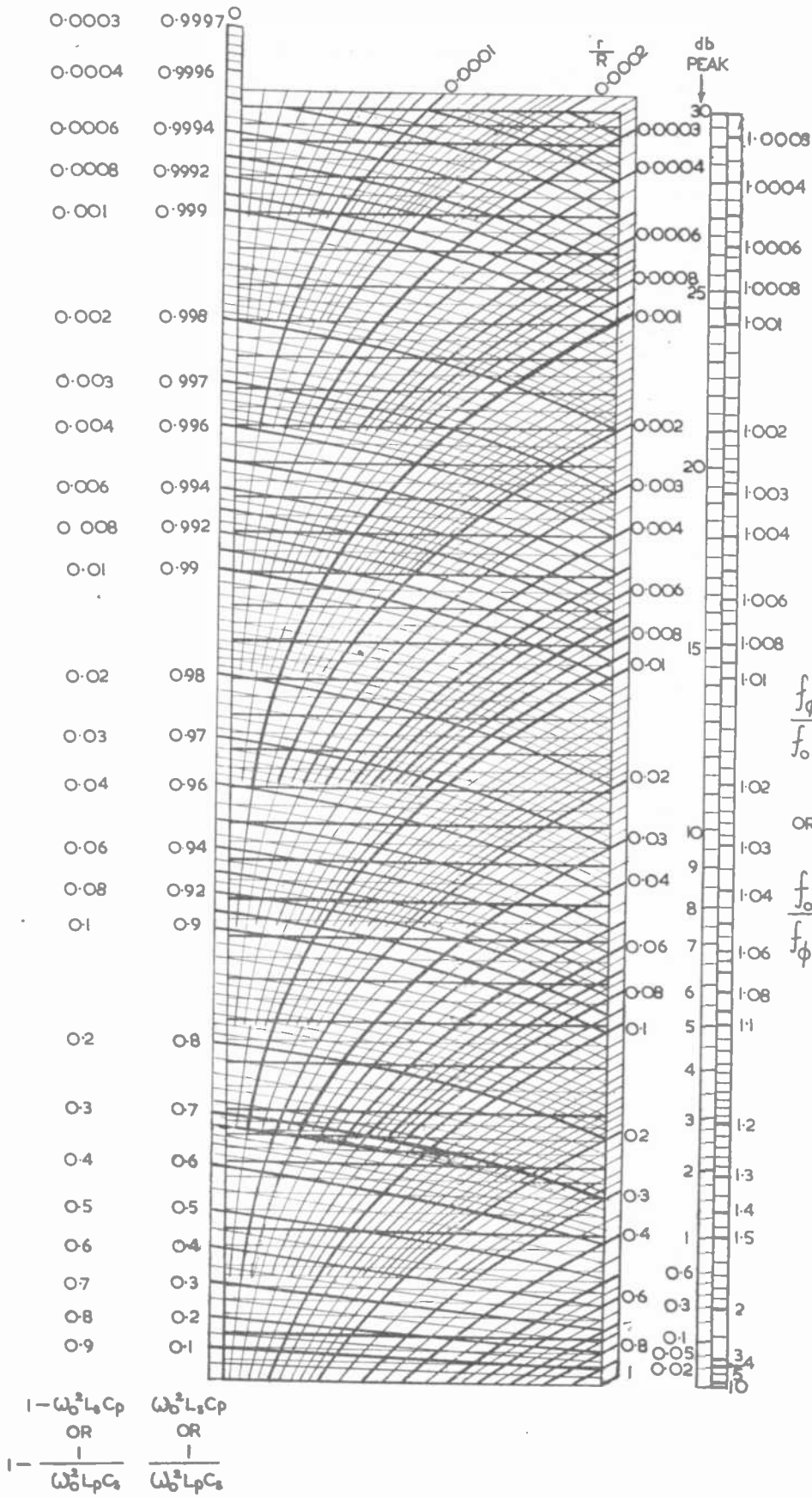

Chart 1.
Determination of db peak

f/f_0 LOW FREQUENCY CUT-OFF NETWORKS

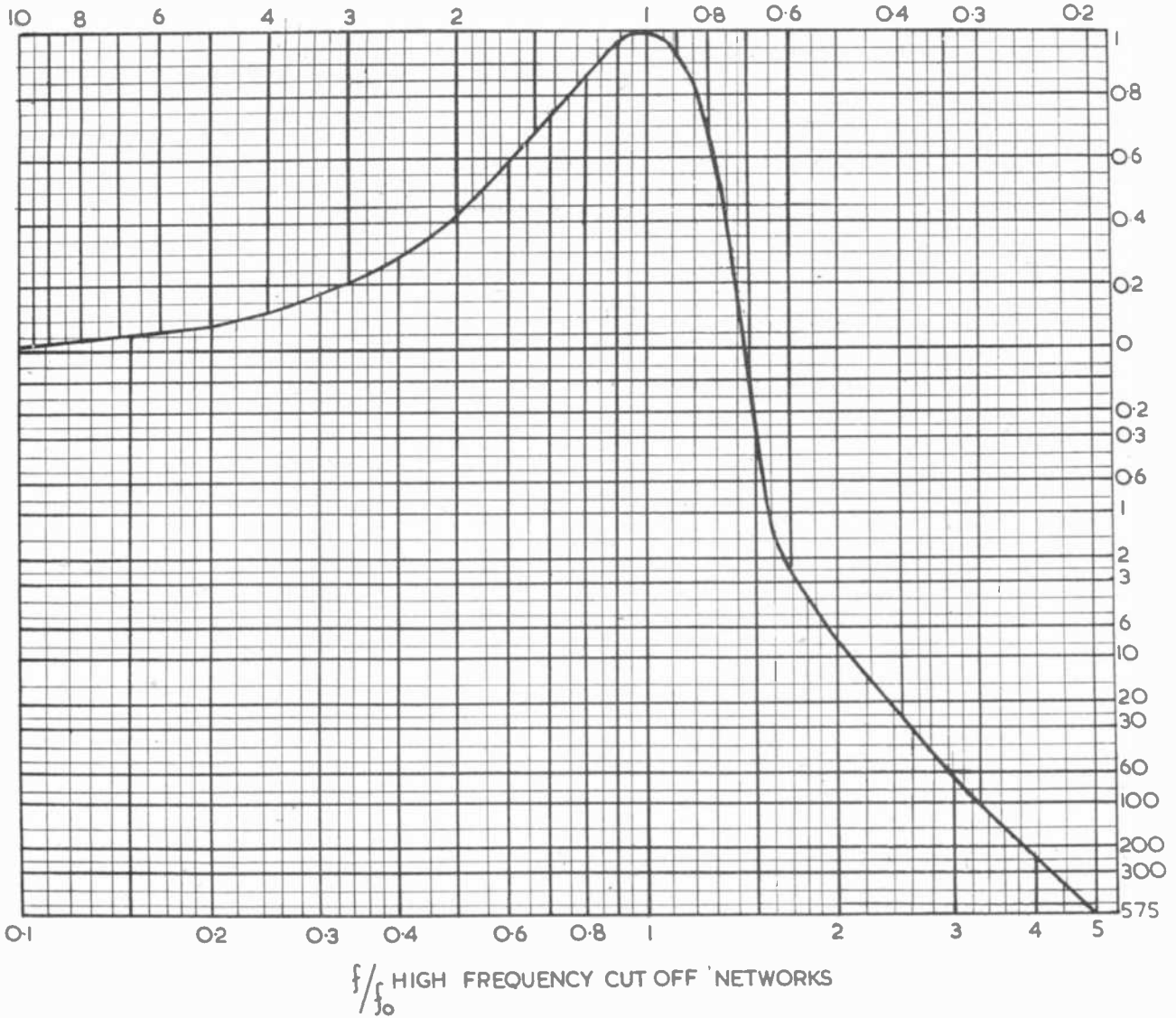

Chart 2. Universal response curve

frequency cut-off networks), to determine the db peak and the relation between the amplitude and phase response reference frequencies. The curved rulings tending to become straight at the bottom of the chart, with the scale at the left-hand side, represent values of E , that is $\omega_0^2 L_s C_p$ or $\frac{1}{\omega_0^2 L_p C_s}$. In the case of high frequency cut-off circuits:

$$1 - \omega_0^2 L_s C_p = \frac{L_s}{2C_p R^2} + \frac{C_p R^2}{2L_s} \dots \dots (15)$$

and for low frequency cut-off circuits:

$$1 - \frac{1}{\omega_0^2 L_p C_s} = \frac{r^2 C_s}{2L_p} + \frac{L_p}{2R^2 C_s} \dots \dots (16)$$

so that a scale for these quantities, also given against these rulings at the left-hand side of the chart, facilitates its use. The curved rulings emerging at the right-hand side and top of the chart represent values of r/R . The intersection between these two sets of curved rulings in the scale provided for the straight horizontal rulings detached from the right-hand side of the chart gives the db peak directly.

Opposite to these readings is also given the relation between the amplitude and phase response reference frequencies.

To apply these charts to the response of coupled tuned circuits, the left-hand edge of this chart may be used. The value of $\frac{k^2 Q^2 - m}{k^2 Q^2 + 1}$ is calculated, and the result applied to the $\omega_0^2 L_s C_p$ scale at the left-hand edge, the corresponding value of db being read off by reference along the horizontal rulings.

Example 1.

Low frequency cut-off network as at Fig. 2(a), due to parallel fed transformer coupling, in which effective primary source resistance, $r = 30k\Omega$; $R = 0.5M\Omega$, representing total iron losses and shunt resistance referred to primary; $L_p = 300H$; and $C_s = 0.05\mu F$.

$$\frac{r^2 C_s}{2L_p} = \frac{9 \times 10^8 \times 5 \times 10^{-8}}{2 \times 300} = 0.075;$$

$$\frac{L_p}{2R^2 C_s} = \frac{300}{2 \times 0.25 \times 10^{12} \times 5 \times 10^{-8}} = 0.012$$

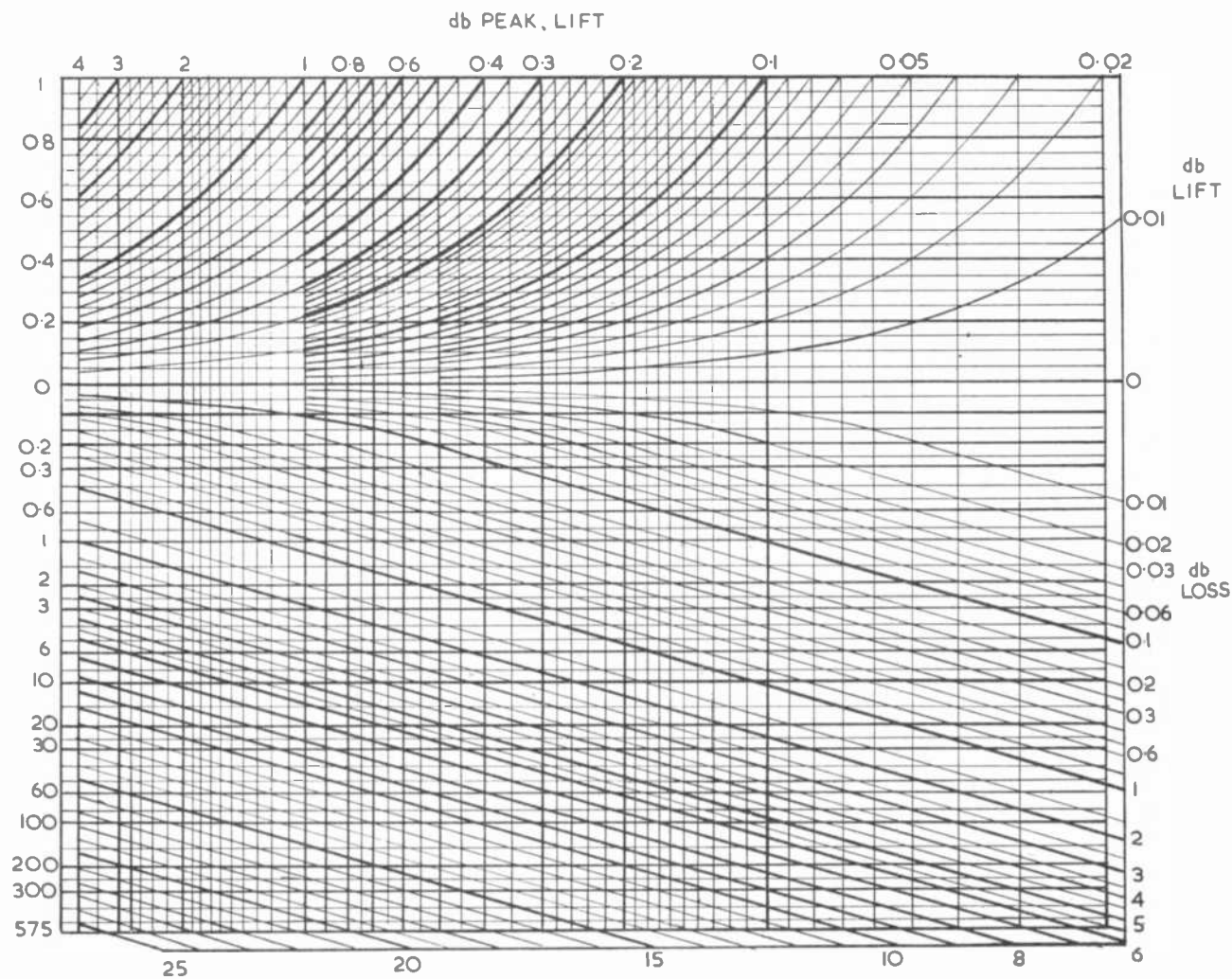

Chart 3. Reference for Chart 2—0.02 to 4db peak

$$\frac{1}{\omega_0^2 L_p C_n} = 1 - 0.075 - 0.012 = 0.913; r/R = \frac{3 \times 10^4}{5 \times 10^5} = 0.06.$$

Applying these values (0.913 or 0.087 and 0.06) to Chart 1, the db peak is found to be almost exactly 6db. The peak frequency will be 1.078 times the frequency at which the phase transfer angle is 90°. Using the reciprocal scale on a slide rule, this shows that the reference frequency for the phase charts (given in the next part of this data sheet) is 0.93 times the peak frequency. (Peak frequency can be calculated directly from equation (5), but a chart in the third part of this data sheet will provide for this calculation.)

Example 2.

High frequency cut-off network as Fig. 1 (a) in which L_s is due to leakage inductance in an intervalve transformer, ratio 3/1 step-up. The primary source resistance is 5kΩ, which referred to the secondary gives $r = 45k\Omega$; $R = 1M\Omega$; $L_s = 4.5H$ (referred to secondary); $C_p = 100pF$.

$$\frac{L_s}{2C_p R^2} = \frac{4.5}{2 \times 10^{-10} \times 10^{12}} = 0.0225;$$

$$\frac{C_p r^2}{2L_s} = \frac{10^{-10} \times 20.25 \times 10^8}{2 \times 4.5} = 0.0225.$$

$$\omega_0^2 L_s C_p = 1 - 0.0225 - 0.0225 = 0.955. \quad r/R = \frac{4.5 \times 10^4}{10^6} = 0.045.$$

Applying these values (0.955 or 0.045 and 0.045) to Chart 1, the db peak is found to be 7.9db, and the phase reference frequency is 1.045 times the peak frequency. Notice that this example used the right-hand edge of the chart: this is because the series and shunt damping components are equal.

Example 3.

An output transformer is to operate between a valve whose average A.C. resistance is 0.1MΩ, and a referred resistive load of 10kΩ; the primary self-capacitance, total, is 1,000pF; and the leakage inductance referred to the primary is 60mH.

Using the network of Fig. 1 (b):

$$\frac{L_n}{2C_p R^2} = \frac{6 \times 10^{-2}}{2 \times 10^{-9} \times 10^{10}} = 0.003;$$

$$\frac{C_p r^2}{2L_n} = \frac{10^{-9} \times 10^8}{2 \times 6 \times 10^{-2}} = 0.833;$$

$\omega_0^2 L_n C_p = 1 - 0.003 - 0.833 = 0.164$; $r/R = 10^4/10^5 = 0.1$. Applying these values to Chart 1, the db peak is found to be 0.1db, and the reference frequency for the phase characteristic is 2.6 times the peak frequency.

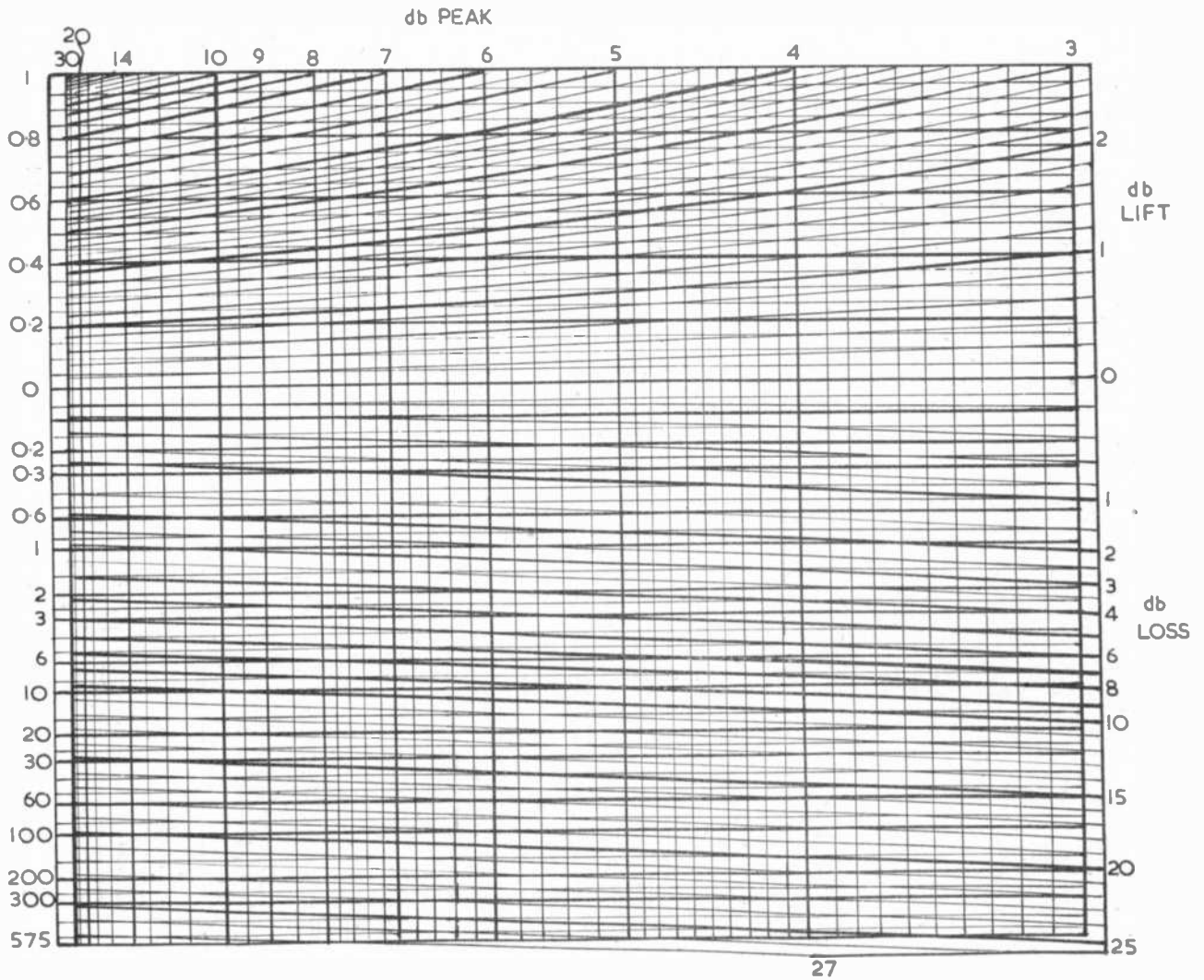

Chart 4 Reference for Chart 2-3 to 30db peak

Example 4.

Two tuned circuits, coupled, have the following characteristics: $k = 0.025$; $Q_1 = 53$; $Q_2 = 212$; $f_0 = 1\text{Mc/s}$.

$$Q = \sqrt{Q_1 Q_2} = 106; n = \sqrt{Q_2 / Q_1} = 2; m = \frac{1}{2}(n^2 + 1/n^2) = 2\frac{1}{2} = 2.125. \text{ Whence } \frac{k^2 Q^2 - m}{k^2 Q^2 + 1} = \frac{2.65^2 - 2.125}{2.65^2 + 1} = 0.61.$$

From Chart 1, this gives 2db peak, at a frequency given by (13) as

$$f_o = 10^6 / 212 \sqrt{2.65^2 - 2.125} = 10.4\text{kc/s}.$$

Fig. 3. Illustrating the use of Chart 2 in conjunction with Charts 3 and 4

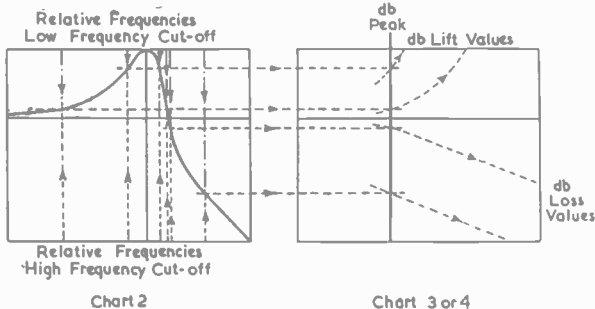

CHART 2.

This is a universal amplitude response curve for all peaking cases employing the two reactance networks of Figs. 1 and 2. The frequency scale at the bottom of the chart is for high frequency cut-off networks, while that at the top of the chart is for low frequency cut-off networks. The shape is chosen to provide the best compromise as to accuracy of reading throughout the frequency range presented. The vertical scale is not directly in decibels, but in arbitrary units, convertible into decibels by reference to either Chart 3 or Chart 4.

CHARTS 3 AND 4.

Chart 3 provides for degrees of peaking between 0.02 and 4 db, while Chart 4 provides for cases giving between 3 and 30db peak. When plotting a response curve, Chart 2 is used in conjunction with either Chart 3 or Chart 4, the numerical reference at the right-hand side of Chart 2 being identical with that at the left-hand side of Charts 3 and 4 to facilitate reference. To find the response at any frequency referred to the peak frequency, the vertical line on Chart 3 or 4 corresponding to db peak forms a reference line. Fig. 3 illustrates the method. Referring from the desired frequency on Chart 2 to the curve, the corresponding reference point on the scale at the right-hand side is noted and transferred to the scale at the left-hand side of Chart 3 or 4. Referring along the horizontal reference lines to intersect with the vertical db peak reference line,

the db lift or loss relative to mid-band response is given at the end of the sloping or curved rulings. Applying this method to the examples chosen for Chart 1 will illustrate this use.

Example 1.

Using the frequency reference at the top of Chart 2, in conjunction with Chart 4 to obtain db values, the following points can be tabulated;

f/f_0	0.2	0.3	0.4	0.5	0.6	0.7	0.8	0.9	1
db	-26.5	-19	-13.2	-8.4	-4.6	-0.35	+3.1	+5.1	+6
f/f_0	1.2	1.5	2	3	4	5	6	8	10
db	+4.8	+3.1	+1.7	+0.75	+0.42	+0.25	+0.2	+0.12	+0.08

Examples 2-4.

Using the frequency reference at the bottom of Chart 2, in conjunction with Chart 4 for example 2 and Chart 3 for

examples 3 and 4, the following values can be tabulated.

f/f_0	0.1	0.2	0.3	0.4	0.5	0.6	0.7
db, Ex. 2	+0.09	+0.28	+0.7	+1.2	+1.9	+3	+4.1
db, Ex. 3	+0.0025	+0.0075	+0.017	+0.028	+0.042	+0.058	+0.072
db, Ex. 4	+0.03	+0.12	+0.29	+0.49	+0.73	+1.05	+1.33
f/f_0	0.8	0.9	1	1.2	1.5	2	3
db, Ex. 2	+5.4	+7	+7.9	+5	-1	-8.8	-17.6
db, Ex. 3	+0.084	+0.097	+0.1	+0.08	-0.03	-0.75	-4.1
db, Ex. 4	+1.63	+1.9	+2	+1.53	-0.45	-5.9	-14.2
f/f_0	4	5					
db, Ex. 2	-23.5	-27					
db, Ex. 3	-8.3	-11.4					
db, Ex. 4	-19.8	-23.2					

The Loading Error in Linear Potentiometers

By G. M. Parker

IN electrical computing equipment and simulators it is frequently necessary to convert a shaft rotation into a voltage proportional to the angle through which the shaft has rotated.

The usual method of doing this is to obtain the voltage from a linear potentiometer fixed to the shaft, and fed by a fixed voltage E , either A.C. or D.C.

Since some current flows in the circuit fed by the potentiometer, represented by a resistance R_L , the output voltage is not strictly proportional to the slider position, and it is

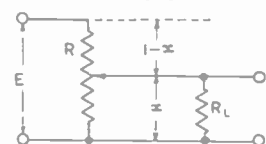
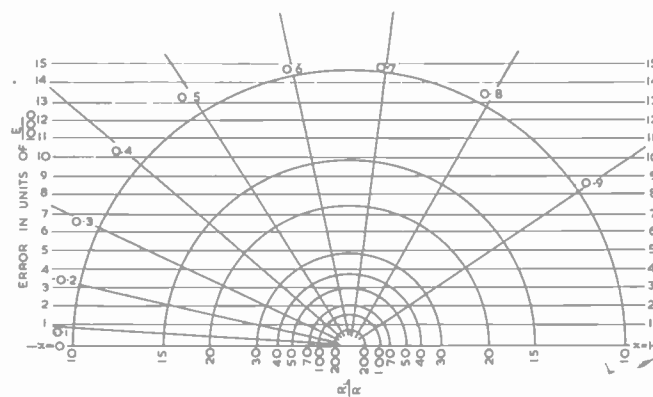

Chart 1. For use with single-end potentiometers



the purpose of the charts to enable this departure from linearity to be determined for any position of the slider.

This error will depend on the ratio of R_L to R , and the charts show what linearity is obtainable with practical values of this ratio.

Since a maximum value of R_L usually applies, and R cannot be reduced indefinitely owing to power consumption considerations, some loading error is unavoidable, and it may be necessary to abandon a linear potentiometer and use one whose card is graded to suit a particular ratio of R_L to R .

The two charts cover the cases of single-ended and push-pull potentiometers, and the method of use is the same in both cases.

The semicircles represent various values of R_L/R , on a reciprocal scale, numbered along the left-hand side of the charts. The radial lines, numbered at their ends, represent the slider position x , which has a range from 0 to 1. The vertical lines, numbered at top and bottom, give the departure from linearity in thousandths of E , the input-

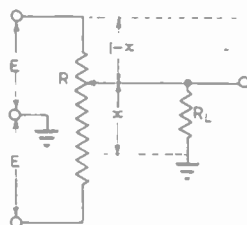
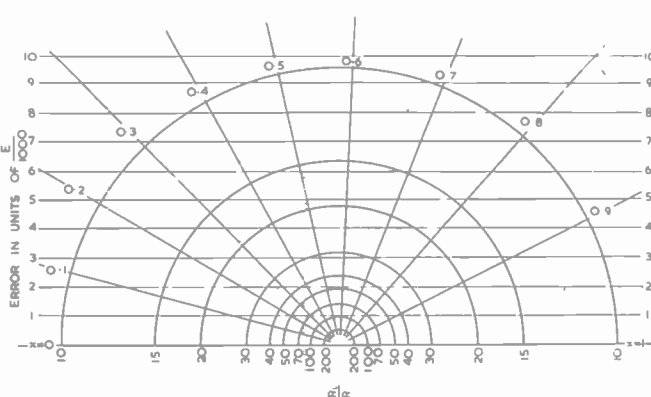

Chart 2. For use with push-pull potentiometers



voltage; i.e., they represent Δ in the equation:

$$E_o/E = x - \frac{\Delta}{1,000}$$

It will be seen that the maximum error Δ , in the single-ended case, always occurs at a value of x of about 0.67, for all values of R_L/R . In the push-pull case this figure is about 0.58. As an example of the use of the charts, consider the push-pull case, and suppose we have to find the value of R_L/R in order that the maximum error shall be less than 0.5 per cent of E .

Following the vertical line numbered 5, we become tangent to a circle numbered about 19, and this is the least value of R_L/R that will give the desired linearity of output.

Letters to the Editor

(We do not hold ourselves responsible for the opinions of our correspondents)

Are We Becoming Slaves to Standardization

DEAR SIR,—I have read with interest the letter from Mr. Godfrey in the October, 1951 issue, and enjoyed his constructive criticism of the several British Standards publications in the electrical engineering field.

Abbreviations are possibly the most difficult subject on which to obtain agreement to a standard practice, because an abbreviation is not made until the term, which is abbreviated, has become so widely used that an abbreviation is generally understood. By that time there have probably been many abbreviations employed by different writers.

The abbreviation for alternating current as "A.C." has come into general use, but A.V. or D.V. for alternating voltage or direct voltage have never come into use. It is not a matter for logic—one must accept the fact, and refer to an A.C. voltage. It is sheer carelessness and lack of thought which then appears to infer that A.C. is the abbreviation for "alternating" and gives rise to such a statement as "An A.C. current."

I agree with Mr. Godfrey that it would be simpler if lower case letters could be standard for these abbreviations, but again, I think it is not a question of logic but of practice. The abbreviation has to be in use for several years before the use of a lower case is acceptable. The life history of an abbreviation appears to be:—

- (a) the term in full,
- (b) the abbreviation by using the first (or other) letters in capitals,
- (c) the capitals become lower case.

A typical example is:—

- (a) Root mean square
- (b) R.M.S.
- (c) r.m.s.

It takes a considerable time for a lower case to become general usage, and it is only in recent years that r.m.s. has been used so much that it no longer looks strange.

I should like to suggest that the next step in the growth of an abbreviation should be the omission of the full stops between the letters, viz. rms.

As regards the abbreviation for cycles per second, viz. c/s, kc/s, and Mc/s, it has been claimed that there is an illogicality here and that kc/s should be Kc/s. I think it is illogical, but kilometre is always abbreviated as km, and I have never heard a convincing case for changing the small k to capitals.

If there were any change I should prefer it to be due to an agreement with the American Standards Association. The current American standard for cycles per second is cps "which may be further abbreviated to c or C in combinations"; for example, kc or KC for kilocycles per

second. Personally, I dislike intensely losing the "s."

I like the following American general principles:—

- the same abbreviation is used for both the singular and plural of a name;
- the same abbreviation is used both as a noun and as an adjective, and
- the period being omitted except where the omission would result in confusion.

For letter symbols (as distinct from abbreviations) in general there are almost as many possible standards as there are intelligent people willing to take the trouble to work out a logical system. May I advance the plea that when a standard has been published by the B.S.I., people should cease using their private system and conform to the published standard. By this means the standard will be improved by their constructive criticism. BS 1409:1947 for electronic valves is a young standard. I strongly support Mr. Godfrey's statement that no author should be without it, and its application is essential if chaos is to be avoided.

Yours faithfully,

J. READING,
London, E.C.1.

Slaves of Standardization?

DEAR SIR,—Two forms of abbreviation are commonly used for units based on the metric system; orthographic and technical.

In orthographic abbreviations, the spelling is shortened according to custom or the light of nature, as in ma. and cms. Technical abbreviations, on the other hand, are formed according to a well defined rule which adds standard prefixes to a capital letter standing for the unit concerned, giving mH, pF, and KM for example.

The technical form of abbreviation has obvious merits, but these are less apparent to the Buying Office and the Typing Pool who, being inadequately equipped, are far too busy to fiddle with technical niceties and the Greek alphabet, much prefer to deal with orders for 8 mfd. condensers and 2 meg. resistors.

Both forms of abbreviation thus have their uses, but it is better not to mix them as your correspondent, Mr. Godfrey, seems satisfied to do. In particular, if there can be only one symbol for tenths of a bel, as he so strongly insists, consistency in technical abbreviation must make this dB and not the orthographic variant db.

Yours obediently,

F. CAMPBELL ROSE,
Bushey Heath, Herts.

The author replies:

DEAR SIR.—Mr. Campbell Rose confuses symbols or conventional signs with abbreviations.

This is obviously from his reference to the Greek alphabet which is often used for symbols but not for abbreviations.

Standard abbreviations present no difficulty to the typist, whether the abbreviations are orthographic or technical; symbols are in a different category and cannot be reproduced without printing devices.

Adherence to custom and "the light of nature" (whatever that means) is the antithesis of British Standards and the reason for their existence. Many of them are open to criticism, but at least they represent a consensus of expert opinion. I have nothing to do with their production, but use them in the interest of uniformity. I find it no more difficult to use mA, cm or kM than the alternatives used by Mr. Campbell Rose.

My heart bleeds for the decibel; it has long since lost its parent and your correspondent does not even give the parent a capital initial, except in his abbreviation.

Yours faithfully,

J. W. GODFREY,
London W.1.

Mutual Inductance Between Coaxial Coils of Equal Diameter

DEAR SIR,—The simple empirical formula¹ for the inductance of a solenoid of radius r inches, length l inches and a total of N turns

$$L = \frac{0.1 r^2 N^2}{l + 0.9r} \dots\dots\dots (1)$$

is probably well known but it does not appear to have been realized that from this same formula can be derived simple expressions for the mutual inductance between two parts of a continuous coil or between two coaxial coils of equal diameter spaced apart. The accuracy of the derived expressions is governed by the accuracy of the original formula which, according to Wheeler, has an error of less than 1 per cent when l/r exceeds 0.8 or less than 4 per cent when l/r is greater than 0.4. Under normal circumstances the derived expressions for mutual inductance will tend to be more accurate than can be determined by total inductance measurements, which involve the difference of two large quantities.

Referring to the tapped coil shown in Fig. 1, the inductance of the complete coil (L_t) and its parts (L_1 and L_2) may be determined from (1) and from these results mutual inductance may be calculated as follows.

$$M = \frac{1}{2} [L_t - L_1 - L_2]$$

$$= \frac{1}{2} \left[\frac{0.1r^2 N_t^2}{l_t + 0.9r} - \frac{0.1r^2 N_1^2}{l_1 + 0.9r} - \frac{0.1r^2 N_2^2}{l_2 + 0.9r} \right]$$

where $l_t = l_1 + l_2$.

rotated. A typical "Rotator" is described and illustrated.

Recording and record playing equipment and circuits are described fairly thoroughly in Chapters 13, 14 and 15. Many modern changers, including slow speed ones, are illustrated.

Chapter 16 is a poor one about mechanical construction of receivers. The type of reader who would read this book is hardly likely to gain much from such photographs as the one of a blank chassis used in a midget A.C./D.C. receiver (Fig. 16-14), or the photographs and drawings of cabinets.

The Preface and loose cover imply that the book is written for courses in technical schools, the Armed Forces and home study. This reviewer thinks it is much better for students to learn fundamental facts about circuits and avoid the danger of considering, say, aerial, A.M. I.F., F.M. I.F., and television tuned circuits as being quite different, as this book tends to do. For this reason there is considerable repetition and overlapping in the book. The book is claimed to be non-mathematical, and is nearly so. When figures are used they often make things more difficult rather than help, as mathematics surely should. One example is on Page 150 where oscillator tracking is "explained". To show why different L.C. values are needed for aerial and oscillator circuits an example is given of the M.V. band. Instead of explaining values in terms of the ratio of the extreme frequencies covered by each circuit, the writers become involved in the kc/s covered as a percentage of the lowest frequency of each unit. They then say that the mixer frequency shift ratio is almost twice that of the oscillator (it is actually about 3:2) and that for this reason a smaller coil and tuning capacitor must be used. Actually, of course, it is only the square root of the effective ratio of the extremes of capacitance of the tuning capacitor plus strays which determines the ratio of the extreme frequencies. The section also contains such loose and misleading statements as "If the coil is slug tuned, a slug adjustment may take the place of the padder capacitor" and "... padder (capacitor) adjustment effectively adjusts the inductance in the unit".

The book is, however, very readable and for this reason may appeal to many people who would like to know more about radio, but who do not like serious study.

C. H. BANTHORPE

Sound Film Projection

By F. W. Campbell, T. A. Law, L. F. Morris and A. T. Sinclair. Edited by E. Molloy. 4th Edition, revised and enlarged. 330 pp. + 8 pp. index. 228 illus. Geo. Newnes Limited. 1951. Price 30s.

BY the time a book of this character has reached four substantial editions in six years it may well be considered to have reached the status of a standard text-book on the subject. On the other hand rapid developments in the whole field of projection of pictures with sound for public entertainment and instruction obviously necessitate continual revision. The Editor would appear to have been particularly fortunate in his choice of four contributors for this subject since each is drawn from one of the major

companies providing equipment of the type described in the book.

Those engaged in the motion-picture projection industry will be well advised to study the entirely new section which has been added in this latest edition dealing with the problems of television projection equipment, which is by no means abstruse, on the contrary, it is eminently practical. Although necessarily short, the section, illustrated with diagrams and with photographs well up to the standard of the rest of the book, deals very adequately with this new development.

Apart from its use as a general reference book this volume should certainly be in the hands of all newcomers to the industry as a necessary adjunct to their proper training.

S. W. BOWLER

The Waveguide Handbook

Edited by N. Marcovitz. 428 pp. 1st Edition. McGraw-Hill Publishing Company. 1951. Price 64s.

THIS is one of the last of the Radiation Laboratory Series written by the war-time staff of the Massachusetts Institute of Technology and, like the other volumes of the series, it is a worthy addition to the literature on microwaves. Its object is to make available the results of the enormous amount of theoretical work done by Professor Schwinger and his colleagues, of whom the editor of this book was one. It is all the more welcome because much of the information it contains has until now been available only in classified reports.

The fundamental theme of the book is that the problems encountered in microwaves can be reduced to equivalent circuits which can then be analysed by well-known methods. A normal waveguide, for example, is analogous to a conventional transmission line and this analogy is the subject of the first two chapters. The description of the fields within the guides is not ignored, however, and numerical tables and field plots provide all the information likely to be required.

The full value of the equivalent circuit representation becomes apparent in the third chapter when the subject of waveguide discontinuities is introduced. The exact solution of such problems would entail the specification of the electromagnetic field at all points in the guide—such a detailed description is of little value to the engineer and the advantage of the equivalent circuit representation is that the essential properties of the discontinuity can be specified by a small number of parameters, usually in the form of reactances. There is a section on the methods by which these parameters may be deduced from the measurements of standing-waves (the actual measurement techniques are not discussed as they form the subject of another volume of the series), and it is followed by a description of the ways of calculating the parameter. These two sections are particularly valuable and could well be expanded in the next edition.

The remainder of the book is devoted to numerical results on a variety of junctions, irises, bends, and similar waveguide components. In each case, a diagram of the equivalent circuit is followed by analytical expressions for

CHAPMAN & HALL

FUNDAMENTALS OF AUTOMATIC CONTROL

by

G. H. Farrington
B.Sc., A.C.G.I.

300 pages 169 figures 30s. net

Primarily intended for those interested in any of the applications of automatic control, the book gives a general survey of the wide field which such applications may involve.

REPORT WRITING

by

Carl G. Gaum
Harold F. Graves
Lyne S. S. Hoffman

384 pages 18 figures 35s. net

For all whose work involves the preparation of clear and accurate reports, this book will prove a most valuable guide.

37 ESSEX STREET, LONDON, W.C.2.

Just Published

The latest
"Electronic Engineering"
monograph

RESISTANCE STRAIN GAUGES

By J. Yarnell, B.Sc., A.Inst.P.
Price 12/6

This book deals in a practical manner with the construction and application of resistance gauges and with the most commonly used circuits and apparatus. The strain-gauge rosette, which is finding ever wider application, is treated comprehensively, and is introduced by a short exposition of the theory of stress and strain in a surface.

Order your copy through
your bookseller or direct from

Electronic Engineering

28 ESSEX STREET, STRAND,
LONDON, W.C.2.

BOOK REVIEWS (Continued)

the circuit components. A brief description of the method by which these expressions were obtained is accompanied by a statement of the conditions under which they are valid. Numerical results are presented either in the form of tables or as curves, which have been prepared with great care and can be read with the greatest of ease. Where the theory is incomplete, it is supplemented by experimental results. The reviewer has been unable to examine all these results in detail, but the ones which have been inspected have been found to cover all the ranges of guide signs and wavelengths in common use. This book is essentially one for reference and will undoubtedly be in constant use in any laboratory where microwave work is in progress. Naturally there are some omissions, but it would be churlish to complain of these when such a wealth of information is presented. The only major criticism is that there is a lack of references, but the editor has promised to rectify this in a subsequent edition.

J. BROWN

Pianos, Pianists and Sonics

By G. A. Briggs. 192 pp. Chapman & Hall Ltd. 1951. Price 21s.

MR. BRIGGS scored an immediate hit with his previous books on sound reproduction and allied subjects. This latest venture is somewhat more heterogeneous in texture, but there is a core of considerable technical interest.

A neat summary of the history and construction of the piano leads to several sections dealing with touch and tone, harmonic analysis, room acoustics and sundry forms of vibration. These represent much painstaking work on the part of the author, and to many, these features will be well worth the price of the book. No attempt is made to place many of the author's observations on too academic a footing, as indeed must follow when so large a part of the subject matter properly lies in the sphere of art, and, consequently, personal assessment.

At the foot of page 89, a suggestion is put forward for obtaining harpsicord-like tones from a piano. For a number of years, when the John Compton Organ Co. provided a grand piano playable from the console of their theatre organs, an electro-mechanical device laid a very light chain across the strings when required, thus simulating the effect Mr. Briggs mentions.

Perhaps it would be regarded as too technical to explain how the starting transients and accompanying noise range are generated; nevertheless these can be seen in some of the photographs and contribute appreciably to the fidelity of piano tone. A more comprehensive bibliography would help here. The author is a little unkind to the more advanced American makers now using cast aluminium frames; this reviewer has heard first-class pianos using these

methods as well as plastic keys and all-metal action, and could not agree there was any degradation of tone; but it is recognized that tonal standards are entirely a matter of personal taste.

Whether the technical reader is interested in the fact that the author has consumed 40 pianos in his lifetime, or in how seven concert pianists attained their present status, is a moot point; it certainly lends variety to this book, which can be recommended to all interested in how a piano is made the way it is, and why.

ALAN DOUGLAS

Audio Handbook No. 1—Amplifiers

By N. H. Crowhurst, A.M.I.E.E. 64 pps. 38 figures. Norman Price (Publishers), Ltd. 1951. Price 3s. 6d.

THIS book is neither a theoretical treatise on the design of amplifiers, nor yet a constructional manual. It is in fact intended as a guide to "trouble shooting" for the constructor who has built an amplifier and then finds that it does not work properly. To this end a trouble tracing guide has been included which refers the reader to the appropriate chapter in the book.

In the various chapters the most common causes of trouble (e.g. distortion, instability, hum, intermodulation, etc.), are dealt with in some detail, and sufficient basic theory is given to enable the constructor to locate the trouble and to apply an intelligent remedy.

Fifty Years of British Standards

103 pp. British Standards Institution. August, 1951. Price 10s. 6d.

THIS attractive volume contains a most interesting record of the British Standards movement since its origin in 1901. It was then known as the Engineering Standards Committee. Its development is traced through the foundation of the British Standards Institution, the part played by Standards in two world wars, its expansion and influence abroad up to the present day.

The book pays tribute to some of the brilliant figures in industry, science and the arts who have helped to build the movement during its half-century of existence. A valuable chapter on the relationship between standardization and research is also included.

The reviewer considers that the book fulfils its purpose—to publicize the work of the Institution and its value in this industrial age—in a pleasant and very readable manner.

Modern Valve Comparison Manual

Compiled by B. B. Babani. 64 pp. Bernard's (Publishers) Ltd. 1951. Price 3s.

THIS small book is No. 98 of Bernard's Radio Manuals, and has been issued owing to the great increase in the number of new valves produced by British and American manufacturers during the last few years.

The book is in three parts: part 1 is an index of British and American valves having direct equivalents; part 2 is a complete equivalents list of British and American types, and part 3 is an extensive list of British and American Navy, Army, Air Force and C.V. types with their commercial equivalents.

Osram Valve Manual—Part I

255 pps. April, 1951. The General Electric Co. Ltd. Price 5s.

THE full operating data and characteristic curves for the Osram and G.E.C. range of receiving valves, cathode-ray tubes, photo-electric cells, Geiger-Muller tubes, regulator tubes and crystal valves are given. Typical circuit diagrams for various types of audio amplifiers and R.F. units are also included.

Data on transmitting and larger industrial valves will be given in Part II of the Osram Valve Manual which will be published shortly.

A Comprehensive Radio Valve Guide

By W. J. May. 52 pp. Bernard's (Publishers) Ltd. 1951. Price 5s.

THIS valve guide gives details of the base connexions and "typical operating conditions" of over 200 valves, which include most of the English and American receiving valves, C.R.T.s and voltage and current stabilizers at present in use. It thus provides a handy reference guide, although the information is not, of course, sufficient for design purposes.

The Radio Handbook

Edited by R. L. Dawley. 736 pp. 13th Edition. Editors and Engineers, U.S.A. 1951. Price \$6.50.

THE thirteenth edition of this handbook resembles very closely the previous editions. It has, however, been revised and new sections have been added to cover modern developments. The method of presentation is very similar to that of the Radio Amateur's Handbook.

Approximately two-thirds of the book is devoted to basic theory, while the remainder consists of constructional details of various pieces of equipment, such as transmitters and modulators. Although a very large amount of ground is covered there is not sufficient detail on any subject for it to be of use to the serious student or designer.

"Wireless World" Diary 1952

80 pp. reference material. Diary pages of a week to an opening. Hiffe and Sons Ltd. October, 1951. Price 6s. 1½d. (Morocco leather) or 4s. 3½d. (Rexine).

THE 80 pages of reference material contains general information and addresses of radio organizations in the United Kingdom and abroad, design data and technical information in every day use.

The section on technical data includes formulae ranging from Ohm's Law to P.A. power requirements; abacs for the graphical estimation of data such as coil windings and circuit constants; circuit diagrams varying from simple detector circuits to a 90Mc/s convertor, and details of television and F.M. aeri-als.

NOTES FROM THE INDUSTRY

Inter-Commonwealth Post-Graduate Scholarships in Science. The Royal Society Empire Scientific Conference and the British Commonwealth Scientific Official Conference in 1946 recommended the preparation of a list of post-graduate scholarships available for scientific study within the Commonwealth. The task of compiling the list was assigned to the British Commonwealth of Nations Scientific Liaison Offices in London.

When B.C.S.O. (London) opened in 1948 consideration was given to implementation of the recommendation. Thanks to the generous co-operation of universities, institutions and Government departments throughout the Commonwealth the publication "Inter-Commonwealth Post-graduate Scholarships in Science" has now been completed.

Since the main objective of the list is to encourage the movement of scientists within the Commonwealth, only those awards open to members of at least one Commonwealth country or Colony, other than the awarding one, has been included.

The entries are set out in tabular form showing, in addition to the names of the scholarships and the agencies awarding them, details of the fields of study, where tenable, duration and value, closing dates for applications and the addresses to which these should be sent. There are more than 350 separate entries in the list: many of these cover a number of scholarships so that the total number of available awards is much greater. The list is therefore a valuable work of reference for students and educational authorities.

It is published on behalf of B.C.S.O. (London) by His Majesty's Stationery Office, price 5s.

A Commemorative Plaque to John Logie Baird was recently erected by the L.C.C. on the front of 22 Frith Street, Soho. The plaque is circular in shape and the inscription reads: "London County Council. In 1926 in this house John Logie Baird, 1888-1946, first demonstrated television."

Baird was born in Scotland and was educated at the Royal Technical College, Glasgow. He came south to Hastings, where a house in Queen's Avenue bears a plaque recording the experiments in television which he conducted there in 1924. The beginning of 1926 found the inventor in an attic laboratory in Frith Street over the rooms of a Mr. Cross, owner of Cross's Pictures, Ltd. On Tuesday, January 26 of that year he carried out the world's first demonstration of television before an audience consisting of some 40 members of the Royal Institution. The image was transmitted from one room to another. The apparatus which Baird used is now in the Science Museum.

The Electrical Industries Benevolent Association's Annual Ball will be held on Friday, December 7, at the Midland Hotel, Manchester, from 7.15 p.m. to 1 a.m. (dinner at 8 p.m.). Applications for tickets, price £2 5s. each, should be made to Mr. Claude Brookes, Salford Electrical Instruments, Ltd., Peel Works, Silk Street, Salford 3.

The Television Society's Annual Exhibition for 1951 will be held on December 28-29 in the basement of Century House, Shaftesbury Avenue, London, W.C.2, by kind invitation of Mullard, Ltd. The exhibition will be open on December 28 for members and their friends from 6 p.m. to 9.30 p.m. On December 29, it will be open to the public by invitation ticket from 10.30 a.m. to 9 p.m. Light refreshments will be available.

The Kelvin Gold Medal for 1950 has been awarded to Dr. Theodore von Karman, F.R.S., Professor of Aeronautics and Director of the Guggenheim Aeronautical Laboratory of the California Institute of Technology, in recognition of the eminent services he has rendered to engineering science in those branches of engineering work with which Lord Kelvin was especially identified, and to commemorate which this medal was instituted.

Director General of Electronics Production.—Mr. N. C. Robertson, M.B.E., F.R.S., A.I.E.E., deputy managing director of E. K. Cole, Ltd., recently accepted the position of Director General of Electronics Production. This position makes him responsible for the production of all radio, radar, telecommunication and electronic equipment for the Ministry of Supply.

The British Institution of Radio Engineers has been honoured by His Royal Highness the Duke of Edinburgh, K.G., F.R.S., accepting Honorary Membership of the Institution.

Mr. Clifford, the secretary of the Brit. I.R.E. has been visiting India during November in order to establish sections of the Institution to operate under an Indian Advisory Committee. It is planned to hold a Convention of Indian members in Bombay in February, 1952 for the presentation of local and other papers intended to show the development and applications of radio and electronic engineering in India in both the communications and industrial fields.

British Electronic Industries, of 28 Upper Richmond Road, London S.W.15, announces that the business formerly carried on under this name has been changed, and is now known as Allied Electronics, Ltd.

B.B.C. Engineering Information Department Appointment. Mr. P. E. F. A. West of the B.B.C. Engineering Information Department has recently been appointed Assistant to the Chief Engineer, and Mr. M. G. Foster has taken over his previous post.

New Managing Director of E.M.I. Research Laboratories, Ltd. The appointment of Mr. G. E. Condliffe, O.B.E., B.Sc., M.I.E.E., as managing director of E.M.I. Research Laboratories, Ltd., was announced recently.

High Definition Films, Ltd. A company called High Definition Films, Ltd., has recently been formed for the development of the use of electronic film cameras. The directors of the company are as follows: Mr. Norman Collins, Viscount Duncannon, Mr. T. C. Macnamara, Mr. A. D. Peters, Sir Robert Renwick, Bart. K.B.E., and Mr. C. O. Stanley, C.B.E.

An Electronic Digital Computer. We regret that an error occurred on page 341 of the September, 1951 issue in the circuit of Fig. 8. The grid of V11 should be connected through rectifiers to cathodes No. 0, 1, 7 and 8 of the scaling tube, and not to No. 0, 1, 8 and 9 as shown.

Since the article was prepared, a twelve cathode scaling tube, Ericsson Type GS12A has superseded the GS11A and is now used in the translator circuit. The ten cathode tube used throughout for numerical storage is still Ericsson Type GC10A.

Errata. We regret that an error occurred on page 435 of the November issue. In the caption marked (Top left) the main transmitter power should read 45kW not 13/88kW. In the October issue on page 409, the price of "Fractional Horse Power Motors" was given as 52s. It should have been 30s.

BINDING OF VOLUMES

Arrangements have now been made for a binding service starting with the 1951 volume at an inclusive charge of £1.

Copies will be bound, complete with index and with advertising pages removed, in a good quality red cloth covered case blocked in gold on the spine.

Home and Overseas readers who wish to have their copies bound are asked to comply with the following instructions:—

(1) Tie the twelve issues (January to December, 1951) securely together before parcelling.

(2) Enclose a remittance for £1 and a gummed label bearing the sender's name and address.

(3) Enclose the copies, remittance and label in a closed parcel and address to:—

The Circulation Dept. (E.E. Binding),
28, Essex Street,
Strand, London, W.C.2.

(No other correspondence is necessary)

* * * * *

The following are also available from our Circulation Dept. :—

A limited number of Bound Volumes for 1951. Price two guineas, post free.

Binding Cases for the 1951 volume. Price 5s., postage 6d.

The Index for Volume XXIII (1951), free.

"Easibind" Cases for binding current issues, or complete volumes. Price 12s. 6d., postage 6d.

MEETINGS THIS MONTH

THE BRITISH INSTITUTION OF RADIO ENGINEERS

London Section
Date: December 13. Time: 6.30 p.m.
Held at: London School of Hygiene and Tropical Medicine, Keppel Street, London, W.C.1.
Lecture: Electronic Analogues of Physiological Processes.
By: W. Grey Walter, M.A., Sc.D. and H. W. Shipton, A.M.Brit.I.R.E.

Scottish Section
Date: December 6. Time: 7 p.m.
Held at: Institution of Engineers and Shipbuilders, Glasgow.
Lecture: Automatic Precision Temperature Recorders incorporating the Electronic Potentiometer.
By: C. H. Offord.

Merseyside Section
Date: December 6. Time: 7 p.m.
Held at: Electricity Service Centre, Whitechapel, Liverpool.
Lecture: Multi-Station V.H.F. Communication Systems using Frequency Modulation.
By: W. P. Cole, B.Sc. and E. G. Hamer, B.Sc., A.M.Brit.I.R.E.

North Eastern Section
Date: December 12. Time: 6 p.m.
Held at: Neville Hall, Newcastle-on-Tyne.
North Eastern Television Convention.

South Midlands Section
Date: December 12. Time: 7.15 p.m.
Held at: Corporation Street Civic Restaurant, Coventry.
Lecture: Improvements in and relating to Loud-speaker Design.
By: R. T. Lakin, A.M.Brit.I.R.E.

West Midlands Section
Date: December 18. Time: 7 p.m.
Held at: Wolverhampton and Staffordshire Technical College.
Lecture: Use and Application of Industrial H.F. Heaters.
By: F. W. Budge.

BRITISH SOUND RECORDING ASSOCIATION

London Meeting
Date: December 21. Time: 7 p.m.
Held at: Royal Society of Arts, John Adam Street, London, W.C.2.
Members Night: Short papers on "Hot Stylus Technique," "Pick-up Tracking Errors," etc., followed by discussions.

Portsmouth Centre
Date: December 20. Time: 7 p.m.
Lecture: Building High Fidelity Amplifiers.
By: S. Goodsell.

THE INSTITUTE OF NAVIGATION

Date: December 21. Time: 5 p.m.
Held at: The Royal Geographical Society, 1 Kensington Gore, London, S.W.7.
Lecture: Meteorology and Navigation.
By: Lt. Commander P. G. Satow, D.S.C., R.N.

THE INSTITUTE OF PHYSICS

Electronics Group
Date: December 11. Time: 5.30 p.m.
Held at: The Institute's House, 47 Belgrave Square, London, S.W.1.
Lecture: Recent Research in Electron and Particle Excited Luminescence and its Practical Significance.
By: Dr. G. F. J. Garlick, F.Inst.P.

London and Home Counties Branch
Date: December 12. Time: 5.30 p.m.
Held at: The Royal Institution, London.
Lecture: The Early Days of Radar.
By: Sir Robert Watson-Watt, C.B., F.Inst.P., F.R.S.

North Eastern Branch
Date: December 6. Time: 6.15 p.m.
Held at: King's College, Newcastle-on-Tyne.
Lecture: Forty Years in Industrial Research.
By: Dr. B. P. Dudding, M.B.E., F.Inst.P.

Scottish Branch
Date: December 11. Time: 7 p.m.
Held at: The University, Glasgow.
Lecture: Using an Automatic Calculating Machine.
By: Professor D. R. Hartree, F.Inst.P., F.R.S.
Date: December 12. Time: 7 p.m.
Held at: The University, Edinburgh.
Lecture: As in Glasgow.

INSTITUTION OF ELECTRICAL ENGINEERS

Unless otherwise stated, all London meetings will be held at the Institution, Savoy Place, London, W.C.2, at 5.30 p.m.

Radio Section

Date: December 5.
Lecture: An Investigation into the Mechanism of Magnetic-Tape Recording.
By: P. E. Axon, O.B.E., M.Sc.
Date: December 17.
Informal Lecture: What Practical Benefits can Communication Engineers expect from the Modern Information Theory?
By: E. C. Cherry, M.Sc.(Eng.).

Measurements Section

Date: December 6.
Discussion on: The Servicing of Electrical Instruments in Large Industrial Undertakings.
Opened by: A. J. Young.
Date: December 11.
Lecture: A Graphical Analysis for Non-linear Systems.
By: Miss Pei-Su Hsia, Ph.D., B.Sc. (To be read by Professor M. G. Say, Ph.D., M.Sc.)
Lecture: A System of Utilizing Coarse and Fine Position Measuring Elements Simultaneously in R.P.C. Servo-Mechanisms.
By: J. C. West, B.Sc.

Education Discussion Circle

Date: December 12.
Discussion on: Activity Methods in Technical Education.
By: R. D. Watts, B.Sc.

Utilization Section

Date: December 13.
Lecture: The Characteristics and Control of Rectifier-Motor Variable Speed Drives.
By: P. Bingley.

Supply Section

Date: December 19.
Lecture: Inhibited Transformer Oil.
By: W. R. Stoker, B.Sc.(Eng.) and C. N. Thompson, B.Sc.
Lecture: The Stability of Oil in Transformers.
By: P. W. L. Gossling, B.Sc. and L. H. Welch, B.Sc.(Eng.).

District Meetings

Date: December 3. Time: 7.30 p.m.
Held at: The Royal Hotel, Norwich.
Lecture: A summary of two papers—"Standardization and Simplification in the Electrical Industry" by J. T. Moore, B.Sc. and "An Organization for Internal Standardization in a Large Manufacturing Company" by P. J. Daglish, B.Sc.
By: P. J. Daglish, B.Sc.

East Midland Centre

Date: December 19. Time: 7.15 p.m.
Held at: De Montford Hall, Leicester.
Faraday Lecture: Sound Recording—Home, Professional, Industrial and Scientific Applications.
By: G. F. Dutton, Ph.D., B.Sc.(Eng.).

Cambridge Radio Group

Date: December 4. Time: 8.15 p.m.
Held at: The Cavendish Laboratory, Cambridge.
Informal Lecture: What Practical Benefits can Communication Engineers expect from the Modern Information Theory?
By: E. C. Cherry, M.Sc.(Eng.).

Mersey and North Wales Centre

Date: December 3. Time: 6.30 p.m.
Held at: The Liverpool Royal Institution, Colquitt Street, Liverpool.
Lecture: The London-Birmingham Television-Cable System.
By: T. Kilvington, B.Sc.(Eng.).

North Eastern Radio and Measurements Group

Date: December 3. Time: 6.15 p.m.
Held at: King's College, Newcastle-on-Tyne.
Lecture: The Life of Oxide Cathodes in Modern Receiving Valves.
By: G. H. Metson, M.C., Ph.D., M.Sc., S. Wagener, Dr.Phil., M. F. Holmes, B.Sc. and M. R. Child.
Date: December 17. Time: 6.15 p.m.
Held at: King's College, Newcastle-on-Tyne.
Lecture: Summary of the papers read at the Conference on "Electrical Instrument Design."
By: G. E. Moore.

North Western Measurements Group

Date: December 18. Time: 6.15 p.m.
Held at: The Engineers' Club, Albert Square, Manchester.
Lecture: Some Special Characteristics of Soft Magnetic Materials Used in Instrument Manufacture.
By: G. A. V. Sowter, Ph.D., B.Sc.(Eng.).

North Lancashire Sub-Centre

Date: December 12. Time: 7 p.m.
Held at: The North Western Electricity Board Demonstration Theatre, Darwen Street, Blackburn.
Lecture: Standardization and Simplification in the Electrical Industry.
By: J. T. Moore, B.Sc.

Scottish Centre

Date: December 11. Time: 7 p.m.
Held at: The Institution of Engineers and Shipbuilders, 39 Elmbank Crescent, Glasgow.
Lecture: Nuclear Particle and Radiation Detectors.
By: D. Taylor, M.Sc., Ph.D. and J. Sharpe, B.Sc.

North East Scotland Sub-Centre

Date: December 12. Time: 7.30 p.m.
Held at: The Caledonian Hotel, Union Terrace, Aberdeen.
Lecture: A Survey of Modern Methods of Presentation of Instrument Readings and Recordings.
By: L. B. S. Golds.
Date: December 13. Time: 7 p.m.
Held at: The Royal Hotel, Union Street, Dundee.
Lecture: As at Aberdeen.

South Midland Centre

Date: December 3. Time: 6 p.m.
Held at: The James Watt Memorial Institute, Great Charles Street, Birmingham.
Lecture: The Sutton Coldfield Television Broadcasting Station.
By: P. A. T. Bevan, B.Sc. and H. Page, M.Sc.
Lecture: The Vision Transmitter for the Sutton Coldfield Television Station.
By: E. A. Nind, B.Sc. and E. McP. Leyton.
Date: December 18.
Held at: The Town Hall, Birmingham.
Faraday Lecture: Sound Recording—Home, Professional, Industrial and Scientific Applications.
By: G. F. Dutton, Ph.D., B.Sc.(Eng.).

Western Centre

Date: December 10. Time: 6 p.m.
Held at: South Wales Institute of Engineers, Park Place, Cardiff.
Lecture: The Life and Work of Oliver Heaviside.
By: Professor G. H. Rawcliffe, M.A., D.Sc.

THE INSTITUTION OF ELECTRONICS

Southern Branch

Date: December 5. Time: 6.30 p.m.
Held at: University College, Southampton.
Lecture: Germanium Crystal Valves: Their Characteristics and Applications.
By: B. R. Bettridge.
Date: December 12. Time: 7 p.m.
Held at: H.M.S. Phoenix, Stansham, Portsmouth
Lecture: Ionization and Nuclear Bombardment.
By: R. E. Ward, A.C.G.I., Wh.Sch.

INSTITUTION OF POST OFFICE ENGINEERS

Date: December 7. Time: 5 p.m.
Held at: The I.E.E., Savoy Place, London, W.C.2.
Lecture: The Application of Machinery to the Sorting of Parcels.
By: P. E. C. Smith, B.Sc., A.M.I.E.E. and H. J. Langton, A.M.I.E.E.

RADIO SOCIETY OF GREAT BRITAIN

Date: December 18. Time: 6.30 p.m.
Held at: The Institution of Electrical Engineers, Savoy Place, W.C.2.
Annual General Meeting.

THE TELEVISION SOCIETY

Date: December 6. Time: 7 p.m.
Held at: The C.E.A., 164 Shaftesbury Avenue, London, W.C.2.
Lecture: Television Receiver Design for British and European Systems—A Comparative Study.
By: B. R. Overton, B.Sc.

Listen to the radio in **EVERY** room

— for as little as 42/-



ONE Stentorian Speaker will enable you to enjoy perfect listening in every room. Simple wiring and a 2 amp. socket in each room, easily and cheaply fixed, mean a Stentorian can become your portable radio, providing entertainment in any room in the house, for as little as 42/-. Reproduction is, in most cases, better than that given by the set itself.

Send for leaflets or, better still, ask your usual dealer to demonstrate.

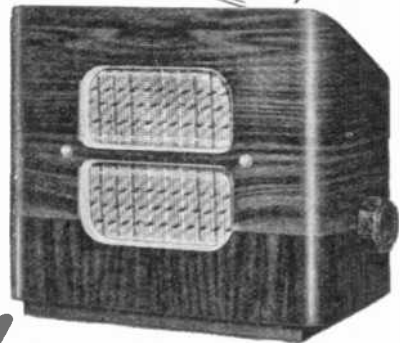

● Illustrated here is the Bude, price 42/-. Other models include the remote control button which, in conjunction with the 'Long Arm' Remote Control, enables the Radio to be switched on or off from any room in the house.

Stentorian EXTENSION SPEAKERS

WHITELEY ELECTRICAL RADIO CO. LTD · MANSFIELD · NOTTS

★ *The Basis of*  *World Standards*

TELCON R.F. CABLES

Technical excellence supported by constant research and an unrivalled knowledge and experience of Radio Frequency Cable applications, ensures the continuance of the lead established by TELCON in this field.

Even before the introduction of Telcothene* as a cable dielectric, an application pioneered by TELCON, a range of Radio Frequency cables with unique capacity and attenuation characteristics was produced, using Telconax.

Today, developments are still going on and the solution of any problems involving the application of Radio Frequency cables will be found in the wide range manufactured by TELCON.

★ *Telcothene (Regd.)—Polythene processed by Telcon to provide specific characteristics*

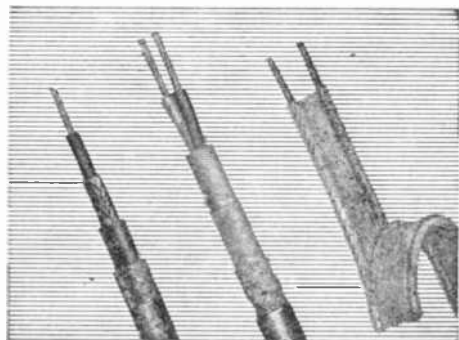

Ask also for details of
TELCON METALS

THE TELEGRAPH CONSTRUCTION & MAINTENANCE CO. LTD 

Head Office : 22, Old Broad Street, London, E.C.2. Tel : LONDON Wall 7104

Enquiries to : Telcon Works, Greenwich, S.E.10. Tel : GREENWICH 3291 

NAGARD HIGH GAIN D.C. AMPLIFIERS



NOTE
NEW ADDRESS

NAGARD
LTD

18, AVENUE RD., BELMONT, SURREY
Telephone No. : Vigilant 0345.

UNIT DESIGN provides for interchange of Amplifier Units fed from a common power unit, which is adjustable for constant voltage over wide range of mains variations.

Each amplifier unit is voltage calibrated by the D.C. Level Control to 5 per cent accuracy and provides push-pull output suitable for undistorted display on 6-in. C.R.T.

TYPE	RESPONSE	GAIN
103/12	0—1 Mc/s	20,000
103/13	0—200 Kc/s	100,000

Both the above are modulated carrier D.C. Amplifiers with two push-pull input channels and our step attenuators.

Type 103/2—Response 0—10 Mc/s, rise time 0.05 μ sec., gain over 200, push-pull output 130 V, can be supplied with cathode follower probe unit for signals up to 50 volts.

FOR THE DISPLAY AND MEASUREMENT OF ALL PHENOMENA WHICH CAN BE TRANSLATED INTO ELECTRICAL POTENTIALS

STABILISED POWER SUPPLY TYPE 705

THIS Unit provides a stabilised direct voltage, continuously variable from 200-350 volts, which may be used with either the positive or negative lines earthed or with the output floating. An unstabilised alternating supply of 6.3 volts, the centre tap of which may be strapped to earth, is also available.

Both voltage and current meters are incorporated to enable a continuous check to be kept on the operating conditions, and the instrument is suitable for either bench use or forward mounting on a standard 19 in. rack.

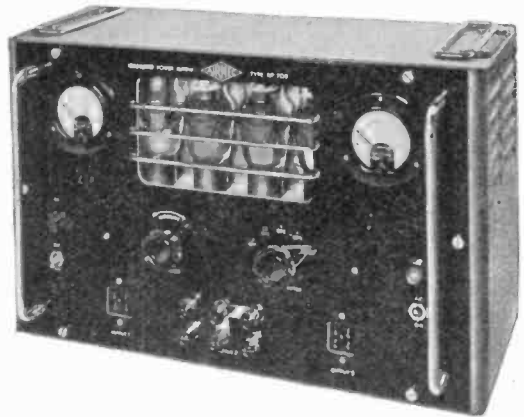

SPECIFICATION

Stabilised Output : Continuously variable from 200-350 volts at maximum currents of 200-100 milliamps.

Stability : $\pm 0.5\%$ for $\pm 10\%$ supply voltage change. +0, -0.5% from no load to full load.

Impedance : 5 ohms.

A.C. Output : 6.3 volts 5 amps.

Dimensions : 19 in. wide \times 12 in. high \times 8 $\frac{1}{2}$ in. deep.



Illustrated descriptive leaflets of this or any other Airtec instrument will be forwarded upon request

AIRTEC
LABORATORIES LTD.

HIGH WYCOMBE
Telephone: High Wycombe 2060

BUCKINGHAMSHIRE

ENGLAND
Cables: Airtec High Wycombe

A.T.M.

WIDE BAND MATCHING UNIT

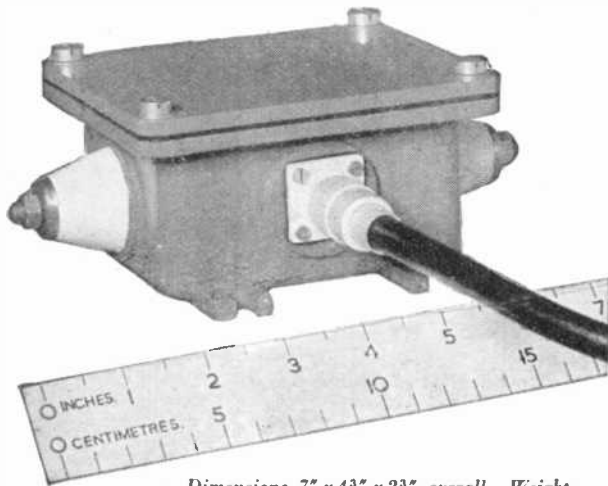

Dimensions 7" x 4½" x 2½" overall. Weight 4½ lb. approx. Construction complies with climatic and weather-proof requirements of the relevant Inter-Service specifications.

The "A.T.M." wide band matching unit is designed to meet the need for matching different impedances over an extensive frequency range. The type shown here is for matching a 600-ohm balanced open-wire feeder from a receiving aerial to a 75-ohm unbalanced coaxial cable. Alternative types can be provided for matching other impedance values, either balanced or unbalanced according to individual requirements. The units are compact and light in weight.

Please write for full details.

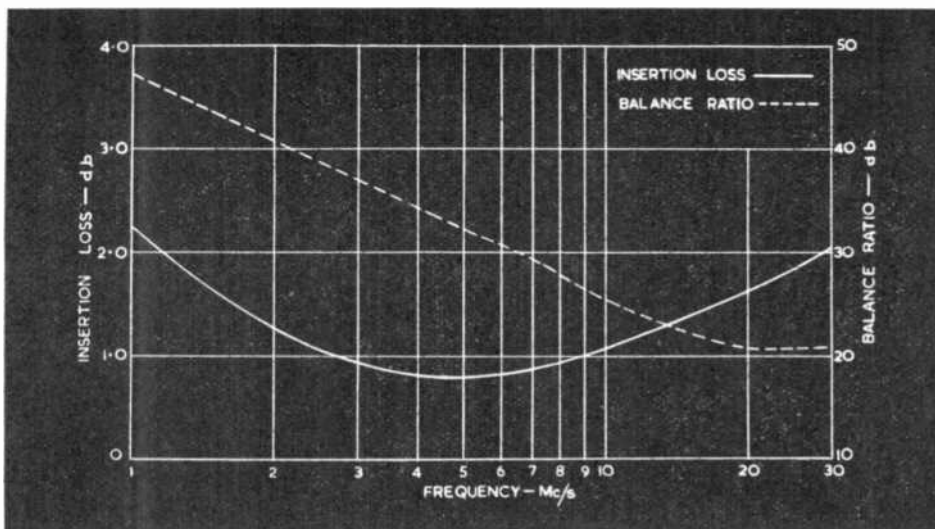

*Characteristics of Wide Band Matching Transformer.
600Ω Balanced: 75Ω Unbalanced. Power rating: 1 watt.*

AUTOMATIC TELEPHONE & ELECTRIC CO. LTD.

(RADIO & TRANSMISSION DIVISION)

Strowger House, Arundel Street, London, W.C.2



Telephone: TEMple Bar 9262

Telegrams: Strowgerex, London.

A14061-B 107



Backed by 50 years manufacturing experience Connollys range of winding wires are unsurpassed for quality. Whether the insulation consists of Enamel, Cotton, Silk or Rayon, strict technical control over every stage of manufacture—plus a priceless fund of experience—ensures uniformity of quality of the highest degree.

Send for free leaflets describing these products



FOR ALL TYPES OF WINDING WIRES

The largest manufacturer of fine enamelled wire in the world

CONNOLLYS (BLACKLEY) LTD.
MANCHESTER 9 CHEetham Hill 1801

London Office : 34 Norfolk Street, London, W.C.2

TEMple Bar 5506

Birmingham Office : 19 Bent Avenue, Quinton, Birmingham, 32.

WOODgate 2212

Austinlite 'Fifty'

50 amps at 450 volts A.C. (slow break). 20 amps at 250 volts D.C. (quick break). Also available with 6 or 8-way mechanism for tapping etc.

Austinlite 'Thirty'

30 amps at 250 volts A.C. (slow break). 15 amps at 440 volts A.C. (slow break). 5 amps at 230 volts D.C.

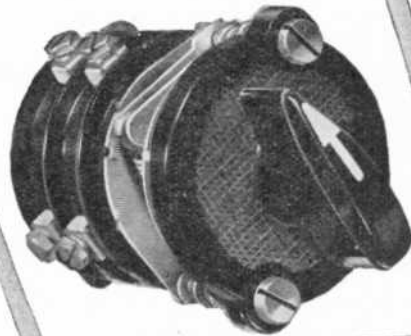

Austinlite switches are built for heavy duty.

Their intelligent use for all forms of motor control including reversing, star delta starting and dynamic braking can save the expense of separate contactors or relays.

For heater selection, on load transformer tap changing, or change-over switching, they are unrivalled. Why not

send us details of your switching problem?

Cut your control gear costs

Austinlite switches are used and specified by: The Admiralty; British Electricity Authority; The Air Ministry; British Broadcasting Corporation; General Post Office; Crown Agents for the Colonies; National Physical Laboratory; Royal National Lifeboat Institution and most of the leading electrical manufacturers in Great Britain.

A *Chance* PRODUCT

AUSTINLITE LIMITED (A subsidiary of Chance Brothers Limited)
 Dept. A.5, Lighthouse Works, Smethwick 40, Birmingham. Tel: West Bromwich 1824

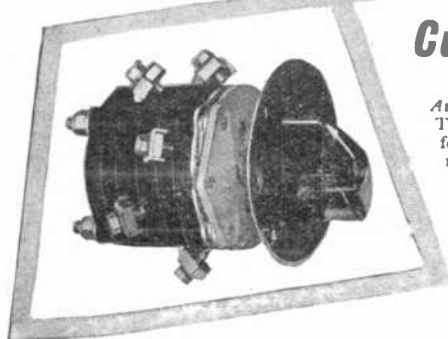

Put your name on our mailing list

for **TECHNIQUE**

A JOURNAL OF INSTRUMENT ENGINEERING

AVAILABLE FREE OF CHARGE

- Resistors
- Inductors
- Capacitors
- Attenuators
- Oscillators
- pH Meters
- Tuning Forks
- A.C. Bridges
- Key Switches
- Stud Switches
- Phonic Motors
- Galvanometers
- Control Knobs
- Standard Cells
- Wave Analysers
- Transformers & Chokes
- Instrument Dials
- Resistance Boxes
- Wheatstone Bridges
- Phototelegraphic Equipment
- Servo & Remote Control Equipment

- • • • TO RESEARCH WORKERS
- • • • TO TECHNICIANS
- • • • TO SCIENTISTS
- • • • TO ENGINEERS

and others who are interested in scientific and electronic instruments and their applications

**POST
THIS
COUPON
TODAY**

MUIRHEAD & CO., LTD.
BECKENHAM · KENT · ENGLAND

NAME

MAILING ADDRESS

COMPANY

POSITION

MUIRHEAD & Co., LTD.
PRECISION ELECTRICAL INSTRUMENT MAKERS
BECKENHAM · KENT · ENGLAND



Telephone : BFckenham 0041 Telegrams & Cables : MUIRHEADS ELMERS END

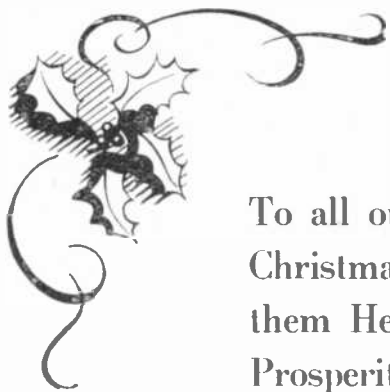

To all our friends we send
Christmas Greetings and wish
them Health, Happiness and
Prosperity in the coming year

from

GARDNERS RADIO *Ltd*
THE HOME OF
SOMERFORD & MINIFORD TRANSFORMERS

SOMERFORD · CHRISTCHURCH · HANTS · PHONE : CHRISTCHURCH 1025

**ACCURACY IS NOT
ENOUGH . . .**

The most accurate measuring instruments in the world are only of use if they can be read easily. A feature of the range of Pullin Rectangular instruments is the extreme legibility of their scales.

Available in all the standard ranges in sizes 3", 3½" and 6". Let us know your requirements and we shall be pleased to make recommendations regarding suitable instruments.

PULLIN RECTANGULAR INSTRUMENTS
Measuring Instruments (Pullin) Ltd., Electrin Works, Winchester St., London. W.3. Phone: ACOrn 4651

Condenser leadership - from the inside!

Unique wire and cyelet assembly ensuring complete mechanical and electrical connection.

Robust outer aluminium casing.

Synthetic rubber bungs giving full hermetic seal.

Heavy gauge aluminium wire secured to the foils.

Pure aluminium foil and paper element.

"All-aluminium" non-corrosive internal construction.

Viscous electrolyte.



T.C.C. "Picopacks" feature a unique yet simple construction which alone makes possible the manufacture of these miniature electrolytic condensers. In keeping with the famous T.C.C. "Micropack" and "Lectropack" ranges, they embody the "ALL-ALUMINIUM" technique using specially developed viscous electrolytes giving good characteristics at high and low temperatures. A range covering working voltages from 6 to 350 D.C. has been standardised, having numerous applications in such small assemblies as are found in car radios, mobile transmitters, hearing aids, etc.



'PICOPACK' ELECTROLYTIC CONDENSERS

(REGD.)

THE TELEGRAPH CONDENSER CO. LTD. · RADIO DIVISION · LONDON · W.3 · Tel: Acorn 0061 (9 lines)

**Which switch
fits the
niche?**

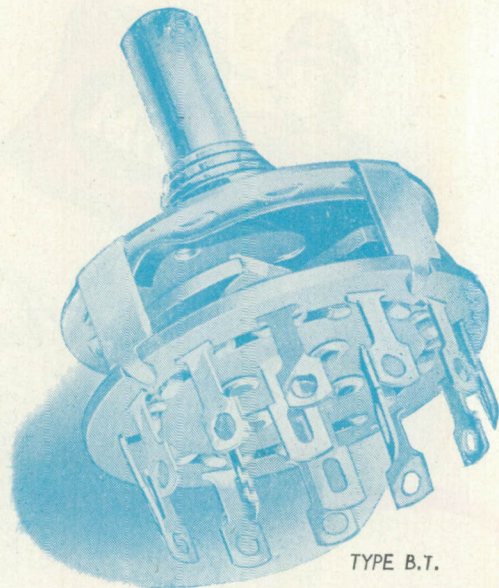

TYPE B.T.

By the time that has rolled round your tongue half a dozen times the Type B.T. Switch could be fitted! It's that sort of switch—small, compact, designed specially to fit easily into small spaces. It'll save you a lot of trouble. We have recently included some new features. Here they are—

WALTER SWITCHES—MADE FOR LIFE

**Walter
Instruments
LIMITED**

- The contact blades are fixed in a new way. This makes them completely rigid all the time.
- The drive spindle is positioned definitely in the wafer. This provides double bearing.
- Steady contact resistance.
- Improved insulation between contacts.
- Positive contact.
- Self-cleaning action.

All these make the Type B.T. a better switch—more efficient and lasting. In fact just the switch you need for limited space and simple switching.

WALTER INSTRUMENTS LIMITED, GARTH ROAD, LOWER MORDEN, SURREY. TELEPHONE: DERWENT 4421-2-3

C.R.C.47



An Announcement. . .

DUREX ABRASIVES LTD. wish to announce that as from June 14th, 1951, the name of the Company has been changed and is now the MINNESOTA MINING & MANUFACTURING COMPANY LTD. Identification will be as before, except that the words "Scotch Boy" will be used instead of "DUREX" as a prefix to the name of the material, e.g., "Scotch Boy" Magnetic Recording Tape instead of "Durex" Magnetic Recording Tape.

Existing high standards in the quality of the products will be maintained, the change is in name only.

'SCOTCH BOY' Magnetic Recording TAPE



ANOTHER  PRODUCT

Manufactured by :—

MINNESOTA MINING & MANUFACTURING COMPANY LTD
167, STRAND, LONDON, W.C.2, and SLOUGH

The "Belling-Lee" page for Engineers

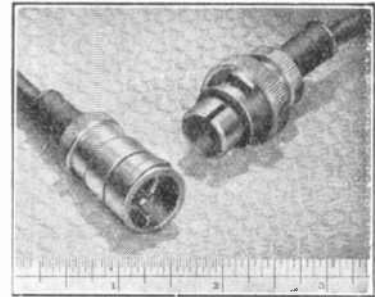
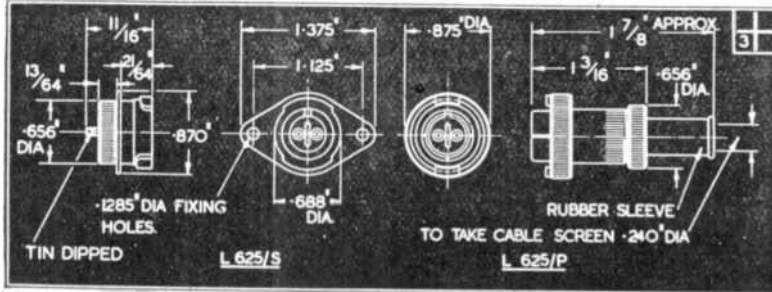

"SCREENECTORS"

This new range of screened connectors in light alloy is based upon the draft R.E.C.M.F. specification for a non-reversible screened plug and socket to load cables up to 0.24 in. diameter over the braid.

Single or multi-pole contacts may be assembled into the common housings which are designed so that various applications may be employed—e.g., line connector, flex plug and chassis socket and vice versa, through chassis (bulkhead) connector, each part interchangeable in its appropriate position in the assembly.

METHOD OF LOADING IS SHOWN BELOW

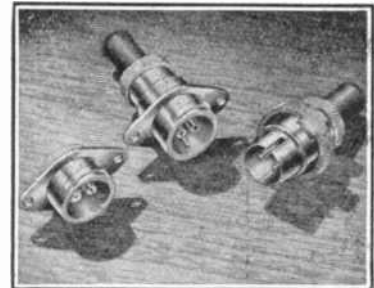
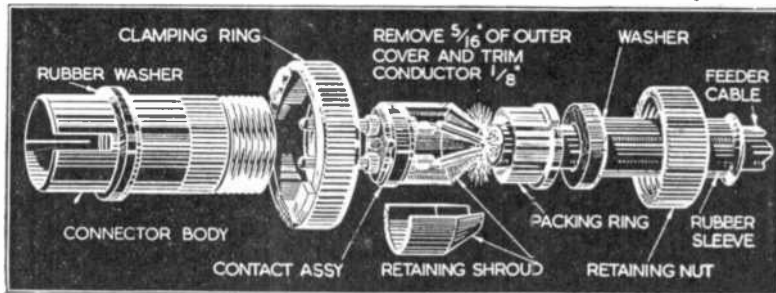

Assembly	Coaxial	2-pole	3-pole
Flex plug	L722/P	L625/P	L715/P
Chassis socket	L722/S	L625/S	L715/S
Through chassis socket	L723	L689	L716
Flex socket	L724	L690	L717

Type	Characteristic impedance ohms *	Contact Resistance	Capacitance *	
			Conductor/Conductor	Conductor/Screen
Coaxial	75	Less than 5 milliohms each	1 pF	2.5 pF
2-pole	100			
3-pole				

* At 1 Mc/s

Other design features include: (1) High grade bakelite insulators. (2) Simple assembly and loading. (3) Positive quick-action locking device. (4) Machined light alloy screened housing finished for instrument panel requirements.

The characteristics of these connectors are shown opposite.

BELLING & LEE LTD
CAMBRIDGE ARTERIAL RD., ENFIELD, MIDDX., ENGLAND

WAVE ANALYSER

TF 455D/1

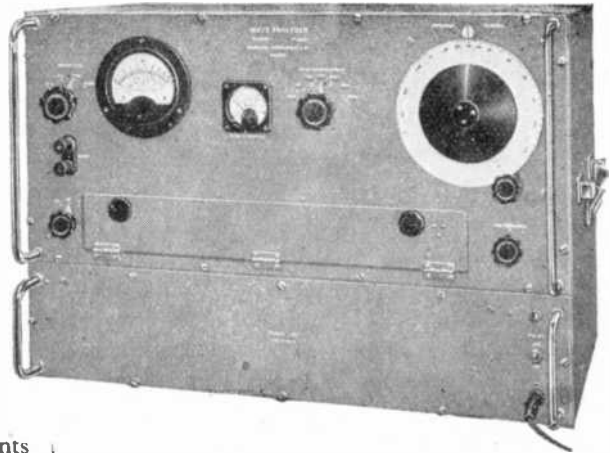

For direct measurement of the components of complex audio waves, the TF 455D/1 comprises a super-heterodyne system with intermediate frequency amplifier tuned sharply to 500 kc/s. The local oscillator, supplying a variable carrier, is calibrated in terms of input frequency.

The instrument covers the band 20 to 16,000 c/s with input amplitudes between 100 microvolts and 100 volts, extensible to 30 μ V and 300 V. Normally mains-operated, it may also be used on batteries.

MARCONI instruments

MARCONI INSTRUMENTS LIMITED, ST. ALBANS, HERTS. PHONE: ST. ALBANS 6161/7

London Office: Marconi House, Strand, W.C.2.

Midland Office: 19 The Parade, Leamington Spa.

Northern Office: 30 Albion Street, Hull.

Vacuum Leak Detection

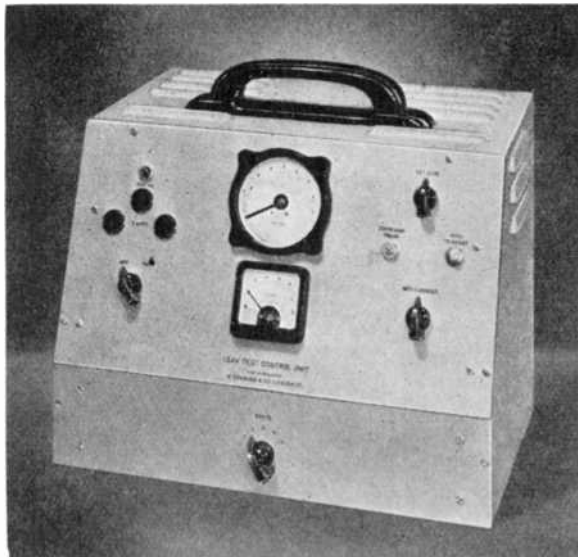

... now a simple
problem

... most ably and conveniently mastered by
the introduction of Edwards' ...

**PALLADIUM BARRIER LEAK
DETECTOR** The unique sensitivity and
specific response of this instrument bring
it within comparison with the mass spec-
trometer ... but without its complications
or expense.

Also available ...

HIGH FREQUENCY TESTERS
for probing delicate glass-work. Continuous
in operation and can be held and con-
trolled in one hand.

Warm Seasonal Greetings to our
Many Friends at Home and Overseas

W. EDWARDS

& CO. (LONDON) LTD.
LOWER SYDENHAM · LONDON · S·E·26

Telephone: SYDenham 7026 (8 lines)

... For better vacuum service

30 YEARS VACUUM EXPERIENCE

Telegrams: Edcohvoc, Souphone, London.



3J/160E (TRIODE)

Filament 10 volts 29 amp.

Ratings V_a 3 kV. I_a 1 amp.

W_a 1 kW. Max. frequency 120 Mc/s.

Overall diameter 2.5 ins.

Max. height 5.2 ins.



3J/260E (TRIODE)

Filament 10 volts 80 amp.

Ratings V_a 11 kV. I_a 5 amp.

W_a 20 kW. Max. frequency 30 Mc/s.

Overall diameter 8.031 ins.

Max. height 15.125 ins.

Standard

THORIATED TUNGSTEN VALVES

Incorporate thoriated tungsten filaments. Efficient air-blast cooling. Require exceptionally low filament power. Facilitate the design of simpler and smaller radio equipment

3J/192E (TRIODE)

Filament 5 volts 66 amp.

Ratings V_a 7 kV. I_a 2 amp.

W_a 4.5 kW. Max. frequency 22 Mc/s.

Overall diameter 5.875 ins.

Max. height 8.750 ins.



5J/180E (PENTODE)

Filament 10 volts 28 amp.

Ratings V_a 6 kV. I_a 1.5 amp.

W_a 3.5 kW. Max. frequency 25 Mc/s.

Overall diameter 5.875 ins.

Max. height 8.750 ins.

Standard Telephones and Cables Limited

Registered Office: Connaught House, Aldwych, London, W.C.2

RADIO DIVISION, OAKLEIGH ROAD, NEW SOUTHGATE, LONDON, N.11

FERROXCUBE

FERROMAGNETIC FERRITE

FOR TELEVISION

THE improvement in television components, with their smaller size and greater efficiency, is largely due to Ferroxcube, the new Mullard magnetic core material. The uses of Mullard Ferroxcube in the production of TV components fall into these three main groups:

LINE OUTPUT TRANSFORMER CORES

Since the advent of wide-angle television tubes, with the accompanying demand for increased E.H.T. supplies, the need for line output transformers of the highest possible efficiency has been greater than ever. Mullard Ferroxcube, with its low iron losses, completely fulfils this need — also facilitating the assembly of small, compact transformer units by means of solid, non-laminated U-shape cores.

DEFLECTION COIL YOKES

Mullard Ferroxcube cores in ring form are ideal for producing the magnetic circuit around deflection coils. Used in this way, Mullard Ferroxcube makes possible the construction of efficient deflector coils with a high Q factor. In order to simplify assembly problems, these ring cores are supplied either in the form of a complete circle, as two semi-circles, or as castellated yokes.

LINEARITY AND PICTURE WIDTH CONTROLS

Mullard Ferroxcube can very conveniently be extruded into rods and tubes. In this form it is ideal for use in linearity and picture width controls, providing a smooth control in a compact assembly.

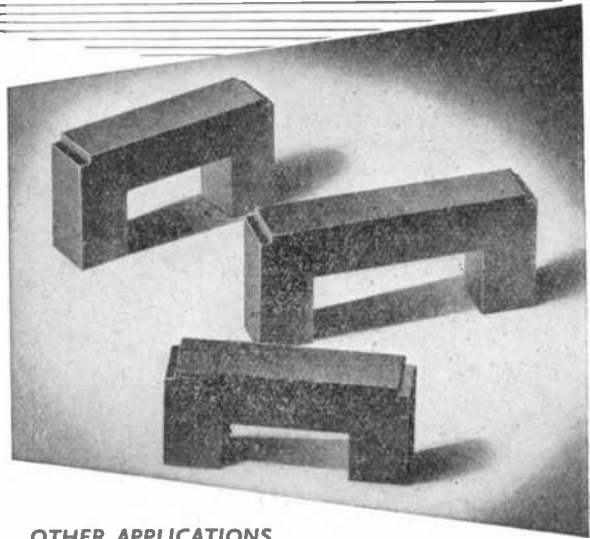

OTHER APPLICATIONS

In addition to its uses in television receivers, Mullard Ferroxcube is also being widely employed in line communications, radar, and other specialised electronic equipments. The purposes for which it is already being most successfully applied in such equipments include filter networks, wide band transformers, magnetic amplifiers, and pulse transformers.

PLEASE WRITE FOR FULL DETAILS



Mullard FERROXCUBE

FERROMAGNETIC FERRITE

MULLARD LIMITED • CENTURY HOUSE • SHAFTESBURY AVENUE • LONDON • W.C.2. (MF376)

MUREX are now making

ZIRCONIUM

ROD • WIRE • SHEET

in commercial quantities

In addition to Tungsten, Molybdenum and Tantalum we are now making ZIRCONIUM ROD, WIRE and SHEET in commercial quantities. We shall be pleased to have details of your requirements. Technical literature available on request.

MUREX LTD • (Powder Metallurgy Division) • Rainham • Essex Tel.: Rainham, Essex, 240
LONDON SALES OFFICE: CENTRAL HOUSE, UPPER WOBURN PLACE, W.C.1 Tel.: EUSto 8265

COMMUNICATIONS

Redifon Radio

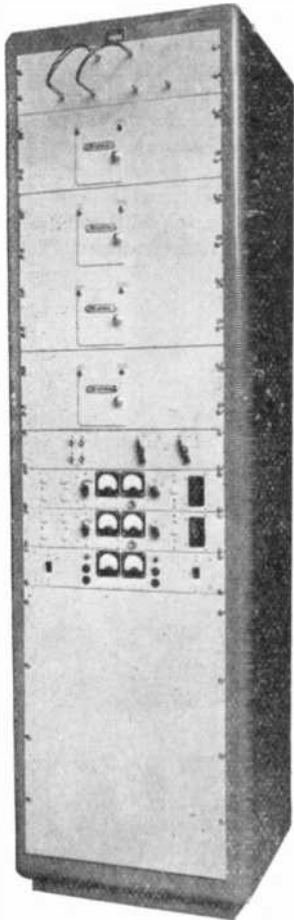

The Redifon R93 fixed frequency, high stability receiver is particularly suitable for monitoring, diversity reception or frequency shift operation. A typical application is this twin-channel, dual diversity, frequency shift radio teleprinter terminal. Multi-channel diversity or non-diversity racks can also be provided which incorporate a multi-receiver coupling unit (Redifon Type MCU.1) allowing up to eight receivers to be fed from a single aerial.

Recommendations for complete receiving stations employing these and other systems will gladly be submitted on request.

REDIFON LIMITED
BROOMHILL ROAD, WANDSWORTH,
LONDON, S.W.18

Designers and Manufacturers of Radio Communications and Electronic Equipment.



COLLOIDAL GRAPHITE

AND THE

ELIMINATION

OF

STATIC

INSTRUMENT WINDOWS. A thin transparent coating of 'dag' colloidal graphite may be used to dissipate static from plastic windows.

BELTS. Canvas, rubber or leather drive belts and conveyors may be coated with 'dag' colloidal graphite to 'bleed-off' static which may prove hazardous, or may cause paper and other materials to be held to the belt surface by electrostatic attraction.

AIRCRAFT. Static may be discharged from wing surfaces by wicks which have been impregnated with 'dag' colloidal graphite.

Applied by brush, spray or dip, 'dag' colloidal graphite may be used as: Electrodes in Cathode Ray Tubes, Geiger counters, Light cells, Radiation meters, Screens on T.V. cabinets to suppress E.H.T. radiation, Resistors—printed and conventional types.

POST THIS COUPON TODAY

TO: **ACHESON COLLOIDS LIMITED**
18 PALL MALL, LONDON, S.W.1

Please send me additional information on the above or other applications for 'dag' in the field of electronics.

NAME

ADDRESS

D/18

ACHESON COLLOIDS LIMITED
18 PALL MALL LONDON S.W.1



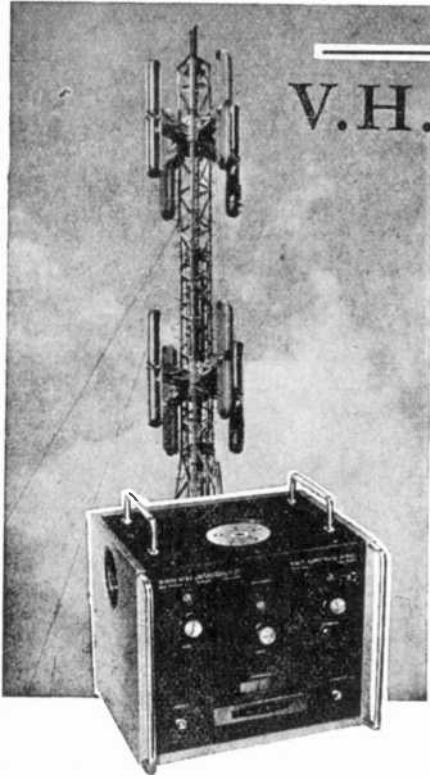

V.H.F. Bridges

Balanced measurements up to 100 M/cs
 Unbalanced measurement up to 250 M/cs

DURING the last few years a number of techniques have been developed for making V.H.F. impedance measurements with an accuracy of 1% or 2%, so that a V.H.F. Bridge is no longer a novelty. It is still, however, comforting to have a bridge with which parasitic capacities do not cause serious errors in measurement. Wayne Kerr bridges avoid the difficulties arising from parasitic capacities by the use of transformer ratio arms, which give extremely low impedances between the bridge terminals and from the bridge terminals to ground. These V.H.F. bridges are as stable and as simple to use as an audio frequency bridge.

Wayne  Kerr

THE WAYNE KERR LABORATORIES LTD., NEW MALDEN, SURREY Tel: MALden 2202

ISOLATE that **VIBRATION** through **EQUIFLEX**

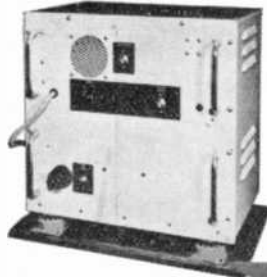

THE ALL-METAL SPRING MOUNTING

- EQUAL FLEXIBILITY
IN ALL DIRECTIONS
- CAN BE LOADED IN ANY DIRECTION
- UNAFFECTED BY CLIMATIC CONDITIONS
- VARIOUS TYPES FROM 1-35 lbs PER UNIT
- VIBRATION IS BOTH DANGEROUS AND COSTLY

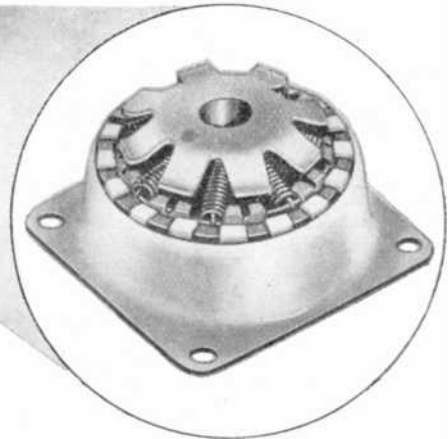

Write for Catalogue and Price List to
A. WELLS & CO. LTD.
 STIRLING R^o WALTHAMSTOW, LONDON E.17.

M.O.S. TYPE APPROVED. PATENT NO. 571026
 FOREIGN PATENTS GRANTED

VIBRATION MEASUREMENT

A wide range of equipment developed and manufactured by De Havilland Propellers Ltd., and distributed by Mullard Ltd.

Moving Coil Vibrators. For driving fatigue test specimens and as general purpose exciters investigating resonant frequencies.

Driving Amplifiers. To provide a power source for the excitation of vibrators.

Self-Drive Unit. A pre-amplifier for use with the above to excite test specimens at their resonant frequencies.

Strain Gauges. For the localised measurement of structural stresses and vibrating strains in moving parts.

Moving Coil Pick-ups. For measuring linear vibration amplitudes, phase angles and frequencies and for investigating resonant and nodal patterns.

Pressure Pick-ups. Unit for the remote indication of steady or fluctuating pressures in pipe lines or containers.

Cathode Ray Oscillographs. Used in conjunction with pick-ups and strain gauges for illustrating and measuring stress, strain and vibration.

Portable and Rack Mounted Signal Amplifiers. For amplifying signals produced by strain gauges and pick-ups when used with recorders and indicators.

Multi-Channel Recording Cameras. To obtain permanent records of recurrent and transient phenomena. Used in conjunction with signal amplifiers, strain gauges and pick-ups.

Steady Stress Bridge. Multi-connection bridges for rapidly determining steady strains detected by resistance strain gauges.

Slip Ring Units. Equipment for use with strain gauges when applied to rotating machinery.

Full details of any of the above equipments are available on request.



Mullard

CONDUCTIVITY EQUIPMENT · POTENTIOMETRIC TITRATION APPARATUS · ELECTRONIC POLAROGRAPHES · TEMPERATURE CONTROLLERS · UNIVERSAL MEASURING BRIDGES · VALVE VOLTMETERS · F.M. SIGNAL GENERATORS · OSCILLOSCOPES

MULLARD LIMITED, EQUIPMENT DIVISION, CENTURY HOUSE, SHAFESBURY AVENUE, LONDON, W.C.2. TELEPHONE: GERRARD 7777

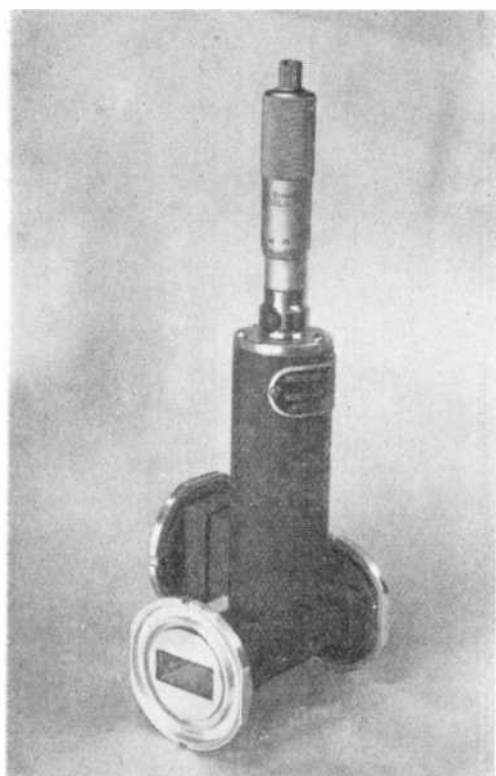

CAVITY WAVEMETER

MODEL 32/2000 IS A TRANSMISSION INSTRUMENT COVERING THE RANGE 8825 TO 10,000 Mc/s. When loaded by our crystal mount 32 1500 the Q is in the order of 10,000.

Other instruments in our X band range are—

- STANDING WAVE INDICATORS
- VARIABLE ATTENUATOR
- COAXIAL WAVEMETER
- BI-DIRECTIONAL COUPLERS
- KLYSTRON MOUNTS, etc., etc.

LET US QUOTE FOR YOUR SPECIAL REQUIREMENTS WE WILL MANUFACTURE TO YOUR DRAWINGS OR DESIGN TO YOUR SPECIFICATION

MICROWAVE INSTRUMENTS LTD

WEST CHIRTON INDUSTRIAL ESTATE
NORTH SHIELDS, NORTHUMBERLAND. N. Shields 2817

ALWAYS "FIT"



SUSPENSION DRAWER SLIDES, SUN and PLANET FRICTION ELIMINATORS and SHEAVES.

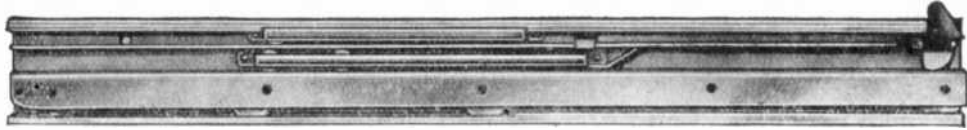

Type A Slides as above supplied in 15 $\frac{1}{2}$ ", 17 $\frac{1}{2}$ ", 21", 23 $\frac{1}{2}$ ", 25 $\frac{1}{2}$ " and 27 $\frac{1}{2}$ " lengths. Heavy type A Slides supplied in lengths 23 $\frac{1}{2}$ ", 28 $\frac{1}{2}$ ", 32" and 37". Type A series case strips may be drilled and countersunk or provided with ears or lugs.



Twoarm Type B Slides supplied in 23 $\frac{1}{2}$ " lengths down to 9" lengths. 13 gauge Heavy Type B Slides in lengths up to 30".

We also supply heavy duty castors up to 30 tons capacity each, including twin pneumatic wheeled types up to 40" diameter.

OVER 6,000 TYPES AVAILABLE

Ask for Brochure.

Engineers, Patentees and Sole Manufacturers

AUTOSET (PRODUCTION) LTD., Dept. O, Stour St., Birmingham 18.

Phone : EDG 1143/4.

Est. over 30 years.

Please mention "Electronic Engineering."

AT3

Ceramic Hermetic Seals & Bushes
by
UIC

The advertisement features a collection of various ceramic hermetic seals and bushings. On the left, there is a large, dark rectangular component with two small cylindrical protrusions on top. In the center, a cylindrical seal with a white ceramic body and metal end caps is shown. To the right, several different types of bushings and seals are displayed, some with threaded ends and others with smooth ends. At the bottom, a long metal strip holds a row of small, uniform cylindrical seals. The background is a plain, light-colored surface.

UNITED INSULATOR CO. LTD. OAKCROFT RD. TOLWORTH · SURBITON · SURREY
TELEPHONE: ELMBRIDGE 5241 CABLES: CALAMEL, SURBITON

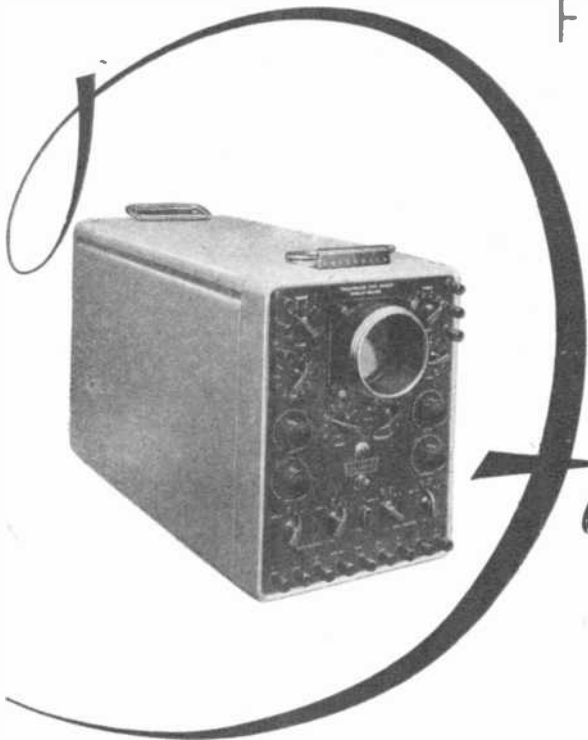

For critical analysis
or routine production

The 1684D,2 Cathode Ray Oscilloscope has been designed to meet these diverse requirements of laboratory, field and production units. Symmetrical d.c. circuiting is employed throughout, the amplifiers having a high and uniform sensitivity from zero frequency up to 3 Mc/s.

Furzehill

FURZEHILL LABORATORIES LIMITED
BOREHAM WOOD, HERTS. TEL: ELStree 3940

PERMANENT MAGNETS

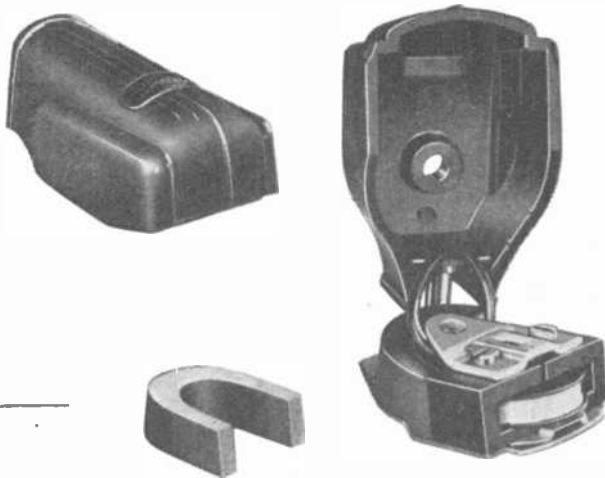

A COMPLETE SERVICE—
ADVISORY AND SUPPLY—
FOR SPECIALISED
INDUSTRIES



Illustration shows a compact gramophone pick-up head utilizing modern Alcomax Permanent Magnet.

(By courtesy of Collaro Limited)

DARWINS LTD

TINSLEY · SHEFFIELD · 9

027

Pretoria Automatic COIL WINDING MACHINE

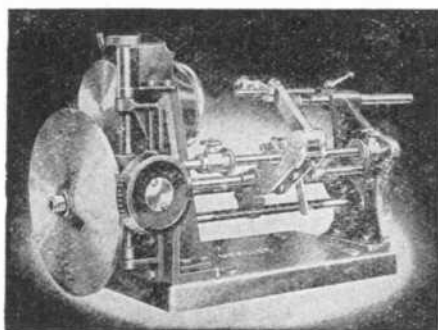

THE PRETORIA is the ideal motor-driven machine for maintenance departments and repair workshops. It winds various types of coils from $\frac{1}{8}$ " to 6" in length and up to a maximum diameter of 5" with wires ranging from 22 to 48 S.W.G. Many refinements are embodied previously obtainable on only elaborate machines.

NEVILLE'S (LIVERPOOL) LTD.

A Subsidiary of Aeronautical and General Instruments Ltd.
PURLEY WAY, CROYDON, ENGLAND.

Phone : THOrnton Heath 3211 Cables : "Instradio, Croydon"

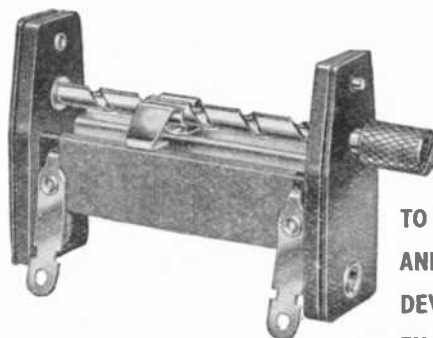

TO RADIO
AND T/V
DEVELOPMENT
ENGINEERS

This midget pre-set variable resistor with new double-slider gives greater stability and makes accurate adjustment easier. Designed for panel or chassis mounting: available in any value from 10 to 25,000 ohms.



Charfleet Industrial Estate, Canvey Island, Essex. Phone : Canvey 691

ALL-POWER REGULATED POWER SUPPLIES

Semi-standard designs are available covering output voltages from 0.1 to 2,000 volts and output currents from 1mA to 10 amps.

Special Units can be made to any Specification, and although the demand for our products is continually increasing we can still offer reasonably prompt delivery.



ALL-POWER TRANSFORMERS LTD.

CHERTSEY ROAD, BYFLEET, SURREY.

TEL.: BYFLEET 3224.



...You find them everywhere...

"CASTLE" ENGINEERING COMPONENTS

By their quality you will know them — Repetition Work in all Metals — Precision Turned and Screwed — Machining and Light Assemblies

Brochure on request



THE CASTLE ENGINEERING COMPANY (NOTTINGHAM) LIMITED

Telephone Nottingham 45068 (3 lines)  Telegrams Casteng Nottingham
HASLAM STREET · CASTLE BOULEVARD · NOTTINGHAM

B.P.L. TEST SETS

B.P.L. D.C. TEST SET - £7 5 0

B.P.L. UNIVERSAL TEST SETS
£8 17 6

B.P.L. UNIVERSAL TEST SETS
20,000 Ω/v £11 10 0

B.P.L. SUPER RANGER £19 19 0

B.P.L. SUPER RANGER 20,000 Ω/v
£22 15 0

All prices subject to trade discount. Available for immediate delivery from our stockists, M.R. Supplies Ltd., 68, New Oxford Street, W.C.1. or write to :

BRITISH PHYSICAL LABORATORIES HOUSEBOAT WORKS, RADLETT, HERTS.

Telephone : Radlett 5674/5/6

WODEN COMPOUND FILLED TRANSFORMER CO. LTD

TRANSFORMERS & CHOKES

for **UTMOST RELIABILITY**

Woden Compound Filled transformers have been developed for use in exacting industrial and climatic conditions and have the following features :-



- Complete moisture-proof filling compound
- Universal fixing for above or below chassis wiring
- Constant fixing centres and overall size
- Occupy minimum space and ensure clean and compact layout

Send for latest catalogue

WODEN TRANSFORMER CO, LTD., MOXLEY ROAD, BILSTON, STAFFS.

I.T.L.

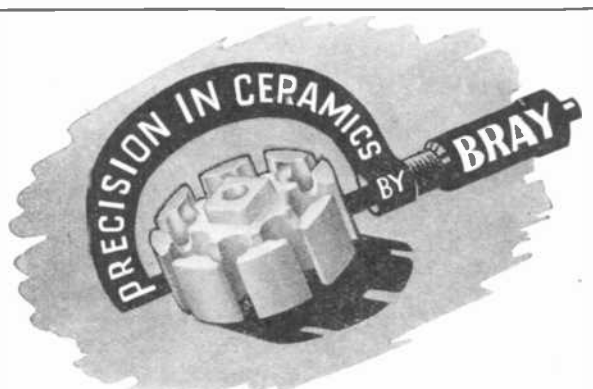

Quantity production of small automatically made pieces in St-tite, Porcelain, and Rutile materials for electric cooling and heating equipment, and telecommunication apparatus.

BRAY



GEO. BRAY & CO. LTD., Leicester Place, Leeds 2.

Tel.: 20981/8. Grams: "Bray, Leeds 2"



*Pioneers and specialists
in Small Valves*

SUBMINIATURES
MINIATURES
MIDGETS
GAS TRIODES
ELECTROMETERS
COLD CATHODE
TUBES

HIVAC LTD

GREENHILL CRESCENT, HARROW-ON-THE-HILL,
MIDDLESEX.

Telephone: HARrow 2655

**DONOVAN ACCESSORIES —
FOR THE ELECTRONIC
APPARATUS MANUFACTURER!**



TYPE J.95 TERMINAL BLOCKS
Made in 15, 30 and 60 amp. sizes



TYPE C.30 PUSH BUTTON UNIT
arranged for mounting on
customers' own cover plate.

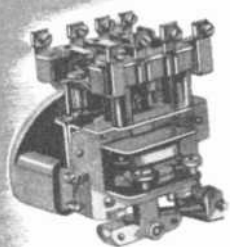

**TYPE A.11 A.C. POWER
RELAY** — 4-pole with N.O.
or N.C. contacts.

THE DONOVAN ELECTRICAL CO. LTD.
Safuse Works · Stechford · Birmingham 9

“VARIAC”

Regd. Trade Mark

Infinitely Variable
VOLTAGE REGULATING TRANSFORMER

Smooth Control

Linear scale,
various markings.

115 or 230 volts
service or others
if required.

Special types
for 500 cycle or
2,000 cycle, etc.,
can be supplied.

Low tempera-
ture rise.

Bench or panel
type mounting,
reversible shaft.

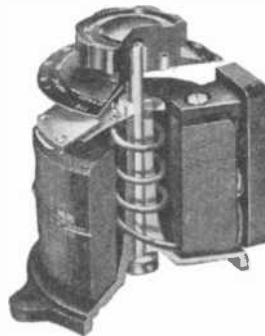

Reasonable
overload capa-
city.

Output in-
dependent of
load.

Single or duplex
voltage outputs.
(Type 100 R.M./
2B).

Supplied with or
without screen.

Ring-type
laminated core.

The 'sectional-
ised' illustration
shows Types 200
(580 and 860 va).
Larger types are
made-up to 7
Kva.

Write for Catalogue V549 for complete data

CLAUDE LYONS LTD.

ELECTRICAL & RADIO LABORATORY APPARATUS, ETC.

180 Tottenham Court Road, London, W.1, and
76 Oldhall Street, Liverpool 3, Lancs.

Dainite

A PERSONAL SERVICE
IN

MOULDED RUBBER COMPONENTS

OUR TECHNICIANS ARE AT YOUR SERVICE

THE HARBORO' RUBBER CO. LTD.
MARKET HARBOROUGH. Telephone: 2274 5

Industrial High Vacuum



By J. R. Davy, B.Sc., F.P.S., Chief Physicist, Messrs. Barr & Stroud, Ltd. The author has had considerable experience in the application of high-vacuum technique in industry, and his book is of great value to the high-vacuum physicist and to industrial technicians and students. It deals fully with the pumping system and allied mechanisms, with the application of the plant to industrial purposes, and with the basic theory. 82 illustrations. 25/- net.

Pitman

Parker Street, Kingsway, London, W.C.2

CO-AXIAL RELAY

TYPE SCX

Characteristic Impedance 45 or 70 Ω .

Body size only

$2\frac{1}{2}'' \times 1\frac{3}{8}'' \times 1\frac{5}{8}''$.

Further details in List 245/B.

NOTE:

Reserved at present for Services and Industrial purposes.

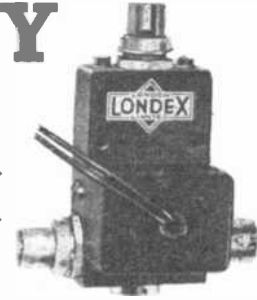

LONDEX LTD

Anerley Works,
London, S.E.20.

Tel.: SYDenham 6258.

*The First published design
for B.B.C. F.M. Reception*

A HOME BUILT FREQUENCY MODULATED RECEIVER

By K. R. STURLEY, Ph.D., M.I.E.E.

Contains full details and wiring diagrams for the construction of a frequency-modulated receiver for reception of the B.B.C.'s new high-fidelity F.M. transmitter at Wrotham (Kent). Included in the booklet is a design for a suitable aerial system and a simple modulated test oscillator for alignment of the I.F. stages.

Price **4/6d.**

Post Free 4/9d.

Obtainable from :—

ELECTRONIC ENGINEERING

28 ESSEX STREET, STRAND, LONDON, W.C.2.

SERVOTRONIC SALES

OFFER

MAGSLIPS and SELSYNS

for

SERVO CONTROL EQUIPMENT

ELECTRICAL COMPUTATION

REMOTE INDICATION

SYNCHRONOUS LINKS

Write for our Brochure 'Synchros' and Price List

ABBAY ROAD, BELVEDERE, KENT

Telephone: Erith 2479

AMBITIOUS ENGINEERS

HAVE YOU HAD YOUR COPY OF "ENGINEERING OPPORTUNITIES"?



Whatever your age or experience—you must read this highly informative guide to the best paid engineering posts. The handbook contains particulars of A.M.I.C.E., A.M.I.Mech.E., A.M.L.M.I., A.M.Brit.I.R.E., and other important Engineering Examinations, and outlines home-study courses in all branches of Civil, Mechanical, Electrical, Automobile, Radio and Aeronautical Engineering, Draughtsmanship, Building and Plastics, General Certificate of Education, etc. We Guarantee "NO PASS—NO FEE". If you are earning less than £14 a week you cannot afford to miss reading "Engineering Opportunities." It tells you everything you want to know to secure your future. Write for this enlightening guide to well paid posts NOW—FREE and without obligation.

BRITISH INSTITUTE OF ENGINEERING TECHNOLOGY **BIET**

337a Shakespeare Hse., 17/18 Stratford Place, London W1

"SPEARETTE" MINIATURE VALVE

PIN

ALIGNING TOOLS

TYPES AVAILABLE FOR

B7G - B8A - B9A

VALVE BASES

SPEAR ENGINEERING CO. LTD.

TITAN WORKS, WARLINGHAM, SURREY.

Telephone: Upper Warlingham 2774.



POTENTIOMETERS

Wire-wound and Composition types. Single, Ganged, Tandem Units. Characteristics: linear, log., semi-log., non-inductive, etc. Full details on request.

RELIANCE

RELIANCE MFG., CO. (SOUTHWARK), LTD.,
SUTHERLAND ROAD, HIGHAM HILL, WALTHAMSTOW, E.17.
Telephone: Larkwood 3245



Dept. E.E

18 TOTTENHAM COURT ROAD, LONDON, W.1

Tel.: MUSEum 2453/4539

Shop hours: Monday - Friday 9-5.30

Saturday 9-1

RELAYS

D.C. COIL RESISTANCE

3,000 TYPES: 1.9Ω to 80,000Ω
600 TYPES: 0.4Ω to 9,200Ω

ALSO LARGE STOCKS OF DOUBLE & TRIPLE-WOUND AND SLUGGED COILS.

CONTACTS

3,000 TYPES: up to 8 sets.
600 TYPES: up to 4 sets.

3,000 TYPES: Make (M), Break (B), in Twin-silver, Twin-platinum, Dome-silver (2 amp.), Tungsten (5 amp.), and Flat-silver (8 amp.). Change-Over (C), in all but Tungsten: Make-Before-Break (K), in Twin-silver and Twin-platinum.

600 TYPES: (M), (B) and (C), in Twin-silver and Twin-platinum.

SPECIAL

S.T. & C. Type Polarised Relays.
6 coils: 180 ohms + 180 ohms + 180 ohms + 180 ohms + 115 ohms + 115 ohms on same bobbin. Contacts: Single change-over. Dimensions: 3½" × 3½" base; 6½" overall height.

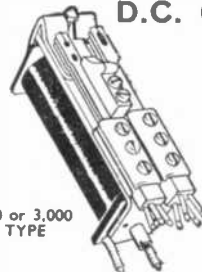

600 or 3,000 TYPE

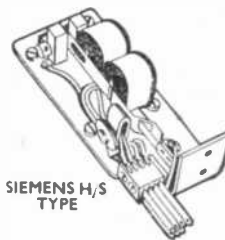

SIEMENS H/S TYPE

"TECHNICAL EXCELLENCE"

—combines with beauty and soundness of DESIGN in the

OXLEY

AIR DIELECTRIC TRIMMER



With: 10.5 m/m. Length: 22 m/m. Height: 1.8 to 80P—7.5 m/m. 1.8 to 80P—10 m/m. 2 to 20P—11 m/m. 8 to 82P—12 m/m. Low: Straight line closely. Power Factor: Less than .001. Insulation: Over 2,000 megohms. Voltage: 500 D.C.

OXLEY DEVELOPMENTS CO. LTD.
ULVERSTON, NORTH LANCs. TEL: ULVERSTON 2306

ELECTRONIC CONTROLS
SOUND REPRODUCING EQUIPMENT
TRANSFORMERS
Hifi
REGD TRADE MARK
RESEARCH & DEVELOPMENT
CHOKES
PRECISION INSTRUMENTS

HIFI LTD., 150, HIGH STREET, LYE, STOURBRIDGE, WORCS. Telephone: LYE 261

"J.B." SERVICE (BEXLEYHEATH) LTD.
5 MAYPLACE ROAD WEST, BEXLEYHEATH, KENT

OFFER

PRESTCOLD REFRIGERATION UNIT FOR RIVET STORAGE. METERED TEMPERATURE DOWN TO 10° C. £150.

ANTENNA PEDESTALS, ROTATING, NAVY TYPE, CNM-10 ACH. 115 VOLT, 60 CYCLE. £50.

RESISTANCES VARIABLE, HAND-WHEEL DRIVE 10 OHMS, 3.5 AMP., 5.70 OHMS, 7.8 AMP., 5.7 OHMS, 8 AMP. ALL TYPES, 17/6 EACH.

PUBLIC ADDRESS SPEAKERS, 2" 3" FLARE. EXCELLENT CONDITION. £3.

SOCKETS, CLIX TYPE, REF. 10H/260B. ENQUIRIES INVITED FOR QUANTITIES.

ALL-METAL SPRING MOUNTS, WELLS TYPE ENQUIRIES INVITED FOR QUANTITIES.

WILKINSON'S OF CROYDON

AUTO TRANSFORMER, 230/115 volts 500 watts 50 cycles, fully shrouded, new. Made by Met. Vic., £4 10s. each.
RECTIFIERS, SELENIUM, 1/2 wave 12 V 200 mA, 2s. 6d. each; 444 V 40 mA, 9s. 3d. each; Voltage Doubler, 168 V 40 mA, 7s. 6d. each; 24 V 25 amp. Funnel cooled, 87s. each; Bridge type 24 V 75 mA, 3s. 4d. each; 36 V 2.5 amp, 27s. each; 48 V 75 mA, 5s. 7d. each; 48 V 150 mA, 6s. 10d. each; 96 V 600 mA, 31s. each; 96 V 2.5 amp, 66s. each.
MIRROR GALVANOMETERS 30 microamps per standard scale 20" sweep strong construction 5" by 3", £7 10s. each.
TEST SET 205. Wavemeter range. 3.05 to 3.35 centimetres, built-in oscillator with 9 valves including Klystron type CV.129, etc., in good condition, £20.
MICROAMMETER 0-50 2 1/2 Flush Type, contained in Test Set 28. A very sensitive meter. Only 50s. each complete.
PHOTOMULTIPLIER with Network No. 931A, 90s. each.
BLASTING GALVANOMETER, Scale 0-25. Westinghouse. With leather case. New and boxed, 55s. each.
TELEGRAPH RELAYS, No. 4121C, 40s. each.

19, LANSDOWNE ROAD, CROYDON
CRO : 8839

Miniaturised Transformers



The high efficiency of these very small transformers is due to the special laminations, hydrogen annealed after stamping. Size of Transformer shown: 3/8" x 7/16" x 1/2" dia. bobbin.

Primarily developed for hearing aids, the miniature transformers we manufacture have been found eminently suitable for use in small portable radios, radio control work, communications and model making. Inquiries invited for miniature transformers in small or large quantities, also for other miniaturised components.

JOHN BELL & CROYDEN
 117, HIGH STREET, OXFORD 'Phone 48362

MAGNETIC RELAYS

LARGEST STOCK IN GREAT BRITAIN OF RELAYS, KEY SWITCHES AND UNISELECTORS

Government Contractors

RELAYS P.O. 3000 - 600 - SIEMENS' HIGH SPEED
 400v. A.C. 50cy.

ALL NEW EX-MINISTRY GOODS

JACK DAVIS (Relays) LTD. DEPT. E.E.
36 PERCY STREET, LONDON, W.1.

Phones: MUSEum 7960 LANgham 4821

LUMINESCENT MATERIALS

FOR

ELECTRIC DISCHARGE LAMPS

CATHODE RAY TUBES

X-RAY SCREENS

INSTRUMENT DIALS

DECORATIVE DISPLAYS

SPECIAL PHOSPHORS MADE TO CUSTOMERS' SPECIFICATIONS

★ ★ ★

DERBY & COMPANY LTD.

Offices:

11-12 St. Swithin's Lane, London, E.C.4.

Telephone: AVENUE 5272.

Telegrams: PLATIVET, London

Works:

Millmarsh Lane, Brimsdown, Middx. HOWard 2208

BRADMATIC LTD.

Offer the **BRADMASTER**
Model 5 Tape Desk

- Built to professional standards.
- Two speeds—3 1/2 and 7 1/2 inches per second.
- Easily adjusted for single or twin track recording.
- Fast wind and rewind—full reel rewound in 1 1/2 minutes.
- Heavy alloy flywheel. Freedom from "wow" and "flutter"
- Double servo brakes on each hub.
- Push-button control.
- Three heavy duty motors.
- Three shielded Bradmatic heads.
- Size: 13 1/2 in. by 15 1/2 in. by 6 1/2 in. deep.

PRICE: (Fitted with SRP heads) £41 0 0
 (Fitted with 6RP heads) £42 0 0

Hi-fidelity Magnetic Sound Heads

type SRP (record/play)	£ s. d.
type SE (erase)	3 5 0
... ..	3 5 0

Super fidelity magnetic sound head:

type 6RP (record/play head)	3 15 0
Composite Screening Cans (steel and mumetal)	4 6
Oscillator, Coils type 1B	9 0
Plate Coils, type 1B	9 0

Tape on 7-inch reels, 1,200 ft.:

Emitape type 65 (low coercivity)	1 15 0
Emitape type H6O (high coercivity)	1 15 0
Scotch Boy (Durex)	1 15 0
G.E.C. type A	1 10 0

Amplifiers and Microphones, etc., supplied

Trade Supplied.

Send for Lists to the Sole Manufacturers:

BRADMATIC LIMITED

STATION ROAD • ASTON • BIRMINGHAM 6

Phone: EAST 0574. Grams: Bradmatic, Birmingham.

INDEX TO ADVERTISERS

Acheson Colloids Ltd.	39	Donovan Electrical Co., Ltd.	46	Oxley Developments Co., Ltd.	48
Airmec Laboratories	28	Ed'son Swan Electric Co., Ltd., The	22	Painton & Co., Ltd.	3
All-Power Transformers Ltd.	44	Edwards & Co. (London), Ltd., W.	36	Parmeko Ltd.	25
Alston Capacitors	5	Egen Electric Ltd.	44	Partridge Transformers Ltd.	12
Automatic Telephone & Electric Co., Ltd.	29	Electronic Engineering Monographs	47 & 495	Pitman & Sons Ltd., Sir Isaac	47
Autoset (Production) Ltd.	42	English Electric Co., Ltd., The	18	Radio Resistor Co., Ltd.	9
		Eye shed & Vignoles Ltd.	14	Radiospares Ltd.	12
		Furzehill Laboratories Ltd.	43	Redifon Ltd.	39
Baker Platinum Ltd.	16	Gardner's Radio Ltd.	32	Reliance Mfg. (Southwark) Ltd.	48
Bell & Croyden, John	49	General Electric Co., Ltd., The	13	Salford Electrical Instruments Ltd.	19
Belling & Lee Ltd.	35	Harboro' Rubber Co., Ltd., The	46	Sungamo-Weston Ltd.	Cover iii
Bradmatic Ltd.	49	Hivac Ltd.	46	Sankey & Sons Ltd., Joseph	Cover ii
Bray & Co., Ltd., George	45	Hifi Ltd.	48	Servotronic Sales	48
British Institute of Engineering Technology	48	"J.B." Service Ltd., The	49	Spears Engineering Co., Ltd.	48
British Physical Laboratories Ltd.	45	Londex Ltd.	47	Standard Telephones & Cables Ltd.	23 & 37
British Thomson-Houston Co., Ltd.	15	Lyons Ltd., Claude	46	Telegraph Condenser Co., Ltd., The	17
		Marconi Instruments Ltd.	36	Telegraph Construction & Maintenance Co., Ltd., The	27
Castle Engineering Co. (Nottingham) Ltd., The	45	Marconi's Wireless Telegraph Co., Ltd.	24	Tufnol Ltd.	11
Chance Bros.	30	Measuring Instruments (Pullin) Ltd.	32	United Insulator Ltd.	42
Chapman & Hall Ltd.	495	Metropolitan-Vickers Electrical Co., Ltd.	21	Vortexion Ltd.	Cover i
Cinema-Television Ltd.	7	Microwave Instruments Ltd.	41	Walter Instruments Ltd.	33
Cole Ltd., E. K.	5	Minnesota Mining & Manufacturing Co., Ltd.	34	Wayne-Kerr Laboratories Ltd., The	40
Connolly's (Blackley) Ltd.	30	Muirhead & Co., Ltd.	31	Wells & Co., Ltd., A.	40
Coosor Ltd., A. C.	20	Mullard Ltd.	26, 38 & 41	Whiteley Electrical Co., Ltd.	27
		Multicore Solders Ltd.	Cover iv	Wiggin & Co., Ltd., Henry	50
Darwins Ltd.	43	Murex Ltd.	38	Wilkinson, L.	49
Davis Supplies Ltd., Alec	48	Nagard Ltd.	28	Woden Transformers Co., Ltd.	45
Davis (Re'ays) Ltd., Jack	49	Neville's (Liverpool) Ltd.	44	Wright, Bindley & Gell Ltd.	12
Derby & Co., Ltd.	49				

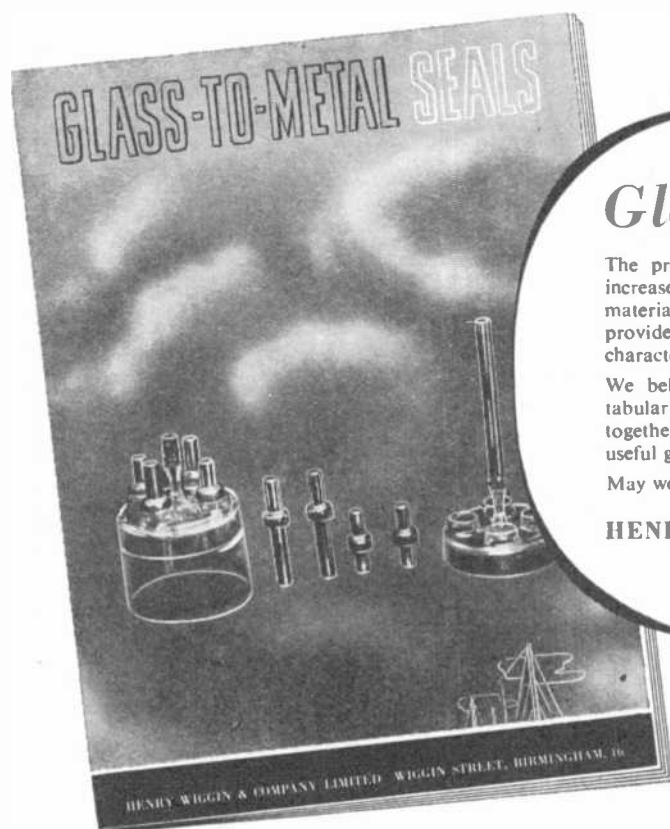

Glass-to-metal Seals

The present abnormal conditions of supply have placed increased emphasis on the correct choice of constructional materials. As an example, the Nilo range of nickel-iron alloys provides a range of compositions each having distinctive characteristics and developed to meet a specific requirement.

We believe that our revised publication, which includes tabular data on the properties of the various grades of alloy, together with examples of their industrial use, will prove a useful guide to the selection of the correct grade of material.

May we send you a copy?

HENRY WIGGIN & COMPANY LIMITED

Wiggin Street, Birmingham 16

16/10/50



No 10. Multi-Range Testing Instruments

Best known of all instruments for the testing and servicing of radio and television equipment is undoubtedly the Weston Model E.772 Analyser, a first-class portable instrument with a sensitivity of 20,000 ohms per volt on all D.C. ranges and 1,000 ohms per volt on all A.C. ranges. The additional features of wide range coverage, robust construction and simplicity in operation contribute toward making the E.772 ideal also for laboratory and research work. Full details of this instrument and also of the Model S.75 — a Test Set covering 53 ranges — will gladly be supplied on request.

THE WESTON E 772

Super Sensitive Analyser

SANGAMO WESTON LIMITED

Enfield, Middlesex. Tel: Enfield 3434 (6 lines) & 1242 (4 lines). Grams: Sanwest, Enfield.

Branches: Glasgow, Manchester, Newcastle-on-Tyne, Leeds, Liverpool, Wolverhampton, Nottingham, Bristol, Southampton and Brighton.

THE FINEST CORED SOLDER IN THE WORLD

proved in use over 12 years

BY LEADING MANUFACTURERS OF

Electronic Equipment

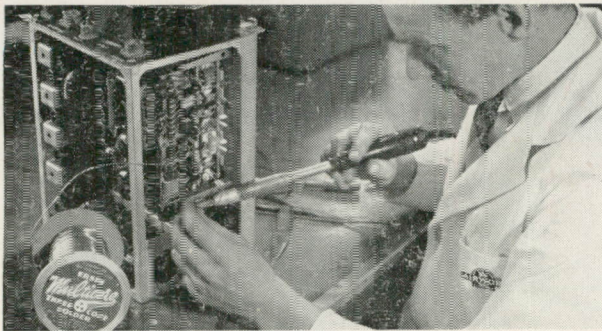

Ersin Multicore being used in servicing a modern aircraft transmitter receiver at Airwork's Maintenance Workshops, Gatwick.

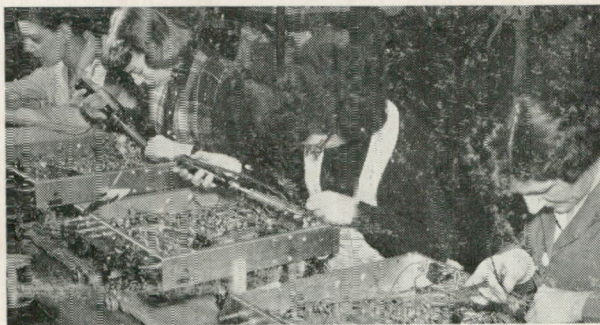

Assembling television receivers at the DuMont Factories, Newark U.S.A. with British-made Ersin Multicore Solder

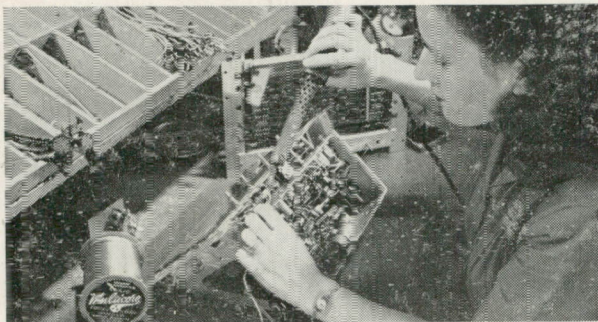

Considerable quantities of Ersin Multicore are used at the factory of the Amalgamated Wireless (Australia) Ltd., Sydney, Australia.

During 1939-45, more Ersin Multicore was made and used in the manufacture of electronic equipment for the Services than any other activated, non-corrosive, flux-cored solder in the world.

During 1946-51, the demand for Ersin Multicore increased to such an extent that regular supplies were exported to more than 48 overseas countries—even to the U.S.A., where many home-produced brands can be obtained at a lower price.

HERE ARE SOME OF THE REASONS WHY ERSIN MULTICORE HAS ATTAINED SUCH WORLD-WIDE POPULARITY :-

- The 3-cored construction guarantees flux continuity and prevents "dry" or H.R. Joints.
- Multiple core composition means thinner walls of solder, which result in instant melting.
- The correct proportion of flux to solder is always assured—no extra flux is required.
- Ersin Flux reduces surface tension of molten solder, causing it to wet metals rapidly. It also cleans oxidised metallic surfaces.
- Soldered joints made with Ersin Multicore remain free from corrosion even after prolonged exposure.
- The flux residue is impervious to moisture, hard, non-sticky, non-toxic and avoids accumulation of dirt.
- For more than 12 years, the same unvarying and consistently high quality has been maintained.
- Fully approved by A.I.D., A.R.B., and G.P.O. and complies with U.S. Govt. specifications, B.S.S. 219 & 441 and M.A.P., D.T.D. 599.

Ersin Multicore is now available in 377 different packings, 2 flux percentages, 8 alloys and 9 gauges. We will be pleased to send to manufacturers, without charge, new technical literature and bulk prices. Service engineers and radio enthusiasts can obtain Size 1 cartons from most radio and electrical shops.

SIZE 1 CARTONS 5/- RETAIL

Catalogue Ref. No.	Alloy Tin/Lead	S.W.G.	Approx. Length per Carton
C 16014	60/40	14	13 feet
C 16018	60/40	18	37 feet
C 14013	40/60	13	13 feet
C 14016	40/60	16	26 feet

7lb. reel for factory use, Size 1 Carton for Service Engineers.



Ersin Multicore Solder

MULTICORE SOLDERS LTD.,
MELLIER HOUSE, ALBEMARLE STREET, LONDON, W.1 • REGent 1411