

THE ED

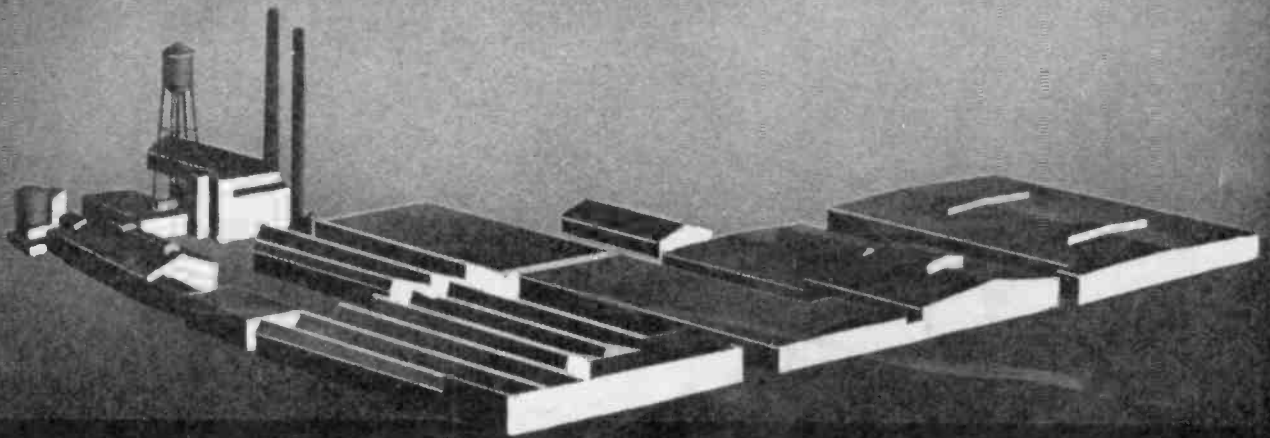

CAPACITOR

Vol. 4

NOV.-DEC., 1940

No. 8

CORNELL-DUBILIER ELECTRIC CORP.
HAMILTON BOULEVARD
SOUTH PLAINFIELD, N. J.

Mr. Martin Lisicky, Jr.
115 E. Lehigh St.
Coaldale, Pa.

Sec. 562, P. L.&R.
U. S. POSTAGE
PAID
So. Plainfield, N. J.
Permit No. 1

RADIO SERVICE HINTS

Practical Suggestions on Solution of Radio Servicing Problems Encountered in Actual Experience by Servicemen Everywhere

This section, conducted by our servicemen readers, will be a regular feature of the C-D Capacitor, and is intended to provide other servicemen with helpful notes on testing, locating troubles in specific models of sets, repairing them, or any other suggestions to simplify service work.

Cornell-Dubilier will pay \$2.00 for each hint published in this section. Notes must be limited to 75 words, or less. Any number of hints may be submitted at one time. Unpublished items will not be returned. Be sure to give your name and mailing address. Send hints to: Editor, C-D Capacitor, Cornell-Dubilier Electric Corp., So. Plainfield, N. J.

RCA Model Victor BP-10

Since this is one of the smallest of battery portables, many owners of these sets have complained that the flashlight cells expire quickly, and cause distorted tone. The writer found instances where the A+ lug of the switch was grounded to the metal case.

To correct this, place adhesive or friction tape on the metal casing to prevent contact. Also insulate "A" leads to battery holder. Distortion is often caused by reversal of the flashlight cell in holder which changes bias characteristics and tone quality.—*L. W. Krizan, Chicago, Ill.*

Pilot Light Tube Tester

Here is a useful gadget used by the servicemen in our shop which others might find equally as handy.

Remove the bulb from any burned out tube base. Saw a slot across the center of a bayonet-type lamp socket and solder the terminals to the filament prongs of the tube base.

Set the lamp socket in the center of the tube base with sealing wax. Tape the lamp socket before pouring the wax to prevent the wax from running into the socket. Insert a lamp in the socket for the desired filament voltage and the adapter can then be employed to test filament circuits.—*Clair V. Johnson, Cannon Falls, Minn.*

Firestone S-7402-1

On the few sets of this model which have come into the writer's shop for repair, it was found that the volume of reception could be increased appreciably by resetting the loop aerial back away from the chassis about a half inch. Half inch bushings were used and longer mounting screws substituted.—*Edgar O'Rourke, Bear Lake, Mich.*

Zenith Model 8S359

Hum in this set as well as others of this type, is often caused by a defective 6U5/6G5 tuning eye tube. Before removing the chassis of any set employing this type of tuning eye tube, the writer has made it a practice to remove the tube in order to determine if the trouble is caused from this source. If the hum stops, obviously, replace this tube with a new one.—*R. B. Olson, Rockford, Ill.*

Airline Models 62-251-55

If sets of these models are found to be noisy or particularly sensitive to static discharges, while all tubes and other parts in the circuit check satisfactory, this trouble may develop in capacitor C-20. This is a .01 mfd. 400 volt unit connected between the antenna post and broadcast preselector coil.

To correct this condition the writer suggests replacing this capacitor with a .05 mfd. 600 volt tubular unit.—*Henry J. Sundmeyer, London, Ark.*

An AVC Aligning Circuit

Here is another practical aligning arrangement employing a 6G5 tube for checking AVC action of receivers.

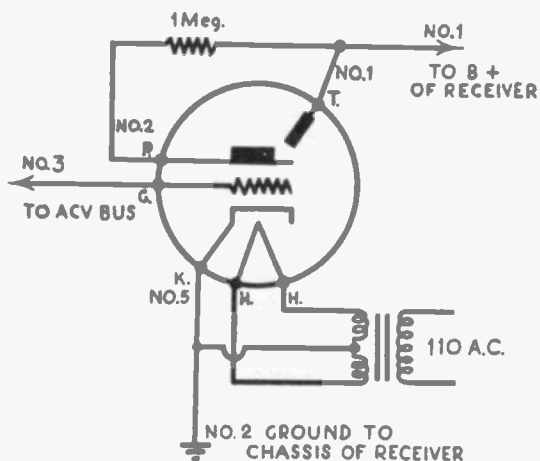

To align a circuit of a set clip No. 1 is attached to the high voltage of the set; clip No. 2 ground to chassis; and clip No. 3 to the AVC bus. Not only does this instrument permit inspection of AVC action without disturbing receiver connections, but its demonstration often leads to a lucrative tuning-eye installation.—*John T. Frye, Logansport, Ind.*

Soldering Iron Heat Regulator

Resistances, lamps, coils, and what-not are used in connection with the A.C. line to regulate soldering temperature and principally to save current. The writer found that the iron

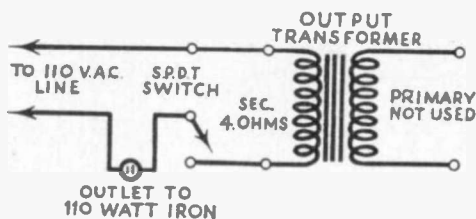

charred after a few hours of use, or the resistor would burn out.

A simple method of regulating the temperature of the iron when not being used is to connect the secondary of an old output transformer in series with the line as shown in the diagram above. Full voltage can be employed to heat the iron, and thereafter throw the switch to the choke regulator, which also gives a hum to indicate the current is on.—*W. F. Onder, Kimmswick, Mo.*

Repairing Voice Coils

Here is a good way to repair speakers which often have been found to cause distortion. In many cases the first few turns on the voice coil work loose and cause the trouble. In speakers where the cone cannot be removed, the cone can be raised carefully far enough to apply a thin coat of aeroplane dope or collodion glue to the first few turns of the coil. This will alleviate the trouble which quite frequently is the result of loose turns of wire on the voice coil.—*Robt. J. Oja, Calumet, Mich.*

Cadillac C-8 Auto Radio

When one or more of the bush-buttons stick or fail to return to their normal position when an adjacent pushbutton is depressed, remove entire unit of seven pushbuttons from dash board and inspect slots on each side of individual catalin pushbuttons to ascertain if any of the small polished ball bearings are missing from these slots or "ball races." Before replacing missing ball bearings rub a light film of machine oil in slots and on sides of pushbuttons.

When unit has been replaced on dash board all pushbuttons will then operate freely.—*F. J. Prosser, Garfield Heights, Cleveland, Ohio.*



A Free Market-Place for Buyers, Sellers, and Swappers.

These advertisements are listed FREE of charge to C-D readers so if there is anything you would like to buy or sell; if you wish to obtain a position or if you have a position to offer to C-D readers, just send in your ad.

These columns are open only to those who have a legitimate, WANTED, SELL or SWAP proposition to offer. The Cornell-Dubilier Electric Corp. reserves the right to edit advertisements submitted, and to refuse to run any which may be considered unsuitable. We shall endeavor to restrict the ads to legitimate offers but cannot assume any responsibility for the transactions involved.

Please limit your ad to a maximum of 40 words, including name and address. Advertisements will be run as promptly as space limitations permit.

WANTED—N.R.I. or I.C.S. radio servicing course in good condition. Will pay cash, but price must be reasonable. Michael A. Kozak, 5048 Homestead St., Philadelphia, Pa.

SWAP—Superior model V-45 tube checker for Rider's service manuals Nos. 5 and 6, or what have you? John Stine, 112 Glover St., Jersey Shore, Pa.

WANTED—Bright young man, high school graduate to work in radio development and experimental dept. of growing radio company. Please state age, experience, education and minimum salary acceptable. Scientific Radio Laboratory, 1101 E. Corrington, Peoria, Ill.

FOR SALE—Hallicrafter S-19 Sky Buddy receiver, in perfect condition. Used only 4 months. Best cash offer takes it. 4402 Washington St., Roslindale, Boston, Mass.

FOR SALE OR SWAP—Hallicrafter Sky Buddy 1940 model for cash or tube tester, or servicing instruments. Bob's Radio Service, Box 266, Red Hook, New York.

FOR SALE—1938 Sky Buddy, 3-band communications receiver, excellent condition, used as a stand-by. In original carton. First \$17.50 takes it. C. K. Bowman, Box 104, Corydon, Iowa.

WILL TRADE—New Remington Rand electric razor. Want used Royal or Underwood typewriter. Write to Jack Lizak, 154 So. 3rd St., Brooklyn, N. Y.

FOR SALE OR SWAP—Rider Chanalyst, 4 mos. old, never used, \$65.00, or what have you to trade. Fred. L. Hussey, 18 Summer St., Malden, Mass.

WANTED—Books or equipment on induction coils, Tesla or Odin coils or other high frequency equipment. State price or will trade Hallicrafters Sky Chief and miscellaneous radio parts. G. Northrup, 1040 Gordon St., Birmingham, Michigan.

POSITION WANTED — Young man 25, Mass. Radio & Tel. School graduate. Have two years experience in radio repairing. Have own test equipment. Ambitious, honest, good worker, and can use typewriter, touch system. Ernest Deslauriers, 188 Coffin Ave., New Bedford, Mass.

FOR SALE OR SWAP—Hallicrafter set, oil xmitter condensers, tubes, auto radios, Triplett 1503 tube tester, radio magazines, Univex 8 mm. movie camera, projector, exposure meter, splicers, etc. Want good S.W. factory-built receiver. Have cash. Oliver F. Klein, 2235 N. 39th St., Milwaukee, Wis.

FOR SALE OR TRADE—Turntable, crystal pickup, 2 dynamic 12" speakers, velocity mike with desk stand and matching transformer, 20 watt Jefferson amplifier in parts and tubes. When assembled, makes P.A. system worth over \$100.00. Want amateur communications set. Auggies Radio Service, 4631 Plummer St., Pittsburgh, Pa.

FOR SALE—Million SY Signalyzer, in new condition, with instructions, \$25.00. New 45 power Wollensak telescope, leather case, holder, \$25.00, a real bargain. Will trade for 16 mm. movie equipment or films. South Zanesville Hardware, South Zanesville, Ohio.

(Continued on page 15)

ANALYZING RADIO NOISES

By the Engineering Department, Cornell-Dubilier Electric Corp.

PART III

Radio Shaver Noises

Since practically all types of electric shavers employ interrupting contacts which operate at a great rate of speed, almost a continuous spark is created. The radio interference from this type of appliance is of high intensity generally identified as a continual buzzing sound in the radio receiver.

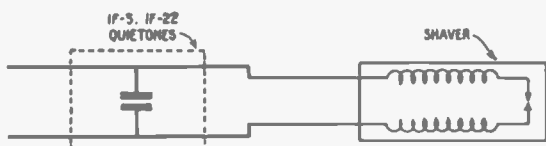

Fig. 1.

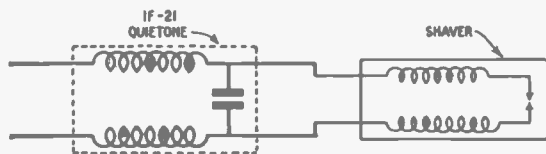

Fig. 2.

Figs. 1 and 2 show the electrical circuits and connections for application of both capacitive and capacitive-inductive filters to shavers. As a shaver is usually enclosed in an insulated case, the frame being inaccessible, it is of no advantage to use a filter which provides a frame connection.

Figs. 3 and 4 show two designs of capacitive filters, one which is attached between the shaver line plug and the power supply receptacle. The other is in effect a filtered line cord with the capacitor placed in the attachment plug, an assembly which replaces the usual shaver line cord. Both of these filters effect a marked improvement in noise conditions.

The capacitive-inductive filter shown in Fig. 5 is recommended where maximum reduction of interference is desired. It will eliminate line noise and decreases direct radiation from the shaver.

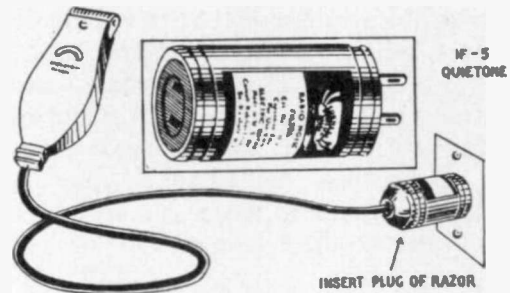

Fig. 3.

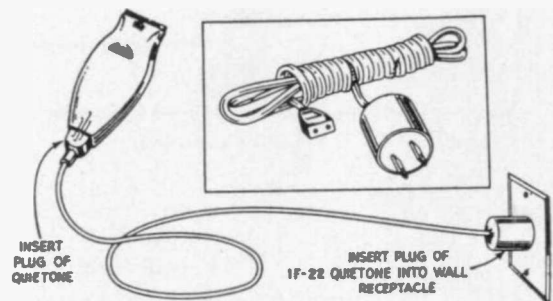

Fig. 4.

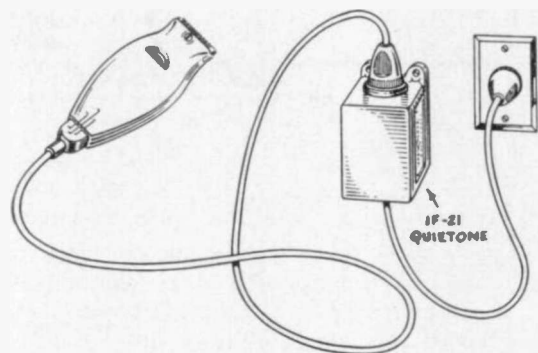

Fig. 5.

Although filters may be connected to shavers, they should not be operated too near to the receiving equipment. Since there can be no filter connection to the frame of the shaver a certain amount of radiated energy may be present, a condition which may be reduced to have a negligible effect on the receiver by observing this precaution.

Noises Caused by Food Mixers, Refrigerators and Similar Types of Household Appliances

Many small electrically operated household appliances contain Universal motors which are the source of considerable radio noise. While manufacturers of this type of equipment frequently install small capacitor filters, they are, in general, not adequately equipped to prevent interference with radio reception.

frame connection is employed to reduce direct radiation of the noise energy.

Typical commercial type filter installations as shown below.

Fig. 8 illustrates the plug-in type filter which is attached between the food mixer and the power line receptacle. This filter is recommended for vacuum cleaners, drink mixers, and similar types of household appliances.

A capacitive-inductive filter shown in Fig. 9 is connected to a domestic refrigerator. This type of filter is em-

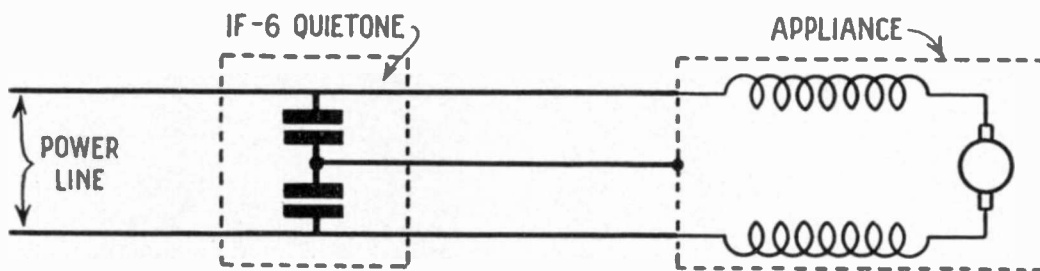

Fig. 6.

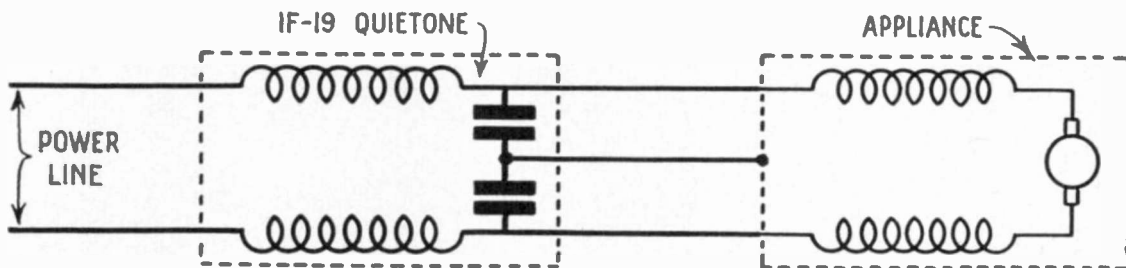

Fig. 7.

Figs. 6 and 7 show the electrical circuits and connections for application of both capacity and capacitive-inductive filters to appliances. As the appliance is usually enclosed in a metal housing, the type of filter providing a

employed only on electrical refrigerators where a capacitive filter does not give satisfactory results. The capacitive-inductive filter is generally required for devices which create a severe dis-

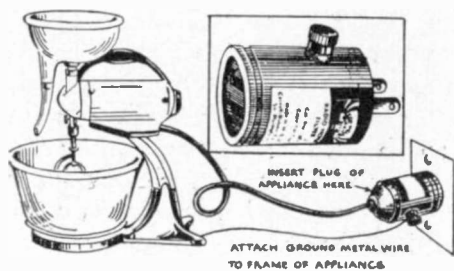

Fig. 8.

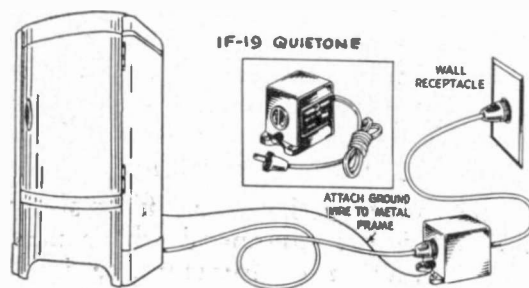

Fig. 9.

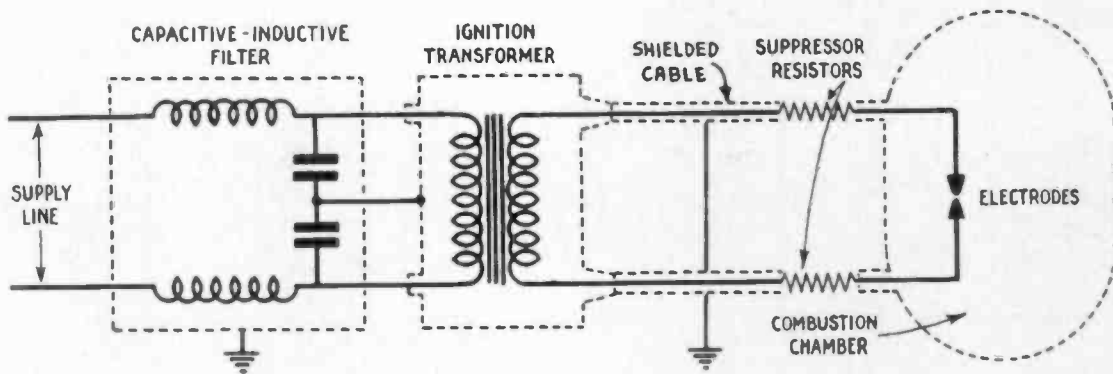

Fig. 10.

turbance, such as hand grinders, electric drills and sanding machines.

Where it is practical, and will not interfere with the operation of an appliance, a shielded line cord should be used. For ordinary installations the appliance line cord should be cut as short as possible, as each additional inch length of the cord will reduce the effectiveness of the filter.

Ignition Type Oil Burner Noises

All oil burners are provided with a device which ignites the atomized oil fuel as it enters the combustion chamber. Three types of devices are employed for this purpose, the gas pilot which does not create a radio disturbance, gas-electric ignition, and electric ignition which are sources of radio noise. The two latter types are by far the most widely used.

Radio interference caused by oil burners is mainly due to the intense arc set up at the time of ignition of the fuel oil. While other parts, such as the thermostat, blower motor, and control mechanism, may contribute to the general noise conditions, they are much less objectionable and only occasionally require filters.

Fig. 10 shows the electrical circuit and connection for application of a capacitive-inductive filter to an oil burner. The filter is installed at the primary of the ignition transformer with very short lead connections. Every inch of the conductors between the secondary winding and the spark electrode should be effectively shielded

with braided copper shielding as these leads usually radiate a strong radio noise signal.

It is essential to shield and ground all parts of the oil burner which may radiate noise energy. The frame of

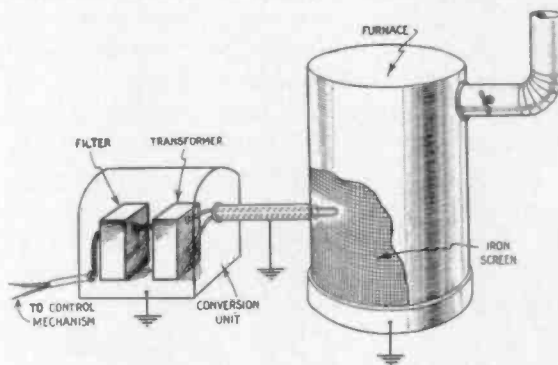

Fig. 11. Conversion Type Oil Burner With Electric Ignition.

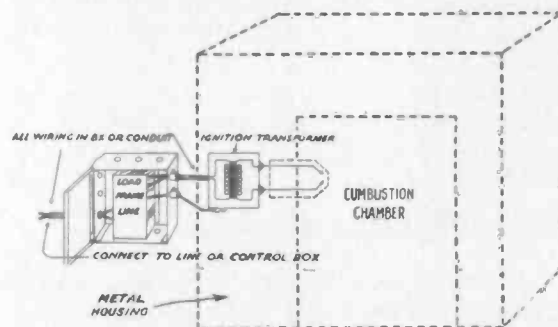

Fig. 12. Filter Installed on Standard Oil Burner.

the oil burner, housing of the combustion chamber, as well as the shielding on all wires should be bonded together with low impedance electrical connections.

The entire system should be maintained at ground potential by means of a short low impedance, ground wire.

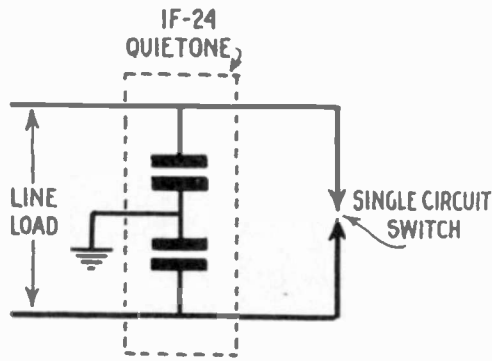

Fig. 13.

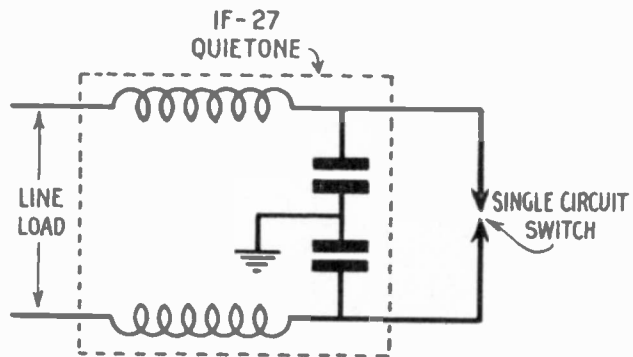

Fig. 14.

Fig. 11 shows a conversion type oil burner installed on a coal burning furnace. For such installations it is frequently necessary to apply a galvanized iron screen around the sides and base of the fire box for effective shielding. These screens and all metal parts of the furnace should be bonded together and connected to the housing of the conversion unit which is in turn connected to an effective ground.

It is occasionally necessary to apply suppressor resistors in series with the high tension ignition leads. The usual resistor value employed for this purpose is 10,000 ohms 5 watts.

A commercial filter installation on an oil burner is shown in Fig. 12. The filter is mounted near the ignition transformer so that extremely short connections can be made. All connecting leads to the transformer and the power lines or control mechanism should be run through BX which is securely bonded to the ground lead.

Sign Flasher Noises

Thermostats, sign flashers, traffic signals, relays and similar apparatus which employ switches or contacts to change circuit conditions are identified as noise producing equipment. The high frequency disturbance is set up by an electrical spark which occurs in a capacitive-inductive circuit which takes place as a normal function of these devices.

While this class of electrical equipment does not cause a continuous interference condition in the radio receiver, it is particularly annoying in

the form of intermittent clicks which appear in regular intervals of time.

Figs. 13 and 14 show electrical circuits in connection with application of both capacitive and capacitive-inductive filters to a switching circuit. In the above instances, the filter is provided with a frame lead to reduce the radiation of noise energy from the equipment.

For multi-circuit sign flashers, one filter is applied to each flashing circuit as shown in Fig. 15. The filter is arranged to prevent conduction of noise energy back to the power lines and also to prevent this conduction to the main part of the line where it would cause good radiating facilities.

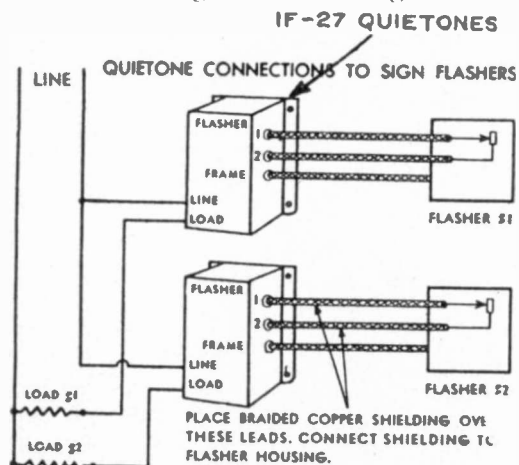

Fig. 15. Filter Connections to Multi-Circuit Sign Flasher.

The selection of a capacitive or capacitive-inductive filter is generally determined by the expense which can be permitted for each particular application, installation and by the area affected by the circuit.

(To be continued)

FILTER DESIGN CALCULATOR*

An electric filter consists of a combination of condensers and inductance coils in a circuit designed either to pass or to by-pass a specified band of frequencies in the current supply to a given load. It is known as a low-pass filter when it passes a band of frequencies between zero and f_c , the cut-off frequency, and by-passes frequencies higher than f_c . It is known as a high-pass filter when it passes all frequencies higher than f_c and by-passes all frequencies lower than f_c . The cut-off is not absolute, or sharply defined, in a single section of a filter, but can be closely approximated by employing several sections.

Two types of low-pass and high-pass filters are in general use. Because of their general shape, these are known as T-types and π -types, respectively. The two types for both low- and high-pass filters are shown at the top of Fig. 1. Here it may be noted that the high-pass filters of both types have condensers in series with the load, R, and inductances in parallel, thus passing the high frequencies to the load and by-passing the low frequencies. Conversely, the low-pass filters have inductances in series, thus passing the low frequencies, and condensers in parallel, thus by-passing the high frequencies, in the current supply to the load.

The fundamental specification for both design and performance is that the internal impedance of a section without load be equal to the impedance of the load. This is in accordance with the well-known fact that any electrical device operates most efficiently when the impedance of the external load matches the internal impedance of the source of power. Furthermore, the best performance is provided by a resistive load, R, which absorbs real power rather than by a reactive load which alternatively stores and restores wattless power.

The correct values of inductances and capacitances for low-pass and high-pass filters of either the T- or the π -type can be mechanically found by means of the chart shown on page 10, at the bottom of which are printed the directions for use. The chart is seen to consist of three sets of double scales. That on the left is a scale of cut-off frequencies for both low- and high-pass sections. That on the right gives load resistances in ohms, the left-side scale being used for figuring inductances and the right-side scale for figuring capacitances. That in the center gives inductance values on the left side and capacitance values on the right side. The L and C values thus obtained are to be used as the values in the circuit diagrams for the several sections shown at the top of the chart. The manner of use can easily be learned by following through several typical examples.

Power Supply Filter

What are the proper values of L and C in a filter for smoothing the ripple in the rectified 60-cycle single phase current supply to a 3,000-ohm load, assuming it to be known that 120 cycles is the lowest frequency in the output from such a filter?

The first step is to select the desired cut-off frequency, making due allowance for the fact that the cut-off is not sharp. From the performance curves, to be explained later, it can be seen that a 40-cycle cut-off will eliminate a goodly part of the 120 cycle and higher frequency components. So let us provisionally select 40 cycles as the desired cut-off for a low-pass filter.

By connecting 40 on the frequency scale to 3000 on the right side of the load scale, we find that a straight-edge intersects the left-center scale at 24 henries. By connecting 40 on the frequency scale to 3000 on the right

* By Arthur H. Halloran, Editor, in "Amateur Radio Defense" magazine.

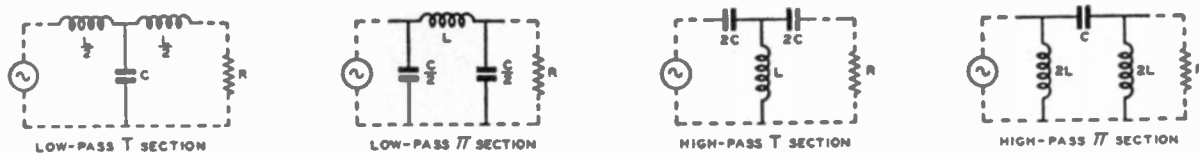

FREQUENCY SCALE
LOW-PASS HIGH-PASS

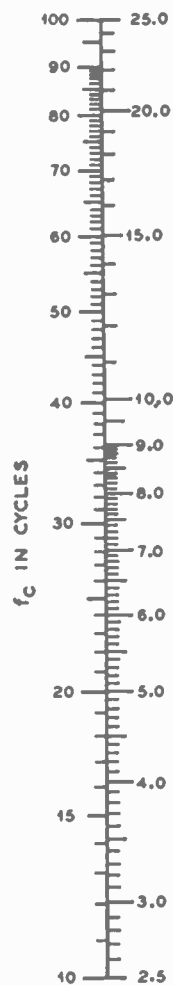

VALUES

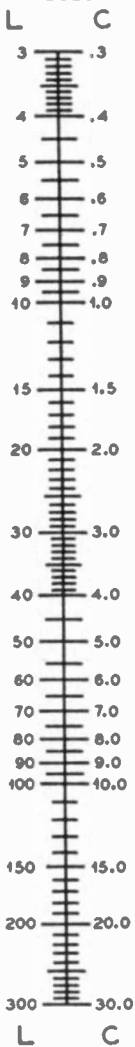

LOAD RESISTANCE

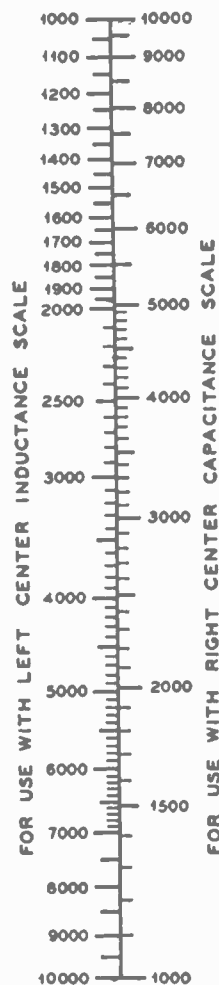

Fig. 1—Filter Design Calculator Chart for π - and T-type Sections.

To find L , connect cut-off frequency on left-hand scale (using left-side scale for low-pass and right-scale for high-pass) with load on left-side of right-hand scale by means of a straight-edge, and read value of inductance where edge intersects left-side of center scale. Readings are in henries for frequencies in cycles per second.

To find C , connect cut-off frequency on left-hand scale (using left-side scale for low-pass and right-side scale for high-pass) with load on right-side of right-hand scale, and

read value of capacitance where straight-edge cuts right-side of center scale. Readings are in microfarads for frequency in cycles per second.

For each tenfold increase in frequency divide L and C values by 10, thus giving direct readings of L in millihenries and C in thousandths of a microfarad for frequencies in kilocycles, and of L in microhenries and C in micro-microfarads for frequencies in megacycles.

For each tenfold increase in load, multiply L by 10 and divide C by 10. For each tenfold decrease in load divide L by 10 and multiply C by 10.

side of the load scale, we find that the straight-edge intersects the right-center scale at 2.6 mfd. But as a 2.6 mfd condenser is not likely to be available, let us see what cut-off frequency would be provided by a 2.5 mfd condenser and what would then be the proper inductance.

Upon connecting 2.5 on the right-center scale with 3000 on the right-load scale the straight-edge will be seen to intersect the frequency scale

These calculations apply directly to filters which are designed solely for the purpose of eliminating undesired frequencies. They can also be applied to the design of a "brute-force" filter which consists essentially of two π -type sections with larger-than-calculated values for the two condensers, which also act as buffer and power-storage units. But that is another story.

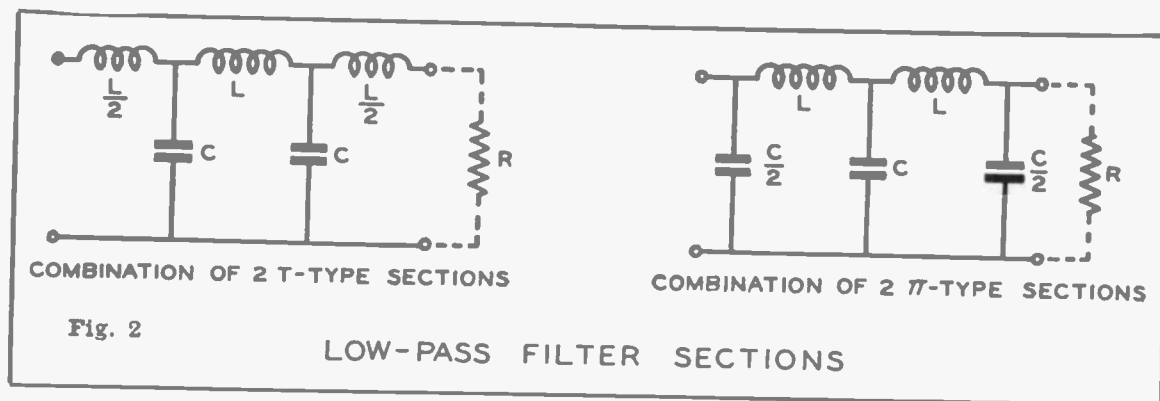

at 42 cycles. This is far enough from the undesired 120 cycle to insure good results and may be selected as the practical cut-off frequency. Then on connecting 42 on the frequency scale to 3000 on the left side of the load scale, we find that the left-center scale is intersected at 23 henries.

As these values of L and C are good for either T - or π -type filters, the next step is to decide which type to use. For a low-pass T -section each of the two series elements is seen to have a value of $L/2 = 11.5$ henries, and the shunt arm to have a value of $C = 2.5$ mfd. For the low-pass π -type, the one series element has a value of $L = 23$ henries, and each of the two shunt elements a value of $C/2 = 1.25$ mfd. As later study of the performance curves will show that both types have the same effect on phase angle and attenuation, final decision as to which to choose is largely a matter of dollars and cents. From the curves it will be found that much better results can be secured by combining two sections, as shown in Fig. 2.

Bandwidth Control Filter

What values of L and C are required in a filter to cut-off frequencies higher than 3000 cycles in 500-ohm line between a speech-amplifier and a high-level modulator in a 'phone transmitter?

This is also a low-pass filter. Its cut-off frequency is 100 times greater than the 30 cycles shown on the frequency scale, which requires that the L and C values shown on the chart be divided by 100. But the load is $1/10$ the 5000-ohm load shown on the chart, which requires that the above value of $L/100$ be divided by 10, thus giving the inductance in millihenries instead of henries. The above value of $C/100$ should, for the 500-ohm load, be multiplied by 10, thus giving $C/10$ as the value for the capacitance, i.e., the chart reading should be divided by 10.

By connecting 30 on the frequency scale with 5000 on the left side of the load scale, corresponding to 3000 cycle value for the cut-off frequency, and the 500-ohm value for the load, the

straight-edge will cut the inductance scale at 53, thus calling for 53 millihenries. Likewise upon connecting 30 on the frequency scale with 5000 on the right side of the load scale, the straight-edge will cut the capacitance scale at 2.1, thus calling for a 0.21 mfd condenser, an odd size.

By selecting a standard 0.2 mfd condenser for C, we find that the cut-off frequency is 3100 cycles, and that the corresponding inductance is 50 millihenries. This calls for two 25 millihenry coils with a 0.2 mfd condenser in a T-type section, or one 50 millihenry coil with two 0.1 condensers in a π -type section.

Band-pass filters are somewhat more complicated in design, inasmuch as they have two sets of cut-off frequencies, a low and a high. A low-pass filter is a band-pass section with a low cut-off at zero and a high-pass filter is a band-pass section with a high cut-off at infinity. A simple form of band-pass filter can be made by connecting a low-pass section in series with a high-pass section, provided that the higher cut-off frequency be twice as great as the lower.

No further examples should be needed to enable the reader to solve any problem in the design of low- or high-pass sections in the same manner as illustrated above, using the left-side frequency scale for low-pass and the right-side frequency scale for high-pass.

Design Formulas

The chart gives approximate results which can easily be checked by the following formulas:

Low-Pass Section: $L = R/\pi f_c$, $C = 1/\pi f_c R$.
 High-Pass Section: $L = R/4\pi f_c$, $C = 1/4\pi f_c R$

where L is in henries, C in farads, R in ohms, and f_c , the cut-off frequency, is in cycles per second.

Verification of these formulas for the values of L and C depends upon proving that the resistance to the current which is delivered to a load by either a T- or a π -type section is given by

$$R = \sqrt{L/C} \dots\dots\dots (1)$$

and that the resonant frequency for a high-pass filter is given by

$$f_o = 2f_c \dots\dots\dots (2)$$

where f_o is the resonant frequency and f_c is the cut-off frequency, whilst that for a low-pass filter is given by

$$f_o = 1/2 f_c \dots\dots\dots (3)$$

These proofs are given below. It may here be noted that eq (2) and (3) show that the cut-off frequency for a high-pass filter is 1/4 of that for a low-pass filter, which explains the double frequency scale in Fig. 1. Supplementing these equations we also have the well-known formula

$$f_o = \frac{1}{2\pi\sqrt{LC}}$$

$$\text{whence } \sqrt{C} = \frac{1}{2\pi f_o \sqrt{L}} \dots\dots\dots (4)$$

$$\text{and } \sqrt{L} = \frac{1}{2\pi f_o \sqrt{C}} \dots\dots\dots (5)$$

Anticipating the proof of eq (1), (2) and (3) we have from eq (1) and (4)

$$\sqrt{L} = R\sqrt{C} = \frac{R}{2\pi f_o \sqrt{L}}, \text{ whence } L = \frac{R}{2\pi f_o}$$

Likewise from eq (1) and (5) we have

$$\sqrt{C} = \frac{1}{R\sqrt{L}} = \frac{1}{2\pi f_o R \sqrt{C}}, \text{ whence } C = \frac{1}{2\pi f_o R}$$

Upon replacing f_o by $2f_c$ from eq (2) in these formulas for L and C, we have

$$L = \frac{R}{4\pi f_c} \text{ and } C = \frac{1}{4\pi f_c R}$$

for a high-pass filter. Likewise upon replacing f_o by $1/2 f_c$ from eq (3), we have

$$L = \frac{R}{\pi f_c} \text{ and } C = \frac{1}{\pi f_c R}$$

for a low-pass filter.

These values of L and C are for the total inductance or capacitance in the series or shunt arms. By referring to the filter circuit diagrams in Fig. 1 it may be noted that in order to provide a total inductance of L in the series arm of a low-pass T-section, each of the two coils in series must have an inductance of L/2; the single

condenser in the shunt arm has a value of C . For the high-pass T-section with two condensers in series in the series arm, each condenser must have a capacity of $2C$ in order to give a total capacity of C ; the single coil in the shunt arm has an inductance of L . For the case of the low-pass π -type, the single coil in the series arm has an inductance of L , and each of the two condensers in parallel in the shunt arm has a capacity of $C/2$. Likewise for the high-pass π -type, the single condenser in the series arm has a capacity of C , and each of the two coils in parallel in the shunt arm has an inductance of $L/2$.

Proof of the impedance equations is based on the assumption that the resistance of the load is equal (or matched) to the internal reactance of the filter section, thus providing maximum transfer of power and eliminating the effects of reflected currents. This assumption ignores the reactance of the load and the resistance of the filter section, and thus pre-supposes an ideal condition which cannot be realized in practice. But inasmuch as these two sets of neglected factors tend to cancel one another and as the values of constructed coils and condensers are seldom the same as specified, the formulas are universally used for figuring filter design and performance.

Economy in thought may be promoted by first solving for general cases of T- and π -types and then substituting the values of L and C which provide either high-pass or low-pass sections. In so doing, let the series impedances be designated by x , the shunt impedances by y , the load resistance by R , and the internal impedance by Z .

Impedance of T-Sections

The two T-type sections in Fig. 1 can then be represented by Fig. 3(a), whose equivalent circuit is shown in Fig. 3(b). The equivalent circuit shows $x/2$ to be in series with a parallel circuit consisting of y and $(R+x/2)$. The impedance of the parallel circuit is found by solving for U in the equation

$$\frac{1}{U} = \frac{1}{y} + \frac{1}{R + x/2} = \frac{2y + x + 2R}{xy + 2yR}$$

This parallel circuit is in series with $x/2$ to give a total impedance

$$Z = \frac{x}{2} + U = \frac{x}{2} + \frac{xy + 2yR}{xy + x^2/4 + xR/2 + yR} = \frac{x/2 + y + R}{xy + x^2/4 + xR/2 + yR}$$

Upon substituting Z for R , under the specification that they be matched, and upon solving for Z , we have

$$Z = \frac{xy + x^2/4 + xZ/2 + yZ}{x/2 + y + Z} = \sqrt{xy} \sqrt{1 + x/4y}$$

For the low-pass T-type section in Fig. 1, $x/2 = \omega L/2$ and $y = -1/\omega C$. Consequently

$$\sqrt{xy} = \sqrt{-\omega L/\omega C} = \sqrt{-L/C}$$

$$\sqrt{1 + x/4y} = \sqrt{1 - \omega^2 LC/4} = \sqrt{1 - f^2/4f_o^2}$$

where $f_o^2 = 1/2\pi LC$ gives the resonant frequency f_o .

The cut-off frequency, f_c , marks the boundary between the frequencies which are passed and those which are by-passed, and is that frequency for which the impedance is zero. As L/C is not zero, we have, upon substituting f_c for f ,

$$\sqrt{1 - f_c^2/4f_o^2} = 0, \text{ whence } f_c/2f_o = 1 \text{ and } f_c = 2f_o.$$

Finally, upon substituting f_c for $2f_o$ in the equation for Z , we get

$$Z = \sqrt{-L/C} \sqrt{1 - (f/f_c)^2} = \sqrt{L/C} \sqrt{(f/f_c)^2 - 1} \dots \dots \dots (6)$$

As will later be explained more fully, the factor $\sqrt{L/C}$ has the nature of a resistance to the real current which is passed to the load, and the factor

$$\sqrt{(f/f_c)^2 - 1} = j\sqrt{1 - (f/f_c)^2}, \text{ where } j = \sqrt{-1},$$

represents either the opposition to the wattless current which is by-passed from the load, or the phase displacement of the real current. In all this discussion $\omega = 2\pi f$, $\omega_o = 2\pi f_o$, and $LC = 1/\omega_o^2$.

For the high-pass T-section, $x/2 = 2C$ with a total series reactance of $x = -1/\omega C$, and $y = \omega L$. Consequently,

$$\sqrt{xy} = \sqrt{-\omega L/\omega C} = \sqrt{-L/C}$$

$$\sqrt{1+x/4y} = \sqrt{1-1/(4\omega^2 LC)} = \sqrt{1-(f_0/2f)^2}$$

whence $Z = \sqrt{-L/C} \sqrt{1-(f_0/2f)^2}$

For zero impedance $f = f_c$, as before, and we have $(f_0/2f_c)^2 - 1 = 0$, whence $f_c = f_0/2$. This proves eq. (2).

In terms of the cut-off frequency, the internal impedance of a high-pass T-section is thus

$$Z = \sqrt{L/C} \sqrt{(f_c/f)^2 - 1}$$

4(b). The impedance of the parallel arm consisting of $2y$ and R in Fig. 4(b) can be found by solving for U in the equation

$$\frac{1}{U} = \frac{1}{2y} + \frac{1}{R} = \frac{R + 2y}{2yR}$$

U is connected in series with x to give an impedance

$$W = U + x = \frac{2yR}{R + 2y} + x$$

$$= \frac{2yR + xR + 2xy}{R + 2y}$$

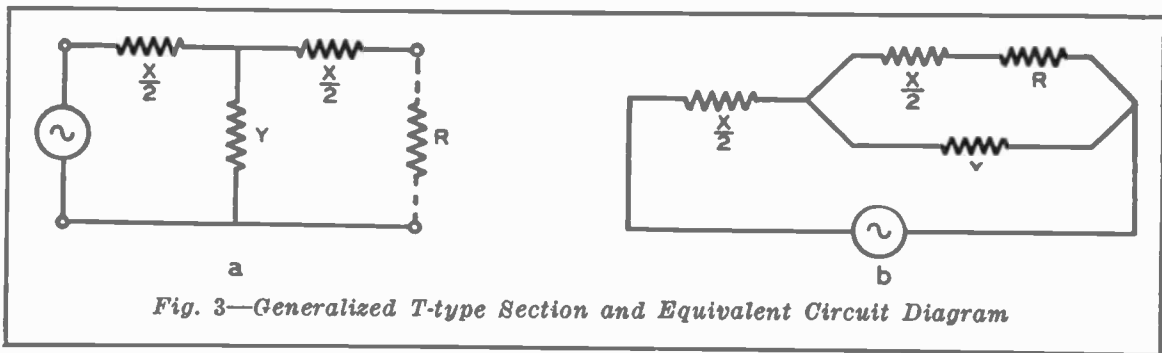

Fig. 3—Generalized T-type Section and Equivalent Circuit Diagram

As in the case of a low-pass current filter, its resistance to the current passed to the load is expressed by $R = \sqrt{L/C}$.

Impedance of π -Type Sections

By using the generalized designations for series and shunt elements, the π -type filter sections in Fig. 1 can be represented by Fig. 4(a), whose equivalent circuit is shown in Fig.

W is connected in parallel with $2y$ to give the total impedance found by solving for Z in the equation

$$\frac{1}{Z} = \frac{1}{W} + \frac{1}{2y} = \frac{R + 2y}{2yR + xR + 2xy} + \frac{1}{2y}$$

$$= \frac{4yR + 4y^2 + xR + xy}{2y(2yR + xR + 2xy)}$$

Upon substituting Z for R it can easily be found that

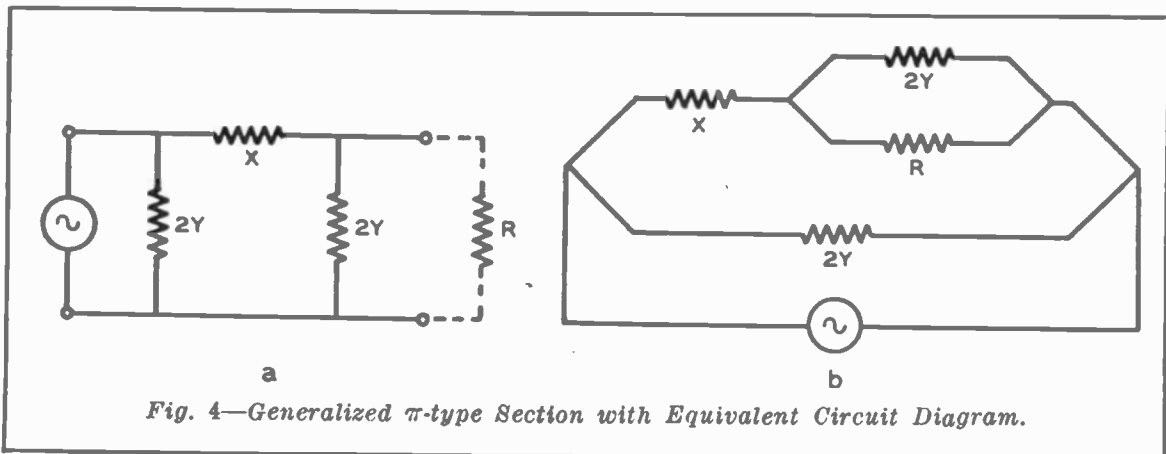

Fig. 4—Generalized π -type Section with Equivalent Circuit Diagram.

$$Z = \frac{\sqrt{xy}}{\sqrt{1 + x/4y}}$$

For the low-pass π -type in Fig. 1, $x = L$ with a series reactance of ωL , and $2y = C/2$, whence the shunt reactance is $-1/\omega C$. Consequently,

$$\begin{aligned} xy &= \sqrt{-\omega L/\omega C} = \sqrt{-L/C} \\ \sqrt{1 + x/4y} &= \sqrt{1 - \omega^2 LC/4} = \sqrt{1 - (f/2f_c)^2} \\ &= \sqrt{1 - (f/f_c)^2}, \end{aligned}$$

since we have already found that $f_c = 2f_0$ for a low-pass filter. For the total impedance we finally have

$$Z = \frac{\sqrt{-L/C}}{\sqrt{1 - (f/f_c)^2}} = \frac{\sqrt{L/C}}{\sqrt{(f/f_c)^2 - 1}}$$

where $\sqrt{L/C} = R$ represents the resistance to the current which is passed to the load.

For the high-pass π -type in Fig. 1, $x = C$ with a series reactance of $-1/\omega C$, and $2y = 2L$, whence the shunt reactance is ωL . By following the procedure previously employed we can readily find that

$$Z = \frac{\sqrt{L/C}}{\sqrt{(f/f_c)^2 - 1}}$$

where $\sqrt{L/C} = R$ represents the resistance to the current which is passed to the load.

THE RADIO TRADING POST

(Continued from page 4)

SALE OR TRADE—Candid miniature type camera, Detrola model K, has Wollensak f. 3.5 lens. Speeds up to 1/200 sec. Has focusing and aperture adjustments and built-in exposure meter. Includes leather case, K-2 filter and portrait lens. Want Rider's manuals. George H. Koether, Jr., Severn Park, Round Bay, Md.

WANTED—5-10-20 meter xtrmr. 75 watts or less, must be good. Will sell or swap Ralston record code lessons complete, as good as new. Also have G.M. Visi-tron P.E. cell, used. Make offer. Jack Watt, Supreme Radio Service, Ontonagon, Mich.

WANTED—Dry-disc type battery charger. Please state make, model, condition and price. Jack's Radio Shop, 77-04 Woodside Ave., Elmhurst, N. Y.

WILL SWAP—Complete radio laboratory training course, including parts. Want volt-ohm-milliammeter or tube checker, or what have you. David E. Reid, 650 West End Ave., Carthage, N. Y.

FOR SWAP—Part of my firearms. 2 .45 automatic Colts, 1 Luger 9 mm., will trade for a good analyzer and tube combination, Supreme 385 preferred. Joseph V. Oliveri, 548 South Ocean Ave., Patchogue, N. Y.

FOR SALE—Rider's manuals Vols. 1, 2, 3, 4, 5, and 6. Will take \$25.00 for the lot or \$4.50 each. All in perfect condition. Have two sets to sell. Will sell any one or all. B. J. Dilley, Century Radio Service, 10008 1/2 S. Main St., Los Angeles, Calif.

WANTED—Rider's manuals vols. 6, 7, 8, 9, 10 and 11. Please state condition and individual vols, or group, and lowest possible price. Norman E. Nelson, P.O. Box 211, Mayville, North Dakota.

FOR SALE—Supreme 89 DeLuxe tube checker \$10.00 cash. Philco 088 signal generator \$8.00. Sprayberry radio course \$10.00. Ghirardi's radio service and field service data \$2.50. All in perfect condition. Peter McLaughlin, 1115 Chanslor Ave., Richmond, Calif.

WANTED—A 300-watt or larger multi-match class B modulator transformer. Must be a real bargain. Bruce H. Cox, Winston Salem Post Office, Winston Salem, N. C.

TRADE OR SALE—Astatic T3 crystal mike and grip-to-talk stand. Also American D5-dynamic for 50 ohm line. Practically new in perfect condition. Want Colt or S.W. 38 special revolver or bolt action rifle. Curtis & Davis Radio Service, 921 Walnut St., Coffeyville, Kansas.

WANTED—Late Sprayberry and NRI complete radio courses. Must be in A1 condition. State lowest cash price. Radio Electric Service, 323 Broad St., Grove City, Pa.

FOR TRADE—Remington Noiseless portable typewriter, about 3 years old. Will swap for a good tube checker or what have you. Harry L. Tucker, 1426 21st Street, N. W., Washington, D. C.

FOR SALE OR TRADE—B flat tenor sax and trumpet. Will trade for equal value in good radio test equipment such as Oscilloscope, signal tracer, electronic voltmeter, etc., or sell for cash. Garland R. Fougber, Gar's Radio & Elec. Service, Oshkosh, Nebraska.

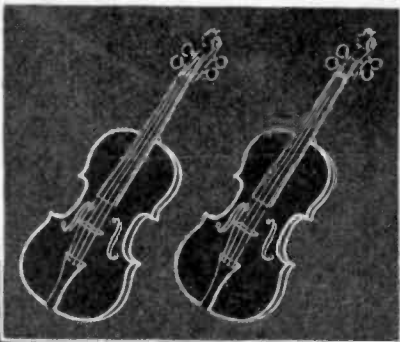

ONE VIOLIN looks like another. It takes a skilled musician to recognize the Stradivarius. He sees the hidden quality. In capacitors, too, quality lies hidden. The thing that gives you extra service is found in capacitor ingredients.

EXTRA SERVICE!

That's the reason..

THERE ARE MORE CORNELL-DUBILIER CAPACITORS IN USE THAN ANY OTHER MAKE

LOOKING like any other capacitors, C-Ds are different underneath. Hidden in the ingredients is an extra measure of quality. This quality accounts for the longer life, greater dependability, extra service engineers enjoy in C-Ds. You can expect extra service every time you specify Cornell-Dubilier capacitors. It's built in! . . . a product of C-D specialization — actually, extra years of capacitor experience. Next time, get the capacitor that offers you extra value at no extra cost.

REMEMBER! Only C-D union-made capacitors give you the EXTRAS at no extra cost.



Only Cornell-Dubilier Electrolytics offer all these **EXTRA FEATURES!**

- Special high voltage paper separator
- C-D etched plate
- Special C-D electrolyte
- Special high formation process



Write for Catalog No. 185-A

**CORNELL-DUBILIER
ELECTRIC CORPORATION**

1004 HAMILTON BLVD. • SO. PLAINFIELD, N. J.

Get the extras

— WITH CORNELL-DUBILIER CAPACITORS!