

UNIV. OF
TORONTO
LIBRARY



Digitized by the Internet Archive
in 2011 with funding from
University of Toronto

<http://www.archive.org/details/generalelectricr18gene>

GENERAL ELECTRIC REVIEW

INDEX TO VOLUME XVIII

January, 1915—December, 1915

TK
/
G-5
V. 8

INDEX TO VOLUME XVIII

	PAGE		PAGE
Absolute Zero, The, by Dr. Saul Dushman	93, 238	Dark Room, X-Ray, A Model, by Wheeler P. Davey	1107
Acid-Dipping, Electroplating and Japanning Plant, A Modern, by Horace Niles Trumbull	1121	Depreciation of Property, by W. B. Curtiss	1099
Agriculture, Electricity in, by C. J. Rohrer	483	Developments in Electrical Apparatus During 1914, by John Liston	80
A.I.E.E., History of Schenectady Section of the, by S. M. Crego	1006	Direct Current, High Potential Methods of Obtaining, by Stuart Thomson	1084
A.I.E.E., Notes on the Activities of the, 71, 148, 222, 301, 405, 594		Drill, Rock, The Fort Wayne Electric, by C. Jackson	273
Air Cleaning Apparatus for the Ventilation of Generators and Transformers, by Wm. Baum	801	Earth Connections, Proper Construction of, by G. H. Rettew	904
Air Supply, Test for Dirt in an, by S. A. Moss	622	Economies in Operating Small Cars, by J. F. Layng	790
Altitude, Effect of, on the Spark-over Voltages of Bushings, Leads and Insulators, by F. W. Peek, Jr.	137	Electric Power Industry, The, by D. B. Rushmore	427
Aluminum Company of America, at Massena Springs, N. Y., The 45,000-kw. Synchronous Converter Substation of the, by J. L. Burnham and R. C. Muir	873	Electrical Development, The Trend of, by Paul M. Lincoln	784
Apprentice System at the Lynn Works of the General Electric Company, The, by Theodore Bodde	35	Electrical Engineering at Columbia University, The New Advanced Course in, by W. I. Slichter	940
Automobile Industry, Electricity in the, by F. M. Kimball	550	Electricity in the Automobile Industry, by Fred M. Kimball	550
Ball Bearings in Electric Motors, by F. H. Poor	631	Electricity in the Construction and Operation of the Panama Canal (Supplement to July issue), by Edward Schidhauer	679
Berkshire Street Railway, Semi-outdoor Portable Substation for, by W. D. Bearce	44	Electrique, The Osborne, by O. E. Thomas	299
Bethlehem-Chili Iron Mines Company, The 2400-volt Railway of the, by E. E. Kimball	12	Electricity in Agriculture, by C. J. Rohrer	483
Burning Powdered Coal, Some Problems in, by Arthur S. Mann	920, 959	Electro-culture: A Resumé of the Literature, by Helen R. Hosmer	14
Butte, Anaconda & Pacific Railway, Contact System of the, by J. B. Cox	842	Electron Discharge, The Pure, and Its Applications in Radio Telegraphy and Telephony, by Irving Langmuir	327
Cars, Small, Economies in Operating, by J. F. Layng	790	Electroplating, Acid-Dipping and Japanning Plant, A Modern, by Horace Niles Trumbull	1121
Car Operation and Power Consumption, Relation Between, by J. F. Layng	973	ELECTROPHYSICS	
Cathode Rays and Their Properties, by J. P. Minton	118	Application of the Electron Theory to Various Phenomena, by J. P. Minton	287
Cathode Ray Tube and Its Application, The, by M. E. Tressler	816	Electromagnetic Radiation from the Viewpoint of the Electron Theory, by J. P. Minton	387
Cathode Ray Tubes, Some Characteristics of, by J. P. Minton	636	Cathode Rays and Their Properties, by J. P. Minton	118
Central Station, The Possibilities Open to the, in Solving the Freight Terminal Problem, by Jas. A. Jackson	1142	Electron Theory of Electric Conduction in Metals, by J. P. Minton	204
Chicago, Milwaukee & St. Paul Railway Company, The First 3000-volt Locomotive for the, by E. S. Johnson	1154	Some Characteristics of Cathode Ray Tubes, by J. P. Minton	636
Chicago, Milwaukee & St. Paul Locomotives, The, by A. H. Armstrong	600	Emergency Transformer Connections, by George P. Roux	832
Chicago, Milwaukee & St. Paul Railway, The Electrification of the Puget Sound Lines of the, by A. H. Armstrong	5	Enameling Ovens, Electrically Heated, by C. W. Bartlett	1130
Chicago, Milwaukee & St. Paul Railway, The 1500-volt Electrification of the, by W. D. Bearce	644	Engines, Internal Combustion, Parallel Operation of Alternating Current Generators Driven by, by R. E. Doherty and H. C. Lehn	167
Coal, Powdered, Some Problems in Burning, by Arthur S. Mann	920, 959	Engineer, The Status of the, by Dr. E. W. Rice, Jr.	234
Coatings, Protective, for Metals, by H. B. C. Allison	878	Engineering in the Navy, by W. L. R. Emmet	1097
Coffee Plantation, Hydro-electric Installation on a, by J. H. Torrens	219	Eye and Illumination, The, by H. E. Mahan	268
Cohoes Company at Cohoes, N. Y., Hydro-electric Development of the, by B. R. Connell	340	Factory Lighting , by G. H. Stickney	67
Columbia University, The New Advanced Course in Electrical Engineering at, by W. I. Slichter	940	Factories, Isolated Power-house for, by W. E. Francis	1057
Compensators for Mazda C Lamps, by H. D. Brown	596	Fire Departments, Portable Searchlights for, by L. C. Porter and P. S. Bailey	1144
Consumer, The Small: A Problem, by A. D. Dudley	657	Freight Terminal Problem, The Possibilities Open to Central Stations in Solving the, by Jas. A. Jackson	1142
CONTROL . (See also Protection).		Frequency Changers, Parallel Operation of, by G. H. Rettew	836
Sprague-General Electric PC Control, by C. J. Axtell	985	Gases, The Kinetic Theory of , by Dr. Saul Dushman	952 1042, 1159
Control and Protection of Electric Systems, by C. P. Steinmetz	887	Gases, Noble, Notes on the, by W. S. Andrews	226, 408
Coolidge Tube, Application of the, to Metallurgical Research, by Dr. Wheeler P. Davey	134	Gears and Pinions, Railway Motor, Operating Conditions of, by A. A. Ross	249
Cooling Power Transformers, Principal Factors Governing the Choice of Method of, as Related to Their First Cost and Operating Conditions, by W. S. Moody	839	Genemotor, The, by M. J. Fitch	384
Corona and Spark-over in Oil, The Law of, by F. W. Peek, Jr.	821	General Electric Company's Exhibits at the Panama-Pacific International Exposition, by G. W. Hall	561
Current, Growth of, in Circuits of Negative Temperature Coefficient of Resistance, by F. W. Lyle	1129	GENERATORS	
		Air Cleaning Apparatus for the Ventilation of Generators and Transformers, by Wm. Baum	801
		Parallel Operation of Alternating Current Generators Driven by Internal Combustion Engines, by R. E. Doherty and H. C. Lehn	167
		Grounding, General Notes on, by H. M. Wolf	991

	PAGE		PAGE
Heating and Heating Appliances, Electric, by C. P. Randolph.....	523	Lubrication, The Theory of, by L. Ubbelohde, Translated by Helen R. Hosmer.....	966, 1074, 1118
High Frequency, by F. W. Peek, Jr.....	934	Magnetic Properties of Steel, The Effect of Chemical Composition Upon the, by W. E. Ruder.....	197
High Potential Direct Current, Methods of Obtaining, by Stuart Thomson.....	1084	Magnetization Curves, Some Notes on, by John D. Ball.....	31
High Voltage Direct-current Substation Machinery, by E. S. Johnson.....	641	Marine Work, Electricity in, by Maxwell W. Day.....	504
High Voltage Arrestor for Telephone Lines, by E. P. Peck.....	189	Metal, Protective Coatings for, by H. B. C. Allison.....	878
Hoists, Large Steam, Tests of, by H. E. Spring.....	179	Metals, Radiography of, by Wheeler P. Davey.....	795
"Home Electrical" at the Panama-Pacific International Exposition, The, by Don Cameron Shaffer.....	572	Meter Design, Induction, Some Notes on, by W. H. Pratt.....	277
HYDRO-ELECTRIC DEVELOPMENTS		Mica, Built Up, X-Ray Examination of, by C. N. Moore.....	195
Hydro-electric Development of the Cohoes Company, at Cohoes, N. Y., by B. R. Connell.....	340	Mine Haulage Motor, The Modern, by C. W. Larson.....	264
Water Powers of New England, by H. I. Harriman.....	358	Mining Work, The Use of Electricity in, by D. B. Rushmore.....	527
Hydro-electric Installation on a Coffee Plantation, by J. H. Torrrens.....	219	Motion Picture Machines, Current Supply for, by H. R. Johnson.....	895
Impregnating Coils, The Process of, and a Large Impregnating Plant, by Robert Reid.....	48	MOTORS	
Industrial Applications of Electricity, Some, by A. R. Bush.....	460	Electric Motor in the Printing Industry, The, by W. C. Yates.....	1136
Industrial Research, by L. A. Hawkins.....	416	Ball Bearings in Electric Motors, by Frederick H. Poor.....	631
Industry, The Electric Power, by D. B. Rushmore.....	427	Methods of Removing the Armature from Box Frame Railway Motors, by J. L. Booth.....	908
Industry, The Individual and Corporate Development of, by C. P. Steinmetz.....	813	Modern Mine Haulage Motor, The, by C. W. Larson.....	264
Insulating Materials, The Volume Resistivity and Surface Resistivity of, by Harvey L. Curtis.....	996	Power Consumption of Railway Motors, by H. L. Andrews and J. C. Thirlwall.....	944
Insulations, Solid, Electrical Characteristics of, by F. W. Peek, Jr.....	1050	Railway Motor Characteristic Curves, by E. E. Kimball.....	296
Insulation Testing, by G. B. Shanklin.....	1008	Short Method for Calculating the Starting Resistance for Shunt, Induction and Series Motors, A, by B. W. Jones.....	131
Iron-cobalt Alloy, Fe,Co, and Its Magnetic Properties, The, by Trygve D. Yensen.....	881	Subdivision of Power as Solved by the Small Motor, The, by R. E. Barker and H. R. Johnson.....	555
Japaning, Acid-Dipping and Electroplating Plant, A Modern, by Horace Niles Trumbull.....	1121	MOTOR DRIVE	
Jitney Problem, The, by J. C. Thirlwall.....	604	Electrical Equipment of the Vermont Marble Company, by John Liston.....	1015
Kenotron, The, A New Device for Rectifying Alternating Currents, by Dr. Saul Dushman.....	176	Electricity in Agriculture, by C. J. Rohrer.....	483
Kinetic Theory of Gases, The, by Dr. Saul Dushman.....	952, 1042, 1150	Electricity in Marine Work, by Maxwell W. Day.....	504
LAMPS		Electric Power in the Textile Industry, by C. A. Chase.....	540
Compensators for Mazda C Lamps, by H. D. Brown.....	596	Industrial Applications of Electricity, Some, by A. R. Bush.....	460
Electric Lamp Industry, by G. F. Morrison.....	497	Supplying of Power to the Quaker Oats Company, by J. M. Drabelle.....	42
High Candle-power Mazda Lamps for Steel Mill Lighting, by G. H. Stickney.....	377	Use of Electricity in Mining Work, The, by D. B. Rushmore.....	527
Incandescent Lamps for Projectors, by L. C. Porter.....	371	Multi-recorder, A Cursory Account of the First Lightning Storm of the Season as Given by the Records of the, by E. E. F. Creighton.....	860
Modern Street Lighting with Mazda Lamps, by H. A. Tinson.....	659	Navy, Engineering in the, by W. L. R. Emmet.....	1097
LIGHTING		Negative Temperature Coefficient of Resistance, Growth of Current in Circuits of, by F. W. Lyle.....	1129
Brief Review of the Electric Lighting Industry, by C. W. Stone.....	439	N.E.L.A. Lamp Committee Report, A Review of the, by G. F. Morrison.....	925
Eye and Illumination, The, H. E. Mahan.....	268	New England, Water Powers of, by H. I. Harriman.....	358
Factory Lighting, by G. H. Stickney.....	67	Noble Gases, Notes on the, by W. S. Andrews.....	226, 408
High Candle-power Mazda Lamps for Steel Mill Lighting, by G. H. Stickney.....	377	OBITUARY	
Illumination of the Panama-Pacific International Exposition, by W. D. A. Ryan.....	579	In Memoriam: Douglas S. Martin.....	76
Lighting of Ships, The, by L. C. Porter.....	143	In Memoriam: John P. Judge.....	672
Modern Street Lighting with Mazda Lamps, by H. A. Tinson.....	659	In Memoriam: Dr. and Mrs. F. S. Pearson.....	930
Sign and Building Exterior Illumination by Projection, by K. W. MacCall and L. C. Porter.....	282	In Memoriam: George Crellin Cartwright.....	1169
Lock Entrance Cannon for the Panama Canal, by L. A. Mason.....	210	Oil, The Law of Corona and Spark-over in, by F. W. Peek, Jr.....	821
LOCOMOTIVES		Ontario Municipal Railway, The 1500-volt Direct-current Electrification of the, by G. H. Hill.....	10
Chicago, Milwaukee & St. Paul Locomotive, The, by A. H. Armstrong.....	600	Oscillations, Damped, the Production of, by Leslie O. Heath.....	1110
First Diesel Locomotive, The Chicago, Milwaukee & St. Paul Railway, Canada, The, by E. S. Johnson.....	1154	Ovens, Enameling, Electrically Heated, by C. W. Bartlett.....	1130
Operation and Rating of the Electric Locomotive, The, by A. H. Armstrong.....	828	Panama Canal, Electricity in the Construction and Operation of the, by Edward Schildhauer.....	679
Loading Locomotives for the Panama Canal, The, by C. W. Larson.....	101	Ancon Quarry.....	688
		Balboa Sand Dock.....	688
		Control of the Lock Machinery.....	748
		Distribution at Locks.....	716
		Gatun Hydro-electric Station.....	688
		Gatun Locks and Dam.....	679
		Interlocking (Panama Canal Lock).....	754

	PAGE
Panama Canal, Locomotive Design, Details of.....	732
Machinery for the Operation of the Locks and Spillways	722
Pacific Locks and Dam.....	687
Reserve Station.....	708
Towing Locomotives.....	729
Transmission System.....	709
Panama Canal, Lock Entrance Caisson for the, by L. A. Mason.....	210
Panama Canal, The Towing Locomotives for the, by C. W. Larson.....	101
Panama-Pacific International Exposition, The Illumination of the, by W. D'A Ryan.....	579
Panama-Pacific International Exposition, The General Electric Company's Exhibits at the, by G. W. Hall	561
Panama-Pacific International Exposition, The "Home Electrical" at the, by Don Cameron Shafer.....	572
Parallel Operation of Alternating-current Generators Driven by Internal Combustion Engines, by R. E. Doherty and H. C. Lehn.....	167
Parallel Operation of Frequency Changers, by G. H. Rettew	836
Paths of Progress, The, (Editorial).....	3, 79, 155, 231, 314, 415, 599, 783, 867, 939, 1011, 1091
Periodic Law, The, by Dr. Saul Dushman.....	614
Pinions (See also Gears)	
Power, Subdivision of, as Solved by the Small Motor, by R. E. Barker and H. R. Johnson.....	555
Power Consumption of Railway Motors, by H. L. Andrews and J. C. Thirlwall.....	944
Power House, Isolated, for Factories, by W. E. Francis..	1057
Practical Experience in the Operation of Electrical Machinery, by E. C. Parham.....	58
Alternator Speed Low.....	1082
Armature Threw Solder.....	58
Belts, Loose.....	59
Brush-holders Shifted.....	57
Burn-out due to Core Loss.....	217
Brake Adjustments, Electric.....	401
Capacity Current.....	58
Clutches, Adjusting Single-phase Motor.....	929
Commutators, Loose.....	56
Commutator Winding, Improvised.....	403
Connection, Loose.....	56
Contact-shoe Pressure, Excessive.....	217
Crane Troubles.....	1005
Core, Loose.....	58
Deflections, Misleading.....	402
Devices, Misapplication of.....	401
Elevator Trouble.....	1155
Elevator Speed, Erratic.....	59
Equalizer on the Wrong Side.....	305
Field Connection Error.....	928
Generators Motoring at No-Load.....	305
Hot Box Indications.....	57
Instrument Connections Wrong.....	404
Load was Unbalanced.....	1082
Motor Acceleration, Jerky.....	218
Motor Heating, Repulsion.....	667
Motor Mounting, Changing.....	306
Motors, Repulsion Induction, Heating and Sparking of.....	147
Motor Reversed.....	1155
Motor Stopped and Reversed.....	1004
Motor Throwing Oil.....	307
Motor on an Inertia Load, Variable-Speed.....	667
Motor Would Not Start.....	928
Power-Factor, Low.....	56
Pump Output, Excessive.....	147
Reactor Starting-Box Trouble.....	403
Repulsion-induction Motors, Heating and Sparking of.....	147
Resistance Wire Crossed.....	1174
Rotor Rubbed Stator.....	218
Shunt Ratio, The Wrong.....	666
Slip-ring Contacts, Imperfect.....	304
Stations in Series.....	861
Stator Coil Connections.....	1083
Transformer Connections.....	862

	PAGE
Practical Experience, etc., by E. C. Parham Cont'd	
Transformer Failures.....	146
Transformers, Parallel.....	861
Voltage, Service, Too Low.....	668
Voltage, Unstable.....	1005
Printing Industry, The Electric Motor in the, by W. C. Yates.....	1136
Projectors, Incandescent Lamps for, by L. C. Porter.....	371
Protection and Control of Industrial Electric Power, by C. P. Steinmetz.....	979
Protection of Railway Signal Circuits against Lightning Disturbances, by E. K. Shelton.....	1127
Quaker Oats Company, The Supplying of Power to the, by J. M. Drabelle.....	42
Radiography of Metals, by Dr. Wheeler P. Davey.....	795
Radio-telephony, by W. C. White.....	38
Radio Telegraphy and Telephony, The Pure Electron Discharge and Its Application In, by Irving Langmuir.....	327
Railways, Electric, A Review of, by W. B. Potter and G. H. Hill.....	444
RAILWAY EQUIPMENT	
Automatic Railway Substations, by Cassius M. Davis	976
Contact System of the Butte, Anaconda & Pacific Railway, by J. B. Cox.....	842
Operating Conditions of Railway Motor Gears and Pinions, by A. A. Ross.....	249
Selection of Railway Equipment, The, by J. F. Layng	126
Railway Motor Characteristic Curves, by E. E. Kimball.....	296
Sprague-General Electric PC Control, by C. J. Axtell	985
Rectifying High Tension Alternating Currents, A New Device for, by Dr. Saul Dushman.....	156
Refrigeration Field as It Exists Today, A Survey of the, by H. I. Hollman.....	65
Refrigeration, A Standard in, by L. A. Simmons.....	1170
Research, by Dr. W. R. Whitney.....	1012
Research, The Relation of, to the Progress of Manufacturing Industries, by Dr. W. R. Whitney.....	868
Research, Industrial, by L. A. Hawkins.....	416
Resistance Standards, Precision, Ten-to-one Ratio for Comparing, by C. A. Hoxie.....	915
Resistance, Starting, for Shunt, Induction, and Series Motors, A Short Method for Calculating the, by B. W. Jones.....	131
Resistivity, Volume, and Surface Resistivity of Insulating Materials, The, by Harvey L. Curtis.....	996
Resolutions Presented to C. A. Coffin and E. W. Rice, Jr., by Association of Edison Illuminating Companies, Reproduction of the (Supplement to March issue).	
Rheostats, Water, by N. L. Rea.....	1001
Rock Drill, The Fort Wayne Electric, by C. Jackson.....	273
Searchlights, Portable, for Fire Departments, by L. C. Porter and P. S. Bailey.....	1144
Ships, The Lighting of, by L. C. Porter.....	143
Short Circuits, Electrical, Mechanical Effects of, by S. H. Weaver.....	1066
Sign and Building Exterior Illumination by Projection, by K. W. Mackall and L. C. Porter.....	282
Signal Circuits, Railway, Protection of, Against Lightning Disturbances, by E. K. Shelton.....	1127
Slot Insulation Design, Some Aspects of, by H. M. Hobart	360
Status of the Engineer, The, by E. W. Rice, Jr.....	234
Steel Castings, An X-Ray Inspection of, by Dr. Wheeler P. Davey.....	25
Steel, Magnetic Properties of, The Effect of Chemical Composition Upon the, by W. E. Ruder.....	197
Steel Mill Lighting, High Candle-power Mazda Lamps for, by G. H. Stickney.....	377
Spark-over Voltages of Bushings, Leads and Insulators, Effect of Altitude on the, by F. W. Peek, Jr.....	137
Sprague-General Electric PC Control, by C. J. Axtell.....	985

	PAGE
SUBSTATIONS	
Automatic Regulation of a 1500-kw. Steam-turbine Converter Station of the Aluminum Company of America at Massena Springs, N. Y., The, by J. L. Burnham and R. C. Muir	873
High Voltage Direct-current Substation Machinery, by E. S. Johnson	641
Semi-outdoor Portable Substation for Berkshire Street Railway, by W. D. Bearce	44
Supplies, Devices and Appliances for the Distribution, Control and Utilization of Electricity, by S. H. Blake	553
Switchboard Apparatus: Some Recent Developments In, by E. H. Barker	646
Telephone Lines, High Voltage Arrester for, by E. P. Peck	189
Temperature Coefficient Formula for Copper, by John D. Ball	669
Test for Determining Air Supply, by S. A. Moss	922
Test, The High Temperature, by Wm. P. Woodward	398
Tests, Electrical, Made in 1883 and Their Influence on Modern Testing, A Series of, by A. L. R. Hrer	22
Tests of Large Steam Hoists, by H. E. Spring	179
Textile Industry, Electric Power in the, by C. A. Chase	540
Thury System of Direct-current Transmission, The, by Wm. Baum	1026
TRACTION	
Economies in Operating Small Cars, by J. F. Layng	799
Electrification of the Puget Sound Lines of the Chicago, Milwaukee & St. Paul Railway, The, by A. H. Armstrong	5
Relation Between Car Operation and Power Consumption, by J. F. Layng	973
Review of Electric Railway, A, by W. B. Potter and G. H. Hill	444
Semi-outdoor Portable Substation for Berkshire Street Railway, by W. D. Bearce	44
2400-volt Railway of the Bethlehem-Chili Iron Mines Company, The, by E. E. Kimball	12
1500-volt Direct-current Electrification of the Ontario Municipal Railway, The, by G. H. Hill	10
1500-volt Electrification of the Chicago, Milwaukee & St. Paul Railway, by W. D. Bearce	644

	PAGE	
TRANSFORMERS		
Air Cleaning Apparatus for the Ventilation of Generators and Transformers, by Wm. Baum	801	
Emergency Transformer Connections, by George P. Roux	832	
High Potential Transformer Testing Equipment, by Wm. P. Woodward	398	
Mechanical Stresses in Shell Type Transformers, by J. Murray Weed	60	
Notes on the Operation of Transformer used with 2-kw., 100,000-cycle Alternator, by S. P. Nixdorff	308	
Open-delta or V Connection of Transformers, by George P. Roux	52	
Principal Factors Governing the Choice of Method of Cooling Power Transformers as Related to Their First Cost and Operating Conditions, by W. S. Moody	839	
Transients, The Infinite Duration of, by Charles L. Clarke	73	
Transmission Line Calculator, A, by Robert W. Adams	28	
TRANSMISSION		
Electric Transmission of Power, by R. E. Argersinger	454	
Theory of Electric Waves in Transmission Lines, by J. M. Weed	1148	
Thury System of Direct Current Transmission, The, by Wm. Baum	1026	
Wireless Transmission of Energy, by Elihu Thomson	316	
Ventilation of Generators and Transformers, Air Cleaning Apparatus for the, by Wm. Baum		801
Vermont Marble Company, Electrical Equipment of the, by John Liston	1015	
Waves, Electric, Theory of in Transmission Lines, by J. M. Weed		1148
Welfare Work, by Jesse W. Lilienthal	1092	
Wireless Transmission of Energy, by Elihu Thomson	316	
X-rays, by Dr. Wheeler P. Davey	258, 353, 625	
X-ray Dark Room, A Model, by Wheeler P. Davey	1107	
X-ray Examination of Built-up Mica, by C. N. Moore	195	
X-ray Inspection of a Steel Casting, An, by Dr. Wheeler P. Davey	25	
X-rays, Some Notes on, by W. S. Andrews	152	
Zero, The Absolute, by Dr. Saul Dushman	93, 238	

QUESTION AND ANSWER INDEX

1913—1914—1915

	Q. & A.	YEAR	PAGE
ARRESTER, LIGHTNING			
Charging	No. 79	1914	159
Charging resistance, Function of	No. 39	1913	466
General characteristics of	No. 88	1914	338
Oil, Moisture in	No. 44	1913	538
BATTERY, STORAGE			
Batteries, Storage, Characteristics of	No. 82	1914	159
Charging, Characteristics of	No. 85	1914	160
BRACES, CROSS ARM			
Electric, Characteristics of	No. 103	1914	1062
BRUSHES			
Electric, Characteristics of	No. 101	1914	755
BUSHBAR			
Electric, Characteristics of	No. 102	1914	1061
CABLE			
Electric, Characteristics of	No. 104	1914	1063
High Voltage, Characteristics of	No. 105	1914	1064
Low Voltage, Characteristics of	No. 106	1914	1065
Medium Voltage, Characteristics of	No. 107	1914	1066
Oil, Characteristics of	No. 108	1914	1067
Temperature, Characteristics of	No. 109	1914	1068
Voltage, Characteristics of	No. 110	1914	1069
Weight, Characteristics of	No. 111	1914	1070

	Q. & A.	YEAR	PAGE
CABLE—Cont'd			
Pot heads; Necessity for	No. 156	(1915)	1169
Size for a certain installation	No. 81	(1914)	159
Varnished cambric, advisability of using this type in ducts	No. 74	(1913)	1002
CANDLE-POWER			
Concentrated beam of light; Suitability to use as a measure of	No. 36	(1913)	465
CELL			
Electrolytic			
Current conduction when copper plating	No. 14	(1913)	275
Primary			
Polarization reduced by zinc amalgam	No. 49	(1913)	539
COILS			
Choke			
Iron-cored, Characteristics of	No. 84	(1914)	160
Reactance formula for various shapes	No. 102	(1914)	507
Field			
Polarity testing while on machine	No. 42	(1913)	537
Short circuits in field winding of railway motor; Detection of	No. 150	(1915)	1086

COILS—Cont'd	Q. & A.	YEAR	PAGE
Reactance			
Current division between two parallel circuits interconnected by coil; Calculation of.....	No. 58	(1913)	683
110,000-volt coil; Impracticability of constructing a.....	No. 154	(1915)	1168
Protection by a coil automatically inserted in a line; Lack of.....	No. 154	(1915)	1168
Reactance resulting from varied combination of coils; Method of calculating.....	No. 11	(1913)	274
(And relays). Troubles on lines; Practicability of segregating.....	No. 146	(1915)	935
COMMUTATOR			
Grooving; Reasons for.....	No. 2	(1913)	207
CONTACT			
Area and pressure, relative electrical importance of each.....	No. 43	(1913)	538
CONVERTER, SYNCHRONOUS			
Brushes raised at starting a commutating pole machine, reasons.....	No. 77	(1914)	80
Connections and unbalanced three-wire d-c. load.....	No. 142	(1915)	670
Line drop; Limit and effect of.....	No. 109	(1914)	772
Neutral for three-wire d-c. line derived from machine's step-down transformers.....	No. 89	(1914)	338
Polyphase machine operating single-phase; Effect of.....	No. 118	(1914)	1003
Shunt around commutating pole winding should be inductive; Reasons why.....	No. 29	(1913)	463
CORONA			
Insulation; Effect on.....	No. 63	(1913)	999
CURRENT			
Charged dust particles; Effect of direct current on.....	No. 103	(1914)	508
Earth; Possibility of obtaining from.....	No. 100	(1914)	506
CUT-OUT, FILM			
Substitute for standard material.....	No. 25	(1913)	344
ENGINE			
Hunting caused by relation of governor to automatic voltage regulator on driven generator.....	No. 55	(1913)	612
EXCITER			
Control by automatic voltage regulator.....	No. 98	(1914)	506
Driving methods.....	No. 16	(1913)	276
FEEDER			
Trolley circuit considerations.....	No. 119	(1914)	1003
FIRE			
Checking in electrical machines; Methods of.....	No. 38	(1913)	466
FREQUENCY-CHANGER			
Advantages and disadvantages of synchronous motor and induction motor driven sets for tying-in two systems.....	No. 51	(1913)	609
FURNACE, ELECTRIC			
Construction, special design.....	No. 71	(1913)	1002
Melting of non-ferrous metals; References on.....	No. 66	(1913)	1000
GENERATOR			
Forced-draft ventilation for low-speed machines.....	No. 157	(1915)	1169
Alternating-Current			
Armature reconnection for a different voltage; Possibility of a certain.....	No. 92	(1914)	428
Bearing current; Explanation of.....	No. 26	(1913)	344
Bearing current; Detection and measurement of.....	No. 136	(1915)	311

GENERATOR—Cont'd	Q. & A.	YEAR	PAGE
Alternating-Current			
Control of two paralleled machines individually by two automatic voltage regulators.....	(No. 107)	(1914)	771
.....	(No. 116)	(1914)	1002
Coupling two machines mechanically to run in parallel.....	No. 91	(1914)	340
Flux; Full-load value relative to no-load value of.....	No. 106	(1914)	771
Induction machines driven by low-pressure steam turbines.....	No. 96	(1914)	431
Overheated solid core when three-phase machine runs single-phase.....	No. 132	(1915)	228
Power-factor on short circuit.....	No. 54	(1913)	612
Power-factors 70 and 100 per cent, difference in input.....	No. 143	(1915)	671
Regulation; Question of improving.....	No. 20	(1913)	343
Wave shape of inductor type machine.....	No. 56	(1913)	683
Direct-Current			
High-voltage machines existent and design limitations.....	No. 140	(1915)	410
Load divided disproportionately between two paralleled machines.....	No. 3	(1913)	207
Overload capacity vs. storage battery auxiliary.....	No. 82	(1914)	159
Shunt around commutating pole winding should be inductive; Reasons why.....	No. 29	(1913)	463
Voltage of two machines in series, difficulty in maintaining on increase of load.....	No. 47	(1913)	538
Voltage regulation of automobile lighting generators by third-brush method.....	No. 114	(1914)	932
Turbine			
End-thrust, possible effects when unbalanced.....	No. 105	(1914)	508
Integral vs. external fan ventilation.....	No. 110	(1914)	772
GROUNDING			
National Electrical Rules for neutral Street lighting circuits, protection against grounding by trees.....	No. 125	(1915)	74
.....	No. 33	(1913)	464
HARMONICS			
Definition and testing for presence.....	No. 147	(1915)	936
HORN-GAP			
Breakdown voltages compared with those of needle-gap.....	No. 52	(1913)	611
INSULATION			
Corona's effect.....	No. 63	(1913)	999
INSULATOR			
Leakage current, its nature, and why it takes place.....	No. 59	(1913)	755
KW., APPARENT KV-A., WATTLSS KV-A., AND P-F.			
Inter-relationship.....	No. 151	(1915)	1086
LAMP			
Efficiency of carbon and tungsten incandescent types.....	No. 83	(1914)	160
LIGHTING			
Mines supplied from 230-v. taps of 4600 2300-v. transformer.....	No. 27	(1913)	463
Voltage regulation of automobile generators by third-brush method.....	No. 114	(1914)	932
LINE, TRANSMISSION			
Current division between two parallel circuits interconnected by reactance coil.....	No. 58	(1913)	683
Multiple vs. single.....	No. 65	(1913)	1000
Reactance of three wires in a plane.....	No. 28	(1913)	463
Sag and size of conductor.....	No. 139	(1915)	410
LOAD			
Steel mill; Average running load for.....	No. 80	(1914)	159
Three-wire circuit; Calculation for a.....	No. 69	(1913)	1001

	Q. & A.	YEAR	PAGE
METER			
Hot-Wire			
Construction and uses for which it is especially suited.....	No. 10	(1913)	274
Watt			
Curve-drawing, connections.....	No. 75	(1914)	80
Reversal of one on low power-factor when two are measuring three-phase power.....	No. 4	(1913)	208
Power-factor of three-phase line obtained from ratio of two readings..	No. 35	(1913)	465
Watt-hour			
Frequency, effect of change on accuracy.....	No. 99	(1914)	506
Protection against lightning.....	No. 73	(1913)	1002
METERING			
Three-phase power; Explanation of two-meter method of measuring...	No. 48	(1913)	539
MILS			
Square and circular mils; Difference between and method of calculating	No. 7	(1913)	208
MOTOR			
Explosion-proof types; Construction of.....	No. 21	(1913)	343
Open and enclosed types; Definition of. (Later, See: Standardization Rules of the A.I.E.E. edition of Feb. 1, 1915, §§ 160-172).....	No. 86	(1914)	338
Output of d-c. machine, proof that maximum occurs when loaded to half speed.....	No. 34	(1913)	465
Induction			
Brass vs. fiber slot wedges for holding in coils.....	No. 41	(1913)	537
Dynamic braking of squirrel-cage type by application of direct current to stator.....	No. 68	(1913)	1001
Generator; Ability to act as a.....	No. 104	(1914)	508
Half-voltage; Characteristics at.....	No. 93	(1914)	428
Knocking sound.....	No. 97	(1914)	431
Low-speed type; Characteristics of..	No. 108	(1914)	771
Low-voltage; Characteristics as affected by.....	No. 50	(1913)	539
Phase-wound rotor type; Relation of heating to speed of.....	No. 57	(1913)	683
Poles, change in number limited by certain factors.....	No. 145	(1915)	864
Quarter-phase to three-phase reconnection.....	No. 153	(1915)	1168
Rotor-bar insulation charred, its effect on machine's characteristics..	No. 126	(1915)	74
Rotor-bar insulation charred, its repair and effect on machine's characteristics.....	No. 137	(1915)	409
Starting difficulty.....	No. 72	(1913)	1002
Three-phase machine operating on two-phase circuit.....	No. 1	(1913)	207
Twenty-five cycle machine operating on 60-cycle supply.....	No. 101	(1914)	506
Unbalanced phase voltages; Heating of three-phase machine on.....	No. 135	(1915)	311
Unbalanced phase voltages; Heating of two-phase machine on.....	No. 128	(1915)	75
Railway			
Commutator bars burned as a result of reversed armature field.....	No. 12	(1913)	275
Field coils; Detection of short circuits in.....	No. 150	(1915)	1086
Low voltage as cause of increased deterioration in running locomotives..	No. 120	(1914)	1003
Synchronous			
Power-factor; Calculation of improvement produced in.....	No. 37	(1913)	466

	Q. & A.	YEAR	PAGE
MOTOR—Cont'd			
Synchronous			
Power-factor; Explanation of influence on.....	No. 46	(1913)	538
NEUTRAL			
Delta connected transformers; Method of bringing out from.....	No. 149	(1915)	1085
National Electrical Rules on grounding of.....	No. 125	(1915)	74
OZONE			
Concentration, Degree of.....	No. 62	(1913)	999
Respiration; Effect on.....	No. 6	(1913)	208
PHASING-OUT			
Combinations that are possible in connecting two three-phase lines..	No. 78	(1914)	159
Voltage measurements between two lines, peculiar readings.....	No. 121	(1914)	1004
PHASE-RELATION AND ROTATION			
Definitions and determination.....	No. 144	(1915)	863
POLARIZATION			
Reduction by zinc amalgam in primary cells.....	No. 49	(1913)	539
PORCELAIN, ELECTRICAL			
Wet and dry process product; Characteristics of.....	No. 17	(1913)	276
POWER-FACTOR			
Combination of several; Calculation of	No. 8	(1913)	274
Improvement by synchronous motor; Calculation of.....	No. 37	(1913)	466
Synchronous motor influence.....	No. 46	(1913)	538
Three-phase value obtained from ratio of two wattmeter readings...	No. 35	(1913)	465
REGULATOR			
Automatic Voltage			
A-c. to d-c. operation; Change from..	No. 117	(1914)	1002
Control of two paralleled a-c. generators individually by two regulators	(No. 107 (1914) 771 No. 116 (1914) 1002)		
Exciter controlled by.....	No. 98	(1914)	506
Hunting caused by relation to governor on engine driving generator...	No. 55	(1913)	612
Induction			
Three-phase unit operating single-phase.....	No. 87	(1914)	338
RELAY			
Rupturing capacity of oil switch; Effect of time limit on.....	No. 30	(1913)	463
RESISTANCE			
Temperature coefficient of copper...	No. 113	(1914)	932
Transformer windings; Measurement of.....	No. 129	(1915)	75
Charging			
Function of as applied to lightning arrester.....	No. 39	(1913)	466
Field Discharge			
Action; Explanation of.....	No. 23	(1913)	343
ROD, LIGHTNING			
Effectiveness of protection.....	No. 90	(1914)	340
SIGN, FLASHING			
Control of electric lamps.....	No. 13	(1913)	275
SWITCH, OIL			
Baffles; Purpose of.....	No. 95	(1914)	431
Connections of circuit-opening equipment.....	No. 94	(1914)	429
Direct current; Utilization on.....	No. 32	(1913)	464
Interrupting action; Explanation of.	No. 9	(1913)	274
Rupturing capacity and time-limit relay.....	No. 30	(1913)	463
TEMPERATURE			
Kelvin scale, basis and layout.....	No. 141	(1915)	670

	Q. & A.	YEAR	PAGE
TRANSFORMER			
Boosting with an ordinary single-phase unit.....	No. 155	(1915)	1169
Breakdown due to high electrostatic stress on a certain grounded neutral circuit.....	No. 40	(1913)	537
Burnout; A peculiar.....	No. 24	(1913)	344
Division of load between two paralleled units.....	No. 22	(1913)	343
Exchange current between two paralleled units.....	No. 31	(1913)	464
Internal explosion, cause and prevention.....	No. 122	(1914)	1230
Lighting of mine by 230-v. tap on 4600/2300-v. unit.....	No. 27	(1913)	463
Neutral brought out from delta connected secondaries.....	No. 149	(1915)	1085
Overheating of one delta leg.....	No. 131	(1915)	228
Overheating of one paralleled with another.....	No. 45	(1913)	538
Parallel operation of two banks, connections Y-delta, delta-delta.....	No. 61	(1913)	999
Phasing-out of small polyphase units.....	No. 112	(1914)	932
Phasing-out of large three-phase units.....	No. 111	(1914)	931
Power-factor when short circuited.....	No. 76	(1914)	80
Ratio change by bringing out a tap.....	No. 70	(1913)	1001
Regulation; Method and example of calculating.....	{No. 5	(1913)	208
	{No. 53	(1913)	612

	Q. & A.	YEAR	PAGE
TRANSFORMER—Cont'd			
Resistance measurement of windings.....	No. 129	(1915)	75
Two-phase to three-phase transformation, per cent taps and vectors.....	No. 130	(1915)	227
Two-phase to three-phase transformation with three units.....	No. 133	(1915)	310
Twenty-five cycle unit operating on 60-cycle supply.....	No. 64	(1913)	1000
Meter			
Advantages to be gained from their employment.....	No. 18	(1913)	276
Leads (current and potential) in the same conduit.....	No. 127	(1915)	75
Protection against lightning.....	No. 73	(1913)	1002
Series			
Open circuited secondary, reason for excessive voltage rise.....	No. 15	(1913)	276
TURBINE			
Relief valve on low-pressure end.....	No. 124	(1914)	1230
WELDING, ARC			
Alternating current inapplicable.....	No. 134	(1915)	310
WIRE			
Enamelled			
Advantages and properties of this type of insulation.....	No. 19	(1913)	343
Trolley			
Catenary suspension; Stress formulæ for.....	No. 123	(1914)	1230

INDEX TO AUTHORS

	PAGE		PAGE
Adams, Robert W.		Blake, S. H.	
Transmission Line Calculator.....	28	"Supplies:" Devices and Appliances for the Distribution, Control and Utilization of Electricity...	553
Allison, H. B. C.		Bodde, Theodore	
Protective Coatings for Metal.....	873	Apprentice System at the Lynn Works of the General Electric Company, The.....	35
Andrews, W. S.		Booth, J. L.	
Notes on the Noble Gases.....	226, 408	Methods of Removing the Armature from Box Frame Railway Motors.....	908
Some Notes on X-rays.....	152	Brown, H. D.	
Andrews, H. L.		Compensators for Mazda C Lamps.....	596
Power Consumption of Railway Motors.....	944	Burnham, J. L.	
Argersinger, R. E.		45,000-Kw. Synchronous Converter Substation of the Aluminum Company of America at Massena Springs, The.....	873
Electric Transmission of Power.....	454	Bush, A. R.	
Armstrong, A. H.		Some Industrial Applications of Electricity.....	460
Chicago, Milwaukee & St. Paul Locomotive, The.....	600	Chase, C. A.	
Electrification of the Puget Sound Lines of the Chicago, Milwaukee & St. Paul Railway, The.....	5	Electric Power in the Textile Industry.....	540
Operation and Rating of the Electric Locomotive, The.....	828	Clarke, Charles L.	
Axtell, C. J.		Infinite Duration of Transients, The.....	73
Sprague-General Electric PC Control.....	985	Connell, B. R.	
Bailey, P. S.		Hydro-electric Development of the Cohoes Company at Cohoes, N. Y., The.....	340
Portable Searchlights for Fire Departments.....	1144	Cox, J. B.	
Ball, John D.		Contact System of the Butte, Anaconda & Pacific Railway, The.....	842
Temperature Coefficient Formulæ for Copper.....	669	Crego, S. M.	
Some Notes on Magnetization Curves.....	31	History of Schenectady Section of the A.I.E.E.....	1006
Baker, R. E.		Creighton, E. E. F.	
Subdivision of Power as Solved by the Small Motor, The.....	555	Cursory Account of the First Lightning Storm of the Season as given by the Records of the Multi-recorder.....	860
Bartlett, C. W.		Curtis, Harvey L.	
Electrically Heated Enameling Ovens.....	1130	Volume Resistivity and Surface Resistivity of Insulating Materials, The.....	996
Baum, Wm.		Curtiss, W. B.	
Air Cleaning Apparatus for the Ventilation of Generators and Transformers.....	801	Depreciation of Property.....	1099
Thury System of Direct-current Transmission, The.....	1026	Davis, Cassius M.	
Bearce, W. D.		Automatic Railway Substations.....	769
Semi-outdoor Portable Substation for Berkshire Street Railway.....	44		
1500-volt Electrification of the Chicago, Milwaukee & St. Paul Railway, The.....	644		
Beckert, E. H.			
Some Recent Developments in Switchboard Apparatus.....	646		

	PAGE		PAGE
Daavey, Wheeler, P., Dr.		Langmuir, Irving	
Application of the Coolidge Tube to Metallurgical Research.....	134	Pure Electron Discharge and its Application in Radio-telegraphy and Telephony, The.....	327
Model X-Ray Dark Room, A.....	1107	Larson, C. W.	
Radiography of Metals.....	795	Modern Mine Haulage Motor, The.....	264
X-rays.....	258, 353, 625	Towing Locomotives for the Panama Canal, The.....	101
X-ray Inspection of a Steel Casting, An.....	25	Layng, J. F.	
Day, Maxwell W.		Economies in Operating Small Cars.....	790
Electricity in Marine Work.....	504	Selection of Railway Equipment, The.....	126
Doherty, R. E.		Relation between Car Operation and Power Consumption.....	973
Parallel Operation of Alternating Current Generators Driven by Internal Combustion Engines.....	167	Lehn, H. C.	
Drabelle, J. M.		Parallel Operation of Alternating Current Generators Driven by Internal Combustion Engines.....	167
Supplying of Power to the Quaker Oats Company, The.....	42	Lillenthal, Jesse W.	
Dushman, Saul, Dr.		Welfare Work.....	1092
Absolute Zero, T.....	93, 238	Lincoln, Paul M.	
Kinetic Theory of Gases, The.....	952, 1042, 1159	Trend of Electrical Development, The.....	784
New Device for Rectifying High Tension Alternating Currents, A.....	156	Liston, John	
Per. He Law, The.....	614	Developments in Electrical Apparatus During 1914... ..	80
Dudley, A. D.		Electrical Equipment of the Vermont Marble Company.....	1015
Small Consumer, The: A Problem.....	657	Lyle, F. W.	
Emmett, W. L. R.		Growth of Current in Circuits of Negative Temperature Coefficient of Resistance.....	1129
Engineering in the Navy.....	1097	Mackall, K. W.	
Fitch, M. J.		Sign and Building Exterior Illumination by Projection.....	282
Genemotor, The.....	384	Mahan, H. E.	
Francis, W. E.		Eye and Illumination, The.....	268
Isolated Power House for Factories.....	1057	Mann, Arthur S.	
Hall, G. W.		Some Problems in Burning Powdered Coal.....	920, 959
General Electric Company's Exhibits at the Panama-Pacific International Exposition, The.....	561	Mason, L. A.	
Harriman, H. I.		Lock Entrance Caisson for the Panama Canal.....	210
Water Powers of New England.....	358	Minton, J. P.	
Hawkins, L. A.		Electrophysics: Cathode Rays and their Properties... ..	118
Industrial Research.....	416	Electrophysics: Electron Theory of Electric Conduction in Metals.....	204
Heath, Leshe O.		Electrophysics: Application of the Electron Theory to Various Phenomena.....	287
Production of Damped Oscillations, The.....	1110	Electrophysics: Electromagnetic Radiation from the Viewpoint of the Electron Theory.....	387
Hill, G. H.		Electrophysics: Some Characteristics of Cathode Ray Tubes.....	636
1500-volt Direct-current Electrification of the Ontario Municipal Railway, The.....	10	Moody, W. S.	
Review of Electric Railways, A.....	444	Principal Factors Governing the Choice of Method of Cooling Power Transformers as Related to their First Cost and Operating Conditions.....	839
Hobart, H. M.		Moore, C. N.	
Some Aspects of Slot Insulation Design.....	366	X-ray Examination of Built-up Mica.....	195
Hollman, H. I.		Morrison, G. F.	
Survey of the Refrigeration Field as it Exists Today, A.....	65	Electric Lamp Industry, The.....	497
Hosmer, Helen R.		Review of the N.E.L.A. Lamp Committee Report... ..	925
Electro-culture, A Resume of the Literature.....	14	Moss, Sanford A.	
Translation: The Theory of Lubrication, L. Lubbeholdt.....	966, 1074, 1118	Test for Dirt in an Air Supply.....	622
Houx, C. A.		Muir, R. C.	
Tentative Rules for Comparing Precision Resistance Standards, A.....	915	45,000-kw. Synchronous Converter Substation of the Aluminum Company of America at Massena Springs, N. Y., The.....	873
Jackson, C.		Nixdorff, S. P.	
Port Wayne Electric Rock Drill, The.....	273	Notes on the Operation of Transformers used with 2 kw., 100,000 Cycle Alternator.....	308
Jackson, Jas. A.		Parham, E. C.	
Possibilities Open to the Central Station in Solving the Freight Terminal Problem, The.....	1142	Practical Experience in the Operation of Electrical Machinery, 56, 146, 217, 304, 401, 666, 861, 928, 1003, 1082, 1146	
Jackson, E. S.		Peck, E. P.	
First 3000-watt Locomotives for the Chicago, Milwaukee & St. Paul Railway Company, The.....	1154	High Voltage Arrester for Telephone Lines.....	189
High-voltage Direct-current Substation Machinery.....	641	Peck, F. W., Jr.	
Johnson, H. R.		Electrical Characteristics of Solid Insulations.....	1050
Current Supply for Motor Printing Machines.....	895	High Frequency.....	934
Substitution of Power as Supplied by the Small Motor, The.....	555	Law of Corona and Spark-over in Oil, The.....	821
Johnson, B. W.		Effect of Altitude on the Spark-over Voltages of Bushings, Leads, and Insulators.....	137
So. M. E. E. E. Calculating the Starting Resistance for Starting a Motor and Series Motor, A.....	131	Porter, L. C.	
Kirkhall, Fred M.		Incandescent Lamps for Projectors.....	371
Electricity in the Cotton Textile Industry.....	550	Lighting of Ships, The.....	143
Kimball, E. E.			
Rubber Motor for Printing Presses.....	296		
2400-volt Rectifier for the Building of Life Iron Mines at Paterson, N. J., The.....	12		

	PAGE		PAGE
Porter, L. C.		Steinmetz, C. P.	
Portable Searchlights for Fire Departments.	1144	Control and Protection of Electric Systems.	887
Sign and Building Exterior Illumination by Projection	282	Individual and Corporate Development of Industry, The	813
Poor, F. H.		Protection and Control of Industrial Electric Power. . .	979
Ball Bearings in Electric Motors.	631	Stickney, G. H.	
Potter, W. B.		Factory Lighting.	67
Review of Electric Railways, A.	444	High Candle-power Mazda Lamps for Steel Mill Lighting	377
Pratt, W. H.		Stone, C. W.	
Some Notes on Induction Meter Design	277	Brief Review of the Electric Lighting Industry, A. . .	439
Randolph, C. P.		Spring, H. E.	
Electric Heating and Heating Appliances.	523	Tests of Large Steam Hoists.	179
Rea, N. L.		Thirlwall, J. C.	
Water Rheostats.	1001	Jitney Problem, The.	604
Reid, Robert		Power Consumption of Railway Motors.	944
Process of Impregnating Coils, and a Large Modern Impregnating Plant, The.	48	Thomas, O. E.	
Retnew, G. H.		Osborne Electriquette, The.	299
Parallel Operation of Frequency Changers.	836	Thomson, Stuart	
Proper Construction of Earth Connections.	904	Methods of Obtaining High Potential Direct Current	1084
Rice, Jr., E. W.		Thomson, Elihu	
Status of the Engineer, The	234	Wireless Transmission of Energy	316
Rohrer, A. L.		Tinson, H. A.	
Series of Electrical Tests made in 1883 and their Influence on Modern Testing, A	22	Modern Street Lighting with Mazda Lamps.	659
Rohrer, C. J.		Torrens, J. H.	
Electricity in Agriculture.	483	Hydro-electric Installation on a Coffee Plantation, A. .	219
Ross, A. A.		Tressler, M. E.	
Operating Conditions of Railway Motor Gears and Pinions.	249	Cathode Ray Tube and Its Application, The	816
Roux, George P.		Trumbull, Horace Niles	
Emergency Transformer Connections.	832	Modern Acid-Dipping, Electroplating and Japanning Plant, A.	1121
Open-Delta or V Connection of Transformers.	52	Ubbelohde, L.	
Ruder, W. E.		Theory of Lubrication, The	966, 1074, 1118
Effect of Chemical Composition Upon the Magnetic Properties of Steel, The.	197	Weaver, S. H.	
Rushmore, D. B.		Mechanical Effects of Electrical Short Circuits.	1066
Electric Power Industry, The	427	Weed, J. Murray	
Use of Electricity in Mining Work, The	527	Mechanical Stresses in Shell Type Transformers. . . .	60
Ryan, W. D'A.		Theory of Electric Waves in Transmission Lines . . .	1148
Illumination of the Panama-Pacific International Exposition.	579	White, W. C.	
Schildhauer, Edward		Radiotelephony.	38
Electricity in the Construction and Operation of the Panama Canal (Supplement to July REVIEW).	679	Whitney, W. R., Dr.	
Shafer, Don Cameron		Research.	1012
"Home Electrical" at the Panama-Pacific Interna- tional Exposition, The.	572	Relation of Research to the Progress of Manu- facturing Industries, The.	868
Shanklin, G. B.		Wolf, H. M.	
Insulation Testing	1008	General Notes on Grounding.	991
Shelton, E. K.		Woodward, Wm. P.	
Protection of Railway Signal Circuits Against Lightning Disturbances.	1127	High Potential Transformer Testing Equipment	398
Simmons, L. A.		Yates, W. C.	
Standard in Refrigeration, A.	1171	Electric Motor in the Printing Industry, The.	1136
Slichter, W. I.		Yensen, Trygve D.	
New Advanced Course in Electrical Engineering at Columbia University, The.	940	Iron-cobalt Alloy, Fe ₃ Co, and its Magnetic Prop- erties, The.	881

GENERAL ELECTRIC REVIEW

A MONTHLY MAGAZINE FOR ENGINEERS

Manager, M. P. RICE

Editor, JOHN R. HEWETT

Associate Editor, B. M. EOFF
Assistant Editor, E. C. SANDERS

Subscription Rates: United States and Mexico, \$2.00 per year; Canada, \$2.25 per year; Foreign, \$2.50 per year; payable in advance. Remit by post-office or express money orders, bank checks or drafts, made payable to the *General Electric Review*, Schenectady, N. Y.

Entered as second-class matter, March 26, 1912, at the post-office at Schenectady, N. Y., under the Act of March, 1879.

VOL. XVIII., No. 1

Copyright, 1914
by General Electric Company

JANUARY, 1915

CONTENTS

	PAGE
Frontispiece	2
Editorial: The Paths of Progress	3
The Electrification of the Puget Sound Lines of the Chicago, Milwaukee & St. Paul Railway BY A. H. ARMSTRONG	5
The 1500-Volt Direct-Current Electrification of the Ontario Municipal Railway BY G. H. HILL	10
The 2400-Volt Railway of the Bethlehem-Chile Iron Mines Company BY E. E. KIMBALL	12
Electro-Culture, a Resumé of the Literature BY HELEN R. HOSMER	14
A Series of Electrical Tests Made in 1883 and Their Influence on Modern Testing BY A. L. ROHRER	22
An X-Ray Inspection of a Steel Casting BY DR. WHEELER P. DAVEY	25
A Transmission Line Calculator BY ROBERT W. ADAMS	28
Some Notes on Magnetization Curves BY JOHN D. BALL	31
The Apprentice System at the Lynn Works of the General Electric Company BY THEODORE BODDE	35
Radiotelephony BY W. C. WHITE	38
The Supplying of Power to the Quaker Oats Company BY J. M. DRABELLE	42
Semi-Outdoor Portable Substation for Berkshire Street Railway BY W. D. BEARCE	44
The Process of Impregnating Coils; and a Large, Modern Impregnating Plant BY ROBERT REID	48
Open-Delta or V-Connection of Transformers BY GEORGE P. ROUX	52
Practical Experience in the Operation of Electrical Machinery Loose Commutator; Loose Connection; Low Power-Factor; Hot Box Indications; Burn-out Due to Core Loss; Alternator Speed Low; Loose Core; Loose Belts; Erratic Elevator Speed; Brush-holders Shifted. BY E. C. PARIHAM	56
Mechanical Stresses in Shell-Type Transformers BY J. MURRAY WEED	60
A Survey of the Refrigeration Field as it Exists Today BY H. I. HOLLEMAN	65
Factory Lighting BY G. H. STICKNEY	67
Notes on the Activities of the A. I. E. E.	71
From the Consulting Engineering Department of the General Electric Company	73
Question and Answer Section	74
In Memoriam: Douglas S. Martin	76



A View on the Chicago, Milwaukee & St. Paul Railway. We publish in this issue an interesting account of the 3000-volt direct-current electrification to be carried out by this Railway

GENERAL ELECTRIC

REVIEW

THE PATHS OF PROGRESS

It is particularly gratifying that we are able to announce the closing of so large and important a contract for steam road electrification as that of the Chicago, Milwaukee & St. Paul Railway in this the first issue of a new year. We have included in this issue also a brief description of the 1500-volt direct-current electrification of the Ontario Municipal Electric Railways, and the 2400-volt railway of the Bethlehem-Chile Iron Mines Company. We feel that the very fact that such important work as the above undertakings represent is being actively pushed at the present time should be a distinct encouragement, as showing a marked improvement in the industrial and financial conditions and a faith in the immediate future of the economic status of the country.

The electrification of the Puget Sound Lines of the Chicago, Milwaukee & St. Paul Railway is the most important steam road electrification ever undertaken or even seriously contemplated; in fact the letting of this particular contract would seem to mark a new era in electric railway work. The initial work includes the electrification of one complete engine division 113 miles in length and the total mileage, when yards, sidings, etc., are considered, amounts to 168 miles. This work is already under way and in the early future, if the initial work proves successful, three additional engine divisions will be electrified, making approximately 440 miles of main line track or a total of 650 miles, when yards, sidings, etc., are included. It would appear that all this work is well assured and plans are even being made to extend the electrified zones to the coast which would mean 850 route miles of main line steam road converted to electric operation.

One of the most interesting, and at the same time most important features concerning this large contract is that the change in motive power is not being brought about by any local conditions such as the necessity

of abating the smoke nuisance, but is being made by the railway company on the straight plea of the economies that are to be secured by electric traction. The operating results of the Butte, Anaconda & Pacific Railway, which we published in the November issue of the REVIEW, would indicate that there is every justification for anticipating economies that will more than offset the added interest charges on the capital to be expended in effecting the change.

The whole engineering world that is interested in railway work will undoubtedly pay special attention to the fact that the three contracts we have mentioned in this editorial are all to be operated at higher direct-current potentials. The Chicago, Milwaukee & St. Paul Railway will operate at 3000 volts, the Ontario Municipal Railways at 1500 volts, and the Bethlehem-Chile Iron Mines Railway at 2400 volts. It surely must be considered a most significant fact that, in such a very great percentage of the large contracts that have been placed during recent years in this country for heavy traction work, higher direct-current potentials have been specified. The reason for this is undoubtedly the success that has already been achieved with direct-current apparatus working at higher voltages. The very fact that the Chicago, Milwaukee & St. Paul Railway Company has adopted a trolley potential of 3000 volts shows that the limit had not previously been reached where economies could be secured by increasing the trolley potential without sacrificing any of the vital attributes of traction work, such as safety, reliability of operation and an all-round efficiency.

Another point of great interest concerning two of these electrifications, namely, the Chicago, Milwaukee & St. Paul and the railway of the Bethlehem-Chile Iron Mines Company is that the locomotives are to be provided with regenerative control. On an electric railroad scheme of the magnitude

of the Chicago, Milwaukee & St. Paul Railway distinct operating advantages should result from the provision of electric braking for the heavy trains on the steep down grades, necessarily encountered in railroad work in such mountainous regions. This is distinctly in line with the "safety first" policy of modern railroading, as electric braking removes any danger of accident due to overheated brakeshoes and wheels, and furthermore results in power economy and a lower cost of maintenance.

The direct-current railway motor has long been recognized as the most reliable, efficient and flexible means of delivering power to the drivers of a locomotive and now that direct-current regenerative braking has become an accomplished fact it makes the high voltage direct-current system most admirably fitted to fulfill all the requirements of general steam railroad electrification. We consider the introduction of electric braking, while still retaining the well tried and proved direct-current apparatus, to be a distinct step in the advance of the art.

Referring to the Chicago, Milwaukee & St. Paul electrification, each locomotive, of 260 tons local weight, will have 200 tons on drivers, an equipment of eight motors, having a combined rating of 3440 horse power, and a hauling capacity of 2500 tons trailing load on a one per cent grade at a speed of approximately 16 miles per hour. This great hauling capacity, combined with such a high speed on ruling grades as 16 miles per hour, is of particular interest to the steam railway operator who has been educated in the school of Mallet operation, in which speeds as low as seven miles per hour constitute frequent practice. The introduction of such an advanced type of motive power should result in somewhat radical changes in the methods of operation

standardized with the use of the steam engine.

The adoption of a trolley potential of 3000 volts enables an economic distribution of the feeder copper with the spacing of substations 35 miles apart. The reduction of the necessary substation apparatus that will be secured in this manner, in spite of the fact that such heavy trains are to be hauled up mountain grades, brings the cost per mile of track electrified down to a very reasonable figure, and further, it emphasizes the sturdy capabilities of the direct-current substation apparatus.

Mr. A. H. Armstrong in his article shows the ample provisions that have been made for power supply, and that owing to favorable local conditions the railway company has been enabled to enter into a contract whereby energy will be supplied at 0.536 cents per kw-hr. based on a 60 per cent load factor. Such figures for energy, even when taken in bulk, are unusual and can only be obtained in cases where the hydro-electric resources have been so wisely conserved and so thoroughly developed as in the case of the Montana Power Company. If such thorough developments take place in other localities it will play an important part in stimulating the further electrification of our steam railways.

As we said at the outset, we hope that work of such a magnitude as that described in this issue being undertaken at this time will encourage others to look on the bright side of present conditions. As this is the first issue of a new year, it seems appropriate to express the hope that 1915 may be full of prosperity and that we may have the pleasure of recording many notable steps of progress in the engineering arts and industrial research during the next twelve months in this REVIEW.

THE ELECTRIFICATION OF THE PUGET SOUND LINES OF THE CHICAGO, MILWAUKEE & ST. PAUL RAILWAY

By A. H. ARMSTRONG

ASSISTANT ENGINEER, RAILWAY AND TRACTION ENGINEERING DEPARTMENT,
GENERAL ELECTRIC COMPANY

The author gives a brief account of the scope of the work to be undertaken on this the most important of steam road electrifications. He gives a description of the power supply available, the cost of power to the railway company, the type of substation and rolling stock equipment, and the overhead construction to be adopted. It is of special interest to note that the trolley potential is to be 3000 volts, which is the highest direct-current potential yet adopted in this country for railway work.—EDITOR.

Plans for the electrification of the first engine division of the Chicago, Milwaukee & St. Paul Railway have now been completed and contracts have been let with the General Electric Company for electric locomotives, substation apparatus and line material, and with the Montana Power Company for the construction of transmission and trolley lines. The initial electrification of 113 miles of main line between Three Forks and Deer Lodge is the first step toward the electrification of four engine divisions extending from Harlowton, Montana, to Avery, Idaho, a total distance of approximately 440 miles with approximately 650 miles of track, including yards and sidings. While this comprises the extent of track to be equipped in the near future, it is understood that plans are being made to extend the electrification from Harlowton to the Coast, a distance of 850 miles, should the operating results of the initial installation prove as satisfactory as anticipated.

The plans of the Chicago, Milwaukee & St. Paul Railway are of especial interest, as this is the first attempt to install and operate electric locomotives on tracks extending over several engine divisions, under which conditions it is claimed the full advantage of electrification can be secured. The various terminal and tunnel installations made in the past have been more or less necessary by reason of local conditions, but the electrification of the Chicago, Milwaukee & St. Paul is undertaken purely on economic grounds with the expectation that superior operating results with electric locomotives will effect a sufficient reduction in the present cost of steam operation to return an attractive percentage on the large investment required. If the savings anticipated are realized in the electric operation of the Chicago, Milwaukee & St. Paul Railway, this initial installation will constitute one of the most important mile-stones in electric railway progress, and

it should foreshadow large future developments in heavy steam road electrification. The success of electric operation on such a large scale will at least settle the engineering and economic questions involved in making such an installation, and will limit the future problems of electrification to the ways and means of raising the required capital to effect the change in motive power.

The first step taken towards electrification by the Chicago, Milwaukee & St. Paul Railway was to enter into a contract with the Montana Power Company for an adequate supply of power over the 440 miles of main line considered for immediate electrification. The precautions taken both by the Railway Company and Power Company to safeguard the continuity of power supply should guarantee a reliable source of power, subject to few interruptions of a momentary nature only.

The Montana Power Company covers a great part of Montana and part of Idaho with its network of transmission lines which are fed from a number of sources of which the principal are tabulated below:

Madison River	11,000 kw.
Canyon Ferry	7,500 kw.
Hauser Lake	14,000 kw.
Big Hole	3,000 kw.
Butte, steam turbine	5,000 kw.
Rainbow Falls	21,000 kw.
Small powers aggregating	7,390 kw.
Total power developed	68,890 kw.

Further developments part of which are under construction are as follows:

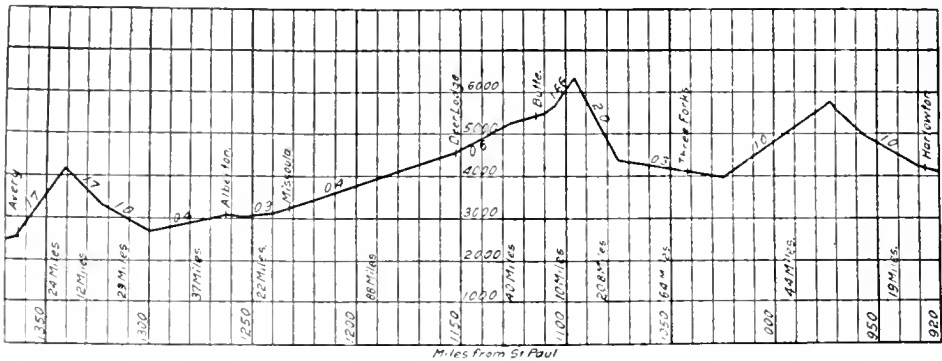
Great Falls	85,000 kw.
Holter	30,000 kw.
Thompson Falls	30,000 kw.
Snake River	20,000 kw.
Missoula River	10,000 kw.
Total power undeveloped	175,000 kw.

Total power capacity developed and undeveloped, 244,000 kw.

The several power sites are interconnected by transmission lines; the earlier ones are supported on wooden poles and operate at 50,000 volts and the later installations are supported on steel towers and operate at 100,000 volts. Ample water storage capacity (300,000 acre-feet), is provided in the Hebgen Reservoir and this is supplemented by auxiliary reservoir capacity at the several power sites which brings the total up to 418,000 acre-feet. The Hebgen Reservoir is so located at the head waters of the Madison River that water drawn from it can supply in turn the several installations on the Madison and Missouri rivers, so that the same storage water is used a number of times, giving an available storage capacity considerably greater than is indicated by the

which will permit feeding each substation from two directions and from two or more sources of power. This transmission line will be constructed with wooden poles and suspension type insulators, and will operate at 100,000 volts. It will follow in general the right of way of the Railway Company, except where advantage can be taken of a shorter route over public domain to avoid the necessarily circuitous line of the railway in the mountain districts.

The immediate electrification of 113 miles will include four substations containing step-down transformers and motor-generator sets with the necessary controlling switchboard apparatus to convert 100,000 volts, 60 cycles, three-phase power to 3000 volts direct current. This is the first direct-current



Profile of Section of the Chicago, Milwaukee & St. Paul undergoing Electrification

figures given. It would seem, therefore, in changing from coal to electricity as a source of motive power, that the railroad is amply protected as regards reliability and continuity of power supply.

Due to the great facilities available and the low cost of construction under the favorable conditions existing, the Railway Company will purchase power at a contract rate of 0.536 cents per kilowatt-hour, based upon a 60 per cent load-factor. It is expected under these conditions that the cost of power for locomotives will be considerably less than is now expended for coal. The contract between the Railway and Power Companies provides that the total electrification between Harlowton and Avery, comprising four engine division, will be in operation by January 1, 1918.

In order to connect the substations with the several feeding-in points of the Montana Power transmission lines, a tie-in transmission line is being built by the Railway Company

installation using such a high potential as 3000 volts, and this system was adopted in preference to all others after a careful investigation extending over two years. The 2400-volt direct-current installation of the Butte, Anaconda & Pacific Railway in the immediate territory of the proposed Chicago, Milwaukee & St. Paul electrification has furnished an excellent demonstration of high-voltage direct-current-locomotive operation during the past year and a half, and the selection of 3000 volts direct current for the Chicago, Milwaukee & St. Paul Railway was due in a large measure to the entirely satisfactory performance of the Butte, Anaconda & Pacific installation.

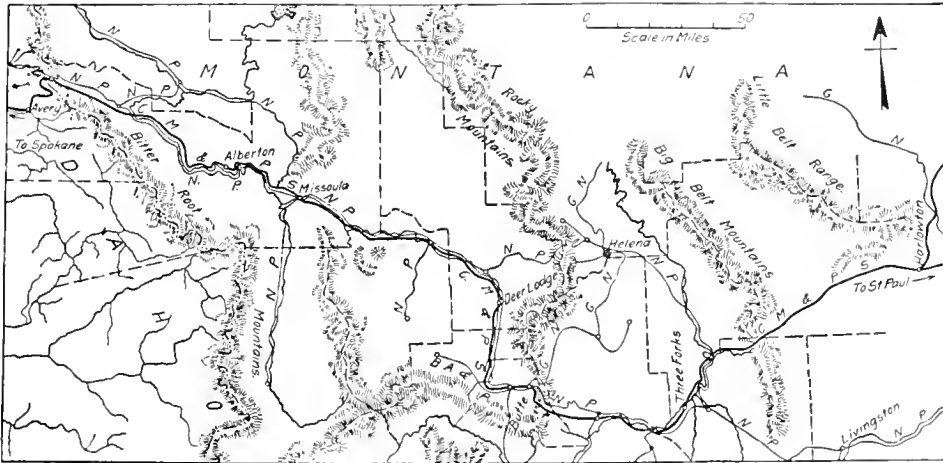
The equipment for this road was also furnished by the General Electric Company, and a comparison based on six months steam and electric operation shows a total net saving of more than 20 per cent on the investment or total cost of electrification. These figures of course do not take into

account the increased capacity of the lines, improvement to the service, and the more regular working hours for the crews. The comparison also shows that the tonnage per train has been increased by 35 per cent, while the number of trains has been decreased by 25 per cent, with a saving of 27 per cent in the time required per trip.

Substations

The substation sites of the Chicago, Milwaukee & St. Paul Railway electrified zone provide for an average intervening distance of approximately 35 miles, notwithstanding that the first installation embraces

1500-volt direct-current generators connected permanently in series for 3000 volts. The fields of both the synchronous motors and direct-current generators will be separately excited by small generators direct-connected to each end of the motor-generator shaft. The direct-current generators will be compound wound and will maintain constant potential up to 150 per cent load and will have a capacity for momentary overloads up to three times their normal rating. To insure good commutation on these overloads the generators are equipped with commutating poles and compensating pole face windings. The synchronous motors will also be utilized



Map showing Section of the Chicago, Milwaukee & St. Paul to be Electrified

20.8 miles of two per cent grade westbound and 10.4 miles of 1.66 per cent grade eastbound over the main range of the Rocky Mountains. With this extreme distance between substations and considering the heavy traffic and small amount of feeder copper to be installed, it becomes apparent that such a high potential as 3000 volts direct current permits of a minimum investment in substation apparatus and considerable latitude as to location sites.

The substations will be of the indoor type, the transformers being three-phase, oil-cooled, with 100,000-volts primary and 2300 volts secondary windings. The synchronous motors will operate at the latter potential. The transformers will be rated 1900 and 2500 kv-a. and will be provided with four $2\frac{1}{2}$ per cent taps in the primary, and 50 per cent starting taps in the secondary.

The motor-generator sets will comprise a 60-cycle synchronous motor driving two

as synchronous condensers and it is expected that the transmission line voltage can be so regulated thereby as to eliminate any effect of the fluctuating railway load.

The location and equipment of the several substations is as follows:

Morel, two 2000-kw. motor-generator sets; Janey, three 1500-kw. motor-generator sets; Piedmont, three 1500-kw. motor-generator sets; and Eustis, two 2000-kw. motor-generator sets.

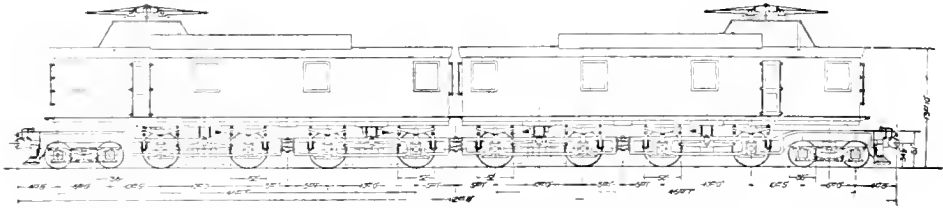
Overhead Construction

Trolley construction will be of the catenary type in which a 40 trolley wire is flexibly suspended from a steel catenary supported on wooden poles, the construction being "bracket" wherever track alignment will permit and "cross span" on the sharper curves and in the yards. Steel supports instead of wooden poles will be used in yards where the number of tracks to be spanned

exceeds the possibilities of wooden pole construction. Poles for the first installation are already on the ground and 30 miles of poles are set. Work in this direction will be pushed with all speed and will be completed ready for operation in the fall of 1915, on the delivery of the first locomotives.

As the result of careful investigation and experiments a novel construction of trolley will be installed composed of the so-called

will weigh approximately 260 tons and will have a continuous capacity greater than any steam or electric locomotive yet constructed. Perhaps the most interesting part of the equipment is the control, which is arranged to effect regenerative electric braking on down grades. This feature as yet has never been accomplished with direct-current motors on so large a scale. The general characteristics are tabulated below.



Outline of 260-Ton Electric Locomotive for the Chicago, Milwaukee & St. Paul Railway

twin-conductor trolley. This comprises two 40 wires suspended side by side from the same catenary by independent hangers alternately connected to each trolley wire. This form of construction permits the collection of very heavy currents by reason of the twin contact of the pantograph with the two trolley wires and also insures sparkless collection under the extremes of either heavy current at low speed or more moderate current at very high speeds. It seems that the twin-conductor type of construction is equally adapted to the heavy grades, calling for the collection of very heavy currents, and on the more level portions of the profile where maximum speeds of 60 m.p.h. will be reached with the passenger trains having a total weight of over 1000 tons. The advantage of this type of construction is due partly to the greater surface for the collection of current, and partly to the very great flexibility of the alternately suspended trolley wires, a form of construction which eliminates any tendency to flash at the hangers either at low or high speed. Including sidings, passing and yard tracks, the 113 miles of route-mileage is increased to approximately 168 miles of single track to be equipped between Deer Lodge and Three Forks in the initial installation.

The locomotives to be manufactured by the General Electric Company are of special interest for many reasons. They are the first locomotives to be constructed for railroad service with direct-current motors designed for so high a potential as 3000 volts. They

Total weight	260 tons
Weight on drivers	200 tons
Weight on each guiding truck	30 tons
Number of driving axles	8
Number of motors	8
Number of guiding trucks	2
Number of axles per guiding truck	2
Total length of locomotive	112 feet
Rigid wheel-base	10 feet
Voltage of locomotive	3000
Voltage per motor	1500
H.P. rating one hour—each motor	430
H.P. rating continuous—each motor	375
H.P. rating one hour—complete locomotive	3440
H.P. rating continuous—complete locomotive	3000
Trailing load capacity, two per cent.	1250 tons
Trailing load capacity, one per cent.	2500 tons
Approximate speed at these loads, and grades	16 m.p.h.

The Chicago, Milwaukee & St. Paul Railway, from Harlowton to the Coast crosses four mountain ranges. The Belt Mountains at an elevation of 5768 feet, the Rocky Mountains at an elevation of 6350 feet, the Bitter Root Mountains at an elevation of 4200 feet and the Cascade Mountains at an elevation of 3010 feet. The first electrification between Three Forks and Deer Lodge calls for locomotive operation over 20.8 miles of two per cent grade between Piedmont and Donald at the crest of the main Rocky Mountain Divide, so that the locomotives will be fully tested out as to their capacity and general service performance in overcoming the natural obstacles of the first engine division. The initial contract calls for nine freight and three passenger loco-

tives having the above characteristics. The freight and passenger locomotives are similar in all respects except that the passenger locomotives will be provided with a gear ratio permitting the operation of 800 tons trailing passenger trains at approximately 60 m.p.h., and will furthermore be equipped with an oil-fired steam-heating outfit for the trailing cars. The interchangeability of all electrical and mechanical parts of the freight and passenger electric locomotives is considered to be of very great importance from the standpoint of operation and maintenance.

The cab consists of two similar sections extending practically the full length of the locomotive. Each section is approximately 52 feet long and the cab roof is about 14 feet above the rail exclusive of housings for the ventilation. The trolley bases are about five feet about the roof owing to the unusual height of the trolley wire which will be located at a maximum elevation of 25 feet above the rail. The outer end of each cab will contain a compartment for the engineer while the remainder is occupied by the electric control equipment, train heater, air-brake apparatus, etc.

Motors

The eight motors for the complete locomotive will be Type GE-253-A. This motor has a normal one-hour rating of 430 h.p. with a continuous rating of 375 h.p. The eight motors will thus give the locomotive a one-hour rating of 3440 h.p. and a continuous rating of 3000 h.p. which makes it more powerful than any steam locomotive ever built. The tractive effort available for starting trains will approximate 120,000 lb. at 30 per cent coefficient of adhesion.

Each motor will be twin-g geared to its driving axle in the same manner as on the Butte, Anaconda & Pacific, the Detroit River Tunnel and the Baltimore and Ohio locomotives, a pinion being mounted on each end of the armature shaft. The motor is of the commutating-pole type and has openings for forced ventilation from a motor-driven blower located in the cab.

The freight locomotives are designed to haul a 2500-ton trailing load on all gradients up to one per cent at a speed of approximately 16 m.p.h., and this same train load, unbroken, will be carried over the 1.66 and two per cent ruling grades on the west and east slope of the Rocky Mountain Divide with the help of a

second similar freight locomotive acting as a pusher. Track provision is being made at Donald, the summit of the grade, to enable the pusher locomotive to run around the train and be coupled to the head end to permit electric braking on down grade. In this case the entire train will be under compression and held back by the two locomotives at this head end, the entire electric braking of the two locomotives being under the control of the motorman in the operating cab of the leading locomotive. It is considered that electric braking will prove very valuable in this mountain railroading, as in addition to providing the greatest safety in operation, it also returns a considerable amount of energy to the substations and transmission system which can be utilized by other trains demanding power. In this connection, the electric locomotives will have electric braking capacity sufficient to hold back the entire train on down grades, leaving the air-brake equipment, with which they are also equipped, to be used only in emergency and when stopping the train. There is therefore provided a duplicate braking system on down grades which should result in safety of operation, and should eliminate breakdowns, wheel and track wear and overheating, as well as leading to a reduction in maintenance and an improvement in track conditions.

With the completion of the remaining engine divisions it is proposed to take advantage of the possibilities afforded by the introduction of the electric locomotive by combining the present four steam-engine divisions into two locomotive divisions of approximately 220 miles length; changing crews, however, at the present division points. As the electric locomotive needs inspection only after a run of approximately 2000 miles, requires no stops for taking on coal or water, or layover due to dumping ashes, cleaning boilers or petty roundhouse repairs, it is expected that the greater flexibility of the locomotive so provided will result in considerable change in the method of handling trains now limited by the restrictions of the steam engine.

The electrification of the Chicago, Milwaukee & St. Paul Railway is under the direction of Mr C. A. Goodnow, Assistant to the President in charge of construction, and the field work is under the charge of Mr. R. Beeuwkes, Electrical Engineer of the railway.

THE 1500-VOLT DIRECT-CURRENT ELECTRIFICATION OF THE ONTARIO MUNICIPAL RAILWAY

By G. H. HILL

ASSISTANT ENGINEER, RAILWAY AND TRACTION ENGINEERING DEPARTMENT,
GENERAL ELECTRIC COMPANY

The general faith in higher direct-current potentials for railway work is exemplified by the equipment selected for the important work described by the author. The work now being done on the Ontario Municipal Railway is only the nucleus of much more extensive undertakings by the same road in the future. The scope of the present work is shown in the accompanying article.—EDITOR.

Various municipalities of the Province of Ontario, Canada, have been considering for some time an extensive system of inter-connecting electric railways. The general scheme provides for a network of interurban roads supported, as it were, by a backbone of main line electrification handling a relatively heavy freight service. The links connecting the cities and towns will be municipally owned and operated, thus continuing the already extensive municipal ownership feature existing in Canada.

The scheme, in brief, contemplates new roads, or electrification of existing roads through the central part of that portion of the Province lying between Lake Erie and the Georgian Bay from Sarnia on the west to Toronto and Whitby on the east, passing through London, St. Mary's and Guelph. This route follows generally the transmission system of the Hydro-Electric Power Commission from Niagara Falls. Several branches and connections are contemplated communicating with all the larger cities in that portion of the Province.

The proximity of the transmission system affords excellent facilities for substation locations and precludes the necessity of building a distributing transmission line along a large part of the right-of-way.

The Hydro-Electric Commission of Ontario, Sir Adam Beck, Chairman, and Mr. F. A. Gaby, Chief Engineer, will perform the double function of consulting engineer and contractor for the entire project, installing all equipment ready for operation. The individual sections of the system will then be turned over to the municipalities to operate.

The city of London has taken the initial step and is now proceeding with the electrification of that portion of the main line between Port Stanley on Lake Erie and London, about 21 miles north thereof.

This road has for several years been leased to the city of London to the Pere Marquette

Railroad and forms an important connecting link between the Lake Erie freight ferries and distributing centers of the Province. The chief commodity for transportation is coal from Pennsylvania.

The single track line is approximately 23.5 miles long and passes through Whites, St. Thomas, Glanworth and Westminster, connecting with the main lines of the Grand Trunk, Michigan Central and Canadian Pacific Railroads. The profile includes a maximum of 1.0 per cent grade north of Port Stanley and contains other grades of 0.8 per cent and 0.5 per cent for short distances.

The scheduled service will comprise a locomotive freight traffic and multiple-unit passenger car trains between the two terminals. Sixty-ton locomotives will take loaded freight cars from the ferry boats at Port Stanley and haul them in trains of approximately 800 tons to St. Thomas and London, returning with trains of empty cars. In addition to the above there will be local merchandise freight between the stops along the line. The passenger service will be performed by limited and local trains consisting, a large part of the time, of a motor car and one trail car providing a half-hourly service in each direction, the limited and local alternating.

The Hydro-Electric Commission made a careful investigation of operation when using both high voltage direct current and single-phase alternating current on the trolley, with the final adoption of 1500 volts direct current.

The energy will be supplied from two substations: One located at London in an extension of the present Hydro-Electric substation, and the other at a distance of 14.2 miles from London near St. Thomas. The latter will be a new substation. Each will be equipped with synchronous converters with their respective transformers and switchboards, converting from 110,000 volts, 25-

cycle alternating current to 1500 volts direct current.

The overhead structure will be of the familiar single catenary type supported on side brackets from lattice steel poles placed approximately 180 ft. apart on the tangent. The 0000 B.&S. copper trolley wire will be supplemented by suitable copper feeders.

The rolling stock covered by the initial order placed with the General Electric Company includes three 1500-volt, 60-ton locomotives, five 4-motor 1500-volt passenger car equipments complete with multiple unit control and air brakes, and four trail car control and air brake equipments.

The locomotives are of Type 4-0-4 and will be carried on two swivel trucks bringing all the weight on the drivers, the equipment being housed in a steel box type cab extending over practically the entire length of the locomotive. Each will be provided with four GE-251, 750/1500-volt motors designed for 750 volts across each armature and insulated for 1500 volts. Two motors will be connected permanently in series and the two-motor groups thus formed will be capable of connection in series or parallel for speed control.

The cab will be divided into three compartments, one at each end for accommodating the operator and the intervening compartment where the control equipment and accessories will be located. The operating compartments will be provided with 1500-volt electric heaters.

Each of the GE-251 motors will have an hourly rating of 245 h.p. with 1500 volts on the trolley. At this rating the locomotives will exert a tractive effort of 21,500 pounds.

Control will be effected by a double end Type M standard equipment, a master controller at each operating position actuating the main 1500-volt contactors by means of a 600-volt circuit supplied from a dynamotor. Multiple-unit train operation is arranged for so that the simultaneous control of three locomotives coupled together can be accomplished from any master controller. The equipment is also so designed that a locomotive may haul a train of eight or ten passenger trail cars and provide lighting energy for them.

The current collectors will consist of pantograph slide trolleys having two contact pairs pressing against the trolley conductor. Two of these devices will be furnished on each

locomotive. They will be electro-pneumatically controlled from any operating position with one, two or three locomotives hauling a train.

Each motor passenger car will be driven by four GE-225-750/1500-volt fully ventilated commutating-pole motors connected two groups of two in series. The one-hour rating is 125 horse power with 1500 volts on the trolley.

Each motor car has sufficient capacity to haul one trail car and provision is made for the motor and trail cars to be operated in trains up to a total of three motor and three trail cars. All trail cars will be equipped with master controllers at each end so that multiple-unit train operation is possible from either end of any motor or trail car.

Control energy for a motor and trailer will be derived from a 1500/600-volt dynamotor on each motor car. The dynamotor will also supply energy for lighting one motor and one trail car. Main and auxiliary train cables will run continuously throughout a train, provision being made for the simultaneous raising and lowering of all pantographs and also for simultaneous sanding (by electro-pneumatic valves) of all cars from any operating position. The pantograph trolleys will be identical with those on the locomotives.

Each car will carry a combined straight and automatic air-brake outfit of the variable release type, with the air supply furnished by 1500-volt compressors. The compressor governors will all be equalized on a special wire running throughout the trains in the auxiliary train cable.

The cars which will be placed in service on the London and Port Stanley Railway will be built to the Commission's specification. They will be all steel, 59 feet long and thoroughly modern in every respect. The motor and trail coaches will be identical except for motors. The former will weigh approximately 51 tons loaded and equipped, while the latter will have an approximate loaded weight of 32 tons.

The growth of the Ontario Municipal system will be watched with much interest since it marks a rather novel departure on a large scale from the usual American procedure.

THE 2400-VOLT RAILWAY OF THE BETHLEHEM-CHILE IRON MINES COMPANY

By E. E. KIMBALL

RAILWAY AND TRACTION ENGINEERING DEPARTMENT, GENERAL ELECTRIC COMPANY

The work to be done in developing the rich iron mines at Tofo, Chile, includes the construction of a very difficult line of railway which is to operate at 2400 volts direct-current, the building of a steam power station and transmission line, the installation of electric shovels and crushers, and the building of a settlement for the officers and operators of the company. The author gives a short outline of the work contemplated and cites some of the local conditions which make this undertaking one of particular difficulty.—EDITOR.

One often notices in technical papers and popular magazines articles describing the wonderful mineral resources of South America, especially large deposits of iron and copper ores, but few realize how rapidly and on what a large scale these resources are being developed and where the products find a market. A remarkable deposit of iron ore is found at Tofo, Chile, where the Bethlehem-Chile Iron Mines Company is preparing to mine this ore with the aid of electric power and to ship it to the United States for use in the blast furnaces at South Bethlehem, Pa.

These mines occupy the summit of two hills, approximately 2000 ft. above sea level and about four miles in an air line from the port of Cruz Grande. The remarkable feature of these mines is that there are great quantities of ore in sight and it is nearly pure iron (67 per cent Fe.). With the opening of the Panama Canal to commerce this ore can be mined and shipped by that route from Chile to New York and thence to South Bethlehem, Pa.

An electric railway operating at 2400 volts is now being built to develop these mines. In addition to this electric railway the development will include a steam-power station and high tension transmission lines, from the port of Cruz Grande to Tofo, and the installation of electric shovels, crushers and other machinery for mining operations at Tofo. Ore pockets and vessel loading piers will be constructed at Cruz Grande. It requires also the building of residences for officials and establishing ample water supply and fire protection as well as the provision of an electric lighting system for the villages, piers, etc.

At present a certain tonnage of ore is mined by steam drilling and transported to the coast over a telpherage system which consists of a string of ore buckets suspended from a steel cable supported on steel towers and operated by the weight of the loaded buckets descending, which furnish power for taking up the cables. This system is started by a gas engine, but when once started it requires no external force to keep it running, in fact,

part of the energy is dissipated in operating a large fan which is used for governing the speed. Probably one of the chief reasons for adopting this system was on account of the small amount of power required to operate it.

It was essential that means be provided for saving water and fuel, in other words, power. Obviously, the power taken by the empty trains ascending the grades, if supplied by loaded trains descending, would represent a saving which could not be effected by minor economies of fuel. This feature in the railway electrification, therefore, received a great deal of attention both from the standpoint of saving power and on account of other practical operating advantages.

The railroad from the mines to the piers is approximately 15 miles long with an average grade for nearly the entire distance of three per cent. This is also the maximum grade. Its alignment is far from straight, as may be seen from the fact that in an air line the mines are only four miles from the coast, whereas the railroad reaches the same height only after traversing 15 miles.

In the operation of heavy grade sections of steam railroads great difficulty has been found in getting rid of the heat from brake-shoes and wheels, which is another argument in favor of electric braking on the locomotives. In the study of this problem it was shown that regenerative braking could be accomplished successfully on a high voltage direct-current system, that is, the motors under the locomotive are made to act as generators and return energy to the trolley to be used by another locomotive ascending, or back to the power house where it would help supply the demands of the mines.

These locomotives will weigh 110 tons on drivers and will be equipped with four 300-h.p., 1200 2400-volt motors operated two connected permanently in series on 2400 volts. The initial installation will consist of three of these locomotives, each having a capacity to haul a 450-ton train up grade at 10½ m.p.h. and exerting the same braking effort when regenerating at 12 m.p.h.

In case the locomotives are operating with the maximum train weights down grade a portion of the braking will be done with air brakes, and when stopping air brakes will be used alone.

The trolley will be of 4/0 grooved copper wire, catenary suspended from a steel messenger supported by a mixture of bracket and cross span construction on wood poles. These poles will be of cedar and will be shipped from the United States, as Chile grows no timber suitable for this purpose. A duplicate 22,000-volt high tension transmission line will in general follow the trolley and will be carried on the same poles when possible. In places, however, it will leave the railroad right of way for a more direct route to the mines. These transmission lines will supply power for the operation of crushers, electric shovels, pneumatic tools and machine shops, as well as for pumping water and other sundry purposes.

The mining of this ore will be accomplished by blasting the ore exactly as in modern rock quarries, and then by means of electric shovels it will be loaded onto side-dump cars, when it will be hauled a short distance to the crusher plant and crushed to a size suitable for use in blast furnaces. The crushed ore will fall by gravity into bins ready for loading into hopper cars; it will then be hauled to the vessel loading piers and dumped into ore pockets. From here it is loaded by gravity into 17,000-ton steel vessels specially constructed for this purpose and shipped to unloading piers in New Jersey, and there loaded onto cars for South Bethlehem, Pa., where it is ready for the blast furnaces. The transportation of the ore is, therefore, a big item of its cost and every facility has been provided to save the expense of handling it.

In the power house oil-fired boilers are to be used which will permit of an easy control of the heat with every fluctuation of load, and because of absence of dirt the usual partition between the generator room and the boiler room will be omitted so that the operators will be able to anticipate changes in load in time to make proper adjustments. The oil is received in tank vessels and pumped to an oil storage tank above the power station. From the main reservoir it runs by gravity to the auxiliary reservoir near the station and is fed to the burners by means of a small pump. The boilers will be set high so that grates may be installed if there is any advantage to be obtained from the use of coal.

One of the interesting features of this installation is the ingenious method employed for evaporating boiler "make-up" water from sea water. This is done by an evaporating condenser through which is "by-passed" a part of the exhaust steam from the turbines. By adjusting the difference in the vacuum between the main and the evaporating condensers the amount of evaporation can easily be governed without affecting the economy of the steam turbines appreciably.

The generating room contains two 3500-kw. three-phase, 60-cycle, 2300-volt Curtis G-E steam turbines with direct-connected exciters for supplying power to the railroad and the mines; two 300-kw. three-phase, 60-cycle, 600-volt turbines for operating motor-driven auxiliaries, fire pumps, etc., and at night, lights for the piers, villages and mines when the main turbines are shut down. To accomplish this result there is installed a small bank of step-up transformers so that the high tension lines may be energized at minimum loss. This arrangement avoids considerable complication in the switchboard wiring and avoids providing steam-driven auxiliaries with complicated steam and water piping.

Power for the operation of the mines and crusher plant is stepped up by means of two banks of transformers, each bank consisting of three 667-kv-a., 60-cycle, 22,000-2300-volt oil-cooled transformers. At the mines the voltage is stepped down again to 2300 volts for local distribution. Power for the operation of the railroad is taken through two 1000-kw., three-unit motor-generator sets, each consisting of one 1400-kv-a., 0.8-p-f. three-phase, 60-cycle, 2300-volt synchronous motor-generator set direct-connected to two 500-kw., 1200/2400-volt direct-current generators, designed to operate two in series on 2400 volts. These sets have direct-connected exciters on each end for exciting the synchronous motor and d-c. generators. Space has been left in the design of the building for future boilers, main turbines and motor-generator sets when required.

The power station building will be located on solid rock foundations and a type of construction employed which is particularly adapted to resist earthquake shocks, which are frequent and sometimes violent and followed by tidal waves. It will, therefore, be located back from the water's edge, on high land reasonably safe from these disturbances. A pump house of very sturdy construction will be erected at the water's

edge to supply circulating water to the condensers and for fire protection for the village and piers.

Nearly all the sources of fresh water supply are located in the valley behind the mines and it requires pumping to the mine level for use at the mines. The excess is stored in reservoirs between the mines and Cruz Grande

for such purposes for which it is suitable and also to relieve the pressure on the pipes at Cruz Grande. At the present time a great deal of this work has been completed and a temporary pumping and lighting plant is installed near one of these springs and supplies water for the mines and lights for the villages.

ELECTRO-CULTURE: A RESUMÉ OF THE LITERATURE

By HELEN R. HOSMER

RESEARCH LABORATORY, GENERAL ELECTRIC COMPANY

The literature published on electro-culture is extensive but scattered. The writer has made an excellent review of this published matter, dividing the subject according to the different methods used to stimulate plant life by electricity. The progress, or lack of progress, made by the application of each method, is discussed, and the conclusion is reached that these investigations, on the whole, have been too cursory. A valuable list of references is also given.—EDITOR.

The scientific literature of the last ten years has contained frequent references to the art of increasing plant growth and yield by the application of electric stimuli of certain kinds, an art most commonly designated as electro-culture. The material given, however, represents very little experimental work in proportion to its volume, consisting in the main of more or less complete historical reviews concluded by a few paragraphs describing some recent investigation. The effect upon a reader desiring to become acquainted with the work done within a reasonable length of time is irritating, to say the least. In view of the growing interest in intensive methods of agriculture, and also in methods of filling in the valleys in the load curves of central stations, there is reason to expect a much more exhaustive investigation of this subject in the not remote future. For this reason it has seemed desirable to collect the facts from the scattered sources, and attempt to arrange them in a form more convenient for use, that is, from the point of view of the invader of the province rather than the historian.

It has been found that the experiments of the past fall naturally into five classes, differing principally in the method of application of electrical energy. These methods are:

- I. Illumination by electric light.
- II. Conduction of atmospheric electricity from an elevated collector to an electrode in the soil, or to discharge points above the plants.
- III. Constituting the soil the electrolyte of a voltaic cell by burying in it the plates of dissimilar metal connected by a conductor.

IV. Passing current from an external source through the soil between electrodes buried therein.

V. Production of a silent or glow discharge through the air from overhead antennae to the soil.

These methods will be taken up in the order given, which is approximately that of their importance.

METHOD I

Illumination by electric light.

There seems to have been relatively little work done upon the effect of illuminating plants by artificial or electric light. In 1861 "Hervé" Mangon found that electric light influences the formation of chlorophyll in a way similar to that of sunlight. That the absorption and assimilation of carbon dioxide occurred as usual under the electric arc was shown by Prèllieux eight years later.¹

In 1880 Wilhelm Siemens confirmed these observations, but found that under certain conditions injurious effects were obtained, and hence he used an opalescent glass shade over the light.

These facts were further confirmed by Schraier in 1881, and by Bailey, Cornell University, in 1891. Bonnier in 1892, and Couchet in 1901, studied the structure alteration in plants and the leaf growth in relation to the electric light.

Since 1891 this line of attack has been neglected, probably because of the attention attracted by the work of Lemström, and the success of his method.

Dorsey, however, in 1914, mentions the treatment of hothouse radishes and lettuce for three hours each day beginning at sunset,

with red light from a 100-watt lamp, and with blue light from a Cooper-Hewitt lamp. The lettuce was affected favorably, the radishes unfavorably.²

METHOD II

Conduction of atmospheric electricity from an elevated collector to an electrode in the soil, or to discharge points above the plants.

Among the earliest attempts to apply atmospheric electricity to plant culture appears to have been that of Abbe Bertholon, in 1783. He called his apparatus the electro-vegetometer. It consisted of a number of metal points similar to a lightning rod, supported at a considerable elevation, and connected by a conductor to an iron bar furnished with discharge points which hung down just over the plants treated. The whole apparatus was insulated by wooden supports. The Abbe stated that the use of this arrangement always produced an increase in the fertility, vigor, and growth of the plants.³

Later, 1879, Grandeau and his pupil LeClerc showed by careful comparative measurements, analyses, etc., that protection of plants from atmospheric electricity by enclosure in wire cages often retards the growth over 50 per cent. But Naudlin repeated his experiment a little later with results diametrically opposite. The more recent experience of Pinot de Moira agrees with that of Grandeau.

A modification of Bertholon's method called the geomagnetifère system has been quite commonly used in France. This consists of an elevated conductor connected to wires running through the soil under the plants to be influenced. A typical installation is that of Pinot de Moira at Clifton, Eng., which was in operation for several years to good advantage.

Berthelot carried on considerable work at Meudon in France. He found that the growth of plants on the top of a 28-meter tower was greater than at the foot.

Lieutenant Basty experimented with metal rods terminating in a ball of non-oxidizable metal at the lower end which was buried in the ground as deeply as the roots of the plant were likely to penetrate and projected from two and one-half feet to six and one-half feet above the surface, depending upon the plant treated. The first height was used for strawberries. He claimed that beneficial results were noted about each rod for a radius equal to half the height.⁴

METHOD III

Constituting the soil the electrolyte of a voltaic cell by burying in it two plates of dissimilar metals connected by a conductor.

Speschew in Russia obtained marked results from plates of different metals buried in the ground connected by wire.

More recently, 1906, Rawson and Le Baron⁵ have used the same method in greenhouses. Plates of copper and zinc were sunk at opposite ends of lettuce beds and gave a potential difference of 0.5 volts and current of from 0.4 to 15 milliamperes. The lettuce thus treated was ready for market a week sooner than that not treated.

Priestly³ tried the method of Speschew, using plates of copper and zinc between which beans were planted. The plants treated appeared two days earlier, developed more rapidly, and the average size and weight of the mature beans was about a third greater. Some other qualitative experiments were inconclusive. The current in very damp soil was twelve milliamperes between plates of 200 sq. in., four feet apart.

Newman,⁶ however, states that the results of a dozen experiments indicated no effect whatever, and that the reports of others have been in confirmation of this fact.

METHOD IV

Passing current from an external source through the soil between electrodes buried therein.

This method of plant stimulation has been the source of numerous conflicting reports, and its applicability seems still to be in doubt. A number of investigators have found that it increases the rate and proportion of germination.

E. H. Cook⁷ states that this is the only effect that he was certain was produced by currents of 100 milliamperes at 20 volts.

Kinney⁸ in 1898 and Ahlvingren in 1899, confirmed his results. The former considered three volts the optimum, but the latter believed this to vary for different plants, and, under different conditions, for the same plant. Lewenherz's conclusions also agreed with the above, but he considered also that the direction in which the current traversed the seed was of importance.

Kövessi,⁹ 1912, on the other hand, as a result of over 1100 pot tests, came to the conclusion that direct currents through the soil are without exception harmful both to

germination and later growth. Schneckenberg,¹⁰ commenting upon this paper, remarks that he ought to have known this fact from a knowledge of the simple laws of electrochemistry and endosmosis before performing the 1100 experiments, but goes on to point out that Kóvessi's statement should read "horizontal direct currents through the soil" and must not be extended to cover any other type of electrical treatment. Kóvessi does not state what strength of current he employed.

Gerlach and Erlwein,¹¹ 1910, describe experiments with low potential direct current, 6 volts, 0.2 to 0.4 amperes, at Bromberg, upon an area of 914 sq. ft. planted to barley and cabbages. Iron plates buried in the soil were used for electrodes. The treatment was continuous night and day until harvest. No beneficial effect was obtained.

Peaslee,¹² 1910, using direct current in greenhouse experiments on the germination and rate of growth of seedlings, such as cauliflower, cabbage, beets, etc., experienced failure until he lowered his current density and adopted carbon electrodes, which, unlike some metals, do not react with the soil to form deleterious salts. He obtained the most favorable results at a power consumption of between 0.5 and 0.6 watts per cu. ft. which gave increased fertility of seed, more rapid and vigorous development, and increased size of plant, especially of the root. In the case of a cauliflower, the advantage in respect to growth was nearly 150 per cent. Radishes carried through to a marketable size had a root growth 403 per cent, and a top growth 117 per cent greater than the control* plants.

Similar tests with alternating current were consistently negative again until the watts per cu. ft. were reduced to 0.0114 (current = 0.000034 amp. per sq. in.) when an increased fertility of 50 per cent and an increased growth of 32 per cent was obtained.

Dorsey,² 1913, tried some greenhouse experiments using direct current (1.5 volts and 0.0003 to 0.07 amp., and 3 to 8 volts and 0.0007 to 0.05 amp.) and also 60-cycle alternating current, 110 and 220 volts between carbon electrodes. The results were bad in both cases. The temperature of the treated beds was a degree higher than the controls.

It is evident that the investigation of this type of electric treatment has been entirely insufficient to lead to any trustworthy con-

clusions. The controlling factors have scarcely been indicated as yet.

METHOD V

Production of a silent or glow discharge through the air from overhead antennae to the soil.

The stimulation of crops by a discharge of electricity through the air to the soil seems to be the method best founded upon theory and most promising in practice.

Prof. Lemström¹³ of Helsingfors University, Finland, first remarked upon the fact that the extraordinarily rapid and fruitful growth of such vegetation as survives the frosts in the Arctic and sub-Arctic regions can not be accounted for, as has been suggested by the long hours of daylight. He showed that the total light and heat supplied are actually less than at the latitude of Petrograd or Christiana, on account of the low elevation of the sun above the horizon. It has been proved beyond doubt that there exist in the atmosphere of these high latitudes much stronger currents passing to the earth than is the case further South. These are evidenced by their luminescent effects, such as the Aurora. A great proportion of the vegetation, especially that peculiar to northern regions, is equipped with pointed leaves, etc., which are especially adapted to electrical discharge. Moreover, in studying sections of fir trees, Lemström found a periodicity in the occurrence of especially large growth which is the same as that of the occurrence of sun spots and auroras, i.e., every 10 or 11 years. Lemström goes into these indications and the further electrical phenomena and facts from which he was led to begin his investigations in considerable detail in his book "Electricity in Agriculture."

He suspected that the electrical influence played a part hitherto overlooked in the growth of vegetation in other parts of the world. With this in view, he tried to reduplicate the conditions of the Arctic by producing a similar electrical tension in the atmosphere. He applied a positive potential from an influence machine of which the negative was grounded to a wire network suspended above the plants, producing a silent discharge to the earth. He worked first with pots, and then in the open field. His power consumption was low, as indicated by the fact that a 0.1 horse power motor served to drive his influence machine.

Lemström extended his researches to different farms in Finland and, in later years, to

* The control plants, etc., are used in the same manner as the experimental experiments carried on in the greenhouse, but without elec-

other countries. The procedure was tested under his supervision at Durham College, England; in Burgundy, near Breslau in Germany, and at Atvadaberg. His book contains full details as to the extent, circumstances, and results of all these experiments. As a result of his experience he concludes that the minimum increase in yield for all crops under the proper conditions should be about 45 per cent. For certain crops it may rise as high as 100 per cent. Improvement occurs whether the network be charged positively or negatively to the soil, but better results were obtained in the former case. The effect is not apparent alone in the quantity, but an improvement of quality, and a shortening of the period of growth, sometimes by 50 per cent, is general. Analyses are given to indicate that in the case of grain there is an increase in the proteid content. Frequent instances were encountered where the electric current was deleterious, but repetition of the work under improved conditions eliminated the trouble. Thus it was found that during drought or in hot sunshine the plants suffer harm, and certain species, among which may be mentioned peas, cabbages, and carrots, are particularly sensitive. Watering, and discontinuing the treatment during the middle of the day has produced equally good results with these vegetables. Lemström points out that lack of uniformity in cultivation, nature of soil, and fertilization between the experimental and control plots often leads to erroneous conclusions. The better cultivated and fertilized a field is, the larger the percentage increase in yield due to electro-culture.

Lemström devotes a chapter to directions for the choice and installation of apparatus, with an estimate of costs.

Lemström's procedure suffered from a great disadvantage. His influence machine was quite inadequate for the purpose, hence his overhead wires could not be hung more than 16 in. above the plants, which interfered with economical cultivation of the soil.

At Gloucester,³ experiments with a somewhat more powerful machine, enabling the elevation of the wires to five feet above the ground gave results with various crops as follows:

Beets, 33 per cent increase.

Carrots, 50 per cent increase.

Turnips, increase: not quantitatively measured.

The beets raised under electrification gave on analysis about 14 per cent more sugar than the control crop.

This increase in sugar content has been confirmed by almost every investigator, irrespective of whether his results were favorable to the process in other ways.

In 1904, Newman^{3, 6} performed some similar tests with a small Wimshurst machine driven by an oil engine, operating upon fifteen greenhouses, and upon an area in the open amounting to about a thousand square yards, including control plots. The wires were strung about 16 in. above the plant tops and were furnished with downward directed points of fine wire for discharge points. Ordinary telegraph insulators were sufficient except in wet weather, when almost all the energy was lost by leakage down the supports.

The treatment was applied for a period of 108 days, 9.3 hours daily, the first half of the time mainly by day, the last half by night. The results from the electrified plants were as follows:

Cucumbers, 17 per cent increase.

Strawberries, five-year plants, 36 per cent increase.

Strawberries, one-year plants, 80 per cent increase, and produced more runners.

Broad beans, 15 per cent decrease, ripened five days sooner.

Cabbages, (spring) mature 10 days sooner.

Celery, two per cent increase.

Tomatoes, no effect.

The cucumbers were all affected by a bacterial disease about the middle of their growth, and this made much greater headway on the non-electrified plants. Aside from the troubles with the influence machine and oil engine, which were rather inadequate, the installation required no attention except for the clearing away of cobwebs and stray shoots, etc., from the network.

This work was continued on a larger scale, Newman³ working in conjunction with Sir Oliver Lodge. The latter overcame several of the inherent difficulties of the process by the invention of a mercury arc rectifier supplying a 100,000-volt direct current. The new installation consisted of an oil engine and dynamo producing three amperes, at 220 volts, which was transferred by an induction coil and then rectified.

This higher potential made it possible to raise the conducting network to 16 ft. from the ground, thus permitting of easy cultiva-

tion without lessening the beneficial effect of the current.

Preliminary experiments upon wheat at Gloucester having been very favorable, Newman subjected 11 acres to treatment. The overhead network consisted of stout telegraph wires mounted upon poles in rows 102 yards apart, the distance between successive poles being 71 yards, and thin galvanized wires stretched 12 yards apart crosswise to act as discharge wires. A difference in the rate of growth was noticeable very early, and at harvesting the straw averaged from four to eight inches taller, and the Canadian wheat ripened three or four days sooner. The yields were 39 per cent better for Canadian wheat, and 29 per cent better for English. Further, the electrified wheat sold for 7.5 per cent better price on account of its superior quality.

Breslauer,¹ who has written a critical review of the subject up to 1910, and kept in close touch with the progress of the work in Germany, tells (1909) of the results obtained at Halle by Kuhn, and at Holstein, Neumark, and Westpreussen.

At Halle experiments were made under various conditions of fertilization and irrigation upon a total area of about 14 acres, besides the control areas. This field installation was also raised to 16½ ft. above the ground. The good effect upon rye was already noticeable in June. It was observed here especially that when the wind blows the effects of the treatment are felt from 10 to 16 ft. and sometimes 50 ft. beyond the limits of the field experimented upon, and whenever the control fields are adjacent, reduces by so much the apparent improvement due to electrification. This wind effect was also noted in work at Holstein.

After the completion of these experiments, a year later, 1910, Prof. Kühn,¹⁴ the German "Nestor of agriculture," under whose immediate supervision they were conducted, was not enthusiastic as to the results. He stated that little was to be expected from the English procedure, as the advantage apparent during growth did not appear in the yield. His control fields of grass and grain gave the better results. Only fodder and sugar beets were bettered, the latter indeed having an increased sugar content. Clover and cabbage gave uncertain results. He considered that the cost would demand at least a 15 per cent increase in yield.

It is interesting to note that the investigation conducted at Halle showed that the process and

apparatus is entirely practicable. He estimates the cost of an equipment for 61.8 acres as follows:

Generating apparatus.....	\$595.00
Field equipment.....	595.00
Power consumption, 5kw-hrs. per day (at 5c) = 25c, for season, 150 days =	\$ 37.50
Interest on \$1190.00 at 5 per cent....	\$ 59.50
Sinking fund at 7 per cent.....	83.30
Repairs at 2 per cent.....	23.80
Power	37.50
Labor (one man two hours a day)....	47.60
Total.....	\$251.70
Medium to poor yield from wheat: 2000 lb. per acre.	
For 61.8 acres.....	\$2380.00
30 per cent increase.....	714.00
Profit \$714.05—\$251.70 =	\$462.30.
Ordinary profit from 61.8 acres =	\$71.40.

In a later contribution Breslauer¹⁵ describes the measurement of current and power consumption by typical installations at Hoppegarten.

A movable coil ammeter of great sensitiveness was inserted in the ground wire. The order of magnitude of the voltage was determined by measuring the length of spark in the air, it being known that between balls of 25 mm. diameter it requires about 3000 volts per mm. to produce a spark.

In dry, and not extremely hot weather, with an east wind, the voltage averaging about 65,000 volts, he estimates that, allowing for a certain inequality of distribution, the current for every 10 sq. ft. is about 0.43×10^{-5} milliamperes.

Hence the energy consumption is about $0.26 \cdot 10^{-3}$ amp. \times 65,000 volts = 17 watts = $0.28 \cdot 10^{-3}$ watts per 10 sq. ft.

This is from 1000 to 10,000 times the transfer of electric energy occurring naturally during a year, as estimated by Kähler.¹⁶

Gerlach and Erlwein¹¹ give an account of agricultural experiments upon the Kaiser Wilhelm Institute of Agriculture Experimental Grounds at Mocheln for which the equipment was supplied by the firm of Siemens & Halske.

The electrical treatments included high tension static electricity, making the net positive in some cases, and negative in others, and high tension, single-phase alternating current.

The network consisted of a heavy galvanized wire supported on well insulated poles around the outside of the field, and suspended

from this, across the field, thin galvanized iron wires at a height of 20 ft.

The electrical equipment consisted of a four-horse power alcohol motor belted to a direct-current dynamo, and a transformer. The two influence machines were run by direct-current motors.

The experimental plots comprised an area of 800 sq. yds. besides control plots of one-half this area located at a distance of 330 ft. The plots were treated with various kinds of fertilizer, some were irrigated and others not. The crops included cabbages, barley and oats.

The alternating-current antennae averaged a voltage of about 20,000, the static antennae 30,000 volts. The power consumption for the former was about 770 volt-amperes, for the latter about 30 watts. The irradiation was begun after planting, and continued 45 days continuously day and night. No difference was apparent between the electrified and untreated plants, though there was a considerable difference between the watered and unwatered, and between those differently fertilized. Mention is made of the occurrence of a drought. The harvest, occurring 120 days after sowing showed practically identical yields for treated and untreated plants, with slight evidence of injury by the alternating current.

The account gives the most extreme detail of electrical outfit and arrangement, but is vague as to the weather conditions, etc., which other investigators have found so important.

Höstermann,¹⁷ 1910, used a network of telephone wires from 6½ to 8 ft. above the ground and 13 ft. apart, and obtained his current from the atmosphere by means of a steel cable 820 ft. long, supported by a balloon or by several kites. He estimated, having an instrument reading to only five volts, from other measurements, that he got a potential of about 25,000 volts. This method gave him the best results of any, increasing the yield on various crops from 15 to 40 per cent. He found that the atmospheric potential gradient varied with the season, the time of day, the temperature, and the weather, reaching maxima from December to February, shortly after sunrise and just before and during dusk, at low temperatures, and during fog, snow, hail or rain and especially during thunderstorms.

The conditions under which treatment is applied are important, it being very essential that there should be moisture in the air as

irradiation during dry and sunny weather often results injuriously to the plants. The most favorable times for treatment correspond with those of maximum potential gradient, i.e., very early morning and evening, and especially during a fog. He points out that the climate of England is especially adapted, and should give good results, especially as the treatment seems to compensate in part for lack of sunshine.

Exclusion of the influence of atmospheric electricity reduced the yield nearly 15 per cent.

Höstermann, also using high potential pulsating direct current from a dynamo machine and transformer found that extended treatment was of little, or injurious effect, but more moderate application increased the yield in some cases 25 per cent. The crops treated included strawberries, spinach, lettuce, radishes, etc.

Stahl,¹⁸ 1911, claims he was able, using electrical stimulation, to bring a crop of corn to maturity after the winter wheat was reaped on July 25. He used a direct-current potential of about 250,000 volts (600 cycles) stepped up from a 60-cycle, 110-volt line and rectified mechanically. The wires were mounted eight feet from the ground, and two to three feet apart. The treatment was applied to one acre morning and evening, and the electric bills averaged two to three dollars per month. A variety of vegetables were treated. All matured much more quickly and resisted drought better. Only qualitative results are given.

Gloede¹⁹ used the treatment in growing flowers and found greatly increased vigor as well as resistance to harmful fungi. In a small outdoor plot 20 feet square he ripened 362 muskmelons from seed in less than nine weeks, and the fruit was noticeably sweeter than usual.

An installation near Prague,²⁰ designed by Breslauer, operated upon an area of 89 acres by means of a network of iron supported by porcelain insulators upon wooden poles at intervals of 328 feet apart across which was stretched a network of 0.008-in. wire at a height of 13 feet above the ground. Direct current at 120 volts, 2 amp., was supplied by means of a mercury interrupter, a transformer, producing 100,000 volts, and a rectifier. The network was always made positive, and the treatment applied only a few hours each day, being always discontinued in case of rain, which caused leakage, and of great heat, under which latter condition the current is injurious. In spite of an unusually dry

season yields in some cases double that of the control plots were claimed. Details as to sort of crop and actual yields are not given.

Basty,⁴ experimenting on a regimental garden, in France claimed good results.

Dorsey² applied to small greenhouse beds for an hour night and morning, daily, alternating current of 200,000 cycles frequency, at 10,000 volts from a Tesla machine and transformer, consuming about 130 watts. He used a network of 0.01-in. wire at a height of 15 in. above the bed. He found by weighing representative plants a marked gain amounting to 75 per cent for lettuce. This method gave better results than illumination or earth currents.

He next applied a silent discharge by means of a network of 0.08-in. copper wire, nine feet above the ground, 15 feet apart on insulators designed for 60,000 volts, to over an acre of garden using 10,000 to 20,000 volts at 30,000 cycles for five hours daily for two months and 50,000 volts for one month. Interruption of service makes the results only qualitative in value. Almost all of the irradiated plants, including radishes, lettuce, beets, cabbages, cucumbers, turnips, melons, tomatoes, and parsnips, gave a better growth than on the untreated acre. Beans and peas were affected slightly, but all the other plants matured at least two weeks earlier than the control plants. Tobacco showed a 20 per cent gain.

Peaslee,¹² 1913, applied 100,000 volts from a Wimshurst machine on wires 10 in. from the soil to seedlings, with results which he describes as disastrous, at first. Later, by applying the voltage only at night and on cloudy days he increased the growth of strawberries 27 per cent, and beetroots 14 per cent, tops 39 per cent. He could not establish any optimum voltage. He found that the size of the wires made no difference. Climatic variations appeared to have considerable effect.

Preliminary tests with a Tesla coil gave qualitatively similar results.

CONCLUSION

The impression gained from the literature of electro-culture is that the last word is by no means said. From the nature of the publications it would appear that the individual investigations have been too cursory. There has been too little systematic variation of conditions, and especially of the electrical conditions. It seems highly desirable that a much more extensive investigation,

providing the possibility of trying different intensities of electrification under various conditions of cultivation, irrigation, etc., all during the same season, should be carried out. It is significant that the only investigator to attempt an extended examination of the field was able to locate and eliminate many faults in his method, and thus obtain good results in the end in almost every case, often reversing his previous experience. If Lemström, working with his very imperfect equipment and limited resources could attain so much success, greater development still should be possible with the more adaptable apparatus now available.

The theories as to the actual mechanism of the action of the electric discharge upon plants, involve questions of physiological and botanical chemistry whose answers are still too uncertain to make their consideration here of profit. Lemström,¹³ Priestly,³ Escard,²¹ and Peaslee¹² discuss the subject briefly, and references to points more or less related to it are given in the bibliography appended to this article.

REFERENCES

- (1) Breslauer, M. *Elektrochem Z.* 16, 1-5 (1909)
35-9
72-5
224-8
History. Experiments. (Method V) at Halle and in Holstein. Estimate of costs and profits of installation.
- (2) Dorsey, H. G. *Elec. (L)* 72, 442-3 (1913)
Elektrotech Z. 35, 236-8 (1914)
(Methods I, IV and V.) Experiments at Dayton, Ohio.
Method IV unfavorable. Others good.
- (3) Priestly, J. H. *Proc. Bristol (Eng.) Naturalists Soc.* 1, 190-203 (1907).
History and account of experiments. (Method V) by Lodge and Newman at Bitton, Gloucester and Evesham. Theory and references.
- (4) Charriere, G. *Abstract, Elektrochem Z.* 19, 15 (1912).
(Methods II and V.) Note on experiments of Davidoff on Long Island and Basty in France.
- (5) Rawson and LeBaron *Elec. World*, 47, 1067 (1906).
Elec. (L) 57, 305-6 (1906).
(Method III.) Favorable.
Unconvincing reporters account.
- (6) Newman, J. E. *Elec. (L)* 66, 915-6 (1911).
(Method V.) Experiments at Bitton. Favorable. Very brief.
- (7) Cook, E. H. *Elec. (L)* 41, 787-8 (1898).
(Methods II and V.) Favorable especially to germination.
- (8) Kinney, A. S. *Bull.* 43, Hatch Experimental Station Mass., Agricultural College.
"Electro-Germination."
Detailed Abstract, *Electric Engineer (N. Y.)* 23, 289-92 (1897).
(Method IV.) Laboratory experiments. Favorable. Minimum optimum, and maximum voltage.
- (9) Kovessi *La Houille Blanche* 8, 223 (1912).
Compt. Rend. 154, 289-91 (1912).
Abstract, Elektrochem Z. 19, 224 (1912).
(Method IV.) 1100 experiments
Unfavorable.
Compt. Rend. 155, 63-6 (1912).
Electrochemical explanation of preceding.

- (10) Schneckenberg, E. *Elektrochem Z.* 19, 151-4 (1912).
Kovessi duplicated facts known which apply only to Method IV.
- (11) Gerlach and Erlwein *Elektrochem Z.* 17, 31-6, (66)-8 (1910).
(Method IV.) Experiments at Moehehn. Unfavorable. Engineering details.
- (12) Peaslee, W. D. *J. Elec. Power and Gas* 32, 69-72 (1914).
(Methods I and V.) Favorable under proper conditions.
- (13) Lemstrom, S. *Electricity in Agriculture*, 72 pp. Van Nostrand.
Detailed account of experiments 1886-1903. Favorable. Theory, etc.
- (14) Kuhn, J. *Elektrotech Z.* 31, 380 (1910).
(Method V.) Experiments at Halle, (see also 1). Injurious to some crops, favorable to others. Brief.
- (15) Breslauer, M. *Z. Elektrochem.* 16, 557-9 (1916).
(Method V.) Energy and current required.
- (16) Kahler, K. *Phys. Z.* 9, 258-60 (1908).
Measurement of electrical precipitation.
- (17) Hostermann *Abstract; Elektrotech Z.* 31, 294-5 (1910).
(Method V.) Experiments at Dahlem. Favorable under proper conditions.
- (18) Stahl, W.
Gloede, R. *Elec. World* 58, 1549-50 (1911).
(Method V.) Experiments at Evanston, Ill. Favorable.
- (19) Cook, F. L. *Elec. Review. West. Elect.* 59, 975-6 (1911).
(Method V.) Brief account. Gloede's experiments. Favorable.
- (20) Editorial *Elektrotech Z.* 33, 1108-9 (1912).
(also p. 1260).
(Method V.) Experiments at Prague. Brief. Favorable.
- (21) Escard, J. *Rev. gen. des. Sciences pur. et app.* April 30, 1913.
History and summary. Fundamental Electrical facts and theory.
- Heber, G. *West Elec.* 39, 59 (1902).
(Method IV.) Small scale experiments. Favorable.
- Lodge, O. *Elec. Engr. (L)* 42, 110-14 (1908).
History, brief. Experiments near Gloucester. Favorable.
- Breslauer, M. *Elektrotech Z.* 29, 915-6 (1908).
Brief review of data.
- Clark, T. *Elec. Rev. West. Elec.* 59, 976 (1911).
Improved static machine for electro-culture.
- Guarini, E. *Elec. World* 41, 554-6 (1902).
Review of Lemstrom's work.
- Chouchak *L'Eclairage Electrique* 37, 101-8 (1903).
Review of subject and theory.
- Bose, J. C. *Compt. Rend.* 158, 1907 (1914).
Effect of Method IV upon absorption of ammonium phosphate from solution by live and dead seedlings.
- Berthelot *Compt. Rend.* 131, 772-81 (1900).
Chemical and electrical conditions during silent discharge.
- Lob, W. *Abhand. deut. Bunsen Ges.* 1914.
Abstract; *Elektrotech und Maschinenbau* 32, 640-1 (1914).
Effect of silent and glow discharge upon starch, peptone, etc., solutions. Chemical reactions.
- Elster, J.
Gentel, H. *Ann. Phys.* 2, 425-16 (1900).
Dissipation of electricity into the atmosphere.
- Schneckenberg, E. *Elektrochem Z.* 17, 333-7 (1911).
Elektrochem Z. 18, 5-7 (1911).
Motion of plants and animals in the electric current. Review of literature.
- Waller, A. D. *Proc. Roy Soc.* 67, 129-37 (1900).
Electrical effects of light upon green leaves.
- Green, R. *Phil. Trans. Roy. Soc.* 188, 188.
Action of light on diastase.
- Pollacci, G. *Atti. Inst. Bot.* 2, (No. 11) 7-10 (1905).
Influence of electricity upon carbohydrate formation.
- Bach *Compt. Rend.* 36, 479.
Possible effect of electricity upon formation of formaldehyde from carbon dioxide.
- Euler *Ber. deut. Chem. Ges.* 37, 3415 (1904).
Finds Bach's supposition untrue in experiment.

A SERIES OF ELECTRICAL TESTS MADE IN 1883 AND THEIR INFLUENCE ON MODERN TESTING

By A. L. ROHRER

ELECTRICAL SUPERINTENDENT, SCHENECTADY WORKS, GENERAL ELECTRIC COMPANY

Because of the phenomenally rapid advance that has been made in the development of electrical devices and their applications, it is only natural that our interest is mainly focused on our present activities in the industry and on the future possibilities in the science. Under these conditions it is refreshing to turn and glance backward at the results of a series of tests made about thirty years ago to determine the relative merits of the pioneer engineering work of that period.—EDITOR.

The celebration of the thirtieth anniversary of the 1884 Electrical Exposition (held in Philadelphia, last June, under the auspices of the Franklin Institute), calls to mind some important electrical tests made for the Committee on Scientific and Educational Appliances of the eleventh Cincinnati Industrial Exposition, which was held in 1883.

This committee was headed by the very active Chairman, Professor Wm. L. Dudley, the other members being Messrs. W. A. Collord, Alfred Springer, F. W. Clark, and Joseph H. Feenster—all successful business men. The Committee determined to undertake a series of tests of the efficiency of electric lighting systems and so advertised the situation in its circulars, which were widely distributed. Special premiums were offered for (1) the best system of arc lighting, (2) the best system of incandescent lighting, (3) the best dynamo machine for arc lighting, (4) the best machine for incandescent lighting, (5) the best arc lamp, and (6) the best incandescent lamp.

Professor William L. Dudley selected the jury, which consisted of Dr. T. C. Mendenhall, of Ohio State University, Chairman; Professors H. T. Eddy and Thomas French, Jr., of the University of Cincinnati, and Mr. Walter Laidlaw, Mechanical Engineer, with Lane & Bodley Company, of Cincinnati. This jury, in turn, selected as its assistant Mr. A. L. Rohrer, who was then a student in physics at the Ohio State University. The jury was instructed to make such tests and measurements as seemed desirable and possible under the circumstances, and which would aid in arriving at a verdict upon the relative merits of the different exhibits.

In response to the proposal four systems of electric lighting were entered for competition.

(1) The Thomson-Houston Electric Company submitted a system of arc lighting.

(2) The Edison Company for Isolated Lighting submitted a system of incandescent lighting.

(3) The United States Electric Lighting Company offered a system of arc lighting.

(4) The United States Electric Lighting Company also submitted a system of incandescent lighting.

The exposition opened on September 5, 1883, closed on October 6, and the jury was requested to make its report of the awards one week before the closing date. Several things conspired to make these tests less complete in some respects than was thought desirable by those interested. The time at the disposal of the jury was short, however, which, combined with the fact that the members of the jury were all engaged in professional work and were therefore unable to devote their entire time to the work, had much to do with governing the completeness of the tests. The general plan adopted was to have all the energy that was consumed by the dynamo measured by means of dynamometers, and all the electrical energy in the circuit was to be determined by well-known methods. The energy consumed by the lamps was also to be measured, as was the illuminating power. The measurements were therefore of three kinds:—Dynamometric, electric, and photometric.

It is rather interesting to relate that the dynamometric measurements were determined by the use of the cradle dynamometer, which at that time was a recent invention of Professor C. F. Brackett, of Princeton University, and that was the first time the cradle had been built in practical form (a small model having been built previously by Professor Brackett). The form of this dynamometer is now well known so that even a general description of it is unnecessary.

It is also interesting to relate that the measurements of electrical energy were made by the use of a pair of Sir William Thomson's

graded instruments, the ammeter and the voltmeter. This set of instruments had been imported by the Electric Supply Company of New York especially for the use of the jury, and at that time were known as the only reliable instruments of their kind.

During the tests of the arc-lighting machines, the whole current was taken through the current galvanometer. With the incandescent system, the total current in the circuit sometimes was as much as 175 amperes, so that the jury found it necessary to make use of a shunt, probably the first time a shunt had been used on such a large scale. This shunt was of sufficient capacity and resistance that about one-fifth of the current was taken through the galvanometer.

The photometric measurements presented the most difficult problems for the jury. Even at that time the expression of illuminating power in candles was considered a matter of uncertainty and, as the test was intended to be purely a competitive one, the jury decided to ignore entirely the question of candle-power and confine itself to a comparison of the lamps under consideration. A 16 c-p. lamp was used as a standard and all measurements were made in terms of that.

It is not necessary in this article to go into all of the interesting details with regard to these tests. The jury was working in practically a new field, and there arose many problems which had to be solved. As a result of these tests, a unanimous verdict was agreed upon by the jury, which recommended the following to the Committee on Scientific and Educational Appliances:

(1) To the Edison Company for Isolated Lighting, a silver medal for the intrinsic merit and superior excellence and efficiency of their dynamo-electric machine for incandescent lighting.

(2) To the Thomson-Houston Electric Company, premium of \$500 for intrinsic merit and superior excellence in the following particulars, namely, highest total efficiency, construction of lamp, and control of system.

(3) To the Edison Company for Isolated Lighting, gold medal for the intrinsic merit and superior excellence and high efficiency of their incandescent electric lamp.

(4) To the Thomson-Houston Electric Company a special premium of a gold medal for the intrinsic merit and superior excellence of their lamp for arc lighting in the

following particulars, namely, efficiency and regularity of action.

(5) To the United States Electric Lighting Company, silver medal for the intrinsic merit and superior excellence of their dynamo-electric machine for arc lighting.

(6) To the United States Electric Lighting Company of New York, a premium of \$300 for the intrinsic merit and superior excellence for the second best system of incandescent electric lighting.

(7) To the United States Electric Lighting Company, a premium of \$300 for the intrinsic merit and superior excellence of the second best system of arc lighting.

During the progress of the tests the jury listened to the briefs which were submitted by the representatives of the various companies which had entered their apparatus. It might be interesting to give the names of these gentlemen. The Edison Company for Isolated Lighting was represented by Messrs. John W. Howell and Luther B. Steringer. The Thomson-Houston Electric Company was represented by Professor Elihu Thomson, Mr. S. A. Barton, General Manager, and Mr. E. F. Peck, who was in charge of the exhibit. The United States Electric Lighting Company was represented by Messrs. Curtis, Hine, and one or two others whose names have been forgotten.

A detailed description of the tests made by this jury, and a summary of the results obtained will be found in *Science*, Vol. III, No. 54 (the issue of February 15, 1884). It is very interesting because of the detailed reference to the methods employed in making the tests and because of the fact that, after many years of experiments with various apparatus and methods, it appears that the methods which are now thought most suitable (at least for precision), are in most cases those that were used in these 1883 tests.

For example, the efficiency was determined by the input-output method using a direct means of measuring the power supply. The cradle dynamometer was employed which, in modified form, is what is used today in the standardizing laboratory and which gives very satisfactory results as far as accuracy goes.

During the 31 years which have passed between the time when these tests were made and today, we have passed through a long series of methods, based on the separate determination of "stray power" or loss, in testing

efficiencies. A few years ago some awoke to a realization that we were expending much more time and effort to get at the result by indirection than would be required to go straight to the answer by direct measurements. The fact was also quite strongly brought out at the Convention of the American Institute of Electrical Engineers held in February, 1913, that, even when the extreme amount of detail which is demanded is carefully observed, there are certain "undetermined losses" which are appreciable and which cannot be taken care of now.

In the various discussions covering this point, some strongly contended that what we want to know ultimately is the *efficiency* and that it would be better to go after this directly as we did in some instances with success. Eventually, this point of view will no doubt prevail, although just now it is considered to be not advisable to say much about it on account of the impression that prevails in some quarters that such processes are necessarily much more expensive and require more time than the methods that are now used, namely, the separate determination of the losses.

In other words, the tendency now is to go back to the methods of this 1883 test.

With regard to the electrical measurements, the situation is quite similar. The output was measured in some cases by a shunted ammeter, and the development of this idea has produced the most perfect current measuring instruments which have so far been known.

For a long time after these 1883 tests, attempts were made to produce accurate and convenient instruments for switchboard use, as well as for precision testing, in which the total current was passed through the instrument. With the exception of the Siemens dynamometer and the Kelvin balance, they have all passed into history and, although these instruments can still be classed as the best which were ever produced, they have not remained in use for direct-current measurements on account of their inconvenience.

In reference to the photometric measurements, the incandescent lamp standard was

used. This is now almost exclusively employed as a standard. We have passed through a long series of standards for photometric work, most of which were unheard of after a few years and all of which now have practically been abandoned. One can recall a few of these, such as Methvens standard, the amyl-acetate standard, the pentane standard, the Carcel standard, and others. Outside of a few national physical laboratories and museums none of these will be found at the present time.

With reference to the tests of the galvanometers, standard cells were used. These, of course, were not the perfect Weston cells which we now have available, but were Daniell cells. Working with standard cells found little practical support for many years but now we have completely returned to this apparatus. Potentiometers and improved standard cells are the recognized methods found in the highest class of work. In fact, the desirability is now being considered of making terrestrial magnetic measurements with reference to the standard cells, instead of by the inverse process which was formerly employed. The permanence and sensitivity which can be obtained with modern cells and galvanometer is such that a magnetic needle suspended in a coil of known constants can be used to determine the earth's magnetism by the deflection obtained with much more accuracy than the electromotive force of the cell can be determined from the coil and independent measurements of the earth's magnetic field.

Further comments would serve to bring out the same main point, which is that we are proceeding today along the same broad lines that were laid down in these 1883 tests, and that we have tried almost everything else in the meantime but have returned to these older methods. This is not due to chance development, but can be explained by the fact that those who had this matter in hand at this early date had more than ordinary appreciation of the proper way to attack a problem, that is, directly from the front, to which method we have been compelled to return.

AN X-RAY INSPECTION OF A STEEL CASTING

By DR. WHEELER P. DAVEY

RESEARCH LABORATORY, GENERAL ELECTRIC COMPANY

In the August, 1914, issue of the REVIEW we published an article illustrated with "X-ray" photographs which gave an idea of the extraordinary ability of the Coolidge X-ray tube to successfully penetrate both thin and thick objects. In the following article is described one of the most recent commercial applications of the tube, viz., that of detecting flaws in steel castings. The service that this tube may render in the art of steel founding can easily be realized.—EDITOR.

It has always been true that as soon as a new tool is perfected unsuspected applications of that tool rapidly develop. This has been especially true in the case of the Coolidge X-ray tube. It is planned to publish from time to time results of such special applications as may come within our experience. Possibly the question of observing the "pipe" in a steel ingot by the use of the X-ray, thereby being able to determine just where the ingot should be "cropped" may seem still somewhat removed, at least in so far as commercial applications are concerned. There is no inherent impossibility in the process however. The case now being described is a long step in this direction. It is the object of this article to describe in detail what has already been done in the way of an X-ray examination of a certain steel casting of which suspicion had been aroused as to its homogeneity when in the machine shop.

The original casting was two and one-half inches thick and weighed about a ton. When received at the Schenectady Works of the General Electric Company it had been machined down to approximately the desired shape and thickness. The amount still to be taken from the faces was not more than one-eighth inch and in some places was only one-sixteenth inch, but when this was removed it was found that some small imperfections had been cut into. These extended over an area about five inches long and one and one-half inches wide.

The mechanical department at once chiseled away a part of the surface at this point, and then sent the casting to the Research Laboratory to determine if, by means of an X-ray examination, it might be possible to reveal still other hidden blow holes or imperfections.

A Coolidge tube especially made for use on high voltages was set up in front of that part of the casting where the imperfections had been found. An 8 by 10-inch Seed X-ray plate was mounted immediately behind the

casting and the plate was backed by a large sheet of lead. The distance from the source of X-ray to the plate was 20 inches. The tube was excited by an induction coil with a mercury-turbine interrupter. The current through the tube was 1.25 milli-amperes and the potential across the terminals of the tube corresponded to that sufficient to break down a 15-inch spark gap between needle points. The X-ray plate was exposed two minutes. At the place where the radiograph was taken, the finished casting was about nine-sixteenths of an inch thick. The radiograph obtained is shown in Fig. 2. The casting was then moved eight inches and another radiograph made. In this way a number of exploratory

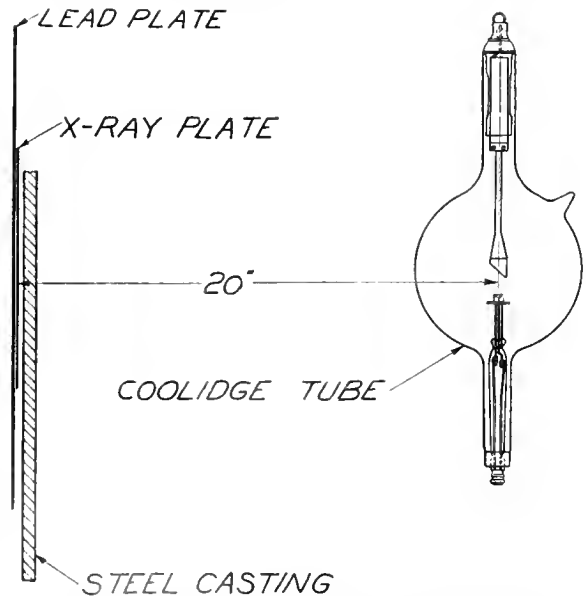


Fig. 1. Diagram of Set-up for Taking Pictures of Steel Casting. Drawn to one-eighth scale

radiographs were taken through different points of the casting.

All the radiographs thus taken showed plainly the tool marks on the surface of the casting. *All but one* showed peculiar markings

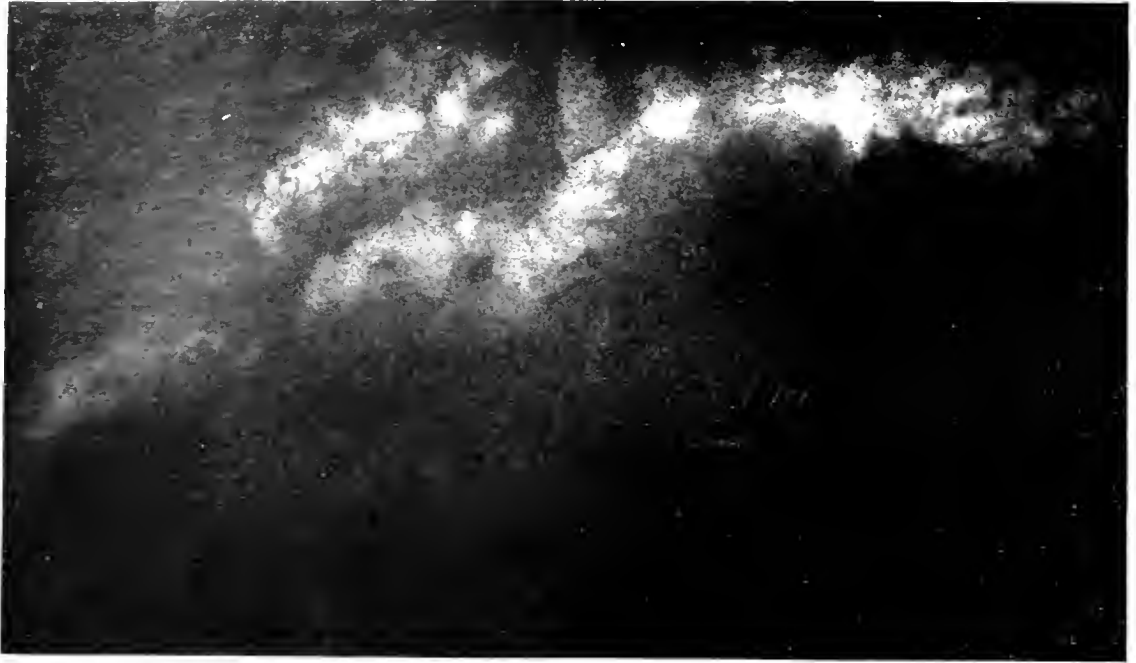


Fig. 2 Radiograph of Steel Casting. Some of the imperfections have been chiseled out of the steel. The chisel marks and some remaining imperfections show plainly.



Fig. 3 Radiograph of Steel Casting showing flaw in center of casting. This flaw was later punched from the casting.

which were of such shape as to strongly suggest that they were indeed the pictures of holes in the interior. In the words of the surgeon it was decided "to confirm the diagnosis by making an exploratory incision."



Fig. 4. Photograph of Top Surface of Casting at place where piece was punched out. Note that no imperfections are visible. The U is a punch mark to identify top of piece cut out

A circular piece, one inch in diameter, was punched from the casting at a point where one of the radiographs indicated that a blow hole should be found. (Location of sample

This has proved, then, that with the proper X-ray exposure blow holes or cavities may be disclosed in apparently solid metal of considerable thickness. A careful comparison of the X-ray photographs and the button photo-



Fig. 5. Photograph of Bottom Surface of Casting at place where piece was cut out. Note that no imperfections are visible at the surface

graphs leads to the conclusion that very small air inclusions are made visible; and the fact that the tool marks are plainly visible on the X-ray plate confirms this fact.



Fig. 6. Photograph of one Edge of Button which was cut from the Casting (see Fig. 3) showing position of hole. Button was $\frac{1}{8}$ inch thick

shown by circle on Fig. 3.) Figs. 4 and 5 show that the surfaces of the casting were entirely free from blow holes at the point where the button was removed. Figs. 6 and 7 show the ends of the hole in the button.



Fig. 7. Photograph of Edge of Button opposite to that shown in Fig. 6

Such studies point to the desirability of great care in metal casting where imperfections, ordinarily invisible, are of great danger, and where X-ray analysis or some other method is not used to check them.

A TRANSMISSION LINE CALCULATOR

BY ROBERT W. ADAMS, E. E.

The transmission line calculator described in this article was developed to simplify the calculation of the voltage drop and power loss in a-c. transmission lines. The author condenses the preliminary work necessary for a graphic solution of vector diagrams and then explains how, by means of the curve and charts published herewith, the succeeding steps necessary to a complete solution are arrived at.—EDITOR.

Perhaps the most tedious problem which confronts the average electrical engineer is the accurate calculation of voltage drop and power loss in alternating-current transmission lines. This calculation is one that frequently has to be repeated several times before the most economical and efficient design is secured, and on this account the orthodox trigonometric method, while not in itself unduly difficult, becomes very laborious in its practical application.

Accordingly, there have been proposed a number of "short-cut" methods, designed to reduce the labor of computing voltage drop in lines of moderate length in which capacity can be neglected; and one of these, the Mershon chart, has been very successful in abbreviating a portion of the process without departing from the strict mathematical solution of the vector diagram. This chart, however, in common with most of the other graphic methods, cannot be applied to a specific problem until a certain amount of arithmetical calculation has been performed, and it is this extra labor which is the most fruitful source of error and delay.

With the idea of shortening this labor and lessening the chance of error, the author has

(1) The first step is the determination of a "Transmission Factor" from the formula:

$$K = \frac{kv-a. \times \text{distance in miles}}{10 \times \text{kilovolts}^2}$$

This formula combines the load kilovolt-amperes, the distance that the power is transmitted in miles, and the pressure in thousands of volts between the wires at the receiver end of the line, in such a way that both decimals and large numbers are avoided and the fraction can frequently be solved by mere inspection.

(2) The second step is the determination of the percentage resistance and reactance components of the line drop (represented

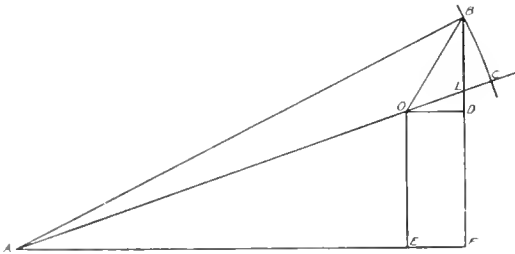


Fig. 1 Diagram Representing the Magnitude and Phase Relation of the Transmission Generated Voltage, Receiver Voltage, and Line-Drop Voltage

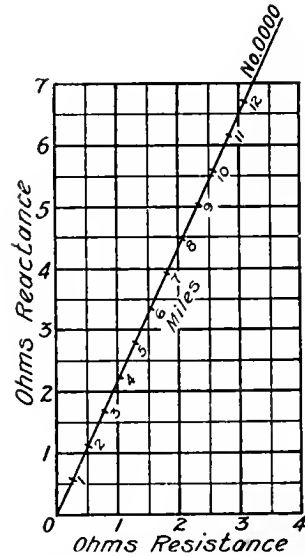


Fig. 2. Curve Sheet Showing the Relation between the Resistance, Reactance, and Length for No. 0000 Wire, for 60 Cycles and 18-Inch Spacing

condensed into two steps the preliminary work necessary to the graphic solution of the vector diagram.

by the base OD and the altitude DB of the line-drop triangle in Fig. 1). This is accomplished by multiplying by K: (a) the resistance in ohms per mile of a single wire of the size selected, (b) the reactance in

ohms per mile of this wire at the given frequency and spacing of conductors.

When the per cent resistance and reactance drops have been determined in this manner, they can be applied to the Mershon chart or used in the trigonometric

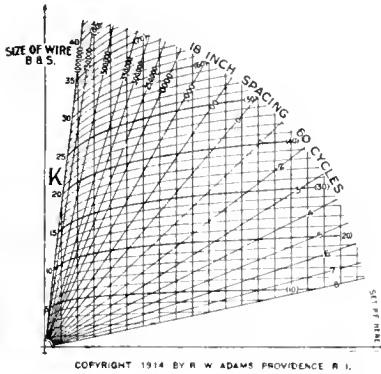


Fig. 3. A Chart from which the Transmission Factor *K* may be obtained for Various Wires at 18-Inch Spacing and 60 Cycles

solution of the line-drop diagram (it being noted that they refer to three-phase work and are to be multiplied by two if the circuit is single-phase).

In order to express graphically the whole simplified method just outlined, the author has constructed a calculating device that

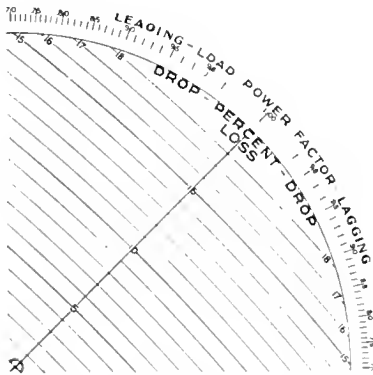


Fig. 4. A Transparent Chart, which when Superimposed on the Chart of Fig. 3 with due Respect to Power-Factor, Indicates the Line-Drop in Per Cent of Receiver Voltage

As the computing scale requires no special explanation, we may proceed to describe the evolution of the wire diagram.

Considering first a single No. 0000, B.&S. copper wire at 60 cycles and 18-inch spacing, we find that it has a definite resistance and reactance for a given length in miles, as shown in Fig. 2. For instance, a ten-mile length has a resistance of 2.6 ohms and a reactance of 5.6 ohms, as indicated by the heavy triangle.

This triangle corresponds in shape to the line-drop triangle of the vector diagram, and can be converted into such a triangle by multiplying the three sides by a factor which takes proper account of the nature of the load.

The three sides then become:

$$\frac{\text{Ohms resistance} \times \sqrt{3} \times \text{three-phase current} \times 100}{\text{receiver voltage}} = \text{per cent resistance drop.}$$

$$\frac{\text{Ohms reactance} \times \sqrt{3} \times \text{three-phase current} \times 100}{\text{receiver voltage}} = \text{per cent reactance drop.}$$

$$\frac{\text{Miles} \times \sqrt{3} \times \text{three-phase current} \times 100}{\text{receiver voltage}} = K.$$

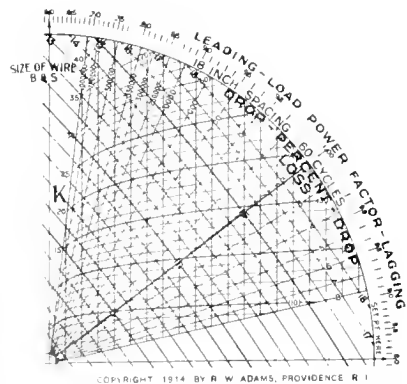


Fig. 5. An Illustration of a Setting of the Chart of Fig. 4 Superimposed on that of Fig. 3

consists of a circular slide-rule scale for computing the value of *K*, together with a wire diagram for locating the apex of the line-drop triangle, and a transparent chart to indicate the actual drop in per cent of the receiver voltage.

It follows that for any given value of *K* (as previously determined for the given load by means of the computing scale), there is a corresponding point on the sloping line for No. 0000 wire which locates the apex of the per cent line-drop triangle representing the

effect of this load on a circuit of this wire. Similar sloping lines can be drawn for the other sizes of wire and the corresponding points can be connected up to form curves,

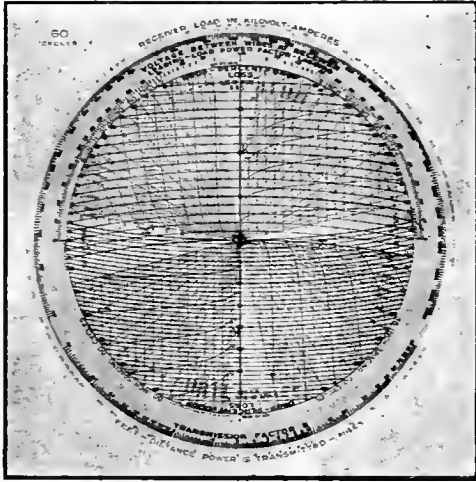


Fig. 6. A Photograph of a Page of the Calculator showing the Curves which were illustrated in part in Figs. 3, 4 and 5

by means of which the apex of the line-drop triangle can readily be determined for any value of K .

The result is shown in Fig. 3, which is a reduced view of one quadrant of the stationary diagram of the Transmission Line Calculator. The resistance and reactance scales are omitted from the final diagram, as they are not essential to the practical working of the device.

We can now, by means of K , locate on the diagram the apex of any line-drop triangle, and it remains to make use of this graphically with due reference to the power-factor of the load so as to indicate the true percentage drop in the transmission line. In other words, referring again to Fig. 1, we have the point B and wish to know the distance OC , which is determined in the figure by the arc BC ,

drawn with its center at A and intersecting AO prolonged.

In order to reproduce this arc graphically we construct a transparent chart consisting of a series of percentage arcs drawn from a common center A , and pivot this chart at the lower left-hand corner of the wire diagram.

This chart, a portion of which is shown in Fig. 4, is furnished with a central reference line which corresponds to OC and which can be set at any angle to the base line of the diagram by means of a suitable power-factor scale.

When the transparent chart has been set in this manner to correspond with the load power-factor, as shown in Fig. 5, and the apex of the line-drop triangle has been located for the given circuit conditions as previously explained, we have only to find the arc nearest this apex and follow this arc to the graduated reference line of the chart. There the true line drop, corresponding to the distance OC , can be read directly in per cent of the receiver (or load) voltage.

If, instead of following the arc as outlined above, we follow the nearest vertical line of the diagram to the reference line of the chart, we can there read the power loss in the circuit, expressed in per cent of the delivered power. This appears in Fig. 1 as the distance OL , which obviously bears the same ratio to the line AO , representing 100 per cent, as the resistance drop OD bears to the power component AE of the load voltage.

We can, therefore, by means of this wire diagram and transparent chart, determine the line drop and power loss correctly for any circuit of 18-inch spacing at 60 cycles; and, by constructing similar diagrams for other common spacings and frequencies, we can expand the range of the device so as to include the whole field of transmission and distribution at moderate voltages.

The result appears in Fig. 6, which shows a complete page of the Transmission Line Calculator as arranged for four standard spacings at 60 cycles. It is equipped with a transparent chart which is in the form of a disk having at its edge a circular slide-rule for computing the value of K for any given load, voltage, and distance of transmission.

SOME NOTES ON MAGNETIZATION CURVES

BY JOHN D. BALL

CONSULTING ENGINEERING DEPARTMENT, GENERAL ELECTRIC COMPANY

The study of magnetics is one which in the past has received a large amount of attention. In recent years, however, its necessity for successful electrical design has become more and more realized; and, as a result, we are rapidly gaining additional information from day to day which is making itself apparent in the manufacture and characteristics of the machines now placed on the market. The following group of three short articles contains ideas that will similarly prove to be a valuable addition to our knowledge of magnetization curves.—EDITOR.

I. EXTRAPOLATION OF MAGNETIZATION CURVES

For designing machines and for various other purposes, it is often necessary to know the values of magnetization for higher induction than is usually given by test which, with the ordinary apparatus employed for testing magnetic material, is usually limited to an upper range of values of magnetization forces of from 200 to 400 gilberts. Obtaining higher values therefore involves special testing apparatus (attended with considerable cost and care in making the determinations) or the extrapolation of the curves obtained in the ordinary way.

Because of the nature of the magnetization curve, direct extrapolation is difficult and, for a given induction, the value of the magnetization taken from such an extrapolated curve is likely to be in considerable error. A rational extension to the curve may be made, however, by means of the equation that is found by the use of the reluctivity curve, which is the reciprocal of the permeability plotted against H . Such a curve approximates a straight line over a wide range of values as has been described elsewhere.*

The reluctivity, ρ , has been expressed by the equation $\rho = \alpha + \sigma H$, wherein α is a constant representing the distance from the X -axis to the intercept of the $\rho-H$ curve if continued along the straight line and σ a constant representing the slope of the line. Therefore, the induction

$$\beta = \frac{H}{\rho} \text{ or } \frac{H}{\alpha + \sigma H} \tag{1}$$

This is approximately true within the range of ordinary test when the total β of the magnetic material and of the air are taken together and also when the metallic density β_0 which is equal to $\beta - H$ is considered. The true or metallic reluctivity

$$\rho_0 = \alpha_0 + \sigma_0 H \tag{2}$$

wherein α_0 and σ_0 are constants, calculated on the basis of metallic density, and in consequence differ slightly from α and σ .

Fig. 1 gives magnetization, permeability, and reluctivity curves for sheet steel plotted from the data given in Table I.

It will be noted that β and β_0 are practically identical up to $H=10$ and differ but slightly at $H=200$. Taking values of H and ρ from $H=50$ to $H=200$ as representing

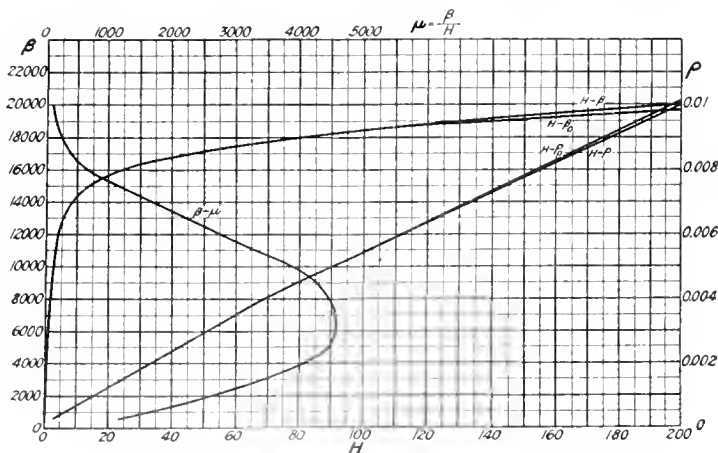


Fig. 1. Curves of Magnetization, Permeability, and Reluctivity for sheet steel plotted from the data furnished in Table I

the straight line, we obtain by the $\Sigma\Delta$ method† the equations:

$$\rho = 0.00058 + 0.0000475 H$$

$$\beta = 0.00058 + 0.0000475 H$$

* Trans. A.I.E.E., Vol. VIII, p. 485 et. seq.
 † "Engineering Mathematics," Steinmetz, Ed. 1911, p. 294.
 GENERAL ELECTRIC REVIEW, Vol. XVI, 1913, p. 750

† "Engineering Mathematics," Steinmetz, Chapter VI.

$$\rho_0 = 0.00062 + 0.0000479 H$$

$$\beta_0 = \frac{H}{0.00062 + 0.0000479 H}$$

These equations show close agreement between ρ and ρ_0 .

Theoretical considerations prove that the use of ρ_0 is much better, as the curve representing $\rho_0 - H$ may persist as a straight line; whereas the curve $\rho - H$ must continually bend downwards and have the curve $\rho = 1$ as its asymptote (otherwise it would show the material to become diamagnetic at very high inductions and eventually possess infinite reluctance or zero permeability, which cases could only be true if metallic densities are considered).

When obtaining extrapolations of the $\beta - H$ curve, by the means outlined above, (as β and not β_0 is desired in the curves used for design purposes), it might be a temptation to use equation (1), but if such is done, we would become involved in considerable incon-

sistencies. Therefore, when extensions of the $\beta - H$ curve are desired, it is necessary to use the equations of β_0 and to add to the results obtained the values of H , which gives the equation:

$$\beta = \frac{H}{\alpha_0 + \sigma_0 H} + H \tag{3}$$

A study of the equations will readily show the advisability of using the latter equation. When high values are reached α or α_0 becomes negligible and the equation becomes

$$\beta = \frac{1}{\sigma},$$

which is to the effect that a final value

of saturation is reached which, in amount, is the reciprocal of the slope of the $\rho - H$ curve. As a matter of fact β does not represent an absolute saturation value as, after the material is saturated, β continues to increase by the same amount as the increase in H .

Fig. 2 gives curves showing the plotted results of Table II. These data were calculated by equations (1) and (3).

TABLE I

H	β	$\beta_0 = \beta - H$	$\rho = \frac{H}{\beta}$	$\rho_0 = \frac{H}{\beta_0}$	$\mu = \frac{\beta}{H}$
200	19,960	19,760	0.01002	0.01012	99.8
150	19,240	19,090	0.00780	0.00786	128.2
100	18,390	18,290	0.00544	0.00546	183.9
50	17,130	17,080	0.00292	0.00293	342.6
30	16,390	16,360	0.00183	0.00183	646.3
10	14,500	14,500	0.00069	0.00069	1,450.0
5	12,540		0.00040		2,508.0
3	10,620		0.00028		3,540.0
2	8,700		0.00023		4,350.0
1.5	6,900		0.000217		4,600.0
1.25	5,810		0.000215		4,645.0
1.0	4,260		0.000235		4,260.0
0.75	2,060		0.000364		2,750.0
0.5	590		0.00085		1,180.0

TABLE II

H	β	$\beta = \beta_0 + H$ Results for β obtained by equation (3)	β Results for β obtained by equation (1)	Difference	Per Cent Difference
500	20,400	20,900	20,500	400	1.9
1,000	20,650	21,650	20,800	850	3.9
1,500	20,700	22,200	20,900	1,300	5.9
2,000	20,800	22,800	20,900	1,900	8.3
3,000	20,800	23,800	20,950	2,850	11.9
5,000	20,820	25,820	21,000	4,820	18.6
10,000	20,820	30,820	21,000	9,820	31.8

It will be noted that the per cent error in β at $H=10,000$ is not large, but that if the errors of H at a given value of β were considered, the errors become enormous.

Conclusion

In extrapolations of magnetization curves the equation $\beta = \frac{H}{\alpha + \sigma H}$ introduces large errors. It is necessary to use $\beta = \frac{H}{\alpha_0 + \sigma_0 H} + H$ or some other form that provides for the metallic density to which the H values are added.

II. SO-CALLED "KNEES" OF THE MAGNETIZATION CURVES

When discussing magnetization curves we frequently hear statements that machines are designed at inductions which are defined with reference to the "knee" of the saturation or magnetization curve. As example: In such and such an apparatus the flux density should be below the "knee," in a certain magnet the design is to have the flux density well on or above the "knee," or the "knee" of the curve for a certain magnetic material occurs at a certain density.

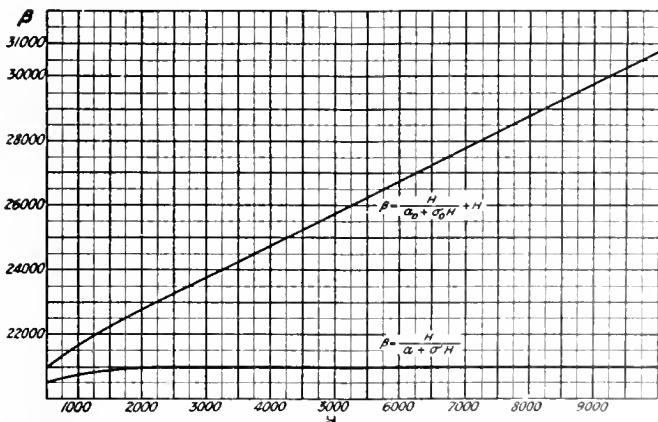


Fig. 2. Extrapolations of Magnetization Curve plotted from the calculated results of Table II

enon, but is largely a function of the scale selected to represent the magnetizing forces. This fact may be illustrated by reference to Fig. 3. The data from which these curves

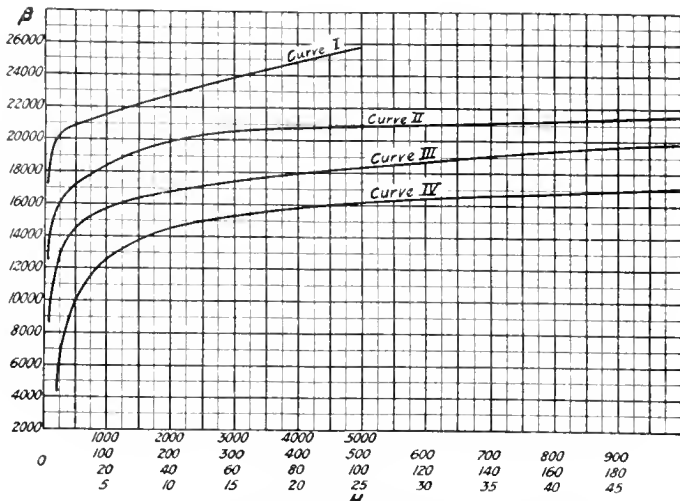


Fig. 3. Successive Portions, plotted to differing scales, of a single Magnetization Curve. Note the startling fact that the "knee" appears to be located at different β and H values

were plotted will be found in Tables I and II of Section I of the present article. A glance at Fig. 3 will readily show that the point of maximum curvature (which is usually the interpretation of the "knee"), occurs at different densities on the different curves, which are all plotted from the same data, and differ only in that different scales for H are employed.

The "knee," if derived from these curves, would be in the vicinities of the following values:

Curve No.	Flux Density at "Knee"
1	20,500
2	16,500
3	14,500
4	12,500

Fig. 4 shows the second curve of Fig. 3 taken alone in which the above induction values are emphasized by small circles. Fig. 4 shows there are no evidences in this case of bends which are shown by plotting to the other three scales. Referring to Fig. 5 and Fig. 6, wherein the data are plotted on logarithmic and semi-logarithmic paper re-

This conception of matters has beyond a doubt led into many errors and uneconomical designs due to the fact that this so-called "knee" is not entirely a magnetic phenom-

spectively, we have curves in which equal percentage of increase of H gives equal abscissae. Here we have no evidences of "knees" at points in the above tabulation, which further proves the point. The top curve of Fig. 3 is steeper at the high inductions than the other three, due to the fact that the iron is saturated and the increase of β is mostly due to the air.

The above discussion applies to related curves, as for example, wherein line voltage of machines is plotted against field current, etc.

The conclusion is that the so-called "knee" of the curve is a mechanical bend, the position of which is due largely to the scale selected. This fact should be carefully considered when interpreting curves of this nature.

III. MAGNETIZATION CURVES PLOTTED ON LOGARITHMIC PAPER

Owing to the shape of the regular $\beta-H$ curves used for design purposes, the curves are usually divided and plotted to several scales to facilitate clearness. If this is not done it is difficult to determine β values at low values of H up to the mechanical bend, or so-called "knee," unless results are calculated from a permeability curve. It is likewise difficult to determine values of H at high values of β . Several scales are likely to lead to confusion and the number of changes of scale is thus limited. If only one scale be used, we have a typical curve such as shown in Fig. 4. This figure is drawn from data in Tables I and II in Section I of this article.

It is desirable to select a method of drawing magnetization curves which

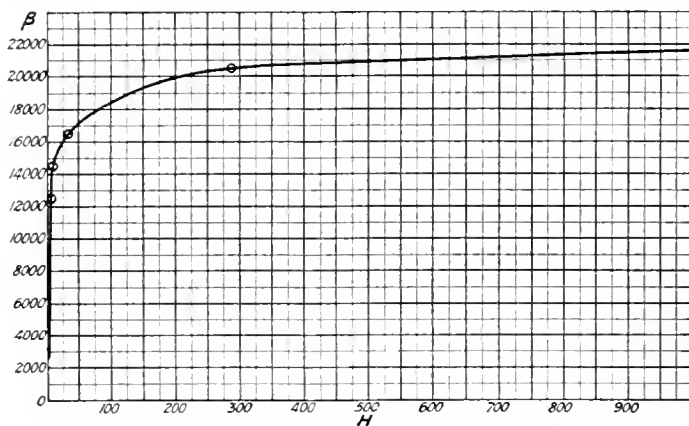


Fig. 4. The Complete Magnetization Curve shown in parts in Fig. 3. The circles indicate the locations at which the "knee" occurs if curve was drawn to each of the scales used in Fig. 3

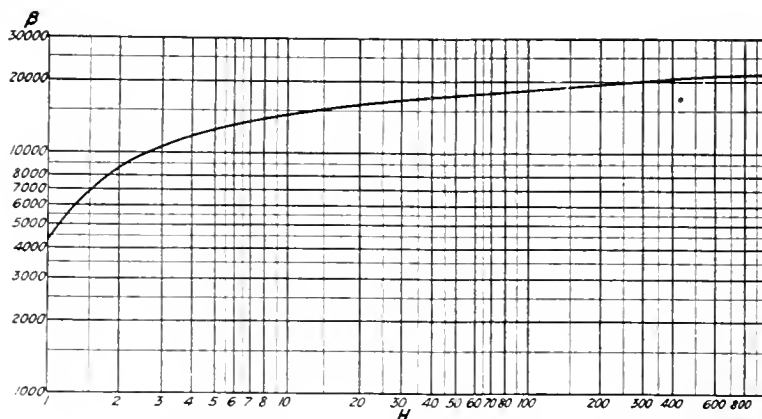


Fig. 5. A Magnetization Curve plotted on paper having logarithmic abscissa and ordinate scales (same values of β and H used as in Fig. 4)

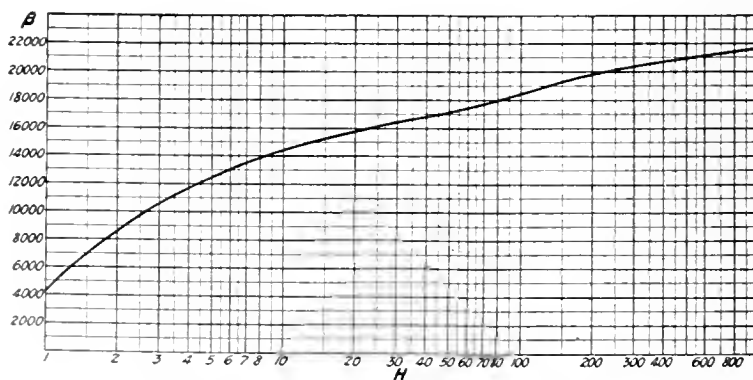


Fig. 6. A Magnetization Curve plotted on paper having a logarithmic abscissa scale and a uniform ordinate scale (same values of β and H used as in Figs. 4 and 5)

will give a wide scale for H at low values, and which will cause the scale to be contracted at high values. On general principles, it is also desirable to obtain a curve having a general slope of approximately 45 deg.

A method of obtaining such a curve as above outlined would be to plot the data on logarithmic paper. Such paper is on the market and is easily obtained. On such paper the vertical and horizontal scales are both divided according to logarithmic progression. Plotting the data of Fig. 4 on such paper gives the curve shown in Fig. 5. This draws out the H scale in an excellent manner but the arrangement is poor considering the ordinates, as at high values of β the scale is contracted and at low values it is needlessly exaggerated. A better scheme for plotting such a curve is to use paper with a logarithmic scale for the abscissae and a straight, or even-division scale, for the ordinates. The data of Fig. 4

so plotted are shown in Fig. 6. This gives a very desirable H scale and a very good scale for β . It also gives a good mechanical slope. Paper of this ruling possesses a great advantage in that any desirable scale may be used for ordinates, whereas for a logarithmic scale *in both directions*, the choice is much restricted. Considering Fig. 5 we have a single very readable curve. The knee of the saturation curve is not so pronounced in this case as when plotted on regular even-division paper, but this constitutes a further change in favor of the logarithmic paper because, as has been shown in Section II of the present article, the knee is not in reality a definite point as its location depends upon the scale employed when plotting the curve. Fig. 6 contains three blocks of abscissae. An additional block either way would give either a very wide H scale at low values or a very contracted one at high values, which is in accordance with what is desirable.

THE APPRENTICE SYSTEM AT THE LYNN WORKS OF THE GENERAL ELECTRIC COMPANY

By THEODORE BODDE

The advantage accruing from the employment of specially trained men is fully realized by most large manufacturers, and the results in improved products and more efficient service from such employees have led many concerns to introduce the so-called apprenticeship course, which is simply a school for the education of the workmen in the fundamentals, theoretical and practical, on which a particular industry is built. The essentials of such a course are outlined in this article.—EDITOR.

In a large factory building belonging to the General Electric Company, at West Lynn, Massachusetts, there exists a unique school of practical electrical and general technical knowledge; unique, because it combines and mingles intimately the practical factory atmosphere with the theoretical ether of science.

This educational institution, commonly called an apprentice system, gives practical instruction through factory work and theoretical knowledge through class room lectures. The class room work is so arranged as to occupy slightly less time in years than the practical work. If a student therefore fails to pass in one of the classes and is obliged to repeat it, he can still finish all classroom work within the prescribed time limit of apprenticeship.

The educational institution provides as well for young men with no more than a grammar school education as for high school graduates. The grammar school graduates are placed in the so-called apprentice school, while the high school graduates enter the engineering school. They are selected out of a large number of applicants.

In the apprentice school, the young men are developed into efficient skilled workmen,

assistant foremen and foremen, and tool designers. In the engineering school they are converted into efficient practical engineers.

The classroom work of the apprentice school stretches out over a period of nine terms of 14 weeks each. That of the engineering school covers a period of seven terms of 14 weeks each. There are three terms in each school year.

The teaching staff consists of six instructors and one superintendent.

The above outlines in a general way the system of this technical school. We will now consider some of the different principles and methods which are followed in the electrical department, in order to give a general idea of the system.

To the apprentices one term of electricity is given, while to the students of the engineering school five terms of electricity are allowed.

The first principle followed, for the purpose of effectually impressing the mind of the young man, is that of concrete representation of the different truths which are taught him. The reason for this lies in the fact that these young men have generally left school at an early age. Consequently, theory and its demands on the imagination are almost

unknown to them and the imagination has not been trained to its full strength. On the other hand, having been in contact with matter and material things during the greater part of their lives, they can, with no difficulty whatever, see through material things and material representations, where they would be powerless were those representations only abstract ones. Therefore, it is through this concrete method of representing things that one must appeal to them.

Technical education consists in impressing on the mind the relations between natural phenomena; in other words, in leading the pupil to discover the links connecting different facts. In popular language this discovery is expressed by the saying: "I see," which means nothing else than "I see the link; I understand;" for when we see a thing we understand it. Now if this connecting link can be made visible by means of really visible things, instead of by things which are only visible through an effort of the imagination, we shall be able to make all things understandable to those whose imagination is not strong enough for that effort, and technical education for the masses will become possible.

It is true that education consists also in training that very effort of the imagination which is needed for the concentration of the mind. It is this branch of education which produces thinkers. It produces, however, perfect fruit only when applied to the very few who have a natural aptitude for thinking. The large mass take up only facts and relations and become effective tools, but very few among them become thinkers and leaders. In our present civilization it is well that this should be so. At the same time we may long for some future in the advancing ages when this condition will no longer be necessary, and everybody will be trained for the beauty and development of himself and of the race.

At present, the world needs many tools for its material growth, and the General Electric Company, which is itself a small world, daily feels the need for efficient tools, and all efforts are exerted in this direction. If, now and then, thinkers are mixed among the tools, they will be recognized sooner or later, and will step out of the mass through their own efforts. Hence, for the present, the methods of education should not be molded for them but for the large masses. Neither should the methods of education be molded for the other extreme, the dummy. In the General Electric apprentice and engineering school, the dummies are eliminated while passing from the

lower classes to the higher ones. This is done by a simple weeding out process, through keeping a close observation and a just record of their doings and progress throughout each term. An educational committee meets every week and carefully eliminates the chaff from the wheat, the result being that the higher classes are very nearly perfect.

The following are some examples of the concrete representation of things as applied in the electrical engineering department of this school:

Throughout the first term, the text book of W. H. Timbie, "Essentials of Electricity," is used. The beginners have special trouble in grasping the idea of line drop in transmission lines and other similar very real and important phenomena in power transmission. The reason is obvious. Transmission lines are so large that they have never been grasped in their entirety in the imagination of the student; they are too long to be contained in the narrow space of his vision. In order to overcome this difficulty, a miniature transmission line was made, reproducing in every way the phenomena of a large power transmission. The lines are made of thin resistance wire and are stretched across the whole length of two blackboards which run along the wall of the classroom. A set of incandescent lamps at about the middle of the line produces one load, and another set of lamps at the end of the line produces another load there. The beginning of the wires are switched to two binding posts, between which are 275 volts d-c. By varying the number of lamps, different loads are put on the line at different points, thus producing different currents and different line drops in the sections of the line. These values are measured in a direct way by the students. This gives them practice in the manipulation of d-c. voltmeters and ammeters. The readings are then written down in chalk directly over the corresponding sections on the blackboard. From these results, calculations are made relating to power loss in the different sections of the line, voltage on the loads, power delivered to the loads, total power transmitted, etc. All these calculations, written down again on the blackboard over the corresponding part, are then finally checked up by means of direct measurements.

The three-wire balanced and unbalanced systems are also reproduced in miniature by the same means, and the general run—first measurements, then calculations, and at last checking up by other measurements—essentially the same as before.

It is remarkable what good results this method of teaching has produced.

In a latter part of the term the d-c. generator and motor phenomena are illustrated by means of an old fashioned bipolar shunt wound dynamo which has been fixed for the purpose and provided with a flywheel. This makes possible the illustration of the counter-electromotive force which exists in a running motor. Suppose the dynamo has been connected up at the end of the above described miniature transmission line, and runs as a motor. A set of lamps on the same transmission line shows its bright lights as a result of the power which it takes from the same source. If now the double-pole switch between the binding post and the transmission lines is suddenly opened, the motor, because of the inertia of its flywheel, will become a generator, and the lamps will still show their bright lights, this time, however, taking their power from the dynamo side; for the current on that side is reversed, as is clearly shown by means of an ammeter. The voltage on the line can be measured at the instant that the double-pole switch is opened, which serves to illustrate in a clear and real way the counter-electromotive force which existed an instant before while the dynamo was still running as a motor.

Thus the student becomes familiar with all the secrets of the dynamo. Even this counter-electromotive force, so often the stumbling block to beginners, becomes visible, almost palpable to them, and impresses itself on their minds. The measurements of voltage and currents, in relation to the speeds through which the flywheel passes, are then written down, calculations are made and again experimentally verified, and it is thus that the different phenomena enter into the mind almost without effort; for the student is interested in these different operations from start to finish, and is not tired out by an undue effort of the imagination. The channels between his senses and his mind are wide open, and the knowledge enters without effort.

During the second term of electricity, Swoope's textbook, "Lessons in Practical Electricity," is used. This textbook is rich in material, and in this lies its great merit, for it offers many topics to be treated and talked about in the classroom. It describes many experiments, and to follow these descriptions requires a certain amount of the student's imagination. It is to be noticed again that the student of the engineering school is a high school graduate and has had

his imagination trained originally to a greater extent than has the average apprentice. As the time is limited, considering the large scope of the book, this term is mainly devoted to theory, though here and there concrete illustrations are made if the described experiments of the book do not convey the fact clearly enough to the mind.

The third term of electricity is devoted entirely to experiments and laboratory work. Large d-c. and a-c. dynamos and the necessary instruments are put into the student's hands, and under the direction of their instructor they make the usual practical tests relating to voltage, speed, load, losses and efficiency. It is surprising how quickly the students get hold of this term's work and of the right way of doing things. Their enthusiasm and pleasure in the work is very visible in the neatness with which they make up their reports. Some of these are almost pieces of art, so carefully are the sketches drawn and the curves traced.

After this term of heavy practical work, the student goes back again to pure theory. Two terms of advanced electricity along the lines of Franklin & Esty's textbook of electrical engineering now follow. During this time the student has ample occasion to verify and think theoretically over the different points and phenomena which have come up during the former term, and thus the last foundation stone of electrical knowledge is deposited in his brain.

The classroom in which the student gets these advanced courses of electrical engineering is in the laboratory, so that the whole atmosphere is impregnated with the practical developments of the great industry. Dynamos, rheostats, and all kinds of motors look at him from all sides while he ponders over some intricate problem, and like real friends suggest ideas to him. The walls carry charts illustrating such useful rules as the famous Fleming's three-finger rules for motor and generator directions, and the unconscious daily look at these charts produces on the student's mind a lasting impression, in the same way as in daily life the advertising poster impresses the public mind. If there is any formula, any figure, difficult yet useful to remember, there is no better and easier way of mastering it in one's memory than by posting it in some conspicuous place to which the eye is turned every day. These repeated impressions will leave their mark without requiring any acrobatic effort of the brain.

RADIOTELEPHONY

By W. C. WHITE

RESEARCH LABORATORY, GENERAL ELECTRIC COMPANY

Radio communication, the term recently adopted by the profession in lieu of the popular but inappropriate word "wireless" can be divided into two general classes—telegraphy and telephony. During the past ten years or more many experiments in radiotelephony have been recorded, but communication by this means has never enjoyed the practical or commercial applications that are common to radiotelegraphy. This article describes the principles involved in radiotelephony, and the difficulties encountered which have so far kept it more or less in the experimental stage.—EDITOR.

Introduction

Shortly after radiotelegraphy had become an accomplished fact, radiotelephony was proposed and experiments undertaken along that line. The fact that apparatus was at hand by which the voice could be made to give a variable form of electric current and apparatus by which this form of current could be made to reproduce the original voice made the problem seem simple in comparison with the original development of the telephone.

In order to understand the problems of radiotelephony and why it has made so much slower progress than radiotelegraphy, it is necessary to review some of the principles involved in radiotransmission in general.

Fundamentally, what happens in radiotransmission is that a certain amount of energy is generated and liberated at the transmitter, from which it radiates more or less in every direction, and a very minute portion of it is intercepted at the receiving station where it energizes the receiving apparatus. This is therefore a transfer of energy and as such requires a medium.

It has been shown that light and radio-waves are similar phenomena in this medium which we call the ether. Now as to how these radio or electromagnetic-waves are set up in the ether, a rough analogy will help to make the theory clear. Imagine a paddle dipped vertically into a body of water; if this is moved very slowly back and forth water will merely flow from the volume in front of the advancing paddle around the edges to the space just vacated. Floating corks arranged in a circle about the paddle and at a radius of several feet away would not show any movement, proving that all the energy used in moving the paddle was expended as friction at its surface or in eddies or currents set up in the immediate vicinity.

Now suppose the frequency of the back and forth motion is increased. Common experience tells us that waves will be set up which become appreciable after a certain frequency of motion has been passed. Bodies

floating in the water at a distance will be moved up and down (even against an applied friction) as the waves pass them, showing that in the case of the rapidly swinging paddle its energy is used up in two ways; in the first place, as friction, as already mentioned and, in the second, by waves which transfer the energy through the medium away from the source until it sets some mass swinging whose friction dissipates the energy transmitted. Naturally, if one wishes to make short length waves a small paddle would be moved rapidly, and for long wave lengths a large paddle moved slowly.

In order for a medium to transfer energy away from a source by wave motion, it must have inertia; and of the tangible mediums with which we are familiar, the less their density the higher the rate of vibration must be before an appreciable portion of energy leaves the source by means of wave-motion radiation.

Returning now to electromagnetic-waves: If a straight conductor in space is carrying an alternating current at 60 cycles frequency, the only loss we could measure would be that due to its resistance. It is true, of course, that if a conductor of a second closed circuit were to parallel the first conductor, a current would be induced in the former which would consume energy. This is due to a magnetic field about the first conductor which may be said to grow from and collapse upon its source twice each cycle, but never traveling away from it continuously.

If a conductor carries a current at say 100,000 cycles, energy in the form of electromagnetic-waves will leave it and travel away with the velocity of light, and, if these waves intercept another circuit, a current of 100,000 cycles frequency will there be set up. The amplitude of these waves decreases as the distance from the source increases; and experience shows that a certain loss of energy occurs as the waves travel in space, due, undoubtedly, to atmospheric conditions, which loss is termed "absorption."

It is not to be inferred from these arguments that there is any theoretical reason why water waves or electromagnetic-waves of very low frequency cannot be produced. For instance, a huge barrier 1000 miles long moved through an amplitude of, say 1000 miles, in the middle of the Pacific ocean with a swing once a day, would set up waves of enormous power, probably causing a tidal flood on the shores of the ocean.

In a similar way, a huge electrical capacity in the transmitting radiating circuit, charged at an enormously high potential, would radiate waves at a frequency of 60 cycles. It is impractical, however, to construct an aerial radiating system of sufficient capacity, and corona losses prevent the utilization of a high enough voltage.

The simplest and most commonly employed method of obtaining high-frequency currents is by spark excitation. A weight suspended by a spring will have a natural period of vibration, depending upon the stiffness of the spring and the mass of the attached body. It will take up this frequency of vibration when struck an upward or downward blow and continue its oscillations for some time. In an analogous way an electrical circuit having inductance and capacity will have a high-frequency electric current set up in it when its circuit is completed by a spark which allows readjustment of the charge stored in it.

As mentioned, a high-frequency current is set up in the circuit of the distant receiver, due to the aerial wires (these intercepting the electromagnetic-waves from the transmitter). As these currents are minute, the most sensitive form of current indicator must be employed.

In order to get an idea of the magnitude of the currents and the amount of energy involved, a few quantitative examples will be given. The radiating circuit of a radio-transmitter is said to have a certain number of ohms resistance which may be defined as that quantity which when multiplied by the square of the current in amperes gives as a product the number of watts dissipated. A large station designed to transmit a distance of 1000 miles or more may use 75 amperes in a circuit of 8 ohms so-called antenna resistance.

In a receiving station 2000 miles away, having a resistance of 25 ohms in its receiving circuit and apparatus, a current as high as 50 microamperes may be set up, which means about 6×10^{-3} watts. When we consider the

distances, this current seems large; the pointer of the usual type of sensitive, portable, direct-current voltmeter will give about a one millimeter movement with such a value of direct current. It is to be remembered, however, that in the receiver circuit the capacity and inductance are adjusted for resonance for the incoming frequency, so that in order to realize this amount of current in any indicating device, its resistance must be very low.

Now for direct currents the d'Arsonval galvanometer principle, such as employed in most direct-current indicating instruments, is the most practical form of sensitive current indicator. For alternating currents of frequencies of about 150 to 2000 cycles, the Bell telephone receiver is most sensitive and simple. A good telephone receiver is responsive to one-tenth of one microampere alternating current at a frequency of 500 cycles.

The currents induced in the receiving circuit, from a transmitter generating its oscillations by spark discharges as mentioned, consist of groups of very high frequency current coming at intervals determined by the rate of spark discharge.

It is evident, then, that in the receiving circuit some device must be utilized which will respond to the minute high-frequency currents set up, or they must be transformed into a form of current to which a galvanometer or telephone is adapted.

This latter method is most commonly employed, several rectifying devices being available which change the high-frequency groups more or less perfectly into a half-wave alternating current having the same frequency as the spark intervals at the transmitter. Such a form of current will actuate a galvanometer or give response in a telephone, the latter being ordinarily used because of greater convenience and speed of operation. In practice, the sparks at the transmitter are made to occur at rapid and regular intervals, so that a fairly pure musical note is heard in the receiving telephone.

Different spark frequencies will produce corresponding tones in the receiving telephones. This really illustrates the fundamental principle of a radiotelephone transmitter, viz., the radiating of high-frequency electromagnetic-waves in groups corresponding to the tone to be transmitted.

Modifications Necessary for Telephony

In order that the voice may be reproduced in an ordinary Bell telephone receiver, a

current must be passed through its winding which has an alternating-current component corresponding in frequency and wave shape to the fundamental and overtones in the voice, and in amplitude to its loudness.

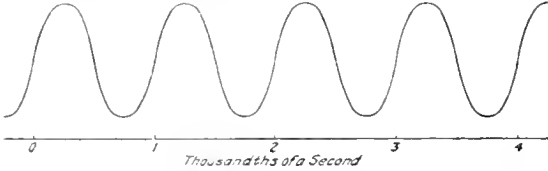


Fig. 1. A Series of Direct-Current Waves which are made up of a 1000-Cycle Alternating Current and a Continuous Current

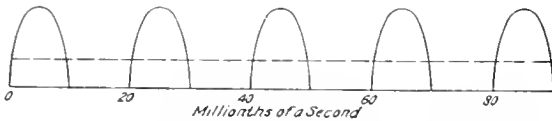


Fig. 2. An illustration of a Rectified 50,000-Cycle Alternating Current. The dotted line indicates the average of the instantaneous peak values

Now, if in a receiving circuit as described a continuous high-frequency current were induced in the aerial circuit, instead of in groups periodically by the spark transmitter, a direct current would flow through the telephone receiver pulsating at a frequency far too high to hear, the effect being identical to that of a continuous current.

The alternating-current component necessary to reproduce speech may be obtained by varying the amplitude of this continuous current at the proper variable rate, which in turn can be accomplished by varying the rate of amplitude change in the high-frequency waves, intercepting and setting up corresponding currents in the receiving aerial.

These various forms of currents can best be made clear by some simple diagrams illustrating the principles involved.

Fig. 1 illustrates a direct current consisting of an alternating current of 1000 cycles frequency superimposed upon a continuous current. Such a frequency passing through a telephone receiver would produce a high pitched musical tone.

Fig. 2 illustrates a rectified high-frequency current of 50,000 cycles, the negative half of the wave being suppressed by the rectifying device. Such a form of current passed through a telephone or direct-current instrument will give a response or indication, as if a continuous current were passing whose value is equal to the average of the instan-

taneous values, or about 32 per cent of the peak value of the rectified wave. This is shown by dotted line.

Fig. 3 represents a high-frequency current of 50,000 cycles, varying in amplitude so as to reach a minimum every 0.0005 of a second, or at a rate corresponding to 1000 cycles per second.

Such a current, passed through a rectifying device, is shown in Fig. 4 and the dotted line shows the equivalent average current which is of 1000 cycles, and produces the effect of such a current in a telephone receiver. A direct current added would make it identical to Fig. 1. A musical tone may thus be produced in the receiving circuit by a periodic variation in the value of the current in the transmitting circuit.

Under actual conditions the variations will follow an irregular curve, due to the overtones and inflections of the voice, and the rectified high-frequency wave form will be complicated by the fact that the rectifying devices used do not rectify perfectly, and because condensers are used to store the energy of succeeding waves so that the high-frequency current does not actually have to pass through the telephone windings.

The usual form of radiotelegraphic receiving apparatus is therefore suitable for tele-

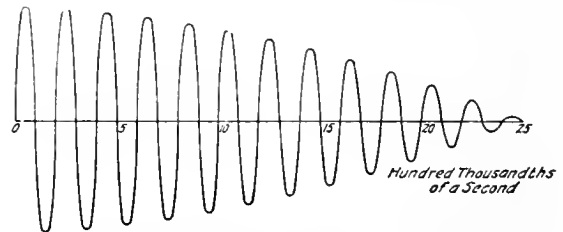


Fig. 3. A Representation of a 50,000-Cycle Alternating Current of Varying Amplitude

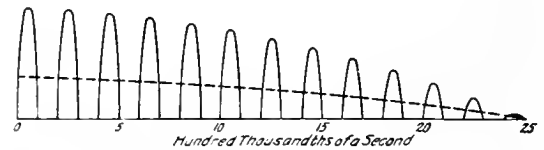


Fig. 4. The formation which the wave shown in Fig. 3 assumes when rectified. The dotted line is of an equivalent 1000-Cycle Current

phony, so that the modifications necessary are in the transmitting equipment.

The first feature is that the transmitting station must be capable of generating high-frequency currents and radiating them so

that the currents induced in the receiving apparatus when rectified will cause no disturbing noise in the telephone receiver. This may be done in two ways, either by a continuous high-frequency wave, or by one generated by the spark system described, the sparks, however, occurring one after the other so rapidly that their frequency is above the audible range where the telephone and ear are not sensitive and any resultant tone would not interfere with the reception of speech.

So far, the former method has proved the more practical, and the continuous high-frequency currents are generated either by an alternator of special design, or by some form of high-voltage direct-current arc shunted by a capacity and inductance. The Poulsen arc-generator is an apparatus of this type.

The second important feature in the transmitter is some method by which the amplitude of the high-frequency current may be controlled and modulated by the voice so that the amplitude of the radiated waves follows closely every variation in the voice. Since the voice in speech is a complex set of sound waves varying continually in frequency and amplitude, and containing overtones, it will be realized that it is very difficult to modulate a current of, say, even 10 to 20 amperes through a wide variation and preserve at the same time the correct relative intensity of the different voice frequencies involved in order that the articulations at the receiving station is good.

This matter of sufficient energy control is the one big problem in long-distance radiotelephony, and is the factor which has made it impossible so far to attain anything like the distance range that is accomplished in radiotelegraphy.

A great deal of work has been done by different investigators on the improvement of microphone transmitters which will handle heavy currents and give good articulations.

The ordinary microphone transmitter, such as is in use on all telephones, operates with about a quarter of an ampere and about 10 volts across it. This means a control in energy variation of but a few watts. Modifications in such a type of microphone transmitter may be made so that it will control several amperes, and special microphones have been built to handle considerably more current, but so far none have been perfected to control the large currents such as are used in high-powered radio-stations.

There are two promising fields for radiotelephony. The first is for long distance, where wire telephony at present is impossible over submarine cables, and expensive on land. The other is for relatively short distance, for use between ships and from shore to nearby ships; the latter being used in connection with the land lines, so that conversation may be had with vessels not too far from land with the same ease that we now talk from one city to another.

For the realization of this latter application several additional difficulties remain to be overcome. The great difference between transmitted energy and received energy prohibits the simultaneous use of sending and receiving apparatus, so that some form of throw-over device has been found necessary to change connections to either one or the other. Although the high-frequency alternator and the Poulsen arc give good results, both require more or less attention and are not suitable for small ship installations.

For use in connection with existing land lines, the problem of control is even more difficult, as here we have only minute currents to effect the control of a large amount of energy.

It is doubtful whether radiotelephony will ever supersede our present wire system on short distances over land, but it will undoubtedly be of immense value in fields where the wire telephone is impracticable.

THE SUPPLYING OF POWER TO THE QUAKER OATS COMPANY

By J. M. DRABELLE

THE IOWA RAILWAY & LIGHT COMPANY

These notes describe the method adopted for supplying power to the Quaker Oats Company's plant after the growth in business had rendered the original plant too small for the present requirements.—EDITOR.

A rather unusual and interesting installation has been made by the Iowa Railway & Light Company of Cedar Rapids, Iowa, to supply electric power and high-pressure steam to the plant of the Quaker Oats Company, which has at Cedar Rapids the largest cereal mill in the world.

The Iowa Railway and Light Company generates power at 2300 volts, two-phase, 60 cycles; the Quaker Oats plant generated its power at 240 volts, three-phase, 60 cycles. The problem of arranging for the supply of purchased power may be stated as follows: A maximum of 3000 kw. at 85 per cent power-

The power plant of the Quaker Oats Company originally consisted of one 800-kv-a. engine-type alternator and one 400-kv-a. engine-type alternator. Two years ago, owing to the increased requirements for power, that company installed a 500-kw. 85 per cent power-factor steam turbine and generator. The demand for power, however, kept increasing, and since the entire mill had been built around the engine room and boiler room, no space was available for the installation of the needed additional machinery. The milling company therefore contracted with the local power and light company

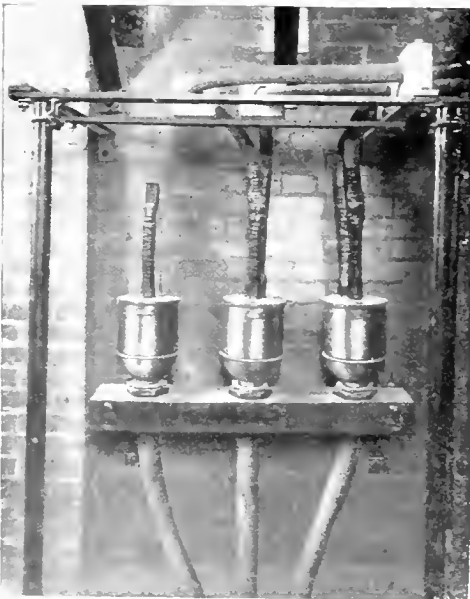


Fig. 1. The Method of Mounting the Potheads at the End of the Lead-sheathed Cables

factor, two-phase, 2300 volts, was to be transmitted by underground cables a distance of 1850 feet to a transformer substation, that was located by the mill and there by means of the T connection be transformed to three-phase power at 240 volts.



Fig. 2. Control Board, Showing Operating Lever of the Oil Switch and the Curve-drawing Instruments

for electric power to be used in driving the machinery, and for steam to be used in the cooking processes.

The underground cable installation consists of three 750,000 cir. mil., two-conductor, concentric cables. Two of these cables are

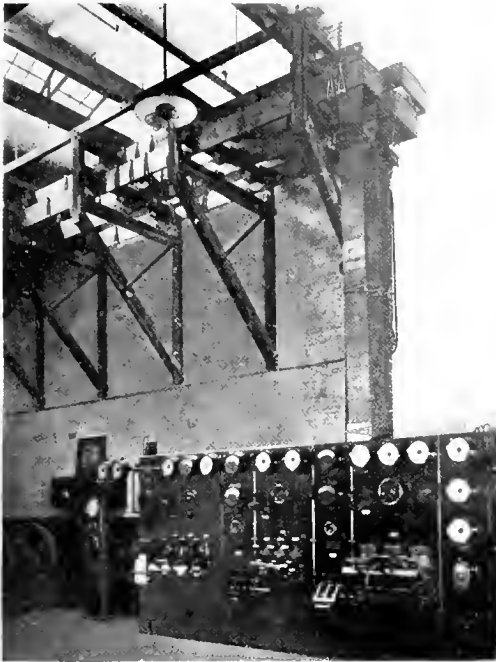


Fig. 3. Photograph Showing the Switchboard, and the Massive Busbars with their Supports

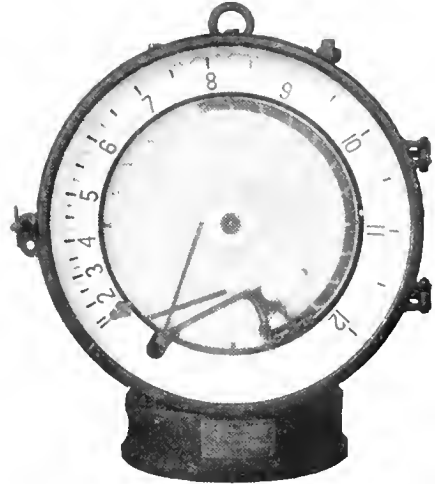


Fig. 4. Photograph of the Indicating Recording Integrating Flow Meter used in this Installation

maintained in service, and the third is held for a spare. One end of the cables, with their potheads, are shown in Fig. 1. An insulation of $\frac{7}{32}$ -in. varnished cambric was used between the inner conductor and the outer conductor; a similar one being used between the outer conductor and the lead sheath. The lead sheath was $\frac{1}{8}$ in. thick.

Three water-cooled, 1500-kv-a., 2300 volts to 240 volts, two to three-phase transformers were supplied. Two are used in the T-connection and the third is held as a spare. The transformers are provided with round-pattern thermometers and with water bells.

The switchboard installation, which is shown in Fig. 3, is particularly interesting and is easily the most unusual feature of this installation. The leads after leaving the pothead are brought to an oil switch that is connected to the transformers. For protecting the cable from static disturbances, graded-shunt multigap arresters are provided. The low-tension leads of the transformer are brought through a single opening in the tank to prevent eddy currents; from the terminal board, 10-in. by $\frac{1}{4}$ -in. copper bars run to a disconnecting switchboard that consists of six 6000-amp., single-pole lever switches. From this disconnecting switchboard, the

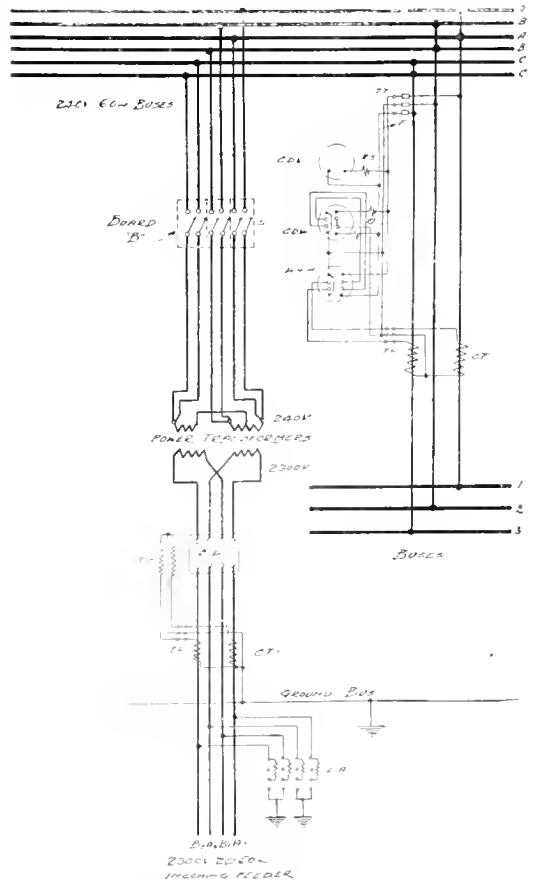


Fig. 5. Diagram of the Switchboard Wiring, Back View

bus system is carried approximately 40 feet to the distributing board of the Quaker Oats Company. The busbars consist of six bars, two sets in parallel per phase, and each phase bar is made up of two 10-in. by $\frac{1}{4}$ -in. copper bars. The weight of copper used in making these connections was 18,000 pounds.

The control panel has an oil switch mounted on the back, and the following instruments are mounted on the front: One 3-phase, 3-wire, 60-cycle, 240-volt, 10,000-amp. watt-hour meter; one curve drawing voltmeter, 180-260 volts; and one curve drawing wattmeter, 4000 kilowatt scale.

Calibrating links are provided for in order that testing instruments may be readily inserted in the circuits for checking. Two

10,000-amp., 2000 to 1 ratio, current transformers operate the current coils of the wattmeters.

Steam is supplied to the Quaker Oats Company through an 8-in. extra heavy pipe line, 1150 feet long. All flanges, fittings, etc., are of cast steel. Expansion is allowed for by long bends. The steam pressure is 190 pounds with 100 degrees superheat. The steam is metered by an indicating, recording, integrating steam flow meter, an illustration of which is shown in Fig. 4.

This load of the Cereal company, which is being carried by the Iowa Railway & Light Company, is the largest power load in the state carried by a public service corporation.

SEMI-OUTDOOR PORTABLE SUBSTATION FOR BERKSHIRE STREET RAILWAY

BY W. D. BEARCE

RAILWAY AND TRACTION ENGINEERING DEPARTMENT, GENERAL ELECTRIC COMPANY

The semi-outdoor portable substation, consisting of an open section for the transformer, oil switch and other accessories, and two closed compartments for lightning arresters and the synchronous converter, is especially suited for service on roads with limited overhead clearance. A small reduction in weight and total cost over the totally enclosed type is also possible, owing to the omission of a portion of the superstructure, and a further advantage lies in the fact that all high tension apparatus is kept on the outside of the cab. The following article describes in detail the equipment of a portable station of this type now being operated by the Berkshire Street Railway.—EDITOR.

In order to increase the flexibility of substation equipment many electric railways have adopted the expedient of equipping a portable substation which can be put in service at any point on the system on short notice. Temporary power requirements may occur at outlying amusement parks and fair grounds, or on extensions where permanent substations are under construction. An equipment of this kind can also be used in emergency as a reserve unit available at any of the permanent substations.

During the past summer the Berkshire Street Railway placed in service a number of 300-kw. commutating pole synchronous converters, one of which was installed in a portable substation. The railway system on which this equipment operates includes about 110 miles of interurban trackage in Western Massachusetts. These lines radiate from Pittsfield extending north to North Adams and Bennington, Vt.

This portable substation is of the semi-outdoor type, consisting of an open section for the outdoor type transformer, oil switch,

current transformer, choke coils, disconnecting switches, etc., and an enclosed section divided into two compartments for the lightning arrester and synchronous converter with switchboard equipment. Owing to the low clearances of several overhead bridges the car height has been limited to 11 feet 6 inches above the rails.

The car body is an all-steel structure built in accordance with Master Car Builders' standards and fitted with steps, hand rails, ladders etc., as required by the Interstate Commerce Commission under the safety appliance acts.

The under frame is made up of four 12-inch steel channels extending the entire length of the platform. The two center channels are tied together by three-eighth-inch top and bottom plates, forming a box girder, thus securing the necessary stiffness without depending upon the car flooring. All of the channels are securely fastened together at the ends by steel members and cross-braced by 12-inch steel channels. There is also a cross bracing of six-inch steel

angles in the intervening central section of the framing.

A suitable foundation for the converter is provided by two pairs of six-inch steel channels placed across the car and firmly riveted to the underframing. The space between each pair is filled with concrete. Provision is also made for the usual levelling plates and anchor bolts. Ventilating openings in the floor of the car insure a supply of cool air when the machine is in operation. These openings are fitted with removable sheet iron covers and permanent wire mesh screens.

The car flooring consists of one-quarter-inch sheet steel, which extends across the

formed by thin sheet steel framed with angle iron. This shield protects the high tension bushings of the transformer which are brought out in a horizontal direction on account of the very limited overhead clearance. Some protection is also afforded the oil switch units and the current transformer. At the other end of the supporting frame, a short cover extends over the incoming line leads and those to the lightning arrester compartment. The incoming insulators at each side of the choke coils are suspended from cross steel angles tied into the framing.

Doors are provided on each side of the closed compartment and there are two glass windows located in each side of the operating



Fig. 1. Side View of the Semi-outdoor Portable Substation

plates on top of the center girder. The side and roof framing of the closed section and partitions of the car consist of steel channels and angles suitably braced and riveted together. The sides and roof are enclosed with sheet steel. A section of the roof over the converter is fastened with bolts so that it may be readily removed for installing or dismantling the apparatus when a crane is available. A galvanized sheet metal ceiling is built on the interior, forming air pockets which prevent any direct radiation of heat when the car is standing in the sun and also to drain any condensation to one side of the car away from the apparatus.

At the open end of the car a framework of channels is erected which forms a support for the disconnecting switches and choke coils. The framework, together with the transformer, also supports a snow shield

compartment. The windows are pivoted at the center to allow for suitable ventilation.

The trucks are of the diamond frame, arch bar type equipped with 33-inch wheels mounted on Master Car Builders' standard steel axles and fitted with cast iron journal boxes. They are designed to take a curve of approximately 40 foot radius.

Standard automatic air brake equipment is supplied with shoes acting on all wheels and with hose connections, thus conforming to the Master Car Builders' standards for steam railroad lines. A handwheel and brake shaft is also provided for operating the brakes at one end of the car. Current is taken into the car through three 33,000-volt disconnecting switches designed for outdoor service. These switches are so connected that they cut out all of the apparatus in the station, including the lightning arrester. An eight-foot switch

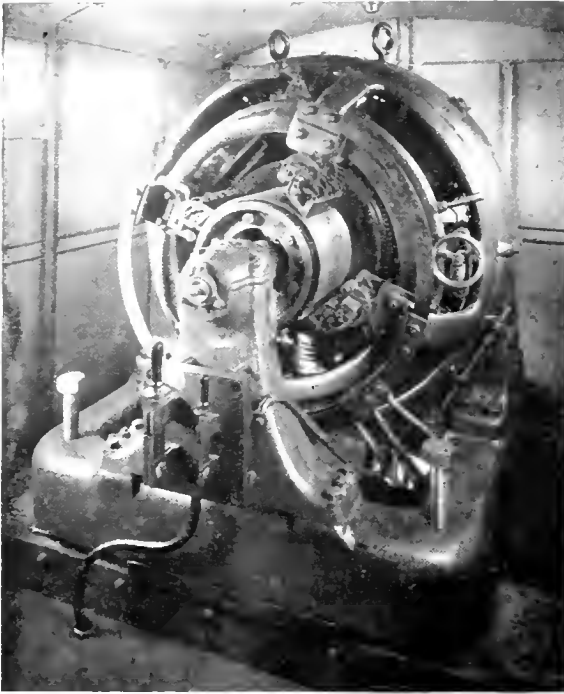


Fig. 2. The 300-kw., 600-volt, Commutating-pole Synchronous Converter Installed in the Portable Substation

hook is furnished for manual operation of the switches. From these switches current passes through three 200-ampere choke coils supported in a horizontal position and thence to the 300-ampere, 45,000-volt, triple-pole oil switch. This switch is enclosed in three separate tanks, the mechanism being operated from a single handle mounted on the control panel. A separate current transformer is provided for automatically tripping the oil switch in case of overload and for operating a bell alarm to notify the attendant when the switch opens. The oil switch is instantaneous in action, thus affording complete protection to machines and feeders under short circuit conditions.

The transformer is an oil insulated, self-cooled, outdoor-type unit, rated 330-kv-a., three-phase, 25 cycles. Voltage taps are provided on the primary side for operating at 33,000, 32,000 or 11,000 volts Y, by using either a tap or multiple connection of the primary windings. The substation can thus be connected to any of the high tension lines on the company's system. The secondary winding is designed for 385 volts and has 50 per cent starting taps. The secondary leads are

enclosed in a sheet iron box from which connections are made through a conduit to the operating compartment.

The transformer is of the standard railway type, designed with high inherent reactance and giving a practically flat compounding on the d-c. side of the converter. The continuous rating is in accordance with the A.I.E.E. recommendations, the allowable temperature rise after 24 hours' operation at full load being 35 degrees C. The temperature rise after two hours' operation at 150 per cent load will not exceed 55 degrees C.

The operating compartment of the car contains a three-phase, 600-volt commutating pole synchronous converter operating at 750 r.p.m. and a three-panel controlling switchboard. The converter has a normal rating of 300 kw. continuously, standard 50 per cent overload for two hours, and a momentary capacity of three times normal, or 900 kw. The machine is started from the a-c. end from 50 per cent starting taps on the transformer. There is also a series resistance in circuit to cut down the initial rush of current. The temperature guarantees and insulation tests follow the recommendations



Fig. 3. The Control, Feeder and Starting Panels (left to right) of the Portable Substation Switchboard

of the A.I.E.E. The compound field is designed to give a practically flat compounding at all loads without shunt field adjustment. The machine is equipped with speed limiting device, mechanical end play, field break-up switch, equalizer switch, negative line switch and shunt field rheostats. There is also the usual brush raising device to be used with a-c. starting. An opening is provided in the floor for connecting the equalizer to the stationary substation, if parallel operation is desired.

The switchboard is of natural black slate mounted on pipe framework and includes a transformer panel, d-c. feeder panel, and an a-c. starting panel. The transformer panel is 48 inches by 20 inches and the feeder and starting panel 48 inches by 16 inches. All the panels have 20-inch sub-bases. The transformer panel carries a 1500-ampere ammeter with shunt, a 750-volt voltmeter, a 300-0-300 scale wattless component indicator, two two-point potential receptacles, and the operating lever for the automatic high tension oil switch.

The d-c. feeder panel is equipped with a single-pole, 600-volt, 1000-ampere carbon break circuit breaker which is hand-operated and has a bell alarm switch; a back-of-board mounted rheostat with handwheel for the converter field; a single-pole, 600-volt, 1000-ampere line switch; and a 600-volt, 500-ampere, two-wire recording watt-hour meter mounted on the sub-base.

On the synchronous converter starting panel there is a double-pole, double-throw, 800-ampere starting switch and two double-pole, single-throw, 100-ampere switches with enclosed fuses for lighting and heating circuits.

The d-c. lightning arrester for the 600-volt feeder circuit is of the aluminum cell type and is mounted in the rear of the switchboard panel. The high-tension multigap lightning arrester is contained in an enclosed central room and consists of a series of spark gaps shunted by graded resistances, but without series resistance. It may be connected for protection of either the 33,000-volt circuits

or the 13,000- and 11,000-volt high tension lines.

The current for lighting and heating is taken from the partial voltage taps on the transformer secondaries. The heaters are fastened to the partition and side of the car

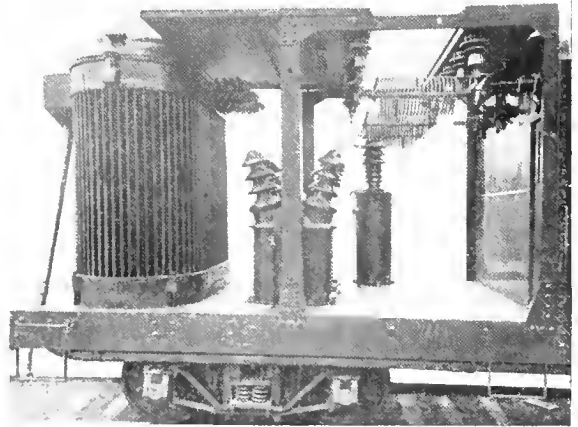


Fig. 4. The Outdoor Section of the Portable Substation Showing Transformer, Oil Switch, Choke Coils and Current Transformer

at one end of the switchboard. They consist of three units normally rated at 900 watts each. Separate switches are provided to secure a gradation of heat.

The principal dimensions and data of this substation are as follows:

Length overall	38 ft.
Width over sides of car	8 ft. 4 in.
Maximum width (over side channels)	8 ft. 6 in.
Height overall (including running board)	11 ft. 6 in.
Height of floor above rails	3 ft. 8½ in.
Total length of enclosed cab	23 ft. 6 in.
Length of converter or operating room	14 ft. 6 in.
Length of lightning arrester compartment	9 ft.
Length of outdoor section	14 ft. 6 in.
Truck base	25 ft.
Wheel base	5 ft. 2 in.
Wheels	33 in.
Track gauge, standard	4 ft. 8½ in.
Total weight	80,000 lb.

THE PROCESS OF IMPREGNATING COILS; AND A LARGE, MODERN IMPREGNATING PLANT

By ROBERT REID

MECHANICAL SUPERINTENDENT'S OFFICE, GENERAL ELECTRIC COMPANY

The author of the article below first briefly reviews both the method of impregnating coils with an insulating compound and the equipment necessary for the process. Following this is a description of the design and the recent installation of a plant which is capable of impregnating nine-foot by twenty-foot coils.—EDITOR.

The proper impregnation of the various types of armature coils, field coils, relay coils and coils used in industrial control work, also the drying and filling of wood is a subject which is of vital interest to all electrical engineers. How best to secure the complete penetration and filling of all the interstices of the coils with an insulating compound that will not be too brittle when cold, and yet capable of withstanding a reasonably high degree of temperature, is the problem. While undoubtedly all engineers are more or less familiar with the general process of impregnation, the following facts in connection with the apparatus may be of interest.

The installation consists principally of two tanks; one is known as the mixing tank in which the compound is melted and thoroughly mixed by being stirred with paddles on a vertical shaft, the other is known as the treating tank in which the articles to be impregnated are placed. The two tanks are connected at the bottom by means of a pipe with a shutoff valve. Suitable vacuum pumps, air compressors, condensers, and air dryers are also essential parts of the outfit.

A description of the operation of impregnating follows:

The treating tank having been filled with the coils, etc., the cover is placed and securely fastened with heavy swing bolts and nuts. The vacuum pump is then started and a vacuum as near as possible to 29 in. or 30 in. is maintained for from one to one and one-half hours. During this time all the air from the interior parts of the coil and wrappings is exhausted.

When the proper period of time for complete exhaustion has elapsed, the valve in the pipe connecting the two tanks is opened thus allowing the compound to flow into the treating tank. The temperature of the treating tank in the meantime has been maintained at such a point as to insure the thorough drying of the articles and also to prevent any deterioration of the material.

In some cases, when sufficient impregnating material has entered, the valve is closed and air compressed to about 100 or 125 lb. per sq. in. is admitted directly on top of the compound. This pressure is maintained for about one or one and one-half hours. This method gives good results when the coils are short and do not lie near the surface of the



Fig. 1. Lower Forms for Impregnating Pit Walls set in place

compound, otherwise there might be great danger of some portion being exposed.

The other method is to pass all of the compound over from the mixing to the treating tank and then turn the air pressure into the mixing tank. This method ensures the

treating tank being always full during the operation, and eliminates all danger of any parts being exposed during the time that the coils are under pressure (in this method also the time is usually equal to about one or one and one-half hours). The compound is then returned by opening a valve in the mixing tank to the atmosphere and introducing compressed air to the treating tank, which forces the compound back.

The air dryer, as the name implies, is for drying or removing as much moisture as possible from the compressed air before allowing it to enter the tanks, while the condenser takes care of the air on the vacuum side.

The impregnating tanks are usually made double, that is, with an inner and outer wall. Some of the smaller sizes are made of cast iron, but all of the larger sizes are of steel plate with riveted or welded joints as may be preferred.

The chamber between the two shells is for the heating element; steam at such pressure as will yield the required temperature being used direct. In some cases, in the larger tanks, a steam coil submerged in oil is located in this space. The body of hot oil



Fig. 2. Loads as placed on the Tank to Facilitate Sinking it into place

tends to maintain a more uniform temperature in the tanks.

There are other designs consisting of only a single tank with a steam coil inside it. In such a tank the heating coil comes into direct contact with the compound. All tanks

regardless of the type are covered with asbestos or magnesia covering.

In one of the latest impregnating plant installations, the tanks have a double shell and the space between contains only hot oil as the heating medium. This appears to have many points of interest and advantage. When steam-heating coils are used the pressure must be maintained at all times because if, for any reason, the pressure drops there is a corresponding drop in the temperature of the compound. In the case of direct heating by oil, if the body of the oil is sufficiently large, a more uniform condition can be maintained. The temperature is not easily affected; it will decrease very slowly, and yet is capable of being raised in a very short space of time to the required temperature.

The great length of armature coils for horizontal turbine-generators was largely responsible for the installation of this latest and also one of the largest sets of its kind in existence. The inner shell of each tank is 9 ft. inside diameter by 20 ft. deep in the straight part while the outer shell is 10 ft. in diameter, which gives about a 4 in. space between the two shells. The lower heads are of dished steel, rolled to shape. The upper part of the shells are securely riveted to a heavy cast steel flange that carries forty-eight 2 in. eyebolts by which the cover is fastened down. The cover also is made of a dished steel head with a cast steel flange.

Both mixing and treating tanks are similar in construction except for a slight difference in the covers. The mixing tank is provided with a stirring device and its cover carries the necessary gearing, bearings, motors, etc., for this operation.

Oil having been chosen after careful consideration as the heating medium, it became necessary to consider its heating and proper

circulation. Each tank has its own heater, circulating pump, piping system, and temperature recording gauges and thermometers, so that it is possible to see at all times just what temperatures have been obtained, both in the oil and in the compound.



Fig. 3. View of the Tank in place within the Pit

Hot oil leaving the lower part of the heater passes to the bottom of the large tanks, thence around the bottom and up the sides leaving at the top, going thence through the circulating pump to the top of the heater, etc.

While both tanks have independent circulating or heating systems, they are both connected to a common expansion tank that is placed at the highest point on the line. The top of this tank is sealed to prevent oxidation as far as possible, and has an overflow connecting with the sewer so that any unforeseen expansion of the heated oil will be taken care of.

All machinery, air compressor, pump, stirrer, paddle, hoist for heating tank, and oil circulating pumps, connected with the apparatus is motor driven, the motor varying in size from 35

horse power on the compressor to 5 horse power on the oil pumps.

When it is considered that these tanks must be of sufficient strength to withstand both a collapsing and a bursting effect it can readily be seen that the material and workmanship must be of the best. Roughly, a vacuum of 30 in. will give a collapsing pressure of about one ton per sq. ft. of surface. This means that the cover of the tank must sustain approximately a total load of 65 tons while under vacuum.

It may be of interest to know that a total of about 3600 gallons of heating oil are required for both tanks, while 220 barrels of compound are required to fill the mixing tank. Both tanks, and all of the piping and valves are very carefully covered with magnesia covering so that the difference of temperature of the heating oil entering and leaving the heater is very small (about 5 deg. variation).

The installation of this plant presented many difficulties. Only about 4 ft. of the tanks project above the floor level, the remainder being below in a basement. This basement (the outside measurements of which are 40 ft. by 26 ft. by 25 ft. deep), made of

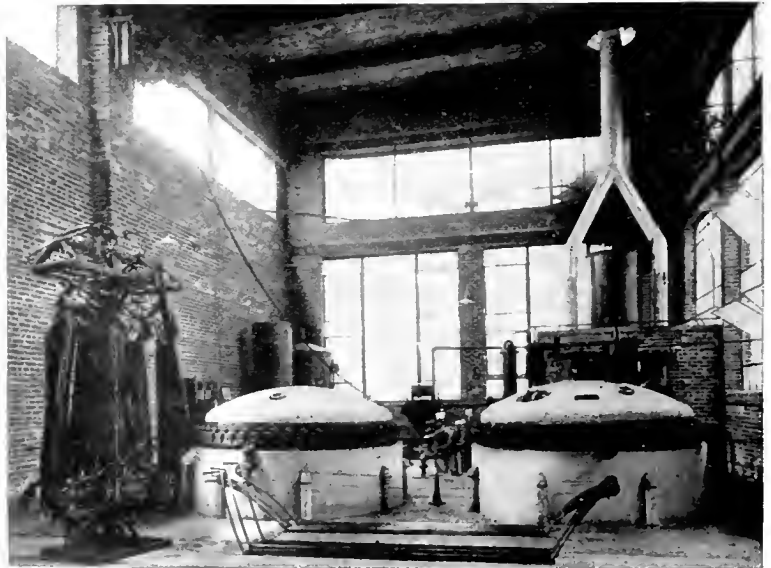


Fig. 4. General Interior View of the Impregnating Plant. The Tops of the Two Nine-foot by Twenty-foot Tanks are shown in the center

concrete, is very strongly reinforced, and is damp proof. Due to its nearness to a massive building, and to the nature of the soil, it was

decided to make only a partial excavation and to construct this enormous concrete tank in the excavation, and by removing the soil underneath, allow it to gradually settle to the required depth. It was first attempted to remove the soil by washing it out with water under pressure but the air-lock system was finally adopted. Two air locks were used and the concrete tank was successfully lowered to place. (A number of branches of trees were encountered at a depth of about 25 to 30 ft., the wood resembling that of the elm tree. It was very light in color when broken but rapidly turned dark when exposed to sun-light).

Fig. 1 shows the setting up of the forms for the concrete.

Fig. 2 shows how the tank was loaded down to assist in lowering it into place, and Fig. 3 shows the tank in place and the workmen removing the air-locks preparatory to closing the openings in the floor. Figs. 4 and 5 show views of the completed

interior. Fig. 6 shows a smaller outfit of which the impregnating tanks are 3 ft. in diameter and 4 ft. deep. The heating element

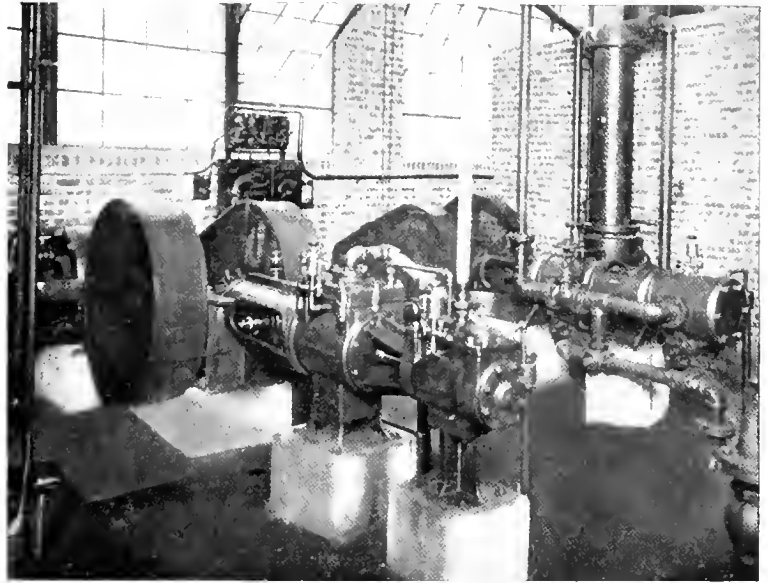


Fig. 5. The Air-Compressor, Vacuum Pump, and Condenser installed for use in the Impregnating Plant

in these tanks is steam introduced directly into the space between the inner and outer shells.



Fig. 6. A Three-foot by Four-foot Impregnating Set of Tanks at the Left and a Four-foot by Eight-foot Synthetic Resin Vulcanizer at the Right

OPEN-DELTA OR V-CONNECTION OF TRANSFORMERS

BY GEORGE P. ROUX

CONSULTING ELECTRICAL ENGINEER, PHILADELPHIA, PA.

The merits of the scheme of employing the open-delta or V-connection of transformers in a case of emergency or as a permanent condition has often been questioned. The proposition has both been opposed and defended. The following article presents a clear analysis of the matter and after considering the scheme from the standpoints of capacity, stresses, stability, etc., conclusions are drawn which are formulated at the end of the article.—EDITOR.

A style of connection of single-phase transformers for three-phase transformation of voltage which is very often used, not only in case of emergency but also in ordinary operation, is the open-delta or V-connection.

For ordinary and permanent operation, the use of two single-phase transformers V con-

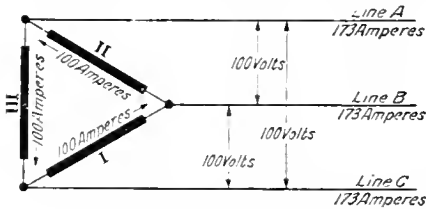


Fig. 1. Diagram of Three Single-Phase, 10 kv.-a., Transformers Connected in Closed Delta

nected to transform a three-phase current to a lower voltage, appeals to many of us, especially in cases where an increase in load is expected in the future, when a third transformer can be added changing the connections from open to closed delta. The initial investment in transformers is reduced one third, while provision is made for the future addition.

As an emergency connection of two transformers in a bank of three, for example, in case of an accident to the third one, this style of connection is very often resorted to, with acceptable results, while the disabled transformer is being repaired.

In both cases, however, we are apt to lose sight of the fact that the capacity of two transformers connected in open delta is not equal to the sum of the capacity of each one, and furthermore, that a number of conditions are changed which affect the operation of both primary and secondary circuits, as well as the operating characteristics of the transformers themselves. These conditions we propose to review and analyze in this article.

In order to have a clear view of the situation, let us take first the case of three single-phase transformers connected in delta, each

transformer having a capacity of 10 kv.-a., 100 volts and 100 amperes, as shown in Fig. 1; and deal in all the following cases with transformers of the same ratio, same impedance, and connected to a non-inductive load with each phase balanced. We have then at full load a voltage per line of 100, and a current per line of $100 \times 2 \cos. 60 \text{ deg.} = 100 \times 1.73 = 173$ amperes. Since the phase-angle relation between the transformers is 120 deg., or twice 60 deg., the relation between the line current and the phase current is therefore 30 deg. for one branch, and 60 deg. between two branches.

Adding vectorially the two currents with a phase angle of 60 deg., as in Fig. 2, $OA + OB = OC$, the line current. Also $(OA + OB) \cos. 30 \text{ deg.} = \text{line current } OC$.

As each line is in parallel with each phase, the phase voltage is equal to the line voltage or 100 volts. Thus, the total power in the bank of transformers as shown and connected in Fig. 1 is $3 \times 100 \times 100 = 30$ kv.-a. or $\sqrt{3} \times 100 \times 173 = 30$ kv.-a.

Assume, for some reason, that transformer III must be removed from the delta-connected bank, leaving only transformers I and II in service, as for instance in case of a breakdown in transformer III.

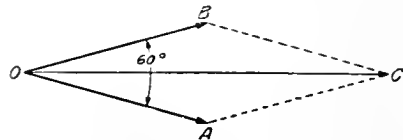


Fig. 2. Vector Addition of Two Currents 60 Electrical Degrees Apart

We now have a bank of only two transformers which are connected as in Fig. 3, and each is of the same size and capacity as those in Fig. 1.

It is obvious that in a three-phase system, in order to supply 30 kv.-a. from two transformers instead of three, the line current and

voltage must be the same in each case, that is, 100 volts and 173 amperes.

The capacity of each transformer in a bank of three, as in Fig. 1 connected in closed delta, was

$$\frac{\sqrt{3} \times 100 \times 173}{3} = 10 \text{ kv-a.}$$

The capacity of each transformer in a bank of two, as in Fig. 3 connected open-delta or V, would appear to be

$$\frac{\sqrt{3} \times 100 \times 173}{2} = 15 \text{ kv-a.}$$

We see at once that the two remaining transformers, *I* and *II*, in this new system of connection will be loaded above their rated capacity, which is 10 kv-a. only; and, although it may seem that the increase of current in the winding of each transformer is only $50 \times 33\frac{1}{3} = 16\frac{1}{2}$ per cent, such is not the case.

Analyzing the conditions set forth in Fig. 3 as to phase relation of the current in each transformer, we see conditions peculiar to two transformers operating in series, viz. across lines *A* and *C*.

First: The current in line *A* (173 amperes), entering transformer *II* at *a* must necessarily flow with all its intensity in the winding, and therefore the value of the current in transformer *II* is 173 amperes, it being raised from 100 amperes in the closed delta connection to this 173 in the open-delta connection.

This is due to the fact that since the total power to be supplied is equal to $EI\sqrt{3}$, where *E* is the line voltage and *I* the line current, each transformer in the open-delta connection has to supply $\frac{EI\sqrt{3}}{2}$ and each winding will be subjected to a voltage *E*, (line voltage), and in addition to a current

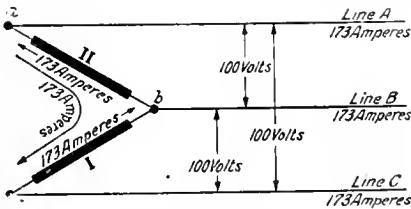


Fig. 3. Diagram of Two Single-phase, 10 kv-a., Transformers Connected in Open Delta or V

equal to *I*, (line current). Such a condition gives rise to a phase displacement, between the line voltage *E* and the current in the transformer winding, equal to:

$$\frac{\sqrt{3}}{2} = 0.866 = \text{cosine } 30 \text{ deg.}$$

In the delta connection, we note that they were connected with a phase relation of 120 deg., or 180 deg. - 120 deg. = 60 deg. between currents in the windings.

In the open delta this condition has been changed and the difference in phase between the current in each winding is 180 deg. -

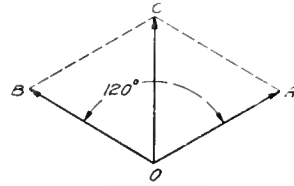


Fig. 4. Vector Addition of Two Currents 120 Electrical Degrees Apart

($2 \times 30 \text{ deg.}$) = 120 deg. The resultant of two currents 120 deg. apart has the same value as either of the components as shown vectorially in Fig. 4, where $OA \text{ plus } OB = OC$, as also $OA \text{ cos. } 120 \text{ deg.} = OA$ because cosine 120 deg. = 1.

Therefore the line current $I = 173$ amperes has a value of $I \text{ cos. } 120 \text{ deg.} = 173 \times 1 = 173$ amperes in the winding of transformer *II*; and, as transformer *I* operates under identical conditions, the current flowing in it is of equal value.

In Fig. 5 we have represented the three transformers connected in delta. The immediate effect resulting from the release of transformer *III* is similar to the case of a step ladder in which the braces, which keep the legs from spreading, have been severed owing to the weight on the ladder and to other concurrent conditions; the legs have spread apart, each one to an angle greater than the former by 30 deg., therefore the stress in each leg has increased to a value equal to

$$\text{cos. } 30 \text{ deg.} = S.$$

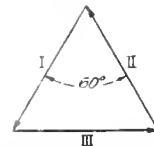


Fig. 5. Diagram of a Closed-Delta Connection Made up of Three Single-phase Transformers

We can realize that this new condition is very unstable, as there is nothing to prevent the legs from spreading further apart, on account of the absence of the connecting member *III*, which, to a certain extent

and within a certain limit, kept the two legs *I* and *II* in a determined angular position.

We can then write again, but this time correctly, that the output of the two transformers left in open delta, from the previous bank of three in closed delta, is

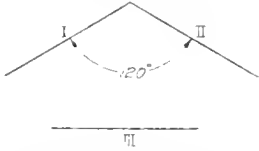


Fig. 6. A V-Connection Constructed from the Delta of Fig. 5 by Disengaging Transformer III and Spreading the Phase Angle Between I and II

$$\frac{EI \times 3}{\cos. 30 \text{ deg.}} = \frac{100 \times 173 \times 1.732}{0.866} = 34.64 \text{ kv-a.}$$

and each transformer must have a capacity of

$$\frac{34.64}{2} = 17.32 \text{ kv-a.}$$

It follows that when two transformers are left in open delta from a bank of three in closed delta, to supply under the same conditions the full load of the three delta-connected transformers, they will each be subjected to an overload of 73.2 per cent, or, vice versa, the line can be loaded to only 57.7 per cent of its rated supply capacity to operate the transformers under normal rating conditions.

The voltage and current relation in the two systems of connections is best shown in Figs. 7 and 8, from which it can be seen that while the three delta-connected transformers operate with current and voltage in phase in their winding, in the open delta they operate at 86.6 per cent power-factor, or specifically, with a current lagging behind the voltage 30 deg. in one transformer and leading by 30 deg. in the other.

Taking for instance the current in line *C* of the delta-connected transformers in Fig. 7, which is in phase with the imaginary *Y* current of the transformers, we can see that upon reaching the point of connection of transformers *II* and *III* the line current splits itself into two components each 30 deg. apart from the line current or in proportion to the impedance of the paths offered to its flow, which in our case is the same, each component

being equal to $\frac{173}{2 \cos. 30 \text{ deg.}} = 100$ amperes. If

the impedance of each transformer is not the same, as in the case of unbalanced load, then the currents will divide in the inverse ratio to the impedances. We note that each current component is then in phase with the voltage.

Looking now at the open-delta connection of transformers *I* and *II* in Fig. 8, and taking the line *C* again, the line current is, as in the above case, in phase with the *Y* voltage of the transformers; and when it reaches transformer *II* it finds only one path to follow, instead of two as before, and strikes transformer *II* at an angle of 30 deg. behind the voltage, thus lagging 30 deg. or 0.866 per cent.

In line *B* similar action takes place (except that line current, *B*, leads voltage of transformer *I*) and the two currents emerging from transformers *I* and *II* combine with a phase angle of 120 deg. into a resultant equal to each of its components, as explained before and shown in Fig. 4, or 173 amperes which flows back to the generator through line *A*.

This operation is repeated in each cycle and in each phase, and needs no further explanation.

There are other peculiarities inherent to the open-delta connection which materially affect the operation of three-phase transformers or apparatus so connected.

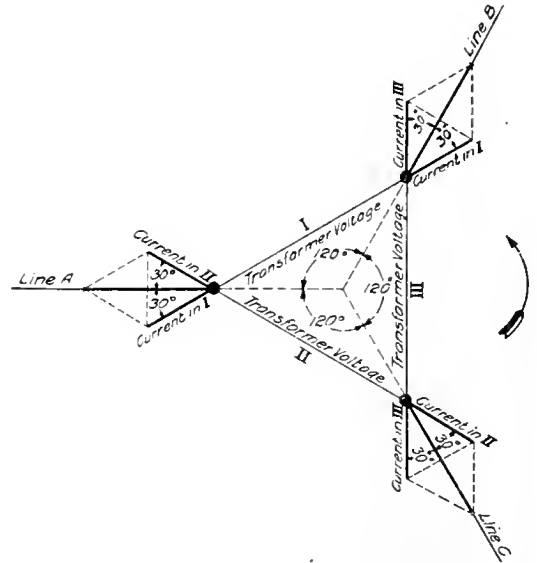


Fig. 7. Diagram of the Phase Relations of the Voltages and Currents in a Closed-Delta Transformer Connection

The line current entering a system of interconnected transformers divides itself in the inverse ratio to the impedance of the paths offered for its flow. Any difference in the value of the respective internal impedances is likely to cause an unbalance of the secondary voltage and primary current, which

under certain operating conditions very often met may reach dangerous proportions.

Likewise, the production of electrostatic stresses has fatal consequences, due to the fact that the mean potential of the primary windings is not the neutral potential.

For these reasons, the use of the open-delta connection with transformers of high voltage is not recommended, as destructive potentials may be caused by unbalanced loads with electrostatic stresses, due to the instability of the internal impedance of the transformers under operating conditions which in turn cause an unbalanced voltage in the system.

For low primary voltages, 10,000 volts or less, and relatively small installations, this system can be used sometimes to decided advantage.

At non-inductive load, it will be found that the current is lagging in one transformer, and leading in the other. When the load becomes

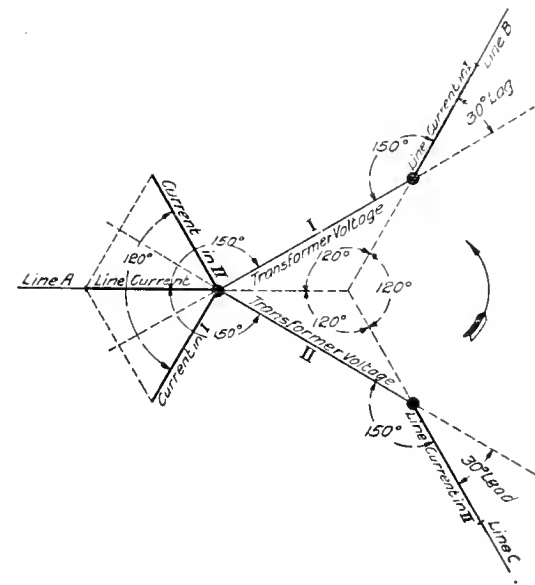


Fig. 8. Diagram of the Phase Relations of the Voltages and Currents in an Open-Delta Transformer Connection

inductive, the relation of current to voltage changes and the phase angle displacements increase in one transformer and decrease in the other, thus making very unstable conditions. Therefore, if, when supplying a balanced

three-phase load it is found necessary to connect a single-phase non-inductive circuit to the open-delta connected transformers, it is advisable to take this circuit off the leads *a* and *c* of the bank (see Fig. 3) rather than off one or the other transformer leads.

Concerning the reduction in the transformer bank capacity, it is worth noting that in three-phase to three-phase transformation the three styles of connection commonly used also give different ratings.

Taking single-phase transformers provided with all necessary taps and connecting them in different ways, their rating taken as a bank compares as follows:

Three transformers in closed delta—Total capacity 100.00 per cent.

Two transformers in open delta—Total capacity 57.7 per cent.

Two transformers in *T* or Scott connection—Total capacity 62.2 per cent.

In figuring the proper capacity of transformers which are found advisable to operate in open delta to supply a certain load, the size of each transformer in kv-a. is found by dividing the total load to be supplied by 2 and adding 15.466 per cent to the result, in order to supply the kv-a. due to the lagging current peculiar to this type of connection.

From the preceding discussion, which is based on permissible heating, it appears that the *T*, double-*T*, or Scott connection of two transformers for three-phase operation is more economical than the open-delta connection, on account of the somewhat greater available kv-a. capacity.

However, since the open-delta connection uses no taps, it permits a greater simplicity in the construction of a transformer which naturally lowers the cost of the unit and renders attainable a greater degree of ruggedness for the same cost than can be obtained in a transformer for *T* connection which requires taps. Transformers without taps are better balanced internally to withstand electromagnetic and electrostatic stresses.

In conclusion, it may be said that there may be cases, however, where transformers having special taps for the *T* connection might well be found useful in times of emergency or in cases of temporary installation, because of their greater kv-a. capacity as brought out in this article.

PRACTICAL EXPERIENCE IN THE OPERATION OF ELECTRICAL MACHINERY

PART IV (Nos. 19 TO 28 INC.)

BY E. C. PARHAM

CONSTRUCTION DEPARTMENT, GENERAL ELECTRIC COMPANY

19 LOOSE COMMUTATOR

A common symptom of disorder in direct-current generators and motors is the blackening of the commutator bars and the ultimate eating out of the mica from between them, if the cause of the symptom continues. The simplest case to diagnose is where the blackening is local to two or more pairs of bars that are so located at intervals around the commutator that the locations seem to be associated with the plan of winding and connecting the armature. A poor soldering job throughout will cause so many poor connections that the commutator will blacken all over. An actual open circuit due to a coil being mechanically injured, or to its having burned in two, or to one of its leads having burned free from the commutator, will cause a traveling spark that will soon burn the mica from between the affected bars and characterize the trouble at once.

A certain motor had been driving shop shafting for several years, during which time the commutator held a high polish. The motor was then transferred to duty in which the armature was reversed frequently while under load, under which conditions it soon developed armature open-circuit symptoms. Resoldering of the leads brought about no permanent improvement. The brushes sparked badly, but the machine was maintained in service until a new armature could be obtained. The new armature performed its functions perfectly.

It was decided then to rewind the old one because its insulation had become too dry. On stripping, several coil leads were found to be actually broken and several more were about to break. Further inspection disclosed the fact that the commutator was so loose that it could be worked back and forth one-quarter of an inch. (The armature had not been designed for reversal operation and consequently it could not withstand the severity of that service.)

20 LOOSE CONNECTION

Plausible symptoms may sometimes prove misleading. An operator was using a three-

phase induction motor to run a laundry machine. The motor had worked satisfactorily for two years and then began to give starting trouble. Sometimes the closing of the compensator would start the motor and sometimes it would not. At such times as the rotor failed to move it would hum; anyone familiar with the symptom would have immediately suspected single-phase operation, hence a loose or open connection. In all the preceding cases the last of several attempts to start the motor had been successful.

One day the motor could not be started at all; the operator opened the compensator and cleaned the contacts; the motor then started promptly and ran without trouble all the forenoon. The next afternoon the motor again could not be started, and the cleaning of the compensator contacts this time did no good. While the operator was throwing the compensator "on" and "off," trying to humor the motor into a start as he had done many times before, a workman threw a rolled-up wet shirt at another workman. The shirt hit the ceiling and then dropped onto the stator wires just where they come out of the motor. The motor started at once and after throwing the compensator over normal operation continued.

The operator was quick to connect the throwing of the shirt and the starting of the motor; and he had a mind to leave the shirt where it was as a permanent institution but more mature thought prevailed and he found that the pushing in of the stator wires was as effective as the shirt. The trouble was a stator lead which was loose inside the sleeve connector, the two being held together by the tape that bound the joint. Sometimes the two made contact and at other times they did not, hence the erratic starting actions.

(21) LOW POWER-FACTOR

When an alternating-current generator supplies under-loaded transformers and induction motors, the current of the generator lags behind its e.m.f. Under this condition more exciting current must be furnished by the exciter if the alternating voltage is to be

maintained at normal. (The effect of lagging armature current is to cause the magnetizing action of a given armature coil to oppose the magnetizing action of that field pole which it is opposite. This decreases the resultant field cut by the armature conductors so that they do not generate as high an e.m.f. as they do when the voltage and current are in phase and the opposing armature reaction is at a minimum. In other words, a lagging current tends to demagnetize the field poles, and, if normal voltage is to be maintained, the field strength must be restored by increasing the amount of current drawn from the exciter.)

An operator complained that his exciter commutated badly and that he was unable to keep up the voltage on the alternator. These two symptoms in themselves suggested that an overload was the trouble and excessive heating of the exciter confirmed this suspicion. Since the exciter circuit included no ammeter its output was not shown. An inspector cut in an ammeter which indicated the exciter to be continuously overloaded 40 per cent. The operator then stated that the exciter was guaranteed to maintain normal a-c. voltage at 0.8 power-factor and that his power-factor was better than 0.8. Rough calculations based on station wattmeter, ammeter, and voltmeter readings showed that the power-factor was between 0.55 and 0.60 at the time of the readings. The operator was well enough satisfied with these results to substitute a larger exciter for the work.

(22) HOT BOX INDICATIONS

If trouble of any kind occurs in lay-outs that involve electrical apparatus it is usually the case that some one of the electrical devices is promptly blamed as being the cause. Apparently it never occurs to many operators that troubles may arise from abnormal conditions in the connected load.

In a certain instance an operator complained to the power company that the voltage supplied was varying widely and was causing speed variations in an induction motor that was driving a centrifugal pump. The power company failed to see how this could be possible but, to satisfy the consumer, applied a recording voltmeter, which showed the voltage to be well maintained.

On looking further for the trouble, it was found to be due to a hot box on the pump shaft; the box would alternately bind and release, thereby causing the motor speed to vary according to this variable load which

was imposed upon its regular load. (The operator should have observed that voltage variations could not have been the cause of trouble because other induction motors on the same service were not affected.)

A short time afterward, the same pumping unit, after working all day, refused to start on closing the control switch the next morning. The panel starting-contactor closed promptly but the operator reported the motor was "dead." It took an inspector about five minutes to find out that there was nothing wrong with the motor. On turning the rotor back to let out the back-lash due to the belt coupling, and closing the control switch, the rotor promptly took up the back-lash but refused to rotate further. An investigation showed the trouble to be in the same pump bearing that had given trouble before; it was now frozen tight. A new lining, plenty of oil, and a smooth shaft remedied matters.

(23) BURN-OUT DUE TO CORE LOSS

A solid iron core would offer such a low resistance to the eddy currents set up by the core cutting the magnetic lines of the field that these currents would be very large and cause prohibitive heating. Laminations, when insulated from each other, introduce resistance, and thereby reduce the volume of current in the core to a very small value.

A certain armature had been burned out by the power current that followed a lightning discharge to the core. The damaged coils were removed, the core cleaned and scraped, and new coils installed. The machine ran without trouble for several months and then burned out again in the same place. Attributing the second failure to poor repair work, about twice as many coils were removed as before and the machine again repaired. Before it had a chance to fail again, the operator had a whiff of burning insulation, investigated and found excessive heating, which was confined to the repaired area.

An "armature man" was called in. On removing the repaired coils, inspection disclosed that the insulation armor of some of them was being burned from the outside; the cotton insulation on the wires was in good condition, showing that the trouble did not come from within. The armature was stripped, the core disassembled to and including the burned area, several inches of new laminations installed, and the coils replaced. On drying out and again placing the machine in service, no tendency to heat more in one place than in another was exhibited.

The cause of the heating had been the burning together of the laminations; the effect was equivalent to having a part of the core made of solid iron.

(24) ALTERNATOR SPEED LOW

Exciters for alternators may be steam-driven, water-driven, or motor-driven; or the exciter armature may be wound upon an extension to the alternator shaft or may be belted to that shaft. In either of the two latter cases, any factor that affects the speed of the alternator will directly affect that of the connected exciter. With an independently driven exciter, low alternator speed will not affect the exciter speed, excepting insofar as the increased exciter current required may overload the exciter and reduce its speed for that reason. In any event, low alternator speed means more exciting current to maintain normal alternator voltage. With low exciter speed, the exciter field current must be increased to maintain the exciter voltage, even if the alternator speed is normal. Therefore, with direct-connected sets, low alternator speed lowers the alternator e.m.f., not only because the relative motion between armature conductors and the magnetic lines is slower, but because the lower exciter speed produces lower exciter voltage, hence less exciting current and a weaker alternator field for the alternator armature conductors to cut.

An operator once complained that he could not maintain his switchboard voltage, even with the exciter and alternator rheostats all cut out. What was really needed for the fluctuations of his load was automatic voltage regulation (which he afterward installed); but, to meet the immediate requirements, an inspector analysed the conditions and found most of the trouble to be due to low speed of the alternator and connected exciter. Readjustment of the engine governor to give normal speed at full alternator load and more attention given to keeping up the steam pressure during the load swings, which lasted for an appreciable time, improved the operation considerably.

(25) LOOSE CORE

In the older types of armature core construction a single key, in conjunction with the end-plates, was relied upon to hold the core laminations securely. For the work to which motors were then assigned and for the comparatively moderate speeds that then prevailed, this method was satisfactory. Today, however, speeds are high and motors

are applied to carry practically every type of load; consequently, their mechanical fastenings are designed accordingly. Occasionally, one of the old types of motor (many of which are still in use) is applied to work which it cannot continue to perform because it was not designed for that service; trouble soon follows.

As an example of such a case an inspector was called to determine the cause of sparking and eating out of the commutator mica of a large 500-volt bipolar direct-current motor that recently had been applied to operate a stone crusher. The crusher was equipped with a very insignificant flywheel. As the operator had just resoldered the armature leads thereby eliminating possible poor contacts, the inspector ripped off the armature hood and examined the leads themselves. Several of them were found to be broken but their ends still made contact; several other leads were about to break. After blocking the armature shaft and the crusher so that the shaft could not rotate, he applied a crowbar to the core and found the core to be loose on the shaft. Of course, there was no alternative but to reassemble the core.

The sparking had been due to open circuits which had been caused by the relative movement between the commutator and the core breaking the armature leads. The service was improved further by later increasing the size of the flywheel and by providing a special water-rheostat to start the outfit without unduly overtaxing the motor.

(26) LOOSE BELTS

Belts, as well as motors, are liable to be gradually overloaded without the fact being realized that abnormal service is being called for.

A small alternator from which a number of single-phase motors were to be supplied with energy for operating printing presses, cutters, etc., was recently installed. It was found impracticable to run the printery with the motors because they would not hold up their speed under the conditions normally to be expected. The operator and all concerned of course blamed the generator and motors, because they were the new part of the outfit. An inspector was called in and he diagnosed the trouble as a case of general belt slipping. The prime-mover was a low-head waterwheel of ample size, but the several pulleys used in the transmission were small and their speeds were low. One intermediate six-inch belt, which was running at but 600 feet per minute,

was called upon to transmit 25 h.p. or more. When an attempt was made to start the largest motor while other loads were active, the exciter field fell to almost zero on account of reduced speed. The pressing of an iron pipe against one belt as an idler increased the alternator speed 400 r.p.m.; the same application to another belt increased the alternator speed another 100 r.p.m. By systematically tightening the belts throughout the line, the alternator and exciter speeds were brought to normal value at moderate loads, but still the speeds would not hold up under the conditions imposed by taking a heavy cut on the cutting machine. It was necessary to substitute larger belts and pulleys in two places.

Excessive belt tensions are of course to be avoided; but, inasmuch as loss in production is equally objectionable, the speed of the prime mover and its dependent belted machines should be periodically checked and, if the efficiency of transmission is shown thereby to be immoderately low, measures should be taken to eliminate the defect so far as is possible. This axiom applies of course irrespectively of whether the machines concerned are electrical or mechanical.

(27) ERRATIC ELEVATOR SPEED

A conservative "rule of thumb" often used for checking the safe carrying capacity of leather belts is: *One inch of single belt traveling at the rate of 1000 feet per minute will transmit one horse power.* It is assumed in this statement that the belt is tight enough to prevent slipping. An operator once complained that his elevator speed was surging and that, under the heavier but permissible loads, the speed dropped sufficiently to interfere with his production. As the armature of the driving motor had just been repaired and as the elevator had given no trouble up to the time of this repair, the motor was blamed for the trouble.

An inspector could find nothing electrically wrong with the motor, but he did determine that the motor was 50 per cent overloaded when the elevator was loaded to its rating. This overload did not last long enough, however, to do any harm. Operating conditions were favorable as the motor ran continuously and the elevator was controlled by means of tight and loose pulleys. At the time of shifting to the tight pulley with a loaded elevator, the motor drew 70 amperes at 115

volts, which corresponded to approximately 10 h.p. The five-inch motor pulley turned at 1450 r.p.m. when under heavy load; this meant a belt speed of 1900 feet per minute. From the rule given the single belt could transmit 1.9 h.p. per inch of width at this speed. The four-inch width, then, was good for $4 \times 1.9 = 7.6$ h.p.

As a matter of fact the belt was carrying more than this amount. Tightening it increased its capacity but, to make assurance doubly sure, a two-ply belt was substituted for the single one and all trouble ceased.

(28) BRUSH-HOLDERS SHIFTED

Operators who are accustomed to running reciprocating pumps may be surprised at some of the characteristics of centrifugal outfits. One of the differing features is the rate at which a centrifugal pump's output will increase with the speed.

An operator purchased a motor-driven centrifugal pump set and installed it. Immediately after starting it up the motor sparked badly and in a few minutes was so hot that it smoked. (If the operator had known as much about the output of a centrifugal pump as he did about that of a reciprocating pump he would have suspected the cause of the trouble at once.) As is usual in such cases, the motor was blamed and an inspector called in to locate the origin of the trouble. An ammeter cut into the supply wires showed that the motor was heavily overloaded and a rough measurement of the water delivered by the pump showed the amount was far in excess of that which the operator had specified.

In measuring the speed, however, to check some readings, the speed was found to be greater than that ordinarily corresponding to about three-quarters load; this of course could not be the case with a perfectly normal accumulatively-connected compound-wound motor, the speed of which drops rapidly on increase of load. The field connections were checked and found to be correct, but in checking them the inspector noticed that one of the brush-holder insulating washers was broken. The operator explained that it had received a blow at the time of installing the set. It developed that at the same time, the whole brush-holder construction had been forced around against rotation, thereby enabling the armature reaction to weaken the motor field and thus increase the motor speed.

MECHANICAL STRESSES IN SHELL-TYPE TRANSFORMERS

By J. MURRAY WEED

TRANSFORMER ENGINEERING DEPARTMENT, GENERAL ELECTRIC COMPANY

A quantitative knowledge of the magnetic stresses in transformers is becoming more and more important as the size of the apparatus and system increases. In this timely article the author discusses various factors which have a bearing on the magnitude of the magnetic stresses at short circuit, and their bearing upon the size and cost of transformers. He points out that the stresses in large transformers are much greater than in small ones of a similar design, and therefore that an increase in the cost, for an equal degree of safety, must necessarily result. Also, the greater the capacity and the lower the voltage of the transformer the greater will be the extra cost for limiting the stress to a safe value. Therefore, in the latter case it is often more economical to introduce external reactance than to have it self-contained in the transformer. He concludes by checking his equations with equivalent ones derived by Dr. Steinmetz, and gives experimental verification of the formulae. This article is a continuation of the matter given under the subject "Magnetic Leakage in Transformers" in the December, 1912, and the January, 1913, issues of the REVIEW.—EDITOR.

The following formula for the calculation of mechanical stresses in a transformer was derived in the former article and appeared as equation 28.

$$S_{me} = \frac{2.82 \times 10^{-7} n_c^2 I^2}{p} \text{ lb. per sq. inch} \quad (1)$$

This formula gives the stress due to the leakage field in any gap between coils (see Fig. 1) in terms of the number of turns effective at the particular gap, the length of leakage path and the current flowing.

The term $n_c I$ equals ampere-turns effective between coils where the stress is calculated, the current being that for which it is desired to calculate the stress, presumably the short-circuit current. The length of the leakage path, l , is taken empirically as $\sqrt{l_1 l_2}$. (See Fig. 2.)

The preceding formula is very convenient for calculating the stress when the limiting value of current is known; but when the current is limited by the reactance of the transformer, with full voltage applied, the following formulae are of convenience to the designer in showing just how the design may be altered to the best advantage for reducing or limiting the stresses.

Confining n_c in equation (1) to its maximum value, which occurs between the primary and the secondary coils, we may substitute for I the value obtained by dividing the voltage of the transformer by its reactance (neglecting the resistance component of the impedance).

The approximate formula for reactance, as obtained from equation (9) of the former article (Dec. 1912 issue of the REVIEW) is

$$X = \frac{2.7 f n^2 (mlt) d}{10^7 l G} \text{ ohms} \quad (2)$$

where f is the frequency, and n the total number of turns in the transformer winding.

The term (mlt) stands for mean length of turn (see Fig. 2) and is one dimension of the leakage area and d the other.

$$d = \frac{X}{3} + \frac{Y}{3} + Z \quad (3)$$

is the distance between primary and secondary windings plus one-third of the distance through the high-tension and the low-tension coils (including ducts) of a single group of coils (see Fig. 1). G is the number of such groups of coils.

Equation (2), and those which follow in this article, apply only when the number of turns in all of the coil groups of the transformer are equal, so that the total number of turns in a transformer is

$$n = n_c G \quad (4)$$

Attention should be called with emphasis to the fact that, since the maximum stress in the transformer is that found in the gap between high-voltage and low-voltage coils where n_c is maximum and is proportional to $(n_c \text{ max.})^2$, no transformer is properly designed from the standpoint of mechanical stresses which does not have equal numbers of turns in all high-voltage—low-voltage groups. Unequal grouping will increase the reactance somewhat for a given number of groups, thus reducing the factor I in equation (1), but $n_c \text{ max.}$ will be increased much more than I will be reduced. Unequal grouping is also unfavorable from the standpoint of eddy-current loss. Only designs of equal grouping are considered in this article.

From equation (2), we now have

$$I = \frac{E}{X} = \frac{10^7 l G E}{2 f n^2 (mlt) d} \quad (5)$$

whence, substituting this value of I in equation (1)

$$S_{max} = 7.05 \times 10^6 \times \frac{E^2}{f^2 n^2 (mlt)^2 d^2} \text{ lb. per sq. in.} \quad (6)$$

The only quantities appearing in equation (6) that can be changed in the design are n , (mlt) and d . These quantities appear also in equation (2) for the reactance. A study of these two equations will show how the stress may be limited to a required safe value with a minimum increase in the reactance. Attention must also be given, of course, to the effects which the changes in the quantities n , (mlt) and d have upon the other characteristics of the transformer, such as cost and efficiency. The designer will note, also, that these quantities are not independent of each other, as an increase in n for instance with constant magnetic density in the core will result in a decrease in the cross-section of the core and consequently in

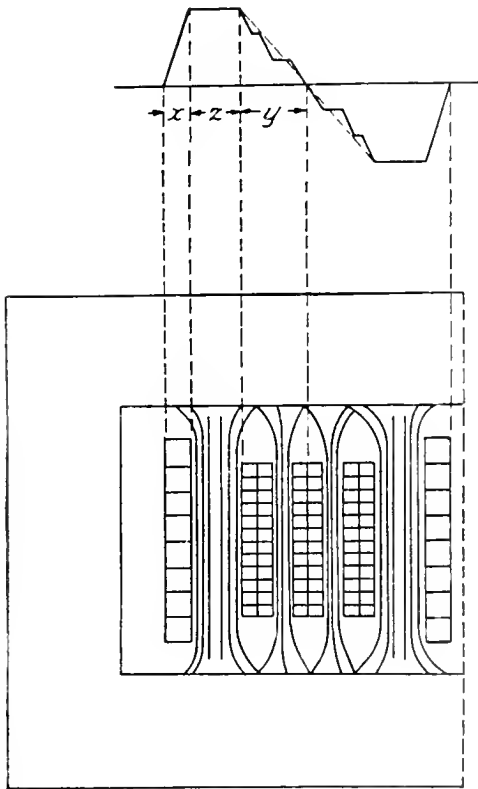


Fig. 1. A Sectional View taken through the Conductors of a small Shell-type Transformer

the dimension (mlt) , though the decrease in this dimension will not be in the same proportion. It requires one who is familiar with all of these relations to interpret the equations to the best advantage for any particular case.

An increase in the number of turns, with a corresponding reduction in (mlt) to maintain constant density in the core, will increase the reactance by a larger factor than that by which the stress is reduced, since (mlt) appears in the numerator of equation (2) in the first power and in the denominator in equation (6) in the second power. If the size of the core is not changed, keeping (mlt) constant and allowing the flux density to decrease as the number of turns increases, the factor of increase in the reactance is the same as the factor of decrease in the stress, since n appears in the second power both in the numerator of equation (2) and in the denominator of equation (6).

Having a constant flux density in the core, allowing the dimension (mlt) to reduce as n increases, the cost will increase or decrease depending upon the number of turns as compared with the cross-section of the core, since there is a definite relation of these two quantities which gives the minimum cost. On the other hand, their relative values may be varied through a considerable range on either side of this most economical relation with but a small increase in cost. But if the design is varied too much, by increasing the number of turns with a corresponding reduction in the cross-section of the core, the cost will begin to increase rapidly.

Where the cross-section of the core remains constant, permitting the flux density to decrease as the number of turns is increased, the cost of the transformer will always increase with increased number of turns.

Turning our attention now to the factor d , a decrease in the number of high-voltage—low-voltage coil groups will increase the X and Y terms of this factor. Since these terms are divided by 3, however, and since no change is made in the Z term (distance between primary and secondary), the increase in the value of d is much smaller than the decrease in G . It is seen, therefore, that the increase in reactance is much larger than the decrease in stress since, while d appears in the second power in the denominator of equation (6) and only in the first power in the numerator of equation (2), G is found in the denominator of equation (2) and not at all in equation (6). This change will always result in a reduction of cost, however, since the necessary length of the magnetic circuit is reduced by the elimination of some of the insulation spaces between the high-voltage and the low-voltage groups.

On the other hand, if the value of d is increased by increasing the distance between the high-voltage and the low-voltage windings, without changing the number of groups (increasing the Z term only), the decrease in the mechanical stress at short circuit is large as compared with the increase in reactance. Moreover, since this term (Z) enters into d at full value, this is an effective manner of reducing the stress. It results in an increase in cost, however, due to the necessary increase in the length of the magnetic circuit. This is often the only method by which the stress may be limited to the desired value without excessive reactance, and without excessive loss due to eddy currents, which, as shown in the former article (Jan., 1913, issue of the REVIEW) is proportional to the square of the maximum density of the leakage flux, or to n_s^2 . It is always necessary to consider this loss in high-reactance transformers and it must be calculated as well as the mechanical stress and the reactance.

Equation (6) may be somewhat simplified, reducing the number of constants to a single numerical value, by substituting the value of E from the fundamental voltage equation of the transformer, namely

$$E = \frac{\sqrt{2} \pi f n \phi}{10^8} \quad (7)$$

whence

$$S_{max} = 1400 \frac{\phi^2}{(mlt)^2 d^2} \quad (8)$$

where ϕ is the total flux of the transformer, i.e., its maximum value.

Although not so convenient as equation (6) for studying the relation of the mechanical stress (as affected by various factors of design), to the reactance of the transformer, equation (8) shows more clearly the direct relation of some of these factors to the mechanical stress.

This equation shows again that the stress is reduced by reduction in the flux, with (mlt) constant, which means an increase in the number of turns with constant cross-section of core. It shows also that the stress is reduced by increase in (mlt) , with constant flux, which means a constant number of turns and an increased cross-section of the core. The flux density of the core is reduced in either case, which shows very clearly that high flux densities in the core result in increased mechanical stresses. With a given cross-section of the core, the stress is proportional to the square of the flux density.

This conclusion is based upon the assumption that the change in the number of turns accompanying the change in flux does not affect (mlt) or d , which is not correct unless it can be effected by the elimination of an entire high-voltage—low-voltage group.

The effect of increased kv-a. capacity upon the mechanical stresses may be seen from equation (8). Thus, if we start from a normal design for a 250 kv-a. transformer and increase all dimensions alike, keeping the same magnetic and current densities in core and windings, and assume that the space factor is not changed, a 4000 kv-a. transformer will have all the dimensions doubled, and the total flux ϕ will be multiplied by four. The two factors in the denominator, which are dimensions, are both doubled, while the factor in the numerator is multiplied by four. The stress is, therefore, the same as before. This conclusion is based upon the assumption that d was doubled, which means not only that the space factors within the high-tension and the low-tension groups of coils have not been reduced by the increased size of the transformer, but also

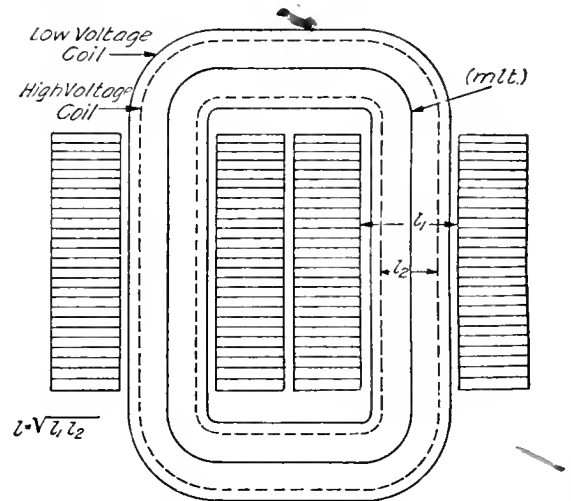


Fig. 2. A Sectional View Parallel to the Conductors of a small Shell-type Transformer

that the distance between the high-tension and the low-tension has been doubled. Since the space factors are actually reduced, the distance between the high-tension and the low-tension must be more than doubled to give this result. Also, if in accordance with common practice, the number of groups has been increased in the larger transformer,

which would reduce the value of d , the distance between the high-tension and the low-tension must have been still further increased to give the same value of d as that used before the grouping was changed. Normally, from the standpoint of insulation, the distance between the high-tension and the low-tension would be the same for the large transformer as for the small one. It is thus seen that with otherwise normal design the stresses will be much larger in the large transformer than in the small one and that, in order to limit them to the same value, the cost of the transformer must be considerably increased above that of the otherwise normal design.

The greater the capacity, and the lower the voltage, the greater will be the extra cost for limiting the stresses. There is a point where the cost will be less to supply an external reactance in connection with the transformer, for limiting the current and thereby the stresses in the transformer, than to adopt the abnormal and expensive design that would otherwise be required for this purpose.

It is interesting to note that if the value of I in equation (4) be substituted for but one of the factors in equation (1), the result will be

$$F_{max} = 1.41 \frac{EI}{fdG} \text{ lb. per sq. inch.} \quad (9)$$

This is the equation obtained by Dr. Steinmetz in his paper on "Mechanical Forces in Magnetic Fields."*

Dr. Steinmetz's derivation for this formula is as follows:

Assume that the secondary group is moved toward the primary group until the centers of the groups coincide. The turns of the primary coils cut the leakage flux producing a voltage

$$e = n \frac{d\phi}{dt} 10^{-8}$$

The work done during this motion is

$$\omega = \int e I dt = n I \phi \times 10^{-8} \text{ joules}$$

but

$$\phi = \frac{Li}{n} 10^{-8}$$

whence

$$\omega = I^2 L$$

The energy stored in the magnetic field, which has been eliminated was

$$\omega_1 = \frac{I^2 L}{2}$$

The mechanical work done is

$$\omega_2 = \omega - \omega_1 = \frac{I^2 L}{2} = F d g 10^{-7} \text{ joules}$$

where d is a distance in centimeters corresponding to the force F in grams which existed in the initial position, and g the acceleration due to gravity is 981. This gives

$$F = \frac{I^2 L}{2gd} 10^7 \text{ grams.}$$

Substituting the value of L from the equation

$$E = 2\pi f L I$$

we obtain

$$F = \frac{EI}{4\pi fgd} 10^7 \text{ grams per sq. cm.}$$

Reducing to practical units,

$$F = 0.705 \frac{EI}{fd} \text{ lb. per sq. inch}$$

where d is in inches. This value of F corresponds to the effective values of voltage and current, and is the average force. The maximum value will be proportional to the product of the maximum values of current and voltage, so that

$$F_{max} = 1.41 \frac{EI}{fd} \text{ lb. per sq. inch.}$$

This force corresponds to a single group of coils, the voltage E being the proportional part of the total voltage of the transformer corresponding to this group. If E is the total voltage of the transformer, and the groups of coils all have equal numbers of turns, and are equally spaced so that the total voltage will be divided equally among them, the force corresponding to each group, and therefore to the entire transformer, is

$$F_{max} = 1.41 \frac{EI}{fdG} \text{ lb. per sq. inch.}$$

This equation does not show the distribution of the stresses within the transformer, nor the effects of the factors of design upon the stresses.

Tests have been made to confirm the calculations made for the total force developed in a transformer. The formulæ for these calculations, which have been given in the former article, are

$$F_{max} = 2.82 \times 10^{-7} \frac{ng^2 I^2 (mlt)}{l} \text{ pounds} \quad (10)$$

and

$$F_{ave.} = 1.41 \times 10^{-7} \frac{ng^2 I^2 (mlt)}{l} \text{ pounds} \quad (11)$$

* A.I.E.E. Proceedings, December, 1910.

A description of the tests referred to will now be given. Two sets of low-tension coils from 25-cycle, self-cooled, 200 kv-a. transformers of 33,000/3300-volt rating were assembled loosely on the same core, with

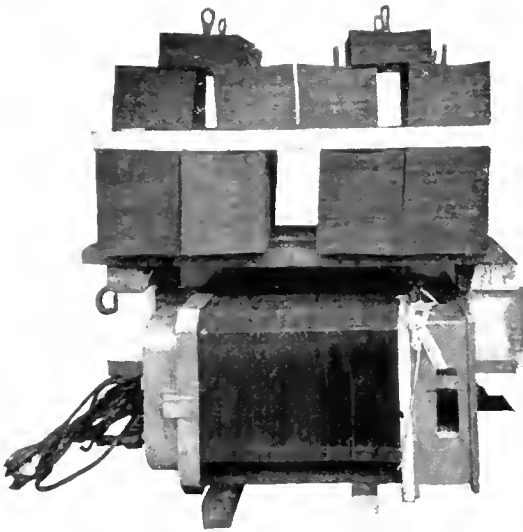


Fig. 3. A Photograph Showing the Scheme Employed for Experimentally Testing the Correctness of the Mechanical Stress Calculations

pressboard collars between the coils. With the core on its side and the coils in a horizontal position, channel irons were placed through the openings supporting a platform upon which weights were placed. The eight coils were connected, four as primaries and four as short-circuited secondaries, and, with different weights upon the platform, the voltage and current were increased until the weights were lifted (see Fig. 3). As the current increased a point was reached where vibration began. The vibration became more and more violent until the weights were actually lifted. The current which caused vibration to begin was that giving a maximum force equal to the weight lifted (equation 10), while the current which lifted the weights was that corresponding to an average force equal to the weight (equation 11). Up to a point where primary and secondary coils began to separate, lifting the weights, the current and applied voltage were directly proportional to each other. If the voltage was increased beyond this point, the distance between the primary and the secondary coils was increased, giving increasing reactance, while the current increased very little. The height to which the weights were lifted

depended upon the separation between the primary and the secondary which was required to give a reactance voltage corresponding to the applied voltage. The data for the calculation of the forces by equation (11) are, in this case,

$$(mlt) = 9.65 \times 12 = 116 \text{ in.}$$

$$l = 8\frac{1}{2} \text{ in.}$$

$$n_g = 41 \times \text{number of coils effective.}$$

The results obtained from these tests are given in Tables I and II.

TABLE I
TESTS AT 24 CYCLES

Coil Arrangement	Current	Voltage	Per Cent Full Load	Lifted	Calculated
S-P-S-P-S-	325	218	535	* 400	340
P-S-P	505	365	834	*1000	825
	597	485	987	*1600	1155
	732	650	1210	*2200	1750
	764	675	1260	*3400	1885
P-S-S-P-P-	370	450	610	1700	1765
P-S-S	444	675	732	*2900	2540
	582	800	960	*5300	4370
S-S-S-S-P-	125	300	206	700	805
P-P-P	168	607	277	1300	1450
	203	712	335	1900	2120
	230	848	380	2500	2730
	276	908	455	3700	3920
	314	1130	518	*5500	5080
	401	1365	661	7900	8290

TABLE II
TESTS AT 40 CYCLES

Coil Arrangement	Current	Voltage	Per Cent Full Load	Lifted	Calculated
S-S-S-S-P-	128	930	211	700	844
P-P-P	170	1030	280	1300	1490
	202	1160	333	1900	2100
	230	1350	380	2500	2720
	261	1530	430	3100	3510
	285	1725	470	3700	4200
	336	1680	552	5500	5810

The tabulated weights in the "lifted" column include the weights of the coils, the channel irons, and the platform. The readings were necessarily rough, since they had to be taken hastily in order to prevent the weights from being shaken off the platform and the coils from getting too hot. The weights indicated by the asterisks(*) were not actually lifted, the tests having to be stopped too soon for the reason stated.

A SURVEY OF THE REFRIGERATION FIELD AS IT EXISTS TODAY

BY H. I. HOLLEMAN

CONSTRUCTION ENGINEERING DEPARTMENT, GENERAL ELECTRIC COMPANY

Refrigeration as applied to the preservation of perishable products has long been practiced, but the attention which has been given the art as a means of increasing human efficiency and comfort has not been commensurate with its possibilities. The following article briefly reviews past and present work, then predicts the future developments of refrigeration as applied to bettering living conditions, and finally describes the benefits which will be derived therefrom by the electrical industry.—EDITOR.

The addition of heat to various substances under various conditions for various purposes that tend toward the comfort and general advancement of the human race, is a practice which dates from pre-historic times. On the other hand, the *extraction* of heat, which, taken in its broader sense is of but slightly less importance, has been left to the present generation to bring into its fullest development.

The addition of heat had an early origin probably because of the fact that it was practically necessary, that the process was easy, and that the needed materials were readily obtained; whereas, the delay in the use of heat extracting mediums can be attributed to the fact that practically the reverse conditions existed. Today, however, the efficiency of every individual and the preservation of the perishable products of his labors are of such vast importance that heat extraction or refrigeration has become a necessity. Its practicability has been secured through the advancement of science, which has put within our hands the necessary mediums and machines for its successful accomplishment.

The great drawback now is the cost. This, however, is of small importance compared to the benefit derived; and it merely remains to give the public at large the correct viewpoint, before refrigeration will become practically as common as heating. The value of refrigeration to humanity is impossible of expression in terms of dollars and cents. For instance, what is the value of a ticket for a theater which is too warm for comfort as compared to one for the same theater when refrigerated to a comfortable temperature? Or what is the relative efficiency of men working in rooms at 70 deg. F. and 90 deg. respectively? Or how much more fit for a day's work is a man who has slept in a room at 70 deg. F than a man who slept in a room at 90 deg? The value of refrigeration as a preservative of food products is well recognized and yet there is no way of estimating the vast saving accomplished each year in this manner.

There are a great many ways of refrigerating; in fact, so many that this article could not cover even a brief description of them. However, we can classify refrigeration under three general heads as follows:

1. By natural ice.
2. By refrigerating mixtures.
3. By mechanical refrigeration.

Refrigeration by natural ice is of great importance in the colder climates. The unreliability of the supply and the high cost of transporting the ice to the warmer climates make this form of refrigeration of small importance, however, when the subject is considered as a world-wide proposition. According to some of the most eminent authorities, the application of this form of refrigeration (even in the colder climates) is rapidly on the decline and it is predicted that the near future will see mechanical refrigeration replace that by natural ice in the majority of its uses.

The use of refrigerating mixtures is of still less importance than the use of natural ice. In fact, at its present development, it is of practically no commercial value.

This then brings us to the last general class, which is the one most widely used today and the one upon which we must rely for future development. Under this head, we have two subheads which include all mechanical refrigerating systems that are of real commercial importance, viz.:

1. The compression system.
2. The absorption system.

The compression system is the one in which a gas is compressed and cooled under compression (usually to a liquid) and is then expanded; and, in expanding, absorbs heat from the material to be refrigerated either directly or indirectly. The expanded gases are then drawn into the compressor again and thus the cycle is completed.

The absorption system is the one in which the expanded gas is absorbed by a liquid whose evaporating point is much higher than that of

the refrigerant. The mixture is then heated, driving off the refrigerant as a gas at a high pressure. This gas is then cooled under compression (usually to a liquid) and expanded as in the compression system, the expanded gas being absorbed in the simpler systems by another tank of absorbing fluid which in turn is heated.

Each of these systems requires power in some form in order to operate. The compression system, which bids fair to become the most popular, requires more; and herein lies one of the greatest opportunities for the future expansion of the electrical industry. The uses of refrigeration are many, and the total power load required when developed is enormous. The applications of refrigeration can be classified under two of the general heads mentioned before, viz.:

1. Refrigeration for the preservation of perishable products.
2. Refrigeration for the comfort and increased efficiency of humanity.

There has been so much said and written about the former, that the importance of the latter has been neglected. It is, therefore, to this latter class that it is wished to call attention. The one great function in this field is the cooling of workshops, offices, sleeping rooms, public halls, etc. When we consider that such a tremendous portion of the habitable surface of the earth (the tropical and semi-tropical countries) is more in need of refrigeration than heat for buildings, we are astounded to see what little progress has been made in this direction. There is, of course, a greater cost to refrigeration but it is not as great as we would at first imagine.

If we compare heating with refrigerating it will be seen at a glance that, in comparison with direct heating from coal or wood, the cost of refrigeration will be excessive, since the B.t.u. in generated power is seldom greater than 12 per cent of the B.t.u. in coal. However, if we compare refrigeration on the same basis as heating (that is, refrigerate and heat with same form of power, say for instance electricity) it will be found that much less power is required to refrigerate under average summer conditions than to heat under average winter conditions.

Take for example the heating of a room in winter as compared to the cooling of it to a comfortable temperature in summer.

Assume a room 12 ft. by 15 ft. by 10 ft., with an average radiation of 0.2 B.t.u. per hour per degree difference per sq. ft. surface,

and with one change of air per hour at 1 B.t.u. per 50 cu. ft. of air degree rise in temperature.

Radiating surface of the room = 450 sq. ft.

Cubical contents of the room = 1800 cu. ft.

Temperature at which the room is to be kept = 70 deg. F.

Take the average temperature of atmosphere in the winter as 30 deg. F.

Taking the average temperature during the summer months as 90 deg. F.

Assume the cost of electric current as 2 cents per kw-hr.

The heat units per hour necessary for maintaining the room at 70 deg. F. during the winter amount to

$$0.2 \left(450 + \frac{1800}{50} \right) (70 - 30) = 3744 \text{ B.t.u.}$$

On the other hand, the heat units per hour necessary to be absorbed from the room in order to maintain it at a temperature of 70 deg. F. during the summer amount to only

$$0.2 \left(450 + \frac{1800}{50} \right) (90 - 70) = 1870 \text{ B.t.u.}$$

To reduce these figures to comparative costs, we find that the 3744 B.t.u. per hour for heating corresponds to 1.1 kw-hr., which at 2 cents per kw-hr. equals 2.2 cents per hour or 52.8 cents per day of 24 hours.

According to the best authorities, we find that a small ice plant will produce a ton of ice for \$1.50 per ton (including all overhead charges etc.), when buying power at 2 cents per kw-hr. A ton of ice represents a cooling effect of 364,000 B.t.u. From this we see

that one ton of ice will cool $\frac{364,000}{1870} = 141$ such

rooms, or each room will cost $\frac{1.50}{141} = 1.06$ cents

per hour or 15.45 cents per 24 hours for refrigeration as contrasted against 52.8 cents for heating electrically.

Applying the above to hotels, as being the easiest way to estimate the value of refrigeration, we feel safe in saying that that portion of the traveling public which would refuse to pay 15 cents a day for a refrigerated room is quite small. Also, when we take into consideration the fact that the size of the plant necessary for hotel refrigeration would be large and would produce refrigeration more cheaply than the plant under consideration, and that the rooms under most conditions would only need refrigeration for 10 hours per day, and that hotels can be built with a much smaller

radiation factor than those of today, it is easy to see that the actual cost per room for refrigerating a hotel will be very low in comparison to the comfort derived. The same is true when applied to theaters, churches, sleeping rooms, workshops, office buildings, etc., but each needs to be approached from a different angle in order to properly realize the value in each case.

It has been predicted, by those in best position to know, that refrigeration will some day be to the South what heating is now to the North. The uses of refrigeration in tropical countries are almost innumerable; and even in the southern part of this country we find that the physical and the mental well-being of a large portion of the population suffer from continued excessive heat. In that section of this country, the refrigeration of sleeping rooms, hospitals, schools, and public halls would be of incalculable value.

It takes but a glance at the situation to realize that the possibilities for such use of electric power are vast; and it is to be hoped that the large power companies will soon be brought to realize this condition and wage an

active campaign for the double purpose of profit and education.

It is only within the last few years that the central-station management has begun to realize the possibilities of a marked increase in their load factors resulting from the use of electric power in ice plants.

Since that time, electrically-driven ice plants have sprung up all over the country, both as isolated plants purchasing power from a central station and as those in connection with and a part of a central station. When we analyze a refrigeration load, such as one of those previously enumerated, we find that it is just as beneficial for the central station as for the ice plant and is, moreover, much greater in its possibilities. It is easier to show profit in applying refrigeration to the preservation of a product than in applying it for increasing the efficiency of the producer; therefore, the producer has suffered. However, judging from the reports published in the engineering magazines of the installation of refrigerating plants in some of the new theaters, hotels, offices, buildings, etc., we believe the time has come when the producer's welfare will be valued as highly as his product.

FACTORY LIGHTING

BY G. H. STICKNEY

EDISON LAMP WORKS, HARRISON, N. J.

The lighting of factories and offices has received a great deal of attention during the past few years, and we have published several articles in the REVIEW on this subject. Not so long ago the matter was given little attention; but it did not require much time for the illuminating engineer to prove conclusively to the manufacturer that it was poor economy to keep down the light bills at the expense of the workman's efficiency and the quality of his product. The campaign inaugurated in the cause of safety has focused further attention on the subject of correct lighting; and in this article, which was presented at the Safety and Sanitation Conference held under the auspices of the American Museum of Safety, it is shown that it is not sufficient to provide merely enough light, but that the position of the light sources and the proper diffusion of the light are important factors in securing the best illumination, with the least fatigue to the workmen's eyes.—EDITOR.

Believing as I do, that good lighting in factories is one of the most effective agents in promoting industrial safety, I especially appreciate the privilege of being designated by the Illuminating Engineering Society to address you on the subject.

While a very conspicuous advance in lighting methods has been made by progressive manufacturers, notably in the iron and steel industry, there are still a large number of manufacturers who seem to regard the lighting as an expense to be reduced to the lowest possible minimum.

The increased appreciation of daylight is indicated by the modern type of building construction; in which the light-finished, high studded workroom, with large window

areas, often equipped with diffusing glass, and sometimes supplemented with saw-tooth roofs, permits the fullest possible utilization of natural light.

It is in the artificial lighting, however, that the greatest progress has been made. The wonderful developments in high efficiency units have greatly enlarged the possibilities of factory lighting during the hours of diminishing daylight and darkness, or in places where daylight can not penetrate; so that now a proper lighting installation is not only an important safeguard, but an actual economy. Manufacturers who are today securing poor illumination with older form of illuminants, can by a revision of their lighting equipment, procure a good

illumination, not only without much additional cost, but in many cases with an actual reduction in the operating cost.

The Association of Iron and Steel Electrical Engineers, in 1910, turned their attention to good lighting as a means of accident prevention. They found, as a result of probably the most extensive investigation of the subject that has as yet been made, that a higher standard of illumination was demanded for efficient manufacturing than simply for accident prevention. Their report of progress, presented at the convention in September, 1913, showed from actual figures that in the last two years the amount of illumination furnished in iron and steel mills has increased 35 per cent; and in this connection, it is interesting to note that this 35 per cent increase was accompanied by a reduction of five per cent in the power consumption.

The economic value of good illumination, aside from accident prevention, is evident when we consider the greater facility with which an employee can work under good illumination, and the greater accuracy with which gauges can be read and tools set.

One large manufacturer, on investigating his lighting conditions, found certain departments in which, during the winter months, the operatives were practically idle for about an hour a day solely on account of darkness.

Good artificial illumination can be furnished in such a factory for eight hours a day at a cost equivalent to about five minutes of the time of the workmen benefited. This illustrates the extravagance of poor lighting. If time permitted, one could readily demonstrate that, for a great variety of conditions, good illumination reduces the manufacturing costs by increasing production, raising the quality of workmanship and reducing the number of defective parts and "seconds."

The question of safety as influenced by illumination presents two phases: First, the prevention of accidents; and second, the preservation of eyesight. While these two phases are often closely related, there are many conditions in which they are entirely independent of each other. The phase of accident prevention is illustrated in the case of the foundry or other shop where cranes or other powerful machinery are in operation.

The liability of crane and elevator accidents is very much reduced with proper lighting.

In the foundries and yards of a plant, it is practically impossible, even with safety

committee inspection, to eliminate irregularities under foot. If not illuminated these may readily cause falls, with resulting injuries; and in foundries where molten metal is carried and hot metal abounds, they may often cause serious burns.

Even though guarded to the fullest extent, powerful machinery—in which materials are machined and fashioned into articles of commerce, and in which the arms and limbs are as readily crushed—presents a menace unless the operatives are given an opportunity to see and thus avoid the danger points.

Now let us consider the preservation of the eyesight. Although the blind are trained to do remarkable work in certain lines, there is practically no manufacturing operation in which a blind person is not at a disadvantage, while there are many which cannot be carried on without accurate visual inspection. Some of these operations produce considerable strain even under good illumination, and to require their performance under poor illumination is certain to result in more or less rapid impairment of vision. While economy should in all cases require the best lighting practice, humanity demands it.

In view of the preceding discussion, one might very properly ask: "What is good illumination?" Judging from some of the attempts that have been made to solve lighting problems, the conclusion might be drawn that simply a higher intensity of light is the answer. Undoubtedly a higher intensity of illumination is needed in most workrooms, but there are other features of equal and sometimes greater importance. The minimum intensity acceptable generally depends upon the reflecting power of the surfaces to be seen, the fineness of the detail to be observed, the time of observation and the closeness of application. Unless glare be introduced, a higher intensity of light is rarely objectionable, except from the standpoint of cost.

Owing to the remarkable adaptability of our eyes, we are able to get along satisfactorily with very much lower intensities of artificial light than are usual with natural light. The gain secured by the increase of intensity is not proportional to the intensity, and there is a point beyond which the gain would not warrant the additional cost. However, the standard of artificial lighting intensities is being raised, on account of the lessening cost of light, increasing cost of labor and overhead charges, and especially the increasing appreciation of the value of light.

Perhaps the best way to consider the other feature of good illumination will be to point out some of the most common shortcomings found in factory lighting.

From my own observations, the most common defect is excessive glare and absence of diffusion. Glare is usually caused by bright lights in the field of vision. This may emanate directly from the light source or may be reflected to the eye by a glossy surface; it can also be caused wherever excessive contrast of intensity appears in adjacent fields of vision. The dazzling effect is not only unpleasant, but interferes with seeing. Under continued exposure, eye strain and even permanent injury to the eye may result.

I have seen lights intended to illuminate stairways so arranged that, on descending, one could hardly see where to step on account of the glare. Such conditions are conducive to bad falls, whereas if the eyes were properly shielded from the glare, a lower intensity would have been ample.

The unshielded light hung over a machine is a common source of eye fatigue. The glare may not be very evident at first glance, but when the workman's eyes have been subjected to such light for a long time, discomfort and inability to see result.

The workman frequently complains of insufficient light when in reality the intensity may be higher than is required for the work. In case an attempt is made to meet the complaint by installing a larger light, the workman's eyes are subjected to a still more severe strain. The proper correction should be to shield the light by means of a proper reflector, and as such a reflector would tend to direct more of the light upon the work, the working intensity would be increased; so in many cases it is possible to reduce the size of the lamp, or better yet, to relocate the lamp so as to enlarge the area illuminated.

When a light can not be removed entirely from the field of vision, its brilliancy should be reduced by means of diffusing globe or reflector, so as to increase the apparent size of the light source and reduce the contrast between it and the background. This has the additional advantage of reducing the sharpness of shadows in the illumination, a result which is of considerable importance in rendering the various parts of a machine or other object readily discernible.

Glare received from specular reflection of glazed paper, desk tops, polished metal, etc., often induces eye trouble, headache, and other

indispositions; though the sufferers may not be aware of the cause. The remedy is to change the relative positions, so that the reflected light is kept out of the eyes as much as possible, and to enlarge the dimensions of the light source, as already mentioned.

Another defect commonly found in industrial lighting is improper distribution. This may be due to too wide a spacing of lighting units. Under this condition some parts of the room are insufficiently lighted while other parts may have more light than is necessary.

Improper direction of light may illuminate the wrong side of the machine, leaving the important parts in shadow. If the bright parts are near the shaded ones whatever illumination may fall upon the shaded portion is rendered less effective by contrast.

Unsteady or flickering illumination is always objectionable; both on account of discomfort and the inability to see. Such variation should always be avoided, whether caused by the units themselves or by the light passing through moving wheels, etc.

Since the purpose of the lighting is to enable the operative to see, good illumination can not be prescribed until we have some knowledge of the use to which it is to be put. In order to plan the lighting of a factory properly, one should be familiar with the processes employed, the arrangement of the machinery and the work tables, as well as the quality of the product manufactured. Practice has established certain methods of lighting which, if properly applied, are satisfactory for the different processes of manufacture. Thus we know approximately how much illumination is necessary for the ordinary grade of work as performed on a lathe, as well as the direction desirable. As far as possible, therefore, the experience gained in well-lighted factories should be utilized in planning the lighting installation. The pamphlet entitled "Light; Its Use and Misuse" which has been issued by the Illuminating Engineering Society, is full of useful suggestions in connection with the lighting problem, while the pamphlet, "Modern Industrial Lighting" issued by the Commercial Section of the National Electric Light Association, endeavors to make some specific application of this information. A similar booklet has been issued by the National Commercial Gas Association. Books and articles, manufacturers' publications, etc., furnish much useful data on this subject.

Where extensive lighting problems are to be solved, it is advisable to retain a competent engineer with illuminating engineering experience. However, the following comments on various methods of factory lighting will give some idea of the general practice.

The practice in factory lighting has developed along a few fairly definite lines, which may be designated as localized lighting, general lighting, combined general and localized lighting and localized general or group lighting.

Localized lighting originated with the low power portable or semi-portable lighting units. These were under the control of the individual workman, to be placed or shifted wherever he desired. Such lamps were commonly used without reflectors and produced small patches of uneven illumination, as well as more or less glare. In many cases lighting with these lamps is now being supplanted by other methods, on account of the following disadvantages. Lamp breakage is likely to be high, and the expense for installing, energy supply and maintenance excessive, depending upon the conditions and arrangement of work. Moreover, the attention of the workman is called to the lighting and much time is often lost from his regular work in adjusting the lamp. There are, however, certain operations which require light inside of a small cylinder or other enclosed space; or where very high intensities are required over small areas, and for these no other method is as practicable as localized lighting. For such conditions, the lamp should be equipped with a reflector to shield the workman's eyes and reflect the light in useful directions. Localized lighting should also be used in connection with general lighting, as referred to later.

"General lighting" came into common practice with high power lamps. Since with these units economy makes a wide spacing necessary, the best method of applying them is to equip them with diffusing globes and reflectors, so arranged as to distribute the illumination as evenly as possible. Lamps are hung high, in proportion to their power and the intensity required, and equally spaced throughout the room. The ideal sought is equal intensity over the entire area. General lighting is provided in three principal ways, which are known as direct, indirect and semi-indirect lighting. With direct lighting, the larger part of the light is distributed directly from the lighting unit to the surfaces to be lighted. With indirect lighting, the

light source is concealed and the light thrown upon the ceiling or wall and thence redistributed for use. With the semi-indirect lighting, the light source is shaded by a translucent reflector and the larger part of the light thrown upon the ceiling or walls for redistribution. Direct lighting, depending upon the equipment, may have excessive brilliancy or any degree of diffusion. It is used to a much larger extent in factory lighting because factory ceilings are seldom good reflectors. Direct lighting units are less affected by dust accumulations. The indirect and semi-indirect give excellent diffusion, and are often applied with good effect in offices and drafting rooms when light ceilings are available.

"Combined general" and "localized lighting" is often desirable. With this, a low general illumination is supplied by large units and more intense localized illumination at particular points by low power units. The localized lighting may be supplied continuously or temporarily as needed. For example, in lighting automatic machinery, a moderate illumination may be sufficient at all times except when a machine is being inspected, set up or adjusted, when a localized light may be needed for the particular machine.

"Localized general" or "group lighting" is a recent practice which has sprung up since a range of intermediate sizes of lighting units has become available. This practice differs from general lighting in that, instead of striving for even intensity throughout the room, lamps are arranged to give higher intensities and correct direction of light at the machines or tables and a lower intensity at intermediate points. It differs from localized lighting in being planned so as to give some illumination, sufficient for the needs, in all parts of the room. It is, therefore, an intermediate practice between the extremes of localized and general lighting. Its application is extending very rapidly, since it meets effectively and economically factory requirements for a large portion of the ordinary processes and buildings.

Each of these various methods of lighting has some field in which it is to be preferred to any of the others. The selection depends upon the character and construction of the building, the process of manufacture, the source of energy available and various local conditions.

That the progress in good factory lighting will be even more rapid in the future seems

unquestionable. The interest of the public has been indicated by the recent labor legislation passed in New York State; and the broad basis on which this is being undertaken is indicated by the fact that the Museum of Safety and the Illuminating Engineering Society were consulted with regard to those portions

of the law which had to do with factory lighting.

While good factory lighting is likely to be made compulsory by law, it is hoped that the manufacturers will be sufficiently awake to their own interest to take any necessary steps of their own initiative rather than through compulsion.

NOTES ON THE ACTIVITIES OF THE A.I.E.E.

Standardization Rules

A new edition of the A.I.E.E. Standardization Rules bearing the date of Dec. 1, 1914, is now in effect and supersedes the 1914 edition. Many radical changes have been made. Copies may be obtained from the office of the Secretary of the A.I.E.E., 33 West 39th St., New York City.

Institute Meeting in New York, Dec. 11, 1914

The 302d meeting of the American Institute of Electrical Engineers was held at the Engineering Societies Building, 33 West 39th St., New York, on Friday, December 11th. Two papers were presented at the meeting as follows: *Insulator Depreciation and Effect on Operation*, by Mr. A. O. Austin and *Effect of Altitude on the Spark-Over Voltages of Bushings, Leads and Insulators*, by Mr. F. W. Peck, Jr.

These two papers appear in the December issue of the Proceedings of the Institute.

LYNN SECTION

On December 2d, Prof. Elihu Thomson addressed a meeting of about 370 members on *Wireless Telegraphy*.

The lecture was illustrated with numerous lantern diagrams. Prof. Thomson first spoke of very early experiments by himself and Prof. Houston, which were conducted much before those of Hertz, and which showed definitely the propagation of ether disturbances to distances very great in proportion to the dimensions of the apparatus employed. He then showed by means of a series of well chosen diagrams the close relation of wireless to metallicly-directed transmission, and pointed out the difference between the conditions obtaining in a Hertzian oscillator and a wireless transmission. It was shown how one-half of the figure which represents the ether disturbance, in the case of the Hertz experiments, is absent in wireless transmission, being suppressed by the conducting surface of the earth. The importance of the

conducting surface, principally the salt water surface of the earth, was carefully brought out, and the effect of dry earth masses in obstructing the waves was described. It was also shown how interference waves may occur when alternative paths of different lengths are present.

The manner in which the wireless waves follow the earth's surface was illustrated, and Prof. Thomson explained his theory of why this should be as it is. It is to the effect that the surface electric currents which are necessarily positioned in the water surface of the earth, compel the electrostatic and electromagnetic waves with which they are untied to follow the earth's curvature. The losses due to corona were mentioned and an explanation of daylight wireless transmission losses was proposed, which was to the effect that the liberation and re-absorption of ions produced by ultra-violet ionization caused a frittering away of the energy of the waves.

On December 14th, Mr. Howard W. DuBois, Consulting Mining Engineer, spoke in Burdett Hall to a large audience. The subject was *Alaska, Our Land of Midnight Sun*. The speaker outlined some of the large hydro-electric projects in connection with mining operations, spoke of the Government's new railroad policy, and made extended reference to Alaska's agricultural possibilities. The Alaskan coal deposits and the large scale mining operations in connection with low grade gold ores and the very high grade of copper ore in the Copper River district were described. The lecture was illustrated by 100 very beautifully colored lantern slides taken from photographs made by the speaker when in Alaska.

On January 6, 1915, a paper entitled, *Modern Views of Electricity* will be read by Prof. D. F. Comstock of the Massachusetts Institute of Technology.

On February 3, 1915, Major J. A. Shipton, United States Army, addresses the Section on a subject which will be announced in due course.

PITTSFIELD SECTION

At the November 19th meeting of the Pittsfield Section of the A.I.E.E. Mr. W. L. R. Emmet read a paper, illustrated by lantern slides, on *The Mercury Vapor Turbine*. The main outlines of the paper have been covered by the author in the GENERAL ELECTRIC REVIEW of January and February, 1914.

Prof. W. S. Franklin, of Lehigh University, will lecture to the Section on January 7th, his subject being *Electric Places*.

The Section each year conducts for its members, classes in advanced theory, the subjects this year being, Electro-chemistry and Electric Waves.

SCHENECTADY SECTION

The Ninth Season of the Schenectady Section of the A.I.E.E. was opened by an introductory address by Mr. F. C. Pratt on October 6, 1914. This was followed by an illustrated lecture by Mr. J. B. Taylor, entitled, *The Color of Light*.

On October 20th a lecture was given by Dr. E. J. Berg, on *Differential Equations used in the Study of Transient Phenomena*.

On November 17th a large audience was addressed by Dr. E. K. Mees, Head of the Research Laboratory of the Eastman Kodak Company, on the subject of *Methods of Photographic Investigation*.

On December 1st and 2d, Mr. J. B. Taylor addressed the Section on *The Choralcelo and Other Electrical Musical Instruments*.

Applications of electricity to the musical field were considered briefly under three general heads.

The use of electric motors, more as forms of mechanical energy, in which application the "blowing" of pipe organs is the most extensive. Automatic pianos or orchestrions make use of electric motors. Large solenoids have been used to strike the bells forming chimes in church towers.

In the second group electricity is used for control. Here again the pipe organ is the typical example; contacts are made on

pressing the keys, or on actuating the other devices which energize the magnets by electro-pneumatic valves controlling the admission of air to the pipes. This electric control, as distinguished from simple mechanical connections or tubular pneumatic action, gives quicker response, greater freedom of arrangement of the key-board and instrument proper, and affords the player a variety of effects and greater ease of handling.

In the third application, of which the choralcelo is an example, the musical tones themselves are produced more directly by the electric currents. The telharmonium was referred to and described briefly. In this instrument a "musical central station," consisting of 150 or more alternating current generators of different frequencies produce music at points more or less remote from the center of control through the medium of telephone receivers and wound re-enforcing horns.

In the choralcelo the musical tones are produced on steel strings like those in a piano. The strings are made to vibrate continuously by an electromagnet placed a few millimeters away and supplied with a pulsating current of the same frequency as the natural vibration period of the string. Similarly flat bars of wood or metal, of proper length and weight to correspond to the musical scale, are vibrated continuously by the application of electro-magnets. The variety of tonal effects available by various combinations of strings and bars as well as further variety from applying harmonic frequencies was demonstrated.

The December 15th meeting was devoted to the subject of *Abnormal Luminous Manifestations*. The speakers and their subjects were: "Lightning," by Prof. E. E. F. Creighton, and "Phosphorescence and Fluorescence," by Mr. W. S. Andrews. Each paper was accompanied by experimental demonstrations.

On January 5, 1915, Mr. S. H. Blake will read a paper on *Electric Illumination*. Mr. Halvorson and others will collaborate and there will be experimental demonstrations of an especially interesting nature.

FROM THE CONSULTING ENGINEERING DEPARTMENT OF THE
GENERAL ELECTRIC COMPANY

THE INFINITE DURATION OF TRANSIENTS

Many mathematical formulas relating to various operations of electricity pertaining to transients indicate that the transient period never ends—as oscillatory current never ceases to oscillate, the current resulting from suddenly applying a constant voltage to a circuit with self-induction never stops increasing in strength, etc., at least not within finite time. Such equations involve exponential functions of ϵ related to time, all of which lead to infinite time as essential to a steady electrical state.

We are told in the textbook that after a certain time the oscillatory current has “practically disappeared,” that in a fraction of a second, or within a few seconds, the difference between the rising current in the circuit with constant impressed voltage and its value at infinite time is “negligible,” etc. But they never imply that the theory of operations is defective in the slightest degree, or at least not in respect to the infinity of the time-element when the steady condition is attained.

The question once arose in the mind of the writer: Do the formulas correctly express the facts as to time, or do conditions exist that have not been taken account of, which, if embodied in the formulas, would show that a steady condition will be attained in finite time?

The possible influence of the increase in resistance due to the heating effect of the current, as an agent for bringing about a steady current flow in a finite time, was naturally thought of. Reasoning directly applied to the simple case of constant voltage applied to a circuit having only resistance and self-induction, and indirectly by analogy derived from other domains of physics involving the effect of heat, at first appeared to indicate a steady current in finite time; and likewise in the still simpler case of a circuit with only resistance, in which latter case, however, although the current instantly arrives at maximum value, and thus at zero time instead of infinite time, it is obvious that the heating effect of the current will at once begin to increase the resistance and decrease the current strength. But a little further consideration of the problem determined an opposite conclusion in both the above cases. As a matter of reasoning, the reader must be left to consider the subject, if he so chooses, in his own way.

An effort was made analytically to test the question from the heat standpoint for the simplest case, that of current in a circuit of simple resistance and constant voltage:

We then have

$$ir = E, \quad (1)$$

and the well-known empirical formula $r = r_0 (1 + \alpha h + \beta h^2)$, expressing the relation between resistance and temperature of a conductor. To condense, we will omit the last term, and write

$$r = r_0 (1 + \alpha h). \quad (2)$$

In fact, it would make no difference in the final result, so far as determining whether the current becomes constant in finite time, if we wrote $r = \theta h$.

The rate of heat generation in the circuit is Ei ; if the temperature of the surrounding medium is h_1 , which we assume constant with no detriment to the accuracy of the particular problem in hand, the

rate of heat dissipation will be expressed, with no inaccuracy for our purpose, by $\eta (h - h_1)$; whence the rate of heat accumulation will be $\delta [Ei - \eta(h - h_1)]$ and we have for the equation representing rate of temperature rise:

$$\frac{dh}{dt} = \lambda \delta [Ei - \eta (h - h_1)]. \quad (3)$$

From (1) and (2)

$$ir_0 (1 + \alpha h) = E, \quad (4)$$

or

$$h = \frac{E - r_0 i}{\alpha r_0 i}. \quad (5)$$

Differentiating (4)

$$di + \alpha h di + \alpha i dh = 0, \quad (6)$$

and substituting from (5) in (6)

$$dh = -\frac{E di}{\alpha r_0 i^2} \quad (7)$$

Substituting (5) and (7) in (3), and reducing, we finally have

$$\frac{E di}{[\lambda \delta \eta E - \lambda \delta \eta r_0 (1 + \alpha h_1) i - \alpha \lambda \delta r_0 E i^2] i} = dt, \quad (8)$$

which is of the form

$$\frac{E di}{(a + bi + ci^2) i} = dt.$$

Therefore,

$$\int_p^i \frac{E di}{(a + bi + ci^2) i} = \int_0^t dt,$$

whence

$$\frac{E}{2a} \log \left[\frac{i^2}{a + bi + ci^2} \right]_p^i - \frac{Eb}{2a} \left(\frac{1}{\sqrt{-q}} \log \left[\frac{2ci + b - \sqrt{-q}}{2ci + b + \sqrt{-q}} \right] \right)_p^i = t \quad (9)$$

in which $q = 4ac - b^2$ is < 0 , and $p = \frac{E}{r_0 (1 + \alpha h_1)}$

represents the current value at zero time, when the conductor will be at the temperature h_1 of the surrounding medium.

From the last equation, the value of the current i will include an exponential function of the logarithmic base e in respect to time. Therefore the heating effect of the current upon the resistance of the circuit will not cause the diminishing current to arrive at a steady value in finite time, and obviously the same may be said in respect to a rising current when self-induction is present.

The limiting or steady value of i in infinite time is

$$i_\infty = -\frac{\sqrt{-q} + b}{2c}, \quad (10)$$

which in the final numerical result will have a plus value.

CHAS. L. CLARKE.

QUESTION AND ANSWER SECTION

The purpose of this department of the REVIEW is two-fold.

First, it enables all subscribers to avail themselves of the consulting service of a highly specialized corps of engineering experts, or of such other authority as the problem may require. This service provides for answers by mail with as little delay as possible of such questions as come within the scope of the REVIEW.

Second, it publishes for the benefit of all REVIEW readers questions and answers of general interest and of educational value. When the original question deals with only one phase of an interesting subject, the editor may feel warranted in discussing allied questions so as to provide a more complete treatment of the whole subject.

To avoid the possibility of an incorrect or incomplete answer, the querist should be particularly careful to include sufficient data to permit of an intelligent understanding of the situation. Address letters of inquiry to the Editor, Question and Answer Section, General Electric Review, Schenectady, N. Y.

GROUNDING NEUTRAL: N. E. CODE RULES

- (125) Fig. 1 illustrates a single-phase three-wire distribution system using two step-down transformers. What are the requirements of the National Electrical Code with regard to grounding the neutrals *b* and *e*?

Assuming that lines *a*, *b* and *c* are of the primary or high-potential side of the system, the grounding of *b* as shown in Fig. 1 is not specified in the National Electrical Code. The direct grounding of the neutral of a high-potential system is left to the discretion of the company operating the system. The protection of high-potential lines by lightning arresters, however, is required by the Code.

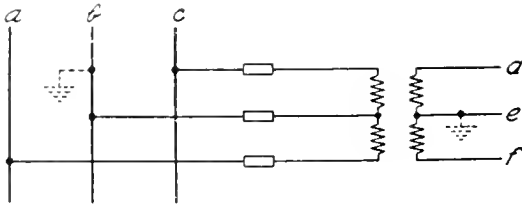


Fig. 1

Assuming that lines *d*, *e* and *f*, Fig. 1, are the low-potential secondary of the system, the National Electrical Code requires that *e* must be grounded if the voltage between *e-f* or *e-d* is less than 150 volts, and may be grounded if the voltage exceeds 150 volts.

Private industrial lighting or power plants are exempt from the above rules unless the voltage of the primary exceeds 500.

While the National Electrical Code is non-committal in regard to grounding the neutral of a high-potential system, it insists on the use of lightning arresters and recommends several methods for grounding them. The Electrical Committee of the Fire Underwriters has regarded the grounding of electric systems as a means of reducing the risk of shock or injury to persons, but which at the same time tends to increase rather than reduce the fire hazard. In view of the fact that the standard lighting voltage is now almost universally used by all classes of consumers, the "fire hazard" yielded to the "life hazard" only in that field of a-c. and d-c.

service covered by a voltage not exceeding 150, and beyond that voltage the grounding is optional. Some measure of this sort was considered necessary because of our every-day personal contact with lighting fixtures and their wires, which, as a result of familiarity, naturally engenders carelessness. Since the voltage of this type of circuit usually ranges from 100 to 125, the arbitrary value of 150 volts was chosen as the high limit in order that the entire field of ordinary lighting circuits would be covered, and thus a greater assurance of personal protection be obtained. F.A.B.

INDUCTION MOTOR: ROTOR BAR INSULATION

- (126) If the fiber insulation in the slots between the bars and the rotor iron of a squirrel cage induction motor becomes charred: (1) Will the motor take more power? (2) Will the speed be affected? The question has reference to rotor slot insulation only, the stator windings being assumed to be in perfect condition.

The electrical characteristics of such a motor, so far as we have been able to determine, will be the same whether bar insulation is used or not.

The present method of placing copper bars in the rotor slots is to use no packing or insulation whatever. The bars and the slots are made approximately the same size, which necessitates that the bars be forced into the slots under pressure. Before adopting this method, machines of this type were carefully compared in test with others of the insulated rotor bar type. The test results of the two types were so nearly alike that the rotors could not be identified by them.

The whole matter resolves itself into the question: "What will be the mechanical stability of the bars in case their insulation is burned out?" If an insulating packing is used and later becomes burned, the bars might become loose in the slots and tend to rattle, which action may ultimately break the joint between the bars and the end rings. There are, nevertheless, a number of motors operating in this manner and comparatively no difficulty has been experienced with them. By using no insulation, there is no packing that can be destroyed and consequently the bars will always remain firm in the slots.

It is to be noted that practically all motors with so-called "slot armor" are grounded in one or more places due to the sharp edges of the iron laminations against the copper bars, and also that the horn fiber is used for mechanical packing, while its value as an insulator is purely incidental.

A.E.A.

METER TRANSFORMERS: CURRENT AND POTENTIAL LEADS

(127) Is there any trouble likely to result from placing the leads of both the potential and current transformers for a polyphase meter in the same conduit?

Provided the insulation used on the leads is sufficient to withstand the voltage strain, we see no objection to this practice, for the effect of mutual induction of the leads upon the registration of the polyphase meter is too small to be considered.

F.P.C.

INDUCTION MOTOR: HEATING ON UNBALANCED POLYPHASE SUPPLY

(128) What would be the effect on the characteristics and the heating of a two-phase, squirrel-cage rotor, induction motor to run it from a supply consisting of T-connected, three-to-two-phase transformers in which a teaser tap of 92.5 per cent is used instead of one of the correct value, 86.7 per cent?

A three-to-two-phase T transformer connection, even when employing correctly spaced taps, will cause a small flow of wattless current in the transformers. If the voltages are not correct in ratio, as when the 92.5 per cent tap is used, the amount of this wattless current will be considerably increased.

The effect of such a supply on the operating characteristics of a motor cannot be definitely stated for it will depend entirely upon the motor's design constants. The tendency of the unbalancing, however, will be to cause the motor to act as a phase converter, drawing power from the lightly loaded line and distributing it to the heavily loaded line.

This phase-converter action will cause additional heating of course. Considering an average polyphase motor, this 7 per cent unbalancing may cause an increase of 30 to 40 per cent in the temperature of its hottest part.

A.E.A.

TRANSFORMERS: RESISTANCE MEASUREMENT

(129) What is the best and quickest method to employ in measuring both the hot and cold resistances of a large number of transformers when under test?

Specify the ranges of the instruments and the standard resistances required.

The method which has afforded the most satisfactory results under the conditions named is that of direct-current potential drop. In the employment of this method a steady reliable source of direct current and a rapid but accurate means of measuring the current and its potential drop are necessary.

As a source of supply a storage battery will maintain a steadier value of current than will the usual generator and be more completely satisfactory as a whole. If the measuring set is to be constantly in use, it would be better to use two sets of storage batteries so connected by switches that while one is discharging the other is charging. By means of a four-pole double-throw switch this operation can be accomplished automatically.

For measuring the current, the most convenient method is undoubtedly that of a milli-voltmeter used in connection with the shunts calibrated especially for it. The location of these are indicated by *S* and *M'* in Fig. 1. By changing the

position of plug *P*, any shunt may be placed in the circuit so that the milli-voltmeter will register the drop across it. It has been found convenient, in measuring the resistance of the usual run of transformers, to have these shunts calibrated so that 0.15 amperes through the smallest shunt and 50 amperes through the largest shunt will produce a full-scale deflection.

For measuring the voltage drop across the transformer windings a second milli-voltmeter combined with multipliers provides the most convenient method of reading from 1 to 50 volts. The multipliers are represented in Fig. 1 by *M*, the milli-voltmeter by *M'*. The key, *K*, serves to complete the circuit through the milli-voltmeter and also to prevent the liability of burning out the instrument by allowing instantaneous trial contacts to be made.

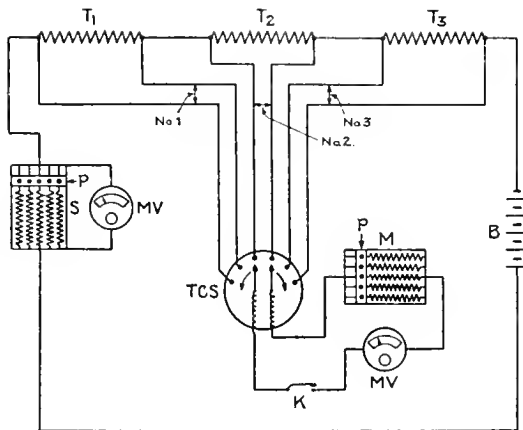


Fig. 1

It may then be convenient to arrange two or more voltmeter circuits, as shown by 1, 2 and 3 in Fig. 1, so wired through a three-circuit switch, *TCS*, that each in turn may be connected to the voltmeter. The transformer windings *T*₁, *T*₂ and *T*₃ may then be connected in series and the resistance of each be measured in such quick succession as to be made almost simultaneously. This practice will be found particularly effective in measuring resistances at the completion of temperature tests.

Although a milli-voltmeter may be said to be automatic, and consequently furnishes quick results for that reason, for potential drops of one volt or less it becomes rather unsatisfactory. Under such conditions a potentiometer, though slower in making the measurements, should be used. Its superiority lies in the fact that a dry battery of standard voltage is bucked against the drop across the windings and, when a balance is obtained as shown by a galvanometer, there is no current flowing in the so-called "drop lines" (which are the voltage measuring lines that are tapped to the transformer windings).

The most suitable current to hold while measuring resistance appears to be from 10 to 15 per cent of the current capacity of the windings which are being measured; this is usually great enough to give a good reading on the instruments and is yet so low that the temperature of the transformer windings will not be materially affected.

H.C.C.

IN MEMORIAM

It is with the deepest sorrow that we record the death of Douglas S. Martin, a former editor of the REVIEW, which occurred in a military hospital at Boulogne, France, on Sunday, November 22d.

Mr. Martin was wounded by shrapnel on the battle field at Messines near Ypres, on November 1st. He was carried to a field ambulance by two men in his own squadron, and his wounds were attended to at a field hospital. He was then taken to the hospital at Boulogne, where it was at first thought he would recover; but after three weeks of suffering septic poisoning developed, and on Nov. 22d he joined the ranks of those who had "served to the uttermost."

Mr. Martin was a student of the Central Technical College of London, and after his graduation he entered the employ of the British Thomson-Houston Company at Rugby, England. In 1911 he came to the United States to accept the position of Assistant Editor of the GENERAL ELECTRIC REVIEW, and succeeded to the editorship in 1912. He was an energetic and capable writer on technical subjects, and as an editor his initiative and personality did much to increase the usefulness and prestige of the REVIEW.

With the object of improving his knowledge of practical field work, particularly in regard to high tension transmission systems, he resigned his position as editor in July, 1913, and went to Vancouver, B.C., from which point he traveled south along the Pacific coast, working in various capacities on a number of engineering projects. During this period, he continued his literary contributions to the technical press, and early in 1914 returned East, becoming a member of the editorial staff of the *Electrical World*. He organized the more recent statistical work of the paper, constituting practically a new department, of which he remained in charge until his departure for the front. Although only 27 years old, Mr. Martin had already attained a high standing in his profession.

Upon the outbreak of the European conflict, Mr. Martin, who had had considerable military training in the yeomanry of his country, immediately volunteered for active service, and as he was an accomplished horseman, a good shot, and in excellent physical condition owing to his activity in outdoor sports, his services were accepted promptly. He was assigned to the 16th Lancers, which was part of the first British expeditionary army, so that within a very short period he had exchanged the quiet of the editorial office for the gruelling turmoil of the

battlefields of Flanders. This, in a letter written at this time, he characterized as the "greatest of good luck."

Again, in a letter dated Monday, August 31, 1914, he says: "I got home here last Friday afternoon. I signed up for Kitchener's Army on Saturday, and took the shilling this morning. I expect to be detailed to some regiment tomorrow and, of course, shall be with them till the end of the war." He wrote again on September 20, 1914. "I am working myself awfully hard with sword, lance and rifle, so that I can get away with one of the early drafts. Tired but fit."

Although the bones of the lower leg were

broken, the knee cap injured, and the muscles and tendons of the leg torn, in writing from his bed in the Boulogne hospital he made light of his wounds, representing them as being slight.

Douglas Martin was a young man of finest qualities; his engaging personality, finished and able conversation, and his accomplishments in vocal and instrumental music won for him many admiring and devoted friends. Talented, lovable, and loyal to the core, with the promise of a brilliant future, his untimely death is a great and irreparable loss to all who knew him well. The sincere sympathies of his many friends in America are extended to his mother and the other members of his family in their bereavement.



DOUGLAS S. MARTIN

GENERAL ELECTRIC REVIEW

A MONTHLY MAGAZINE FOR ENGINEERS

Manager, M. P. RICE

Editor, JOHN R. HEWETT

Associate Editor, B. M. EOFF
Assistant Editor, E. C. SANDERS

Subscription Rates: United States and Mexico, \$2.00 per year; Canada, \$2.25 per year; Foreign, \$2.50 per year; payable in advance. Remit by post-office or express money orders, bank checks or drafts, made payable to the *General Electric Review*, Schenectady, N. Y.

Entered as second-class matter, March 26, 1912, at the post-office at Schenectady, N. Y., under the Act of March, 1879.

VOL. XVIII., No. 2

Copyright, 1915
by General Electric Company

FEBRUARY, 1915

CONTENTS

	PAGE
Frontispiece	78
Editorial: The Paths of Progress	79
Developments in Electrical Apparatus During 1914	80
BY JOHN LISTON	
The Absolute Zero	93
BY DR. SAUL DUSHMAN	
The Towing Locomotives for the Panama Canal	101
BY C. W. LARSON	
Electrophysics: Cathode Rays and their Properties	118
BY J. P. MINTON	
The Selection of Railway Equipment	126
BY J. F. LAYNG	
A Short Method for Calculating the Starting Resistance for Shunt, Induction and Series Motors	131
BY B. W. JONES	
Application of the Coolidge Tube to Metallurgical Research	134
BY DR. WHEELER P. DAVEY	
Effect of Altitude on the Spark-Over Voltages of Bushings, Leads and Insulators	137
BY F. W. PEEK, JR.	
The Lighting of Ships	143
BY L. C. PORTER	
Practical Experience in the Operation of Electrical Machinery	146
Current Transformer Failures; Heating and Sparking of Repulsion-Induction Motors; Excessive Pump Output.	
BY E. C. PARHAM	
Notes on the Activities of the A. I. E. E.	148
From the Consulting Engineering Department of the General Electric Company	152



Towing Locomotive About to Ascend the Incline Leading to Top Level of the Gatun Locks. Standing in the Foreground are: (left to right) Edward Schildhauer, Electrical and Mechanical Engineer, Isthmian Canal Commission; Lt. Col. William L. Sibert, Member of Isthmian Canal Commission and Atlantic Division Engineer; C. W. Larson, Industrial Locomotive Designing Engineer, General Electric Company

GENERAL ELECTRIC

REVIEW

THE PATHS OF PROGRESS

In our February issue we usually try to review the progress made during the year just past, so in this number we publish an article that outlines the progress made in the development of electrical apparatus during 1914. Of necessity this review must be very incomplete as many developments are not learned till long after their inception and usually a considerable time elapses between the inception and application in actual practice. It will be noted that the progress cited is mostly in the nature of details of design and an increased capacity of apparatus.

It would be a great mistake to surmise that this condition of affairs foretells any slowing down of progress in the electrical industry. Indeed, it rather lays emphasis on how far and how fast the art has advanced. We should note with interest and encouragement the almost daily invasion of electrical appliances to fields of work where formerly methods less up-to-date and less efficient were employed. The inherent characteristics of electrical apparatus and appliances seem bound to extend the use of electrical machinery far beyond even its present enormous field, as we are verifying every day the fact that electricity furnishes the most flexible, reliable and efficient medium for transmitting energy from its source of origin to its many points of application.

As we become more and more dependent on machinery for our economic progress, in just such a measure are we increasing our dependence for future developments on those who are perpetually increasing the efficiency of our electrical apparatus and rendering it more effective in its everyday applications. In reviewing progress we are apt to cite brilliant examples of discoveries, and to neglect giving due credit to those responsible for improvements in detail. In reality we, as a community, owe a tremendous debt to the "detail man"—the silent but perpetual worker, whose energy year in and year out is devoted to making improvements in details. These improvements in details constitute a host of inventions, many of them so small in

themselves that they seldom merit the name, nevertheless we are becoming more and more dependent on them for our progress.

The growth of the electrical generating unit to 35,000 kw. has only been made possible by an incessant study of, and improvement in, details; and the ever increasing potentials at which we can transmit our energy are due to the small rather than the large advances made in the art of design and construction.

The advantage derived by the electrical industry as a whole and especially by the operating fraternity from this gradual advance, in distinction from a spasmodic development, have been great. To cite a specific example direct-current railway apparatus has developed from the old standard of 600 volts through successive stages—1200 volts, 1500 volts, 2400 volts, up to the most recent 3000-volt apparatus to be employed by the Chicago, Milwaukee & St. Paul Railway. As each step in advance was made new fields for electric traction were opened by the added economies to be secured—and old installations in many cases adopted the higher potential apparatus as a means of effecting more economical operation on systems that had already been running for years. In no case was a wholesale discarding of electrical machinery, that still was capable of many years' good service, made necessary, which would have been the case had radically new development been substituted for a gradual improvement in details.

So many of our modern developments are dependent upon the discovery and application of new materials, better suited to the severe conditions imposed by the constant demand for higher efficiency in weight, output, etc., than the materials formerly in use, that the research work done in this direction is constantly tying the industrial research laboratory closer and closer to the design office and the workshop. This phase of our industrial life has now reached a stage where the research laboratory must be looked upon as an indispensable factor in the modern manufacturing plant, if we are to keep abreast of the times and show a satisfactory rate of progress as each year passes.

DEVELOPMENTS IN ELECTRICAL APPARATUS DURING 1914

By JOHN LISTON

PUBLICATION BUREAU, GENERAL ELECTRIC COMPANY

It is often difficult clearly to comprehend the scope of the numerous minor changes effected in electrical manufacture during any given period, but a knowledge of the improvements thus made is essential in defining the yearly progress of the industry. In this article the author presents in a logical manner the improvements made in certain important classes of apparatus.—EDITOR.

While some unique developments have characterized the progress made by the electrical industry during 1914, the general advance has consisted very largely of improvements in apparatus which had already attained relatively high efficiencies, both electrically and mechanically.

Although many of the changes effected apparently concern only minor details of construction, their cumulative results show marked progress for the past year for the electrical art as a whole. Briefly stated, there has been achieved, refinement in design resulting in increased efficiencies for many classes of apparatus, economical concentration of large energy values in single machines, and a broadening of the field of application based on experiment and analysis of exhaustive operating data.

In order adequately to represent the trend of design and manufacture, this review will refer briefly to certain specific cases which will serve to indicate the character and extent

of recent improvements made in General Electric products; the data for the various sections being segregated under apparatus headings.

Steam Turbo-Generators

Early in the year the first of the large horizontal Curtis steam turbine generator sets was placed in commercial service: It consists of a 20,000 kw. unit installed for the Commonwealth Edison Company of Chicago, and has already been in successful operation for almost a year.

A still larger unit having an output of 30,000 kw., 6600 volt, 25 cycles, at 1500 r.p.m., operating normally under 185-pound steam pressure was placed in service by the New York Edison Company in November, 1914, having been constructed and installed in less than a year; a remarkably short period for a generating set of this capacity. The effective concentration of energy value achieved in the construction of this machine

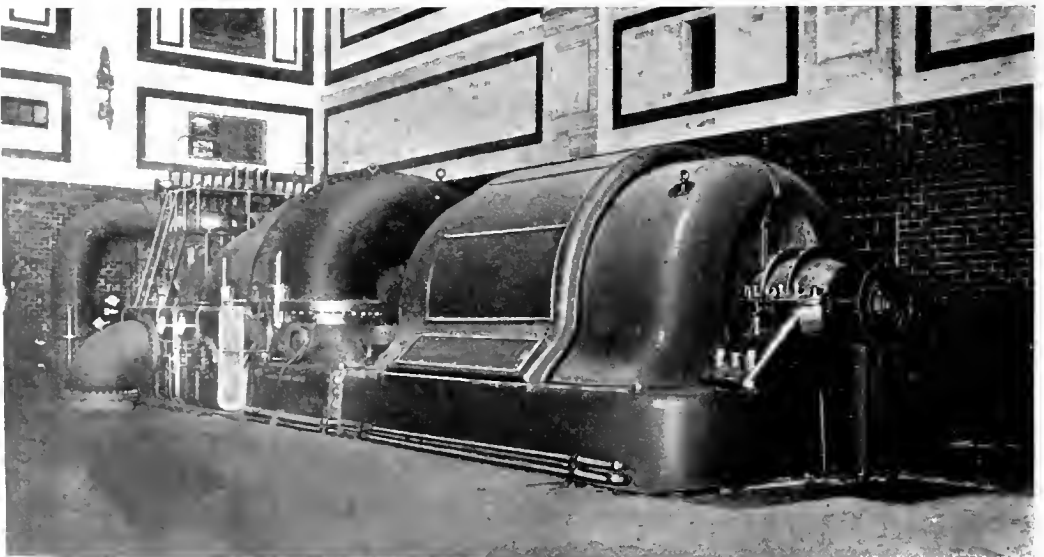


Fig. 1. 30,000-Kw. Steam Turbo-Generator, New York Edison Co.

is clearly indicated by the relatively small amount of space required for its installation; the overall dimensions being: Length, 57 ft. 4 in.; width 19 ft. 8 in.; and height 14 ft. 3 in. We hope to publish a detailed descriptive article covering this installation in an early issue of the *GENERAL ELECTRIC REVIEW*.

A number of similar machines, ranging in capacity from 20,000 kw. to 35,000 kw., are on order, and several of these have been shipped, or are nearing completion in the Schenectady Works. It should be borne in mind that all of these large machines consist of a single generator direct connected to and mounted on the same bedplate with the turbine. They constitute the largest single generating units so far designed or constructed by any manufacturer, and those already placed in service have without exception established gratifying records in regard to reliability, steam economy and overall efficiency.

The inherent simplicity and relatively compact arrangement of these large turbo-generators have made it possible to effect their installation in remarkably brief time when their great output is considered. As an example of this, a 12,500 kw. set was completely installed for the Toledo Railway

at 3600 r.p.m., and a maximum continuous capacity of 140 watts.

A steam pressure of about 90 pounds is maintained constantly by means of an automatic regulating inlet valve, and a safety pop valve is also provided. The turbine is a single-stage unit direct coupled to a direct-current compound wound generator, and by means of a differential brake magnet coil any fluctuations in the load are automatically compensated for so that constant voltage is maintained from no load to full load.

This little self-regulating set has ample mechanical strength and has to date successfully withstood severe practical service tests of more than six months duration, and it will undoubtedly have a wider field of application than that for which it was originally designed. Its overall dimensions are: Length, $23\frac{1}{2}$ in.; width 15 in.; height, $14\frac{3}{4}$ in.; and its weight, 130 pounds.

Waterwheel Type Generators

Conspicuous among the improvements for this class of apparatus is the suspension thrust bearing designed for vertical shaft type waterwheel generator sets, the bracket of which is rigidly supported by the generator stator, with the bearing carrying the entire weight imposed by rotor, waterwheel and water thrust. Among the larger machines for which these thrust bearings have been provided may be mentioned two 11,170-kv-a., 6600-volt, 60-cycle sets, operating at 180 r.p.m.; three 9000-kv-a., 12,000-volt, 40-cycle sets, operating at 185 r.p.m.; four 10,000-kv-a. units, 6600-volt, 60-cycle sets, operating at 200 r.p.m. All of these generator sets are tested to withstand double normal speed, and the thrust bearings of the four groups referred to sustain respectively aggregate weights per unit of 75, 77, 100 and 175 tons.

An indication of a recent tendency in hydroelectric development, brought about primarily through improved efficiency in waterwheels, is the use of generators of relatively small capacity and low speed which have rendered it possible effectively to utilize numerous low head water powers which heretofore could not be economically developed. Among the machines which have been constructed to meet these conditions during the past year, with a rating lower than 1000 kv-a., are generators having rated capacities of 600 kv-a., at 48.5 r.p.m., down to 150 kv-a. at 180 r.p.m. Slightly larger units have been utilized at relatively low speeds and these may be typified by reference to

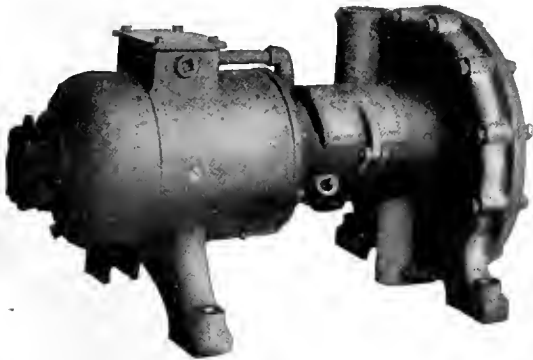


Fig. 2. 100-Watt Steam Turbo-Generator for Steam Locomotive Lighting

& Light Company, and placed in commercial service within fourteen days of its arrival at Toledo.

In striking contrast to the large machines referred to above is the diminutive turbo-generator developed during the year for supplying current for incandescent headlights and cab lights on steam locomotives. This set has a normal rating of 100 watts, 6 volts,

six 2000-kv-a., 6600-volt, 25-cycle sets, which are designed for operation at 68.5 r.p.m.

Among the larger sets may be mentioned the two 12,000-kv-a., 6600-volt, 60-cycle

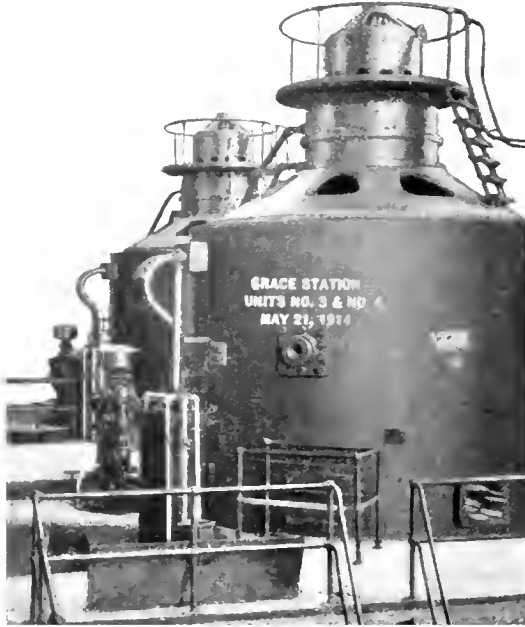


Fig. 3. 12,000-Kv-a. Waterwheel-Driven Generators, Utah Light & Power Co., Grace, Utah

vertical shaft waterwheel-driven generators placed in operation by the Utah Power & Light Company at its main generating station at Grace, Utah. While these machines have

been exceeded in capacity by generators of a similar type previously installed, they have been designed and constructed for operation at the highest speed at which sets of this capacity have as yet been called on to operate; i.e., 514 r.p.m.

In order to obviate the destructive effects frequently produced by corona in high potential generators and synchronous motors, there has been devised a corona shield which has proven thoroughly practical in operation and has been used to a constantly increasing extent during the past year. It consists of a layer of tinfoil placed over the ordinary insulation and covers that part of the coil which is enclosed by the slot, extending far enough beyond the slot to give ample room for protecting, with tape and varnished cambric, the projecting ends of the tinfoil covering. The corona shields are finally connected, by thin copper strips, with the stator laminations, through which they are effectually grounded.

A number of direct-current generators of exceptional capacity, designed for waterwheel drive, have also been constructed during the year, and at present work is nearing completion on a lot of 11 horizontal shaft direct-current machines of this type, each having a rated output of 5200 kw., 520 volts, at 170 r.p.m. These exceed in size any generators of their type previously built.

Gas-Engine Driven Generators

Due to improvements in design and regulation, the past year has witnessed consider-

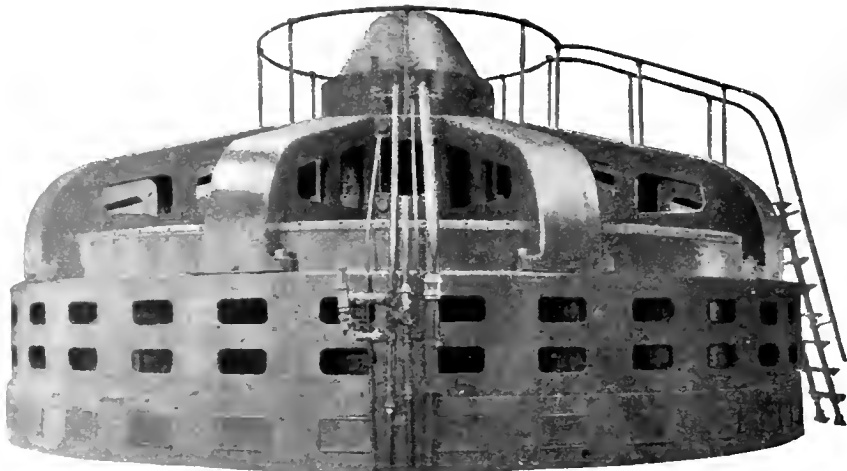


Fig. 4. 6250-Kv-a. Waterwheel-Driven Generator Showing Construction of Suspension Thrust Bearing Bracket

able advance in the use of 60-cycle gas-engine driven generators, and at the present time there are nearing completion three units of 1390 kv-a. capacity, 2300 volts, 60 cycles, arranged for operation at 116 r.p.m. They will be utilized by the Monongahela Traction Company of Fairmont, West Virginia, and are the largest 60-cycle generators designed for gas-engine drive. Other and larger units had, however, been constructed prior to 1914 for 25-cycle operation; the rating for these machines, which were built for the Bethlehem Steel Company, being 3125 kv-a.

An equitable basis of guarantee for the parallel operation of both gas-engine and steam-engine driven generators has been devel-

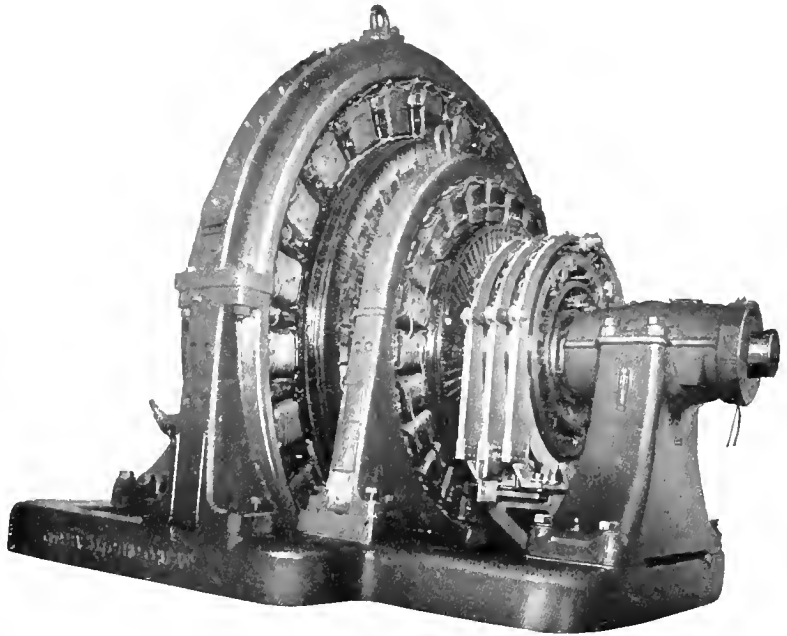


Fig. 6. 2250-Kw. Synchronous Converter with Synchronous Booster, Boston Edison Co.

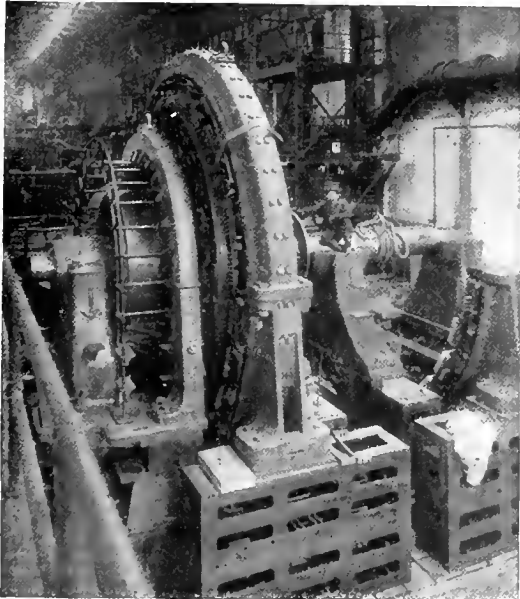


Fig. 5. 5200-Kw., 250-Volt Direct Current Generator for Waterwheel Drive

oped by the General Electric Company which, if generally accepted, should prove of considerable value to the builders of engines and generators, and to the operator.

This guarantee is based largely on the determination of the natural period of the generator in relation to the various characteristics of the complete unit, including flywheel and the operating features of engines and governors, and presents in a logical manner the data necessary for an accurate pre-determination of results.

Synchronous Converters

The advance in this class of apparatus has been marked chiefly by the increased unit capacity of 60-cycle machines produced; a representative installation consisting of two 2250-kw., 225/275-volt converters equipped with synchronous boosters has been constructed for the Boston Edison Company. These machines have approximately 50 per cent greater capacity than any 60-cycle machines of this type heretofore developed, and their successful operation has resulted in the adoption of still larger units.

As evidence of this a single order was received for eighteen 500-volt, 60-cycle synchronous converters with commutating poles, having an output of 2500 kw. each; an aggregate rating of 45,000 kw. They are to date the largest 60-cycle synchronous converters. This record order has already been partially filled, and the machines will be installed at Messine, N. Y., for the Aluminum Company of America.

The equipment of synchronous converters with synchronous boosters which are integral parts of the complete machine, together with an arrangement for automatic control, constitutes a most important improvement in synchronous converter operation and insures a positive and automatic adjustment of the direct-current voltage. This is accomplished through control of the field excitation of synchronous converters provided with commutating poles, and insures correct excitation at all loads and voltages.

Synchronous Condensers

A horizontal shaft 6000-kv-a., 50-cycle, 500-r.p.m. synchronous condenser constructed for the Southern California Edison Company of Los Angeles is of unusual interest due to the fact that it was designed for operation on a 16,500-volt line; no machines of this type having previously been built for potentials exceeding 6600 volts.

In addition to the precautions necessary for insulation against this unusual potential, special efforts were made in designing the machine to minimize the losses, and as a result there was produced a synchronous condenser of very high efficiency which is utilized for power-factor correction. It is self-starting by means of a compensator and requires less than half its rated kilovolt-amperes for starting.

Phase Advancers

While synchronous condensers are ordinarily applied for improving the power-factor of a system, the phase advancer is designed primarily for improving the power-factor of individual induction motors, although in special cases it is capable of wider application. This machine, which has been made commercially practicable within the past year, is described in the June, 1914, GENERAL ELECTRIC REVIEW, but its characteristics may be briefly outlined as follows:

The phase advancer stands in the same relation to an induction motor as an exciter does to a synchronous motor. However, for the induction motor, continuous current can not be used for the magnetizing current in the secondary because the motor slips under load. The magnetizing current must be a polyphase current of low frequency which corresponds in each instance to the slip of the induction motor.

The phase advancer consists of a continuous-current drum armature with a commutator having three brush studs per pair

of poles displaced relatively to one another by 120 electrical degrees. The stator merely consists of a frame with the laminations assembled but having no slots or windings.

The phase advancer is direct connected to a small squirrel cage constant speed induction motor. The power necessary to drive the phase advancer is only that required to supply the friction windage and hysteresis losses and is therefore comparatively small, i.e., about one h.p. for a 600-h.p. 2200-volt induction motor. The copper losses are provided by the main induction motor rotor.

Frequency Changers

A notable frequency changer set was recently installed to interconnect the Boston Edison and Boston Elevated systems. This is a horizontal shaft set, the 60-cycle unit being rated at 9500 kv-a., 13,800 volts, and the 25-cycle unit rated at 9000 kv-a., 13,200 volts; it operates at 300 r.p.m. and is reversible. It is totally enclosed and provided with inlet for external air supply which discharges into the station. One frame is adjustable so that if the equipment is duplicated

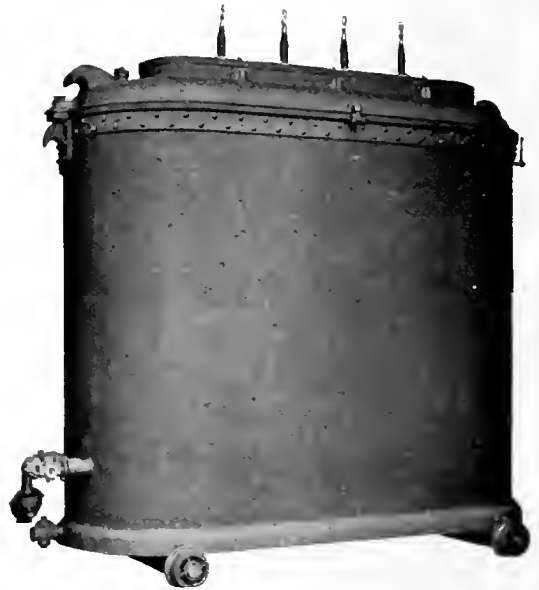


Fig. 7. 7500-Kv-a., 12,000/24,000 Y, Three-Phase Water-Cooled Core Type Transformer

both sets may be arranged equally to share the load, and in order to facilitate inspection or to make repairs each frame is arranged to move on steel rollers parallel to the shaft. This is the largest frequency changer set

produced by the General Electric Company, and is probably the largest machine of this type in service today.

Transformers

Prior to 1914 the largest core type transformers produced by the General Electric Company did not exceed 2000 kv-a. in rated capacity, but during the year the maximum rating was carried up to 7500 kv-a.

The maximum rating of single-phase water-cooled shell type transformers has also been increased by the construction of four units of 8333-kv-a. capacity.

There has been a marked reduction in interruption to service in transformers of recent design as they are now capable of withstanding momentary short circuits under sustained primary voltage without injury to the coils. This has been accomplished largely through changes in the grouping of the coils and working to higher inherent reactance.

A feature of unusual interest for the year is the development of a combination trans-

former of normal load without the circulation of water and without exceeding its specified temperature rise. On the other hand, this transformer may be designed for normal operation as a self-cooled unit, and be provided with

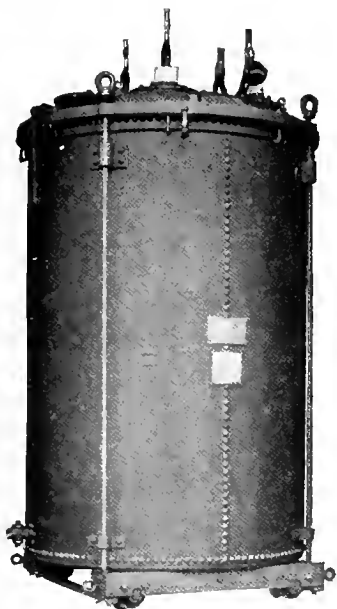


Fig. 8. 8333-Kv-a. Single-Phase Water-Cooled Shell Type Transformer

former which may be operated either self-cooled or water-cooled. It may be designed for normal operation with water circulated through the cooling coils, in which case it may also be safely operated at 50 per cent

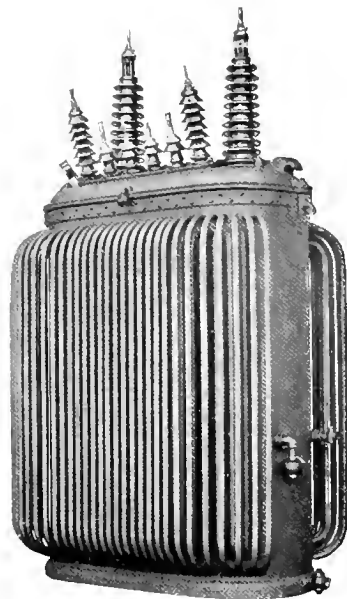


Fig. 9. 1250-Kv-a. Combination Self-Cooled-Water-Cooled Outdoor Transformer

the necessary cooling coils which, when utilized, permit operation efficiently at 50 per cent above the normal capacity. The economical advantages of such transformers are obvious, especially for localities where the purchasing rate of water is high and the transformer is fully loaded only part of the time. This design also provides a factor of safety in case of interruption in the water supply, in which event the apparatus may still be operated at partial load instead of being shut down.

Feeder Regulators

Early in 1914 a single order for 100 feeder regulators was received from the Commonwealth Edison Company, Chicago, Ill. These regulators are rated at 36 kv-a., 60 cycle, 150 amp., and are of the automatically operated induction type, designed for 2400-volt primary and 240-volt secondary. When placed in service they are utilized for maintaining constant voltage on alternating-current feeders having an aggregate capacity of 36,000 kv-a. Prior to the placing of this, the largest single order for this type of ap-

paratus, the Commonwealth Edison Company had already installed approximately 300 General Electric regulators for similar service, making a notable aggregate equipment of 400 units of this type.

Reactances

With the steady growth in the size of power plants and distribution systems, there has arisen among operators a fuller conception of the practical value of providing ample protective equipment, such as voltage reducing devices for cutting down the station voltage under short circuiting conditions, arcing ground suppressors for short circuiting arcs caused by grounded phases on delta connected transmission systems, and the recently developed and improved current limiting reactances. A fuller appreciation of such devices is amply attested by a continual increase in the number of propositions for power station equipment which include this class of apparatus.

The reactance developed by the General Electric Company has been improved to a considerable extent during the past year and the changes made have been based largely on the experience gained in numerous applications of the earlier types utilized for the protection of feeder lines. In order to facilitate calculations on the equipment necessary to meet the requirements of power systems having widely varying operating conditions and capacities, these reactances are now made in three distinct forms.

Electric Railways

The decision of the Chicago, Milwaukee & St. Paul Railway Company to electrify its mountain grade divisions in Montana marked one of the most important steps ever taken in steam road electrification. The order for high-voltage direct-current electrical equipment placed with the General Electric Company includes nine freight and three passenger locomotives, weighing approximately 260 tons each, all equipped for regenerative braking; 10 three-unit synchronous motor-generator sets with transformers; and switching apparatus for the equipment of four substations totaling 17,000 kw. in capacity. Overhead line material is also included for the initial electrification of 113 miles, or 168 miles on a single track basis.

The railroad company has plans under way for the electrical operation of the entire 440 miles of main line transcontinental road between Avery, Idaho and Harlowton, Montana.*

In the selection of 3000 volts direct current as the operating voltage, this road was doubtless influenced to a large extent by the attractive performance of the 2400-volt direct-current equipment of the Butte, Anaconda & Pacific Railway.†

An interesting railway is being constructed by the Bethlehem-Chile Mines Company in Tofo, Chile. This road will be used for conveying iron ore from the mines about 2000 feet above the sea level, a distance of about 15 miles to the Port of Cruz Grande on the coast. The equipment of this road will include three 110-ton, 2400-volt direct-current electric locomotives which will be supplied by two three-unit 1000-kw., 2400-volt synchronous motor-generator sets. This substation will be fed over a 22,000-volt transmission line from a main power house which will contain three 3500-kv-a. and one 300-kv-a. Curtis steam turbines.

The average grade on this road is about three per cent and the locomotives are to be equipped for regenerative control feeding power back into the system on the down grades.

Work is proceeding rapidly on two other

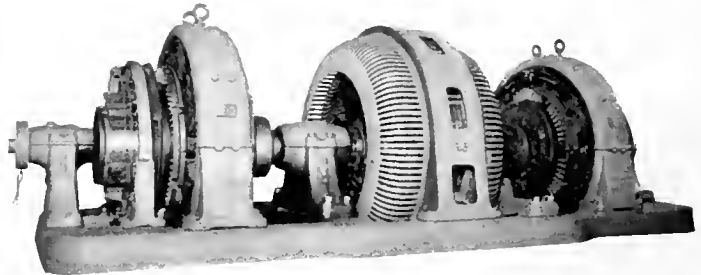


Fig. 10. Motor-Generator Set for Canadian Northern Railway, 2100-H.P., 11,000-Volt Motor, Driving Two 750-Kw., 1200-Volt D-C. Generators Connected in Series for 2400-Volt Railway Service

2400-volt railway electrifications, the Michigan Railway Company and the Canadian Northern Railway, which are expected to be in commercial operation early in 1915.

Another important endorsement of the high voltage direct-current system is the decision of the Ontario Hydro-Electric Power Company to employ 1500 volts direct current for the electrification of the London & Port

* See GENERAL ELECTRIC REVIEW, Nov., 1914.

† See GENERAL ELECTRIC REVIEW, Jan., 1913.

Stanley Railway.* Orders have been placed for the initial rolling stock, including three 60-ton electric locomotives, five four-motor multiple unit cars, and four trail cars. This road is about 24 miles long and connects Port Stanley on Lake Erie with London, Ontario. The electrification of this steam road division is the beginning of an extensive system owned and operated by the municipalities in this section.

High-voltage, direct-current equipment has also been ordered during the year for a number of other interurban railways, including the following: Chicago, Milwaukee & St. Paul, (Great Falls Electrification), 1500 volts; Imperial Railways of Japan, 1200 volts; Toronto Suburban Railway, Canada, 1500 volts; Willamette Valley Southern Railway, 1200 volts.

The Pacific Electric Railway has ordered 96 ventilated motors for new cars on the Los Angeles-San Bernardino-Riverside division.

The principle of ventilation as employed on all modern General Electric motors has been adopted by many railways in all parts of the world. Motors of this type have been selected by the New York Municipal Railway Company for the operation of 200 new cars in the new Brooklyn Subway, and 334 motors of a similar type have also been ordered by the Northwestern Elevated Railway of Chicago.

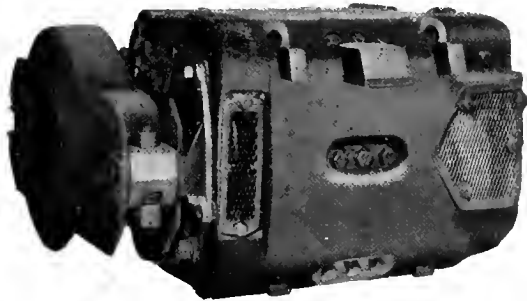


Fig. 11. GE-248-A Railway Motor Adopted for New York Municipal Railways

The Chicago Surface lines are using 200 GE-242 ventilated motors which were ordered during the year, and delivery is being made on an additional order for 456 of these motors. The GE-247 is a new ventilated type railway motor designed for 24-inch wheel low floor city

cars. Four-hundred of these motors are being placed in service on the Pittsburgh Railways.

Mine Locomotives

All of the mine locomotives manufactured by the General Electric Company in 1914 were



Fig. 12. 50-Ton 1200-Volt Locomotive for Willamette Valley Southern Railway

provided with commutating pole motors and ball bearings as standard equipment, and the operating records of those placed in service during the year show that these improvements have reduced the number of interruptions to service and have resulted in decreased maintenance costs.

The increasing output of many mines has rendered it necessary to equip them with locomotives of relatively large capacity, capable of handling heavy trips over steep grades and for long hauls. For this class of service there have been built a number of three-motor, 15- and 20-ton locomotives. The 20-ton unit combines some unusual features in design and construction: The body is made of rolled steel, each side frame being cut from a solid rolled steel slab, while steel slabs in conjunction with steel channels are used for the end frames. The three driving motors are each rated at 85 h.p. and are of the split frame type. These particular locomotives were built for 42-inch gauge, but the same construction and capacity can be utilized for a minimum of 36-inch gauge.

Up-to-date practice in haulage locomotives may be represented by reference to the constructive features of a typical 16-ton single-truck three-motor unit. In this, the latest type of industrial locomotive, the truck frame is built of steel throughout, both the sides and ends being cut from single pieces of solid slab. The platform is built of steel channels

* See GENERAL ELECTRIC REVIEW Jan., 1915.

and plates, and the cab of steel sheets. It is a standard gauge machine and, in so far as possible, all details have been developed along the lines of standard railway practice, the wheels, axles, journal boxes, brake beams, brake shoes and couplings being all in accord-



Fig. 13. 20-Ton, Three-Motor Mine Locomotive, 42-In. Gauge

ance with MCB requirements. It is driven by two 60-h.p., 500-volt motors and equipped with straight air brakes.

An interesting type of locomotive has also been constructed for service at the mines of the Braden Copper Company in Chile, S. A. It is a 25-ton double-truck machine for 30-inch gauge, and has an overall height of only seven and one-half feet. The four driving motors are each rated at 45 h.p., 250 volts, multiple unit control and automatic air brakes being also included in the equipment. It is probable that this locomotive is the heaviest and narrowest gauge, and has the lowest overall height of any machine of this type ever built.

There has been a definite increased demand for the storage battery type of locomotive for gathering work, as it has been demonstrated that in this service each locomotive will effectively displace at least two or three mules. Heavy units are not as a rule required and the locomotives of this class so far provided have been rated at from three to seven tons. Most of these are of the straight storage battery type, but a limited number have, in addition, been equipped so that they can operate from a trolley wire when in the main headings of a mine. The advantages of this arrangement are obvious in that by means of a small self-contained motor-generator set, the battery may be automatically charged while the locomotive is running on the trolley. When the locomotive is working in the rooms, gathering the cars, a varying percentage of the battery charge will be consumed, but as soon as the locomotive is again operated on the trolley, these losses are auto-

matically compensated for and with this dual system of operation the battery need never be entirely discharged and if space limitations are severe it permits the use of a smaller battery than would otherwise be necessary. A representative machine of this type has been in operation in a West Virginia mine for a period of about four months. It runs on a 42-inch gauge track and its overall height does not exceed 30 inches.

Mine Hoists

The largest induction motor shaft hoist equipment in America was placed in operation in November, 1914, at Lansford, Pa., for the Lehigh Coal & Navigation Company. The driving motor is rated at 750 h.p., 300 r.p.m., three-phase, 25 cycle, and drives through a single reduction gear.

Positive control of the hoisting speed is secured by means of an improved type of liquid rheostat and high tension air break contactors; the motor circuit being 2300 volts. This hoist serves a 600-ft. vertical shaft hoisting 11,500 pounds per trip at the rate of 90 trips per hour, with a maximum rope speed of approximately 1600 feet per minute.

The liquid rheostat referred to above was developed primarily for mine hoist service and insures safe operation at quick reversal. It employs two sets of fixed electrodes at different elevations; one set being widely spaced, while the other set has large electrode areas and has small spacing in order to obtain a very low final slip. The two sets of electrodes are connected in parallel after the electrolyte has reached a certain level corresponding to a predetermined decrease in rotor



Fig. 14. Combination Storage Battery and Trolley Type Mine Locomotive with Platform Removed to Show Internal Arrangement

voltage. All parts of the rheostat itself are stationary, thus insuring absolute reliability; the electrolyte level being varied through the operation of a movable weir and a small motor-driven pump.

Steel Mills

The tendency toward the exclusive use of electricity for all power application in modern rolling mills is indicated by the equipment selected by the Bethlehem Steel Company for its new plant at South Bethlehem. In equipping the new buildings no steam drive or steam auxiliaries have been provided. The electrical energy is generated with gas engine drive and for power application three-phase, 25-cycle, 6600-volt induction motors have been used throughout. In this new plant

Electric Furnaces

The fact that the electric furnace offers a compact, reliable and economical method of manufacturing crucible quality steel has now become more generally recognized among iron and steel foundries and, in consequence, there has been an appreciable increase in the number and size of the equipments recently installed or in process of construction, and a concomitant improvement in details tending toward improved efficiency.

Perhaps the most striking advance has been

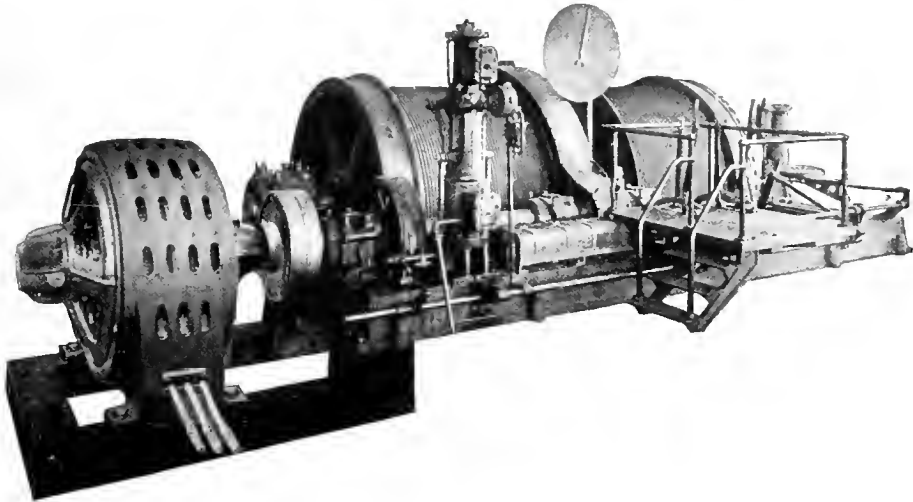


Fig. 15. 750-H.P. Induction Motor Driving Mine Hoist

there are General Electric motors ranging from 350 h.p. to 3000 h.p. both of the single-speed and two-speed pole changing type, the aggregate rating being approximately 12,000 h.p.

In order to provide speed control for induction motors which will meet the variable load requirements of rolling mills a speed regulating set applicable for this class of work has been developed, and during the year has been practically applied by the American Iron & Steel Company, Pennsylvania Steel Company, Forged Steel Wheel Company and Union Rolling Mills. These speed regulating sets enable the induction motor to carry varying loads at constant speed, giving it for all practical purposes the speed characteristics of the shunt wound direct-current motor, while at the same time retaining the simple and strong mechanical features of the induction motor.

in the induction type of furnace as, prior to 1914, the largest unit of this type in the United States had a capacity of only two tons, whereas during the year this was carried to 20 tons, two units having been completed. This 20-ton furnace is of the two-ring type and in operation utilizes single-phase current of five-cycle frequency at 5000 volts, and it has been necessary to supply a special motor-generator set in connection with it, consisting of a two-pole single-phase generator having an output of 4000 kv-a. at 5000 volts, five cycles, which is direct driven by a three-phase, 25-cycle, 2300-volt synchronous motor.

The exceptional size of the furnace, which is the largest of any type in the United States, used for refining steel, is best illustrated by reference to the core and coils, which elements for each furnace have a weight of approximately 60 tons. In operation the furnace rings are charged with molten metal,

every part of which is thereby subjected to intense, uniform and positively controlled heat, and is then poured off after a treatment lasting from 60 to 90 minutes.

For the arc type of electric furnace special forms of transformers and auxiliary equipment have been designed, together with a reliable system of automatic control which is particularly interesting to the practical operator, in that, except for a short period after starting the furnace, a constant power input is maintained at such a value as may be predetermined by the operator.

The resistance type of furnace, which utilizes heat generated by passing the electric current through a resistor composed of

ment is indicated by numerous successful substations in small towns, farms, mines and quarries, pumping outfits, small isolated manufacturing plants and various contracting and construction jobs.

Experience has shown that to avoid interruptions to service the equipment supplied to meet the operating conditions indicated above must be proof against damage from the weather and, in order to provide this protection, all operating parts of switching apparatus supplied by the General Electric Company, which are liable to rust, are given a very effective protective treatment.

While considerable work has been accomplished in the effective equipment of

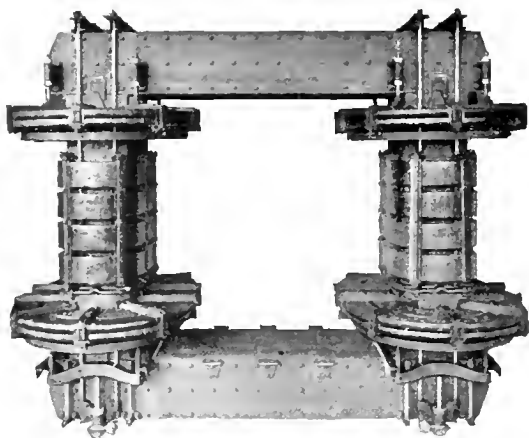


Fig. 16. Arrangement of Core and Coils for 20-Ton, Two-Ring Induction Furnace

foundry coke, with auxiliary heating from a carborundum arch which radiates heat downward on the charge, has also been provided with a simple current relay control which insures the maintenance of a constant temperature over a range of approximately 600 to 1300 deg. C.

Switching Apparatus

There are numerous localities remote from low-voltage distribution, but accessible to high-voltage transmission lines, where the small rural substation can be economically utilized for the distribution of electrical energy in capacities as low as 3 kv-a. Under proper conditions a market of this kind offers the operating company a sound financial basis for service, providing that the equipment can be installed at a reasonable price, and can be depended upon to operate with low maintenance expense. The great extent of the field for this class of electrical equip-



Fig. 17. Resistance Type Annealing Furnace with Control Panel—Later Forms of this Furnace are Sheathed with Cast Iron Plates

rural substations prior to 1914, the activities of the past year have been along the line of standardizing apparatus suitable for use in connection with various transmission voltages, and in improving or redesigning standard apparatus previously utilized. The complete standardized line now available has been proven reliable in service and is designed to minimize danger to the equipment in case of disturbance on the main line, and while it is proof against injury to itself or other apparatus, it does not require skilled attendance. Furthermore, it is very largely semi-portable, so that it can be installed or removed promptly and economically, and the fact that the entire line has been standardized permits an accurate predetermination of the cost of a rural substation when the operating conditions and service required are known. It also makes it possible to secure for the small community many of the economies inherent in high tension transmission.

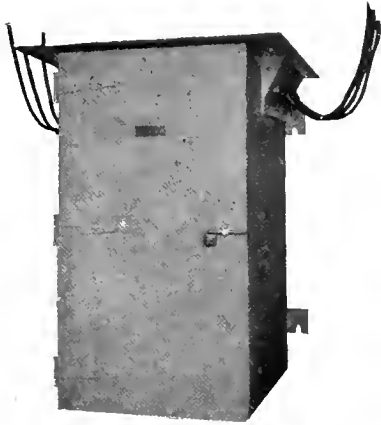


Fig. 18. 2500-Volt, Three-Phase Switch House for Outdoor Installation

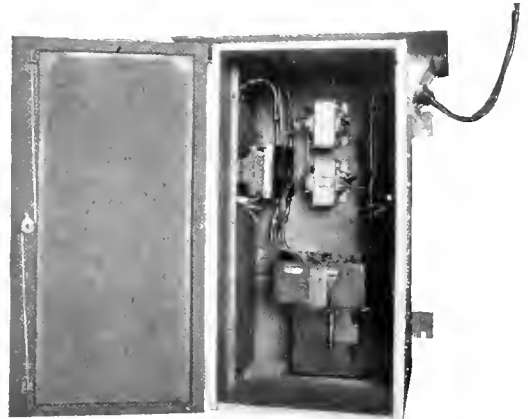


Fig. 19. 2500-Volt, Three-Phase Switch House Showing Inside View with Meter Panel Removed

A new type of solenoid-operated manhole oil switch has been developed which is entirely self-contained, and gives the advantage of remote control in that the switch may be operated from a distance with absolute reliability, even if the switch compartment is completely flooded. The compact arrangement and water-tight construction of this oil switch render it specially valuable for manhole service, or for use in other locations liable to flood.

A number of notably large circuit breakers have recently been constructed, the maximum

capacity provided for being 20,000 amperes. This type of breaker is operated by a single-coil solenoid with the usual automatic overload trip, and has, in addition, a shunt trip coil plunger which acts directly on the circuit breaker locking latch, instead of on a trip on the solenoid.

A new and ingenious electrostatic synchronism indicator has been developed. The instrument case resembles an ordinary round pattern switchboard instrument, and inside of this are receptacles for holding three special glowers which project through holes in the case cover. All connections from the line to the device are made through condensers which consist of suspension insulators

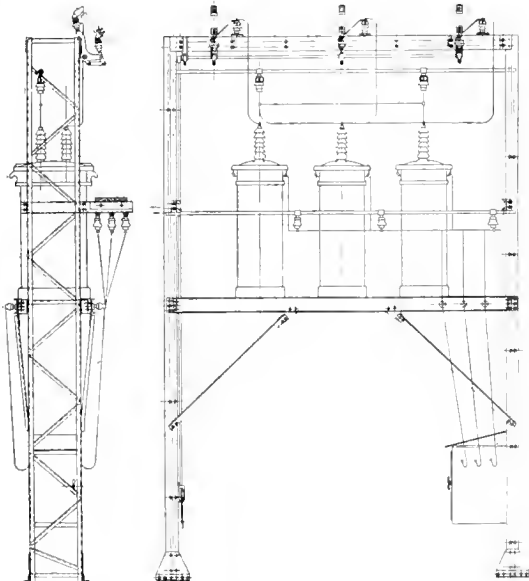


Fig. 20. Arrangement of Switching Apparatus and Three Single-Phase Transformers for Supplying 150 kv-a. at 2300 Volts from a Three-Phase 35,000-Volt Transmission Line

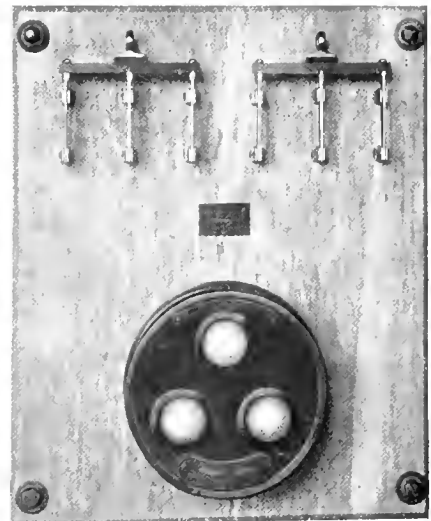


Fig. 21. Electrostatic Synchronism Indicator

having an insulation equal to that used on the line.

Normally, the glowers have the appearance of ordinary spherical frosted incandescent lamp bulbs, but when there is a proper difference of potential across the terminals, they glow with a reddish hue, due to the use of a special gas.



Fig. 22. Compensator Type Incandescent Lighting Unit Equipped with Concentric Reflector and Prismatic Refractor

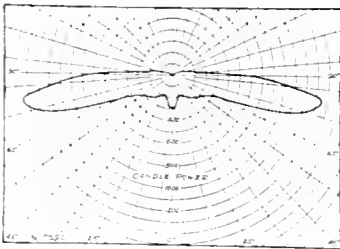


Fig. 23. Characteristic Distribution Curve of the Above Unit with 600 c.p. Mazda Series Lamp

The instrument can be operated on a line having a pressure as low as 13,200 volts, and can be made suitable for practically any voltage above this by simply cutting in the proper number of insulators.

Lighting

The commercial application of the high efficiency mazda lamp involved the design of a complete new line of fixtures. These were rendered necessary, partly by the in-

crease in size and modifications in the shape of the lamp which were found advisable due to the concentration in a single incandescent unit of the large candle-powers which the high efficiency type of lamp permitted, but largely because of the increased temperatures experienced in their operation.

During the past year these lamps have been successfully adopted for street lighting in a number of cities, and for series operation they have been provided with a new type of compensator having efficiencies of from 93 to 95 per cent with power-factors of from 97 to 98 per cent.

There has also been developed by the General Electric Company a prismatic refractor which, in combination with suitable

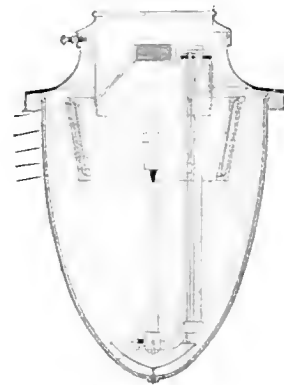


Fig. 24. Luminous Arc Lamp with Prismatic Refractor

reflectors, insures a more effective control of the light distribution than any type of globe yet developed.

For street car headlights a new line of concentrated filament incandescent lamp has been provided, and a large percentage of those now in service are equipped with a new and highly efficient form of glass parabolic reflector.

The improved efficiencies which have been obtained during the year in luminous arc lamps have been due very largely to the production of an electrode which, for a given current consumption, produces from 30 to 50 per cent more light than any electrode previously utilized.

This has been accomplished through exhaustive research work resulting in new electrode compositions, containing a larger proportion of titanium than older electrodes. The use of this element in suitable combination enables this type of arc lamp to give

the highest illumination efficiencies yet obtained by any commercial lamp. In addition to this the arc lamp mechanism has been simplified and the light distribution improved by the adoption of a prismatic refractor similar in principle to that designed for the high efficiency mazda lamp, but differing from it in form.

These cumulative improvements have resulted in the production of a new line of 5-ampere luminous arc lamps which give practically the same illuminating values formerly obtained with 6.6-ampere lamps. A 5-ampere series rectifier is also available for operation in connection with the new lamps.

The vast number and varied character of the developments in the modern electrical industries renders it exceedingly difficult to give in a necessarily limited article, a truly comprehensive description of the progress made in any year, but in the foregoing the writer has endeavored to show the general trend of the changes inaugurated in the manufacture of electrical apparatus, by reference to a limited number of specific examples and, in conclusion, it may be reiterated that most of the equipments cited have already been subjected to the stresses of commercial service and have successfully withstood the pragmatic test.

THE ABSOLUTE ZERO

PART I.

BY DR. SAUL DUSHMAN

RESEARCH LABORATORY, GENERAL ELECTRIC COMPANY

During the last three or four years a large number of important investigations have been carried out on the properties of substances at extremely low temperatures. The results obtained have been intensely interesting, both from a practical and theoretical point of view. In the first part of the paper the author discusses the logical foundations of our present temperature scale and the various methods that have been used to attain extremely low temperatures; while in the next issue he will deal with the behavior of different substances at low temperatures and point out the important bearing of these investigations. The original conception of temperature was simply that of denoting the state of heat or cold of a body. Subsequently, the necessity arose for quantitatively comparing different states of heat or cold.—EDITOR.

Conception of Temperature

Early conceptions of temperature, heat, cold, and quantity of heat were very confused. There was a great deal of groping in the dark before the idea of measuring heat quantitatively was arrived at and the difference between quantity of heat and temperature was understood. It was generally known that the volume of a body altered with its state of heat or cold and so there followed the idea of using a volume of a mercury or a gas column, placed in contact with the body, as a mode of determining its temperature.

Having noticed that there is no change in volume at the melting point of ice and the boiling point of water (at constant atmospheric pressure) it was also agreed to use these two fixed points for the graduation of thermometers.

There arose, however, the necessity of indicating temperatures above and below these two fixed points, and the question also arose as to the manner in which the scale between the two fixed points should be divided.

On comparing the expansion of different substances it was observed that the expansion in most cases is approximately linear. Thus when we use as thermometric substance a mercury column and divide the volume between the two fixed points into one hundred equal divisions, we find that whether we take air, alcohol, or glass, each of these substances has an approximately constant coefficient of expansion throughout the same range of temperatures. It thus became possible to extend the scale of temperatures below the freezing point of water and above its boiling point.

A further generalization was observed.

All gases expand about $\frac{100}{273}$ of their volume

at the melting point of ice when the temperature is raised to that of boiling water. Here then we have a property which is independent of the nature of the substance used. What could be more natural than the decision to use a gas as standard thermometric substance?

Gas Thermometry

It is necessary to distinguish in this connection between the gas thermometer at constant pressure and that at constant volume. Denoting the temperature on the Centigrade scale by t , and the corresponding pressure and volume by P_t and V_t respectively, the temperature is defined as follows:

$$t = 273 \left(\frac{P_t - P_o}{P_o} \right) \text{ at constant volume}$$

$$= 273 \left(\frac{V_t - V_o}{V_o} \right) \text{ at constant pressure}$$

where P_o and V_o denote the pressure and volume respectively at the freezing point of water.

Now if we plot t as abscissa and $\frac{P_t}{P_o}$ as ordinate, we find that at $t = -273$, P_t/P_o becomes equal to zero; similarly $\frac{V_t}{V_o}$ becomes equal to zero at $t = -273$. In other words, on the constant volume thermometer, the pressure vanishes at a temperature of -273 deg. C., while on the constant pressure thermometer, the volume vanishes at this temperature. Here then we apparently reach a *non ultra plus* in the region of low temperatures. We might, therefore, be justified in designating this lowest temperature as an *absolute zero*.

At first glance, the conclusion based on the above considerations that there must exist a lower limit of temperatures might seem rather arbitrary. Why choose -273 deg. C. any more than -5500 deg. C., which corresponds to the temperature at which a volume of mercury would vanish? (The coefficient of expansion of mercury is $\frac{1}{5500}$ per degree Centigrade.) When it is, however, considered that *all* substances in the gaseous state exhibit practically the same coefficient of expansion, and furthermore that gases probably represent the simplest state in which matter can be obtained—when these facts are duly considered, it is seen that the choice of -273 deg. C. as the absolute zero is not so arbitrary.

There is, however, a much more cogent reason for concluding that an absolute zero actually exists and that it coincides with the absolute zero as defined on the ideal gas thermometer.

Absolute Scale of Temperature

It was first pointed out by Lord Kelvin that the scale of the ideal gas thermometer

coincides with another scale of temperatures which can be based upon the second law of thermodynamics and is therefore *independent of the properties of any particular substance*.

In its most general form this law states that for the conversion of energy in the form of heat into mechanical energy there is required a *difference in temperature*; and the maximum fraction of the total heat energy at any given temperature that is convertible into work depends upon the available temperature drop only and not upon the nature of the engine used for the operation. It is for this reason that we cannot withdraw heat from the ocean and convert it into mechanical work. The steam engine, as well known, is a direct application of the above principle. The greater the difference in temperatures of boiler and condenser, the greater the efficiency.

Let us denote by Q_1 the amount of heat absorbed at the higher temperature, θ_1 , by any sort of reversible engine that is capable of converting heat into work. For our present purpose we do not need to worry about the exact thermometric scale which we adopt to measure θ . Let θ_2 denote the temperature of condenser and Q_2 the heat given out by the engine at this temperature. The difference $Q_1 - Q_2$ corresponds to the amount of heat converted into work, and the fraction $(Q_1 - Q_2)/Q_1$ measures, therefore, the efficiency of the process.

According to the second law of thermodynamics, this efficiency depends upon the temperatures θ_1 and θ_2 , that is, upon the temperatures of the hot and cold reservoirs. We can assign to θ_1 and θ_2 such values that they represent the ratio of the quantities of heat Q_1 and Q_2 ; that is, we write

$$\frac{Q_2}{Q_1} = \frac{\theta_2}{\theta_1}$$

This manner of reckoning temperatures immediately leads us to the notion of an absolute zero of temperature, for the equation can be written in the form

$$\frac{Q_1 - Q_2}{Q_1} = \frac{\theta_1 - \theta_2}{\theta_1}$$

At $\theta_2 = 0$, all the heat Q_1 taken in from the hot reservoir will be converted into work, and since we cannot imagine any better efficiency than this, it is impossible for θ_2 to be negative. "Thus $\theta_2 = 0$ is the lowest temperature conceivable. The zero on this scale is consequently an absolute zero of temperature independent of the properties of any particular substance, for when the

efficiency of one reversible engine is unity, the efficiency of every other reversible engine working between the same source and condenser will also be unity, and hence if θ is zero for one substance, it will also be zero for every other. *This zero is therefore absolute.*"

We are still at liberty to choose the size of a degree on this scale. If we choose the new scale so that there may be 100 degrees between the freezing and boiling points of water, we find that the absolute zero is 273 degrees below the freezing point of water.

Definition of Ideal Gas

The scale of an ideal gas thermometer is therefore identical with the absolute scale defined in the above manner. In this connection we may define an ideal gas as "one which follows Boyle's law and in which a free expansion, with no external work, would cause no change in temperature * * * * No real gas satisfies these conditions exactly, but all the common thermometric gases, as they are used in gas thermometers, do satisfy them approximately. Hence it is that the ordinary gas scales and the thermodynamic scale are all approximately the same, and the problem of finding the mutual relations of the various scales is reduced to the *investigation of the departures of the actual gases from the ideal state and the computation of corrections for the departures.*"*

The kinetic theory of gases enables us probably to obtain a clearer conception of what is actually meant by an "ideal gas." According to this theory the pressure exerted by any gas against the walls of the containing vessel is due to bombardment by a large number of infinitesimally small particles (molecules) which are in rapid motion. The pressure therefore increases with the number of molecules per unit volume and their average velocity. The volume actually occupied by the molecules themselves is assumed to be infinitesimal as compared with the volume in which they are present. The collisions between the molecules must be perfectly elastic, otherwise the energy of the gas would tend to decrease indefinitely. Heat applied to the gas is converted into kinetic energy of the molecules; thus the average kinetic energy forms a measure of the temperature of the gas.

When the gas expands, heat is absorbed because the molecules have to perform a certain amount of work against the external

pressure acting on the walls. In a perfect gas the amount of heat absorbed is exactly equal to the amount of external work done. If, however, additional energy is required to overcome any attractive forces between the molecules themselves, the amount of external work will be less than the total energy absorbed. Similarly, if the forces between the molecules are repulsive, the discrepancy between external work and heat absorbed is in the opposite direction. We are thus led to conceive of a perfect gas as one in which the volumes of the molecules are practically reduced to points, while the forces acting between them are diminished to a negligible factor.

From the kinetic point of view the absolute zero is the temperature at which the molecules of a gas lose all kinetic energy. That such a state may be impossible to realize in practice, only leads to the further belief that we can never actually attain the absolute zero.

Gay-Lussac's Experiment

The notion of a perfect gas arose from two facts: first, the validity of Boyle's law over very large ranges of pressures and temperatures for nearly all the ordinary gases, and second, the demonstration by Gay-Lussac that the temperature of a gas does not change by any noteworthy amount when the volume merely increases without doing external work.

The latter experiment has become a classic in the history of science. Gay-Lussac connected two receivers by means of a tube furnished with a stop-cock, and immersed them in a bath of water which served as a calorimeter. One of the receivers was filled with air under pressure, the other was exhausted. On opening the stop cock between the two vessels, the pressure naturally became equalized. However, the temperature of the surrounding water remained at the same value as before the expansion. The conclusion drawn was therefore that "no change of temperature occurs when air is allowed to expand in such a manner as not to develop mechanical power."†

Porous-Plug Experiment

The experiment was subsequently repeated by Joule and Thomson under much more accurate conditions and the conclusion of Gay-Lussac shown to be not quite true for ordinary gases. The latter investigation is known as the "porous-plug" experiment and for a detailed description of this the

* E. Buckingham, Bull. Bur. Standards, 3, 237 (1907). Reprint No. 57.

† Preston, p. 286.

reader may refer to any text-book on heat. In this experiment the gas is forced to flow steadily through a porous plug, which is so insulated that no heat can enter or leave it by conduction. The pressure and temperature are observed on both sides of the plug and from these observations it is possible to determine whether there is any change of temperature when the gas expands without performing mechanical work. It was found by Joule and Lord Kelvin that hydrogen becomes warmer, while all the other ordinary gases become colder in passing through the capillaries of the plug.

With the data obtained from the porous-plug experiment and the further observations on the manner in which the different gases deviate from Boyle's law at different pressures and temperatures, it is therefore possible to calibrate the indications of the ordinary air or hydrogen gas thermometer (the usual form is that at constant pressure) in terms of absolute or thermodynamic scale.*

Radiation Scale of Temperature

It was shown experimentally by Stefan, and deduced theoretically by Boltzmann that the radiation within an enclosure whose walls are maintained at a uniform temperature is absolutely independent of the nature of the enclosure, and varies with the fourth power of the temperature. If E denotes the amount of energy radiated per unit area of a black-body radiator at temperature θ , we have the relation

$$E = b \theta^4$$

At the absolute zero, the energy radiated is zero, and if we choose a suitable value of the constant b , we can make the radiation scale of temperature agree with the absolute scale at all temperatures. We are thus provided with another method of calibrating thermometers and pyrometers in terms of the thermodynamic scale.

Methods of Attaining Low Temperatures

The different methods which have been used for attaining low temperatures may be classified under the following heads:

(1) Methods involving the use of freezing mixtures.

(2) Methods involving the liquefaction of gases under pressure and the subsequent evaporation of these liquids.

(3) Cooling of gases owing to adiabatic expansion.

(4) Cooling of gases owing to the Joule-Thomson effect.

* E. Buckingham, Bull. 57, Bur. of Standards.

Freezing Mixtures

The addition of salt to water lowers its freezing point by an amount which increases with the concentration of the salt in solution. On the other hand, the solubility of salt in water decreases with the temperature. Consequently, at a certain definite temperature the solution freezes as a whole, the composition of the solution being the same as that of the ice-salt mixture which separates out. This temperature, which is the lowest at which salt and ice can exist in equilibrium with a solution of salt in water, is known as the *cryohydric* temperature, and the mixture of ice and salt which has this definite melting point is known as a *cryohydrate*. From these facts it is easy to give an explanation for the cooling effect of such freezing mixture.

If we mix ice, salt and water at a temperature above the cryohydric point, the water will tend to dissolve salt until it becomes saturated; on the other hand, ice will melt and tend to dilute the solution which will again dissolve more salt, and this will result in the melting of more ice. As the freezing mixture is assumed to be well insulated thermally, the temperature must decrease owing to the latent heat abstracted for melting the ice, until finally a temperature is attained at which the solution has the same composition as the ice and salt mixture which separates out from it on freezing.

The temperatures obtainable by the use of cryohydrates range as low as -55 deg. C. The following table gives the compositions of a few of these cryohydrates together with the temperature of the cryohydric point.

CRYOHYDRATES

Name of Salt	Cryohydric Point (Degrees Centigrade)	Percentage of Anhydrous Salt in Freezing Mixture
Calcium chloride	-55	29.8
Sodium bromide	-24	41.33
Sodium chloride	-22	23.60
Sodium nitrate	-17.5	40.80
Ammonium chloride	-15	19.27
Magnesium sulphate	-5	21.86

Liquefaction of Gases by Pressure

The freezing of water at ordinary temperatures owing to very rapid evaporation is a familiar phenomenon. The temperature of any liquid tends to maintain itself at that value which corresponds to the pressure of the vapor above it. If now a vessel of water is placed under the receiver of an air-pump

and the water vapor pumped out very rapidly, the temperature of the water is decreased, owing to the heat absorbed in evaporation, to a point at which the pressure of the water vapor in the receiver is in equilibrium with the water.

Similarly the temperature of any liquid can be lowered very considerably if it be allowed to evaporate very rapidly, and upon this principle depends the use of liquefied gases in producing low temperatures.

It is possible, by the use of very high pressures, to liquefy a large number of gases at

By evaporating liquid CO₂ at ordinary pressure it was found possible to attain a temperature of -78 deg. C. In present practice, the liquid carbon dioxide contained in a steel cylinder is allowed to evaporate at atmospheric pressure; and owing to the rapid evaporation some of the out-flowing liquid solidifies to a snow-like mass. This is mixed with ether or toluene and used for maintaining a constant temperature of -78 deg. C.

In the case of liquefied ammonia and sulphur dioxide, the temperatures obtainable by allowing these to evaporate at atmospheric pressure are -31 deg. C. and -10 deg. C. respectively. By allowing these liquids to evaporate at 0.1 atmospheric pressure, the temperature is lowered still more, and in the case of CO₂, Faraday obtained a temperature of -110 deg. C. by evaporating the liquid under very low pressure.

Critical Temperature

There remained some gases, however, which Faraday and subsequent experimenters were unable to condense even with the highest available pressures. These were therefore designated as "permanent" gases, and included CH₄, NO, CO₂, O₂, N₂ and H₂. Subsequently there were added to this list the so-called "noble" or rare gases, krypton, argon, neon and helium.

Andrews (1869) first pointed out that extremely great pressure alone is not sufficient for the liquefaction of gases. It is also necessary to cool the gas below its *critical temperature*. At this temperature the gas may be condensed by a pressure which is known as the *critical pressure*, while at higher temperatures the gas remains incondensable no matter how high the pressure is raised. The following table gives the critical temperature and critical pressure of a number of gases.*

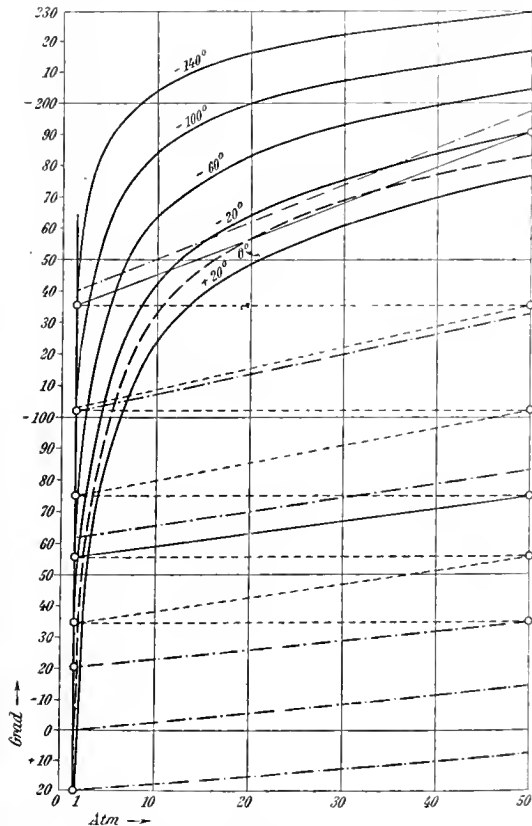


Fig. 1. Decrease in Temperature of Air Obtainable with Adiabatic Expansion (full line curves) and Joule-Thomson Expansion (dotted lines)

ordinary temperatures. Faraday was one of the first experimenters to make extensive use of this method for liquefying gases. He used thick-walled glass U-tubes, generated the gas in one limb and allowed it to condense under its own pressure in the other limb, which was cooled in an ice-salt mixture. The following gases were condensed by him by this method: SO₂, HL, CL₂, NH₃, C₂N₂, H₂S, HBr, PH₃, HCl, N₂O, CO₂ and C₂H₄.

Gas	Symbol	Critical Temp. (Degrees Centigrade)	Critical Pressure (Atmospheres)
Helium	He	-267.84	2.26
Hydrogen	H ₂	-241.1	11.
Nitrogen	N ₂	-146	35
Carbon monoxide	CO	-139.5	35.5
Argon	A	-122.4	48
Oxygen	O ₂	-118.8	50.8
Nitric oxide	NO	-92.9	64.6
Methane	CH ₄	-81.8	54.9
Carbon dioxide	CO ₂	31.1	73
Hydrogen chloride	HCl	51	81.5
Ammonia	NH ₃	131	113
Sulphur dioxide	SO ₂	157	78.25
Water	H ₂ O	374	217.5
Mercury	Hg	1270	...

* K.*Jellinek, Lehrbuch der physikal. Chemie, I (1), p. 444.

It can be observed from this table that the gases which had been condensed by Faraday and others before the investigations of Andrews have this feature in common, that their critical temperatures lie above 0 deg. C.

As a result of Andrews' work, it became evident that in order to liquefy the so-called permanent gases it is necessary to cool them to temperatures still lower than those hitherto attained.

Cooling of Gases by Adiabatic Expansion

When a gas is allowed to expand reversibly, that is, in such a manner that the pressure of the gas is always just equal to the external pressure, work is done against this external pressure. If the gas is maintained at constant temperature, the expansion is said to be isothermal, and the energy required to overcome the external pressure is absorbed from the constant temperature reservoir. If, however, the gas is insulated thermally, so that heat can neither enter nor leave it, the energy required for expansion is absorbed from the kinetic energy of the gas molecules themselves, so that the temperature of the gas decreases. Such an expansion is said to be adiabatic, and the relation between the pressure and temperature in the case of an ideal gas is given by the equation

$$\frac{T_0}{T} = \left(\frac{p_0}{p}\right)^{\frac{K-1}{K}}$$

where K is a constant for each gas. In the case of air the value of this constant is 1.40.

The curves shown in Fig. 1 indicate the cooling effect to be expected by expanding air adiabatically at different initial temperatures from higher pressures to 1 atmosphere. Thus starting with air at 20 deg. C. and 50 atmospheres, the temperature can theoretically decrease to -177 deg. C. (96 deg. K.)* If the compressed gas is initially cooled to -60 deg. C., the lower limit of temperature becomes -204 deg. C. (69 deg. K.). It is evident therefore that it is possible to obtain considerable cooling by adiabatic expansion (A).

L. Cailletet condensed in this manner the gases oxygen, nitrogen and carbon monoxide in small amounts. More recently Claude has applied the same principle to the construction of an apparatus for the continuous production of liquid air.

Cascade Method of Liquefying Gases

R. Pictet developed a very useful method of liquefying gases which has since then been

applied to great advantage by Kammerlingh Onnes in his cryogenic laboratory at Leyden. The fundamental principle of this method consists in cooling a gas (A) below its critical temperature by the rapid evaporation of another condensed gas, then using the liquefied gas A to cool a third gas B below its critical temperature, and so on.

Kammerlingh Onnes attains a constant temperature of -217 deg. C. (56 deg. K.) as follows: Methyl chloride is condensed by pressure at ordinary temperature and then allowed to evaporate under reduced pressure. This produces a temperature of -90 deg. C. and is used to condense ethylene (critical temperature, 10 deg. C.). The latter, in turn, when evaporated under reduced pressure produces a temperature of -165 deg., which is below the critical temperature of oxygen. By liquefying the last gas at the temperature of -165 deg. and evaporating the condensed product under reduced pressure it is possible to obtain a temperature of -217 deg. and maintain it for quite a long time.

Fig. 2 illustrates the method diagrammatically. The methyl chloride is condensed

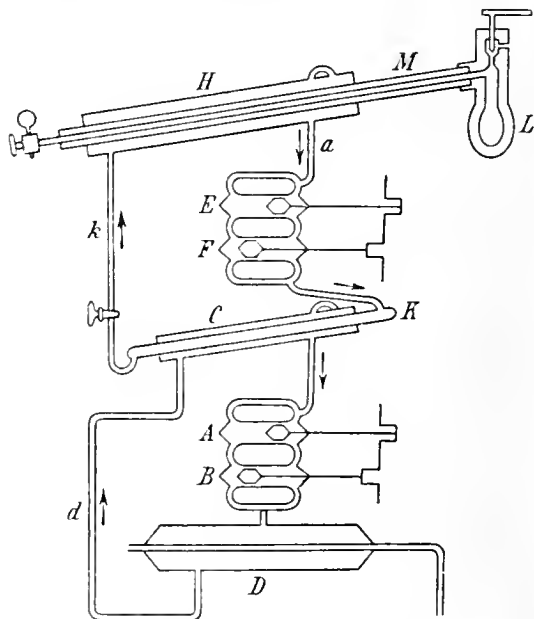


Fig. 2. Cascade Method of Liquefaction

by the compressor B and drawn through d into the outer tube of the condenser C. It is there evaporated by the exhaust pump A at a temperature of -90 deg. C. The ethylene passes through a similar cycle by means of the compressor B and exhaust pump

* We will use the symbol "deg. K." to denote degrees absolute. (K. = kelvin.)

E, producing a temperature of -165 deg. in *H*. The oxygen is generated in *L* and condenses under its own pressure in the tube *M*.

A consideration of the vapor pressure curves of different gases as drawn in Fig. 3* shows that this method is not applicable to the liquefaction of either hydrogen or helium, since the critical temperatures of both these gases are much below the lowest temperatures obtainable by evaporating the gases of higher boiling point.

Cooling of Gases Owing to Joule-Thomson Effect

If a gas is allowed to pass through a capillary tube from a higher to lower pressure, it ought, in the ideal case, to show no change

a lowering of temperature when expanded through a capillary. In the case of hydrogen and helium, there is a heating effect; but this gradually diminishes as the temperature at which expansion occurs is lowered, and below the so-called inversion temperature (-90

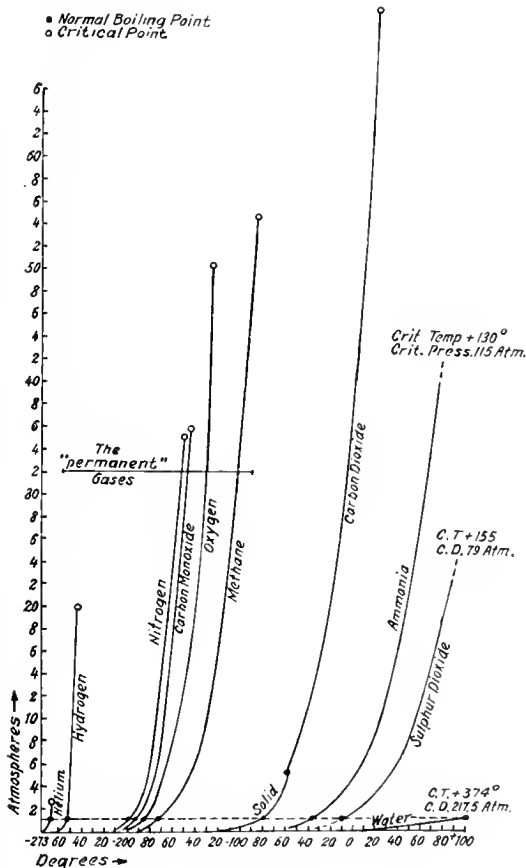


Fig. 3. Liquefaction Temperatures of Gases at Different Pressures

in temperature, since no external work is gained or lost. The porous plug experiment which has already been mentioned, shows however, that all ordinary gases, with the exception of hydrogen and helium, experience

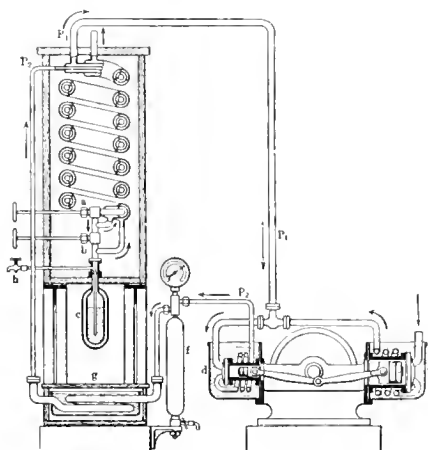


Fig. 4. Linde's Process for Liquefying Air

deg. C. for hydrogen) there is a cooling effect as in the case of the other gases.

Linde's process for the liquefaction of air depends upon this principle. It is illustrated diagrammatically in Fig. 4. The air is compressed to 20 atmospheres in the compressor *e* and then passes into the smaller compressor *d* where the pressure is increased to 200 atmospheres. The gas then passes through the pipe *P*₂ and the water-separator *f* into the cooling spiral *g* which is immersed in ice and salt (-20 deg. C.). The cooled gas then passes through the series of pipes *P*₂ and expands in the nozzle *a* to 20 atmospheres. The temperature falls during this operation to -78 deg. C. By passing this cooled air over other pipes carrying air at an initial temperature of -20 deg. C., the latter is cooled still further, so that when it expands in the nozzle *a*, its temperature falls well below -78 deg. C. By using three systems of concentric pipes the air is finally cooled down to a temperature at which it can be liquefied. The expansion valve *b* is then opened, so that a fraction of this cooled air expands from 20 atmospheres to 1 atmosphere and condenses. The liquid air is collected in the Dewar flask † C.

† In order to prevent the rapid evaporation of liquid air and similar products, Dewar suggested the use of double-walled flasks in which the space between the walls has been well evacuated. A vacuum is the best heat insulator known.

* K. Jellinek, loc. cit. p. 451.

The cooling effect actually produced in a Linde machine under operating conditions is shown in Fig. 4 by the fine dashed lines. Thus, air at -20 deg. is cooled to -36 deg. by expanding from 50 atmospheres to 1 atmosphere. If this cooled air is compressed and again expanded, the temperature drops to -54 deg., and then to -101 deg., -136 deg. and finally -190 deg. At this temperature liquid air has a vapor pressure of 1 atmosphere, so that the expanding air condenses.

In 1898 Dewar succeeded in liquefying hydrogen by the same method. As this gas has an inversion temperature of -90 deg. C., he cooled it in liquid air before subjecting it to the Joule-Thomson process.

By evaporating liquid hydrogen at low pressure it becomes possible to obtain temperatures ranging from -252 deg. C. (the boiling point at atmospheric pressure) to -259 deg. C., that is, from 21 deg. K. to 14 deg. K. This is still, however, above the critical temperature of helium.

As the inversion temperature of this gas occurs at 33 deg. K., its liquefaction presented

immense difficulties. In 1908, Kammerlingh Onnes succeeded in liquefying helium by cooling the gas first in liquid hydrogen and then cooling it still further by the Joule-Thomson process. The boiling point of helium at atmospheric pressure is 4.29 deg. K., and by evaporating the liquid under reduced pressure, Onnes has been able to obtain a temperature of 1.48 deg. K. (-271.6 deg. C.). These temperatures were measured by means of a low pressure helium thermometer, on the assumption, of course, that the gas laws are perfectly valid for helium under these conditions. Whether this assumption is justifiable cannot as yet be definitely stated. This much, however, is certain, that by evaporating liquid helium under very low pressure we are able to obtain a temperature which is within less than two degrees of the absolute zero.

In the next issue we shall discuss the behavior of different substances at these low temperatures, and point out the theoretical importance of the study of these low-temperature phenomena.

THE TOWING LOCOMOTIVES FOR THE PANAMA CANAL

BY C. W. LARSON

INDUSTRIAL LOCOMOTIVE DESIGNING ENGINEER, GENERAL ELECTRIC COMPANY

The January, 1914, number of the GENERAL ELECTRIC REVIEW contained eight articles describing the electrical and mechanical controlling devices for the lock machinery of the Panama Canal; and the July, 1914, number contained three articles describing the hydraulic turbines and equipment, the electric generators, and the controlling switchboard equipment located in the power station at Gatun which furnishes energy for operating the canal. The following article describes the ship *towing locomotives* used at the locks. The first part of the article is devoted to the presentation of the reasons why none of the hitherto existing systems of maneuvering ships in close quarters could be satisfactorily applied to the locks of this canal. Following this is a description of the system developed to fulfill the conditions. Next is a minute description of the locomotives themselves. These, it is very satisfying to know, are fully in keeping with the other unique devices which have been developed to make this wonderful canal possible.—EDITOR.

The President of the United States in June, 1905, appointed a Board of Consulting Engineers, men of international reputation, "for the purpose of considering the various plans proposed to and by the Isthmian Canal Commission for the construction of a canal across the Isthmus of Panama."

The majority report of this Board of Consulting Engineers contains the following:

"The three accidents at St. Mary's Falls Canal occurred within a period of nine years, where there is only one lockage of about 20 feet. If six locks should be adopted in a plan for the Panama Canal, each having a lift of 30 feet or more, as has been proposed in several projects, it would not be unreasonable, with an equal number of vessels, to look for six times the number of accidents in the same period of time, which would be at the rate of two per year. If groups of locks should be arranged in flights, as has also been proposed in some projects, the imminence of disastrous accidents would be greatly enhanced, as would be the amount of damage to the structures and to the vessels involved. Indeed, it is highly probable that the grave disaster of a great ocean steamship breaking through the gates of the upper lock and plunging down through those below might be realized."

It is true that the majority of the Board favored the adoption of the sea-level canal, but the foregoing quotation showed the necessity, in their opinion, of safeguarding the passage of vessels through the locks.

Investigations of collisions between ships and lock gates invariably show that "there was a misunderstanding in signals between the captain and the engineer." Bearing in mind that the engineer of the ship is so situated that he does not know the exact position of the ship, with respect to the lock,

he cannot check his actions by the probable result.

A system, therefore, which permits the checking of the movement of the ship with the signal given by the pilot or captain of the ship will eliminate improper manipulations to a very great extent.

Various systems are in vogue at dry-docks which are based on the principle that the operator sees the result of his action. The employment of winches or capstans has been looked upon with a great deal of favor. These are usually placed at intervals along the dock walls, and the lines from the ship are carried forward to the successive capstans as the ship advances. Such a system involves the risk of the ship not being properly safeguarded when the lines are transferred to the successive capstans. An improvement has been made by the installation of a capstan at the head of the dock, centrally located, and used for imparting a straight motion to the ship. Numerous lines from the ship to the dock wall are carried by men, and the capstans are employed to counteract any wind pressure, currents, etc., and assist generally in maneuvering the ship. While an improvement over former methods, it did not, however, possess the flexibility and reliability required for the operation of the locks of the Panama Canal, neither would it have eliminated the breaking of the lines at critical moments, which is regarded as one of the essential requirements in successfully handling ships in canal locks.

After a very thorough study of the entire problem of maneuvering the ships through the locks of the Panama Canal, it became evident that the ships should not proceed through the locks under their own power, and that a substitute for the ship's power should embrace the following requirements:

- (a) The ability to place the ship in proper relation to the lock.
- (b) The capability of keeping the ship in its course.
- (c) The accelerating and retarding of the ship without rupturing the lines.
- (d) The lines when once attached should be used without change for lockage in flight.
- (e) The services of a small number of skilled operators rather than a large number of unskilled men.

The towing system described in the following pages was designed and patented by Mr Edward Schildhauer, Electrical and Mechanical Engineer of the Isthmian Canal Commission.

Towing System

In passing through the canal from the Atlantic to the Pacific, a vessel will enter the approach channel in Limon Bay, which extends to Gatun a distance of about seven miles. At Gatun it will enter a series of three locks in flight and be raised 85 feet to the level of Gatun Lake. It may then steam at full speed through the channel in this lake, for a distance of 24 miles, to Bas Obispo, where it will enter the Culebra Cut. It will pass through this cut, which has a length of nine miles, and reach Pedro Miguel, where it will enter a lock and be lowered 30 feet. Then it will pass through Miraflores Lake for a distance of one and one-half miles until it reaches Miraflores, where it will be lowered 55 feet through two locks, to the sea level, after which it will pass into the Pacific through an eight and one-half mile channel.

The main features of all the lock sites are identical and the following brief description of the Gatun Locks, with especial reference to the arrangement of the towing tracks, ship channels, inclines and approaches, is given to present a clearer conception of the towing scheme in general. A more detailed description of the locomotive itself will then follow.

The general layout of the Gatun Locks is clearly shown in Fig. 1. It will be noted that there are two ship channels, one for traffic in each direction. The channels are separated by a center wall, the total length of which is 6330 feet. There are two systems of tracks for the locomotives, one which they use when towing and the other when they are returning idle. This, however, refers only to the outer

walls, since for the center wall there is only one return track in common for both the towing tracks. The towing tracks are naturally placed next to the channel side, and the system of towing normally utilizes not less than four locomotives running along the lock walls. Two of them are opposite each other in advance of the vessel, and two run opposite each other following the vessel, as seen in Fig. 2. The number of locomotives is increased, however, when demanded by the tonnage of the ship.

Cables extend from the forward locomotives and connect respectively with the port and starboard sides of the vessel near the bow, and other cables connect the rear locomotives with the port and starboard quarters of the vessel. The lengths of the various cables are adjusted by a special winding drum on the locomotive so that the vessel will be placed substantially in mid-channel. When the leading locomotives are started they will tow the vessel, while the trailing locomotives will follow and keep all the cables taut. By changing the lengths of the rear cables the vessel can be guided, and to stop it, all the locomotives are slowed down and stopped, thus bringing the rear locomotives into action to retard the ship. Therefore, the vessel is always under complete control thoroughly independent of its own power, and the danger of injury to the lock walls and gates is thereby greatly lessened.

The illustration in Fig. 12 shows how effectively the four locomotives keep the vessel under control and in the center of the channel, while Figs. 8 to 13 give a general idea of the method of handling vessels of various sizes. They also show general views of the lock walls, towing tracks, and inclines, the steepness of the latter being especially noticeable. Of particular interest is Fig. 11, which represents a trial tow approaching the second level. The water in the middle lock or at this second level is at sea-level, a condition not obtained in regular operation; and this trial was made to demonstrate that the towlines would clear the lock walls.

The towing tracks have a specially designed rack-rail extending the entire length of the track and centrally located with respect to the running rails. It is through this rack-rail that the locomotive exerts the traction necessary for propelling large ships and for climbing the steep inclines.

Rack-rail is also provided on short portions of the return track so as to lower the loco-



R2

000

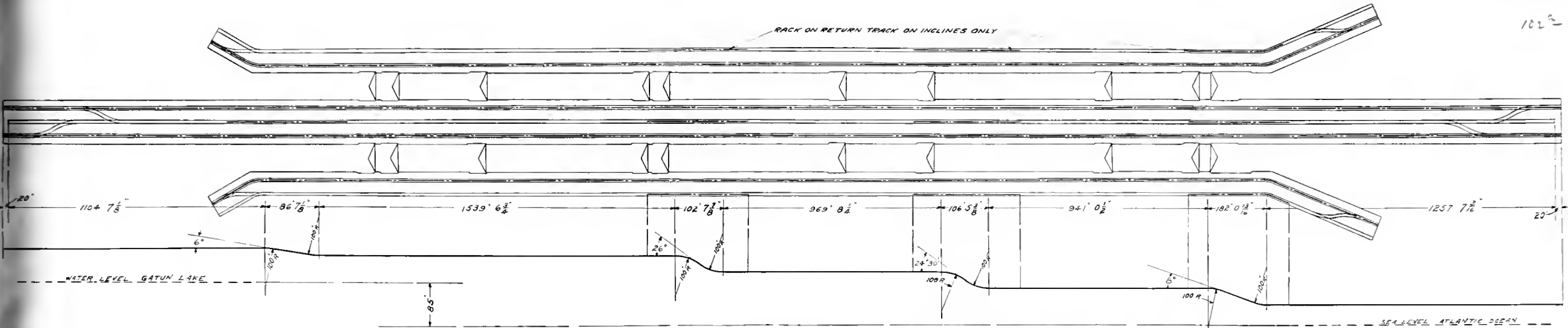


Fig. 1. A Drawing of the General Layout of the Gatun Locks. The heavy dot-dash line indicates the portion of the towing locomotive track that is equipped with rack-rail

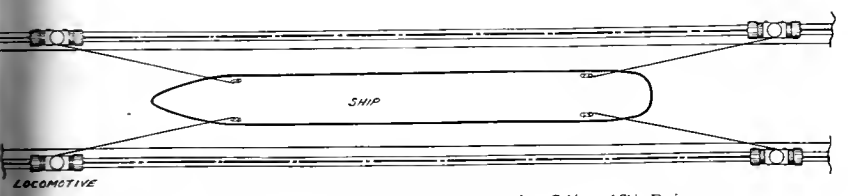


Fig. 2. Diagram Showing the Relative Location of the Locomotives, Cables and Ship During the Operation of Towing

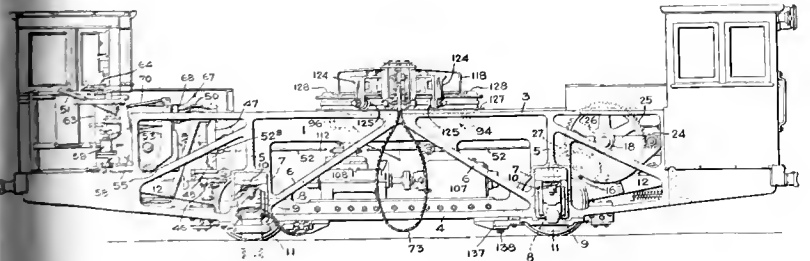


Fig. 5. A Side Elevation of a Towing Locomotive with the Covers Removed

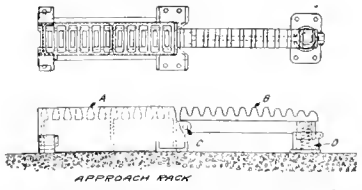


Fig. 3. A Section of the Fixed Rack-Rail at the Left and a Section of Movable Rack-Rail is Hinged at C. One of these movable sections is located at each end of the rack-rail

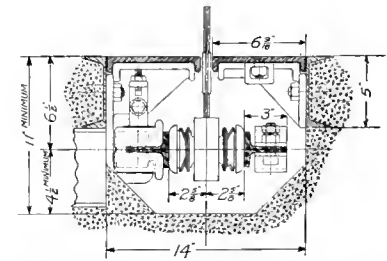


Fig. 4. A Section of the Conduit Showing the Current Collecting Device for Two Phases and the Underground Rails from which the Current is Taken

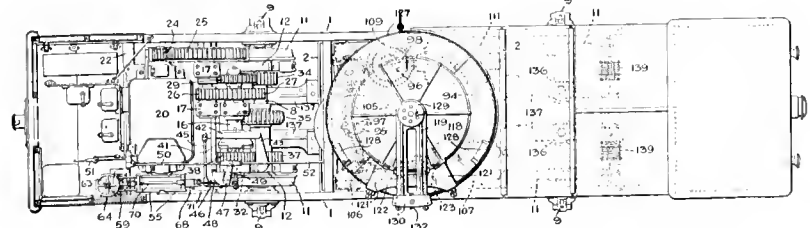


Fig. 6. The Plan View of a Towing Locomotive with the Covers Removed from the left-hand End

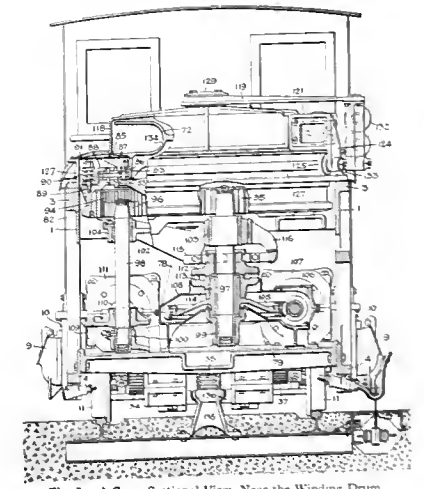


Fig. 7. A Cross Sectional View, Near the Winding Drum, of a Towing Locomotive

motives safely from one level to the next. The steepest slope is 26 deg. or 44 per cent, hence the need will be seen for rack-rail even on the return track, it being known that any traction locomotive with the usual wheel drive, even with brakes set, would begin to slide on a 16 per cent grade and could therefore not be controlled. With a rack-rail, however, traction is limited only by the capacity of the driving motors and not by the adhesion of the wheel treads to the rails.

A small portion of rack-rail is shown in Fig. 3, *A* being the rack-rail proper and *B* the approach to it. *B* is hinged at *C* so that it can be depressed on the approach of the rack-pinion of the locomotive. The teeth of the approach section are under size and are shaped off at the extreme end so that the teeth of the pinion will mesh properly and thus prevent excessive strain on the pinion and the axle. The spring *D* restores the approach to proper position after the locomotive has passed over. The rack-rail is of the shrouded type, and each tooth space

the walls. A further feature of the rack-rail is the projecting edges which permit thrust-wheels attached to the locomotive to run



Fig. 8 Electric Locomotives Locking 85-ft. Piles through the Pedro-Miguel Locks

along the under side and prevent the overturning of the locomotive, in case some unforeseen operating condition should produce an excessive pull on the tow-line. These thrust-wheels serve to counteract the lateral component of the tow-line pull and the flanges act for emergency only, as the weight of the locomotive is sufficient to prevent overturning with the normal pull of 25,000 pounds on the tow-line. These thrust-wheels are shown in Fig. 7.

Three-phase, 25-cycle, 220-volt alternating current is used for operating the locomotives, and the current is supplied to the locomotives through an underground contact system. The collecting device is illustrated in Fig. 4, while Fig. 7 shows its position with respect to the track, it being adjacent to the running rail on the side remote from the lock. Two

T-rails (shown in black section) form two legs of the three-phase circuit and the third leg is formed by the main track rails. A



Fig. 9. The "Ancon" Entering the Upper Gatun Lock from the Middle West Chamber under the Tow of Electric Locomotives

has a drain-hole cast in the bottom to carry off water and other accumulations to suitable drain pipes or ducts set in the concrete of



Fig. 10. The First Trial Run of the Towing Locomotives at the Gatun Locks. A barge was used in making this test

specially designed contact plow slides between the two T-conductors and transmits the power from the rails to the locomotive. This contact plow passes through the slot opening in the conduit cover and is flexibly connected to the locomotive in such a manner as to follow all irregularities in the tracks and crossovers, and therefore insures a continuous supply of power.

Locomotive Design

The working parts of the locomotive are supported by two longitudinal upright cast-steel side frames, No. 1, Fig. 5, connected by transverse beams, No. 2, Fig. 6. These frames are, in effect, deep rigid trusses, having upper and lower members connected by posts, No. 5, and diagonal braces, No. 6, Fig. 5. The middle portion of each frame



Fig. 11. The First Trail Tow with the Barge at the Second Level of the Gatun Locks, Rear Locomotives Ascending the Incline. The water in this middle lock (second level) is shown at sea level, a condition not obtained in regular operation. This trial was made to demonstrate that the tow lines would clear the lock walls



Fig. 12. Four Towing Locomotives Attached to the Submarine Tender "Severn" in a Gatun Lock Ready for Lowering the Water-Level. A group of submarines may be seen at the far end of the lock

has its upper and lower members parallel and horizontal, but the end portions have their lower members inclined upward toward the ends of the frame. The pedestals, No. 7, for the wheel axles, No. 8, are located at the junction of these end portions with the middle portion, and are of the usual locomotive type, having vertical parallel jaws between which the journal, No. 9, slides. Springs, No. 10, are interposed between the

tops of the journal boxes and the tops of the pedestals, and the locomotive is thus mounted upon four wheels, No. 11, carried on the two axles, No. 8, the wheel-base being 12 feet and the overall length of the locomotive over 32 feet.

Each axle is driven by its own motor, independent of the other, and as the construction is identical at both ends of the machine, a description of one end will suffice for both.



Fig. 13. The "Severn" Leaving the Upper East Chamber in the Tow of Electric Locomotives

A cast-steel suspension bracket, No. 12, Fig. 14, is hinged at one end upon the axle. Its bearings, No. 13, which fit the journals on the axle are secured in place by caps, No. 14,

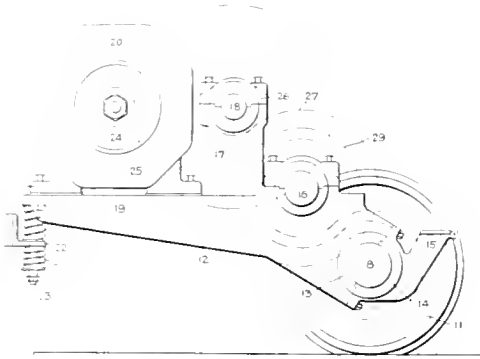


Fig. 14. A Side Elevation of the Traction Brackets

which are provided with oil cellars, No. 15. The bracket is provided with bearings for a transverse jackshaft, No. 16, parallel with the axle, and it has pillow blocks, No. 17, for a countershaft, No. 18, also parallel with the axle. It has a substantial horizontal platform, No. 19, to support the driving motor, No. 20, and its outer end is supported at each corner by two springs, No. 21, placed above and below a stationary angle-iron, No. 22, and connected to the bracket by a bolt, No. 23, so as to afford a yielding support in both upward and downward movements of the bracket.

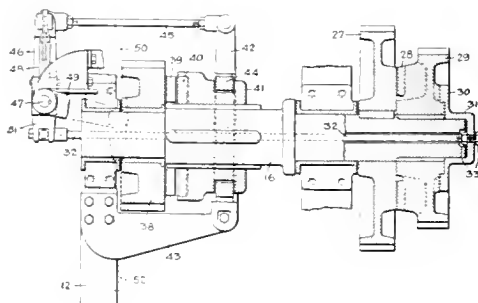


Fig. 15. A Longitudinal Horizontal Section of a Clutch Shaft

The motor, No. 20, is of the three-phase, slip-ring type, enclosed, and identical to the rugged steel-mill design, and it is geared by pinion, No. 24, and spur gear, No. 25,

to the countershaft, No. 18, which carries a pinion, No. 26, meshing with a spur gear, No. 27, Fig. 15, keyed to the jackshaft, No. 16. On the outer side of the spur gear, No. 27, are formed clutch teeth which cooperate with similar teeth, No. 28, on the adjacent side of a gear, No. 29, which is sleeved upon the jackshaft, and which can be slid lengthwise thereon to engage and disengage the clutch teeth. The means for sliding this gear consists of a disk, No. 30, secured to the gear and having a central hub, No. 31, fitting over the end of the jackshaft, Fig. 15. A rod, No. 32, Fig. 15, runs through a central hole in the shaft and through the center of the hub, No. 31, to which it is connected by nuts, No. 33, in such a manner as to permit the disk to rotate with the wheel, and at the same time to cause it to slide the wheel axially when the rod is reciprocated. A pinion, No. 34, Fig. 17, is keyed to the axle, No. 8, and is wide enough to always mesh with the gear, No. 29, so that when the clutch teeth, No. 28, are engaged, the motor will propel the locomotive by the adhesion between the wheels, No. 11, and the rails of the track, and this only when running without load and between inclines.

When the locomotive, however, reaches one of the inclines between the locks, the grade of which may be as much as 44 per cent, or when it is towing a ship, the cog-rail system is utilized to enable the locomotive to climb the grade or to exert the traction necessary for pulling large ships. The cog or rack-rail is laid between the track rails, and the locomotive is provided with a cog wheel or rack pinion, No. 35, Fig. 17, secured to or integral with a sleeve, No. 36, which rotates freely on the axle. A gear wheel, No. 37, secured to or integral with this sleeve, meshes with a gear, No. 38, Fig. 15, which turns loosely on the jackshaft. Clutch teeth, No. 39, on this gear can be engaged by teeth, No. 40, on a clutch, No. 41, which is splined to a jackshaft. A two-armed lever, No. 42, fulcrumed on a bracket, No. 43, straddles the shaft, No. 16, and is pivoted to a collar, No. 44, riding in a groove in the clutch, No. 41. The lever is connected by a link, No. 45, to one end of a lever, No. 46, Fig. 15, turning loosely on a vertical rockshaft, No. 47. An elastic arm is keyed to the shaft and engages lugs on the lever, No. 46. The arm, No. 48, is composed of a laminated flat-steel spring, Fig. 16, and a second arm, No. 49, is keyed on the shaft and connected by a rod, No. 50, to a handle in the cab of the locomotive. The

handle can be locked by a suitable latch and notched quadrant, and the other end of the lever, No. 46, is pivoted to the rod, No. 32, so as to throw out the clutch, No. 28, when the clutch, No. 40, is thrown in, and vice versa.

The elastic arm, No. 48, serves to throw the clutches automatically; it being understood that the four-jaw clutches in most cases do not mesh when thrown but that the operating handle is thrown full stroke and locked. This puts the springs under heavy tension. The locomotive is then started slowly and when the clutches are in alignment the springs throw them without any attention by the operator.

The two rocker shafts at opposite ends of the locomotive are connected by the rods, No. 52, pivoted to rocking arms, No. 52a, on the shafts and to an intermediate lever, No. 52b, fulcrumed on the pedestal supporting the winding drum. Figs. 16 and 19 will be of assistance in making clear the foregoing description of clutches and gear.

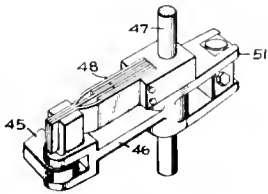


Fig. 16. A Drawing of the Clutch Operating Mechanism

The two traction motors, No. 20, are controlled by suitable controllers installed in the cabs at the ends of the locomotives, and the circuits are such that both motors can be controlled from either cab, and can be operated singly or in multiple as desired. Current is taken from the supply conductors by the special current-collecting device previously described and shown in Figs. 4 and 7.

It will be observed that each motor, with all its gearing and clutches, is mounted independently of the frame of the locomotive, to which it is connected only by the springs, No. 21, which give an elastic support for the outer end of the bracket, No. 12, Fig. 14, on which the mechanism is carried.

In connection with each motor a powerful brake is installed, and as during operation the motors are at all times geared either to the axles or to the cog wheels, the truck wheels, No. 11, are not provided with any brake rigging. The motor brake is shown in Figs. 5 and 6, but it is more clearly illustrated

in Figs. 18 and 20. On the motor shaft is keyed a brake disk or drum, No. 53, Fig. 18, and to opposite sides of it are applied the brake shoes, No. 54, carried by the brake

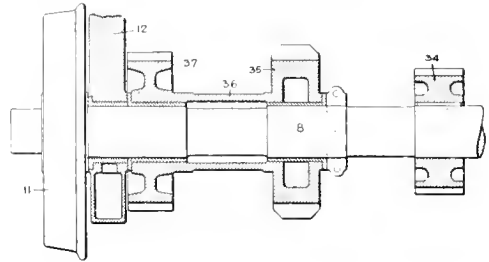


Fig. 17. A Longitudinal Horizontal Section of an Axle Shaft

levers, No. 55, which are pivoted at No. 56 upon a stationary bar, No. 57, projecting from a frame, No. 58, which supports a solenoid, No. 59. The movable core of this solenoid is pivoted to the long arm of a lever, No. 60, which is fulcrumed at No. 61 on one of the brake levers. A rod, No. 62, connects the angle of this lever with the other brake lever, thus constituting a sort of toggle between the two levers. When the core of the solenoid drops, it actuates the lever and the rod in such a manner as to draw the two brake levers toward each other, thereby applying the brake shoes to the drum. The winding of the solenoid is in circuit with the controller of the motors, so that when the

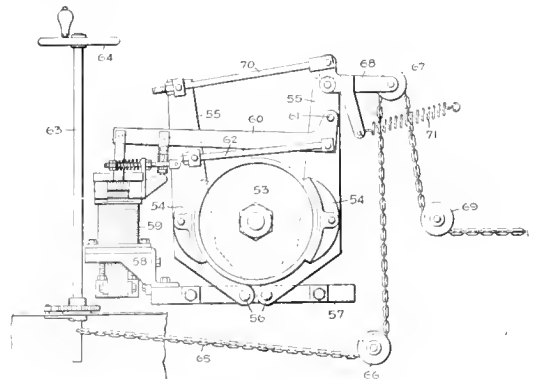


Fig. 18. A Side Elevation of the Combination Hand and Solenoid Brake and Rigging

current is turned on to energize the motor windings, the solenoid will lift its core and thereby release the brakes. The first point of the controller releases the brakes without applying power to the motors, thereby pro-

viding a coasting point. But should the motor current be shut off, either intentionally or accidentally, the core will instantly drop by gravity and its weight will exert a powerful

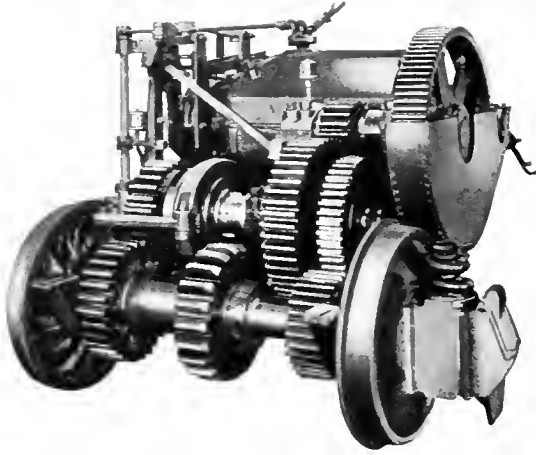


Fig. 19. A Front View of a Traction Motor Unit with a Journal Box in Place

leverage upon the brake levers to stop the motors and the locomotive. This action occurs simultaneously on both motors, and brake action is powerful enough to stop the locomotive within two revolutions of the wheels.

In addition to this automatic brake, means are provided for applying the brakes manually in order to supplement the action of the automatic feature, if necessary, when descending a grade or when approaching a rack-rail. An upright shaft, No. 63, Fig. 18, provided with a hand-wheel, No. 64, has attached to it one end of a chain, No. 65, which runs under a stationary pulley, No. 66, up over another pulley, No. 67, on one end of an elbow-lever, No. 68, pivoted to one of the brake levers, and thence under a stationary pulley, No. 69, to the opposite end of the locomotive. The elbow-lever, No. 68, has its other arm connected by a rod, No. 70, to the other brake lever, the rod being adjustable in length as shown. The lever, No. 68, and rod, No. 70, constitute a toggle connecting the brake levers. A spring, No. 71, tends to lift the arm carrying the pulley, No. 67, and thus hold off the brake shoes. When the brake staff is turned, it winds up the chain and draws down the pulley, No. 67, thereby applying the brake shoes to the drum. In this way, the operator can add hand power to the effect of

the electric brake and thus produce a greater braking action without interfering with the automatic operation of the solenoid.

As appears from Fig. 6, the brake levers, No. 55, are double, only the rear member of each being shown in Fig. 18. This avoids any bending strains on the pivots. The levers, No. 60, and No. 68, and the rods, No. 62 and No. 70, constituting the two toggle systems, are located between the two members of each lever, as are also the brake shoes, No. 54. The chain, No. 65, extends from the pulley, No. 69, to the similar point in the brake rigging of the motor at the other end of the locomotive, so that the operation of either of the brake staffs will apply both brakes simultaneously.

It will be noted that while the hand and the solenoid brake mechanism operate entirely independent of each other, both apply braking power through the same levers and wheel.

Passing now to the features which render the locomotive peculiarly adapted for towing purposes, it is observed that the drum, No. 72, Fig. 22, on which the cable, No. 73, Fig. 5, is wound, is located midway between the ends of the locomotive and above the upper member, No. 3, Fig. 5, of the side frames, so that the cable can be led off on either side of the machine and through a wide range of angles to the line of travel. The hub, No. 74, Fig. 22, of the drum is pivoted to the hub, No. 75, of the spider, No. 76, which in turn rotates upon the upper portion of a massive, tubular,

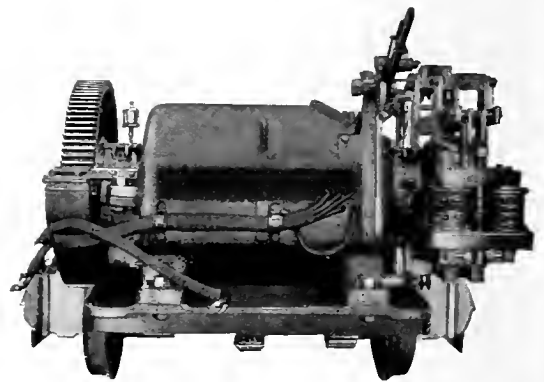


Fig. 20. Rear View of a Traction Motor Unit

vertical cylindrical column, No. 77, rising from a pedestal, No. 78, Fig. 25, secured to the base plate or floor, No. 79, Fig. 7, which is supported upon the lower members, No. 4,

of the side frames. The upper portion of the pedestal is held in a brace, No. 80, Fig. 24, which is shown as a heavy X-shaped casting, fastened to the upper members, No. 3, of the side frames and to two of the cross beams, No. 2. This brace fits the pedestal just below the shoulder, No. 81, Fig. 22, on which the hub, No. 75, is stepped.

The spider, No. 76, Fig. 22, supports a circular rim, No. 82, which has a horizontal upper surface, No. 83, and a flange, No. 84. On the surface, No. 83, is secured a flat smooth bronze ring, No. 85, and a second brass ring, No. 87, similar to the first, lies on top of a steel ring and is secured to a flanged follower, No. 88. Sixteen studs, No. 89, project up from the rim, No. 82, through holes in a horizontal flange of the follower and are encircled by strong springs, No. 90, which abut between the flange and nuts, No. 91, on the studs and press all three rings tightly together. The steel ring, No. 86, is secured to lugs, No. 92, on a flange, No. 93, projecting downward from the winding drum, No. 72, so that the rings constitute a friction clutch between the spider and the drum.

Inside the flange, No. 84, on the spider is secured a large internal gear, No. 94, with which mesh two driving pinions, Nos. 95 and 96, Fig. 7, secured respectively to two upright shafts, Nos. 97 and 98. Step bearings, Nos. 99 and 100, are provided for these shafts in the base of the pedestal, No. 78,

104, for the upper portions of the vertical shafts. A worm gear, No. 105, Fig. 7, is clutched to the shaft, No. 97, and is driven by a worm, No. 106, on the shaft of an electric motor, No. 107, bolted to the base, No. 79, of the locomotive. This gearing is pro-

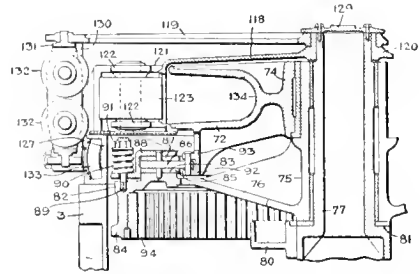


Fig. 22. Cross Sectional View of the Cable Guiding Devices taken through Line x-x of Fig. 21

tected by a casing, No. 108. A bevel gear, No. 109, is keyed to the upright shaft, No. 98, and meshes with a bevel pinion, No. 110, on the shaft of an electric motor, No. 111, fastened to the base.

The motor, No. 111, with bevel-gear pinion is used for driving the drum at a high speed when coiling the cable that has been cast off, and it remains permanently in gear. The other motor, No. 107, with worm-gear drive is used for taking in the cable when it is under load, and the drum operates as a windlass or capstan.

Due to the greater gear reduction, it operates the drum at a much slower speed, and consequently with motors of approximately equal size, a greater force may be exerted on the tow-line than would be possible with the lower speed reduction which is used with the high-speed coiling motor, No. 111. The worm-gear drive is disconnected from the drum when not in use. To accomplish this a clutch is provided, having one member, No. 112, Fig. 7, splined to the shaft and the other member, No. 113, attached to the hub, No. 114, of the worm gear, which is sleeved on the shaft. A lever, No. 115, Fig. 26, fulcrumed to a lug, No. 116, on the arm; No. 101, is pivoted to the hub of the clutch member, No. 112, and its other end is attached to the movable core of a solenoid, No. 117, which is connected in the controller circuit of motor, No. 111, so that whenever the circuit of the latter is closed to coil up the cable rapidly, the solenoid will lift its core and also lever, No. 115, thus throwing out the clutch of the winding motor. The first point of the con-

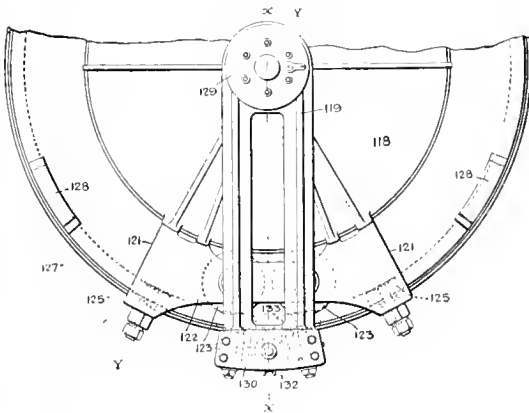


Fig. 21. Plan View of the Cable Guiding Devices

Fig. 7, while arms, Nos. 101 and 102, Fig. 6, projecting from the upper portion of the pedestal just below the brace, No. 80, Fig. 7, constitute guide bearings, Nos. 103 and

trolley which operates motor, No. 111, raises the clutch and on the second point the motor starts.

The guide which directs the cable, as it is paid out or wound up, is mounted so as to

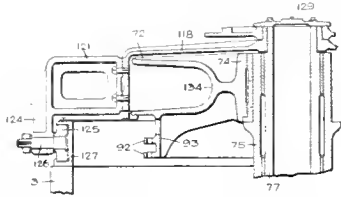


Fig. 23. Cross Sectional View of the Cable Guiding Device taken through Line Y-Y in Fig. 21

revolve on the axis of the drum. It comprises two angularly adjustable portions, Nos. 118 and 119, Figs. 21 and 22, the former being a circular bell which serves as a cover for the winding drum. The hub, No. 120, Fig. 22, of the bell is journalled on the upper end of the column, No. 77, being stepped on a shoulder thereon. At one side the housing is cut away to admit the cable to the drum, and on each side of this opening is bolted one end of a frame comprising box-like ends, No. 121, Fig. 23, connected by two parallel bars, No. 122, Fig. 22, one above and the other below the opening. Between the bars and on either side of the opening are two upright guide rolls, No. 123, Figs. 21 and 22, having cylindrical faces, and rotating on journals held by the bearings in the bars, No. 122. At each end of this frame arms, No. 124, Figs. 7 and 23, extend downward and support two rollers, No. 125, Fig. 7, mounted on horizontal studs, No. 126, Fig. 23, secured in the arms. These rollers are adapted to travel between the upper and lower flanges of a

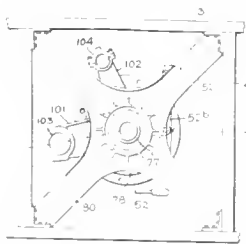


Fig. 24. Plan View of the Pedestal and Base

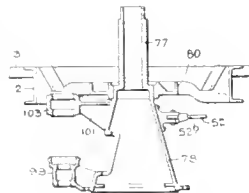


Fig. 25. Vertical Cross Section of the Pedestal and Base taken through Line z-z in Fig. 24

circular channel-iron, No. 127, Fig. 23, which is fastened on top of the side frames concentric with the column, No. 77, and forms a track supporting the outer end of the frame,

Nos. 121 and 122, thus relieving the column, No. 77, of the weight. Stops, No. 128, Fig. 5, are fastened to the top of the channel-iron, No. 127, to limit the angular play of the guide member, No. 118. They can readily be taken off, and the housing can be turned until the rollers, No. 123, are on the opposite side of the locomotive, after which the stops can be attached on that side to limit the movement of the housing.

The other guide member, No. 119, is a radial casting having one end turning freely on the hub of member No. 118, Figs. 7 and 21. A cap, No. 129, Fig. 21, is provided at the top of the column, No. 77, which protects the joint and prevents the guide members from accidentally coming off. The outer end of member No. 119 is an upright rectangular frame, No. 130, in whose top and bottom is journalled on a vertical axis a swivel, No. 131, carrying two grooved sheaves, No. 132, these

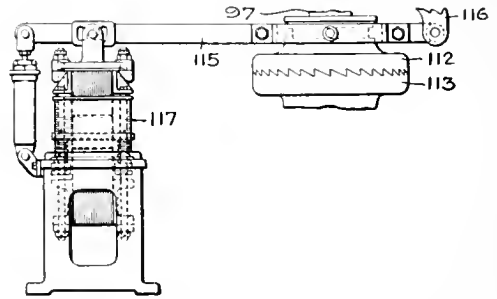


Fig. 26. Clutch Operating Mechanism for Slow-Speed Winding

also being led one above the other on horizontal axes. The edges of these sheaves are in close contact, so that their grooves form an opening through which the cable, No. 73, passes, approximately in line with the middle of the guide rollers, No. 123. The frame, No. 130, is supported by rollers, No. 133, Fig. 7, running in track, No. 127, and the guide member has an angular movement with reference to member No. 118, limited by the frame No. 130 striking the ends of the frame No. 121. When the cable is pulled either forward or backward from the middle position, which it occupies in Fig. 5, the swivel permits the grooved rollers, No. 132, Fig. 22, to move with it, and the guide member, No. 119, swings also, so that the rollers, No. 132, continue to support the rope in a line with the middle of the rollers, No. 123, without being themselves subjected to any side strain. All lateral strains are sustained by heavy guide rollers, No. 123, the cable moving

up and down between them as it winds on the drum. The latter is in the form of a deeply grooved wheel, the groove, No. 134, being U-shaped. Figs. 27, 28 and 29 clearly illustrate the construction of the equipment just described.

Fig. 29 shows the cable guard. This is a steel casting having a thickness of only three-eighths of an inch. The diameter is four feet six inches and the circular flange is 17 inches deep. This casting was pronounced to be beyond the possibilities of the ordinary open-hearth furnace by a number of steel foundries. They were eventually produced, however, in the contractor's electric furnace, where it was possible to intensify the heat, thus making the metal flow more rapidly. No failures occurred. With the exception noted, all the other principal steel castings for these locomotives were produced at the plant of the Wheeling Mold & Foundry Company, Wheeling, W. Va.

In order to resist the tendency of the locomotive to tip over when an excessive load comes on the cable, a stout rack-rail, No. 135, Fig. 7, is, as previously mentioned, laid between the traction rails of the track, and two horizontal flanged wheels, No. 136, are arranged between each pair of wheels, No. 11, and engage the opposite sides of the rack. These wheels are carried on heavy bars, No. 137, whose inner ends are pivoted at No. 138, Fig. 5, to the base of the machine, so that

One of the most important parts of the locomotive is the "slip-friction" device consisting of two special alloy rings, mounted on the spider, as has been previously explained.

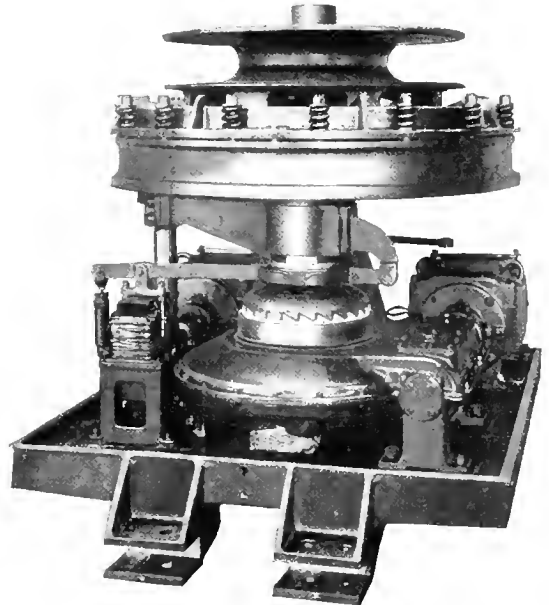


Fig. 27. Complete Assembled Windlass and Base

Between these rings a steel disk is fastened to the rope drum, and the amount of tension on the tow-line is adjusted by the pressure

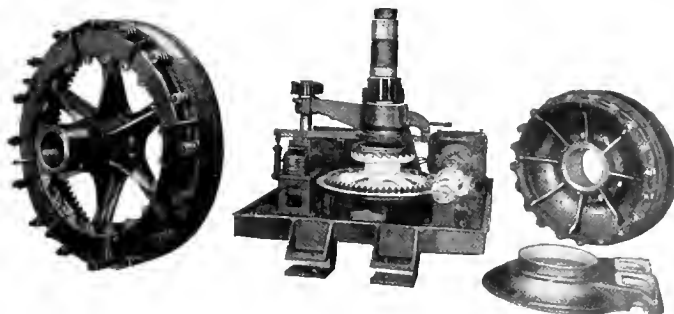


Fig. 28. Parts of the Windlass and Base and a Partial Assembly

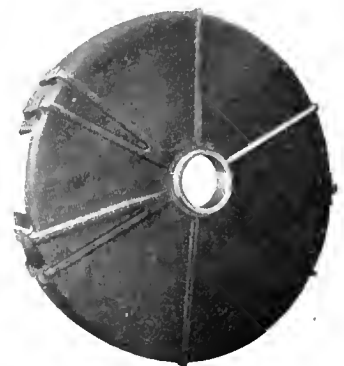


Fig. 29. Guard for the Towing Cable

the bars can move horizontally. Their outer ends are engaged by strong springs, No. 139, which afford the necessary flexibility for smooth operation.

between these three disks, and is obtained by tightening the spiral springs on the clamping ring. In order, therefore, to make the slipping tension of the tow-line proportional

to the pressure between the friction disks, a rubbing surface having an absolutely constant coefficient of friction is essential. In order to find such a metal, certain tests were made as indicated by the curves in Fig. 30, which is self-explanatory. The low-friction metal, having a friction coefficient of 0.1, is practically constant under all pressures and condition of the surfaces, and therefore was selected for the work. This metal also showed but very little difference in friction coefficient between starting and running. The results of the special tests were furthermore amply verified by the final test of the friction disks of each machine under the full rated tow-line pull of 25,000 pounds by means of the dynamometer testing outfit shown in Fig. 31. All 40 machines were given this slip test 25 times from each cab and all passed the government requirements not to exceed a variation of five per cent above or below the normal of 25,000 pounds.

In connection with the slip test, further data on the slow-winding motor was ob-

tained, as furnished in curves shown in Fig. 32. The winding motor is a 20-h.p. (one-hour rating), three-phase, high-torque, squirrel-cage type, induction motor controlled

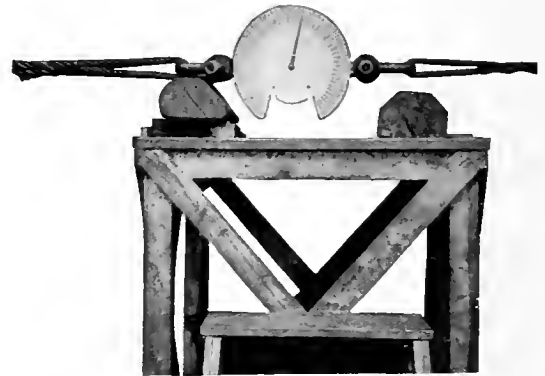


Fig. 31. Dynamometer and Stand for Testing the Towing Pull of the Locomotives

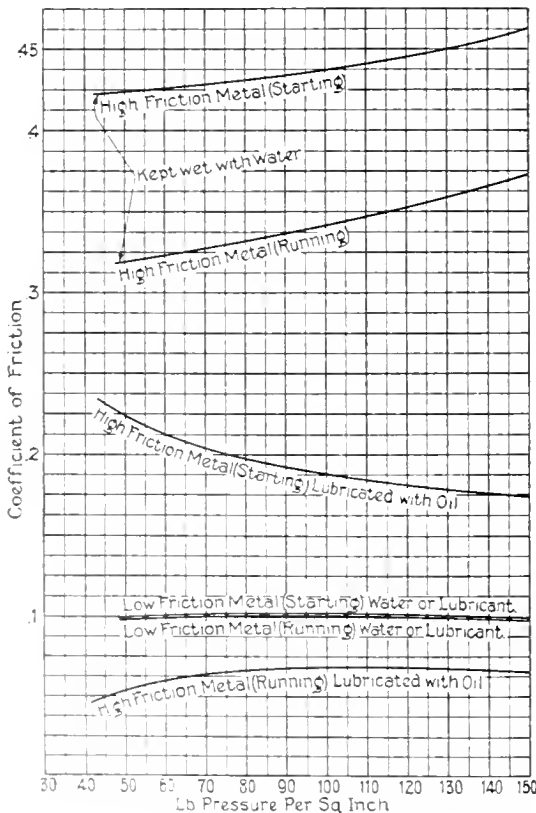


Fig. 30. Curves Showing the Results of Tests to Determine the Proper Friction Metal

from a drum-type reversible controller in either of the two cabs. From the curves it is seen that the motor has ample power to take care of any sudden pull on the tow-line up to 40,000 pounds, which is well above the normal requirement of 25,000 pounds. The speed of winding is at the average rate of 12 feet per minute.

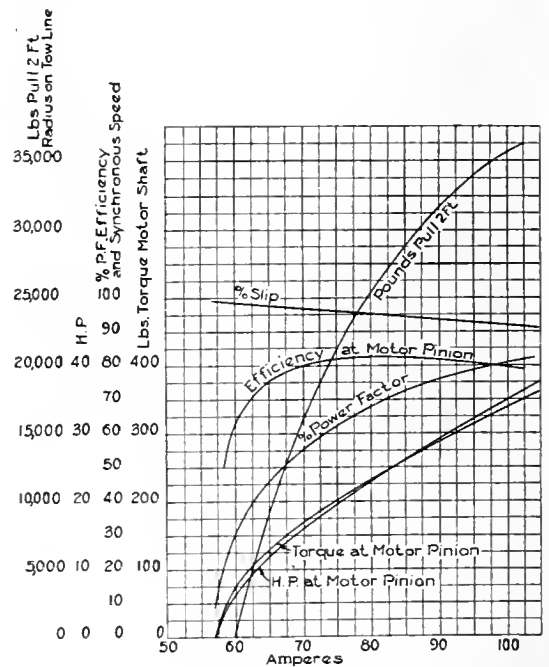


Fig. 32. Characteristic Curves of the Windlass Motors

The rapid-coiling motor is permanently geared to the drum and is of the same type, size, and capacity as the winding motor, and is subjected to its maximum load when accelerating the heavy drum to the high speed required for coiling or paying out the rope, this being 16 times the slow-winding speed at full load, or about 200 feet per minute.

The slow-winding and the rapid-coiling motors are operated by similar controllers and the circuits electrically interlocked so as to prohibit application of power to either motor unless the controller of the other motor is in the "off" position.

Each of the two main traction motors has a rating of 75 h.p., and is of the slip-ring induction type, operated by a system of contactors with a master controller in each cab. The motors, by means of the change in gearing from straight traction to rack-rail towing previously described, drive the locomotive at a speed of two miles per hour when towing and five miles per hour when returning idle. These motors act as induction generators running above synchronous speed when the locomotive is passing down the steep inclines and thereby exert a retarding brake effect to keep the speed uniform. Speed tractive effort and efficiency tests were made with results as plotted in the curves of Fig. 33.

The curves in Fig. 34 give some interesting data on the time of acceleration of ships in the lock chambers. These values have been obtained from certain tests and theoretical

calculations based on data given by several well-known authorities.

For determining the resistance of ships in deep open water, the following formula is

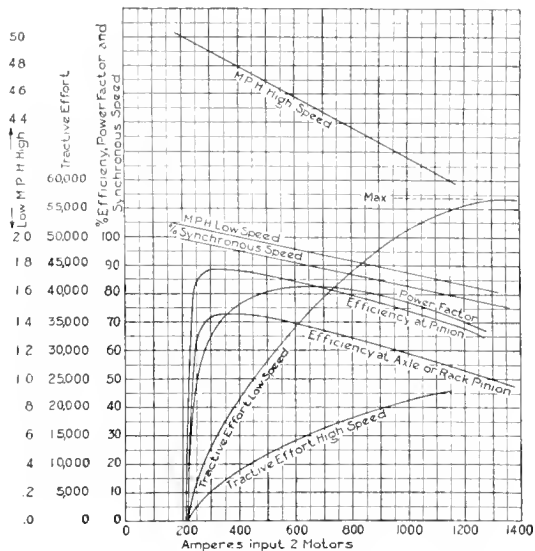


Fig. 33. Characteristic Curves of the Traction Motors

given by Captain Charles W. Dyson in his work, "The Estimation of Power for Propulsion of Ships."

$$R = f S V^{1.85} + \frac{b D^{\frac{3}{2}} V^4}{L}$$

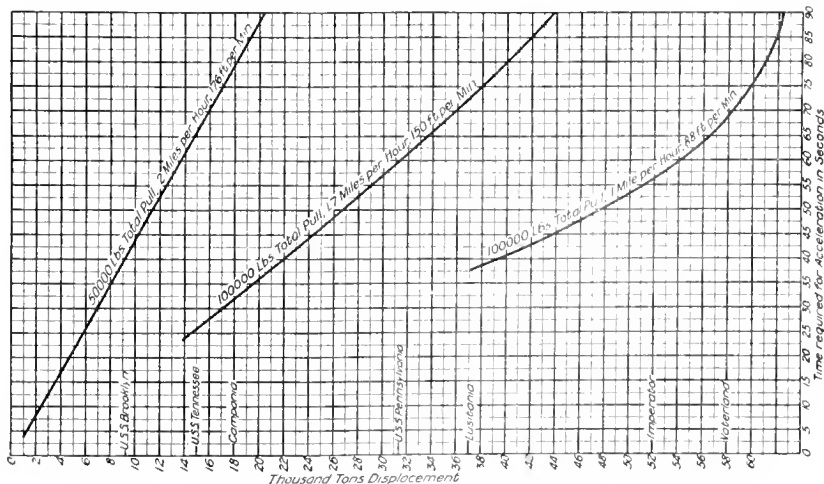


Fig. 34. Curves Showing the Time Required for the Acceleration of Ships

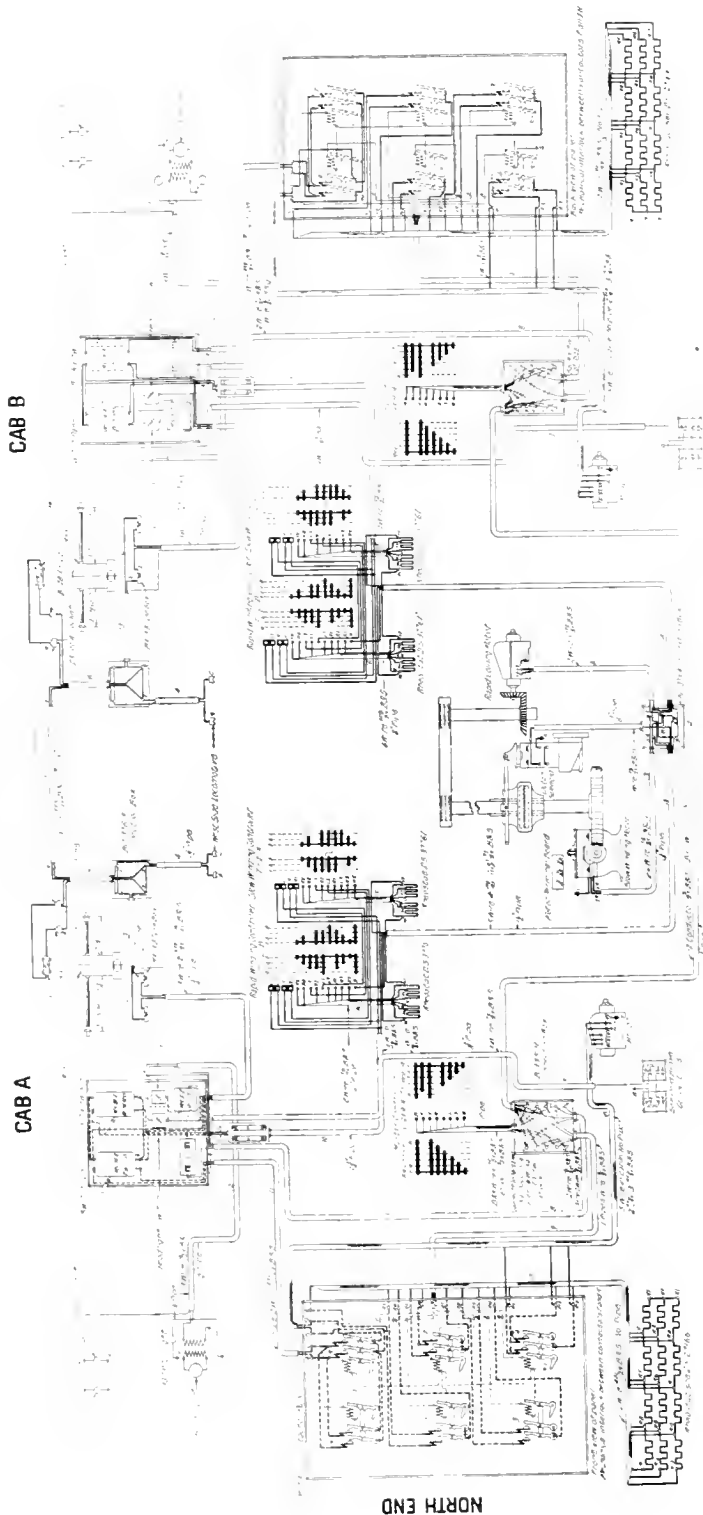


Fig. 35. Wiring Diagram of the Electric Connections used on the Towing Locomotives

Where

R = Resistance in pounds.
 f = Surface friction coefficient, varying from 0.008 to 0.009.

S = Wetted surface in square feet.

V = Speed in knots per hour.

b = Form-factor, varying from 0.35 for fine long ships to 0.50 for freighters.

D = Displacement of ship in tons.

L = Length of ship in feet on load water line.

This formula gives, as stated, the resistance in deep open water, and it is well known that this is greatly increased when the ship is passing through narrow channels, due to the reaction of the water on the side walls and bottom. This additional resistance may be found by the following formula, given in a report by the State Engineer of New York on the proposed Barge Canal (see *Engineering Record*, June 29, 1901):

$$R_1 = \frac{6.8}{r - 1.3}$$

Where

r = ratio $\frac{\text{canal section}}{\text{midship boat section}}$

In order to obtain the total ship resistance the value of R previously obtained should be multiplied by the value obtained for R_1 .

Space does not permit of a detailed description of the locomotive control apparatus, but a fairly good idea will be had by reference to the diagram of connections shown in Fig. 35.

Figs. 36 to 43 are of interest in showing the progress of the work during the construction period.

The contract for the locomotives was awarded to the General Electric Company at Schenectady, N. Y., U. S. A., May 24, 1913. Shipment was

made of the first machine January 12, 1914, and the total shipment of the forty locomotives was completed November 6, or at the very high average rate of one locomotive per week. The maximum rate of production was, however, even higher, twelve locomotives being completed in nine weeks' time.

The interest and untiring energy of the factory employees engaged in this work demand particular notice. The men individually made it their task to accomplish a maximum each day to meet the urgent needs of the Panama Canal and evinced a striking spirit of patriotism and pride in the carrying out of their share of the big undertaking.

The locomotives have a net weight of 86,000 lb. and a gross shipping weight of 92,500 lb. They were mounted on specially designed skids and shipped by rail to New York, where they were loaded on board ship, as deck cargo, by means of a Merritt-Chapman 125-ton floating derrick. Fig. 40 shows the loading on the S.S. "Ancon," which in this case carried six locomotives to the Isthmus.

Summary

The towing locomotives as described and illustrated possess the following operating characteristics:

(1) When towing, the speed can be accelerated from zero to two miles per hour.

(2) When running idle, the speed can be accelerated from zero to five miles per hour, permitting return trips at increased speed.

(3) The windlass will pay out or wind in cable at the low rope speed and at the full tow-line pull of 25,000 lb. either with the locomotive running or at rest.

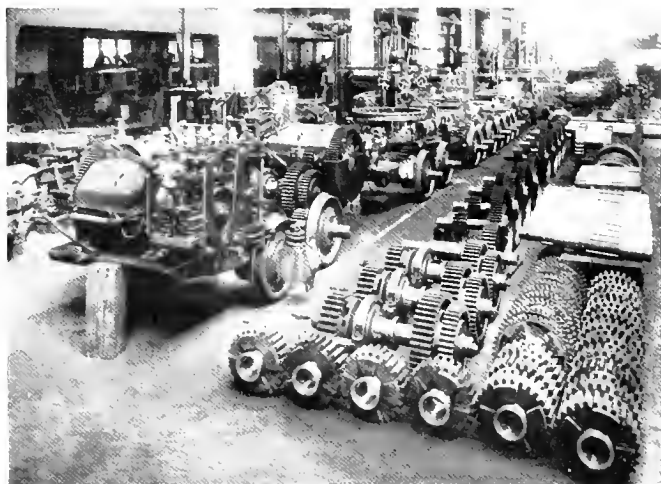


Fig. 36. A Portion of the Assembly Floor of the Contractor's Factory Showing a Locomotive Truck Partially Assembled and Additional Finished Material

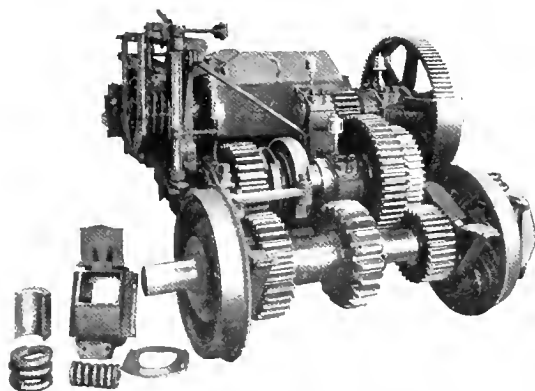


Fig. 37. Front View of a Traction Motor Unit with a Journal Box Disassembled

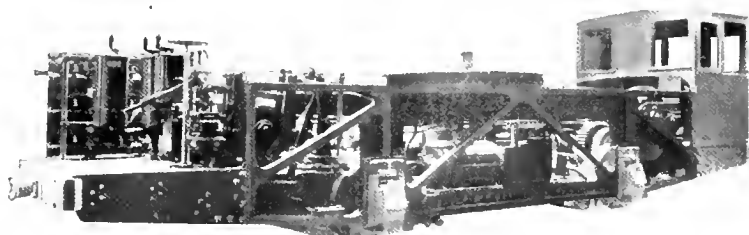


Fig. 38. A View of the Locomotive Shown in Fig. 38, but Taken from the Opposite Side, with Covers and One Cab Removed Showing the Controllers and Front of One Control Panel



Fig. 39. Method Employed in Slings a Locomotive from a Crane Hook in the Factory

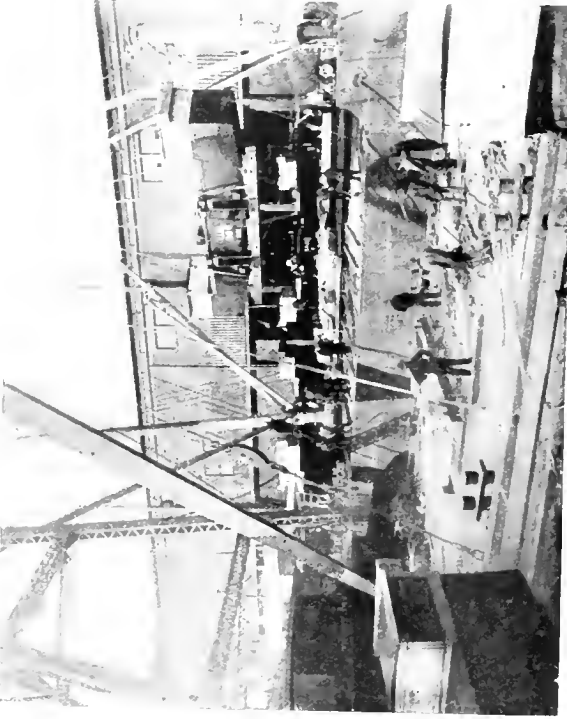


Fig. 40. A Towing Locomotive being Transferred to the Deck of the "Ancon" Bound for Cristobal

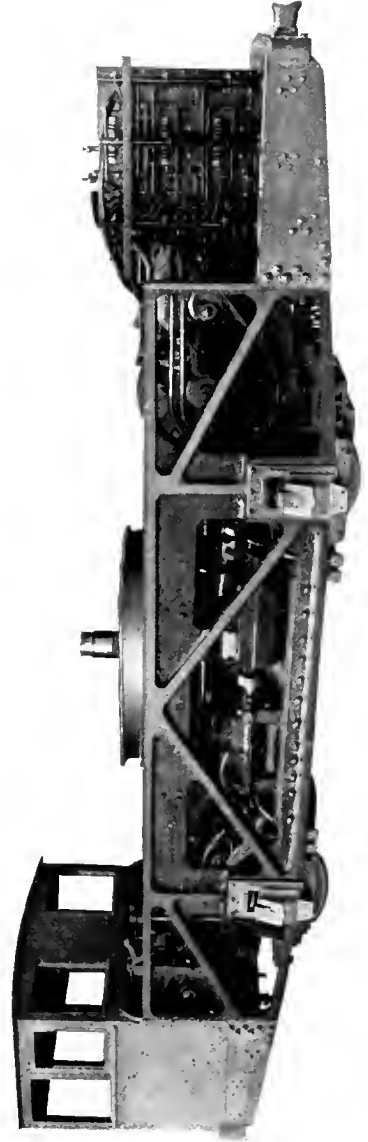


Fig. 41. A Side View of a Towing Locomotive with Covers and One Cab Removed Showing the Back of a Control Panel

(4) The windlass will pay out or coil in cable at the high rope speed with tow-line taut either when the locomotive is running or at rest.

(5) The windlass is equipped with a safety friction device which is adjustable to any predetermined value of tow-line pull.

Conclusion

The first impression may be gathered that these machines are somewhat complicated, but considering their many functions and great flexibility to perform them, it must be agreed that the design is peculiarly simple.

The locomotives have fully demonstrated in actual operation that the requirements contemplated by the Engineers of the Isthmian Canal Commission under Circular 650 have been successfully met.

During the first three months of commercial operation of the Canal, from August 15 to November 15, 1914, the cargo transported through the Canal and towed through the locks by the locomotives amounted to 1,079,521 tons.

During the fiscal year ending June 30, 1914,



Fig. 42. A View of a Locomotive Crated and Mounted on a Flat-Car Ready for Shipment to the Steamship that was to Carry it to Canal Zone

the Panama Railroad carried 643,178 tons of through freight between the two seaboard, and in the preceding fiscal year 594,040 tons. From this it is seen that between six and seven times as much cargo is passing over the Isthmus now as passed over this route when goods were transhipped by rail.

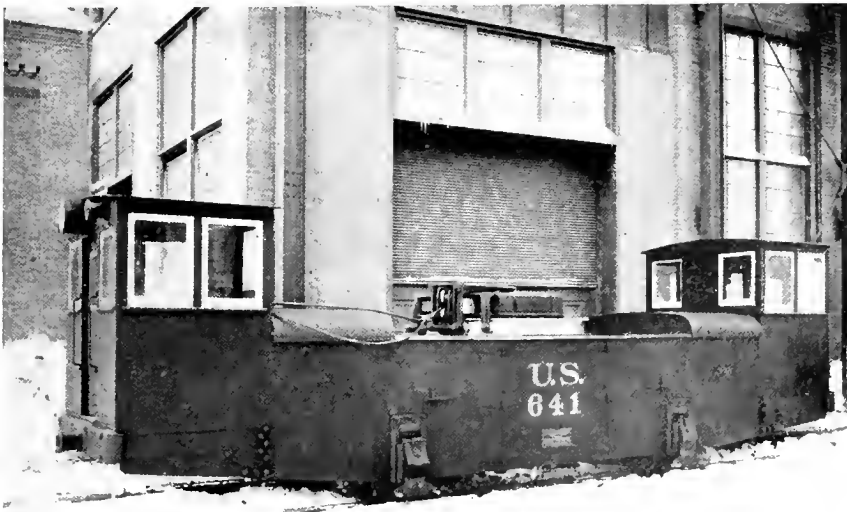


Fig. 43. A Towing Locomotive on the Test Track in the Contractor's Yard

ELECTROPHYSICS

PART I.

By J. P. MINTON

RESEARCH LABORATORY, PITTSFIELD WORKS, GENERAL ELECTRIC COMPANY

This is the first of a series of articles dealing with "electrophysics" that we propose to publish during the year. These articles will not all be written by the same author. The present contribution on the cathode rays and their properties forms an interesting introduction to the subject, and will be followed next month by an article on the "electron theory." It is hoped that these contributions will give a useful outline, in simple language, of a subject which we feel is of great interest and importance to the engineering fraternity. These articles originated in a series of papers presented before the Electrophysics class of the Pittsfield Section of the A.I.E.E. They are being revised and amplified by the authors for our columns.—EDITOR.

CATHODE RAYS AND THEIR PROPERTIES

Introduction

The purpose of this article is threefold; first, to demonstrate experimentally that there are small negatively electrified particles of "something" which are called electrons or corpuscles; second, to show that the properties of these particles are entirely independent of the substances from which they come, and, therefore, lead us to the fundamental conception of matter; and third, to give us a working knowledge of the electrons in order that we may pursue our future study on the electron theory and its applications. In the succeeding articles, we shall develop the electron theory of electric conduction through solids and gases, and apply it to a number of different phenomena.

We shall consider in the present article:

1. Historical review (1859 to 1892).
2. Experiments on cathode rays, and the conclusions derived therefrom which lead us to the fact that there are small negatively electrified particles called electrons. (a) Chemical; (b) Heating, (c) Mechanical; (d) Electrical; (e) Magnetic; (f) Experimental conclusions.
3. Experimental determination of the charge (e), the mass (m), and the velocity (v), of electrons.
4. The constancy of the ratio $\frac{e}{m}$, and its significance on the fundamental conception of matter.
5. The origin of the mass of the electron, and the variation of this mass with the velocity of the electron.
6. Distinction and relation between mechanical and electromagnetic mass.
7. Summary and conclusions.

I. HISTORICAL REVIEW

In the preparation of this historical review Prof. J. J. Thomson's book on "The Con-

duction of Electricity Through Gases" has been freely made use of.

Cathode rays were discovered by Pluecker¹ in 1859; he observed on the glass of a highly exhausted tube in the neighborhood of the cathode a bright phosphorescence of greenish-yellow color. He found that these patches of phosphorescence changed their position when a magnet was brought near them, but that their deflection was not of the same nature as that of the rest of the discharge. He ascribed the phosphorescence to currents of electricity which went from the cathode to the walls of the tube and then retraced their path for some unknown reason.

The subject was next taken up by Pluecker's pupil, Hittorf,² to whom we owe the discovery that a solid body placed between a pointed cathode and the walls of the tube casts a well-defined shadow, whose shape depends only upon that of the body, and not upon whether the latter be opaque or transparent, an insulator or a conductor.

This observation was confirmed and extended by Goldstein,³ who found that a well marked, though not a very sharply defined shadow was cast by a small body near the cathode, whose area was much greater than that of the body. This was a very important observation, for it showed that the rays producing the phosphorescence came in a definite direction from the cathode. If the cathode were replaced by a luminous disk of the same size no shadow would be cast by a small

REFERENCES

- ¹Pluecker, Pogg. ann., 107, p. 77, 1859; 116, p. 45, 1862.
 - ²Hittorf, Pogg. ann., 136, p. 8, 1869.
 - ³Goldstein, Berl. Monat., p. 284, 1876.
 - ⁴Varley, Proc. Roy. Soc., xix, p. 236, 1871.
 - ⁵Crookes, Phil. Trans. Pt. 1, 1879, p. 135, Pt. 2, p. 641, 1879.
 - ⁶Hertz, Weid., ann., xlv, p. 28, 1892.
 - ⁷Bancroft, Jour. Franklin Inst., Feb., 1913.
 - ⁸Millikan, Phys. Review, Vol. 32, p. 349-397, 1911; Aug., 1913, pp. 109-143.
- J. J. Thomson, (1) Corpuscular Theory of Matter. (2) Conduction of Electricity through Gases. These two books will be found helpful.

object placed near it, for though the object might intercept the rays which came normally from the disk, yet enough light would be given out sideways by other parts of the disk to prevent the shadow being well marked. Goldstein, himself, introduced the term "Kathodenstrahlen" (cathode rays) for these rays, and he regarded them as waves in the ether, a view which received much support in Germany.

A very different opinion as to the origin of these rays was expressed by Varley,⁴ and later by Crookes,⁵ who advanced many weighty arguments in support of the view that the cathode rays were electrified particles shot out from the cathode at right angles to its surface and with great velocity, causing phosphorescence and heat by their impact with the walls of the tube, and suffering a deflection when exposed to the magnetic field by virtue of the charge they carried. The particles in this theory were supposed

all are familiar. A diagram of the tube is given in Fig. 1, an explanation of which follows: Suppose the vacuum in this tube has been reduced to 0.006 m.m. of mercury, or six microns, and that a static potential of, say 15 kv. is applied between the cathode (*c*) and the grounded anode (*a*); the negative terminal being connected to (*c*). A discharge will pass through the tube due to the applied potential.

(a) Now let us see what happens from a chemical point of view. First, we shall notice a great number of phosphorescent patches or spots of light on the glass wall over the distance (*c*) (*d*), Fig. 1. The color of these patches depends on the nature of the glass; thus with soda glass the light is yellowish-green, with lead glass it is blue. These spots can be made to move over the surface of the glass by means of an electric or magnetic field without affecting the nature of the discharge. This will be made clearer later

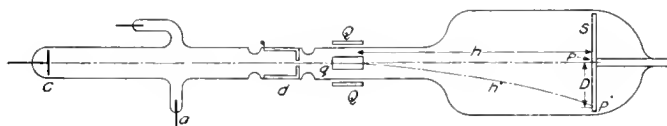


Fig. 1. Cathode Ray Tube

to be of the dimensions of the ordinary molecules. The discovery made by Hertz⁶ that the cathode rays could penetrate thin gold leaf or aluminum was difficult to reconcile with this view of the rays, although it was possible that the metal when exposed to a torrent of negatively charged particles, itself acted like a cathode and produced phosphorescence on the glass behind. This view, however, is not startling since radio-activity has been developed, for here we have particles going through metals much thicker than gold leaf.

During the past 20 years the workers in the field have increased wonderfully, and include such men as Weidemann, Schmidt, Van't Hoff, Drude, Lorentz, Aberham, Einstein, J. J. Thomson, O. W. Richardson, Kaufmann, Comstock, Millikan, and many other men. No attempt will be made to follow their work, but, in a general way the results of their experiments which lead us to the conception of an electron will be given.

II. EXPERIMENTS ON CATHODE RAYS

For these experiments let us consider the discharge in a cathode ray tube with which

in this article. The phosphorescence noted is evidently due to something striking the glass at these particular places, rather than to any wave motion of light, for this could not be made to move over the surface in the manner described below.

We also note that there is a violet-reddish colored stream of "something" which appears to come from the center of the cathode (*c*), and extends over a distance of perhaps three inches toward (*d*), depending on the conditions of the experiment. This stream is perhaps from one-sixty-fourth inch to one-eighth inch in diameter; the larger streams being observed the greater the pressure in the tube, up to perhaps 12 or 15 microns. If we put in the tube a diaphragm, (*d*) Fig. 1, of some material, say brass, with a hole through it about one-sixty-fourth inch in diameter, part of this stream will be intercepted while the rest of it will continue until it strikes the screen (*s*) at the point (*p*). This is shown by the fact that, if the screen is made of potassium bromide, there will be a round bluish-yellow colored spot about one-thirty-second inch in diameter on the surface of this salt. It appears, therefore, that this

COLOR OF LUMINESCENCE

Salt on the Screen (s)	Cathode Rays	Chemical Reaction	Precipitation
<i>NaCl</i>	Bluish-white	Blue	Bluish-white
<i>NaBr</i>	Bluish-white	Blue-white	Bluish-white
<i>NaI</i>	Greenish-white	White-(greenish?)	Greenish-white
<i>KCl</i>	Bluish-white	Blue	Bluish-white
<i>KBr</i>	Blue	Blue	Blue
<i>KI</i>	Green	Greenish-white	Green

stream of "something" starts from the cathode (*c*) and moves to the other end of the tube very rapidly, for we can detect no difference with the eye in the time of appearance of the stream at (*c*) and at (*p*). The name "Kathodenstrahlen" (cathode rays) was given to this stream of "something" by Goldstein in 1876. The phosphorescence produced by these rays is a chemical phenomenon as is shown by the above table taken from the works of W. D. Bancroft.⁷

The following is another table taken from the same reference.

	Light Color
<i>Pb SO</i> ₄ +cathode rays.....	Blue
<i>Pb</i> + <i>O</i> = <i>PbO</i>	None
<i>PbO</i> + <i>SO</i> ₂ = <i>Pb SO</i> ₄	White
<i>Pb</i> +(<i>NH</i>) ₂ <i>S</i> ₂ <i>O</i> ₈ = <i>Pb SO</i> ₄ +(<i>NH</i>) ₂ <i>SO</i> ₄	Blue
<i>Zn SO</i> ₄ +cathode rays.....	Bluish-white
<i>Zn</i> + <i>O</i> = <i>ZnO</i>	Green
<i>Zn O</i> + <i>SO</i> ₂ = <i>Zn SO</i> ₄	Green
<i>Zn</i> +(<i>NH</i>) ₂ <i>S</i> ₂ <i>O</i> ₈ = <i>Zn SO</i> ₄ +(<i>NH</i>) ₂ <i>SO</i> ₄	Bluish-white
<i>Cd SO</i> ₄ +cathode rays.....	Yellow
<i>Cd</i> + <i>O</i> = <i>Cd O</i>	Yellow
<i>Cd O</i> + <i>SO</i> ₂ = <i>Cd SO</i> ₄	Yellow
<i>Cd</i> +(<i>NH</i>) ₂ <i>S</i> ₂ <i>O</i> ₈ = <i>Cd SO</i> ₄ +(<i>NH</i>) ₂ <i>SO</i> ₄	White

Considering the first table, suppose that solid *NaCl* is precipitated out of a solution of *NaCl*. This action consists in *Na* and *Cl* ions uniting to form *NaCl* which is precipitated when the solution becomes over saturated. If this formation of *NaCl* from its ions is observed in a dark room, a bluish-white phosphorescence will be observed. Now, this is the color caused by the action of cathode rays on *NaCl*. So we conclude that the cathode rays cause *NaCl* to split up into its ions, and the immediate combination of these ions give off the bluish-white light that we observe. Similar remarks apply to the other salts listed in the table. With reference to the second table, we see that cathode rays cause lead and zinc sulphates to break up into zinc, lead, and sulphate ions, and the reverse action emits the light of the color stated. Particles of zinc and lead have been found where the rays fell on the sulphates of these metals. Sometimes the reverse

action is very slow as in the case of *KBr* which requires several hours to reach the initial conditions again. In the case of other salts, like calcium tungstate, the reverse action is practically instantaneous. The former is called phosphorescence and the latter is called fluorescence.

If the screen (*s*) is an oxidized copper plate, the cathode rays soon cause a bright copper colored spot to appear; that is, these rays exert a reduced action. The rays also affect photographic plates as was shown in a recent article (Comptes Rendus, 158, pp. 1339-1341, May 11, 1914) by A. Dufour on "The Cathode Ray Oscillograph." He obtained photographs corresponding to a deflection of the ray stream of 1 mm. in 3×10^{-6} sec. It was necessary to use very strong rays to obtain such results.

(b) Having considered some of the chemical effects produced by these rays, let us next take up their thermal effects. These have been investigated by J. J. Thomson, E. Weidemann, Ebert, Ewers, and others, all of whom have found that these cathode rays heat bodies on which they fall. If the rays are concentrated by using a spherical shell cathode, platinum may be raised to incandescence, thin pieces of glass fused, and the surface of diamond charred. A simple example will give some idea of the amount of energy carried by these rays. It must be stated first, however, that these rays are composed of negatively charged electrons as will be shown later. So let *n* be the number of electrons striking the surface in unit time, *m* the mass of the electron, and *v* its velocity, the energy *E* given up to the body in unit time by the electrons is

$$E = \frac{1}{2} n m v^2 \text{ where this is the total kinetic}$$

energy transformed into heat energy on striking the surface. If *e* is the electronic charge, then the current carried by these

$$\text{rays is } I = ne, \text{ or } n = \frac{I}{e}. \text{ Hence } E = \frac{1}{2} I \frac{m}{e} v^2.$$

Now 10^{-5} amperes is a fair value for I , and if $v = 5 \times 10^9$ cm. per sec., $\frac{m}{e} = 6 \times 10^{-8}$, then

$$E = \frac{10}{2} \times 10^{-5} \times 6 \times 10^{-8} \times 25 \times 10^{18} = 7.5 \times 10^7$$

ergs. Since one calorie equals 4.2×10^7 ergs, E equals approximately 1.7 calories. All of this energy does not produce heat, but some is used in producing Röntgen rays, secondary cathode rays, and some electrons are reflected.

(c) Mechanical effects of cathode rays are also important. A typical example of this was carried out by Crookes in 1879. He placed the axle of a very light mill with a series of vanes on glass rails in a vacuum tube. When the discharge passed through the tube the cathode rays struck against the upper vanes and the mill rotated, traveling toward the positive end of the tube. If the potential was reversed, the direction of rotation also reversed, showing that the cathode rays were now moving in the opposite direction. Since the upper limit of the momentum given to the vanes by the rays is of the order of magnitude of 10^{-2} dynes, this alone cannot account for the rotation of the vanes. It was shown later to be largely due to the heating effect produced by the cathode rays on the side on which they impinged.

Another exceedingly important mechanical effect is that these rays pass through a thin gold leaf, and where the velocity is quite high they have passed through 1 mm. of aluminium. This is equivalent to passing through 250 miles of molecules if they were two inches in diameter. This had an important bearing on the final acceptance of the view that cathode rays consisted of very small particles and were not a wave motion of any kind.

It may be mentioned here, as stated under I , that the fact that the cathode rays came from the negative terminal in a definite direction was a further proof that these rays consisted of particles of "something." The name electrons was given to these particles in 1896. It was also shown that these electrons came directly from the cathode, otherwise they would not have been intercepted by an object placed in their path.

(d) The electrical effects produced by these rays show conclusively that they are particles of matter. First of all, if a beam of light passes through the air and falls on the wall, the spot of light will not be affected by presence of a magnetic or an electric field

near this wall. Furthermore light does not possess an electric charge, for electricity always associates itself with matter.

It has been shown that cathode rays move from the negative to the positive terminal, and must, therefore, possess a negative charge. This is further affirmed by the fact that, if a direct current potential is applied to the set of quadrants QQ , Fig. 1, the phosphorescent spot on the screen (s) will move in such a direction as demanded of a negative charge by the fundamental laws of electricity. Bodies upon which the rays strike acquire a negative charge. Those experimental facts will suffice to show that the cathode rays possess a negative charge, and must be associated with small particles of matter. The charge on these particles is a certain definite quantity (as will be shown later), and one never finds an electric charge which is not a multiple of this fundamental and elementary unit of electricity. This, then, indicates that the cathode rays are atomic in structure and the electricity resides on these small particles.

(e) Cathode rays are deflected by a magnet when the field is not parallel to the direction of motion of the electrons. This also indicates that we are dealing with concrete particles which carry a negative charge as shown by the direction of the deflection.

(f) To summarize: It has been shown that there are such things as cathode rays as revealed by the effects they produce, viz., chemical, thermal, mechanical, electrical, and magnetic. Furthermore it has been shown that they are atomic in structure, being composed of small negatively electrified particles. These are the accepted conclusions of the scientific world.

III. DETERMINATION OF (e), (m), and (v)

Let us, now, investigate the properties of these electrons somewhat in detail. We shall first determine experimentally their charge (e), their mass (m), and their velocity (v). Referring to Fig. 1, suppose that we have a stream of electrons passing through the tube and that they produce a phosphorescent spot at (p). Now suppose to the quadrants QQ is applied a steady known potential which causes the spot to move to a new position (p^1). Let (h) be so large that $h = h^1$ for our purpose.

In moving over the length h , the electrons fall through a distance D due to the electric field applied to QQ . As in the case of falling

bodies, we have: $D = \frac{1}{2} at^2$, where a is the acceleration of the electrons due to the electric force E applied to the quadrants, and t is the time required to move over the path

h . Now $t = \frac{h}{v}$, and the force on an electron

equal $Ec = Ma$ or $a = \frac{Ec}{m}$. If we substitute

these values for t and a in the equation for

D , we obtain $D = \frac{1}{2} \frac{Ech^2}{mv^2}$, or $\frac{e}{m} = \frac{2D}{Eh^2} v^2$.

In this equation you will find the three fundamental quantities of an electron, viz., e , m , and v . If we know v , we can, therefore,

obtain $\frac{e}{m}$ which is called the specific charge.

To do this a magnetic field is superimposed upon the electric field at the quadrants QQ in such a way as to balance the effect produced by the latter field. Now Rowland showed experimentally that the force on an electron due to the magnetic field is $Hcv \sin \theta$, where θ is the angle between the electric and magnetic fields and H is the strength of the latter. Making $\theta = 90$ deg. (or $\sin \theta = 1$) we

have, therefore, $Hcv = Ec$ or $v = \frac{E}{H}$. Both E

and H can be easily measured, so that v is known. This velocity never exceeds 3×10^{10} cm. per sec. the velocity of light; 10^9 is a fair velocity for the electrons. In radio-activity v is perhaps 2.5×10^{10} cm. per sec. and in the cathode ray tubes it is about 5×10^8 cm. per sec. Putting this value of v in the equation

for $\frac{e}{m}$, we obtain $\frac{e}{m} = 1800 \times 10^4$. Now $\frac{e}{m}$ for

the hydrogen ion is 10^4 , so that the specific charge of an electron is about 1800 times as large as that of the hydrogen ion, the smallest particle of matter yet known. To settle this point we need only to measure the charge (e) of the electron. At least eight different methods have been used for this purpose. These methods are two radio-active, one Brownian movement, one radiation, two "cloud formation," one Zemann effect, and the famous oil-drop method of R. A. Millikan⁷ of the University of Chicago. It is well to note that the values given by these methods agree within three per cent of that given by Millikan, who is absolutely certain of his value to 0.1 per cent. The other in-

vestigators do not claim any such accuracy for their results. His method of determining e is briefly as follows:

He immersed a brass vessel in an oil bath to maintain a constant temperature. Within this vessel were two parallel metallic plates 1.6 cm. apart. The air pressure in the brass chamber could be varied at will by means of pumps. X-rays could be passed through a glass window so as to ionize the air between the plates, thus causing free electrons to exist in this space. Now, by means of an atomizer extremely small (0.0005 cm.) drops of oil could be sprayed between the plates, and when either an ion or an electron stuck to the drop it would acquire a corresponding charge. He applied a potential to the plates and so could move the oil drop up and down at will. He could also detect, by a change in the velocity of the drop, when a new charge attached itself to the drop; which was viewed by means of an optical system. He used the following formula to calculate the charge on the drop due to (n) elementary charges:

$$e_n = \frac{4\pi}{3} \left(\frac{9\eta}{2} \right)^{\frac{2}{3}} \left(\frac{1}{8(\sigma - \rho)} \right)^{\frac{2}{3}} \left(\frac{v_1 + v_2}{F} \right) v_1^{\frac{1}{2}}$$

where (η) is the coefficient of viscosity of air, (σ) the density of the oil, (ρ) the air density, (v_1) the speed of descent of the drop under gravity, and (v_2) its speed of ascent under the influence of an electric field of strength F . All of these quantities were known to 0.1 per cent. The equation was based on three assumptions, viz., the drag which the medium exerts upon a given drop is unaffected by its charge; neither distortion due to the electric field nor internal convection within the drop modified appreciably the law of motion of the drop; the density of the oil drops is independent of their radii down to 0.0005 cm. Millikan not only showed that these assumptions were justifiable, but their effects were not present at all.

By means of the above equation he obtained a series of values for (e_n), and taking the lowest one he found all the others to be exact multiples of it. This value we naturally accept as the elementary charge. He has carried out a great number of tests under various conditions as regards size, temperature, pressure, and gives $e = 4.774 \pm 0.009 \times 10^{-10}$ electrostatic units.

Now, this value is the same as that carried by a hydrogen ion, which must, therefore, carry one of these elementary charges. We are led then to the experimental conclusion

that the mass of the electron is $\frac{1}{1800}$ of that of the hydrogen atom, which until now was the smallest particle of matter we had known. We are forced, therefore, to the fact that matter is still further divisible than we were led to believe by the atomic hypothesis. The mass of the electron is, therefore, $m = 4.8 \times 10^{-10} \times 3 \times 10^{-10} = 1.8 \times 10^{-19}$, which gives $m = 8 \times 10^{-27}$ grams. This is true for velocities which are not very close to 3×10^{10} cm. per sec. as will be shown shortly.

IV. CONSTANCY OF $\frac{e}{m}$

The ratio $\left(\frac{e}{m}\right)$, (e), and (m), have been measured for many different kinds of gases, solids, and elements under various conditions. In every case all of these quantities were constant (except for velocities near that of light) and entirely independent of the substance from which they were obtained. Consequently, the electron is a fundamental unit of electricity and matter, and all matter must have it as one of its constituents. The other constituent or constituents, as the case may be, must be matter which acquires a positive charge by losing electrons and gain a negative charge by addition of electrons. If there are positive electrons, however, this conclusion need not be true; but the scientific world has tried in vain to discover them for the past 15 years. Until they are discovered, we must content ourselves to build up a theory of matter with the electrons as a basis. This is the so-called electron theory of matter, and, since they always possess a negative charge, they form the basis of the electron theory of electricity. Both of these theories, which will be developed in the next article, are "subject to change without

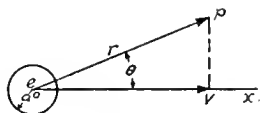


Fig. 2

notice." As to the nature of positive electricity we know nothing except it must exist.

V. ORIGIN OF THE MASS OF THE ELECTRON

It is a well-known fact that when a current of electricity flows through a wire a magnetic field is set up in the space around it. Simi-

larly, a charged body moving through space sets up a magnetic field in the surrounding space. Hence, if we have a charged body, it will require more energy to set it in motion with a velocity (v), than would be required

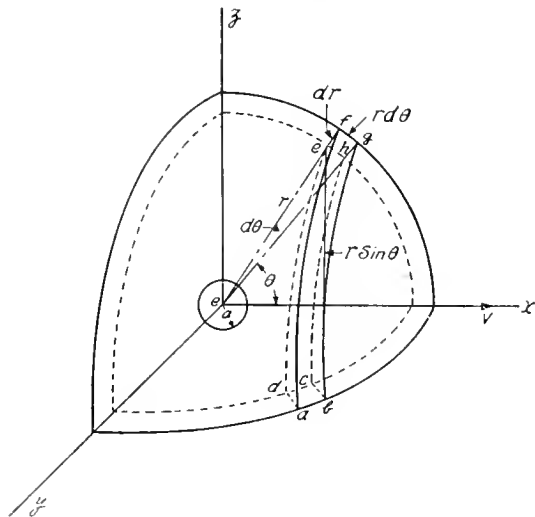


Fig. 3

to set it in motion with the same velocity if it were not charged. In the first case the energy required is $\frac{1}{2} M v^2$ plus the magnetic

energy, and in the second case it is $\frac{1}{2} M v^2$.

Since the velocities are equal, it follows that the charged body apparently has a greater mass than the uncharged one. This fictitious mass due to a magnetic field surrounding a moving, charged body is called the electromagnetic mass of the body.

Now let us determine the electromagnetic mass of a charged sphere of radius a , moving through space with a velocity (v), where (v) is not too nearly equal to the velocity of light (c). Let (e) be the charge on the sphere. Rowland has proved experimentally that the magnetic force at a point p , Fig. 2, due to the charge (e) moving along OX is:

$$H = \frac{c v \sin \theta}{r^2} \tag{1}$$

The energy density at (p) due to the magnetic field alone is $D_M = \frac{H^2}{8 (\pi i = \pi)}$

or, by equation (1):

$$D_M = \frac{e^2 v^2 \sin^2 \theta}{8 (\pi i = \pi) r^4} \tag{2}$$

Changing Fig. 2 to Fig. 3, the volume

$$a b c d e f g h = \frac{(\pi)}{2} r \sin \theta r d r d \theta.$$

Multiplying this equation by 4, we have

$$4 a b c d e f g h = 2 (\pi) r^2 \sin \theta d \theta d r \quad (3)$$

This equation gives the volume of an element of an imaginary sphere in the space surrounding the charged sphere. The magnetic energy in this volume is, therefore, by equations (2) and (3).

$$(\Delta) E_H = \frac{c^2 v^2 \sin^2 \theta}{8(\pi) r^4} \times 2(\pi) r^2 \sin \theta d \theta d r$$

or

$$(\Delta) E_H = \frac{c^2 v^2 \sin^2 \theta d \theta d r}{4 r^2}.$$

Hence, the total energy due to the magnetic field in the space surrounding the sphere is

$$E_H = \int_0^{(\pi)} \int_a^{(\infty)} \frac{c^2 v^2 \sin^2 \theta}{4 r^2} d \theta d r$$

$$E_H = \frac{c^2 v^2}{4} \int_0^{(\pi)} \int_a^{(\infty)} \frac{\sin^2 \theta}{r^2} d \theta d r$$

$$E_H = \frac{c^2 v^2}{4 a} \int_0^{(\pi)} \sin^2 \theta d \theta$$

$$E_H = \frac{c^2 v^2}{4 a} \left[-1 + 3 \cos \theta (\sin^2 \theta + 2) \right]_0^\pi$$

$$E_H = 1.3 \frac{c^2 v^2}{a} \quad (4)$$

The total energy, E_T , therefore, possessed by the moving charged sphere is

$$E_T = 1.2 M v^2 + 1.3 \frac{c^2 v^2}{a}$$

or

$$E_T = 1.2 \left[M + \frac{2}{3} \frac{c^2}{a} \right] v^2, \quad (5)$$

where M is the mechanical and $\frac{2}{3} \frac{c^2}{a}$ the electromagnetic mass. If we assume an electron to be spherical and that it acts as though the charge were located at the center, equation (5) applies to it just as it does to the sphere.

In 1901 Kaufmann determined experimentally the value of the quantity in brackets in equation (5) for different velocities of the electrons. The results he obtained are illustrated in Fig. 4, where (c) is the velocity of light. From this curve we see that the apparent mass of an electron becomes infinite when $v=c$, and that it changes very little up to 2.7×10^{10} cm sec. If the curve were con-

tinued to $v=0$, it would cut the ordinate $v=0$ at M , which is the mechanical mass of an electron. Since this latter mass does not change with v , it follows that the electromagnetic mass must increase very rapidly when $v \rightarrow c$ (means v approaches c as a limit).

This is also the conclusion at which one arrives from a purely mathematical consideration. The deduction is quite complicated and I shall not frighten you by giving it in this article. The equations show, however, that when $v \rightarrow c$ there is a weakening in both the electric and magnetic fields in the regions of $a o b$ and $c o d$, and an increase in the regions $a o d$ and $b o c$, see Fig. 5. When $v=c$, the fields are zero except in the plane $g o h$, where they are infinite. Hence when $v=c$, the electromagnetic mass of an electron becomes infinite. Since by far the greater part of the mass of an electron is electromagnetic, it must necessarily possess very little inertia, even up to velocities comparable with those of light.

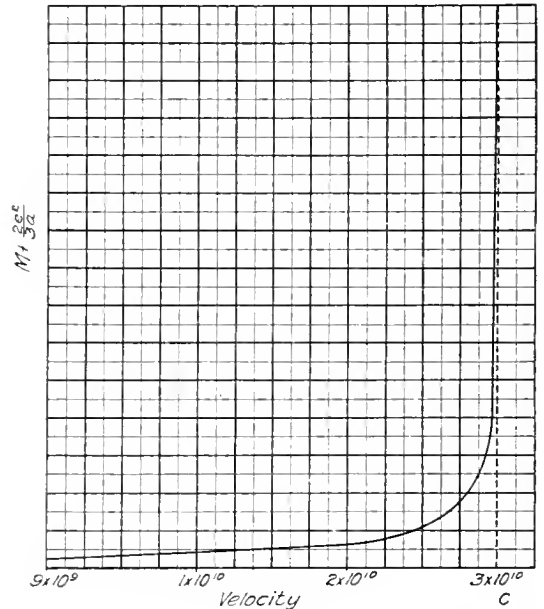


Fig. 4

Equation (5) must be modified to correspond with this change in mass according to the following equation

$$E_H = 1.2 \left[M + f(v) \frac{2}{3} \frac{c^2}{a} \right] v^2 \quad (6)$$

where $f(v) = 1$ when $v = 0$, and $f(v) = \infty$ when $v = c$. In this connection the following table, which was taken from J. J. Thomson's *Corpuscular Theory of Matter*, p. 33, will be interesting.

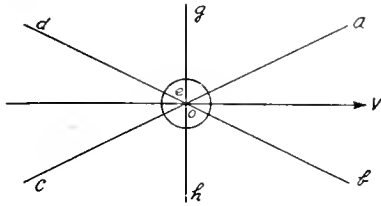


Fig. 5

Velocity of Electron	Ratio of Total Mass to that of a Slow Electron	$f(v)$
2.36×10^{10} cm/sec.	1.65	1.50
2.48×10^{10} cm/sec.	1.83	1.66
2.59×10^{10} cm/sec.	2.04	2.00
2.72×10^{10} cm/sec.	2.43	2.42
2.85×10^{10} cm/sec.	3.09	3.10

A consideration of these values obtained by Kaufmann will show that the mass of an electron is almost wholly due to the magnetic energy in the space surrounding it. Thomson concludes that the mass of an electron is entirely electromagnetic in origin. This conclusion is not justifiable for velocities below 2.59×10^{10} cm/sec. as is seen from the table above so that the electron must possess some mechanical mass even though it may be an extremely small per cent of the total.

Assuming the mass (m) of an electron to be wholly electromagnetic, we can calculate its radius (a) as follows:

From equations (5):

$$m = \frac{2}{3} \frac{e^2}{a} \quad \text{or}$$

$$a = \frac{2}{3} \frac{e^2}{m}. \quad (7)$$

We have seen that $\frac{e}{m} = 1.8 \times 10^7$, and that $e = 10^{-20}$ electromagnetic units. Substituting these values in (7), we obtain $a = 10^{-13}$ cm. approximately; the radius of an atom or molecule is about 10^{-8} cm.

The relation and distinction between mechanical and electromagnetic mass in the above discussion have been pointed out. In addition, it has been shown that:

(1) Electromagnetic mass must have weight; or

(2) Electromagnetic mass = constant \times mechanical mass. Some theoretical physicists even go so far as to assume all mass is electromagnetic. On account of insufficient time, however, the line of argument leading up to these conclusions is not given.

VI. SUMMARY AND CONCLUSIONS

From the information here given we must conclude that there are small negatively electrified particles called electrons, the properties of which are entirely independent of their source. We have seen that these electrons exist in matter as well as separated from it like cathode rays, Beta particles from radioactive substances, in gases where a discharge of electricity is passing, etc.

In concluding this article the author wishes to say that he has endeavored to briefly present the experiments upon which the electron theory is based, and has not developed it at all, simply suggesting it. He has also endeavored to familiarize you with the electronic conception sufficiently to develop the theory and apply it to various phenomena in the succeeding articles.

THE SELECTION OF RAILWAY EQUIPMENT

By J. F. LAYNG

RAILWAY AND TRACTION ENGINEERING DEPARTMENT, GENERAL ELECTRIC COMPANY

The author deals with some of the important considerations governing the selection of car equipments for city and suburban service. By making an analysis of the pressures of wheel treads, he determines the method of mounting the motors that will give the maximum adhesion available for traction. It is then possible to determine the equipment that will be most suitable to operate on severe grade conditions, and also to obtain the best schedule speed on all rail conditions.—EDITOR.

The purpose of this article is to designate, in a general way, the facts concerned in the selection of car equipments to meet the varied conditions which confront railway engineers when purchases are to be made. The situation can best be covered by an analysis.

In general, there are at least six different classes of service for equipment at the present time, viz., city, interurban, elevated, subway, steam railway terminal electrification and main line railway electrification. Insofar as the present discussion is concerned, only city and interurban service will be considered.

The electrical equipment of city car service may be divided into two classes, viz., two and four-motor equipments; of trucks, in general, there are three types, viz., single trucks, maximum-traction trucks, and double trucks. The number of combinations that can be made when applying power to the car with these elements is surprising. The proportion of the total car weight on the driving wheels largely determines the schedule possibilities and the grade-climbing capacity of a car. With the single-truck, two-motor equipment, all the weight is on the driving wheels so that this combination would be ideal were it not for the fact that the demands of seating capacity and riding quality put limitations on the single-truck car that usually make it necessary to have double-truck equipments. With the double-truck car there are many complications which arise when selecting a distribution of power for the driving axles. A selection which will give uniform weights on the wheel treads will, of course, give the ideal car, for it will reduce wheel slippage to a minimum under all conditions. During the period of acceleration there is a shifting of the car-body weight so that there is a lesser weight on the front center-plate than on the rear center-plate. The car-body weight assumed for all the double-truck cars considered in this discussion is 20,000 pounds or 10 tons, and this mass is assumed to be accelerated at the rate of $1\frac{1}{2}$

miles per hour per second. There is a retarding pressure of 137 pounds per ton, or a total of 1370 pounds, due to acceleration. It is assumed that the center of this mass is 24 inches above the center-plate, and that the king-pins are 20 feet between centers. When the car is accelerating there is a shifting of car body weight around the center of the mass, which, with the car body as described when accelerating at $1\frac{1}{2}$ miles per hour per second, gives 9863 pounds weight on the front center-plate and 10,137 pounds on the rear center-plate. The same shifting of weights, but in different proportions, takes place on the trucks. This action is independent of the position of the motors on the trucks.

Later on it will be shown that with a four-motor equipment and motors "inside hung" it is possible to secure the nearest approach to equalization of the weights on the wheel treads.

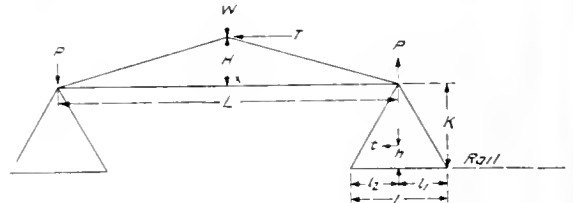


Fig. 1

- L = Distance between truck centers.
 H = Distance of center of gravity of car body above center plate.
 W' = Weight of car body in pounds.
 T = Retarding pressure of car body during acceleration.
 P = Pounds pressure transferred from front truck to back truck at king-pin.
 W_1 = Weight on front center-plate.
 W_2 = Weight on rear center-plate.
 p_1 = Pounds pressure transferred from front to rear axle (center-plate load).
 p_2 = Pressure transferred from front to rear axle (truck load).
 p = $p_1 + p_2$.
 W'_f = Weight on front axle exclusive of truck weights.
 W'_r = Weight on rear axle exclusive of truck weights.
 b = Weight of truck.
 t = Retarding pressure of truck during acceleration.

The question is frequently asked—"What equipment shall we buy, two-motor or four-motor?" To this question a direct answer cannot be given; it is a question of judgment. The answer is determined by the amount of wheel slippage that is allowable. On this

account, generally speaking, double-truck two-motor equipments are not satisfactory where the grades exceed five per cent, or on a bad rail such as is produced by snow, sleet, mud, or leaves on the track. Wheel slippage is the factor which usually decides whether or not four-motor equipments are chosen.

The combinations of weight distribution and the weight on the individual wheel treads during the period of acceleration present a very interesting problem. The maximum schedule will of course be maintained by the equipment which has the most nearly equal weight distribution on the wheel treads.

In addition to the many combinations of motor mounting for a single car, we have trailer operation to consider and also the effect of these trailers on wheel slippage, both on level track and also on grades. An analysis of the weight distribution on single-motor cars indicates clearly the reason for usually selecting four-motor equipments when trailer operation is to be considered. This analysis of weight distribution shows why, when the grades to be negotiated are more than five per cent it is the general practice to use four-motor equipments for double-truck cars.

There are at least twelve to fifteen different combinations of mounting motors on the different types of trucks in general use. For the present purpose, twelve combinations will be considered. With each of these there is a different weight on wheel treads during the acceleration period. In arriving at the values given in Fig. 2, it is assumed:

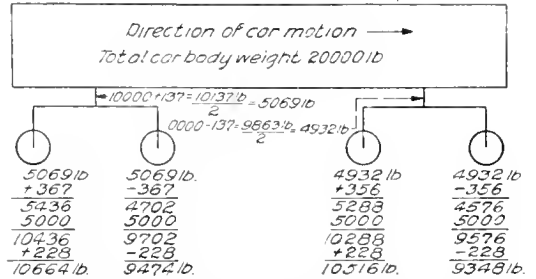
1st. The car is accelerating at one and one-half miles per hour per second on tangent level track.

2nd. The single-truck car weighs complete 10 tons, has a ten-foot wheel base, and the center of gravity of the car is 24 inches above the center-line of the axles.

3rd. All double-truck car bodies complete with car-body equipment weigh 20,000 pounds each with no live load.

4th. Double-truck cars have trucks weighing 6000 pounds each. Those having inside-hung motors have 72-in. wheel-base and those having outside-hung motors have 54-in. wheel-base. The distance from the surface of the center bearing-plate to the center-line of the axle is 12 inches, the wheels are of 33-in. diameter, the center of gravity of the truck with motors is 16½ in. above rail for motors shown in Fig. 2, and the distance between the truck centers is 20 feet. The weights and lengths of each end of the car are equal.

5th. There is a slight downward tilting of the car body and trucks during the acceleration which will make a slight variation in the figures as given, but as these variations are inappreciable and would complicate the explanation, no allowance has been made for this variation. The rotative effects of dead



Weights as given are for weights on wheels of each axle
Fig. A. Specific example of how to determine the distribution of car weights when the center of gravity of the trucks and motors is taken as 18 in. above head of rail

Distribution of Car Weights on Wheel Treads During Period of Acceleration (Four Motors Outside Hung)

Car body weight, 20,000 lb.
Truck weight, 6000 lb. + two motors, each 2000 lb. = 10,000 lb. total.
Wheels 33 in. diameter.
Wheel-base 54 in.
Truck centers 20 ft. or 240 in.
Center-plate 12 in. above center-line of axle and 28½ in. above wheel tread.
Center of gravity of car 24 in. above center-plate.
Center of gravity of trucks with motors 18 in. above wheel tread.
Car acceleration 1½ miles per hour per second.
Ninety-one lb. required to accelerate one ton one mile per hour per second $\times 1 \frac{1}{2} = 137$ lb.
Car body weight transferred from front to rear center-plate = $\frac{137 \times 20,000 \text{ lb.} \times 24 \text{ in.}}{2000 \text{ lb.} \times 240 \text{ in.}} = 137$ lb. which gives 9863 lb. weight on front center-plate and 10,137 lb. on rear center-plate.
The 9863 lb. on front truck has transferred weight from front to rear axle as follows: $\frac{137 \times 9863 \times 28 \frac{1}{2}}{2000 \times 54} = 356$ lb. transferred weight.
The 10,137 lb. on rear truck has transferred weight from front to rear axle as follows: $\frac{137 \times 10,137 \times 28 \frac{1}{2}}{2000 \times 54} = 367$ lb. transferred weight.
Within the truck and motors there is also weight transferred from front to rear axle as follows: $\frac{37 \times 10,000 \times 18}{2000 \times 54} = 228$ lb.

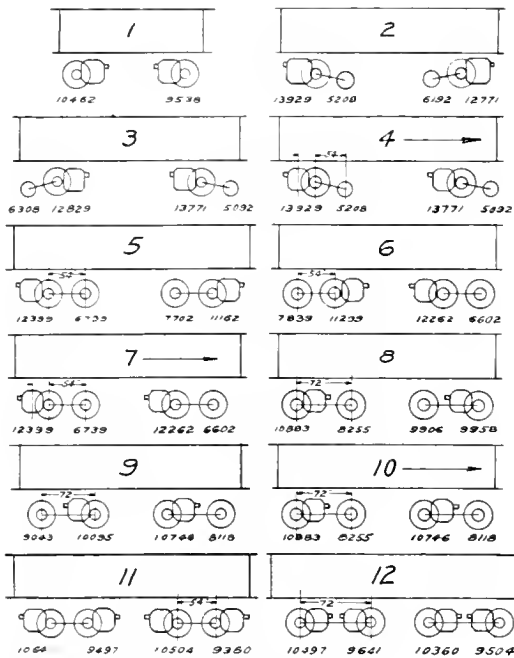
axles have not been considered, as the variation would be slight.

Based on these facts, the outlines in Fig. 2 have been made.

The formulas from which the weight pressures were calculated are derived in the following, in which the diagram in Fig. 1 and its key are used as a base.

The retarding pressure of the car body will be

$$T = \frac{137 W'}{2000}$$



DIRECTION OF ALL CARS →
 FIGURES GIVEN ARE WEIGHTS ON WHEEL TREADS WHEN
 ACCELERATING 1½ M.P.H. PER SECOND

Fig. 2. Twelve Methods of Mounting Motors on Trucks, Showing Relative Weight Distribution During Acceleration

The transfer of weight from the front center-plate to the rear center-plate is found by taking moments about a point X as follows.

$$\frac{137 W'H}{2000} = 2 P \frac{L}{2} = PL$$

$$P = \frac{137 W'H}{2000 L}$$

$$W'_1 = \frac{W'}{2} - P$$

$$W'_2 = \frac{W'}{2} + P.$$

The transfer of car-body weight from the front axle to the rear axle is determined, as follows:

$$\frac{T}{2} K = p_1 l_1 + p_1 l_2 = p_1 (l_1 + l_2) = p_1 l.$$

$$p_1 = \frac{TK}{2l}.$$

The transfer of truck weight from the front to the rear axle is determined thus:

$$t = \frac{137 b}{2000} = \frac{137 b h}{2000} = p_2 l$$

$$p_2 = \frac{137 bh}{2000 l}$$

$$\text{Then } p = \frac{TK}{2l} + \frac{137 bh}{2000 l}$$

And the distribution of wheel pressure will be as follows:

Front truck

Rear truck

$$W'' = W'_1 \frac{l_2}{l} - p \quad W'' = W'_2 \frac{l_2}{l} - p$$

$$W''' = W'_1 \frac{l_1}{l} + p \quad W''' = W'_2 \frac{l_1}{l} + p$$

Considering the weights on the individual wheel treads, it will be seen that with the single-truck car, shown in Fig. 2, there is a noticeable shifting of the weight from the front axle to the rear axle during acceleration. The wheel-tread weights for the maximum-traction trucks are also somewhat different from those we would naturally expect from the static weights (in all the assumptions made for maximum-traction truck calculations, it has been assumed that the static weights on the driving wheels are 70 per cent of the total). It is a natural conclusion that with four-motor equipments the nearest to equal distribution of weight on wheel-treads under all conditions would be procured. However, by comparing diagrams 11 and 12, Fig. 2, it will be noted that the inside-hung motor arrangement shows a considerable improvement over four-motor equipments with outside-hung motors. All of the weights as given in the different diagrams are for cars accelerating at 1½ miles per hour per second on straight level track. When accelerating on grades the values will be somewhat different, but not as much as one would naturally be led to expect.

Another feature of these calculations which should be considered in connection with the weights is that cars which have long platforms on one end only have not been considered. There are so many variations in this respect in cars operated in regular service that it would be impossible to make general statements covering this condition. Dimensions and weights on both ends of the cars have therefore been assumed to be equal.

After the question of deciding how many motors are to be used on a car, the next factors to consider are how to get the greatest

amount of work out of the motors per pound of weight, how to secure the motor that will use the least power, and at the same time to obtain an equipment at a price that will be justified by the results of these savings.

It is a universally accepted fact that a ventilated motor will have a greater work capacity per pound of weight than a non-ventilated motor. The past few years' experience has led all of the truly progressive engineers to specify that the motors which they are about to purchase must be ventilated. It is also a generally recognized fact that by using field control the work capacity of a motor, that is properly designed, is increased. When considering the use of field control, the service should be carefully reviewed to see if the increased cost and the complications of the field control are warranted by the savings in power and weight of the extra control apparatus required. The cost of a motor designed for field control is but slightly greater than that of one for full-field running only, but there is also an increased cost in the control and car wiring for the former type of motor. There are practically twice as many field connections as are found in the ordinary full-field equipments. These extra connections make the locating of trouble more difficult. All of these factors must be taken into consideration. Practically all the savings secured by field control are made during the period of acceleration, and, since this is the case, rapid acceleration decreases the power saving. Another way of partially expressing this idea is that where stops are infrequent the saving is proportionately small. On account of the complications in wiring and control but comparatively few field-control four-motor equipments have been installed. However, for two-motor equipments many purchases of field-control equipments for frequent stop city service have been made.

During the past three years there has been an increased amount of interest exhibited regarding 24-inch wheel equipments for city service. Motors that are particularly efficient and well constructed have been designed for use with these equipments. Due to the decreased weight of the wheels and trucks as well as to the reduction in the weight of the motors, this subject has engaged active study. In addition to the weight savings there has also been an innovation in control which consists of a change in the standard motor circuit connections so that three running speeds are obtained. With this combination of control there is a considerable saving in

power consumption. In some cases a saving of seven or eight per cent may be expected. It is necessary, however, in connection with this control to carefully analyze the service, for experience has shown that the heating is not equally divided among the four motors of the equipment. Referring again to the reduction in the weight of trucks for these equipments, it can be stated that for the standard 33-inch wheel equipment (which it was formerly the practice to use) these trucks would weigh approximately 12,000 pounds per pair, and that it is now possible to purchase trucks with 24-inch wheels which will weigh but 8000 pounds per pair. The weight of an individual motor which was formerly designed to operate with the 33-inch wheels would be approximately 2000 pounds while the 24-inch wheel motor complete weighs but 1750 pounds. It can therefore be seen that a saving of 4000 pounds can be made in the trucks alone and in the motors 1000 pounds additional, making a total reduction in car weight of 5000 pounds. This weight saving is something that cannot be ignored. There have been a number of 24-inch wheel equipments purchased during the past year and the results of their performance will be followed very carefully. In all probability, within the next year or two, some very pertinent facts will be available.

In the selection of interurban equipments the same considerations in regard to motor distribution apply as have been mentioned for city cars. Practically all equipments in this class of service employ four motors, and it is the usual practice for the motors to be inside-hung. There has not been a general adoption of field control for interurban work due to the fact that as a rule the stops, as compared with city service, are relatively infrequent and therefore the savings which can be made with city equipments is not so apparent in the interurban equipments.

When purchasing any large number of new equipments the savings which may be procured with higher voltages than 600, which has been the standard in past years, are very attractive due to the savings which would seem to be possible. However, an analysis of many of the existing interurban road conditions develops the fact that these interurban roads also supply city service to a large number of small towns through which they pass, and that on these city equipments very extensive changes would have to be made. That is, the electrical equipment would all practically have to be renewed on these cars.

Provided this change is not made the line must be so sectionalized that the town sections would still operate on 600 volts, and after all of the savings and the additional costs have been taken into consideration, it has been found that in a great many cases the change was not warranted. Of course, if these properties were entirely new the proposition would be a much different one, and in all probability the installation of the higher voltages would be more than warranted.

A large number of interurban roads have practically reached the limit of their earning power as they are securing all of the business which there is at the present time, and the only additional business which can come to them is through the natural increase of business due to the growth of the community. This has lead the management of these properties to carefully consider and to estimate the cost of entering into the business of hauling car-load freight. As a result it would not be surprising if a large number of roads purchase locomotives in the near future in order to increase their earnings per mile of track. To select the motors for this service, it has usually been the practice to start with locomotives weighing approximately 40 tons. Sometimes these units are of the regular locomotive type and sometimes of the baggage-car type. These units as a rule are equipped with four 125-h.p. motors. On some properties this business has grown to such an extent that it is necessary to use 60-ton locomotives which are usually equipped with four 225-h.p. motors.

In the selection of an equipment for either city or interurban work, it is necessary to have a very definite picture of the work to be done. Very careful consideration of the actual work that is desired to be accomplished should be given by the management of the railway company; and when working up data for a proposition, it is very dangerous for the railway company to put leeway in the figures which they give to the manufacturing company. When certain equipment is recommended by a manufacturer the railway company can always place dependence upon it,

for in the recommendation the manufacturer has of necessity already embodied a certain margin of safety.

If there has been an allowance made earlier by the railway company as to schedule speeds, stops per mile, duration of stops, etc., and then the manufacturing company, ignorant of the previous allowances, also makes additional ones in each of these factors; the equipment will be larger than is actually required to perform the work, and this would be caused simply by doubling the allowances. The number of stops and the duration of stops which are made per mile by any equipment are very deceptive. The only way in which this information can be obtained is by actual observation and careful records. The problem is not a difficult one, but is just an actual statement of the facts. If these few statements were given careful consideration frequently, considerable of the extra figuring and time of all parties concerned would be saved. The securing of accurate service data insures the purchase of the proper size equipment. This means an equipment which will give satisfaction and also will be secured at a reasonable cost.

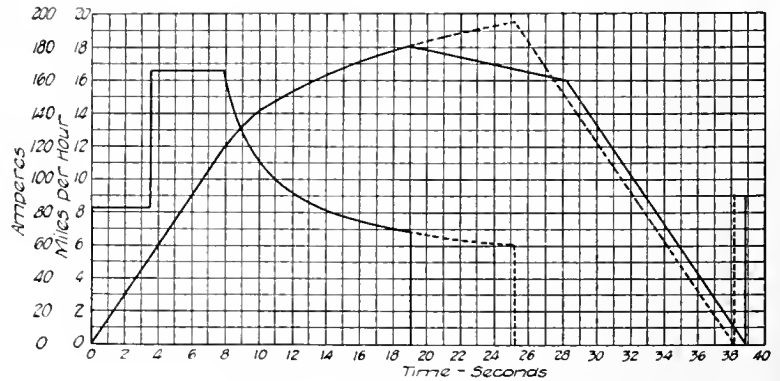


Fig. 3. Speed-time and Energy Curves for 20-ton Cars Showing

Comparison of energy consumption for slightly different schedules.
 Service assumptions:
 Two-motor equipment—50-h.p. motors.
 20 tons total car weight.
 550 volts average.
 1-75 stops per mile.
 1½ m.p.h.r.s. accelerating and braking rate.
 20 lb. per ton friction.

Dotted line curves indicate:
 Maximum schedule 9.6 m.p.h. No coasting.
 Energy consumption 145 watt-hour per ton-mile.
 Full line curves indicate slightly decreased schedule, 9.45 m.p.h., coasting about 30 per cent distance. Energy consumption 122 watt-hour per ton-mile.
 Showing a saving of 19 per cent in energy.

In a general way, it can be said that attempting to run a faster schedule than normal is very expensive. An illustration of what happens to power consumption under this condition with 20-ton cars is shown by the speed-time and energy curve shown in Fig.

3. This is based on 7.75 stops per mile. With 9.6 miles per hour schedule speed, 145 watthours per ton mile will be used. By slowing this schedule to 9.45 miles per hour, 122 watthours per ton mile are required; a saving of 19 per cent. It would seem that in the selecting of the equipment and in the

laying out of schedules a considerable power saving could be made by being a little more reasonable in the running time. Of course there is a natural tendency to run the highest possible schedule speeds at the present time, which has been brought about by the recent increase in "platform" wages.

A SHORT METHOD FOR CALCULATING THE STARTING RESISTANCE FOR SHUNT, INDUCTION, AND SERIES MOTORS

By B. W. JONES

INDUSTRIAL CONTROL DEPARTMENT, GENERAL ELECTRIC COMPANY

Since at the present time practically all motors are shipped from the factory complete with the proper starting rheostat, the information given in this article will be of use mainly to the factory designing engineer; yet at the same time formulæ of the kind will be of great assistance in some cases of temporary motor installations where it is necessary to regulate the starting characteristics of the motor. The author deduces simple formulæ for the resistance steps for maximum and minimum given values of accelerating current with given number of rheostat divisions and value of internal motor resistance, for shunt, series and induction motors singly, and for two and four series motors in series-parallel. The theory on which the method is based is then given, and a concrete example for each of the cases assumed is worked out.—EDITOR.

In commercial practice it is necessary to calculate a large number of starting rheostats for the shunt, induction, and series types of motors, and therefore it is essential that a short method be used. Of the methods available, the one described in the present article has been found in practice to give remarkable satisfaction.

First, either the maximum or the minimum accelerating current peak is assumed, together with the number of rheostat divisions and the internal motor resistance. If it is a series-motor resistance, then the speed characteristic curve of the motor is necessary. During acceleration the successive divisions of resistance are short-circuited as fast as the current decreases to a fixed assumed value, and all the current peaks are of equal value.

It should be noted that if all values are in percentages it will cause less confusion. Therefore, all of the series-motor formulæ will be expressed on that assumption.

Let

V = Line volts.

I_1 = Minimum acceleration current = $\frac{V}{R_1}$.

S_1 = (For series motors) speed corresponding to I_1 .

I_2 = Maximum acceleration current = $\frac{V}{R_2}$.

S_2 = (For series motors) speed corresponding to I_2 .

S_3 = Speed corresponding to $1.5 I_1$.*

R_1 = Total resistance to give minimum current = $\frac{V}{I_1}$.

R_2 = Total resistance to give maximum current = $\frac{V}{I_2}$.

r = Internal resistance of motor.

$r_1; r_2; r_3; r_4; \text{ etc.}$ = Resistance of the successive divisions of the rheostat.

n = Number of rheostat divisions.

X = Ratio $\frac{\text{maximum acceleration current}}{\text{minimum acceleration current}}$
= $\frac{I_2}{I_1}$.

$Y = (S_1 - S_3)^*$

$A_1 = \frac{100 V - I_1 r}{S_1 I_1}$.

$A_2 = \frac{100 V - I_2 r}{S_2 I_2}$.

$Z = \frac{A_1}{A_2}$.

For Shunt or Induction Motors

I. Assume that the minimum accelerating current, the number of rheostat divisions, and the internal resistance of the motor are known.

$\text{Log } X = \frac{1}{n+1} \log \frac{R_1}{r}$.

$r_1 = (X - 1)r$.

$r_2 = X r_1$.

$r_3 = X r_2$.

$r_n = X r_{n-1}$.

*See footnote, page 132

II. Assume that the maximum accelerating current, the number of rheostat divisions, and the internal resistance of the motor are known.

$$\text{Log } X = \frac{1}{n} \log \frac{R_2}{r}$$

$$r_1 = (X - 1)r$$

$$r_2 = Xr_1$$

$$r_3 = Xr_2$$

$$r_n = Xr_{n-1}$$

It is apparent that if any three values are known, the fourth can be found.

For Series Motors

III. Assume that the minimum accelerating current, the number of rheostat divisions, and the internal resistance of the motor are known.

The following is an empirical formula:

$$\text{Log } X = \frac{1}{n + 1} \log \frac{R_1}{1.5 \left(\frac{n + 1}{n + 2} \right) Y}^*$$

Then, from the article "Determination of Resistance Steps for the Acceleration of Series Motors" by E. R. Carichoff and H. Pender in the GENERAL ELECTRIC REVIEW, July, 1910, we take

$$r_1 = A_1 (S_1 - S_2)$$

$$r_2 = Zr_1$$

$$r_3 = Zr_2$$

$$r_n = Zr_{n-1}$$

IV. Assume the same conditions as in III, but that there are two motors to start in series-parallel.

For the series position:

$$\text{Log } X = \frac{1}{n + 1} \log \frac{R}{r + 1.5 \left(\frac{n + 1}{n + 2} \right) Y}$$

$$r_1 = r(Z - 1) + A_1(S_1 - S_2)$$

$$r_2 = Zr_1$$

$$r_3 = Zr_2$$

$$r_n = Zr_{n-1}$$

For the multiple position:

$$\text{Log } X = \frac{1}{n + 1} \log \frac{R_1}{3 \left(\frac{n + 1}{n + 2} \right) Y}$$

$$r_1 = A_1(S_1 - S_2)$$

$$r_2 = Zr_1$$

$$r_3 = Zr_2$$

$$r_n = Zr_{n-1}$$

* Note that the denominator, $1.5 \left(\frac{n + 1}{n + 2} \right) Y = 0.75 \left(\frac{n + 1}{n + 2} \right) \left(\frac{s - s_1}{l - l_1} \right)$

It is sometimes convenient and slightly more accurate to make l_1 as near equal to l as can be approximated instead of $l_1 = 1.5l$.

V. Assume the same conditions as in III, but that there are four motors to start in series-parallel. Four motors are to be in series at starting and two are to be in series for permanent running.

With this condition if r = internal resistance of two motors then the formulæ in V are to be applied.

THEORY

I. From geometrical progressions:

$$\text{Sum} = r + rX + rX^2 + rX^3 + \dots + rX^n + r + X^{n+1}$$

(Where n equals two less than the number of terms which correspond to the number of rheostat divisions.)

Therefore the last term, R_1 , which is the sum of all the previous terms is:

$$R_1 = rX^{n+1}$$

$$X^{n+1} = \frac{R_1}{r}$$

$$\text{Log } X = \frac{1}{n + 1} \log \frac{R_1}{r}$$

II. If n represents three less than the number of terms, then the next to the last term is

$$R_2 = rX^n$$

$$X^n = \frac{R_2}{r}$$

$$\text{Log } X = \frac{1}{n} \log \frac{R_2}{r}$$

III. For series motors a modification of the above is necessary. Since there are already too many variables to solve the equation, it is necessary to resort to an empirical formula which is accurate enough for all practical purposes.

The motor field flux varies as a function of the current, and the current fluctuation is a function of the motor's internal resistance and the number of rheostat divisions. Therefore in place of

$$r \text{ there is placed } 1.5 \left(\frac{n + 1}{n + 2} \right) Y^*$$

$$\text{Log } X = \frac{1}{n + 1} \log \frac{R_1}{1.5 \left(\frac{n + 1}{n + 2} \right) Y}$$

IV. The only difference between starting one motor from rest to full speed or two motors in series from rest to one-half speed is that an extra resistance, (r), is inserted in the circuit. Since the two motors in series attain only one-half speed, the sum of the two counter e.m.f. increments are the same as those of one motor running full speed when

the current peaks in each case are the same. Therefore, the formula becomes

$$\text{Log } X = \frac{1}{n+1} \log \frac{R_1}{r + 1.5 \left(\frac{n+1}{n+2} \right) Y}$$

When the two motors are changed to the parallel connection and are accelerated from one-half to full speed, then the extra resistance (r), that was in the series connection, is eliminated and the average counter e.m.f. increment corresponding to each current peak is doubled. Therefore, the formula becomes

$$\text{Log } X = \frac{1}{n+1} \log \frac{R_1}{3 \left(\frac{n+1}{n+2} \right) Y}$$

V. For the series-parallel operation of four motors, the motors are assumed to be connected as follows: During series operation all the motors are in series, and during parallel operation two sets each consisting of two motors connected in series are across the line. Then, if the internal resistance of two motors is considered as r , the same formulæ as given in **V** hold true.

EXAMPLE I

Assume: A 25 h.p., 230-volt shunt motor. Minimum accelerating current = 100 amp. Internal resistance of motor = 0.2 ohms. Number of rheostat divisions = 4.

Formula

$$\begin{aligned} \text{Log } X &= \frac{1}{n+1} \log \frac{R_1}{r} \\ &= \frac{1}{5} \log \frac{2.3}{0.2} = \frac{1}{5} \log 11.5 = \frac{1}{5} (1.061). \\ &= 0.212 \end{aligned}$$

Therefore $X = 1.63$.

Then $r_1 = (X - 1)r = 0.126$ ohms
 $r_2 = Xr_1 = 0.205$ ohms
 $r_3 = Xr_2 = 0.334$ ohms
 $r_4 = Xr_3 = 0.544$ ohms

Total external resistance 1.209 ohms
 Internal motor resistance 0.200 ohms
 Total resistance 1.409 ohms

Therefore as a check $\frac{230 \text{ volts}}{1.409 \text{ ohms}} = 163 \text{ amp.}$

EXAMPLE II

Assume: Same conditions as in Example I, except that the maximum current is known

(163 amps.) and the minimum current is to be found.

Formula

$$\begin{aligned} \text{Log } X &= \frac{1}{n} \log \frac{R_2}{r} \\ &= \frac{1}{4} \log \frac{1.409}{0.20} = \frac{1}{4} \log 7.05 = \frac{1}{4} (0.849) \\ &= 0.212. \end{aligned}$$

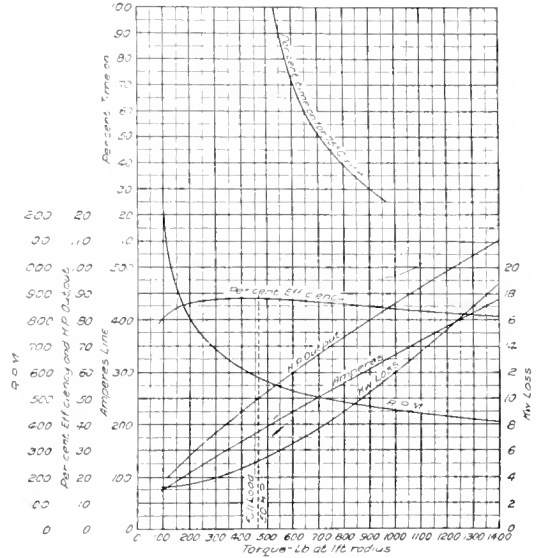


Fig. 1. Characteristic Curves of a 50-H.P., 239-Volt Series Motor

Therefore $X = 1.63$ (same as in Example I). The remaining is the same as in Example I.

EXAMPLE III

Assume: A 50-h.p., 230-volt series motor. Minimum accelerating current = 185 amp. Internal resistance of motor = 0.087 ohms. Number of rheostat divisions = 4.

Referring to characteristic curves of this motor, Fig. 1, all values should be reduced to percentages. The speed and current for minimum accelerating values, together with line voltage, will always be considered 100 per cent.

Let

$V = 230 \text{ volts} = 100 \text{ per cent volts.}$
 $I_1 = 185 \text{ amp.} = 100 \text{ per cent amp.}$
 $S_1 = 578 \text{ r.p.m.} = 100 \text{ per cent speed corresponding to 100 per cent amp.}$
 $S_3 = 487 \text{ r.p.m.} = 83 \text{ per cent speed corresponding to 150 per cent current.}$
 $Y = (S_1 - S_3) = (100 - 83) = 17 \text{ per cent.}$

Formula

$$\begin{aligned} \log X &= \frac{1}{n+1} \log \frac{R_1}{1.5} \frac{Y}{n+2} \\ &= \frac{1}{5} \log \frac{100}{1.5 \times 5.6 \times 17} = \frac{1}{5} \log 4.7 = \\ &= 0.135. \end{aligned}$$

Therefore, $X = 1.364$.

$$A_1 = \frac{100 \times 100 - 100 \times 6}{100 \times 100} = 0.94$$

$$A_2 = \frac{100 \times 100 - 136.4 \times 6}{87 \times 136.4} = \frac{9180}{11850} = 0.775.$$

$$\frac{A_1}{A_2} = Z = 1.21.$$

$$r_1 = A_1(S_1 - S_2) = 0.94(100 - 87) = 12.20$$

per cent ohms.

$$r_2 = Zr_1 = 14.80 \text{ per cent ohms.}$$

$$r_3 = Zr_2 = 17.95 \text{ per cent ohms.}$$

$$r_4 = Zr_3 = 21.75 \text{ per cent ohms.}$$

Total external resistance 66.70 per cent ohms.

Internal motor resistance 6.00 per cent ohms.

Total resistance in circuit 72.70 per cent ohms.

$$R = \frac{V}{I_1} = \frac{230}{185} = 1.24 \text{ ohms.}$$

Therefore, to reduce the percentages to actual values

$$12.20 \text{ per cent of } 1.24 = 0.151 \text{ ohms}$$

$$14.80 \text{ per cent of } 1.24 = 0.184 \text{ ohms}$$

$$17.95 \text{ per cent of } 1.24 = 0.222 \text{ ohms}$$

$$21.75 \text{ per cent of } 1.24 = 0.270 \text{ ohms}$$

$$\underline{\underline{0.827}}$$

The other variations for two or four motors, if worked in per cent volts, current, speed, and resistance, are so similar to those just given that it is not considered necessary to work out an example.

APPLICATION OF THE COOLIDGE TUBE TO METALLURGICAL RESEARCH

By DR. WHEELER P. DAVEY

RESEARCH LABORATORY, GENERAL ELECTRIC COMPANY

Two other articles describing the applications of the Coolidge X-Ray tube have appeared in the REVIEW, one "Some Interesting Applications of the Coolidge X-Ray Tube" in the August, 1914, number, p. 792, the other "An X-Ray Inspection of a Steel Casting" in the January, 1915, number, p. 25. The present article deals with the examination of the interior structure of copper castings and presents an interesting stereoscopic radiograph of a block of porous copper from which, by the aid of a stereoscope, the pores can be viewed in perspective.—EDITOR

Dr. Weintraub in the February, 1913, number of the *Journal of Industrial and Engineering Chemistry* describing boron and its compounds says:

"Boron suboxide, a by-product obtained in the manufacture of boron, can be used for obtaining high conductivity cast copper. Copper cast without additions is full of pores and blowholes, and therefore mechanically unfit and of very low electric conductivity; the removal of the gases from copper by the known deoxidizers is liable to give an alloy containing a small amount of deoxidizer, an amount sufficient, however, to lower the conductivity of the copper very considerably. Boron suboxide, however, has the property of deoxidizing copper without combining with it, as boron suboxide has no affinity for copper. Tons of copper are cast now by this

process, improving the quality of the product and at the same time cheapening it."

In the refining of copper for electrical purposes, the electrically deposited metal is melted in a reverberatory furnace. A world of delicate chemical control is connected with this furnace refining. When ready to pour, the metal is cast into open iron moulds which give a copper pig or bar of about 75 lb. in weight.

If the metal were merely melted and then poured the casting would be full of blowholes and would be of low electrical conductivity. The molten copper is allowed to oxidize in the furnace and the oxidation is augmented by air blown into the metal. When the melt contains five or six per cent of oxide, the major part of the other impurities have been burned away and the work of

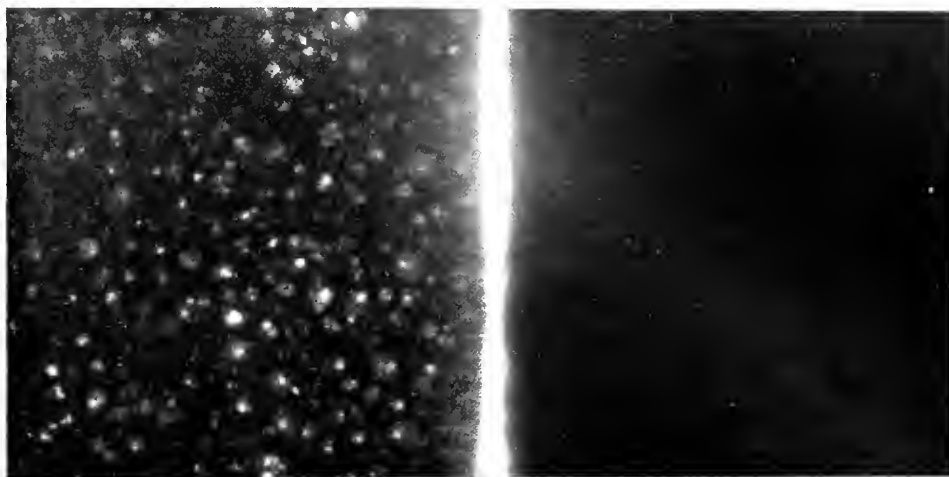


Fig. 1. Radiograph of a Block of "Unboronized" (Pure) Copper side by side with a Block of "Boronized" (Pure) Copper. Note difference of internal structure

reduction is started. As ordinarily done, this consists in the so-called "poling." Green sticks are submerged in the molten copper and the gases and carbon reduce the oxide, and such harmful products as sulphur dioxide are driven out of the metal. The proper time for pouring is not that representing complete reduction of all oxide, as it has been determined by experience that over-poling also gives a porous inferior ingot.

It was once believed that the copper absorbed carbon which in over-poled copper caused the rising in the mold and the porous

condition when cast. Hampe corrected this idea and attributed the porous state of over-poled copper to the effect of absorbed hydrogen and carbon monoxide. In any case the fact remains that if we merely melt copper and cast it we get a porous casting, and if we thoroughly remove dissolved oxygen by carbon or similar reducing agents, we also get a porous casting.

The use of the boron flux of Weintraub has done away entirely with the difficulty of obtaining sound castings of high electrical conductivity. It seemed interesting to illustrate the effect on the porosity by an investi-



Fig. 2. Ordinary Photograph of the Block of "Unboronized" Copper

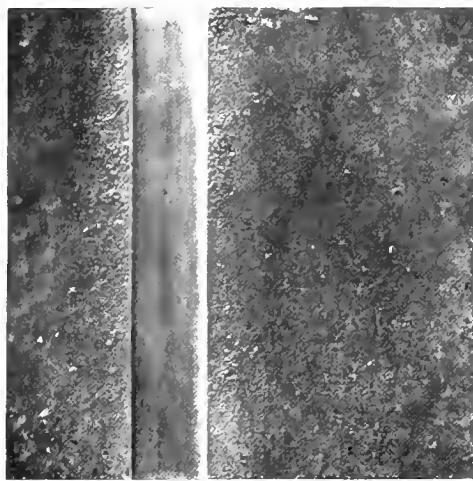


Fig. 3. Ordinary Photograph of the Block of "Boronized" Copper

gation using X-rays. For this purpose some high grade copper was melted in the usual way and poured into a sand mold to give a block 10 by 10 by $\frac{3}{4}$ inches. Another portion was treated with one per cent of the boron flux at the time of pouring and was cast in a similar mold. These two castings were then placed side by side on an 8 by 10-inch Seed X-ray plate, 22 inches from the focal spot of a Coolidge X-ray tube and exposed for two minutes. The current through the tube was 2.8 milli-amperes and the potential difference across the tube corresponded to a 10-inch parallel spark gap between points. The resulting radiograph is shown in Fig. 1. The copper cast in the ordinary way is seen to be full of pores. The cast with the boron flux is so perfect that no holes are visible. The two castings were then taken to the machine shop and a portion of the surface of each was machined as smooth as possible. Ordinary photographs were then taken, see Figs. 2 and 3. As was to have been expected from the radiograph, Fig. 1, the holes were clearly visible in the common copper. In the "boron-

ized" copper the holes are either entirely absent or are microscopic.

The advantage of the radiograph in experimental work is obvious. Without the use of X-rays it is necessary to machine off layer after layer of the sample in order to expose to view any hidden defects. Even when this is done it remains for the experimenter to build up a mental picture of the defects in his casting on the basis of what he has seen on each of the exposed layers. From the radiograph it is possible to see *all of these defects at once* without destroying the casting. If it seems desirable, it is easily possible to make stereoscopic radiographs whereby the defects may be seen in their entirety and their depths easily estimated. Such a stereoscopic radiograph of a portion of the pure copper casting is shown in Fig. 4. This figure should be viewed through an ordinary stereoscope.

In view of the results shown above, the X-ray examination of metals as a means of metallurgical research seems to have certain attractive and desirable features not found in other methods and to open a wide field for further work.

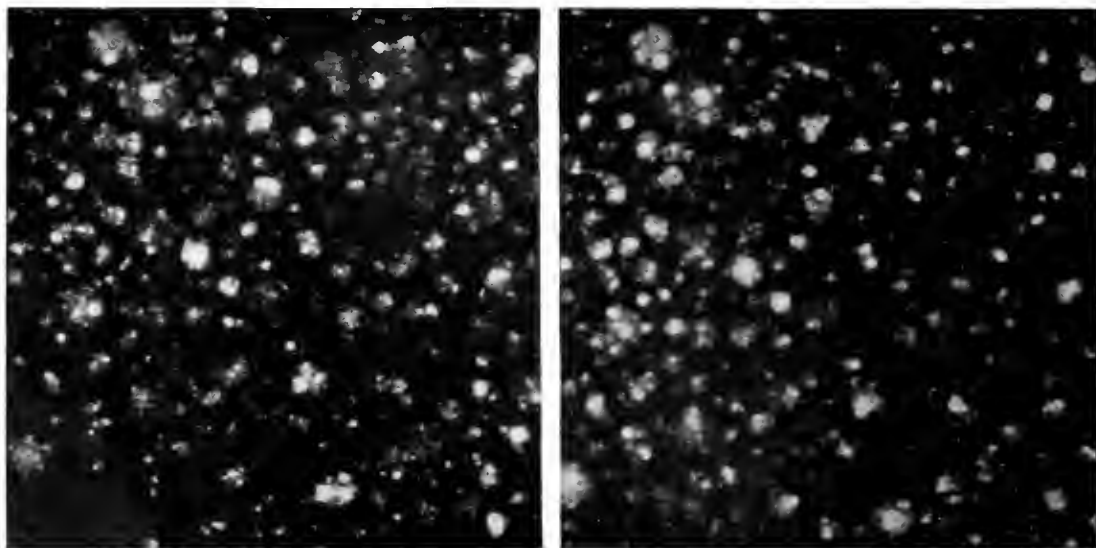


Fig. 4. Stereoscopic Radiograph of a Portion of the Block of Unboronized Copper (Actual Size).
When viewed through a hand-stereoscope this shows the size and relative depths of the pores

EFFECT OF ALTITUDE ON THE SPARK-OVER VOLTAGES OF BUSHINGS, LEADS AND INSULATORS

By F. W. PEEK, JR.

CONSULTING ENGINEERING DEPARTMENT, GENERAL ELECTRIC COMPANY

It has been a long-established fact that geographical altitude (or air pressure) and temperature has a very material effect on the value of an insulator's spark-over voltage. Although these influences have been recognized, we believe that the following article records the results of the first comprehensive tests to determine their amounts. When given sufficient data regarding an insulator, the tabulations and charts in this article enable the spark-over voltage to be determined at any temperature and atmospheric pressure. The article was presented as a paper at a meeting of the A.I.E.E. in December, 1914.—EDITOR.

The following investigation was made to determine the effect of air density, and therefore of altitude or barometric pressure, and temperature, upon the spark-over voltages of leads, insulators, etc.

The dielectric strength of air decreases with decreasing pressure and increasing temperature; that is, with the relative density or with the average spacing of the molecules. If the relative density is taken as unity at a standard pressure of 76 cm. and a temperature of 25 deg. C., the relative density at any other pressure and temperature is

$$\delta = \frac{3.92b}{273+t} \text{ where}$$

b = barometric pressure in cm., and
 t = temperature in degrees C.

For the uniform field between parallel planes the spark-over voltage decreases di-

rectly with δ . If c is the spark-over voltage for a given spacing at $\delta=1$, the spark-over voltage c_1 at $\delta=0.5$ is

$$c_1 = 0.5 c.$$

The effect is the same for the same value of δ whether δ is changed by temperature or by pressure. This has been shown elsewhere.* For non-uniform fields, as those around wires, spheres, insulators, etc., the spark-over voltage decreases at a lesser rate than the air density. The theoretical reasons for this have been given, as well as the laws for regular symmetrical electrodes, for cylinders, and spheres.†

It is, however, not possible to give an exact law covering all types of leads, insulators, etc., as every part of the surface has its effect.

* *Law of Corona II*, A.I.E.E. TRANS., 1912, p. 1051.

† *Law of Corona II*, A.I.E.E. TRANS., 1912, p. 1051, and
Law of Corona III, A.I.E.E. TRANS., 1913, p. 1767.



Fig. 1. Cask for Study of Variation of Spark-Over and Corona Voltage with Air Density or Altitude

TABLE I
SUSPENSION INSULATOR

Bar. Cm.	Vac. Cm.	Pressure Cm.	Temp. Deg. C.	δ	Kilovolts Arc-over
75.4	37.4	38.0	22	0.50	121.0
75.4	34.3	41.1	22	0.54	131.0
75.4	30.0	45.4	22	0.60	144.0
75.4	26.4	49.0	22	0.65	158.5
75.4	23.0	52.4	22	0.70	165.0
75.4	19.3	56.0	22	0.74	177.5
75.4	17.5	57.9	22	0.77	183.2
75.4	15.0	60.4	22	0.80	195.0

TABLE II
LEADS See Fig. 17

CORRECTION FACTOR FOR LEAD SHOWN IN

δ	CORRECTION FACTOR FOR LEAD SHOWN IN			
	Fig. 2	Fig. 3	Fig. 4	Fig. 5
1.00	1.00	1.00	1.00	1.00
0.90	0.92	0.91	0.92	0.92
0.80	0.83	0.82	0.83	0.85
0.70	0.74	0.72	0.75	0.77
0.60	0.70	0.65	0.64	0.66
0.50	0.61	0.56	0.54	0.57

The following curves and tables give the actual test results on leads, insulators, and bushings of the standard types. The correction factor for any other lead or insulator of the same type may be estimated with sufficient accuracy. When there is doubt, δ may be taken as the maximum correction. It will generally be advisable to take δ because

the local corona point on leads and insulators will vary directly with δ . This is so because the corona must always start on an insulator in a field which is locally more or less uniform.

The tests were made by placing the leads or insulators in a large wooden cask 2.1 meters high by 1.8 meters inside diameter, exhausting the air to approximately $\delta=0.5$, gradually admitting air and taking the spark-over voltage at various densities as the air pressure increased. The temperature was always read, and varied between 16 and 25 deg. C. The cask is shown in Fig. 1.

At the start a number of tests were made to see if a spark-over in the cask had any effect upon the following spark-overs by ionization or otherwise. It was found that a number of spark-overs could be made in the cask with no appreciable effect. During the test, the air was always dried and the surfaces of the insulators were kept clean.*

Table I is a typical data sheet. Tables II and VI give even values of δ and the corresponding measured correction factors. If the spark-over voltage is known at sea level or $\delta=1$ (76 cm. bar., temperature 25 deg. C.) the spark-over at any other value of δ may be found by multiplying by the corresponding

* In these tests, corrections have been made for wave shape, etc., and the voltages checked by sphere gap. Voltages measured by needle gap are incorrect and indicate higher voltages than really exist.

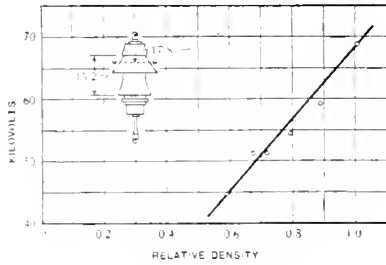


Fig. 2. Arc-Over Voltages at Various Densities

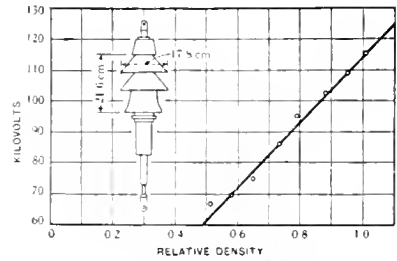


Fig. 3. Arc-Over Voltages at Various Air Densities

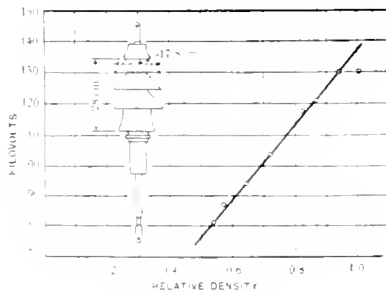


Fig. 4. Arc-Over Voltages at Various Densities

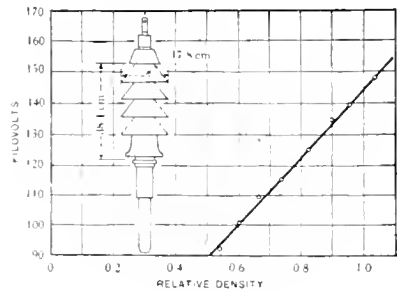


Fig. 5. Arc-Over Voltages at Various Densities

correction factor. It will be noted that in most cases the correction factors are very nearly equal to δ .

Fig. 15 is a curve giving different altitudes and corresponding δ at 25 deg. C. If the spark-over voltage is known at sea level at 25 deg. C., the spark-over voltage at any other altitude may be estimated by multiplying by the corresponding δ , or more closely if the design is the same as any in the tables, by the correction factor corresponding to δ . If the local corona starting point is known at sea level, it may be found for any altitude by multiplying by the corresponding δ . The barometric pressure corresponding to different altitudes is given in Fig. 16. Figs. 17

to 20 show the insulators used in these tests.

As an example of the methods of making corrections: Assume a suspension insulator string of four units with a spark-over voltage

TABLE III

POST AND PIN INSULATORS (See Fig. 20)

δ	CORRECTION FACTOR FOR INSULATOR SHOWN IN		
	Fig. 6	Fig. 7	Fig. 8
	Post	Pin	
1.00	1.00	1.00	1.00
1.90	0.93	0.91	0.94
0.80	0.84	0.81	0.86
0.70	0.76	0.73	0.75
0.60	0.68	0.62	0.65
0.50	0.60	0.52	0.53

TABLE IV

SUSPENSION INSULATOR, FIG. 9 (See Figs. 18 and 19)

δ	CORRECTION FACTOR FOR UNITS IN STRING AS FOLLOWS				
	Number of Units				
	1	2	3	4	5
1.00	1.00	1.00	1.00		
0.90	0.96	0.93	0.90		
0.80	0.91	0.84	0.80		
0.70	0.86	0.76	0.70		
0.60	0.80	0.66	0.60		
0.50	0.72	0.55	0.50		

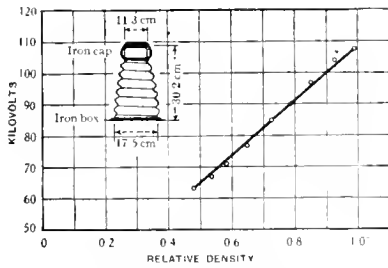


Fig. 6. Arc-Over Voltages at Various Air Densities

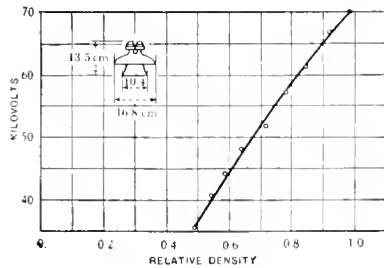


Fig. 7. Arc-Over Voltages at Various Densities

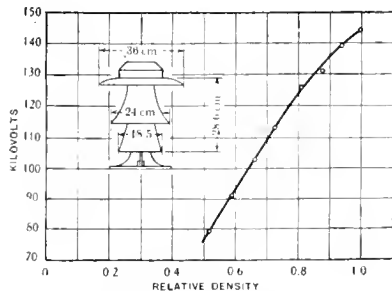


Fig. 8. Arc-Over Voltages at Various Densities

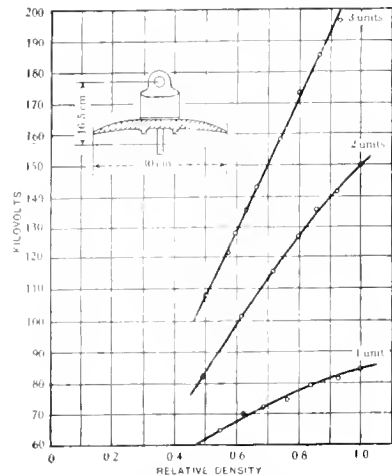


Fig. 9. Arc-Over Voltages at Various Air Densities

of 205 kv. (at sea level, 25 deg. C. temperature). $\delta = 1$. What is the spark-over voltage at 9000 ft. elevation and 25 deg. C.?

From Fig. 15, the δ corresponding to 9000 ft. is

$$\delta = 0.71.$$

TABLE V

SUSPENSION INSULATOR, FIG. 10 (See Figs. 18 and 19)

CORRECTION FACTOR FOR UNITS IN STRINGS AS FOLLOWS					
Number of Units					
	1	2	3	4	5
1.00	1.00	1.00	1.00	1.00	1.00
0.90	0.95	0.91	0.90	0.90	0.91
0.80	0.89	0.81	0.81	0.81	0.82
0.70	0.80	0.72	0.72	0.72	0.73
0.60	0.70	0.63	0.63	0.63	0.65
0.50	0.57	0.53	0.53	0.53	0.57

TABLE VI

SUSPENSION INSULATOR, FIG. 11 (See Figs. 18 and 19)

CORRECTION FACTOR FOR UNITS IN STRINGS AS FOLLOWS					
Number of Units					
	1	2	3	4	5
1.00	1.00	1.00	1.00	1.00	1.00
0.90	0.94	0.92	0.90	0.90	0.91
0.80	0.87	0.84	0.80	0.80	0.81
0.70	0.81	0.73	0.70	0.70	0.71
0.60	0.72	0.63	0.60	0.60	0.61
0.50	0.62	0.52	0.50	0.50	0.51

Then the approximate spark-over voltage at 9000 ft., 25 deg. C. is

$$e_1 = 0.71 \times 205 = 145 \text{ kv.}$$

If this happens to be the insulator of Fig. 10, the correction factor corresponding to $\delta = 0.71$ is found in Table V, by interpolation, to be 0.73. The actual spark-over voltage for this special case is

$$e_2 = 0.73 \times 205 = 150 \text{ kv.}$$

The first estimate is on the safe side and close enough for all practical purposes. Thus, for practical work the correction may generally be made directly by use of Fig. 15.

The spark-over voltage of an insulator is 100 kv. at 70 cm. barometer and 20 deg. C. What is the approximate spark-over voltage at 50 cm. barometer and 10 deg. C.?

$$\delta_1 = \frac{3.92 + 70}{273 \times 20} = 0.94$$

$$\delta_2 = \frac{3.92 \times 50}{273 + 10} = 0.61$$

$$e_1 = 100 \times \frac{0.61}{0.94} = 65 \text{ kv.}$$

If the local corona starting point is known at, say, sea level, it may be found very closely for any other altitude by multiplying by the correction δ .

The spark-over voltage of insulators will vary somewhat from day to day, due to humidity. There is also some variation for different units. The humidity voltage variation on the insulator is possibly as high as 7

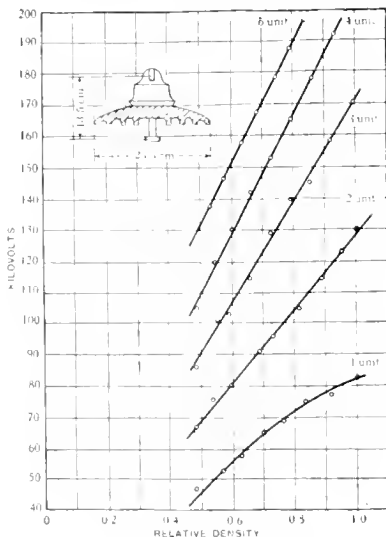


Fig. 10. Arc-Over Voltages at Various Air Densities

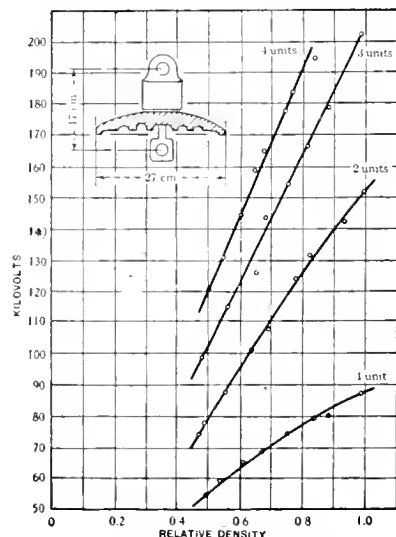


Fig. 11. Arc-Over Voltages at Various Air Densities

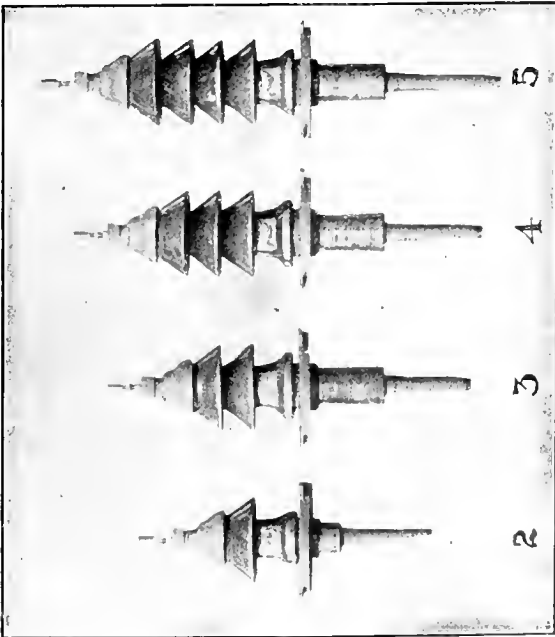


Fig. 17. Spark-Over Taken on Upper Part of Lead; Lower Part in Oil
Numerals refer to figure number of data curve

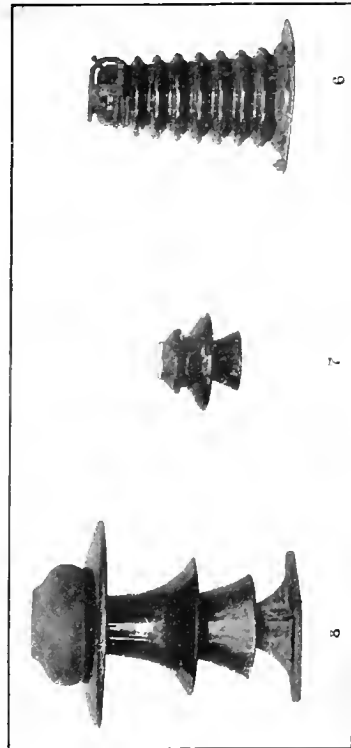


Fig. 20. Types of Porcelain Insulators Tested at Various Air Densities
Numerals refer to figure number of data curve

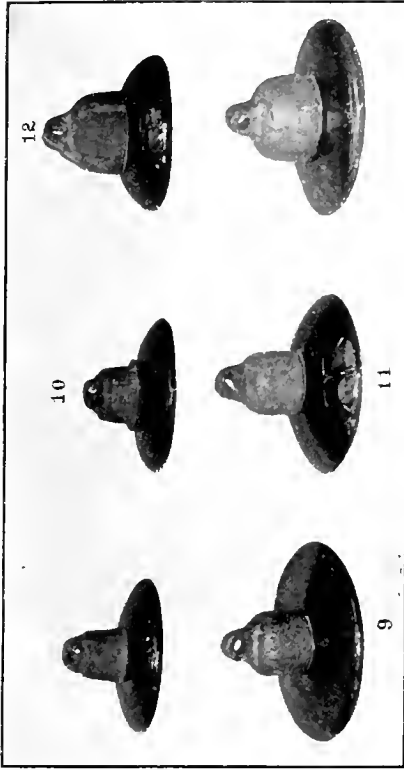


Fig. 18. Types of Porcelain Insulators Tested at Various Air Densities
Numerals refer to figure number of data curve

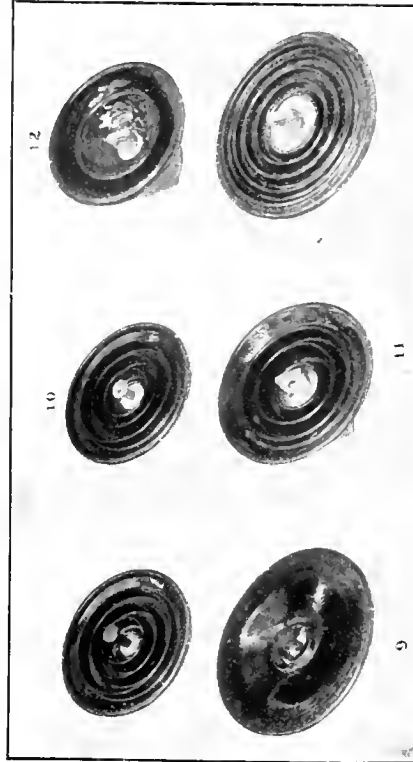


Fig. 19. Types of Porcelain Insulators Tested at Various Air Densities
Numerals refer to figure number of data curve

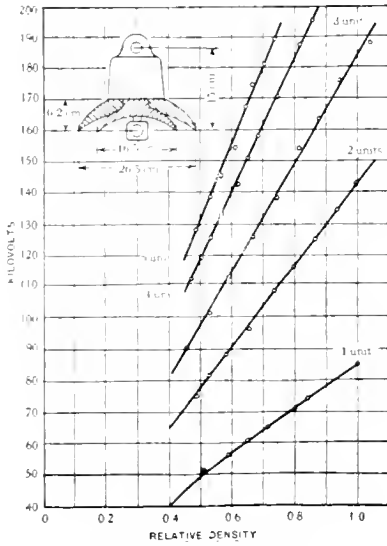


Fig. 12. Arc-Over Voltages at Various Air Densities

per cent, from day to day. Comparative tests of different types, when desired, should be made at the same time. The humidity correction, on the insulator itself, is too complicated to make and of no practical value.

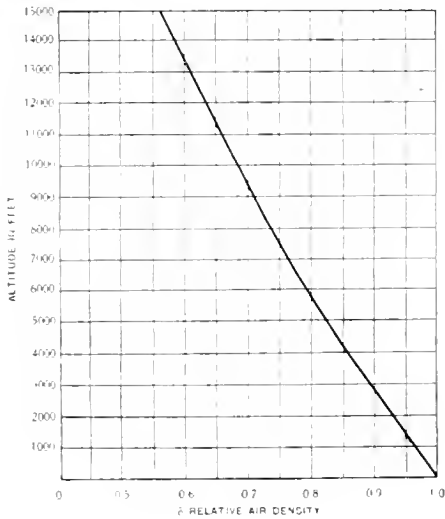


Fig. 15

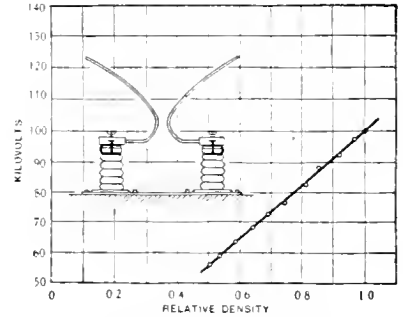


Fig. 13. Arc-Over Voltages at Various Air Densities
Horn gap spark-over. Gap spacing 14 cm.
Diameter of horns 1.27 cm.

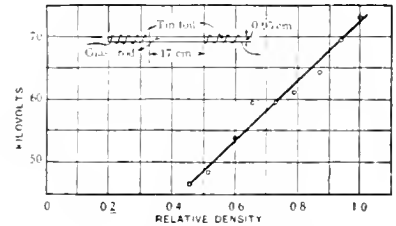


Fig. 14. Arc-Over Voltages at Various Air Densities

Care must be taken, however, to use a measuring gap unaffected by humidity; that is, a sphere gap.

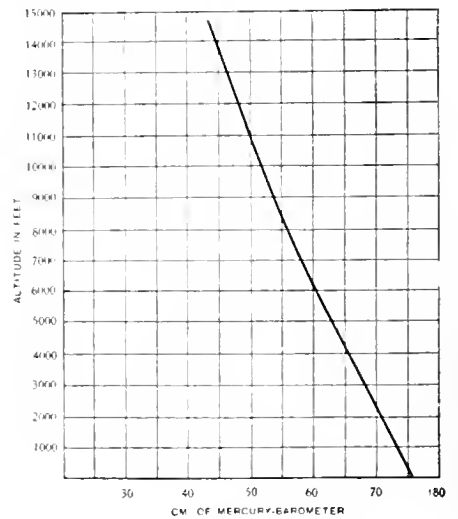


Fig. 16

THE LIGHTING OF SHIPS

By L. C. PORTER

EDISON LAMP WORKS, HARRISON, N. J.

Much has been published regarding the superiority of the drawn-wire tungsten-filament lamp over the old carbon-filament lamp in installations on land. This article analyses the conditions which determine illumination on shipboard; and shows that the new lamp when installed there displays the same excellent qualities that it does on land.—EDITOR.

Lighting practice ashore has advanced so far and so rapidly during the past few years that the public, now, not only appreciates but demands good lighting everywhere. As a result, ship owners have been made to feel this influence; and, in consequence of this, a large amount of attention and study has been given to the lighting of passenger and naval ships. The vast superiority of the tungsten-filament lamp over the carbon-filament lamp having become universally recognized on land, it is only natural that the newer lamp should also replace the older when used on shipboard. As a matter of fact, this is what is taking place.

The use of tungsten lamps aboard ships offers several mechanical advantages in addition to those obtained by their use ashore. Space and weight are of considerable moment on board our modern high-speed passenger boats. Reliability is also of great importance. Repairs when necessary must frequently be made at short notice and without most of the

and lighter generating apparatus, lighter wiring throughout the ship, less coal storage space necessary, etc.

It frequently happens, when changing over the lighting equipment of a ship from carbon



Fig. 2. Dining Room on the "Adirondack" of the Hudson Navigation Company



Fig. 1. The Saloon on the Steamship "Priscilla" of the Fall River Line

facilities obtainable ashore. The use of tungsten-filament lamps, consuming approximately 1.10 watts per c-p. as against 3.10 to 3.50 by carbon-filament lamps, means smaller

lamps to tungsten lamps, that one generator may be shut down and held in reserve. Smaller and lighter storage batteries for emergency use are required for tungsten lamps than for carbon lamps.

On certain steamers, people often ride solely for pleasure or for pleasure and business combined. To assist in drawing their patronage a lighting system must be devised which is not only necessary but ornamental as well. For this reason all-frosted lamps are almost invariably found on passenger vessels. These lamps frequently are made further decorative by the use of round bulbs and occasionally by placing them in elaborate chandeliers or equipping them with fancy reflectors. The general interior finish aboard ships is white. The bright all-frosted tungsten-filament lamps harmonize well with white wood work. Artistic effects are given the most consideration on ocean liners and the least on ferry boats. Between these two comes the great class of coastwise, river, and lake steamers.

The lighting problems of passenger vessels may be divided into five main parts: (1) social halls, (2) dining rooms, (3) smoking rooms, (4) staterooms, and (5) passageways. In



Fig. 3. Smoking Room on one of the Old Dominion Line Steamers

addition to these there are certain parts of the ship where a relatively small number of lamps are used, such as engine rooms, bar rooms, barber shops, boiler rooms, freight holds, etc.

Investigation shows that there are two general types of steamers in the coastwise, river, and lake class, those making comparatively short runs and those making trips of several days. On the former, the social halls consist of a large well, or opening running up one or two decks above the main deck. This class of social hall is well illustrated by the photograph taken on the Fall River Line steamer "Priscilla." Fig. 1. On ships making long trips, the social halls are smaller and generally but one deck high. Also they are usually not lighted quite as elaborately. Ceiling lamps are found frequently supplemented by lamps in wall brackets.

Illumination measurements, taken on a large number of ships lighted with carbon lamps, showed an average foot-candle intensity, on a plane three feet above the floor, of 1.1 on long trip ships, and 1.5 for the short run class.

An interesting demonstration of the great improvement obtained by substituting tungsten-filament lamps for carbon lamps was made in the social hall of a boat of the short run type. Thirty-eight sixty-watt all-frosted carbon lamps, giving an average intensity of 1.4 foot-candles for an energy consumption of 2.3 watts per square foot, were

replaced by thirty-eight twenty-five-watt all-frosted tungsten lamps. These lamps gave 2.7 foot-candles illumination with an energy expenditure of 1.0 watt per sq. ft.

Dining rooms are very similar on each class of ship. Round-ball enclosing globes located on the ceilings were considerably used. On one ship the 16-c-p. clear carbon lamps in enclosing globes were replaced lamp for lamp by 25-watt clear tungsten lamps. The carbon lamps gave 1.1 foot-candles for 1.5 watts per sq. ft., while the tungsten lamps in the same fixtures gave 1.4 foot-candles for 0.6 watts per sq. ft. Fig. 2 shows a section of the dining room of the Hudson River Line steamer "Adirondack."

Smoking rooms have a fairly high ceiling on the short run ships and a low one on the long trip class. Fig. 3 shows the arrangement employed in the smoking-room of a steamship on the line of the Old Dominion S. S. Co., which illustrates the latter type of lighting. All-frosted lamps located overhead are usually used. The average illumination 3 feet above the floor was found to be 1.25 foot-candles for an energy consumption of 2.09 watts per square foot.

In passageways a low illumination is all that is needed. This is frequently obtained by small lamps located on the ceiling spaced about 10 feet apart. The average intensity is about 0.8 foot-candles.



Fig. 4. Stateroom on the "City of Montgomery," Savannah Line

The staterooms are generally rather poorly lighted, having but one lamp located in the center of the ceiling. Great improvement is obtained by locating this lamp over the center and one foot out from the mirror, thus allow-

ing comfortable shaving, etc., and at the same time giving good general illumination in the room. A stateroom on the Savannah Line steamer "City of Montgomery," having a

lamp for lamp by 40-watt medium efficiency tungsten lamps. The former gave an average of 1.13 foot-candles, on a plane 3 feet above the floor, with an energy consumption of 1.96



60 Watt Carbon Lamps



40 Watt Mazda Lamps

Figs. 5 and 6. New York City Ferryboat "Richmond"

lamp at the center of the ceiling and a portable lamp near the berths, is shown in Fig. 4.

The lighting of ferries was found to be very uniform. In practically all cases the cabins were lighted by carbon lamps, in one- or two-light fixtures located on the walls over the

watts per sq. ft., while the latter gave 3.36 foot-candles for 1.50 watts per sq. ft. Figs. 5 and 6 show this cabin before and after the change.

Battleships present a different lighting problem from any other class of vessels. A warship's ability to fight, fight hard and effectively, is its primary function. The lighting must be so arranged as to enable the men to use the apparatus to the best advantage. A battleship is also the business office, the factory, the recreation ground, and the home of a thousand men. The happier and more contented these men are, the more efficient will they be. Realizing that plenty of light correctly applied increases the efficiency of the human machine, the U. S. Government has taken up the lighting of its ships from a scientific standpoint. Drawn-wire tungsten-filament lamps have proved by actual test that they will stand up under the severe strains of battle practice, the tropics, the extreme cold of a Maine winter, a storm, and a full-power run; in short all the various conditions encountered by our ships. These lamps in connection with scientifically designed reflectors are now being generally adopted by the Navy for use aboard ship.

On ocean steamers, great attention is paid to obtaining aesthetic effects, as illustrated by



Fig. 7. Palm Garden on the "Victoria Louise", of the Hamburg-American Line

seats. In a few cases round-ball all-frosted lamps were in use. On the N. Y. municipal ferry boat "Richmond," one hundred 60-watt high-efficiency carbon lamps were replaced

the photograph of the palm garden of the Hamburg-American Line steamer "Victoria Louise," Fig. 7. Investigation shows that round-bulb all-frosted tungsten-filament lamps are most generally in use for this class of ship lighting. Overhead lighting supplemented by table lamps and lamps in wall brackets is found to be a most usual arrangement. The illumination intensities vary quite widely, averaging however about 2 foot-candles on a plane 3 feet above the floor.

The introduction of the rugged drawn-wire tungsten-filament lamp has opened up a big field for its application to practically all classes of marine lighting.

As the result of many tests, several steamship companies are arranging to equip their boats with drawn-wire tungsten-filament lamps in place of the carbon lamps previously used.

In many instances it is impractical to change the existing wiring of a ship and, for this reason, the recommendations for a new

ship would vary considerably from those for a ship at present in commission. When the wiring is already installed, the expense involved in changing the outlets may more than offset the advantages to be secured by such a rearrangement of units as will provide the most economical and effective operation. On the ships which have been studied it was usually apparent that a better economy, and often a more effective illuminating effect could be produced by the use of a smaller number of tungsten-filament lamps of higher c-p., but in every case it was considered unwise to change the existing outlets. However, advantage has been taken of the higher efficiency of the tungsten-filament lamp to increase the intensity and, at the same time, reduce the lighting cost by substituting, lamp for lamp, 25- and 40-watt tungsten-filament lamps for the high wattage carbons. In some instances it was possible to also improve the diffusion by substituting frosted bulbs for clear ones.

PRACTICAL EXPERIENCE IN THE OPERATION OF ELECTRICAL MACHINERY

PART V. (Nos. 29 TO 31 INC.)

By E. C. PARHAM

CONSTRUCTION DEPARTMENT, GENERAL ELECTRIC COMPANY

(29) CURRENT TRANSFORMER FAILURES

Neglecting the no-load or magnetizing current of a constant-potential transformer, the primary current is proportional to the secondary current as is shown by the following succession of actions. Increased secondary current increases the opposing secondary flux which neutralizes more of the primary flux and thus decreases the counter e.m.f. of the primary coil, thereby permitting the primary current to increase until the core flux is restored to approximately its no-load value. In other words, the core flux is maintained at a practically constant value because the primary current automatically responds to changes in the secondary current.

With current transformers the conditions are different. The value of the primary current depends upon an external load over which the current transformer has no control. Assume that the current-transformer primary current, which is the current output of some generator, is kept constant at full-load value. A suitably calibrated instrument, placed in the secondary circuit, will indicate the value of the primary current,

although the secondary current to which the indication is due is but a small known part of the primary current. Owing to there being many more secondary than primary turns, the ampere-turns of the two windings are approximately equal and the opposing flux caused by the secondary is able to neutralize the flux of the primary to such an extent as to keep the core flux density below the value that would generate objectionable heating.

Next assume the secondary to be short-circuited, another instrument placed in series with the existing one, and the temporary short-circuit (used to avoid opening the secondary) removed. The secondary resistance will now be greater than it was with but one instrument in circuit and consequently there will be a tendency for the secondary current to decrease. Any decrease in the secondary current, however, increases the core flux because less of the primary flux will be neutralized. The increased flux cutting the secondary turns increases the secondary e.m.f. and thereby restores the secondary current almost to its former value. Up to the instrument capacity of the transformer,

additional instruments further increase the core flux and, hence, the secondary e.m.f. The secondary current is thus maintained so close to the correct value that the error may be neglected except in precision work.

The greater the number of instruments used in series, the greater will be this error, the hotter the transformer will become on account of the greater flux density at which the iron is worked, and greater will be the voltage to which the secondary insulation is subjected.

If the secondary be opened, its flux-neutralizing capacity ceases entirely and the core flux density, due to the unopposed primary flux, becomes abnormal and the heat resulting from rapidly reversing the flux at this density soon raises the iron to a temperature dangerous to the coil insulation. Furthermore, this greatly increased flux cutting the secondary turns induces therein an e.m.f. far exceeding that which obtains under normal conditions. These two effects conspire to break down the secondary insulation.

Therefore it is necessary to issue a warning against operating a current transformer with its secondary circuit open.

(30) HEATING AND SPARKING OF REPULSION-INDUCTION MOTORS

Repulsion-induction motors operating under normal conditions are characteristically free from sparking. Even when irregularities exist, the sparking may be so slight as to mislead one who is accustomed to operating only the other kinds of commutator motors.

Once, an operator noticed that one of his press motors was overheating and was sparking; similar motors operating similar presses were giving no trouble. In an effort to determine the cause of the difficulty, the operator interchanged two of the motors—a good one and the one under consideration. The trouble remained with the same motor. This cleared the press and the starter from suspicion and focused his attention upon the motor. He then cut an ammeter successively into the stator circuit of each of three duplicate press motors, which had evidenced no trouble, and thereby found that the current required under regular working conditions was $2\frac{1}{2}$ amperes. The faulty motor was operating under exactly the same conditions of load as were the three good motors just mentioned, but the ammeter when placed in its circuit indicated 5 amperes. Since the full-load current rating of the motors was 3.8 amperes the motor under examination

was carrying a current overload of nearly 30 per cent.

Reversing the compensating field connections only made matters worse. By shifting the brushes a little at a time, he found a position where the current was of the same value as for the good motors. He was now reasonably sure that the motor would not overheat, but as the sparking had not been lessened he called in a repair man whose examination disclosed an open-circuited armature lead. This condition was indicated by the burning out of the mica between diametrically opposite pairs of commutator bars. The repair of this lead resulted in perfectly normal operation.

(31) EXCESSIVE PUMP OUTPUT

The amount of water delivered by a centrifugal pump depends, among other things, upon the speed of the impeller. The delivery and speed variations, however, are not directly proportional to each other for, by reason of the characteristics of this type of pump, a certain per cent increase in speed produces a greater per cent increase in the amount of the water delivered. Therefore, if on account of high or low line voltage, or on account of design irregularities, the speed of the motor of a motor-driven centrifugal pump falls below or rises above the permissible five or six per cent speed variation, the water delivery may be materially affected; and, in the case of increased speed, the motor may be overloaded seriously. All conditions will be covered in a specification stating the speed at which the pump shall deliver water at a certain rate without the motor temperature rise exceeding a certain number of degrees after the motor has operated continuously for a stated length of time.

A certain operator once complained that his pump motor was running "red hot" on regular duty but was otherwise entirely satisfactory. Ammeters connected into the motor circuit showed the motor was heavily overloaded. Measurement of the water delivery rate showed it to be about twice that which had been specified. The pump maker was notified and his subsequent investigation revealed the fact that the wrong impeller had been supplied with the outfit. The pump manufacturer got out of his difficulty to advantage, however, because the operator was so much pleased with the water output that he had been obtaining that he readily agreed to pay the difference in price between the motor that had been furnished and the one that was large enough for the work.

NOTES ON THE ACTIVITIES OF THE A.I.E.E.

Standardization Rules

The January issue of the Proceedings of the A.I.E.E. contains an article by Dr. A. E. Kennelly, Chairman of the Standards Committee, of which the following is an abstract:

The American Institute of Electrical Engineers maintains, among its standing committees, a "Standards Committee," which is charged with the important duty of maintaining a series of Standardization Rules for the benefit of the Institute and its members. The fifth and most recent edition of the Standardization Rules, which is dated December 1, 1914, was adopted by the Board in July, 1914. It covers 96 pages.

Object of the Rules. The main purpose hitherto aimed at by the Standards Committee in the rules has been to draw up engineering definitions of terms, phrases, and requirements, relating to electrical machinery and apparatus, so that the meaning of technical terms might be standardized among the members of the Institute. Particular effort has been directed towards defining, in engineering terms, the rating of electrical machinery, and the requirements connoted thereby. This work serves the entire electrical industry, including manufacturers, purchasers, technical advisers, operators, and consumers. It is therefore desirable that the representation of electrical interests on the Standards Committee should be as wide as possible, in order that the needs of all classes of electrical workers should be adequately presented and mutually protected.

Relations of the Standards Committee to other Engineering Bodies. The work of the Standards Committee naturally brings the committee into contact with bodies engaged upon standardization in neighboring fields. Thus, it has for a number of years co-operated with the Bureau of Standards at Washington, D. C. The Bureau has not only been continuously represented by one or more of its officers on the Committee, but it has also undertaken important researches in electrical engineering at the request of the Committee. Thus, in 1910, the Bureau, at the request of committee, made an extensive investigation into the conductivity of commercial copper and has since published complete copper wire tables* based on those researches, for the benefit of the electrical industry.

The A.I.E.E. Standards Committee has also at different times worked in co-operation with Standards Committees of the American Society of Mechanical Engineers, the Illuminating Engineering Society, the Institute of Radio Engineers, the American Society for Testing Materials, the National Electric Light Association, the Association of Edison Illuminating Companies, and other bodies, upon questions of standardization involving work in their respective fields. It is probable that a standards committee representing the entire engineering force of America may ultimately be secured for dealing with general engineering questions.

International Standardization. The conditions which affect the mutual relations of different engineering societies in America regarding standardization, naturally extend themselves internationally between corresponding engineering societies in other

countries. It becomes impossible to carry standardization beyond a very elementary stage in any one country, without influencing the work and procedure along similar technical lines in other countries. It therefore becomes desirable to enter into mutually co-operative relations with electrical engineering societies and their standardizing committees abroad. Co-operative relations have been entered into at different times between the A.I.E.E. Standards Committee and corresponding committees in other countries, to considerable mutual advantage; but especially through the influence of the International Electrotechnical Commission, an international body engaged in international electrical engineering standardization. The American Standards Committee of the A.I.E.E. was the first national committee to formulate and publish electrical standardization rules, and similar committees have since come into existence in various other countries. It is neither necessary nor desirable that electrical apparatus built in one country should conform in structural details to that built in other countries; but it is surely desirable that the rating, and rating terms, employed in specifying the behavior in different countries should correspond, since no country can permanently profit by ambiguity, in the meaning of its technical phraseology, as applied to the physical behavior of apparatus.

The Standards Committee of the A.I.E.E. has no direct representation on the International Electrotechnical Commission (I. E. C.); but it has close relations with the U. S. National Committee of the I. E. C., and, through the intervention of the latter committee, it has been able to present its needs and recommendations to the I. E. C. Various rulings of the I. E. C. at past international meetings are now incorporated in the latest edition of the Rules.

The Relations of the Standards Committee to the Institute Membership. The work of its Standards Committee constitutes a distinct asset to the Institute, and to the membership. The committee meetings usually occur at monthly intervals in the New York headquarters of the Institute. Notices of these meetings are communicated in advance to the Standards Committees of other engineering societies, and are regularly announced at headquarters. Suggestions regularly reach either the A.I.E.E. Secretary, or the Secretary of the Committee, and receive careful consideration by the Committee. It is very desirable to secure frequent and copious suggestions, from the Institute membership at large, as to how the Rules operate in practice, and how they may be improved.

The Standards Committee is thus a body earnestly devoting its time and service to the welfare of the electrical engineering industry, in the belief that precision in standardization means an advance in the ethics, the science, the business and the welfare of engineering.

The 303rd meeting of the American Institute of Electrical Engineers was held at the Engineering Societies Building in New York, on Friday, January 8, at 8:15 p.m.

Mr. I. W. Gross presented a paper entitled, *Theoretical Investigation of Electric Transmission Systems Under Short Circuit Conditions*. The leading features of the trans-

* Regular Bulletin of the Bureau of Standards, "Copper Wire Tables."

mission system under short circuit conditions were treated as follows:

First. Mechanical forces between the phases of three-conductor, three-phase cables when carrying short-circuit current. Under this heading the forces between busbars were also investigated.

Second. The heating of the conductors of the cable from the instant of short circuit to a time 0.8 second later was traced analytically, during the transient state of the current, and typical computed heating curves were presented.

Third. The effectiveness of the method of placing reactors between generator terminals and the bus from which power is taken, and additional reactors between generators and an auxiliary synchronizing bus were analyzed. This latter scheme was compared with the present well-recognized schemes of feeder and busbar reactors.

It was shown that the average mechanical forces existing between conductors of a three-phase cable carrying short-circuit currents, and between busbars, rise to relatively high values at the instant of trouble. These forces can be reduced in cables by either limiting the current or increasing the distance between conductors. The same applies to busbars, and in addition, the position of the busbars can be adjusted by placing them in the same plane so that the mechanical forces may be considerably reduced.

The heating of the cables may be the limiting feature in controlling the short-circuit current, since it is quite possible for the temperature of the conductor to rise to such a point as to endanger the insulation of the cable even in the very short time that it takes an oil switch to operate after the short circuit has occurred. When the characteristics of the generators under short-circuit conditions are known, it is possible to compute the temperature rise, even although the current is of transient character.

In using reactors to limit the current flow on a power system, the method of plain feeder reactance is not fully effective, as trouble on the main station bus is almost certain to cause to drop out of step all synchronous apparatus on the system. Further, this method offers no protection to machines against poor synchronizing.

Station busbar reactance is effective under short-circuit conditions, but under normal operation is objectionable on account of the large voltage drop in transmitting power from one end of the bus to the other.

The scheme of feeding from the machine terminals, and paralleling generators on a separate bus, as brought to light by Mr. Stott, is extremely flexible and very effective in furnishing protection. It can limit the current to a safe value without an excessive amount of reactance in the circuit; it can protect the machines against mechanical injury due to poor synchronizing; and can transmit power from between different points of the bus with far less voltage drop than with the bus reactance scheme. It makes possible the use of generators having a low inherent reactance, provided, of course, the machine is designed to withstand dead short circuit at its terminals. Further, the lower the reactance of the generator the less is the probability that the synchronous apparatus on the system will be out of step due to reduced power house voltage. The possibilities of this system are as yet probably not fully realized.

The full text of the paper appears in the January issue of the Proceedings of the Institute.

LYNN SECTION

The regular meeting of the Lynn Section of the A.I.E.E. was held on the evening of January 6th and was attended by 250 members. Prof. Comstock, of the Massachusetts Institute of Technology, gave a most interesting talk on the *Modern Theory of Electricity and Matter*. The subject was introduced by a review of the older theories of the molecular constitution of matter and the kinetic theory of gases, and it was pointed out how the recent measurements of the Brownian movements of particles confirmed the kinetic theory, and how in the spinthroscope the effect of the impact of single particles of atomic magnitude is made evident. The general magnitude of molecules and atoms was described.

Electrical discharges through gases were discussed and it was pointed out that here we have the simplest means of studying the phenomena of electric currents. The vacuum discharge consists in the actual transport of particles of electricity, and the particles involved are all of one size irrespective of the material from which they are torn, and all carry the same electric charge, which is the smallest quantity of electricity known to exist, and is called the "Electron." Further, these particles have a mass of about $1/2000$ part of that of the hydrogen atom. To illustrate the intensity of the electrical forces, it was stated that could two particles of the

size of pin-heads, located a mile apart, carry charges in proportion to that of the electron, they would act upon each other with a force of hundreds of tons.

The electric current in a wire was described as a slow migration of electrons and the contrast of the speed of the electrons to the speed of propagation of electric disturbances was emphasized.

The talk was illustrated by a number of lantern slides and by many apt analogies. The statements relative to the numerical magnitudes of the quantities discussed made the talk most interesting and instructive.

On February 3rd, Major J. A. Shipton will speak before the Lynn Section on a military topic, and on February 17th, Mr. J. L. Woodbridge will speak on *The Characteristics and Uses of Storage Batteries*.

PITTSFIELD SECTION

On the 7th of January Prof. W. S. Franklin, of Lehigh University, read a paper to the Section on the subject of *Electric Waves*. His paper was illustrated with lantern slides and dealt mainly with the derivation of the fundamental equations of wave motion. It is hoped that an abstract of this lecture may be given in a later number of the REVIEW.

On Friday, January 29th, Dr. Irving Langmuir of the Research Laboratory, Schenectady, will lecture to the Section on the subject of *Modern Theories of Electricity*.

SCHENECTADY SECTION

There was a meeting of the Schenectady Section of the A.I.E.E. at Edison Club Hall, on the 5th of January. The general subject for the evening was *Electric Illumination* and after a few introductory remarks by Mr. S. H. Blake, the following papers were presented:

The Arc as a Street Illuminant, by Mr. C. A. B. Halvorson, Designing Engineer of the Arc Lamp Department at the Lynn Works.

Comparison of the Operation of Low-Current and High-Current Gas-Filled Lamps on Series Circuits, by H. D. Brown of the Consulting Engineering Department.

Characteristics of Gas-Filled Mazda Lamps, by Mr. L. A. Hawkins, Research Laboratory.

The papers were illustrated by lantern slides and by means of a large variety of experimental apparatus in operation.

Mr. Halvorson first brought out the point that to render an illuminant suitable for street lighting service even a very simple lighting unit like a high-current mazda lamp must be provided with various attachments such as a weather protective casing, a compensator coil, socket, globe holder, refractor or outer globe, etc., which in the end makes the complete outfit look very much like the familiar street-lighting arc lamp.

He then showed a vertical distribution curve of the light from a clear-glass lamp of the gas-filled mazda type, without reflector, refractor or diffusing globe. This curve indicated that as much light is thrown above the horizontal as below. For street illumination the most useful light is that which is distributed on an average of 10 degrees below the horizontal. In order therefore to utilize as much of the total light flux of the lamp as possible, it is necessary to equip the lamp with a suitable reflector and refractor which redirect the light from the upper hemisphere and from under the lamp. By this means the maximum light is thrown in the desired direction. Similar curves were then shown of the light distribution of the flame lamp, the titanium lamp, and of the magnetite lamp with high-efficiency electrodes, with and without redirecting and diffusing devices. Samples of the various lamps mentioned were shown in operation.

Mr. Halvorson then analyzed and described the evolution of the refractor, the recent introduction of which into practical use in connection with large street lighting units he regarded to be of great importance. He showed that without the refractor a single reflector of suitable shape 16 feet in diameter would be necessary to redirect all the upward light from an arc lamp. By the use of biplane or triplane small-diameter (about 20 inches) reflectors it is possible to obtain the equivalent of the effect of this very large reflector. However, the refractor has the further advantage that it not only redirects the upward light but also the light from under the lamp. The construction of the refractor was shown to consist of two clear-glass cone-shaped globes ground so that one fits perfectly inside of the other. On the outside surface of the inner globe, horizontal prisms are moulded to give the light-redirection desired, while on the inside of the outer globe are moulded vertical prisms designed to diffuse the light. When the globes are fitted together the combined unit presents smooth surfaces inside and out, so that it can readily be kept clean.

Curves were shown of the very remarkable improvements in light efficiency obtained with magnetite lamps by the use of the new "high-efficiency" electrodes. It was further shown that by the use of flattened electrodes, about one-quarter inch wide, in place of round electrodes of the same cross-sectional area, not only is better distribution obtained, but higher efficiency, greater steadiness, cleaner burning, and it is possible to run the arc satisfactorily at lower current and arc voltage. This latter fact means that the lamps can be put out in smaller units, a matter of the greatest importance in arc lighting.

A large ornamental globe and fixture of the type used for street illumination in Washington, D. C., was shown, and in the globe were mounted a magnetite arc lamp and a high-current mazda lamp of equal wattage. The lamps were switched on separately so that the color and intensities of the lights could be compared.

In closing, Mr. Halvorson commented briefly on the subject of maintenance and operating costs.

The paper indicated that arc lamp developments have been keeping step with the remarkable advances that have been made in the incandescent lamp field and show that the arc lamp, for street lighting purposes at least, is a very important factor.

In Mr. Brown's paper the author explained that with the development of gas-filled lamps there appeared two types, designated respectively as "low-current" and "high-current." He compared the use of these two types on similar series circuits. The low-current type may be operated directly on existing series systems, while the high-current type is adapted to standard circuits by means of auto-transformers whose functions are to transform the line current to the proper value for the lamps, and also to

protect the lamps against abnormal conditions. From calculations based on experimental and design data, the following conclusions were drawn:

(1) For abnormal conditions of primary voltage fluctuation or accidental shorts on the secondary, the compensator units are better protected against extreme conditions; and, even for moderate fluctuations, the resulting effect on the lamp is appreciably less and therefore the use of compensators offers a greater reliability.

(2) For normal operation it is shown that the lowering of the primary power-factor, due to the introduction of compensators in the secondary, is not a serious loss, since the use of the more efficient high-current lamps allows the operation of a few more units for full load on the series transformers and consequently more available light of a better quality.

Mr. Hawkins in his paper very clearly explained the principle of operation of gas-filled incandescent lamps, the various stages of their development, and the reason why this construction which now seems so simple, was not obvious before. He carried out two striking experiments, one showing the very remarkable improvement in candle-power and efficiency effected simply by winding the tungsten-wire filament of the gas-filled lamp in the form of a tight spiral instead of looping it on supports as with vacuum lamps, and the other showing the marked advantage to be obtained from the use of high-current (15 to 20 amp.) over low current (6 to 7½ amp.) in securing high-efficiency at equal wattage.

On the 19th of January, Dr. W. D. Coolidge, Assistant Director of the Research Laboratory of the General Electric Company, presented a paper entitled *Recent Developments with X-Rays*. This paper will be abstracted in the March issue of the REVIEW.

FROM THE CONSULTING ENGINEERING DEPARTMENT OF THE
GENERAL ELECTRIC COMPANY

SOME NOTES ON X-RAYS

In view of the remarkable improvements in X-ray generators, recently achieved by Dr. W. D. Coolidge and Dr. I. Langmuir in the General Electric Research Laboratory, and in view also of the wonderful use of these rays lately made by Dr. W. H. Bragg and his son, W. Lawrence Bragg, in the determination of the atomic structure of crystals, etc., it may be timely to present a brief retrospective sketch pertaining to the general subject of X-rays.

From time almost immemorial three states of matter have been recognized: The solid, the liquid, and the gaseous; but in the year 1816, that profound philosopher, Michael Faraday, conceived of its existence in a *fourth state*, to which he gave the peculiar and significant name of "Radiant Matter," and he considered this state of matter to be as distinctly different from the gaseous state as the gaseous is from the liquid, or the liquid from the solid.*

In 1879, 63 years after the date of Faraday's remarkable conception, Sir William Crookes delivered his memorable lecture on "Radiant Matter" before a meeting of the British Association at Sheffield, England. In this lecture he exhibited and described very highly exhausted tubes which were almost identical in outside form and internal construction with some of our present X-ray tubes, being furnished with large concave cathodes, small anodes, and intermediate pieces of iridio-platinum, the latter corresponding to the targets of our X-ray tubes.

Sir William Crookes unquestionably produced X-rays when he made his classical experiments on "Radiant Matter," but he did not chance to bring any substance within range of their influence that would have made them directly or indirectly apparent, so their existence at that time remained undiscovered.

In 1893, fourteen years after the delivery of this lecture, we hear of Dr. Philip Lenard experimenting with Crookes' tubes in Heidelberg, Germany. Lenard made a tube with a little aluminum window through which the cathode rays could shine out into the open air, whereas they had previously been confined to the inside of the tube by the glass wall which they could not penetrate. Lenard then discovered that these rays, which have been called "Lenard Rays," could be deflected by magnetism, could produce photographic action and cause fluorescence in certain substances, barium-platino-cyanide being affected in the highest degree.

Two years later we find Prof. Wilhelm Konrad Röntgen also experimenting with Crookes' tubes in the Institute of Physics in Wurzburg, Bavaria. He covered one of these tubes with black paper, and when it was excited by the current from an induction coil, noticed that a piece of cardboard which had been coated with barium-platino-cyanide, and was lying on the table near by, glowed with a bright green fluorescence, although the black paper completely shielded every ray of visible light that was produced inside the tube by the electrical discharge.

Röntgen's trained intellect led him at once to connect this remarkable phenomenon with the existence of the hitherto unknown radiation, to which both the glass of the tube and its covering of black

paper were transparent, and which caused the fluorescence of the barium-platino salt. Placing his hand between the glowing screen and the darkened tube he saw not only the dim shadow of his hand on the shining surface, but also the darker outlines of the bones within.

Thus were the X-rays at last brought to light: foreshadowed in Faraday's conception of "Radiant Matter" in 1816; actually produced, but unrecognized, by Crookes in 1879; carried to the very verge of revelation by Lenard in 1893; and discovered by Röntgen on November 8, 1895.

The announcement of his discovery was made by Dr. Röntgen in a paper read at the Institute of Physics of the University of Wurzburg in Bavaria, in December, 1895.

In this paper the method of generating X-rays was explained, their fluorescent effect on a cardboard screen coated with barium-platino-cyanide was described, and their action on the photographic plate recorded as a fact of special significance. The relative transparency of various bodies to the newly discovered rays was also noted, and some negative results were mentioned regarding attempts to reflect and refract them. He also stated in this paper that the term "rays" was used for the sake of brevity, the prefix "X" being given to distinguish them from other rays, such as Lenard's for example.

On January 7, 1896, the news of Prof. Röntgen's marvelous discovery was cabled to this country and its extraordinary character and value were immediately recognized, while its novel and almost magical possibilities appealed so strongly to the public at large that the announcement spread in an incredibly short period.

Some time naturally elapsed after the discovery of X-rays by Dr. Röntgen before their curative as well as their destructive qualities were fully recognized. During this period many ardent and enthusiastic experimenters received serious injuries as a result of their inexperience, and in a few lamentable cases X-ray burns produced even fatal results.

This stage of unfortunate ignorance, however, soon passed, and improvements in X-ray apparatus generally were rapidly developed, so that the rays could be properly administered without danger to either the patient or the operator, and at the present time every well equipped hospital in the country has an efficient X-ray generating apparatus. Thus in the course of less than twenty years Dr. Röntgen's great discovery has developed into one of the most beneficent agents for the alleviation of many bodily ailments, and by reason of the later improvements, referred to in the beginning of this article, their further scope, not only in medical treatment, but also in many branches of scientific research, will be greatly enlarged.

W. S. ANDREWS.

ERRATA: Attention is called to two corrections to apply to the article "From the Consulting Engineering Department of the General Electric Company" in the January number of the GENERAL ELECTRIC REVIEW.

Twenty-one lines from the bottom of the right-hand column, p. 73, the equation as printed

$$\int_p^{\infty} \frac{Edi}{(a+bi+ci^2)^2} = \int_p^{\infty} dt \text{ should be } \int_p^{\infty} \frac{Edi}{(a+bi+ci^2)^2} \int_0^{\infty} dt$$

Eight lines from the bottom of the same column the word "infinite" should be "in finite".

*See Dr. Benoit Paul "Life and Letters of Faraday," Vol. I, 118.

GENERAL ELECTRIC REVIEW

A MONTHLY MAGAZINE FOR ENGINEERS

Manager, M. P. RICE

Editor, JOHN R. HEWETT

Associate Editor, B. M. EOFF
Assistant Editor, E. C. SANDERS

Subscription Rates: United States and Mexico, \$2.00 per year; Canada, \$2.25 per year; Foreign, \$2.50 per year; payable in advance. Remit by post-office or express money orders, bank checks or drafts, made payable to the *General Electric Review* Schenectady, N. Y.

Entered as second-class matter, March 26, 1912, at the post-office at Schenectady, N. Y., under the Act of March, 1879.

VOL. XVIII., No. 3

Copyright, 1915
by General Electric Company

MARCH, 1915

CONTENTS

PAGE

Supplement: Reproduction in Colors of Resolutions Presented to C. A. Coffin and E. W. Rice, Jr., by the Association of Edison Illuminating Companies	
Frontispiece	154
Editorial: The Paths of Progress	155
A New Device for Rectifying High Tension Alternating Currents. BY DR. SAUL DUSHMAN	156
Parallel Operation of Alternating Current Generators Driven by Internal Combustion Engines PART I: Factors Affecting Generator Design. BY R. E. DOHERTY	167
PART II: Factors Affecting Engine Design. BY H. C. LEHN	
Tests of Large Steam Hoists BY H. E. SPRING	179
High Voltage Arrester for Telephone Lines BY E. P. PECK	189
X-Ray Examination of Built-Up Mica BY C. N. MOORE	195
The Effect of Chemical Composition upon the Magnetic Properties of Steels BY W. E. RUDER	197
Electrophysics: Electron Theory of Electric Conduction in Metals BY J. P. MINTON	204
Lock Entrance Caisson for the Panama Canal BY L. A. MASON	210
Practical Experience in the Operation of Electrical Machinery, PART VI Excessive Contact-Shoe Pressure; Electric Brake Adjustments; Rotor Rubbed Stator; Jerky Motor Acceleration. BY E. C. PARIHAM	217
A Hydro-electric Installation on a Coffee Plantation BY J. H. TORRENS	219
Notes on the Activities of the A. I. E. E.	222
From the Consulting Engineering Department of the General Electric Company	226
Question and Answer Section	227



A Picturesque View of Indians' Huts at Puerto Barrios, which is the Atlantic Terminus of the Railroad Through Guatemala City to San Jose on the Pacific Coast of Guatemala. A description of a small hydro-electric development in this interesting country will be found in this issue

GENERAL ELECTRIC

REVIEW

THE PATHS OF PROGRESS

With this issue we publish a unique supplement. It gives us special pleasure to meet the request to give greater publicity to the resolutions which we reproduce, as we feel that from the very nature of things few are in a position to recognize the great service done the electrical industry by some of those who were so active in its infancy.

Twenty-five years ago there were some few active workers who by their energy, faith and forethought were laying the foundation stones on which the electrical industry of today stands. The number of workers soon greatly increased and some, that undoubtedly did much to further the great enterprise, have been lost sight of, but it is inevitable in all human affairs that many workers never get their due reward.

The electrical industry of today when viewed from its broadest aspect is the greatest of all industries and has, so far as the human mind can judge, the greatest future before it. No one factor with the single exception of the invention of the steam engine, with which it is so inseparably connected, has done more to bring about the changes in our economic and social mode of living which we have witnessed during the last quarter of a century. When we add to the electrical industry proper the activities it has stimulated in a host of others such as the iron, copper, power, lighting and railway industries, etc., we are forced to a recognition of the growth of the electrical industry as the most potent factor in modern industrial life; and when we add to these the scientific accomplishments which would have been non-existent but for the advent of an electrical age we have to acknowledge that the electrical industry has been a most mighty factor in our modern intensive scheme of civilization.

In some future issue we shall attempt to review the electrical industries and show their scope, but what we are particularly interested in at this present writing is the thought—whence all these wonderful developments have sprung.

A final analysis could only lead to the conclusion that it is a tremendous triumph of mind over matter—the useful forces of nature converted to the service of man. It is of special importance to note that these great things have been accomplished by the mind of man firstly, by the hand of man secondly; the thought came before the work and accomplishment, and that during the last quarter of a century we have been witnessing to a greater extent than ever before the development of the experiments of yesterday, which are the first fruits of productive thought, into the industries of today.

The men to whom the electrical industry owes most today are those who thought of its possibilities and the part it could play in our future development. Without their activities and forethought, without their resourcefulness and faith, the work of a great industrial army would never have been brought into being. The type of mind that has the power to originate and the type of mind that has the power to organize are the greatest capital assets that the industrial world possesses. These are the foundation stones on which the whole fabric of our modern structure rests. In spite of anarchy, in spite of socialism, in spite of government and mis-government, in spite of the ever continuing war of the many against the few, of those that have against those that have not, the work of the brain must always take a higher stand, whether the thinkers get their reward or not, than the work of the hand. Both types of the work are absolutely essential to our modern scheme of life, but it is inevitable that the creative genius must always be greater than the hand which fashions the material thing created by the mind.

The foundations of the great operating companies were being laid at the same time as those of the great manufacturing companies, and so it gives us special pleasure to record a tribute from the representatives of the great Edison Illuminating Companies to two of those who have not only been pioneers of the industry, but who have been active workers from its inception up to the present time.

A NEW DEVICE FOR RECTIFYING HIGH TENSION ALTERNATING CURRENTS

THE KENOTRON

BY DR. SAUL DUSHMAN

RESEARCH LABORATORY, GENERAL ELECTRIC COMPANY

In the following paper the writer discusses an interesting application of the theoretical investigations on electron emission from incandescent metals. The construction of a high voltage rectifier illustrates the old expression that the theory of the present may become engineering practice of the future.—EDITOR.

Introduction

The emission of negatively charged corpuscles or electrons from heated metals may be illustrated by the following arrangement. In an ordinary lamp bulb containing a tungsten or carbon filament there is also sealed in a metal plate. After the lamp is well exhausted it is observed, on charging the filament negatively (making it cathode) with respect to the plate, that a current passes across the vacuous space. If the filament is charged positively this current disappears. Furthermore, the magnitude of this electron emission (thermionic current) from the heated cathode increases with increase in the temperature of the filament.

This effect had been observed by Edison and was more fully investigated in the case of carbon lamps by Fleming.* In view of the unilateral conductivity possessed by such an arrangement as that described above, Fleming applied it as an "electric valve" to rectify electric oscillations such as are obtained from a "wireless" antenna, and therefore render it possible for these oscillations to affect a galvanometer or telephone.†

That the current from a hot cathode in an exhausted bulb is due to a convection of electrons, that is of negatively charged corpuscles having a mass which is about 1/1800th of that of a hydrogen atom, may be shown by deflecting the current in magnetic and electrostatic fields and determining the ratio e/m . Another method is that described below and which depends upon the space charge produced by the electrons under certain conditions.

The relation between thermionic current and temperature of cathode was further investigated by Richardson and he found that in all cases the relation could be accu-

rately represented by an equation of the form,

$$i = a\sqrt{T} \epsilon^{-\frac{b}{T}} \quad (1)$$

where a and b are constants for the particular metal and i is the saturation thermionic current per unit area at the absolute temperature T .

Subsequent experiments, however, by other investigators tended to throw much doubt upon the actual existence of a pure electron emission from a heated metal in a good vacuum. It was found that different gases affected the values of the constants a and b to an immense extent, so that at the same temperature the thermionic currents obtained varied over a very wide range. Furthermore, it seemed that the greater the precaution taken to attain high vacuum, the smaller the thermionic currents obtained, and the conclusion was drawn that in a "perfect" vacuum the thermionic currents would disappear altogether. In fact, the view generally held until the past year by the German physicists and by quite a few English physicists was that the thermionic currents were due to chemical reactions in a gas layer at the surface of the heated metal, and that therefore there was no justification for believing in the existence of a pure electron emission *per ipse* from a heated metal.

This subject was taken up in the Research Laboratory of the General Electric Company, by Dr. Irving Langmuir, and he found that in the case of heated tungsten filaments the electron emission at constant temperature *increased* as the vacuum improved until a constant value was attained which varied with the temperature in accordance with Richardson's equation. Dr. W. D. Coolidge applied this fact to the construction of a hot cathode Röntgen ray tube‡ in which electrons are produced from a heated filament in a highly exhausted bulb. A tungsten

**Phil. Mag.*, 37, 122, 1896.

†*Phil. Mag.*, 37, 476, 1905. See also J. A. Fleming, *Wireless Telegraphy and Telephony*, p. 107.

‡W. D. Coolidge, *Phys. Rev.*, Dec., 1913.

target is used as anode and by applying very high voltages (50,000 to 100,000) the electrons are given velocities great enough to produce very penetrating X-rays when they strike the target.

During the last few years Dr. Langmuir has carried out a detailed investigation of the whole subject of electron emission from heated metals and the results obtained have led to a large number of interesting and highly important applications.

While a complete summary of these applications will be presented by Dr. Langmuir at a future meeting of the Institute of Radio Engineers, it has been considered advisable to publish a preliminary account of one important application of hot cathode tubes in the development of which the writer has been interested. This concerns the application to the rectification of high tension alternating currents.

The Hot Cathode Rectifier

As mentioned above, the fact that an exhausted tube, containing two electrodes, one of which is heated by some external source, acts as a rectifier, has been known for a number of years. But difficulties were met with in the way of applying this practically. The magnitude of the current obtained was apt to vary quite erratically, especially with slight variations in degree of vacuum. Furthermore, in the types of hot cathode rectifiers exhausted by ordinary methods, the electron emission is accompanied by a blue glow. This glow becomes more and more pronounced the higher the voltage at which the rectifier is operated, and it is found that under these conditions the cathode gradually disintegrates so that the rectifier becomes inoperative.

An explanation of these phenomena gradually developed as a result of the above mentioned investigations on thermionic currents in high vacua. It was perceived that the blue glow is due to the presence of positively charged gas molecules (ions), and that the disintegration of the cathode is due to bombardment by these positive ions moving with high velocity. But when the vacuum is made as perfect as possible, the conduction occurs only by means of electrons emitted from the hot cathode, and there is no evidence whatever of any blue glow or other forms of gaseous discharge. Thus, while it had previously been considered that a certain amount of gas is absolutely essential to obtain conduction from a hot cathode, and the presence of blue glow was taken to be a

necessary accompaniment of conduction in such cases, it was found that by adopting certain methods of treatment and the use of high vacua, a hot cathode rectifier could be constructed in which all of the difficulties discussed above are avoided.

Special methods have been developed for treating all metal parts and glass walls so that they are made as free of gas as possible. A Gaede molecular pump in series with two other pumps is used to evacuate the tubes. It has been shown by the writer* that by using this arrangement together with a liquid air trap inserted between rectifier and molecular pump, it is possible to attain a vacuum as high as 5×10^{-7} mm. of mercury. At this pressure the mean free path of an electron is so great that the chance of its colliding with any gas molecules and thus forming ions by collision is reduced to a minimum.

In the Coolidge X-ray tube there is no difficulty in obtaining such a good vacuum that no gaseous discharge occurs even when 150,000 volts is applied across the electrodes. There appears to be no limit to the voltage for which the tube may be constructed except that due to electrostatic strains. A further discussion of this point is, however, reserved for a subsequent section.

Electron Emission in High Vacuum

Regarding the difficulty of obtaining constant values for the thermionic currents at given temperatures, it has already been mentioned that in a sufficiently good vacuum the results obtained are perfectly definite and reproducible. In the case of tungsten in a "perfect" vacuum the value of the constants *a* and *b* in the Richardson equation are 23.6×10^9 and 52500 respectively, where *i* is measured in milli-amperes per square centimeter.†

Using these constants, the values of *i* calculated for different values of *T* are as given in the following table:

TABLE I

<i>T</i>	<i>i</i> /cm ²
2000	4.2 milli-amps.
2100	15.1
2200	48.3
2300	137.7
2400	364.8
2500	891.0
2600	2044.0

*S. Dushman, Phys. Rev., April, 1914. The complete paper will appear very shortly in the same journal.

†I. Langmuir, Physikal. Zeit., 15, 516 (1914).

In Fig. 1 these results have been plotted on semi-logarithmic paper. Plotting directly values of i against those of T one obtains a curve of the form shown in Fig. 2.*

Space Charge Effect

It was observed by Langmuir that in addition to this temperature limitation the electron current may be also limited by *space charge*. With a low potential difference between the electrodes the phenomena observed are as follows:

As the temperature of the cathode increases, the electron emission increases at first in accordance with the equation of Richardson. However, above a certain temperature this current becomes constant; further increase in temperature does not cause any corresponding increase in thermionic current. The temperature at which this limitation occurs increases with increase in anode potential. The curves shown in Fig. 2 illustrate this very well. They represent the results observed when the thermionic current was measured from a 10-mil tungsten filament situated along the axis of a cylindrical anode 7.62 cm. long and 1.27 cm. in radius. Thus, with a potential difference of 55.5 volts, the electron emission increased according to the equation of Richardson until a temperature of about 2300 deg. K was attained. With further increase in temperature, the thermionic current remained absolutely constant. But when the voltage was increased to 87.5, the thermionic current continued to increase up to 2350 deg. K. With a voltage of 129, the increase in thermionic current was observed up to 2400 deg. K.

This effect (which is observed *only in extremely good vacua*) is due to the existence of a space charge produced by the emitted electrons. In other words, the electrons emitted from the hot cathode produce an electrostatic field which tends to prevent the motion of any more electrons toward the anode. As the positive potential on the latter increases, more and more electrons are permitted to reach the anode.

From theoretical considerations it was deduced by Langmuir that the thermionic current ought to increase with the three-halves power of the voltage (until the saturation

current as defined by the Richardson equation is attained), that is, for electrodes of *any shape*, the space charge current

$$i_s = k \cdot V^{3/2} \tag{2}$$

where V denotes the potential difference and k is a constant depending on the shape of the electrodes, their area and the distance apart.

For the case of a heated filament in a concentric cylindrical anode (infinite length)

$$i_s = \frac{2\sqrt{2}}{9} \sqrt{\frac{\epsilon}{m}} \frac{V^{3/2}}{r} \tag{3}$$

where i_s is the thermionic current per unit length and r is the radius of the anode.

Converting into ordinary units (milliamperes and volts) this equation becomes

$$i_s = \frac{14.6}{r} \times V^{3/2} \times 10^{-3} \tag{4}$$

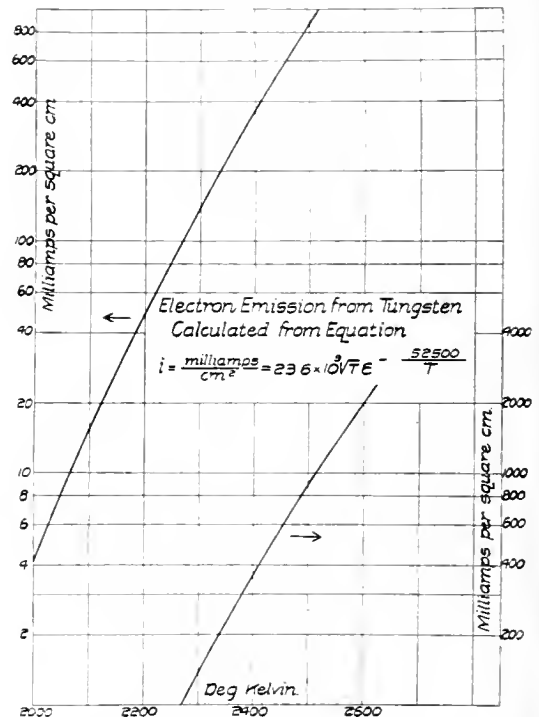


Fig. 1. Electron Emission from Tungsten in a "Perfect" Vacuum

The data shown in Fig. 2, which were obtained in the course of an investigation carried out by the writer, are in full accord with the results calculated from this equation. Substituting for r the value 1.27 cm., and noting that the actual length of cylinder used was 7.62 cm., the values of the constant factor as obtained from the observed space

* S. Dashman, Phys. Rev., 4, 121 (1914). The area of the hot filament used was 0.61 cm². The experiments from which this curve was plotted were performed some time ago. Both the degree of vacuum attained and the accuracy of temperature determination were not as good as that obtained in measuring the values of a and b given above. When it is considered that an error of 25 degrees in the determination of the temperature at 2400 deg. K. is sufficient to account for the difference between the values of the constants and those given in the curve, the discrepancy does not appear so great.

charge currents for different voltages do not differ by more than 2 per cent from 14.6.*

In the case of a heated tungsten plate parallel to another plate, the space charge current per sq. cm.

$$i_s = 2.32 \times 10^{-3} \times \frac{V^2}{x^2} \quad (5)$$

where x is the distance between the plates in centimeters.

It ought to be observed that up to a point at which the diameter of the filament amounts to about five per cent of the diameter of the anode cylinder, or of the distance between the plates, the space charge voltage is independent of the actual diameter of the filament.

The thermionic current from a hot cathode may therefore be limited either by tem-

perature or by space charge. When i_s has attained the value i which corresponds to saturation thermionic current from the filament at the given temperature, further increase in voltage has no effect.

On the other hand, with a given voltage drop, the current increases with the temperature until i is equal to i_s , and further increase in temperature leads to no corresponding increase in thermionic current. This is the case illustrated in Fig. 2.

The existence of this space charge effect is evidence of the absence of any positive ionization, and serves, therefore, as additional confirmation of the conclusion that the currents obtained from a hot cathode in a very high vacuum are due to a pure electron emission, and are not dependent upon the presence of any small amounts of gas.

In this respect the behavior of a hot filament in a good vacuum differs radically from that exhibited by a Wehnelt cathode. In the case of the latter the currents obtained are due largely to the presence of positive ions, as is shown by the absence of space charge effects. The result is that the cathode disintegrates under the action of positive ion bombardment, and a rectifier containing such a cathode therefore cannot be used with potentials higher than a few hundred volts at most. On the other hand, in the case of a rectifier containing a hot filament as cathode and exhausted to as high a degree of vacuum as possible, there is no conduction except by electrons. In order to distinguish the latter type of hot cathode rectifier from other forms in which positive ions play an essential role, the designation, *kenotron*, has been specially coined. This word is derived from the Greek adjective *kenos*, meaning "empty" and the suffix *tron* signifying an instrument or appliance. The applicability of the name is self-evident.

Having indicated the possibility of the construction of a high voltage hot cathode rectifier, we shall now proceed to discuss the principles underlying the designing of such rectifiers.

Principles of Design of Kenotrons

The question as to the proper design of a kenotron may be treated under three headings:

1. The amount of current to be rectified.
2. The maximum permissible voltage loss in the rectifier.
3. The proper form of electrodes to prevent electrostatic strains on the filament.

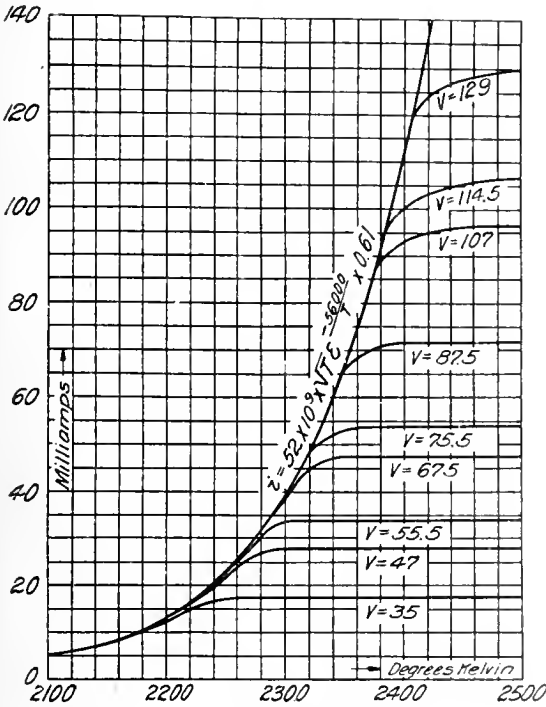


Fig. 2. The Effect of Space Charge on the Thermionic Currents

perature or by space charge. With a given temperature of the cathode, the thermionic current will increase at first as the positive potential on the anode is increased, and for each voltage V , there will be a corre-

*It is evident that equation (3) may be used as a method for the determination of e/m . The results obtained therefore serve to confirm once more the conclusion that the negative current from the hot cathode is due to electrons

(1) Current Carrying Capacity of the Kenotron

The current carrying capacity of a kenotron when given sufficiently high voltage between the electrodes, is limited only by the area of the surface emitting electrons (that is, length and diameter of filament) and its temperature. The data given in Table I and the curve shown in Fig. 1 are therefore of fundamental importance in this connection. The next consideration is, of course, the "life"* of the filament at any temperature, and normally the maximum temperature at which the filament is maintained should be such that the "life" of the filament is over 1000 hours at least.

Thus, a 5-mil filament at 2400 deg. K. (corresponding to 1 watt per candle) has a life of about 4000 hours. The electron emission per 1 cm. length of 5-mil filament at this temperature, as calculated from Table I is 15 milli-amperes. The energy required to maintain the filament at this temperature is about 4.5 watts per cm. length.

Where the kenotron is required for currents of 100 milli-amperes or more, it is better to use a 7 or 10-mil filament. This is of advantage in two respects. Not only is there an increase in area per unit length, but also the life is much longer at the same temperature. On the other hand, the temperature can be increased and the life of the filament still be maintained at over 1000 hours. Thus, in the case of a 10-mil filament at 2500 deg. K., the life is pretty nearly 3000 hours, while the electron emission is 70 milli-amperes per cm. length.

The data shown in Table II are of great interest in this connection. As "safe" temperature we consider that at which the life of the filament is over 2000 hours. The last column also gives the watts per cm. length of filament, a figure which is of importance in calculating the losses in the rectifier itself. ‡

TABLE II

Diam. of Filament in Mils	"Safe" Temperature	Electron Emission per Cm. Length	Watts per Cm. Length
5	2475	30	3.1
7	2500	50	4.6
10	255	100	7.2
15	2575	200	11.3

*The "life" of a filament is usually taken in this laboratory as the time required to evaporate 10 per cent of the diameter. For data on the rate of evaporation of tungsten filaments the reader is referred to the paper by Langmuir, Phys. Rev., 2, 329 (1913).

†These figures are based upon data published by Langmuir, Phys. Rev., 34, 401 (1913).

‡The current necessary to heat the filament varies from 2 to 10 amperes, according to the diameter of the filament and the temperature, and may be obtained either from a storage battery or small transformer.

(2) Voltage Drop in Kenotron

Owing to the existence of the space charge effect it is evident that for any given current carrying capacity i of a kenotron there will exist a voltage drop V in the rectifier itself and the relation between these will be of the form indicated in equation (2).

We can now consider the manner in which the kenotron operates when placed in series with a resistance across a source of high voltage.

Let E denote the value of this voltage at any instant, and i_s the current rectified. If V denote the voltage drop through the kenotron, and R , the resistance of the load, it follows from equation (2) that

$$i_s = kV^{\frac{3}{2}} = k(E - i_s R)^{\frac{3}{2}} \quad (2a)$$

With constant value of E , the current rectified increases as R is decreased until i_s has attained the value i corresponding to saturation thermionic current at the temperature at which the cathode is maintained. If now R is decreased still further, i remains constant, and consequently the *voltage over the kenotron increases beyond that given by equation (2)*. That is, this equation gives the *minimum voltage drop through the kenotron when rectifying a given current i_s* ; but when operating in series with a resistance, the *voltage drop in the kenotron is that available above the $i_s R$ drop in load*. In case of a short-circuit on the latter, where R decreases indefinitely, the total voltage of the source is taken up by the kenotron, thus liberating the whole of the energy, Ei , as heat at the anode, and the latter may be raised to a temperature at which it will melt or volatilize and ruin the tube.

It is necessary to emphasize this characteristic behavior of the kenotron, and in practice care should be taken to provide against short-circuiting of the load, or some form of protective device should be used.

The watts lost in the kenotron owing to the space charge effect is

$$W_R = Vi = kV^{\frac{5}{2}} \quad (6)$$

Because of the high degree of vacuum, none of the electrons lose energy by collision with gas molecules. The whole of their kinetic energy is therefore liberated as heat at the anode, just as the energy of rifle bullets travelling through a comparatively frictionless medium is converted into heat at the target. Denoting the number of electrons emitted per unit area and per unit time by n , and their velocity by v , it

follows that the energy converted into heat at the anode is

$$n \left(\frac{1}{2} m v^2\right) = n e V = i V \quad (6a)$$

If to this be added the watts w_H used in heating the filament, then the total loss in energy becomes

$$w_L = w_H + w_R \quad (7)$$

Of this energy loss, the whole of w_R and a large fraction of w_H are used up in heating the anode.

It is evident that if the anode becomes too hot the rectification will tend to become imperfect. The rectifier must, therefore, be so designed that the space charge voltage is not great enough to cause heating of the anode when the requisite current is being carried by the tube. The amount of energy (in watts per square centimeter) required to maintain tungsten at a temperature T is given by the equation,*

$$W_S = 12.54 \left(\frac{T}{1703}\right)^{4.74} \quad (8)$$

Table III gives the values of W_S for different temperatures. The last column gives the corresponding values of the electron emission per unit area in milli-amperes.

TABLE III

T	W_S	i
1000	0.96	1.2×10^{-11}
1500	6.9	6×10^{-4}
1800	16.4	0.3
2000	26.9	4.2
2500	77.5	890

From these data it may be concluded that about 10 watts per sq. cm. of anode area is quite permissible. This would correspond to a temperature of about 1600 deg. K., that is a very bright red heat. At this temperature the electron emission is still less than 0.02 milli-ampere per sq. cm.

(3) Electrode Design

There remains only one other point to consider in the design of kenotrons and that is the prevention of electrostatic strains on the filament. As is well known, the electrostatic force between two charged surfaces increases as the square of the voltage difference. At voltages of 25,000 and over, this force becomes quite appreciable and unless special precautions are taken in the design of electrodes, it is possible at such

voltages to actually pull the heated filament over towards the anode. When the kenotron is used in series with a load on a high tension alternating current circuit, there is a very low potential difference between the electrode during the half cycle that rectification occurs, while during the other half cycle the whole of the voltage drop generated by the transformer or other source of alternating current occurs in the rectifier itself. It is therefore necessary to design the kenotron so that the electrostatic forces acting on the filament are reduced to a minimum.

Various types of construction have been adopted to take care of this difficulty. A straight filament in the axis of a cylindrical anode; a V- or W-shaped filament placed symmetrically between two parallel plates; or a headlight filament inside a molybdenum cap, each of these types of construction has been found practicable up to certain voltages.

Of course, electrostatic forces can be overcome by placing the filament at quite a distance from the anode and shielding the former in the same manner as is done by Coolidge in his Röntgen ray tube. But under these conditions the "space charge" voltage (which increases with the first or second power of the distance, see equations 4 and 5) becomes excessively high and the energy loss in such a rectifier would be altogether too large.

Different Types of Kenotrons

The different types of kenotrons mentioned in the previous section are illustrated in Figs. 3, 4 and 5. In the following section it is intended to discuss briefly the characteristics of rectifiers that have been constructed along these lines and to point out the relative advantages and disadvantages of each type.

Fig. 3 shows a molybdenum cylinder A with a coaxial filament F . For direct current voltages up to 15,000 the diameter of the cylinder need not exceed one-half inch (1.27 cm.), while the length may be made as much as four inches (10 cm.) A 10-mil filament is used as cathode.

At a temperature of 2550 deg. K. (see Table II) the maximum current obtainable from such a kenotron is about 400 milli-amperes, and the voltage drop necessary to produce this current as calculated from equation (4), and actually observed, is

$$V = \left(\frac{400 \times 1.27 \times 10^3}{14.6 \times 2 \times 10} \right)^{\frac{2}{3}} = 145.$$

*I. Langmuir, Phys. Rev., 34, 401 (1912). The same equation is also approximately true for molybdenum.

The space charge equation for this kenotron is

$$i_s = 230 \times 10^{-3} \times V^{\frac{3}{2}} \text{ milli-amperes.}$$

At 145 volts, $W_R = 145 \times 0.400 = 58$ watts. Also $\omega_H = 72$ (Table II). The total energy used up in the rectifier is therefore 130 watts.

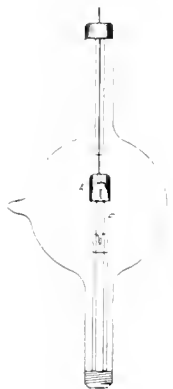


Fig. 3 Molybdenum Cap Type of Kenotron

As the radiating area of anode surface is about 80 sq. cm., this energy loss corresponds to slightly over 1.5 watts per sq. cm., which is just sufficient to maintain the anode at a dull red heat (1100 deg. K.). Since the kenotron is capable of rectifying $0.400 \times 15,000 = 6$ kw., the energy loss in the tube corresponds to about 2 per cent of the total amount of energy rectified.

For direct current voltages up to 75,000 or 100,000, the diameter of the cylinder is increased to about 5 cm. For mechanical reasons it has been found necessary, in this case, to attach the filament to a molybdenum rod framework, which serves to increase the space charge voltage above that calculated from equation (4). In a tube intended to rectify 10 kw. at 100,000 volts the current carrying capacity required is 100 milli-amperes. This electron emission is easily obtained from about 4 cm. of 7-mil filament at a temperature around 2400 deg. K.

The space charge data of Table IV were obtained with one kenotron (No. 72) of this type:

These observations are in accord with the equation

$$i_s = 6 \times 10^{-3} \times V^{\frac{3}{2}}$$

The energy loss in the tube owing to this space charge voltage amounts to 65 watts for 100 milli-amperes. Adding to this about 50 watts consumed by the filament, the total

energy lost in the kenotron is about 125 watts which represents only 1.25 per cent of the total energy which the tube is capable of rectifying.

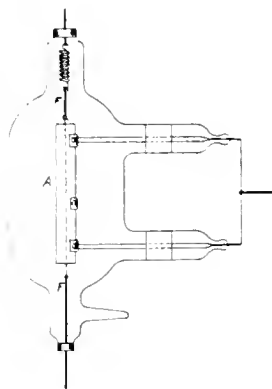


Fig. 4. Kenotron Containing Cylindrical Anode

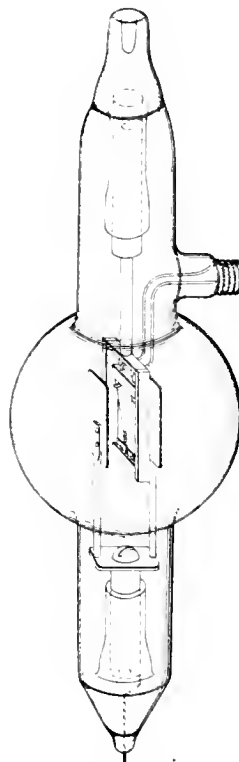


Fig. 5. Kenotron with Filament Between Two Parallel Plates

A form of kenotron which is suitable for voltages not over 10,000 and currents ranging up to 100 milli-amperes is that shown in

TABLE IV

V	i
310	33 milli-amperes
260	25
130	9

Fig. 4. It consists of a small filament such as is used in automobile headlights inserted in a molybdenum cap about 1.6 cm. ($\frac{5}{8}$ inch) in diameter.

The following table gives the currents actually obtained with different voltages in the case of kenotrons containing a 7-mil headlight filament (No. 50), and 5-mil headlight respectively (No. 51).

TABLE V

KENOTRON NO. 50		KENOTRON NO. 51	
V	i_s	V	i
20	2.7	100	19
40	7.6	150	36
80	25.0	200	55
120	46.0		
160	70.0		
200	96.0		
240	115.0		

In the case of No. 50, the observations are very accurately represented by the equation

$$i_s = 34 \times 10^{-3} \times V^{\frac{2}{3}}$$

While in that of No. 51, the corresponding equation is

$$i_s = 19.5 \times 10^{-3} \times V^{\frac{2}{3}}$$

In neither case is it necessary to heat the filament to a temperature above 2400 deg. K. The radiating surface of the anode is about 4 sq. cm. and the total energy loss for 100 milli-amperes is about 50 watts.

The case of a V-shaped filament between two tungsten plates is illustrated in Fig. 5.

In one case (kenotron No. 66) the plates were about 2 cm. apart, while in another kenotron No. 70) the plates were twice as far apart. Table VI gives the characteristics for each kenotron.

The filament in kenotron No. 70 was about 7, while that in No. 66 was about 6 cm. long.* Each tungsten plate was about 2.5

*Owing to lead losses only the central portion of the filament was at the temperature indicated.

TABLE VI

KENOTRON NO. 66			KENOTRON NO. 70		
Fil. Temp.	V	i	Fil. Temp.	V	i
2340	260	25	2320	340	28
2370	260	35	2370	340	50
2410	260	90	2400	340	54
2450	260	100	2500	340	60
2500	260	100	2500	260	42
2500	130	35	2500	130	14

$$i_s = 24 \times 10^{-3} \times V^{\frac{2}{3}}$$

$$i_s = 9.9 \times 10^{-3} \times V^{\frac{2}{3}}$$

$\times 5$ cm.; so that the total radiating surface was about 25 sq. cm. Kenotron No. 66 could be used up to about 40,000 volts, while No. 70 showed no sparking or straining of filament up to 60,000 volts.

By using a W-shaped 7-mil filament (total length about 20 cm.) between two tungsten plates 5 cm. square and situated 1.25 cm. apart (kenotron No. 54), the space charge voltage for given current carrying capacity was considerably reduced. The space charge equation for this kenotron was found to be

$$i_s = 103 \times 10^{-3} \times V^{\frac{2}{3}}$$

Owing to the small distance between the plates, the filament was not situated exactly symmetrically with respect to them, and it was therefore not thought advisable to use the kenotron with direct current voltages higher than 25,000.

Here again, the energy loss in the kenotron for a 10-kw. unit (current carrying capacity of 400 milli-amperes) is well below 2 per cent.

A comparison of the different types of kenotrons illustrated above leads to the following conclusions:

(1) For current carrying capacities up to 500 milli-amperes, either a cylindrical anode with a filament down the axis, or a W-shaped filament placed between two parallel plates may be used. The first named type can apparently be made much more efficient as regards losses due to space charge effect.

(2) Where currents of the order of 100 milli-amperes or less have to be rectified, and the maximum direct current voltage is not over 15,000, the molybdenum cap type is one that is simpler mechanically and also quite efficient.

(3) For voltages up to 100,000, the cylindrical anode type has proven itself to be very practicable and efficient.

Oscillograms of Performance of Kenotrons with Alternating Current Voltages

In order to illustrate the characteristics of a kenotron when used with a-c. sources, a number of oscillograms were taken. Film

maximum voltage 180. The lower graph shows that the rectification obtained was absolutely perfect; also the peaked nature of the current wave shows that it was limited by space charge throughout the whole cycle.

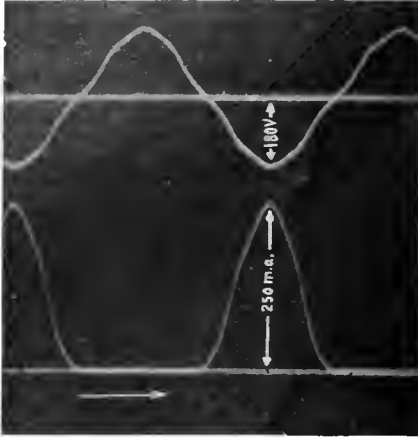


Fig. 6. Half-wave Rectification, Upper Curve Gives Voltage Over Kenotron; Lower Curve Gives Current Rectified. Note the Effect of Voltage Limitation

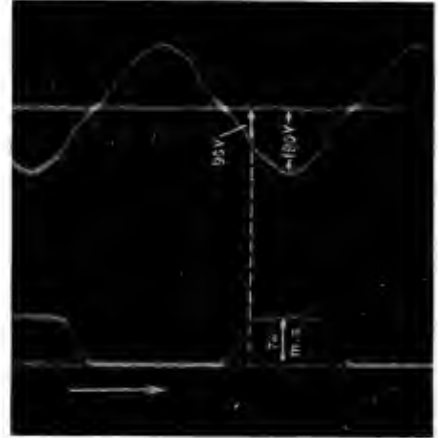


Fig. 7. Same as Fig. 6. Note the Effect of Temperature Limitation

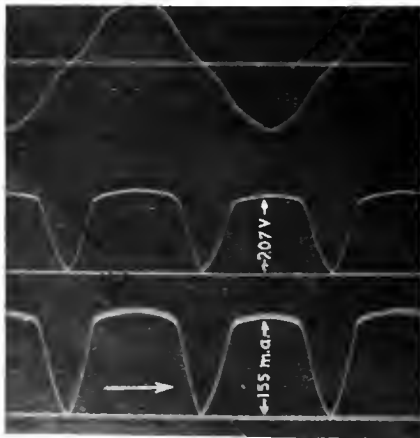


Fig. 8. Full Rectification, Using Arrangement Shown in Fig. 10. Upper Curve—Voltage Over Primary of Transformer, Middle Curve—Voltage Over Load; Lower Curve—Current Rectified. The Latter was Limited by Temperature of Cathode in Each Case

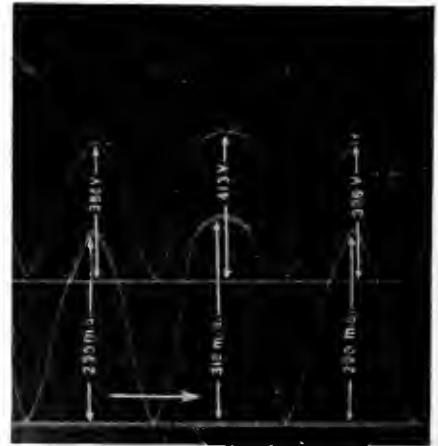


Fig. 9. Same as Fig. 8. The Current Rectified was Limited on One Half Cycle by Temperature and on the Other Half by Voltage

Fig. 6 was obtained with kenotron No. 54 placed directly across the 60-cycle, 122-volt terminals. The upper curve represents the voltage of the generator, while the lower curve gives the current through the kenotron. The effective a-c. voltage was 122 and the

It will be remembered that for this kenotron the space charge equation as obtained from direct current measurements, was

$$i_s = 103 \times 10^{-3} \times V^{\frac{3}{2}}$$

It was therefore expected that this relation ought to hold quantitatively for simultaneous values of voltage and current as measured on the oscillogram. The results obtained confirmed this expectation splendidly.

The following table gives the values of i_s as observed and calculated for values of V corresponding to different intervals of a second t after the beginning of the cycle:

TABLE VII

t	V (upper curve)	i_s (lower curve)	i_s (calculated)
0.0015	64	55	53
0.0022	130	150	153
0.0031	165	207	212
0.0042	180	250	251

A direct current milli-ammeter in series with the oscillograph read 68 m.a.

Film Fig. 7 was obtained with the same arrangement of apparatus, but the filament temperature was made so low that the maximum current obtainable was well below the space charge current for 180 volts. The current curve begins to flatten at a point for which $V=90$. The corresponding space charge current as calculated from the above equation is 88 milli-amperes, while the oscillogram indicates 74 milli-amperes. The direct current milli-ammeter showed a current of 28 m.a.

The oscillograms shown in films Figs. 8 and 9 were obtained with an arrangement of apparatus similar to that shown in Fig. 10. The low tension side of a potential transformer TT , ratio of coils 20 to 1, was connected to the 122-volt alternating current generator, while the high tension coils were connected to two kenotrons AF and $A'F'$ as shown in the diagram. (The condenser C shown in the diagram was omitted.) The direct current was taken from the middle point of the transformer and the filaments. A load of two 250-volt carbon lamps (60-watt type) was connected in series with a milli-ammeter and the current strip of the oscillograph to the terminals BB' . The kenotrons used were not of the same construction, with the result that the space charge voltages for the same current were quite different.

The upper curve in each film gives the voltage over the primary of the transformer, the middle curve gives the voltage over BB' , while the lower curve gives the current through the load. In taking film Fig. 8, the temperature of the filaments was maintained very low, with the result that both current and voltage waves were flattened considerably. The slight irregularity in the amplitudes of the two half cycles was due to the fact that it was almost impossible to adjust

the temperatures of the two filaments so that they would possess the same electron emission. The direct current milli-ammeter read 100 milli-amperes.

Film Fig. 9 shows an interesting case in which the thermionic current from one kenotron was limited by space charge, while that from the other was limited by temperature. The d-c. ammeter indicated 140 m.a. When taking the oscillogram of the current through the load, the voltmeter strip was opened, and when photographing the wave of voltage over load the current indicating strip of the oscillograph was short-circuited.

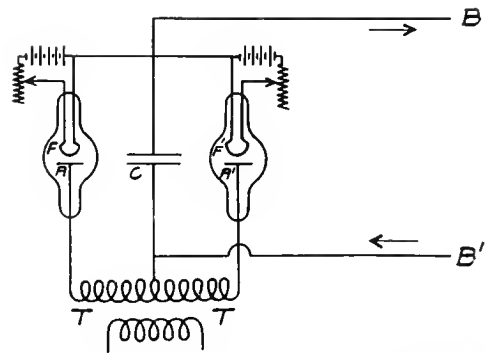


Fig. 10. Arrangement for Rectifying Both Half-waves, Using Middle Point Connection on Transformer

Summary

Summarizing briefly what has been stated regarding the hot cathode rectifier (kenotron) it has been shown that:

(1) The current rectification is due to the emission of electrons from a heated filament in as good a vacuum as can be obtained. The current carrying capacity of the kenotron depends *only* upon the area and temperature of the filament, and increases with the latter according to an equation of the form:

$$i = a \sqrt{T} \epsilon^{-\frac{b}{T}} \tag{1}$$

where i denotes the saturation thermionic current.

(2) The voltage drop in the kenotron depends upon the area, shape and distance apart of the electrodes, and increases with the current actually rectified according to an equation of the form

$$i_s = k.V^{\frac{2}{3}} \tag{2}$$

where i_s denotes the space charge current.

When i is measured in milli-amperes, the magnitude of k varies in ordinary cases from 5×10^{-3} , for very high voltage kenotrons, to

250×10^{-3} for lower voltage kenotrons. In other words, for a potential drop in the kenotron of 100 volts, the rectified current varies from 5 to 250 milli-amperes.

As has been mentioned on page 160, equation (2) gives the minimum voltage drop over the kenotron when it is operated in series with a resistance under most efficient conditions. Owing, however, to the fact that the filament temperature limits the maximum current which the kenotron can rectify, it is

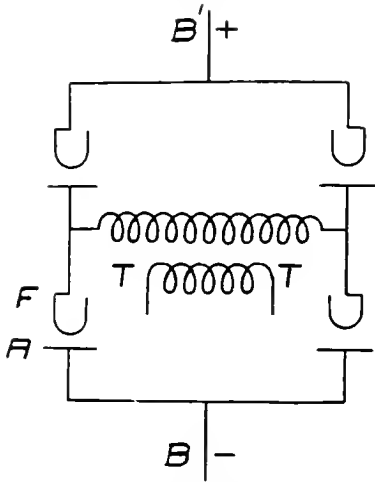


Fig. 11. Arrangement of Four Kenotrons for Making Use of Full Voltage of Transformer

possible for the voltage over the latter to exceed the value given by equation (2) as the rectifier takes the difference between the maximum voltage available and that consumed in the load. Care should therefore be taken in using the kenotron to avoid short circuits of the load, or some form of protective device should be used.

(3) The actual energy losses in the kenotron may be reduced to less than two per cent of the total energy rectified when the tube is operated to its full voltage limit.

(4) Up to the present, kenotrons have been constructed for direct current voltages as high as 100,000; but there is every expectation of being able to extend the field of application to 150,000 and even 200,000 volts.

The maximum current rectified has been as much as 1500 milli-amperes (1.5 amperes); but it is much more convenient to construct these rectifiers in the form of 10-kw. units where the voltages required exceed 25,000. For lower voltages, smaller units are advisable.

(5) A great advantage possessed by the kenotron is that two or more of them can be operated in parallel. From the remarks made above in connection with equation (2-a), it is evident that when a number of kenotrons connected in parallel are placed in series with a resistance, the current through the latter will control the voltage drop and current through each kenotron so that in each case an equation of the form (2-a) is satisfied.

The kenotron thus possesses at least two advantages over the mercury arc rectifier; firstly, because it may be operated at higher voltages, and secondly in the fact that several kenotrons can be operated in parallel.

Applications of the Kenotron

No doubt a number of applications of this device will suggest themselves to electrical engineers and physicists. A few words, indicating the possible fields of application that have already been suggested, will probably not be out of place.

In the *physical laboratory* where *small direct currents* of a few milli-amperes at *very high voltages* are required, as for spectroscopic work, operating small discharge tubes, etc., the kenotron ought to prove exceptionally useful. An arrangement similar to that shown in Fig. 10, and consisting of two kenotrons of the headlight filament type with a 60:1 potential transformer will act as a satisfactory source of direct current voltages up to 4500 or 5000. By inserting a condenser *C* of sufficiently high capacity between the terminals *BB'* the direct current obtained may be made as free from pulsations as desired. The kenotron could also be used for testing the dielectric strength of insulation with high voltage direct currents.

The writer has obtained as much as 400 milli-amperes direct current at 6000 to 7000 volts by using in the same manner a 500-cycle generator and a 100 to 10,000-volt transformer.* By inserting capacity between the high tension direct current terminals, it was found possible to reduce fluctuations in the resulting direct current to less than five per cent when 100 milli-amperes was being used at 6000 volts.

Fig. 11 shows an arrangement of four kenotrons in which the whole of the voltage generated by the transformer is utilized. *BB'* are the direct current leads.

* The kenotron operates just as satisfactorily on 100,000 cycles as on ordinary frequencies.

The combination of kenotrons and transformer could be used to replace the cumbersome static machines and the still more complicated mechanical rectifiers that are at present used to produce high voltage direct current for *X-ray tubes* and the *precipitation of dust, smoke, etc.*

Another field of application that appears to be very much within the limits of possibility is that of *high voltage direct current transmission*. While this system has not been used to any extent in this country, it is a well known fact that the Thury system has

met with great success in Europe*. To transmit 1000 kw. by 100 kenotrons, working in parallel at a voltage of 50,000 to 75,000 is quite a feasible proposition.

In conclusion the writer wishes to express his indebtedness to Dr. Langmuir and Mr. W. C. White of the Research Laboratory for valuable suggestions and kind co-operation during the work on the development of the above device.

*J. S. Highfield, Journ. Inst. Elec. Eng., London, 38, 471; 49, 848; 51, 640. In these papers the advantages of high voltage direct current transmission are discussed very fully.

PARALLEL OPERATION OF ALTERNATING CURRENT GENERATORS DRIVEN BY INTERNAL COMBUSTION ENGINES

IN TWO PARTS

In preparing the component parts of this article, each author (one representing the generator designer and the other the engine designer) has presented his subject with the express purpose of assisting the other to a better understanding of the factors that affect parallel operation of a-c. generators driven by internal combustion engines, as determined by his end of the set; for it is only through co-operation between the builders that generator and engine can be constructed with the correct characteristics to insure satisfactory operation when coupled together. Excessive variation in angular velocity, or hunting, is the chief trouble to guard against, and the greater part of the article is devoted to a discussion of the natural period, or frequency, of the units, with the object of avoiding a condition of resonance.—EDITOR.

PART I. FACTORS AFFECTING GENERATOR DESIGN

By R. E. DOHERTY

ALTERNATING CURRENT ENGINEERING DEPARTMENT, GENERAL ELECTRIC COMPANY

The rotor of an alternator which is operating in parallel with others will tend to swing to and fro at a definite frequency through the position of uniform rotation, if the equilibrium of driving and resisting forces is disturbed, just as a weight suspended by a spring will oscillate if the equilibrium of the force of gravity and the tension in the spring is disturbed. This is an inherent characteristic of synchronous machines. Hence, when an alternator is driven by a reciprocating engine which develops, inherently, a periodically varying turning effort, or driving force, there exists as a natural result a possibility of unstable operation of the alternator—a possibility that the natural frequency at which the rotor tends to oscillate may be equal to or very near the periodic variations of the driving force. This condition of resonance, like that of the spring and weight receiving impulses in synchronism with natural oscillations, will cause swinging, or "hunting" of the rotor. The amplitude of such rotor oscillations, as measured by the maximum displacement of the rotor from its stable position (the position of uniform rotation) is determined by two factors; namely, the magnitude of the varia-

tion in angular velocity (itself the result of periodically varying driving force working against the practically constant resisting force of load and friction), and the proximity to a condition of resonance. A large amplitude of swing might be produced by a small periodic variation in angular velocity, if the natural frequency of the alternator is very near the frequency of the variation; and it is also possible to have a large amplitude, even if the two frequencies are different, if the periodic variation in angular velocity is large. Yet, since both of these factors may be fixed at predetermined values by the use of proper flywheel effect, it is not necessary to have either at a dangerous value.

These facts have been matters of record for a long time, having been established in the early days of steam engine units. But even today a case now and then appears where these factors were not properly investigated in the design of the unit, especially in internal combustion engine units, and the usual result in such an instance is excessive hunting. In the case of internal combustion engines, the additional and more serious variations in the turning effort as compared with the steam engine unit, make it very

necessary to consider carefully in each instance the natural frequency as well as the periodic speed variation, when the flywheel is being designed. But of course the engine builder, who ordinarily designs and builds the flywheels, can not settle with accuracy the proper value of natural frequency, unless he has at his disposal the generator constants on which the natural frequency depends.

In reviewing the theoretical considerations of the problem, and in calling attention to some serious operating conditions which were found on an investigation of several gas engine stations, the object of this article is to encourage a further study of the problem in general, and bring about co-operation between the engine and generator builders in designing new units.

In order to develop the relation by which the natural frequency may be predicted, and to study the limitations of permissible variation in angular velocity which are required by the alternator, it is necessary first to look into the electrical effect of the oscillatory movements of the rotor. Suppose a generating system is delivering load: an alternator is brought up to speed and synchronized in the ordinary way; and the governor or throttle is set so that the wattmeter reads zero, that is, the alternator is carrying no load. Under this condition the voltage generated by the alternator reaches maximum and zero at precisely the instants the line voltage reaches its maximum and zero values. That is, the two voltages are in phase opposition at all instants; and if the field excitation is adjusted for a value of generated voltage equal to the line voltage, then the ammeter, as well as the wattmeter, will read zero. If the field excitation is adjusted for a higher or lower value of voltage, that is, if the alternator is over or under-excited, the ammeter will indicate the resulting wattless current required to consume the difference in voltage; but the wattmeter will still read zero. If, however, the engine is adjusted so that it tends to run at a higher speed, the rotor will tend to advance from the position in rotation it maintained before adjustment. This of course means that the center line of field flux has advanced, and that therefore the voltage generated by this flux reaches a maximum at a relatively earlier instant. Hence there has been produced a corresponding difference in the phase of the line and alternator voltages—in the time at which they reach their respective maximum values. This difference in phase, produced by the

advance of the rotor, allows current to flow, which, by its distorting effect on the magnetic field, restrains the advance; and in proportion as the displacement from the original position increases, the phase difference, and therefore the current, also increases, the latter producing proportionally increased restraining force (the force which tends to restore the rotor to the original position). This force, working at the peripheral velocity of the machine, measures the power input to the alternator; and the current produced by the displacement is the working current, or the energy current of the alternator. Obviously if the displacement were produced in the opposite direction by exerting a drag on the shaft, the alternator would be operating as a synchronous motor. Hence, to sum up, energy current is produced by displacement alone; and this current and the force produced by it, tending to restore the rotor to the zero position, are both proportional to the displacement. Also, if the alternator is working at a given load, the stable position of the rotor is naturally at a given displacement from the zero position; but any tendency to change the rotor from this stable position will be resisted, as in the case of no load, by a restoring force proportional to the displacement from the stable position.

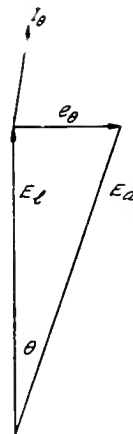


Fig. 1

These considerations afford a working basis, showing that the motion executed by the rotor during an oscillation is harmonic, because the restoring force, that is, the accelerating force, is proportional to displacement; that the natural forces of the alternator which characterize it as a synchronous machine are the very forces that make it oscillate or "hunt" when subjected to per-

turbing influences; and that aside from the natural oscillations, the periodic displacement which the prime mover imposes upon the rotor, purely by reason of uneven turning effort with its resulting variation in angular velocity, will produce proportional current and power oscillations.

The relations between voltages and also between displacement and restoring force are shown diagrammatically in Figs. 1 and 2. In Fig. 1, E_l represents line voltage; E_a , the counter-generated voltage of the alternator; θ , the displacement angle; e_θ , the resulting cross voltage, which, acting on the impedance of the alternator, produces the working current i_θ , almost 90 deg. lagging behind e_θ , and therefore almost in phase with E_l . In Fig. 2, θ again represents the displacement angle from the zero position 0; and the ordinates, f_θ , represent the restoring force at the different displacements; F_r , the force corresponding to one electrical radian displacement, that is, to the displacement which would make e_θ equal to the line voltage. (This, for convenience in proportionality, carries the assumption that the arc and chord of a circle are equal, slightly past accurate limits, but the assumption as applied involves error only to the extent of the difference between arc and chord at the angle of hunting, not at one radian. And that difference is very small.)

To relate the factors operating during natural oscillations of the rotor, assume that any angle θ_1 is the limit of swing; that is, $2\theta_1$

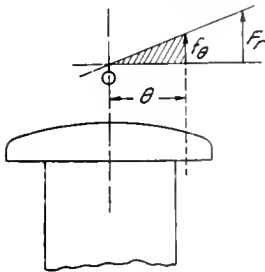


Fig. 2

is the total amplitude. The restoring force corresponding to a displacement θ_1 electrical degrees is

$$f_{\theta_1} = \frac{\theta_1 F_r}{57.3} \text{ lb.} \tag{1}$$

where F_r is the restoring force in pounds corresponding to one electrical radian displacement.

The work, W , which will be done on the rotor by f_θ in the movement of the rotor

during oscillation, through the angle θ_1 is represented by the shaded area, Fig. 2, and is equal to

$$\frac{f_{\theta_1}}{2} \times \text{displacement of } \theta_1 \text{ deg.} \tag{2}$$

A displacement of θ_1 electrical degrees represents $\frac{\pi \theta_1}{90 q}$ feet at a radius of 1 ft., where q = number of poles.

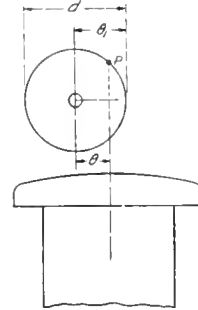


Fig. 3

Substituting in (2), the work becomes

$$W = \frac{\pi F_r \theta_1^2}{1031 q} \text{ ft. lb.} \tag{3}$$

When the rotor swings through the zero position, this work will have been transformed into kinetic energy,

$$\frac{1}{2} M V^2 \tag{4}$$

where M = mass of rotating element.

V = maximum velocity of swing in feet per second of the center of gyration. Reducing to one ft. radius for convenience, M becomes $\frac{W R^2}{g}$ where $W R^2$ = weight of rotating element \times (radius of gyration)² in lb. ft.², g = gravity, and V becomes the maximum velocity of swing in feet per second at one ft. radius.

Substituting in (4), the kinetic energy is

$$\frac{W R^2 \times V^2}{2 g} \text{ ft. lb.} \tag{5}$$

But since the motion is harmonic, V may be taken as the constant velocity of a point, p , moving in a circle whose diameter is

$$d = 2\theta_1 = \frac{2\pi \theta_1}{90 q} \text{ feet} \tag{6}$$

as shown in Fig. 3. The movement of the rotor during oscillation of $2\theta_1$ deg., being harmonic, is such that the center line of the pole, indicated by the arrow, is at all instants under the point p .

Let T equal time in seconds required by the point p to traverse the circumference of

the reference circle. This of course is also the time required by the rotor to make one complete swing. Then

$$V = \frac{\pi d}{T} \text{ ft. per sec.} \quad (7)$$

From (6) and (7)

$$V = \frac{\pi^2 \theta_1}{45 q T} \text{ ft. per sec.} \quad (8)$$

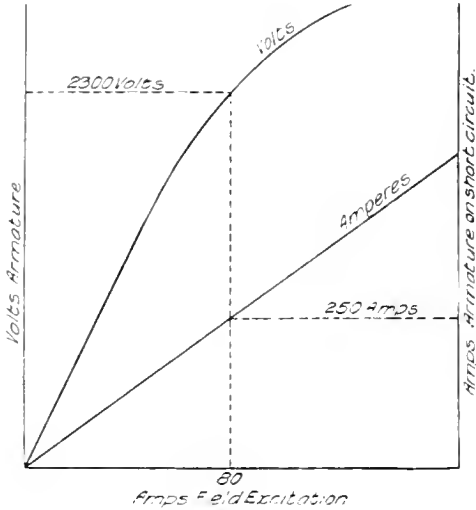


Fig. 4

and the kinetic energy is, from (5) and (8)

$$\frac{\pi^4 W R^2 \theta_1^2}{4050 g q^2 T^2} \text{ ft. lb.} \quad (9)$$

Equating (3) and (9)

$$T^2 = \frac{79 W R^2}{F_r q g} \quad (10)$$

Putting $g = 32.16 \text{ ft. per sec.}^2$ and substituting

$$q = \frac{120 f}{S} \quad (11)$$

where $f =$ generator frequency in cycles per second and

$$T^2 = \frac{R.P.M.}{0.0205 W R^2 S F_r f} \quad (12)$$

Now, since

$$F_r = \frac{33000}{0.746} \times \frac{P_o}{S} \quad (13)$$

where

$P_o =$ Kw. corresponding to the value of e_a at one electrical radian displacement, and the current produced thereby when acting across the impedance of the machine; that is, the kilowatts corresponding to normal voltage and short circuit current of the alternator,

$$P_o = 0.291 \times 10^3 \frac{W R^2 S^2}{P_o f}, \text{ and}$$

$$T = 0.001705 S \sqrt{\frac{W R^2}{P_o f}} = \text{seconds per oscillation.}$$

Hence the natural frequency in oscillations per minute is

$$F = \frac{35200}{S} \sqrt{\frac{P_o f}{W R^2}} \quad (14)$$

An example will illustrate the application of equation (14).

Fig. 4 shows the saturation curve and short circuit characteristic for a 500 kv-a. three-phase, 60-cycle, 200-r.p.m. 2300-volt alternator. At the field excitation, 80 amperes, which gives 2300 volts on open circuit, the corresponding short circuit current is 250 amperes. These values correspond to

$$P_o = \frac{\sqrt{3} \times 2300 \times 250}{1000} = 1000 \text{ kw.}$$

The combined $W R^2$ of the flywheel and alternator is 285,000 lb. ft.². Hence the natural frequency is

$$F = \frac{35200}{200} \sqrt{\frac{1000 \times 60}{285000}} = 80.5 \text{ oscillations per minute.}$$

The accuracy of equation (14) applied as above is probably within 4 or 5 per cent as indicated by tests made by a majority of investigators, the calculated result usually being lower than the actual. The writer has had the opportunity of observing accurately the natural frequency in two instances. In these cases the calculated value was 4 per cent low in one, a 75 kv-a., 60 cycle, 276 r.p.m. generator; and exactly right in the other, a 300-h.p., 60 cycle, 720 r.p.m. synchronous motor. Whatever error occurs is due principally to the fundamental assumption that the distortion of the magnetic field under load is not affected by the increase in reluctance which the distorted field encounters in a salient pole alternator.*

It is of interest to note, in passing, that the natural frequency of a given unit is independent of speed, and depends only upon the magnetic loading of the alternator. Because, for a given value of field exciting current (which corresponds to a definite magnetic loading when the machine is operating on open circuit), the short circuit current is practically the same for any speed, except zero, of course; and the voltage E_a is proportional to the speed S , as is also the frequency f . That is, the product, $P_o \times f$, in

*For a further study of natural frequency the reader is referred to "Notes on Flywheel," H. H. Barnes, Jr., A.I.E.E. vol. 23, p. 353; "Operation of Alternators," A. E. Everest, J.I.E.E., vol. 50, p. 520; "Parallel Running of Alternators," F. Punga, Elek. Zeit. June 11, 1914; "Coupling Flywheel Alternators in Parallel," Boucherot, Int. Elec. Congress, 1905, vol. I, p. 692.

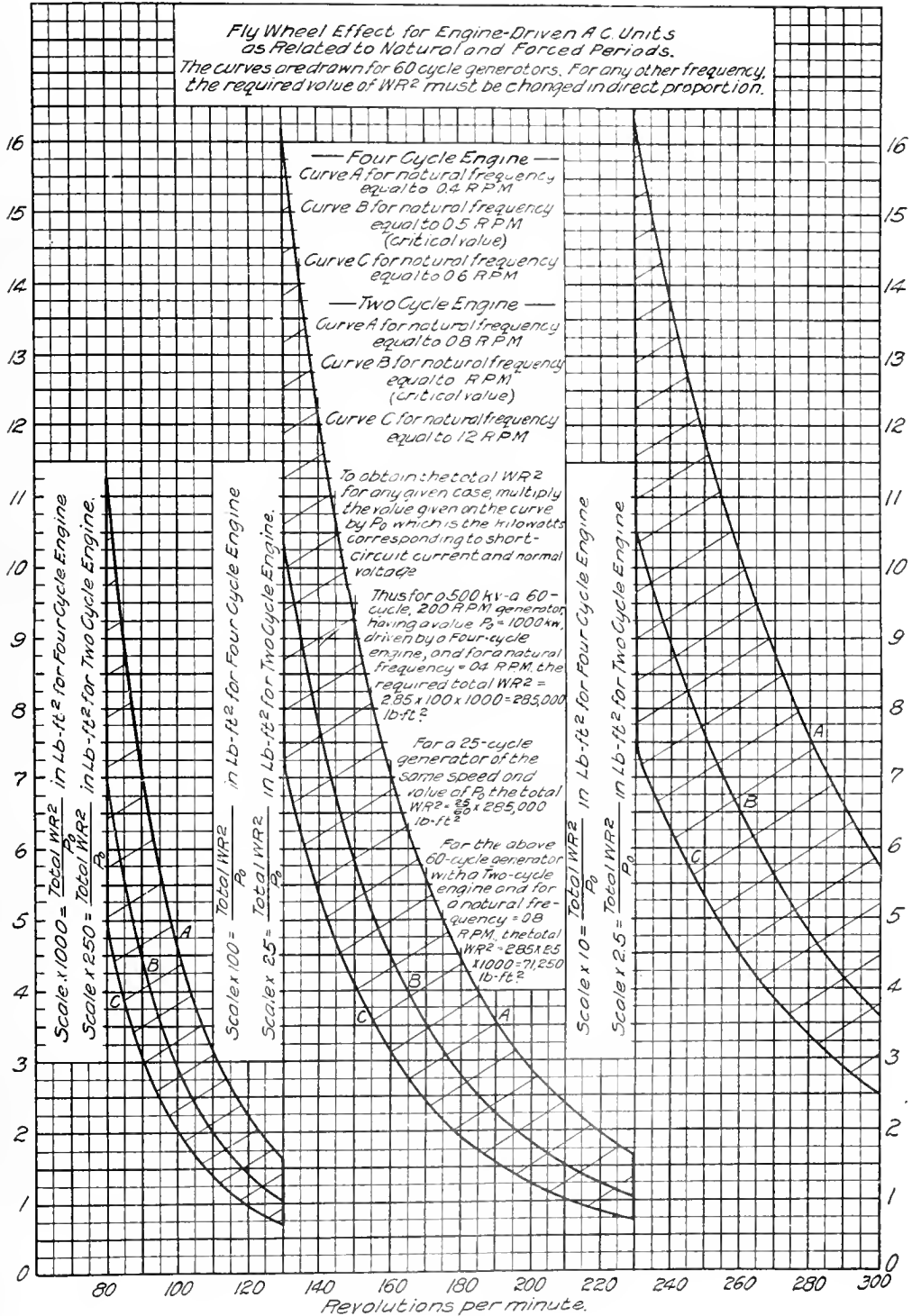


Fig. 5

equation (14) is proportional to S^2 . Hence F must be constant, if the magnetic loading is constant, and if this loading is changed—if the magnetism in the machine is changed— F changes in proportion. For instance, if the voltage of a system of alternators in parallel is increased, say 10 per cent, by increasing the field excitation, the natural frequency of all the alternators will be increased by about 10 per cent.

Load and power-factor conditions somewhat modify the value of natural frequency as given by equation (14), which, with the factor P_0 as defined, applies to no-load conditions. The synchronizing-force-per-degree-displacement has a different value under no-load conditions, as already pointed out. Under load and low power-factor conditions this force has a different and greater value, and the difference is a measure of the change in natural frequency. That is, if under load conditions the synchronizing force is increased by, say, 10 per cent, it is equivalent to increasing the value of P_0 by the same percentage; and the natural frequency is changed by the extent to which the increased P_0 modifies the value of equation (14), or about 5 per cent. Ordinarily, the change in natural frequency under load conditions is not serious if the voltage is kept reasonably constant. Roughly, one can estimate the change by the increase in the internal voltage, that is, in the magnetic loading.

Returning to the question of design of new units, it is possible to determine P_0 from the design of the alternator. This makes it possible to design the flywheel by equation (14) to produce any desired value of natural frequency, and therefore to avoid values dangerously near frequencies of the engine variations or impulses. Experience has shown that if the natural frequency of the unit is at least 20 per cent different from the frequency of any of the periodic impulses of any of the engines in parallel, there will be no trouble from resonant hunting. The critical frequencies to be avoided are:

For a four-cycle engine: particularly one-half the revolution of the crank, but also the revolutions of the crank.

For a two-cycle engine: particularly the revolutions of the crank, but also twice the revolutions of the crank.

It will be noted that the lowest critical frequency in either case is the cam shaft revolutions.

As an illustration, the danger zones of natural frequency for a generator to be driven

by a twin-tandem, double acting, four-cycle, 200-r.p.m. gas engine is 80 to 120, and 160 to 240 periods per minute. For a two-cycle engine running at the same speed, the danger zones would be 160 to 240, and 320 to 480.

In Part II of this article the causes and the relative magnitude of the several engine impulse frequencies are discussed.

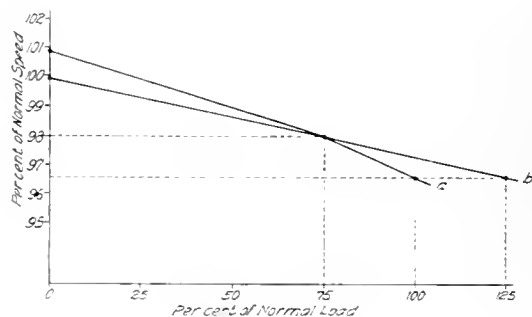


Fig. 6

Turning now to the permissible periodic displacement of the rotor due to variations in angular velocity, it has been shown that, regardless of how a displacement is produced, it will cause a proportional flow of energy current. If a current I_0 , corresponding to the power P_0 , flows at a displacement of one electrical radian, then for one degree the current will be

$$\frac{I_0}{57.3}$$

Since the permissible value of such a pulsating current is properly based on the normal rated current of the alternator, the permissible number of degrees displacement is related to P_0 . For the older type of steam engine driven units which were put in service before the days of voltage regulators, and which therefore had close voltage regulation (large value of P_0 as compared with the normal rating), the limit was set at ± 2.5 electrical degrees. But for modern units, designed for use with regulators, and especially the single (maximum) rated generators for use with internal combustion engines, P_0 is much smaller—of the order of 1.4 to 2.0 times the normal rating. For these machines, the permissible angle has been increased to ± 3 degrees, which would give, in the case of $P_0 = 1.5$ normal rating, a pulsating current

$$\frac{3 \times 1.5 I_n}{57.3} = 0.079 I_n$$

where I_n = normal current. If the generator was operating at a power-factor lower than

unity (and most generators are operated under that condition), the pulsations would be somewhat reduced, because there would be very little variation in the wattless component.

Hence the flywheel must fulfill two conditions: It must limit the periodic variation in angular velocity so that the resulting displacement will not exceed ± 3 electrical degrees, and at the same time must give a natural frequency 20 per cent different from the frequency of any of the engine variations. That is, if it works out that the flywheel effect which is required to limit the displacement to ± 3 degrees gives a dangerous natural frequency, then the flywheel must be increased to remove the natural frequency from the danger zone.

The curves shown in Fig. 5 give the plotted results of equation (14). Three values of flywheel effect are given for each speed for 60-cycle alternators, driven by either two or four-cycle engines: the upper and lower curves give respectively the required value of $(\text{total } WR^2 \div P_0)$ for a natural frequency 20 per cent below and 20 per cent above the lowest engine impulse frequency, which is the cam shaft revolutions. The middle curve gives the critical value which will make the natural frequency equal the cam shaft revolutions.

Yet, the factor of flywheel effect, while of primary importance, is not all that must be considered if satisfactory parallel operation is to be assured. It is a well-known fact that if the governors of the several units operating in parallel do not have similar characteristics (in that the curve of per cent speed against per cent load is the same for all units), then parallel operation will be unsatisfactory because the division of load among the several units will not be in proportion to their capacities. In Fig. 6, curves *a* and *b* are the load characteristics of units *A* and *B* respectively. The governor characteristics determine these curves. For this case there is only one point (98 per cent speed) at which the units divide load in proportion to their capacities. At 96.5 per cent speed, for instance, *A* would carry 100 per cent, *B* 125 per cent of rated load. If the curves *a* and *b* are made to coincide by adjusting the governors, then, of course, a proper division of load will occur at all loads and speeds. But these points are sometimes overlooked. Trouble from this source occurs chiefly in stations where engines of different manufacture are installed.

The governor is sometimes the cause of trouble of a different sort. When a momen-

tary change in speed occurs, say at a change of load, the governor, by reason of the principle on which it operates, tends to overcompensate for the speed change, with the result that oscillations will be set up unless there is sufficient friction in the governor mechanism, or in a suitable dashpot, to damp them out. This also is a fact, long established, yet now and then overlooked on gas engines.

Nor is this all. It is essential to good parallel operation that the adjustments of feeding and igniting mechanisms, when once made properly, do not change. Poor operation would naturally be expected if the adjustments were had to the extent of giving an enormous difference in work of the different cylinders. Experience has shown in a number of instances that although the parallel operation was satisfactory at the time the engine was put in proper adjustment, yet after a few weeks of work, large swinging of meter needles occurred because the adjustments had become defective. In many instances the operator has no means of indicating the engines, and is therefore helpless to make accurate readjustments. Hence the permanence of adjustments is a seriously important point to be considered in the design of the engine.

If all of the above points were considered in the design of new units, the parallel operation would probably be quite satisfactory, without having to take any additional precaution in the design of the generator over what is taken in the ordinary steam-engine driven generator. But, in view of the remaining possibilities of the unfavorable conditions just described, it is advisable for the present to equip the rotor of the generators with a low resistance amortisseur winding, which dampens any tendency to oscillate by consuming as loss the energy of the oscillation. However, it should be remembered that to get good parallel operation by such means, i.e., by overcoming by the use of a loss producer on the generator the effect of certain features of the engine which have not yet been perfected in all cases, the object is being accomplished at a constant running expense. And therefore in the interest of progress and efficiency, as well as of quiet meter needles, it seems that by working along lines which have been suggested, the engine designer could achieve a great deal toward carrying further the remarkable progress which has already been made in perfecting the gas and oil engines for driving alternators in parallel.

PART II. FACTORS AFFECTING ENGINE DESIGN

BY H. C. LEHN

SNOW STEAM PUMP COMPANY

In the preceding pages, the electrical functions involved in the solution of this problem are investigated, and their prime importance as factors thereof is shown. There is also pointed out the desirability of co-operation between the generator and engine builder in the design of new units, since the generator builder only is in possession of the required electrical data. It is to be noted further that as data of the mechanical factors involved are in general available only to the engine builder, co-operation is mutually desirable. Generally, the amount of data required to be interchanged is small, and its comparison will at once determine the most desirable flywheel effect. In some few cases, however, the correct solution will not be so readily apparent, and more accurate and complete data will be desirable, assuming that a generating set of the highest possible efficiency is to be produced.

Turning now to a consideration of the engine factors of the problem, it has already been shown that electrical considerations make necessary the limitation of the angular displacement by a certain amount. The magnitude of the displacement is dependent upon the variation in the turning effort. In particular, its graph is the space curve of which the plotted turning effort is the corresponding acceleration curve. The latter is the resultant of various forces acting in the engine, and in its calculation there are met a considerable number of factors which do not lend themselves readily to the ordinary mathematical operations. Hence, the usual method of determining the displacement is by two graphical integrations of a plotted turning effort curve. This procedure requires considerable time, and has the further disadvantage of not showing the relative value of the various factors, a change in any one of them necessitating a complete redrawing of the curve. In the present article an analytic method will be used, in which these disadvantages are not present, and by means of which a comparison of various types of engines with regard to displacement and natural period will be possible.

The analytic solution may be arrived at as follows: The varying turning effort acting on the crank is a periodic function of the time

and hence, by the Fourier theorem, may be expressed in a series of multiple sines and cosines. If then there is obtained an equation for the acceleration of the rotating parts due to the varying turning effort, in a series of sines and cosines, the second integral, which will be the curve of displacement, can be at once written.

The turning effort equation in this form will then be:

$$\frac{d^2 \delta_f}{dt^2} = \frac{g}{w_c} (A_1 \sin qt + A_2 \sin 2qt + B_1 \cos qt + \text{etc.})$$

from which

$$\delta_f = \frac{g}{w_c q^2} (-A_1 \sin qt - \frac{A_2}{4} \sin 2qt - B \cos qt - \text{etc.}) \quad (1)$$

in which,

δ_f = displacement in feet on the crank pin circle.

w_c = equivalent weight of the rotating parts at the crank pin circle.

$q = \frac{2\pi}{T}$, where T is the time in seconds of the longest forced period (which in the present case will be one revolution of the engine), so that,

$q = \frac{\pi N}{30}$, where N equals rev. per min. of the engine.

g = gravity = 32.2.

t = time in seconds.

The variation in speed is very small and may be considered constant; hence θ , the crank angle, may be put for qt , and since only the maximum displacement is required, it will be convenient to write Z for the maximum value of the series of sines and cosines, with their coefficients.

(1) then becomes

$$\delta_f = \frac{900}{w_c \pi^2} g \frac{AZ}{N^2}$$

where A = cylinder area in square inches, Z being taken on the basis of one square inch.

Reducing to mechanical degrees:

$$\delta_o = \left(\frac{360}{2\pi r} \right) \left(\frac{900}{w_c \pi^2 g} \frac{AZ}{N^2} \right)$$

where r = length of crank in feet, and finally to electrical degrees for 60-cycle current, and reducing

$$\dot{\delta} = 6.03 \times 10^8 \frac{AZ}{WRN^3}$$

or in terms of WR^2 , the flywheel effect,

$$\dot{\delta} = 6.03 \times 10^8 \frac{ArZ}{WR^2 N^3}, \text{ and} \quad (2)$$

$$WR^2 = 6.03 \times 10^8 \frac{ArZ}{\dot{\delta} N^3}; \quad (3)$$

(2) and (3) are in terms of the engine dimensions and speed except the factor Z , which is determined by the values of the coefficients of the terms. These values will be initially dependent upon the height and slope of the indicator card, and upon the inertia force of the reciprocating parts, and will be further modified to a considerable extent by the number of cylinders and arrangement of cranks. If then there is obtained a relation between the contour of the indicator card and the values of the coefficients, by properly combining for each cylinder and for the inertia the equation for any type of engine can be written. The most convenient form in which to establish this relation will be to express the coefficients in terms of the indicated mean pressures, since the latter is the basis of the engine output. With a given mean pressure, the slope of the expansion line will vary with the clearance volume, and with the time of ignition and regularity of combustion. The slope of the compression line will depend almost entirely upon the clearance volume. The latter ranges from about 22 per cent of the piston displacement for natural gas to about 11 per cent for blast furnace gas; and with fairly even combustion the exponent of the curve may be taken as 1.3. Where there is after-burning, the exponent will be lower at the beginning of the stroke, increasing more or less regularly with the piston travel; and in such cases it will be found that the expansion curve agrees closely with a curve having a constant exponent of 1.3 but greater clearance volume, which in only a very slow burning card will be greater than 25 per cent. Natural gas cards with

large clearance volume seldom show after burning to a great extent, so that a range of clearance volume of from 10 to 25 per cent should include all fairly normal cards from any gas. Such minor irregularities as the flattening of the card at the beginning of the stroke and the drop of pressure near the end do not affect the turning effort appreciably, and need not be considered.

To include oil engines, it would be necessary to extend the lower limit of the range for clearance volume percentage to about 6. Besides, the indicator cards are normally flat to an appreciable extent at the beginning of the stroke. For these reasons it is best to deal with oil engines separately.

In order to facilitate the forming of the equations for any combination of cylinders and cranks, it is best to derive the values of the coefficients separately for each event of the engine cycle. In the derivation of the formula, the fundamental period was taken as one revolution of the crank and this corresponds to the impulse period of a single cylinder, single-acting, two-cycle engine, and a twin-cylinder, single-acting, four-cycle engine, which are the simplest types used

Clearance Volume Per Cent	EXPANSION OVERSTROKE P_0 TIMES		EXPANSION UNDERSTROKE P_0 TIMES	
	25	10	25	10
$\text{Sin } \theta$	-0.450	-0.405	+0.474	+0.437
$\text{Sin } 2 \theta$	-0.066	-0.080	-0.048	-0.074
$\text{Sin } 3 \theta$	-0.014	-0.023	+0.008	+0.017
$\text{Sin } 4 \theta$	-0.004	-0.008	-0.002	-0.003
$\text{Cos } \theta$	-0.242	-0.318	+0.169	+0.258
$\text{Cos } 2 \theta$	+0.023	-0.018	+0.037	+0.015
$\text{Cos } 3 \theta$	+0.105	+0.007	-0.009	-0.009
$\text{Cos } 4 \theta$	+0.006	+0.008	+0.005	+0.006

P_0 = absolute mean pressure.

θ = crank angle measured from inner dead center.

for parallel operation. In any single acting engine only two events are possible; namely, expansion on the overstroke and compression on the understroke. In a double-acting engine occur the additional events of expansion understroke and compression overstroke. It develops, however, that the values of the coefficients for compression understroke are the same as those for expansion overstroke, but the cosine terms take the opposite sign, and exactly the same relation holds between compression overstroke and expansion understroke. Thus the matter is simplified to

deriving the coefficients for two events only, and for each event for the maximum and minimum percentage of clearance volume. The values of the coefficients to the first four terms for the displacement curve are given on the preceding page. It will be observed that the relative value decreases rapidly with the number of the term, and it was found that terms beyond the fourth are negligible.

While it is unnecessary to review in detail the principles upon which the construction of the turning effort diagram is based (which may be found in any text book on mechanics), it may be well to note, that instead of the

usual form of $P \frac{\sin(\theta + \phi)}{\cos \phi}$ for the resultant

turning effort of a force P at the wrist pin, there has been used its equivalent (within negligible error) of $P \left(\sin \theta + \frac{\sin 2\theta}{2l} \right)$, where

the constant l , the connecting rod length divided by the crank length, replaces the variable ϕ , the connecting rod angle. The table above is for $l=5$, the usual value and the coefficients will change but slightly for other values of l . It is also to be noted that the table is based on the absolute mean pressures, so that for single acting engines, in which one end of the piston is subjected to the atmospheric pressure of 14.7 lb. per sq. in. (at sea level) there must be subtracted from the equation $14.7 \sin \theta + 1.47 \sin 2\theta$.

The equation of the inertia turning effort is easily formed. The expression for the accelerating force at the wrist pin due to the inertia of the reciprocating parts is given in all text books, and is:

$$K_o = -0.000341 GrN^2 \left(\cos \theta + \frac{\cos 2\theta}{l} \right) \quad (4)$$

where

K_o = inertia force at the wrist pin per sq. in. of piston area.

G = weight of the reciprocating parts per sq. in. of piston area.

r = crank length in feet.

N = r.p.m.

Multiplying (4) by $\sin \theta + \frac{\sin 2\theta}{2l}$ gives the inertia turning effort at the crank pin per square inch of piston area. The resulting expression easily reduces to

$$Kc = 0.000341 GrN^2 \times$$

$$\left(+ \frac{\sin \theta}{4l} - \frac{\sin 2\theta}{2} - \frac{3 \sin 3\theta}{4l} - \frac{\sin 4\theta}{4l^2} \right)$$

for which the corresponding displacement equation is

$$K = 0.000341 GrN^2 \times$$

$$\left(- \frac{\sin \theta}{4l} + \frac{\sin 2\theta}{8} + \frac{\sin 3\theta}{12l} + \frac{\sin 4\theta}{64l^2} \right)$$

By forming from these values of the coefficients the equation of the displacement curve for the maximum and minimum conditions, it is possible to determine the variation of the displacement as the mean pressures and contour of the indicator card change, and the effect on it of a change in the inertia. There can also be noted the effect of a difference in mean effective pressure in the separate cylinders of a multi-cylinder engine—a condition which ordinarily exists, to a small extent at least. In determining the maximum displacement from the equations, the approximate crank angle at which it occurs will, except in a few cases, be evident from the predominating term, and it is then necessary to plot a small portion of the curve only in the locality of that angle.

Values of Z , the maximum ordinate of the displacement curve for various types of engines, are given in Table I. These values include a fair, but not excessive, allowance for slight differences in the mean pressures of multi-cylinder engines, as well as for other factors which do not appear in the indicator diagram, such as scavenging pumps on two-cycle engines, air compressors on oil engines, and the varying friction of the engine. For this reason the displacement figured therefrom will be somewhat greater than would be shown by a plotted curve where these factors are not taken into account. It is found that the difference in displacement for the maximum and minimum values of cylinder clearance volume is small; and for the further reason that indicator cards from an engine in operation will show some variation in contour as well as mean pressure, it has been considered unnecessary to include a clearance volume factor in the equations. Again, in all types of engines in which the predominating torque has a period of one revolution, the effect of the inertia is very small, since the principal torque of the latter has a period of one stroke. For the same reason, in such combinations of cylinders as result in a predominating torque

having a period of one stroke, the displacement is determined largely by the inertia forces, and in such cases it is necessary to include an inertia factor in the equations.

The maximum initial displacement has been fixed by electrical considerations at three electrical degrees either side of mean. Accordingly, this value has been substituted for δ in (3), and the resulting constant combined with Z is given as C in the table.

Then WR^2 for three electrical degrees

$$= \frac{C Ar}{N^3} \tag{4}$$

from which

$$\delta = \frac{3 C Ar}{WR^2 N^3} \tag{5}$$

Both for 60-cycle current.

It will be of interest to establish a relation between the formula for displacement given above and that for natural frequency, developed in the preceding article, and thus correlate the two requirements. For this purpose the equation for natural frequency (14) in the preceding text will be put in the following form:

$$F = \frac{273,000}{N} \sqrt{\frac{kv-a}{WR^2} \kappa}$$

in which $kv-a$. = rating of generator.

κ = short circuit ratio,

and the constant is for 60-cycle current. This formula may be put in terms of the rated indicated mean effective pressure P and of the engine dimensions as follows:

$$kv-a. = \frac{I.H.P. E E^1}{1.34 p}$$

where

$I.H.P.$ = indicated rated horse power.

E = mechanical efficiency of engine.

E^1 = generator efficiency.

p = power-factor.

and

$$I.H.P. = \frac{2 P A r e N}{33,000}$$

where e is the number of impulses per revolution.

Combining these two equations, substituting the value of $kv-a$. thus found, and also substituting for WR^2 equation (3) and dividing by N gives:

$$Q = 0.075 \sqrt{\frac{P e E E^1 \kappa}{p Z}}$$

where

$$Q = \frac{\text{natural frequency}}{\text{engine rev. per min.}}$$

TABLE I
FORMULAE FOR DISPLACEMENT

	No.	Type of Engine	Angle Between Impulse Deg.	Longest Torque Period	Z			
					Gas Engines	Oil Engines	Gas Engines	Oil Engines
Single Acting		Single-cylinder Two-cycle	360	θ	P	$1.1P$	$2 \times 10^8 P$	$2.2 \times 10^8 P$
		Twin-cylinder Four-cycle	360	θ	$1.1P$	$1.2P$	$2.2 \times 10^8 P$	$2.4 \times 8^3 P$
		Three-cylinder Four-cycle	240	1.5θ	$0.7P$	$0.8P$	$1.4 \times 10^8 P$	$1.6 \times 10^8 P$
		Four-cylinder Four-cycle	180	2θ	$0.51K - 0.23P$	$0.51K - 0.23P$	$1.02 \times 10^8 (K - 0.45P)$	$1.02 \times 10^8 (K + 0.45P)$
		Twin-cylinder Two-cycle	180	2θ	$0.23K - 0.15P$	(a) $0.24K - 0.27P$ b) $0.14P$	$4.6 \times 10^7 (K - 0.65P)$	$4.8 \times 10^7 (K + 1.12P)$ $2.8 \times 10^7 P$
Double Acting		Single tandem Four-cycle	180	θ	(c) $0.14K - 1.4 \sqrt{P}$ (d) $1.5 \sqrt{P}$		$2.8 \times 10^7 (K - 10 \sqrt{P})$	$3 \times 10^8 \sqrt{P}$
		Twin tandem Four-cycle	90	θ	$0.056K + 0.09P$		$1.12 \times 10^7 (K + 1.6P)$	

P = Rated indicated mean effective pressure.

K = Centrifugal force of reciprocating weights per sq. in. of piston for one crank = $0.000341 G r N^2$.

(A) With equal pressures in all cylinders.

(a) For K , not less than 160 (c) For K , not less than 175.

(b) For K , 160 or less (d) For K , 175 or less.

Values of E , E^1 and p ordinarily met with in practice which would make F a maximum are: $E = 0.85$; $E^1 = 0.92$; $p = 0.70$ which for $\delta = 3$ electrical degrees gives

$$Q = 0.139 \sqrt{\frac{P e \kappa}{Z}} \quad (6)$$

and likewise values for a minimum

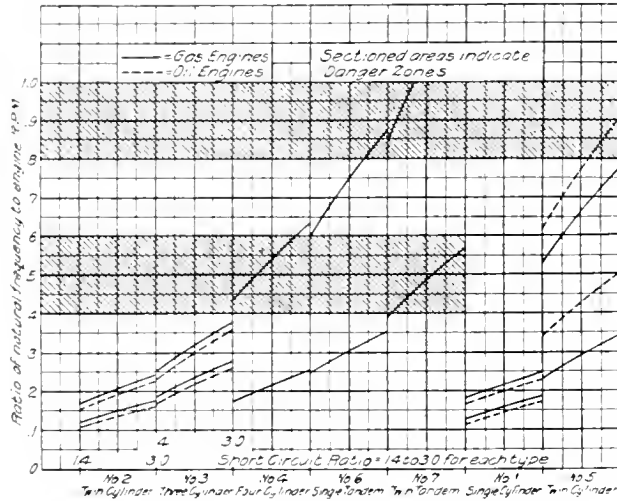


Fig. 7

$E = 0.70$; $E^1 = 0.88$; $p = 0.90$, giving

$$Q = 0.1075 \sqrt{\frac{P e \kappa}{Z}} \quad (7)$$

From equations (6) and (7) it will be observed that, for any given displacement, the ratios of the frequencies are independent of the engine dimensions and speed. Equations (6) and (7) are plotted in Fig. 7 for the various types of engines, and for maximum values of $\frac{P}{Z}$ in equation (6) and minimum values in (7);

the figures referring to the corresponding types in Table I. It will be noted that in the simpler forms of engines the natural frequency is far removed from the danger zones, and that in such cases only the displacement need be considered, while as the number of impulses per revolution increases,

the natural frequency approaches and passes the danger zones, necessitating the consideration of both frequency and displacement, and in the extreme cases, frequency only, in calculating the flywheel weight.

In applying the formulæ for displacement due regard should be given to the increase in the initial displacement as dependent upon the ratio of the forced and natural frequencies, which increase is equal approximately to $\frac{1}{1 - (\frac{F}{f})^2}$, damping neglected,

in which F is the natural and f the forced frequency.

All of the foregoing indicates to what extent the solution of the problem is a matter of design, while the conditions occurring in operation which affect paralleling are described in the previous article. The necessity of proper balancing of cylinders, and of designing adjusting mechanism so that the adjustments may be maintained, is referred to; and in connection with this it is interesting to note that in the case of double-acting engines, it has been possible in actual cases to reduce the displacement by operating with a higher mean effective pressure in the under-stroke ends. The reason for this fact is apparent when the signs of the overstroke, understroke, and inertia torques of one revolution period are compared.

Again, with regard to governors, it is almost entirely a case of adjustment in the field. Governor action is hardly susceptible to calculation, but analysis seems to show the presence of a natural period, which may in some cases approach the forced period of the engine and thus cause hunting, even when the other characteristics of the governor are correct. The actual governor period, however, is altered by friction, so that accurate predetermination is impossible.

The general tendency, when not in conflict with the other requirements, should of course be toward a light flywheel; for then not only are the natural vibrations more quickly damped out, but by reason of less bearing friction the overall efficiency of the unit is improved.

TESTS OF LARGE STEAM HOISTS

By H. E. SPRING

POWER AND MINING ENGINEERING DEPARTMENT, GENERAL ELECTRIC COMPANY

In order to present a convincing argument for the substitution of electric motors for existing steam engine equipment on mine hoists it is necessary to be able to show the mine owner some figures on cost of operation, as the question of economy is uppermost in any undertaking that is conducted for profit making. Complete and accurate tests on motor operated hoists may be obtained with relatively little difficulty, but a test of the average steam hoist, to be of value, involves a great amount of work and oftentimes proves to be a serious problem. In this article the author recommends a procedure for conducting tests on steam operated hoists that will give accurate figures on performance and cost of operation over any desired period of time.

—EDITOR.

There is unquestionably great need of a series of carefully conducted tests on the various types of large steam hoists operating under the different conditions found in practice. Conditions obtaining at mines are usually unsatisfactory for the economical generation and transmission of steam; the boiler plants are usually small and scattered, and if centralized, steam lines of 1000 to 4000 feet in length are not uncommon. Some properly conducted steam hoist tests would most certainly furnish still further convincing evidence of the economy and other advantages of electrically operated hoists.

A few tests, results of which have been published and which really approach actual operating conditions, are mostly of foreign origin. Tests of too short duration and occurring under as near ideal conditions as possible are of little value except possibly for attractive advertising. Tests true to conditions are difficult to carry out in a reliable manner and require prolonged, patient, and conscientious effort on the part of all concerned. Besides the expense involved, the special arrangement necessitated for accurate results would in many cases hinder the work at a busy mine, and this is no doubt the reason for the lack of information on the subject.

The service required of a steam hoist is of a distinctive character, and includes among other things, variation of speed and horse power output from zero to a maximum and back to zero again every time a hoist trip is made, heavy starting requirements, and no defined length of cycle or interval between cycles; these being factors that are not encountered in the tests of steam engines as applied to ordinary industrial installations.

Installations rarely if ever occur where only the hoist engine is fed from the boiler plant and often the steam line is in common with that of other apparatus. It is particu-

larly essential in testing that arrangements be made to secure a self-contained unit and at the same time to retain actual operating conditions as nearly as possible. The conditions under which the rearrangement and changes of apparatus around the plant must be accomplished are usually not of the best. Preparation is more or less handicapped because the greater part of the work has to be done at night or on Sunday; and in addition to this it is necessary in most cases to keep up steam and have the hoist in readiness at all times for miscellaneous hoisting or removal of the men from the mine in an emergency. If a separate man and supply hoist are utilized in addition to the main hoist, the situation is relieved somewhat and more freedom is allowable for rearrangement; but in any case due precaution must be exercised at all times to avoid any possibility of a serious tie-up in the operation of the mine, or the jeopardization of human life.

Because of the pulsating flow of the steam taken by the hoist, the measurement of the steam consumption by the use of a flow meter gives unreliable results. Even though a flow meter were at all applicable it would only be effective in measuring the steam for running purposes, and would not be sufficiently sensitive to include standby losses. On account of the clearance space in the cylinders, the varying conditions of load, and the varying quality of steam, the determination of steam consumption from indicator cards is only a makeshift method at best.

The extent to which a steam hoist test may be carried is almost unlimited and is determined by the anticipated scope and usefulness of the results. The cost of operation is usually the main information wanted and this may be obtained by taking a short cut, thereby sacrificing data which really are not necessary in determining the total cost of operation, but which would prove of value and interest, and might point out possible

means of improving the existing steam operation. Operating conditions at any one mine are usually indicative of general practice in that particular locality, and an insight into methods employed may prove widely useful, especially so if electrification is contemplated. If it is the intention to determine, in addition to the cost of operation, the fuel and steam consumption during different periods of the day (segregating the idle period as far as practical from the active period), the power delivered by the engine, the quality of the steam, and various other results, very complete tests and data are necessary.

No hard and fast rules can be made for conducting steam hoist tests because of the variance in mine plant practice, different types of engines, different kinds of mines, and the ultimate results desired. Each case demands its own particular solution, and for that reason any attempt to set down rules covering all tests is impossible. The best that can be done is to outline in a very general way how the ordinary difficulties can be met and the tests carried out. It is hoped that the following suggestions, explanations, and reasons why some things are done will prove of benefit in conducting a steam hoist test where complete information is the object, and will serve as a guide for any steam hoist test whatever the scope of the ultimate results.

Preparation

Proper preparation and forethought will, as in any tests, prevent a great deal of confusion and misunderstanding during the tests, and will insure complete data and results. The time selected for the test and the rearrangements of the plant should be such as to permit a continuous test of at least a week's duration at a time when the mine is operating under normal conditions.

The most important and usually the most difficult procedure is that of cutting off the necessary boiler capacity for operating the hoist. The first problem is that of estimating the boiler requirements of the hoist, either by estimating for the hoist itself, or for the other apparatus and leaving the remainder for the hoist. Every effort to accurately determine and isolate the necessary hoist boiler capacity will be well repaid, as the temporary changes effected must not materially change the ordinary everyday operation. In the majority of cases all the boilers of the same boiler plant feed into the same steam header, and it is possible to blank

flange sections of this header, thereby segregating the boilers. The difficulties depend on the manner in which the steam lines are connected into the header.

A separate boiler feed pump is necessary for the isolated boilers. Any auxiliary apparatus, such as boiler feed pumps and blowers which are necessary for the operation of the boilers or hoist, should be fed, if possible, from the same system, so that the arrangement constitutes a complete self-contained steam generating unit and hoist equipment.

Exhaust steam for feed water heaters is seldom if ever drawn from the hoist engine itself. Other apparatus being the source of exhaust steam for feed water heaters, the true economy of the hoist engine will not be obtained unless the heaters are eliminated from the hoist system. Of course there may be exceptions to this statement in case the exhaust steam can not be utilized for any other purpose, and it is a very important factor in increasing the hoist engine economy. Feed water drawn from the condenser hot well of condensing hoist engines must ordinarily receive further heating from heaters, and such feed water heaters should receive the same consideration as with simple or compound non-condensing engines.

The total steam consumed must necessarily include all steam chargeable to the rearranged hoist system, and the only reliable way to get accurate results is by measurement of the feed water. Water meters, as a rule, cannot be relied upon for accurate work and should only be used as a check on other measurements. Means of weighing the feed water can easily be provided for by the use of two receptacles (tanks or barrels) arranged one above the other, the water being admitted to the upper receptacle, weighed, and then allowed to flow into the lower receptacle, to which the feed pump is connected.

Arrangements for weighing the coal for hand firing are easily carried out. One means of doing it is by the use of an ordinary pair of scales and wheel-barrow. Where mechanical stokers are employed, the boilers, as a rule, can be hand fired if necessary, and the same method pursued as outlined above; but more nearly normal operating conditions will be maintained if arrangements are made to weigh the coal in such a manner that it can be fed by the mechanical stokers. Precaution must be taken in any case to prevent use of coal which by accident or otherwise has not been weighed.

The necessary arrangements at the hoist engine proper ordinarily make up a small part of the total difficulties of preparation. The cylinders of practically all modern engines have one-half-inch tapped holes for making the indicator pipe connections. If the holes are not bored, the cylinder heads should be removed, if possible, so that the exact position of the piston and the size of ports and passages may be known; thus insuring that the holes will be bored in the correct place and facilitating the removal of all chips and particles of grit. This method involves a great deal of time and labor, and probably for that reason would not be permissible with a hoist engine. It is possible to drill the holes without removing the heads by admitting a little steam just before the drill penetrates the shell, thus blowing the chips and grit outward. Care must be taken, of course, to protect the workman operating the drill. Indicator cards are important, but the physical impossibility of obtaining them should not interfere with the carrying out of the remaining tests. No putty or red lead should be used in making any of the pipe joints, as particles of these materials are liable to cause trouble with the indicators. Steam-tight joints can be made, if a connection fits loosely, by winding a little cotton waste into the threads. If an indicator for each end of each cylinder is available the piping will need to contain a two-way cock for each indicator. Where only one indicator is obtainable for each cylinder, a three-way cock for each indicator will provide the means of transferring from one end of the cylinder to the other.

Up-to-date indicators have a self-contained or a separate attachment for reducing the motion of that part of the engine from which the indicator is primarily driven. The cross-head is usually chosen as the most reliable and convenient part of the engine for this connection. It is hardly worth while explaining in detail the various accessory appliances which have to be made up in the field for taking indicator cards, as a little judgment and ingenuity will easily determine the best methods for meeting the conditions at hand. Single indicator cards are valuable as far as the total power developed by the hoist engine during a complete hoist trip is concerned, and therefore continuous indicators must be utilized. A detailed description of the parts and the operation of continuous indicators is unnecessary, as such information is always accessible in engineering handbooks

or can be obtained by application to the manufacturers.

The usefulness of continuous indicator cards depends on the record of the engine speed in r.p.m. kept at regular intervals during the time the cards are taken. The

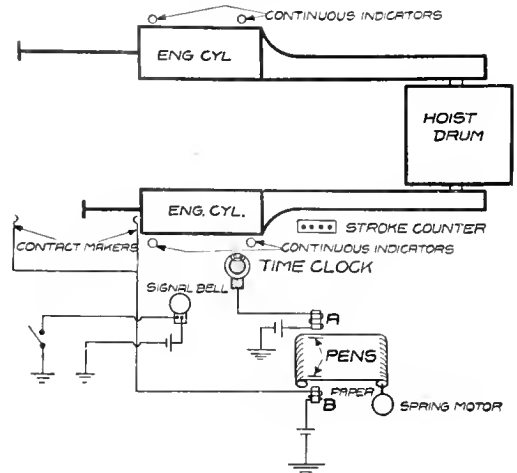


Fig. 1. A Convenient Arrangement of Apparatus for Taking Continuous Indicator Engine Diagrams

arrangement shown in Fig. 1 will prove convenient and reliable for recording the speed graphically. The spring motor feeds the paper along at a uniform rate; A and B are pens actuated by magnets; A is controlled by the time clock and divisions representing time in seconds are recorded on the paper; B is operated by the contact-maker and every stroke of the engine is indicated on the paper.

The contact maker is shown operated by the tail rod of the engine, but it can be placed at any other convenient place; the more contacts made per revolution the better, especially with a low speed engine. From the complete record on the paper, speed-time curves can be plotted. The signal bell can be displaced by some other means of signalling, if advisable, as the amount of signalling will not be great. The stroke counter is of use in recording the total number of engine strokes and serves as a check on the graphic instrument; it is also useful in establishing and checking the number of hoist trips for various periods, particularly when the hoisting is all done from one level.

Steam pressure records, temperature readings, and determination of quality of steam in the hoist house will require various tappings

into the steam line for gauge connections, thermometer wells, etc., and such apparatus should be located as near as possible to the hoist engine. The same general preparation applies for obtaining boiler plant pressure and temperature readings of the feed water and steam. Readings of temperatures, pressures and quality of steam are not of extreme importance as far as the hoist test results are concerned, but will prove interesting information and could possibly be used in getting at approximate operating characteristics of the boiler plant alone. A little judgment of the conditions will decide whether the information is worth the time and labor required.

The application, limitations, and operation of calorimeters for determining the quality of steam are carefully explained in the various engineering handbooks and in manufacturers' catalogues or pamphlets, and therefore will not be dealt with here. It is assumed that a throttling calorimeter can be used; but if the percentage of moisture is very irregular and is in excess of three per cent, a separator must be used in connection with the throttling calorimeter, or else a separating calorimeter substituted for the throttling calorimeter and separator.

It is essential that the records be complete, that the readings be consistent, and that they bear definite relation to each other. One great asset in promoting this is by properly prearranged log sheets. The required number can easily be prepared before the tests, by means of carbon copies or by mimeograph. Plenty of blank space should be left for possible changes, additional data and remarks. A sufficient number should be provided so that each day's tests can be put together and kept separate from the succeeding day's tests, as this will be advantageous in working up the tests.

The following headings for log sheets will serve as a guide, and can be modified to fit the conditions encountered:

BOILER PLANT

Coal, Steam Pressure and Temperature

1. Time.
2. Coal consumed.
 - (a) Number of r. r. loads.
 - (b) Weight in pounds.
3. Steam pressure.
4. Steam temperature.
5. Pressure.

Feed Water

1. Temperature.
2. Specific gravity, if measured.

3. Weight water in pounds.
4. Feed water temperature.
5. Remarks.

HOIST DUTY

1. Time.
2. Productive.
 - (a) Number trips and origin.
 - (b) Weights.
3. Non-productive.
 - (a) Men (No. trips, weights and origin).
 - Lowered.
 - Hoisted.
 - (b) Material (No. trips, weights and origin).
 - Lowered.
 - Hoisted.
 - (c) Waste (No. trips, weights and origin).
4. Remarks.

HOIST ENGINE

1. Time.
2. Steam.
 - (a) Pressure.
 - (b) Temperature.
3. Indicator cards.
 - (a) Number of card.
 - (b) Weight hoisted and classification.
 - (c) Stroke counter readings.
4. Remarks.

MISCELLANEOUS HOISTING OBSERVATIONS

1. Time.
 - (a) Beginning of trip.
 - (b) Time for acceleration.
 - (c) Time for retarding.
 - (d) End of trip.
 - (e) Rest period.
2. Maximum engine r.p.m.
3. Total revolutions of engine.
4. Load and classification.
5. Remarks.

*QUALITY OF STEAM TESTS BY THROTTLING CALORIMETER

1. Time.
2. Gauge pressure in steam line (p).
3. Gauge pressure in calorimeter (p_c).
4. Atmospheric pressure (p_a).
5. Temperature in calorimeter (t).
6. Absolute pressure in steam line (P).
7. Absolute pressure in calorimeter (P_c).
8. Total heat corresponding to P_c (X).
9. Heat of vaporization corresponding to P (r).
10. Heat of liquid corresponding to P (Xq).
11. Temperature of saturated steam corresponding to P .

The above headings can be rearranged or combined to give the most convenient arrangement in taking the data.

$$* \text{Priming} = 1 - \frac{X + .48 \cdot t - (t_c) - q}{r}$$

By productive hoisting is meant the hoisting of coal, ore, or whatever material the mine derives its revenue from. Non-productive hoisting includes all remaining hoisting, such as men, material, supplies and waste. Origin refers to the point from which the hoist load comes, and applies mainly to a multi-level shaft or slope mine. If two recording pressure gauges are available, readings from indicating gauges can be eliminated except for calorimeter tests. Graphic records of pressure at the boilers and hoist engine give a much better picture of all-day operation.

Procedure

All testing apparatus, steam and water lines, and other rearrangements should be thoroughly inspected in order to make sure that everything is in shape for accurate results. Apparatus for weighing or measuring, such as scales, tanks, gauges, etc., must have their accuracy established before beginning operations, as well as occasionally during the tests.

Preliminary sample indicator cards should be taken, as they will show the operating characteristics of the engine and may be the source of permanent improvement of the engine economy through resetting the valves. Such discrepancy in valve setting is rather remote, but if it exists and it is deemed advisable by the owner to remedy it, much time and energy will be saved by its detection before starting a series of tests.

The time of beginning the test is not very important, since the total time should consume at least a week, thereby taking account of day-to-day conditions. In any case the test should include Sunday, as a better conception of standby losses is then obtained than at any other time.

In order to associate one reading with another, readings for the different sections of the rearranged plant must all be taken at the same time, and the simplest method is to read on the hour and half-hour. Consistent and associated readings provide means of segregating the various periods from each other, make the tests complete for this period, and thus permit of definite results being obtained for any particular period desired.

The depth of the fire in the boilers can be estimated at the beginning and the same depth approximated as near as possible at the end. An assistant will have to be in constant attendance to oversee and register

the amount of coal consumed. If wheelbarrows and a pair of scales are used, an average wheelbarrow load can be weighed and the scales locked at this weight; succeeding loads are then added to or reduced to meet this predetermined weight. Approximately the same amount of weighed coal should be maintained before the boilers; the quantity depends on conditions, but should be definitely known at the beginning and end of the test. In order to avoid error, every time a load is weighed a notation should be made; the total weight per half hour being computed from these notations.

The height of the water in the boilers as shown by gauge should also be noted and this water level maintained throughout the tests, so that the weights of feed water will line up consistently with the other data for any period.

The duties of weighing and recording the amount of feed water require the attention of two assistants, one for weighing the water, and the other for feeding the water properly to the boiler. The receptacle, whatever it may be, to which the feed water pump is connected should be kept filled to approximately the same level all the time. The receptacle in which the feed water is weighed must not be of too great a capacity comparatively, as the weights may appear inconsistent when segregating a short period of operation.

Continuous indicator cards represent the total work done by the engine, and cards should be taken for each distinctive condition of load and speed under which the hoist engine operates. Diagrams for special conditions, such as for determining the frictional losses of the hoist, head sheaves, and shaft itself, will also prove instructive and valuable, and opportunity for obtaining such cards should not be neglected. It is necessary that diagrams be taken on both ends of each cylinder, as a satisfactory card from one end does not prove in any way that like conditions prevail at the other end. A continuous indicator for each end of each cylinder, when operated simultaneously, gives the whole story.

Referring to Fig. 1, the method of taking cards simultaneously is as follows: The spring motor is started and the man in charge signals his assistants to get ready for the next hoist cycle; he then starts the time clock, and also makes sure that the circuit for *B* is all o.k. All indicators can be put into working order with the exception of the con-

tinuous feed before the above signal is given. At the signal which occurs before the hoist starts, the continuous feeds are turned on. Succeeding cycles may now be taken without further adjustment, unless the time between cycles makes it undesirable to let the clock and spring motor run continuously. Record the reading in log sheet of the stroke counter at the beginning and end of each cycle, as this serves as a check on the record made by *B*. Also note time at which cards are taken, the weight of productive, or non-productive material hoisted or remarks concerning conditions, and the number of each card. A simple system of numbering on the time records and indicator diagrams themselves will establish their relation to each other. Notation must also be made on the indicator diagrams to show whether they were taken on head end or crank end, and whether left or right cylinder. One assistant can manipulate both indicators on one cylinder, as the difficulties of starting and stopping the indicators simultaneously, such as experienced with constant speed engines, are eliminated; no record being made on the cards until the engine starts, and the record ceasing when the engine stops.

In case only one indicator per cylinder is available, trial continuous cards must be taken simultaneously on both ends of the cylinder. From these cards a definite ratio of power delivered by head and crank ends of the same cylinder is established, and in order to accomplish this result two indicators will have to be temporarily attached to one cylinder. This ratio can be determined approximately also by taking a continuous card on one end of the cylinder during one cycle, and then with the same indicator taking a continuous card on the other end of the cylinder, during a cycle when the conditions are practically the same as those at the time the first continuous card was taken.

A sufficient number of cards should be taken each day to be certain that day-to-day conditions are covered, as well as to make sure that the operating characteristics of the engine are maintained constant.

Unless extremely difficult conditions prevail, one assistant can take the readings classified under "Hoist Duty." The magnitude of the daily record of output kept at the mines by the mining companies varies greatly. The quantity of data and the difficulties of getting authentic data depends entirely on whether the mine is opened by a shaft or by a slope; whether hoisting is all

done from one level or from several levels; and if a slope, whether a skip or several cars are used for transporting the product. If a shaft, the number of levels will not be great; they will be definitely located, because of their distance apart, and a complete record will be comparatively easy to obtain. If a slope, it will be exceptional if hoisting is all done from one loading station; usually numerous levels or headings situated at rather irregular intervals branch off on either side of the main slope, each in itself constituting a loading station; consequently a full understanding of where each trip comes from requires a rather elaborate record. The total number of the productive trips per day, and the total weights of product with its segregation into quantity per level, if more than one level, will ordinarily be obtainable from the tipple record. The total productive trips for each period can also be taken from the tipple record, if it is consulted every half hour, and by a little pressure brought to bear on the right place it may be possible to obtain the origin of the product as well; otherwise the origin must be obtained by observation, as will also the information concerning non-productive hoisting. The non-productive weights will have to be estimated. The total daily mine record will serve as a check on the total daily readings obtained by observation.

The taking of indicator cards, sampling coal, and steam calorimeter tests can be filled in between the regular half-hour readings, thus making it possible to obtain some help from the assistants taking the half-hour readings. At night, or during any other period outside of the regular hoisting period, it will be possible to double up on the keeping of records and arrangements made whereby the force can be materially reduced, probably only two men being required.

"Miscellaneous Hoisting Observations" give a very good idea of how the hoist is operated during light and heavy hoisting periods, with regard to maximum rope speed, total running period and rest period. These observations may be dispensed with in case the indicator cards and time records are sufficiently complete to supply the information.

Before recording any readings for determining the quality of steam, live steam should be admitted to the calorimeter for at least ten minutes, to insure the temperature of the instrument coming to full heat. When all is ready, take the following readings simultaneously: p , t_c , p_c and p_a ; P and P_c

come directly from readings taken; t_a , X , r , q and t_a are taken from steam tables. Sufficient sets of these readings should be obtained at various times and under various conditions to cover any contingency which might arise.

Sampling coal for moisture and heating value is a rather extensive process, and if carried out, a handbook or some other source of detailed information should be consulted. Samples for moisture can be taken every day, while two samples for heating value and analysis, tested in two separate laboratories, will suffice.

There is a certain amount of miscellaneous information which is necessary in getting at the total cost of operation (which is usually the ultimate object in view); also for getting at steam consumption per unit of useful work and various other results. As regards the boiler plant, this data should cover the entire boiler plant from which the boilers for operating the hoist were segregated. It will usually be easier to obtain the data in this way, and from this determine what belongs to the hoist account. Practically the only way of arriving at the boiler plant operating costs chargeable to the hoist is by applying the cost per ton of burning the coal under regular conditions to the coal burned during the test. It may not be possible to obtain installation costs, labor costs, coal burned, and maintenance, repairs and supplies as outlined below, because of the various ways of accounting, and in that case it is necessary to make the best of what is available. Some of the data may appear superfluous, but it is better to have too much information than not enough. The following notes, as well as any useful pencil diagrams or layouts, should therefore be taken at some time during the tests:

Boiler Plant

Installation cost and present value.
 Type and make of boilers.
 Rating in horse power and dimensions.
 Grate surface.
 When installed and present condition.
 Mechanical stokers used (if any).
 Economizers or feed water heaters (if any).
 Feed pumps (type and size).
 Injectors.
 Boiler house, cost, dimensions, etc.
 Boilers blanked off
 Accessories blanked off.
 Diameter, length and condition of steam main to hoist.
 Kind and price (delivered) of coal burned.
 Number of firemen and wage.
 Number of ash handlers and wage.

Number repair men and wage.
 Maintenance, repairs and supplies for past six months or year.
 Tons coal burned during past six months or year.

Engine and Hoist

Installation cost and present value.
 When installed and present condition.
 Type and make of engine.
 Size of steam cylinders.
 Diameter of piston rod.
 Kind of valves.
 First, second or third motion.
 Type of drum (cylindrical or conical, etc.).
 Single or double drum; clutched or fixed.
 Drum dimensions.
 Balanced or unbalanced hoisting.
 Type of brakes and how operated.
 Dimensions and value of building.
 Number of hoist engineers and their wage.
 Engine and hoist maintenance, repairs and supplies for past six months or year.

Mine

Total length of haul.
 Length of haul (ground level).
 Inclination to horizontal.
 Number of levels.
 Location of levels (profile of slope or shaft).
 Weight of cage.
 Weight of car.
 Weight of skip.
 Number of cars per trip.
 Size of rope.
 Condition of shaft or slope.
 Tons productive for past six months or year.
 Tons non-productive for past six months or year (estimated).

Calculations from Tests

It is first necessary to arrange and condense the data into the most convenient form for quickly arriving at the final results and for making up the report. Time will be saved by arranging the data so that the day and night, or hoisting and idle periods, can be totaled separately for each 24 hours. The idle period referred to includes all time besides what is considered the regular hoisting period, or periods. Tables for each 24-hour results, with the following headings, are suggested.

BOILER PLANT AND STEAM READINGS

1. Time.
2. Coal.
 - (a) Pounds consumed.
 - (b) Heating value.
 - (c) Moisture.
3. Pounds feed water.
4. Steam pressure.
 - (a) At boiler plant.
 - (b) At hoist engine.
5. Steam temperature.
 - (a) At boiler plant.
 - (b) At hoist engine.
6. Quality of steam.
7. Remarks.

HOIST DUTY

1. Time.
2. Trips.
 - (a) Productive.
 - (b) Non-productive.
 - Lowered.
 - Hoisted.
 - (c) Total.
3. Weight in tons.
 - (a) Productive.
 - (b) Non-productive.
 - Lowered.
 - Hoisted.
 - (c) Total.
4. Average haul in feet.
 - (a) Productive.
 - (b) Non-productive.
5. Average vertical lift in feet.
 - (a) Productive.
 - (b) Non-productive.
6. Horse power hours net work.
 - (a) Productive.
 - (b) Non-productive.
 - (c) Total.
7. Remarks.

INDICATOR CARDS

1. Time.
2. Card number.
3. Weight hoisted, or lowered, and classification.
4. Length of haul in feet.
5. M. E. P.
 - (a) H. E. each cylinder.
 - (b) C. E. each cylinder.
6. Total revolutions of engine.
7. Average r.p.m.
8. I. H. P. hours.
 - (a) H. E. each cylinder.
 - (b) C. E. each cylinder.
 - (c) Total for engine.
9. Remarks.

Every item under "Boiler Plant and Steam Readings" is available directly from the log sheets, with the exception of heating value of coal, moisture in coal, and priming of the steam.

The results covered by "Hoist Duty" require rather extensive calculations, especially if hoisting is not all done from one level. The "Average Haul," when hoisting from several levels, is determined for the period by dividing the sum of the net weights hoisted multiplied by the distance hauled, by the total net weights hoisted for the period. If a vertical shaft, the "Average Vertical Lift" is the same as the "Average Haul." Horse power hours net work =

$$\frac{\text{Net weight in lb. hoisted} \times \text{vertical lift}}{33,000 \times 60}$$

The continuous indicator diagrams should first have lines drawn perpendicular to the atmospheric line through the points which mark the ends of the strokes. If an ordinary planimeter is used, the area of each individual diagram must be taken separately and

then all added together, taking cognizance of positive and negative areas; but, if an integrator is put into service, the resultant area of the continuous diagram can be obtained direct from the planimeter. The mean effective pressure in either case is obtained by dividing the resultant area by the product of the length of an individual diagram (shown by the vertical lines) and the total revolutions, and then multiplying this average height by the scale of the indicator spring. Now by multiplying together the mean effective pressure, effective area of piston in square inches, length of stroke in feet, and total number of revolutions, the result will be foot-pounds of work produced by one end of one cylinder during a hoist cycle; and this result divided by $60 \times 33,000$ gives indicated horse power hours. The sum of the indicated horse power hours of the different cylinders is the total indicated horse power hours per trip. The total number of revolutions per trip is taken from the graphic speed record and checked by the stroke counter. Providing that a sufficient number of cards have been taken, it will be possible to determine closely the indicated horse power hours required for each kind of trip made, and from this the approximate total indicated horse power hours per day, or for any period of the day.

The individual diagrams on the continuous cards may show reverse power, and if so indicate that the engine is being "plugged" during retard for the purpose of bringing the hoist to rest without applying the brakes. So-called "plugging" is brought about by reversing the engine and admitting steam. The piston, however, is going in the reverse direction to that of the steam, and the result is that the steam and air confined in the cylinder are finally forced back into the steam line. Usually the overall economy is not affected materially by this operation, because no steam is exhausted to the atmosphere, and the only detrimental effects accrue from radiation and the admission of cold air through the exhaust ports and thence into the steam line. Another method of retarding, which is sometimes used but which is not as effective as "plugging," consists of throwing the valve gear on the central position (point of no valve movement) thereby closing all the ports and causing the air and steam confined to be compressed and expanded alternately. The only retarding effect resulting from such practice is that incident to the difference of power required to compress the



Fig. 2. Continuous Indicator Diagram of Twin Simple Hoist Engine

air and the power obtained from it by expansion.

Fig. 2 shows a continuous indicator card taken on a twin simple hoist engine.

Fig. 3 gives the curves that were made up from the set of cards, including the one shown in Fig. 2. Typical curve sheets such as these should be made up in addition to the above results.

The final test results can be expressed in several different ways, depending on what unit basis is used and on the detailed results desired. Some of the following items suggested for making up the table of final results may not be desired, but nevertheless the list will give the form of the various results obtainable. The totals for the complete test should be given at the bottom of this table.

1. Date.
2. Time in hours.
 - (a) Hoisting.
 - (b) Idle.
3. Tons hoisted.
 - (a) Productive.
 - (b) Non-productive.
 - (c) Total.
4. Pounds coal consumed.
 - (a) Hoisting time.
 - (b) Idle time.
 - (c) Total.
5. Pounds feed water.
 - (a) Hoisting time.
 - (b) Idle time.
 - (c) Total.
6. Indicated horse power hours.
 - (a) Productive.
 - (b) Non-productive.
 - (c) Total.
7. Horse power hours net work.
 - (a) Productive.
 - (b) Non-productive.
 - (c) Total.

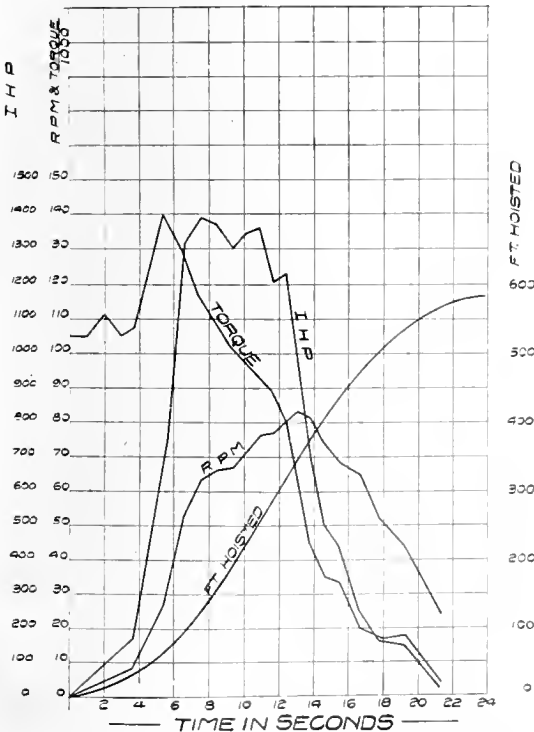


Fig. 3. Curves Plotted from Continuous Indicator Diagrams

The test records will also permit still further segregation of the active hoisting period or the idle period so that results concerning some distinctive period of the day can be obtained.

The Report

The value of a report does not depend on its length, but on convenient arrangement, on the brief, concise statement of facts and results, and on the curves and diagrams included. The very first part of the report, after a general idea of the conditions has been obtained, should be the summary of results, the detailed information making up the latter part of the report. The best arrangement is subject to personal opinion, but the following outline with accompanying explanation is a very good arrangement:

General.—Brief introduction concerning location of mine, product mined, and normal method of operation.

Object of Tests.—A short, straight-to-the-point statement of what ultimate result, or results, the tests were made for.

Existing Conditions.—List of apparatus with its condition and arrangement before rearrangement for test was effected. The

data given under "Procedure" for "Mine" should also be included here.

Rearrangement for Tests.—List of rearranged apparatus, specifying its arrangement in conjunction with the plant itself and with the extra test apparatus.

Procedure.—A brief outline concerning the method of running the test.

Summary and Conclusions.—The length and scope of the summary depends on how much detail is desired. The following list of results for the complete test may be revised to suit conditions and requirements.

- Total hoisting time in hours.
- Total idle time in hours.
- Total length of test in hours.
- Total number productive trips.
- Total number non-productive trips.
- Total number trips.
- Total productive tons hoisted.
- Total non-productive tons hoisted.
- Total tons hoisted.
- Total pounds coal consumed during hoisting time.
- Total pounds coal consumed during idle time.
- Total pounds coal consumed.
- Total pounds feed water during hoisting time.
- Total pounds feed water during idle time.
- Total pounds feed water.
- Total indicated horse power hours productive.
- Total indicated horse power hours non-productive.
- Total indicated horse power hours.
- Total horse power hours net work productive.
- Total horse power hours net work non-productive.
- Total horse power hours net work.

- Pounds coal per hour hoisting time.
- Pounds coal per hour idle time.
- Pounds coal per ton hoisted.
- Pounds steam per ton hoisted.
- Pounds steam per pound of coal consumed.
- Pounds steam per indicated horse power hour.
- Pounds steam per net horse power hour.
- Heating value of coal.
- Moisture in coal.
- General quality of steam.

The conclusions drawn depend on conditions met with, but are ordinarily confined to ways and means of possible increase in economy in operating the plant and to an explanation of the test results, which are not self-explanatory.

Detailed Report.—This part of the report is simply for reference in getting details concerning the results given in the summary. All the tables made up in the form given under the section "Calculations from Tests," should be included here. Sample copies of log sheets and indicator cards may also be included if advisable. Tables of capitalization and operating cost should not be incorporated in the report unless the final results and summary cover cost of operation.

Curves.—Almost innumerable curves can be made up. The most instructive will probably be a curve sheet for each day's operation plotting pounds coal consumed, pounds feed water used and horse power hours

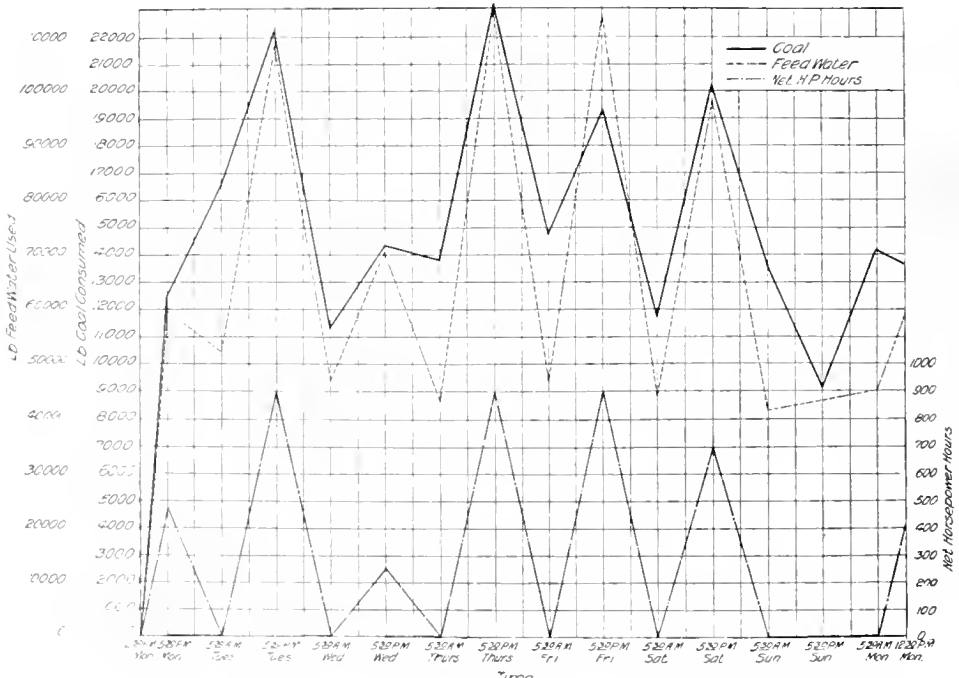


Fig. 4. Curves showing Engine Performance as Determined by One Week's Test

net work, against time. A curve sheet such as this can also be made up for the total test using each day's results as a point. Fig. 4 is illustrative of curves made covering a week's test.

No doubt the lists of test data, etc., have appeared to be of a more detailed nature than necessary, and have included data which have nothing to do with the hoist test itself. Such data and information are mentioned,

however, because of their value and application to the final test results. With this end in view, the final results can now be used, in conjunction with the data at hand, for obtaining the total cost of operation per year for this particular mine; and all the results thus possible to obtain can in turn be applied to other mines, providing proper cognizance is taken of the idle time, tonnages, and the various other vital points involved.

HIGH VOLTAGE ARRESTER FOR TELEPHONE LINES

BY E. P. PECK

ASST. ELECTRICAL ENGINEER, GEORGIA RAILWAY AND POWER COMPANY

The ordinary telephone instrument, with its fine wire coils, contacts, etc., is a very delicate instrument and when used on lines paralleling high tension transmission lines requires a protective device that will effectively shield it from the abnormal stresses resulting from a cross between the telephone line and the transmission line, a stroke of lightning, etc. This article describes a telephone lightning arrester, built in three sizes, which will adequately protect the instrument on transmission systems operating at voltages up to 250,000, or higher.—EDITOR.

The protection of telephones and other terminal apparatus connected to telephone lines paralleling high voltage power lines has been a very serious problem. The requirement is that the delicate telephone windings of approximately 0.005 wire, hook switch contacts, etc., with very close spacings, must be so protected that they will remain in good operating condition after an almost unlimited voltage has been repeatedly applied to the lines to which the telephone is connected.

This extreme requirement has apparently been fulfilled by an arrester that has been designed and that has stood tests and operating service which seem to prove that it will give the telephone good protection when voltages of any value or frequency are applied to the telephone lines. So far we have found but one exception: When the power impressed on the telephone line is not sufficient to blow a five-ampere fuse, but with voltage high enough to keep the arrester continually discharging, the telephone equipment will be eventually damaged. An explanation of this will be given later in the article.

The telephone high voltage arrester, which is designed for voltages from 33,000 to 250,000 or higher, is satisfactory, as far as protection is concerned, for use on any telephone, but its size and cost prohibit its use on lower voltage lines. For this reason a smaller arrester is being designed for use on telephone lines paralleling power lines of from 2600 to 35,000 volts, and another one has been made for use on lines which are not subjected to higher voltages than 2500. All of these arresters apparently give thorough protection from any instantaneous application of high voltage, such as a stroke of lightning. The high voltage arrester was mentioned by Mr. C. E. Bennett, Electrical Engineer for the Northern Contracting Company, in an article in the December number of the *GENERAL ELECTRIC REVIEW*.

About three years ago it was necessary to protect some telephone lines which were subjected to crosses with a 22,000-volt power line. An arrester, shown in Fig. 1, was made up of an old marble slab, glass tube expulsion fuses, and some other material which was on hand. It was our intention to

try out the practicability of this arrester with as small a cost as possible and later build one with better mechanical arrangement. In this arrester the line wires connected at the top and the telephone wires

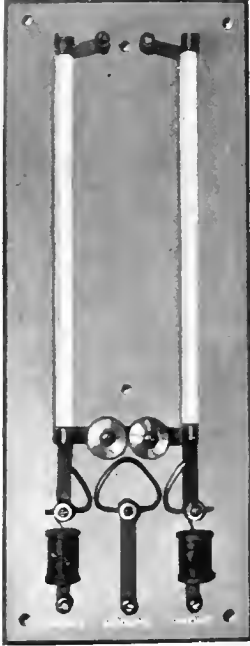


Fig. 1. First Experimental Arrester

and ground wires at the bottom. A spark gap of 0.004 inch between knurled brass cylinders was placed from line to line on the telephone side of the fuses. This gap was set very close for the reason that it was desired to hold the voltage across the terminals of the telephone to a very low value, as it is voltage from line to line and not the voltage from line to ground which burns up the telephone coil. Just below this line-to-line gap are gaps from line to ground.

An examination of a number of damaged telephones showed that in very many cases the end turns of the telephone bell coils were the ones that were damaged. Therefore two small choke coils were placed on the arrester, although at that time the idea was not to consider them as choke coils but simply as very highly insulated end turns of the telephone coils. Our tests have proved, however, that these coils also act very definitely as impedance coils when subjected to high frequency impulses.

This arrester has since been rearranged mechanically and a vacuum gap, manufactured by the General Electric Company, has been added in parallel with the air gap from line to line. The vacuum gaps that were used break down at approximately 350 volts, thereby limiting the voltage across the telephone terminals to this low value. These vacuum gaps were first wired to the existing arresters and it was found that after they were added, practically complete protection was furnished the telephone.

The arrester shown in Fig. 2 is one designed for lines which are not subjected to crosses with power lines of more than



Fig. 2. Low Voltage Telephone Arrester

2500 volts. In this arrester standard fuses are used and vacuum gaps are used entirely for relief gaps; the two outside vacuum chambers being connected from each line to ground and the center vacuum chamber connected from line to line. This arrester cannot be used where the operating voltage of the telephone line from line to ground is higher than about 50 volts. On

ordinary telephone lines the voltage from lines to ground is much lower than this.

Another arrester is being made for use where the voltage, in case of a cross with a power line, will be between 2500 and 35,000 volts. This arrester will be similar to the larger arrester in all electrical details but will be much smaller.

The next arrester was made for use on telephone lines which were strung on the same towers and about ten and one-half feet from 110,000-volt power lines. This arrester is shown in front and side views in Figs. 3 and 4. The telephone lines are insulated for 22,000 volts and have a normal operating voltage to ground of approximately 5500 volts when drainage coils are disconnected. The voltage from line to line is normally too low to be measured with commercial instruments. Fig. 5 shows the arrangement and connections of this arrester.



Fig. 3. High Voltage Telephone Arrester

Attention is called to the horn gaps shown at the top of this figure, which should preferably be mounted outside of the building, but between the telephone instrument and the first tower. This horn gap, which is set at about three-eighths of an inch, is a very

essential part of the arrester, as it protects the top of the arrester frame and the fuses, and also the top insulator of the arrester. This protection is necessary, as an application of 50,000 volts or higher, continuously, on



Fig. 4. High Voltage Arrester—Side View

the top of the arrester will destroy this portion of it, although the arrester itself will afford the telephone instrument complete protection. It would be possible, of course, to build an arrester which would stand a continuous application of 110,000 volts without these auxiliary gaps, but the expense of providing 20-foot fuses mounted independently on 110,000-volt insulators is entirely out of the question when the same results can be achieved so simply.

The arrester proper consists of what we call the gap unit, and expulsion fuses between the gap unit and the telephone line. The expulsion fuses are two feet long and arc mounted on a very substantial frame which serves as a disconnecting switch. With the switch pulled the main part of the arrester is dead and fuses can be changed safely. The mechanical arrangement is very similar in principle to the 25,000-volt telephone arrester made by the General Electric Company.

The gap unit is mounted on a separate insulator and is tied with a plate to the bottom insulator of the fused switch. This stiffens the switch base and the gap unit base, making them both quite rigid. A number of materials were tried for the gap unit base before one

was found which would stand the necessary high voltage test and also be sufficiently strong mechanically. Some samples of marble were found which were satisfactory, but more than half the bases made from selected

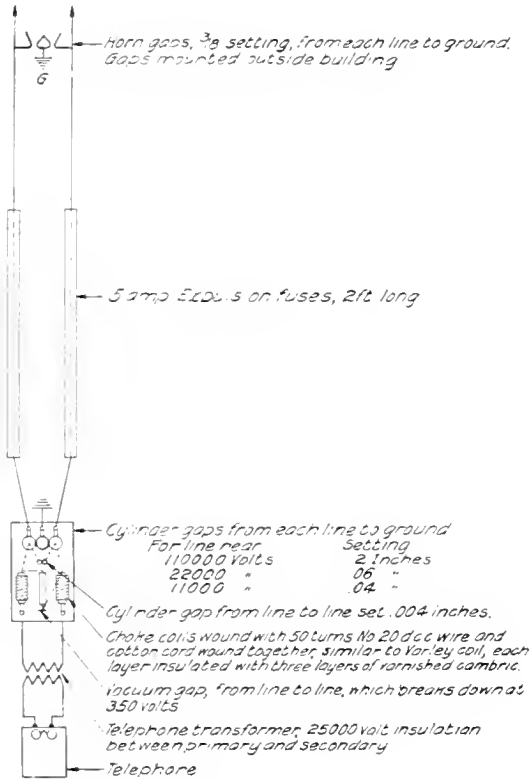


Fig. 5. High Voltage Arrester. Connections and Data

marble had to be discarded because of partially conducting veins in the marble. The material finally used is a kind of Bakelite fiber.

The gap unit consists of three brass cylinders connected as shown in Fig. 5, the two outside cylinders connecting to the telephone lines and the center one to ground. The spacing of these cylinders, which are adjustable, should be such that the gaps between them will not arc over with the normal voltage of the telephone line, but should arc over at approximately 25 per cent higher voltage than normal. These gaps to ground, on account of their wide spacing (approximately 0.2 inch) offer practically no protection to the telephone coils, but they do relieve the strains from line to ground which are impressed on the high voltage winding of the telephone transformer, and also act as a pro-

tection against high voltage reaching the operator. Just below the ground gaps are two brass cylinders connected from line to line. These gaps, also adjustable, are set at 0.004 inch and arc over at approximately 700 volts. In parallel with this air gap is a vacuum gap which breaks down at 350 volts.

Choke coils, with the individual turns highly insulated, are mounted between the relief gaps and the telephone transformer. This telephone transformer, which has 25,000-volt insulation between the primary and secondary windings, is recommended in all cases on account of the protection it furnishes the operator.

With the arrester connected we have not lost a single telephone transformer and only one telephone coil after several months service. Before the arresters were installed telephone transformers and telephones were burned out every few days during the lightning season.

Referring again to the expulsion fuses: these are fused with five-ampere fuse wire. This size was chosen because we did not wish to get a fuse so low that it would blow in case of a slight disturbance on the line; but on the other hand we did not wish a fuse so large that the gap units would be damaged after the fuses were blown repeatedly in service. Our operating results have shown that this size fuse is very satisfactory.

Calibration curves were made of the arcing voltage between the particular cylinder gaps used on this arrester. It was found that the arcing voltage varied greatly with different kinds of knurling on the cylinders.

When taking voltage measurements on the telephone line it was found that the voltage readings taken with a dynamometer voltmeter were very greatly in error. On the telephone line in question, the wave form of the voltage as shown by oscillograph records is very irregular, having a high peak. Therefore the voltage shown by the voltmeter was much lower than the voltage shown by sphere gaps. As the spacing of the ground gaps should be in proportion to the voltage from the telephone line to ground, it is important that this point be noted as it caused us considerable trouble before we found out the reason for the cylinder gaps discharging after they had been apparently set above the arcing voltage.

High voltage may be applied to telephone lines in several different ways, all of which must be taken care of. The action of the arrester under different conditions of voltage

application will be explained. If one telephone wire becomes crossed with one high voltage line, the current will flow over this wire and across the ground gap to ground without flowing through the telephone, provided both ground gaps are set exactly the same. If it happens that the ground gap on the opposite side is set one or two thousandths of an inch closer than the gap on the wire carrying the high voltage, the current will tend to flow through the telephone instrument and discharge through the smaller gap. In this case the vacuum gap will come into action, shunting out the telephone and preventing damage to it. In addition to the current flowing to ground, another current must pass through the telephone or the arrester to charge the other line wire. This also is taken care of by the vacuum gap.

If both telephone wires are crossed with one high voltage wire, the action of the arrester is practically the same, as the smallest ground gap will arc over first and the vacuum gap will discharge the other line without damage to the telephone.

It is possible, although not probable, that each of the telephone wires will become crossed with separate power wires, thus impressing full line voltage across the telephone lines. In this case the vacuum gap will take the full discharge.

The tremendous currents carried would destroy any piece of apparatus of reasonable size, if the cross continued for an appreciable length of time; therefore the five-ampere expulsion fuses are connected between the relief gaps and the line. In any of the cases above mentioned, or of a stroke of lightning on the line, these fuses clear up promptly. After the fuses have blown there is no further strain on the telephone or the arrester, but in case of a cross with the power line the tops of the fuses are still subjected to extreme voltage. The gaps outside the building will then arc over, relieving the stress at the top of the fuses until the telephone line burns down. This of course would take place anyway, because the insulators on the telephone line would arc over. Therefore these horn gaps will not cause any added trouble, but simply ensure that the protective apparatus is not damaged before the line does burn down.

On tests made on the arrester it was found that if the voltage were raised slightly above the breakdown voltage of the vacuum gap, the vacuum gap would be destroyed after a time if the current were too low to

blow the fuses and were held on continuously. It has been found that this condition is unusual and that the expense of renewing vacuum gaps has been negligible. After the vacuum gap has been destroyed, the cylinder gaps connected in parallel with it,



Fig. 6. Telephone Arrester Operating on 118,000 Volts from Power Line

which are set at 0.004 inch, will arc over, thus preventing an extreme rise in voltage on the telephone. This cylinder gap breaks down at approximately 700 volts and will not entirely protect the telephone if the voltage is continued for a long time. None of these occurrences are necessary, however, if there is an operator in the station, as the telephone bell will continue to ring as long as voltage is applied. This should be a signal to the operator to clear the arrester by pulling out the fused switch. As the telephone is inoperative on account of excessive noise at this time, there is no objection to clearing the arrester from the line.

Very extensive tests have been made on this arrester for the purpose of finding out if it would give complete protection to the

telephone in cases of crosses with extremely high voltage lines. Tests were made in the General Electric Company's research laboratories with high voltage at 200,000 and 500,000 cycles. Other tests were made with power from high voltage 60-cycle lines at 22,000, 50,000 and 110,000 volts.

Fig. 6 shows the arrester operating on 118,000 volts connected directly on the

that the cylinder gap which is in parallel with the vacuum gap did not discharge, but that the vacuum gap carried the full current. The expulsion fuses blew and the arc extinguished with a very sharp report, and immediately after the expulsion fuses cleared up the three-eighth-inch horn gap arced over. Then the lines connecting the horn gaps to the power line were fused.



Fig. 7. Bank of Four High Voltage and Four Low Voltage Arresters at Boulevard Substation, Georgia Ry. & Pr. Co.

power system from line to line. A standard General Electric telephone transformer and a telephone bell were connected to the lower side of the arrester. When the test was completed this telephone transformer and bell were put back in service and are still operating, as they were not damaged. It will be noted that three-eighth-inch horn gaps are connected two in series from line to line on the line side of the arrester, and that these gaps are wired directly to the 110,000-volt power lines. Very close observation of the arrester at the time of this test showed

This connection was made with 25-ampere fuse wire, as we did not wish to subject the 110,000-volt power system to a continued short circuit.

This test, as well as a number of others, showed that the vacuum gap will apparently take care of an enormous current without damage to itself, provided the current is interrupted promptly, as is done by these expulsion fuses. Before this extreme test was made, the breakdown voltage of the vacuum gap was 350, after the test the breakdown voltage was 390.

X-RAY EXAMINATION OF "BUILT-UP" MICA

BY C. N. MOORE

RESEARCH LABORATORY, GENERAL ELECTRIC COMPANY

Until very recently the thought of an X-ray tube immediately called to mind its application to medicine and surgery. The Coolidge tube, however, has broadened the useful scope of the application of X-rays so successfully that it is now employed widely for engineering purposes. In recent issues of the *GENERAL ELECTRIC REVIEW* we have described the method of examining steel castings and copper castings for internal defects; and the present article treats of the X-ray inspection of built-up mica.—EDITOR.

The process of manufacturing "built-up" mica for use as an insulating material in electrical machinery consists essentially in pasting together, at an elevated temperature under pressure, thin flakes of mica with a suitable binder, planing down the resulting product to the required thickness, and cutting it into sheets of the required size. In this process, certain defects which would affect the insulating qualities of the finished product have to be guarded against. Among these are the presence of foreign materials of a metallic nature, and of areas not of the required thickness. In practice, these defects are detected by subjecting the material to very careful visual inspection and gauging with a micrometer. This, however, entails considerable labor. The successful application of X-rays to the detecting of defects in such materials as steel and copper castings, already described in earlier issues of this publication, suggested the possibility of utilizing X-rays as a means of increasing the efficiency of the regular inspection of mica.

With this end in view, Dr. Davey and the writer obtained micas (some known to be good and others known to be defective) for examination in the Research Laboratory. These samples were about 0.032 of an inch in thickness and had been cut into small sheets of the required size for placing in the commutators. These pieces were placed upon a fluorescent screen in a specially designed viewing box (Fig. 1) at a distance of 20 inches from a Coolidge X-ray tube. When the tube was operating with a current of about 6 milli-amperes and a parallel spark gap of six inches, the structure of the mica, as shown on the fluorescent screen, could be viewed from the outside of the box by means of a mirror set at an angle of 45 deg. to the screen.

Some of the samples examined contained small particles of iron oxide not visible to the eye on the surface of the sheet of mica. As iron oxide is much more opaque than mica to X-rays, this material showed up as black spots in the image of the mica on the fluorescent screen. Other samples examined contained small sections not as thick as the main portion of the sheet. These sections, being more transparent to X-rays, showed up as light spots in the image on the screen. Samples of uniform thickness which contained no foreign material gave images of uniform density upon the screen. It was found that the examination could be made

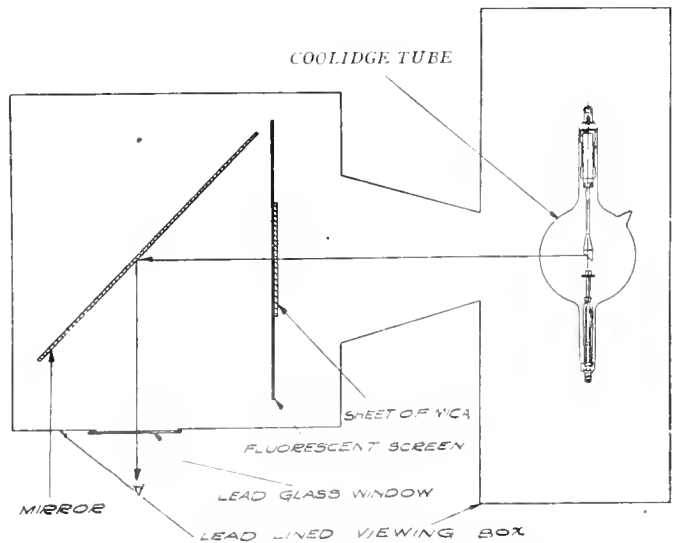


Fig. 1. Arrangement of Coolidge Tube and Viewing Box for Inspection of Built-up Mica

very accurately and rapidly, one glance at the image on the screen being sufficient to detect the presence of any defects.

The nature of the images on the fluorescent screen is shown in the radiographs. These were taken on Seed X-ray plates, with an exposure of five minutes at a distance of

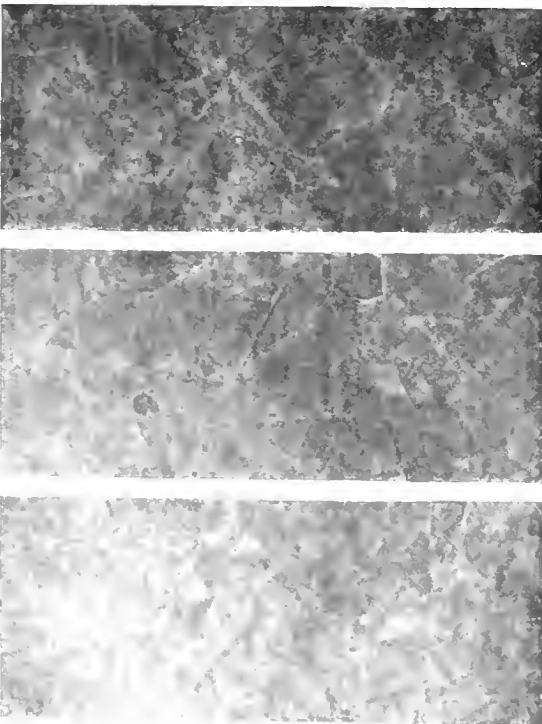


Fig. 2. Radiograph of Three Sheets of Built-up Mica of Fairly Uniform Thickness

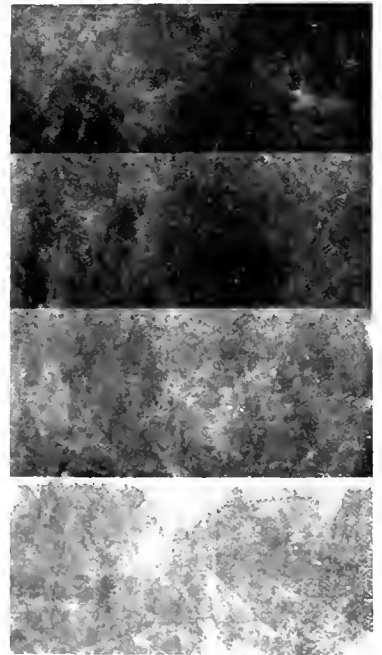


Fig. 3. Radiograph of Sections of Built-up Mica showing a Difference of Thickness of 0.005 in.

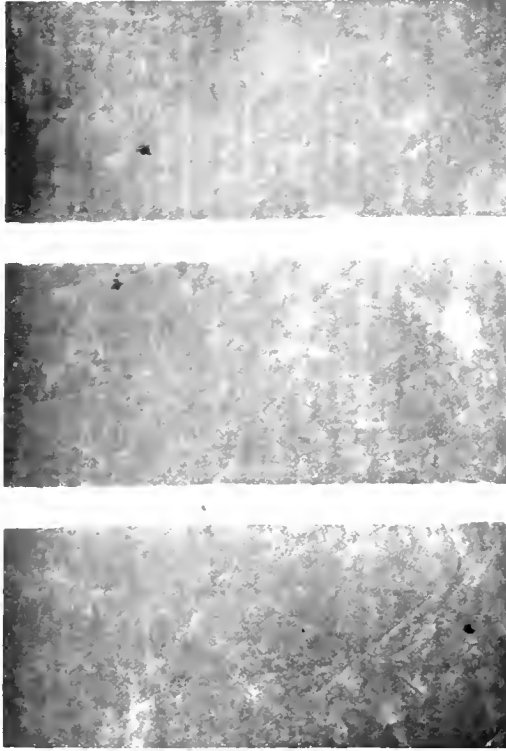


Fig. 4. Radiograph of Mica showing Presence of Particles of Foreign Material

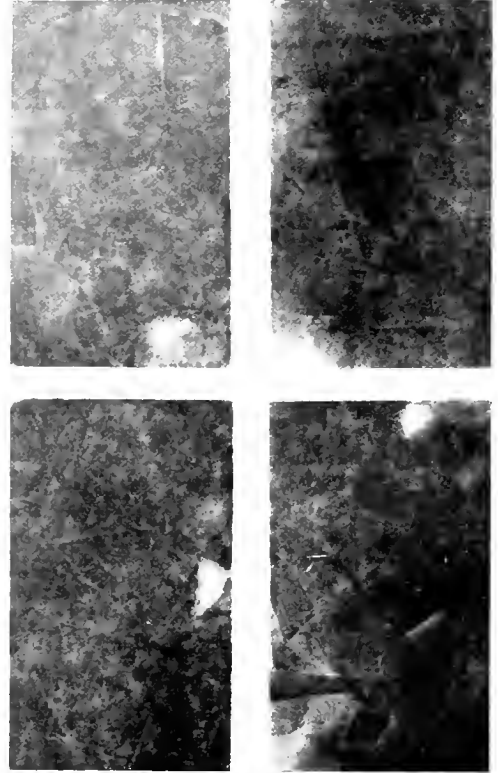


Fig. 5. Radiograph of Four Sheets of Mica 0.032 in. Thick with Small Areas of Thinner and Thicker Sections which show up respectively as Light and Dark Spots

30 inches from a Coolidge tube. The tube was operated from an induction coil on 10 milli-amperes with a parallel spark gap of four inches. Fig. 2 shows the radiograph of three sheets of fairly uniform thickness. The various flakes of mica which go together to make up the finished sheet are plainly visible. As these flakes are in most cases only a few thousandths of an inch in thickness, this radiograph shows what small differences of thickness may be detected by means of the X-rays and the fluorescent screen. Fig. 3 illustrates this more clearly. In this case a sheet of mica 0.050 of an inch thick was planed down so that successive sections were 0.045, 0.035 and 0.020 inch thick. The radiograph of this sheet shows that a difference in thickness of 0.005 of an inch may readily be detected.

The ease with which foreign material may be detected is shown by Fig. 4. The particles of iron oxide present in this particular case were not visible on the surface, but they are plainly visible as black spots in the radiograph taken of the sheets of mica.

Fig. 5 shows a radiograph of four sheets of mica 0.032 of an inch thick with small areas considerably thinner than the main portion of the sheet. These thinner areas show up as light spots in the radiograph.

The results obtained on an experimental scale in the laboratory have demonstrated the adaptability of the X-ray apparatus as a factory tool for the inspection not only of "built-up" mica but of any similar material of not too great a thickness.

THE EFFECT OF CHEMICAL COMPOSITION UPON THE MAGNETIC PROPERTIES OF STEELS

BY W. E. RUDER

RESEARCH LABORATORY, GENERAL ELECTRIC COMPANY

A number of years ago it was universally believed that the purity of a piece of iron was a direct indication of the serviceability of the magnetic properties of that sample. Later experiment has disproved this belief and showed that the changes produced in the magnetic characteristics of iron by the addition of certain foreign materials is, in reality, commercially beneficial. The following article discusses the effects upon the magnetic properties of iron by the addition of silicon, aluminum, arsenic, tin, copper, cobalt, nickel, chromium, tungsten, molybdenum, sulphur, phosphorus, and oxygen. It also discusses the non-ferrous alloys and makes reference to several prominent theories purporting to explain the phenomenon of magnetism.—EDITOR.

There is a legend that 24 centuries B.C. Hoang Ti, Imperial navigator for China, piloted his fleet of junks to victory by means of a floating piece of loadstone.

It was not until the time of Marco Polo, however, that its use as a compass was known in Europe. Frequent mention of its peculiar properties were made before this by Lucretius, Pliny and Plato, and it is said that the Priests of Samothrace made a steady and comfortable income from the sale of magnetized iron rings which were supposed to cure all manner of ills. Thus was born the idea which we now have expressed in the modern "electric belt," and magnetism has been a most lucrative field for all kinds of medical quacks down to the present day.

The two metals most used in the electrical industry of today are copper and iron, and any saving, even in the smallest amount, of either, in electrical design, means an immense saving in the total quantity used. In iron, two diametrically opposite sets of properties are desired depending upon the uses to which it is to be put. For permanent magnets, it

is desirable to have a high coercive force and a high remanence; while for magnetic circuits a high permeability combined with low coercive force is most desirable. The latter of these two uses is by far the most important in that it involves considerably more material and all kinds of electrical generating apparatus.

Besides the desirability of having a high permeability and a low watt loss, it is also necessary to have permanency of magnetic quality, i.e., the losses as calculated in the design must not change under the conditions in which the apparatus is operated. A high electrical resistivity is also desirable so that the Foucault currents may be limited.

For a long time pure iron was considered the best possible material for magnetic circuits, and specifications always called for a pure grade of Norway iron—then, the purest commercial grade of iron. This material satisfied the demands for a fairly good permeability and low hysteresis loss, but unfortunately after running for a short time it was found that both the permeability

and hysteresis had deteriorated, often in the case of the latter, as much as 100 per cent or more. Several years ago some engineers discovered that slight amounts of impurity, such as silicon and manganese, did not injure

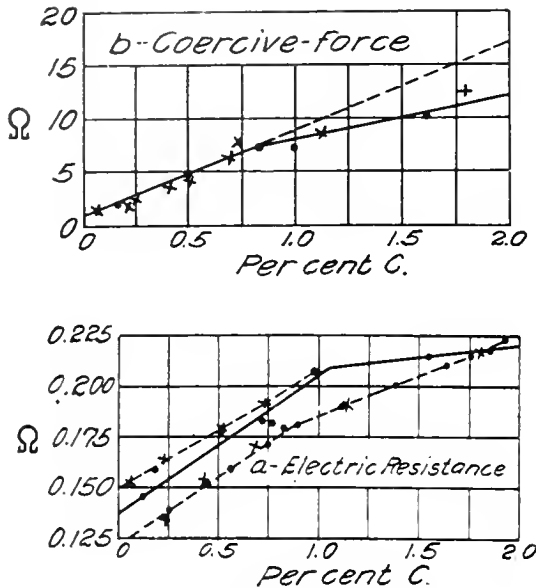


Fig. 1. Effect of Carbon Content upon Resistivity and Coercive Force. (Gumlich)

the magnetic properties and did prevent to a large extent the deterioration of magnetic quality with time. These impurities are of the same kind, and are about the same in amount, as exist in the best grade of basic open hearth steel. This represented the first great step forward, and in 1900, Barrett, Brown and Hadfield published their results obtained on alloys of iron with as high as five per cent of silicon or aluminum which showed the remarkable fact that additions of non-metals or semi-metals, which had no magnetic properties in themselves, would still improve the magnetic quality of iron. Since that time there have been several improvements, but mostly in the mechanical working of the sheets and in their annealing and heat treatment. The useful magnetic properties of iron and its alloys are effected in three ways; first, by composition, second, by mechanical treatment during the process of manufacture, and third by the crystalline structure.

This article will deal only with the effect of chemical composition upon the magnetic properties of steel.

Carbon, always present to a greater or less extent in commercial steels, has a decided influence upon their magnetic properties. Gumlich, working at the Physikalisch-Technische Reichsanstalt, recently published some interesting results upon the influence of this element. These are given in part below.

The electrical resistance rises about 0.06 ohm per m. and sq. mm. for each per cent of C. The curve, however, bends at about one per cent C. and above that the increase is less rapid. Practically the same result is obtained when the coercive force is plotted against per cent carbon.

We know that in all slowly cooled iron-carbon alloys the carbon exists as pearlite up to the eutectoid point, i.e., about 0.85 per cent C., above this percentage the carbon exists as cementite (Fe_3C), the normal carbide of iron, and the curve indicates that the cementite carbon diminishes the conductivity less than does the pearlite carbon. This is explainable by the lamellary structure of the pearlite which is made up of alternate layers of Fe_3C and pure iron each about 1/25000 of an inch or less in thickness.

The effect upon the hysteresis loop is to make it broader and lower because the permeability is decreased from about μ max = 5000 for 0.02 per cent C. to μ max. = 450 for 1.8 per cent C.

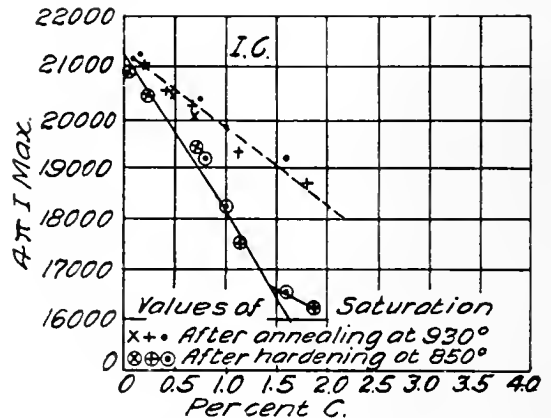


Fig. 2. Showing Decrease in Saturation Value for Increased Carbon Content in Annealed and Hardened Steels. (Gumlich)

The value of saturation, $4\pi I$, which is the true index for magnetic quality, diminishes about 1400 for each per cent of carbon present, so that for pearlite (0.86 per cent C.) its value is 20,200 and for cementite it can be calculated

to be about 12,500, considering pure iron to have a value of 21,600 (see curve, Fig. 2). For hardened steels it will be observed that the decrease is more rapid owing to the percentage of C. held in solution. The break at 1.4 per cent is due to the fact that at the quenching temperature, 850 deg. C., no more carbon was dissolved so the curve becomes parallel to that for the annealed samples which have no dissolved C.

If, now, these alloys be subjected to hardening at different temperatures, we find that the coercive force and resistance rise directly in proportion to the percentage of dissolved carbon as is shown in the curve (Fig. 3).

Only the curve for specimens quenched at 800 deg. C. are given and it will be observed that there is again a sharp break at about one per cent C. This is due to the fact that only this percentage of carbon is soluble in the iron at this temperature. At higher temperatures the curve is smooth, though it bends a little due, no doubt, to the formation of austenite at the higher quenching temperatures.

Silicon and Aluminum

It has been mentioned before that silicon has a decided effect upon the magnetic quality. It is difficult to understand at first how so

silicon is not a direct one; first, because the magnetic quality does not improve in proportion to the increasing silicon content, and second, because the saturation value falls off steadily with increased percentage of silicon

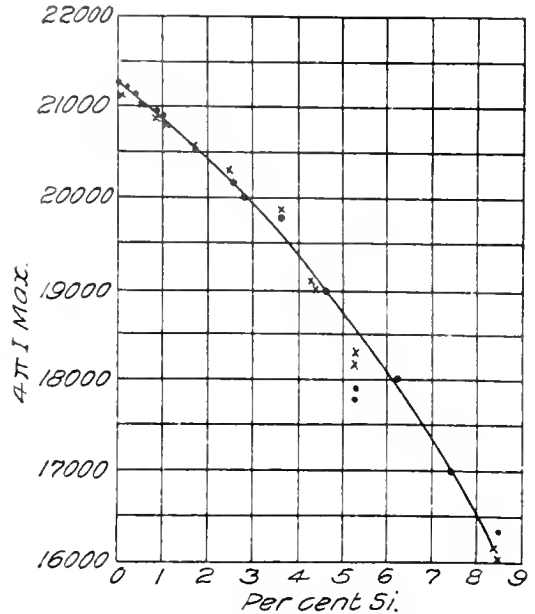


Fig. 4 Showing Decrease in Saturation Value of Steels with Increased Si Content. (Gumlich)

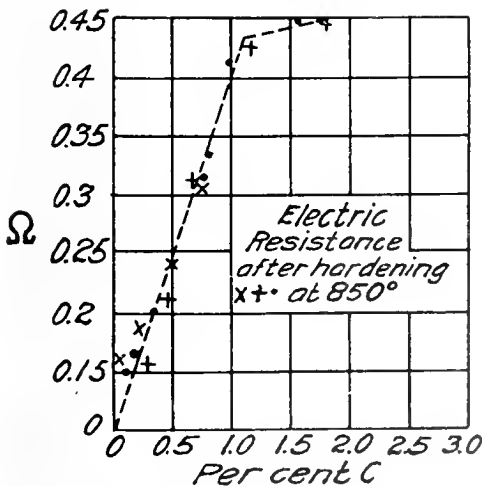


Fig. 3. Effect of Hardening upon the Electric Resistance of Carbon Alloys. (Gumlich)

magnetically inert an element as silicon could produce a better magnetic quality. The term "better," however, is used in the sense of more useful, rather than in an "absolute" sense, for the improvement obtained from

from 21,600 to 16,500 for 8.5 per cent silicon, as shown in the curve, Fig. 4.

This curve shows that the silicon acts largely as a foreign substance, diminishing the active cross-section of the iron and therefore the saturation value.

In brief, the real effect of the silicon upon the steel is this:

(1) It prevents the formation of hardening carbon, even with comparatively quick cooling, and with the higher percentage (3-5) even the formation of pearlite is prevented and all the carbon exists in the harmless graphitic state.

Charpy and Cornu (C.R., May 26, 1913), show that at least 800 deg. must be attained in annealing to change all of the pearlite to graphite for steels having a silicon content of 3.8 per cent, and in general the temperature at which the separation begins is lower as the silicon content is higher.

(2) It cleanses the metal of harmful oxides and dissolved gases.

(3) It produces a larger grain structure in the metal.

(4) It increases the resistivity of the metal from 12 to about 60 or 75 microhms per cm. cube, depending upon the contents. (See curve, Fig. 5.)

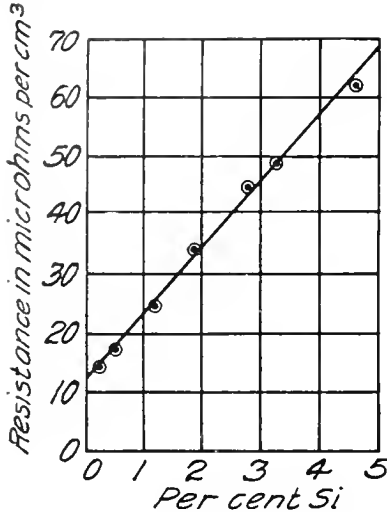


Fig. 5. Effect of Si upon Resistivity. (Burgess)

Paglianti (*Metallurgist* 9, pp. 217-230) made up a series of Si alloys containing 0.2 to 5 per cent Si and drew the following conclusions: The specific gravity diminishes regularly from 7.87 to 7.57 with increased Si over the range studied. For high induction the permeability falls off with increased Si, but for $B=7000$ there is a considerable enhancement of the quality with the addition of Si. With annealed alloys the maximum value of μ was 1500 with 0.2 per cent Si, 3300 with 2 per cent Si, and 2800 with 5 per cent Si. For $B=13,000$ the hysteresis loss with 2 per cent to 5 per cent Si was only half that with 0.2 per cent Si.

The results obtained by Burgess (*Met. Chem. Eng.* 8, 131) are shown in the curves, Fig. 6.

The results which have been obtained in the laboratory with ring samples of 0.015-inch sheet differ somewhat from each of these and are shown in Fig. 7.

Silicon has the effect, however, of making the sheets more brittle. Brinell hardness numbers increase fairly uniformly from 125 with 0.2 per cent Si to 290 with 5 per cent Si (Paglianti). Its use is therefore limited to stationary apparatus such as transformers, although some alloys with 1 to 2½ per cent are used in induction motors. In general, however, generators and motors operate at

such high flux density that the advantage of low watt loss is offset by the decrease in permeability at these high densities, so it is still the practice in this kind of apparatus to use a pure grade of open hearth steel with only about 0.02 to 0.1 per cent Si to limit the aging.

In general, aluminum has the same effect upon the magnetic properties as silicon. It is not, however, in as general commercial use as silicon.

Arsenic and Tin

Burgess and Aston have shown that these elements, like silicon and aluminum, also have the effect of raising the electrical resistance of the steel and of inducing a large grain structure which has a good effect upon magnetic hysteresis.

The effect of tin is to increase the permeability of higher ranges and to decrease the hysteresis loss to a lower value even than silicon. This loss decreases gradually with increasing percentage content of tin.

Tin is, in this respect, better than arsenic which also reduces the hysteresis loss more than silicon when as much as 3.5 per cent is added, but it has the disadvantage of being very brittle.

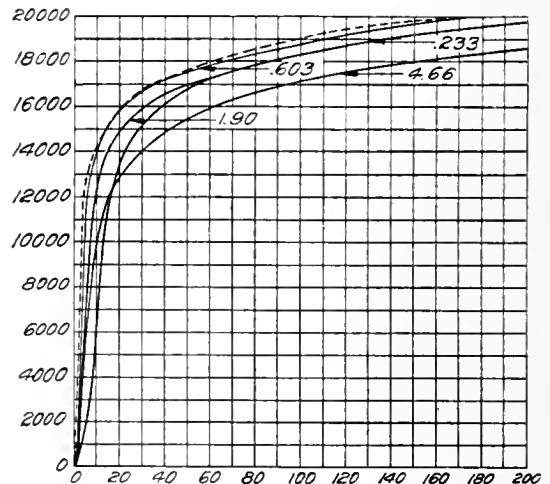


Fig. 6. Magnetization Curves. Iron-Silicon Alloys. Annealed 675 Deg. (Burgess)

Both arsenic and tin have the advantage over silicon of increasing the permeability in the higher working ranges of density. This increase is hard to explain in view of the fact that, like silicon, they are both non-

magnetic elements, and more accurate work on these alloys is necessary before we can explain their results. The action is, no doubt, in view of the more recent work on gases in pure iron, one of a cleansing nature.

Copper

The addition of copper has been suggested as a means of increasing the permeability of iron. In fact, a patent has been taken out upon such a process. The writer has been able to find no case, however, in which the permeability was increased or the coercive force decreased. In fact, the contrary was found to be true, the magnetic quality deteriorating almost in proportion to the percentage of copper added. The one advantage to be gained is that of increased tensile strength in 1 per cent to 2 per cent copper alloys without a very great decrease in magnetic quality. The electrical resistance also rises to a maximum of 17 microhms for 1½ per cent copper at which point it is about 1.40 times that of standard iron.

Cobalt and Nickel

The writer knows of no published results on a systematic study of cobalt alloys with iron, and such results would undoubtedly be quite instructive in view of the interesting results obtained from nickel. Weiss has found, however, that the alloy Fe_2Co has a saturation value 10 per cent higher than pure iron. This is the only alloy known having such properties. The writer's own results have checked this finding.

Nickel (Burgess & Aston, *Met. Chem. Eng.* 8, pp. 23-26), when added in quantities less than 2 per cent, causes little change in magnetic quality. With increasing nickel content, the permeability rapidly falls off and the alloys of 25-30 per cent of nickel are almost completely non-magnetic.

A still further addition of nickel again improves the quality up to 50 per cent, so that for fields under 14,000 B the permeability is higher than that of pure iron and its hysteresis loss is only 50 per cent of that of iron. The sudden drop in permeability above 14,000 B, however, together with its cost prohibits its use as a transformer material.

Chromium, Tungsten, Molybdenum, etc.

Metals, such as chromium, tungsten, molybdenum and manganese, have the general property of increasing magnetic hardness, that is, they increase the remanence and more particularly the coercive force. These are the properties which are desirable for permanent

magnets. It has been found that they work best in combination with carbon or some other element, such as silicon or vanadium. Nickel, though it sometimes aids, in general is found to be injurious to permanent magnetic

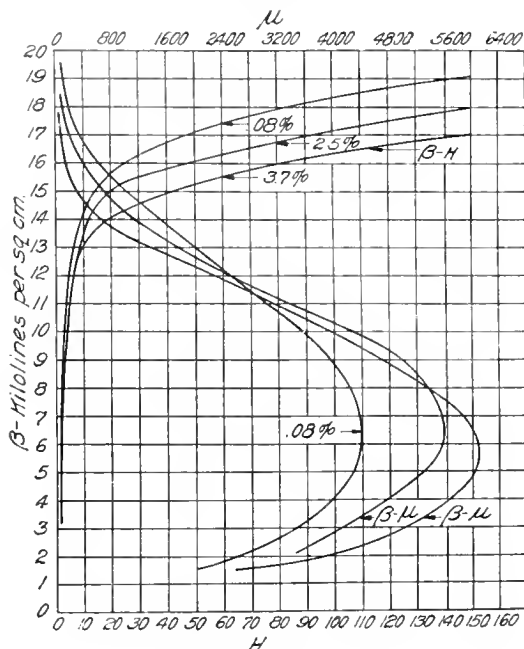


Fig. 7. Effect of Silicon upon the Permeability and Magnetization Curves

quality. Moir (*Phil. Mag.*, May, 1914), has made a study of the magnetic properties of a graded series of chromium alloys.

The curve (Fig. 8) shows the considerable decrease in permeability caused by the addition of 25 per cent of chromium, both before and after annealing.

Steels which are practically non-magnetic can be made by the addition of 12 per cent Mn with about 1 per cent C, which is known as Hadfield's manganese steel. This material has a practically constant permeability of about 1.3. The manganese may be increased to 18 per cent in some cases with the same result. A slight change in heat treatment may create or destroy the magnetic property in such a steel, because Mn has the property of lowering the change point so much that the gamma iron remains unchanged with reasonably quick cooling and gamma iron is non-magnetic.

Sulphur, Phosphorus and Oxygen

Of the elements, sulphur, phosphorus and oxygen, it may be said in general that they

are all injurious. Even though they exist in most cases in very small percentages, they combine in such a manner with the iron to form sulphides of iron and manganese, phosphides and oxides, that they occupy

injurious, magnetically, than the metal added. The additional effects are those of increased resistivity—always at the expense of magnetic quality however—and an increase in the size of the grain.

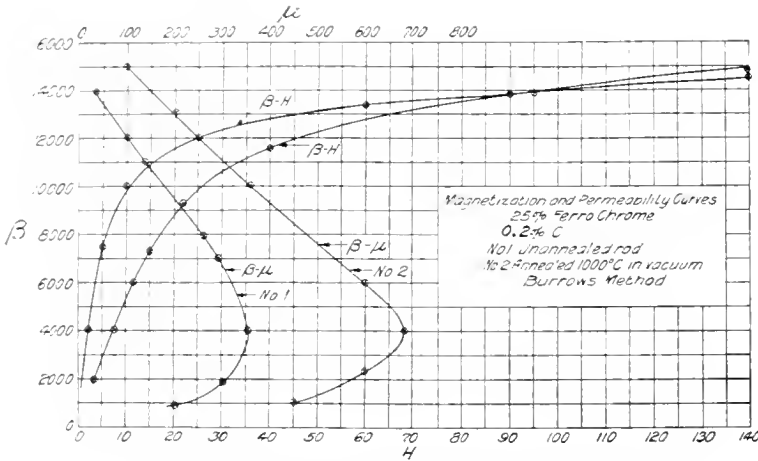


Fig. 8. Magnetization and Permeability Curves; 25 per cent Ferro-chrome, 0.2 per cent carbon. No. 1, Unannealed Rod; No. 2, Annealed 1000 Deg. C. in Vacuum, Burrows Method.

considerably more space than the analysis indicates.

In any case their removal always results in a considerable increase in magnetic quality.

This brings us to a consideration of some of the more recent work on pure electrolytic iron. As pure as commercial iron is, the further purification by electrolysis has made it possible to produce material having a very high permeability and low hysteresis loss. Dr. Breslauer in an article in the E.T.Z. has calculated that a saving of from 15 to 50 per cent in the weight of iron is possible.

The chief disadvantage of this material is its low resistivity—10 microhms per cm⁻³. In generators, however, its high permeability more than offsets its high eddy loss, which is of less consequence in this form of apparatus.

In spite of the high purity of this material, a still greater improvement has been obtained by heating the sheets of alloyed or pure iron to a high temperature in vacuo, or by fusing in vacuo. The effect of this treatment is evidently to remove practically the last traces of impurity, notably sulphur and oxygen.

The important point about this work on extremely pure iron is that it shows that the good results obtained by additions of other elements are all secondary, i.e., their effect is that of purifying material that is more

injurious, magnetically, than the metal added. Their magnetic values are very low compared with good iron; the best value of permeability being about 90-100 at a density of 2200 B. A magnetizing force of 70 which gives a flux of about 17,000 B (lines per sq. cm.) in soft iron gives only 4000 B in the best of these alloys.

The likeness in structure between these alloys and iron is striking, but no definite structure or kind of crystal has been attachable to the strongly magnetic forms as differing from the weak or non-magnetic modifications.

Prof. A. A. Knowlton describes three kinds of crystals separated by their different behavior under the action of the etching reagent, and finds a definite relation between one of these and the saturation value of I, but subsequent workers have not been able to find this relation or to isolate this particular crystal structure. The following statement is taken from a paper by Heusler and Take (*Trans. Faraday Society*, October, 1912):

1. In order to account for the pronounced ferro-magnetism of the Heusler alloys, aluminum or tin-manganese bronzes, Guillaume assumes with Faraday that pure manganese exists in a strongly magnetic modification, which undergoes transformation at a very low temperature; this temperature is said to be raised by the addition of Al or Sn, so that the magnetism of these alloys becomes apparent. This hypothesis is not based upon facts, and the arguments are not sufficiently supported; it would, moreover, not explain the strong ferro-

Non-Ferrous Alloys

About the non-ferrous magnetic alloys much is yet to be learned. These alloys are named after Dr. Heusler who first called attention to them in 1898. A clear understanding of the reason for their magnetic properties and the laws governing them would add much to our understanding of the ultimate nature of magnetism and a brief word here as to their composition and properties would not be out of place. They consist approximately of 62.5 per cent Cu, 23.5 Mn and 14 Al, i.e., Mn and Al in the proportion of their respective

magnetism of the Heusler manganese alloys with As, Sb, Bi and B.

2. Heusler, on the other hand, has advanced a hypothesis which explains all the phenomena; for he has not only discovered the ferro-magnetic alloys, but he also first proved, in 1903, that the appearance of the strong ferromagnetism is due to the formation of chemical compounds, and that the ferromagnetism is thus a molecular phenomenon.

This article may appear more or less a jumble of facts having, in many cases, no continuity of reason. This is largely due to the fact that no theory has yet been evolved which fits in with all of the facts, and research along magnetic lines is largely a matter of cut and try, especially when dealing with alloys of a possible commercial importance. Several theories have been evolved and they are all ingenious, but they have always followed, rather than led, the experimental work. The latest and most interesting theory has been the adaptation, by Langevin of Paris, of the electron theory to magnetism. It does not attempt to predict, of course, what element is to be added to iron to make it more useful, or what element is the most harmful, but these things must be left to be decided by experiment.

As far as a practical use can be made of it, Langevin's theory scarcely goes much further than Ampere's resistanceless circuit theory or the well known molecular theory of Ewing. From a mathematical and theoretical point of view it undoubtedly adds much toward correlating our recent views of energy and matter. (See Dushman, *GENERAL ELECTRIC REVIEW*, 1914, July, Sept., Oct. and Dec.)

The recent work of Bragg (*Phil. Mag.*, Sept., 1914), who has succeeded in determining not only the crystalline structure but the relative location of different atoms in a molecule, has opened the way for an explanation of the ultimate nature of magnetism which will take into consideration the relation of the

position of the elements in the crystalline space lattice to the resulting external effect which we call magnetism. After a thorough study of iron and its alloys by this method we shall be able to completely correlate the jumble of facts which now constitutes our knowledge of the effect of added elements upon the magnetic properties of iron. The magnetic and non-magnetic phases of the Heusler alloys, or Hadfield's manganese steels, may then be explained by a deformation, or permanent alteration of the atoms from their original equilibrium in their crystalline space lattice. Magnetic hardening which so often accompanies real hardening may then be explained on the same ground, viz., that of a strain set up between the atoms in their space relation in the crystal.

The chief difficulty encountered by the experimenter has heretofore been that of obtaining accurate magnetic tests. Most workers along this line have used rods or wires for convenience, and have obtained results which, while they have a comparative value, are quite inaccurate and misleading. Burgess and Aston, who have covered more ground than any one else in the investigation of alloys for magnetic quality, used this form of test piece, recognizing its limitations.

The ring method has long been the standard of magnetic testing. C. W. Burrows (*Bull. Bur. Sids.*, 6) has developed an end compensation method for straight bars which makes it now possible to obtain permeability results on bars which are as reliable as those obtained from rings.

This article has only dealt with the effects of composition upon magnetic quality. The mechanical treatment and crystalline structure also have a very decided influence which can, in extreme conditions, wipe out all the beneficial results of a proper composition.

ELECTROPHYSICS

PART II

By J. P. MINTON

RESEARCH LABORATORY, PITTSFIELD WORKS, GENERAL ELECTRIC COMPANY

In our previous article of this series the author dealt with the properties of cathode rays and electrons. In the present installation the principles of the conservation of electricity and the nature of its flow are considered first; followed by a discussion of the electron theory of matter and electricity and its application to the electrical and thermal conductivity through metals, and also the relationship between these two phenomena. A modified electron theory is also discussed, and the article concluded with a brief summary of the subjects covered in this contribution.—EDITOR.

ELECTRON THEORY OF ELECTRIC CONDUCTION IN METALS

Introduction

In the first article, on the properties of cathode rays and electrons, we considered the experimental results upon which the electron theory is based. No conclusions were drawn, whatsoever, except those which could be drawn from the data at hand. In this article, however, the electron theory of matter and electricity will be briefly developed, and applied to the conduction of electricity through metals. Some contradictions will be encountered, but this means that the nature and the dynamical behavior of a complex piece of matter is certainly not fully known, and does not mean that we are on the wrong path. On the contrary, it is believed that we are, indeed, on the right path to the real understanding of matter and electricity, even though this understanding may be far distant.

The subjects to be considered in this article are:

- I. Preliminary statements on the Principle of the Conservation of Electricity, and on the nature of Flow of Electricity.
- II. Electron Theory of Matter and Electricity.
- III. Application of this theory to:
 - (a) Electrical Conductivity through Metals.
 - (b) Thermal Conductivity through Metals.
- IV. Relation between Thermal and Electrical Conductivities of Metals.
- V. Number of Free Electrons in a Cubic Centimeter of Metal.
- VI. Modified Electron Theory, and its Application to Electrical and Thermal Conductivities of Metals.
- VII. Summary and Conclusions.

We shall now take up these various subjects in the order given.

I. CONSERVATION OF ELECTRICITY AND THE NATURE OF ITS FLOW

Electricity, like matter and energy, is indestructible and cannot be created. If a certain amount of electricity disappears from one place, it always appears in another. For example, if a positively charged sphere is connected to one which is not charged, there is a flow of electricity from the former to the latter. The quantity of electricity lost by one is exactly equal to that gained by the other. Furthermore, the apparent destruction of electricity is due to the neutralizing effect of positive and negative charges on each other.

Again, a positively charged body will induce a negative charge on a body placed near it. At first thought one might say that electricity has been created in this case. Such is not the case, however, for the positively charged body simply attracts the negative constituents and repels the positive ones of the uncharged material. Hence, electricity is separated, not created, and this separation continues until equilibrium exists between the forces thus set up. Hence, there is no such a thing as a generator of electricity, but should properly be called an electrical separator. Consequently, any theory of electricity must explain how this separation of the already existing charges is brought about. We shall see that the electron theory of electricity does this very nicely.

Since we are to consider metallic conduction in this paper, it will be important to first point out how electricity is carried from one place to another. There are displacement (I_d), convection (I_v), and conduction (I_c) currents, and the total current (I) passing through any medium is, $I = (I_d + I_v + I_c)$.

In regard to displacement currents we can imagine an air bubble within a piece of soft rubber. Now, if the air bubble expands or

contracts, the rubber will be displaced throughout its volume, and this corresponds to displacement currents, as in a perfect vacuum condenser where there are only displacement currents. For an alternating potential there is a corresponding displacement current, but for a direct potential the displacement current becomes zero when the stress in the medium balances the force producing the strain.

The flow of ions through electrolytes and gases, of charged particles of mercury vapor in mercury lamps and rectifiers, of electrons in gases and solids, correspond to what are called convection currents. The electron theory deals entirely with these currents.

Now, as to the nature of conduction current we know nothing, and do not even know that there is such a thing. Indeed, in the light of our present knowledge of the electron theory of metallic conduction, it appears that there is no such a thing as a conduction current in metals, but that it is all convection current due to the electrons. Let us, then, take up the development of the electron theory and its application to metallic conduction.

II. ELECTRON THEORY OF MATTER AND ELECTRICITY

We have seen in the previous paper that electrons come from metallic cathodes and they must, therefore, exist in metals, being torn out of them by the electrical forces brought into action. We also saw that when the cathode rays strike a fluorescent substance, say calcium tungstate, some of the electrons remain in the substance. There are many other illustrations which we could use to show that electrons form an important part in the formation of a piece of matter. It has been shown, as in the case of cathode rays, that electrons exist free from matter. Now, the question is how do they combine with matter? Since in gases there are neutral molecules and atoms, it follows that electrons must exist within these in order that the positive and negative electricity may balance each other. So when gases are solidified, electrons must form an important part of the resulting solid matter being bound within the molecules and atoms. We have ample evidence to prove the free electrons exist in gases, and therefore solids if the gases are solidified. Similar remarks apply to vapors, such as mercury vapor for example. Electrons are shot off from radio-active substances and metals heated to a high temperature. In the same way we can show the electrons exist in

all substances. Since, in many cases, they can be liberated from these substances without apparent disintegration of the material, it follows that these electrons must exist in the free as well as the combined states in all substances. The free state refers to their existence outside the atoms or molecules, and the combined state means that they exist within these.

Having shown that electrons exist in all substances, let us see to what extent they are in the free and combined states in these substances. Now, all electronegative elements, like chlorine, sulphur, etc., take on a negative charge, and hence most of the electrons are in the combined state within these. In the case of electropositive elements, like silver, copper, zinc, etc., we have just the opposite state of affairs, and in these there are a great many free electrons as compared with those in the electronegative elements. This means that there is always negative electricity in a piece of matter, and there must, therefore, always be positive electricity. Take the case of a salt, say silver chloride, as an example. The silver is electropositive while the chlorine part of the molecule is electronegative. An atom being electropositive means, from the theory we are developing, that the atom has liberated some of its electrons. Hence this leaves the silver part of the molecule positive, and, therefore, it is difficult for the silver atom to lose more electrons because of the electrical forces brought to bear as a result of the loss of electrons. Since the chlorine part of the molecule is electronegative (that is, it has a capacity for taking on electrons to give it a negative charge) it means that the electrons liberated by the silver atom are taken up by the chlorine radical. After this radical has taken on some electrons, its negative charge will tend to oppose the taking on of any more of them. Both of the actions here described continue until equilibrium is established, when the exchange of electrons ceases. We naturally expect, therefore, that most of the electrons in a salt are in the bound or combined state. However, it is quite likely that a small percentage of all the electrons present are in the free state. This same line of reasoning applies to acids and bases. The conception of free and bound electrons will be utilized in applying the electron theory.

Our conclusions are based upon our experiences, and our experiences indicate that a piece of matter is built up of positive and negative electricity, electrons, atoms, mole-

cules, bound and free energy, and things that we do not yet know about. So, a piece of matter is an extremely complicated thing. Let us, now, take up the electron theory of the conduction of electricity through metals.

III. (a) ELECTRON THEORY OF METALLIC CONDUCTION

From the above discussion we see that there are a great many free electrons in a piece of metal as well as combined ones. Now, the first theory we shall develop considers only the free electrons and that these are in a continual state of vibration between the metallic molecules and atoms. This movement is in all conceivable directions, so that there is no resultant transfer of electrons along a wire. In this case there is no current flowing. Suppose, however, an electric force (E) is applied to the wire. Then, there will be a resultant transfer of electrons along the wire in the direction opposite to the electric force on account of the electrons possessing a negative charge.

We see, therefore, that we are dealing with two electronic velocities; the first (v) being that due to the random vibration between the collisions of the electrons with one another and with the molecules and atoms, and the second (U) being the resultant drift of the electrons along a wire constituting the flow of current; (U) and (v) are average values, of course. Now, in this theory we apply Boltzman's principle, namely, that in any gas the mean kinetic energy of all molecules are equal. So, we assume that the free electrons of a piece of metal act like a gas, and hence, the kinetic energy of the electron must be the same as that of a hydrogen molecule at the same temperature. Since the mass of the electron

is about $\frac{1}{3500}$ of that of the hydrogen molecule, it follows that (v^2) must be about 3500 times the square of the velocity of the hydrogen molecule. The mean velocity of the latter, as shown by the kinetic theory of gases, at 0 deg. C. is about 1.7×10^5 cm. sec. so that $v^2 = 3500 \times (1.7 \times 10^5)^2$, or $v = 2 \times 10^7$ cm. sec. approximately, which is the velocity (v) of the electron. (U) is so much smaller than this that it need not be considered in obtaining the mean kinetic energy of the electron within the wire under consideration. For, suppose $U = 1$ cm. sec., then from equation (1) below $I = NeU$. Now, we shall see later in this article that $N = 10^{24}$ approximately, so that $I = 10^{24} \times 4.8 \times 10^{-19} \times 1 = 4.8 \times 10^5$ amp.

approximately, which is very large. Since this current is excessive, it follows that (U) must be small.

Let us, now, derive expressions for the magnitudes of the current and the electric conductance from this theory. We all know that the current (I) flowing across an area of one sq. cm. equals the charge per cu. cm. multiplied by the velocity of drift (U). If there are (N) free electrons per cu. cm. and e is the charge on each electron, then Ne equal the charge per cu. cm. So that,

$$I = N e U. \quad (1)$$

We can get an expression for (U) in the following manner. During the time an electron is moving along its mean free path it traverses a distance due to (E):

$$D = 1/2 a t^2 \quad (2)$$

where a , the acceleration due to the force Ee acting on the electron between collisions is:

$$a = \frac{Ee}{m} \quad (3)$$

Substituting equation (3) in (2) we obtain:

$$D = \frac{E e t^2}{2 m} \quad (4)$$

Since $D = U t$, we have from (4)

$$U = \frac{E e t}{2 m} \quad (5)$$

now equation (5) applies to the electron during its motion between collisions, so that (t) is the average time between the impacts of all the electrons. From the kinetic theory of gases,

$$v = \frac{h}{t} \quad (6)$$

where (h) is the mean free path of the electrons, and (v) their average velocity of vibration over this path. Eliminating (t) from equations (5) and (6) we get:

$$U = \frac{E e h}{2 m v} \quad (7)$$

Hence, when we substitute this value of (U) in equation (1) we have: (See note at the end of this article.)

$$I = \frac{N E e^2 h}{2 m v} \quad (8)$$

which is an expression for the intensity of the electronic current in any substance. If there are only a few free electrons (N) in a substance, as in the case of glass, and other insulating materials, salts, as well as in electro-negative elements, there must, according to this theory, be a relatively small current

passing. On the other hand, if there are a great many free electrons in a substance, as in the case of the electropositive elements (metals), then there will be a relatively large current flowing. All this is in agreement with experimental observations. In this theory the atoms have played no part in the metallic conduction which, of course, is also in agreement with observation. If (E) is a complicated function, as in the case of high frequency phenomena, then equation (8) will be modified accordingly. In fact, (E) can represent a steady potential, a harmonic one, or any sort of a potential. It would be necessary, of course, to start with the fundamental differential equations of motion for such an analysis of the problem.

Before passing on to the thermal conductivity, it will be well to show that equation (8) is in agreement with Ohm's law. Before showing this, however, let us modify this equation. The kinetic theory of gases tells us that the average kinetic energy of a hydrogen molecule at an absolute temperature (T) is $\alpha T = \frac{1}{2} m v^2$, so that this is also, according to our theory, the average kinetic energy of the electron at an absolute temperature (T). (α) is a constant and equals 1.5×10^{-16} approximately. Putting $2 \alpha T = m v^2$ in equation (8), we have:

$$I = \frac{N E e^2 h v}{4 \alpha T} \quad (9)$$

and since the conductance σ is the current per unit electric force,

$$\sigma = \frac{N e^2 h v}{4 \alpha T} \quad (10)$$

Now, Ohm's law states that the conductance is independent of (E), which is in agreement with equation (10). It may be further stated that since resistance equal $\left(\frac{1}{\sigma}\right)$ equation (10) shows that the resistance varies directly as the absolute temperature. We may look upon resistance as being due to the collisions between the electrons and the atoms. One would also expect frequency to have an effect on the resistance because of the change in the number of collisions per cycle with increased frequencies. All these effects have been noted.

III. (b) THERMAL CONDUCTIVITY

If one part of a piece of metal is at a higher temperature than another, then the average kinetic energy of the electrons in the hotter

regions will be greater than that of those in the colder portions.

Considering that the electrons act like a gas, then it is clear that across any section separating the hot from the cold portions, a transfer of electrons will take place. Due to the greater kinetic energy of the electrons on the hot side of the section, there is a transfer of heat to the cold portion of the metal as the electrons pass from the former to the latter. If we assume that all the heat is carried in this manner, then it has been shown in works on the kinetic theory of gases that κ , the thermal conductivity, is given by:

$$\kappa = 1/3 N v \alpha h \quad (11)$$

IV. RELATION BETWEEN THERMAL AND ELECTRICAL CONDUCTIVITIES

Having obtained the expressions for the thermal and electrical conductance, let us see what relation exists between them. To do this we simply divide equation (11) by equation (10) thus,

$$\frac{\kappa}{\sigma} = 1/3 N v \alpha h / \frac{N e^2 h v}{4 \alpha T}$$

or

$$\frac{\kappa}{\sigma} = \frac{4 \alpha^2 T}{3 e^2} \quad (12)$$

or at $T = 300$ deg. C., absolute.

$$\frac{\kappa}{\sigma} = \frac{4 \times (1.5)^2 \times (10^{-16})^2 \times 3 \times 10^2}{3 \times (5 \times 10^{-10})^2} = 4 \times 10^{-11}$$

approx. in C.G.S. electrostatic units. Equation (12) shows us that the first theory of electronic conduction in metals leads us to the conclusion that the ratio of the thermal to the electrical conductivity should be the same for all metals, and should vary directly as the absolute temperature, being entirely independent of all metals. So that with good electrical conductivity goes good thermal conductivity. The following table shows how nicely these theoretical conclusions are verified by actual experiments.

Metal	$\frac{\kappa}{\sigma}$ (at 18° C.)	Temp. Coef. of $\frac{\kappa}{\sigma}$ add
Al	7.08×10^{-11}	0.043×10^{-11}
Cu	7.4×10^{-11}	0.039×10^{-11}
Ag	7.6×10^{-11}	0.037×10^{-11}
Au	8.0×10^{-11}	0.036×10^{-11}
Pb	7.9×10^{-11}	0.040×10^{-11}
Pt	8.3×10^{-11}	0.046×10^{-11}

We shall have occasion to point out some variations in this ratio in the next article.

Since (κ) is very nearly constant over a certain range of temperature, it follows from this theory that (σ) must decrease with increasing temperature; this agrees with experiment.

V. NUMBER OF FREE ELECTRONS IN METALS

It will be of interest to obtain an approximation to the number of free electrons there must be in one cu. cm. of a metal according to this first theory. In the case of silver for

example $\sigma = \frac{1}{1600}$ at 0 deg. C. Now, we will

not be far wrong if we assume the mean free path of the electron (h) to be about 10^{-7} cm. Substituting the various values which have been given for the quantities involved in equation (10), we get $N = 10^{24}$ approximately, which is equivalent perhaps to five or six free electrons for each atom of silver.

Perhaps it will be well at this point to refer to values obtained by other methods. J. J. Thomson concludes from work on the coefficient of absorption of radiation by a metal that the number of free electrons in silver appears to be *not less* than about 11 for every atom of silver. Earlier than this Drude and Schuster in determining the absorption of light by metals concluded that silver possessed about one, mercury about three and one-half, and antimony about seven and one-half, free electrons for each atom of metal. Work with Dulong and Petit's law, that the product of the atomic weight and specific heat is nearly the same for all metals and is constant, has led to the conclusion that the *maximum* number of free electrons is two per atom of metal. This conclusion is based on the assumption that all the heat energy be attributed to the free electrons associated with the atoms. In the next article will be given another method by which we can estimate the number of free electrons in metals. Since the order of magnitude for the number of free electrons in metals is the same when determined from such different methods as here indicated, it would appear that there is some element of truth in this theory of free electrons. It will be well to note that equation (8) shows that the electric conductivity does not depend only on the number of free electrons in a metal. The value of (N) might be somewhat greater for poorer conducting metals than for good ones. The difference is accounted for by (h) and (v) being different for different metals.

It is very important to notice in connection with equation (10) that if (σ) is constant (as it is under given conditions), then ($N h v$) must be constant. Now, if the mass of the carrier of electricity was much greater than the electron, then ($h v$) would be less, and hence, (N) much larger than given by the above values. So that the number of carriers of electricity in this case would be much larger than the number of atoms of silver. We are forced to say, therefore, that these carriers cannot have masses comparable with those of the atoms, which likely take little part in the phenomenon of electric conduction.

Perhaps it will be well to point out a very noticeable contradiction in the theory as developed here. The energy required to raise the temperature of an electron 1 deg. C. is $\alpha = 1.5 \times 10^{-16}$ ergs. about. So, if there are 10^{24} free electrons in one cu. cm. of silver, then to raise the temperature 1 deg. C. of the electrons alone would require $(1.5 \times 10^{-16} \times 10^{24}) = 1.5 \times 10^8$ ergs, or about 4 calories. But to raise the temperature 1 deg. C. of one cu. cm. of silver requires only 0.6 calories. Hence, the electrons alone use more energy, according to our theory, than do the electrons plus the atoms by actual experiment. (See note at the end of this article.) We must therefore modify the theory, somewhat, in order that it shall agree with the experimental fact. This change is made as follows:

VI. MODIFIED ELECTRON THEORY

On account of this contradiction in the case of specific heats, it is quite certain that the electrons cannot be in thermal equilibrium with its surrounding metallic molecules. In order to overcome this discrepancy J. J. Thomson has modified the above theory, and supposes that the electrons shoot from one atom directly into another one, and thus thermal equilibrium is not established between the atoms and electrons. This motion is in every possible direction, and hence, there is no resultant flow of current. (The positive and negative atoms form small electric doublets.) If, however, a potential is applied to the wire, then he considers the atomic doublets are polarized, much the same as some people consider the atoms of a permanent magnet are polarized. The negative sides of the doublets will be pointing in one direction, and the positive sides in the other. The result of this polarization is that more electrons move in one direction under the action of an electric force than in any other, so that a passage of current occurs.

The final equations he obtained were:

$$\sigma = \frac{2 e^2 d p n b}{9 (\alpha) T} \quad 13$$

$$\kappa = \frac{n b^2 p \alpha}{3} \quad 14$$

$$\frac{\kappa}{\sigma} = \frac{3 b (\alpha^2) T}{2 d e^2} \quad 15$$

Where (p) is the frequency with which a doublet liberates electrons, (n) is the number of polarized doublets per cu. cm., (b) is the distance between the charges in the doublet, and (d) is the distance between the centers of the adjacent doublets. In a metal (b) is nearly equal to (d) so that $\frac{b}{d} = 1$ (approximately). Hence, in this case the ratio of the conductivities on the new theory would be to that on the old in the proportion of 9 to 8 as given by equations (12) and (15). This theory as well as the old is in agreement with facts, but this theory tells us that this ratio is not an absolute constant on account of the factor $\left(\frac{b}{d}\right)$, which varies slightly for good conductors and more for bad ones. This is in agreement with fact.

VII. SUMMARY AND CONCLUSIONS

In this article have been mentioned the principle of the conservation of electricity and the three methods by which we consider it to flow. It has been pointed out how the electron theory applies to this important principle in that it explains the separation of the already existing charges. We have seen that this theory deals with convection currents entirely, and that it explains fairly well both qualitatively and quantitatively the part now played by conduction currents, about which we know nothing.

Although we have not developed an entirely satisfactory electron theory, as has been pointed out, yet, since we are learning more about electrons and the laws which they obey under all conditions, we are fairly certain that we are advancing toward a more complete understanding of the various phenomena of electric conduction.

NOTE:—A more rigorous treatment of this problem along the same line for a steady electric force (E) would lead to the result:

$$I = 2 \sqrt{\frac{2}{3\pi}} \frac{N E e^2 h}{m v}$$

(See G. H. Sirens, "Electron Theory of Metallic Conduction," *Phil. Mag.* pp. 173-183, Jan. 1915.) This is also the same result that Lorentz obtained in his book on "The Theory of Electrons." H. A. Wilson (*Phil. Mag.* Nov. 1910) obtained still another expression for (I); it differs, however, from these only in the constant term. The above equation is about twice as great as indicated by equation (8). The above equation would lead to a value for (N) about half as great as does equation (8). Even this, however, would not yield values for specific heats that were in agreement with observations.

In connection with the question of specific heats one may refer to Lindemann, "Theory of Metallic State" *Phil. Mag.*, p. 129, Jan. 1915. In this article the author states, "The hypothesis put forward in this paper is, that far from forming a sort of perfect gas the electrons in a metal may be looked upon as a perfect solid." Statements similar to this indicate that our conception of the electron itself has not changed so much as has our conception of its intimate association with matter.

LOCK ENTRANCE CAISSON FOR THE PANAMA CANAL

BY LEWIS A. MASON

ASSISTANT DESIGNING ENGINEER IN OFFICE OF THE ENGINEER OF MAINTENANCE OF THE PANAMA CANAL

Eight articles describing the devices controlling the lock machinery of the Panama Canal appeared in the January, 1914, number of the *GENERAL ELECTRIC REVIEW*; three articles describing the generation and distribution of electric power for the Canal Zone were contained in the July, 1914, issue; and the towing system and locomotives were described in an article in the February, 1915, issue. The following pages present an interesting description of the mechanical, hydraulic, and electrical features of the lock entrance caisson which is to be used at the locks to hold back the water and to pump out the chambers when repairs are to be made to apparatus that is normally submerged.—EDITOR.

In connection with the various equipment required for the maintenance of the Panama Canal Locks, the Union Iron Works Company, of San Francisco, has recently completed a huge floating gate or caisson which will be used for closing the entrance to any one of the lock chambers of the Panama Canal when it is desired to paint or make repairs to any one of the mitering lock gates and for similar use in the Balboa dry dock. It also can be used for unwatering any one of the lock chambers, for the purpose of making an inspection of the culvert, rising stem gates, or cylindrical valves.

The clear width of the lock chambers is 110 feet. Beyond the line of the emergency dams, the approach is widened by an offset of three feet on both sides. The shoulders so formed, with the connecting horizontal sill across the bottom of the chamber, afford a frame or seat into which the caisson is fitted to dam off the interior of the lock chamber.

This is accomplished by floating the caisson from its mooring position by means of a tug boat, or other motive-power water craft, to the particular lock chamber entrance which is to be dammed. After being placed in its recess across the lock entrance, water will be let into the lower compartments, thereby causing it to sink until properly seated. When this is completed, an electric power cable will be connected from the main power cables, provided within the lock walls, to a terminal box located on the top deck and at the end of the caisson. This point is electrically connected through the switch-board within the caisson to the various motors that operate the pumps. The pumps will then unwater the lock chamber, and the water pressure on the outer side of the caisson will force it securely against its seat in the masonry.

When it is desired to remove the caisson, the lock chamber will first be filled with water by opening the culverts within the

lock walls. This will balance the water pressure on both sides of the caisson, at which time the water within it will be pumped out, thereby causing it to float and allow it to be towed away.



Fig. 1. An End View of the Caisson Taken but a Short Time Before it was Launched

The caisson is designed for use at all of the lock entrances, and has a light-draft of 32 feet to permit its being handled conven-

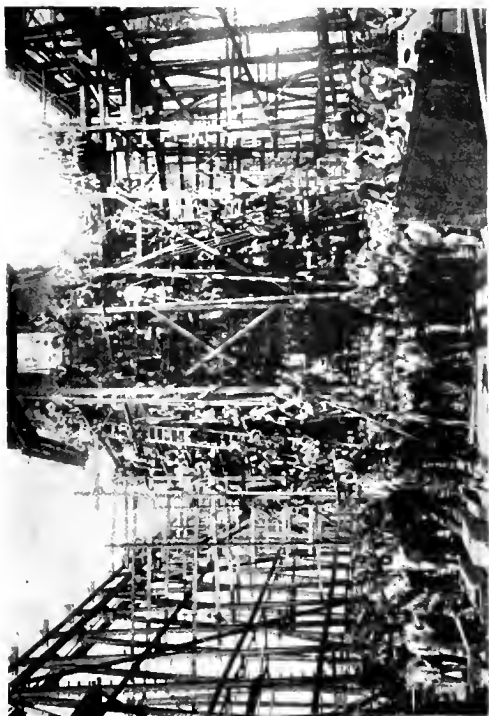


Fig. 3. Photograph of the Caisson and the Workmen Employed in Building it

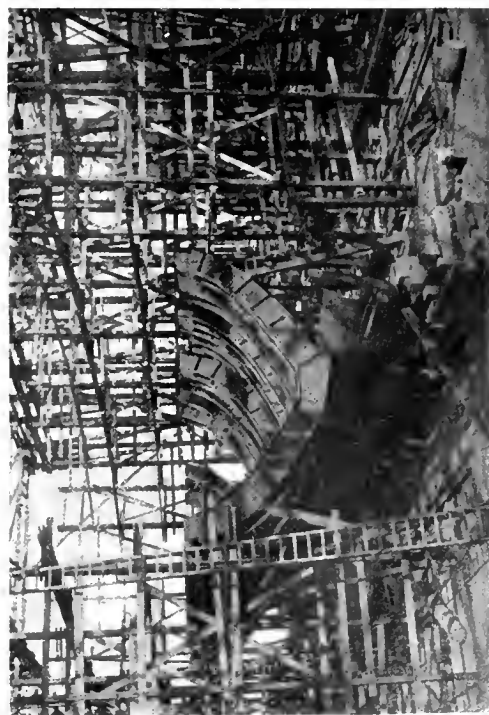


Fig. 2. Photograph of the Caisson in a Very Early Stage of Construction



Fig. 4. An Interesting Photograph of the Launching of the Caisson



Fig. 5. The Caisson Under Tow on Its Way to the Panama Canal Zone

iently through the various locks. The top of the sill at the Pacific end of the Miraflores locks is 50 feet below mean sea-level, and with the tidal fluctuation which raises the level of the water as high as 11 feet above mean tide this requires that the caisson be sunk to a draft of 61 feet when used at high tide. Provision for a proper freeboard requires an aggregate depth of the structure of 66 feet. The achievement of statical stability at the various depths of immersion without undue bulkiness or excessive weight in the different drafts makes the caisson of especial interest.

In form, the bottom of the hull is convex, the ends pointed, and the sides sloped inward from the maximum width of 36 feet, at about one-third the way up from the keel, to a breadth one-half as great at the top deck.

framing built intercostally and extending from the keel to the top deck transmits the panel loading to the various horizontal decks and breasthooks. The essential features of the structure are the transverse and longitudinal framing, with bulkheads; the horizontal plate decks, girders and stringers; the girders at the vertical ends and along the keel; the end breasthooks; and the sheathing plates to cover the skeleton for forming the hull proper. These elements are made from open-hearth structural steel.

The transverse framing system consists of nine cross-frames, spaced 12 feet apart from the middle of the caisson and extending to its entire height, and the intermediate frames, spaced two feet apart between the main cross-frames. All are built intercostally between the five horizontal decks.

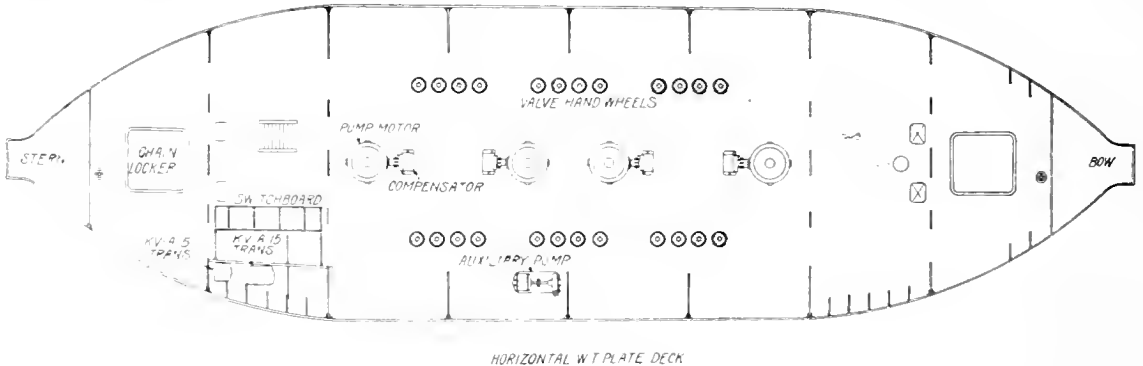


Fig. 6. Plan View of the 37 Ft. Deck Showing the Location of the Electrical Apparatus

A typical transverse cross-section of the caisson resembles in outline the vertical section through a pear-shaped, carbon-filament electric globe. The horizontal lengthwise sections vary with the inward slope of the sides; in general, they resemble those of the ordinary vessel of commerce, and may be described as flattened ellipses, blunt at the ends in order that they may connect to the vertical end-girders, or stems. The maximum length of the caisson from vertical end to vertical end is 112 ft. 6 in. The extreme length is 113 ft. 10 in. This includes the timber cushions.

It is desired that the side walls of the caisson shall carry practically all the static load from the caisson when it is supporting the water pressure. Accordingly, there are a number of horizontal decks and breasthooks, or bulkheads, between the main decks at the ends which carry the hydrostatic load at the vertical ends. A system of vertical

The last cross-frame at each end is made water-tight, by the same principle as is used in merchant ships, in order to form peak trimming tanks for maintaining a level keel when placing the caisson in its recess across any one of the lock chambers. The seven other cross-frames serve as swash bulkheads for controlling the water within it.

The five horizontal decks are located at the respective following distances above the centerline of the keel plate: 16 ft., 25 ft., 37 ft., 49 ft., and 65 ft. The 16 ft. and 25 ft. decks are entirely plated over with the exception of openings left to allow for the removal of pumps, valves, etc.

The 37 ft. deck is entirely plated over and is made absolutely water-tight. It has water-tight manholes for gaining access to the various compartments below and water-tight hatches for the removal of the pumps or valves in case it is necessary to make repairs, etc., to them. This deck is made of

sufficient strength to withstand a hydrostatic head of 25 ft. Upon it is placed the various motors for operating the pumps, the switch-board, the water gauges, the chain lockers, etc. The horizontal deck 49 ft. above the center line of the keel is of the open-truss construction, and has diagonal bracing for the central two-thirds of its length and plating covering for the ends. The top deck, 65 ft. above the center line of the keel, is plated over from end to end and has openings for manholes, skylights, deck cranes, companionways, ballast compartment vent pipes, and scuppers.

The breasthooks, or short decks, of which there are six in number, serve to transmit part of the loading from the horizontal decks to the vertical end-girders. In addition to the decks and breasthooks, there are located equidistant between the keel and the 16 ft. horizontal deck two lines of intercostals extending longitudinally and securely riveted to the transverse frames and to the sheathing.

For transmitting the end reactions from the horizontal decks and breasthooks to the vertical end-girders, or stems, steel castings are provided and made to fit very closely between the horizontal decks and breasthooks and the vertical ends, to which they are securely riveted.

The skeleton or framing is entirely sheathed over with steel plating worked in in-and-out strakes, running longitudinally over the transverse frames, making lap seams and butt joints which have double splic plates. Around all of the openings in the plate decks, and in the sheathing, doubling or reinforced plates are fitted. To protect the sheathing when maneuvering the caisson near the lock walls, fenders are provided on the exterior of the sheathing along the 25 ft. and 49 ft. levels, and vertical fenders are placed between the horizontal ones, at seven of the amidship cross-frames. The fenders are built of bent plates, securely riveted and calked to the sheathing plates; the space between is filled with "Petrolastic" cement—a by-product of crude oil. Its specific gravity is 1.02; its expansion at a temperature of 110 deg. is 0.0018, and its melting point lies between 150 and 200 deg. F.

Because of the long towing distance from the place where the caisson was built two large towing rings are provided and are securely fastened to the sheathing and to the 43 ft. breasthook at both ends and on each side of the caisson. As a means for

towing the caisson from its mooring position to any one of the lock sites, there are three towing rings provided which are securely riveted to the sheathing along the level of the 37 ft. horizontal deck on both sides of the caisson.

Along the exterior of the keel and the vertical ends, steel castings (the cross-sections of which are channel-shaped) are provided and are securely riveted to the keel, vertical ends, and sheathing. Into these there are neatly fitted and bolted British Guiana greenheart and Australian ironbark timber cushions. There is also a cushion fitted along the sides of the keel and along the sides of the vertical ends, which are also made of the timbers mentioned. These cushions come into contact with the caisson's seat provided in the lock chambers and form a water-tight seal.

Miscellaneous Fittings

Through a water-tight companionway on the top deck a stairway leads down to the 37 ft. operating deck. Ladders from this deck are provided for gaining access to the various lower compartments. Ladders are provided in the end peak trimming tanks, extending from manholes in the top deck to the 16 ft. horizontal deck, or bottom of the trimming tank. For getting aboard the caisson a ladder is provided on each side and is attached to the sheathing. It extends from the level of the 32 ft. water-line to the top deck.

There are three portable cranes located on the top deck, one at each end of the caisson and one in the center. The two end cranes are similar in construction, and are capable of raising or lowering a load of 3000 lb. at a radius of 14 feet by two man-power. These cranes are used for lifting various loads onto the caisson from the lock walls, as well as for handling electric power cables. The middle crane is heavier in construction than the end cranes and is capable of raising or lowering a load of 3000 lb. at a radius of 25 feet by two man-power. This crane will handle the pontoon (stowed on the top deck) when it is desired to make the pump suction extension attachments, and is capable of lifting the top sections of either one of the two skylights. Hand-operated deck capstans are provided and placed at each end of the caisson on the top deck. The capstans are installed for the purpose of warping the caisson into its recess. Each is capable of withstanding a pull of 10,000 pounds.

Two ventilators, each 16 inches in diameter, with hoods and turning mechanism of the standard navy type, are placed on the top deck for ventilating the operating room. Both of these ventilators extend from the top deck to a short distance below the 49 ft. horizontal deck. At the end of one is fitted and connected an electric-driven multivane exhauster to supply a means for assisting the air to escape from the various water-ballast compartments when they are being filled. There are eight 6-inch diameter air vents, extending from the various ballast compartments to the top deck, and one air vent in each of the end peak trimming tanks placed in the top deck. Two skylights 8 ft. by 16 ft. in size are fitted in the top deck, symmetrical about the axis of the caisson. The tops are made in two parts, for easy removal. In each top section there are openings fitted with water-tight covers, which can be opened or closed by means of a raising apparatus located and secured under the top deck and operated by means of a handwheel from the operating deck.

To increase the draft of the caisson to a depth sufficient to insure its stability at light draft, without water in the ballast compartments, approximately 800 tons of permanent ballast, composed of iron punchings, etc., and concrete, is placed in the bottom.

An anchor chain, made of material $1\frac{9}{16}$ inches in diameter, is provided at each end for mooring the caisson to floating buoys in the fresh water lakes when it is not in service. The anchor chains are raised or lowered by means of the hand-operated winches, located at each end on the top deck.

Pumping System

The main pumping system consists of four vertical-shaft, bottom-suction type centrifugal pumps which, with their individual driving motors, constitute four units. Each unit is designed for an average capacity of 13,000 g.p.m. against a maximum head of 70 ft., this capacity being the average to prevail between heads varying from zero to the maximum (70 ft.). The suction opening of each pump is 22 inches in diameter and the discharge 20 inches.

From the illustration of the outline drawing of the complete pumping unit, it will be seen that the intermediate shaft connecting the pump to the driving motor is supported by an intermediate guide bearing. The drawing also shows that the thrust bearing, which

carries the load of the revolving element, is located at the motor deck and is contained in a base-plate which, in turn, acts as a support for the motor itself. The thrust bearing is of the ball-bearing type, and is made self-oiling by means of an oil pump which takes its supply from a revolving pin located beneath the bearing and which returns the oil to a reservoir that surrounds the ball bearing. The intermediate guide bearing and the pump bearing are water lubricated. The pump casing, together with the impeller, is made of cast-iron and is bronze lined at the points where the impeller comes in contact with the casing, also where the shaft passes through the bearing and the stuffing box.

The pumping plant is employed for a double purpose: first, for emptying the water ballast from the caisson when it is to be removed from its position against the sill and, second, for unwatering all lock chambers except those which can be emptied by gravity. (The only chambers in the Panama Canal that can be emptied by gravity are the upper lock chambers at Gatun; the elevation of the floor there is $13\frac{2}{3}$ ft. above sea level.)

The capacity of the pumping system is designed so that it will pump out, in not more than 25 hours, all of the water in the upper and lower chambers of one flight of the Miraflores locks between mean sea-level (elevation zero) and the top of the sill of the lower chamber (-50 ft.); the tidal level to be at elevation zero when the pumping is begun and the tide to be rising. The total quantity to be pumped is estimated at 10,285,000 cubic feet. Of this quantity 518,000 cubic feet is allowed for leakage through the various cylindrical and rising stem gate valves in the lock culverts, as well as allowances for leakage around the sills of the mitering lock gates and the caisson sill. The pumps will pump out, when operating at any stage of the tide, the water on the floors of the lower lock, from the top of the sill (-50 ft.) to 2 ft. below it. To do this 22-inch suction pipes are attached to the auxiliary suction inlets of the caisson, and these extend to and into the nearest lateral culvert in the lock chamber. When not in service, the suction extension pipes, of which there are four in number, are stowed in cradles provided for the purpose on the 49 ft. horizontal deck. They are handled by the large deck crane located in the center line of the top deck.

An electric-driven horizontal centrifugal pump, with a $3\frac{1}{2}$ in. diameter suction and

a 3 in. discharge, is located on the operating deck. It has pipe connections leading from the suction to a manifold and from the discharge to another manifold. From these manifolds piping is connected to the end peak trimming tanks, to the deck scuppers, to the sea, and to a mud-slushing device. The mud-slushing device is intended to remove mud from the caisson sill in an endeavor to prevent it from adhering to its seat when in the act of rising. The pumping equipment was manufactured by Henry R. Worthington, Harrison, N. J.

Electrical Equipment

The main pumps are driven by 200-h.p. vertical induction motors, wound for 25 cycles, 2200 volts, three-phase, and which have a speed of 750 r.p.m. The motors for operating the ventilating fan and the 3-inch, or auxiliary pump, are induction motors of the horizontal type, and are wound for 25 cycles, 220 volts, three-phase. For lighting purposes, 110 volts are used. All of the electric motors (with the exception of the one for driving the multivane exhauster, and their controlling switchboard are located on the operating deck, 37 ft. above the base line. All of the valves in the pumping system are operated from this same deck.

The switchboard consists of five panels, and, from right to left, facing the front of the board is arranged as follows: One, three-phase, three-wire, incoming line panel; two, three-phase, three-wire, double-circuit motor panels; one, three-phase, three-wire, motor feeder and lighting transformer panel; and one, single-phase, two-wire, ten-circuit lighting panel. Grille work having hinged doors provided with locks enclose the ends of the board and prevent access to its rear except by those authorized persons who are furnished with a key. From the top of the panels, and extending upward for some distance above the busbars, grille work is also provided.

The arrangement of the switchboard apparatus, including bus and connection bars, is especially compact and is supported in a most substantial manner. This can easily be seen from the back view of the installation. The bus and connection bars are of three-quarter inch solid copper rod, the connection bars being soldered into terminals which are fastened to the busbars. The busbars are supported to the pipe framework by special bus supports designed for use in connection with this and other Panama

Canal switchboard installations by the General Electric Company of Schenectady, N. Y., which also supplied the electrical equipment for the caisson. The framework itself is of standard type, but was specially galvanized and painted to enable it to withstand the

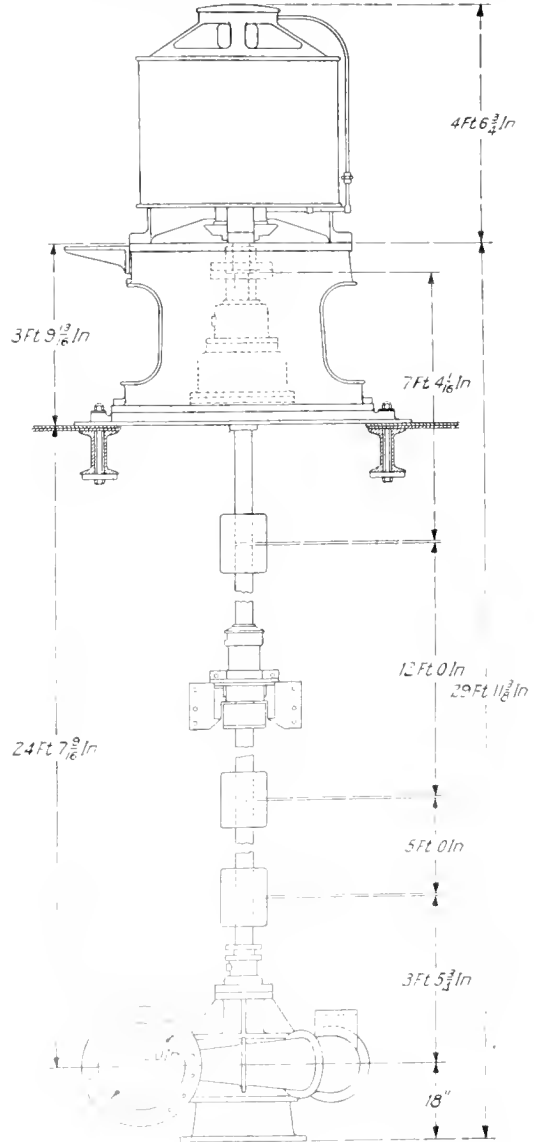


Fig. 7. Elevation of the Pump Motor, its Base, Shafting, Bearings and the Pump

particularly severe climatic conditions prevailing on the Isthmus.

Another feature of interest is the method employed for disconnecting the oil switches from the circuit, when it is desired to remove

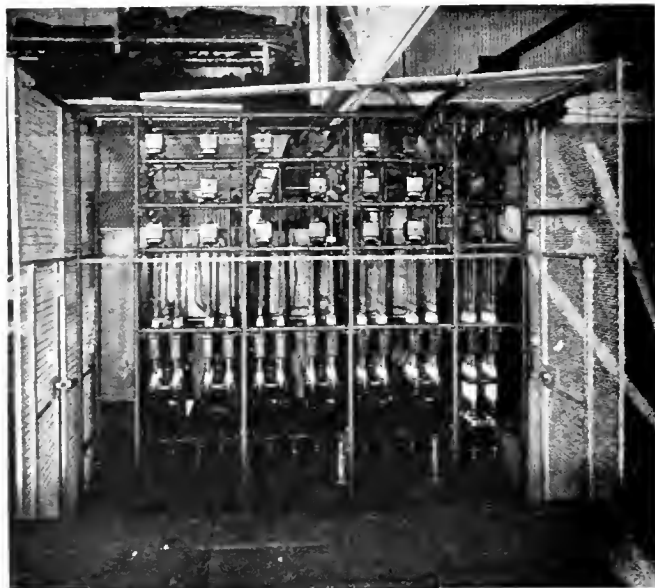


Fig. 8. Rear View of the Operating Switchboard

the oil cans or otherwise to do work about the back of the board. By means of handles located below the oil-switch operating handles, a switch can be placed in or disconnected from its circuit at will whenever the oil switch contacts are open, but at no other time.

The pipe framework supports vertical metal guides, which carry the oil-switch operating mechanism, and a slate base which forms a portion of the switchboard panel. By means of a lever and toggle mechanism, the oil switch, the slate base, and the other parts carried on the guides may be raised or lowered.

Above the oil switch and mounted on the pipe framework is a stationary base which carries the disconnecting studs of the oil switches. The current leads are connected to the tops of these studs; and at the bottom of each stud is a flared contact which engages with a wedge-shaped contact on the upper end of the oil switch stud, and thus places the switch in circuit. Moulded insulating shields surround (except at the bottom) each disconnecting contact and extend sufficiently below the contact fingers to insulate the fingers and prevent acci-

dental contact, whether the oil switch is or is not disconnected from the circuit.

The oil switch can not be connected to or disconnected from the circuit except when it is in the open position, which guards against the circuit being closed or opened by the disconnecting contacts. This feature is made possible by an interlock that prevents the oil-switch lifting and lowering handle from being operated unless the oil-switch operating handle is in the open position. This oil switch arrangement is the development of a patent by Mr. E. Schildhauer, Electrical and Mechanical Engineer of the I.C.C.

The electric current is supplied to the motors in the caisson from the main power cables installed within the lock walls. The motors, therefore, cannot be operated until the caisson is seated in one of the recesses provided for it in the locks,

or when at its mooring position in Gatun Lake or Miraflores Lake.

The purpose for having a power connection at its mooring position is to permit the operation of any one of the pumps for examination and inspection.

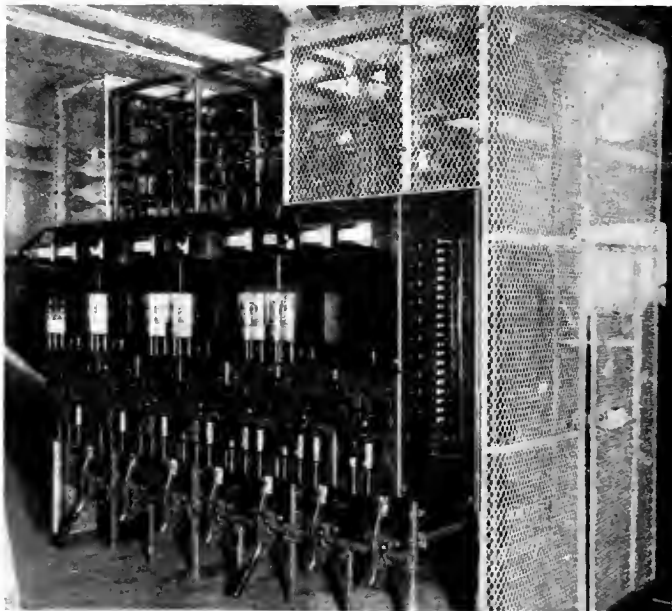


Fig. 9. Front View of the Operating Switchboard

PRACTICAL EXPERIENCE IN THE OPERATION OF ELECTRICAL MACHINERY

PART VI (Nos. 32 TO 35 INC.)

By E. C. PARHAM

CONSTRUCTION DEPARTMENT, GENERAL ELECTRIC COMPANY

(32) EXCESSIVE CONTACT-SHOE PRESSURE

Motor overloads are sometimes due to rather unexpected causes. Electrical inspectors are prone to exhaust the possibilities of electrical diagnosis, in times of trouble, before looking for mechanical irregularities that would account for unusual actions in electrical apparatus.

An inspector was called to find out why the starting resistor of a certain three-phase induction motor driving a monorail crane would get white hot whenever an effort was made to operate the crane.

The crane had just been installed and it was, of course, to be expected that the starting resistors would heat somewhat more than normally, because the crane action is stiff and the numerous bearings have not found a seating. In this particular case, however, the extent of the heating, considering the promptness with which the crane would start, suggested a condition more serious than initial stiffness.

In order to make an electrical test of the crane wiring, it was deemed advisable to insulate the crane from its source of power by inserting thin sheets of insulating fiber between the three overhead contact rails and the corresponding contact-shoes which are pressed against the rails by means of springs. To pry the shoes down from the rails required two men with two four-foot jimmies. What springiness there was to the contact-shoe action was due to upward pressure springing the 2 in. by $\frac{3}{8}$ in. T-sections of which the contact rails were made. When the shoes happened to be directly under an insulator, there was no spring action at all. This condition of affairs was due either to the shoe-stands being too high or to the contact rails being too low; whatever was the cause, the crane was being continuously subjected to the retarding action of a strong track brake.

Considering the fact that some high-speed, third-rail, electric railway cars use shoe pressures that do not exceed 30 pounds per

shoe, the load to which the two 3-h.p. crane motors were being subjected may be appreciated.

(33) ELECTRIC BRAKE ADJUSTMENTS

It would seem that the harder the service and the more exacting the local conditions to which electrical appliances are subjected, the greater the equipment is neglected. Where fastenings are most likely to be shaken loose by unavoidable vibrations, inspections for loose parts seem to be most lax. Really, the opposite should be true. These impressions are justified by the frequency with which solenoid-braked foundry crane-hoist motors giving slight troubles are permitted to become serious troubles simply for want of the prompt detection that would result from regular inspection for loose parts.

An operator once complained that his crane-hoist motor had "stuck with a pot of metal in the air." Inspection showed that if the motor had not stuck, it probably would have been wrecked. The normal adjustment of the air-gap of the solenoid brake was from $\frac{3}{4}$ in. to 1 in. The gap had been allowed to become 3 in. As a result, the hammering at the brake end of the motor, when the brake operated, loosened every bolt on that end of the motor. The end-shield bolts had worked entirely out, notwithstanding the fact that they had been secured by lockwashers, which had let the rotor down onto the stator. Fortunately the revolving magnetism did not provide sufficient torque to turn the rotor in this locked position; otherwise both rotor and stator probably would have been irreparably damaged.

The adjusting mechanism of a solenoid brake is not complicated, and the attention that it requires is not the attention of an electrician but that of a crane-man. Nearly every concern of sufficient size to use a power crane has at least one mechanic qualified to detect when a piece of apparatus is shaking itself to pieces. Most operators, however, seem to dissociate electrical apparatus from

every-day common sense relief measures which are always worth at least a fair trial.

(34) ROTOR RUBBED STATOR

If the fuses used are not too large, the first indication that an induction motor's rotor is rubbing its stator, may be the melting of the fuses because of the increased load incident to the additional mechanical friction.

A certain 5-horse power, three-phase induction motor sometimes would start upon applying the power and sometimes it would not start; but the stator would give the characteristic single-phase hum and the rotor would oscillate through a very small arc suggesting that it might start in either direction. All of the windings and wiring proved by test to be free from open-circuits, grounds, and wrong connections, and the air gap (which was normally 0.015 in.), freely admitted a 0.01 in. "feeler" all around the rotor and at both ends. These tests were made with the motor disconnected by the removal of its pinion. Upon reinstalling the pinion and wedging the gear, so that it could not move the load, and then applying the power and observing the rotor closely, it could be seen that upon each application of the power the rotor would move upward in a direction corresponding to the direction of the force applied to the gear by the pinion. On most trials, with the wedge withdrawn, the movement was insufficient to cause the rotor to touch the stator and on such occasions the rotor would start, and after it was in motion no irregularity could be observed. Now and then, however, the rotor would rise far enough to stick and it would start only upon advancing the controller to farther notches. The lifting of the rotor indicated no bearing wear, but by removing the rotor and linings a test of their fit showed a slight wear just at the place that would account for the symptoms noted. This slight wear, probably in conjunction with a slight eccentricity in the rotor core, accounted for the fact that sometimes the motor would start and sometimes it would not. The rotor surface had so much oil on it that a slightly rubbed place could not have shown very plainly, but such a place undoubtedly existed, and when this place was in line with the bearing wear at the time of applying power the rotor would stick.

The lesson to be drawn from this experience is that the air gap of a motor at rest may be thoroughly correct as far as a feeler will

indicate, but, if the bearing wear is in the upper part of the linings and the direction of rotation is such as to force the rotor upward at starting, the rotor may strike the stator.

(35) JERKY MOTOR ACCELERATION

In some classes of foundry work that is handled by electric cranes a smoothly graduated motor acceleration is essential; especially is this the case during the period of separating the cope from the flask, for then an impulse may shake down sand and destroy the mould. The binding between the cope and the flask complicates matters, because it introduces a condition where a comparatively strong pull must be immediately followed by an easing off, which is not always to be obtained satisfactorily. Where a variety of work is to be handled smoothly, it is necessary to use a controller that has many notches. Where the weights to be handled are limited to a few standards, the resistance graduations can be refined to suit the weights involved. In either case, wide fluctuations in the supply voltage make it difficult to get equal degrees of smoothness for all weights and voltages.

An electric crane, the hoist control of which had been entirely satisfactory for a long time but which had been getting more and more jerky during a period covering about two years, finally became impracticable and an inspector was called in. The crane evidenced good care, as far as the crane man was concerned, and the controller fingers and contacts were in excellent condition. Being convinced that neglect was not the cause of the impulsive acceleration, the resistor was next investigated. Tests with a voltmeter showed widely varying voltage drops per section of the resistor, and one of the sections caused no drop at all. The resistor was housed in a perforated box that served also as a seat for the crane man. Upon removing the box cover and sides to inspect for bad connections and for broken and short-circuited grids, the causes of the impulses became evident—they were two files, a screw-driver without a handle, a cold chisel, an oblong roll of copper wire, two carbon brushes, and seven perfectly good cartridge fuses. Without these the resistor was all right, as was demonstrated by a trial. To prevent a repetition of such a condition in the future, a piece of one-quarter-inch mesh wire netting was fastened to the under side of the resistor cover before replacing it.

A HYDRO-ELECTRIC INSTALLATION ON A COFFEE PLANTATION

By J. H. TORRENS

The author gives a brief account of the conditions existing in Guatemala where native labor still performs many operations now done by machinery in more developed countries. He then proceeds to give a description of the hydro-electric plant of the Finca Ona Plantation which is the largest in Guatemala. The process of preparing coffee for the market and the different operations carried out by the aid of electric motors are described.—EDITOR.

Guatemala is the largest, the most thickly populated, and probably the furthest developed of any of the Central American Republics. Although more than the usual quota of tropical products are raised there, the industry of coffee growing is the one of paramount importance.

Before entering into a description of the hydro-electric installation that will be considered, a few remarks concerning the geography of Guatemala and the conditions existing there will be of educational service

while they own as much as 85 per cent of the coffee estates.

The primitiveness of the transportation facilities will be easily comprehended when it is considered that most of the freight is carried on the backs of Indian porters. These bearers will jog along easily at a five-mile-an-hour pace with a pack of 150 lb. and are ably capable of managing packs weighing as much as 200 lb.

The work on the coffee plantations is carried on by native Indians, and these



Fig. 1. View Showing the Old Rope Drive Transmission



Fig. 2. Hydro-electric Power Plant at Finca Ona

in presenting a conception of the great and practically unentered field of coffee plantation electrification.

American capital is responsible for the railways which connect Puerto Barrios of the east with the capital, Guatemala City, and with San Jose and Ocas on the Pacific coast. Except for the omission of a few miles of track between Coatepeque and Pajapita (as a matter of fact this gap is now nearly bridged) the Pan-American Railroad makes it possible to travel from New York City to the capital of Guatemala, which is at an altitude of 5000 feet.

The commerce of the country is largely under the control of European countries; and it is said their investments in coffee plantations alone amount to about \$60,000,000,

receive about eleven cents a day for their labor.

Located in the western part of the country, among the foothills of the Sierra Madre Range at altitudes of from 2000 to 4000 feet, are some of the world's best coffee plantations. The climate in that section is particularly suited to coffee growing. The Finca Ona plantation, which is situated in that vicinity, is one of the largest in Guatemala, its annual production being about 1,000,000 lb.

The owners of this estate recently decided to adopt electric drive for the various machines used in preparing coffee for the market, and, as the conditions on this plantation may be considered to be typical of others throughout the coffee growing districts a description of its electrification should prove interesting to



Fig. 3. View of a Transmission Pole and a Group of Coffee Trees

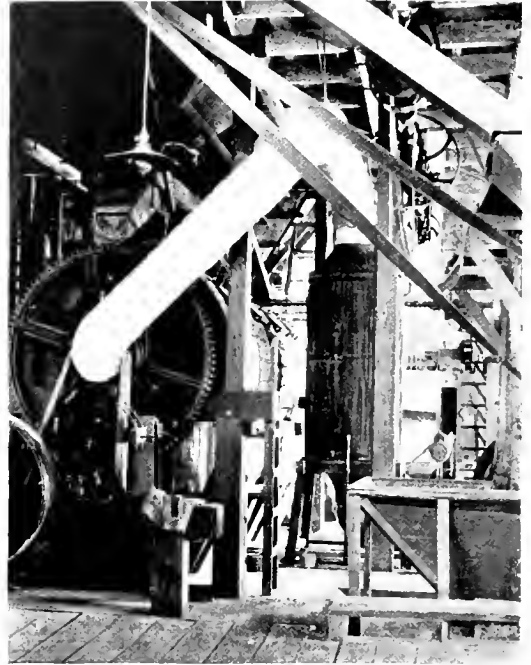


Fig. 5. Revolving Drum used for Drying the Coffee Berries



Fig. 4. Electric Driven Retrilla or Coffee Huller

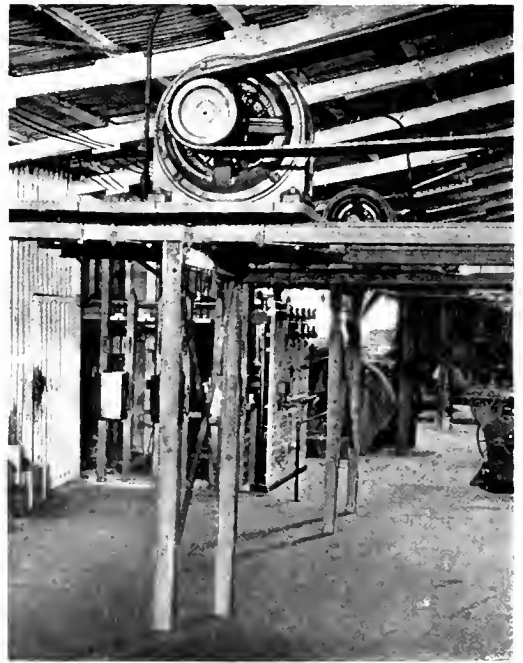


Fig. 6. Method Employed in Mounting the Motors

the coffee planter, to the manufacturer of coffee-milling apparatus, and to the electrical engineer as well.

The original source of power for the plantation was a Pelton waterwheel, for which it was necessary to bring water a distance of nine miles in a ditch. The difficulties which arose in the wet season from this method of water supply can be easily imagined.

The power generated by the waterwheel was then transmitted 600 ft. by a rope drive. Two steam engines, one of 25 h.p. and the other 60 h.p., supplemented the waterwheel. The extremely difficult conditions of transportation from the railroad 30 miles away rendered the cost of imported fuel almost prohibitive, while the practice that had cleared all timber from valuable coffee lands made wood for fuel quite scarce. Consequently, power generated by steam was very expensive.

A site at a convenient water-fall, which was about a mile from the factory, was chosen for the location of the electric generating station. From there the power is transmitted to the various motors and lights.

The hydraulic development was designed for about 500 cu. ft. of water per minute at an effective head of 270 ft., through 780 ft. of 18 in. pipe to two Pelton waterwheels mounted on same shaft and rated at 230 h.p., 450 r.p.m. A Pelton self-contained, oil-pressure governor regulates the speed by the deflecting-hood method.

The electrical apparatus in the powerhouse consists primarily of one revolving-field, 16-pole, 150-kv-a., 450-r.p.m., 2300-volt alternator direct-coupled to the waterwheel. The exciter is mounted on the same shaft. Frequent earthquakes make it imperative to mount the machines in a very substantial manner on heavy stone and cement foundations. All wiring is carried in conduit to a blue Vermont marble switchboard mounted on standard pipe framework. There are two feeder panels, one supplying 120 kw. at 2300 volts to the main factory over a transmission line about a mile long, the other supplying a branch factory about one-half mile away with 15 kw. at 2300 volts. Both lines are thoroughly protected from lightning, first, by a well-grounded barbed-wire running from pole-top to pole-top throughout the entire distance, and, second, at both ends by the latest type of aluminum-cell electrolytic lightning arresters. For transmission poles, 35-lb. iron rails 30 ft. long were

used. These were "footed" five feet in the ground in concrete.

At the factories the power is transformed to 220 volts for both motors and lights. All motors are of the three-phase squirrel-cage

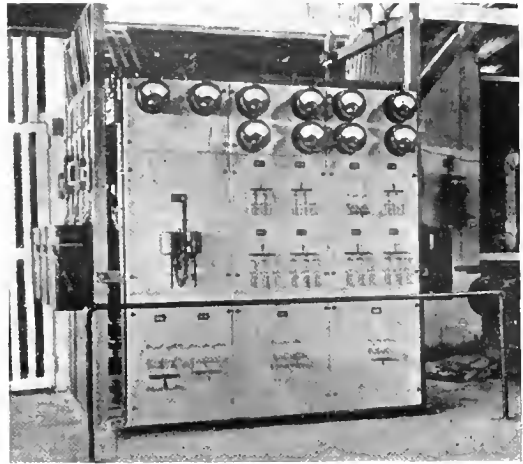


Fig. 7. Front View of the Distribution Switchboard

type, complete with starting compensators, and designed for a no-load speed of 600 r.p.m.

To follow the coffee through the various processes in its preparation may be interesting as well as illustrative of the application of the motor drive. A 20 h.p. induction motor drives a battery of peeling machines to which the red coffee berries are fed as they come from the trees. These machines remove the tough outside skin and separate the two berries, or halves, which then go to the fermentation tanks where they remain in water for about 60 hours.

At the end of this time, the thin membrane-like skin about the berries begins to loosen. All the good berries (those which float are not good) are taken out and placed in the sun on the "patio" where they are dried (by constant turning) to the extent that they cease to adhere to each other. This process requires several hours.

After the berries are superficially dried in this manner they are placed in a large sheet-iron cylinder called "the drier."

Those at Ona are about 6 ft. in diameter and 12 ft. long and through them steam-heated air at about 60 deg. C. is forced by a blower. In this cylinder the coffee is continuously revolved at 15 r.p.m. for 24 hours; this operation is a particular one and

requires close attention. It leaves these drums perfectly dry and is then raised to the top of an ingenious machine which removes and carries away the hulls, polishes, and cleans the berries. From here the coffee is carried to the classifying and separating machines, the better grades being further sorted by hand labor. Each drier, huller, and separator has its own motor, the respective capacities being 10, 20, and 10 horse power. All the starters are conveniently grouped near the main switchboard, where each motor has also an ammeter.

Among other useful motor applications on the plantation might be mentioned a 15-h.p. motor, direct-gearred to a Goulds' triplex pump which raises water 180 ft. for general use. This motor is operated also from the main switchboard. It is only necessary to visit the machine from time to time to see that the bearings are properly lubricated. A 2 h.p. motor which drives an ice machine is another valuable adjunct.

All the electrical apparatus is three-phase, 60-cycle, and was manufactured in America. Because of the crude and primitive methods by which the apparatus would have to be transported, it was necessary that the design employed be one that would permit of the apparatus being conveniently dismantled and, in addition, limit the maximum weight of a single piece to 1500 lb. Transportation part of the way was carried on by teams of bulls hauling a crude cart which was arranged so that when its two rear wheels were removed the rear half rested on a pair of sled runners. These latter were used to secure a braking action on the steep down grades. In other places the apparatus was carried on the backs of Indians. Thirty men carried a 40-kw. transformer weighing 1500 lb. in this manner.

The best construction possible was used throughout, and the work of installing all the apparatus was carried to completion in about three months.

The electrification holds a rather unique position as it is one of the first installations of American apparatus in that country where European apparatus and interests predominate. It is also the first electrification of a coffee plantation of importance and is consequently being closely watched.

Undoubtedly the continuance of the unusually successful operation already enjoyed by this plantation, since its electrification, will induce other coffee growers to duplicate the change on their plantations.

NOTES ON THE ACTIVITIES OF THE A. I. E. E.

Third Mid-Winter Convention

On Wednesday, Thursday and Friday, February 17th, 18th and 19th, the third New York Mid-Winter Convention of the American Institute of Electrical Engineers was held at Institute headquarters, Engineering Societies Building, 29-33 West 39th Street, New York.

A very attractive program was prepared, including a number of pleasure events as well as an interesting selection of papers. The following papers were presented:

The Characteristics of Electric Motors Involved in their Operation, by D. B. Rushmore.

Effect of Moisture in the Earth on Temperature of Underground Cables, by L. E. Imlay.

Oil Circuit Breakers, by K. C. Randall.

Comparison of Calculated and Measured Corona Loss Curves, by F. W. Peek, Jr.

A 100,000-Volt Portable Substation, by Charles I. Burkholder and Nicholas Stahl.

Distortion of Alternating-current Wave Form Caused by Cyclic Variation in Resistance, by Frederick Bedell and E. C. Mayer.

Dimmers for Tungsten Lamps, by Alfred E. Waller.

Searchlights, by C. S. McDowell.

Electrical Precipitation—Theory of the Removal of Suspended Matter from Fluids, by W. W. Strong.

Theoretical and Experimental Considerations of Electrical Precipitation, by A. F. Nesbit.

Practical Applications of Electrical Precipitation, by Linn Bradley.

Electrical Porcelain, by E. E. F. Creighton.

Institute Library

The American Institute of Electrical Engineers, the American Society of Mechanical Engineers, the American Institute of Mining Engineers and the United Engineering Society have a joint library consisting of their individual collections. This library is located on the two upper floors of the Engineering Societies Building. The library is conducted as a free public library of reference, and now contains about 60,000 volumes, and over 600 sets of periodicals.

One of the most important features of the library is the research department, which places the facilities of the library at the disposal of out-of-town members. Upon application to the library, bibliographies are prepared on any desired engineering subject, and abstracts, translations or photographs are furnished. A small fee is charged for this work.

LYNN SECTION

A Modern Army in the Field, by Major Shipton, U. S. A.

The meeting of February 3rd was attended by about 390 members and guests. The speaker of the evening was Major J. A. Shipton, U.S.A., Commandant at Ft. Terry, New York. His subject was the *Conduct of a Modern Army in the Field*.

The structure of an army division was described, this being the smallest unit complete in itself, containing elements of all branches of the service; viz., infantry, artillery, signal, engineering, aerial, hospital. This unit contains 22,000 men, and 750 officers. Details were given in order to bring out the definiteness of the structure and purpose of the various elements. The manner of maintaining communications with the base by means of commercial railways, military railways and wagon trains was illustrated. The completeness and definiteness of the organization were particularly impressive, as illustrated by the specific duties of the various officers and groups in the general structure of the army.

Next methods of issuing orders were described and here again the absolutely clear cut manner of issuing commands by five paragraph typewritten orders added further to the impression of the absolutely methodical manner of conducting military operations. Finally the manner of conducting the army at the time of an offensive engagement was outlined.

The lecture maintained the interest of the whole attendance and was very instructive. Numerous lantern diagrams were used to make the points under discussion clear.

Theories of Electricity and Matter, by Professor Comstock

The lecture by Professor Comstock, of the Massachusetts Institute of Technology, on January 6th, so interested the membership that in response to numerous requests a special course was arranged for. On Tuesday, February 9th, the first of the series of four or

five weekly lectures on *Modern Theories of Electricity and Matter* was given by Prof. Comstock.

Lectures for the Near Future

On February 17th, the Lynn Section listened to a most interesting talk on the *Characteristics and Uses of Storage Batteries*, by Mr. J. Lester Woodbridge, Chief Engineer of the Electric Storage Battery Company. The talk was illustrated by apparatus especially arranged for demonstration purposes. A more detailed statement will occur in the next issue.

On March 3rd, Mr. A. G. Davis, the head of the Patent Department, General Electric Company, will speak of the *Relation of Patents to Industrial Progress*.

On March 17th, Dr. W. P. Davey, of the Schenectady Research Laboratory, will speak on *Recent Development in X-Ray Work*.

PITTSFIELD SECTION

Electric Waves, by Professor Franklin

Announcement was made in the February REVIEW of the Paper by Prof. W. S. Franklin, of Lehigh University, on the subject of *Electric Waves*, given January 7th.

The lecture covered the ground of Professor Franklin's recent Institute paper on *Line Surges*, but especial attention was given to the underlying mathematics of that paper. Indeed the primary object of the lecture was to illustrate the use of differential equations in physics by setting up the differential equations of wave motion and integrating and interpreting them in their application to some of the simplest transmission line phenomena.

The lecturer pointed out the two cases in which the differential equations of wave motion on a transmission line are integrable in finite terms, namely: (a) the case in which wire resistance and line leakage are zero; and (b), the case in which voltage and current are assumed to be everywhere harmonic and synchronous. The latter case leads to the ordinary problem of the alternating current transmission line in its steady state, and the former leads to an approximate solution (approximate because of the neglect of wire resistance and leakage) of the problem of transient effects on a transmission line. The lecture was devoted entirely to the latter case.

Theories of Electricity, by Dr. Langmuir

Dr. Irving Langmuir, of the Research Laboratory, Schenectady, read a paper on

Friday, January 29th, on *Modern Theories of Electricity*.

Dr. Langmuir first sketched the historical conceptions of electricity and matter, and gradually led up to the atomic theory of electricity and the electron theory of the constitution of the atom, by means of which theories he explained the modern ideas of the conduction of electricity through gases and metals. The operations of the Cathode Ray Tube and the ordinary and Coolidge types of X-ray tubes were explained.

Curves were shown of the radiation of energy from black bodies, and an explanation given of Planck's Law and the Quantum Theory.

The various theories of the structure of the atom were touched on, as well as the results of the study of the spectra of the elements by means of high frequency.

Finally, Dr. Langmuir showed how, by means of the new theories, many phenomena formerly obscure were now explained, how the periodic tables of the elements have been supplemented and given increased importance; also how the gaps have been filled so that a continuous relation has been found between waves of all frequencies, from the long 60-cycle waves to the extremely short X-rays.

The lecture was illustrated by numerous lantern slides and experiments.

SCHENECTADY SECTION

X-Rays, by Dr. Coolidge

Dr. W. D. Coolidge, Assistant Director of the Research Laboratory of the General Electric Company, addressed the meeting of the A.I.E.E. January 19, 1915, in the auditorium of the Edison Club, Schenectady, N. Y., on the subject of *Recent Developments with X-rays*. The following is an abstract of his valuable address:

Prof. W. C. Röntgen of Wurzburg, Bavaria, suspected that when a current of electricity passed through a glass tube containing a gas at very low pressure, invisible light waves were given off. The idea occurred to him that such rays might affect a fluorescent screen in much the same manner as did ultra-violet rays. In order to cut out the visible light from his vacuum tube he wrapped it in heavy black paper. Upon operating the tube to make certain that the covering was completely light-tight, he noticed to his surprise that the fluorescent screen which he had left on the table three or four meters away glowed brightly.

Röntgen investigated the properties of the X-rays with characteristic German thoroughness. By 1897 he had amassed such a volume of information about X-rays that nearly every essential piece of research on their properties up to 1908 can

be found in its more elementary form in his three original memoirs.

Röntgen's original tube of 1895 was, judged by modern standards, a pretty crude affair. The cathode was flat and emitted a diffuse bundle of cathode rays which, upon hitting the glass at the far end of the tube, produced X-rays. In 1896 Campbell-Swinton added a platinum target upon which the cathode stream hit. This increased the penetrating ability of the rays obtained. In the same year Jackson made the cathode concave so as to focus the cathode stream upon a small area of the target. By giving more nearly a point source of X-rays this increased the clearness of radiographs for diagnostic purposes. The X-ray tube was soon changed in form but not in principle. A device was added by which the pressure inside the tube could be increased at will, and various means were tried for removing heat from the focal spot of the target.

Meanwhile in 1912, Dr. Coolidge discovered the process of making ductile tungsten such as is used in the filaments of Mazda lamps. Shortly after this discovery he became interested in perfecting a wrought tungsten target for X-ray tubes. During this work it became necessary to operate the tubes up to the limit of their capacity in order to find out how much abuse the tungsten targets would stand. During the course of this work he found that the ordinary aluminum cathode could be melted if sufficiently high currents were sent through the tube. He tried to remedy this by substituting a cathode made of tungsten whose melting point is very high. But such tubes were found to be very unstable. When current was sent through such a tube, the vacuum increased rapidly until finally no current would pass through the tube until gas had been liberated from the vacuum regulator. From a practical standpoint such a tube was hopelessly unsatisfactory. Finally it was found that if the process of operating the tube and immediately reducing the vacuum were repeated rapidly enough, the cathode became hot enough to glow, and that after this the tube would operate for several minutes at a time without it being necessary to let in fresh gas from the regulator. This suggested the idea of a cathode heated by some external means.

Richardson, and others in 1902, had shown that electrons could be obtained by merely heating the cathode, but had not been able to obtain constant results. Dr. Langmuir, of the Research Laboratory of the General Electric Co., had shown that the rate of emission of electrons from a hot tungsten cathode in a very high vacuum depended only upon the temperature.

If we heat a tungsten filament, electrons are given off and soon a condition of saturation occurs around the filament. If the filament is made the cathode of a low-potential circuit, a small current passes. If the voltage is increased, a larger current passes. Finally a voltage is reached which sweeps away every electron as fast as it emerges from the hot tungsten. For all voltages above this, the current is constant, and is independent of the voltage. Thus we have a resistance as far removed from the ordinary Ohm's law resistance as possible. This is not because the conduction is carried on in any different way, but because the number of available electrons is limited. (The reason that Ohm's law holds in conduction through wires is that the supply of available electrons in the wire is practically unlimited.)

As a source of electrons in his tube, Dr. Coolidge made use of a small spiral of tungsten wire heated

white hot from a storage battery in exactly the same way in which electric automobile lights are operated. This spiral is the cathode and a block of gas-free tungsten is the anode. The rate at which electrons are given off from the spiral depends upon its temperature, which is under the immediate control of the person operating the tube. The voltage across the tube is also controllable at will. As the voltage employed in ordinary X-ray work is much greater than is necessary to snatch all the electrons across from cathode to anode as fast as they are evaporated from the filament, even at the highest currents now in use in X-ray work, the voltage and current passing through the Coolidge tube are totally independent. Both may be adjusted to any desired value with any degree of precision desired and at any such adjustment the X-ray performance of the tube can be duplicated time after time.

Lantern slides were shown illustrating the development of the X-ray tube, and the kind of work which it is possible to do with an X-ray tube. Many of these pictures have already been published in the *GENERAL ELECTRIC REVIEW*, August, 1914, and January, 1915.

Chemistry of the Blood, by Dr. Whitney.

On the evening of February 2nd, at the auditorium of the Edison Club, Dr. W. R. Whitney, Director of the Research Laboratory, General Electric Company, delivered an interesting lecture on *The Physical Chemistry of the Blood*. The attendance was quite large, including a number of medical men who attended as guests. A lively discussion followed the lecture. Among those who engaged in the discussion were W. L. R. Emmet, J. B. Taylor, Dr. W. L. Towne and Dr. Krida.

Dr. Whitney's talk was a review of the properties of the blood, with the intention of showing some possible advantages to be gained by application of facts of physical and inorganic chemistry to such a complex solution. It was pointed out that the blood is all kinds of a solution: gaseous, electrolytic, simple osmotic, colloidal, and crass suspensoid. Through them all the electric effects of salt ions and charged colloidal particles were called to mind by illustrations. The characteristic effects of the sodium and calcium ions in true blood and in physiological salt solutions in case of excised hearts, and the activity of white corpuscles in phagocytosis, were referred to. The mutual

effects of electrolytes and charged colloids were reviewed, with the idea of pointing a possible way for further study of the reactions of immunity which seem to occur usually, if not always, in the blood between colloidal parts of the solution. To give some idea of the complexity of this field, the entire group of immunity reactions were reviewed. These included production of anti-toxins, precipitins, agglutinins, bacteriolysins, hemolysins, and a review of phagocytosis. While the cases of visibly complicated and augmented phagocytosis are certainly not yet explained by the simple electrostatic reactions of purely inorganic colloids, the assumption that the specific nature and neutralizing process of colloiddally suspended toxins and anti-bodies might be due to different magnitudes of electric charges is worth considering. These are at present explained by the assumption of countless specific and different chemical compounds which are assumed to be normally present in all blood, to slight extent in all cases of immune or anti-bodies, and to be only augmented by the process of immunization.

G. E. Moving Pictures

On February 16th, Mr. F. C. Bateholts delivered a lecture on the *General Electric Company's Moving Pictures for the Panama Exhibition*. Mr. Bateholts displayed the educational-advertising motion pictures of the General Electric Company, and gave an interesting talk on the educational and advertising value of motion pictures. He also gave an interesting account of the General Electric Company's lecture bureau service. Among the pictures shown were those of the Schenectady Works, Lynn Works and the Harrison Works, and also some pictures of the work on the Panama Canal.

Program for March

During the month of March the following speakers will deliver papers in the auditorium of the Edison Club, viz:

- March 2nd, W. L. R. Emmet, on *Driving Ships' Propellers*.
- March 16th, S. B. Paine, on a subject to be announced later.
- March 30th, C. D. Knight, on *The Principles and Systems of Control for Electric Motors*.

**FROM THE CONSULTING ENGINEERING DEPARTMENT OF THE
GENERAL ELECTRIC COMPANY**

NOTES ON THE NOBLE GASES

The term "noble" has been conferred upon certain rare gases of comparatively recent discovery, for the same reason that this term was long ago applied to certain metals such as gold and platinum, indicative of their scarcity and value, together with their general permanency under ordinary conditions. The noble gases now known are argon, helium, neon, krypton and xenon, all of which appear to be absolutely permanent, or chemically inert in respect to one another and to every other element.

Argon

This is the most plentiful of all the noble gases, being present by volume in atmospheric air to the extent of about 0.9 per cent. Nitrogen can be made to combine with oxygen by the electric spark, but argon, being without chemical affinity, cannot be thus oxidized. Because of this peculiar lack of affinity, argon was originally obtained by Cavendish in 1785 as a permanent gaseous residue after the complete oxidation of atmospheric nitrogen by the electric spark and the absorption in caustic potash of the products thus formed. Cavendish, however, did not recognize his residue as a new element and his interesting experiment bore no fruitful results until it was repeated in 1894 by Rayleigh and Ramsay. These distinguished scientists discovered its elementary character by an examination of its spectrum, and it was named "argon" from two Greek words signifying "without work," i.e., without chemical affinity, for it has been found impossible to produce a combination of this gas with any other element.

Unlike the other noble gases, the luminescence of argon under electrical excitation in a vacuum tube is feeble. It is chiefly remarkable for a change in color from red to blue according to the density of the exciting current; a weak current producing a red luminescence, which changes to a blue when the current density is increased.

The spectrum of argon consists of many lines extending throughout the visible range, and the change in color of luminescence from red to blue is chiefly caused by a strengthening or weakening of the red and blue lines respectively, so that either one or the other is presented to the unassisted eye as the predominating color of the light.

Argon is a monatomic gas, which signifies that its atom and molecule are identical. It is 19.94 times heavier than hydrogen, its atomic weight being 39.88, considering oxygen as 16.

Helium

A study of the spectrum of the sun's corona by Lockyer in 1868 revealed a bright yellow line which could not be found in the spectrum of any other element known at that time. The unknown element which produces this line was named "helium" (from the Greek work for sun) and it remained a puzzle to scientists until 1895, when Sir William Ramsay observed the same bright yellow line in the spectrum of a gaseous mixture extracted from the rare mineral *cleveite*. He finally succeeded in isolating an elemental gas from this mixture, the spectrum of which showed many very beautiful lines, prominent among which was the brilliant yellow line that had been first detected by Lockyer. This line is known in spectrology as D_3 and its wave length is approximately 5875.5 Angstrom units (1 A.U. = 10^{-8} cm.).

The complete spectrum of helium includes seven principal lines, colored respectively red, yellow, green, blue-green, blue, blue-violet and red-violet, but the vivid brilliancy of the yellow line D_3 gives a strong predominating yellow tone to the luminescence of this gas when it is confined in a capillary tube and excited by electricity.

Helium is the second lightest of all the gases, its specific gravity being 3.99 as compared with oxygen at 16. It is particularly remarkable in being a bi-product of the disintegration of radium, and therefore a striking example of the natural evolution of matter from one apparently elementary state to another, or, in other words, of the transmutation of the elements. This gradual formation of helium from radium is, however, the result of interatomic energy over which we have at present no control, either to hasten or retard its operation; so it cannot properly be cited as a modern realization of the ideas of the ancient alchemists who imagined the possibility of transmuting one element into another by a chemical process.

Helium is monatomic, and like its companion noble gases, it shows no affinity for any other element, no compounds of helium having been discovered. It has been extracted from other minerals besides *cleveite* and has also been found in certain mineral waters, notably in the hot water from the King's Well in Bath, England, in which it is associated with argon. It is also present in the atmosphere in very minute quantity.

W. S. ANDREWS.

QUESTION AND ANSWER SECTION

The purpose of this department of the REVIEW is two-fold.

First, it enables all subscribers to avail themselves of the consulting service of a highly specialized corps of engineering experts, or of such other authority as the problem may require. This service provides for answers by mail with as little delay as possible of such questions as come within the scope of the REVIEW.

Second, it publishes for the benefit of all REVIEW readers questions and answers of general interest and of educational value. When the original question deals with only one phase of an interesting subject, the editor may feel warranted in discussing allied questions so as to provide a more complete treatment of the whole subject.

To avoid the possibility of an incorrect or incomplete answer, the querist should be particularly careful to include sufficient data to permit of an intelligent understanding of the situation. Address letters of inquiry to the Editor, Question and Answer Section, General Electric Review, Schenectady, N. Y.

TRANSFORMERS: TWO-PHASE TO THREE-PHASE TRANSFORMATION

(130) When two similar transformers are connected for changing two-phase current to four-wire three-phase, what are the percentages of the windings included between the taps, and what are the vector relations of the current and the voltage at unity power-factor and at less than unity power-factor?

Referring to Fig. 1, which shows the connections for transforming four-wire two-phase to four-wire three-phase by two transformers, b is a 50 per cent tap on the secondary winding of one transformer, and e and f are 28.9 and 86.7 per cent taps respectively on the secondary of the other transformer.

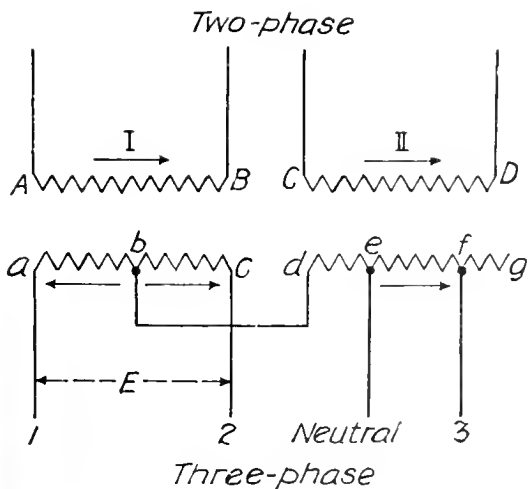


Fig. 1

Fig. 2 represents the current and the voltage vector relations in the primary windings, and Fig. 3 the same in the secondary windings. In the vector diagrams, the voltage are represented by the solid lines, while the dotted lines indicate the position of the current vectors when lagging at an angle of θ . The direction of the vector is based upon the assumption of the positive direction of the currents being as shown by the arrows in the transformer windings in Fig. 1.

R.K.W.

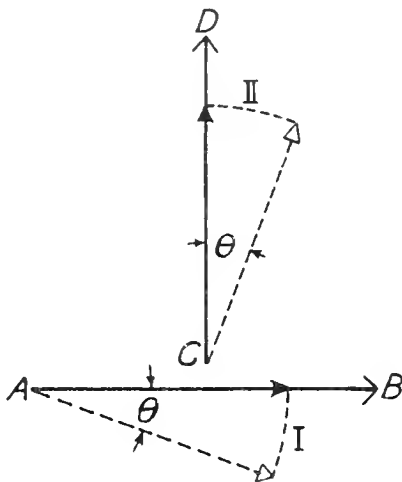


Fig. 2
Two-phase vectors
 $AB=CD$... Voltages
 $I=II$... Currents

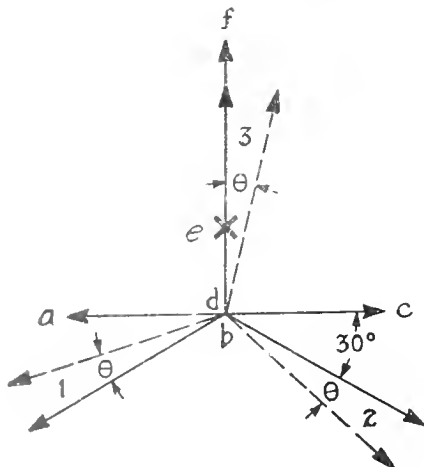


Fig. 3
 $ab=bc=0.5E$
 $af=0.867E$
 $dc=0.289E$
 $a_1=f_1=g_1=E$ } Voltages
 $1=2=3$... Currents

TRANSFORMERS: UNEQUAL CAPACITY
CONNECTED IN DELTA

(131) Please explain the reason for the following phenomena.

A bank of three, 6600/220-110 volt, single-phase transformers were connected with both their primaries and their secondaries in delta. One of these units was of 4 kv-a. and the other two of 3 kv-a. Wishing to obtain single-phase power to operate a contactor board, the disconnecting switches 1 and 3 in the primary leads of the transformers were closed (see Fig. 1). Not having an a-c. voltmeter, a 250-volt lamp was placed across the secondary of the 4-kv-a. transformer, but it did not burn at 220-volt brilliancy.

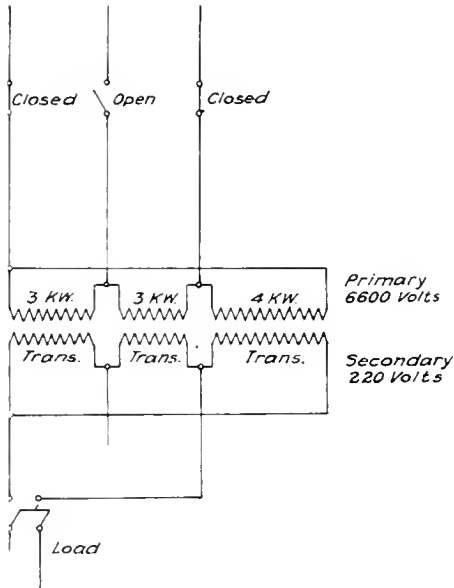


Fig. 1

After about five minutes operation as just described, the two 3-kv-a. transformers began to smoke profusely and therefore all disconnecting switches were opened. The two 3-kv-a. transformers were then removed and the 4-kv-a. unit was thrown across the line. The lamp when placed across the secondary of this transformer burned brightly, and no further trouble was experienced.

With such a connection as is shown, whatever happened when the single-phase was connected would also have happened if the three phases had been connected. The action taking place, therefore, indicates that there must have been some mistake in the connections of the delta which produced a circulating current of sufficient magnitude to heat the small transformers far above their rated temperature rise. It is possible that the polarities of all three transformers were not the same, and that, in connecting both sides in delta, a large unbalanced

voltage was obtained. With the connections as given, the two 3 kv-a. transformers are in series with each other, and both in multiple with the 4 kv-a. transformer. If the polarities of the 3 kv-a. units are alike and the same as that of the 4 kv-a. nothing extraordinary could happen, but if the polarity of the 4 kv-a. were opposite to that of the two 3 kv-a. transformers the machines of the whole bank would add their voltages in series and the circulating current in the delta would be limited only by the sum of their three impedances. A heavy circulating current would also result if the two 3 kv-a. machines were unlike polarity, but connected as though they were alike.

A possible difference in the ratios of the three transformers would also give an unbalanced voltage on the secondary side, which would cause circulating current.

With connections as shown in Fig. 1, the trouble was no doubt due either to a difference in polarities or ratios.

R.K.W.

ALTERNATOR: THREE-PHASE, RUNNING
SINGLE-PHASE

(132) Why does running single-phase produce such disastrous results in a three-phase alternator?

Doubtless the effects referred to in the question were noted in a solid steel rotor alternator and were made known by the iron of the field becoming seriously overheated.

The reason why such an action may take place in a three-phase alternator under the conditions named will be made obvious by a comparison of the behavior of the flux in a polyphase alternator with that in a single-phase alternator.

In a polyphase alternating-current generator the armature reaction (or the magnetomotive force of the current) is constant in intensity, and revolves synchronously with regard to the armature, i.e., stationary in relation to the field.

In a single-phase alternator the armature reaction is pulsating and ranges between zero and $n I \sqrt{2}$ (n = the number of turns per pole and I = the current per turn in effective amperes). The flux through the field poles, which is the resultant of the constant field excitation and the pulsating excitation of the armature, is a pulsating flux of twice the frequency of the machine. Consequently, in the field of a single-phase machine there would be the heavy hysteresis losses corresponding to double the frequency of the machine, if some means of lessening them was not employed. To accomplish this purpose, a laminated construction is used in the field of single-phase machines or heavy damping windings are provided and arranged in such a manner as to cut down the pulsating effect of the armature current. In those single-phase machines where the hysteresis losses would tend to be particularly excessive, due to the flux pulsation, both of the remedial measures named are embodied in the design of the machine.

It will readily be seen from these descriptions that the standard polyphase alternator cannot be expected to operate satisfactorily as a single-phase machine except at a considerably reduced output.

T.S.E.

GENERAL ELECTRIC REVIEW

A MONTHLY MAGAZINE FOR ENGINEERS

Manager, M. P. RICE

Editor, JOHN R. HEWETT

Associate Editor, B. M. EOFF
Assistant Editor, E. C. SANDERS

Subscription Rates: United States and Mexico, \$2.00 per year; Canada, \$2.25 per year; Foreign, \$2.50 per year; payable in advance. Remit by post-office or express money orders, bank checks or drafts, made payable to the *General Electric Review*, Schenectady, N. Y.

Entered as second-class matter, March 26, 1912, at the post-office at Schenectady, N. Y., under the Act of March 1879.

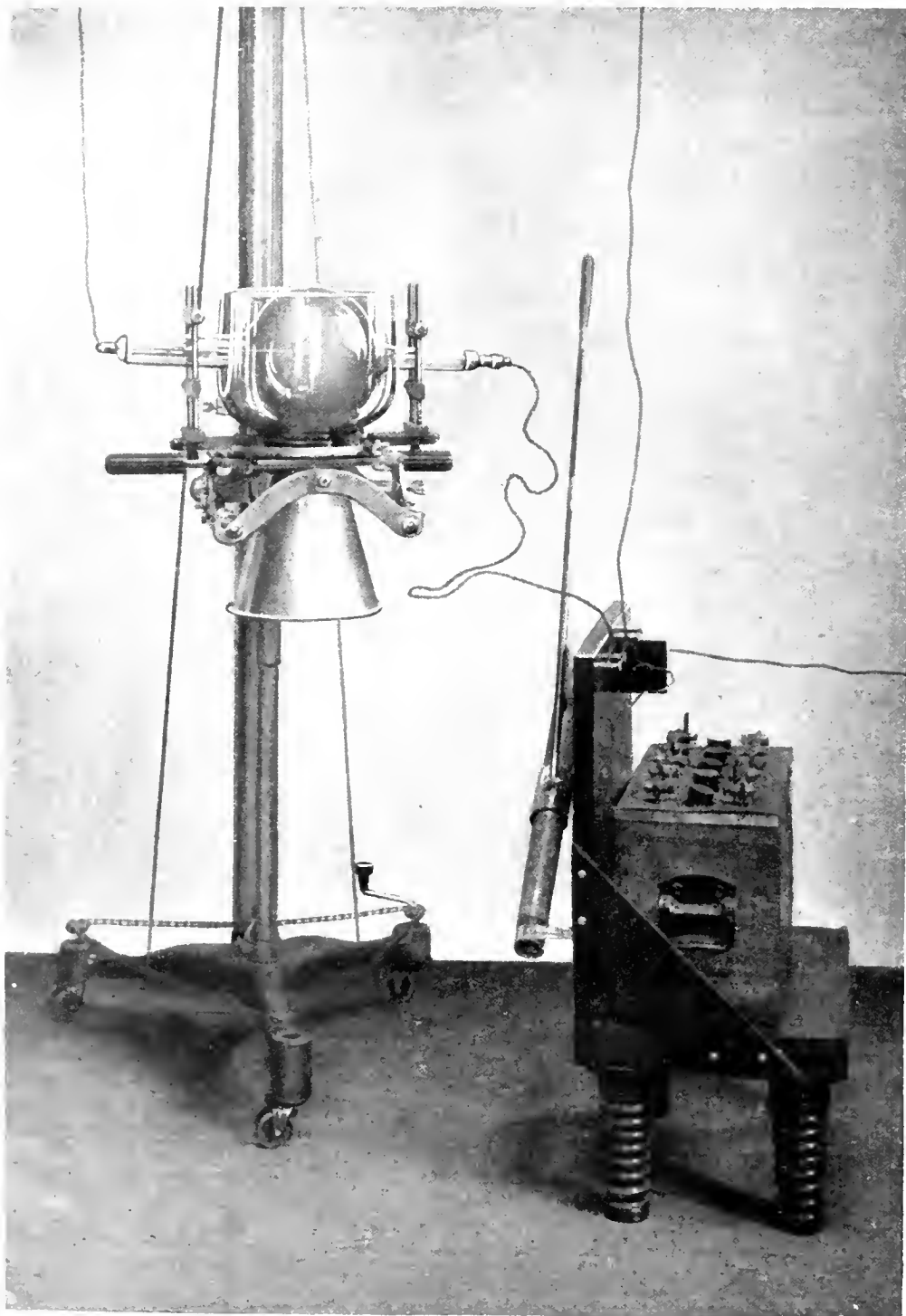
VOL. XVIII., No. 4

Copyright, 1915
by General Electric Company

APRIL, 1915

CONTENTS

	PAGE
Frontispiece	230
Editorial: The Paths of Progress	231
The Status of the Engineer	234
BY DR. E. W. RICE, JR.	
The Absolute Zero, Part II	238
BY DR. SAUL DUSHMAN	
Operating Conditions of Railway Motor Gears and Pinions	249
BY A. A. ROSS	
X-Rays, Part I	258
BY DR. WHEELER P. DAVEY	
The Modern Mine Haulage Motor	264
BY C. W. LARSON	
The Eye and Illumination	268
BY H. E. MAHAN	
The Fort Wayne Electric Rock Drill	273
BY C. JACKSON	
Some Notes on Induction Meter Design	277
BY W. H. PRATT	
Sign and Building Exterior Illumination by Projection	282
BY K. W. MACKALL AND L. C. PORTER	
Electrophysics: Application of the Electron Theory to Various Phenomena	287
BY J. P. MINTON	
Railway Motor Characteristic Curves	296
BY E. E. KIMBALL	
The Osborn Electriquette	299
BY O. E. THOMAS	
Notes on the Activities of the A.I.E.E.	301
Practical Experience in the Operation of Electrical Machinery, Part VII	304
Imperfect Slip-ring Contacts; Equalizer on the Wrong Side; Generators Motoring at No-load; Changing Motor Mounting; Motor Throwing Oil	
BY E. C. PARHAM	
From the Consulting Engineering Department of the General Electric Company	308
Question and Answer Section	310



The Coolidge X Ray Tube and Accessories. At the left is the tube inside a lead-glass bowl, both mounted on a stand so as to be easily adjusted to any convenient position and angle.
At the right on an insulating stand are the storage battery for heating the cathode filament and the rheostat by which the temperature of the filament is adjusted

GENERAL ELECTRIC

REVIEW

THE PATHS OF PROGRESS

When the full text of the papers read on "The Status of the Engineer" at the mid-year convention of the A.I.E.E. in New York on February 17th, is published in the Proceedings of the Institute it will undoubtedly attract wide attention and lead to considerable discussion, as the subject is one of paramount interest to every unit of the profession. We reproduce the very interesting paper read by Dr. E. W. Rice, Jr., President of the General Electric Company, and feel sure that our readers will derive considerable pleasure from the manner in which he has handled the subject.

At present we do not propose to enter into a discussion of the specific remarks in these papers, but rather to make a brief analysis of the general subject.

There has been, and we feel with perfect justice, a very general feeling that the engineer has not received due recognition or compensation for the part he has played in remodelling our state of civilization. We also feel that every one who has anything like an adequate conception of the changes that have been made both directly and indirectly by the activities of the engineer will fully reciprocate in this feeling. If we concede without argument that this is the case, the interesting problem would seem to be to ascertain the whys and wherefores of this condition of affairs. We confess that the problem is not particularly easy, but there seem to be certain factors which upon analysis are fairly evident. To make our point, a brief mental picture of "what was" and "what is" in one particular instance will help.

Let us consider the old warship of a hundred years ago and compare it with the latest modern superdreadnaught, and we must remember these old men-of-war aroused admiration and respect fully akin to that accorded to the latest leviathans. One hundred years ago the finest ship afloat absolutely depended upon the wind for her motive power and if becalmed was of little

more use than a log floating on the surface of the waters. Her armament consisted of cast iron muzzle loading guns which were laboriously handled by manual labor and there was nothing in her from stem to stern that resembled a machine with the possible exception of the pumps, composed of hollow tree trunks, and the capstan that raised the anchor in the good old fashioned way.

Such is the ship "that was" and what a contrast to the ship "that is"! The modern superdreadnaught with engines of 60,000 horse-power, and rumor has it that at a pinch with forced draft 100,000 horse-power is not impossible. A speed independent of wind and weather of 25 knots and may be, if necessary, this can be increased to nearer 30 knots per hour. Batteries of 15-inch guns that could hurl projectiles weighing nearly a ton for distances not far short of 20 miles. Torpedo tubes capable of firing torpedoes 21 inches in diameter and every vital part protected with solid steel 14 inches in thickness. The modern battleship is indeed a most highly developed organism with man-made organs.

Now all these developments that have changed the ship of yesterday into the ship of today have been brought about by the engineer, but it should be noted that in talking of the engineer we use this term throughout in the same broad sense as it is used by Dr. Rice in his address. " * * * we do not propose to limit our definition of 'engineer' to one educated in or following the strictly technical professions of civil, mechanical and electrical engineering, but shall include in addition all educated men laboring in the broad fields of chemistry, physics, medicine and other organized scientific activities."

With a picture of the ship of a hundred years ago and of the ship of to-day in our minds we are in a position to state certain facts that are vital to our analysis:

There was no engineer on the old ship and when the Admiral gave his word of command

he was telling others to perform operations any one of which he would have been perfectly capable of performing himself, and there was not one technicality with which he was not well versed. The ship was navigated, fought and handled in every respect by manual labor.

Today the Admiral can neither "go ahead" nor "go astern," nor turn his ship, he cannot bring his ammunition to his guns, he cannot train or fire his modern monsters, he cannot handle his torpedoes, he cannot even weigh his anchor without his engineer. This is the triumph of the engineer, but it must be noted that the Admiral still gives the word of command and it should also be noted that it is only in comparatively recent years that the engineer has been ranked as an officer.

This same general condition exists in all of our industries, in railways, in lighting and power stations, in mining, in our manufacturing industries, in fact, in everything that is modern and up-to-date. We owe the inception, development, and successful operation to the engineer. The engineer is the one indispensable factor, and without him and his work progress would be at a standstill; and yet he neither controls them nor dictates the policies of the thing of his own creation, and what is of more importance he apparently is constantly seeing others reap the harvest for which he has so diligently sown. Now we believe that such is the case, but we know that no effect is produced without a definite cause, so the cause for this state of affairs is the interesting thing:

Firstly, we believe that there is one fact that is often lost sight of, namely, that when the engineer is really successful, in the material sense, besides doing what, for want of a better term (and to avoid the misnomer of pure engineering), we shall call engineering work proper, he becomes active in organizing the work of others, and if successful in his broader activities his work often leads him further and further from engineering problems and more and more to organizing and managing the work of others until he is recognized as manager or head in his particular sphere of work. As he assumes wider responsibilities his financial reward increases, but he is not then the highly paid engineer, but the successful manager or business man, as the case may be. In these cases, and we believe they are many, the engineer has reaped the harvest for which he has sown, but not necessarily as an engineer. So when the engineer gets to the stage of

giving the "word of command" he is often lost sight of as the engineer and assumes another title.

Again, there are many fields of engineering activities where the engineer has done his work so perfectly that the very work that required engineering talent in the past has been reduced to almost routine work and can now be successfully performed by the machines of his creation and a type of labor partially or totally unskilled. In such cases, and they are legion, the engineer has displaced himself by the product of his own brains. Indeed, in the field of operating engineers this is particularly noticeable, where the perfection of mechanical and electrical devices has been brought to such a state that the engineer holds much the same position as a lifebelt—for the greater part of the time he is not wanted, but when he is wanted his services are imperative if a disaster is to be avoided. This situation has reduced the number of engineers employed in the operation of large engineering undertakings, and we often find only one or two engineers directing the work of a host of less skilled attendants from whom no great degree of technical knowledge is required.

So it would seem that the engineer has in a multitude of cases displaced other workers by introducing new methods and again by the perfection of his own devices in turn displaced himself. This undoubtedly has led to many men of good engineering training having to perform work which those with a less costly preparation could perform almost as well, which naturally leads to dissatisfaction. This is most unfortunate for the would-be engineer, but it seems inevitable and apparently is the same in some other professions.

So in the field of operation and construction we shall still see the old rule of life prevail—many will enter this field of activities but comparatively few will become really successful in the material sense—and we shall still see many men discontented with their lot not necessarily because their work is not congenial, but rather because after an expensive education and much self-sacrifice and arduous labor in early life they are not able to reap the harvest they feel that they have sown for.

The real field for engineering is the same today, and will be in the future, as it has been in the past, namely, development work, showing the world at large "how to do for one dollar what a fool can't do for two,"

and it is to this great field of development work that we must call the most able young men of this generation and of generations to come; our future absolutely depends upon the engineer in just the same degree as our past progress and prosperity has been due to his work. Anything that discourages the brains of future generations from wishing to enter the engineering profession is a menace to our future welfare, and it is for this reason that we feel apprehensive of any movement that would make the engineering field appear less attractive.

If the feeling generally prevails that engineering work is becoming so standardized and so reduced to routine work that it is not worth a young man's while to prepare himself at the great cost involved for the profession, or again if he should feel that, even if he were fortunate enough to work himself up to a position where he was really doing important development work, that the reward would be altogether inadequate for the effort he has expended then we are not going to progress in the future as in the past. The spreading of this feeling must be avoided. We fully recognize that our future economic stability demands the organization of engineering work and that it is essential after developments have been made by the engineer that production and operation must be standardized as far as possible, and indeed, that this is one important phase of the engineer's work; but we also realize that if the idea prevails that this organization is being pushed beyond its limits to the extent that it is inimical to *the status of the engineer* we shall have many difficulties to face in the future. It seems that we should certainly form our policies in such a way that the engineering profession shall never come to be regarded in the same light as journalism, of which it has been so often said that it is an excellent profession to get into if you are quite sure you can get out.

There is another side of the question; and one of the speakers in New York thought the engineer had nothing to complain of and that all things being considered the average engineer was as well rewarded for his work as the average man in other professions. This would be hard to prove or disprove without a most exhaustive study, and even if it were proved, the point would still remain that the engineering profession is giving more to the world than any other profession, and it is essential that it should be attractive to the young man of the future.

Certainly there are many walks of life in which the material rewards are all out of proportion to the service rendered to the state when compared with those in the engineering profession. A young man in choosing his profession naturally realizes this, but in the recent past the engineering professions have been talked of as those of the greatest possibilities, so that if the feeling becomes general that these possibilities are not as good now as they were in the past we shall fail to secure the most desirable young men of today as our engineers of the future.

Up to this point we have only talked of material rewards and now if we regard the engineering profession in another light it seems that the rewards are far above those in most other professions. All those engaged in the great modern science of development, to which our engineering professions have been so largely reduced, have the immeasurable joy of achievement or the possibility of achievement, and it is the intense interest in striving for accomplishment that makes the engineering professions what they are, and what has made the engineer the man of courage and resourcefulness, of patience and determination, of self-sacrifice and unending work. The very intensity of work with which the engineer devotes himself to his daily task precludes the constant thought of self-advancement and the desire to leave an all absorbing field of activities for others where the material reward would be greater, but the interest and worth-whileness of life would be less.

The engineer must often have the idea that he is being exploited by others because of this very loyal devotion to work rather than to self-interest, and undoubtedly this has been the case in many instances; but we hope and trust that the very fact that the engineer has changed the world to such an extent that we are finding it every day more necessary that our commercial men, financiers, etc., should know more of the engineer and of his work to enable them to transact business in a world whose modern foundations rest on a structure of engineering accomplishments will lead to a more perfect understanding, and, may be, to a better material reward for the engineer in the future. All of these different units have a common object; their work is the part of one great plan, and any factor in our great scheme of life that is so absolutely indispensable to our future progress must surely hold an enviable position in years to come.

THE STATUS OF THE ENGINEER

BY DR. E. W. RICE, JR.

PRESIDENT, GENERAL ELECTRIC COMPANY

The author, who has "lived with and worked alongside of engineers for more than thirty years," has written this contribution from his rich experience. He relates some of the achievements of the engineer and calls attention to the changes that this work has brought about in our state of living during the last four decades. The personal characteristics of the engineer are referred to in an interesting manner, and stress is laid on the fact that honesty is natural to the profession. Dr. Rice thinks that it is now incumbent on the engineer to take a hand in the greatest work of all, the government of the country, by showing an active interest in the framing of our laws and in guiding the work of the many commissions that form such a prominent part in our modern government. This address was read before the A.I.E.E. on the evening of February 17, 1915.—EDITOR.

The status of the engineer is an important subject, and should be of vital interest to every one of us.

It is well for us to pause a few moments from our daily task and make a brief survey of the engineer's work, to consider its important influence upon the life of this busy world, and especially to enquire what new service awaits the engineer now and in the immediate future.

During this discussion we do not propose to limit our definition of "engineer" to one educated in or following the strictly technical professions of civil, mechanical and electrical engineering, but shall include in addition all educated men laboring in the broad fields of chemistry, physics, medicine and other organized scientific activities.

I do not think that we can be accused of serious exaggeration in saying that the world is indebted to such men for the application of steam to ships, cars and workshops; for the invention of the sewing machine, the typewriter and the phonograph; for the introduction of the bicycle, automobile and aeroplane; they have brought the marvels of photography into existence, giving us the moving picture, X-rays and colored photographs. High explosives have been created to build and to destroy. We must thank such men for the untold blessings of anesthetics; for showing us how to successfully limit and combat epidemics of dread diseases.

Coming to our own special field, the members of our profession have given the world the telegraph, the ocean cable, the telephone and the wireless; created electric lights for our homes, cities and workshops; the electric motor to run our trolley cars, railroads and factories; have designed dynamos and great transmission lines with which to save and make useful the otherwise wasted power of our waterfalls. These and many other contributions equally wonderful and equally useful—miracles at first but now mere commonplaces and necessities—have been evolved from the brains of our busy

scientific engineers largely during the past 40 years.

But I will not weary you with a further recital of engineering achievements, as such a recitation of even the shortest possible catalogue would consume the entire evening.

My object in thus calling attention to the relatively recent contributions of engineers to the wealth and resources of the world is not to tickle your pride in belonging to the engineering profession, but rather to awaken your sense of responsibility for the great changes in our daily life, our methods and opportunities of conducting business and all other activities, which have been brought about directly and indirectly by such accomplishments, and to make some suggestions for the meeting of this responsibility.

Is it not a fact that civilization in its present form would never have arisen and would speedily come to an end if deprived of the engineer and his services? Has not the equilibrium of the world been upset by these very gifts of the engineer?

Is it not evident that such tremendous additions to our power, knowledge and wealth must have a powerful influence upon every phase of our existence? Have not our relations with nature and with each other been profoundly affected and as a result required many new adjustments?

The discovery of new trade routes has, as is well known, completely changed in times past the history of nations and the fate of their peoples. The discoveries of our scientific engineers during the past 40 years have been of greater importance than discoveries in trade routes, and it is inevitable that in adapting itself to the new conditions society should be deeply affected. The adaptation of man to his new environment could not take place without strain and friction. Are we not now in the midst of such a process of adjustment?

Of course, we all appreciate that the labor and thought of many other men of vision

and enthusiasm were needed; men experienced in finance, commerce, trade and government, to render the all essential aid required to introduce and to adapt to our daily lives these great contributions. But it would seem to be self-evident that without the creative work of the scientific and technical engineers these things would not have seen the light of day.

This remarkable development was fairly started during the first half of the 19th century under the guidance of the civil, mechanical and chemical engineer, but was tremendously accelerated by the advent of the electrical engineer about 40 years ago. His work during the past decades has reacted upon that of the other engineering professions and stimulated and made possible the almost equally marvelous development in mechanical, chemical and other lines of activity. Therefore, I regard all those who have been able to participate in the service of electrical science as happy and fortunate individuals. It is true that the financial reward has not always been great; on the contrary, it has often been extremely meager when compared with the rewards which frequently come to the successful lawyer, financier or merchant, but our engineer has been rewarded by something more valuable and precious than gold—the thrilling joy of achievement. There can be no greater satisfaction than that which comes to a man who believes that he is the first to discover some new force or to make some new and useful invention.

I have lived with, and worked alongside of, engineers more than 30 years. I think I understand the engineer's aspirations and character. I can say that it is a case where familiarity has not bred contempt, but, on the contrary, has inspired respect and affection.

The engineer is popularly supposed to lack certain qualities needed in a successful man of business, or to make a good salesman, or to handle important financial matters, or to fill positions requiring general executive ability. Is this popular idea justified? We may admit that an engineer who has devoted his entire time to his exacting work may be lacking in the knowledge and experience of other lines of activity, but it does not prevent him from having certain natural qualities, integrity, tact and aggressiveness combined with general intelligence and common sense. These qualities are personal and not professional. No group of men has a monopoly of such qualities and in none are they entirely

lacking. These qualities are to be found as generally among engineers as among other men.

It has been further charged that as an engineer deals with nature and natural laws his experience has been limited to impersonal objects, and that he must fail to appreciate or understand the complicated human element which is the important factor in business or in political life. This may be also partially true, particularly in the case of some of those whose work has been confined to that of pure research or pure science, but is not a general condition even among such men, and by no means the condition among engineers who of necessity are brought more or less in contact with the human element.

I have noticed that an engineering education and training have generally developed a man's powers of observation and his desire and ability to learn. He becomes skeptical of mere theories, doubts tradition and spurns superstition, but he constantly searches for the truth and is not afraid of facts. He habitually tries to see things as they are and not as he thinks they should be. He is never satisfied that "whatever is, is right," but is ever trying for something better. I do not need to tell this audience that engineers do not always agree as to the interpretation of facts, but opinion is frankly based upon facts and not upon preconceived notions. One who refuses to face or acknowledge facts loses his influence upon his fellows and his standing among his brother engineers. The engineer is always "from Missouri."

There is an old proverb which runs somewhat as follows: "One look is worth a thousand words." I like that proverb, and it is, I think, a fair description of an engineer's point of view. How often you hear the expression among engineers: "Well, let's go and take a look at it." Is not this the spirit which is needed in respect to other problems in the social, industrial and political world? Do they not need less talking about and more intelligent looking at?

It is true that the engineer deals primarily with nature, but nature does not lie. The engineer, therefore, learns early in life the utter uselessness and folly of deceit. He knows that it would be silly to the point of insanity to try to fool nature. He is constantly on his guard not to fool himself and is therefore not likely to try to fool others. In fact, he loses in time the desire to deceive, even if he ever had it. Honesty becomes a habit, not the honesty of the old line trader formu-

lated in the saying "Let the buyer beware," but the kind of honesty which scorns to take advantage of the negligence or ignorance of his customer, which involves honest thinking as well as honest action. It is quite possible that this habit may make him at first the easy prey of dishonest men, but it is a quality which commands respect and which wins in the end. It is needed and appreciated in business of all kinds and sizes, little and big. It is helpful to little business. But big business is doomed to big and disastrous failure unless saturated with honesty.

The engineer's training also tends to produce in him a fine blend of conservatism and radicalism. He is not afraid of a thing because it is new and he is not slavishly bound to precedent; on the contrary, he is frequently the creator of new things and a breaker of precedent, but he also believes in continuity and is not likely to let go of the old until he has a good hold of the new. He does not adopt an idea merely because of its novelty, but demands before adoption the acid test that it should be really better than the old.

There is, therefore, a large field of service open to the engineer in manufacturing, commerce, farming and all other business activities of our country for which his education and training have made him eminently fit. In fact, his work in science and engineering, already briefly alluded to, has succeeded in so increasing the magnitude, variety and intricacy of manufacture and trade that the special knowledge of the trained engineer is already in demand in almost all departments of our commercial and business life. Even in the specialized field of selling, the old type of salesman with precious little technical knowledge has been largely displaced by the engineer salesman.

There is, however, another opportunity for service awaiting the engineer of a most valuable and patriotic character. The biggest business after all is that of running this great country of ours. The United States not only operates the largest businesses itself in its various departmental activities, but through its legislators and various commissions it has taken a lively and paternal interest in private business. It makes the rules for the conduct of our business which fundamentally affect our future for good or for evil. It seems to me that the engineer ought to take an important part not only in conducting this great enterprise but in helping to make the rules for our faith and conduct.

I recently heard a member of Congress say that in looking at Congress one was merely seeing as if reflected in a mirror the great people who elected it, and that if we, the people, did not like the looks of ourselves we should not get angry and break the mirror but go and wash our faces. Now, while that was a very humorous and witty simile it seemed also to convey a homely truth and a sensible suggestion. I began to wonder how much there was in the suggestion, and thought I would ascertain just how accurate a reflection of our people and its activities was to be found in Congress and Legislature. I thought it would be interesting to learn the profession or avocation of those whom we have elected to represent us in Congress. I have here a list from which I will briefly abstract:

1914

SENATE OF U. S.		HOUSE OF REPRESENTATIVES	
	No.		No.
Lawyers.....	71	Lawyers.....	275
Farming.....	5	Editors and publishers.....	23
Banking.....	4	Merchants and mfrs.	32
Publishing.....	4	Other business.....	32
Merchants, mfrs., railroads, real estate.....	7	Farming.....	14
U. S. Navy.....	1	Banking.....	4
Medical profession.....	1	Educational profession.....	6
Not specified.....	3	Medical profession.....	5
		Architects.....	3
		Engineers.....	1
		Not specified.....	40
Total.....	96	Total.....	435

It will be noted that 75 per cent of the Senators are classified as lawyers, and 65 per cent in the House come under the same classification. I may say, incidentally, that I did not find a single one among the Senators who professed to be an engineer, and only one in the House of Representatives. An examination of the roster of the State of New York shows a similar condition, a large majority of the membership of both the Senate and Assembly being classified as lawyers. Now, I do not know how these facts impress you, but the witty simile of which I spoke rather lost its point as a conveyor of homely truth in the light of the facts. A body whose composition is about 70 per cent lawyers cannot be considered as a very accurate reflection of the people of this country.

Now, I have the utmost respect for members of the legal profession. We are all constantly trusting lawyers with our most important business matters and intimate private affairs. No profession has higher ideals and no profession comes nearer to realizing these ideals in practice. They deserve our confidence. I also yield to no one in my admiration of the ability, integrity and patriotism of the great men whose names have honored the legal profession and shed luster upon our country; men who frequently at great personal sacrifice have given the best part of their lives to the service of their country.

However, I think it is competent for us to enquire as to whether there is not a disproportionate number of members of the legal profession in our law making bodies. Is it for the best interests of this country to have any one kind of talent and training or point of view so overwhelmingly represented? There is a pretty general opinion in this country that we are afflicted with too large a number of laws, and it has been suggested that there may be a connection between the number of laws and the number of lawyers in our legislative bodies. Is it not also a strange anomaly that a country which owes so much of its phenomenal prosperity to the creative work of engineers should have practically excluded such men from its Congress and Legislatures? Would not our general condition have been better if years ago we could have injected into the composition of our law making bodies a number of high class, sensible engineers? It seems to me that our engineers have a duty to perform, that they owe it to themselves and to the country not to be satisfied with being simply hired to give their views and professional opinion upon programs prepared by other men, but should sit with our rulers and share directly in the responsibilities of government.

It is reasonable to expect that men who have been the greatest factor in the creation

and conservation of our material wealth and resources should have sound and constructive ideas of practical value upon the matters which our commissions are created to control. Therefore, our great Commissions which are charged with such tremendous power and grave responsibilities should have among their members competent engineers of experience as well as lawyers, practical business men and experts in the special province over which the Commission has jurisdiction.

One of the most hopeful signs of the times is the great awakening of the business men of this country to the imperative necessity of taking an intelligent interest in our Government, and it looks as if our business men now propose to make a business of seeing to it that they are properly represented in the business of government. Engineers should arouse themselves and participate in this great movement.

While up to the present no better or more practical means has been discovered than our great political organizations for giving effect to the wishes of our citizens, it is becoming increasingly evident to thinking men that no permanent advance can be made by simply turning out one political party and substituting representatives of another as our rulers. An intelligent and continuous effort should be made to improve the composition of our legislative bodies. We are essentially a nation of manufacturers, traders and farmers. We are all part of an organization with a mechanism which is so delicate, extensive and complicated that it must be controlled and managed with the greatest wisdom and intelligence if we wish to continue to progress in prosperity and lead happy and useful lives. It seems to me that in the future it will be the duty as well as the privilege of the engineer who so largely contributed to the production of this complicated mechanism to assist in its management in order to assure its preservation.

THE ABSOLUTE ZERO

PART II

BY DR. SAUL DUSHMAN

RESEARCH LABORATORY, GENERAL ELECTRIC COMPANY

This article is a continuation of the contribution by Dr. Dushman that appeared in our February issue, and contains a summary of the results that have been obtained during the last few years from investigations on the properties of substances at extremely low temperatures. The discovery of a "superconducting" state for pure metals at these temperatures is especially noteworthy. The general conclusion toward which these investigations lead is that at very low temperatures the properties of all substances tend to obey very simple laws and that all these properties are probably connected by functions which are of the same form for all substances.—EDITOR.

INTRODUCTION

In a previous issue we reviewed very briefly the logical foundations of our present temperature scale and the various methods that have been used to attain extremely low temperatures. Before proceeding to discuss the behavior of different substances at these low temperatures, it may not be out of place to digress briefly in order to point out reasons which have impelled physicists to undertake laborious and difficult investigations in a field which at first sight might appear so "impractical." For, after all, we live in a pragmatic age and the layman may be pardoned for asking the pertinent question, "Of what use is it?"

We do not need to go further back than 25 years to realize that for a long time scientific investigations were mostly confined to a very narrow region of temperatures, between approximately the minimum freezing point of ice-salt mixture, -22 deg. Cent., and the boiling point of mercury, 360 deg. Cent. Upon the results obtained in this manifestly limited field were founded a number of generalizations and theories for the interpretation of the whole realm of natural phenomena. The fundamental principles of dynamics and statics, the laws of chemical combination, the electromagnetic theory of light, the classical system of thermodynamics, and the kinetic theory of gases—this whole structure was a magnificent attempt to explain and correlate the results of observations in many different fields of investigation. It is true that the structure was somewhat contradictory in its style of architecture, and rather unstable in a good many places; but in spite of these deficiencies it appeared fairly satisfactory, especially if one did not look at it as a whole, and merely considered the separate portions.

But the past two or three decades have seen a most amazing expansion in our knowledge of the universe. The requirements of the industrial arts on the one hand, and the increased facilities and desire for purely theoretical investigations on the other, have both contributed to accumulate an immense number of observations in diverse fields of science.

It was in this manner that the development of processes and operations involving the use of very high temperatures led to a more careful study of the properties of substances at these temperatures. Furthermore, it was necessary to devise methods of high temperature thermometry. Hence arose a number of investigations which finally led to a radical revision of all our previous concepts of energy. This story has been told in another connection, and one can only refer here briefly to the work of Lummer and Pringsheim and others on the laws of radiation of a black body which led Planck to formulate an atomistic theory of energy. The Electromagnetic Theory, the Principle of Equipartition, the Law of Continuity of Dynamical Effects—all of which are based upon the same fundamental equation, nay, even these equations, were called into question and the necessity arose for re-stating them in new language.

There was all the more incentive for doing this, as discoveries in other realms of physics seemed to demand equally radical changes in our former views. The almost simultaneous discovery of X-rays and radioactive phenomena led to results that could not be correlated with the classical views. The atom could no longer be regarded as a metaphysical entity; here were atoms actually disintegrating in front of our eyes; we could count them and trace the life history of each one. But

during the process of disintegration these atoms emit sometimes positively charged particles of atomic dimensions, and at other times negatively charged corpuscles which possess $\frac{1}{1800}$ of the mass of a hydrogen atom.

Therefore, the atom itself must be a very complex structure.

The theory of discontinuous emission of energy quanta propounded by Planck could thus find a parallel in the theory of radioactive transformations proposed by Rutherford and Soddy. But Planck's theory was found to be capable of much further application than to the explanation of the laws of radiation. Almost immediately after Planck formulated his theory, Einstein pointed out that on the basis of the same theory it ought to be possible to predict the specific heats of bodies at different temperatures and that at extremely low temperatures the specific heats of all substances ought to decrease indefinitely. This conclusion appeared all the more interesting because it agreed with a semi-empirical conclusion at which Nernst had arrived from a consideration of the effect of temperature on the equilibrium of chemical and physical reactions. Since Einstein's deductions appeared just as valid as Planck's assumptions, it became of vital interest to determine accurately specific heats at very low temperatures.

But the determination of specific heats has not been the only interesting problem in the realm of low temperatures. The electrical and thermal conductivity, and the magnetic properties are equally important subjects of investigations. We are still far from being able to apply the electron theory to calculate the conductivity of a metal at any temperature. A knowledge of the laws governing the variation in the electrical resistance of pure metals near the absolute zero would aid considerably in placing the electron theory on a more definite basis.

The investigation of the properties of substances at extremely low temperatures thus appears of vital importance not only in order to refute or confirm the atomistic theory of energy, but also in order to give us more definite views of the actual mechanism of electrical conduction in metals.

That the results of these investigations are bound to profoundly affect our future theories of the structure of matter is quite evident. We have been accustomed to considering the gas laws as typical of matter in the simplest state. The kinetic theory of

gases attempts to explain these laws by assuming that the molecules of the gas are in constant motion with an average kinetic energy that increases with the absolute temperature. Similarly the heat energy of solids is ascribed to oscillations of the atoms about mean positions of equilibria. From this point of view it would follow that near the absolute zero all vibrations among the atoms ought to decrease in amplitude considerably. Under these conditions might we not expect some general laws for solids corresponding to those observed in the case of gases? Attempts have been made in the past two or three years to develop a theory of the solid state along these lines, and while this work is as yet far from complete, a few generalizations have been deduced which are of extreme interest.

In the following paper we shall discuss the results of the investigations at low temperatures under the following headings:

- (1) Specific Heats.
- (2) Electrical Properties.
- (3) Magnetic Properties.

(1) SPECIFIC HEATS AT LOW TEMPERATURES

The Quantum Theory

As the quantum theory has been discussed very fully in another connection,* it will be sufficient to state rather briefly the fundamental assumptions of this theory and the reader can refer to the previous articles for more detailed discussion.

In electrical engineering, we are familiar with the production of high frequency alternating currents by the discharge of a condenser through an inductance. We have in this case, a *continuous oscillation* in the electrical energy from a potential form (when in the condenser) to a kinetic form in the inductance, and the result is the emission of electromagnetic waves whose frequency depends upon the magnitudes of the inductance and capacity. Since light and heat are similar to those electromagnetic waves and differ only in possessing much higher frequencies we must conceive of their being likewise produced by some form of oscillator. In the case of visible light, the existence of the Zeeman effect and analogous observations lead to the belief that the radiation is produced by the oscillation of electrons around positively charged centers.

Now the fundamental assumption made originally by Planck can be stated thus: In the

* S. Dushman, GENERAL ELECTRIC REVIEW, Sept., 1914.

emission and absorption of electromagnetic energy and the interchange of energy between an oscillator and the surrounding space can occur only *discontinuously, in multiples of a unit quantum $h\nu$* , where ν denotes the frequency of the radiation and h is a universal constant.

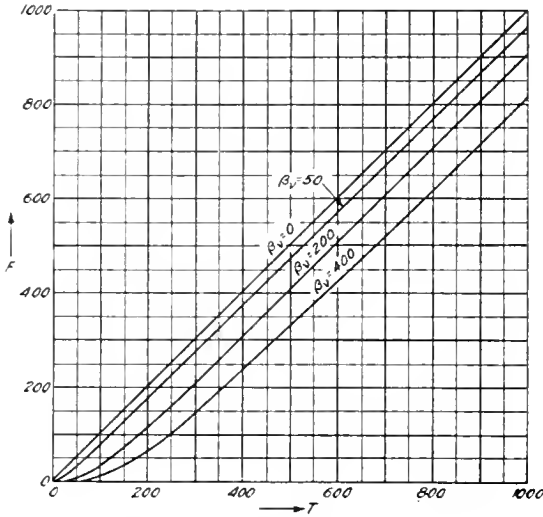


Fig. 1. Curves Illustrating Einstein's Formula for the Total Energy (E) of Solids where $E = 3 RF$

From this assumption Planck deduces the conclusion that the average energy possessed by any oscillator is

$$U_\nu = \frac{1}{2} \frac{h\nu}{e^{kT} - 1} \tag{1}$$

for each degree of movability or freedom. In the case of a linear oscillator possessing two degrees of freedom the average energy is double, and-so-forth.

Einstein's Formula for Atomic Heats at Low Temperatures

As mentioned above, Einstein carried this theory one step further by concluding that in the case of heat emission and absorption there must exist similar discontinuities. There are good reasons for believing that the longer heat waves emitted by solids are due to vibrations of the atoms themselves. Moreover, consideration of the elastic properties of solids leads also to the conclusion that the atoms in these cases are held together by quasi-elastic forces so that they vibrate about a mean position of equilibrium. Such an atom possesses therefore both kinetic and potential energy, is in fact an oscillator similar to that used for producing electro-

magnetic waves. Einstein, therefore, felt justified in applying the quantum theory to this case and he deduced the interesting result that while for ordinary temperatures the atomic heat for most solids should be about six (as demanded by the Dulong and Petit law) this value must tend to diminish with decreasing temperature until it becomes equal to zero at the absolute zero.

Since a vibrating atom in a solid possesses both kinetic and potential energy and the average kinetic energy must be the same as that of a monatomic molecule in the gaseous state, it follows from equation (1) that the average energy per atom of the solid ought to be

$$U_\nu = \frac{3 h\nu}{e^{kT} - 1} \tag{2}$$

Denoting the total energy per gram atom by W , and the number of atoms per gram atom by N (6.06×10^{23}), equation (2) becomes

$$W = \frac{3 N h\nu}{e^{kT} - 1} = 3 R \frac{\beta\nu}{e^{\beta\nu} - 1} \tag{3}$$

where $k = \frac{R}{N}$ denotes the atomic gas constant, and β is written for h/k .

It is evident that for small values of $\beta\nu$ or very large values of T , W becomes approximately equal to $3 RT$, while in all other cases it is less. Fig. 1 shows the form of the function $F = \frac{\beta\nu}{e^{\beta\nu} - 1}$ for different values of T

and for the values $\beta\nu = 50, 200$ and 400 . As T increases, the value of F approaches it more and more until at $T = \infty$ the two are equal: but at any given temperature T , the value of F differs from that of T more and more as $\beta\nu$ is increased. According to the law of Dulong and Petit the atomic heat of all monatomic solids ought to be proportional to the temperature. This would correspond to the case where $\beta\nu$ is infinitesimal, and in Fig. 1 it is indicated by the straight line.

Debye's Formula for Atomic Heats

The actual observations of Nernst and others on the specific heats of bodies at low temperatures were found to be in fair agreement with Einstein's equation at higher temperatures, but discrepancies became more and more noticeable as the temperature was decreased. While there was a qualitative agreement between the atomic heat-temperature curves calculated according to this

equation and those actually observed, the formula was found to be completely inadequate as temperatures nearer the absolute zero were approached.

Nernst and Lindemann were therefore led to suggest a modification of Einstein's equation which gave very good agreement down to the very lowest temperatures. But their formula had no theoretical basis, and it was only very recently that Debye deduced a formula which has proven to be valid over the whole range of temperatures. According to Debye, it is not right to assume that the atoms of solids are capable of vibrating with only one frequency: The propagation through solids of vibrations of low frequency, such as sound waves, shows that there must exist a whole series of values of ν . Only it is necessary to assume that there is an upper limit to this range of frequencies, and furthermore that the total number of different frequencies cannot exceed $3 N$. Debye shows that the maximum frequency (ν_m) and the distribution of lines in this acoustical spectrum may be calculated in the case of monatomic solids from the elastic constants of the material, and deduces the following formula for the atomic heat, C_v , at constant volume.*

$$C_v = 3 R \left[\frac{12}{x^3} \int_0^x \frac{a^3 da}{e^a - 1} - \frac{3 x}{e^x - 1} \right] \quad (4)$$

where $x = \frac{\beta \nu_m}{T} = \frac{\Theta}{T}$.

In obtaining this formula Debye also makes use of the quantum theory, but instead of assuming like Einstein, that each oscillating atom can absorb or emit different multiples of the unit energy quantum $h\nu$, he assumes that each individual frequency possesses the average energy

$$\frac{h\nu}{e^{\beta h\nu} - 1}$$

It is rather difficult to understand exactly what this means physically, but we shall find that Keesom and others have found it necessary apparently to introduce somewhat similar ideas in order to account for the rate of change of the electrical conductivity of metals at low temperatures.

The function Θ is designated by Debye as the "characteristic" temperature of the particular solid, and he shows that it can be calculated from the density, compressibility,

Young's modulus of elasticity and the modulus of torsion.

Equation (4) may be stated thus:

The atomic heat of monatomic solids is a universal function of the ratio Θ/T where Θ is a characteristic temperature for each substance depending upon its density and elastic constants.

Fig. 2 gives the plot of the value $\frac{C_v}{3R} = \frac{C_v}{C_v^\infty}$

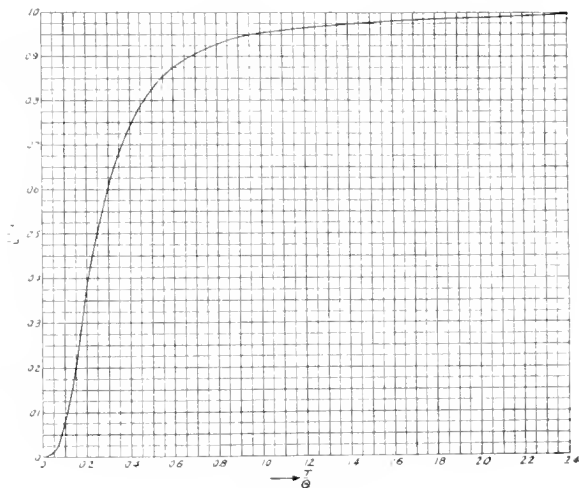


Fig. 2. Atomic Heat of Monatomic Solids According to Debye's Formula

as calculated by Debye from equation (4). At constant value of T/Θ , the atomic heats of all monatomic substances are the same. Knowing therefore the value of Θ for any substance it is possible from this graph to determine the atomic heat at any temperature.

For very low values of T/Θ , that is large values of x , equation (4) assumes the much simpler form:

$$C_v = 3 R \times 77.94 \left(\frac{T}{\Theta} \right)^3 \quad (5)$$

That is, at sufficiently low temperatures the atomic heat varies as the third power of the absolute temperature, or the total energy of monatomic solids at temperatures near the absolute zero is proportional to the fourth power of the absolute temperature. This relation is therefore analogous to the Stefan-Boltzmann law for the total energy radiated by a black body.

At very high temperatures, that is extremely small values of x , the expression inside the brackets in equation (2) reduces to unity, so that,

$$C_v = 3 R,$$

which corresponds to the Dulong and Petit law.

* Ann. Physik, 59, 789 (1913).

The actual observations at very low temperatures are in splendid agreement with equation (5). In Fig. 3 are shown the curves for the atomic heats of diamond, lead and aluminum. The third-power law (equation 5) is actually found to hold over quite a considerable range of temperatures. Thus, in the case of silver it holds up to 273 deg. K., (0 deg. C.), and in the case of diamond up to about 200 deg. K. Table I contains the values of Θ for a number of different metals. The data under Θ_1 were calculated by Debye from the elastic constants, while those under Θ_2 were determined from the observations on the specific heat.

TABLE I

Metal	$\beta_{\nu} = \Theta_1$	Θ_2
Al	399	396
Cu	329	309
Ag	212	215
Au	166	
Ni	435	
Fe	467	
Cd	168	
Sn	185	
Pb	72	95
Bi	111	
Pt	226	

When it is considered that the elastic constants were obtained at room temperature and on different samples of metal from those used in the determination of the specific heats, the agreement must be considered as very good.

It is interesting to note that while Debye deduced his formula for monatomic solids only, the third-power law was found by Eucken and Schwerts* to hold just as well for the specific heats of the minerals fluorspar (17.5 deg. to 86 deg. K.) and pyrite (21.7 deg. (17.5 to 84 deg. K.).

More recently Nernst has attempted to deduce a formula similar to Debye's, making use of the assumption that the distribution of energy quanta takes place among groups of atoms, rather than among different frequencies.† But the experimental evidence is hardly sufficient as yet to be able to decide between these different theories.

Specific Heat of Gases

When a gas absorbs heat a part of this is used up as increased energy of translation of the gas molecules, while the other fraction

is used up in increasing the rotational energy. According to the classical theory the specific heat at constant volume per molecular weight should be $\frac{1}{2} R = 1$ calorie for each degree of freedom. Since a molecule consisting of two atoms possesses three degrees of freedom in virtue of its translational energy and two in virtue of the rotational energy, the specific heat per molecule should be $\frac{5}{2} R = 5$ calories.

Actual observation showed that at lower temperatures the molecular heat of hydrogen at constant volume tends to diminish to a constant value 3,‡ and Nernst suggested that this must be due to the diminution in rotational energy as the temperature is lowered, just as the energy of vibration of atoms decreases with decreasing temperature.

Applying equation (1) to the rotational energy of a diatomic molecule (E_r), we obtain the relation

$$E_r = \frac{h\nu}{e^{\frac{h\nu}{kT}} - 1} \quad (6)$$

where ν is the frequency of rotation.

On the other hand, if I denote the moment of inertia of the molecule rotating about its center of gravity,

$$E_r = \frac{I}{2} (2\pi\nu)^2 \quad (7)$$

Eliminating ν from these two equations we should obtain an expression for the variation with the temperature of E_r . The actual observations on the specific heat of hydrogen between the temperatures 35 and 273 deg. K.§ were found to be quite different from those expected on the basis of this calculation.

Einstein and Stern** have therefore suggested that instead of (6) we ought to write the equation for E_r thus:

$$E_r = \frac{h\nu}{e^{\frac{h\nu}{kT}} - 1} + \frac{h\nu}{2} \quad (8)$$

That is, they assume the existence of an average latent energy $\frac{h\nu}{2}$, which is possessed by the rotating molecule even at the absolute zero. In this assumption they are in accord

‡ According to Keesom (see reference p. 243) the specific heat of all gases at very low temperatures varies as the third power of the absolute temperature, so that this value 3 for the specific heat of hydrogen is only constant over a certain range of temperatures.

§ A. Eucken, Berl. Akad. Ber. 1912, 141.

** Ann. d. Physik, 40, 551 (1913).

* Verh. d. Deut. phys. Ges. 15, 578 (1913).

† A. Eucken, Abh. d. D. Bunsen Ges., 7, 390 (1914).

with Planck's most recent modification of the quantum theory. Furthermore, the photoelectric effect and emission of electrons by X-rays seemingly lead to the conclusion that the electrons in a metal possess a similar latent energy whose magnitude is $\frac{h\nu}{4}$ for each degree of freedom.

The formula deduced for the specific heat of gases on this assumption accords well with the experimental data obtained by Eucken. It is, however, only fair to state, that almost as good an agreement has been obtained by Ehrenfest* without introducing the idea of a residual energy.

W. H. Keesom has also tried to apply the quantum theory to the translational energy of a gas.† He uses arguments analogous to those of Debye, that is, from the elastic properties of the gas (these can most readily be calculated in this case from the velocity of sound in the gas) he calculates a semi-fictitious maximum frequency, ν_m , and then derives a formula for the specific heat of gases which is similar to that given above for solids. From the observed measurements of the pressure of helium at very low temperatures he is also inclined to favor the assumption that a zero point energy exists. In other words, while the rate of increase of energy per degree (the specific heat) tends to decrease to zero as the temperature is lowered, it

absolute zero, a latent energy whose magnitude is $\frac{h\nu}{4}$ for each degree of freedom. But it must be stated that more facts will have to be obtained before it will be possible to draw any definite conclusions in this direction.

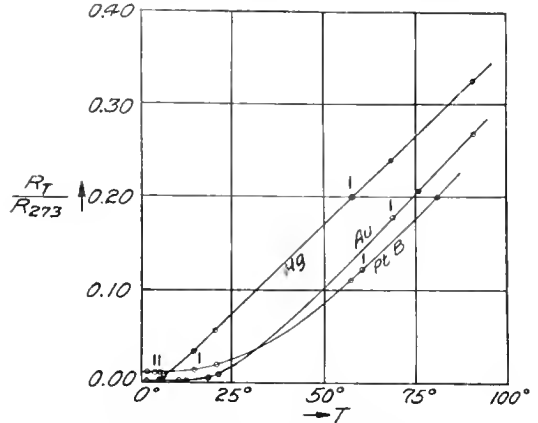


Fig. 4. Specific Resistance of Gold, Mercury and Platinum at Low Temperatures

(2) ELECTRICAL PROPERTIES AT LOW TEMPERATURES

Electrical Resistance

It has been known for a number of years that the resistance of metals decreases with the temperature. More recently a large number of investigations have been carried out in order to obtain accurate data on the variation of the electrical resistance of pure metals at extremely low temperatures, and the results have led to far-reaching speculations on the mechanism of the conduction of heat and electricity in metals.

Fig. 4 gives the results obtained by Clay and Onnes‡ on the resistance of mercury (Hg), gold (Au) and platinum (Pt) at temperatures ranging from 100 deg. K. down to the very lowest temperature attainable. Fig. 5 shows the same results plotted on a

much larger scale. The ordinate gives the ratio between the specific resistance at T to that of 0 deg. C. (273 deg. K.).

"Superconducting" State

The behavior of mercury is specially noteworthy. At 4.3 deg. K., the resistance

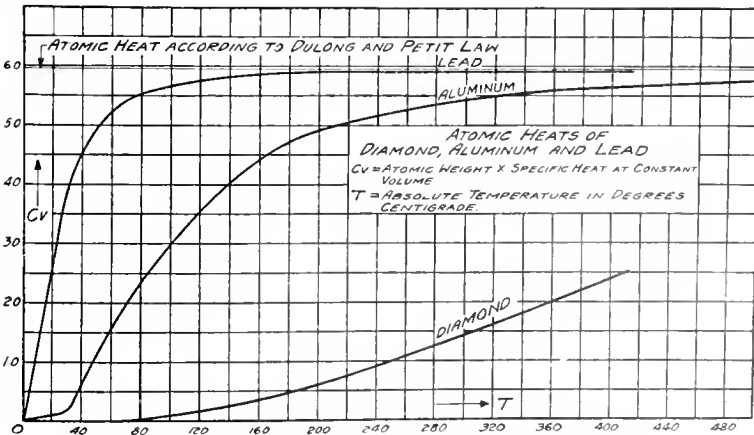


Fig. 3. Atomic Heats of Diamond, Aluminum and Lead

does not necessarily follow that the total energy itself becomes zero at the absolute zero. There are a number of reasons for believing rather that there exists, even at the

* Verh. d. D phys. Ges. 15, 451 (1913).

† Physik. Ztsch 14, 665 (1914).

‡ Abh. d. D Bunsen Ges. (1914), p. 246.

is 0.0021 of its value at 273 deg. K.; but at 4.21 deg. the resistance decreases very rapidly to a value which is less than one-millionth of that at 0 deg. C. As Onnes expresses it, the mercury becomes "superconducting." Very recently Onnes has extended these results and finds that at 2.45 deg. K., the resistance is less than 2×10^{-10} of that at 0 deg. C., the potential difference at the extremities of the mercury column (contained in a tube 0.004 mm² cross-section) being only 0.56 microvolt when the current density in the mercury was 1024 amperes per square millimeter.*

The same phenomenon has also been observed by Onnes in the case of tin and lead. The sudden disappearance of the resistance in the case of tin takes place at 3.806 deg. K., the ratio of the resistance at 3.8 deg. K. to that at 273 deg. K being less than 10^{-7} .

Lead becomes "superconducting" when immersed in liquid helium (4.3 deg. K.); the change, however, from the ordinary to the superconducting state occurs between 14 and 4.3 deg. K. All these metals show the existence of threshold values for the current density, that is, with current densities above a certain definite value, the superconducting state does not occur. Using a lead wire 0.025 mm.² cross-section, the threshold value at 4.25 deg. K. was observed to be between 420 and 940 amperes per square millimeter.†

Onnes applied this result to the production of "resistanceless" coils having a great number of windings in a very small space, and therefore possessing high inductance. It is well known that if a coil through which a current is passing is suddenly short-circuited, the rate at which the current in the coil decreases to zero depends upon the ratio of the resistance to inductance. Using coils of lead wire immersed in liquid helium, Onnes found that even after several hours, the current through the short-circuited coils had not diminished noticeably.

So far the existence of a superconducting state has been noticed only in the case of the three metals, mercury, tin, and lead. Each of these metals could be obtained in an exceptionally pure form. Onnes believes that all the other metals will show similar behavior at temperatures near the absolute zero when they can be obtained in a sufficiently pure state.

The behavior of the samples marked *Pt-B*, *Au* (111) and *Au* (V) must be ascribed to the predominant influence exerted by slight traces of other metals at these very low temperatures.

Failure of the Older Theory of Conduction

The curve for gold in Fig. 3 is typical of the behavior of all the metals in temperature range 273 deg. K. to 20 deg. K. The resistance tends to approach the value zero asymptotically much in the same way as the specific heat. This fact has led to attempts to apply the quantum theory to explain the variation in electrical resistance at low temperatures.

According to the electron theory of conduction the specific conductance, $\frac{1}{R_T}$, is given by the relation‡

$$\frac{1}{R_T} = \frac{N e^2 L}{2 m u} \quad (9)$$

where

N = number of free electrons per unit volume

L = mean free path

e = unit electric charge

m = mass of electron

u = average velocity of the electrons.

The assumptions used in deriving this equation are that electric conduction is due to a convection of charged particles (electrons) and that the collisions between atoms and electrons are non-elastic. But by making the further assumption that the free electrons in a metal possess the same average kinetic energy as the molecules in a gas at the same temperature, that is, that

$$\frac{1}{2} m u^2 = \frac{3}{2} k T \quad (10)$$

it is possible to deduce a relation between the thermal and electrical conductivities which is known as the Wiedemann-Franz law. This law states that the ratio of the electrical to the thermal conductivity is a constant for all metals at the same temperature and varies directly as the absolute temperature.§

The agreement between the empirical law obtained by Wiedemann and Franz and the relation deduced by means of considerations

‡ E. P. Adams, Proc. Am. Inst. El. Eng., 32, 1159-1233 (1913).
N. Campbell, Modern Electrical Theory (1913), also
J. P. Minton, GENERAL ELECTRIC REVIEW, March, 1915,
p. 204.

§ The constant $\frac{3}{2} k$ is sometimes denoted by the symbol α .

¶ J. P. Minton, GENERAL ELECTRIC REVIEW, March, 1915,
p. 207.

* Science Abstracts, A, p. 114 (1914).

† Science Abstracts, A, p. 385, (1914).

based on the electron theory of conduction was taken to be a signal confirmation of the accuracy of these views. But it has been shown by Lorentz and others that the assumption that the average kinetic energy of the electrons increases as the absolute temperature leads to conclusions which are at variance with the known distribution formulae for the energy radiated from a black body.*

Furthermore, on the basis of the ordinary theory it is difficult to explain why the kinetic energy of the electrons should not exert an effect on the observed specific heats. Thus, if the number of free electrons is assumed to be the same as the number of atoms, and each electron is assumed to possess an average kinetic energy of $\frac{3}{2} kT$, the observed specific heat per gram-atom should be $\left(6 + \frac{3}{2}\right) Nk = 7.5$ calories, a conclusion which is not at all in agreement with the observed values. (See section 2 above).

Wien's Modification of the Electron Theory of Conduction

These difficulties have led physicists in the past couple of years to discard the assumption expressed by equation (10). This naturally leads to the rejection of any theoretical basis for the Wiedemann-Franz law. Since equation (9) is merely an expression of Ohm's law in terms of the electron theory, it is taken as the starting point of the new theory which seeks to explain the observed variations in the specific resistance of metals as the temperature is lowered.

While according to the older theory of Drude and Riecke, the value of the ratio N/nu was assumed to vary with the temperature, Wien assumes that this ratio remains independent of the temperature, while the mean free path, L , is the only quantity that does change. We know that in a metal the atoms vibrate about equilibrium positions which are arranged in regular lattice forms. The electrons travel between the rows of these atoms. The observed values of the specific heats show us that at very low temperatures the vibration of the atoms becomes extremely small in amplitude, and the number of vibrating atoms decreases rapidly. Thus, an electron starting out under the influence of even a small electric force, can travel a big distance without suffering collision with an atom; that is, the resistance

appears extremely small. At higher temperatures the atoms begin to vibrate more and more, so that the mean free path of the electron between collisions decreases; the kinetic energy of the electrons appears as Joule's losses in the conductor.

As this theory requires that the kinetic energy of the electrons should be independent of the temperature, it is necessary to assume the existence of this energy even at $T=0$. Here then we have again the conclusion which has been mentioned above, that there exists a zero point energy for the electrons in a metal.

Assuming that the mean free path, L , varies inversely as the square of the amplitude of the vibrating atoms, Wien deduces a relation of the form

$$R_T = Af \left(\frac{\Theta}{T} \right) \quad (11)$$

where A is a constant, and f is a definite function of the ratio between the quantity $\Theta = \beta \nu_m$ and T . It will be remembered that the quantity Θ has already been referred to in section (2) as Debye's "Characteristic" temperature.

At very low temperatures, the equation reduces to

$$R_T = BT^2 \quad (12)$$

and at very high temperatures, it becomes of the form

$$R_T = CT \quad (13)$$

A , B , and C are constants which vary for different metals.

Over an intermediate range of temperatures the following relation holds fairly well:

$$\frac{R_T}{R_{273}} = T \left(\frac{1}{273} + \frac{\Theta}{298,000} \right) - \frac{1}{4} \frac{\Theta}{273} \quad (14)$$

This is in agreement with the observation that the specific resistance of most metals varies linearly with the absolute temperature. The values of the temperature coefficient of the resistance calculated from this equation are, however, found by Wien to be uniformly higher than the observed values (which range around 0.004 for most metals).

Corresponding States

The occurrence of the quantity $\Theta = \beta \nu_m$ in the expression for the electrical resistance as a function of the temperature shows the existence of an intimate relation between the specific heat and electrical resistance. E. Grüneisen† has drawn attention to this

* S. Dushman, GENERAL ELECTRIC REVIEW, Sept., 1914.

† Verh. d. D. physik. Ges. 15, 186 (1913).

relation and has, in fact, deduced the empirical relation

$$\frac{R_T}{T} = K C_p \tag{15}$$

where C_p denotes the specific heat per gram-atom at constant pressure, and K is a constant.

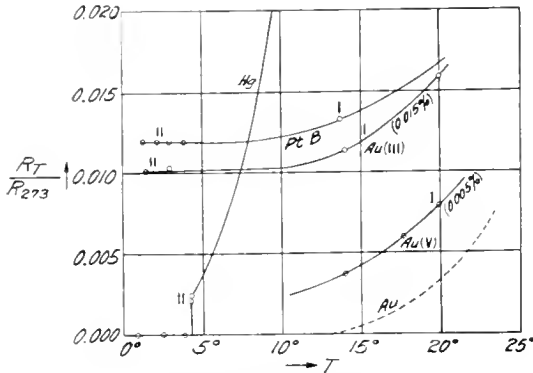


Fig. 5. Curves same as shown in Fig. 4, drawn on magnified scale to illustrate the "superconducting" state of mercury

It has already been observed that the function Θ has been designated by Debye as the "characteristic" temperature. The atomic heat of all monatomic substances is a unique function of the ratio Θ/T . In a similar manner we find that according to Wien $R_T T^2$ multiplied by a constant (which varies with each metal) is a unique function of Θ/T .

The ratio Θ/T thus plays the same role in connection with the properties of monatomic solids at low temperatures, as the ratio T_c/T does in the consideration of the properties of gases and liquids, where T_c denotes the critical temperature. There is no doubt that in the near future it will be possible to develop an equation of state for solids which will be quite as general as the conclusions which Van der Walls has developed for the transition from the gaseous to liquid state, and just as the ratio T_c/T is of importance in considering corresponding states of gases and liquid, so the ratio Θ/T must be the standard of reference for considering the properties of solids at low temperatures.

Fig. 6* is of interest in this connection as it represents an attempt to correlate the electrical resistance with the values of $\Theta = \beta \nu_m$ derived from specific heat determinations.

* H. S. Park, Ann. N. Y. Acad. Sci., 15, 706 (1914)

There appears to be a general tendency for the resistance to decrease with increasing value of $\beta \nu_m$.

Difficulties in Wien's Theory

There are, however, some difficulties that prevent us from completely accepting Wien's theory as it stands. The Wiedemann-Franz law remains completely unexplained, and it is difficult to see how else it can be explained except by assuming that at least a fraction of the electrons possess an average kinetic energy which is the same as that of the molecules of a gas. Furthermore, as well known, the electron emission from hot metals increases exponentially with the temperature as shown by Richardson. This points to the conclusion that the kinetic energy of the electrons must also increase with the temperature—at least at the higher temperatures.

On the other hand, Wien's theory does accord quantitatively with the experimental data at temperatures down to 20 deg. K. (No theory seems to have been advanced to account for the superconducting state.) Keesom has therefore attempted to reconcile the observations at low temperatures with those at higher temperatures by applying the conclusions which he has deduced regarding the specific heat of monatomic gases. He considers the electrons in the metal at very low temperatures as similar in all respects to a monatomic gas under the same conditions, and applies the quantum theory to calculate the variation in the concentration of free electrons with the temperature. He finds in this manner that at higher temperatures the average kinetic energy of the electrons is that demanded by the Law of Equipartition and the electron emission must therefore vary according to a law which is approximately the same as that deduced by Richardson. With decreasing temperature, the number of free electrons decreases and tends to a constant value at extremely low temperatures. In this region the velocity also tends to a constant value. The theory advanced by Keesom thus leads to conclusions which are in accord with Wien's theory for low temperatures, and with the older theory at higher temperatures.

Thermo-Electromotive Force. Peltier-Effect

The thermo-electromotive force is due to the potential difference developed when electrons are transferred from the hot junction of two different metals to the cold junction.

If N_A and N_B denote the concentrations in the two metals A and B , the difference of potential at the surface of contact according to the older theory is

$$V_{AB} = \frac{2k}{e} T \log \frac{N_A}{N_B} \quad (16)$$

Keesom shows that this formula holds only at the higher temperatures. At low temperatures the potential difference is

$$V_{AB} = 2.52 \times 10^{-22} T^3 \left(\frac{1}{N_B^2} - \frac{1}{N_A^2} \right) \quad (17)$$

That is, the rate of change of thermo-electromotive force with temperature tends to vanish as the absolute temperature is approached. The equation is in agreement with the observations of Onnes and Holst at the temperatures of boiling helium.

The *Peltier effect* corresponds to the work required to transfer unit electric charge across the junction of two metals containing different concentrations of electrons. According to Keesom the amount of heat developed at very low temperatures owing to this effect should vary as the fourth power of the absolute temperature.

It is interesting to note that according to the above conclusions, the electrical resistance, the specific heat, the thermo-electromotive force, the Peltier effect, and probably most of the other properties obey such very simple laws at temperatures near the absolute zero. Not only do the actual values of each of these tend to disappear at extremely low temperatures,* but their *differential coefficients with respect to the temperature tend towards the limit zero* in the same manner. This is in accord with the predictions made by Nernst from a consideration of the rate of change with the temperature of the total energy of monatomic solids, and shows in another way that there exists an intimate relation between the specific heats and the other properties of solids at very low temperatures.

(3) MAGNETIC PROPERTIES

Langevin's Theory of Paramagnetism

A large number of investigations have been carried out during recent years in Onnes' laboratory, on the magnetic properties of different substances at low temperatures. While a more complete discussion of our present theories on the nature of magnetism must be reserved for a future occasion, a few remarks on Langevin's theory of paramag-

netism is necessary in order to understand why so much effort has been spent in investigating the effect of temperature on the magnetic susceptibility.

Langevin assumes that the magnetism induced in paramagnetic substances is due to an orientation of the elementary magnets (which may consist of electronic orbits) under

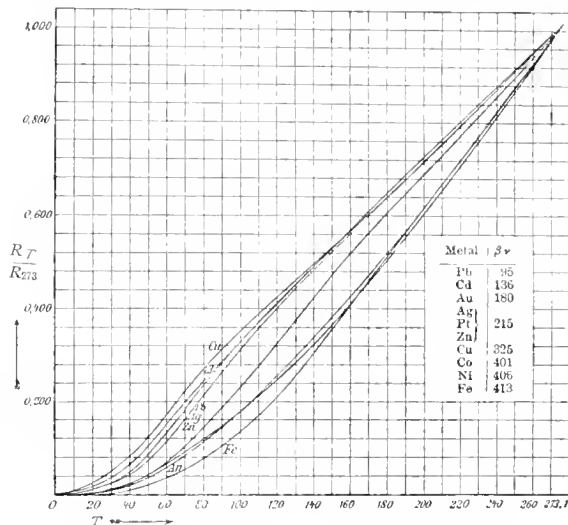


Fig. 6. Specific Resistance of Various Metals from 273 deg. K. to 20 deg. K.

the influence of the magnetic field, which is opposed by the ordinary vibration due to heat energy. At any temperature there results therefore a static equilibrium between the force due to the outside magnetic field and that due to thermal agitation. Langevin was able to deduce from this the relation which had been previously derived by Curie from experimental data, and which states that the paramagnetic susceptibility (X) is inversely proportional to the absolute temperature, that is,

$$X = \frac{C}{kT} \quad (18)$$

where C is a constant.

Deviations from Curie's Law at Low Temperature

Onnes and his collaborators have, however, found that substances which follow this law at higher temperatures may begin to deviate from it at lower temperatures in such a direction that the susceptibility is lower than that deduced from the observations at higher temperatures. In explanation of this Oosterhuis† has suggested that most probably

* This statement is not true of all the properties if it be assumed (see pp. 242 and 248) that a zero-point energy exists.

† Phys. Zeitschrift, 14, 862 (1913).

it is no more justifiable to apply in this case the laws of statistical mechanics than in that of specific heats. According to the quantum theory, the average energy of an oscillator with two degrees of freedom is not kT , as demanded by the principle of equipartition, but

$$U = \frac{h\nu}{e^{kT} - 1} + \frac{h\nu}{2} \quad (19)$$

[Compare equation (8) above.]

Oosterhuis therefore writes equation (18) in the form

$$X = \frac{C}{U} \quad (20)$$

where U is determined from equation (19) and ν refers to the frequency of vibration of the molecular magnet.

It is interesting to observe that according to this equation the curves giving the relation between the reciprocal of the magnetic susceptibility

$\left(\frac{1}{X}\right)$ and T are of the *same form*

as those indicated in Fig. 1 for the function F ; but the actual values of $\frac{1}{X}$ are proportional

to the quantity $\left(F + \frac{\beta\nu}{2}\right)$. That is, the value

of $\frac{1}{X}$ does not decrease indefinitely (as demanded by Curie's law) but tends to approach

a practically constant value which is equal to

$\frac{k}{C} \left(\frac{\beta\nu}{2}\right)$, as the temperature approaches that

of absolute zero.

The introduction of the term $\frac{h\nu}{2}$ is justified on the following basis. If the thermal agitation of the molecular magnets ceases at the absolute zero, there is no force tending to oppose that of the magnetic field, all the elementary magnets must therefore orient themselves under the action of this field, that is, it must be possible to attain magnetic saturation. The fact that such saturation is not even approximately attained is taken to indicate that the molecular magnets possess a latent energy which is independent of the temperature and has the value $\frac{h\nu}{2}$.

Zero-Point Energy

As pointed out by Oosterhuis* and as mentioned above, the existence of a zero-

point energy is therefore made probable by four different lines of investigations.

(1) The change in the specific heat of hydrogen at low temperatures has been explained by Einstein and Stern in a satisfactory manner by this assumption.

(2) Keesom has shown that a similar assumption seems to be required for the translational energy of gas molecules in order to explain the deviations from the ordinary gas laws of a helium thermometer at low temperatures.

(3) The assumption of a zero-point energy has been shown by Keesom to be of great importance in the theory of free electrons in metals. Moreover by making this assumption the views of Wien and the conclusions of the older theory are reconciled.

(4) The deviations from Curie's law observed at low temperatures may be correlated and quantitatively explained by this assumption.

While it may be possible to explain each of these sets of observations without the necessity of introducing a zero-point energy, yet the cumulative effect of these four different lines of investigations is strongly in favor of the assumption that the molecules of a gas and the free electrons in a metal possess a latent energy which is independent of the temperature and persists even at the absolute zero.

CONCLUSION

The above are, briefly, some of the speculations and conclusions which have been suggested by the results of the investigations at low temperatures. The absolute zero appears to us from the point of view of the present theories as a sort of *unattainable limit*. As we approach this temperature more and more closely, the practical difficulties in the way of obtaining still lower temperatures become greater and greater until finally they become insurmountable. All the criteria by which we ordinarily determine temperature gradually disappear and the absolute zero itself becomes, as it were, a will-o'-the-wisp which continually draws us on and yet remains just as remote from our reach.

However, the investigations at low temperatures lead to this important conclusion: that the properties of all substances tend to obey very simple laws under these conditions, and furthermore, that all these properties are probably connected by functions which are perfectly general and valid for all substances.

* Science Abstracts, A, 1914, p. 59.

OPERATING CONDITIONS OF RAILWAY MOTOR GEARS AND PINIONS

By A. A. Ross

RAILWAY AND TRACTION ENGINEERING DEPARTMENT, GENERAL ELECTRIC COMPANY

The following article contains information which should prove to be of much practical value to those interested in the operation of railway motor gears and pinions. After locating and identifying those causes which have produced unsatisfactory operation, the author discusses each one and formulates such recommendations as will lessen the premature breakage and excessive wear of bearings and teeth. The limitations of motor design as influenced by the use of standard $14\frac{1}{2}$ deg. pressure angle and 20 deg. stub pressure angle teeth are defined. The most beneficial relative hardness of gear to pinion is named, and a description of good and bad methods of mounting and dismantling pinions is given. The article is concluded by a discussion and statement of reasonable gear mounting pressures.—EDITOR.

The limitations imposed upon the space available for gears and pinions in the design of modern railway motors, and the severe conditions under which railway motor gears and pinions are operated, necessitate the use of materials which will insure protection against breakage and secure the maximum resistance to abrasive wear. While the gear and pinion manufacturers have been striving to meet these conditions with various grades of steel and special methods of treating the steel, very few operators have taken steps to improve operating conditions.

Apparently the average operator has never given this side of the question serious consideration, a pinion is a pinion and a gear is a gear, and if they break or wear out rapidly it is simply defective material and up to the manufacturer to make good. If the manufacturer does not feel so inclined the operator invariably changes to some other manufacturer's product, and in nine cases out of ten the original trouble recurs. Had the operating conditions been definitely known, the trouble might have been overcome with the original material and the operator, the manufacturer and the trade benefited thereby.

The mere replacement of a gear or pinion covers a very small percentage of the actual cost to the operator. The writer will endeavor to briefly outline these conditions in the following order:

Motor design limitations.

Variation in gear and pinion life.

Operators' responsibility for broken gears and pinions.

Motor Design Limitations

The involute or single curve tooth is best suited and most commonly used for railway motor work, for two reasons; first, on account of the greater thickness at the root of the tooth, and second, because the distance

between the centers of the gear and pinion can be slightly increased without seriously affecting the mesh of the teeth.

In city service 3 diametral pitch teeth are the most popular, with an occasional application of $3\frac{1}{2}$ and 4 diametral pitch on small motors for 24-inch wheel equipments. For heavy high speed duty, such as interurban, suburban and locomotive service, the size of teeth is usually either $2\frac{1}{2}$, $2\frac{3}{4}$, 2 or $1\frac{3}{4}$ diametral pitch. For the smoothest operation the teeth should conform to the standard $14\frac{1}{2}$ -degree pressure angle, but on account of high tooth loads the motor designer is frequently forced to use the 20 degree pressure angle stub tooth.

A comparison of the $2\frac{1}{2}$ pitch standard and 20 degree angle stub teeth is shown in Figs. 1, 2 and 3. The contours of the teeth in the layouts are theoretically correct and may vary slightly from the actual teeth, but the working contacts are sufficiently correct for comparisons. They certainly will not improve as the teeth become worn. It will be noted that the diameter of the base circle from which the involute or face radius of the tooth is generated decreases as the pressure angle increases. Consequently, the tooth with the 20 degree pressure angle is much thicker at the base. The "Whole Depth" of a stub tooth is usually made equal to the next half size smaller standard tooth; that is, the addendum or the distance from the pitch diameter to the top, and root or the distance from the pitch diameter to the base of $2\frac{1}{2}$ pitch stub corresponds to the 3 pitch standard; the 2 pitch stub to the $2\frac{1}{2}$ pitch standard, etc., but the pitch diameter, the tooth thickness at pitch line, the face and flank radii of the tooth are the same for both standard and stub.

The stub tooth is from 40 to 50 per cent stronger than the standard, but the mesh or working contact of the teeth is not so desirable.

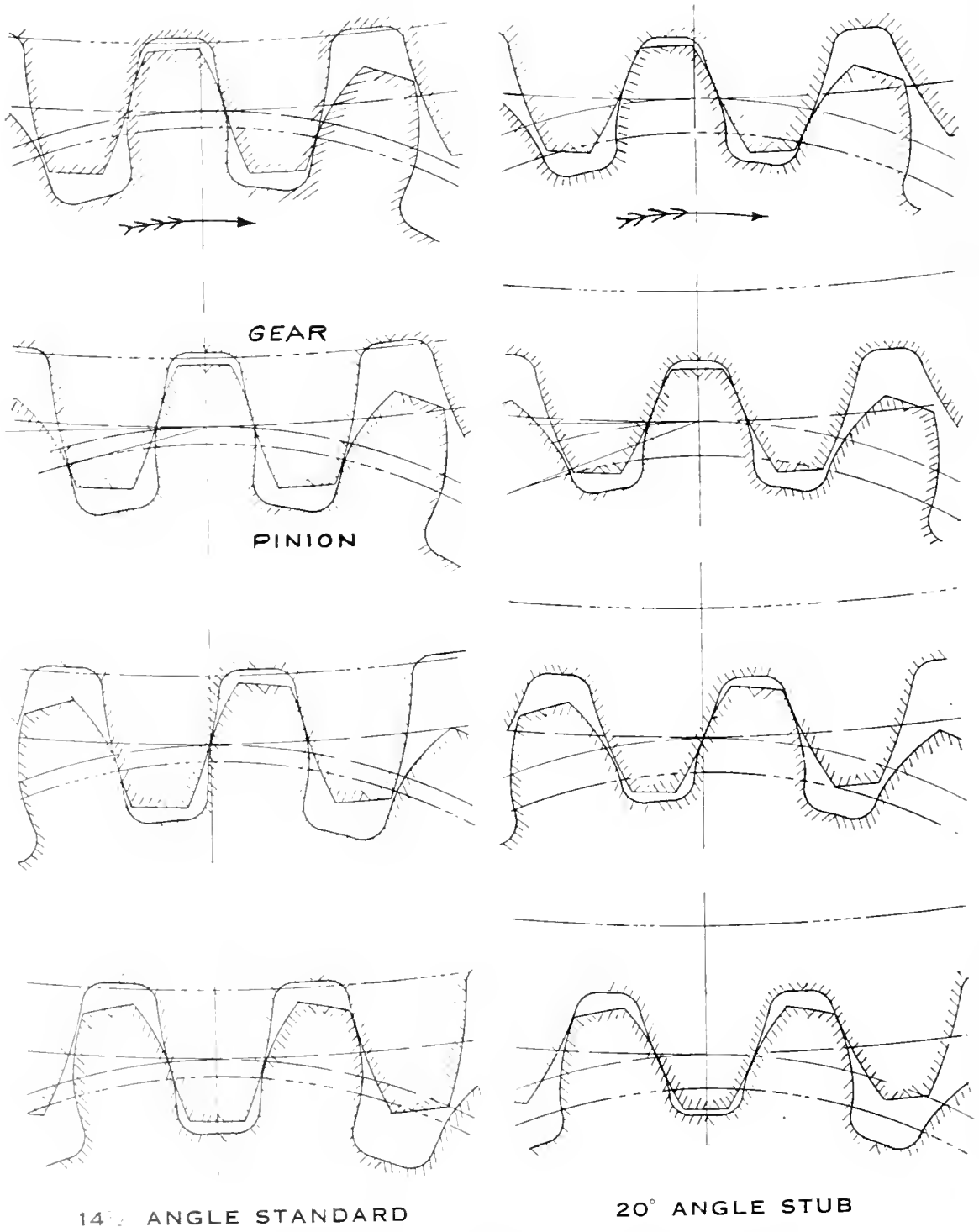


Fig 1. Four Different Mesh Positions of a 2 1/2 Pitch, 18 Tooth Pinion, and 68 Tooth Gear

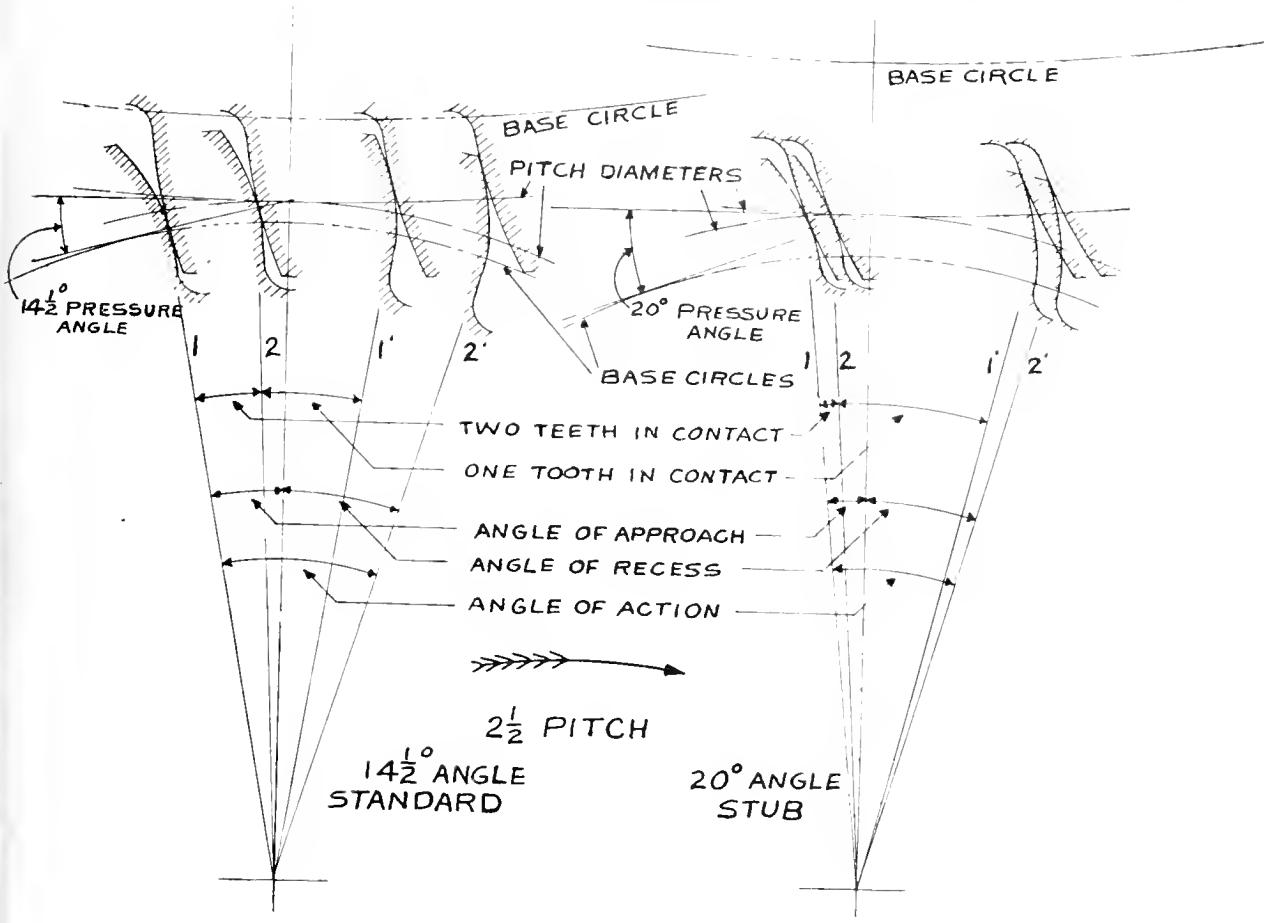


Fig. 2. Angle of Action of the Teeth shown in Fig. 1

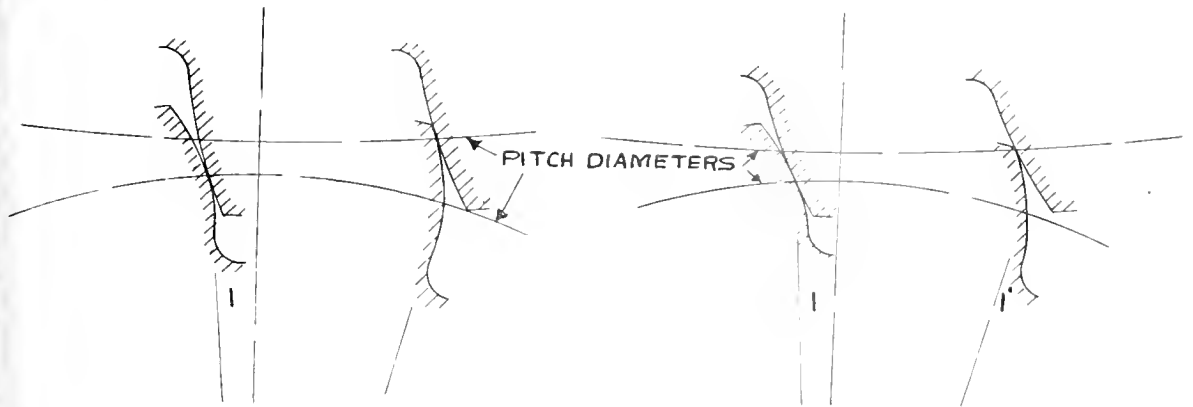


Fig. 3. Angle of Action of the Teeth shown in Fig. 1, but with Distance between Gear Centers Increased

Fig. 1 shows a $2\frac{1}{2}$ pitch, 18 tooth pinion and a 68 tooth gear standard and stub in mesh in four different positions.

Fig. 2 shows the angle of action of this combination or the angle through which the pinion passes while a tooth is in contact. Teeth Nos. 1 and 1' are two successive teeth. No. 1 is just coming in contact and 1 and 1' travel to the 2 and 2' positions before 1' or 2' as shown disengages. Therefore between 1 and 2 positions there are two teeth in contact and between 2 and 1' positions only one tooth is in contact. It is obvious at a glance that the working contact of the standard is much better than the stub and that the contact of the stub tooth in the 1' position is at the extreme top or excessive friction point before it is relieved by the incoming No. 1 tooth.

In Fig. 3 the distance between the centers of the gear and pinion have been increased to represent the conditions when the armature linings are worn $\frac{1}{16}$ in. and the axle lining about $\frac{3}{16}$ in. No. 1' tooth is about to disengage as No. 1 engages. While the working contact is bad on the standard, it is considerably worse on the stub.

Comparative tests which the writer has followed, and reports from operators, would indicate that 20 deg. stub tooth gearing is more noisy than the standard. No doubt this is due to the inferior mesh.

The increased angle of pressure will increase the pressure on the bearing linings but the increase is so slight that the effect on the life of the linings is negligible.

The reader will, no doubt, ask the questions: Why adopt the 20 deg. angle stub tooth since it does not give the best service? Why not gain the required strength by choosing a larger standard tooth? In this the designer is usually limited to a ratio suitable to meet service requirements. To maintain this ratio and adopt a larger tooth is very often impossible for the following reasons:

First. It would mean an increase in the distance between the center of the gear and pinion which adds to the weight and price of the motor, both of which would be seriously objectionable to the operator.

Second. The design of the trucks may not permit an increase in the distance between the center of the axle and suspension side of the motor.

Third. The minimum number of teeth in the pinion is limited to the diameter of the shaft and thickness of the section of metal between the base of the tooth and bottom

of the keyway. Consequently the larger tooth invariably means a considerable increase in the outside diameter of the gear. Such an increase may not be possible on account of the wheel diameter and track clearance limits.

Regardless of the mesh there are large quantities of stub tooth gearing being operated throughout the country, and with the exception of the complaint on noise, they are giving perfect satisfaction. Apparently, the difference in total life has not been noticed. However, the writer would recommend the use of the standard tooth wherever it is possible to apply it, for railway motor gearing is bad enough at the best. If the use of stub teeth is imperative, limit the practice to teeth whose "whole depth" is not less than the 3 pitch standard, for the average operator will allow the same limits for lining wear regardless of the length of the teeth in his gearing. If the length of the teeth in Fig. 3 were reduced the working contacts would be still worse.

Variation in Gear and Pinion Life

From actual service observations it is evident that in straight carbon steel or non-alloy steel the harder the wearing surface of the tooth, the greater the resistance to abrasive wear. Case hardened material now offered to the trade under various trade

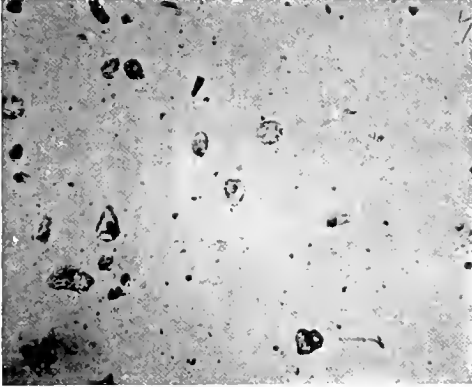


Fig. 4. Sand shown in Vial Represents One Per Cent of Sand by Weight in 12 Lb. of Gear Lubricant

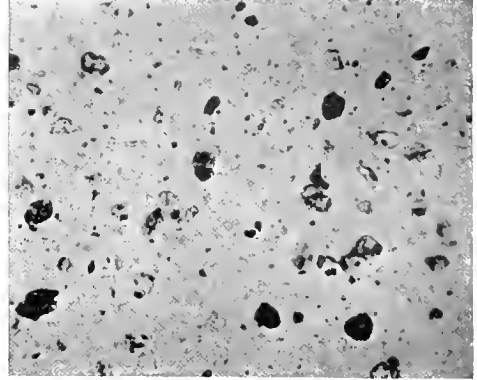
names by practically all gear and pinion manufacturers, affords about the hardest possible tooth surface, but it does not afford maximum protection against breakage. While not wishing to offer excuses for manufacturing

defects, the structure of this steel with its glass hard brittle surface is very susceptible to injury from shocks such as may be transmitted to the teeth during motor flashovers or when at high speed the wheels hit high rail joints, frogs, etc.; but the greatest source of danger lies in the operator's methods of

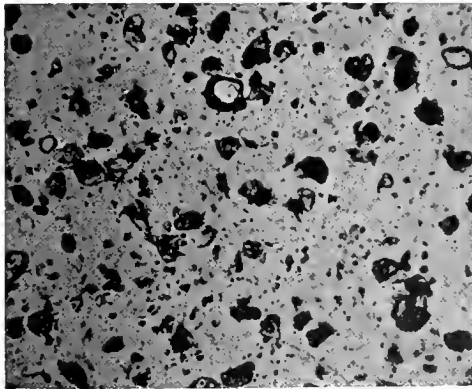
num protection against breakage and a high uniform hardness which resists abrasive wear almost to the same degree as case hardened material, it devolves upon the operator to determine by actual service tests on his own equipment which is the most profitable.



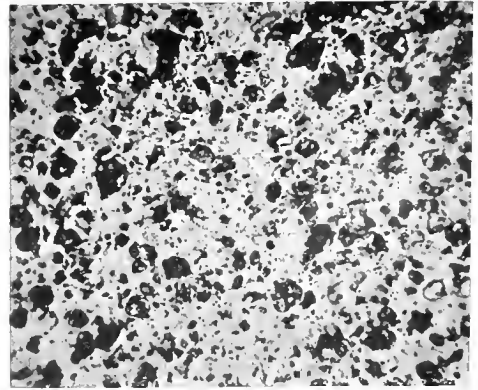
Grease Containing 2 Per Cent of Sand by Weight



Grease Containing 5 Per Cent of Sand by Weight



Grease Containing 10 Per Cent of Sand by Weight



Grease Containing 25 Per Cent of Sand by Weight

Fig. 5. Photo-micrographs (26 dia.) of a Popular Motor Grease Containing Various Percentages of Sand

mounting and dismounting; this will be referred to later. The material is also very expensive to manufacture, but its total life has been so much greater than the old combination which consisted of oil treated pinions and untreated cast steel gears that its first cost and breakage has been overlooked by the operator.

With the advent of the less expensive specially treated homogeneous steel having physical characteristics which afford maxi-

It is unsafe for one operator to use the life values established on some other road for the life is in a great measure affected by the ratio. Still it is quite common to find a radical variation in the life of the same grades of gears and pinions on two roads which have duplicate equipments. Such variations can only be accounted for as follows:

The first and greatest factor is the grit or cutting substance which accumulates in the

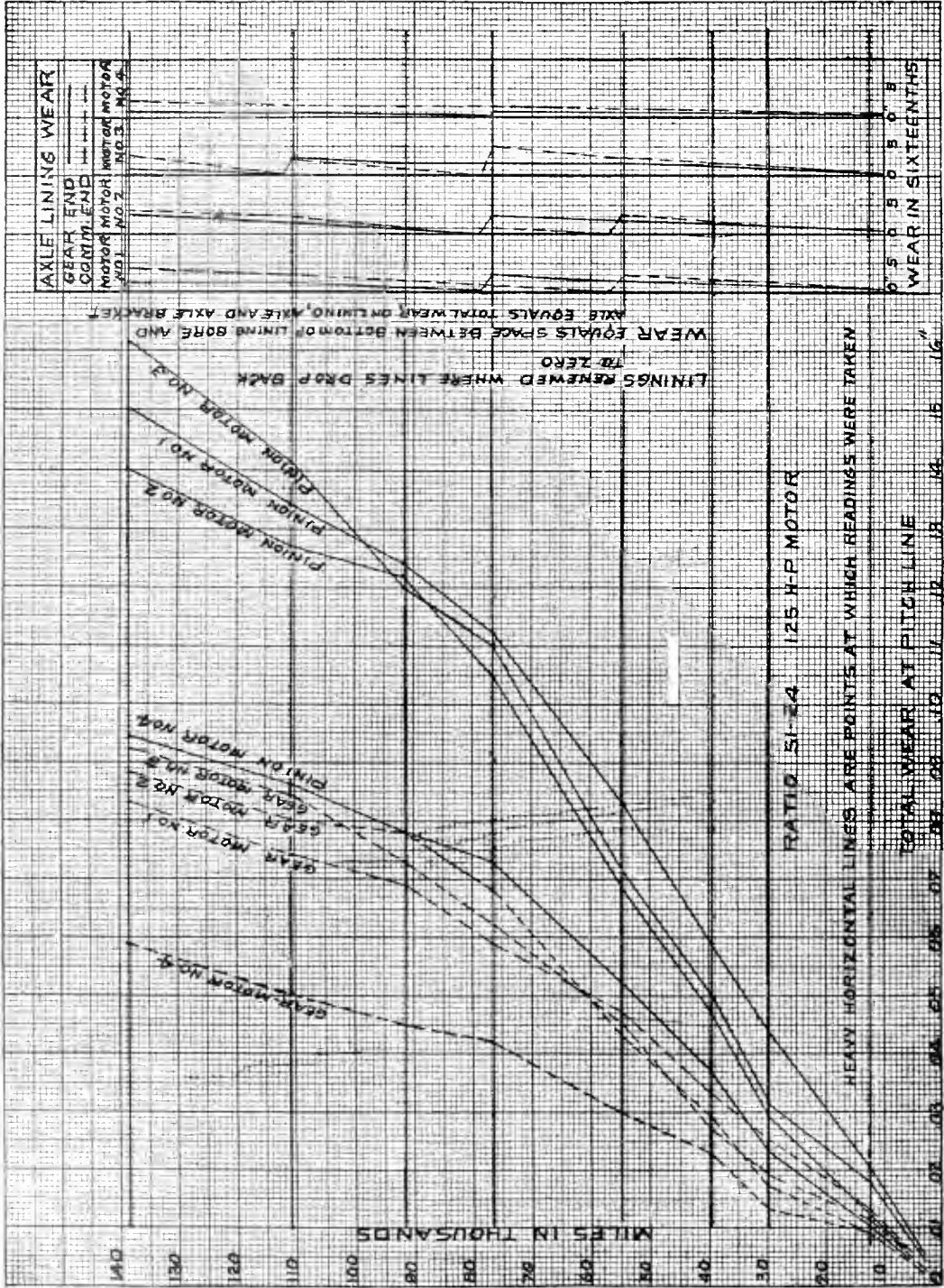


Fig. 6. Curves showing the Effect which Axle Lining Wear has on Gear and Pinion Life

gear pan and when mixed with the lubricant acts as an abrasive lap on the gear, pinion or both. Practically every Master Mechanic will disclaim its presence, but it is there and it has been found in quantities as high as 24 per cent.

It is doubtful if the reader appreciates what even one per cent of sand really means. The average amount of lubricant in gear pans is about 12 pounds. The quantity of sand in the vial; Fig. 4, represents 1 per cent of sand in 12 lb. of lubricant. The vial is 1½ inches in diameter. Pause for an instant and consider what 10 per cent or 10 times, 24 per cent or 24 times, this quantity means.

Fig. 5 shows photo-micrographs of a popular motor grease containing various percentages of sand magnified to 26 diameters. The sand used in the mixture was first screened through an 80-mesh screen.

The sand usually enters between the gear hub and gear pan in the form of street dust, brake shoe dust and wheel wash. Very often the contour of the web and hub of the wheel is such that the natural flow of the wheel wash is against the opening in the gear pan as shown in Fig. 7. It would be much better if this were retarded by either making the diameter of the wheel hub larger or smaller than the gear hub. The clearance between the gear hub and gear pan is sometimes enclosed by a felt dust guard, but this is not a permanent protection as the felt soon fills up with sand, and breaks off. Carelessness when adding lubricant or when the lower half of the pan is lying in the pit during inspection is another source of dirt getting into the grease. One of the largest operators in the east traced the cause of rapid wear to the presence of sand in the lubricant which was carried into the pan by the wheel wash during a period of heavy snow and slush. The sand or stone dust seems to scour the lubricant off the teeth.

Before shipment the finished surfaces of gears and pinions are given a coating of slushing compound to prevent rust. This should be removed before the gears and pinions are placed in service as it becomes filled with lime and sand during shipment.

The second factor is excessive lining wear which permits improper mesh as shown in Fig. 3. The design of the motor and the truck prevents the use of a bearing on each side of the gear and pinion so that when power is transmitted from the pinion to the gear both the armature and axle shafts tend to spring diagonally away from one another.

The armature shaft bearing adjacent to the pinion becomes worn on the side which is farthest from the axle, while the bearing on the other end wears on the side near the axle. The wear on both bearings is not radial with the center of the axle but at two

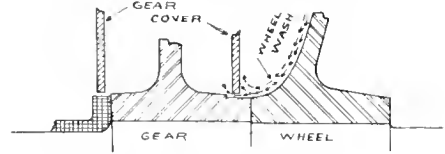


Fig. 7. Diagram showing the Natural Direction of Flow of Wheel Wash Against the Gear Cover

points about 45 degrees above and below the radial line, according to the direction of rotation. This allows the pinion teeth to set at an angle to the gear teeth, which means that the ends of the teeth next the motor receive the greatest percentage of shocks and must perform the major portion of the work. Such conditions account for the greater wear on the motor ends of the teeth. Consequently, very little would be gained by increasing the present standard width of face. Furthermore, the axle linings wear on the upper portion of the bore away from the armature shaft which tends to carry the pitch lines of the gear and pinion still further apart and forces the working contacts to take place on the top or excessive friction points.

Some operators claim that it is impossible to maintain $\frac{1}{8}$ in. as the limit for axle lining wear, as it forces too frequent renewals and that the slight reduction in gearing maintenance is offset by an increase in lining maintenance. If gearing maintenance were the only consideration there might be some ground for the argument, but the improper mesh also produces a noisy chattering, which effects commutation and the nerves of the population living along the route over which the gearing is operated. If the operator doubts the effect on the rest of the equipment let him get into the pit under a motor with the axle linings worn say $\frac{1}{4}$ in., start the car so that the pinion climbs the gear and, as the car gains momentum, note the blow on the axle as the motor settles back into place. This is especially severe on heavy equipments.

The effect which axle lining wear has on gears and pinions is shown in Fig. 6, which is plotted from actual service tests. The axle linings on No. 4 motor show the

least amount of wear; consequently, the wear is less on No. 4 gear and pinion. A handy gauge for checking lining wear is shown in Fig. 8.

Many of the latest types of motors are provided with axle dust guards which com-

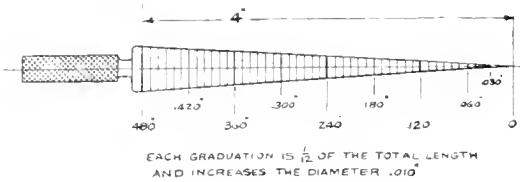


Fig. 8. Gauge for Measuring Lining Wear

pletely enclose the axle between the bearing housings and prevent sand from getting in the linings. This is a step in the right direction, but there is a tendency on the part of the operator to pay less attention to axle lining wear limits owing to the trouble of removing the guards for inspection. A very fair idea of lining wear without removing the guard can be obtained by jacking up the bearing housing with a block and pinch bar.

The third cause is the consistency of the lubricant. There are many good grades on the market but, be the grade what it may, the lubricant should be of such consistency and used in such quantities that the gear teeth will dip frequently. The writer has absolutely no confidence in the virtue of a lubricant so hard that the gear cuts a groove through it and as soon as the grease in the groove is deposited on the sides of the pan, the teeth run dry. The lubricant should be soft enough to level back and be again picked up by the gear teeth. Also, if the lubricant is soft the sand will more readily settle to the bottom. The operator who uses a summer grade during the winter months usually does so at the expense of his gearing.

The number of stops in the schedule, the coasting limits and the motormen's methods of accelerating and braking may be considered the fourth factor.

Operator's Responsibility for Broken Gears and Pinions

By comparing the thickness at the base of the gear and pinion teeth in Fig. 1, it will be noted that the thickness is less on the pinion. This is due to the under cut at the root of the pinion tooth to give clearance for the gear tooth. The pinion teeth being the weaker of the two, it is obvious that the

greatest percentage of tooth failures will occur on the pinion, and as previously mentioned on the motor ends of the teeth. The breaks usually begin in a V-shaped fracture and progress irregularly to the top of the tooth about one-third across the tooth face. The usual question is: What causes the failures, and why should one operator have more than another? Invariably, the operator will put the responsibility up to the manufacturer, but there are many causes for failures over which the manufacturer has absolutely no control and for which the operator is entirely responsible, especially the methods employed when mounting and dismounting the pinions. The most common and injurious method for mounting is that of driving a pinion home with a sledge. Usually one man holds a babbitt metal ring or cup-shaped protector over the end of the pinion while another swings onto it with a 10 or 20-lb. sledge.

Now let us consider what happens to the pinion. The shaft on which the pinion is to be mounted has a tapered fit and every blow of the sledge adds internal stresses to the body of the pinion; the maximum stresses depending on the proficiency of the man who swings the sledge and the number of blows delivered. The section of metal between the root of the tooth and the bore at the large end or between the root of the tooth and the bottom of the keyway on the popular pinions, 14 and 15 teeth, 3 pitch, 17 and 18 teeth, $2\frac{1}{2}$ pitch, is usually just about thick enough to take care of the tooth load stresses, and if excessive stresses are added when mounting, the pinion after being placed in service either splits through the keyway or a portion of one or more teeth directly over the keyway fails from fatigue at low mileage.

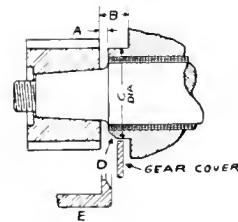


Fig. 9. Diagram of Frame Head and Pinion showing Clearance for Pinion Puller Ring

Some operators make it a practice to heat the pinions in boiling water and then sledge them on as just described. This method is exceptionally severe for the metal is sub-

jected to shrinkage strains plus the stresses set up by sledging.

The following is the safest method and is giving perfect satisfaction on several large roads: The pinion is first slid onto the shaft to make sure that it fits properly and especially that it does not ride the key. It is then placed in boiling water until it is heated clear through; about 45 minutes. (Flame or heating in an oven should never be allowed as the temper of some grades may be easily drawn and the virtue of the treatment lost.) It is then seated quickly on the shaft and rammed home with a wooden block, three or four feet long, about the diameter of the pinion and cupped at the end to clear the shaft. The nut is immediately set up and the pinion rammed once more and the nut again set up. If the pinion is heated clear through and fits the shaft properly it will not work loose.

The fit on the shaft is very important, if the shaft is not perfectly round or if the metal is swelled on each side of the key which can easily be done by using force to seat a key which is too wide for the keyway, or if the pinion rides the key there is a tendency for the mounting stresses to localize at one of the bearing points in the body of the pinion which eventually results in a tooth failure or a crack in the body directly over the point of localization.

The method of dismounting is another great source of pinion tooth failures. It is still common practice to drive wedges between the bearing housing and the end of the pinion. The writer doubts if it is possible to remove a pinion in this manner without subjecting one or more teeth to injurious shocks, especially so with case hardened material which is easily damaged and which is removed several times during its life.

A pinion puller which grips only two or three teeth is equally bad. A puller which grips all the teeth is the safest. There are two or three on the market which can be assembled on all types of split frame motors providing the armature is removed from the motor, but on some of the old types of box frames it is impossible to assemble them unless the outside diameter of the pinion teeth is at least $\frac{3}{4}$ in. greater than the projection shown as C diameter in Fig. 9. Space B will permit a puller jaw thick enough to withstand the stresses. On the later types of box frame motors the frame heads are chamfered as shown at D. Thus, plus the space A, which is usually $\frac{1}{4}$ in. will accommo-

date a puller jaw similar to E and permit the use of satisfactory pullers. Rather than use wedges it would be more economical for the operator to chamfer his frame head in the same manner.

On the other hand, all steel will reach its life limit and break down from what is known as "fatigue" if the load is repeatedly applied even though the load is far less than it can bear indefinitely. This accounts for a great percentage of tooth failures on heavy equipments where the tooth loads closely approach the elastic limit of the material. The failures may occur before the teeth have even approached the wear scrapping point. In such cases the operator should establish a safe mileage limit and scrap the pinions regardless of the amount of wear.

There are so many different grades of gears and pinions on the market that the master mechanic is sometimes uncertain as to which grade of pinion is the most economical to operate with a certain grade of gear.

In the first place it is unreasonable to expect satisfactory results from a combination in which the gear is harder than the pinion for each pinion tooth makes from two to four contacts to each contact of a gear tooth. From actual service observations it is evident that the best results will be obtained by operating together a gear and pinion of the same hardness. This means that the gear will outwear two and sometimes three pinions, and the second and third must mesh against worn gear teeth which will produce noise until the gear and pinion teeth have adjusted themselves to the proper contour. While this adjustment is taking place the wear seems to have a greater effect on the new pinion. The total life of the second and third pinion will be less than the first or original pinion. Some master mechanics ask: "Is it possible for me to obtain a pinion which will give a life equal to the gear?" With the grades of gears and pinions on the market at present the writer's answer—from an economical standpoint—is "No." It can, however, be accomplished by operating a hard pinion and soft gear together, but I think the trade learned from experience when the case hardened pinions first came on the market that such a combination resulted in a reduction in life of the gear, and the gear being the more expensive member of the two it was anything but a profitable combination.

The operator should, therefore, carefully watch the performance of his gears for he

may be getting high pinion life at the expense of his gears.

There seems to be an extreme and unreasonably wide range in the total tonnage limits which various master mechanics have adopted for mounting solid gears without keys. The range varies from 20 to 80 tons. For city service 20 to 30 tons is sufficient and is proving satisfactory on several roads. For interurban service anything over 50 tons seems unreasonable. For instance, take 40,000 lb. as equipment weight, 15,000 lb. for passengers, 30 in. wheel and 5 in. axle and the torque at the gear bore at the slipping point of the wheels is as follows:

40,000 lb. weight of car equipment	
15,000 lb. weight of passengers	
55,000 lb. total	
0.30 per cent coefficient of friction	
16,500.00	
16,500	
4 (no. axles)	= 4125 lb. per axle to slip
	at 0.30 per cent coefficient of friction.

$$\frac{30}{5} \times 4125 = 24,750 \text{ lb.}$$

$$= 12\frac{1}{2} \text{ tons torque at gear bore.}$$

Considering the usual finish on the axle and bore and the ironing effect between the two surfaces when the gear is mounted, it will take a much higher torsional pressure to twist the gear on the axle than the pressure used to mount it. It is common practice to use the same limits for gears and wheels. The high ranges may be necessary for the wheels on account of the end thrusts, but as there is no lateral pressure on the gear the torsional pressure is only to be considered. Of course, there are unknown torques to be considered which may result from momentum when motors are short circuited or suddenly reversed. In the above case had the gear been mounted at 20 tons there would have been a sufficient factor of safety to take care of the unknown torque. Therefore, why use the high tonnage range which makes it difficult to remove the gear and subjects the gear to unknown internal stresses which may cause failures, when it can be avoided?

X-RAYS

PART I

BY DR. WHEELER P. DAVEY

RESEARCH LABORATORY, GENERAL ELECTRIC COMPANY

This is the first of a series of articles on the physics of X-rays. The present article deals with the theory as to their nature. According to this theory these rays belong to that great family of electromagnetic disturbances which includes the waves of the wireless telegraph, and those of infra-red, visible, and ultra-violet light. Future articles will take up the properties of the rays and some of their uses.—EDITOR.

Of all the theories so far proposed as to the nature of X-rays, the Electromagnetic Theory seems to be the most useful.* This theory seeks to account for X-rays in terms of the properties of the electrostatic and magnetic fields of electrically charged moving particles. It is found that such a theory is capable of giving a rational basis for correlating the facts known at present about X-rays and is also able to suggest fruitful topics for further research.

It is well known that if a stationary body, *A*, is given an electric charge, the region around *A* becomes altered in such a manner that a force of repulsion is exerted upon any other body similarly charged. For simplicity

*The word "useful" is used here purposely. No theory is to be regarded as a statement of absolute fact. A theory may be *disproved*, but it can never be *completely proved*. Of two or more theories, all of which are equally consistent with the known experimental data, the one to be preferred is that which is *likely to be of the greatest use in producing results*.

let *A* be spherical in shape and not situated near any other charged body; then, the electric force extends from it radially in all directions. If the location of *A* or the amount of charge upon it is changed, there is a corresponding change in the electric force, and this *change in the electric force* is propagated from *A* with the velocity of light (3×10^{10} cm. per sec.).

Now suppose that *A* is moving with uniform velocity and that this motion has already been kept up for so long a time that the whole electric field of force is in motion with it. This condition of the electric field is represented diagrammatically in Fig. 1. If *A* is suddenly stopped, the condition of the electric field is as represented in Fig. 2a. The direction of motion is represented by *XX'*. If *A* had continued in uniform motion for a time, *t*, it would have reached *A'*, and

would have had a field such as is shown by the lines $A'DE, A'HI, A'X', A'JK$, etc. But, since A has been stopped, it will finally have a field such as is shown by the lines ABC, AFG, AX', ALM , etc. The intermediate stage is shown by the full lines $ABDE, AFHI, AX', ALJK$, etc., where BD, FH, LJ , etc. constitute the *changing portion* of the electric field, which, as has been stated before, moves out from A in all directions with the velocity of light. BD has the same relation to $ABDE$ as the "crack of a whip" has to the whip itself.

The movement of a line of electric force calls into existence a magnetic field, and this holds true independently of whether the movement is caused as previously described or is caused by electric charges passing through a wire. Now, when a current passes through a wire, the direction of the magnetic field is mutually perpendicular to the direction of the electric field and to the direction of the current. Since the electric field of each elementary charge of electricity moves with that charge, we may make this more general statement—*The direction of the magnetic field due to a moving electric field is mutually perpendicular to the direction of that electric field and to the direction in which that field is moving.* We should therefore expect to find that as BD, FH, LJ , etc., move outward from

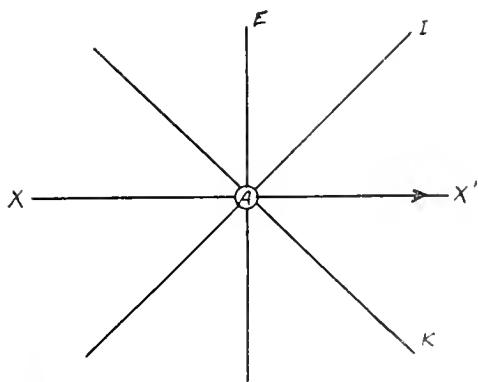


Fig. 1

A they would be accompanied by a magnetic field perpendicular to the paper. The pulse sent out by A upon stopping is therefore partly electric and partly magnetic in its nature and is called an "electromagnetic" pulse.

According to the electromagnetic theory, primary X-rays consist of such pulses as have just been described. If negatively charged particles of matter (variously called corpuscles, β particles, cathode rays, and electrons) are shot out at high velocities

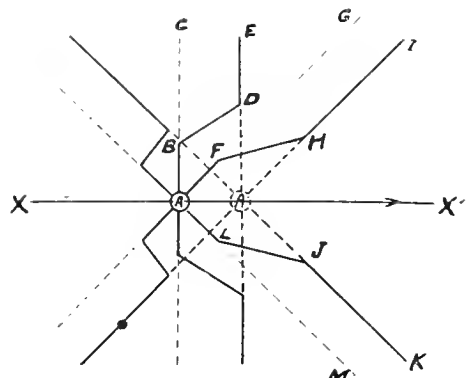


Fig. 2a

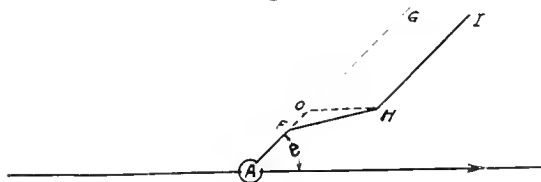


Fig. 2b

toward the target of an X-ray tube, they will experience a great decrease in velocity upon entering the face of the target; and during the time that this retardation occurs, X-rays are produced. Their properties seem to depend only upon the rate of retardation which the cathode rays experience at the target, and this in turn depends only upon the voltage across the terminals of the X-ray tube and upon the material used as a target.

If OH (see Fig. 2b) is drawn parallel to XX' , so as to represent the path taken by H , then FO is called the "thickness" of the pulse FH . We will call this thickness d . The electric force along FH may be considered as being the resultant of two forces, P_1 along FO , and P_2 along OH . Since the dielectric constant of empty space is unity, we have at once

$$P_1 = \frac{\epsilon}{(AF)^2} \quad \text{or} \quad \frac{\epsilon}{r^2},$$

where ϵ is the amount of the charge on A , and

$$P_2 = P_1 \frac{OH}{FO} = \frac{\epsilon}{r^2} \times \frac{OH}{d}.$$

Now let

u = the velocity of A just before being suddenly stopped.

V = the velocity of propagation of the pulse FH (equal to the velocity of light).

T = the time A would have required to have reached A' .

Then

$$OH = AA' = uT$$

and since

$$r = VT$$

it follows that

$$OH = \frac{ur}{V}$$

and

$$P_2 = \frac{\epsilon}{r^2} \times \frac{ur}{dV} = \frac{\epsilon u}{rdV}$$

Since the pulse FH is moving in a direction parallel to AF , we are only interested in that component of P_2 which is parallel to AF , viz., P_2' , where

$$P_2' = \frac{\epsilon u}{rdV} \sin \theta$$

Now the energy of the pulse is partly electrostatic, and partly magnetic. That portion which is electrostatic is equal to $\frac{1}{8\pi}$ times the square of the electric force.

$$E_E = \frac{\epsilon^2 u^2 \sin^2 \theta}{8\pi r^2 d^2 V^2}$$

The magnetic portion is $\frac{1}{8\pi V^2}$ times the square of the magnetic intensity. But the magnetic intensity is V times the electric force which produces it.

$$E_M = \frac{\epsilon^2 u^2 \sin^2 \theta}{8\pi r^2 d^2 V^2}$$

The total energy of the pulse FH is therefore

$$E_{FO} = \frac{\epsilon^2 u^2 \sin^2 \theta}{4\pi r^2 d^2 V^2}$$

The energy of the whole spherical pulse is obviously obtained by integrating E_{FO} , thus giving

$$E = \frac{2}{3} \epsilon^2 \frac{u^2}{dV}$$

where d depends for its value upon the values of θ and u and upon the atomic weight of the material used as a target.

It will be useful to gain an idea of how u depends upon the voltage across an X-ray

tube. If the charge on a cathode particle is ϵ then a voltage E will represent an energy of $E\epsilon$. The mechanical energy of the electron is $\frac{1}{2} mu^2$. By the law of conservation of energy

$$E\epsilon = \frac{1}{2} mu^2$$

or

$$E = \frac{1}{2} \frac{m}{\epsilon} u^2$$

For purposes of convenience this is often written

$$E = \frac{1}{2} \frac{u^2}{\epsilon_m}$$

Now the value of ϵ_m is not a constant but depends in a complicated way upon the value of u . Table I has been calculated from data given by Bucherer (1909), Steinmetz (1898), and Algermissen (1906). Spark gap lengths

TABLE I

u in Miles per Sec.	u in Cm per Sec.	E in Volts	E in Cm. Spark Gap Between Needle Points (A-C.)	E in Cm. Spark Gap Between Balls, 5 Cm. in Diameter (D-C.)
		$\times 10^9$		
11,800	1.88	1,000	0.1	
18,900	3.00	2,330	0.2	
37,900	6.00	10,300	0.8	0.2
	7.50	16,200	1.3	0.4
56,800	9.00	23,770	2.0	0.7
	9.60	27,200	2.3	0.8
63,000	10.2	30,900	2.7	0.9
	10.8	34,800	3.1	1.0
	11.4	39,300	3.6	1.2
74,400	12.0	44,000	4.3	1.4
	12.6	49,100	5.0	1.6
	13.2	54,300	5.9	1.8
	13.8	59,900	6.9	2.1
	14.4	66,100	7.9	2.4
93,000	15.0	72,800	9.3	2.7
	15.6	79,700	10.6	3.1
	16.2	87,200	12.0	3.6
	16.8	95,400	13.6	4.2
	17.4	104,200	15.5	4.9
111,600	18.0	113,400	19.6	5.6
	18.6	123,500	20.0	6.8
	19.2	134,100		8.1
	19.8	146,100		10.1
	20.4	158,900		13.0
130,200	21.0	172,900	30.0	16.2
	21.6	188,100		19.5
	22.2	205,300		
	22.8	224,000	45.0	
	23.4	245,200		
142,600	24.0	268,900		
	24.6	296,000		
	25.2	327,700		

are to be considered only as approximate measurements of voltage under ordinary working conditions.

When the cathode rays strike the target they are not stopped instantaneously at the surface, but merely suffer retardation so that they penetrate for some distance into the body of the target.* After once entering the target, the particles no longer all move in the same general direction, but travel more or less radially. If, for a given velocity of cathode rays, we imagine the target to be made thicker and thicker, a thickness will be reached at last for which there are as many particles emerging in one direction as in any other. This thickness is called "The depth of complete scattering."[†]

In aluminum it is 0.015 cm.; in copper, 0.001 cm.; in silver, 0.001 cm.; in gold, 0.00020 cm.; and in lead, 0.00025 cm. at 90,000 volts. It varies directly as the voltage employed across the tube.

Those primary rays which are able to overcome the absorbing effect of the target reach the surface and emerge into the vacuum space of the tube. Measurements have shown[‡] that if the voltage across the tube is made very small, then the primary rays, at the moment of generation, have their maximum of intensity in a direction perpendicular to the cathode stream, and a minimum of intensity in a direction parallel to the cathode stream. This effect is called "polarization." As the voltage across the tube is increased, the polarization is decreased, until finally it becomes immeasurable. This is explained by assuming that at the higher potentials the rays formed by the initial retardation of the cathode stream are negligible in their effects, when compared with those rays which come out in all directions from the depth of complete scattering.

Secondary Rays

When X-rays are made to impinge upon a substance, that substance itself becomes a

source of X-rays, which are called "secondary rays." Two distinct types of secondary rays are recognized, viz., "scattered" and "characteristic." When X-rays pass through a substance, the emergent beam is found to act in the same way that light acts on passing

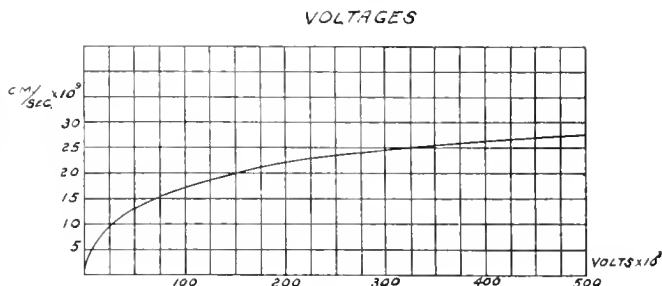


Fig. 3

through a fog. The rays retain all the peculiarities of the incident beam, but have suffered a diffuse reflection or "scattering." Scattered rays emerge from both the incidence and the emergence faces, and the radiation in the emergence direction is much greater in intensity than that in the incidence direction.[§]

Scattering increases with the thickness and with the atomic weight of the scattering substance, and, within the limits ordinarily used, is greater the greater the penetrating ability of the incident rays.

If X-rays of very low penetrating ability are allowed to fall on a substance (called a "radiator"), the emergent beam contains only two components. (a) that portion of the primary beam which has been unaltered and, (b) the scattered rays. If, now, the penetrating ability of the incident beam is gradually increased, a point is at last reached at which a new type of radiation appears, which is characteristic of the substance used as the radiator.[¶]

Barkla and Sadler^{||} have shown that if the incident primary rays are less penetrating than are the secondary rays which are characteristic of the radiator used, then no secondary rays are produced; but if the incident primary rays are more penetrating than the characteristic secondary radiation, then "characteristic" rays are produced.

[§] Barkla and Ayers, *Phil. Mag.*, pp. 270-280, Feb., 1911.
Owen, *Proc. Camb. Phil. Soc.*, vol. 16, p. 161, 1911.
Crowther, *Proc. Roy. Soc.*, pp. 478-494, Feb., 1912.

[¶] C. J. Barkla and C. A. Sadler, *Nature*, 77, pp. 343-344, Feb. 13, 1908, *Nature*, 80, p. 37, March 11, 1909.

^{||} Barkla and Sadler, *Nature*, 80, p. 37, March 11, 1909.

* W. R. Ham, *Phys. Rev.*, xxx, Jan., 1910.
W. P. Davey, *Jour. Franklin Inst.*, Mar., 1911.
L. G. Davey, *Phys. Rev.*, Sept., 1914.

[†] J. A. Crowther, *Roy. Soc. Proc.*, 80, A, pp. 186-206, Mar. 5, 1908.
W. R. Ham, *Phys. Rev.*, xxx, 1, pp. 119-121, Jan., 1910.

[‡] R. Blondlot, *Comptes Rendus*, 136, pp. 284-286, Feb. 2, 1903. *Nature*, 69, p. 463, March 17, 1904.
C. G. Barkla, *Roy. Soc. Phil. Trans.*, 204, pp. 467-479, May 31, 1905. *Roy. Soc. Proc.*, 74, pp. 474-475, March 16, 1905.

H. Haga, *Konink. Akad. Wetensch. Amsterdam Versl.*, 15, pp. 64-68, July 20, 1906.
J. Herwig, *Ann. d. Phys.*, 29, 2, pp. 398-400, May 21, 1909.
E. Basseler, *Ann. d. Phys.*, 28, 4, pp. 808-884, Mar. 16, 1909.
L. Vegard, *Roy. Soc. Proc.*, Ser. A., 83, pp. 379-393, Mar. 22, 1910.

W. R. Ham, *Phys. Rev.*, xxx, pp. 96-121, Jan., 1910.
F. C. Miller, *Franklin Inst. Jour.*, 171, pp. 457-461, May, 1911.

The production of characteristic X-rays is very analogous to the production of fluorescent light. In fact, the analogy is so close that some writers are adopting the term "Fluorescence Röntgen Radiation."

Chapman and Piper* tried to detect a continuance of secondary radiation after excitation from the primary rays had ceased, but were unable to detect even 1/250 of the original radiation 1/3000 of a second after the exciting primary rays had been removed.

Radiators may be classified into four groups in the order of their atomic weights. The radiations given out by the members of each group are very much alike.

Group 1 (1-32).-H-S. When excited by a beam from a "soft" tube the members of this group give off little, if any, characteristic radiation; almost the entire radiation being of the scattered type and this is polarized in a plane perpendicular to the direction of the parent cathode stream. If the tube is made moderately "hard" (i.e., if it gives off rays of moderate penetrating power), a slight amount of characteristic radiation will be displayed, and if the tube is very "hard," a well-defined characteristic beam is given off, having a penetrating ability much different from that of the exciting rays.

Group 2 (52-65).-Cr-Zn. This group gives off a beam composed almost entirely of a true characteristic radiation, even when excited by rays from a "soft" tube, but this radiation has little penetrating ability. With a given excitation, the ionization produced by it is almost 100 times that produced by an equal mass belonging to Group 1.

Group 3 (107-125).-Ag-I. If the exciting beam is only of moderate penetrating ability, this group gives off mostly a scattered radiation, but, unlike that from Group 1, it is unpolarized, and there is a noticeable amount of characteristic radiation present. The relative amounts of scattered and characteristic radiation vary greatly with small changes in the character of the exciting rays.

Group 4 (183-206).-W-Bi. These substances resemble Group 2 in their action. For all these elements the penetrating ability of the characteristic rays is independent of the intensity or of the penetrating ability of the exciting beam, but is

a periodic function of the atomic weights of the radiating elements.**

If the radiator is a chemical compound, the component atoms and radicals determine the character of the secondary rays produced.†

The rays coming from salts are composed of (1), a homogeneous radiation having the same penetrating ability as that from the metal itself, and, (2), a scattered primary radiation considerably more penetrating than that of (1) due to the acid radical. If a metal occurs in the acid radical it has no individual effect, but merely acts with the remainder of the radical.‡

There seems to be a real physical difference between primary X-rays and characteristic X-rays. From the electromagnetic theory, primary rays seem to consist of an irregular succession of "splashes." Experimental evidence (which will be taken up in a later article) seems to show that characteristic rays consist of trains of waves resembling light waves, except for the fact that the wave length is about 1/1000 that of ordinary light. Each element is able to emit characteristic rays whose wave lengths fall into certain well defined groups. Two of these (called *K* and *L* respectively) are of great importance. For any given radiator, rays of the *K* group are about 300 times as penetrating as those of the *L* group. Table II shows the wave lengths of the two most intense members of each group for 39 elements. It will be noticed that, to date, there are many gaps still to be filled in the list. The values given in the table were published by Mosely in the *Philosophical Magazine*, April, 1914.

Chapman has shown§ that if the *L* radiation of one element is of nearly the same wavelength as the *K* radiation of another element, then their atomic weights (A_L and A_K respectively) are related by the formula

$$A_K = \frac{1}{2}(A_L - 48).$$

Whiddington has shown¶ that when any given substance is used as the target of an X-ray tube, it will give off characteristic *K* rays if the speed in cm. per sec. of the cathode rays is greater than 10^8 times the atomic weight of that substance. From Chapman's formula it follows that the characteristic *L* rays would be obtained at a speed of $\frac{1}{2}(A - 48) \times 10^8$ cm. per sec., where *A* is the

** C. G. Barkla and C. A. Sadler, *Phil. Mag.*, 16, pp. 550-584, Oct., 1908.

† J. A. Crowther, *Phil. Mag.*, 14, pp. 653-675, Nov., 1907.

‡ J. L. Glasson, *Camb. Phil. Soc.*, pp. 437-441, June 14, 1910.

§ Chapman, *Proc. Roy. Soc.*, 1912.

¶ Whiddington, *Proc. Roy. Soc.*, 1911.

* Chapman and Piper, *Phil. Mag.*, 19, pp. 897-903, June, 1910.

TABLE II

WAVE-LENGTHS OF VARIOUS CHARACTERISTIC X-RAYS

NOTE.—The most important line in each series is called α .
The next most important is called β .

Elements	K SERIES		L SERIES	
	α $\times 10^{-8}$ Cm.	β $\times 10^{-8}$ Cm.	α $\times 10^{-8}$ Cm.	β $\times 10^{-8}$ Cm.
Al	8.364	7.912		
Si	7.142	6.729		
Ci	4.750		
K	3.759	3.463		
Ca	3.368	3.094		
Ti	2.758	2.524		
V	2.519	2.297		
Cr	2.301	2.093		
Mn	2.111	1.818		
Fe	1.946	1.765		
Co	1.798	1.629		
Ni	1.662	1.506		
Cu	1.549	1.402		
Zn	1.445	1.306		
Y	0.838			
Zr	0.794		6.091	
Nb	0.750		5.749	5.507
Mo	0.721		5.423	5.187
Ru	0.638		4.861	4.660
Rh			1.622	
Pd	0.584		4.385	4.168
Ag	0.560		4.170	
Su			3.619	
Sb			3.458	3.245
La			2.676	2.471
Ce			2.567	2.360
Pr			2.471	2.265
Nd			2.382	2.175
Sa			2.208	2.008
Eu			2.130	1.925
Gd			2.057	1.853
Ho			1.914	1.711
Er			1.790	1.591
Ta			1.525	1.330
W			1.486	
Os			1.397	1.201
Ir			1.354	1.155
Pt			1.316	1.121
Au			1.287	1.092

atomic weight. Table III shows Whiddington's experimental values.

The subject of electromagnetic disturbances was discussed at the beginning of this article

TABLE III

MINIMUM SPEED OF CATHODE RAYS REQUIRED TO EXCITE CHARACTERISTIC RADIATIONS

Radiator	Atomic Weight ($\theta = 16$)	Critical Velocity of Cathode Rays to Excite K Radiation	Voltage Necessary to Give Critical Velocity to Cathode Rays
		cm./sec.	volts
Aluminum	27.1	2.06×10^9	1200
Chromium	52.0	5.09×10^9	7320
Iron	55.8	5.83×10^9	9600
Nickel	58.7	6.17×10^9	10750
Copper	63.6	6.26×10^9	11080
Zinc	65.4	6.32×10^9	11280
Selenium	79.2	7.38×10^9	15400

from the standpoint of a single retardation of the electron. It is evident that, if the electron had been considered as having a regular to-and-fro motion, the resulting electromagnetic disturbance would have consisted of a *train of waves* of a definite wave length. It is therefore natural to assume that characteristic X-rays are produced when certain electrons in an atom are made to vibrate at some natural frequency. Such vibrations could be set up by giving the electron a *single impulse*, provided that the time consumed in communicating the impulse is not more than half the time of one natural vibration of the electron. We thus have a theoretical basis for the experimental facts that secondary rays may be produced both by sufficiently "thin" primary rays, and also by cathode rays of sufficiently high velocity. It is plain *why* the wave-length of characteristic rays remains the same when the breadth of the primary rays is decreased or when the speed of the cathode stream is increased beyond the critical value, and *why* no characteristic rays are produced until these critical values are reached. In short, the electromagnetic theory gives us a rational basis upon which we may correlate the facts known at present about the nature of X-rays.

THE MODERN MINE HAULAGE MOTOR

By C. W. LARSON

ENGINEER, MINE LOCOMOTIVES AND MOTORS

The author first gives a brief history of the step-by-step development that has culminated in the present day high efficiency mine haulage motor, and then proceeds to discuss those features of its design that are new and that have made it a success where the older types failed. Commutating poles, ball bearings, and a proper consideration of the matter of accessibility are largely responsible for the satisfactory performance of the latest type of mine haulage motor.—EDITOR.

The first motor used in mining service was built by the Thomson-Houston Company in 1889, and was of the bipolar open type, much the same in design as the early Edison generators. It was mounted on top of the locomotive and geared down to the drivers by double gear reduction. In 1891 another type was brought out using the locomotive frame for its field.

In 1892 three other types were developed, which were designed for mounting on the axle, using single gear reduction in much the same manner as is the standard practice today.

In 1893 the LWP-5, LWP-20, NWP-12, and the famous GE-800 were introduced to the traction field. In 1896 the GE-1000 was added, and in 1897 the GE-53.

In the next few years many new motors were added to the list and most of the older types dropped out, until in 1905 the following motors by one manufacturer were available for mine locomotives:

NWP	2½,	5 h.p.,	18-in. gauge,	20-in. wheels
CB	15,	6 h.p.,	18-in. gauge,	20-in. wheels
CB	14, 15	h.p.,	24-in. gauge,	20-in. wheels
GE	60, 20	h.p.,	36-in. gauge,	28-in. wheels
GE	800,	25 h.p.,	42-in. gauge,	28-in. wheels
GE	52,	20 h.p.,	48-in. gauge,	28-in. wheels
GE	77,	20 h.p.,	32-in. gauge,	28-in. wheels
GE	79,	23 h.p.,	24-in. gauge,	28-in. wheels
GE	58,	27 h.p.,	39¾-in. gauge,	28-in. wheels
GE	59,	27 h.p.,	35-in. gauge,	28-in. wheels
GE	61,	37 h.p.,	24-in. gauge,	33-in. wheels
GE	53,	42 h.p.,	36-in. gauge,	30-in. wheels
GE	97,	63 h.p.,	42-in. gauge,	30-in. wheels
GE	71,	85 h.p.,	36-in. gauge,	33-in. wheels

The GE types were primarily designed for street car service, but were readily adaptable to mining locomotives.

The GE-53 was particularly well fitted for mine service, and was considered to be as powerful as would ever be needed for locomotives of its gauge. It was known as the best motor at that time on the market. It was used on 10 to 13-ton locomotives, and was thought to have ample capacity to remain standard for many years to come. But after the application of electric power

to mining requirements was better understood, progress came fast, and in two or three years it was found that even the large GE-53 was begging for more air. In other words, the motor was too small for the service required of the 12 and 13-ton locomotives. As the demand for coal increased from year to year, the hauls became longer and the motors were soon too small for the increased duty. Customers also demanded that all motors be of the split-frame type, while the best motors for this class of service were of the box-frame type. It became apparent that an entire new line of motors was needed, and work was therefore begun on them; and in 1909 eight sizes were put in production, with the following ratings:

HM	701,	30 h.p.,	24-in. gauge,	28-in. wheels
HM	702,	46 h.p.,	24-in. gauge,	33-in. wheels
HM	703,	26 h.p.,	28-in. gauge,	24-in. wheels
HM	705,	7½ h.p.,	18-in. gauge,	20-in. wheels
HM	706,	15 h.p.,	24-in. gauge,	22-in. wheels
HM	707,	46 h.p.,	36-in. gauge,	28-in. wheels
HM	709,	68 h.p.,	36-in. gauge,	30-in. wheels
HM	712,	85 h.p.,	36-in. gauge,	33-in. wheels

These motors were designed for 250 and 500 volts.

Attention is called to the increase in horsepower for the minimum gauge as compared with the previous list of motors. These eight sizes were then considered sufficient to take care of all demands for some time to come; but progress soon dictated that a mine locomotive motor should be provided with commutating poles, in order to give better commutation and further increased continuous capacity. Fortunately the 700 line was of such design as to allow the addition of commutating poles, and in order to identify the commutating pole motors from the non-commutating, they were classified in the 800 series. The armatures have also been provided with ball bearings instead of oil bearings. This constitutes the latest improvement, and the complete line today consists of nine sizes, as follows:

HM 801,	30 h.p.,	24-in. gauge,	28-in. wheels
HM 802,	46 h.p.,	24-in. gauge,	33-in. wheels
HM 803,	26 h.p.,	28-in. gauge,	24-in. wheels
HM 806,	15 h.p.,	24-in. gauge,	22-in. wheels
HM 809,	68 h.p.,	36-in. gauge,	28-in. wheels
HM 817,	12 h.p.,	18-in. gauge,	24-in. wheels
HM 819,	38 h.p.,	30-in. gauge,	28-in. wheels
HM 820,	85 h.p.,	36-in. gauge,	33-in. wheels
HM 812,	100 h.p.,	36-in. gauge,	33-in. wheels
HM 824,	125 h.p.,	36-in. gauge,	36-in. wheels

We will now describe one of these motors more in detail, and will select the HM-803, in order to show the high efficiency and high continuous capacity that is obtainable even in the small sizes:

Figs. 1 to 3 show the form and general appearance of the HM-803 motor, which are practically the same for all sizes. It is of octagonal shape and the frame is split nearly horizontally, with suspension lugs on the bottom half. It will also be noted that neither armature nor axle bearings project outwards, this being due to the fact that each size must be designed for maximum power at a minimum gauge. This particular motor will mount on 28 in. gauge, but is also standard for all wider gauges. It should therefore be appreciated that on account of the narrow gauge conditions, every fraction of an inch must be accounted for, and consequently all dimensions must be reduced to a minimum.

Fig. 4 shows the motor open, and that it is necessary to remove only four bolts to open it; also that the field leads are disconnected outside of the frame, while the brush-holders and their leads remain intact. The

Armature

The armature laminations are built upon a separate steel spider on which is also mounted the commutator. The armature shaft can thus be readily removed without disturbing the commutator connections or windings (see Fig. 6).



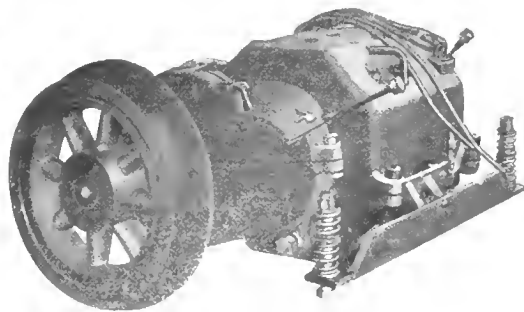
Fig. 1. Type HM-803 Mining Locomotive Motor

Field Coils

The field coils are strap wound, asbestos insulated, and impregnated with insulating compound by the vacuum process, this treatment resulting in a solid, moisture-proof and heat-proof coil of practically indestructible design.

Commutating Poles

There has been and is still today a great deal of misunderstanding as to the correct



Figs. 2 and 3. HM-803 Mining Locomotive Motor Mounted on Axle

compactness and sturdy construction should here be noted.

Fig. 5 shows the bottom half of frame, with the armature and the ball bearings in place, but with the clamping nut and cover removed.

function of the application of commutating poles. There are some who consider that the improvement is necessary only for taking care of high peak loads, and that for motors not subjected to heavy overloads the commutating poles are a luxury and therefore

unnecessary. Fortunately, however, the commutating poles do improve the operating conditions at all loads and speeds if properly designed.

In a mine haulage motor, or any reversible direct current motor, the brushes are per-



Fig. 4. HM 803 Motor with Top Half of Field Removed

manently set on the mechanical neutral, which coincides with the electrical neutral at no load but which does not coincide with the mechanical neutral on non-commutating pole motors for loads other than stated above.

When a motor of the non-commutating pole type with a fixed brush position is put in actual operation, the field flux is crowded into the leading end of the pole face, against the direction of rotation of the armature. This distortion or shifting of the field flux is caused by the armature current. The armature or load current produces a magnetic field at right angles to the magnetic field produced by the main field windings, and its effect is known as armature re-action. This armature re-action, which is readily understood and as pointed out, shifts the electrical neutral backwards and necessitates that the brushes be moved

backwards to this new location if good commutation is to be maintained.

From the above it will be seen that a motor of the non-commutating pole type has characteristics which are unfavorable to commutation at all loads, and in addition is liable to have more or less pitting and burning of the commutator, thus causing excessive heating and wear of the commutator and the brushes. In order to overcome this difficulty, the designer of a non-commutating pole motor must increase the motor field or magnetic density to a high point, so that the effect of the armature re-action will not greatly distort it. In this way he can effect fairly good commutation and greatly reduce the circulating currents and consequently the heating of the short circuited coils of the armature undergoing commutation. But by doing this, he greatly increases his core loss; for it will be remembered that the core loss increases practically as the square of the magnetic density, or with the square of the strength of the field. It will be seen, therefore, that the design of a non-commutating pole motor of this type is more or less a compromise.

For mine haulage this non-commutating pole type of motor is at a great disadvantage: First, because the high magnetic density at which the materials are worked will not permit the motor to slow down in ascending the grades, due to the fact that the high saturation prevents an increase in the field



Fig. 5. End View of HM-803 Motor showing Ball Bearings

flux which is essential for reduction in speed. Therefore the increased torque necessary to haul the load over the grade must be produced by an increase in current, whereas if the motor could decrease in speed due to an increase in flux, the increased torque

necessary would be produced at a much reduced current.

In the design of the commutating pole motor the problem is different. It is no longer necessary to rely on the high magnetic densities. The auxiliary pole is magnetized so that it directly opposes and practically neutralizes the armature re-action in the commutating zone, producing a suitable flux for neutralizing the reactance voltage of the short circuited coil. The motor is therefore relieved of the injurious effect of the armature re-action, and because of this the motor is able to run at lower densities in the magnetic circuit, thus greatly reducing the core loss and consequently the heating, and at the same time enabling the motor to decrease in speed as it strikes the grade or when starting heavy loads to exert a heavy torque without drawing excessive current from the line.

Commutating poles therefore remove the effect of the distortion due to armature re-action, fix the brush position for all loads with either direction of rotation, prevent all sparking and burning in the brushes, and reduce the local current in the armature

curves of this type of motor is shown in Fig. 8.

Ball Bearings

The advantages of ball bearings are briefly as follows:

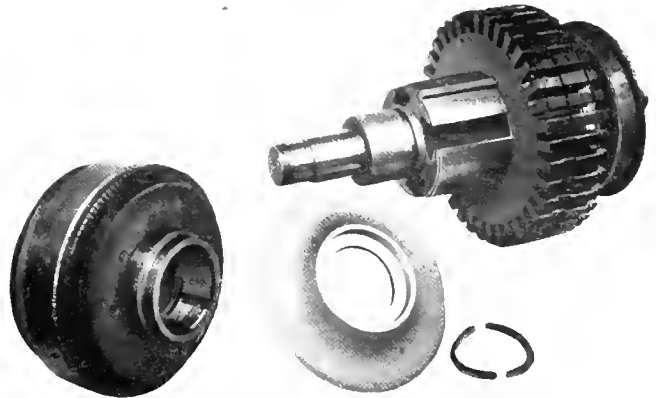


Fig. 6. Commutator and Armature (without winding) of HM-803 Motor

- (1) The armature is prevented from sagging down on poles, thus saving burnouts.
- (2) Inasmuch as no oil is used, the commutator and windings are kept clean and the occurrence of short circuits or grounds are greatly reduced.

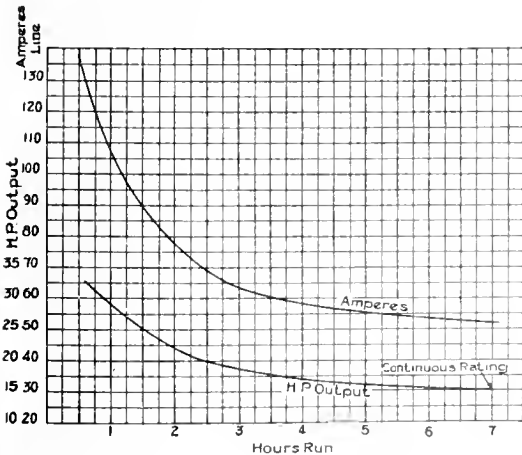


Fig. 7. Current and Power Output Curves of HM-803 Motor

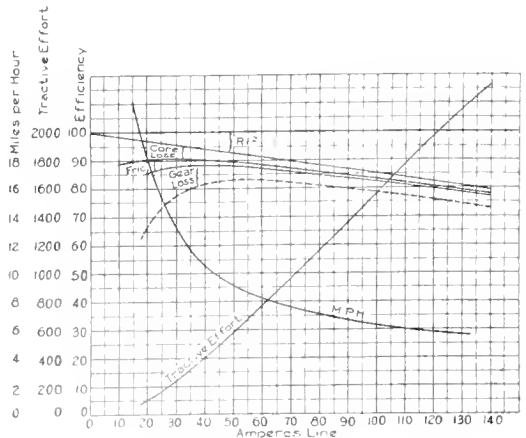


Fig. 8. Typical Characteristic Curves of Type HM Motors

windings to a minimum. This is clearly illustrated by the curves in Fig. 7, which show that by the use of commutating poles it is possible to construct a motor which will have a continuous rating of over 50 per cent of its one hour rating. A set of characteristic

- (3) Increased efficiency, especially in comparison with plain bearings, not properly lubricated.

Fig. 9 shows the ball bearing which has been adopted as standard for HM motors. These bearings are built on the radial prin-

ciple with double rows of balls, and thus carry about three times the number of balls

divide the load. This bearing is also self-aligning, which is a most excellent feature, as there



Fig. 9. Ball Bearings used on all Type HM Motors

as the single-row bearing. This means longer life, as the pressure per ball becomes much less, owing to the great number of balls which

is no binding to be encountered in mounting or running. The mounting of the ball bearing has proven very satisfactory in service.

THE EYE AND ILLUMINATION

By H. E. MAHAN

ILLUMINATING LABORATORY, GENERAL ELECTRIC COMPANY

This article first analyses the anatomy of the human eye, and then enters into an exposition as to the manner in which the eye functions to distinguish different colors of light and to regulate the amount of light which falls on the retina from sources of differing intensity. Having presented this information, the article proceeds to show how illumination can best be arranged to permit of facile vision.—EDITOR.

The eye passes final judgment on a lighting system and, therefore, should receive consideration from the illuminating engineer. To do so, however, the engineer must leave the domain of physics with its exact formulæ and enter the field of physiology. Here he finds the available knowledge rather limited and uncertain. He is not dealing with the rational and coordinate laws of light, heat and electricity, but with the delicate, human organ of the sense of sight—the eye. True, scientific investigators have provided us with much information on the general action of the eye and its relation to light, but there still remains a great deal to be learned before we can make exact allowances for its behavior under artificial lighting systems.

The Anatomy of the Eye

The human eye is illustrated diagrammatically in Fig. 1 and is shown to consist of six essential parts, namely, the cornea, the anterior chamber containing the aqueous humor, the iris, the crystalline lens, the cavity containing the vitreous humor and the

retina. From the following description and the accompanying diagram, it will be observed that the eye resembles very strongly the modern photographic camera.

Let us follow a ray of light through the eye, observe its path and the actions and processes it sets up. The light is admitted through the cornea, a transparent extension of the eyeball shaped somewhat after the fashion of a watch crystal. It passes through the aqueous humor, a transparent jelly-like substance, and reaches the iris. The iris is the colored part of the eye and consists of a circular curtain, a continuation of the middle or choroid coat of the eye and is capable of increasing or decreasing the diameter of its opening—the pupil—allowing more or less light to pass through as is required for correct vision. The light next strikes the crystalline lens, a transparent elastic body controlled by a muscular ring—the ciliary muscles—which enables it to change its curvature to accommodate or focus the eye. Passing through the vitreous humor, the light reaches the retina, which is the delicate network of

nerve centers, possessing the property of converting the radiant energy into the sensation of sight. The retina plays such an important part in the process of seeing that it may interest the reader to know a little about its essential structures.

Rod and Cone Vision

The retina is a very complex structure which, while only about 0.01 inch thick, is composed of ten separate layers, but for the purpose of this article we will consider it as consisting of tiny nerve centers called rods and cones from their shape. The cones are most numerous in the fovea, which is the point of greatest sensitiveness, the ratio of cones to rods decreasing toward the outer regions of the retina. The rods are believed to be active in the determination of form and brightness and the cones in color perception. Furthermore, in dim illumination the rods only are effective, while for higher intensities the cones become active and colors are sensed. You have perhaps experienced at twilight the ability to see objects, although unable to distinguish their color. The cavities at the ends of the rods contain a bluish watery-fluid called visual-purple, which is continually being decomposed by the action of light and constantly replenished from the pigmentary cells in the choroid coat of the eye. However, when the eye is subject to too strong an intensity of light this visual purple is bleached out more rapidly than it can be secreted, with the result that the vision is dimmed or blurred. Darkness or dim illumination will usually enable the eye to recover its normal condition.

century and more recently elaborated upon by Helmholtz. This is known as the Young-Helmholtz' theory and assumes the retina of the eye to have three sets of cones, one sensitive to red light, one to green light and one to

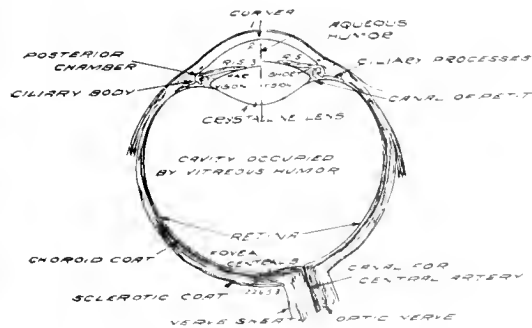
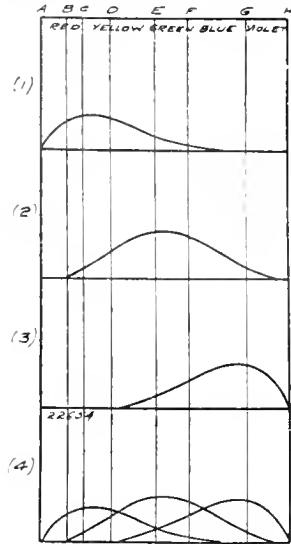


Fig. 1. An Anatomical Diagram of the Human Eye

Color Vision (Young-Helmholtz' Theory)

The most reasonable theory of color sensation and the most generally accepted one is the theory propounded by Dr. Thomas Young in the early part of the nineteenth



(1) Red Vision.
 (2) Green Vision.
 (3) Blue Vision.
 (4) Combination of above, showing over-lapping.

Fig. 2. Curves Illustrating the Young-Helmholtz' Theory

blue light. These colors—red, green and blue—are known as the primary colors. When all three sets of nerves are stimulated, the sensation of white light is realized; when excited separately the sensation corresponding to the set of nerves responding is set up. Intermediate colors are perceived by the three different sets of cones in varying degrees of excitation. The curves illustrating this theory are shown in Fig. 2. The curve for each color sensation is shown to extend beyond the point on the spectrum for which that particular set of cones is particularly sensitive, so that they overlap each other and thus permit of intermediate color sensations.

The Eye as an Optical Instrument

In its path through the eye, the light encounters four refracting mediums, namely, the cornea, aqueous humor, crystalline lens and the vitreous humor, having indexes of refraction of approximately 1.37, 1.34, 1.437 and 1.34, respectively. These refracting surfaces are shown at 1, 2, 3 and 4 on diagram, Fig. 1. It will also be noted that the

eye, unlike most optical instruments, does not focus by changing the distance between the lens and the retina, but by changing the shape of the lens. This is shown by Fig. 1, the position for nearby and distant focus being indicated.

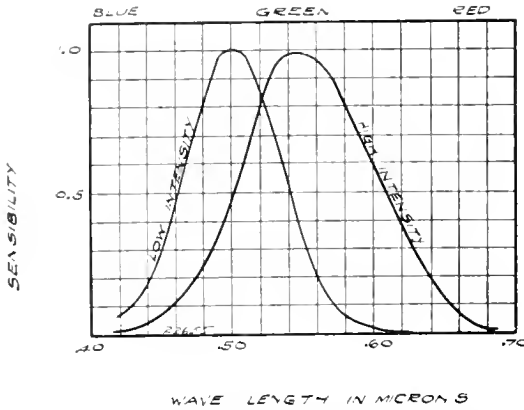


Fig. 3. Curves showing Sensitiveness of the Eye for Different Points of the Visible Spectrum

The eye is subject to the principal defects of the ordinary optical instrument. These are spherical aberration, which causes the central part and the edges of the crystalline lens to focus in different planes, and chromatic aberration or the failure to focus all colors in the same plane. These errors do not enter to any serious degree and cause us no inconvenience in the ordinary process of seeing. On the other hand, the eye is capable of functioning through a wider range of intensities than would ordinarily be expected from any scientific instrument. It serves us with equal convenience for intensities corresponding to faint moonlight or to the direct rays of the noonday sun—a ratio of about 1 to 5,000,000.

The Eye, Light and Color

The eye responds to radiations having wave lengths between approximately 0.76μ and 0.39μ , or, in other words, the visible spectrum extends through slightly less than one octave. The long wave lengths give the sensation of red and as they grow shorter pass in succession through all the colors of the spectrum: Red, orange, yellow, green, blue, indigo, violet. Waves longer than the visible red and shorter than the visible violet

are termed, respectively, infra-red and ultra-violet. These waves do not excite the retina, but the former may be realized as heat and the latter are characterized by their chemical activity. These properties exist in the visible spectrum to a certain extent, diminishing from the two extremes mentioned to a minimum about at the yellow. Furthermore, the eye does not respond with equal sensitiveness at all points of the visible spectrum, but follows the sensation curves shown in Fig. 3. These curves indicate a zero response at the extremes of the spectrum and a maximum response near the middle, shifting toward the blue for faint illumination and toward the red for strong illumination. In other words, for an equal quantity of energy converted into light, the maximum physiological effect will be obtained from green-yellow light.

There also exists a quantitative relation between the stimulus and the sensation, that is, between the intensity of illumination and the visual impression. This relation is known as Fechner's Law and states that the least perceptible increment is proportional to the whole stimulus, that is, the same percentage change in intensity of illumination calculated from the least amount perceptible to the eye gives the same change in sensation. This is graphically shown in Fig. 4 by the logarithmic curve of intensities. The practical application of this law in guiding the engineer in reaching an economic compromise between intensity of illumination and quantity of power expended is self-evident.

Intrinsic Brilliance and Glare

One of the fundamental laws to be observed in placing light sources is to avoid locating



Fig. 4. Curve Illustrating Fechner's Law

lights of high intrinsic brightness in the field of vision. Intrinsic brightness is defined as the candle-power emitted per unit area of surface. For comfortable vision this

* The Greek letter μ is the symbol for the micron which is 1/100,000 millimeter.

value should not exceed 5 to 10 candle-power per square inch. When the eye is compelled to view surfaces which exceed this value, there is likelihood of eye strain, a decided decrease in visual acuity and perhaps permanent injury. This condition may also be brought about by specular reflection from a glossy or polished surface, as is often experienced in reading a book having calendered paper.

Glare, as a cause of industrial and traffic accidents is receiving attention from "safety first" advocates. We all have experienced the difficulty of seeing behind the powerful headlights of an automobile or of trying to see with an unshaded incandescent lamp shining in our eyes. These are everyday examples of glare and might be multiplied many times. A trip through almost any industrial plant will furnish evidence of lowered production, increase of spoilage and general inefficiency of workmen, due to glare in some form or other from the artificial lighting system.

You will recall previous mention of the iris, i.e., the diaphragm controlling the pupillary opening in the eye. The size of this opening is regulated in accordance with the brightness of the field of vision, being made large to admit more light in the case of a dim field and reducing the opening to exclude excess light when exposed to a bright field. Furthermore, the pupil is regulated to conform to the brightest area in view; therefore, when we have a bright light in front of our eye the pupil contracts to protect the eye from the excess light and, hence, fails to admit sufficient light from the less brightly illuminated parts for vision. The sections of relatively lower illumination, therefore, appear under-lighted or dark.

There are two general ways of eliminating glare from a lighting system; these are, first, by removing the source from the line of vision as in cove lighting, totally indirect lighting by fixtures, or direct lighting with units placed well above the line of vision; second, the reduction of intrinsic brightness by enclosing the source in diffusing glass or screening by a correctly designed shade. All these methods involve a sacrifice in efficiency as far as light flux is concerned, but this is usually compensated for by the increased facility for vision as previously outlined.

Diffusion of Light

Daylight provides the most diffused illumination and absence of shadows. It is this

matter of diffusion of light and the presence of shadows that is responsible for many unsatisfactory systems of artificial lighting. For example, under daylight conditions in a factory the workman is surrounded by light of approximately equal intensity. In this same factory, under artificial lighting an operator may have at his machine an intensity perhaps greater than he received by daylight, but his surroundings will be many times darker, hence, when he looks away from his machine to the darker zones he suffers momentary blindness until the pupil is adjusted to the new conditions. This man, therefore, is disabled for a fractional part of his working hours, is incapable of performing his duties and, therefore, is an inefficient workman. Furthermore, at these times when the eye is incapable of functioning, the employee is more susceptible to accident from revolving machinery, etc. That this is actually the case is illustrated by the statistics on industrial accidents, which show that the fatal accidents occurring during the short-day months of November, December and January are about 40 per cent greater than those occurring during the long days of June, July, August, etc. Strong contrast in illumination intensity or the presence of dark shadows are, therefore, inconsistent with good illumination and should be avoided.

Another source of ocular discomfort is a flickering light source, which causes the eye to continually adjust itself for fields of varying intensity. This causes a strained condition of the muscles of the eye and fatigue, preventing the iris from properly protecting the eye and leading in many cases to permanent injury.

Ultra-Violet Light

As previously stated, the eye does not respond to waves shorter than about 0.39μ , that is, to the ultra-violet light. This is because they are almost totally absorbed by the cornea and crystalline lens and because the retina is not responsive to them. Evolution may enable future generations to see these ultra-violet radiations and open up wonderful sights at present closed to us.

Ultra-violet light undoubtedly has an injurious effect upon the eye tissues when present in appreciable quantities. Whether it is the chemical effect of the ultra-violet or the heat effect of the longer wave lengths which has the greater injurious effect upon the eye is open to debate. The fact remains, however, that there is less ultra-violet radia-

tion from artificial lighting sources than from daylight, which fact should dispel fear of ultra-violet light from commercial lighting units. A further protection is guaranteed the eye from the glassware used in connection with most lighting units, ordinary glass being opaque to the ultra-violet rays.

Conclusion

It is hoped that by this brief description of the eye and light it has been shown that there does exist a very important relation between them, and that this relation is of sufficient practical importance to demand attention. Legislators are awakening to this fact and are enacting laws that will protect workers and the general public against incorrect and inadequate lighting. Perhaps a fifth of the states have laws defining in a rather vague and indefinite way the lighting requirements for factories, while a much larger percentage have passed legislation covering the lighting of mines and the use of headlights. It is expected that these laws will be amended in the near future to embody the advances made in the science of illumination. Municipalities are turning their attention to this movement and exercising super-

vision over the illumination of streets, of schools and other public buildings.

In the industrial field, lighting is one of the first items to receive attention from the scientific manager. He appreciates and can actually prove that the quality and quantity of production is enhanced by providing favorable working conditions for his employees, that the liability of accident is minimized, sanitation and health promoted and the good will of the employee obtained thereby. These conditions are all furthered by a properly designed lighting system. All branches of human activity are dependent to a greater or less extent upon light, making it important and vital to the interests of mankind and deserving of study and consideration.

REFERENCES

- Artificial Illumination as a Factor in the Production of Ocular Discomfort.* Trans. I. E. S., Vol. 6, 1911. Nelson Miles Black, M.D.
Radiation, Light and Illumination. Steinmetz.
Lectures on Illuminating Engineering, Johns-Hopkins University.
Some Phenomena of Physiological Optics. Lighting Journal, Vol. 1, 1913. F. K. Rickmyer.
Outlines of Optics. P. G. Nutting.
The Essential Elements of Vision. Trans. I. E. S., Vol. 9, 1914. Hunter H. Turner, M.D.
Light, Photometry and Illumination. Burrows.
Color Matching on Textiles. Paterson.
 Transactions British Illuminating Engineering Society.
 Transactions American Illuminating Engineering Society.

THE FORT WAYNE ELECTRIC ROCK DRILL

By C. JACKSON

ENGINEER, ROCK DRILL DEPARTMENT, FORT WAYNE ELECTRIC WORKS OF GENERAL ELECTRIC COMPANY

The introductory portion of this article contains a brief but very interesting chronological review of the development of the mechanical percussive type of rock drill, an explanation of the physics of rock drilling, and a statement of the mechanical principles which have been embodied in the design of the successful modern drill. The remainder of the article describes in full the construction, operation, and merits of an electric motor-driven rock drill which, because of its superior qualities, it is believed will in time supplant those drills operated by compressed air.—EDITOR.

The development of electrical transmission lines throughout the principal mining centers of the world has led to the partial electrification of large mining properties with excellent economic results. There remain, however, several very important mining appliances or machines, with which wonderful economy may be effected by the application of electric drive. The most important piece of mining apparatus that has baffled the efforts of engineers in the past is the electrically-driven rock drill.

It is the purpose of this article to briefly review the development of the mechanical percussive type of mining rock drill and to describe in detail the construction and operation of the Fort Wayne Type "A" Electric Rock Drill with notes regarding the drilling and practical efficiency.

The idea of fastening a detachable tool or chisel to a mechanically moved piston rod dates from the invention of the steam hammer, about 1842. In 1844 Brunton in England suggested the employment of compressed air for a rock drill and invented a machine called a "wind hammer." In 1853 William Pidding invented a hammer secured to a frame and reciprocated by steam for rock boring. In Germany at the same time Schumann invented a machine for work in the Freiberg mines which in many features anticipated the present type of reciprocating rock drill. In 1855 Bartlett patented a machine which was tried in boring the Mount Cenis tunnel. This drill was improved by Sonneiller and used in boring the tunnel. Two hundred machines had to be kept on hand, however, to insure the constant operation of sixteen. The Sonneiller machine, a true pneumatic percussive drill, was the first to be actually used for tunnelling (1861) and for mining in Belgium (1863).

J. W. Fowle of Boston, in 1849, patented a steam-driven reciprocating drill, the drill bit forming an extension of the piston rod, and arranged to feed toward the rock as the

bit advanced. The piston was rotated a fraction of a revolution at each stroke. This drill embodied the essential principles of the modern reciprocating type air drill and was covered by one of the first United States patents issued on this class of apparatus. The Fowle patent was followed by the patents of Haupt, Taylor, Burleigh, Ingersoll, Sergeant, Wood and Leyner, the Burleigh drill being used in driving the Hoosac tunnel in Massachusetts in 1866.

The history of the rock drill might be called the history of modern mining. Without the rock drill, the matter of commercially producing the world's supply of industrial and precious metals would have proven a much more serious problem.

Rock Drilling

Rock drilling is accomplished by overcoming the cohesion of the rock particles by the application of force. This is effected in several ways: First, by abrasion alone, as in the diamond drill. Second, by combined abrasion and chipping. Third, by percussion, i.e., chipping or crushing.

The modern mining drills are essentially percussive drills and may be divided into two distinct types; one of which is the piston or reciprocating type in which the drill steel or cutting bit is securely clamped to an extension of the piston and contains a ratchet wheel, pawl and rifle bar to rotate the piston and boring tool. The cylinder is mounted in a guide or cradle in such a manner that it may be fed toward the rock, the cradle is attached by its seat to a rigid support. In drills of this type the mechanical efficiency is very low, being estimated at from 5 to 10 per cent.

The mechanical construction of the piston type drill is simple, being well adapted to withstand the rough work and continued strain to which it is subjected in service.

Although the earliest manual method of drilling holes in hard rock was by hammering and revolving a chisel we have no records of

any serious attempts by engineers to employ this principle in the construction of a rock drill actuated by power. It is obvious that the efficiency of this hammer method of drilling is higher than that of the "churn" or reciprocating method. Recent notable

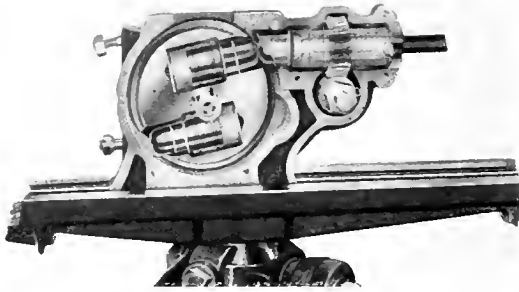


Fig. 1. Phantom View of Drill showing Working Parts

developments in the manufacture of mining drills of this type are the Leyner, Jap, Sullivan and Fort Wayne. Although operating on the hammer principle, the Fort Wayne drill differs from those mentioned, since it is motor-driven instead of being actuated by compressed air.

The Fort Wayne Type "A" Drill

Since the force of the blow in all air drills of the percussive type is obtained by a reciprocating piston within a suitable cylinder, a description of the mechanism and construction of the Fort Wayne drill will be of interest at this time.

As in the development of the air drill, the pioneers in the electric drill field have traveled a rocky road, meeting with almost unsurmountable obstacles and discouragement at every step. Looking backward over a period of 20 years one is impressed with the fact that in almost every attempt to construct an electrically operated drill the designers followed closely the principle employed in the air drill of the reciprocating type wherein the drill steel or cutting bit formed an extension of a piston or plunger.

Unless the drill were of the solenoid type, which for obvious reasons is low in efficiency and of a rather delicate construction, the problem resolved itself into one of converting the rotary motion of the motor armature into a reciprocating motion designed to deliver a blow or heavy impact at each stroke. Efforts to construct a machine of this type sufficiently light and compact to insure port-

ability and at a reasonable cost of upkeep were abandoned after a most thorough service test of many designs.

Before the Fort Wayne drill was designed a thorough investigation of all previous electric rock drills was undertaken, at the conclusion of which an analysis of previous attempts indicated:

First. That the drill should be motor-driven by a substantial motor directly mounted to the drill mechanism to insure compactness and portability.

Second. That converting the rotary motion of the motor armature to a reciprocating motion of either a piston or hammer for an impact imparting device of this type had been thoroughly tried and abandoned, and obviously was not the proper solution of the problem.

Third. There appeared to be no question regarding higher efficiency of drills of the hammer type, i.e., where the drill steel remained stationary and was rapidly struck by a hammer of suitable weight.

With these fundamental points in mind the mechanism illustrated in Fig. 1 was evolved.

The Type "A" drill is of the rotary hammer design operated by an electric motor attached to the frame of the drill proper by means of two permanent studs and two swinging bolts. When the swinging bolt nuts are loosened and the bolts swung up, the motor may be lifted from or replaced on the drill body in one minute.

The mechanism of the drill consists of two parts, a revolving element comprising the



Fig. 2. Left-hand Side of Drill showing Belt and Tightener

hammers and the chuck mechanism for holding and rotating the steel. The revolving helve or striking mechanism is flexibly connected to the driving motor by means of a special endless belt, see Fig. 2, which permits a variation of speed to any degree desired.

Drill Casings

The drill mechanism is totally enclosed within a heavy cast steel casing which protects the working parts from any foreign substance, and is of sufficient strength to withstand any strains incident to extremely hard usage.

Striking Mechanism

Within the revolving element or flywheel are two chambers, in each of which a hammer, consisting of a solid block of special steel, floats freely. As the helve revolves the hammers are thrown outward by centrifugal force and at each revolution strike a blow upon the projecting head of the drill steel cap which transmits the energy of the blow to the drill steel. After delivering its blow the hammer rebounds into the chamber within the helve, where it is completely cushioned upon air which it traps. During the period of recoil (the helve continuing to revolve) the hammer passes the projecting drill steel cap. The hammer is again thrown into the striking position by centrifugal force, during the remaining portion of the complete revolution of the helve. The hammer helve revolves at a speed of 850 r.p.m., and at every revolution each hammer delivers a blow to the drill steel cap. The

drill steel in position to receive the energy of the hammer blow, as well as transmit a rotary motion to it. The hammer blow is delivered to the drill steel cap or tappet which in turn transmits it to the drill steel.

Rotation

The rotation of the drill steel is effected by means of a heavy worm gear reduction driven from the helve shaft. A substantial slip friction cone is mounted on the worm gear shaft which serves to protect the gears and motor from any undue strain in case the rotation of the drill steel is suddenly checked.

Buffer Plates

The drill steel is held in the chuck by several spring steel plates, one of which is a split sliding plate fastened in the closed position in front of the drill steel lug by means of two heavy pins. When the drill steel is not striking rock the energy of the hammer blows is absorbed by these buffer plates which also retain the drill steel in the chuck when "backing out" of deep holes in broken or uneven ground. The drill steel can be changed without the use of wrenches or other tools, the simple operation of pulling out two heavy pins and sliding open the split inner plate is all that is necessary.

Bearings

The rotating parts of the drill, and also the belt tightening pulley, are provided with heavy shock absorbing roller bearings, and the motor with ball bearings of special design. All the bearings are packed in grease to insure satisfactory operation for thirty days without the attention of the operator. All the bearings used are designed for extra heavy duty, and were adopted as standard only after tests covering a period of over two years had demonstrated their ability to withstand the strains and absorb shocks due to the continuous operation of the drill under the most severe conditions.

Motor

The motor is fully enclosed, splash-proof, and capable of successful operation in wet places. It is especially designed to meet the requirements of rock drill service, and does not require the usual starting rheostat or speed controller which are a constant source of trouble in the hands of unskilled labor. The rock drill motor can be quickly connected to the line by means of connector plugs of such design that it is impossible for the most



Fig. 3. A 60-Cycle Motor Drill Outfit Complete

energy of 1700 hammer blows per minute is therefore transmitted to the drill steel.

Chuck

The chuck consists of two parts, the chuck and the drill steel cap. The chuck is a steel sleeve through which the "shank" of the drill steel passes, and is designed to hold the

inexperienced operator to make mistakes. All motors are designed to stand a 50 per cent

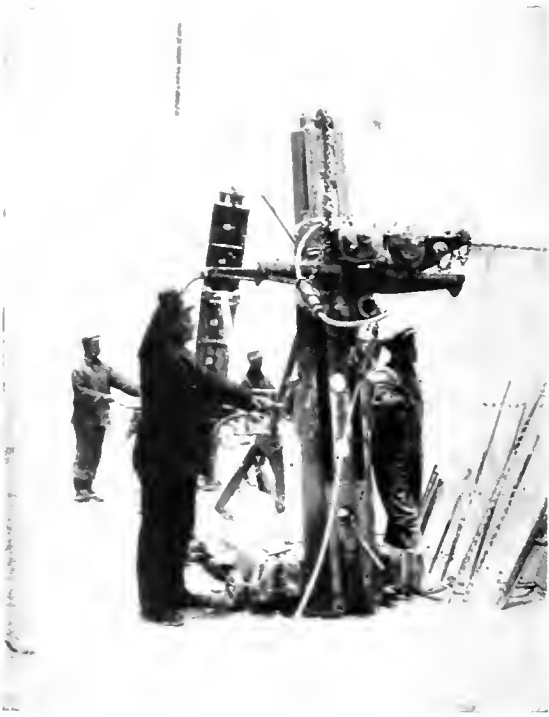


Fig. 4. Drill Mounted on Gadder Post Operating in a Marble Quarry

overload above their rated load capacity, and provision has been made in the drill



Fig. 5. Drill as Employed in "Taking Down Roof" in a Marble Quarry

design, whereby a load in excess of this amount cannot be thrown on the motor.

Direct-current motors for 115, 230 and 550 volts and alternating-current motors of 25 or 60 cycle operating on one-, two-, or three-phase circuits of 110 or 220 volts have already been developed for these drills.

Drill Steel

It is necessary in all drills of the hammer type to employ a simple and effective method to remove the cuttings from the hole being drilled. In order to avoid the use of hollow steel, water under pressure or other methods commonly used for sludging a hole, all of which are inconvenient, and many times a source of trouble and expense, a special steel is used that automatically removes the cuttings from the hole while the drilling is in progress. In this drill steel the well-known principle of the spiral conveyor has been used, and the veins or ribs on the steel proper which give it an auger-like appearance have nothing to do with the drilling, their sole function being to remove the cuttings from the hole.

Power Consumption

The Type "A" rock drill requires from $1\frac{1}{2}$ to $2\frac{1}{2}$ h.p. as a maximum for its operation, including loss in transmission from the generator to the drill, and is not affected by change of altitude or by working in air locks under air pressure. Tests have shown that air drills of equal drilling capacity require from 12 to 18 h.p. not including the loss in the air lines due to friction and leakage.

Economy

Records of the comparative cost of operation of these drills operating side by side with



Fig. 6. A Column Mounted and a Tripod Mounted Drill in a Railroad Tunnel Heading

air drills of equal capacity have demonstrated conclusively:

First. The cost of repairs and supplies does not exceed that of air drills of equal capacity.

Second. The cost of power shows a very marked economy in favor of the electric drill, averaging 85 per cent saving, which saving alone is frequently sufficient to pay for the drill within one year's time.

Third. The cost per ton of rock broken

is almost invariably decidedly in favor of the electric drill, owing to the fact that it will successfully drill any character of hole, including flat or horizontal holes.

The cost of installing and maintaining electric wires is much less than that of an air line. The simplicity of design and small number of working parts assure a low cost of drill maintenance.

SOME NOTES ON INDUCTION METER DESIGN

BY W. H. PRATT

METER AND INSTRUMENT DEPARTMENT, LYNN WORKS, GENERAL ELECTRIC COMPANY

In designing an instrument for measuring a-c. energy, there are a number of variable factors that must be taken into account, among which are current, voltage, power-factor, frequency, wave form, and temperature. A change in any one of the first three will directly alter the amount of energy flowing, and therefore the instrument must be extremely sensitive to variations in these quantities. The other three factors may be considered as of a disturbing nature, and provision made to guard against possible inaccuracies from any of these sources. The effects of each of these factors on the performance of the instrument is reviewed, and the article concludes with a short description of a modern type of induction watt-hour meter.—EDITOR.

The induction meter is a measuring device capable of very considerable refinement, and it will not be amiss to consider some of the conditions under which it must operate, and the manner in which these conditions reflect in the design.

There are, in addition to time, six principal variables of which account must be taken, and no matter what their value (within reasonable limits) the meter record must closely correspond to the watt-hours consumed. Here it may be remarked that, considering the range of conditions to be met and the frequently adverse surroundings of the meter installation, infrequent inspections, etc., the performance of the modern meter is truly remarkable.

The more ordinary form of electrical indicating instruments are expected to be correct, say within three-tenths of one per cent of their full scale ratings, while the useful scale range can hardly be taken as more than from one-fifth scale to full scale (1:5). The induction watt-hour meters are correct within a few per cent at two per cent of their rated capacity and become more and more accurate as the load increases. Above full load, the inaccuracies due to other causes begin to increase, slowly at first, and not until two or three times full load is reached are they worthy of remark. Thus, while within its useful range, the induction meter falls a little behind the indicating instrument in actual

accuracy, yet in its particular field it leaves little to be desired as far as accuracy goes, and its useful working range, in contrast to the 1:5 of the indicating instruments, is 1:100.

As already remarked, there are besides the factor of time six other variables to be considered. These are, first, current value; second, voltage; third, power-factor; fourth, frequency; fifth, wave form; sixth, temperature. The first three, together with time, are direct factors of the quantity to be determined.

First. Taking these up in detail, the effects of change of current are, first, a change of torque directly proportional to the change of field strength produced by the current. This is the effect desired in a meter. The departure from direct proportionality is slight. Synchronous speed, if such a designation is permissible, would be about thirty times full load speed, so that an approach to synchronism cannot be suspected of appreciably modifying the torque. The air gaps in the laminated iron structure are so large that the effects of the variable permeability of the iron, working as it does down to a very low density, are barely noticeable, so that the field strength is almost exactly proportional to the flow of current.

In addition to this primary effect, the field from the current circuit of the meter acts as a permanent magnet, producing a damping in the disk which is proportional to the square

of the field strength, i.e., proportional to the square of the current. This effect begins to be noticeable after passing full load, and is the cause of meters being slow at high over-

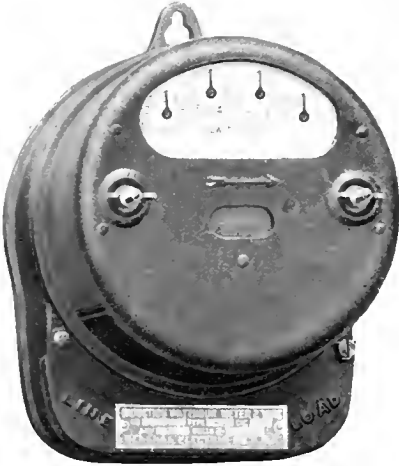


Fig. 1. Exterior View of an Induction Watt-hour Meter, 5 Amp., 110 Volts, and 60 Cycles

loads. In case of lack of electrical symmetry, current in the series circuit may produce a torque, acting forward or backward as the case may be, which effect is also proportional to the square of the current.

Second. Variations of the voltage impressed upon the shunt circuit have much the same effect as variations of current in the series circuit, i.e., the desired effect of variations of torque occur which are closely proportional to the variations in voltage. Damping from the field of the shunt coil is present and, since the range of working voltage is slight, this effect can be permitted to be more prominent than can the corresponding effect from the series coil. The symmetry of the shunt field is deliberately disturbed by means of the light load plate to furnish a slight torque, just enough to balance the friction of the meter.

Third. The third variable is power-factor. An induction meter without any losses in its shunt circuit would behave much as a watt-dynamometer without any inductance in its shunt circuit, i.e., it would produce a torque proportional to the power in the circuit to which it might be connected. Since it is not possible to have a circuit without losses, it is necessary to make the lag of the current in the shunt circuit as large

as possible, and to correct the residual error by some device.

The means actually employed for correction is a secondary circuit, the lag plate, so arranged that the current induced in it produces at the disk a m.m.f. approximately at right angles, with respect to time, to the m.m.f. produced by the shunt coil of the meter, and of such magnitude as to give the resulting m.m.f. the proper phase. This phase correction cannot be made strictly correct except for some particular frequency, hence it is desirable to make it just as small as possible.

Fourth. An increase of frequency causes the disk eddy currents produced by the series field to increase almost proportionately to the increase in frequency, and causes a corresponding decrease in the field from the shunt coil with which they interact to produce torque. Conversely, the disk eddy currents produced by the shunt field remain practically unchanged, since the field strength inducing them has diminished in proportion as the frequency has increased, and interact-

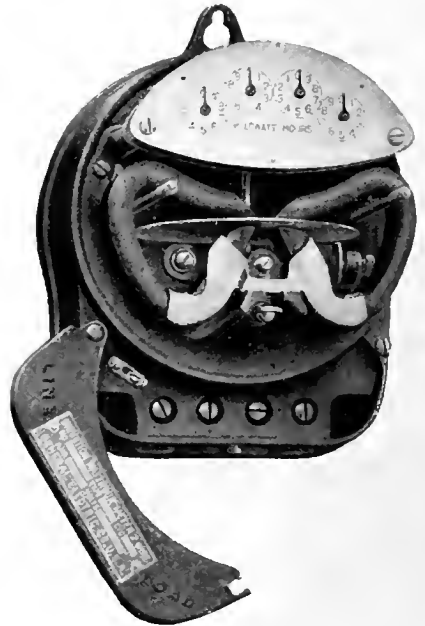


Fig. 2. Interior View of Meter shown in Fig. 1

ing with the unchanged series field produces almost unchanged torque. Thus the two torque terms are, as a first approximation, independent of frequency; in fact, a meter in

which no attempt has been made to correct for phase angle can be used over quite a wide range of frequency without appreciable errors. The disturbances introduced by the devices used for phase angle correction are the principal causes of the small errors which arise in the meters, due to change of frequency. Naturally these errors, while small at high power-factors, increase as the power-factor diminishes.

Fifth. In many types of apparatus, considerations of wave form may be lightly passed over; not so in meters. In fact, while the user of modern meters needs rarely to consider this point except when deciding on a type, it must be most carefully considered in the design. The two principal factors in this connection are the phase angle of the potential circuit and the phase angle of the eddy currents in the disk. Taking the second first, it is easily seen that the disk eddy current circuit, surrounding, say the shunt coil pole, may have an appreciable inductance if the gap in which the disk is located is narrow enough.

The torque producing effect of the eddy current is proportional to its magnitude, the magnitude of the field upon which it reacts, and the cosine of the angular difference in phase of these two quantities. If we had to consider only sine wave circuits, it might be permissible to let the time constant of this

meter for phase angle without other devices, bearing in mind that the eddies induced by the series field must also be considered, and in general, have a different angle of lag.

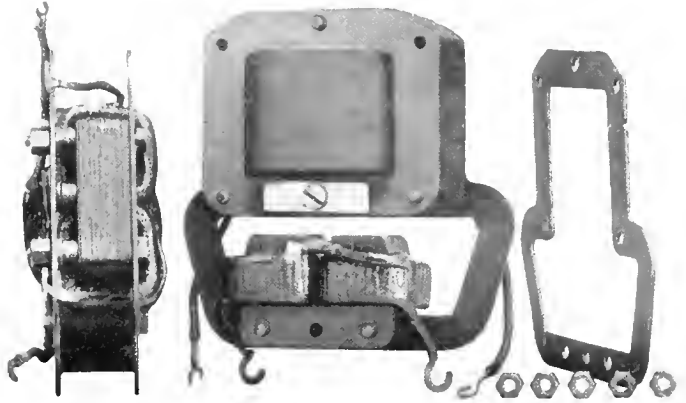


Fig. 4. Elements of a Two-wire, 5 Amp., 110 Volt, 60 Cycle, Induction Watthour Meter

However, while the cosine of 10 deg. is not very far from unity, and the difference could be allowed for, the corresponding departure of a seventh harmonic would be about 51 deg., of which the cosine is 0.63. Also, the magnitude of current would be diminished in proportion to the cosine of this angle, so that the seventh harmonic would

be represented by a torque 0.63^2 times its correct value, i.e., 0.4 only of the seventh harmonic would be recorded. The corresponding meter error for a five per cent seventh harmonic would thus be about three per cent. For inductive load conditions, the error would in general be much greater. It may be noted that the errors arising from this source diminish much more rapidly than the diminution in time constant of the eddy current circuit.

The other important source of wave form error is the deficiency below 90 deg. of the lag of current in the shunt circuit. This is much magnified by the action of the phase adjusting devices. Consider the phase adjustment to be so made that the fundamental is correctly measured. To achieve this, the lag adjusting circuit will have been given an appropriate impedance, which in general will be totally wrong for any of the har-

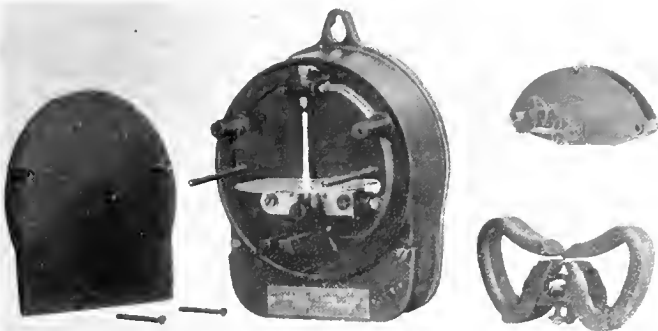


Fig. 3. Parts of the Meter shown in Fig. 1

eddy current circuit be such that there would be a lag of, say ten degrees, in the current behind the flux producing it. This lag might even be chosen so as to nearly correct the

monics. The higher the harmonics, the less important are the winding losses and the more important the losses in secondary circuits. Only by making the departure of the current

series and two shunt poles are used, by attending to certain points in the design, the effect of external fields may be made very small, although this latter arrangement can never be as perfect as the former for constant potential working.

To minimize the damping effect of the series circuit field, it is necessary to weaken this field as far as possible, and correspondingly strengthen the shunt field, keeping their product great enough to maintain the requisite torque; and further, to make the damping of the permanent magnets very high, since the overload drop on the one hand and the errors due to variation of voltage on

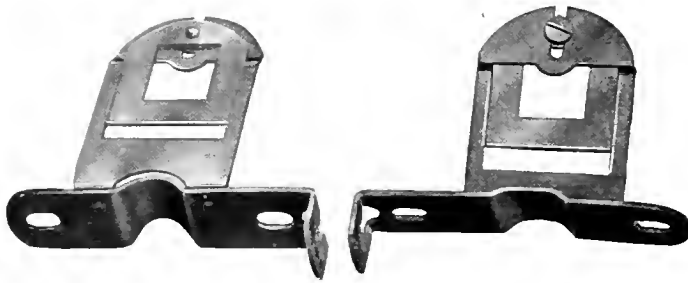


Fig. 5. Tag Plate for an Induction Watthour Meter

in the shunt circuit from 90 deg. slight can the wave-form errors, even on non-inductive load, be made unimportant. Here again the betterment is much more rapid than the diminution of phase angle deficiency.

Sixth. Variations in temperature produce changes in the disk resistance which affect both torque and drag nearly alike. They also, by changing the resistance of the windings and adjusting circuits, modify slightly the constants of the meter. There is also a slight effect on the damping magnets.

In addition to the variables just enumerated, other conditions, such as vibration, or the presence of stray field, may be of such importance as to dictate features of the design.

From the foregoing, many factors governing the design of an induction meter may be drawn. Of course it is desirable to have as high a torque as possible in order to minimize the disturbances due to friction. This requirement suggests strong series and shunt fields, but here we begin to meet limitations. It is desirable that the meter shall be entirely free from the influence of external fields. This is accomplished by using two series poles and a single shunt pole. The two series poles are naturally of opposite polarity, and very close together, and so no matter how small the current value, their field at the disk is so increased on the one hand and diminished on the other, that the resulting effect is practically nothing with the highest stray fields that are ever met. The field of the shunt coil is always close to its full strength so that in comparison to it, any stray field is of negligible value; indeed, when the arrangement is reversed and one

the other, are directly determined by the ratios of series field to permanent magnet field, and shunt field to permanent magnet field respectively. To get the best performance, it is of course necessary to so form the poles of the motor structure that they shall produce a maximum of torque with a minimum of damping.

To secure good performance when working under conditions of low power-factor, especially when variations in frequency or wave-form may be expected, it is necessary to have the lag angle of the current in the shunt circuit very high. This means either very small losses or else a rather high exciting current. The latter is undesirable and the former requires the use of the best materials available, and compact, carefully made coils in order to keep the structure within a small compass. Small losses are in themselves a great advantage, but the real point is that a high lag angle with a proper attention to other points makes superior performance possible.

With a high lag angle, consequently with small phase adjustment, errors due to change of frequency and temperature are minimized, and this in connection with the relation of the disk to its surroundings practically determines the performance for change of wave-form.

Economy, convenience, and esthetic considerations (if this expression may be used in this connection) dictate a small meter. This naturally compels the use of small air gaps, as otherwise too much space would be occupied by the magnetizing coils and cores; but narrow gaps increase the time constant of the eddy current paths in the disk. To

offset this, the disk may be made thin and of high resistance, but this requires strong magnetizing coils in order to obtain the necessary torque, and this, in turn, demands powerful permanent damping magnets. The magnets are thus, to a large extent, the keynote of the whole.

In the design of the I-14 meter, there has been one consideration placed in the forefront; that consideration has been definiteness. However carefully the electrical design may have been made, the benefit would be largely lost in the absence of good mechanical structure. There is in this meter one central casting, of unusual rigidity, to which are directly attached all the elements of the meter. Each element is securely fixed in its proper relation to the frame, and thereby to all other elements. The laminated iron structure and coils are assembled as a unit; the losses in the shunt circuit amount to only one watt, thereby giving an extremely high lag angle in the potential circuit, with the accompanying benefits as pointed out in the foregoing. The high lag angle has necessitated a minimum of lag adjustment, thereby making a very simple structure of the element possible. The adjustment is, moreover, obtained by the mechanical movement of the lag plate whereby more or less flux of the shunt coils is included within its circuit. The lag plate is carried directly by the light load adjusting plate, which together constitute the means for light load adjusting. The actual adjustment is accomplished by turning a micrometer screw and then clamping the plate.

The full load adjustment is accomplished by a radial movement of the pair of damping magnets controlled by an adjusting screw. The magnets are clamped by two screws. The damping magnets in this meter are made with particular care, and by reason of their arrangement make possible a high degree of damping together with a considerable range of adjustment. Very careful proportioning has been necessary to secure these results, since the disk of the meter is unusually small.

The moving element is worthy of particular remark. In order to secure great freedom from wave-form disturbances the disk has been made thin, and to avoid useless weight, the shaft has been made of the light alloy duralumin. Together these have resulted in a very light moving system which should render jewel wear, already a thing of no importance, entirely negligible. Right here let it be said, however, that jewels should not be neglected as regards oiling.

The duralumin, of which the shaft is constructed, is a recently developed alloy of aluminum and copper, the latter, however, being present in a relatively small percentage. Its hardness, which it acquires some hours after appropriate heat and mechanical treatment, is comparable to that of hard brass. The alloy is peculiarly resistant to corrosion, and in the manner in which it is used in this meter, it will outwear brass.

The terminals of the meter are imbedded in compound, in a compartment by themselves, adapted to separate sealing. Other details and the general design can be seen by reference to the cuts.

SIGN AND BUILDING EXTERIOR ILLUMINATION BY PROJECTION

BY K. W. MACKALL and L. C. PORTER

GENERAL ELECTRIC COMPANY, SCHENECTADY, N. Y.; EDISON LAMP WORKS, HARRISON, N. J.

Floodlighting, or sign lighting by projection from a distance, is an innovation which has resulted from efforts to produce a method of efficiently illuminating advertising matter which, on account of its location, cannot conveniently or economically be lighted by the older method of distributing low candle-power incandescent lamps on or in the neighborhood of the sign itself. This article defines the field to which floodlighting can be successfully applied, describes the projecting apparatus and the method of installing it, and gives instructions as to how to make the adjustments. Curves and tables are included which, supplemented by descriptive text, furnish data from which to determine how many floodlighting projectors will be required for a particular installation.—EDITOR.

Artificial light, as a medium for advertising and attracting attention, is exceedingly valuable. This is a well-established fact and is strongly emphasized by the appearance of the business districts of our largest cities.

Light seems to produce a pleasing effect on the human race, for we walk along the best lighted streets, shop in the best lighted stores, and amuse ourselves in the best lighted resorts.

The matter of economically lighting a sign on a water tank far above the ground, a billboard several hundred feet from power lines, chimneys, walls, or the entire exterior of a building has been a problem of no mean value. In cases of this kind, power is not easily accessible and structural conditions make lighting by usual methods (employing several lamps and reflectors located on the signs themselves) too expensive to be considered for an average commercial installation. By projecting a beam of light from a distance onto such signs, however, they can be made very effective at night, in fact, more conspicuous than during the day because of their contrast against the surrounding darkness. The field reached by this class of advertising differs from and supplements that of the regular electric sign on the business street.

Floodlighting, the name given to this illumination by projection, is very effective when applied to the entire outer surface of a building—particularly if the building is light gray or white. Public buildings, statues, and other beautiful pieces of architecture can be made as attractive in appearance by night as during the day by this method of lighting. Such illumination is a dignified and effective method of advertising for the company whose building is so lighted.

The floodlighting projector, shown in Fig. 1, is designed to effectively and economically illuminate such advertising matter as billboards, and thus enable it to continue its usefulness.

This projector consists of a highly polished aluminum parabolic reflector, one-sixteenth

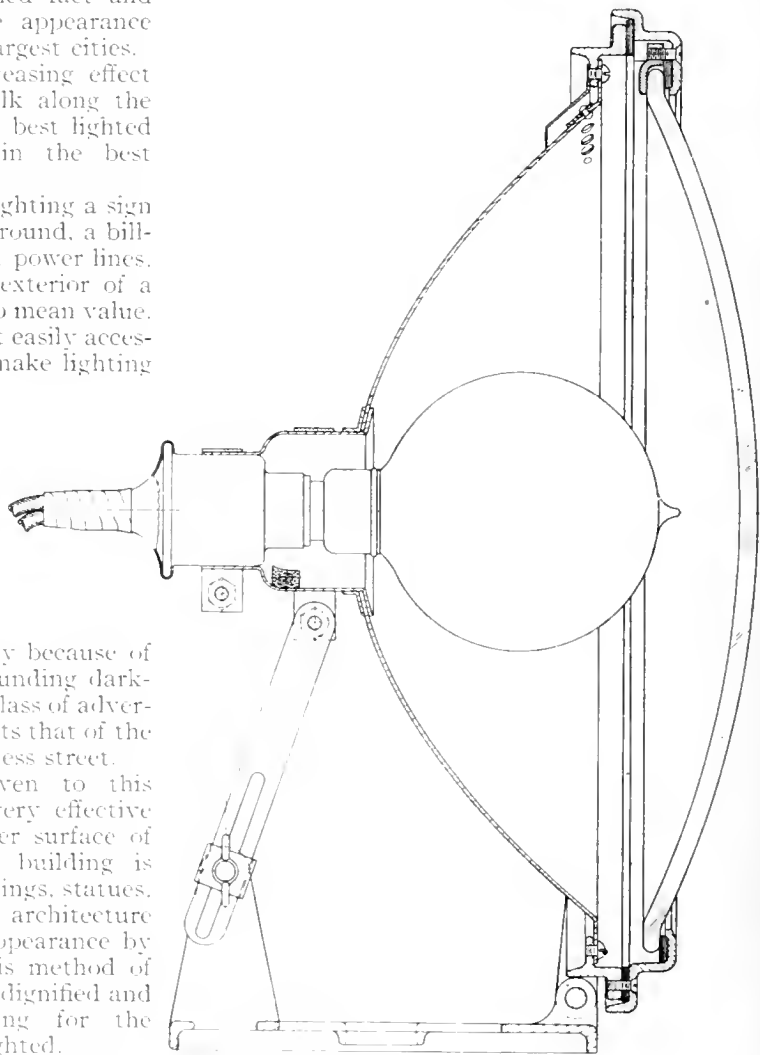


Fig. 1. Sectional Drawing of Complete Floodlight Projector

of an inch thick and 16 inches in diameter, mounted in an iron frame. The front of the reflector is covered with a piece of rounded

heat-resisting glass. This is clamped to the reflector frame and packed in such a manner that the whole is weatherproof and can, therefore, be operated out of doors in any kind of weather. All parts exposed to the weather are either made of non-corroding alloy or protected by weatherproof coating. The projector is so ventilated that currents of cool, fresh air enter near the base of the incandescent lamp, circulate around its stem and bulb and then pass out at the front edge of the top of the reflector, thus assuring proper operation of the lamp. If the reflector of this projector should become tarnished, it can be brightened again by rubbing it radially with a piece of soft cloth or chamois skin (rubbing the reflector around its surface tends to reduce its reflecting qualities).

The installation of the outfit is very simple. The most convenient location within a distance of from 25 to 500 feet from the surface to be lighted is selected and the projector bolted or screwed in place. It may be located on the roof of a building, the side of a wall, or mounted on brackets on a telegraph pole. The base of the projector has slotted bolt-holes, which permit of a slight adjustment before the final location is made. The best illuminating effect can quickly be determined by test before permanently fastening the unit in place. Since the power consumed by the lamp is only 500 watts at 110 volts, the projector may be connected to an ordinary lamp circuit. The entire outfit weighs about 30 pounds.

The lamp most commonly used is a 500-watt focus-type mazda "C" lamp in a "G-40" bulb with a medium screw skirted base. The focus-type lamp has its filament concentrated into a very small space and, by locating the filament at the focal point of the reflector, a narrow beam of light may be projected a great distance. If, however, the surface to be lighted is close to the projector, the lamp filament should be located behind the focal point of the reflector (drawn further into the reflector) in order to spread the beam sufficiently to cover the surface. The very fact that the spread of the beam and its effective distance can be easily and accurately controlled by moving the lamp in and out of focus makes this equipment an ideal one for this type of lighting. The beam may be concentrated to about 6 degrees divergence with an apparent candle-power in the center of slightly over 400,000, by locating the filament exactly at the focus; or, by drawing the filament behind the focus,

the beam may be spread to 18 degrees, with an apparent candle-power of approximately 150,000 in the center of the beam.

The locating of the filament at the focus is accomplished by directing the beam on any convenient surface 100 to 150 feet away and moving the lamp backward or forward

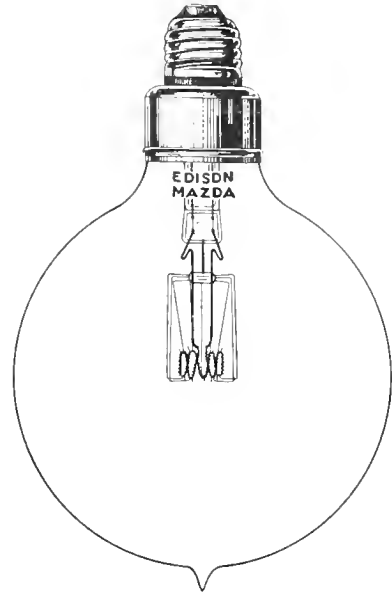


Fig. 2. Focus Type, 500-watt Lamp Used in Projector

until the smallest spot of light is obtained on the lighted surface. When this is determined the focusing device may be locked by tightening a clamp device provided for that purpose. This keeps the lamp from moving after it has been adjusted.

The point of cut-off or edge of the beam is not sharply defined of course; and it is assumed in this article that the point of cut-off is located at that angle at which the intensity falls to 10 per cent of its maximum value. If the lamp filament is drawn too far behind the focal point of the reflector, a dark spot will appear in the center of the beam. This should be avoided.

With the projector located 100 feet away and the beam concentrated to six degrees, the minimum spread of about 10 feet will be obtained with an average intensity across its diameter of 30 foot-candles. By spreading the beam to 18 degrees, the maximum spread will be about 30 feet, with an average intensity of 10 foot-candles. If two projectors are trained on the same area, the intensity will be doubled; if trained side by side, thus keeping

TABLE I

Lengths and Widths of Area Lighted and Average Intensities with Beam Concentrated to 6 Degrees

Angle α of Axis of Beam with Perpendicular to Surface Lighted	D=25 ft.			D=50 ft.			D=75 ft.			D=100 ft.			D=150 ft.		
	L	W	I	L	W	I	L	W	I	L	W	I	L	W	I
0°	2.6	2.6	428.0	5.2	5.2	107.0	7.9	7.9	47.5	10.5	10.5	26.8	15.7	15.7	11.9
15°	2.8	2.7	386.0	5.6	5.4	96.6	8.4	8.1	42.8	11.2	10.8	24.1	16.8	16.3	10.7
30°	3.5	3.0	278.0	7.0	6.0	69.5	10.5	9.1	30.9	14.0	12.1	17.4	21.0	18.2	7.8
45°	5.2	3.7	151.0	10.4	7.4	37.9	15.7	11.1	16.8	20.9	14.8	9.5	31.4	22.2	4.2
60°	10.5	5.2	54.5	21.0	10.4	13.6	31.4	15.7	6.0	41.9	21.0	3.4	62.9	31.4	1.5
75°	39.0	10.1	7.7	78.0	20.2	1.9	117.0	30.3	0.8	156.0	40.4	0.5	234.0	60.6	0.2

Angle α of Axis of Beam with Perpendicular to Surface Lighted	D=200 Ft.			D=300 Ft.			D=400 Ft.			D=500 Ft.			Key to Symbols (Refer to Fig. 3)
	L	W	I	L	W	I	L	W	I	L	W	I	
0°	21.0	21.0	6.7	31.4	31.4	3.0	41.9	41.9	1.67	52.4	52.4	1.07	D = Perpendicular distance in feet from projector to surface lighted.
15°	22.4	21.7	6.1	33.6	32.5	2.7	44.8	43.3	1.51	56.0	54.2	0.97	L = Length in ft. of area lighted.
30°	27.9	24.2	4.3	41.9	36.3	1.9	55.9	48.4	1.08	70.0	61.0	0.70	W = Width in ft. of area lighted.
45°	41.8	29.6	2.4	62.7	44.4	1.1	83.6	59.2	0.60	105.0	74.0	0.38	I = Average intensity in foot-candles on area lighted.
60°	83.8	41.9	0.9	126.0	63.0	0.4	168.0	83.8	0.21	210.0	105.0	0.14	α = Angle which center line of beam makes with surface.
75°	312.0	80.8	0.1	468.0	121.0	0.05	624.0	162.0	0.03	780.0	202.0	0.02	β = Spread of beam in degrees.

TABLE II

Lengths and Widths of Area Lighted and Average Intensities with Beam Spread to 18 Degrees

Angle α of Axis of Beam with Perpendicular to Surface Lighted	D=25 ft.			D=50 ft.			D=75 ft.			D=100 ft.			D=150 ft.		
	L	W	I	L	W	I	L	W	I	L	W	I	L	W	I
0°	7.9	7.9	100.0	15.8	15.8	25.0	23.7	23.7	11.1	31.6	31.6	6.3	47.4	47.4	2.8
15°	8.4	8.1	89.6	16.8	16.2	22.4	25.2	24.3	9.9	33.6	32.4	5.6	50.4	48.6	2.5
30°	10.7	9.2	65.4	21.4	18.4	16.4	32.1	27.6	7.3	42.8	36.8	4.1	64.2	55.2	1.8
45°	16.3	11.5	36.8	32.6	23.0	9.2	48.9	34.5	4.1	65.2	46.0	2.3	98.0	69.0	1.0
60°	34.5	15.8	12.8	69.0	31.6	3.2	104.0	47.4	1.4	138.0	63.2	0.8	207.0	94.8	0.36
75°	182.0	30.0	1.8	363.5	60.0	0.5	545.0	90.0	0.3	727.0	120.9	0.1	1090.0	181.0	0.05

Angle α of Axis of Beam with Perpendicular to Surface Lighted	D=200 Ft.			D=300 Ft.			D=400 Ft.			D=500 Ft.			Key to Symbols (Refer to Fig. 3)
	L	W	I	L	W	I	L	W	I	L	W	I	
0°	63.2	63.2	1.56	95.0	95.0	0.69	126.0	126.0	0.39	158.0	158.0	0.25	D = Perpendicular distance in feet from projector to surface lighted.
15°	67.2	64.8	1.40	101.0	97.0	0.62	134.0	130.0	0.35	168.0	162.0	0.22	L = Length in ft. of area lighted.
30°	81.4	73.6	1.03	128.0	110.0	0.46	171.0	147.0	0.26	214.0	184.0	0.16	W = Width in ft. of area lighted.
45°	130.4	92.0	0.57	196.0	138.0	0.25	261.0	184.0	0.14	326.0	230.0	0.09	I = Average intensity in foot-candles on area lighted.
60°	276.0	126.0	0.20	414.0	190.0	0.09	552.0	252.0	0.05	690.0	316.0	0.03	α = Angle which center line of beam makes with surface.
75°	474.0	240.0	0.03	2180.0	361.0	0.014	2907.0	481.0	0.01	3635.0	600.0	0.005	β = Spread of beam in degrees.

TABLE III

Beam Candle-power of Headlight Having
6 Degrees Spread

Center of beam.....	405,000
1 deg. either side of center.....	375,000
2 deg. either side of center.....	240,000
3 deg. either side of center.....	120,000

TABLE IV

Beam Candle-power of Headlight Having
18 Degrees Spread

Center of beam.....	149,000
1 deg. either side of center.....	148,000
2 deg. either side of center.....	105,000
3 deg. either side of center.....	77,000
4 deg. either side of center.....	61,000
5 deg. either side of center.....	49,000
6 deg. either side of center.....	37,000
7 deg. either side of center.....	23,000
8 deg. either side of center.....	16,000
9 deg. either side of center.....	11,500

the intensity constant, the area lighted will be doubled.

The question of the intensity of light required is one which depends largely on local conditions. If the lettering of the sign is white on a dark background, a low intensity is ample. If, on the other hand, the

sign is dark and surrounded by powerful street lamps or viewed against other light backgrounds, it may be necessary to use a very high intensity to make the sign stand out conspicuously. For average conditions from 2 to 10 foot-candles produce very satisfactory results.

For lighting long narrow surfaces, such as a row of billboards, it is desirable wherever possible to locate one projector at an angle at each end. By locating the projectors at the sides of the board, each one will cover a greater area than if located in front and the beam projected perpendicularly to the surface lighted. For floodlighting the fronts of buildings, it is desirable to locate the projectors at several different points, so as to eliminate the sharp shadows which might result if all the light came from one direction.

When the area of the surface to be lighted and the probable location of the projectors are known, it is a simple matter to calculate the number of projectors required.

The beam of the projector is conical and, if it is directed perpendicularly, it will light up a circular area; but, if it strikes the surface at some angle α , the area lighted will be elliptical.

Table I gives the length and width of the area lighted and the average foot-candle intensity on this area, when the beam is in

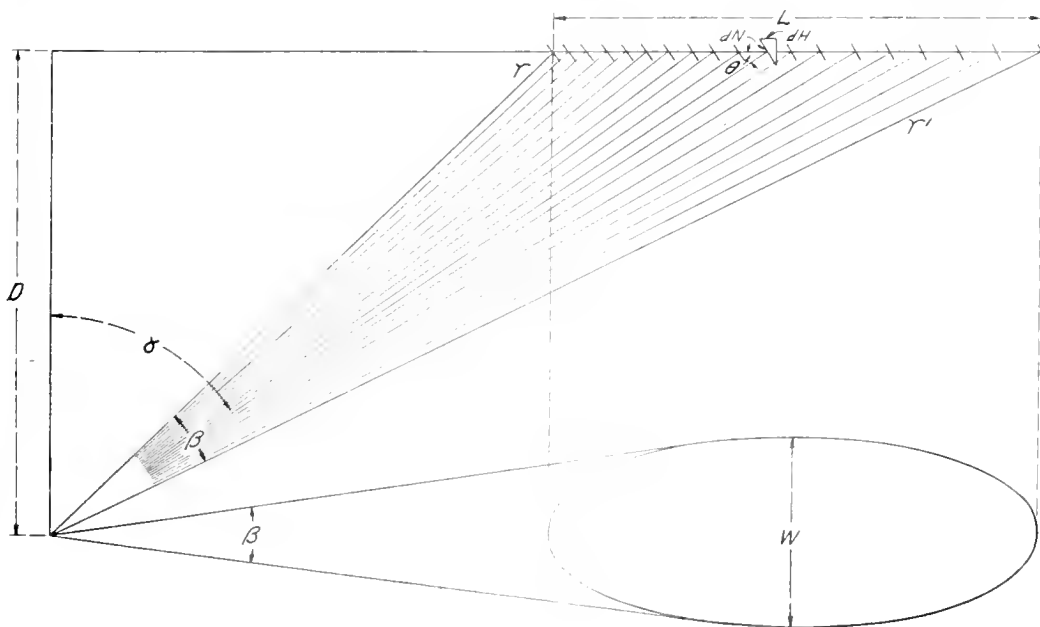


Fig. 3. Plan and Elevation of the Surface Lighted by a Projector when located at one side

concentrated to six degrees; and Table II gives similar data for the beam spread to 18 degrees. These tables are calculated for distances (D) from 25 to 500 feet and angles (α) from 0 deg. to 75 deg. in 15-degree steps. Only in extreme cases should it be necessary

should be multiplied by $\cos \theta$, the angle of incidence to give the horizontal illumination on surface dH . This should be done for each degree along the length (L) of the beam and



Fig. 4. Billboard Lighted by a 500-watt Floodlighting Projector

to use figures below the heavy black lines in Tables I and II.

These data should be sufficient for all practical purposes, but if an elaboration is desired it may be obtained from Tables III and IV.

Tables III and IV give the candle-power of the beam for each degree. By calculating the length in feet of each one-degree ray and dividing its square into the candle-power of that particular ray, the normal foot-candle intensity on surface dN will be found. This normal foot-candle intensity on each area dN

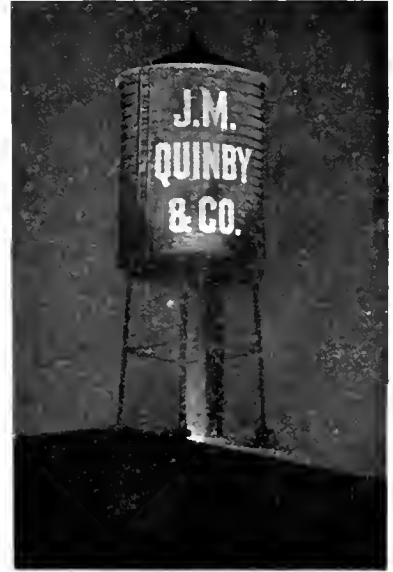


Fig. 5. Water Tank Sign Lighted by a 500-watt Floodlighting Projector

the results averaged. Similar averages taken across the width (H') will be found to be almost identical with the average obtained across the length.



Fig. 6. Public Library, Hartford, Conn., Lighted by 500-watt Floodlighting Projectors

It would seem at first glance that it was unnecessary to calculate the average intensity in this manner but when angle (α) and distance (D) become large, there is a great deal of difference in the length of the two extreme rays (r) and (r'), the two outside rays of the beam.

This floodlighting projector should find a wide use for advertising purposes. Its first cost and maintenance are low, the installation is easy, and it requires no attention whatever, beyond an occasional rubbing up of the reflector and replacing the incandescent lamp at the end of its life.

ELECTROPHYSICS

PART III

By J. P. MINTON

RESEARCH LABORATORY, PITTSFIELD WORKS, GENERAL ELECTRIC COMPANY

In this, the third contribution by Mr. Minton on Electrophysics, the author shows some further application of the electron theory to some of the scientific phenomena with which we are most familiar. Considerable attention is paid to the theory of magnetism. The Peltier, Thomson and Hall effects are discussed, and thermo-electricity, the effects of currents passing through mixed metals, and the emission of electrons from tungsten at high temperatures, are discussed in connection with the electron theory.—EDITOR.

APPLICATION OF THE ELECTRON THEORY TO VARIOUS PHENOMENA

Introduction

In the two articles of this series which have already been published, the experimental results which led to the electron theory were discussed. The theory was then briefly developed and applied to the metallic conduction of electricity. Although the results obtained were not as satisfactory as one would wish, yet many theoretical conclusions were drawn which were verified by experiments. There is hope, however, that many difficulties now encountered will be satisfactorily overcome before many years.

In the present article the theory will be further applied to various phenomena. Since the field of application is so large, it will be impossible to cover it in a satisfactory manner. More permanent good will be derived if only those phenomena with which we are more familiar are considered; most of these will be discussed in a rather general way, and a qualitative explanation given of the observed facts rather than a quantitative one. A bibliography will be found at the end of the article, and those who wish to pursue the work further will find in these references ample material with which to occupy themselves.

With the above object in view, the following subjects will be considered in the present article:

- I. Theory of Magnetism.
 - (a) The Molecular (old) Theory.
 - (b) The Electron Theory.
 - (1) Diamagnetic Substances.
 - (2) Paramagnetic Substances.
 - (3) Non-magnetic Substances.
 - (4) Permanent Magnetism.
 - II. Contact Difference of Potential or Peltier-Effect.
 - III. Thermo-electricity.
 - IV. Effect of Current Passing Through Mixed Metals.
 - V. Thomson-Effect.
 - VI. Emission of Electrons from Tungsten at High Temperatures.
 - VII. "Hall-Effect"—Effect of Transverse Magnetic Field on the Metallic Resistance.
 - VIII. Summary and Conclusions.
- These various subjects will now be taken up in the order given.

I. Theory of Magnetism

(a) *The Molecular Theory.* This theory of magnetism accounts for the various phenom-

ena by assuming that a magnetic substance is made of small elementary magnets. In a non-magnetic state these elementary magnets are distributed with their axes pointing equally in all directions. Under the influence of an external magnetic field (H), each

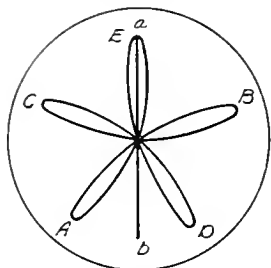


Fig. 1

elementary magnetic is acted upon by a turning force $MH \sin \alpha$, where (M) is the moment of the elementary magnet and (α) is the angle between (H) and the axis of this magnet. The tendency of these couples is to cause the magnets to turn with their axes toward the direction of the existing field. The magnitude of this rotation depends upon the strength of the field and upon the temperature of the substance. If there were no thermal agitation of the molecules, all the elementary magnets would revolve until their axes coincided with the direction of the existing field; this condition being obtained at absolute zero.

In addition to the above effect there is another one of importance. Each elementary magnet has an effect upon the surrounding ones, and thus there is a so-called molecular magnetism, called (H_m). Ferro-magnetic substances at high temperatures are but slightly magnetic; as the temperature is slowly decreased a point is reached at which the substances suddenly become very magnetic, a thing which indicates that a strong molecular field has become active. The resultant magnetic field (H), therefore, is equal to the external field (H_e) plus the molecular field (H_m).

It is quite evident that the molecular theory of magnetism throws absolutely no light upon its real nature, and that it simply considers a large magnet made of molecules (or atoms, as the case may be) which acted like elementary magnets. The question that this theory evades is "Why should molecules act like magnets?" This is the real fundamental question, and the one that demands

an explanation in terms of more familiar phenomena. This explanation is found by the help of the electron theory of magnetism, which will now be briefly developed and a few familiar facts regarding magnetic substances will be explained.

(b) *The Electron Theory of Magnetism.*

In the previous articles on the electron theory it was pointed out that electrons existed both within and without the molecules and atoms. Let us first confine our attention to the electrons within these in order to see how the latter may act like elementary magnets.

Fig. 1 represents a molecule, and (p) represents an electron vibrating along the path (ab) within it. Now, suppose there is superimposed on the molecule a magnetic field whose direction is down perpendicular to the plane of the paper. There will be a force acting on the electron (see first article of this series) and if the electron is at (O) when the field is put on, this force will cause the electron to move along the path (OA). The direction of motion of the electron then reverses at (A) which causes the force on the electron to reverse also. Hence, the electron moves along the path (AB). At (B) the direction of motion and hence the direction of the force are reversed again, and the electron moves along the path (BC). These reversals again take place at (C), (D), and (E), so that the electron arrives at the place of starting, where it again begins its journey over the same path. The number of these reversals depend on the frequency of vibration of the electrons, which must be about 10^{14} in order to account for some of the observed magnetic phenomena. The other electrons within the molecule will be similarly acted upon by the magnetic field. This change of path of the electron to that of a closed curve corresponds to a flow of current within the molecule. The molecule must, therefore, be a source of a magnetic field (provided the effects produced by the various electrons within the molecule are not neutralized) and take the place of the elementary magnet assumed in the molecular theory of magnetism. Let us now apply this theory to a few more important observations.

(1) *Diamagnetic Substances.* Considering again Fig. 1 and the above discussion, we see that energy was required to set the electrons moving along the closed paths as explained above. This energy, of course, came from the applied (external) field. Hence, the internal (or magnetic field due to the elec-

trons within the molecules) field produced must have been in such a direction as to oppose the external field. Hence, the resultant magnetic field is weaker than the applied field (H). Or if we consider a body instead of the molecule, the same result must hold. Such a substance is called a diamagnetic body and is illustrated in Fig. 2. It is seen, therefore, that diamagnetism is due to the induced electronic currents within the molecules or atoms by the application of an external magnetic field. Ordinary bismuth is the second strongest diamagnetic substance known. Recently, Roberts has shown that crystals of graphite are still stronger diamagnetic than bismuth.

(2) *Paramagnetic Substances.* We may consider that if the electrons move of themselves in a closed path, they set up a magnetic field which is opposite that set up by the electrons moving in an orbit on account of an external field. So that if such a body is placed in a magnetic field, the two fields will aid each other, and hence the lines of force will be pulled in to the body as illustrated in Fig. 3. Such a body is called paramagnetic, and iron and steel are the best examples of this. Ferro-magnetic bodies are simply bodies which are strongly paramagnetic.

(3) *Non-magnetic Substances.* If the magnetic field set up by the electrons moving of themselves within the molecules is exactly balanced by the magnetic field set up by the electrons which are set in motion along a closed curve by an external magnetic field, then the body will be non-magnetic. In this case the para and diamagnetic effects neutralize each other. If neither of the effects are present, the body, of course, will be non-magnetic. Copper is a good example of a non-magnetic substance.

(4) *Permanent Magnetism.* Permanent magnets are bodies which are paramagnetic and which have more of the axes of their molecular magnets pointing in one direction than in any other. This is just the same as they consider it in the molecular theory of magnetism. The electron theory simply tells us there are such things as molecular magnets because of electronic currents within the molecules.

Before passing on to the next subject it might be well to remark that, due to the random collisions (and thus no definite direction of motion) of free electrons, these (free) electrons do not enter into the electron theory of magnetism.

II. Contact Difference of Potential

Peltier placed two metals M_1 and M_2 in contact with each other and passed a current of electricity across their junction. He noted that a heating effect was produced at the boundary when the current passed in one

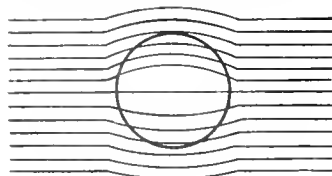


Fig. 2

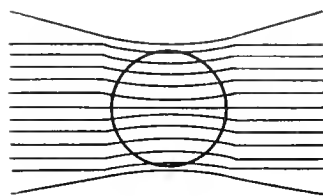


Fig. 3

direction and that the junction was cooled when the current was reversed. In the first case energy was consumed and in the second case energy was liberated. We see, therefore, that the junction of the two metals must be the source of an e.m.f.

Let us see how this phenomena is accounted for by the electron theory. Suppose that the electronic pressure is greater in metal (M_1) than in (M_2). Then more of the electrons will diffuse into (M_2) than into (M_1), so that the former will acquire a negative potential and the latter a positive potential due to their diffusion. The positive potential thus set up in (M_1) will attract the electrons and the negative electricity in (M_2) will repel them. Hence, the flow of electrons will cease when the attraction of the positive electricity in (M_1) and the repulsion of negative in (M_2) just balance the effect of the difference in electronic pressures.

This positive and negative electrification at the surface of the two metals in contact will set up a difference of potential. The value of this difference of potential as given by Drude is:

$$V_1 - V_2 = \frac{4}{3} \frac{\alpha}{c} T \log \epsilon \frac{N_1}{N_2} \quad (L)$$

Where T is the absolute temperature. The other quantities have been defined in the previous articles by the author.

From optical behavior of metals it is inferred that $\log \epsilon \frac{N_1}{N_2}$ is generally less than one, that is, the ratio of N_1 to N_2 is never greater than $2.179 = \epsilon$. So that the maximum value of this potential at $T = 291$ is

$$V_1 - V_2 = \frac{4 \cdot 3 \cdot 10^{-10} \cdot 1.5 \times 10^{-16} \times 291}{3 \cdot 4.8 \times 10^{-10}} = 3.6 \times 10^6$$

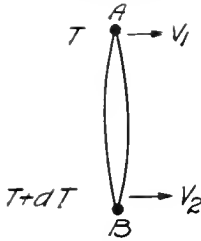


Fig. 4

electromagnetic units. Since one volt equal 10^8 electromagnetic units, the upper limit of $V_1 - V_2$ is about 0.04 volt. Antimony and bismuth have about the highest contact potential which is about 0.033 volt at 18 deg. C. We see that this agrees with theory. We also see that all the metals must contain the same order of magnitude of electrons per cu. cm

III. Thermo-Electricity

Referring to Fig. 4, suppose we have two wires made of different metals joined at (A) and (B) as shown. As explained under the Peltier effect there will be a potential (V_1) at (A) and (V_2) at (B) in the directions indicated by the arrows. If (A) and (B) are at the same temperature, then $V_1 - V_2 = 0$. But if the temperatures at (A) and (B) are respectively T and $(T + dT)$, then by equation (1) above where $V_1 - V_2 = dE$

$$dE = \frac{4\alpha}{3c} (T + dT) \log_e \frac{N_1}{N_2} - \frac{4\alpha}{3c} T \log_e \frac{N_1}{N_2}$$

or

$$dE = \frac{4\alpha}{3c} dT \log_e \frac{N_1}{N_2} \quad (2)$$

$$dE = 125 dT \log_e \frac{N_1}{N_2} \text{ microvolts. } (3)$$

It is here assumed that $\frac{N_1}{N_2}$ is not a function of the temperature, which is probable. It is now clear to us that thermo-electricity is simply a case of contact potential where the

junctions of the metals are at different temperatures.

IV. Effect of Current Passing Through Mixed Metals

Let us now make use of the Peltier-Effect to explain why the ratio of the thermal to the electrical conductivities of alloys is about 20 per cent greater than that of pure metals as pointed out in the second article of this series. This explanation is that given by Lord Rayleigh. He imagined the mixed metals (two different ones) built up in layers as shown in Fig. 5, and that a current is passed through them at right angles to their faces. Now, on account of the Peltier-Effect being present one face of one layer will be heated while the other face will be cooled. As a result of this, there will be a thermo-electric potential $V' = V_1 - V_2$ set up for the first two junctions. There will be a potential $V'' = V_3 - V_4$ set up for the next two faces, and $V''' = V_5 - V_6$ for the next two, etc. The resultant thermo-electric potential is, therefore, $V' + V'' + V''' + \text{etc.}$ Each of these thermo-electric forces are additive and are opposed to the applied potential. Since this thermo-electric potential is directly proportional to the current, it acts just the same as an added resistance and cannot be detected except as such. This effect is not present in the case of pure metals, and for this reason the ratio of the thermal to the electrical conductivities of alloys is greater than for pure metals.

V. Thomson-Effect

Lord Kelvin showed that in some metals an electric current carries heat from the hot to the cold parts of the metal, while in

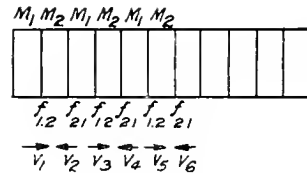


Fig. 5

other metals the transference of heat is in the opposite direction. Let us explain this by means of the theory we are discussing. Consider the current flowing in the metal from a place of higher temperature to one of lower temperature. Then, the electrons in the metal move from the colder to the

warmer part. So that electrons which possess less kinetic energy due to their lower temperature move into a region whose electrons have a greater kinetic energy. Due to this cause alone, therefore, the warmer part of the metal will be cooled while the colder will be heated.

But the number of free electrons in the metal increases with the temperature (approximately as the square root of the absolute temperature). This means that the warmer part already possesses a negative charge with respect to the colder, and will, therefore, tend to prevent electrons from flowing into it. This effect opposes the one mentioned above and may even balance or overcome it. According to this theory, then, the effect noted by Lord Kelvin is to be expected.

VI. Emissions of Electrons from Tungsten at High Temperatures

Suppose that a cylinder of metallic gauze is placed on the inside of a tungsten lamp, and that a wire is brought from this gauze to one side of a galvanometer; the other side of the latter being grounded. Now, when the filament is raised to a high temperature, the galvanometer will be deflected, thus showing that a current is passing from the hot tungsten filament to the gauze, and then through the galvanometer to the ground. This deflection is in the same direction as would be caused by negative electricity. J. J. Thomson first showed in 1899 that this current was due to electrons being emitted from the hot tungsten. They were shot off from the filament, struck the metallic gauze, and then passed through the galvanometer to the ground.

In this connection O. W. Richardson says, "This conception has proved a very fruitful one, and its consequences have been verified in a number of ways. It has provided a quantitative explanation of the variation, with the temperature of the body, of the number of electrons emitted. It led to the prediction of a cooling effect when electrons are emitted by a conductor, and a corresponding heating effect when they are absorbed. Both these effects have since been detected experimentally, and found to be of the expected magnitude, within the limits of experimental error. * * * Finally, the same general train of ideas has led to useful applications in the direction of the theory of metallic conductors, contact potential, and photo-electric action."

Prof. Richardson has recently shown that this current cannot be due to, (1) the evolu-

tion of gas by the filament, (2) chemical action or some other cause depending on impacts between the gas molecules and the filament, (3) the loss of tungsten by evaporation, and (4) any interaction between unknown condensable vapors which do not affect the McLeod gauge.

He shows experimentally that the weight of electrons given off from the tungsten is *three times* the weight of the tungsten lost by the filament and equal to 4 per cent of the total mass of the tungsten. It is, therefore, experimentally proved that this electronic emission from hot tungsten does not involve material composition. In conclusion he remarks, "The experiment also shows that the electrons are not created either out of the tungsten or out of the surrounding gas. It follows that they flow into the tungsten from outside points of the circuits. The experiments, therefore, furnish a direct experimental proof of the electron theory of conduction of metals."

No further remarks need be made on this important conclusion by such a distinguished physicist as O. W. Richardson. We will now take up the last point to be considered in this article.

VII. Hall-Effect—Effect of Transverse Magnetic Field on Metallic Resistance

Hall found that the lines of flow of an electric current through a metallic conductor were distorted when the latter was placed in a magnetic field. Referring to Fig. 6, ($ABCD$) is a flat metal strip, and a galvanometer is connected at two opposite points (P_1) and (P_2). Hall placed the strip ($ABCD$) so that the plane faces were perpendicular to a magnetic field. Then, when he passed a current lengthwise through the strip, the galvanometer was deflected, thus showing that an e.m.f. was acting between (P_1) and (P_2). Bismuth and silver gave a deflection in the same direction, while others, such as iron, cobalt and tellurium, gave deflections in the opposite direction. In some alloys this e.m.f. between (P_1) and (P_2) is in one direction for small values of (H) and in the opposite direction for larger values. In many cases it is not proportional to the magnetic field, otherwise it would not reverse in this manner. This phenomenon is known as the "Hall-Effect." The explanation of this effect from the free electron theory we have developed is somewhat as follows: If the electrons drift with an average velocity (U) from left to right in the metal strip, (H) the

strength of the magnetic field, (e) the charge on an electron, then a force HeU (see first article on "Cathode Rays and their Properties" by the author) will act on each electron vertically upwards in the plane of the paper. This force will produce the same effects in the metal strip as would be produced

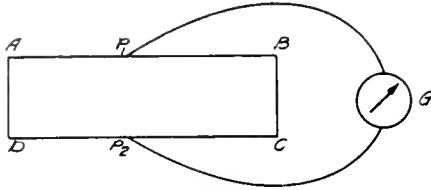


Fig. 6

by an e.m.f. acting on the strip in the same direction. This explanation requires that the effect shall always be of the same sign, a thing which is not true. Some physicists account for the observed phenomena by assuming the presence of positive electrons. This assumption is not satisfactory for positive electrons have not been discovered. Another objection to this assumption is that it would require the effect to be proportional to (H) which is not true as pointed out above.

To account for the observed facts, we might consider that each of the metallic atoms act like small magnets which tend to align themselves in the direction of the magnetic field (H). In the small regions between the poles of the atomic (or molecular) magnets and the external field it is easy to see that the lines of magnetic force are in the opposite direction to those of (H). In these regions, therefore, the forces acting on the electrons are also opposite to those caused by (H). If these atomic magnetic forces are greater than those caused by (H), then the observed effect is opposite to that caused by the latter field. For strong magnetic fields (H) the effect might be in one direction and for weak fields it may be reversed. For certain values of (H) these two tendencies may neutralize each other. This explanation is a satisfactory one from a qualitative viewpoint, but it may not be quantitatively satisfactory. However, the application of the electron theory to such phenomena is striking.

It becomes of interest, therefore, to investigate the effect of a magnetic field on the resistances of metals. A purely mathematical treatment of this effect will be given and then we shall see if the theory is affirmed by experiment.

Consider a current passing along the strip of metal ($ABCD$), from one end to the other, and that a magnetic field is placed down perpendicular to the plane of the paper in the region of the strip. Let us then get the equations of motion of *one* electron between impacts with the metallic atoms and with other electrons. The fifth fundamental equation of the Maxwell-Lorentz electromagnetic theory states that the total force (F) acting on the electron between impacts is:

$$F = Ee + eH \sin \theta \tag{1}$$

where (E) is the electric force in dynes on a unit positive charge, (H) the magnetic force in dynes on a unit north magnetic pole, (e) the charge on the electron, (v) the velocity of the electron, and (θ) the angle between (v) and (H). Let us write this equation in rectangular coordinates, thus:

$$F = e(E_x + E_y + E_z) + e[(v_z H_y - v_y H_z) + (v_x H_z - v_z H_x) + v_y H_x - v_x H_y] \tag{2}$$

Assuming the current flowing along the X axis, and the magnetic field along the Z axis, then $E_y = E_z = 0$, $H_x = H_y = 0$. Let $E_x = E$, and $H_z = H$. Equation (2) then becomes:

$$F = Ee + e(v_x H - v_y H) \tag{3}$$

Now, from the first article of this series, the force of $ev_y H$ is along the X axis, and $ev_x H$ is along the Y axis; there is thus no force along the Z axis under the assumed conditions. The total force on the electron along the X axis is therefore:

$$m \frac{d^2 x}{dt^2} = Ee - He \frac{dy}{dt} \tag{4}$$

and along the Y axis:

$$m \frac{d^2 y}{dt^2} = He \frac{dx}{dt} \tag{5}$$

where m is the mass of the electron. Let us integrate equations (4) and (5). Integrating (5) we get:

$$m \frac{dy}{dt} = H e x + K_1 \tag{6}$$

But when $x = 0$, $\frac{dy}{dt} = 0$, therefore $K_1 = 0$. So

that equation (6) gives:

$$m \frac{dy}{dt} = H e x \tag{7}$$

We obtain the value of (X) in equation (7) from (4) in the following manner. Since the effect produced by the magnetic field is

known to be small, it will be permissible to take for (X) the value it would have if no magnetic field were applied. Hence from (4):

$$m \frac{d^2x}{dt^2} = Ee \quad (8)$$

Integrating:

$$m \frac{dx}{dt} = Eet + K_2 \quad (9)$$

Now $\frac{dx}{dt} = 0$, when $t = 0$, hence $K_2 = 0$. Equation (9) then becomes:

$$m dx = Eet \, dt$$

or

$$mx = \frac{1}{2} Eet^2 + K_3 \quad (10)$$

when $t = 0$, $x = 0$, so that $K_3 = 0$. Whence,

$$mx = \frac{1}{2} Eet^2 \quad (11)$$

Equation (11) gives the distance over which the electron moves due to the electric force (E). Due to the random motion of the electron during this time (t) between impacts the electron will have moved an additional distance vt , where (v) is the vibratory velocity mentioned in the second paper by the writer. So that the total x is:

$$x = \frac{Eet^2}{2n} + vt \quad (12)$$

Substituting this result in equation (7) we get:

$$\frac{dy}{dt} = \frac{He}{m} \left(\frac{Eet^2}{2m} + vt \right) \quad (13)$$

Putting this value of $\frac{dy}{dt}$ in equation (4) we obtain:

$$\frac{d^2x}{dt^2} = \frac{Ee}{m} - \frac{H^2e^2}{m^2} \left(\frac{Eet^2}{2m} + vt \right) \quad (14)$$

integrating,

$$\frac{dx}{dt} = \frac{Eet}{m} - \frac{H^2e^2}{m^2} \left(\frac{Eet^3}{6m} + \frac{vt^2}{2} \right) + K_4 \quad (15)$$

When $t = 0$, $K_4 = \frac{dx}{dt} = v$. Hence, equation (15)

becomes:

$$\frac{dx}{dt} = \frac{Eet}{m} - \frac{H^2e^2}{m^2} \left(\frac{Eet^3}{6m} + \frac{vt^2}{2} \right) + v \quad (16)$$

This $\frac{dx}{dt}$ is the instantaneous velocity of drift of electrons along the strip. The average velocity of drift (U) between collisions due

to (E) and (H) is, therefore, by definition of average value,

$$U = \frac{1}{T} \int_0^T \frac{dx}{dt} dt \quad (17)$$

Where (T) is the time required to transverse the mean free path. Therefore, by equations (16) and (17)

$$\begin{aligned} U &= \frac{1}{T} \int_0^T \left[\frac{Eet}{m} - \frac{H^2e^2}{m^2} \left(\frac{Eet^3}{6m} + \frac{vt^2}{2} \right) + v \right] dt \\ U &= \frac{1}{T} \left[\frac{EeT^2}{2m} + \frac{H^2e^2}{m^2} \left(\frac{EeT^4}{24m} + \frac{vT^3}{6} \right) + vT \right] \\ U &= \frac{EeT}{2m} - \frac{H^2e^2}{m^2} \left(\frac{EeT^3}{24m} + \frac{vT^2}{6} \right) + v \quad (18) \end{aligned}$$

by equation (1) page 206, in the second article of this series, we saw that $I = NeU$, the current flowing across a surface 1 sq. cm. in area at right angles to the electric force. Hence, from equation (18):

$$I = \frac{NEe^2T}{2m} - \frac{NH^2e^3}{6m^2} \left(\frac{EeT^3}{4m} + vT^2 \right) \quad (19)$$

The last term of equation (18) drops out because on the average there will be as many electrons which possess a negative (v) as there are that possess a positive (v). The second term in the brackets of (19) is not zero because (T) is different for those electrons whose initial velocities are in opposite directions. This is due to (E) retarding the motion in one case and aiding it in the other. If we assume this to be the case, then it will be shown shortly that $vT^2 = -\frac{EeT^3}{m}$. Putting this value for vT^2 in equation (19) we obtain:

$$I = \frac{NEe^2T}{2m} + \frac{NEH^2e^4T^3}{8m^2} \quad (20)$$

Comparing equation (20) with (1) and (5) in the second article of this series by the author, we see that the first term of equation (20) is the expression for the current when no magnetic field is present. The effect of the magnetic field, as shown by the second term of the above equation, is to always cause the current to increase. This, however, is not true, and equation (20) must not be accepted.

J. J. Thomson argued that the collisions between the electrons and atoms are greatly influenced by the electronic charges, so that the difference between the periods of electrons moving with and against (E) is quite small; in fact so small that vT^2 in equation (19) can be neglected in comparison with $\frac{EeT^3}{4m}$.

This assumption leads to equation (21) below:

$$I = \frac{NEc^2T}{2m} - \frac{NEH^2c^4T^3}{24m^3} \quad (21)$$

This equation indicates that (*I*) always decreases when the conductor is placed in a magnetic field; just the opposite from equation (20). Neither of these equations are satisfactory for in some pure metals equation (21) holds, while in ferro-magnetic metals equation (20) is in agreement with the observations. For some ferro-magnetic metals equation (20) holds for weak values of (*H*), and for very strong values of (*H*) the effect is reversed so that equation (21) is satisfied. It is obvious, therefore, that neither of the two assumptions made above were justifiable. Let us look into the matter more carefully.

From the discussion on the electron theory of magnetism it is evident that the presence of the magnetic field will alter the arrangement of the atoms and molecules within the metal. This will probably alter the mean free path of the electron, and hence its periodicity (*T*). Let the new period be (*T*₁), then *T* = *T*₁ + *ST*. Calling (*I*) the current if the magnetic field did not exist and (*I*₁) the current after the magnetic field caused a re-arrangement of the atoms and molecules, then by equation (19),

$$I_1 = \frac{NEc^2T_1}{2m} - \frac{NH^2c^3}{6m^2} \left(\frac{EeT_1^3}{4m} + vT_1^2 \right) \quad (22)$$

Subtracting equation (22) from the first term of equation (19) we get:

$$I - I_1 = \frac{NEc^2\delta T}{2m} + \frac{NH^2c^3}{6m^2} \left(\frac{EeT_1^3}{4m} + vT_1^2 \right) \quad (23)$$

Substituting *T*₁ = *T* - δT in (23) and neglecting all terms involving (δT) or higher order terms we obtain:

$$I - I_1 = \frac{NEc^2\delta T}{2m} - \frac{NH^2c^3}{6m^2} \left(\frac{EeT^3}{4m} - \frac{3EeT^2\delta T}{4m} + vT^2 - 2vT\delta T \right) \quad (24)$$

Now, if (*t*₁) is the periodicity of the electron in the direction of (*E*), and (*t*₂) that in the opposite direction, then if (*h*) is the mean free path of the electron,

$$t_1 - t_2 = \frac{h}{v + \bar{U}} - \frac{h}{v - \bar{U}}$$

Putting in the values of (\bar{U}) which we have already obtained in the author's second article of this series we get:

$$-2vT\delta T = \frac{2EcT^2\delta T}{m} \quad (25)$$

and

$$vT^2 = -\frac{EcT^3}{m} \quad (26)$$

Putting equations (25) and (26) in (24) and reducing we get:

$$I - I_1 = \frac{NEc^2\delta T}{2m} + \frac{NH^2c^3}{6m^2} \left(\frac{-3EeT^3}{4m} + \frac{5EeT^2\delta T}{4m} \right) \quad (27)$$

Since *ST* is negligible compared with (*T*) equation (27) reduces to:

$$I - I_1 = \frac{NEc^2}{2m} \left(\delta T - \frac{H^2c^2T^3}{4m^2} \right) \quad (28)$$

This is the final form for the change in current due to the molecular and atomic re-arrangement on account of the magnetic field. It is seen to consist of two terms, one positive and the other negative. In magnetic substances, like iron, we have to assume that (*ST*) is large enough to overbalance the second term for small values of (*H*). Then *I* > *I*₁, and its resistance therefore increases. When magnetic saturation is reached (δT) ceases to change, and with increasing values of (*H*) the second term overbalances the first. The *I* > *I*₁, and hence, the resistance decreases with increasing values of (*H*). We see, therefore, that the theory calls for a reversal of the effect, and this is actually what is observed.

$$\text{Now } I = \frac{E}{R} \text{ and } I_1 = \frac{E}{R_1}$$

so that

$$I - I_1 = E \left(\frac{1}{R} - \frac{1}{R_1} \right).$$

From this result and equation (28) we get:

$$\left(\frac{1}{R} - \frac{1}{R_1} \right) = \frac{Nc^2}{2m} \left(\delta T - \frac{H^2c^2T^3}{4m^2} \right) \quad (29)$$

But in the second article of this series we obtained:

$$\alpha = \frac{1}{R} = \frac{Nc^2T}{2m}$$

Hence, equation (29) can be written:

$$\frac{1}{R} - \frac{1}{R_1} = \frac{1}{TR} \left(\delta T - \frac{H^2c^2T^3}{4m^2} \right)$$

or

$$\frac{R - R_1}{R_1} = \frac{\delta T}{T} - \frac{H^2c^2T^2}{4m^2}$$

and since (*R*₁) nearly equals (*R*),

$$\frac{\delta R}{R} = \frac{\delta T}{T} - \frac{H^2c^2T^2}{4m^2} \quad (30)$$

Now, $\frac{\delta T}{T}$ is very small in comparison with $\frac{H^2c^2T^2}{4m^2}$ for iron for large values of (*H*), so that

$$\frac{\delta R}{R} = \frac{H^2c^2T^2}{4m^2} \quad (31)$$

Grunmack gives for iron:

$$-\frac{\delta R}{R} = 10^{-3}, H = 2 \times 10^4, \frac{c}{m} = 1.8 \times 10^7$$

Putting these values in equation (31):

$$10^{-3} = \frac{4 \times 10^7 \times 3.2 \times 10^{14} T^2}{4}$$

or

$T^2 = 3 \times 10^{-26}$ or $T = 1.7 \times 10^{-13}$, which according to their theory is the average period of the electrons in iron.

$$\dot{F} \text{ for iron } \frac{1}{R} = 10^{-4}, c = 1.6 \times 10^{-20},$$

and since $\frac{1}{R} = \frac{Nc^2 T}{2m}$ we get, by substituting

in these values of $\frac{1}{R}$, T , c , and m ,

$$N = 10^{22} \text{ approximately,}$$

which gives the number of electrons per cu. cm. in iron. You will remember that according to the free electron theory as given in the second article of this series the number in one cu. cm. of silver is 10^{23} . We feel, therefore, that the number of electrons in a cu. cm. of metal is of the same magnitude as the number of atoms, and that the number of electrons per cu. cm. in various metals is of the same order of magnitude.

It will be well to note that since $vT = h$, (the mean free path), (h) is equal to

$$10^7 \times 1.7 \times 10^{-13} = 1.7 \times 10^{-6} \text{ approximately.}$$

By investigating the change in metallic resistance under the influence of a transverse magnetic field, we have been able to account for the noticed change in resistance, to calculate the periodicity (T) of the electron, to calculate their mean free path, and to determine the number of electrons per cu. cm. of the metal under investigation. The field of application for the electron theory is thus seen to be quite extensive.

VIII. Summary and Conclusions

This concludes the first three articles on the electron theory and its application. The theory has now been developed and applied to many different phenomena. We have tried

to show that it is extremely fundamental and far reaching. It is, indeed, applicable to all phenomena observed in connection with gravitation, etc., etc. It is the most searching of all theories known, and because of this fact its application requires great ingenuity on the part of the investigator. One will find attached herewith a bibliography which will be helpful if he desires to pursue this theory further.

BIBLIOGRAPHY

Theory of Magnetism

Curie, Archives des Sciences, ser. 4, 31, p. 5-19, 1911.

Weiss, Journal de Physique, 36, p. 661-690, 1907.

Langevin, Annales de Chemie et de Physique, ser. 5, 8, p. 70-127, 1905.

Kunz, Physical Review, 30, p. 359-370, 1910.

Williams, Univ. of Illinois, Bull. 10, No. 10, pp. 3-64, Nov. 4, 1912. (A good summary of work already done on the electron theory of magnetism.)

Schrodinger, "Kinetic Theory of Magnetism," Akad. Wiss. Wien, Ber. 121, 2a, pp. 1305-1328, July, 1912.

Holm, "Magnetism and Molecular Structure," Ark. for Mat. Astron. Och Fysik, Stockholm, 8, 16, pp. 1-59, 1912.

Contact Potential

Drude, Ann. der Physik, 1, p. 590, 1900.

Drude, Ann. der Physik, 1, p. 593, 1900.

Drude, International Electric Congress, St. Louis, Vol. 1904.

J. J. Thomson, "Corpuscular Theory of Matter."

O. W. Richardson, Phil. Mag. 24, pp. 737-744, Nov., 1912.

"Electron Theory of Thermo-electricity," and Vol. 23, pp. 594, 1912.

Lord Rayleigh, "Collected Works" Vol. IV, p. 232.

Lord Rayleigh, Nature, LIV, p. 154

Emission of Electrons from Hot Metals

J. J. Thomson, Phil. Mag. Vol. XLVIII, p. 547, 1899.

O. W. Richardson, Camb. Phil. Proc. Vol. XI, p. 286, 1901; Phil. Trans. A Vol. CCI, p. 497, 1903; Phil. Mag. Vol. 26, pp. 345-350, Aug. 1913.

Richardson and Cooke, Phil. Mag. Vol. XX, p. 173, 1910, Vol. XXI, p. 404, 1911. Phil. Mag. Vol. XXV, p. 624, 1913.

Metallic Conduction

J. J. Thomson, "Corpuscular Theory of Matter."

O. W. Richardson, Phil. Mag. Vol. 23, p. 594, 1912. Vol. 24, p. 737, 1912.

One will find Owen's, "Recent Physical Research," a very useful book.

The reader can find a great many more references in Science Abstracts, Sec. A. Physics.

*RAILWAY MOTOR CHARACTERISTIC CURVES

By E. E. KIMBALL

RAILWAY AND TRACTION ENGINEERING DEPARTMENT, GENERAL ELECTRIC COMPANY

This article, which is part of the discussion of Mr. E. C. Woodruff's paper on the Graphic Method for Speed-Time and Distance-Time Curves, read before the A.I.E.E. on Nov. 13, 1914, shows how the slide rule, with the addition of two special scales, may be used as a sufficiently accurate substitute for the characteristic curves of a d-c. railway motor. Equations for the curves plotted from the slide rule readings are evolved, and their application illustrated by the solution of a concrete example, in which the horse-power of the motors to fulfill a given set of conditions is determined. Another example is worked out to show how the motor losses may be segregated and the resistance of the motor determined.—EDITOR.

The object of this article is to show by means of two typical characteristic curves of railway motors, how valuable the slide rule is as a handy substitute for the characteristic curves of an actual railway motor.

The steps leading up to the selection of a motor to do a given service without overheating usually require exactly similar calculations or follow the calculations of speed-time and distance-time curves; but there are some short cuts which will lead to a close approximation of the size of motors required. Furthermore, the ordinary characteristic curves giving speed, tractive effort, and efficiency of a railway motor do not contain sufficient information regarding the resistance and core loss of the motor for one to determine the losses which have to be radiated in service, or to correct a characteristic curve for a change in voltage conditions. From an analysis of these characteristic curves the writer expects to point out a procedure which he has found to be very useful in supplying this information when required.

The so-called polyphase slide rule (Fig. 1) is the same as the ordinary slide rule except that it has two additional scales, one in red between the "B" and "C" scales, which is the "C" scale inverted (reversed), and the other on the edge of the rule, which is the scale of the cubes of numbers on the "D" scale. If the ends of the scales are made to coincide, as shown in Fig. 1, and the values read from the "C" and cube scales are plotted against corresponding values from the "A" scale as abscisse, the curves which result resemble the characteristic curves of a d-c. railway motor, as shown by the dotted lines of Fig. 2. That is, from the "A" scale is read per cent amperes, from the middle scale per cent speed, and from the scale on the edge of the rule per cent tractive effort. The setting of the slider in Fig. 1 gives the readings of speed and tractive effort corresponding to

160 per cent normal amperes; that is, 79 per cent speed and 203 per cent tractive effort. In this figure are shown in solid lines the characteristic curves of a composite or typical railway motor in which the values are given in per cent of the one-hour rating of the motor. If the dotted lines are accepted as representing the relation between the amperes, tractive effort, and speed for rough calculations then it can be shown that the efficiency must be constant throughout the entire range. The equation of the dotted speed and tractive effort curves are as follows:

$$\% \text{ speed} = \left(\frac{1}{\% \text{ amp.}} \right)^{1/2}$$

and

$$\text{Per cent T.E.} = (\text{per cent amp.})^{3/2}$$

The writer has made no attempt to derive an equation which will represent the characteristics of a railway motor closer than the ones just given, for the reason that the chief value of these equations lies in the fact that it is easy to remember to read per cent amperes on the "A" scale, per cent speed on the middle scale, and per cent tractive effort on the cube scale.

For speed-time and distance-time curves, one is not so much interested in the relation between speed and amperes or tractive effort and amperes as he is in the relation between speed and tractive effort.

From the above equations it follows that

$$\% \text{ speed} = \left(\frac{1}{\% \text{ T.E.}} \right)^{1/3}$$

or in other words: *The speed of a d-c. railway motor is approximately inversely proportional to the cube root of the tractive effort.*

The dotted speed curve in Fig. 3 is plotted with tractive effort instead of amperes as the variable; that is, the two tractive effort curves of Fig. 2 have been made to coincide and the speed curve modified so as to maintain the same relation between speed and tractive effort as exists in Fig. 2. The closeness with which the dotted and solid speed curves

*Part of discussion of E. C. Woodruff's paper before A.I.E.E. November 13, 1914, on *The Graphic Method for Speed-Time and Distance-Time Curves*.

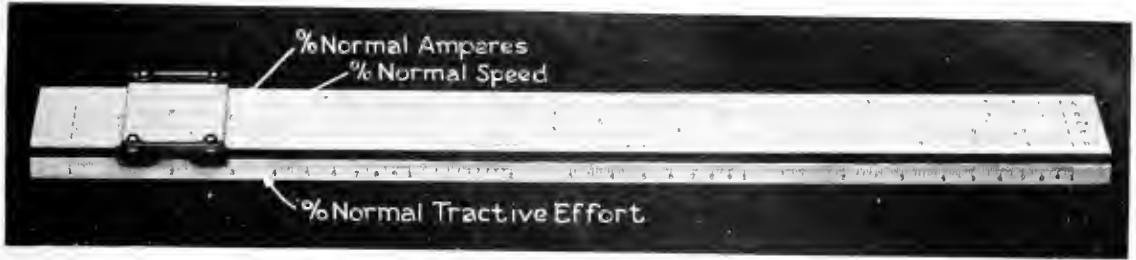


Fig. 1. "Polyphase" Slide Rule

of Fig. 3 agree shows that the relation between speed and tractive effort for the typical railway motor is closely represented by the rule just stated. The value of this relation in determining the capacity of railway

At 60 m.p.h. the tractive effort delivered by the motors just balances the train resistance, viz., 25 lb. per ton. The final speed reached on the control during the period of notching up (beginning of motor curve acceleration) is unknown, but we know what the tractive effort must be to give 0.8 m.p.h.-p.s. acceleration during the control period. It is $80 + 15 = 95$ lb. per ton if we assume it takes 100 lb. per ton to produce 1 m.p.h.p.s., and if the train resistance at this lower speed is taken at 15 lb. per ton.

By the rule just stated

$$\frac{V}{60} = \left(\frac{25}{95}\right)^{1/3}$$

or

$$V = 60 \times \left(\frac{25}{95}\right)^{1/3} = 60 (0.263)^{1/3} = 38.5 \text{ m.p.h.}$$

Likewise for any other speed the tractive effort can be obtained; that is, at 40 m.p.h.

$$\frac{T}{25} = \left(\frac{60}{40}\right)^3$$

or

$$T = 25 \times \left(\frac{3}{2}\right)^3 = 84 \text{ lb. per ton.}$$

Thus, given one condition which must be satisfied, other points follow directly. That is, given the maximum speed and friction corresponding, the speed and tractive effort for any other point can be closely estimated. The usual procedure is as just outlined in the example above.

The equipment selected must be able to accelerate the car at the rate of 0.8 m.p.h.p.s. up to 38.5 m.p.h. without overheating in service. A car geared for a maximum speed of 60 m.p.h. would not usually be used in a frequent stop service, hence high and frequent accelerations are not likely to occur, and it may be assumed that if this rate of acceleration does not exceed the one hour rating of the

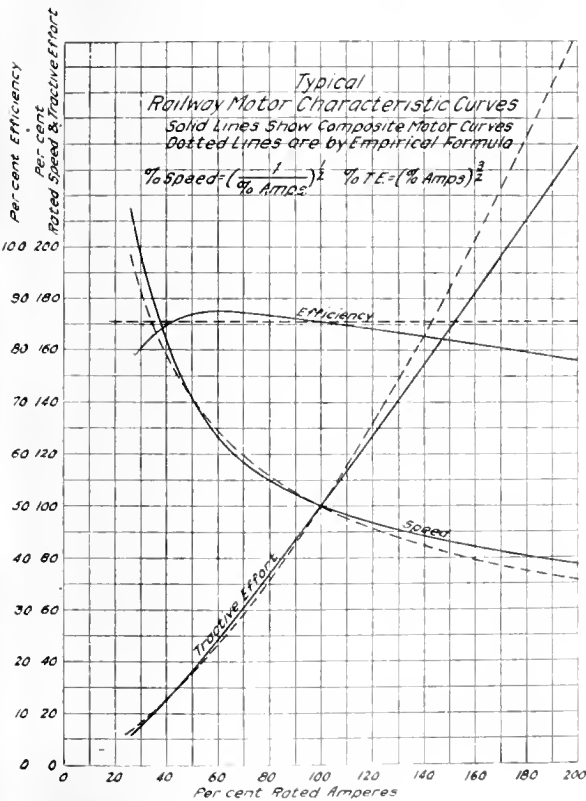


Fig. 2

motors for a given service is best illustrated by an example.

Assume a 50-ton car to be geared for a maximum speed of 60 m.p.h., a train resistance value of 25 lb. per ton at 60 m.p.h., and a rate of acceleration of 0.8 m.p.h.p.s. Determine the horse power capacity of motors required.

motors the equipment will have capacity to do the service; that is

$$\text{horse power required} = \frac{50 \times 95 \times 38.5}{37.5} = 488$$

or let us say four 125-h.p. motors.

One would look for characteristic curves of 125-h.p. motors and select a gearing which would give sufficient tractive effort at 60 m.p.h. to balance the friction.

For lighter and slower speed cars, which are generally used in frequent stop service, a rate of acceleration of 0.8 m.p.h.p.s. is not sufficient either for performing the usual schedules nor does it leave enough margin for radiating the losses in service. It is usual to select an equipment for these services which will produce an acceleration of 1.00 to 1.50 m.p.h.p.s. at the one-hour rating of the motors. This is on the basis of non-ventilated motors.

Ventilated motors radiate losses much faster than the non-ventilated type, hence the horse power rating of motors, if ventilated motors are proposed, will be less than found by the above method. As a first approximation 80 per cent of the values found above will lead to some definite design of motor for which the radiating constants are known. From these it can be determined what the probable heating will be in service.

To segregate the losses of a railway motor and thereby determine its resistance, the writer has found that the core loss may be represented by the equation $(L = K I^2)$, where K is a constant and I represents current.

The standardization rules of the A.I.E.E. (Appendix I of Rules) suggests that the gear and friction losses be taken at five per cent for all loads above $\frac{3}{4}$ load for approximate determinations when tests are not available. Then from an efficiency curve plotted in this fashion we may select two points above $\frac{3}{4}$ load and write the equation for the total losses, eliminate the terms containing core loss and solve for R .

Thus for $\frac{3}{4}$ and $\frac{3}{2}$ load, if

I = amperes at $\frac{3}{4}$ load,

$2I$ = amperes at $\frac{3}{2}$ load,

L = Core loss at $\frac{3}{4}$ load,

$4L$ = Core loss at $\frac{3}{2}$ load,

and K_2 = total losses in per cent at $\frac{3}{4}$ and $\frac{3}{2}$ load respectively.

= 100 - per cent efficiency at $\frac{3}{4}$ and $\frac{3}{2}$ load respectively.

E = rated voltage of motor or voltage marked on curves.

Then

$$I^2 R - L - \frac{5}{100} EI = \frac{K_1 EI}{100} \text{ at } \frac{3}{4} \text{ load (1)}$$

and

$$(2I)^2 R - \sqrt{\frac{5}{2}} L - \frac{5}{100} E (2I) = \frac{K_2 E (2I)}{100}$$

at $\frac{3}{2}$ load (2)

or eliminating L and substituting 1.26 for $\sqrt{\frac{5}{2}}$

$$2.74 I^2 R - \frac{3.7 EI}{100} = \frac{(2 K_2 - 1.26 K_1) EI}{100}$$

$$R = \frac{(2 K_2 - 1.26 K_1 - 3.7) E}{2.74 \times 100 \times I}$$

simplified

$$R = \frac{(8 K_2 - 5 K_1 - 15) E}{1100 I}$$

From the derivation of this formula it follows that care must be taken to select

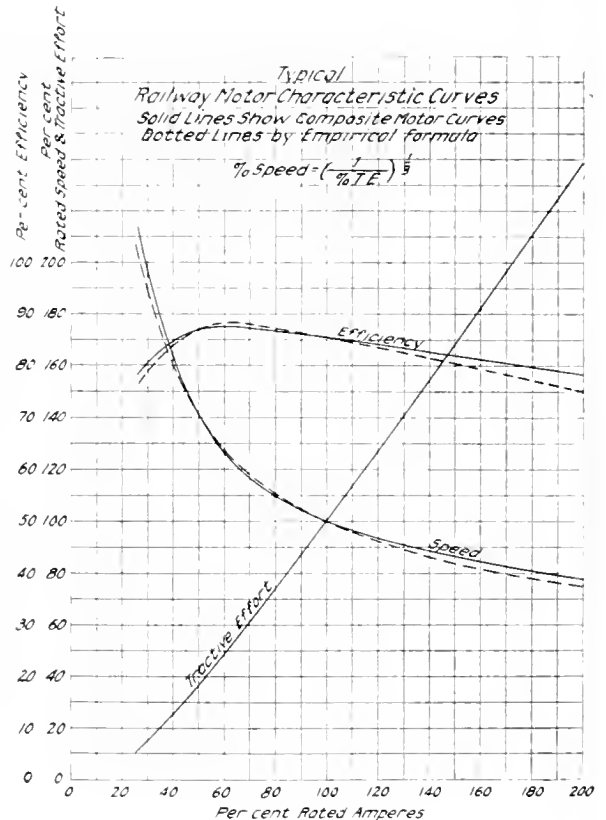


Fig. 3

two points both of which are above $\frac{3}{4}$ load, and the load must bear the relation 2 to 1; i.e., if one point is taken at $\frac{7}{8}$ load the other must be taken at $\frac{7}{4}$ load, etc. I is the current corresponding to the lesser of the two points chosen.

Example: Find the per cent copper and core loss represented by the typical characteristics shown in Fig. 2 or 3.

These curves are shown over a sufficient range to obtain three determinations of the resistance. For check readings, we will take the losses in pairs as follows:

$$K_{80}, K_{160}; K_{90}, K_{180}; K_{100}, K_{200}$$

$$K_{80} = 100 - 86.5 = 13.5$$

$$K_{160} = 100 - 82.0 = 18.0$$

$$K_{90} = 14$$

$$K_{180} = 20.5$$

$$K_{100} = 14.5$$

$$K_{200} = 22.0$$

$$R = \frac{(8 \times 18 - 5 \times 13.5 - 15) E}{1100 \times 80} = 0.0007 E$$

$$R = \frac{(8 \times 20.5 - 5 \times 14 - 15) E}{1100 \times 90} = 0.0008 E$$

$$R = \frac{(8 \times 22.0 - 5 \times 14.5 - 15) E}{1100 \times 100} = 0.000805 E$$

$$\text{Ave. } R = 0.00077 E$$

$$\text{Per cent } I^2R \text{ (1 HR rating)} = \frac{I^2 R \times 100}{E \times I}$$

$$= 100 \times 0.00077 \times 100 = 7.7 \text{ per cent}$$

$$\text{Per cent } CL \text{ (1 HR rating)}$$

$$= 14.5 - (5 + 7.7) = 1.8 \text{ per cent.}$$

The accuracy of this determination of the resistance of a motor depends upon how accurately the efficiency can be read. A single determination may be 25 per cent out because of accumulated errors in reading the efficiency, but usually the error is much less than this.

THE OSBORN ELECTRIQUETTE

By O. E. THOMAS

LOS ANGELES OFFICE, GENERAL ELECTRIC COMPANY

This article tells of an interesting development, and shows the adaptability of the electric drive to new fields. The control features are of special interest, and it should be noted that every detail has been worked out to a point where it is practically "fool-proof."—EDITOR.

One of the latest and most unique applications of electric motor drive is to be seen in the diminutive electric vehicle recently placed on the market. The rolling chair of the seaside resorts is to lose its attendant and is to be propelled by an automobile type motor, deriving its power from a small storage battery. The electrically propelled chair will be known as the "Electriquette."

It is not the plan to furnish operators for these vehicles, care having been taken to make them so simple, safe and practical that any one will be able to operate them without previous experience. How well the designers have succeeded in this regard is evidenced by the photographs.

The chair consists of the chassis on which are mounted the motor, batteries, gearing and operating mechanism, and a body made of heavy rattan. Comfortable cushions for the seat and back are provided. A brief description may be of interest.

The frame is constructed of angle iron bolted and reinforced with cross members. The wheel base is 45 inches and the tread is 33 inches; the motor and gearing are mounted at the rear and the battery at the front.

All the wheels are of cast iron and are provided with flat solid rubber tires. The front wheels are 10 inches in diameter and are mounted in swivel socket bearings attached to the frame, and are assembled with a tie rod and lever for steering. The rear wheels are 14 inches in diameter and are supported independently in bearings which are attached to the frame. One wheel carries the driving sprocket, while the other is fitted with a hub and contracting brake band.

The motor is of special automobile type manufactured by the General Electric Company, rated as GE-1042, 12 volts, 14 amperes, 2000 r.p.m. It is of the enclosed type, and is equipped with ball-bearings and aluminum bearing heads. The weight is approximately 25 lb.

The battery is of the Gould lead cell type, rated at 12 volts and 130 ampere-hours; the normal discharge is 14 amperes at the chair speed of three miles per hour. The battery capacity is sufficient for about eight hours' operation, or approximately a full day's run. Recharging is carried on at a station at night time. Tests have been made, driving the chair fully loaded up a 20 per cent grade.

Under these conditions a battery output of approximately 65 amperes is required.

The motor mounting consists of a single casting comprising the motor cradle, back-

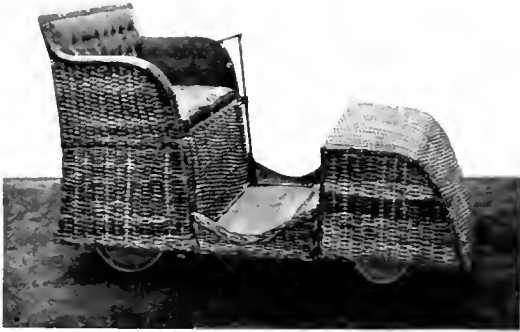


Fig. 1. Electriquette with Split Rattan Body

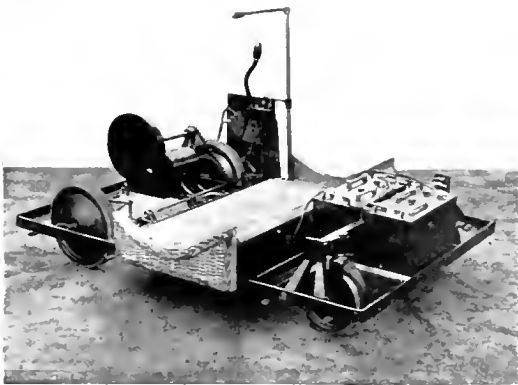
gear bearing housings and supports, as well as the back-gear case. The motor is held in the cradle by two straps. The complete mounting is bolted to the frame and cross members. The left rear wheel carries the sprocket which is chain-driven from a pinion

electric warning bell, is located within convenient grasp of the operator. A safety feature is provided, consisting of a metal board labelled "Emergency Stop." This extends across the floor within the reach of the feet of both passengers. When this stop is pressed, a line switch is opened and the wheel brake is applied and locked. Before the chair can be started again it is necessary to bring the controller to the "off" position, which operation releases the brake and closes the line switch. This feature is of considerable importance and is entirely effective. The chair can be stopped so quickly that it may be safely operated on a crowded thoroughfare.

The bodies are constructed of heavy split rattan, amply reinforced. They are bolted directly to the frame and can be readily removed. The front hood covers the battery and is hinged for easy inspection and charging.

The complete chair weighs 450 lb. It will comfortably seat two persons. In actual operation three or more are often accommodated. In this development the electric motor still further extends its usefulness.

A number of these chairs are already in use on the grounds of the Panama-California Exposition now being held at San Diego,



Figs. 2 and 3. Front and Back Views of Electriquette Chassis

on the back gear shaft, the total gear reduction of the back gear and chain being 28:1.

The controller is of the single knife-blade-contact type, giving two speeds forward and one reverse point. The controller handle, carrying at its end a push-button for an

California, and are proving very popular. About one hundred and twenty-five chairs will ultimately be in service at this exposition, and four hundred or more at the Panama-Pacific-International Exposition opening at San Francisco, February 20, 1915.

NOTES ON THE ACTIVITIES OF THE A. I. E. E.

NEW YORK CONVENTION

The mid-winter convention was held in the Societies' Building in New York on February 17th, 18th and 19th. A large number attended this convention. The papers were of a very interesting character and the convention was conducted in an able manner by the chairman, all the papers being delivered according to schedule, with ample time for discussion.

The Status of the Engineer

An event of more than passing interest was an evening session devoted to addresses on the status of the engineer. The opening address was by Mr. Lewis B. Stillwell, which was followed by short addresses by Messrs. E. W. Rice, Jr., E. M. Herr, Alexander C. Humphries, John Hays Hammond, George F. Swain, H. G. Stott and J. J. Carty. All of these gentlemen, who have been eminently successful in their various lines of activities, gave their views on the subject of the status of the engineer. Some of the things said about the engineer were very complimentary; but some were not, for he was treated with entire frankness. It was pointed out, for example, that the engineer took too small a part in the law-making bodies of the states and nation; that, being absorbed in his enthusiasm for his work, he frequently lost sight of the dollar, allowing the less deserving to get it; etc. On the other hand, in the engineer's favor, it was said that his constant association with facts, and exact analyses of conditions, made him valuable for practically any line of work, and that it particularly fitted him for filling high positions of trust and executive ability. It was aptly remarked by the chairman in this connection that two of the speakers themselves, Messrs. Herr and Rice, who had spent most of their lives as engineers, were now presidents of two corporations, among the largest in the world.

Electrical Precipitation

Among the many papers presented, the three on the subject of "Electrical Precipitation" attracted perhaps the most interest; that is, they drew the largest audience and those who had the opportunity of hearing them felt especially privileged.

The opening address was made by Dr. F. C. Cottrell, who gave a historical sketch of the steps in the development of the art. The

papers and their authors were as follows: *Electrical Precipitation—Theory of the Removal of Suspended Matter from Fluids*, by W. W. Strong; *Theoretical and Experimental Considerations of Electrical Precipitation*, by A. F. Nesbit; and *Practical Applications of Electrical Precipitation*, by Linn Bradley.

The authors treated the theoretical and practical aspects of electrical precipitation of fumes, smoke, dust, etc., in very great detail, and by means of motion pictures, gave a very convincing demonstration of some of the things actually accomplished. Several varieties of chimneys were shown, rigged up with equipment for electrical precipitation. In these pictures, first a dense volume of smoke would be shown issuing from the chimneys and then, after seeing a person throw a switch, the chimneys almost instantly appeared smokeless. The switch in the pictures, of course, controlled the circuit supplying the electric power, by means of which the electrical precipitation was accomplished. These motion pictures were thoroughly convincing.

However, Mr. Bradley added further to the positiveness of these demonstrations by means of a working model. This model consisted of a chimney, attached to which was a blower, the top of the chimney being equipped with a co-axial electrode. A 5-kv-a., 100,000-volt transformer, and a mechanical commutator driven by a synchronous motor, were used to supply the co-axial electrode with the proper character of electrical pressure. The blower was used to supply carbon dust, in order to reproduce the approximate conditions existing in a chimney emitting smoke. By Mr. Bradley's demonstration it was shown that, although a dense mixture of carbon was emitted from the chimney, all of this could be electrically precipitated by means of the device in question. The success of the demonstration won the appreciative applause of the audience.

LYNN SECTION

Lead Storage Batteries, by J. L. Woodbridge

A particularly interesting lecture on the *Lead Storage Battery* was given by Mr. J. L. Woodbridge, Chief Engineer of the Electric Storage Battery Company, February 17, 1915. The following is an extract of Mr. Woodbridge's lecture:

The chemical changes taking place upon charging and discharging were well brought

out by the use of diagrams and slides. The chemical methods of forming the plates were treated from the historical side, the speaker in this connection giving a very good resumé of the development of the plate, from the original experiments by Planté and Faure to the most modern methods of plate manufacture. Numerous types of grids for holding the active material in position, representing the best European as well as American practice, were illustrated by slides. Special stress was laid on the ability of the best lead cells to deliver their charge at many times normal rating in case of emergency without suffering permanent damage. This point was demonstrated by short circuiting and "iron clad" cell, of 600 ampere-hours rating, through a $3\frac{1}{2}$ in. by $3\frac{1}{2}$ in. steel bar, 5 in. long. The current at the beginning of the test was 2000 amperes, which as the bar heated up dropped to 1500 amperes, where it held constant for five minutes; the bar in the meantime being heated to bright incandescence. On a dead short circuit this battery showed 4000 amperes just previous to the test. The plates were in no wise injured by this strenuous discharge, having passed through the same performance some fifty times before.

Mr. Woodbridge then showed characteristic curves relating to specific gravity voltage and temperature as affecting charging and discharging conditions. Emphasis was laid on the fact that charging should be based on specific gravity measurements rather than voltage measurements, and that in charging a battery, the ideal conditions were most nearly approached when the charging load was varied to keep a constant voltage drop across the cell, and the hydrometer relied upon to indicate when the charging should be discontinued. No reliance whatever could be placed upon voltage readings taken with the cell open-circuited. In discharging, the voltage of the battery under load should not be allowed to fall below a certain minimum value, which varied somewhat with the temperature of the cells.

The latter part of the lecture was devoted to slides illustrating large battery installations in many of the big central stations in this country where the batteries are relied upon to carry a portion of the peak or even all the load in case of an interruption to the generator equipment. Several kinds of "end-cell switches" were also described in this connection. Station records showing graphically the effect of "stand by" batteries in large

installations in cases of sudden big demands were shown, which illustrated the need of such arrangements where continuity of service was of paramount importance.

Problems that Confront the Physicist, by Professor Comstock

On March 9th, at the fifth of the special series of lectures by Professor D. F. Comstock, of the Massachusetts Institute of Technology, the speaker discussed the *Present Day Problems that Confront the Physicist*. This series of lectures has been most heartily enjoyed by those attending the course.

Up-to-Date Telephone Problems, by J. G. Patterson

On March 10th, Mr. J. G. Patterson, Engineer of the New England Telephone Company, spoke on *Up-to-Date Telephone Problems*. The talk was illustrated by lantern slides. An extract of this paper will appear in our next issue.

Recent Developments in X-ray Work, by Dr. Davey

On March 17th, Dr. W. P. Davey spoke on *Recent Developments in X-ray Work*.

PITTSFIELD SECTION

The Sixth Annual Dinner of the Section was held on Wednesday, February 24th. Over one hundred members were present. The principal speaker was Dr. W. L. Tracey, of Pittsfield, who gave an outline of some very interesting experiences in Europe at the opening of the present war. Dr. Tracey, it seems, was traveling in Switzerland at the time when the war broke out. The lecture was illustrated by a very complete set of beautifully colored lantern slides.

Leakage Reactances and Short-Circuits, by Professor Adams

On March 11th Professor C. A. Adams, of Harvard University, lectured on *The Leakage Reactance of Synchronous Alternators and Its Relation to Sudden Short-Circuits*. An extract of this paper will be given in the next issue.

Program for April

The following meetings are scheduled for April:

April 1st, Dr. E. B. Rosa, *Recent Work of the Electrical Division of the Bureau of Standards*.

April 22nd, Mr. C. F. Bateholts, *Educational and Advertising Value of Motion Pictures*.

April 29th, Dr. W. R. Whitney, *The Physical Chemistry of the Blood*.

SCHENECTADY SECTION

Control for Electric Motors, by C. D. Knight

On March 2nd, Mr. C. D. Knight, Managing Engineer, Industrial Control Department, General Electric Company, gave an interesting talk on the *Principles and Systems of Control for Electric Motors*. An extract of this paper is given below:

Mr. Knight gave an outline of a program to be carried out by the Industrial Power Committee of the A.I.E.E. for the season of 1914 and 1915, of which Mr. D. B. Rushmore is chairman, and himself a member, the idea being to arrange for a series of papers which could be published at the end of the year in the shape of an industrial power volume covering the latest methods of adapting motors and control to the various industries, such as steel mills, machine tool, mines, rubber, paper, printing, textile and many others. Mr. Rushmore had read a paper outlining the motor situation two weeks previous at the midwinter A.I.E.E. meeting in New York, and Mr. Knight, without dwelling on the details of any one application, reviewed the control situation, stating that these papers would be followed by others which would specialize on each important industry as a unit.

Mr. Knight then described the several up-to-date types of resistances which form the basis of all control apparatus, demonstrating that their chief function is to control the amount of current which is applied to the motor, and so dissipate the energy absorbed by radiation and ventilation as to keep the temperature of the resistance within safe working conditions. He then showed that the property of absorbing energy in the form of heat is known as *thermo capacity*, and that of transferring heat from the unit into the cooler air as *radiation*. As the thermo capacity is the capacity to store energy in the form of heat for each degree rise of temperature, a unit of small cross section carrying low current may have as large a thermo capacity relatively as a unit of large cross section carrying high current. This was shown by two heating and cooling curves for cast iron grids of different capacities.

Mr. Knight then took up the question of temperature co-efficient, showing that a resistance with a zero temperature co-efficient covered the ideal condition. Many forms of wire have this, and that of cast iron is 0.0007, which from a practical point of view is satisfactory. He went on to show that with resistance material having an exceedingly high temperature co-efficient, frequent starting of the motor would increase the resistance to such a degree as to involve the danger of not having the motor start on the first point of the control.

Passing briefly over the well known methods of hand control Mr. Knight went considerably into the latest development of magnetic and automatic control, showing the different methods in vogue for controlling d-c. and a-c. motors. For direct-current the three accepted methods of automatic acceleration are counter e.m.f., current-limit, and time-limit, the first being applicable to d-c. motors only, and the two last to both a-c. and d-c. motors.

In describing the counter e.m.f. method of control, Mr. Knight presented diagrams showing a number of contactors with their coils connected in multiple across the armature, these contactors being adjusted to provide different air gaps between the core and the armature, in order that they may

go in at different values of counter e.m.f. of the motor as this increases. It was demonstrated that this form of control was more satisfactory for use with shunts than with series motors, because the counter e.m.f. of the latter depends upon the current as well as the speed, and it might be possible, if the motor were starting under heavy load, to obtain sufficient counter e.m.f. to close all the contactors before the motor had time to accelerate properly.

Mr. Knight described current limit acceleration as a function of the current; one method of obtaining this consisting of a number of shunt contactors energized by series relays, each relay being held up when the inrush of current for the motor is high at starting and dropping as the current falls, due to the acceleration of the motor. As each relay drops, it energizes the next contactor, which cuts out a step of resistance, finally bringing the motor up to speed.

Another method of current limit acceleration was shown by means of a series contactor, in which the operating coil is in series with the load and operates in such a way as to lock out on high current, and close at some predetermined lower value.

In describing time limit control two methods were shown; one being a solenoid operating an arm over contacts, and being retarded by some form of dashpot in order to get the number of seconds required in accelerating the motor and the other type a motor or magnetic ratchet operated dial in which the variation in time element is obtained by increasing or decreasing the speed of the motor or the strength of the magnets operating the ratchet.

Mr. Knight showed that one very important feature peculiar to the direct current motor is the possibility of operating the motor as a generator for quick stopping, or for retarding the lowering speed when overhauled by a suspended weight, as in crane service. For this purpose a resistance is connected in the armature circuit, which dissipates the stored energy as heat. This method is called "dynamic braking." For quickly stopping an alternating current motor use is sometimes made of a low voltage direct current circuit, which is connected to two of the primary phases, after the motor has been disconnected from the line. Another method, called "plugging" is to connect the motor and apply power in the opposite direction, but the circuit must be opened as soon as the motor has stopped or the motor will run in the reverse direction.

Mention was made of the latest form of liquid rheostat which is used for starting and regulating the speed of large induction motors for mine hoist work. By taking advantage of the water level in the electrode chamber, auxiliary magnet switches can be energized, bringing into action additional resistance plates, this method having increased the resistance range about nine times the former value.

In concluding Mr. Knight referred to the great advantages of automatic over hand control, from both a safety and time saving standpoint, and showed several slides to demonstrate this fact, one of the most interesting being that of a large boring mill in which the automatic panel was totally enclosed and quite a distance from the machine. The operation of the motor was controlled by push buttons, one of which was in the form of a pendent switch hanging inside of the large casting on the mill. The operator could remain inside this casting and control the speed of the machine without being obliged to climb up and signal to his assistant to

perform this feature, which was naturally inherent in the old hand control system.

Driving Ships' Propellers, by W. L. R. Emmet

On March 30th, Mr. W. L. R. Emmet, Consulting Engineer, General Electric Company, will present a paper on *Driving Ships' Propellers*. This paper will be presented before a joint meeting of the Schenectady Section of the A.I.E.E. and the Eastern New York Section of the N.E.L.A. Mr. Emmet's paper will be of considerable interest, in view of the fact that the United States Government has decided to build the *California*, a new dreadnaught, arranged for electric drive. Mr. Emmet is certainly well qualified to discuss this topic, as he has evolved much of what is known about the subject of electric drive for ship propulsion. The success of the electrically propelled *Jupiter* has without

doubt been the means of bringing about the present decision of the navy department to build the *California* with this method of drive.

Lectures for the Near Future

Among the lecturers scheduled for the near future are the following:

Mr. G. Faccioli, Assistant Engineer, Transformer Department, General Electric Company.

Mr. Philip Torechio, Chief Electrical Engineer of the New York Edison Company.

Prof. Elihu Thompson, Consulting Engineer, General Electric Company.

Mr. E. B. Raymond, formerly General Superintendent of the General Electric Works, and at present Vice-president of the Pittsburgh Glass Company.

PRACTICAL EXPERIENCE IN THE OPERATION OF ELECTRICAL MACHINERY

PART VII (Nos. 36 TO 40 INC.)

BY E. C. PARHAM

36. IMPERFECT SLIP-RING CONTACTS

It frequently has been observed that copper brushes when sufficiently burned, due to sparking, will become so much oxidized as to impair the conductivity of their contact surfaces, with the result that a generator on which such brushes are used may be unable to build up its field magnetism.

An effect similar to this was encountered in connection with a slip-ring induction motor used on a foundry crane. The motor was erratic in that sometimes it would start promptly and at other times it would not. Of the three motors used on the crane, the motor in question was the only one that gave this trouble. It would seem that this state of affairs might exist because the other motors were somewhat protected while this one was unprotected and was swung low where it was exposed to the dust and fumes from the moulding floor. As the irregular action persisted even after the pinion had been drawn, the cause could not be attributed to parts other than those local to the motor itself. Upon establishing an independent stator circuit to the line and an independent rotor circuit through temporary resistances, it was found that the uncertain starting feature

still existed. It was while applying an ammeter to test for balanced currents that the nature of the trouble was suggested. The stator circuits proved to be balanced under all conditions and the rotor circuits took equal currents at those times when the motor started promptly. At other times, one rotor circuit or another would take no current that was readable on the only ammeter that was available. In course of further testing of the rotor circuits with a voltmeter, it was found that, with the rotor blocked and the line voltage applied to the stator (which are the conditions under which the voltage generated in the rotor is at its maximum because the slip is 100 per cent) uniform voltages could be read across the slip-rings if the voltmeter test lines were applied to the sides of the rings. When, however, the test lines were applied to the bearing surfaces or to the brush shunts, the results obtained, if readable, were very uncertain. On using a magneto, it was equally uncertain as to whether its bell would ring upon applying the test points to any pair of slip-rings. The rotor was removed and the rings turned down. There was no evidence of burning on the rings, but in turning them down the machinist

found it necessary to take off a full thirty-second of an inch, in order to get under a skin that the lathe tool would not cut. This operation restored the normal characteristics of the motor.

The crane man stated that the motor previously had sparked viciously on account of the rotor rubbing the stator, and that this condition had been aggravated by a loose brush-holder stud. It was after these faults had been corrected that the balky action had become most pronounced.

(37) EQUALIZER ON THE WRONG SIDE

A properly connected equalizer between two compound-wound generators places their series windings in parallel.

If one machine is already connected to the load and the other machine is to be paralleled with it, the voltage of the incoming machine should be adjusted to no-load value after which the equalizer and the main switches should be closed in the order named, unless a special three-pole switch is provided to close them simultaneously. In any event, the instant the equalizer switch is closed a part of the current from the loaded machine passes through the series field of the incoming machine, which increases the voltage of the latter by an amount that represents the voltage active in making it take its share of the total load. Furthermore, assuming that the machines are properly connected, the equalizer current insures that incoming machine will be of the right polarity and it also minimizes the chance of the machine

generator with an older one "because there was something the matter with the new one." He further stated that there were fireworks each time that he had tried to throw the machines together. An investigation disclosed that the operator, who had done his own installing, had connected the equalizer as indicated by the full line *a-b* in Fig. 1. It should have been connected as indicated by the location of the dotted line *c-d*. In other words, the equalizer was connected on the side of the armature opposite to the series field, which resulted in simply increasing the capacity of the busbar *g-h*. Naturally, when the machines were paralleled there was no equalizing action and whichever one happened to have the lower voltage was run as a motor by the one of higher voltage.

If a properly connected equalizer is of sufficient cross-section to permit of its resistance being neglected and if the resistances of the series fields of the two machines are equal, the current from either loaded machine should divide equally between the series fields of the two generators as soon as the equalizer switches are closed.

(38) GENERATORS MOTORING AT NO-LOAD

Fig. 1 illustrates the connections for operating two compound-wound generators in parallel by means of an equalizer. In connection with this diagram will be considered an operator's complaint that one of the two machines would always "motor" the other one when the external load became zero, either as the result of there being cars in service using no current or because of the station circuit breaker opening.

Assuming that the correct no-load adjustments have been made, the currents of the two machines combine to flow through the external circuit, represented by the broken line, as long as this path remains intact. The function of the equalizer connection, which places the series field windings of the machines in parallel, is to minimize the motoring tendencies incident to the machines having unequal voltages. It does this by strengthening the field of the lower voltage machine, thereby increasing its voltage and causing it to take more load as a generator.

When the external circuit is open and the equalizer open but the local circuit around the two machines closed, any difference between the voltage of the two machines will result in the higher voltage machine backing current through the lower voltage machine. As this current must pass through

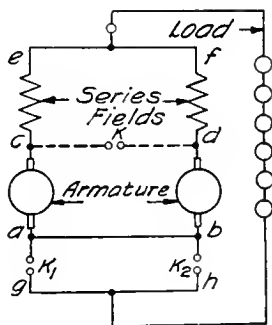


Fig. 1

being "motored" should its no-load voltage have been adjusted to too low a value.

An operator once complained that he could not parallel a new compound-wound

the series field of the lower voltage machine in the reverse direction, it opposes the field due to the shunt winding and further decreases the generated e.m.f., which at this time is really the counter e.m.f. of a differentially connected motor. The motoring current therefore further increases and this increase

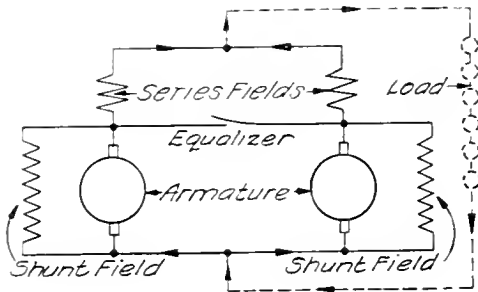


Fig. 2

weakens the field more, thereby still further decreasing the counter e.m.f. The net result of these interactions is that the lower voltage machine quickly assumes the characteristics of a short-circuit across the higher voltage one. Unless circuit-breakers relieve the situation promptly, the motored machine is likely to have its rotation reversed; this will occur if the series winding is strong enough to overcome the shunt field and thus reverse the polarity of the resultant field, because the machine will then operate as a series motor (which turns in the opposite direction from what a series generator would for given connections).

With the external circuit open and the equalizer circuit closed (the condition under which the operator claimed one machine would motor the other) the series fields of both machines are out of action, the equalizer short-circuiting them and at the same time serving as a conductor for completing the local circuit between the two armatures running in the fields excited by their respective shunt windings. The two machines when under this condition may be considered as shunt generators connected together with voltages opposed. So long as the opposing voltages are equal, no current will flow between the armatures; but if for any reason one of the voltages becomes a little higher than the other the lower voltage machine will be motored, although it will continue to run in the same direction because shunt generators and shunt motors operate in the same direction for given connections. The extent

to which one machine will motor the other depends upon the amount of the difference between their voltages. Slight differences may be due to speed variations, to unequal heating of shunt fields, or to different armature reactions incident to unlike brush shifts. To whatever cause the motoring may be due, the motored machine is apt to spark because its brushes are located for generation and not for motor operation.

Assuming the generators to be practically similar in all respects, but that their brush shifts are unequal, the armature reaction of one machine will affect the magnetism of its pole-pieces more than will the armature reaction of the other machine affect its pole-pieces. Although each machine may have first been carefully adjusted to give the correct no-load voltage, the result after the two have been loaded and the load removed (either by the main circuit-breaker operating or by the external load decreasing to zero) may be that the no-load voltages of the two machines will be found to be very different in amount because the residual magnetism of one generator may be much greater than that of the other.

This was the trouble in the case under consideration. The flashing and motoring at no-load was eliminated by giving the brushes of both machines the same number of bars forward shift. It was then necessary to readjust the compounding of one of the machines by changing the length of its series field shunt.

(39) CHANGING MOTOR MOUNTING

Some motors are constructed to permit of floor, wall, or ceiling mounting. In the absence of instructions to the contrary, it is customary to ship the motors arranged for floor mounting.

To adapt them for wall mounting the end shields are rotated 90 degrees, and for ceiling mounting 180 degrees, in order to bring the oiling devices into their normal position. As a rule, the shifting of the end shields shifts the brush-holders to a position which, according to the number of poles, might reverse the direction of rotation or render operation impracticable on account of sparking. One method of checking brush position is first to arbitrarily mark alternate field coils *N* and *S*, as shown in Figs. 3 and 4. If the holders are located midway between coils, Fig. 1, two holders that include a *N* coil, for example, are marked. After shifting the shield, the brush-yoke is shifted until the two

marked holders again include a field coil marked *N* if the direction of rotation is to remain unchanged. Where each holder is located opposite the center of a coil, Fig. 4, a holder opposite a marked coil *N*, for example, is marked and after shifting the shield the marked holder should be placed opposite a field coil marked *N*, if the same direction of rotation is desired.

These instructions expressed in terms of angles would read as follows: After laying the motor upon the floor in the position in which it is later to be mounted on the wall or the ceiling, as the case may be, and rotating the shields to correct the position of the oilers, the rocker arm or yoke should be turned backward through the same angle that the shield has been turned forward. The brushes will then be in the correct position for sparkless operation and for the original direction of rotation. Such a double shift is equivalent to loosening the yoke and holding it stationary while rotating the end shield. As far as sparkless operation in the original direction is concerned, it is immaterial whether the marked brush-holder be moved to its original position relative to the marked field coil or whether it be moved to the same position relative to another field coil of the

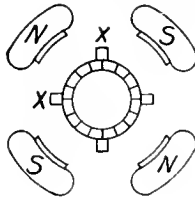


Fig. 3

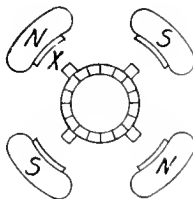


Fig. 4

same mark; in the latter case, however, it may be necessary to lengthen some of the loads.

Failure to observe the requirements of relative brush-position has caused much trouble and delay to operators who have had occasion to shift a motor from one mount to another or who have changed their minds after specifying that a motor should be shipped for a certain mount.

(40) MOTOR THROWING OIL

The tendency of motor bearings to throw oil, that is eventually drawn into the motor to saturate its windings, may be due to a hot bearing, or to a defective bearing, or to excessive and careless application of oil, or to the overflow pipe being stopped up, or to a pumping action that may become effective as the result of excessive lining wear. In most cases, however, excessive and careless oiling is responsible.

Except where information is furnished as to the amount of oil required to refill a bearing, or to renew normal loss, it is the better plan to apply the oil through the overflow pipe. By carefully noting the level of the oil in this pipe, while slowly pouring it in, a reliable indication of the oil level in the bearing becomes available. Most care takers resort to the quicker method of applying the oil through the top opening of the bearing. The objections to this method are that, unless the oiler is careful, he will spill oil outside or, if he is careful but continues to pour oil in until he sees a little run out of the overflow pipe, the overflow will continue for some time after the oiler leaves, since a certain amount of time is required for the oil to work its way down from above, and up through the overflow pipe.

An inspector was asked to prescribe for an elevator motor that was "throwing oil." The motor windings, brushes, brush rigging, slip-rings, floor and elevator platform were saturated and wherever oil could stand in pools it did. If the motor had been engaged in pumping oil, it could hardly have made a better showing. The inspector cleaned everything concerned with the motor, flushed out the bearings with gasolene, refilled the bearings through the overflow pipe until the oil came up to within $\frac{1}{4}$ inch of the top of the overflow, and then had a heart to heart talk with the oiler—which produced satisfactory results.

FROM THE CONSULTING ENGINEERING DEPARTMENT OF THE
GENERAL ELECTRIC COMPANY

NOTES ON THE OPERATION OF TRANS-
FORMER USED WITH 2 KW. 100,000
CYCLE ALTERNATOR

The purpose of these notes is to give an outline and general description of how a current having a frequency of 100,000 cycles may be taken from a 2 kw. generator and transformed so that the maximum output of the machine may be applied to a tuned circuit. This circuit may be a wireless antenna having a given value of resistance,

have an effective resistance of about 2.5 times the ohmic resistance. This increase in resistance is due to the eddy current loss in each conductor, and also to the mutual effect of adjacent conductors when considering a stranded cable of bare wires.

The primary winding is sandwiched in between the secondary to give a fairly close-coupled transformer. The winding ratio is also changeable so that the generator and transformer may be applied to quite a wide

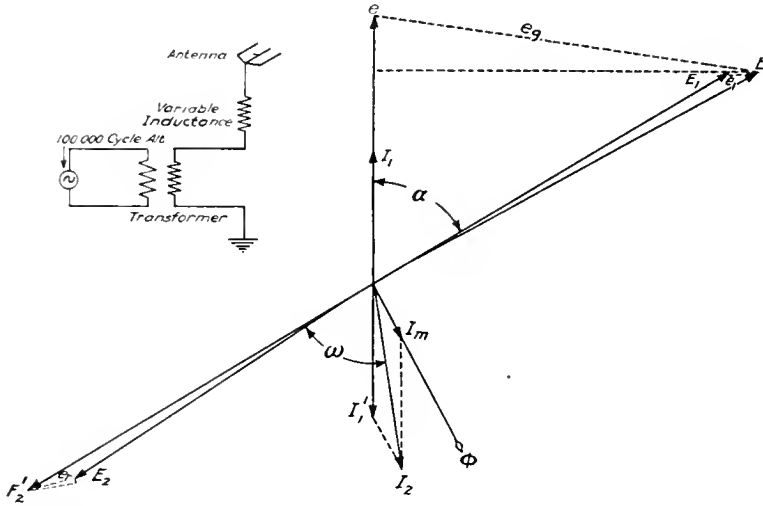


Fig. 1

inductance and capacity, or a circuit arranged to measure the energy input to a certain particular insulation under investigation.

The no-load losses of the transformer, since it has an air core, consists of insulation loss and effective resistance loss. The insulation loss is due to dielectric hysteresis in the insulation between conductors and also between coils. The most efficient insulation is air, and the transformer coils are so made that air is used for insulation between turns. There are several braids of cotton wrapped around the conductor, which acts only as a spacer to provide the desired thickness of air between turns. Sample coils using cambric as insulation between layers were made, and considerable heat was generated from the energy loss in the cambric.

At a frequency of 100,000 cycles per second, the eddy current loss in the conductors becomes an important item. As an example, the coils used in this transformer

range of resistance and still obtain maximum output. A representative load will be described somewhat in detail:

Consider an antenna having a resistance of 20 ohms and a capacity-reactance of 1400 ohms. In this case we will take the magnetizing current flowing in the secondary and let part of the antenna capacity-reactance neutralize this inductance. Thus our circuit is from the generator terminals direct to the primary of the transformer, one terminal of the secondary being grounded, and the other connected to a variable antenna inductance and then to the antenna proper.

Assume the following constants:

- Frequency = 100,000 cycles per second
- Generator open circuit volts = 120
- Generator full load current = 30
- Generator synchronous resistance = 0.8 ohms at 100,000 cycles
- Generator synchronous reactance = 5.8 ohms at 100,000 cycles

The transformer ratio is determined as follows:

120 volts open circuit generator
 $30 \times 0.8 = 24$ volts IR drop in generator
 96 energy volts available

$$\frac{96 \text{ volts}}{30 \text{ amp.}} = 3.2 \text{ ohms resistance load}$$

Since antenna resistance = 20 ohms
 Effective ratio of transformer =

$$\sqrt{\frac{20}{3.2}} = \sqrt{6.25} = 2.5$$

Since the effective ratio of transformation is somewhat less than the ratio of secondary to primary turns, we will assume a ratio of turns of 4:1.

We have then

Transformer (secondary open circuit) resistance = 1.06 ohms at 100,000

Transformer (secondary open circuit) reactance = 15 ohms at 100,000

Transformer (secondary short circuit) resistance = 0.05 ohms at 100,000

Transformer (secondary short circuit) reactance = 1.08 ohms at 100,000

Voltage at generator terminals =

$$\sqrt{(120 - 30 \times 0.8)^2 + (30 \times 5.8)^2} = 200$$

Thus we see that the voltage across the generator has been increased from 120 at no load to 200 under load.

With 200 volts across transformer primary:

Primary magnetizing impedance = 15

$$\text{Magnetizing current} = \frac{200}{15} = 13.3$$

The secondary current or antenna current will then be the vector sum of the load current plus the magnetizing current divided by ratio of turns

$$\frac{41.5}{4} = 10.4$$

$$\text{Thus current ratio} = \frac{30}{10.4} = 2.9$$

The voltage ratio will be about 3.2 (see vector diagram); and

Volts secondary = 640

Fig. 1 shows the vector relations of this type of transformer, using 1:1 ratio.

e = generator open circuit voltage = 120

e_g = generator impedance voltage = 17.5

Since we are considering a circuit in resonance, the energy volts delivered by the generator will be in phase with the generator current and not the voltage at generator terminals.

Thus the transformer primary will have a terminal voltage of:

$E_1 = 200$, and current $I_1 = 30$, lagging by the angle α

e_1 = transformer primary impedance drop = 16

E_1' = transformer primary induced voltage = 185

ϕ = flux

E_2' = transformer secondary induced voltage = 185

$I_1' = I_1 = 30$

Secondary current I_2 = vector sum of I_1' and $I_m = 41.5$

e_2 = impedance drop in secondary = 23

E_2 = secondary terminal voltage = 160

ω = angle lag of I_2 behind terminal volts E_2

It is interesting to note that owing to the very large generator impedance, the magnetizing current is nearly in phase with the load current. By operating with magnetizing current in the secondary, the alternator winding is relieved of this extra current.

In tuning, all that it is necessary to do is to adjust the number of turns in the variable inductance until the current in the antenna circuit reads maximum, the generator speed being held constant by a speed regulator. Then the antenna capacity does two things, namely:

(1) Supplies the magnetizing current for transformer.

(2) Supplies the series capacity reactance necessary to obtain resonance.

Returning to the case of the 4:1 transformer, we have a secondary or antenna current of 10.4 amps. The antenna has 20 ohms resistance and 1200 ohms capacity reactance at 100,000 cycles.

Antenna kv-a. = $10.4^2 \times 1400 = 152$ kv-a.

Antenna voltage = $10.4 \times 1400 = 14,600$ volts

Antenna kw. = $10.4^2 \times 20 = 2.16$ kw.

$$\text{Antenna per cent power-factor} = \frac{2.16}{152} = 1.42$$

S. P. NIXDORFF

QUESTION AND ANSWER SECTION

The purpose of this department of the REVIEW is two-fold.

First, it enables all subscribers to avail themselves of the consulting service of a highly specialized corps of engineering experts, or of such other authority as the problem may require. This service provides for answers by mail with as little delay as possible of such questions as come within the scope of the REVIEW.

Second, it publishes for the benefit of all REVIEW readers questions and answers of general interest and of educational value. When the original question deals with only one phase of an interesting subject, the editor may feel warranted in discussing allied questions so as to provide a more complete treatment of the whole subject.

To avoid the possibility of an incorrect or incomplete answer, the querist should be particularly careful to include sufficient data to permit of an intelligent understanding of the situation. Address letters of inquiry to the Editor, Question and Answer Section, General Electric Review, Schenectady, N. Y.

TRANSFORMERS: TWO-PHASE TO THREE-PHASE CONNECTION

- (133) What is the effect on the current, voltage etc., when using two separate transformers in place of the "main transformer" in a T two-phase to three-phase transformer connection?

The conditions as described in the question are illustrated diagrammatically in Fig. 1 wherein the letters and the "primed" letters serve to distinguish the primary and the secondary windings of the separate transformers. This substitution of two separate transformers (aa' and bb') of the ordinary type for the "main transformer" of a T-connection can never be depended upon to give satisfactory service, for it is necessary that the "two halves" of the "main transformer" (which are replaced by the two separate transformers in this case) be magnetically interlinked. Although of small commercial consequence, attention might be called to the fact that the proposed scheme would give the proper voltages at zero load. For unbalanced loads the phase relations would be distorted badly.

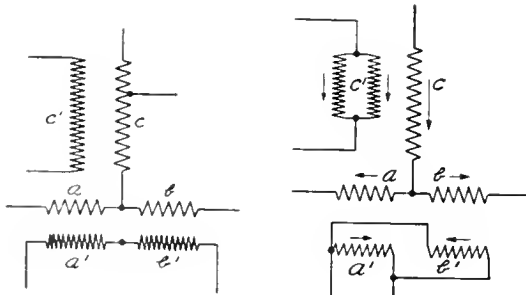


Fig. 1

Fig. 2

The feature of magnetically interlinked transformers, which cannot be obtained for the T-connection with ordinary transformers, can be secured, nevertheless, by the use of transformers that have multiple windings similar to those designed for three-wire distribution. If two such transformers are employed the windings of the one can be interconnected with those of the other so that they will be able to react magnetically on each other when the bank is under load. The winding scheme which should be followed when these three-wire transformers are utilized is shown in Fig. 2.

Especial attention is called to the fact that the windings on the two-phase side of the main

transformer (aa' - bb') in Fig. 2 are parallel connected. The windings of the two-phase side of the teaser transformer (cc') are connected in parallel also. The arrows indicate the direction of current flow when a load is drawn from the teaser winding only, which is the most severe requirement that the bank will be called upon to fulfill. Under these conditions a circulating current flows through the windings a' and b' and prevents unbalancing of the phase relations and the delivered voltage.

R.K.W. and L.F.B.

ARC WELDING: USE OF ALTERNATING CURRENT

- (134) Attempts have been made by a steel foundry to fill holes in steel castings by using alternating current for arc-welding. The energy was supplied directly from a 50-cycle, 440/60-volt, 25-kw., single-phase transformer; and the welding current has ranged from 100 to 400 amperes. Up to the present time the welds produced have been unsatisfactory. Is this due to the fact that alternating current was used instead of direct current; if not, wherein is the installed apparatus unsatisfactory?

We would attribute the lack of success to the use of alternating current for arc-welding. (It is well known that various methods of resistance welding, however, have successfully employed alternating current.) A number of attempts have been made to utilize alternating current for arc welding but, so far as we know, all of them were practically failures.

It is a recognized fact that, if the filling of holes in steel castings is to be accomplished satisfactorily by the arc-welding process, the current which is employed must be direct current.

Practically all commercial equipments for this purpose have a welding potential rating of about 60 volts. The range in current named in the question, viz., 100 to 400 amperes, is sufficient to cover the requirements of the arc-welding work in a steel foundry, with the exception of cutting of gates, risers, etc. For this purpose 600 to 1000 amperes enables the work to be completed in a much shorter time.

The best equipment for an installation of this type would be a flat-compound-wound, direct-current generator driven by a constant-speed induction motor, the motor to have an automatic control device for regulating the amount of current drawn from the line and for preventing an injury to the generator when starting the arc.

J.A.S.

INDUCTION MOTOR: HEATING ON UNBALANCED THREE-PHASE VOLTAGE

(135) What will be the probable increase in the temperature of the "hottest part" of an average three-phase induction motor when supplied with energy from a three-phase line that is fed by two identical transformers "T" connected? (The voltage delivered by the teaser transformer will be the same as that by the main transformer, instead of the correct value 86.7 per cent of it.) The three-phase voltage will of course be unbalanced thereby but it is otherwise to be substantially the normal three-phase voltage value for the motor, and the frequency is to be of the correct value.

The effects on the operation of an induction motor, which are caused by unusual conditions, are so dependent upon the design characteristics of each particular type of machine that it is impossible to make a general statement that can be expected to cover motors of different rating or manufacture.

It will be of interest, nevertheless, to note the test results which were obtained in the following particular instance. A normal type of motor, under test conditions very similar to those named in the question, displayed local heating of about 85 to 90 per cent higher than when the motor was run under balanced voltage conditions. In this particular test the voltages were unbalanced 15 per cent and, as mentioned, the local heating was nearly double.

A.E.A.

ALTERNATOR: BEARING CURRENT

(136) How can the presence of a current flow through the bearings of an alternator be detected, and how can the amount of such a current be measured?

Detection

Probably the most convenient way of ascertaining the presence of a bearing current, if there is one, is to use the following method.

Run the alternator at normal speed and excite it to normal voltage. By means of low-resistance leads, securely connect one terminal of an alternating-current ammeter (which is of about 60 amperes capacity) to a clamping-down bolt of a bearing pedestal and the other terminal to the shaft by a rubbing contact which should be located near the bearing pedestal just named. A brush made of copper gauze or ribbon can be arranged to make a very good rubbing contact on the side of the shaft or on its end. (A carbon brush must not be used because it has a relatively high resistance when compared to that of the remainder of the circuit.) Under these conditions the ammeter may indicate a current or it may not.

If a legible reading is given, there is a current flow through the oil film of the bearing as well as through the meter. (This indirect proof of the presence of a bearing current will apply only when the bearing pedestal is not insulated from the frame of the machine, which is the condition assumed in this explanation.)

If no deflection does take place it may be due to one of two causes:

(a) The magnetic design of the machine is completely symmetrical, thereby no e.m.f. is generated in the shaft that would cause a bearing current to flow.

(b) The current through the ammeter is too small in amount to give an indication on the size of meter which is used.

To determine which of these conditions exist, replace the ammeter with one of 10 or 5 amp. capacity. If a reading cannot be obtained in this manner, the conditions are as described in (a), i.e., because of a completely symmetrical magnetic balance there is no difference of potential generated in the shaft and consequently bearing current is absent. This information would conclude the test. If a definite indication of a current flow can be obtained by the substitution of a smaller capacity ammeter, however, this shows that the conditions named in (b) prevailed when the higher reading ammeter was used. The conclusion to be drawn from such a finding is that a current does flow through the bearings.

Should it be found that a current is present, the mere fact that there is one should not be viewed with uncasiness. The harmful action that can be caused by such a current is limited to the pitting of the shaft and bearing journals or the carbonization of the lubricating oil. Other injurious causes, such as the use of impure oil or insufficient lubrication, are frequently more accountable for an imperfect condition of the shaft and bearings than is a bearing current. Moreover, an advanced stage of bearing surface abrasion due to faulty oil or lubrication may sometimes be erroneously regarded as a condition which was originated by a bearing current pitting the shaft. Therefore, if an investigation of the shaft and bearing surfaces shows that remedial measures are necessary, but the condition of the surfaces cannot be *positively* identified as having originated in pitting, the quality of the oil used and the effectiveness of its application should be examined, remedied if faulty, and exonerated by further trial before the bearing current is held accountable for the damage done. Should it be proved, by eliminating these more prevalent lubrication troubles, that the stray current is responsible for the bearing injury in that particular machine, the harmful effect can be removed by preventing the flow of this current. This can be accomplished by simply removing metal shims to the amount of at least $\frac{1}{32}$ in. in thickness from under one of the bearing pedestals, inserting that number of fiber shims which will make up the same thickness in their place, insulating the bolts and dowel-pins with fiber tubes and washers, and breaking in an equally positive manner all other metallic connections from that bearing to the frame. (Hand-rails, etc., should not be overlooked.)

Measurement

Attempts have been made to determine what is the actual *amount* of the bearing current flowing by means of the connections and ammeter readings described under the previous heading *Detection*. Because it is not frequently appreciated that the application of such a method is useful only insofar as it determines the presence or the absence of a bearing current, it would be well to point out why such meter readings are absolutely valueless as indications of the *amount* of bearing current flowing.

The bearing current circuit, when free from additionally inserted resistance or reactance such as fiber shims, meters, etc., is one of low resistance. In examining only a part of this circuit, that through one bearing, the resistance dealt with is of course much lower, and unfortunately is far from being of constant value due to the changeableness of the oil film.

The actual readings given on the ammeter are, therefore, not to be relied upon to determine the amount of bearing current for two reasons: (1) The amount of current shunted around the bearing by the ammeter and its leads depends upon the size of meter which is used, since in such a circuit the impedance of an ammeter is quite comparable to the resistance of the bearing side of the divided circuit; and, (2), the fluctuating value of the resistance of the oil film causes a varying division of current through the bearing and the ammeter. Even if it were possible to surmount these troublesome factors, it would be practically impossible to obtain the value of the resistance of that

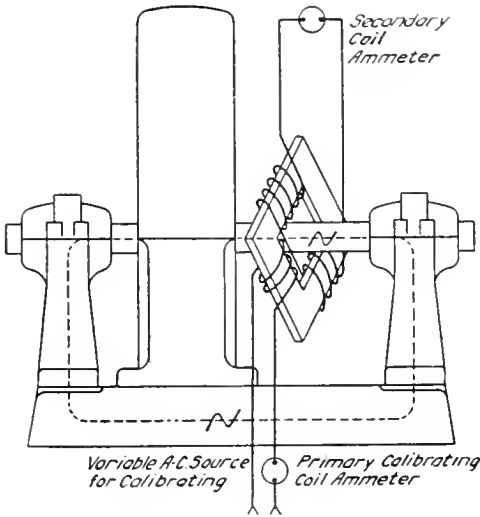


Fig. 1

portion of the bearing circuit which the ammeter and its leads shunt while the alternator is running. Nevertheless it would be necessary to know the value of this resistance to establish the ratio of division of the current between the bearing and the ammeter. There is a method of determining the natural amount of bearing current, however, which can be used; and which, by its application, does not alter in any way the customary path of flow of the bearing current.

This method employs the same principle as the ordinary current transformer, and has been proved in practice to give accurate and reliable results. A description of the necessary apparatus and manner of making the test follows.

Construct a transformer core (a rectangular shape is convenient) of laminated iron to encircle the shaft between the revolving field and either bearing. See Fig. 1. Around this core wind a number of turns of moderately small insulated wire (No. 14 would answer well); these will comprise the secondary of the transformer. The terminals of this winding are then to be connected to an alternating-current ammeter on which readings are to be taken to obtain the shaft (or bearing) current. The primary of the transformer will be the shaft of the alternator.

It now only remains to calibrate the transformer and meter. This is easily accomplished by winding another coil of a few turns (the number should be noted on the transformer core and by it and an

external source of e.m.f. (between which two an ammeter is connected) excite the core. The frequency of this external source of e.m.f. must be the same as that of the alternator being tested. Fig. 1 shows diagrammatically an alternator and the connections of the bearing current measuring devices as described. Impress various voltages on the transformer calibrating primary and take a few simultaneous readings on the primary and secondary ammeters.

Multiply each primary ampere reading by the number of turns in the primary calibrating coil, thus giving the exciting ampere-turns. Plot a curve between these ampere-turns and the corresponding ampere readings which were simultaneously taken on the secondary ammeter. Such a curve is shown in Fig. 2. The function of the calibrating source, ammeter, and exciting coil is now complete and these can be removed.

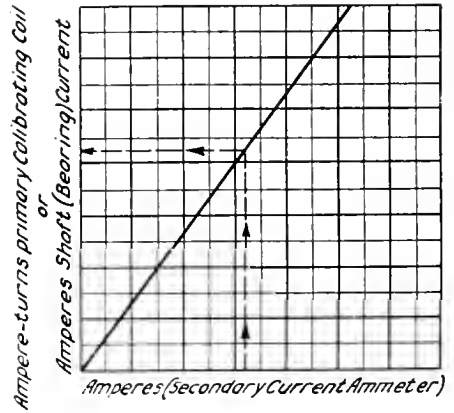


Fig. 2

The circuit composed of the shaft, bearings, and base of the alternator is to be the real primary of the transformer and passes through the transformer core only once. Therefore the *amperes* in this primary circuit and the *ampere-turns* excitation which they impress on the transformer core are equal in number. For this reason the "primary ampere-turn" scale of the curve, Fig. 2, may be renamed "primary amperes" (shaft or bearing amperes).

If the curve is found to be practically a straight line from the origin, the relation expressed graphically by the curve sheet may be replaced by the average multiplying factor which links the values of the primary and secondary amperes for the same excitation. This factor is determined from the curve and will of course be the ratio of transformation of the transformer.

The device is now ready for actual bearing current measurement. (The same ammeter and leads must be used in measuring the transformer secondary current as were present at the time of calibration). The true value of the current is arrived at by running the alternator at normal speed, exciting it to normal voltage, and then taking the reading on the secondary ammeter which, by reference to the curve or by multiplying it by the transformer ratio, will be translated into the actual value of the bearing current.

Ref. "Bearing Currents," by E. G. Merrick, GENERAL ELECTRIC REVIEW, Oct., 1914, p. 936.

GENERAL ELECTRIC REVIEW

A MONTHLY MAGAZINE FOR ENGINEERS

Manager, M. P. RICE

Editor, JOHN R. HEWETT

Associate Editor, B. M. EOFF
Assistant Editor, E. C. SANDERS

Subscription Rates: United States and Mexico, \$2.00 per year; Canada, \$2.25 per year; Foreign, \$2.50 per year; payable in advance. Remit by post-office or express money orders, bank checks or drafts, made payable to the *General Electric Review*, Schenectady, N. Y.

Entered as second-class matter, March 26, 1912, at the post-office at Schenectady, N. Y., under the Act of March, 1879.

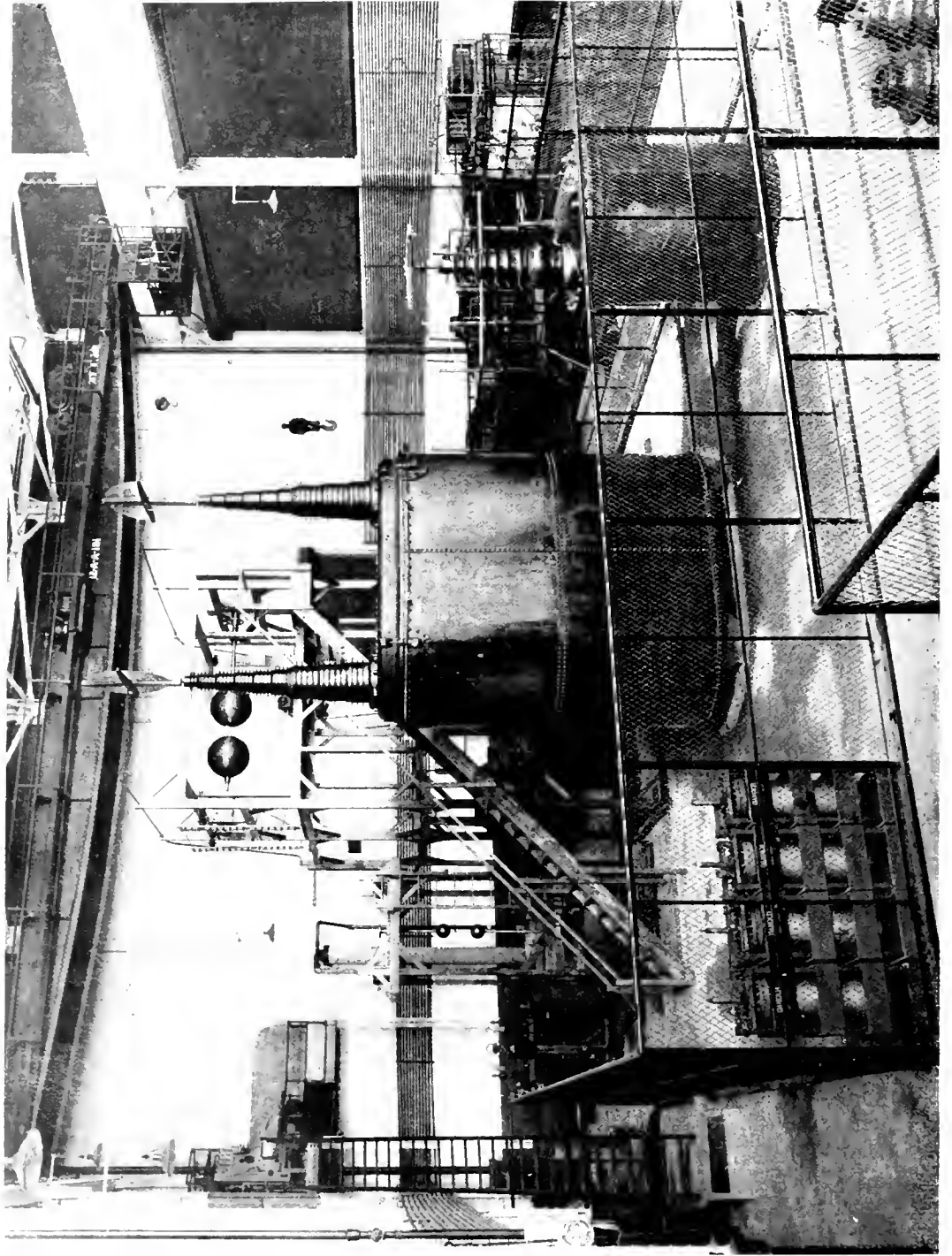
VOL. XVIII., No. 5

Copyright, 1915
by General Electric Company

MAY, 1915

CONTENTS

	PAGE
Frontispiece	314
Editorial: The Paths of Progress	315
Wireless Transmission of Energy	316
BY ELIHU THOMSON	
The Pure Electron Discharge and Its Applications in Radio Telegraphy and Telephony	327
BY DR. IRVING LANGMUIR	
The Hydro-Electric Development of the Cohoes Company at Cohoes, N. Y.	340
BY B. R. CONNELL	
X-Rays, Part II	353
BY DR. WHEELER P. DAVEY	
Water Powers of New England	358
BY HENRY I. HARRIMAN	
Some Aspects of Slot Insulation Design	366
BY H. M. HOBART	
Incandescent Lamps for Projectors	371
BY L. C. PORTER	
High Candle-Power Mazda Lamps for Steel Mill Lighting	377
BY G. H. STICKNEY	
The Genemotor	384
BY M. J. FITCH	
Electrophysics: Electromagnetic Radiation from the Viewpoint of the Electron Theory	387
BY J. P. MINTON	
High Potential Transformer Testing Equipment at Pittsfield	398
BY WM. P. WOODWARD	
Practical Experience in the Operation of Electrical Machinery, Part VIII	401
Capacity Current; Misapplication of Devices; Misleading Deflections; Reactor Starting-Box Trouble; Improvised Commutating Winding; Instrument Connections Wrong	
BY E. C. PARHAM	
Notes on the Activities of the A.I.E.E.	405
From the Consulting Engineering Department of the General Electric Company	408
Question and Answer Section	409



High Voltage Experimental Testing Room

GENERAL ELECTRIC

REVIEW

THE PATHS OF PROGRESS

In this issue we publish a very interesting article by Henry J. Harriman in which he shows the vital part played by water power in the development of the industries of New England. He shows that practically every large town and city in New England can trace its origin to the presence of water power in its immediate vicinity. It is interesting to note in this connection that these same general conditions were, until recent years, true throughout the whole world, namely, that the location of an industry was dictated by the presence of a source of power whether it were coal or water power, the transportation of stored energy such as coal being too expensive to afford profitable operation. In recent years, with our improved transportation facilities, coal has been transported in enormous quantities for manufacturing purposes, but the expense has been great. Our modern flexibility in the choice of a locality for manufacturing centers owes its origin to the introduction of the steam-electric and the hydro-electric power stations and the modern high tension transmission line.

This increased flexibility in our choice of locality for manufacturing centers has greatly stimulated industrial growth of almost every character and is one of the many blessings that has been given us by modern engineering developments. All industry depends primarily upon three factors: energy, material and labor. Formerly we had to bring our material and labor to our source of energy, now we can bring our energy to our source of material or to where our labor markets are satisfactory. In fact, all three of our prime factors are now transportable, giving us a choice which permits the selection of a manufactur-

ing site where operations can be carried out at a maximum efficiency.

It is interesting to note that the same old sources of power can be used with our modern developments, only they are used more efficiently.

Mr. Harriman gives some very impressive figures regarding the available water power in New England and the "theoretically possible" saving in coal to be secured by its development. These figures are as satisfactory as they are large, as the national wealth of a manufacturing country is so inseparably tied up with its source of power that future prosperity will depend in a very great measure upon whether we use good common sense in developing so important a natural resource.

In the future we shall depend less and less upon our coal supply and our rivers and waterways will become of increasing importance. The network of high tension transmission lines that is gradually covering certain sections of the country will spread till it becomes recognized as one of the greatest and most important factors in our industrial life. Our supply of electric energy in any particular area, because of its inherent characteristics that permit it to be generated, converted and transmitted more economically than any other form of energy, will govern whether any particular area is to be industrially prosperous or not. As time goes on we shall devise means and ways of using more energy and less labor in our manufacturing processes, as electric energy is practically the only commodity that has been steadily getting cheaper, while labor has been gradually but insistently getting dearer. This means that energy will play an even more important part in our future industrial progress than it has in the past.

WIRELESS TRANSMISSION OF ENERGY*

BY ELIHU THOMSON

GENERAL ELECTRIC COMPANY, LYNN

Professor Thomson shows in a most interesting way why it is that the wireless waves follow the curvature of the earth. This whole article is so full of scientific interest that no resumé could attempt to indicate its contents. His conception of the transformer as an iron atmosphere to accomplish the transfer of energy from one electric circuit to another is of special interest; he points out that the corona loss governs the limits of the Thomson potential that can be used on the sending antennae of a wireless system in exactly the same way that it governs the limits of potential on our commercial high tension lines.—EDITOR.

It will be my purpose in the present discourse to outline the general nature of wireless transmission and to indicate its relationship to transmission by wire. It will also be my object to show why the wireless energy sent out follows the curvature of the

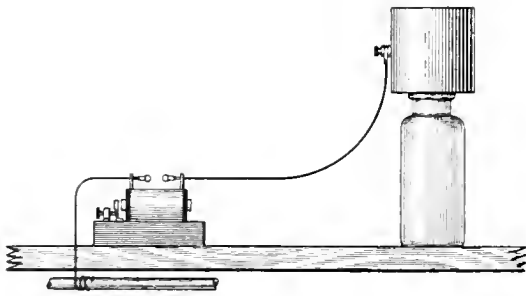


Fig. 1

earth and to explain other features which to many have been more or less puzzling. In short, I desire to present in simple terms a view of the nature of such wireless work, so that anyone reasonably informed about electrical actions can obtain, as it were, a mental picture of the process. I may here state the fact that perhaps one of the earliest experiments bearing on wireless transmission was made in company with Prof. E. J. Houston, while we were both teachers in the Central High School in Philadelphia. This old experiment to which I refer was made about the latter part of 1875, and briefly described in the *Franklin Institute Journal* early in 1876. It consisted in using an induction coil which would give a spark length of several inches, then known as a Ruhmkorff coil, the coil resting on the lecture table, one terminal of the fine wire or secondary of which was connected to a water-pipe ground, while the other was connected by a wire four or five feet long to a large tin vessel

supported on a tall glass jar, insulating the tin vessel from the lecture table. The coil had an automatic interrupter for the primary circuit, and when in operation the terminals of the secondary were approached so that a torrent of white sparks bridged the interval between them, the gap being about two inches or so in length. Fig. 1 shows this arrangement. When the coil was worked in this way, it was found that a finely sharpened lead pencil approached to incipient contact with any metallic object—such as door knobs within the room and outside thereof—would cause a tiny spark to appear at the incipient contact between the pencil point and the metal. This, of course, was not a very delicate detector, but was improved, as in Fig. 2, by putting two sharpened points in a dark box, a device due to Edison. One or both points were adjusted so as to make incipient contact, and the tiny spark observed between the points was an indication of a shock, commotion or wave, electrical in its character, in the ether surrounding the tin vessel mounted on the glass jar. The tests for detecting the impulses were carried on not only in rooms on the same floor, but on the floor above and on the floor above that, and finally at the top of the building, some 90 feet away, in the astronomical observatory. Metallic pieces, even unconnected to the ground, would yield tiny sparks, not only in the basement of the building, but in the



Fig. 2

highest part, with several floors and walls intervening. I mention this old experiment particularly because it has in it the elements, of course in a very crude form, of wireless transmission, the wire and tin vessel attached to one terminal of the coil being a crude

*Lecture by Professor Thomson, reprinted by the courtesy of the National Electric Light Association, New York.

antenna with its spark-gap connection to ground, as afterwards used in wireless work by Marconi, and it also shows a rudimentary receiver or detector, a metallic body arranged in connection with a tiny spark gap, so that electrical oscillations in such body would declare themselves by a faint spark at the gap. It was understood by us at the time that after each discharge of the coil there was, as it were, a shock, or wave in the ether consisting of a quick reversed electrical condition, and it was even imagined that there might be in this process the germ of a system of signaling through space. This old work was almost forgotten when it was recalled by the later work of Hertz, about 1887, who demonstrated by suitable electrical apparatus that waves of the general nature of light or heat could be generated, which waves are transmitted with the velocity of light, 186,000 miles per second, and that by suitable resonators or detectors these waves could be made to declare themselves by tiny sparks. The Hertzian oscillator was, as it were, an electrical tuning fork, having an actual rate of vibration peculiar to itself and dependent on its form and dimensions. It was fed with energy from an induction coil and across its spark gap an oscillating discharge took place, which, at each impulse, died out like the discharge of a condenser, but during this discharge it electrically stressed the ether in one and the other sense, so that an electrical wave was radiated in certain directions from the oscillator. It was found that these waves could be refracted, reflected and polarized, and, in general, dealt with as extremely coarse light or heat waves. We shall refer to these, however, farther on. The general result, however, of the Hertzian experiments was to connect electrical waves in the ether surrounding the apparatus with the light and heat waves and prove the identity of the two kinds of radiation, the differences being only those of wave length or pitch.

Since the Hertzian waves were sent out from the Hertzian oscillator in substantially straight lines, and since in the early days of wireless telegraphy it was common to regard wireless waves as of the same nature or as almost identical with Hertzian waves, the fact that the wireless waves were found to follow the curvature of the earth became a difficulty to be explained. Speaking for myself, I have never found the difficulty to exist. There is really no reason why the waves should not follow the curvature of the earth, as it will be one of my purposes to show.

We will, however, approach the conditions of wireless somewhat gradually.

We will first consider an ordinary wire transmission of the simplest type. Let us assume a line of wire, as in Fig. 3, insulated and connected to one terminal of the battery

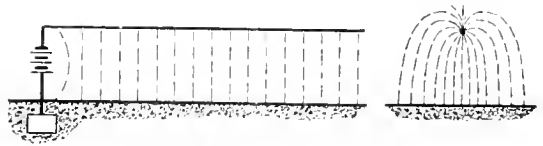


Fig. 3

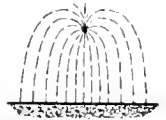


Fig. 4

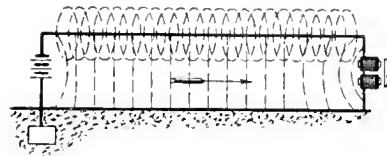


Fig. 5



Fig. 6

while the other terminal is earthed or grounded. A simple telegraph system on open circuit would represent this arrangement. The only effect is that the battery supplies a small charge to the line producing a potential difference between the insulated line and the earth, assuming, of course, that there is no leakage of any kind to disturb the conditions. As soon as the charge is established in the line at the full potential of the battery, which, in ordinary cases, would take place within a very small fraction of a second, a steady or static condition is reached, which might be indicated by electrostatic stress lines drawn from the wire to the ground, as illustrated in Fig. 3 by the fine dotted lines connecting the horizontal line to the ground surface below. If the wire be viewed on end (Fig. 4), we must represent these stress lines as extending out radially from the wire and bending over to meet a considerable portion of the ground surface below. As this arrangement is constituted, there is no energy transfer and the condition is static only. If now the far end of the line is earthed, as through an instrument or device which uses energy, as in Fig. 5, at the moment of such connection there would be a lowering of the intensity of the stress toward the receiving instrument and the line would be discharged were it not for the maintaining action of the battery, which still keeps up the difference of potential between line and ground. If the line is without resistance, this

potential will have the same value all along the line, especially if the line is of uniform section and of uniform distance from the ground. The moment, however, the instrument at I takes energy from the line a current is found in the wire and a return in earth, and

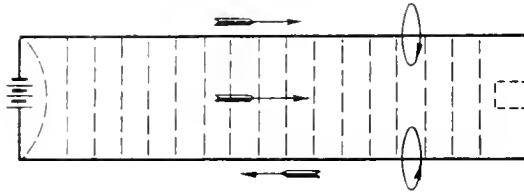


Fig. 7

there is, so to speak, a flow of energy in the space between the wire and earth and in the ether surrounding the wire, in the direction of the arrow—that is, from the generating end to the receiving end. Surrounding the wire at this time there will be a magnetic field, which may be represented by whorls or lines of magnetism, so called, wrapped around the wire like so many hoops of all sizes (Fig. 6), expanding in size away from the wire in all directions; and a similar magnetic effect, of course, is also produced by the return current in the earth. But on account of the conditions of conduction in earth being very devious and irregular, it would be difficult to map the magnetism generated. The system of magnetic whorls so developed on the flow of the current in the system reaches, for any definite current, a definite density after a short interval. In other words, the density of the magnetic field between the wire and the earth increases only up to a certain point. If the current, however, be doubled in any way, that field is doubled in density or there are twice as many lines packed in the space around the wire. If now we took instead of an earth-connected circuit one in which there are two wires extending from the generating battery or generator, the conditions will be the same except that the stress lines will now radiate from each wire and connect the wires by lines directly between them and by other curved lines outside. Such lines, or otherwise conceived "tubes of force," represent the static field or the density and directions of electrostatic stresses in the electrostatic field where one wire will be positive while the other is negative. If, as before, the ends of the wire are free or open-circuited, no energy is transmitted, and the mere static stress exists.

If, however, the wires are connected through an instrument receiving energy or utilizing the energy, then the magnetic system is developed, surrounding each wire and passing between the wires, and on the establishment of any given current these lines accumulate at a rapid rate until, in a small fraction of a second usually, a limit is reached. The magnetic field may then be said to be fully developed. Outside of the pair of wires the magnetic disturbance extends to very great distances, but is necessarily weak far away. The magnetic whorls in this case do not center themselves in circular paths around the wires and at equal distances therefrom, but between the wires they are more condensed or pushed toward the wires themselves—crowded, so to speak—while outside of the wires they expand (Figs. 8 and 9). It must be remembered that these lines of force are merely symbols for what may be likened to a magnetic atmosphere. They indicate the density and direction of certain actions in the ether, called magnetic. It will be important to note, both in wire and wireless transmission, that the energy is transferred in the surrounding medium. The wire in ordinary wire transmission is, in fact, a sort of guiding center or core around which this ether disturbance carrying the energy exists. The wire may be bent or coiled, expanded or contracted without altering the essential



Fig. 8

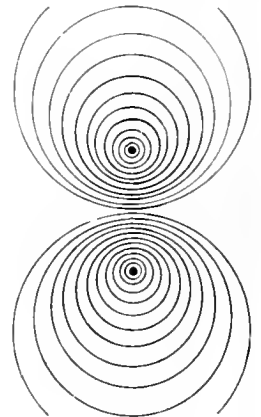


Fig. 9

nature of the process. So far, then, ordinary wire transmission it really a case of wireless transmission, with the wire for a guiding core for the energy (Fig. 10).

It would take us too far to attempt to explain or theorize on the modern view of the

passage of electrons in the wire forming the current, and the field they carry with and about them in giving rise to the stresses in the ether surrounding them. Suffice it to say that a moving electron must not only be accompanied or surrounded by the static stress field which it produces in the ether but also by a magnetic effect representing the energy of motion possessed by it. When a current which has been started in a circuit reaches a definite value it may be said to have reached a steady state. It would then be a continuous current of constant value. Energy can be steadily extracted from such a system only by introducing some apparatus connected with the wire which is the guiding core for this energy.

Let us now consider the case of current of a different character, a fluctuating—or better, an alternating current. Let us substitute for the battery an alternating current generator, and assume a single wire with an earth or wire return, as in Figs. 3 and 5. Here the wire merely becomes positive and negative alternately, for the circuit is incomplete or unconnected as a circuit, and the stress lines from wire to earth or to other

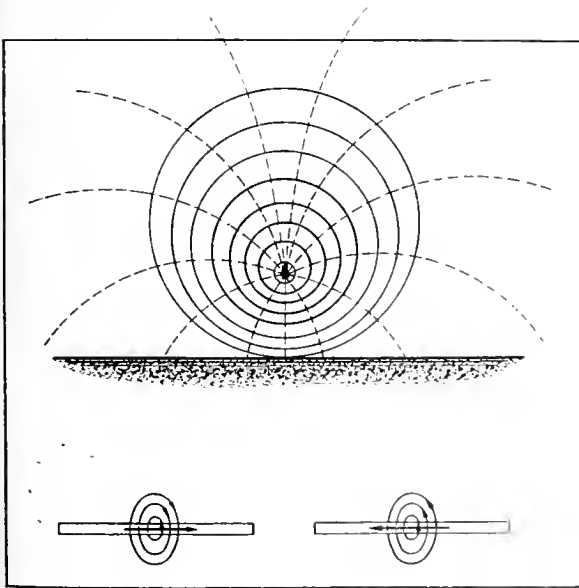


Fig. 10

wires reverse periodically their direction plus to minus and minus to plus. This is true, of course, whether the earth be replaced by a second wire or whether three or more wires be involved, as in a three-phase alternating current circuit. By connecting any two of the

wires through an energy-receiving apparatus *R* (Fig. 11), the same action that takes place with the continuous current may be reproduced except that the energy now comes in waves and is not a continuous flow. In ordinary cases there are 60 complete waves or

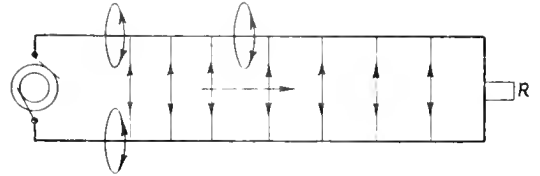


Fig. 11

complete changes from plus to minus and back to plus in each second, and the system is then called one of 60-cycle frequency. A further important difference is to be noted between the alternating-current condition and the continuous. The action in the ether around and between the wires is now in the form of waves, both magnetic and electrostatic. Between wires there is an increase of electrostatic stress to a maximum, a diminution to zero, a reversal, etc. The magnetic field also rises, falls, reverses, and so on synchronously. The condition is no longer static, the medium around the wires is in a dynamic state and it is now possible to abstract energy steadily from it without actually diverting current from the line. We can, in fact, by such a system produce in neighboring conductors similar disturbances or currents, and along with these disturbances we may deliver energy.

The alternating-current transformer is then merely a device for bringing two or more circuits together as near as possible and enhancing the magnetic values which would normally exist around such circuits by the addition of an iron atmosphere, the iron core, so that the greatest possible transfer of energy from one (the primary circuit) to the other (the secondary circuit) may be accomplished. But in the wire itself, which leads from an alternating-current source, since there is an action called a current which changes, pulsates, or alternates, we have also around the wire core waves in the ether which, in fact, spread to very great distances; some small portion of the energy of each impulse not returning to the system, but passing outward into space as radiated energy.

This radiation may be a very small amount per cycle, especially where the outgoing and return wires are near together and parallel.

and with low frequencies, such as 60 cycles, on account of the low number of waves per second and the low speed or rate of change in the fields surrounding the wire, the amount of energy carried off by free radiation into space is indeed negligible. But if we raise the

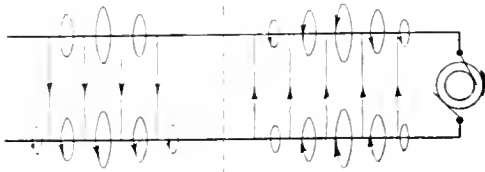


Fig. 12

frequency we raise the amount of energy which can be radiated proportionately to the number of waves per second, and we also make the rate of change higher and the wave slopes steeper, so that as the frequency rises the radiation factor becomes more and more important in dissipating the energy of the system. It will be noticed, however, that such energy is not directed energy. It is diffused through space around the electric system at work and passes off to illimitable distances. Since these impulses in the wire, the electrical waves sent along the wire (with the wire as a guiding core), can at the maximum move with the speed of light—186,000 miles per second—it follows that if the line is sufficiently long or the transmission sufficiently extended or the path of radiation sufficiently distant the wave stresses or fields or currents can exist at different parts of the system in phases either much displaced or entirely opposite. This may be rendered clear by stating that while one portion of a very long line might be positive to earth another portion half a wave length distant from the first along the same line would be negative to earth (Fig. 12). In other words, there may exist upon the system at the same instant a succession of waves in opposite phase. Just as in vibrating strings in musical instruments or vibrating columns of air in organ pipes there are stationary waves, nodes, and internodes, so in electrical systems in vibration there can be nodes and internodes if the conditions are selected for obtaining that effect. Here the dotted vertical line indicates the nodes of the waves. We may thus have so-called stationary electric waves (Fig. 12).

We find that on raising the frequency of an alternating-current system from, say, 60 cycles, the ordinary frequency, to 600 cycles,

an effect which at first was hardly detachable now becomes important. It is the so-called "skin effect" whereby the current in a wire circuit tends to concentrate itself on the outer skin of the conducting wire, neglecting the inner copper, so that the inner core of the wire might be left out. Consider the frequency still further raised, say, to 6000 cycles, this "skin effect" of the conductor still further increases until the copper in the interior of a circular wire of a considerable size is now quite useless, and to get the advantage of such copper we must, as it were, take it out or spread it in a number of parallel wires spaced apart, or make the metal of the conductor in the form of a long sheet or in the shape of a thin tube or a cage of wires (Fig. 13). This, in electrical terms, improves the conductivity and reduces the opposition due to self-induction; the inductance counter e.m.f. Let now the frequency be still further increased to tens of thousands or hundreds of thousands of cycles per second; then our conductor must necessarily become a still thinner or a still more extended sheet.

At the same time, if there are considerable differences of potential between the conductors thus arranged, the radiation factor may at last become very important, so that if the parts of the circuit are far apart, free radiation into space may dispose of a large fraction of the energy sent out. In the Hertzian oscillator, deducting that lost in the spark gap, practically the whole of the remaining energy supplied is radiated into space. The wave frequency may be very many millions per second, and the waves produced are in the nature of coarse light and heat waves. Fig. 14 exemplifies diagrammatically the fact that with very high frequency waves a conductor carrying such waves will have surrounding it, if the space is unrestricted, magnetic systems of lines

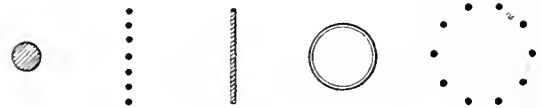


Fig. 13

reversed in direction with nodes between, the distance apart of these waves or nodes being determined by the frequency in relation to the velocity of light, each complete wave outside the wire occupying a length equal to the velocity of light, 186,000 miles per

second, divided by the wave length or frequency.

Figs. 15 and 16 represent forms of Hertzian oscillator, consisting of plates or spheres *a b* of metal, separated by a small spark gap and charged in any suitable way, plus and minus with respect to each other, and allowed to discharge across the gap. The charges are then interchanged between *a* and *b* at a very high rate, though the waves decay rapidly, and the system vibrates only for a short time or until the energy of the charge is dissipated in ether waves of exceeding high pitch into the surrounding medium. Were there no energy lost in the gap itself for forming the spark, and if the metal were a perfect conductor, the full amount of energy represented by any initial charge would be dissipated in the ether in these ether waves. Marconi, however, in his development of wireless telegraphy did not use the complete Hertzian oscillator. In setting up his transmitting antenna he took substantially half an oscillator, the other half being, so to speak, a phantom—the reflected image of the first half, as it were, in the surface of the earth, generally the sea surface. It would be represented by taking an extended copper sheet or surface coated with a fairly good conductor to represent the earth's surface and mounting above it, but insulated from it, a metal body, such as a vertical rod, which could be charged and which could discharge to the sheet through a small air gap. In this arrangement not only would waves be sent out into the surrounding ether space, but there would be current traversing the sheet as waves of current around the spot where the discharge of the insulated body took place. In fact, I think it would be possible to represent experimentally a modern wireless system with a diminutive antenna to represent the transmitting station, and extended copper sheet to represent the earth's surface, and with investigating or receiving antennæ

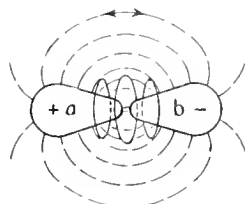


Fig. 15

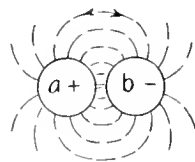


Fig. 16

energy sent out moves in all directions, guided by the conducting water surface or land surface, as the case may be. There will necessarily be a rapid attenuation of the energy as it leaves the sending or transmitting antenna and spreads out to fill a wider and wider space around it. The higher the sending antenna the greater the distance which can be reached before the attenuation is too great for imparting signals.

Let us consider for a moment by the aid of a figure the actions which must occur in wireless transmission on the sending out of energy from the transmitting antenna. Referring to Fig. 17, we will represent by *e-c* the surface of the earth as if it were flat, and for moderate distances this will be substantially the case. We will erect on that surface a tall mast *A* of conducting wire or wires which, at the top, shall have an extension to increase its capacity. This might be a large ball of sheet metal. Usually, for construction to be practicable, it is a set of wires—a sort of cage or a skeleton body. Now, by any system, inductively, conductively, or otherwise, or by what is known as close or loose inductive coupling or what not (Figs. 18, 19 and 20) we cause electric disturbances, such that at one instant the top of the antenna becomes positive and at the next instant negative, many thousands—even hundreds of thousands—of times per second. In other words, we impress a high-frequency wave upon this vertical mast. We will try to present an instantaneous picture or form an instantaneous image of what the condition is at the beginning of the process.

Let us suppose that the charge is positive at the top, and necessarily the surface below



Fig. 14

set up here and there or moved from point to point on the extended surface.

Here, although the disturbance and the energy conveyance is in the ether around the antenna (or the part representing the half of the Hertzian oscillator), the energy is guided

and surrounding the mast will be negative. Electrostatic lines will extend from the mast, and particularly from the expansion at the top down to the earth's surface in all directions around the antenna, as in the figure. The medium around the antenna will be stressed

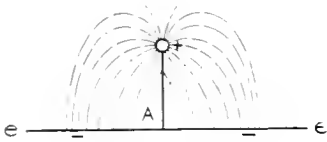


Fig. 17

electrostatically. This would be all, provided the charges were stationary, but the system we are considering is dynamic. The plus charge is replaced by a minus charge at the top, and a current of a high frequency runs up and down the antenna, but so also does this current extend into the sea radially from the foot of the antenna, replacing the negatively charged area by a positively charged zone, as it were, while the top of the antenna is now negative where it was formerly positive. (Fig. 21A, one side only shown, and Fig. 21B, in plan.)

As this action goes on, however, the zone of charged surface widens, and other waves are, so to speak, detached from the antenna, and electrostatic lines join now through the air or ether above the successive zones which surround the antenna as great circles or flat rings of the sea surface. A plus area is followed by a minus, a minus by a plus, etc., and to indicate the effect in the space above, we draw lines which follow these areas, extending up into the ether above the surface, but moving away from the antenna with the velocity of light. The moving charges in the sea surface represent radial currents which are in opposite phase at different portions of the sea surface, and spreading at 186,000 miles per second, and these currents necessarily generate magnetism or lines of magnetic force in the medium directly above them. These lines extend around in zones with diminishing intensity upward from the sea surface as the distance from the surface increases. Even within the water itself a similar action, but more restricted, takes place. The charges in the water are connected by electrostatic stress lines, and the compensating magnetic field follows the current, but this "under water" effect does not concern us, as what we work with is the energy

conveyed in the space above the sea, the other not being so easily recoverable.

The system as thus far constituted is merely an arrangement for delivering energy in high-frequency waves to the widespread medium around the antenna. There is no selective action whereby it is focused anywhere—it is as a "voice crying in the wilderness." It can be picked up or recognized in any direction by anyone who is within range. If, now, we are to receive signals such as are made by interrupting or disturbing at intervals this system of radiation of energy, as in ordinary telegraphy, we must set up somewhere a receiving apparatus which will enable us to pick up whatever small fraction of the energy reaches it and, if possible, a sufficient fraction of such energy for the recognition of the signals. If the signal can be recognized—no matter how small the fraction of the energy sent out is which we collect at the receiving station—the system succeeds. There is no question of efficient transmission, as there is in the ordinary power-transmission systems. The latter are for the transmission of energy with as little loss as possible, the former for the transmission of signals only.

In the antenna transmission just considered it is assumed that the surface of the earth is, generally speaking, a good electric conductor. The surface of the sea is sufficiently good. Dry land surface, however, is not a good conducting sheet, and even though moist it is generally so irregularly conducting that

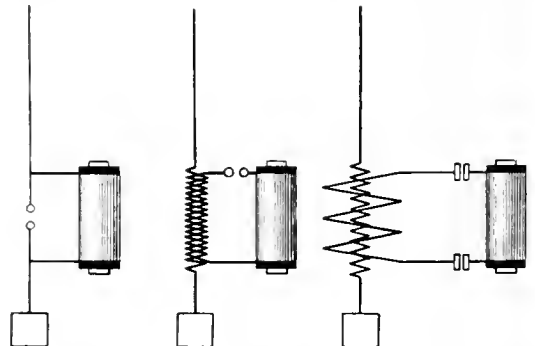


Fig. 18

Fig. 19

Fig. 20

obliteration of the waves and loss or absorption of the energy must necessarily occur. Obstacles, such as dry rock ranges, may absolutely prevent the waves from passing over them. It must be borne in mind that these waves have no inertia, as such, and

that the energy must be guided to its destination by a conducting sheet. This calls to mind the efforts that were made to connect Lynn and Schenectady by a wireless system, but without success. Occasionally signals were received, but in general they were too indistinct to be recognized. It is more than probable that the dry rock ranges of the Berkshires in western Massachusetts were sufficient of an obstacle to prevent the energy of the waves getting across them.

It is also to be questioned whether there may not be another action which interferes with and disturbs the integrity of the waves. It is conceivable that waves may follow a water surface, even around a cape, and that a portion of the energy may take a short cut across the land of the cape. If this be so, the longer course would be around the cape, the shorter course across the land. The wave lengths would remain the same, and an out-of-phase relation or interference phenomenon would take place to a greater or less extent. It is manifestly necessary that the energy, by whatever course it follows, shall reach the receiving apparatus in phase.

Let us now consider for a moment the conditions at great distances over the earth's surface. At moderate distances from the transmitting antenna the surface may be considered as flat. The conducting sheet guiding the energy is flat or plane, but at great distances the curvature of the earth's surface becomes an important factor. For a time there was a great deal of discussion as to the reason why the energy in the wireless transmission seemed actually to follow the curvature of the earth, instead of going straight away, as in the case of Hertzian or heat and light waves. If the waves had been generated by a large Hertzian oscillator, it would not be possible for them to so follow

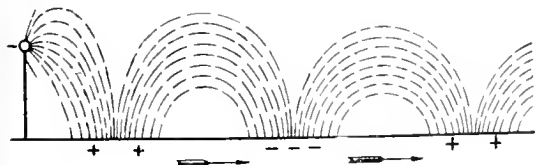


Fig. 21-A

the earth's curvature, but inasmuch as they are in wireless work produced and, as it were, positioned upon a conducting sheet (the sea surface), then it follows that the energy must be guided by that conducting sheet or surface, regardless of its extent or its curvature. I

have never been able to understand why so much discussion has been needed to clear up this point. Wireless waves have no inertia—they follow the course of the charges which produce the stress and of the magnetic field, due to these charges in motion. These

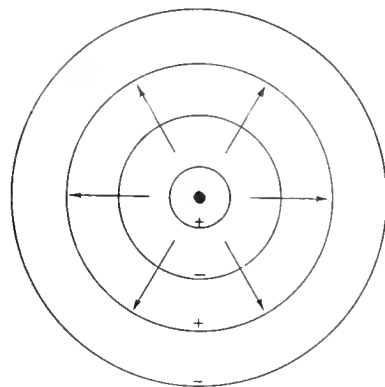


Fig. 21-B

charges in motion are the currents in the conducting sheet, which may or may not be curved. In the curved surface of the ocean the zones of charge continually expanding, plus and minus, respectively, are still connected by the electrostatic lines above them, and the moving charges still generate the same magnetic field as they traverse radially or outwardly in the curved instead of the plane sheet (Fig. 22), and this curved conductor still guides the energy, just as the wire does in ordinary transmission. It would seem, if this is the correct view, that at a distance comparable with that of a quadrant of the earth's circumference the form of the wave would be such as to cause the stress lines to lean backward with respect to the surface, tending to keep their original relation to the transmitting antenna as they were detached therefrom (Fig. 22, at *L*). This assumes that the velocity of transmission is the same as that of the speed of light, both for the currents in the sea and for the stress above it.

Marconi's success as a wireless pioneer depended largely upon the choice of a sufficiently sensitive receiver. Two elements are necessary in the receiver. First, a conducting structure which gathers up the energy from the medium, the ether, above the earth's surface. The other element is a sufficiently delicate means for detecting the slightest changes of electrical condition, not

only actuated by what little energy is received, but so modifying it that it can operate a signal which can be seen or heard. Usually the receiving antenna is a vertical conducting mast or cage, like the sending antenna. In fact, the functions of sending and receiving

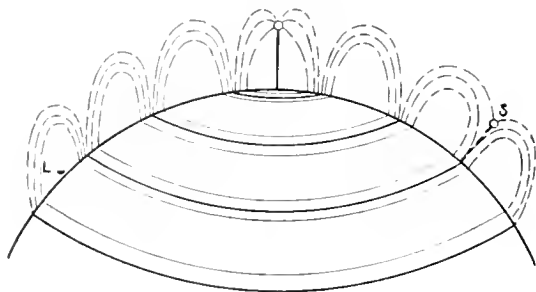


Fig. 22

are interchangeably used on the same structure; the same antenna may be at one time used for transmitting and at another time for receiving.

The receiving antenna (Fig. 22) serves to relieve the electrostatic stress in its vicinity, much as a lightning rod may act to relieve cloud to earth stresses. If its direction could be made to follow or be parallel to the actual course of the transmitted lines in the space near it, it would be most effective, and if, further, it could extend sidewise over a considerable extent of the wave front, it would gather up more energy. These conditions, however, can at best be only approximately met. If the receiving antenna were of such a character as to have no oscillation rate of its own (a damped circuit) it would receive energy in a small amount from the transmitting antenna independent of the frequency, but as this would in most cases be far from sufficient, it is desirable to accumulate energy in the receiver from a train of waves at a definite rate. To do this the principle of syntony or tuning is brought in. Everyone is familiar with the two tuning forks, where one is sounded and the other is placed at a distance away. If the two forks are not in harmony, no effect of the one fork on the other follows, but if they are accurately tuned in unison, the sound of one fork at a considerable distance from the other starts the second in vibration and produces an audible sound from it. The second fork is, in fact, a structure particularly well adapted to gather up the energy of the sound waves which reach it, receiving from each wave a small portion of energy and accumulating

such energy until the fork itself is brought into palpable vibration. By applying this principle in wireless telegraphy—that is, by causing the rate of vibration or frequency of the electrical waves to be the same in the transmission and in the receiving antennæ systems, constructing both to possess a normal rate as if they were to be electrical tuning forks of the same pitch—the amplitude of the received impulses is so greatly increased that signal strength is reached where otherwise failure would have resulted. The one thing which has characterized the more recent advances in wireless telegraphy has been the accuracy of tuning and the removal of disturbing influences which would interfere with the tuning.

Formerly the transmitting circuit was excited by means which tended to disturb the actual normal rate. If excited inductively, the inducing or primary circuit had a rate of its own, which was apt to interfere with that of the vibrating antenna system. However, what is known as loose coupling (Fig. 20), instead of close coupling (Fig. 19), to the primary or exciting circuit causes such confusion of rates to be nearly negligible if, particularly in the exciting circuit, the current is well damped, as it is termed, or confined to a single brief impulse as far as possible. In such case the antenna circuit, in transmitting, acts as if it were a bell struck with a sudden quick blow, and it vibrates at its own rate without disturbance or interference. At the receiving end (and there may be, of course, many receivers in the space around the transmitting antenna), the "listening-in" process consists in adjusting the rate of vibration of the receiving circuit by variable condensers or inductances, so that the maximum loudness of the received signals is attained. The two systems, transmitting and receiving, are then in tune.

Accuracy of tuning is evidently very important if stations are to be simultaneously transmitting when near together, as only in that way can one station send out energy without interfering with the other; the particular receiver for which the signals are intended being tuned for the particular antenna sending these signals. In spite of the accuracy of tuning, however, high-power stations may, in fact, cause high frequency waves of high potential in all surrounding wire or metal structures if near enough. Burn outs, or even fires, may occur from this cause. Hence it is desirable that high-power sending stations should be well

removed from centers of population where there are electric circuits and electrical apparatus likely to be interfered with or injured.

It may be here pointed out that the limit of potential which is available in wireless transmission is the same as that of long distance transmission by wire and for the same cause. Naturally, if the potential on the sending antenna can be raised, the amount of energy which can be put into the wave impulses will be increased, but there comes a time when an increase of potential on the wires of the antenna gives rise to a corona loss—much as the increase of potential in wire transmission produces a corona loss. The conductors of the system, in such a case, are surrounded by a blue discharge which is even visible at night and which frequently can be heard. When this condition is reached every further increase of potential simply increases the corona loss without adding correspondingly to the energy transmission. Just as in wire transmission it can be avoided by increasing the diameter of the conductors, so in wireless work it could be avoided by constructing the antenna system of hollow tubes with smooth exteriors, and the imagination may be permitted to depict a sending tower of polished metal surmounted by a sphere of similar material and worked at millions of volts. No limit can be set to the amount of energy which might thus be radiated, and no limit as yet can be set to the distance around the earth to which signals might be sent by such means.

One curious fact which has been developed in the work of wireless signaling is that daylight, especially sunlight, is very detrimental to transmission as compared with the night. That is to say, if the wireless waves are to traverse the sea surface in sunshine, the chance of receiving them in sufficient force to produce signals at great distances is far less than when they are sent at night. It is probable that this difference is not due to any single cause—it may be the effect of a combination of causes. It is a notable fact, too, that this difference between the effectiveness of daylight transmission and night transmission is accentuated at the higher frequencies.

Though the cause is still somewhat obscure, we may venture a suggestion or hypothesis which may have a bearing on the case. Referring to Fig. 23, we have tried to show the condition. The electrostatic field at the water surface at the same instant is as in Fig. 21 produced in zones around the antenna

A, spreading with approximately the speed of light. It is well known that under the action of the violet and ultra-violet rays of light any surface having a negative charge will leak its charge and ionize the air near it. This may occur in sunlight over such areas as

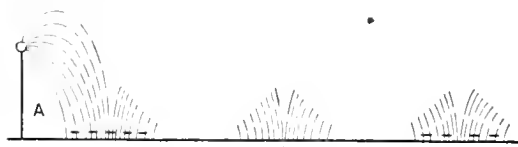


Fig. 23

are marked minus in the figures, and the several minus signs would mark or indicate air ionized and negatively electrified over the negatively charged zones. No action would be expected over the positive areas or zones. But the zones are not stationary; they are widening very rapidly, so that a positive zone or zones takes the place of negative so far as any location is concerned. This may be expressed by saying that the water surface which at one instant was negative and gave out negative ions under the influence of light would, in an exceedingly small fraction of a second and before those ions could get away from electric contact with such surface, become positive and the free ions would now return and neutralize a portion of the positive charge. Thus the negative zones or wave elements would lose part of their charge to ionize air, and the positive waves would be weakened by such negative leak neutralizing them in part. This action, however feeble at each wave, would be continuous over hundreds if not thousands of miles, and continuously damp out the widening system of waves. The effect would be less marked with low frequency waves, as there would be a proportionately less number of opportunities for this neutralization per second. Besides, with the lower frequency there is more time for the separation of the negative ions to such distance from the water surface that they do not combine with the positive charges; being, as it were, better insulated from them or diffused in the air stratum.

In Fig. 24 an attempt is made to picture this action of attenuation in the presence of light. The negative charges in the air layer, as in Fig. 23, have no positive charges under them, the encircling lines about the + and - signs indicating combination and neutralization.

When the wireless waves reach the receiving antenna, owing to attenuation from spreading or loss as above, they are very feeble. The daylight effect, as pointed out by Fessenden, is much less with the lower frequencies, such as 100,000 per second as

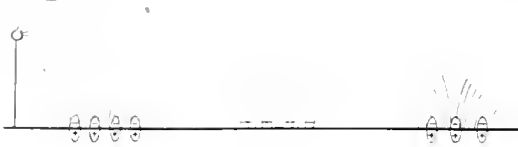


Fig. 24

compared with 600,000 or 800,000 waves. Consequently there is not the same great difference in strength of signals between night and day work with such lower frequencies. Moreover, frequencies of 100,000 or even 200,000 are capable of being generated directly by high-speed high-frequency dynamos with the added advantage that the waves sent out are maintained at their full amplitude and are not, as with waves produced by spark discharges, subject to damping or decay from maximum to zero after a few oscillations.

Whatever the nature of the waves sent out, there is in all cases the need of an exceedingly sensitive apparatus for converting the slight electric effects upon the receiving antenna into signals. The original apparatus of Marconi included the Branly coherer, used by Lodge in Hertzian wave transmission as a detector. It is indicated in Fig. 26 at *K*, with its battery and sounder magnet *M*. The receiving antenna discharge in passing to earth broke down the insulation of the filings of the coherer, so that the local battery current could pass in the circuit, including a magnet *M* and so record the signal. The liquid barretter of Fessenden, the various forms of rectifying crystal detectors and magnetic detectors, have been extensively used. Our time does not permit a detailed description. Fig. 25 indicates at *C* a crystal detector rectifying the impulses from antenna *A* so as to work a high-resistance telephone receiver *T*, to which the operator listens. Fig. 27 shows the same apparatus, but connected inductively to the antenna circuit by a transformer.

Fessenden found that if the succession of heaving wave trains reaching the telephone was such as to produce a low note, the signals were easily drowned by extraneous noises or induced effects. He found that the human ear reached a maximum of sen-

sitiveness at about 900 waves of sound per second, so that the signals were heard distinctly when otherwise they would have been missed. This is the meaning of the substitution of dynamos of about 500 cycles for exciting the wireless antenna in place of the ordinary machines of lower frequency.

The problem of wireless telephony has attracted attention for a number of years past. I well remember witnessing some of the earlier work of Fessenden in this fascinating field, in which he was pioneer. The wireless telephone speech was free from all disturbing noises and interferences so common on ordinary telephone lines. Briefly, such telephony depends on the ability to control the voice transmitting antenna and to do this with a fairly large output of energy.

By employing a method I described about 1892, it is possible to generate a continuous wave train by shunting a direct current arc with a capacity (condenser) in series with an inductance, the frequency rate depending on the electrical constants of these parts of the apparatus. This system, which was the subject of the United States patent taken out by me in the early nineties, has been variously called the Duddell singing arc, or later the Poulsen arc. Poulsen employed it with modifications in his system of wireless telephony. Long before this work of Poulsen, Fessenden had used a high-frequency dynamo for securing the continuous train needed. A suitable microphone transmitter was made to so alter the relations of the waves in transmitting and receiving antenna, that

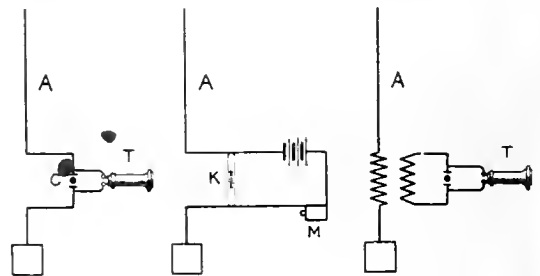


Fig. 25

Fig. 26

Fig. 27

voice waves could be received in an ordinary telephone connected with the receiving antenna system.

Much progress has been made in this department of wireless work, and such telephony between Europe and America may yet become practicable. Methods are being worked out whereby it may be possible to

mold outputs of many kilowatts of energy so as to have them vary with the voice waves, and when this is done many problems, the solution of which now seems remote, may become solved and the results prove of great practical value. It was not, however, my intention to devote time to these later researches, but to endeavor to present to the

mind's eye a view of the nature of wireless transmission which should show the similarities to ordinary transmission by wire and also the difference. Furthermore, I hope I have shown it to be evident that future transmission of energy at high efficiencies will still demand the wire core for guiding that energy to its destination.

THE PURE ELECTRON DISCHARGE AND ITS APPLICATIONS IN RADIO TELEGRAPHY AND TELEPHONY*

BY DR. IRVING LANGMUIR

RESEARCH LABORATORY, GENERAL ELECTRIC COMPANY

The electron emission from heated metals at very low pressures is a subject which has been investigated by scientists for many years, and the observations have been generally explained to be the result of chemical reactions with slight traces of gas. The first half of the following article, which is arranged in the form of a historical review, relates the experiments leading to the conclusion of the existence of pure electron emission in even the highest attainable vacua. After outlining the fundamental principles which govern this phenomenon the author shows how, through the medium of the kenotron (a hot-filament vacuum rectifier described in the *GENERAL ELECTRIC REVIEW*, March 1915, p. 156) and the plotron (a new type of amplifier) both of which employ the pure electron emission from heated metals in extremely high vacua, a very simple and successful equipment has been produced to send and receive radio-telegraphic and radio-telephonic messages.—EDITOR.

Historical

It has been known for nearly two hundred years that air in the neighborhood of incandescent metals is a conductor of electricity. Elster and Geitel studied this phenomenon in great detail and published the results of their investigations in a series of papers in *Wiedemann's Annalen* during the year 1882-1889.

In most of their experiments they placed a metal plate close to a metallic filament within a glass bulb, and studied the charge acquired by the plate under various conditions of filament temperature and gas pressure. They found in most gases that the filament tended to give off positive electricity when it was at a red heat, but at very high temperatures it gave off negative electricity more easily than positive. When the vessel was exhausted as completely as was possible in those days, the tendency to give off positive electricity was much decreased and did not persist, whereas the tendency to emit negative electricity was apparently stronger than ever.

A similar discharge of negative electricity from the carbon filament of an incandescent lamp to an auxiliary electrode placed within the bulb was observed and studied by Edison and has since been known as the Edison effect. Fleming, in 1896 [*Proc. Roy. Soc.* 47, 118, (1896) and *Phil. Mag.* 42, 52 (1896)] investigated and described this effect in detail.

J. J. Thomson [*Phil. Mag.* 48, 547 (1899)] showed that in the case of a carbon filament in hydrogen at very low pressures, the

negative electricity is given off by the filament in the form of free electrons having a mass about 1/1800 of the mass of a hydrogen atom, and constituting in reality atoms of electricity. Owen [*Phil. Mag.* 8, 230 (1904)] showed that a heated Nernst filament also gives off electrons and Wehnelt [*Ann. Phys.* 17, 425 (1904)] proved that the electric current from a lime covered platinum cathode (Wehnelt cathode) is carried in the same manner.

Richardson [*Phil. Trans.* 201, 516 (1903)] applied the electron theory of metallic conduction to the electron emission from heated metals, and was thus able to develop a theory of this effect. In order to account for the conduction of heat and electricity by metals, Riecke and Drude had assumed that metals contain electrons which are free to move under the influence of an electric force and which are in constant vibratory motion similar to that of the molecules of a gas. Richardson assumed that these free electrons are ordinarily held within the metal by an electric force at the surface, just as the molecules of a liquid are prevented from escaping by a surface force related to the surface tension. If the velocity of an electron is sufficiently high, it may be able to overcome the surface force and escape. Since the average velocity of the vibratory motion increases with the temperature, the number of electrons which reach the necessary critical velocity to escape, will increase very rapidly with the temperature. These considerations are strictly analogous to those of the evapora-

*Read before the American Institute of Radio-Engineers, at New York, April 7, 1915. Published with their permission. Copyrighted, 1915, by Institute Radio-Engineers.

tion of a liquid, so that the number of electrons escaping should increase with the temperature according to the same laws as those governing the increase of the vapor pressure of a liquid as the temperature is raised.

It had already been shown that the vapor pressure (p) of a substance varies with the temperature (T) according to a relation of the form

$$p = A \lambda \bar{T} c^{-\frac{\lambda}{2T}}$$

where A is a constant, λ is the latent heat of evaporation of the liquid (or solid), and e is the base of the natural system of logarithms. Richardson was thus led to conclude that the current from an incandescent metal should increase according to an equation of a similar form, namely

$$i = a \lambda \bar{T} e^{-\frac{b}{T}}$$

Here i is the current per square centimeter at the temperature T , and b is a constant which should be half the latent heat of evaporation of the electrons.

Richardson suggested that the currents obtained by the emission of electrons or ions from incandescent bodies should be called *thermionic* currents, a term which has since come into very general use. According to Richardson's theory, an incandescent metal at a given temperature emits electrons at a definite rate which is independent of the electric field around the heated body.

If a positively charged body is placed near the heated filament, the electrons will all be drawn away from the filament and will strike and be absorbed by the positively charged body. The motion of these electrons constitutes an electric current, the hot filament being the cathode and the positively charged body the anode of the discharge.

If, however, there is no electric field around the heated filament, or if a negatively charged body be placed near it, the electrons which are emitted from the filament return to it again and are reabsorbed and therefore no current flows between the two electrodes.

According to this viewpoint the electron emission is the same whether a thermionic current flows or not. As the potential of the cold electrode or anode is increased, a larger and larger proportion of the electrons emitted are drawn to the anode, so that the thermionic current increases. As the potential is further raised, a point is finally reached at which all the electrons emitted pass to the anode, so that

a further increase in voltage causes no increase in current. The current is then said to be "saturated."

Richardson, in 1902, determined the relation between the saturation current from a heated platinum wire and a cylinder around it, and found that i varied with the temperature in accordance with the equation given above. For other substances also he found the relation to hold.

Since 1903, Richardson's theory of thermionic currents has been the subject of much investigation and discussion. H. A. Wilson [Phil. Trans. 202, 243 (1903)] found that the electron emission from platinum at high temperature was decreased to 1/250,000 of its former value by a preliminary heating of the platinum in oxygen or by boiling in nitric acid. The admission of a little hydrogen brought the current back to its former value.

Wehnelt [Ann. Phys. 14, 425 (1904) and Phil. Mag. 10, 80 (1905)] discovered that platinum cathodes covered with lime emit vastly more electrons than platinum alone. He proposed using tubes containing such cathodes as rectifiers for alternating current of 100 or 200 volts, and described a Braun tube in which very soft cathode rays (100 to 1000 volts) could be produced. Wehnelt worked usually with gas pressures ranging from 0.01 to 0.1 mm. of mercury, the lowest pressure recorded being 0.005 mm. Under these conditions the paths of the cathode rays were visible, showing that there was strong ionization of the gas.

Soddy [Phys. Zeit. 9, 8 (1908)] found that the large currents obtainable from a Wehnelt cathode stopped suddenly if the residual gases in the vacuum tube were absorbed by vaporizing some metallic calcium. This work of Soddy attracted considerable attention and made many investigators feel that thermionic currents in general were dependent on the presence of gas.

Lilienfeld, however, considered that Soddy's experiments did not show that the electron emission from the Wehnelt cathode had decreased, but suggested that the decrease in current might be caused by the building up of a negative charge in the vacuum because of the large number of electrons needed to carry the current.

Fredenhagen [Verh. deut. phys. Ges. 14, 384 (1912)] in 1912 studied the electron emission from sodium and potassium, two metals that Richardson had found particularly good sources of electrons, and concluded that the electrons are only emitted

as a result of the presence of gas. He suggested that if a perfectly clean metallic surface could be obtained in a perfect vacuum the electron emission would cease entirely.

Pring and Parker [Phil. Mag. 23, 192, (1912)] in the same year measured the currents from incandescent carbon rods in a vacuum. They found that with progressive purification of the carbon and improvement in the vacuum, the currents decreased to extremely small values. They concluded that "the large currents hitherto obtained with heated carbon cannot be ascribed to the emission of electrons from carbon itself, but that they are probably due to some reaction at high temperatures between the carbon, or contained impurities, and the surrounding gases, which involves the emission of electrons."

More recently Pring [Proc. Roy. Soc. A 89, 344 (1913)] repeated these experiments under still better vacuum conditions and finds the former results confirmed. He concludes that "the thermal ionization ordinarily observed with carbon is to be attributed to chemical reaction between the carbon and the surrounding gas." "The small residual currents which are observed in high vacua after prolonged heating are not greater than would be anticipated when taking into account the great difficulty of removing the last traces of gas."

A similar feeling gradually arose in regard to the photoelectric effect, a phenomenon resembling the electron emission from incandescent metals, except that the electrons are emitted by the action of light—usually ultra-violet light, instead of heat.

Pohl and Pringsheim [Phys. Zeit. 14, 1112 (1913)] find that the photoelectric effect is very much decreased by improving the vacuum, and suggest that perhaps the whole effect is due to interaction between the gas and the metal. Wiedmann and Hallwachs (the latter the discoverer of the photoelectric effect) [Ber. d. Deut. Phys. Ges. 16, 107 (1914)] go further and state emphatically as a conclusion from experiments with potassium that "The presence of gas is a necessary condition for appreciable photoelectric electron emission."

Fredenhagen and Kuster [Phys. Zeit. 15, 65 and 68 (1914)] conclude that the same is true for the photoelectric effect from zinc, and in a still later publication Fredenhagen [Verh. d. Deut. Phys. Ges. 16, 201 (1914)] finds that both the photoelectric and thermionic electron emission from potassium are entirely dependent on the presence of gas.

We see, then, that there were the best of reasons for believing that it would be impossible to get any electric discharge through a perfect vacuum, because one could not expect to get any electrons from the electrodes.

In the operation of ordinary X-ray tubes it was well known that a certain amount of gas was necessary. Porter [Ann. Phys. 40, 561 (1913)] studied the dynamic characteristics of the Wehnelt rectifier and found that with pressures as low as 0.001 mm. there was a tendency for the current to become unstable, fluctuating periodically between zero and a higher value. With higher pressures, this difficulty was avoided, but the characteristics clearly showed a sort of hysteresis loop, the current with ascending voltage being different from that obtained with descending voltage.

My active interest in thermionic currents began in connection with some experiments on electrical discharges occurring within tungsten lamps. According to Richardson's data on the electron emission from such metals as platinum and osmium, the currents that might exist across the evacuated space in a tungsten lamp would be very large; in fact, the current density, at temperatures close to the melting-point of tungsten, might be expected to be several hundred amperes per square centimeter. Of course it is evident at the outset that the current flowing from one part of a filament to the other through the vacuum must actually be very small in any ordinary lamp. It was known that the vacuum in a tungsten lamp is extremely high and measurements indicated that in well exhausted lamps after 100 hours' life the pressure was probably less than one millionth of a mm. of mercury. Taking these two facts into account, the very existence of a tungsten lamp seems strong evidence that thermionic currents in high vacuum must be very small, if not entirely absent.

When this effect was studied in more detail, it was found that the smallness of the currents in a lamp was not due to any failure of the filament to emit electrons, but was due entirely to an inability of the space around the filaments to carry the currents with the potential available in the lamp.

In one case, two single loop tungsten filaments were mounted side by side in a bulb. After the bulb was exhausted in the best possible way and the filaments were thoroughly aged and freed from gas, one of the filaments was heated while a positive potential was applied to the other through a

galvanometer. The hot filament thus served as cathode in the discharge occurring in the lamp. As the current through the cathode was increased, the thermionic current as measured by the galvanometer increased at first, according to Richardson's equation as shown in Fig. 1; but beyond a certain point, the further increase in the temperature of the cathode produced no further increase in thermionic current.

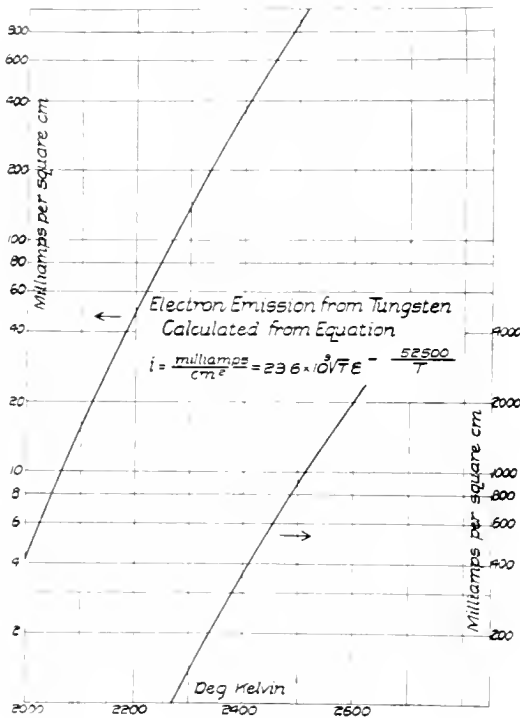


Fig. 1 Electron Emission from Tungsten in a "Perfect" Vacuum

The curve representing thermionic current as a function of temperature therefore consists essentially of two parts: first, a part in which Richardson's equation applies; second, a part in which the current is independent of the temperature. In the first part of the curve it is found that the current is independent of the voltage, or shape and size of the anode, but in the second part of the curve the current is affected by both of these factors and may also be either increased or decreased by placing the lamp in a magnetic field. It is thus evident that the only reason why the current does not continue to increase, according to Richardson's equation, is that the space between the electrodes is only

capable of carrying a certain current with a given potential difference.

The explanation of this phenomena was found to be that the electrons carrying the current between the two electrodes constituted an electric charge in the space which repelled electrons escaping from the filament and caused some of them to return to the filament.

A further theoretical investigation on the effect of this space charge led to the following formulas by which the maximum current that can be carried through a space (of certain symmetrical geometrical shapes) may be calculated.

In the case of parallel plates of large size, separated by the distance x , the maximum current per square centimeter, i , is

$$(1) \quad i = \frac{\sqrt{2}}{9\pi} \sqrt{\frac{c}{m}} \frac{V^{3/2}}{x^2}$$

Here, c is the charge on an electron, m the mass of an electron, and V the potential difference between the plates. If we substitute the numerical value of $\frac{c}{m}$ and express i in amperes per square centimeter and V in volts, then this equation becomes

$$(2) \quad i = 2.33 \times 10^{-6} \frac{V^{3/2}}{x^2}$$

In the case of a wire in the axis of a cylinder, the maximum current per centimeter of length from the wire is given by the equation

$$(3) \quad i = \frac{2\sqrt{2}}{9} \sqrt{\frac{c}{m}} \frac{V^{3/2}}{r}$$

If we substitute numerical values as before, we find

$$(4) \quad i = 14.65 \times 10^{-6} \frac{V^{3/2}}{r}$$

where i is the current in amperes per centimeter of length, and r is the radius of the cylinder in centimeters.

These equations have been found to agree accurately with experiments when the vacuum is so high that there is no appreciable positive ionization.

Extremely minute traces of gas, however, may lead to the formation of a sufficient number of positive ions to neutralize to a large extent, the space charge of electrons and thus very greatly increase the current carrying capacity of the space. For example, a pressure of mercury vapor of about 1/100,000 mm. has, under certain conditions, been found to completely eliminate the effect of space

charge, so that a current of 0.1 ampere was obtained with only 25 volts on the anode, whereas, without this mercury vapor, over 200 volts were necessary to draw this current through the space.

Besides this enormous effect on the current carrying capacity of the space, many gases have a great influence on the electron emission from the cathode. But in every case where the cathode is of pure tungsten, the effect of gas is to decrease, rather than increase, the electron emission. For example, it is found that a millionth of a millimeter of oxygen, or gas containing oxygen, such as water vapor, will cut the electron emission down to a small fraction of that in high vacuum.

As a result of this work, we became firmly convinced that the electron emission from heated metals was a true property of the metals themselves and was not, as has so often been thought, a secondary effect, due to the presence of gas.

Further investigation showed that with the elimination of the gas effects, all of the irregularities which had previously been thought inherent in vacuum discharges from hot cathodes were found to disappear. In order to reach this condition, however, it was not sufficient to evacuate the vessel containing the electrodes to a high degree, but it was essential to free the electrodes so thoroughly from gas that gas was not liberated from them during the operation of the device. It was also necessary to free the glass surfaces very much more thoroughly from gas than had been thought necessary previously. The difficulty thus consists not in the production of the high vacuum, but in the maintenance of this vacuum during the use of the apparatus. As the voltage applied to the terminals was increased and as the current density in the discharge increased, the tendency for the gas residue to become ionized became very much more marked and the difficulties in maintaining a sufficiently high vacuum increased still further. However, by special methods of exhaust and by special methods of treating the electrodes, these difficulties have been overcome and it has thus been possible to construct apparatus in which a large current density can be obtained and potential differences of much more than 100,000 volts may be applied without obtaining effects attributable to positive ionization.

In previous devices which employed discharges through vacuum, either with or without a hot cathode, there was always evidence of positive ionization if the current

density was increased above an extremely low value, or if potentials over 50 or 100 volts were applied while a current of as much as a few milliamperes was flowing. The effects of this positive ionization manifested themselves in many ways. If the ionization was sufficiently intense, a glow throughout the tube was visible. For example, in the Braun tube, with a lime covered cathode, Wehnelt states that a vacuum as high as possible should be obtained, but he speaks of being able to see the path of the cathode rays. It has apparently always been assumed that cathode rays of sufficiently high intensity can always be seen, but of course such luminosity is direct evidence of ionization of the gas. One of the most sensitive indications of the presence of positive ionization is the failure of the current to increase with the voltage in a regular manner, as shown in equations (2) and (4). If much gas is present, and by this I mean a pressure in the order of 1, 10,000th mm., the current-voltage curve often shows decided kinks when the voltage is raised above 50 or 100 volts. In many cases the discharge is unstable and fluctuates periodically between two values. All these effects tend to be extremely erratic, since they vary with the composition and the pressure of the residual gases, and these, in turn, are altered by the discharge taking place through them. For example, in the ordinary X-ray tube, the vacuum continually improves, and it is necessary, from time to time, to admit fresh portions of gas.

With the higher voltages, perhaps the most troublesome features of positive ionization is its tendency to disintegrate the cathode. The positive ions, moving under the influence of the electric field, acquire high velocity, and when they strike the cathode cause rapid disintegration and ultimate destruction of the electrode. With a pure electron discharge, however, there is no disintegration of the electrode caused by the discharge and the filament lasts the same length of time as if no current passed through the vacuum.

Another effect, produced by positive ionization, is the emission of electrons from the cathode under the influence of the positive ion bombardment. These electrons, which constitute the so-called delta rays, escape from the cathode with considerable initial velocity, and are therefore capable of charging up a third electrode in this space to a potential of 10 or 15 volts negative with respect to the cathode.

With the pure electron discharge, none of these effects are present. The cathode rays are entirely invisible, the current voltage curve is a smooth curve, follows the 3/2 power law, in case the filament temperature is sufficiently high and the shape of the electrodes is such that the small initial velocities of the electrons from the cathode do not play too large a role. It is possible to obtain a very high current in this type of discharge, but in order to overcome the space charge effects, it is then necessary to use a very strong electric field close to the cathode.

Devices Employing a Pure Electron Discharge]

Dr. W.D. Coolidge [Phys. Rev. 2, 409 (1913)] has used the pure electron discharge in the construction of a new type of X-ray tube. In this tube the cathode consists of a small, flat spiral of tungsten wire, surrounded by a small molybdenum cylinder which serves as a focusing device, while the anode, or target, consists of a massive piece of tungsten, placed near the center of the tube. With this tube it has been possible to use voltages as high as 200,000 volts in the production of X-rays. The current through the tube is absolutely determined by the electron emission from the filament, which, in turn, depends upon the temperature, in accordance with Richardson's equation.

The advantages of this tube over the ordinary X-ray tubes previously used are many. Perhaps the most important feature is that the current and voltage are under complete control at all times, the current being fixed by the temperature of the cathode while the voltage is simply that furnished by the transformer or induction coil used. The tube seems to have an almost unlimited life, the temperature of the filament being so low that no appreciable evaporation occurs and the absence of gas eliminating the cathodic disintegration usually characteristic of high voltage discharge in vacuum. The tube is entirely constant in its action and the erratic effects usually observed in X-ray tubes are eliminated.

Several other types of apparatus have been developed making use of this pure electron discharge, and these devices possess the same advantages over apparatus formerly used as the Coolidge X-ray tube possesses over the ordinary X-ray tube.

In order to distinguish these devices from those containing gas and in most cases depending upon gas for their operation, the name "Kenotron" has been adopted. This word

is derived from the Greek *kenos*, signifying empty space (vacuum), and the ending, *tron*, used by the Greeks to denote an "instrument."

Kenotron Rectifier

The Coolidge X-ray tube is, of course, a rectifier for high voltage alternating current, but it is not suitably designed for this purpose. In an X-ray tube, the voltage applied must be consumed in the tube itself, whereas in the rectifier the voltage in one direction should be consumed in the load in series with the rectifier, although the voltage in the opposite direction should be taken wholly by the rectifier. In the X-ray tube, because of the great distance between the anode and cathode and the presence of a focusing device around the cathode, the space charge effects are very much exaggerated, so that it is necessary

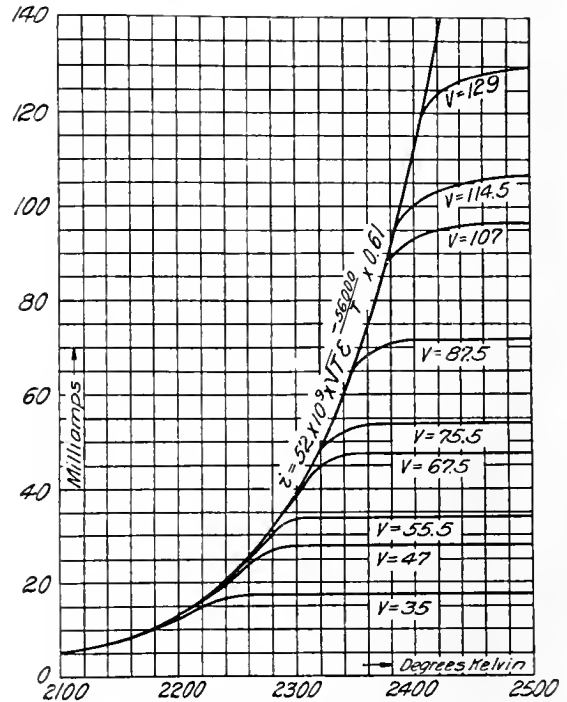


Fig. 2. The Effect of Space Charge on the Thermionic Currents

to apply several thousand volts, in order to get even 10 milliamperes of current. This voltage necessary to overcome the space charge is completely lost when the tube is used as a rectifier.

To overcome this loss of voltage as far as possible, the anode and cathode in the

kenotron are placed close together and everything is avoided which might tend to screen the cathode from the field naturally produced by the anode. In this way it has been possible to build kenotrons which have supplied pure electron currents of over an ampere, with a voltage drop of about 200 volts. This current, however, requires large anodes and cathodes, so that it is usually more convenient to build kenotrons with a current capacity of not over 250 milliamperes, and if it is desired to rectify larger currents than this, to place several kenotrons in parallel.

There seems to be no upper limit to the voltage at which a kenotron can operate. A kenotron has been built capable of rectifying 250 milliamperes at 180,000 volts, and there seems to be every reason to think that kenotrons could be used at very much higher potentials if desired.

The design and the characteristics of kenotrons has recently been described in a paper by Dr. S. Dushman [GENERAL ELECTRIC REVIEW, vol. 10, p. 156, 1915] and I will therefore only briefly describe these devices.

Fig. 2 gives the characteristics of a typical kenotron designed for rather large currents. The curves show the current carried by the kenotron for different filament temperatures at given voltages between the electrodes.

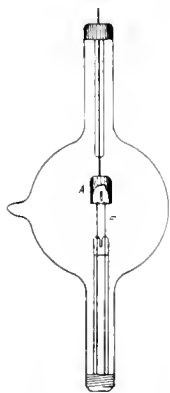


Fig. 3. Molybdenum Cap Type of Kenotron

For example, if the temperature of the filament is 2400 deg. the maximum current that can be obtained with any voltage is about 112 milliamperes. If, however, the resistance of the load is able to hold the current down to a value of say 54 milliamperes, then we see from the curves that the voltage drop in the kenotron would be 75.5 volts, the remaining voltage, which may be

many thousands of volts, being consumed in the load in series with the kenotron.

Figs. 3 and 4 illustrate two forms of kenotrons, one for voltages up to about 10,000, and the other one suitable for use up to 50,000 volts. With voltages higher than about 12,000 to 15,000 volts, the kenotron of the type shown in Fig. 3 is apt to fail, because the electrostatic attraction of the

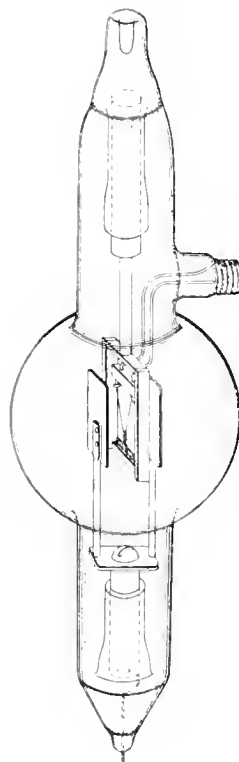


Fig. 4. Kenotron with Filament Between Two Parallel Plates

anode pulls out the helically wound filament and short circuits the device. At the higher voltages, therefore, it is necessary to support the filament and to balance, as far as possible, the electrostatic forces acting on it.

The characteristics of the kenotron are such that the current flowing through it is always perfectly stable, so that several kenotrons can be run in parallel and each one will take its proper share of the current. This is in marked contrast with the behavior of mercury arc rectifiers, which have negative characteristics and therefore, if several are placed in parallel, one of them takes the whole of the current.

Owing to the absence of gas effects, the kenotron is a perfect rectifier, in that no measurable current flows in the reverse direction, even when voltages of 100,000 volts or more are applied. For similar reasons, it is capable of rectifying high frequency currents, as well as low frequency, there being not the slightest sign of any lag effects.

Amplifying or Controlling Devices: Pliotrons

In a pure electron discharge, as the temperature of the filament is raised, a point is always reached where the current becomes limited by the space charge between the electrodes. Under these conditions, only a small fraction of the electrons escaping from the cathode reach the anode, whereas the majority of them are repelled by the electrons in the space and therefore return to and are absorbed by the cathode. From this viewpoint it is evident that if a negatively charged body is brought into the space between the anode and cathode, the number of electrons which then return to the cathode will increase, so that the current to the anode will decrease. On the other hand, if a positively charged body is brought near the cathode, it will largely neutralize the negative charges on the electrons in the space and will therefore allow a larger current to flow from the cathode. In this way it is possible to control the current flowing between the anode and cathode by an electrostatic potential on any body placed in proximity to the two electrodes. This controlling effect may be best attained by having this controlling member in the form of a fine wire mesh, or grid, placed between the electrodes.

The term "Pliotron" has been adopted to designate a kenotron in which a third electrode has been added for the purpose of controlling the current flowing between the anode and cathode. This word is derived from the Greek "pleion" signifying "more." A Pliotron is thus an "instrument for giving more" or an amplifier. A similar use of the prefix "plio" occurs in the geological term "Pliocene."

The three elements, hot filament cathode, grid, and anode, are, of course, similar to the elements of the De Forest audion. However, the operation of the audion is in many ways quite different from that of the pure electron device operating in the way I have described above.

In the audion, as well as in the Lieben-Reisz relay, the amplifying action appears

to be largely dependent upon gas ionization, even when the device operates well below the point at which blue glow occurs. The action is probably somewhat as follows: there is normally present a small amount of gas ionization, due to the passage of the electrons between cathode and anode. The presence of the positive ions partly neutralizes the space charge which limits the current flowing between the electrodes. If a small positive potential is applied to the grid, the velocity of the electrons passing by it is somewhat increased and they therefore produce more ions in the gas. Besides this, as the potential on the grid is increased, the number of electrons passing the grid is increased, and this again tends to increase the amount of ionization. A very slight increase in the amount of ionization brought about in this way very greatly reduces the space charge and therefore largely increases the current that can flow between the electrodes. Thus, with a given construction of grid, filament, and plate, the relaying action may be very greatly increased beyond that which would occur if no gas were present. The amount of gas ionization which is necessary, in order to practically completely eliminate the effects of space charge, is often much too small to produce a visible glow in the gas.

If too much gas is present, or if the potential on the plate or the current flowing to the plate is too large, then the amount of positive ionization may reach such values as to almost entirely neutralize the space charge and thus allow a large current to flow. Under these conditions, the relaying action of the audion is lost. This is the case, for example, when the audion gives a blue glow. In the border land between these two conditions, there is a region of instability in which the sensitiveness of the audion may be enormously great, but it is usually not found very practicable to operate the device in this region because of the difficulties in maintaining adjustment, for any lack of adjustment may cause the audion to go over into a condition of blue glow.

The audion is often used with a condenser in series with the grid. Under these conditions, the audion requires the presence of a certain amount of gas ionization so that the positive ions formed may prevent the accumulation of too large a negative potential on the grid. With the pliotron, owing to the absence of positive ions, if it is desired to use a condenser in series with the grid, this condenser must be shunted by a high resistance and

often a source of potential must be placed in series with the high resistance, in order to supply positive electricity to the grid as rapidly as this tends to be taken up from the electrons given off by the filament.

Construction of Plotron

In the construction of plotrons, it has been found desirable to make the wires constituting the grid of as small cross-section as

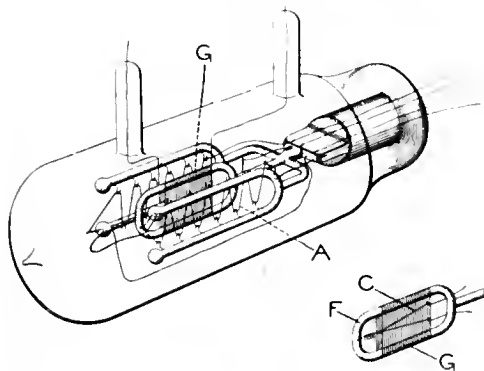


Fig. 5

possible. In this way, even when a positive potential is applied to the grid, the current that flows to the grid may be made extremely small. The use of very fine wire is made pos-

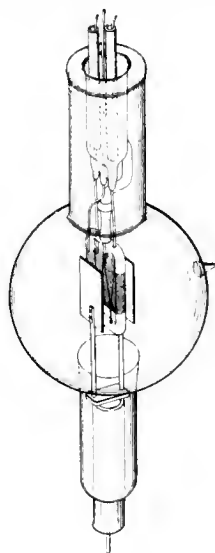


Fig. 6

sible by using a frame of glass, metal or other suitable material, to support the grid. Thus, in Figs. 5 and 6, the filament is mounted in the center of a frame made of glass rods, on which the fine grid wire is wound by means of a

lathe. The grid may thus consist of tungsten wires of a diameter as small as 0.01 mm. and these may be spaced as close as 100 turns per centimeter, or even more.

In Figs. 5 and 6 are shown two types of plotron. Fig. 5 shows a plotron such as used for amplifying radio signals in a receiving

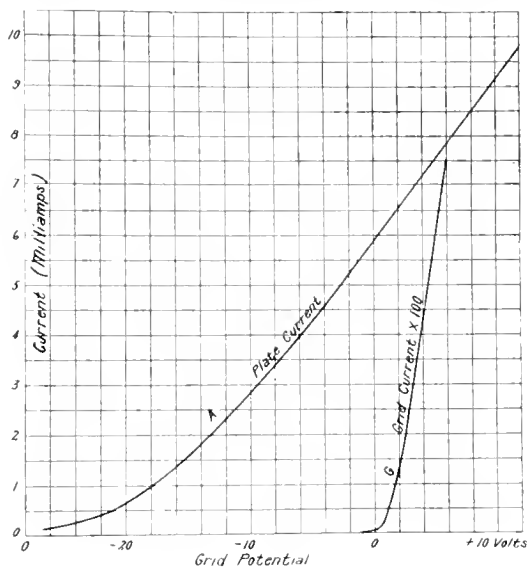


Fig. 7

station. Fig. 6 shows a large plotron which may be used for controlling as much as 1 kw. of energy for radio telephony.

The characteristics of the plotron depend upon the length of filament used, the distance between filament and grid, the spacing between the grid wires, the diameter of the grid wires, the distance between grid and anode, and the size and shape of the anode. The important elements in the characteristics of a plotron are, first, the relation between the current flowing between anode and cathode as a function of the potential on the anode and of that on the grid; second, the current flowing to the grid, as a function of the potential of the grid and the potential of the anode.

Fig. 7 gives the characteristics of a small plotron such as that shown in Fig. 5. Curve A gives the current flowing to the anode for different grid potentials, while the potential of the anode is maintained constant at 220 volts. Curve G gives the current flowing to the grid under the same conditions. For different anode potentials, these curves are shifted vertically, by amounts proportional to the change in anode potential. In fact, it

is found that these curves can be represented with fair approximation by a function of the form

$$i = A (V_a + kV_g)^{3/2}$$

where i is the current flowing to the anode, V_a is the voltage on the anode, V_g the voltage

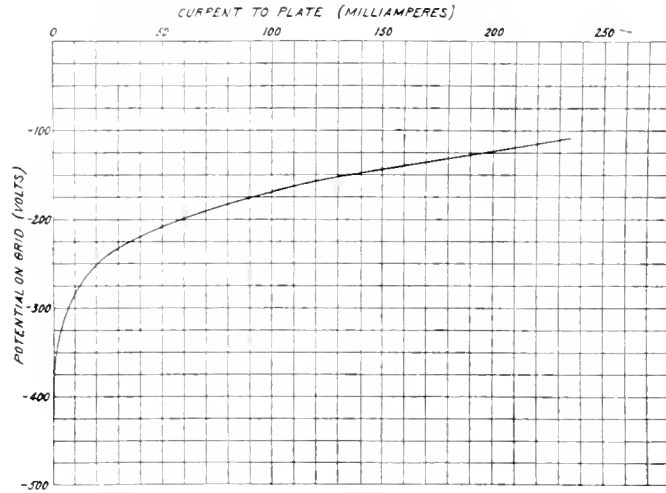


Fig. 8.

on the grid, and k the constant which depends on the relative shapes and positions of the electrodes.

Fig. 8 gives similar characteristics for a large plotron like that shown in Fig. 6. In this case, the anode potential was 8500 volts.

By using a fine grid, the current to the anode can be stopped entirely by even a very slight negative potential on the grid. On the other hand, a rather low positive potential will then be sufficient to draw a large current to the anode. The amount of current taken by the grid would be only a very small fraction of that flowing to the anode, in case the diameter of the grid wires is small compared to the distance between them. On the other hand, with a coarse grid, that is, a grid in which the spacing is large, a rather large negative potential may be necessary, in order to stop the current flowing to the anode. Similar results to those obtained by changing the spacing of the anode may be obtained by changing the relative distances between the electrodes. The effects produced in this way may be expressed approximately by means of the constant k in the above equation, the effect of fine spacing thus

being to increase the value of k , while coarse spacing decreases it.

By using a fairly coarse grid, consisting of fine wire, it is possible to obtain a control of the current to the anode, always using a negative potential on the grid. Under these conditions, since there are no positive ions present, no current flows to the grid, except that necessary to charge it electrostatically to the required potential. It thus becomes possible to control very large amounts of energy in the anode circuit, by means of extremely minute quantities of energy in the grid circuit.

There does not seem to be any upper limit to the voltages that may be used in the plotrons. With voltages over 30,000 it is often necessary to space the electrodes further apart and to use heavier wires for the grid, in order to reduce the danger of breakage of the parts by the large electrostatic forces which then occur.

The current carrying capacity of the plotron is limited only by the size of cathodes that it is found convenient to use and by the voltage available. Large currents cannot be readily obtained with low voltages because of the space charge effects described previously. With voltages above 500 volts, however, it is found practicable to use currents of 300 or 400 milliamperes for a plotron of the type shown in Fig. 6. With high potentials, there is no difficulty in using currents as large as this, provided the energy is consumed in some device in series with the plotron. On the other hand, if the full voltage is applied to the anode while the current is flowing to the anode, the energy liberated in the form of heat may be so great as to volatilize the anode or cause it to radiate so much heat that the glass parts of the apparatus are softened. In a plotron with a five-inch bulb the amount of energy that may be so consumed within the plotron is about 1 kw. Still larger amounts of power may be dissipated if the bulb is immersed in oil and if the grid frame is made of quartz, or other heat resisting material.

It is evident from the characteristics of the plotron that any number of these devices may be placed in parallel and that in this way, very large amounts of power may be controlled.

PLIOTRON IN A RECEIVING STATION

Pliotron as a Detector

If the antenna of a receiving set is coupled directly to the grid of a pliotron and a telephone receiver is placed in series with the anode, signals may be readily detected, but the results obtained in this way are usually very poor. Under these conditions, the sensitiveness of the arrangement is proportional to the curvature of the curve A, Fig. 7 (or, more accurately, proportional to the second derivative of the anode current with respect to the grid potential). This curvature may be somewhat increased by applying a negative potential to the grid, but even under these conditions the sensitiveness of the arrangement is usually not very high.

If it is attempted to use a condenser in series with the grid and thus use the pliotron in the way that the audion is often used (as described, for example, by Armstrong, *Electrical World*, December 12, 1909, p. 1149), it is found necessary to shunt the condenser with the resistance and often place a battery of a few volts in series with the resistance, in order to prevent a large negative charge from accumulating on the grid.

It has been found, however, by W. C. White, that a very minute trace of certain gases may very greatly increase the sensitiveness of this device as a detector. For example, by placing within the bulb a small quantity of an amalgam of mercury and silver, the characteristics of the tube show a kink, as indicated in Fig. 9. With a detector of this sort, if the grid potential is adjusted so that its average value is approximately that at which the kink occurs, there is a very marked increase in sensitiveness. This is due to the fact under these conditions either an increase or a decrease in the grid potential causes a decrease in the anode current. The sensitiveness of this detector is then very high. The quantities of mercury vapor necessary to give this effect are so low that anode voltages of 200 or more may be used without any indication of glow discharge.

Pliotron as Amplifier

The value of a pliotron as an amplifier is dependent primarily upon the slope of the curve between anode current and grid potential; for example, curve A, Fig. 7. A second factor of importance is the magnitude of the current taken by the grid. In order to get the greatest amplifying effect it is desirable to have this current as low as

possible. In a pliotron of the type shown in Fig. 5, the current to the anode increases at the rate of about 1 milliampere per volt change in the grid potential.

By using larger anode potentials, the slope of the curve can be made very much greater, since it becomes possible to use grids of finer mesh. For example, in Fig. 8 it is seen that

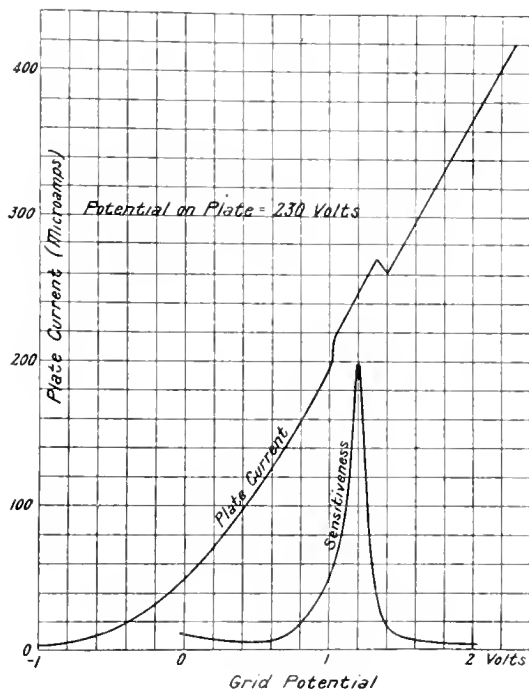


Fig. 9

the slope of the curve corresponds to two milliamperes increase in anode current per volt change in grid potential.

It has been found that there is no sluggishness in the characteristics of the pliotron, even at the highest frequencies.

By connecting the pliotron as amplifier, as shown in Fig. 10, the high frequency currents received from the grid may be amplified from one hundred to six hundred-fold. In this arrangement, it is the high frequency or radio frequency that is amplified, and not the audio frequency. This amplification of the radio frequency possesses the marked advantage that the detector circuit may be tuned to the same frequency as the amplifier circuit, and in this way a very marked increase in selectivity is obtained. In fact, it has been shown by Mr. Alexander-son that the resonance curve of an outfit

consisting of amplifier and detector, both tuned to the radio frequency as shown in Fig. 10, may be obtained from the resonance curve for the detector alone, by squaring the ordinates. For example, if with a single detector, the signals from one station (*A*) are received one hundred times as strong as those from another station (*B*), then, with the above arrangement with the amplifier,

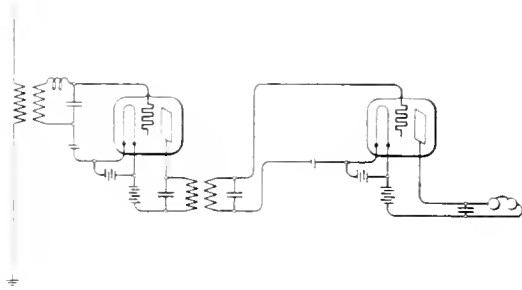


Fig. 10

the signals from *A* will be received one hundred times squared, or ten thousand times as strong as those from station *B*. If two amplifiers be used in this way, the signals from station *A* could be obtained one million (or 100^3) times as strong as those from station *B*.

In practice, this arrangement has been found to give a wonderfully high degree of selectivity.

Of course a pliotron may also be used for amplifying the audio frequency, coupling the circuits together by means of an iron core transformer. A single pliotron, under these conditions, gives an amplification of current of several hundred-fold, when voltages of from one to two hundred volts are used on the anode.

Pliotron as Oscillator

By placing inductance in capacity in the grid and plate circuits and coupling these two circuits together, it is possible to use the pliotron as a source of continuous oscillations. Small pliotrons of the type shown in Fig. 5 may produce oscillations up to a few watts, and these may be used in a receiving station, according to the Heterodyne principle, for receiving continuous oscillations. One pliotron may be used for both amplifying or detecting, and for producing oscillations.

With the larger pliotrons, using voltages of a few thousand volts, up to a kilowatt of radio frequency oscillations may readily be produced by a single tube.

USE OF THE PLIOTRON IN RADIO TELEPHONY

By means of a single large pliotron, it has been found possible to control about two kw. of energy in an antenna, by means of the currents obtained from an ordinary telephone transmitter. There are many arrangements by which this may be accomplished. For example, a two-kw. Alexanderson alternator (100,000 cycles) may be loosely coupled to the antenna and the anode of the pliotron may be connected to a point on the antenna where the potential is normally high. As long as the potential on the grid of the pliotron is strongly negative, no current flows to the pliotron and therefore the full energy is radiated by the antenna. If, however, the negative potential on the grid is decreased, a sufficient current may be drawn from the antenna to strongly damp the oscillations and thus greatly decrease the energy radiated. With sufficiently high potential on the grid, practically the whole of the energy may be diverted from the antenna.

It is thus possible to control the output of the antenna by varying the negative potential on the grid of the pliotron. Since the grid is always negative, no current flows between filament and grid and therefore practically no energy is required to maintain the charge on the grid. In this way, therefore, by connecting the secondary of the transformer between the grid and filament, and placing the primary of the transformer in series with telephone transmitter, it is possible by means of the variations in the currents from the telephone transmitter to obtain potentials on the grid of several hundred volts and thus to control the output of the antenna.

Instead of using an arc or alternator as a source of high frequency current, the pliotron may also be used as generator of the oscillations. One pliotron may be used both for producing the oscillations and for controlling the amplitude of the oscillations, in accordance with the sound waves acting on the telephone transmitter. It is usually preferable, however, to use a large pliotron for producing the oscillations and connecting a small pliotron in the grid circuit of the large pliotron for controlling the output of the latter.

With the above arrangement an extremely simple and efficient radio telephone outfit can be made. Since the pliotron for producing oscillations requires comparatively high direct current voltages, it has been found convenient to combine the pliotron oscillator

with a kenotron rectifier. Two types of apparatus of this type have been in use a considerable time, and it will be of interest to describe these in some detail.

In the first outfit, which is a small outfit having a capacity of about 20 watts in the antenna, the source of power is the local city supply, which is 118 volts, 60-cycle alternating current. This is connected with the primary of a small transformer, having two secondary windings. One of the secondaries is designed to give about 5 volts and furnishes the current used for heating the filaments of the kenotrons and pliotrons. The other secondary of the transformer is wound to furnish a potential of about 800 volts. This is rectified by means of a kenotron and serves to charge a condenser of about six microfarads. In this way a source of high voltage, direct current is obtained in a very simple manner. The plate of the pliotron oscillator is then connected to one of the terminals of the condenser, while the filament is connected to the other. The plate of the second pliotron is connected to the grid of the first, while the grid of the second is coupled by means of a second small transformer to the microphone circuit. With this outfit, both pliotrons may be relatively small, and in order to obtain an energy of about 20 watts in the antenna, it is found that the current drawn from the condenser is so small that the potential supplied by it does not vary sufficiently to be audible in the signals sent out. The different parts of this

apparatus may be made very compact and no adjustments are found necessary in operating the system unless it is desired to change the wave length. In this case, it is only necessary to change the inductance or capacity.

In the second outfit, which is suitable for use up to 500 watts or more, the high voltage direct current is obtained from a small 2000-cycle generator. The current from this is transformed up to about 5000 volts, rectified by kenotrons, and smoothed out by means of condensers. By the use of 2000-cycle alternating current instead of 60-cycle, it is possible to store up large quantities of energy and thus obtain as much as a kilowatt or more of power in the form of direct current with condensers of moderate size. This high voltage direct current is then used, as before, to operate a pliotron oscillator, the output of which is controlled by means of a small pliotron connected to the telephone transmitter.

By means of this system of control the amount of energy in the telephone transmitter circuit need be no larger than those commonly used in standard telephone circuits. It has thus been found possible to connect up this radio telephone outfit with the regular telephone lines so that conversation may be carried out between two people, both of whom are connected with the radio stations by means of the regular land lines. It has also been found possible to communicate both ways over these lines.

THE HYDRO-ELECTRIC DEVELOPMENT OF THE COHOES COMPANY AT COHOES, N. Y.

By B. R. CONNELL

POWER AND MINING ENGINEERING DEPARTMENT, GENERAL ELECTRIC COMPANY

The development described in this article is one more instance of the profitableness of substituting efficiency for inefficiency, of gathering in the pennies that have heretofore slipped through the cracks. The plant, which will be ready for operation by the time this issue is distributed, replaces with one station making use of modern high efficiency apparatus and the most economical head, a number of scattered installations employing waterwheels of more or less obsolete types, working under smaller heads than the maximum. The fact that the expenditure required for a development of this kind was considered justified, forms a basis on which to judge of the increased output that may be expected from the new plant.

General

The Cohoes Falls, on the Mohawk River near its entrance into the Hudson, have long been a point of interest locally and have been utilized to furnish power to nearby manufactories since about 1830. The Cohoes Company was organized a few years before that date and secured control of the entire water power rights at this point, except for the water reserved for canal purposes by the

These early power developments, while noted at the time of their construction, and still of some historic interest, were far from an economical development of the available power, owing to the number of small installations and low heads used, as well as to the fact that a number of the waterwheels are now of an obsolete type. The Cohoes Company therefore decided to develop the power privilege by one large modern hydro-electric

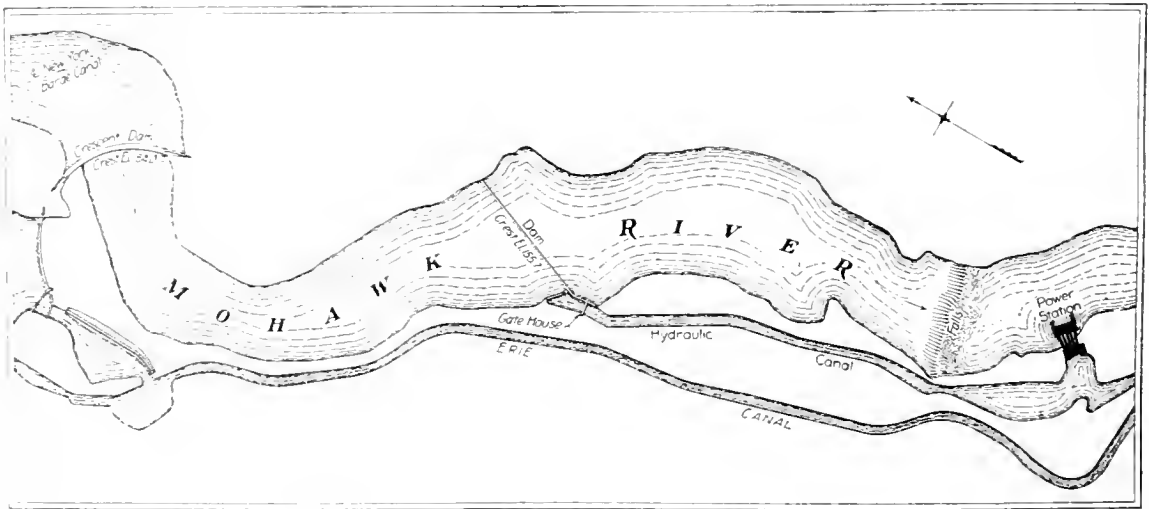


Fig. 1. Map of Mohawk River, Canal and Power Station of the New Development

State. This company built a dam a short ways above the Falls, which has since been replaced several times, the present structure having been built in 1865. A power canal was also constructed in the early development, and was later enlarged and lengthened several times until the present extensive canal system resulted. This canal now furnishes hydraulic power to a large number of manufactories in the city of Cohoes, N. Y.

plant—the most economical manner—and furnish electric power to each of the various industries that had previously maintained its separate power plant.

This new development is now practically completed, and it is expected will be put into commercial operation during the latter part of April. The ultimate installation will have a capacity of 50,000 h.p., 30,000 h.p. of which is installed at the present time. The plant

when completed will be one of the largest and most up-to-date hydro-electric installations in this section utilizing the latest developments in electrical and hydraulic apparatus.

Watershed, Rainfall, Etc.

Practically the entire run-off of the Mohawk Valley, except the water reserved for canal purposes, will be available at this new plant for power purposes, under a normal head of 96 feet. The Mohawk is the largest tributary of the Hudson River and rises in the western part of New York State, flowing eastward for the greater part of its length of 145 miles, until it enters the Hudson at Cohoes. From the data of the latest U. S. geological survey it has a total drainage area, measured at the Cohoes dam, of approximately 3472 square miles.

The yearly rainfall in the Mohawk water-shed ranges from 36 to 55 inches, and the average run-off is approximately 24 inches. The geological survey readings taken at Dunsback Ferry, which is a few miles above the Cohoes Falls, show a stream flow exceeding 2400 second feet for nine months of the year, with 750 as a minimum for the year 1906, which may be taken as a good average year. The period of low water usually occurs during the months of August, September and October.

The Mohawk watershed has a rapid run-off, as there are few large natural reservoirs, and a large section of the country through which it runs is cultivated land rather than forest. The stream flow therefore is not uniform throughout the year, although the percentage run-off is relatively large, being approximately 60 per cent as an average. This condition will be improved considerably by the completion of the New York State barge canal system, which traverses the bed of the river for over 100 miles, as numerous dams are being erected to improve navigation and furnish storage for canal feeders. This will, of course, improve the power conditions and make the stream flow more uniform throughout the whole year.

Canal, Gate House, Etc.

In the new development the Cohoes Company will utilize their present dam across the Mohawk. This is a masonry structure 1443 feet long, located about a mile above the

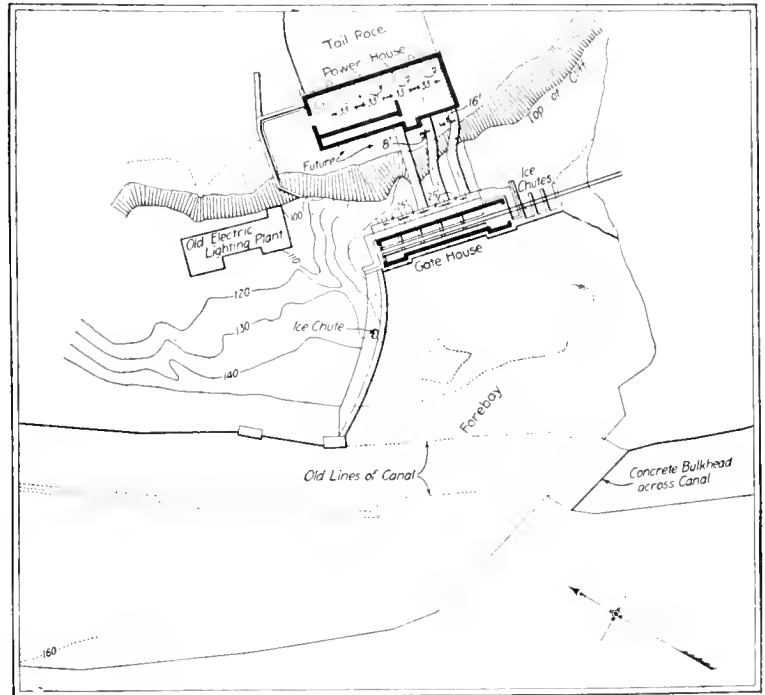


Fig. 2. Plan of Forebay, Gate-house and Power House

power house. From this dam a canal leads to a forebay and station gate house, and at the entrance to the canal head gates are provided, and just below these a spillway to control and regulate the canal level. The old canal, which has heretofore supplied the various mills, has been enlarged for the new development to about double its former capacity, and when completed will terminate in a small forebay directly above the power house, the forebay being formed by concrete walls built between the canal bank and the ends of the gate house. Three small gateways are provided at one end of the gate house for cleaning ice and other material from the forebay. After the completion of the new plant the canal will be closed below the forebay, as soon as the necessary arrangements can be made by the city of Cohoes to take care of the sewerage which is now emptied into the canal in the upper section of the city.

The station gate house is a brick and concrete structure approximately 150 feet long by 28 feet wide, and 31 feet high. Provision has been made in this for five gates and penstocks, three of the penstocks being installed at present. The gates are 20 feet wide by 22 feet high, made of heavy steel framework with a steel plate in front, and arranged to raise and lower on rollers. They are each operated by a 22-h.p. motor through a cable drum on each end, and can be controlled by push buttons either from the gate house or power house. A travelling hoist is provided for handling the racks and stop logs when necessary.

The building is a brick and steel frame structure set on a heavy concrete substructure, the outside being of red brick finished with concrete copings which give it a very neat and substantial appearance. The entire power house occupies a ground space about 170 feet long by 66 feet wide. The generator room faces the river and is approximately 40 feet wide, with an average height of 45 feet. Running the entire length of the generator room is the transformer and switching section of the station, which is a two-story structure with a basement. The headroom on each floor of the section is about 15 feet, and the width 24 feet.



Fig. 3. View of Power House and Cohoes Falls

From the gate house the penstocks drop directly to the wheels, a vertical distance of about 100 feet. These penstocks are 11 feet in diameter and approximately 190 feet long, and are made up of steel plates ranging in thickness from $\frac{3}{8}$ in. to $1\frac{1}{2}$ in. They are anchored firmly in concrete piers, which extend over practically the whole face of the bank, and are also supported by the heavy substructure of the gate house and power house.

Power House

The power house is located at the foot of a steep cliff on the edge of the river, and a concrete retaining wall extending into the river has been built just above to prevent any interference with the tail race water by the river flow, specially at high water periods.

In the generator room there is a 50-ton motor-operated crane, which is capable of lifting the complete rotating element, consisting of the generator rotor, waterwheel runner, and shaft, this being the heaviest single piece to be handled. The generators are spaced on 33-foot centers, thus giving ample room for working around the machines. The station is constructed for the ultimate installation, consisting of five units.

The basement under the switching station is divided into ten bays by the supporting columns, and, beginning with the first one down stream, each alternate bay is occupied by a penstock. Two are to be used for storage, and in the other three are located the oil tanks, filters for lubricating oil, transformer reactances, and generator rheostats. A separate room, laid out with special arrange-

ments for ventilation, is provided for these rheostats. Cool air from basement is taken in through openings in the floor and after passing through the rheostat grids is discharged into an air duct located in the center of the winding stairway in the tower. Arrangements are also made so that this discharge can be closed and the warm air passed into the station when necessary.

On the main floor level of the gallery section are located the locker room, storage battery

The bus work is made up of copper bars and tubing mounted on open insulators, no enclosed bus structure being installed.

On the second floor the benchboard is located in the center of the building, with an overhanging gallery directly in front, from which an unobstructed view of the entire generator room is obtained. To the left of the benchboard is the vertical control board, and beyond this are the arc panels and the 2300-volt bus, switching equipment and cor-



Fig. 4. Exterior View of Power House and Gate-house

room, governor pumps, exciter sets and combination auxiliary and battery switchboard, these occupying the downstream half of this section. In the other half are located the two 800-kv-a. transformer banks and the 12,000-volt solenoid-operated oil switches and busses. The generator and line switches are installed in two parallel rows, with the bus section switches at right angles to them. These oil switches are made up of three single-pole units, each in a separate tank, and the complete switch is set on a concrete base two feet above the floor. The switch tanks are each piped to the main oil tanks so that the oil can be conveniently filtered when necessary.

responding feeders. The bus structure here is also of the open type.

On the other side of the benchboard is a partition wall, and beyond this the 12,000-volt lightning arrester room. Here are also installed the reactances for each outgoing 12,000-volt line, these lines leaving the building vertically through roof-entrance bushings.

Directly back of the bench and vertical control boards is a large office, the front wall of which is formed by the rear panels of the boards serving as a partition. A doorway between the boards leads to the office from the front of the gallery. Back of the office is a tower

which leads from the basement to a height of 55 feet above the roof, and in which are a passenger elevator and a winding stairway with landings at each floor. From the top of this tower a bridge leads to the gate house, and affords passage to and from the power house.

The power house is well lighted in the day time by a number of windows. This is specially true of the generator room, where large corrugated glass windows are installed on all three sides. These are arranged for ventilation at both top and bottom, and have metal framing throughout. In the switching

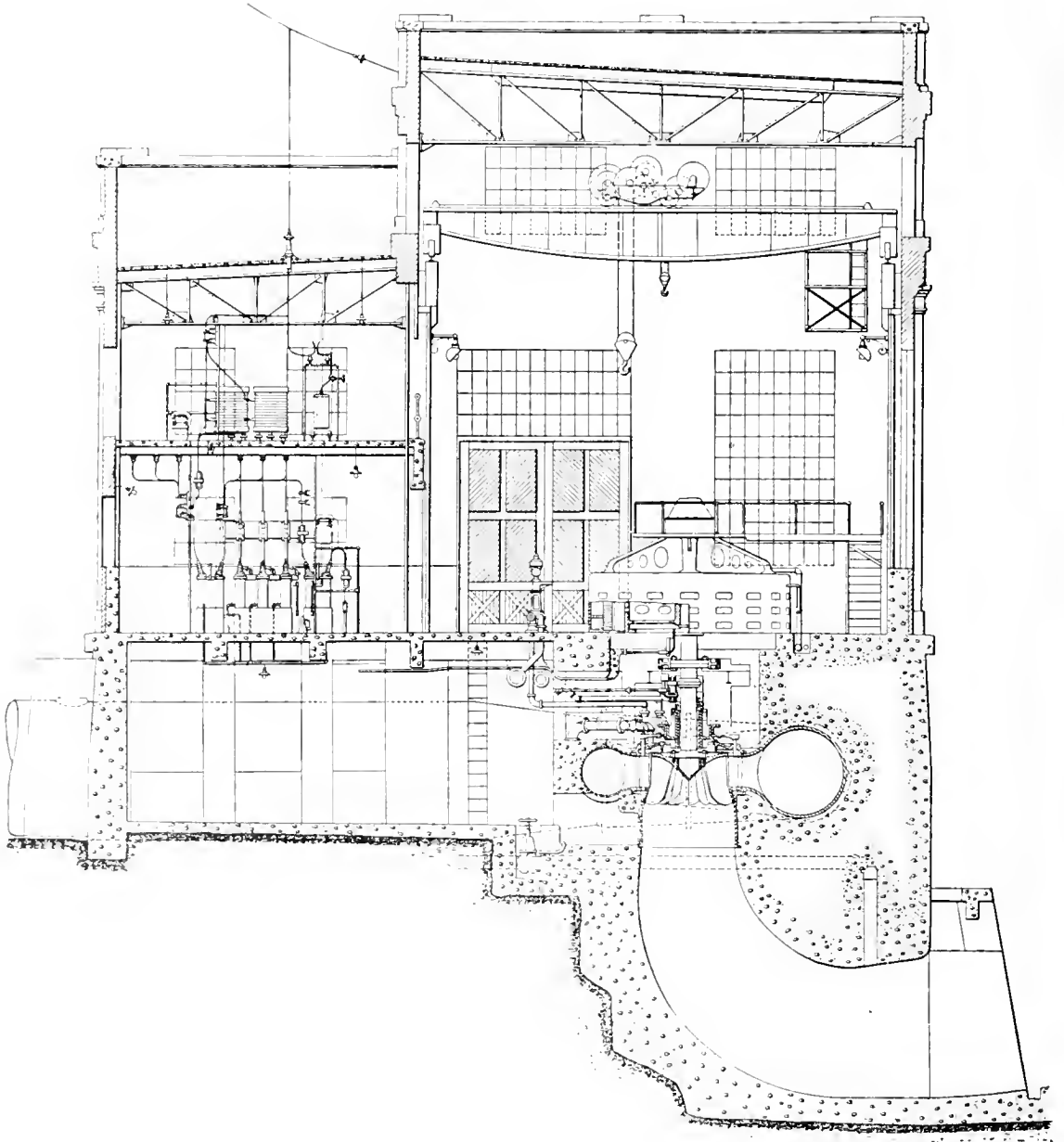


Fig. 5. Cross Section of Power House

sections all the apparatus, including the oil switches and busses, is installed in the center of the section, so that there are no obstructions in front of the window that will interfere with the light. While nothing ornamental is attempted for night illumination, good lighting is furnished in the generator room by 400-watt gas-filled lamps supported in wall brackets and fitted with reflectors. Nine

10,000 h.p. under an effective head of 96 feet and full gate opening. When operating under an effective head of 90 feet and at full gate opening, the rating is 8800 h.p. The normal speed of the wheel is 185 r.p.m. and the maximum runaway speed approximately 300 r.p.m.

The guaranteed efficiencies of the water-wheel, under the normal head of 96 feet and

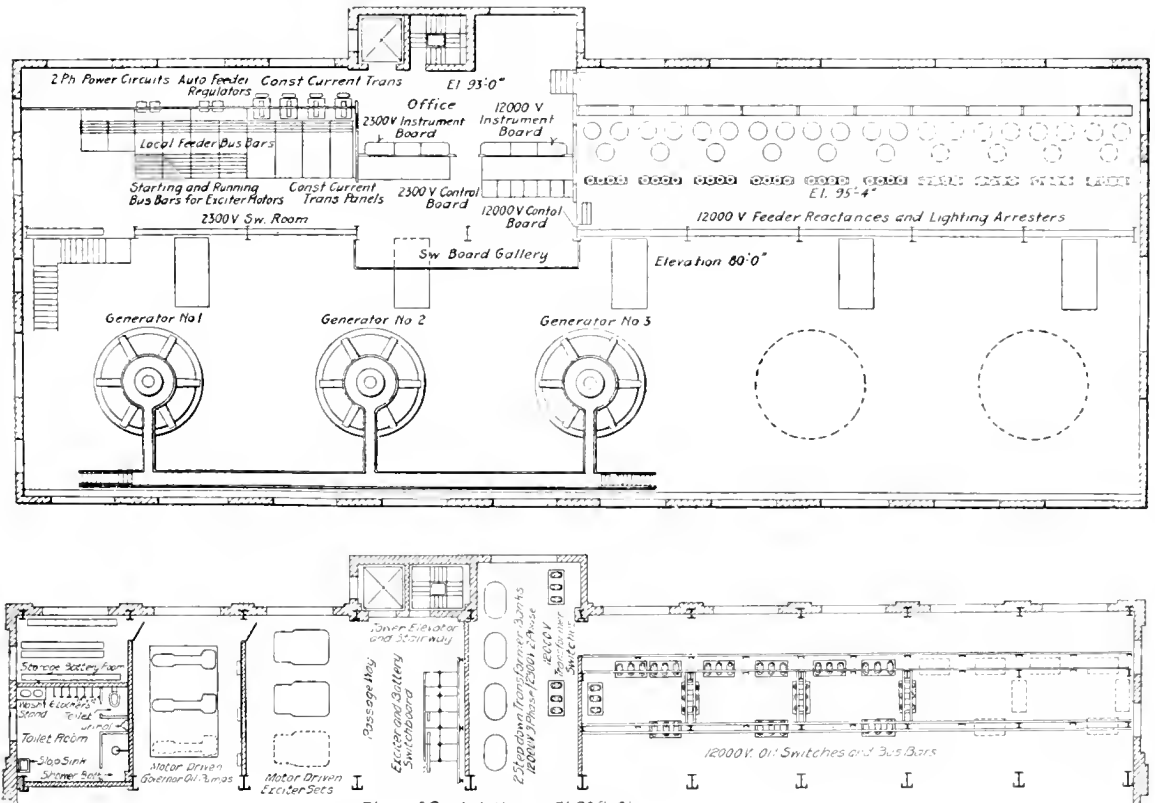


Fig. 6. Plan View of Generator Room and Gallery Sections

lamps are supplied for the generator room. The various gallery sections are lighted from ceiling fixtures containing 100-watt lamps.

The building is arranged for heating by steam in winter when necessary, a small boiler being provided for this purpose. Figs. 5 and 6 show the general plan and arrangement of the power house and apparatus.

Waterwheel and Governing Equipment

The waterwheels are of the vertical shaft single-runner Francis type having a combined radial and axial flow, and a single downward discharge into concrete draft tubes. The normal rating of the wheels is

at a constant speed of 185 r.p.m., are as follows.

10,000 h.p. at 96 feet head	85 per cent
9,000 h.p. at 90 feet head	87 per cent
8,000 h.p. at 84 feet head	88 per cent
7,000 h.p. at 78 feet head	86.5 per cent
6,000 h.p. at 72 feet head	84 per cent
5,000 h.p. at 66 feet head	80 per cent

The speed regulation is based on a total flywheel effect of 1,700,000 (WR²), a pipe line diameter of 11 ft., and a pipe length of 190 ft., and is as follows for different load changes:

Load change,	10%	25%	50%	100%
Speed change,	0.9%	2.1%	3.5%	16%

The governors will restore the speed of the units to within 0.5 per cent of normal from any change in load and will begin to act before the speed has changed more than 0.5 per cent from normal, thus giving a very close speed regulation.

The runner is built of a special mixture of cast iron in a one-piece casting, the cores being specially treated in the foundry to give a very smooth surface on the casting itself, which was carefully machined on all exterior surfaces and carefully balanced in the factory. The runner has a specific speed of approximately 60, and is 75 inches in diameter, measured at mid-point between the hub and pan of the runner.

The complete unit is steadied by two guide bearings, one being furnished with the generator and one with the waterwheel. The bearing on the waterwheel is lined with lignum vitae and is lubricated by means of properly filtered water.

The weight of each complete waterwheel unit is approximately 135 tons; the weight of each volute casing is approximately 60 tons, and of the runner approximately 7 $\frac{1}{2}$ tons.

The turbine gates, together with the stems, are single-piece steel castings, and are machined to present the smoothest possible surface to the water flow. The gates are supported in proper position by hard bronze bushings in the casing heads. Each gate stem is connected to a main operating gate ring by a gate arm, which is attached to the stem by a tapered shank feather key, washer and nut. The main operating gate ring is supported in bronze bearings on the upper casing head and is operated by means of two specially designed servo motors, which rest upon the main casing itself. The governor actuators which control the flow of oil to the servo motors are located on the generator floor. The governor pulleys are driven by means of geared and belted connections to the main waterwheel shaft, and anti-racing mechanisms are provided between the governor actuators and the piston rods of the servo motors. Each governor is provided with an electric synchronizing motor and mechanism for operating the governor from the main benchboard, and also additional means for efficient hand control.

The governor oil system is of the so-called open type. A central pumping station is provided with two pumps of the triplex type, and space for one more in the future installa-

tion. Each pump is large enough to supply the demands of three units, thus allowing one pump to be held as a spare in case of emergency in either the present or ultimate installation. The pump takes its oil from a specially designed sump tank located beneath the generator floor and delivers this oil to the servo motors through an 8-in. pipe line at a maximum pressure of 200 lb. per square inch. After being used by the servo motors the oil is returned to the sump tank through a 12-in. low pressure line, thus it passes through the necessary filters and screens into the original sump.

A specially designed band brake, capable of stopping the entire rotating element in five minutes, is provided on the main shaft between the waterwheel runner and the generator rotor. This brake consists of a flanged pulley rotating in a steel brake band into which are bolted blocks of maple, the band being tightened around the pulley by a worm gear operated by a hand wheel on the main generator floor. The complete brake mechanism is supported by a steel framework resting on cast iron sole plates in the concrete foundations.

The complete waterwheel equipment, servo motors, and governor oil pumping and piping systems were furnished by the Platt Iron Works Company. The governor actuators were furnished by the Lombard Governor Company.

Generators

The present installation consists of three generators of the vertical revolving field type. They are three-phase, 40-cycle machines, and are rated, on a maximum continuous basis, 9000 kv-a. (7200 kw., 0.8 power-factor), at 12,000 volts, 185 r.p.m. When operating under normal load at 0.8 power-factor, the temperature rise will not exceed 50 deg. C. on any part of the machine. The machines are designed with an internal reactance to limit the current of each generator under short circuit conditions to approximately eight times the normal full load value.

The guaranteed efficiencies are:

	Full Load	$\frac{3}{4}$ Load	$\frac{1}{2}$ Load
9000 kw., 1.0 power-factor	96.9	96.3	94.8
7200 kw., 0.8 power-factor	96.0	95.3	93.5

The regulation at 0.8 power-factor is guaranteed to be 14 per cent, and the maximum excitation required 55 kw. at 250 volts.

The armature winding consists of form wound coils of the barrel type, all coils being interchangeable. The windings are Y-connected, but the neutral connection is not brought out to the terminal board at present. Temperature coils are installed in the armature winding in accordance with the latest practice.

The entire weight of the revolving element, including the generator rotor, turbine runner and shafts, is carried by a standard Kingsbury bearing. One guide bearing is also supplied with the generator, and is located directly below the thrust block.

Fig. 7 shows the general mechanical arrangement of the generators, and the heavy bracket arm construction on which is supported the Kingsbury bearing. A gallery is provided on the top of the machine to facilitate inspection

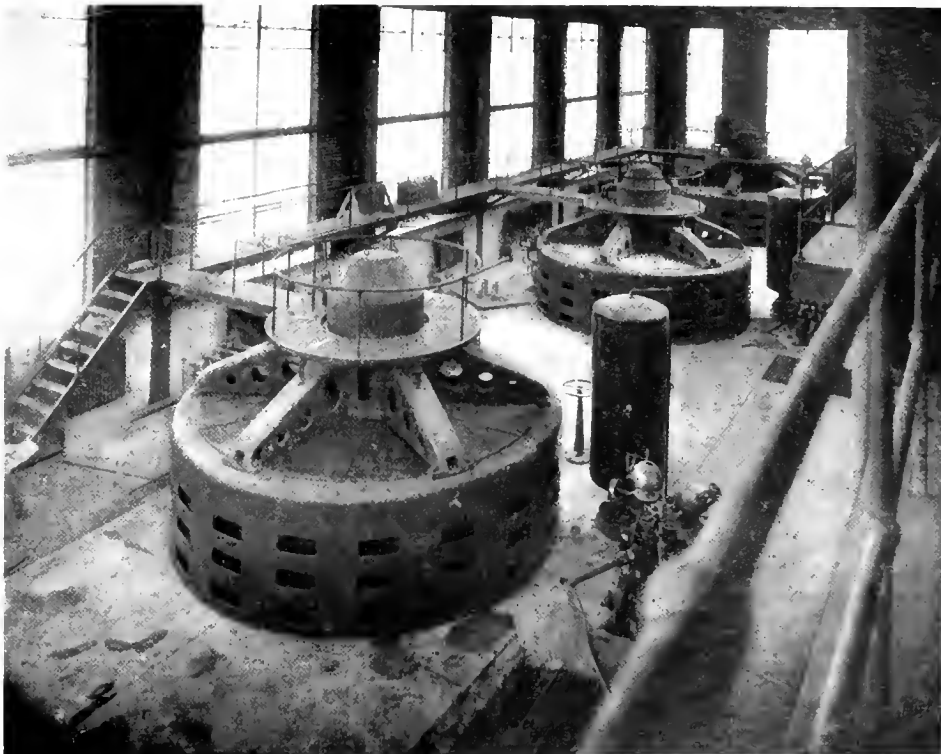


Fig. 7. View of Generator Room showing the 9000 kv-a. Generators

The rotor spider is made up of one solid steel casting, with the pole pieces dovetailed to the main spider, and the whole rotor designed to withstand 80 per cent over speed with an ample factor of safety. The flywheel effect (WR^2) of the rotor is 1,700,000 pound-feet.

The collector rings are brought out below the rotor, eliminating the necessity of carrying the field connections to the top of the machine, either outside the stator frame or through a hollow shaft. Any inspection that may be necessary can be made from the pit below the machine.

tion of the bearing, etc., and from this a bridge leads to the river side of the generator room, where a long narrow gallery is provided which connects with each generator and is reached from the floor level by a stairway at either end.

Particular attention has been given to the ventilation of the generators in the design of the station. The oversight of this important feature in stations otherwise well designed has often led to considerable trouble from overheating of the generators; for if no provision is made for admitting fresh air, the air in the machine pit is used over and

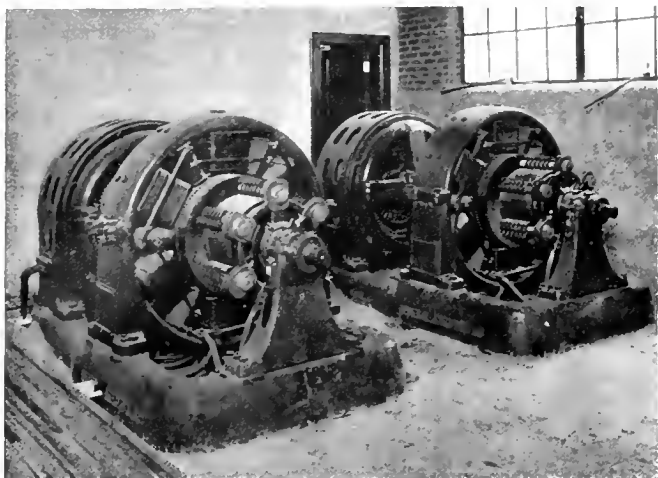


Fig. 8. Motor-driven Exciter Sets

over. Fresh cool air is taken from the outside to the generator pit through air passages specially designed for this purpose, and from this pit the air is drawn up through the machine by the fanning action of the rotor, and discharged through ducts in the stator into the room.

The generator field rheostats are motor-operated and controlled from the bench-board, the motor panels being located back of the auxiliary switchboard on the first floor and the rheostats placed beneath in the rheostat room already described.

A very complete oiling system is installed for the generators, each generator oil line being equipped with sight flow indicators, oil meters, recording and indicating thermometers. Two storage tanks are located in the roof trusses and a filtering equipment in the basement.

The outside diameter of the generator is 16 ft. 4 in. and that of the rotor 12 ft. $5\frac{1}{8}$ in.; the weight of the stator being 57,000 pounds and that of the rotor 64,400 pounds.

Exciters

Excitation is furnished by two horizontal motor-driven exciter sets, each exciter being rated 165 kw., 250 volts, 800 r.p.m. The driving motor is a two-phase, 40-

cycle 2300-volt, form "K" induction motor rated 250 h.p. The exciters are compound wound, with interpoles, and each of sufficient capacity to provide excitation for three generators at full load. In the ultimate installation one additional set of a similar type will be installed as a spare unit.

A TA voltage regulator is provided on the switchboard for use with the exciters, and under normal conditions each exciter will feed into a common exciter bus, from which the generators will receive their excitation. As will be seen from reference to Fig. 7, a double-throw switch is also provided so that either exciter can be thrown on to the direct current power bus, from which the crane is operated.

The induction motors are started from a starting bus taking power from 50 per cent taps on the 2300-volt transformers, so that no starting compensators are required. Fig. 8 shows a view of the exciter sets.

Transformers

There is at present no high tension transmission system, the bulk of the power being delivered at the generator voltage of 12,000

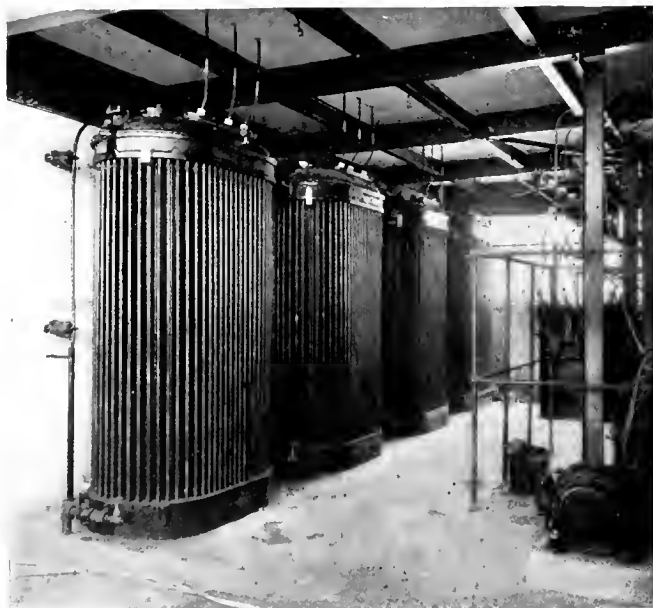


Fig. 9. 400-kv-a. Transformers and Controlling Oil Switches

volts, and therefore step-up transformers are not required.

Four single-phase transformers in two banks are provided to furnish power to the 2300-volt feeders, the street lighting circuits, and the induction motors of the exciter sets. They are oil-insulated, oil-cooled units, each rated 400 kv-a., with 25 per cent overload for two hours. They transform from 12,000 volts, three-phase to 2300 volts, two-phase, and are T-connected on the primary side and four-wire on the secondary side. They have four $2\frac{1}{2}$ per cent secondary taps, and also 50 per cent starting taps for the induction motors. The guaranteed efficiencies at full load is 98.1.

Reactances are placed in each outgoing 12,000-volt feeder and on the primary side of each transformer circuit.

Switchboard and System of Connections

The switchboard equipment consists of three separate boards, viz., the main benchboard, a vertical control board, and one combination exciter and station service board. There are also four independent constant current street lighting panels. All the boards are made of natural black slate, with the exception of the four constant current panels which are blue Vermont marble.

The benchboard controlling the 12,000-volt section of the station, including the generators, exciters, 12,000-volt feeders and bus, consists of seven panels, each with a vertical panel back of it, the whole being enclosed by grille work. There is one combination exciter and transformer panel, two combination generator bus sections and outgoing feeder panels, one combination generator and outgoing feeder panel, two future generator and outgoing feeders (one of which has one bus section equipment installed at present), and one station panel.

The bench section has a mimic bus, showing in detail a complete one-line diagram of the main station equipment. This also contains the control switches for the remote controlled oil switches and the synchronizing receptacles. The vertical section above the bench contains the indicating meters, each generator circuit being provided with an ammeter in each phase, a voltmeter and indicating wattmeter, a power-factor indicator, a speed indicator, and a field ammeter. Each exciter has an ammeter, and one common voltmeter is provided, which can be connected to any exciter. The vertical section below the bench contains the control switches for the remote controlled rheostats and governors, the exciter

and equalizer rheostat handwheels, and the station bell alarm relay.

The vertical section in the rear of the bench panels, which as mentioned above is inside the office, contains the recording and curve-

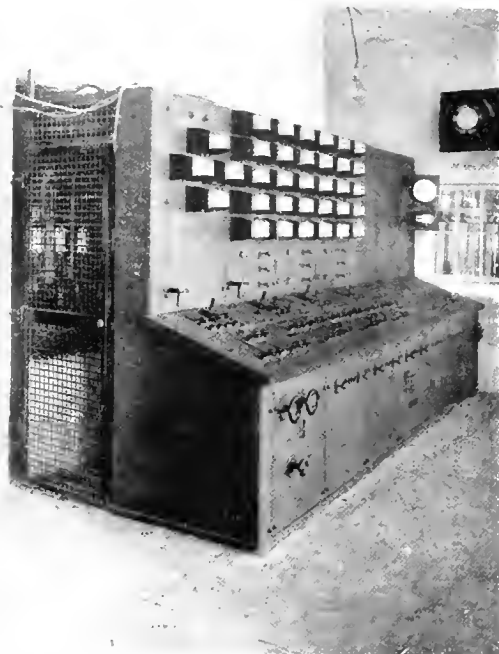


Fig. 10. View of Benchboard

drawing meters, relays and testing terminals for this equipment. A rather novel and useful arrangement is a flat slate bench or table below the testing terminals, extending the full length of the board and about 20 in. wide, which is provided for convenience in meter testing. A curve-drawing wattmeter is provided for the totalizing panel, and a recording wattmeter for each of the outgoing 12,000-volt feeder circuits.

The double vertical board controls the 2300-volt section of the station, and the general arrangement of this is similar to the benchboard, except that there is no bench section. This consists of seven panels with corresponding rear panels. On the central part of the panels is another mimic bus showing a one-line diagram of the 2300-volt equipment, with the indicating meters above. A TA250, K22 voltage regulator is mounted at one end of the board for maintaining the correct field voltage under all conditions of load.

The back section is similar to that of the main benchboard and mounts recording watti-

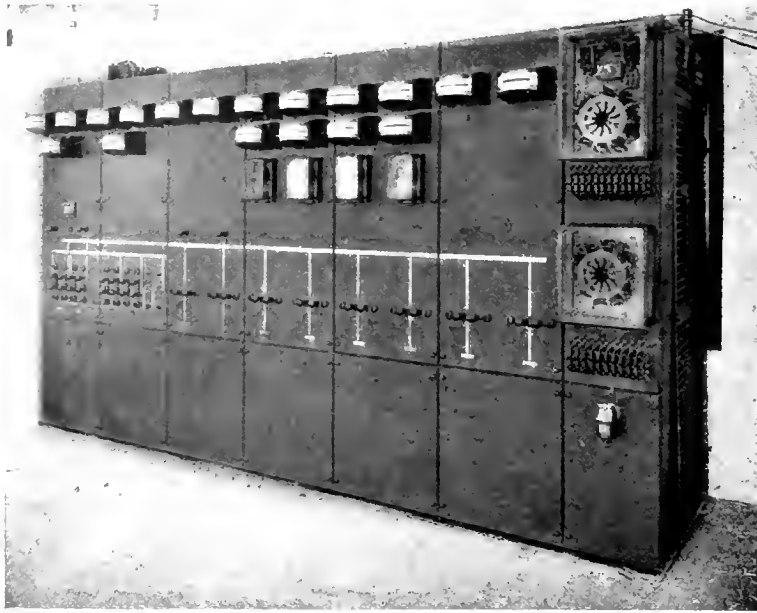


Fig. 11. 2300-volt Control Switchboard

hour meters, relays and testing terminals. It also has a testing meter bench similar to that of the benchboard.

The solenoid-operated remote-controlled generator field switches, the exciter line switches, low-voltage station lighting and power feeder switches, and storage battery control are mounted on a vertical board consisting of six panels. This board is located on the first floor near the first floor near the exciters, all other switchboards being on the first gallery.

The general system of connections of the whole station is shown in Fig. 13. From this it will be noted that the control of the station is really divided into two sections, one the 12,000-volt, three-phase section, including the main generators, ring bus, and 12,000-volt outgoing feeders; the other the 2300-volt, two-phase section, including the induction motors, 2300-volt outgoing feeders, constant current feeders, and the station service equipment through the step-down transformers.

The generator, bus section, and outgoing 12,000-volt feeders are all equipped with K21, solenoid-operated oil switches. The generator switches are of 500 amperes capacity, non-automatic. The bus section switches are 800 amperes and also non-automatic, but the two end switches are arranged so that they can be made automatic by throwing in current transformers and inverse time limit relays through a small knife switch on the benchboard. The outgoing line and transformer switches are of 300 amperes capacity, automatic type, and are also fitted with inverse time limit relays. Provision is made for a fourth oil switch in the main generator circuit in case it is

later decided to bring out and ground the neutral. On the 2300-volt equipment, K5 oil switches are used throughout, and are solenoid-operated except on the street lighting feeders, which are hand-operated. They are automatic and also equipped with inverse time limit relays, with the exception of the switches between the transformers and

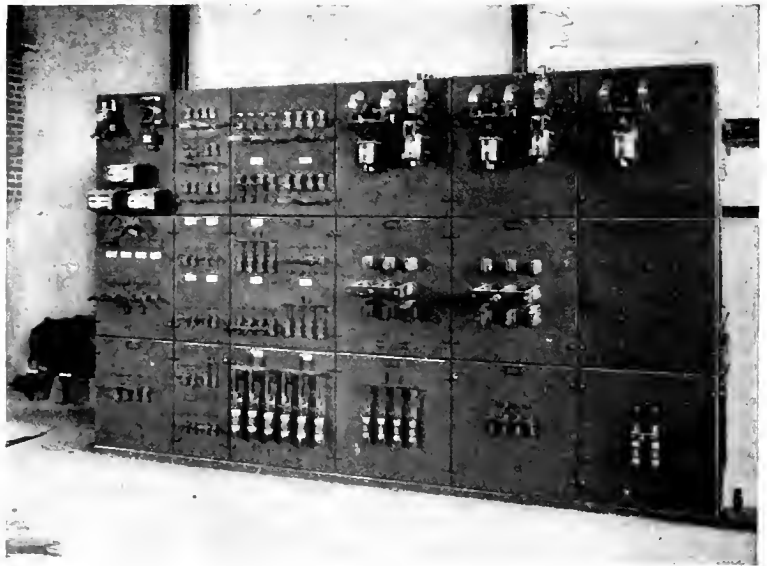


Fig. 12. Exciter and Auxiliary Switchboard and Battery Charging Set

induction motor busses which are non-automatic.

A 125-volt, 60-cell storage battery furnished by the Electric Storage Battery Company is installed for supplying the control circuit and emergency lighting. This has a 200-ampere maximum instantaneous discharge rate and a 10-ampere, 8 hour rate. For charging the battery a 3 $\frac{1}{2}$ -kw. battery charging set is supplied and is operated continuously with the battery floating. The generator is driven by a 220-volt, two-phase motor, the set being located on the first floor near the auxiliary switchboard.

Lightning Arresters

The 12,000-volt feeders are each supplied with triple-pole aluminum cell lightning arresters arranged for an ungrounded system. On the 2300-volt feeders double-pole multi-gap graded shunt arresters are used and for the constant current are circuits, double-pole horn gap arresters are supplied.

Distribution System, Etc.

There are at present six outgoing 5000-kw., 12,000-volt, three-phase feeders, with provision for a future installation of four more; two 2300-volt, two-phase, four-wire power

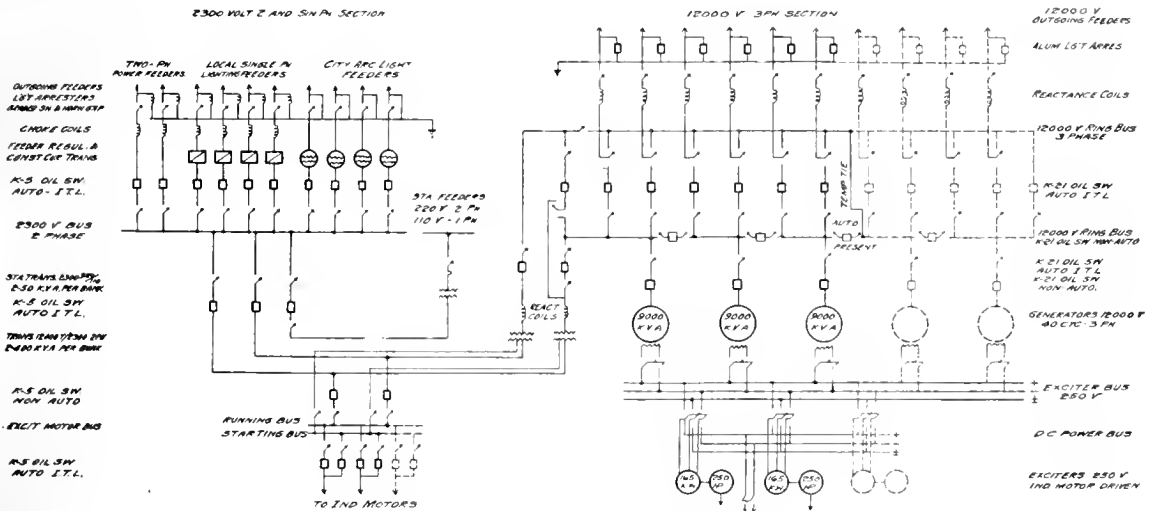


Fig. 13. One-line Diagram of Station Connections

Station Auxiliary Equipment

Energy for the station lighting and small motor service is supplied from the 2300-volt, two-phase bus through two 50-kv-a., single-phase transformers, giving 220/110 volts on the secondary side, the motors all being arranged for 220-volt, two-phase service. One spare transformer unit is furnished.

Single-phase, induction type automatic feeder regulators are installed in each of the 2300-volt local feeders and are supplied complete with limit switches, contact-making voltmeters, line drop compensators, etc. They are designed to give five per cent buck or boost. The constant current transformers are rated 75 light, 2300 volts, 6.6 amperes.

A motor-driven air compressor with automatic governor and supply tanks is installed for general station work.

and tie feeders, four 2300-volt, single-phase local feeders, and four are lighting circuits.

The 12,000-volt lines leave the station through roof entrance bushings in the roof of the gallery section, and the 2300-volt lines through wall entrance bushing. All lines run to steel towers set on extensions of the concrete foundation of the gate house, the 12,000-volt lines being placed at the top and the 2300-volt lines below. From these towers the Troy and Albany lines will go over the roof of the gate house and across the canal, then directly to these two cities; the Cohoes lines running in a general downstream direction, the 12,000-volt lines going to the various mills and the 2300-volt tying into the existing distribution system.

* The street lighting feeders will supply a series incandescent system for the city of

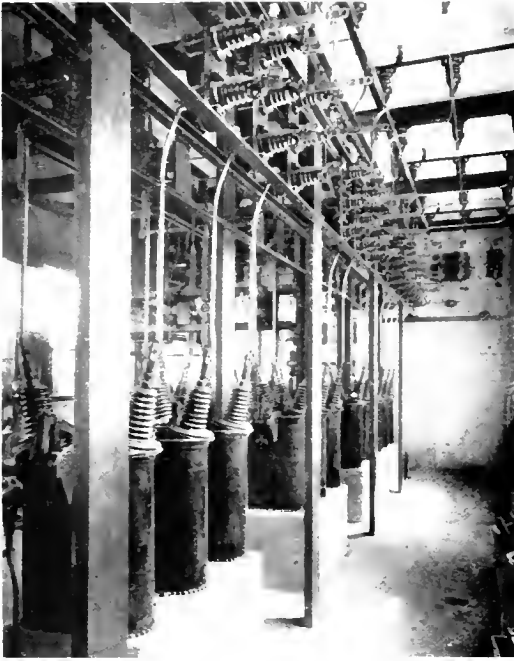


Fig. 14. 12,000-volt Oil Switch and Bus Arrangement

Cohoes and the single-phase feeders will furnish power for commercial lighting, etc. The two-phase feeders will tie in for emergency power with a small water power station of the Cohoes Company located about three-quarters of a mile below, and known as the Champlain Dam station, and also with the steam station of the Harmony Mills. This steam station has a capacity of 2500 kw., power being generated at 600 volts, 40 cycles, three-phase, and stepped up for the tie line to 2300 volts, two-phase by two 50-kw. T-connected transformers. This steam station will be retained by the Harmony Mills, as steam is required in some of their manufacturing processes as well as for heating, and it can also be utilized for emergency service.

Of the 12,000-volt lines, two are to run to Troy and two to Albany, the transmission lines for which will be erected later, and the other two will feed the numerous mills and factories in Cohoes. This mill load will be one of the principal divisions of the load on the new station, as there are at present some 36 mills that it is expected will be connected to the system, taking a total load of over 6000 kw. Of this amount over one-half will be delivered to the Harmony Mills. At this mill and some of the other larger ones, outdoor transformer substations will be installed to step down to 600 volts for the mill service.

Organization, Etc.

The entire engineering work of the installation, including the hydraulic and electrical work, has been done by Sanderson & Porter, of New York City with Mr. Thomas E. Murray as Consulting Engineer. The construction work has been carried on under their supervision and directly by the Cohoes Company, of which Mr. L. Semple is President, Mr. W. P. Parsons, General Manager, and Mr. A. C. Polk, Construction Superintendent.

The electrical equipment of the power station, with some minor exceptions, was supplied by the General Electric Company.

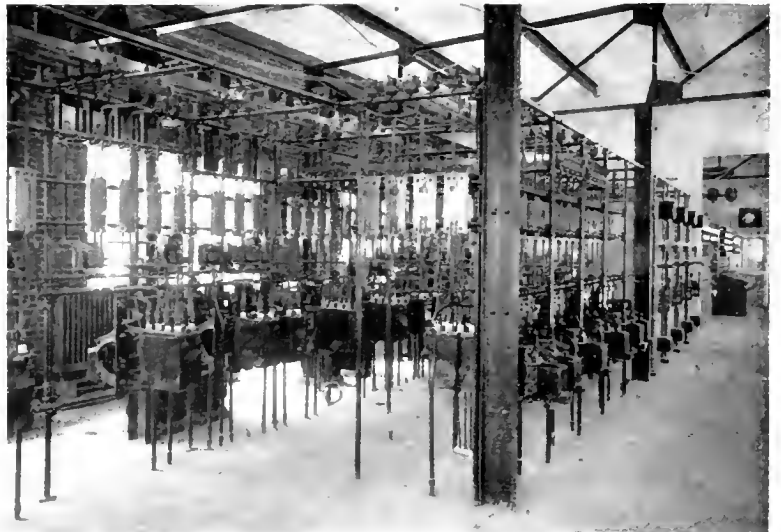


Fig. 15. View of 2300-volt Oil Switch and Bus Arrangement; also Series Lighting Panels

X-RAYS

PART II

BY DR. WHEELER P. DAVEY

RESEARCH LABORATORY, GENERAL ELECTRIC COMPANY

This installment of the series of articles on X-rays treats of the general properties that are possessed by all rays of this name. The introductory paragraph lists the properties, and these are described in detail under their respective headings in the article.—EDITOR.

There are certain general properties which are common to all X-rays. Among these are

- (1) The fluorescent effect
- (2) The photographic effect
- (3) The ionizing effect
- (4) The chemical effect
- (5) The dehydrating effect
- (6) The photo-electric effect
- (7) The action on a selenium cell
- (8) The penetrating effect
- (9) The physiological effect

(1) The Fluorescent Effect

Certain uranium compounds and certain salts of the alkali and alkali-earth metals have the property of fluorescing, i.e., of giving off visible light when exposed to the action of X-rays. Many of these compounds phosphoresce, i.e., continue to give off light, for a short time after the X-rays have been cut off. In order to be of great use in X-ray work, a fluorescent screen should possess the following characteristics: (a) the color of the light should be such as to give good visual acuity; (b) the intensity of light per unit intensity of X-rays should be as great as possible, and should not decrease with continuous operation of the screen; (c) there should be as little phosphorescence as possible, and (d) the crystals of the fluorescent salt must be so small that the "grain" of the screen is not visible when the screen is in use.

The selection of a material possessing these qualifications is a long tedious task, for the fluorescent properties of a given salt are greatly changed by the addition of minute amounts of impurities. A salt showing almost no fluorescence when pure may fluoresce brightly when mixed with but a fraction of one per cent of some other salt. In spite of the fact that each formula for fluorescent material is entirely empirical, there are three or four varieties of screens on the market which meet the requirements given in the preceding paragraph. All of these give off light whose intensity is determined by the current through the X-ray tube, the voltage across the tube, and by the

distance from the target of the tube. If the intensity of the fluorescent light is plotted against either the current or the voltage, the resulting curve is a straight line or a succession of straight lines.* As would be expected, the intensity varies inversely as the square of the distance between the fluorescent screen and the target of the tube.

(2) The Photographic Effect

X-rays have much the same effect on a photographic plate as ordinary light. Just as photographic plates are more sensitive to certain wave lengths of light than to others, in the same way they are found to be more sensitive to certain wave lengths of X-rays than to others. This is usually explained by assuming that the plate is most sensitive when exposed to X-rays of such wave length as will excite characteristic secondary rays from one or more of the elements in the emulsion. Since all manufacturers do not necessarily use the same chemicals in making their X-ray plates, it follows that (a) all brands of plates do not have the same speed when excited by X-rays of the same wave length, (b) a plate which is exceptionally "slow" when excited by rays of long wave length (i.e., little penetrating ability) may be quite "fast" when used with rays of short wave length (i.e., great penetrating ability).

It is impossible to focus X-rays as one would focus visible light in ordinary photography. Radiographs are merely *shadow pictures*. If all parts of the object to be radiographed were of the same transparency to the rays,† all that one could possibly obtain would be a uniform blackening of the photographic plate. But, if one part of the object is more opaque to X-rays than some other part, then the radiograph will show a corresponding change in density. Thus we are able to obtain radiographs of the human body because of the different opacities of

* J. S. Shearer, Amer. Jour. Roent., November, 1914.

† Transparency to X-rays has no relation to transparency to ordinary light. An object may be quite opaque to ordinary light and yet be very transparent to X-rays, and vice versa.

various tissues, and it is possible to show holes in metal castings because of the differences caused in the thickness of the metal.

In ordinary photography the chief variables to be considered are *exposure* and *development*. In radiography there is an additional variable,

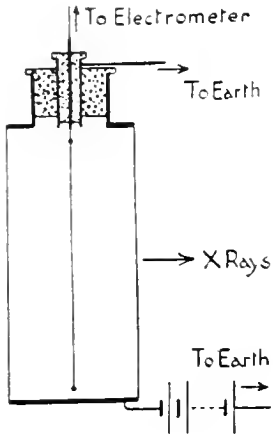


Fig. 1. An Ionizing Chamber

namely, *penetration*. In choosing the proper penetration, the radiographer must constantly bear in mind that as the penetrating ability of the X-rays is increased there is an increased tendency to blur the picture, because of scattered rays. It is also necessary to remember that a radiograph taken with very penetrating rays is less "contrasty" than one taken with rays of moderate penetration. For any given amount of exposure, the optimum penetration is, therefore, that penetration at which the most opaque part of the object permits only a very slight darkening of the photographic plate.

Radiographs are always examined as *negatives*. A radiograph is therefore of proper density when it can be easily viewed against a clear north sky. This is, as a rule, much denser than is advisable for making the best positive prints.

(3) The Ionizing Effect

If a charged body is exposed to X-rays, it will be found to lose its charge. This is explained by assuming that the air in the path of the X-rays becomes broken up into *ions*, or electrically charged atoms. The air thus becomes a conductor of electricity and

causes the charge to leak away. While the quantity of charge carried by different ions is not always the same, still it is always some exact whole number times 4.9016×10^{-10} electrostatic units of charge.*

Fig. 1 shows an ordinary form of ionization chamber. Two thin sheets of aluminum foil form the ends of a metal cylinder. Midway between them and insulated from them is another thin piece of aluminum foil. This middle sheet is connected to a quadrant electrometer, or to an electroscope. In some cases it is possible to obtain a current large enough to measure with a galvanometer connected between the inner and outer plates. This type of ionization chamber has many advantages. (Some of its objectionable features will be taken up later.)

Suppose such an ionization chamber to be exposed to the action of X-rays of constant intensity and wave length. If the difference of potential between the inner and outer sheets is small, the ionization current will be small. As this difference in potential is increased, the ionization current increases, but at last a condition of "saturation" is reached in which the current is independent of the voltage. At very high potential differences the current once more increases and sparking soon occurs. Fig. 2 shows the form of the voltage-current curve of an ionizing chamber.

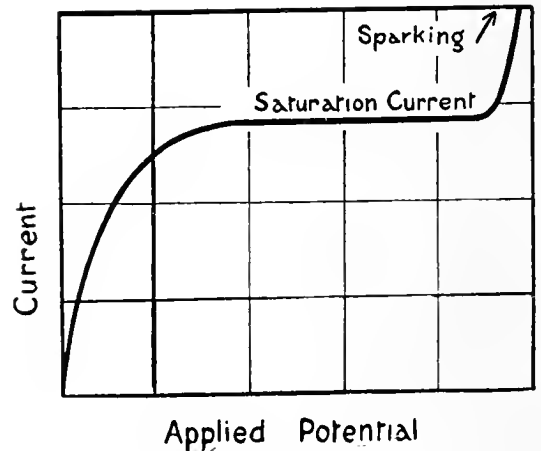


Fig. 2. Voltage-Current Curve of an Ionization Chamber

In scientific work *quantity of X-rays* is measured in terms of the amount of electricity which the rays are able to cause to flow from one terminal of the ionizing chamber to the other. In such measurements it is absolutely necessary to have a saturation current

* R. A. Millikan, *Science*, 23, pp. 436-448, Sept. 30, 1910. This is the strongest evidence we have that electricity has an atomic structure. The charge on an electron is 4.9016×10^{-10} units.

through the ionizing chamber, otherwise the amount of electricity carried across will depend largely upon the potential difference between the plates of the chamber. It is also necessary to make sure that the chamber is of proper design and of suitable material.

Owen,* and Barkla and Philpot† have shown that, except when characteristic rays of the gas were strongly excited, ionization in that gas was practically independent of the wave-length of the X-rays employed. Their results are collected in Table I. Methyl Iodide appears to be an exception to this rule.

In a previous article it was stated that when X-rays of sufficient penetrating ability fell upon a body that body became a source of characteristic X-rays. Under such conditions the body also gives off a large number of electrons (secondary corpuscular radiation). These electrons have the ability to ionize any gas in which they find themselves. It is at once evident that there are serious limitations imposed upon an ionizing chamber. Before the amount of electricity transferred from one terminal to the other may be taken as a measure of the *quantity of X-rays*, it is necessary to make sure that the material used in its construction is not giving off secondary corpuscular radiation. It is equally necessary to make sure that the gas used in the chamber is not itself giving off secondary corpuscular radiation. An ideally designed chamber is so constructed that it is impossible for the direct X-ray beam, or the secondary X-rays scattered by the gas, or the secondary rays characteristic of the gas to strike its walls. It is almost impossible to design a chamber such that all these con-

ditions will be fully met under all circumstances. Usually the design is made such as to be quite satisfactory for use with the wave-length of rays that are to be measured.

In many cases it is necessary to measure the total amount of energy in the X-ray beam. This may be done by using an ionization chamber long enough to completely absorb all the rays.

C. T. R. Wilson has shown‡ that it is possible to condense water-vapor upon ions, thus making the path of the ions visible. Fig. 3 shows the arrangement of his apparatus. A steel ball was fastened to a very heavy ball by a thread. The heavy ball was hung by a stout cord. When the cord was suddenly loosened the ball dropped a short distance, opening a valve. This caused the bottom of the expansion chamber to be quickly lowered and produced a condition of supersaturation of the moisture in the expansion chamber. The stopping of the large ball broke the thread, thus allowing the smaller steel ball to fall freely. In its descent it closed a spark-gap, allowing a condenser discharge to pass through the X-ray tube. After a predetermined interval it closed a second spark-gap which allowed another condenser discharge to pass through a mercury vapor lamp. This illuminated the cloud in the expansion chamber, and enabled the paths of the ions to be photographed. A characteristic photograph is shown in Fig. 4. As a result of his work Wilson could find no direct action of the

* E. A. Owen, Proc. Roy. Soc. A, 86, pp. 426-439, 1912.

† Barkla and Philpot, Phil. Mag. xxv, pp. 832-856, 1913.

‡ Proc. Roy. Soc. A 85, p. 285, 1911.

Proc. Roy. Soc. A 87, pp. 277-292, 1912.

TABLE I
RELATIVE IONIZATION PRODUCED IN VARIOUS GASES BY HOMOGENEOUS X-RAYS

Element Emitting Characteristic K Radiation	IONIZATION RELATIVE TO AIR = 1					
	H ₂ (Beatty)	O ₂ (B.&P.)	CO ₂ (Owen)	SO ₂ (Owen)	C ₂ H ₅ Br (B.&P.)	CH ₃ I (B.&P.)
Fe	0.00571	1.37	1.58	11.3	41.2	
Ni		1.35	1.55	11.6		162
Cu	0.00573	1.38	1.55	11.8	42	152
Zn	0.00570	1.42	1.54	11.5	41.6	
As	0.00573	1.27	1.51	11.7	42.2	158
Se		1.31	1.53	11.8	41.7	
Sr		1.28	1.53	11.8	153	
Mo		1.28	1.54	11.5	213	188
Ag		1.32			272	198
Sn	0.04	1.29			335	205
Sb		1.28				
I						211
Ba						251

X-ray upon the gas. The only role of the X-rays seemed to be that of causing the gas to give off electrons (i.e., ionize the gas). These electrons, by impact upon the molecules of the gas, cause further ionization.

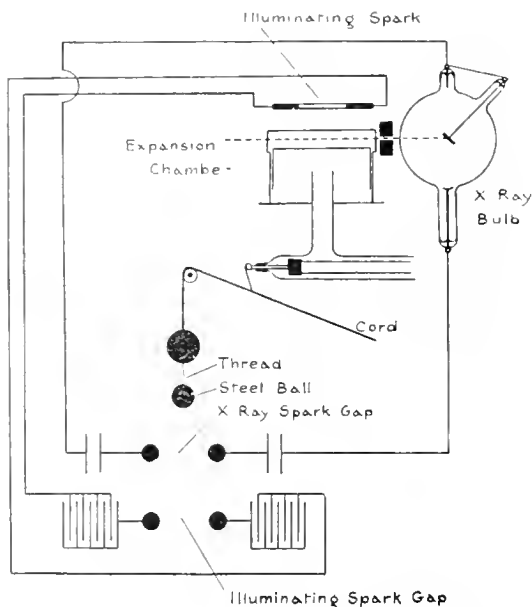


Fig. 3. Diagram of Wilson's Apparatus for Photographing the Paths of Ions

(4) The Chemical Effect

Except for the action of X-rays upon the materials in the film of a photographic plate, the only chemical actions so far noticed seem to be a precipitating effect, and a hydrolytic effect. Iodine is precipitated from its solution in chloroform by exposure to the rays.*

Schwartz has found an ammonium oxalate-mercury bichloride mixture which precipitates calomel under the action of X-rays.†

When starch is exposed to the rays, it is changed into soluble starch and then into dextrin.‡

(5) The Dehydrating Effect

Ammonium, potassium, barium, and magnesium platinocyanides change color when exposed to X-rays, due to dehydration.§

(6) The Photo-Electric Effect

As was stated in the discussion of ionization, when a body gives off characteristic X-rays it also gives off electrons. These electrons leave the body with the same velocity that a cathode stream would need to in order to produce the X-rays characteristic of that body, this is true no matter what the intensity or wave-length of the exciting X-rays may be. This effect corresponds in every way to the well known photo-electric effect in which a clean metal surface gives off electrons when illuminated by ordinary light.

(7) The Action on a Selenium Cell

X-rays affect the electric resistance of a selenium cell in the same manner as light.¶

(8) The Penetrating Effect

All substances exert more or less of an absorbing effect on X-rays. In general, the absorbing effect of any given substance for a given bundle of rays depends upon the material used as a target in the tube, the nature and thickness of the absorbing substance, the history of the radiation after leaving the target, and the potential drop across the tube at the instant the given bundle of rays is given off. Ordinarily, if the target in the tube is a substance of high atomic weight, then rays from that tube will be less readily absorbed than if the target had been of low atomic weight.

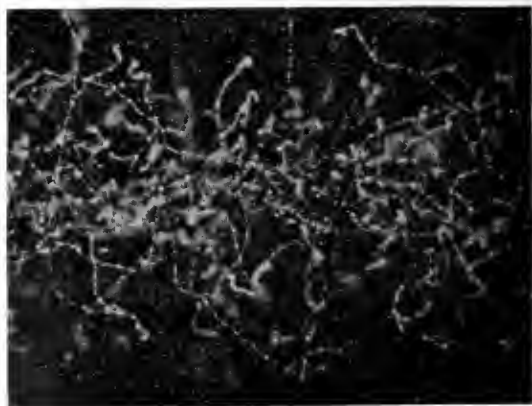


Fig. 4. Photograph of Paths of Ions taken by C. T. R. Wilson

When rays from an ordinary X-ray tube pass through a substance some of the radiation is absorbed, so that the emergent beam acts more feebly on a fluorescent screen, photographic plate, selenium cell, or ionizing chamber. If rays from a platinum-target

* H. Bordier and J. Galimard, Arch. d'Elect. Med. 14, Aug. 10, Sept. 10, 1906.

† G. Schwartz, Wein Med. Presse, xlvij, 2092, 1906.

‡ Colwell and Russ, Arch. Middlesex Hosp. xxvii, p. 63.

§ Bordier and Galimard, Arch. d'Elect. Medical, May 10, 1905.

G. Holzknicht, Arch. d'Elect. Med., Oct. 10, 1910.

¶ Perreau, Comtes Rendus 129, pp. 956-957, Dec. 4, 1899.

Athanasiadis, Ann d. Phys., 27, 4, pp. 890-896, Nov. 26, 1908.

tube, operating under ordinary working conditions, are made to pass through silver, the intensity of the emergent beam may be calculated from the formula,

$$I = I_o e^{-\lambda x}$$

in which

I_o = intensity of the incident beam.

I = intensity of the emergent beam.

e = base of natural logarithms = 2.7182.

x = thickness of the absorber.

λ = coefficient of absorption of the substance used as absorber.

λ is very approximately independent of the thickness of the silver.*

All substances for which the above law holds true[†] are said to be "aradiochroic." If, however, the rays are made to pass through sheets of aluminum, tin, etc., the above law does not hold. The value of λ as calculated by the formula is different for different thicknesses of the absorbing sheet; but, as the thickness is increased, λ approaches more and more nearly to a constant value, and the law holds approximately if the sheet is thick enough. The formula may also be made to apply approximately if the difference in thickness between two absorbing sheets is so small that the value of λ has not changed appreciably, due to the change in thickness. Absorbers which act in this way are said to be "radiochroic," and are often called "filters."

These facts may be explained by assuming that an X-ray tube sends out a complex radiation ("heterogeneous beam") composed of primary rays and secondary rays characteristic of the target. In aradiochroic substances the coefficients of absorption for the component beams are approximately the same. In radiochroic substances the beams are unequally absorbed. If the filter is thick enough to completely absorb all but one of the components, the emergent beam is said to be "homogeneous," and the absorption law will hold accurately for any absorber through which the beam may subsequently pass, provided no secondary rays characteristic of the absorber are produced. It is to be noticed that no substance is absolutely aradiochroic. Silver is probably the most nearly aradiochroic metal for the rays given off by a tube with a platinum target; but it is quite radiochroic for the rays given off by a lead target,‡ because of being more opaque to the "secondary" component than to the "primary" component of the beam. If the absorber is of the same material as the target, it is more opaque to the "primary" component than to the

"secondary" component; but the two absorption coefficients may be so nearly equal as to cause the absorber to appear under some conditions to be almost completely aradiochroic.‡

If the absorber is of the same material as the target, then λ decreases as the potential difference across the tube is increased, and the decrease of λ with the increase of the potential difference is much more marked the higher the potential difference employed.§

If the absorber is a chemical compound, the total absorption under any specified conditions is the sum of the various absorptions caused under those conditions by the various atoms and radicals of which the absorber is composed.¶

As a rough-and-ready means of determining the penetrating ability of X-rays, physicians use what they call "penetrometers." Of these the Benoist and the Whenelt are the most accurate. In both of these instruments the opacity of a standard sheet of silver is matched against the opacity of aluminum of various thicknesses. In the case of the Whenelt penetrometer, a standard piece of silver is fastened to a fluorescent screen. A specially shaped wedge is slid past the screen until a thickness is at last reached such that the illumination of the screen under the aluminum is the same as that under the silver. The penetrating ability or "hardness" of the rays is read on an arbitrary scale.

The Benoist penetrometer consists of a disk of silver 0.11 mm. thick. Around this disk, arranged like a circular staircase, are steps of aluminum, each step being one millimeter higher than the one preceding. A radiograph of the penetrometer is taken and the "hardness" is defined as the number of millimeters of aluminum which are as opaque as the disk of silver. Care must be taken not to over-expose the radiograph, otherwise the whole negative will be blurred and a correct reading will be found impossible.

(9) The Physiological Effect

When X-rays are directed toward a given layer of flesh, in general, some of them pass through while others are absorbed and give up their energy to the flesh. If sufficient

* L. Benoist, *Journal de Physique*, 1901.

† J. Beloit, *Arch. d'Elect. Med.*, Aug. 10, 1910.

‡ W. R. Ham, *Phys. Rev.* xxx, 1, Jan. 1910, pp. 104-105, 118-120.

§ G. W. C. Kaye, *Camb. Phil. Soc. Proc.* 14, pp. 236-245, Oct. 15, 1907.

¶ *Roy. Soc. Phil. Trans.* A, 209, pp. 123-151, Nov. 19, 1908.

§ W. R. Ham, *Phys. Rev.* xxx, 1, pp. 108, 111-113, Jan. 1910.

¶ W. Seitz, *Phys. Zeitschr.* 13, pp. 476-480, June 1, 1912.

Blennard and Labesse, *Comtes Rendus*, 1896, cxxii, pp. 723-725.

energy is thus delivered to the flesh, serious pathological changes result which are of great importance from the viewpoint of the physician, but which do not concern the physical investigator, aside from the question of his own self-protection. A person in good health may have several radiographs taken (sufficient for ordinary diagnostic work) by a well-informed operator, without any danger of an X-ray burn; but the operator, or

* Archives of the Röntgen Ray, July, 1913.

research-physicist, must, because of the possibility of long-continued exposure or more often because of frequent repetition of short exposures, protect himself most carefully. The German Röntgen Society recommends that for work such as is ordinarily done by physicians the protection should consist of at least two millimeters of sheet lead, eight millimeters of X-ray proof rubber impregnated with lead, or lead glass from ten to twenty millimeters thick.*

WATER POWERS OF NEW ENGLAND

BY HENRY I. HARRIMAN

PRESIDENT OF CONNECTICUT RIVER POWER COMPANY

Mr. Harriman shows how the industrial centers of New England owe their origin to the presence of water power in their immediate neighborhood. He cites some of the early conditions governing the use of water power and refers to the available supply and the economies to be secured by their development.—EDITOR.

Conservation and efficiency are the passwords of the Twentieth Century. Conservation deals with the creation of effort; efficiency with its application, and together they symbolize the fundamental philosophy of our time, namely, that all energy and effort should be created in the most economical way, and applied in the most useful manner. Efficiency and conservation deal with all classes and kinds of human and mechanical effort, but they are particularly associated with the generation and application of power, and in this special field the use of electricity has become almost synonymous with efficiency, and its generation by water has, at least in the popular mind, become associated with conservation. It is therefore particularly fitting to briefly consider the utility and value of New England's very great water power resources.

The use of water power in New England dates back to its very earliest history. John Alden owned and operated a water mill near Plymouth, and near Little Compton, Rhode Island, can still be seen the old Peregrine White mill, owned by and named after the first white child born in New England.

Our forefathers in coming to this country were dependent upon their own efforts to raise their own food and build their own shelter, and among the first necessities of life that confronted them was the ability to

grind their corn and wheat into flour, and to saw the timber from which to make their homes. They were familiar with the grist mills and the saw mills of England, and well understood the construction and operation of primitive dams and waterwheels, and the use of the energy of falling water. It was therefore natural that our streams should have been put to useful labor in the very earliest Colonial days.

So vitally necessary to the life of the community did these water mills become that within seventy-five years after the landing of the Pilgrims at Plymouth, two of the colonies had evolved the principle of the Mill Act—a principle entirely unknown to the common law of England—which gave to the owner of a dam-site the right to flow out the land of his neighbor in order that water power might be created.

With this limited right of eminent domain thus early created, there also went a limited duty of public service, and in early Colonial times definite rates were sometimes established by law for the grinding of grain and the sawing of logs. The establishment by law of definite rates was, however, unusual, and more frequently the water mill was co-operatively owned and operated by the largest timber owners of the district. The opportunities for the development of power were, however, so many, and co-operatively

owned mills so numerous, that all vestige of public regulation ceased long before the outbreak of the American Revolution.

The doctrine of the English common law, that the riparian owner on a non-navigable stream owned the bed of the river to the center of the stream, has always been accepted in our New England states, as has also been the right of the owner to construct a dam upon his land, this right being subordinate, however, to the right of all owners along a water course to have the water flow by in a reasonably uninterrupted manner, and to the rights of the public to float logs and to exercise certain other public privileges.

The invention of the cotton gin, the loom and the spinning-jenny ushered in a new era in manufacturing, and greatly increased the demand for mechanical energy, and whereas, up to the beginning of the Nineteenth Century the use of water power has been very largely limited to the making of flour and lumber, with the advent of the new century there was witnessed a very great increase in the development of our streams for the operation of cotton and woolen mills, and associated industries. The process of manufacturing paper from ground wood was also developed, and a large amount of power so utilized. It is true that the steam engine had been invented, coincidentally with the other great inventions that signalized the close of the Eighteenth Century, but it was still a new and crude mechanism, and its use very limited. In fact it is fair to say that up to 1850, 90 per cent of the power required by our industries was derived from the energy of falling water.

New England has always been preëminent as a center for all kinds of manufacturing. Her rugged coasts and barren hills, and her relatively poor soil, did not lead to such an extensive development of agriculture as took place in our Middle and Southern states; and her trend was naturally toward the manipulation rather than the growing of raw products which could better be raised elsewhere. Hence there sprang up, around her more important and accessible water falls, great manufacturing centers, such as Lowell, Lawrence, Lewiston, Manchester, Holyoke, and many other towns.

It was not then possible to carry power any material distance from the site of the fall. The industry must go to the water power and not the water power to the industry. In fact, there is hardly a single manufacturing city of any size in New England whose origin cannot

be traced back to the development of some water fall within its limits.

Manufacturing started in New England long before coal was used, before the locomotive was thought of, and almost before the steam engine had been invented, and the use of water power was almost universal as a source of energy until the close of the first half of the Nineteenth Century. Then, as manufacturing facilities increased and as the more desirable water powers were completely utilized, and as the efficiency and reliability of the steam engine increased, manufacturers turned from water power to steam power, preferring to locate their mills and factories on the sea-board, or in large centers of population where labor conditions were best, rather than to follow the courses of the streams back into the high hills. Thus for nearly forty years water power development in New England was neglected. But with the development of the art of electric generation and transmission it became possible to bring the power to the manufacturer, and to have the double advantage of locating in the large cities, and of utilizing cheap power generated by water.

The beginning of this century was marked by a great development of the more remote water powers of the country, and the transmission of electricity therefrom to the large centers of population. In the New England states, however, the largest and most conspicuous powers had been developed and utilized long before the advent of electric transmission, and therefore the first great distribution systems of the country were built in the Western and Southern states. The Pacific Coast was a pioneer in this class of work, largely because of the scarcity and high price of coal, and the first transmission line to exceed 50 miles in length was built by the predecessor of the Pacific Gas & Electric Company, extending from the foot hills of the Sierras into San Francisco. Another step in electric transmission was marked by the building of a line 150 miles long from the Kern River to Los Angeles while the recent construction of a line from Big Creek to that same city spanning 250 miles marks the maximum transmission distance thus far attained. Extensive electric transmission systems have also been constructed in the Southern states, the Southern Power Company having a network of between 400 and 500 miles of line which link together nearly all of the larger manufacturing centers of North and South Carolina.

While it is true that many of the large water powers near the chief cities of the New England states had been developed long before the advent of electricity, it is still true that few sections of the country offer greater opportunities for hydro-electric development and transmission than our own New England states.

An interesting computation has been made as to the theoretical amount of energy which might under ideal conditions be generated by water in our six states. On the assumption that the average run-off in New England is in excess of 18 in.; that its area is approximately 60,000 square miles, and that its average elevation above sea level is 900 ft., it is computed that it would be theoretically possible to develop, for 3000 hours of each year, 15,500,000 horse power, this being equivalent to the use of 52,000,000 tons of coal annually. Of course such a computation is nothing but an interesting mathematical calculation. It is, however, entirely possible that 10 per cent of this theoretical power may at some time be developed from its streams, and that New England may annually produce energy equivalent to that which could be produced from the use of 5,000,000 tons of coal.

In the New England States there are eight large rivers with very great fall, namely:

	TOTAL FALL IN FEET
Penobscot	1500
Kennebec	1000
Androscoggin	2200
St. Croix	400
Saco	1900
Merrimac	269
Connecticut	2000
Hoosatic	900

These rivers drain 35,000 out of the 60,000 square miles of New England, and because of their great water shed and large drop, are its greatest sources of present and future power. Along these rivers are found its greatest water power developments and its largest manufacturing centers.

An estimate has also been made by the Bureau of Corporations showing that in the six New England states there is now developed and in use over 600,000 horse power of water energy, but that these same water powers if properly reconstructed along modern scientific lines could generate an additional 200,000 horse power. The same report shows that there is possible of creation in the New England states water power developments

aggregating 1,000,000 horse power which by storage and by the utilization of some of the less desirable falls, can be ultimately increased to 2,000,000 horse power. The State of Maine leads, both in developed and undeveloped water power, having a maximum possible development of nearly 1,000,000 horse power; the power of New Hampshire, Vermont and Massachusetts is reckoned between 200,000 and 300,000 horse power each; Connecticut has 160,000 horse power, and Rhode Island ends the list with a possible 16,000.

There is little doubt that New England can absorb all of the power which can be developed within its limits, for it is one of the greatest and certainly the most diversified center of manufacturing in our country. The Census Department gives the total value of all the manufactured products of the United States at \$20,000,000,000 per year, and the six states east of the Hudson, with approximately 2 per cent of the area of the country and about 4 per cent of its population, produce over 10 per cent of this great total. The boots and shoes manufactured in New England are valued at approximately \$300,000,000; its cotton mill products are worth an equal amount; its woolen mills produce goods valued at \$200,000,000 and its paper mills add to this an additional \$100,000,000 of product. It is also interesting to note that in no other section are there so many small manufacturing concerns. Massachusetts alone has over 8000 separate manufacturing companies, the total in the New England states being in excess of 12,000, and while centralization in the ownership and control of industry has been most marked in the Middle and Western states, in New England there has been an actual increase in the number of productive concerns and a decrease in their average size.

The mechanical and engineering problems connected with the development of water power and with the transmission of electricity therefrom, to any distance up to 200 or even 250 miles, may be considered solved, and the question to be settled is now one of commercial feasibility. The generation of electricity may properly be considered a form of manufacturing, water being the raw product, and electricity the resultant, but it differs from ordinary manufacturing in two important essentials. *First*, electricity cannot, to any material degree, be stored or kept for future use. It must be used when and as it is manufactured. *Second*, it can only be trans-

ported over wires reserved for its particular service, and its market is therefore limited to industries which are located within reasonable transmission distance. Conceive, if you can, the difficulties which would face the manufacturer of woolen cloth who must manufacture his goods and deliver them on the same day, who must use his own trucks for the delivery of his own cloth, being denied the use of railroads and other means of transportation, and whose only market lay within a radius of 200 miles of his plant; and yet such is the problem that faces the manufacturer of electricity.

But while great difficulties confront the manufacturer and seller of electricity generated from either water or coal, yet few lines of

many cities carting and teaming can be more cheaply done by the electric truck than by the horse drawn vehicle, and it is estimated that if the horse drawn teaming of New York City was to be done by electric trucks, the amount of electricity required would exceed twice the present output of the New York Edison Company.

Electricity as applied to railway transportation is just beginning to prove its reliability and its feasibility. Already 75 miles of the New Haven Railroad passing through one of the most densely settled sections of the country is operated by electric locomotives and the St. Paul Railroad is electrifying over 400 miles of its lines west of Butte, Montana. Wherever railroads have been



Fig. 1. An Exterior View of the Connecticut River Power Company's Hydro-Electric Station and Dam

industry offer greater opportunities if wisely and conservatively managed. Of all the forms of power, electricity is the most transportable, and within reasonable limits, can be cheaply carried from the place of generation to the place of use. Again, electricity is the most transmutable of all known forms of energy. It can be easily transmuted to the form of light; it can be changed into the form of the most intense heat for use in the electric furnace; it can be applied to the locomotive to give tractive power; it can be changed into mechanical energy for the turning of the wheels of industry. In fact, no other form of energy can be so easily transmitted from place to place, or so easily applied to useful work.

Despite the wonderful growth in the generation and use of electricity within the last decade, it is still fair to say that the electrical industry is in its infancy. For instance, it has been demonstrated that in

electrified much benefit has resulted, both to the corporation and to the public. It has been possible to give a more frequent train service without added cost; there has been great saving in coal, and even a greater saving in maintenance and upkeep; the strain upon the road-bed has been less serious; the smoke nuisance is eliminated, and loss from fires set by locomotive sparks has entirely ceased. These advantages are so important there is little doubt that a very great amount of railroad electrification will take place as soon as financial conditions warrant.

The great extent to which electricity is being used for electro-chemical purposes is hardly appreciated, yet two-thirds of the energy generated by all of the companies at Niagara Falls is now so utilized. In fact, the number of kilowatt-hours consumed in the electric furnace today exceeds the number of kilowatt-hours generated for light and power in the four largest cities of the country,

and yet the possibilities of this industry are but faintly appreciated, and we smile at the prophecy of the scientists that the fertility of the earth will be maintained by the nitrogen abstracted from the air by means of the electric arc.

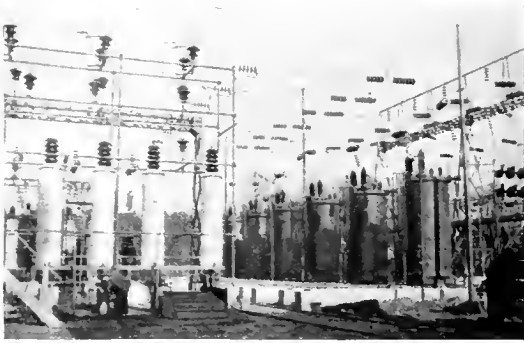


Fig. 2. View of a Bank of Transformers and Lightning Arresters in the Outdoor Substation of the Connecticut River Transmission Company at Millbury

The manufacturer of electricity can also to a very great degree claim exemption from the serious labor problems which face many other forms of industry. A modern hydro-electric plant with its distribution system does not spend more than 10 per cent of its gross income in the employment of labor, whereas the railroad and the trolley must so expend about 50 per cent of its gross receipts, and many manufacturing industries must pay out 75 per cent of their gross income for human effort.

In a comparison of the operating costs of a steam and a hydro-electric plant the ultimate effect of the sinking fund upon the cost of power is not fully appreciated. No one would question the great advantage of the hydro-electric plant over the steam plant if the former could be had without cost, that is, without capital outlay; if its cost was \$50 per kilowatt its advantage would still be unquestioned; at \$150 its value might be debatable, and at \$1000 every one would condemn it. In fact, the relation between the water power and the steam plant is very largely dependent upon the capital cost of the former.

If it is assumed that each kilowatt of machinery in a hydro-electric plant (costing approximately \$150) produces 4000 kilowatt-hours per year, and if it is further assumed that one mill per kilowatt-hour is put into a sinking fund and re-invested in the 6 per cent securities of the company, the fund thus created will have reduced the cost of the plant

from \$150 to \$100 per kilowatt at the end of the tenth year; at the end of the sixteenth year its cost will have been lowered to \$50, and by the end of the twentieth year the plant will have been entirely paid for, and the company owning it will be in the very desirable position of owning a hydro-electric plant without capital charge, and with very slight running expenses.

The economy of generating and distributing electricity in great quantities is now so apparent that no time need be given to its demonstration, and while it is true there are certain industries which require such large amounts of steam for industrial purposes that the central station can never hope to serve them, they are in the great minority, and of the 1,500,000 horse power now used in New England for manufacturing purposes, at least 1,000,000 horse power may and probably will at some time be secured by the electric company. No manufacturer who can buy electricity at a rate equal to or less than its cost if made in his own plant will desire to make expenditures for boilers and engines when that same investment in productive machinery will bring in much greater returns. The big central station is here, and it is here to stay; it will grow larger and larger; it will be located at the best place, and from it will radiate lines which will carry energy for lighting, for trolleys and railroads and for every form of industry.

Assuming then that the great generating plant with its network of transmission lines will supply the energy of the future, the question is often asked as to the relative value of and the relation between the central stations which produce their energy by water and those that generate power by steam, and this involves a consideration of the relative costs of water powers and steam stations, the ability of each kind of station to carry peaks and loads of high load factor, the requirements of the water power for auxiliary electricity during seasons of low river flow, and the ability of the steam station to supply this need of the water power without added capital expense.

A modern and efficient steam plant of large capacity can today be constructed at a cost of from \$75 to \$100 per kilowatt of installed capacity, while a hydro-electric plant will probably cost from \$100 to \$150. Also, the hydro-electric plant must, in many cases, be located much further from its market than the corresponding steam plant, thus adding to its relative cost. It is therefore fair to assume

that the first cost of the water plant will be at least double that of the steam station. But while the cost and consequently the interest on the investment is double, the depreciation and maintenance charges (expressed in percentages) are much less, as there is practically no depreciation or upkeep for water rights, dam or power house, and waterwheels and slow speed generators depreciate less rapidly than boilers, stokers and high speed turbines. It is probably fair to assume that while the fixed charges, which will include interest, maintenance and depreciation on a steam plant will be 15 per cent, the corresponding expenses in connection with

from twelve to twenty-four hours. It is also customary for such plants to have a very much larger capacity of machinery than is required for their average output, as additional machinery can usually be added with a proportionately small increase in outlay; and this combination of the ability to hold the daily flow of the stream and utilize it during the exact hours of the day when most required, and to have large capacity at low cost, makes it possible for the water power plant when run in conjunction with the steam plant to take the winter peaks and the daily swings in load most cheaply and economically, it being far easier to throw on an additional

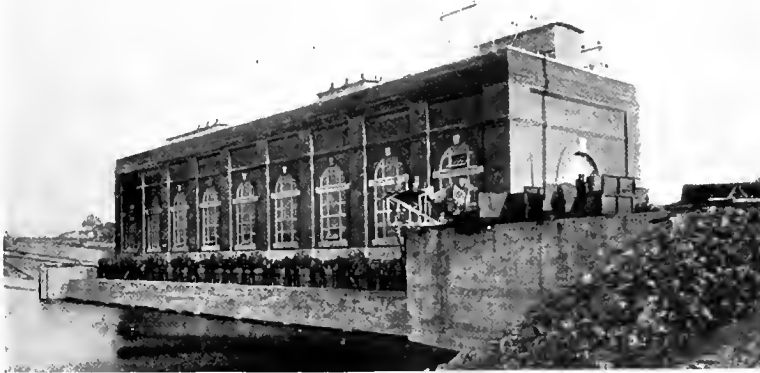


Fig. 3. A Near View of the Hydro-Electric Station of the Connecticut River Power Company, taken from the Forebay

a hydro-electric plant will not exceed 11 per cent. Thus, the fixed charges on a steam plant costing say \$90 per kilowatt will be \$13.50 per year, whereas the corresponding charges on a hydro-electric plant costing \$150 will be approximately \$16.50, the balance being \$3 per kilowatt per annum in favor of the steam plant. The operating expenses of the hydro-electric plant are of course very much less than the corresponding costs for the steam plant. One half-mill per kilowatt-hour is a liberal allowance for a water power plant of large size, whereas the corresponding operating charges of the large steam plant will run from four to ten mills per kilowatt-hour, the variation in steam cost resulting from difference in the size of the plant, its load factor, and its efficiency.

Most successful hydro-electric plants are so designed that their forebays or ponds will hold the average flow of the stream for

waterwheel than to start up extra boilers and steam turbines. Again, the steam plant is of necessity relatively inefficient during parts of the night and on Sundays, when the load is light, but when steam and water plants are run in combination the load can be so divided between them that each plant will carry the load during the times of the day when it can be most efficiently operated. Finally, the water plant during the seasons of the year when the stream flow is large, has the ability to carry an output of high load factor at very low cost, there being no added cost for fuel because of the increase in load factor.

Most of our large New England streams vary greatly in their maximum and minimum flow. For instance, at the Brattleboro plant of the Connecticut River Power Company the flow varies from a minimum of 1500 cu. ft. per second to a maximum of 150,000 cu. ft., the

maximum flow being 100 times the minimum. It would not be profitable to make such a development on the basis of the minimum run-off of the river, and in the plant in instance its primary output requires a flow of about 3300 cu. ft. The extreme low flow of course occurs on only a relatively few days in each year, and in an average year the plant will have sufficient water to carry its full load for nine months, the actual number of kilowatt-hours required from steam being about 3,000,000 out of a total annual output of 50,000,000 kilowatt-hours.

Among the large hydro-electric developments in New England is the plant of the Rumford Falls Power Company on the Androscoggin River at Rumford, Maine, the plant of the Androscoggin Power Company on the same river, near Lewiston, the plants of the Cumberland County Power & Light Company on the Saco River near Portland, the plants of the Bangor Railway & Electric Company near Oldtown and Ellsworth, the plants of the Central Maine Power Company near Waterville, the plant of the Turners Falls Company on the Connecticut River at



Fig. 4 A General View of the Hydro-Electric Plant and Dam of the Central Maine Power Company

It is stated on reliable authority that one-half of the capacity of our central stations is idle 95 per cent of the time, but whether this exact percentage is correct or not it is certainly true that every such station must have a very great spare capacity during much of the year, and fortunately for both the steam and hydro-electric plants, the periods of low water occur during the summer and early fall, when the central station load is at its minimum. Thus the central station can supply the deficiencies of the hydro-electric plant without any increase in installed capacity or fixed charges, and in so doing it will increase its load factor and decrease its unit operating cost.

All of these facts lead to the conclusion that the large steam plant and the large hydro-electric station can develop side by side, each caring for the service to which it is best suited, and each giving to the other economies which neither could have alone.

Turners Falls, Massachusetts, the plant of the Connecticut River Power Company on the Connecticut River near Brattleboro, and the plants of the New England Power Company on the Deerfield River. These various plants have an aggregate capacity of about 250,000 horse power. Nearly all of them have been constructed within the last five years, thus indicating the rapidity with which our streams are being utilized and their energy transmitted to distant cities and towns.

Very considerable progress has also been made in the development of storage and the consequent conserving of the flood waters of the spring months. A dam at the outlet to Moosehead Lake impounds a total in excess of 20 billion cu. ft. and is capable of more than doubling the minimum flow of the Kennebec River at Augusta. Storage reservoirs on the Rangeley Lakes and in the upper waters of the Androscoggin

have assured a minimum flow of 2000 second feet at Rumford Falls and Lewiston, and a reservoir created in Somerset, Vermont, is now storing enough water to produce in existing plants approximately 25,000,000 kilowatt-hours, which would otherwise have been wasted.

We have thus far considered hydro-electric developments in their relation to immediate and present industrial conditions, but their development should also be considered from the broader standpoint of the conservation

and to the production of wealth in other forms. Less than this number of men dug the Panama Canal in nine years, or, in the same period, could have built a double track railroad from New York to San Francisco. Therefore, there can be no doubt that the utilization of our water resources stands on a par with the great inventions and discoveries of the age. Eli Whitney invented the cotton gin, and made it possible for one man to do 50 men's work. Hargreaves, Arkwright and others invented and perfected our cotton and

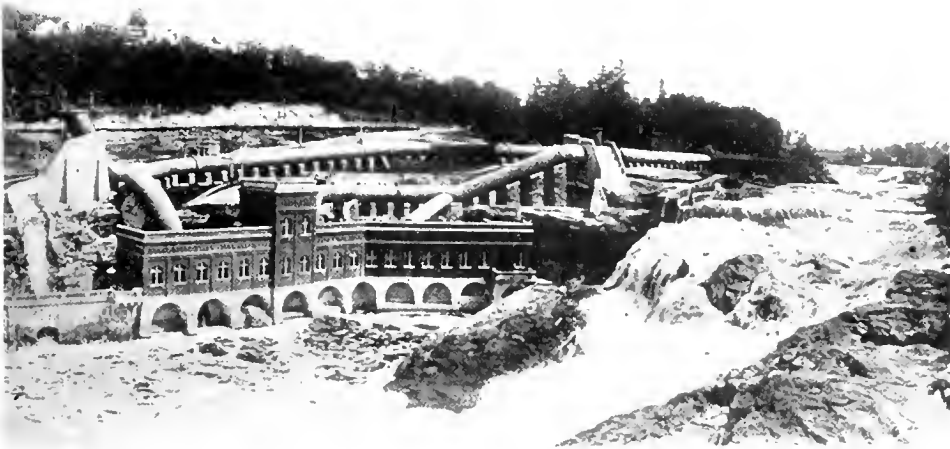


Fig. 5. Hydro-Electric Plant of the Rumford Falls Power Company

of human energy and the liberation of human effort. The water powers of New England are today producing more than two billion kilowatt-hours of energy, which is utilized for the operation of manufacturing plants, for the production of light, for the motive power of trolleys and railroads, and for other purposes. If this energy was produced by coal it would mean the annual consumption of three million tons, worth about 14 million dollars, and to produce, handle and transport this coal would require the continuous labor of 30,000 men working 3000 hours a year. Thus the development of our own home water powers makes it possible for 30,000 men to turn their efforts to other channels of industry

woolen machinery and gave power to one weaver to produce more cotton and woolen cloth than could 100 weavers, 100 years ago, and likewise the great inventions in the electric industry have made it possible for one man at the switchboard of a hydro-electric plant to draw more energy from Nature's storehouse than could 1000 men a century ago.

And while we may discuss the relative merits of this development or that, or the advantages of the steam engine, Diesel engine or waterwheels, in the long run we may feel sure that the energy of falling water will be utilized to the fullest extent and that the powers of our streams will be made to do useful work for the benefit of mankind.

SOME ASPECTS OF SLOT INSULATION DESIGN

BY H. M. HOBART

CONSULTING ENGINEER, GENERAL ELECTRIC COMPANY

The phases of slot insulation design which are treated in this article are the voltage gradient through the insulation from an alternator armature conductor to the sides of the slot, the necessity for using an insulation capable of withstanding a high temperature, and the importance of obtaining complete information on the useful life of insulation. The major share of the article is devoted to a comparison between the unit dielectric stresses in the slot insulation of a low-voltage alternator and those in a high-voltage machine. A specific example is assumed; and an analysis, which is made of several variations in the slot insulation design, instructively demonstrates the magnitude of the influence which insulation thickness and specific inductive capacity have on the design of slot insulation.—EDITOR.

The thickness of the insulation employed in the slots of low-pressure armatures is usually determined largely from considerations of mechanical strength. Were it practicable to ensure continuity and unimpaired mechanical strength at all parts, thinner insulations than those customarily employed would usually afford ample factors of safety so far as regards immunity from disruption by the electrical pressure.

But for armatures wound for high pressures, say, for example, 12,000 volts, the insulation thickness is proportioned chiefly with reference to the strength which the material possesses for withstanding electrical pressures. This may be termed the disruptive strength of the material. Quantitative investigations of the properties of insulating materials are still disappointingly meager. It may, however, be stated that the disruptive strength of insulating materials of the sorts employed for slot insulations does not increase in proportion to the thickness employed. As a rough guide for practical purposes, we may take it that the disruptive strength increases as the two-thirds power of the thickness. If for a certain insulating material, furnished in the form of sheets, the disruptive strength for a thickness of 1 mm. is stated to be 30,000 volts when tested for 60 seconds, we are to understand that a thickness of 1 mm. will, on the average, withstand a crest pressure of 30,000 volts for 60 seconds without puncturing. Applying the rough "two-thirds power" rule, a 0.5 mm. thick sample of the same material will have a disruptive strength of $0.50^{\frac{2}{3}} \times 30,000 = 0.63 \times 30,000 = 18,900$ crest volts, while a 2 mm. thick sample will have a disruptive strength of $2^{\frac{2}{3}} \times 30,000 = 1.59 \times 30,000 = 47,500$ crest volts.

The three results are brought together in the following table.

It is desirable to again emphasize that different materials exhibit different rates of

variation with the thickness as does also a given material under varied conditions. It is rare, however, that it is practicable to obtain materials or conditions ensuring a disruptive strength directly proportional to the thick-

Thickness of Sample	"Disruptive Strength" in (Crest) Volts	"Disruptive Strength" per Millimeter in (Crest) Volts
0.50 mm.	18,900	37,800
1.00 mm.	30,000	30,000
2.00 mm.	47,500	23,800

ness, and for the purposes of this article the "two-thirds power" rule is assumed as being convenient and also sufficiently representative.

In actual practice, slot insulations for 1200-volt armatures are generally about 2 mm. thick, while for 12,000-volt armatures a thickness of about 5 mm. is usually employed. Such insulations have in practice been shown to be adequate to withstand, not only the conditions of usual service but also, when new, the test required by paragraph 254 of the A.I.E.E. rules. This paragraph reads as follows:

254. The Standard Test for all Classes of Apparatus, except as otherwise specified, shall be twice the normal voltage of the circuit to which the apparatus is connected, plus 1000 volts.

The essential conditions of the test are prescribed in paragraphs 248 to 252 inclusive, which read as follows:

248. Condition of Machinery to be Tested.

Commercial tests shall, in general, be made with the completely assembled machinery and not with individual parts. The machinery shall be in good condition, and high-voltage tests, unless otherwise specified, shall be applied before the machine is put into commercial service and shall not be applied when the insulation resistance is low owing to dirt or moisture. High-voltage tests shall be made at the temperature assumed under normal operation. High-voltage tests to determine whether specifications are fulfilled are

admissible on new machines only. Unless otherwise agreed upon, high-voltage tests of a machine shall be understood as being made at the factory.

249. Points of Application of Voltage. The test voltage shall be successively applied between each electric circuit and all other electric circuits and metal parts grounded.

250. Interconnected Polyphase Windings are considered as one circuit. All windings of a machine except that under test shall be connected to ground.

251. Frequency, Wave Form and Test Voltage. The frequency of the testing circuit shall not be less than the rated frequency of the apparatus tested. A sine wave form is recommended. The test shall be made with alternating voltage having a crest value equal to $\sqrt{2}$ times the specified test voltage. In direct current machines, and in the general commercial application of alternating current machines, the testing frequency of 60 cycles per second is recommended.

252. Duration of Application of Test Voltage. The testing voltage for all classes of apparatus shall be applied continuously for a period of 60 seconds.

A 1200-volt armature will, in accordance with the quoted rule, be tested with $(2 \times 1200) + 1000 = 3400$ virtual volts (corresponding to 4800 crest volts). A 12,000-volt armature will be tested with $(2 \times 12,000) + 1000 = 25,000$ virtual volts (corresponding to 35,400 crest volts). Since the thicknesses in these two cases are 2 mm. and 5 mm. respectively, the "disruptive strengths" per mm. of thickness must be at least:

$$\frac{4800}{2} = 2400 \text{ crest volts}$$

and

$$\frac{35,400}{5} = 7100 \text{ crest volts.}$$

The materials must in the two cases be such as shall, under the test conditions, correspond to the following values for samples of 1 mm. thickness:

Working Pressure of Armature	Thickness of Insulation in mm.	Disruptive Strength of a Sample of 1 mm. Thickness
1200	2	$\frac{4800}{2} = 3000$ volts
12000	5	$\frac{35,400}{5} = 12,000$ volts

Evidently we are imposing a much more severe stress on the insulation when we test a 12,000-volt armature with only $\frac{25,000}{12,000}$

$= 2.08$ times the working pressure than when we test a 1200-volt armature with $\frac{3400}{1200} = 2.84$ times the working pressure.

But even the higher value, namely, 12,000 crest volts for a 1 mm. sample, appears at first sight to be exceedingly low when we mention that a 1 mm. thickness of natural mica, if free from impurities, has a disruptive strength of from 80,000 to 90,000 crest volts, while 1 mm. thick samples of many varieties of impregnated fabrics and papers and reconstructed micas test above 20,000 crest volts.

But 1 mm. thickness of natural mica can only be obtained in flat plates, and such plates are rarely free from foreign substances. The purity corresponding to the above-quoted values of the disruptive strength is only obtainable in selected and relatively small pieces. When mica is split up and reconstructed into a sufficiently flexible and reliable form, the product is by no means exclusively pure mica, but has quite a considerable percentage of binding material usually consisting of thin paper and cementing varnish. Such a product when in the form of a flat sample, or circular tube, of 1 mm. thickness should still have a disruptive strength of nearly 30,000 crest volts. But when applied in ribbons or sheets so wrapped on as to form a continuous and uniform insulating covering around the slot portion of the coil, a 1 mm. thickness would hardly have a disruptive strength much in excess of 15,000 crest volts. A 5 mm. thickness would not have five times as great a disruptive strength but would only withstand some $5^{\frac{1}{2}} = 2.9$ times as great a pressure as that withstood by a 1 mm. thick sample, or $(2.9 \times 15,000) = 43,000$ crest volts,

corresponding to a pressure of $\frac{43,000}{\sqrt{2}}$

$= 30,000$ rms volts. This leaves us a margin of only 5000 rms volts above the 25,000-rms-volt test required by the A.I.E.E. rules for a 12,000-volt armature.

It must be remembered that the manufacturer requires his own factor of safety above the A.I.E.E. test, since he cannot afford to build machines which will be on the ragged edge of breaking down when subjected to the specified tests. It is now clear that the margin, instead of being generous, is, in the case of 12,000-volt armatures, so moderate as to require great skill and care in design and construction.

The limits of this article will not permit of allusion to, or much less a comprehensive discussion of, the many points requiring attention in the design of the slot insulation of high-pressure armatures. It has been considered desirable to draw attention to the order of magnitude of the quantities involved. Let us, however, give further consideration to the influence of the specific inductive capacity of the materials entering into the composition of the slot insulation.

Fig. 1 is a diagrammatic representation of a 5 mm. thick homogeneous insulation stressed by 12,000 rms volts. Each mm. of thickness experiences a stress of $\frac{12,000}{5} = 2400$ rms volts. In Fig. 2, the 5 mm. thick-

$\frac{4000}{2.5} = 1600$ rms volts per millimeter, the right-hand layer is stressed to the extent of $\frac{8000}{2.5} = 3200$ rms volts per mm. Both of these values are quite moderate. But let us now consider the conditions represented diagrammatically in Fig. 3. The two layers each have the same specific inductive capacities as in Fig. 2, but while the thickness of the left-hand layer has been increased from 2.5 mm. to 4 mm., that of the right-hand layer has been decreased from 2.5 mm. to 1 mm. We now have

$$X : 12,000 - X = \frac{4}{6} : \frac{1}{3}$$

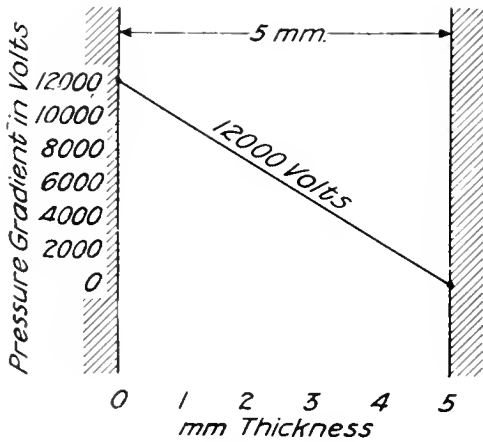


Fig. 1. Homogeneous Insulation Stressed with 12,000 Volts

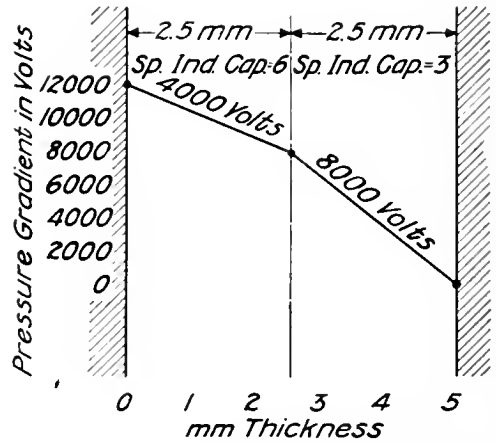


Fig. 2. Insulation of Two Layers of Equal Thickness and Different Specific Inductive Capacity

ness of homogeneous insulation has been replaced with two 2.5 mm. layers, the left-hand layer being of a material with a specific inductive capacity of 6 and the right-hand layer of a material with a specific inductive capacity of 3. The total stress of 12,000 rms volts will be shared between the two layers in direct proportion to their thicknesses and in inverse proportion to their specific inductive capacities. Letting X represent the pressure across the left-hand layer and $12,000 - X$ that across the right-hand layer, we have

$$X : 12,000 - X = \frac{2.5}{6} : \frac{2.5}{3}$$

Therefore

$$X = 4,000 \text{ and } 12,000 - X = 8,000.$$

Consequently, as shown in Fig. 2, while the left-hand layer is subjected to a stress of only

$$X = 8000, \quad 12,000 - X = 4000.$$

The left-hand layer is now subjected to $\frac{8000}{4} = 2000$ rms volts per mm. and the

right-hand layer to $\frac{4000}{1} = 4000$ rms volts

per mm. While these values are still moderate, that across the right-hand layer is considerably above the $\frac{12,000}{5} = 2400$ rms volts per mm., which is the average for the total thickness.

In Fig. 4 the thickness of the right-hand layer is still further reduced and is now only 0.1 mm., the specific inductive capacities being, as before, 6 for the left-hand and 3 for the right-hand layer. We now have

$$X : 12,000 - X = \frac{4.9}{6} : \frac{0.1}{3}$$

$X = 11,500$ rms volts.

$12,000 - X = 500$ rms volts.

For the left-hand layer the stress is $\frac{11,500}{4.9} = 2350$ rms volts per mm. and for

the right-hand layer it is $\frac{500}{0.1} = 5000$ rms volts per mm.

Now retaining the two thicknesses of 4.9 for the left-hand and 0.1 for the right-hand layer, and the specific inductive capacity of 6 for the left-hand layer, let us consider the case where the specific inductive capacity

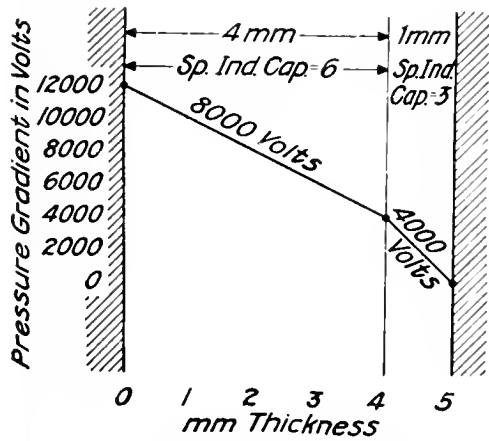


Fig. 3. Insulation of Two Layers of Different Thickness and Different Specific Inductive Capacity

some 700 rms volts. While the precise value depends upon several factors, we are evidently in the neighborhood of values which may occasion discharges across the film of air between the side of the slot and the outer side of the insulation. This will take place more readily at corners, such as at the edges of ventilating ducts.

Instead of employing for the left-hand layer a material with a specific inductive capacity of 6, let us, in the last case, substitute a material with a specific inductive capacity of 2. This gives us

$$X : 12,000 - X = \frac{4.9}{2} : \frac{0.1}{1}$$

$X = 11,500$ rms volts, and

$12,000 - X = 500$ rms volts.

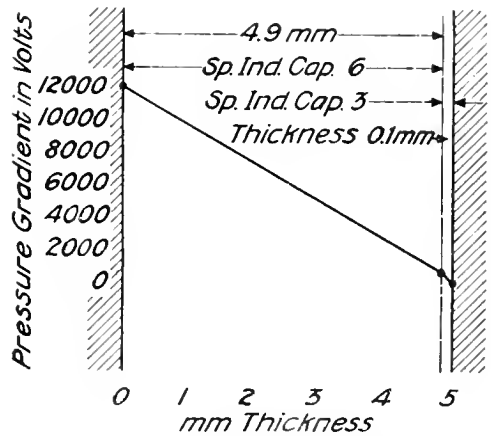


Fig. 4. Insulation of Two Layers of Greatly Different Thickness, the Specific Inductive Capacity of the Thick Layer being Six and that of the Thin Layer being Three

of the 0.1 mm. thick right-hand layer is reduced from the value of three corresponding to Fig. 4 to the value of only 1, corresponding to air. Indeed, we may consider that the right-hand layer is made up of a film of air adjacent to the laminated side of the slot of an armature. We now have

$$X : 12,000 - X = \frac{4.9}{6} : \frac{0.1}{1}$$

$X = 10,700$ rms volts, and

$12,000 - X = 1300$ rms volts.

The air film is stressed to the extent of

$$\frac{1300}{0.1} = 13,000 \text{ rms volts per mm.}$$

It will be noted that in this last case we have a stress of 1300 rms volts exerted on a layer of air of only 0.1 mm. thickness. The disruptive strength of 0.1 mm. of air is only

This value of only 500 rms volts (less than half of that obtained in the preceding case) will not suffice to break down a layer of air of 0.1 mm. thickness. Consequently, from the standpoint of minimizing the slow eating out of the insulation by static corrosion, the material employed for slot insulation should have a very low specific inductive capacity.

But the ideal way of eliminating the difficulty is to fill up all spaces solidly, utterly displacing the slightest traces of air. Since this is exceedingly difficult of complete achievement, it is well worth while providing the further safeguard of also employing for the slot insulation (so far as is consistent with obtaining the other essential qualities) material of very low specific inductive capacity. Unobservable discharges across the thin air films between the insulation and the

sides of the slot may, under certain conditions, produce ozone and nitric acid and thus still further impair the insulation by setting up corrosive chemical reactions.

HEAT-RESISTING QUALITIES

It is, however, not possible to select whatever material best suits us in the matter of disruptive strength and specific inductive capacity. On the contrary, we must consider several other features, notable among which is the capacity for withstanding high temperatures. Nowadays the leading manufacturers are entirely willing to be conservative in the matter of temperatures for those classes of machinery which can be designed for low-temperature operation. But machines of certain types and ratings can only be so constructed that their operation will be attended by very high temperatures in certain parts. There is no known way which would at present meet with approval in avoiding these high temperatures, in extra high-speed turbine generators of very large capacity, or in totally-enclosed motors. It has become a matter of great importance to develop insulating materials which, while satisfactory in all other respects, will also withstand temperatures of the order of 125 deg. C.

Although ordinarily the room temperature is some 25 deg. C., there are summer days when it will rise (in an engine room) to 40 deg. C. A thermometer rise of 50 deg. C. brings us to an ultimate temperature of 90 deg. C., as observed by thermometers at points on the surface. The nature of the construction, which must for mechanical reasons be employed in such machines, renders it inevitable in high-voltage alternators that there will often be local internal temperatures some 30 to 40 deg. C. greater than the maximum surface readings. This leads to a temperature of $40+50+35=125$ deg. C. Usually the hot spots will be at the inside surface of the slot insulation where it lies against the copper coil. If the copper is, as is usually the case, the hottest part, then the temperature difference between the outside surface of the insulation and its inside surface will be greater the thicker the insulation and the less perfectly air has been eliminated from all parts of the insulation.

Consequently if only we can make a good insulation from the standpoint of withstanding the electrical stresses, an insulation which is relatively thin and dense, we not only have the great advantages of the saving in valuable

space in the slot, which can be devoted to copper, but we also will have provided a much better path for conducting away the heat, than we should have with a thick insulation, especially if it be not dense but more or less permeated with air layers and particles. Suppose, for instance, that by means of immense pressure we could compress the usual 5 mm. insulation so as to reduce its thickness to 2.5 mm. We should thereby expel all air particles. We should have doubled the heat conductivity by virtue of halving the thickness, and also we probably should have again doubled it owing to the elimination of all air layers. The resistance to the escape of heat would, in this hypothetical case, have been reduced in the ratio of 4 to 1; and, for the same temperature rise of the copper, we could (assuming negligible heating of the copper by losses in the surrounding iron) allow the winding to absorb an internal I^2R loss four times as great. Thus we see that the same consideration, namely, the obtaining of complete impregnation, which eliminates gradual deterioration of the insulation by static corrosion, also leads to the best results from the standpoint of the transfer of heat.

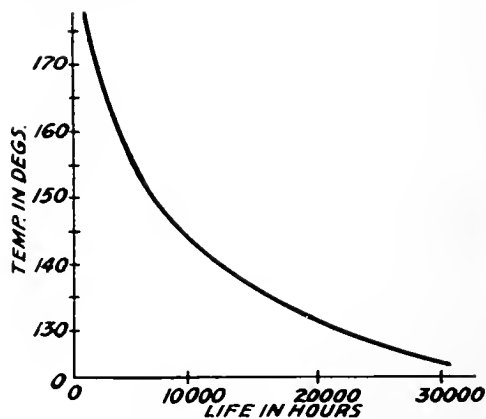


Fig. 5. A Typical Life-Temperature Curve for a Particular Insulation

LIFE OF INSULATION

There is still a serious insufficiency of reliable data as regards the life of various sorts of insulations. When slot insulations have become exceedingly dried and brittle as the result of long use, then, for instance in the case of railway motors, mechanical vibration plays a part in the further deterioration of the insulation. This is also the case, to a certain extent, in stationary motors and

in generators. It is here desired to draw attention particularly to the case of such materials as are required for the slot insulation of large extra-high-speed steam turbine-driven generators.

It would appear to be in the interests of economy that such machines should be worked hard during a short life than to spare them and drag out their life over a long term of years. By adopting the policy of getting all we can out of them in a short space of time, we decrease the total interest and insurance charges on the investment and also the wages per unit of output. Ten years would appear to be an appropriate life to assign to such machines. By the end of ten years the progress of the art is such that we are certain to be able to procure a more economical machine than was available at the beginning of that term of years. In the average lighting and power plant the load factor on the station is of such a value that, taking spare sets into account, we cannot economically keep any one machine in service for more than, say, one-third of the time.

Consequently, instead of being in service for 87,500 hours in the course of the ten years, such a generator will only be in service for some $87,500/3 = 29,200$ hours or, say, 30,000 hours.

As good an indication as possible should be available of the temperature at which an insulation can be used, in order that it should remain thoroughly sound and reliable for at least 30,000 hours. It would be, of course, impracticable to await the completion of 30,000 hour tests, but it should be practicable to make some "equivalent" test consisting of a higher temperature applied for a shorter time. Knowing, for instance, from an actual test, that a certain insulation remains thoroughly sound at the end of a run of 1000 hours at, say, 160 deg., there should be a means, by use of the laws disclosed in such investigations, of deducing data which would enable us to know the life of this same insulation when run at 150 deg., and again at 125 deg. Curves of the type shown in Fig. 5 should be obtained for many insulations under all sorts of conditions.

INCANDESCENT LAMPS FOR PROJECTORS

BY L. C. PORTER

EDISON LAMP WORKS, GENERAL ELECTRIC COMPANY, HARRISON, N. J.

The author first outlines the condensing lens and the parabolic reflector method of producing parallel, or nearly parallel, rays of light when using a point source. Then he describes the high filament concentration which can be employed in the new gas-filled incandescent lamp and shows by figures and curves how such lamps admirably fulfil the requirements for projecting a high-power beam of light from a headlight, stereopticon lantern, or flood-lighting projector.—EDITOR

The introduction of the focus type gas-filled lamp has opened wonderful possibilities in searchlight work. The color, steadiness and reliability of the beam from this lamp, together with the simplicity of its control, make it an almost ideal light source for certain classes of searchlight work, notably, for headlights for street cars and railroad locomotives, for small searchlights for boats, for flood-lighting of signs and building fronts and for stereopticon work, etc.

In order to understand why these applications have become practical for the incandescent lamp, let us review briefly some of the principles involved in the production of a beam of light. There are two general methods of concentrating light into a beam: One by the use of a parabolic reflector,* and

the other by the use of a condensing lens. Either system requires a light concentrated as closely as possible at the focal point of the lens or reflector.

Theoretically, if the light were an actual point located at the focus of a perfect parabolic reflector, or the proper lens system, the light rays from it would be all turned in a parallel direction and a beam of light would be obtained which—neglecting atmospheric absorption—would reach to infinity. In practice, however, it is not possible to produce an actual point source. The beam of light has therefore spread, its maximum divergence being equal to the angle at the center of the lens or reflector formed by the two extreme tangent rays to the light source (*A* and *B* in Fig. 1). From the figure it is evident that the larger the light source the greater will be the spread of the beam; and

* See article "Notes on the Use of Tungsten Filament Lamps with Parabolic Reflectors," by G. H. Stickney, GENERAL ELECTRIC REVIEW, December, 1912, p. 800.

this is accompanied by a corresponding decrease in the beam candle-power. Beyond such a distance that the diameter of the lens or reflector is negligible in comparison to this distance (i.e., where a point in the beam of light would receive light from every

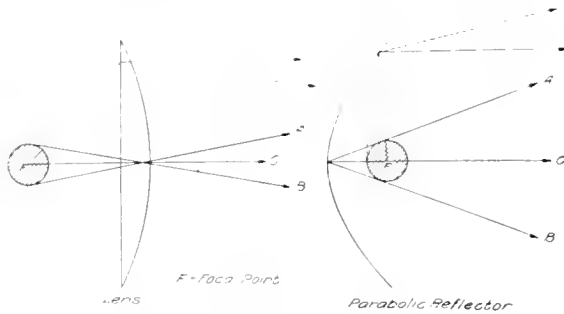


Fig. 1. The Condensing Lens and Parabolic Reflector Methods of Concentrating Light into a Beam

point on the reflecting surface of the parabolic reflector) the intensity varies inversely as the square of the distance from the light source. We see, therefore, that the ordinary type of incandescent lamp, having its filament in the form of a wire looped up and down, is so large that practically no beam at all can be obtained from it.

However, by winding this filament into a closely coiled spiral and bunching this spiral as much as possible, a very much more highly concentrated light source may be obtained. To illustrate: A cylinder 70 millimeters long by 30 millimeters in diameter would be required to contain the filament of the regular 100-watt 110-volt mazda lamp, while that of the 100-watt 110-volt focus type mazda lamp may be contained in a cylinder 12 millimeters by 12 millimeters. The filament of the low voltage lamp can be concentrated into even a smaller volume, because it is not necessary to use so long a wire for low voltage. The light source of the 6-volt 108-watt mazda headlight lamp may be contained in a cylinder $2\frac{1}{2}$ millimeters in diameter by 5 millimeters long, see Fig. 2.

To demonstrate the marked effect of the concentration of the light source upon the resultant beam candle-power, the writer had five special lamps made up, each of 32 candle-power but of varying filament concentrations, as shown in Fig. 3. Each, in

turn, was placed in the same parabolic reflector which was 11 inches in diameter and of 5-inch focal length, and the maximum beam candle-power was measured. The results were as follows:

Lamp	Maximum Beam C-P.
32 c-p. 240 v. carbon, regular	268
32 c-p. 240 v. carbon, stereopticon	555
32 c-p. 120 v. carbon, stereopticon	1400
32 c-p. 40 v. mazda, stereopticon	3335
32 c-p. 6 v. mazda, headlight lamp	3600

Not only can the filament of the lamp be wound into very small volumes, but it can also be made in very high candle-powers. The combination of a high candle-power light source of small volume is the secret of producing a powerful beam of light. Assuming the concentration to remain constant, the beam candle-power will vary directly with the candle-power of the light source. Thus, it can be seen that a much higher wattage lamp will be required at 110 volts than at 6 volts to obtain the same beam candle-power. Tests have shown that a 6-volt 108-watt lamp giving 150 candle-power will produce in a $19\frac{5}{16}$ inch parabolic reflector of $2\frac{3}{4}$ inch focus (G-E Headlight J-S) a beam of 960,000 beam candle-power

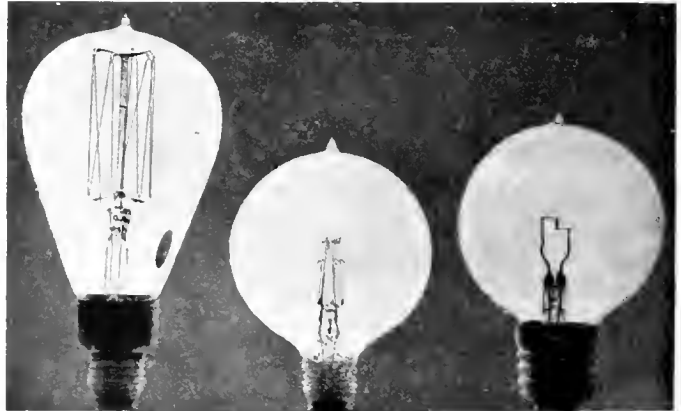


Fig. 2. Relative Size of Filaments of the Regular 100-Watt 110-Volt Lamp, the 100-Watt 110-Volt Focus-type Lamp, and the 108-Watt 6-Volt Headlight Lamp

(these tests refer to a specific type of headlight), while a 500-watt 110-volt lamp of 714 candle-power in the same reflector gives only 710,000—each of these lamps being at present of the highest practical filament concentration. The ratio between the candle-

power of the light source itself and the resultant beam is called the *multiplying factor* of the equipment. For the two lamps in question the multiplying factors are as follows:

Lamp	Multiplying Factor
6 v. 150 c-p.	6400
110 v. 714 c-p.	994

Another element having considerable influence on the resultant intensity of the beam is the focal length of the lens or reflector. The focus type incandescent lamps have an approximately even distribution of light over the entire sphere; hence, the shorter the focal length of the lens or reflector, the greater will be the percentage of the total light flux utilized. In Fig. 4 the shaded portion represents the plane angle of light utilized by reflectors of equal diameter but of long and short focus. The surface of the reflector also has a great deal to do with the beam. The reflection coefficient of polished nickel is approximately 54 per cent, of polished aluminum 61 per cent, and of polished silver 86 per cent. Mirrors made of glass are generally used where the most powerful beams are desired. They can be ground very much more accurately than the metal mirrors can be made and they also protect the silver backing from rapid tarnishing.

The most powerful beams at present are obtained from arc lamps. The candle-power

of sufficient power for many classes of service—such as street car and locomotive headlights, small searchlights, flood and spotlights, signal work, stereopticon lanterns, etc., etc.—can be obtained. It frequently happens that the simplicity of control and safety obtained by the use of an incandescent

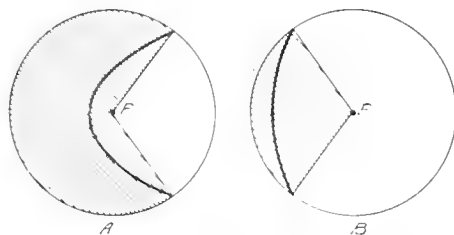


Fig. 4. Diagram of the Amount of Light Utilized by Two Reflectors of Equal Diameter but of Different Focal Length

lamp, for such classes of service, more than offset the somewhat higher intensity obtainable with an arc. The color of the light from an incandescent lamp is also nearer the red end of the spectrum, to which the eye is most sensitive, under common working intensities.* Tests have shown that this, together with the steadiness of the beam from an incandescent headlight, makes it possible to discern objects at a considerably greater distance than is possible with the same beam candle-power from an arc headlight.

The question of color of the beam of a headlight is being given more prominence,

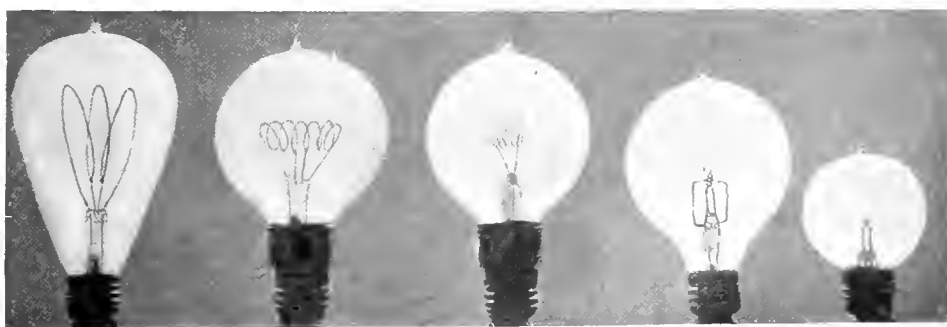


Fig. 3. Five Special 32 c-p. Lamps with Various Size Filaments

per square millimeter of the crater of a carbon arc is about 130, while the maximum obtainable from the same surface of a tungsten filament, at its melting point, is about 70; therefore, it is physically impossible with the present tungsten lamp to produce so powerful a beam as with the arc. Yet, beams

probably partially for commercial reasons, by the introduction of glass mirrors and front plates which give an amber hue to the beam. It is claimed that in this manner the "pick-up" distance of headlights in fog is

* Transactions of the Illuminating Engineering Society, 1914, vol. IX, pp. 909-936.

increased, due to the reduction of back glare from the fog itself; also, that when looking directly toward the headlight, the glare is largely reduced. It is, however, doubtful if the reduction of glare—due to light reflected back into an observer's eyes from the



Fig. 5. The Standard Type of Locomotive Headlight for the 6-volt, 108-watt, Focus-type Lamp

fog—will offset the decrease in intensity of the beam, caused by the use of amber glass, except in the case of very large headlights having exceedingly high beam candle-powers.

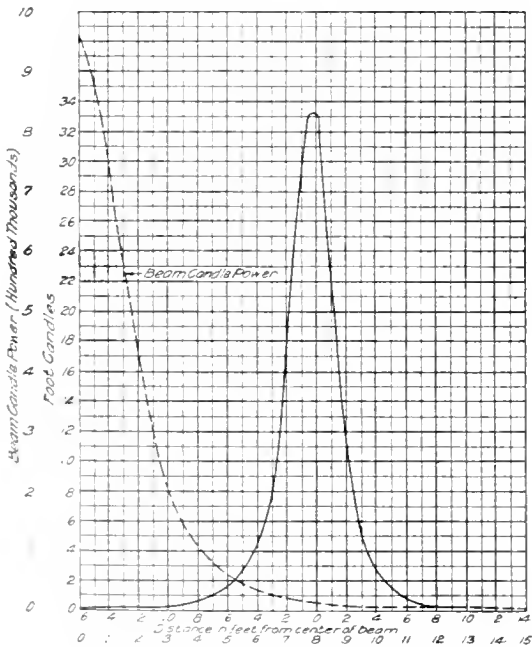


Fig. 6. Distribution Curve of Light from Headlight shown in Fig. 5

The three large classes of service to which the focus type mazda lamp has been applied with marked success are: (1) *Headlights* for autos, trolleys, locomotives and ships; (2) *Stereopticon* work for various types of projectors, lanterns and small moving picture

machines; (3) *Flood-lighting* of painted advertising matter, building fronts, etc.

For the first class of service the 6-volt lamps for auto headlights are well known. Recently 6-volt lamps having highly concentrated filaments of 36, 72 and 108 watts capacity have been standardized for locomotive service. The lamps are operated from storage batteries. There is also under construction a 6-volt turbo-generator outfit of sufficient capacity to take care of the 108-watt headlight, the cab lights and classification signals; this makes the lighting of the locomotive entirely independent of the



Fig. 7. Adjustable Socket for Converting an Oil Headlight into an Electric one

remainder of the train.* The Southern Pacific Railroad, after exhaustive tests of various types of headlights, has adopted the 6-volt 108-watt Edison mazda headlight lamp as standard, and is using several thousands of them. Headlights especially designed for this lamp are now manufactured, see Fig. 5. The distribution curve of this combination is shown in Fig. 6.

In many instances it is desirable to convert an oil headlight already in use into an electric headlight. This may be readily accomplished by replacing the oil burner with an adjustable lamp socket, which will allow of focusing the headlight. A simple device, designed for this purpose, is shown in Fig. 7.

There are at present in service a considerable number of 30-volt turbo-generator sets.

* Journal of Electricity, Power, and Gas, Feb. 7, 1914, pp. 121-125.

For use with these, 30-volt lamps of 100, 150 and 250-watt capacity have been designed. While these are good substantial lamps, they are not so rugged as the 6-volt type and, on account of the longer filament, the concentration is not so good; consequently, the power of the beam is considerably less for equal wattages. These lamps, as well as the 6-volt lamps, are also used for searchlights on boats equipped with 30-volt lighting systems or 6-volt ignition systems.

For street car service, special focus type lamps are available, of 23, 36, 56, 72 and 94-watt capacities, designed to burn in series with four regular street railway lamps of the same capacity on one of the car lighting circuits. In some cases cars are wired so that two circuits pass in multiple through the headlight, which must then be of double the capacity of the lamps in the car. Lamps of 46 and 72 watts are available for use with 23 and 36-watt lamps, respectively, in the car. There is also available an 80-volt 4-ampere focus type mazda lamp for interurban car service. This lamp can be used with the same resistances previously installed for 4-ampere arc headlights, see Fig. 8. The equipment shown in Fig. 8 will throw a beam of about 75,000 candle-power.

Formulae, giving the distances at which a man dressed in light, medium or dark colored clothes can be "picked up" by incandescent headlights of various beam candle-powers, have been worked out by Mr. J. L. Minick, of the Pennsylvania Railroad. They are given in a paper by him, "The

advantages of the incandescent lamp are safety, simplicity and convenience. A stereopticon lantern so equipped is practically free from fire risk. Once the switch is closed, no further attention to the light source is necessary. It is steady and free from the

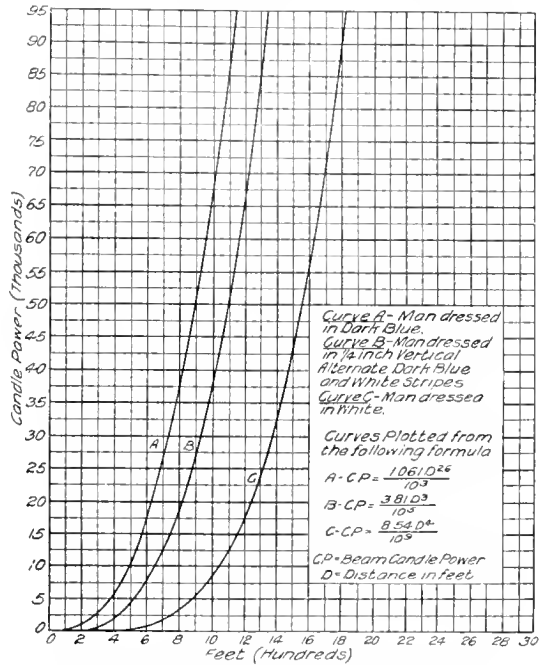


Fig. 9. Curves of "Pick-up" Distance of Incandescent Headlights of Different Beam Candle-power



Fig. 8. Incandescent Headlight Designed for Use on Interurban Cars

Locomotive Headlight," in Vol. IX, No. 9, Transactions of the Illuminating Engineering Society for 1914, page 918. Fig. 9 gives curves plotted from these formulae.

In the second field of application mentioned, i.e., stereopticon work, the chief

humming prevalent with many types of lanterns. Focus type lamps, for use on the ordinary lighting circuits, of 100, 250, and 300-watt capacity are available for this class of service. A special 1000-watt lamp may also be obtained.* These lamps should be used with a spherical mirror back of them. The function of the spherical mirror is to increase the flux of light through the condensing lenses by about 30 per cent and also to produce a more uniform field. It is generally necessary to move the lamp slightly out of focus to eliminate filament images on the screen. There are already on the market several well-known makes of stereopticon lanterns using these lamps. Incandescent lamps, sufficiently powerful for the large commercial moving picture machines, are not yet available, though progress is being made toward this end. For the small

* A separate circuit should be installed where this lamp is used.

moving picture machine, used in the home, the 500 and 1000-watt mazda lamps have proved very satisfactory.

The third class of service—flood-lighting—is a new field, which has recently been opened

and bids fair to be large. A general description of flood-lighting will be found in the April issue of the REVIEW, page 282.

The accompanying table gives data on the focus type mazda lamps now available.

† DATA ON FOCUS TYPE MAZDA LAMPS, JANUARY, 1915

AUTOMOBILE FOCUS TYPE LAMPS

Volts	Amperes	Watts	W.P.C.	Approx. C.P.	Bulb	Dia. of Bulb in Inches	Base	Max. Over-all Length	Light Center (Cap of Base to Center of Filament)	Unit or Standard Package Quantity
6 and 7	2 and 2 1/2	12 and 15	0.95	12 and 15	G-12	1 1/2	Bay. Cand.	2 1/2	1 1/8	5
6 and 7	2	12	0.95	12	G-16 1/2	2 1/8	Bay. Cand.	3 1/8	1 1/2	5
6 and 7	2 1/2 and 3	15 and 18	0.95	15 and 18	G-16 1/2	2 1/8	Bay. Cand.	3 1/8	1 1/2	5
24-90	0.33-0.08	8	1.25	6	G-10	1 1/4	Bay. Cand.	2 1/4	1 1/8	10
24 90	0.62 0.18	15	1.25	12	G-12	1 1/2	Bay. Cand.	2 1/2	1 1/8	5
24 90	1.0 0.26	25	1.25	20	G-16 1/2	2 1/8	Bay. Cand.	3 1/8	1 1/2	5
6 and 7	1	6	1.0	6	G-10	1 1/4	Bay. Cand.	2 1/4	1 1/8	10
6 and 7	1	6	1.0	6	S-8	1	Bay. Cand.	2 1/8	1 3/8	10
6 and 7	1 1/2	9	1.0	9	G-12	1 1/2	Bay. Cand.	2 1/2	1 1/8	5
6 and 7	3 1/2 and 4	0.95	21 and 24	0.95	G-16 1/2	2 1/8	Bay. Cand.	3 1/8	1 1/2	5
14	1 and 1 1/4	0.95	15 and 18	0.95	G-16 1/2	2 1/8	Bay. Cand.	3 1/8	1 1/2	5
18	3/4 and 1	0.95	15 and 18	0.95	G-16 1/2	2 1/8	Bay. Cand.	3 1/8	1 1/2	5
21	3/4 and 1	0.95	15 and 21	0.95	G-16 1/2	2 1/8	Bay. Cand.	3 1/8	1 1/2	5

LOCOMOTIVE FOCUS TYPE LAMPS

5 1/2 and 6	6	36	0.70	51	G-18 1/2	2 3/8	Med. Ser.	3 3/4	2 1/4	100
5 1/2 and 6	12	72	0.68	106	G-25	3 1/8	Med. Ser.	4 3/4	2 3/4	50
5 1/2 and 6	18	108	0.65	166	G-30	3 3/4	Mogul Ser.	5 7/8	3 1/2	24
30 34	3.3-2.9	100	0.80	125	G-25	3 1/8	Med. Ser.	4 3/4	2 3/4	50
30 34	5 4/4	150	0.75	200	G-25	3 1/8	Med. Ser.	4 3/4	2 3/4	50
30 34	8.3 7.3	250	0.70	357	G-30	3 3/4	Med. Ser.	5 1/2	3 1/8	24

STREET CAR FOCUS TYPE LAMPS

*105 115										
110 120	0.21	23	1.55	15	G-18 1/2	2 3/8	Med. Ser.	3 3/4	2 3/8	100
125 130										
*105 115										
110 120	0.33	36	1.55	23	G-18 1/2	2 3/8	Med. Ser.	3 3/4	2 3/8	100
125 130										
*105 115										
110-120	0.42	46	1.55	30	G-25	3 1/8	Med. Ser.	4 3/4	2 3/4	50
125 130										
*105 115										
110 120	0.51	56	1.38	40	G-25	3 1/8	Med. Ser.	4 3/4	2 3/4	50
125 130										
*105 115										
110 120	0.65	72	1.38	52	G-25	3 1/8	Med. Ser.	4 3/4	2 3/4	50
125 130										
*105 115										
110 120	0.85	94	1.38	68	G-25	3 1/8	Med. Ser.	4 3/4	2 3/4	50
125 130										
80	4.0	320	0.75	426	G-40	5	Med. Ser. Skt.	4 7/8	4 3/4	12

STEREOPTICON FOCUS TYPE LAMPS

105 125	0.95 0.8	100	1.23	86	G-30	3 3/4	Med. Ser. Skt.	5 1/2		24
105 125	2 4 2	250	0.8	312	G-30	3 3/4	Med. Ser. Skt.	5 1/2		24
105 125	4 7 4	500	0.7	715	G-40	5	Med. Ser. Skt.	8	4 3/4	12
*105 125	9.5 8	1000	0.6	1670	G-48	6	Mogul Ser.	13	9 1/2	8

FLOOD LIGHTING LAMPS

05 125	4.7 4	500	0.75	666	G-40	5	Med. Ser. Skt	8	4 3/4	12
--------	-------	-----	------	-----	------	---	---------------	---	-------	----

*Special lamp. † Subject to change.

HIGH CANDLE-POWER MAZDA LAMPS FOR STEEL MILL LIGHTING

By G. H. STICKNEY

EDISON LAMP WORKS, HARRISON, N. J.

This article deals chiefly with the characteristics of the gas-filled mazda lamps—how the lamps are constructed, their peculiarities, and what can be expected from them as illuminants. As is now generally known, this lamp gives the best results with large diameter filaments, and hence are most efficient in large sizes. For this reason it is not suitable for all installations, and below certain sizes the vacuum lamps are preferable. The selection of a lamp for a given installation can best be made by consulting the data book of the lamp manufacturers. Some remarks on reflectors for these lamps, with cuts and distribution curves, are included. The paper was read before the Association of Iron and Steel Electrical Engineers.—EDITOR.

At the 1913 convention of the Association of Iron and Steel Electrical Engineers, mention was made of a remarkable increase in the efficiency of the higher power mazda lamps, through improvements involving the introduction of an inert atmosphere within the bulb.¹ It was at that time possible to furnish only meager information. Since then these lamps have gone into standard production, many thousands being now in commercial use. And this type of lamp promises to be by far the most important illuminant for steel mills.

When we consider the recent origin of the incandescent lamp, its present wide-spread application is remarkable. Less than 35 years ago Thomas A. Edison made his first practical incandescent lamp, and yet last

the present time. This seems to indicate that the great advantages of the incandescent lamp are its simplicity, adaptability and reliability.

Now that current cost forms a relatively small part of the operating cost, it would appear that the incandescent lamp will have even greater advantages over competing illuminants, no matter how efficient.

That the incandescent lamp has enjoyed a remarkable rate of increase in efficiency is evidenced by Fig. 1, in which the candle-power per watt for mazda lamps, since 1907, is given. These increases are spectacular when compared with those of other machinery, either for generating or utilizing electric current.

While the gain in lamp efficiency, due to the adoption of the tungsten filament, was so remarkable as to revolutionize the lighting practice of the country, it is interesting to note that the aggregate gain since that time, due to improvements in the tungsten filament lamp, is approximately as great. Nor have the developments been merely in the direction of increased efficiency. Fragility, as it existed in the early tungsten filament lamps, has been eliminated; the blackening of the lamps has been greatly reduced by the elimination of water vapor and other impurities effected by the introduction of chemicals within the bulb; and withal the cost of lamps has been decreased.

The mazda lamp was so thoroughly perfected that the volatilizing point of the filament material became a limiting factor, and it appeared to most lamp users that the ultimate possibilities of the tungsten filament had been approximated.

¹ Harrison and Magdusck, A Progress Report on Illumination, Trans. A. I. and S. E. E.

² John W. Howell, GENERAL ELECTRIC REVIEW, March, 1914.

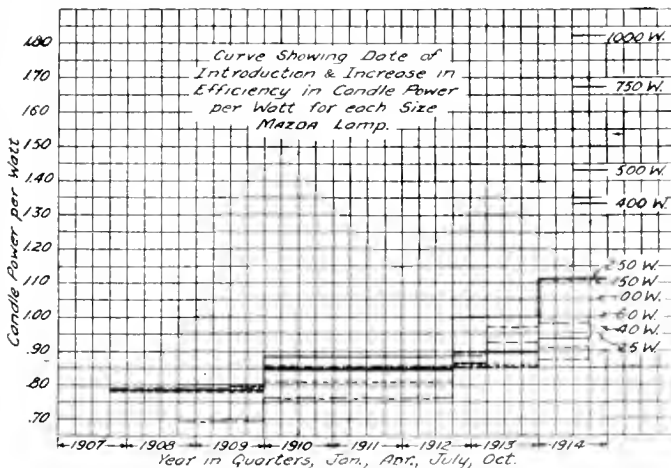


Fig. 1. Curve showing Date of Introduction and Increase in Efficiency in Candle-power per Watt for each size Mazda Lamp

year about 120,000,000 incandescent lamps were made and sold in this country.² Much of this increase was made in competition with more efficient illuminants and with higher costs for electric current than is common at

Then came the news that half-watt tungsten filament lamps were under development. It is not surprising that this news was received with some incredulity. It is interesting to note that this, like most of the recent improvements in incandescent lamps, was not a matter of accident or chance, but the result of rational scientific research, such as produced the ductile tungsten filament, and was the product of the same laboratory.

These investigations are continually being carried on in the research laboratories of the General Electric Company. This particular discovery was the result of an ingenious method of research to determine the effect of various conditions of manufacture on the

tion involved an attempt to produce a high vacuum.

Then followed the long and persistent research along the new line of introducing an inert atmosphere within the bulb, which finally resulted in the brilliant discovery that the tungsten filaments of large diameter in such an atmosphere could be operated at high enough temperatures so that increased radiating efficiency much more than counterbalanced the convection losses.³

Such lamps consumed too high a current to meet the commercial requirements for 110-volt circuits. The advantage of the large diameter filaments was their lower relative convection loss, and it was found possible,

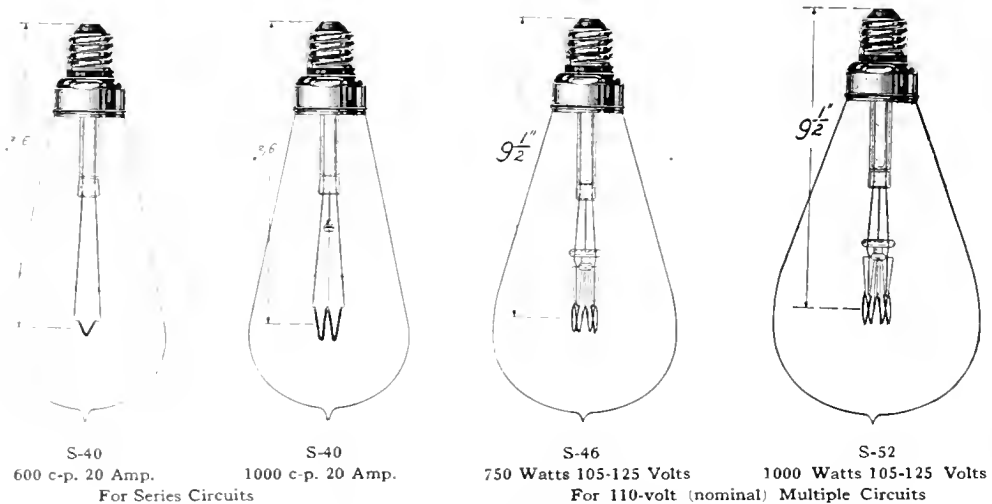


Fig. 2. High Power Mazda Lamps

quality of incandescent lamps, especially with regard to the vacuum. The vacuum was so perfect that it was not possible to measure the amount of gas or vapor within the bulb. Lamps were therefore made as perfect as possible, various gases introduced in definite amounts, and the results studied.

One of the first results was a confirmation of the recognized necessity of eliminating water vapor, which has a particularly deleterious effect. In his early experiments, Edison is said to have attempted to operate carbon filaments in an atmosphere of nitrogen, without success. The convection loss, due to heat carried away from the filament by the surrounding gas, exceeded the gain in radiating efficiency. And thereafter, for nearly 30 years, lamp improvements in this connec-

tion, after further research, to secure approximately the same result from smaller filaments by coiling them into helices of corresponding diameter.

There is still a relation between the filament diameter and the convection loss, since there is a limit to the diameter of the helix for a particular diameter of wire. The larger the diameter of the wire, the larger the helix can be made. With too large a helix the filament is liable to sag, so that some turns will close up and overheat or short circuit, while others will open up and operate at a lower temperature and efficiency.

This explains why high current Mazda lamps are more efficient than low current; or at a constant voltage (for example 110) high wattage lamps are more efficient than low wattage. In fact, for low current lamps the vacuum lamps are the more efficient, so that

³Large and Orange paper, Transactions A.I.E.E., Oct., 1907.

for the present such lamps will continue to be made.

The manufacturers can be relied upon to use and standardize the construction which yields the best quality of lamps. It is, therefore, important to avoid specifying whether vacuum or gas-filled mazda lamps be furnished, otherwise the specification may prevent the user from securing the best possible lamps; and although nitrogen has been largely employed as the inert atmosphere, other gases may be substituted when experience has proved them advantageous. Therefore the specification "nitrogen-filled" should be

avoided. The user's best interest will be served by ordering mazda lamps, as described in the latest data issued by the lamp manufacturers.

In the vacuum lamps, when tungsten is evaporated from the filament, it travels directly away from the filament and forms a coating on that part of the bulb through which the most light passes. In the non-vacuum mazda lamps, any material evaporated from the filament is carried upward by the convection current, so as to form a coating at a point directly above the filament. When the lamp is burned pendant, this occurs near

DATA ON NEW MAZDA LAMPS FOR 110-VOLT (NOMINAL) CIRCUITS

(Lamps Provided with Mogul Screw Bases)

Rated Life of Lamp, 1000 Hours

Watts	Watt per C-P.*	C-P.* per Watt	C-P.*	Spherical Reduction Factor	Mean Spherical C-P. per Watt	Total Lumens	Style Bulb	Maximum Diameter Bulb (Inches)	Length Overall (Inches)
1000	0.55	1.82	1820	0.83	1.51	19000	S-52	6 1/2	13 3/8
750	0.60	1.67	1250	0.83	1.38	13000	S-46	5 3/4	13
500	0.70	1.43	715	0.83	1.19	7440	S-40	5	10
400	0.75	1.33	530	0.83	1.11	5560	S-40	5	10
† 300	0.78	1.28	385	0.83	1.06	4000	S-35	4 3/8	8 3/4
† 200	0.80	1.25	250	0.83	1.04	2600	S-30	3 3/4	7 7/8

* Mean horizontal candle-power.

† Medium screw base.

† DATA ON MAZDA SERIES LAMPS FOR 6.6 AMPERES

(Lamps Provided with Unskirted Mogul Screw Bases)

Rated Life of Lamp, 1350 Hours

Mean Horizontal C-P.	Average Volts	Watts per C-P.*	C-P.* per Watt	Watts	Spherical Reduction Factor	Mean Spherical C-P. per Watt	Total Lumens	Style Bulb	Maximum Diameter Bulb (Inches)	Length Overall (Inches)
600	55.5	0.61	1.64	366	0.80	1.31	7060	S-40	5	10
400	37	0.61	1.64	244	0.80	1.31	4020	S-40	5	10
250	23.9	0.63	1.59	157	0.80	1.27	2520	S-35	4 3/8	9 3/4
100	9.8	0.65	1.54	65	0.76	1.17	955	S-24 1/2	3 1/8	7 1/4
80	8.0	0.66	1.51	53	0.76	1.15	763	S-24 1/2	3 1/8	7 1/4
60	6.1	0.67	1.49	40	0.76	1.13	574	S-24 1/2	3 1/8	7 1/4

* Mean horizontal candle-power.

† Lamps are also made for 7.5, 5.5 and 4 ampere. This table does not cover the full line of series lamps.

DATA ON SERIES LAMPS FOR USE WITH COMPENSATORS ON A.C. SERIES CIRCUITS

(Lamps Provided with Skirted Mogul Screw Bases)

Rated Life of Lamps, 1300 Hours

Mean Horizontal C-P.	Average Volts	Watts per C-P.*	C-P.* per Watt	Watts	Spherical Reduction Factor	Mean Spherical C-P. per Watt	Total Lumens	Style Bulb	Maximum Diameter Bulb (Inches)	Length Overall (Inches)
1000	25.0	0.5	2.00	500	0.78	1.56	9800	S-40	5	12 1/2
600	15.0	0.5	2.00	300	0.78	1.56	6800	S-40	5	12 1/2
400	14.4	0.54	1.85	216	0.78	1.44	3920	S-40	5	12 1/2

* Mean horizontal candle-power.

Current at lamp for 1000 and 600 candle-power, 20 amperes; 400 candle-power, 15 amperes. Compensators are wound for 6.6- and 7.5-ampere circuits.

the end of the neck of the bulb, in a place where the least light is lost by absorption. Except in a few special cases any darkening of the bulb which may appear within the rated life of a mazda lamp, is not likely to reduce the effective illumination to any extent.

As will be appreciated, even after the discovery of the principle there have been many problems to solve, materials to select, and dimensions and shapes to determine, in order to produce lamps for commercial service. It has been important to select such constants as will allow best for future improvements.

Based on these selections, reflector and equipment manufacturers have designed a large number of accessories, of which many are now installed in service, so that today it is important to avoid changes which would affect these designs, both because of the expense to the equipment manufacturers in changing their moulds and dies, and the importance of securing interchangeability for equipments already manufactured and installed. These conditions had to be anticipated as far as possible.

The preceding tables give data applying to some of the principal lamps standardized for multiple and series circuits, while the general appearance of the lamps is shown in Fig. 2.

While the multiple lamp will undoubtedly find greater use in steel plants than the series, there is likely to be an economy in using series lamps for outlying points, to which the following advantages may apply:

1. Low cost of copper for line and small line losses.
2. Convenience of station control.
3. Higher efficiency of smaller sizes of lamps.

Series lamps are made in two styles, straight series and compensator types. The straight series type is intended for use directly on the ordinary small alternating constant current circuits, for example, 6.6 and 7.5 amperes. The compensator types are also supplied from such series circuits, but are for operation in fixtures provided with compensators for stepping the lamp current up to 20 amperes (400 c-p., 15 amp.), so as to take advantage of the higher efficiency of the high current lamp. The compensator may also serve to protect the lamps from excessive surges on the line. The multiple lamps can be interchangeably operated on direct and alternating current circuits and any commercial frequency.

None of these lamps, either multiple or series, show perceptible flicker on 25-cycle circuits. While most of the styles and sizes as now made can be operated with the tip up, it is desirable, when lamps are intended for operation in this position, to specify "for tip-up burning," as it has been found desirable in some cases to slightly modify the construction for this condition.

The light distribution differs a little from that obtained with the ordinary vacuum mazda. This is due to the coiled arrangement of the filament, the effect of which is to give a higher mean spherical reduction factor, i.e., the ratio of mean spherical candle-power divided by the mean horizontal candle-power. This means that for a given mean horizontal candle-power, the total flux of light from the lamp is higher.

The variation of candle-power with voltage is the same as for the older types of mazdas.

A number of engineers have inquired with regard to the coiled arrangement of the filament, whether considerable light were not lost within the helix, and also as to the temperature of the inner and outer surfaces of the helix. With regard to the first inquiry, it will be evident that no energy could be lost within the helix, as any loss of light occasioned by rays falling on the filament would go toward raising the temperature, and hence increase the efficiency of radiation. However, in accordance with Provost's Physical Law, with reference to the "Theory of Exchanges," parts of the filament cannot lose energy by radiation to other parts which are at the same temperature.

Then, as regards the second question, if there is a tendency to produce a higher temperature on one side of the filament, the heat conduction of the material will tend to equalize it, and the diameter of the filament is not enough to allow any considerable difference of temperature to be established. Heat resistance calculations at the research laboratory show that the actual difference in temperature between the inner and outer surfaces is about one degree C., which, of course, is negligible.⁴

Again, a question has been raised as to the allowable variation of voltage due to the fact that the filaments are worked nearer the melting point than in the vacuum lamps. It is true that the new lamps will not withstand as high a momentary voltage as the vacuum mazda lamp. They will, however, stand considerable variation in this direction, at least as much as the carbon filament lamps.

⁴ Paper, Characteristics of Gas-filled Lamps, G. M. J. Mackay, 1914 Convention, Illuminating Engineering Society.

The higher heat capacity of the filaments is instrumental in increasing the allowable maximum voltage. Experience and investigations lead the manufacturers to anticipate no trouble from this cause in commercial service.

Both the thickness of the filament and the coiled arrangement make for ruggedness, so that the lamps will stand fully as much vibration as any other type of lamp. The lamps are designed to have pressure of the gas within

illumination is desired, and reduce the light in other directions where the intrinsic brilliancy may be objectionable. Such a reflector also introduces diffusion, thereby softening the shadows and reducing the glare. Since these non-vacuum lamps operate with the filament at a higher temperature, the brilliancy is a little higher than in the older types,

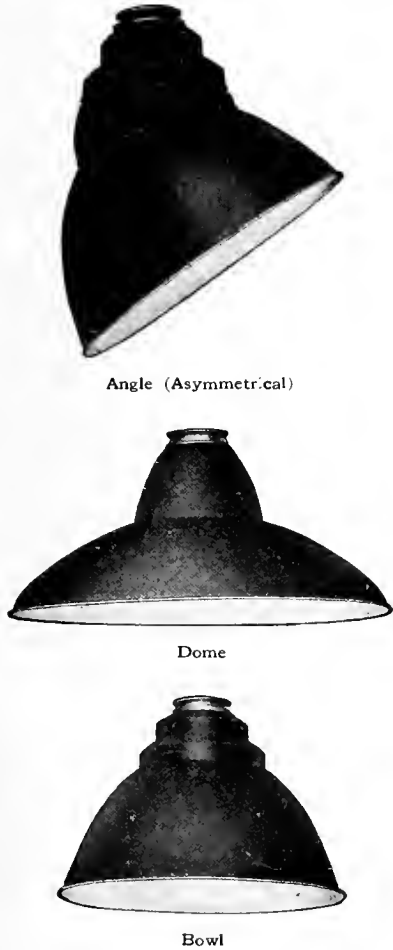
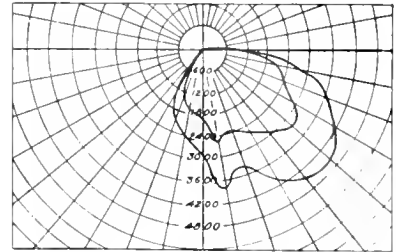
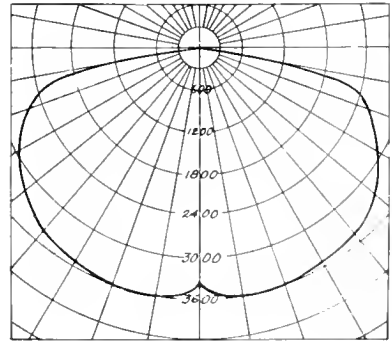


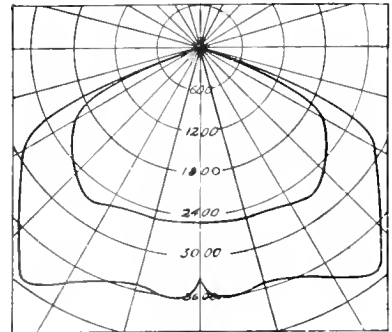
Fig. 3. Enamel Steel Reflectors for 750- and 1000-watt Mazda Lamps



Angle (Asymmetrical)



Dome



Bowl

Fig. 4. Photometric Curves of Enamel Steel Reflectors shown in Fig. 4

the bulb just below the atmospheric pressure when the lamp is hot and somewhat lower when cold.

Equipments

All forms of incandescent lamps are most effective when provided with reflectors that distribute the light in directions where the

and the reduction of brilliancy more important.

Reflectors for vacuum type mazda lamps are suitable for corresponding new lamps. The recent addition of the higher power lamps required the development of new

equipments. It is even more important that these lamps should have proper reflector equipment than with the smaller sizes. In the first place the lamps are likely to be

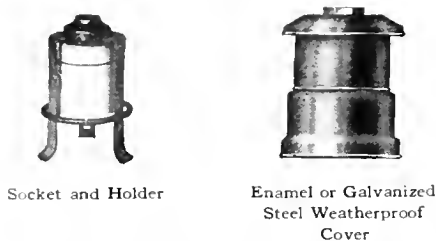


Fig. 5. Holder and Weatherproof Cover for Use with Reflectors shown in Fig. 4

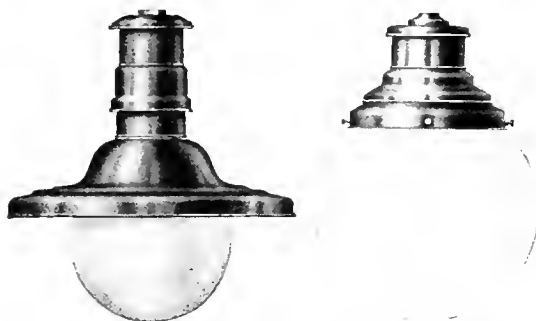


Fig. 6. Outdoor Fixtures with Opal Globes, for High Power Multiple Mazda Lamps



Fig. 7. Outdoor Fixture for High Power Mazda Lamps (Fixtures for series and multiple lamps are similar in appearance)



Fig. 8. Semi-indirect Fixture for High Power Mazda Lamps

placed on wide centers so that good distribution of light is necessary to insure good illumination at intermediate points. The concentrated arrangement of the filament

permits more accurate control of the light distribution by means of reflectors, and conversely makes the use of the proper reflector more necessary.

The higher wattage lamps have more heat to dissipate from a small piece of apparatus; furthermore, gas-filled lamps differ from the vacuum lamps in that the internal convection currents carry heat upward, so that the lamp base runs at fully as high a temperature despite the fact that the heat loss per watt is slightly less. On account of these considerations special attention was required to insure that proper ventilation was provided for in the reflector designs. The experience in the design of arc lamps was useful in this connection.

The lamp manufacturers have endeavored to cooperate closely with those responsible for the design of reflectors and fixtures to make sure that their product complied with these requirements. As a result there are now on the market a wide range of reflector equipments for adapting these lamps to almost any character of service. Practically all of these which have been advertised take care of the ventilation and provide distribution of light for the purposes intended.

For interior lighting in a steel mill, the porcelain enamel steel reflectors are likely to be most extensively used. These are made in three principal types; viz., extensive bowl, distributing dome, and asymmetrical angle. Fig. 3 shows these reflectors as made by one of the leading reflector manufacturers and gives corresponding photometric curves. It will be noted that the same size reflector is used for both the 750- and 1000-watt lamps. Fig. 5 shows a holder and some weatherproof housings designed for use interchangeably with these reflectors.

The bowl and dome type reflectors are well known, while the angle type is being more and more used where the crane arrangement makes it desirable to locate the light sources along a wall, or edge of a bay. These reflectors, while more often used indoors, are sometimes employed for exterior lighting.

For cases where the use of a diffusing globe is desired, fixtures shown in Fig. 8 are avail-

able. These are less efficient than those shown in Fig. 3, and do not permit of as effective control of light distribution, yet, nevertheless, are preferred in many cases.

Fig. 7 shows another type of fixture for use with series or multiple lamps for outdoor service. These fixtures are arranged so that different globe and refractor equipments may be used interchangeably. These units have been especially designed for street lighting and will meet corresponding requirements in large plants. For lower power series lamps, both radial wave and refractor equipments are available and advantageous.

Fig. 9 shows one of the several types of refractor equipments. The radial wave reflector is more efficient both in total and in downward light, and gives a reasonably wide spread. The refractor unit diffuses the light, so that its entire surface appears luminous, and also gives a remarkably wide spread of illumination. The maximum candle-power with the refractor is at 10 degrees below the horizontal, and is approximately double the rated candle-power of the lamp.

For the lighting of large general offices and drafting rooms, having white or light colored ceilings, it is often advantageous to use semi-indirect or indirect lighting. Such lighting provides excellent diffusion, which facilitates the close and careful vision so generally required for bookkeeping, drafting, etc.

These methods of lighting are at their best with the new high power lamp since it is possible to produce even illumination with wide spacing of units, while the high efficiency of the lamps keeps the operating cost relatively low. Fig. 8 shows one of the many styles of semi-indirect fixtures.

The high efficiency lamps also offer new possibilities in the way of advertising lighting, especially for plants located near railroads and thoroughfares. Signs or building fronts may be lighted effectively, at a relatively low construction and operating cost, by projected light.* When surrounded by a dark background, an illuminated sign becomes more conspicuous at night than in the daytime.

Conclusion

In this paper an attempt has been made merely to collect and present briefly data regarding these high power mazda lamps and

typical reflector equipments. No attempt has been made to describe particular installations. Extensive installations have not been in use long enough to contribute information of great value; on the other hand, the Transactions of this Association contain reliable

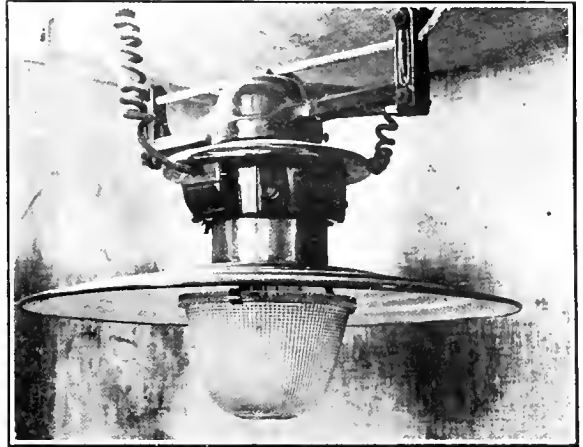


Fig. 9. Refractor Equipment for Low Power Series Mazda Lamp. (This particular unit is provided with a center span suspension. Both bracket and eye suspensions are also made.)

data on the lighting requirements of steel mills,⁵ which, taken with the equipment data here presented, will be sufficient to enable a steel mill engineer to plan effective installations. It is believed that these units will give an added impetus to mill lighting.

A few suggestions have been made for the extension of artificial lighting. By selecting units of most effective capacity, a higher standard of illumination can be provided in some of the important departments, without increased cost, while it seems practicable to extend artificial lighting to some sections of plants where previously the cost has seemed to exceed the advantage gained. Safety has always been the watchword of this Association; and good lighting is unquestionably one of the most effective means toward that end.

⁵ For example, paper on Iron and Steel Works Illumination, C. J. Mundo, presented to the A. I. and S. E. E., September, 1911.

* This subject is dealt with at length in an article in our April issue, beginning on page 282: *Sign and Building Exterior Illumination by Projection*, by K. W. Mackall and L. C. Porter. —EDITOR.

THE GENEMOTOR

(A Single Unit Starting and Lighting System for Moderate-Priced Automobiles)

By M. J. FITCH

WEST LYNN WORKS, GENERAL ELECTRIC COMPANY

The author of the following article first names the reasons for developing the Genemotor, then describes the functions, construction, and operation of the device, and concludes with a brief explanation of its commercial distribution.—EDITOR.

Today, an automobile is hardly regarded as being completely equipped unless it is furnished with an electric starting and lighting device. This regard is one of those examples of our natural trend to welcome any thoroughly practical labor-saving device in our daily activities. The manufacturers of high and medium-priced cars were naturally the first to embody such an equipment in the automobile. As a result of public demand, many of the makers of low-priced cars have adopted an electric lighting equipment as their standard or are prepared to furnish a complete electric starting and lighting equipment at a small additional cost.

A good example of the type of low-priced car, which as marketed by the manufacturer does not include a starting equipment, is the Ford. For cars of about this caliber, and for this make in particular, the General Electric Company has devised a starting and lighting set to which the name Genemotor has been given. This set combines the functions of a generator and a motor in a single unit. The machine possesses both main and commutating poles and windings of a novel type, and operates on 12 volts.

In starting the automobile engine, the characteristics of the Genemotor are those of a compound-wound motor having a heavy series field. Later, when driven at a certain predetermined speed by the engine, the unit automatically assumes practically the same functions as a shunt-wound generator, under which condition it charges the storage battery connected to it.

The combination of windings that is used secures an output of practically constant current and voltage over a wide range of speed; and, through the medium of this inherent regulation, the use of vibrators, voltage regulators, and other similar automatic devices is eliminated.

The frame of the Genemotor is of mild sheet-steel bent into cylindrical form with its edges welded together. To the pinion end

of the cylinder is spot welded a die-drawn, sheet-metal end head. The commutator end head is of cast-iron which with the drawn frame comprises a simple two-piece construction. The commutator and brush rigging are protected by a punched metal insulated cover. The shape of the frame, and to a certain extent its construction, is shown in Figs. 1, 2 and 3.

Mounted on the Genemotor is a small case containing the starting switch and reverse-current cutout as a single unit. The moving member of the starting switch is composed of



Fig. 1. The Genemotor

a number of phosphor bronze leaves clamped together; and the fixed member is a solid copper contact which is an integral part of one of the starting battery leads. The switch is closed by a push-rod extending through the dash, and is automatically opened when the

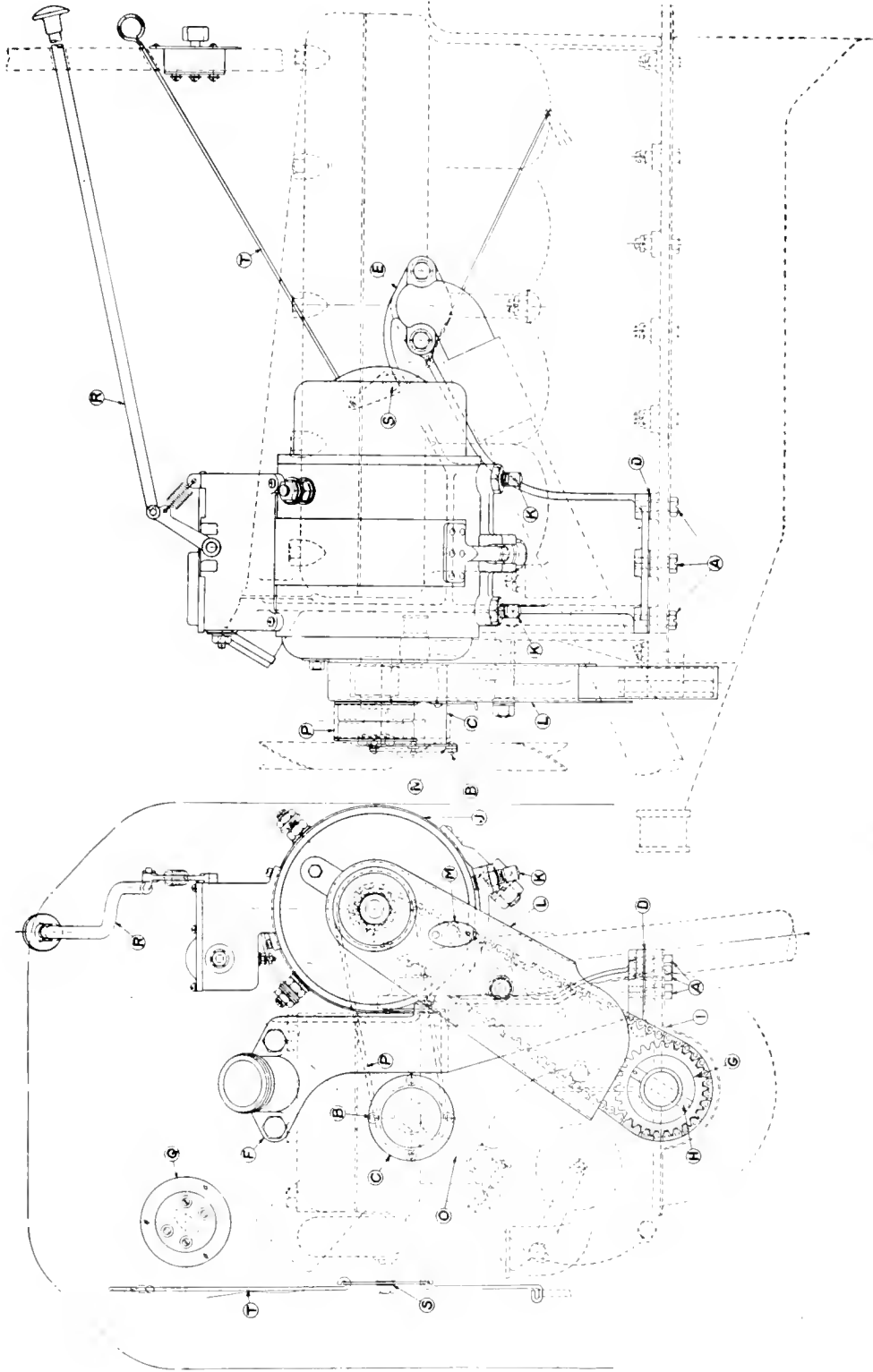


Fig. 2. Outline and Assembly of Genemotor

rod is released. The reverse-current relay connects the Genemotor to the battery when sufficient voltage is generated to charge the battery, and breaks the circuit when the Genemotor voltage falls below that of the battery. This prevents the battery discharging when the Genemotor is at rest. This cutout, or its equivalent, is necessary in all similar systems but is the only automatic device necessary or employed with the Genemotor.

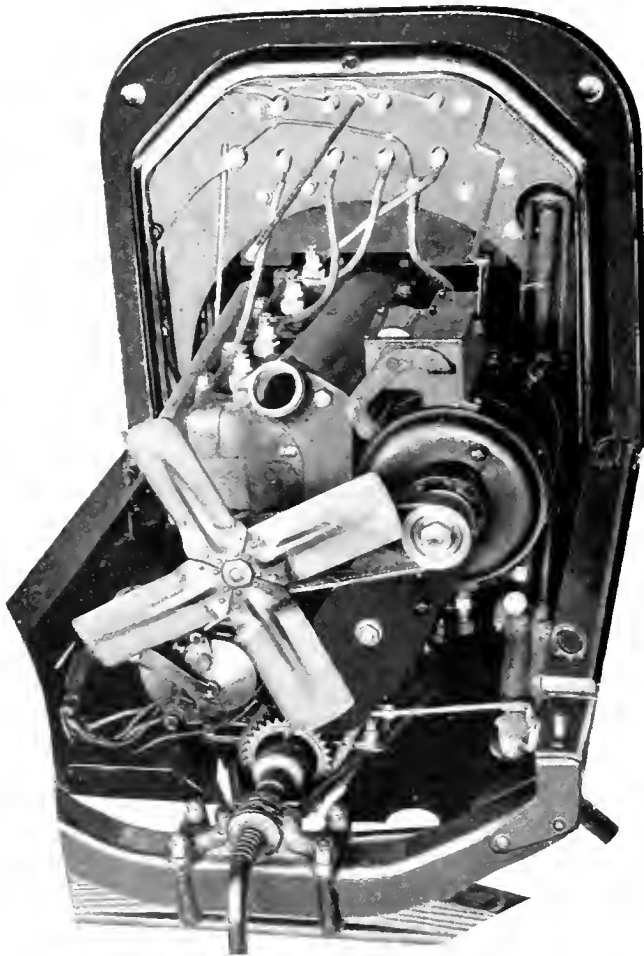


Fig. 3. Genemotor Mounted on Ford Engine

The bracket by which the Genemotor is fastened to the engine is a reinforced, strong but light, sheet-steel punching. Three points of attachment are used, these being both of the water connections and the engine base flange. Incorporated in this bracket are the necessary screws, with lock-nuts for adjusting

the chain, and the steel strap to hold the Genemotor in position.

Power is transmitted to the starting and lighting unit by a single silent-chain of special design and of approximately 2:1 gear ratio. The large sprocket replaces the fan pulley on the engine shaft. All moving parts are enclosed in a suitable dust guard provided with suitable means for lubricating the chain when necessary. A split pulley clamped to the regular fan pulley permits of a continuance in the use of the fan and belt tightening devices.

By means of a suitable connection, furnished with the equipment, the butterfly air intake valve of the carburetor can be closed when starting, thus insuring the delivery of a rich mixture to the cylinder which is very essential in cold weather.

The lighting switch is of the three-way reversible two-wire type which permits the use of all the usual lighting combinations. The necessary lighting wire of correct length with terminals properly tagged is furnished together with starting cable of large cross-section that insures but small drop in the battery voltage.

The battery is of special design and consists of six cells, each cell containing seven $\frac{1}{8}$ -inch plates. It has a capacity of 42 ampere-hours at the 5-ampere discharge rate and, after being fully charged, can be discharged at the rate of 250 amperes with a voltage of not less than 10 at the beginning of the discharge. The battery together with its substantial pressed steel container weighs approximately 60 lb., and the complete system including these batteries totals about 140 lb.

The installation of the system can be accomplished easily, especially so by any of those mechanics who specialize in such work. No changes in the car are necessary and but little fitting, if any, is required.

To start the engine, it is only necessary to close the main switch and, if necessary in extremely cold weather, the butterfly valve. The Genemotor (as a motor) will then produce approximately 100 lb. torque at one foot radius on the engine shaft and will ordinarily spin the engine at about 150 revolutions per minute. When the car is driven at a speed of from 10 to 12 miles per hour, the

cutout operates and automatically the Genemotor (now acting as a generator) will begin to charge the battery. The maximum charging rate of 10 amperes is obtained at a car speed of from 20 to 30 miles per hour; and at no speed will the ampere input to the batteries exceed the safe normal charging rate, even when the batteries are fully charged.

The Genemotor is being distributed throughout the country by Messrs. A. J. Picard & Co., 1720-1722 Broadway, New York City, which concern places the device in the hands of local dealers of automobile supplies in the principal cities. This arrangement greatly facilitates the securing and installing of this starting and lighting equipment for outstanding Ford cars.

ELECTROPHYSICS

PART IV

By J. P. MINTON

RESEARCH LABORATORY, PITTSFIELD WORKS, GENERAL ELECTRIC COMPANY

In this installment the author deals entirely with free electromagnetic waves, and by assuming the existence of electric lines of force shows how these waves are produced. A number of different kinds of electromagnetic waves are discussed, and it is shown that we are justified in considering light waves, infra red rays, gamma rays, Röntgen rays, etc., as of electromagnetic origin. A short discussion is given on the effects of frequency on electrical measurements, with special reference to Maxwell's law.—EDITOR.

ELECTROMAGNETIC RADIATION FROM THE VIEWPOINT OF THE ELECTRON THEORY

Introduction

In the three articles which the author has already written on the electron theory for this series on Electrophysics, the electron conception of matter and electricity was developed. It was shown how this conception of matter and electricity greatly simplified our previous ideas. Things which appeared so divergent and unintelligible become comparatively simple and easy to explain with the idea of the electron. If this does not appear to be evident from previous considerations, let me call attention to radioactivity. The chemists take matter to be fundamental, but in doing so they find it necessary to assume some eighty or ninety different kinds of matter—these are called the elements. No one will admit such a conception as this to be simple by any means. The physicists, on the other hand, do not find it necessary to assume so many different forms of matter. Radioactivity shows how one element breaks down into another one of lower atomic weight, and when we observe such a phenomenon as this, we are justified in assuming only one form of matter to exist. We might call this the parent form and the other apparently different forms, the descendants. Both the parent and the descendants are to be looked upon as made up of exactly the same fundamental "things"

(whatever these may be), but each possesses these fundamental "things" in different combination so as to give different properties. These "things" and their relation to one another is what the theoretical physicist is trying to fathom today. They consist of electrons, electricity, energy and no doubt other "things" about which we know little. Certainly a view like this is more simple to conceive and more far-reaching than the old ideas of matter formerly held by the scientific world.

What I wish to do in this article is to harmonize so many apparently different forms of radiation by showing that they may all be considered of an electromagnetic nature, and hence, fundamentally all are of the same kind. If this can be done, then the engineer, who is so familiar with wireless waves and waves along wires, will not be struck with the power of mystery when reference is made to gamma rays, Röntgen rays, infra red rays, etc. The engineer will also have a better understanding of the connection between the electrons and the electric and magnetic fields than he previously had. Usually, he has no difficulty in thinking about these fields, but he does have difficulty in connecting up these fields with the electrons. In order to eliminate this difficulty, if possible, I shall endeavor to show the connection

that is assumed to exist between these fields and the electrons. When the ideas here set forth are fully developed and understood, one ought to have a much simplified view of the whole subject of radiation, just as the scientist has a simplified view of matter as outlined above.

In order to develop these ideas the following subjects will be discussed:

- I. Bound and Free Electromagnetic Waves.
- II. Lines of Electric Force.
- III. Production of Electromagnetic Waves.
- IV. Kinds of Electromagnetic Waves.
 - (a) Ordinary Electromagnetic Waves.
 - (b) Infra Red Rays.
 - (c) Light Waves.
 - (d) Ultra-violet, Röntgen, and Gamma Rays.
- V. Energy Considerations for Electromagnetic Waves.
- VI. Effect of Frequency on Electrical Measurements.
- VII. Summary and Conclusions.

With the object in view as outlined above, we shall now take up these various subjects in the order given.

I. BOUND AND FREE ELECTROMAGNETIC WAVES

In discussing the subject of Electromagnetic Radiation, we are concerned with what may be called free electromagnetic waves. There are also bound waves of this nature. We must differentiate between these two kinds in order to understand clearly with which kind we are to deal. Many people have most likely listened to the sound of an approaching train by placing their ears against one of the rails of the track. The transmission of these sound waves along the rails may be called transmitted *bound* waves. The free sound waves would be those which pass through the surrounding space so that a person perhaps a mile from the track could hear the approaching train. We may confine light waves within tubes, or we may allow them to pass in all directions through space. The first are bound waves within the tube, and the second are free waves. Similarly, all are aware of the existence along wires of electromagnetic waves, which are called bound waves. Everyone is also familiar with the existence of electromagnetic waves met with in wireless telegraphy; these are called free electromagnetic waves, and they travel through space without the assistance of any guiding wires. These free electro-

magnetic waves, which travel through space in this manner and which are produced in a variety of ways, are the ones which will be considered in this article.

II. LINES OF ELECTRIC FORCE

If there are two particles of electricity (considering electricity fundamental instead of matter) in space, they repel or attract each other, depending on their signs, with a force inversely proportional to the square of the distance between them. But to say that a force exists between these particles does not satisfy us, because our minds are so constituted that we must form a picture of how this force is transmitted. Now, one way to form this picture is to imagine a material medium which will transmit the force; for this purpose the idea of the ether prevailing all space was developed. But it is hard to conceive of an ether, especially when it must be thought of as a material medium. So, we shall form another mental picture of the peculiar way that the action between electric charges may be considered to take place. For this purpose we shall *assume* that each particle of electricity carries with it lines of force, which have been called Faraday tubes. This was the assumption made by Faraday. This is purely an assumption, and what these lines of force are we cannot say any more than we can say what electricity is or what an ordinary piece of matter is. The idea is far more simple than that of matter. There is only *one* kind of line of force according to this assumption, whereas there are many different kinds of matter according to the old ideas. This conception of a line of force is just as fundamental and simple as that of electricity; so, in this electromagnetic theory we are going to develop, the line of electric force is as much a part of electricity as the electric charges themselves. Maxwell proved that the forces between charged bodies could be considered as resulting entirely from tension along the lines of force and a repulsion perpendicular to them¹. So, the second assumption we shall make is that these lines of force, which are carried by every particle of electricity, have the characteristic of being in a state of tension (similar to stretched elastic strings) and of repelling one another sideways. We may consider the force of attraction resulting from stretched strings, and repulsion due to compressed strings.

These lines of electric force may be considered as physical realities, because when a disturbance of an electric charge occurs, this

disturbance is *not* detected *instantly* at a distant point but at a certain definite time *later*. We imagine the "news" (so to speak) of the disturbance to be communicated to a distant point by means of the electric lines of force. If time is required for these lines of force to carry the "news" to a distant point, then it is absolutely necessary to think of these lines of force as possessing inertia. They are to be considered as concrete realities and not merely as curved and straight directions in space like boundary lines between states. The idea of looking for the "electric" line would not be as foolish as looking for the state "boundary" line or a change of color as illustrated on maps. In a number of articles² the idea of a line of electric force being considered a reality has been developed. We are now in a position to take up the production of electromagnetic waves.

III. PRODUCTION OF ELECTROMAGNETIC WAVES

The most simple way to conceive of the production of electromagnetic waves is not to consider a capacity and inductance in series, but instead, to consider the electron with its lines of electric force extending in all directions into the surrounding space. Suppose, then, we give our attention to an electron in free space and one of its lines of force. If the electron has a sudden motion given to it in a direction at right angles to the line, then the end of the line at the electron will be displaced in the direction of motion. But since the line possesses inertia, it will not be displaced over its whole length at the same time. The parts nearer the electron will be displaced sooner than those farther away. Those parts of the line which are at infinite distances from the electron will not receive any displacement until infinite time has elapsed after the displacement of the electron. The result of the motion of the electron is the production of a kink in the line of force which travels outwardly in much the same way a kink travels along a rope when one end of it is suddenly jerked at right angles to its length. The direction of the electric force is, of course, along the line at all its parts.

These ideas will be made clearer if we consider a number of examples. Let us consider two lines of force which leave the electron. Imagine an electron to move rather suddenly from *A* to *B*, Fig. 1. After a short interval of time the state of affairs is as represented in this figure. The two kinks

shown travel outwardly from the electron as shown by the arrows, with a certain definite velocity. Before each kink the line of force is still in a position corresponding to *A*, and behind each kink the lines are in the new position, corresponding to *B*. The dotted lines show the old positions of the lines of electric force.

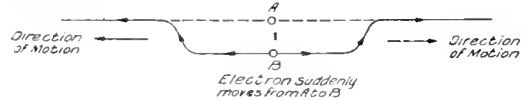


Fig. 1

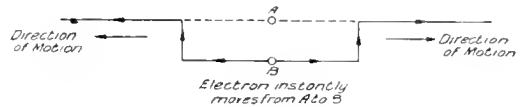


Fig. 2

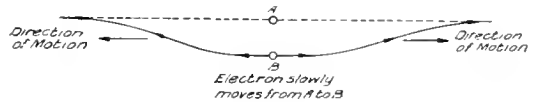


Fig. 3

If the electron moves from *A* to *B* in zero time, after a short interval of time, the condition of affairs is as represented in Fig. 2. When the electron slowly moves from *A* to *B*, the lines of force, after a short interval of time, are as shown in Fig. 3.

When the electron moves parallel with the lines of force, no kinks are produced and the state of affairs is just the same as before the movement took place. Then, let us consider all the lines of force which are attached to an electron. When the electron moves from *A* to *B*, Fig. 4, all of the lines of force with the exception of the two parallel to the direction of motion have kinks produced in them. Maximum kinks exist in those lines at right angles to the direction of motion, and minimum kinks are found in those lines parallel with the direction of motion. The arrows in Fig. 4 indicate the direction of motion of these kinks. The unsymmetry noticed in the figure disappears farther away from the electron.

The cases illustrated by Figs. 1, 2, 3 and 4 are the most simple. Let us now give our attention to some examples which are more interesting from an engineering point of view. In this part of the discussion, the magnetic field will be introduced. Oliver Heaviside

has shown² that a portion of a line of electric force, along which the force is E , moves with a velocity V at right angles to itself (as illustrated in Fig. 2), a magnetic field is produced along this portion equal to $H = EV$. If the portion of the line is not moving at

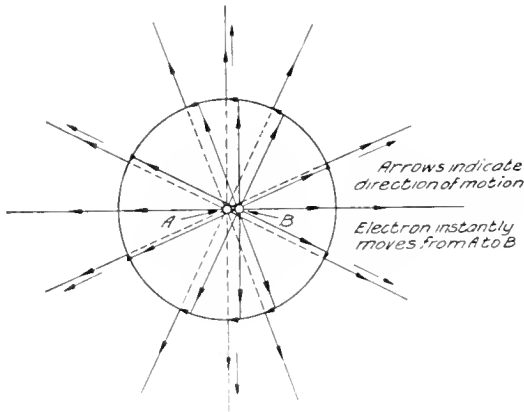


Fig. 4

right angles to itself (as illustrated in Fig. 1) then $H = EV \sin \theta$, where θ is the angle between the direction of V and that of the line of force. This magnetic force is at right angles to both E and V . Consequently, the magnetic field (or lines of magnetic force) is produced by the motion of the electric lines of force which themselves are caused to move due to the motion of the electrons. The electric lines of force are always present whether the electrons move or not, but the magnetic lines of force are present only when the former lines are in motion. Therefore, it is natural to consider the latter arising as a result of the movement of the former.

In Figs. 1, 2, 3 and 4 we have shown no magnetic lines of force; nevertheless these are present in the kinks. If they were placed in the diagrams, they would be represented by dots in the kinks, showing that they were at right angles to the electric lines of force and to the direction of propagation of the kinks. Since we have represented the electric lines of force as being stationary, except in the kinks, then it is clear that no magnetic field exists along these stationary parts.

Let us plot, therefore, the magnetic and electric fields surrounding a very long wire in which electric oscillations are taking place. Now, according to this theory, we are going to think of the electrons in the wire as oscillating, and the lines of electric force, which

can be represented as perpendicular to the wire in all directions, having their ends jerked backward and forward in unison with the electrons. The result is the propagation outward, along these lines of electric force, kinks as represented in Fig. 5. The dots represent the end-on view of the magnetic lines of force; the circles show the magnetic lines of force in the reversed direction. The arrows indicate the direction of propagation as before. These lines of magnetic force are distributed in circles around the wire with the centers on its axis, because the electric field extends radially (except in the kinks where it tends to be parallel with the wire) around the wire. These circles of magnetic force are thought of as expanding outwardly, as the kinks move away from the wire, in much the same way that ripples on water expand when a stone is thrown into it. As the oscillations continue, there is a procession of kinks or waves in the electric lines of force. These are first in one direction, and then in the other, and move outward radially to the wire. Mingled with these, and at right angles to them, are the circular lines of magnetic force, also alternately reversed. At any point in space, not too near the wire, there is an alternating electric force which is parallel to the wire and an alternating magnetic force which is at right angles to it and to the direction of propagation. These two forces are periodic and pulsate together, coming to their maximum values at the same instant at places not too near the wire. The result is the propagation of what is called an electromagnetic wave outward with a certain definite

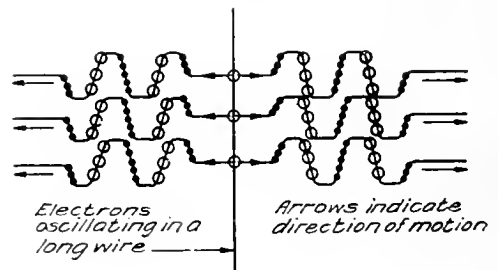
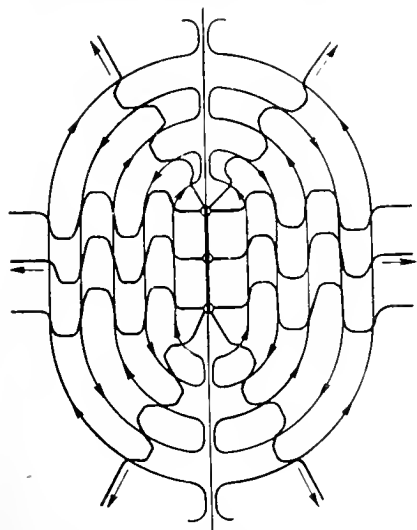


Fig. 5

velocity depending only on the medium through which it passes. If the medium is free space, then this electromagnetic disturbance is transmitted without the assistance of ponderable matter, and the process of this propagation has been defined as electromagnetic radiation.

Next, suppose that electric oscillations are produced in a wire of finite length rather than of infinite length. These oscillations are produced as a result of the to and fro movement of electrons in the wire, just as stated above, and the lines of force are jerked backward and forward as previously described. What happens in this case is illustrated in Fig. 6. In this figure it will be seen that the oppositely directed kinks of the waves are joined together by closed loops of, what may be called, electric forces. The diagram, of course, shows only a plane section of the space surrounding the wire. However, if the whole space around the wire is considered, then two symmetrical loops of electric force may be thought of as expanding into a closed shell of electric force. These shells are thrown off, so to speak, from the wire and travel out through space with a certain definite velocity. The magnetic circles of force also form closed shells of magnetic force, and the direction of the magnetic force in these is at right angles to both the electric force and the direction of propagation of the electromagnetic effect. These shells of magnetic force are not shown in Fig. 6.



*Arrows indicate direction of motion
Electrons oscillating in a short wire*

Fig. 6

gap is inserted in the wire near the earth (see Fig. 7). Imagine the portion of the wire above the gap charged to a high potential. Since the earth is a good conductor, we may think of the earth and the vertical wire as forming two plates of a condenser.

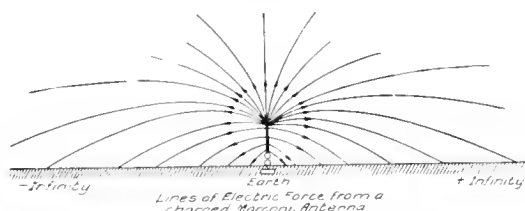


Fig. 7

Then, the lines of electric force will extend symmetrically around the wire, starting, say, from the wire and terminating on the earth in all directions.

Now, suppose, a discharge occurs across the gap. This causes the electrons in the antenna to oscillate and the ends of the lines of force are jerked back and forth as previously described. After a short interval of time, the kinks in all the lines have travelled out equal distances from the antenna. In Fig. 8 is shown the condition of affairs for two complete cycles. A vertical section only to the right of the antenna is shown. In the figure, the oppositely directed portions of the lines of force are joined together in loops of electric force. The dots represent the circles of magnetic force, which may be considered in clockwise direction around the

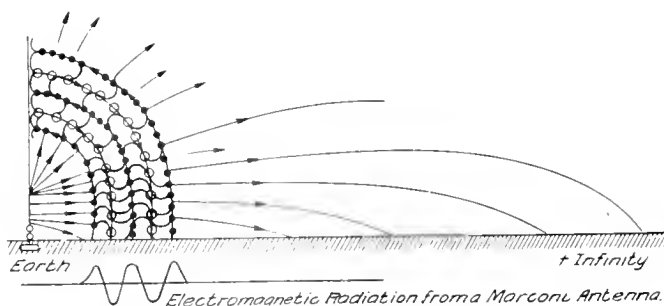


Fig. 8

As a final example of the production of electromagnetic waves, we shall discuss the case of a simple Marconi antenna. It consists of a wire, perhaps 100 feet long, placed vertically with respect to the earth; a spark

antenna and the small circles are to represent the circles of magnetic force which encircle the antenna in anti-clockwise direction. These electromagnetic effects are propagated through space in the same manner as pre-

viously described and constitute what we may call electromagnetic radiation. The shape of the electric waves for the upper portion of Fig. 8 is represented by the lower part of the figure. Now, the shape of these electromagnetic waves, as obtained by this

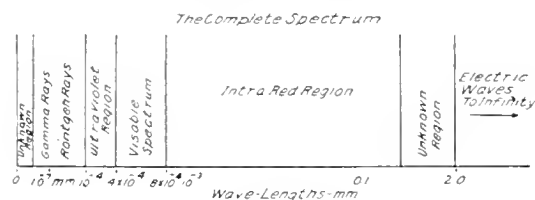


Fig. 9

theory, is exactly that as represented by Fleming⁴ and Franklin⁵, who made use of Hertz's⁶ solution of the general equations of the electromagnetic field in the neighborhood of a small oscillator.

What we mean by electromagnetic radiation, and how we imagine it to be produced, is probably now fairly well understood. It is important, now, to take up the discussion of the various kinds of electromagnetic radiation, of which one frequently hears.

IV. KINDS OF ELECTROMAGNETIC RADIATION

(a) Ordinary Electromagnetic Waves.

The ordinary electromagnetic waves, met with in wireless telegraphy, are those discussed above with the help of Figs. 5, 6, 7 and 8. Thus far, these have only been produced by exciting oscillations in an electric circuit which possess capacity and inductance. By varying the capacity and inductance, it is possible to obtain *elective* waves whose wave-lengths extend from about 2 mm. to infinity. These may be represented in the spectrum, as shown by Fig. 9. Measurements made with these short *elective* waves have furnished an admirable proof of Maxwell's electromagnetic theory. This will be pointed out in the section on the effects of frequency on electrical measurements. Our knowledge of the very short electric waves is due to the work of Lodge, Righi, Lebedew, Lampa, Bose, v. Baeyer, and especially Prof. Rubens of Berlin.

b). Infra Red Rays.

The wave-lengths of the infra red rays extend from about 0.0008 mm. to about 0.3 mm. These infra red rays can be detected by the great heating power or by their action

on phosphorescent substances. They correspond to the heat rays that come to the earth from the sun. The portion of the spectrum occupied by these waves is shown in Fig. 9. It will be seen that an unknown region exists between the shortest electric waves yet produced and these infra red rays. If the capacity and inductance of an electric circuit could be made sufficiently small, then it would be possible to produce electric waves whose wave-lengths correspond to those of the infra red region and to the unknown region. So, we are inclined to believe that these infra red rays are of an electromagnetic nature. This belief is further strengthened by the pretty well established conclusion that light waves are electromagnetic ones. So, on both sides of these heat rays are found electric waves as represented in Fig. 9. It seems, therefore, that we are justified in assuming that infra red waves are of an electromagnetic nature. If this be so, then we may consider them, according to this theory, as due to the movements of electrons within the substances emitting these infra red rays. The movements of the electrons would be oscillatory in nature and of a frequency sufficiently high to produce the waves of the magnitude shown in Fig. 9.

(c) Light Waves.

For a long time it was thought that electromagnetic waves were propagated through space at infinite velocity, as appears to be the case with gravity. Hertz, however, proved experimentally that these waves were transmitted through space at a velocity of 3×10^{10} cm. per sec. which is also the velocity of light through space. We see, therefore, that a very close relationship exists between the propagation of light and of these electromagnetic waves. Maxwell thought for a long time before this that light waves were electromagnetic in character, and he proved theoretically that the velocity of these waves, according to the electromagnetic theory

should be $\frac{1}{\sqrt{\mu k}}$ in transparent media, where

K is the dielectric constant and μ the magnetic permeability of any particular substance. This law has received ample verification, as will be pointed out later in this article. For these and other reasons, we feel fully justified in saying that the propagation of light is an electromagnetic disturbance of the nature described above. If this be true, then we must look for its explanation in the movements of electrons and their lines of electric force.

Let us assume this to be true, and the frequency of oscillation of the electrons about the positive atoms of various substances emitting light to be approximately 10^{15} per sec. (This corresponds to a wave-length of 0.0003 mm. since wave-length times frequency equal 3×10^{10} cm. per sec., the velocity of light.) The phenomena of light then receive a simple explanation. Because, every electron describing a straight or elliptical path sends out waves of both electric and magnetic force, and every electron revolving in a circle gives rise to a steady magnetic field and a revolving electric field. This revolving electric field sent out into space is a twist something like that produced by laying a rather stiff string on a table and quickly twisting one end of it. If this electromagnetic wave is of proper frequency, it is described as "circularly polarized" light in a direction depending upon the direction of rotation of the electron. When the electron revolves in an elliptical path, it sends out what is called "elliptically polarized" light, and when the electron oscillates to and fro in a straight line, it sends out "plane polarized" light. The periodicity, of course, must be of the proper magnitude to be visible as light. We may think of ordinary light as being produced by the random oscillations of the proper frequency of the electrons within the atoms of substances emitting light.

In order for the brain to receive the sensation of light, we might regard the atoms of the eyes as possessing electrons, which are affected by the electromagnetic waves of light. If, then, light waves of a frequency, say, corresponding to yellow light enter the eyes, the electrons within the eyes whose frequency corresponds to that of yellow light take up most of the energy due to the phenomenon of resonance. The additional energy possessed by these electrons is then communicated to the brain. This can be considered only a suggestion.

The portion of the spectrum occupied by these light waves is indicated in Fig. 9, the wave-lengths extend from 0.0004 to 0.0008 mm. If the capacity and inductance of an oscillatory circuit could be made sufficiently small, it would be possible, according to this theory, to produce light directly by exciting oscillations in such a circuit. On account of the experimental difficulties encountered, this has not been attempted.

(d) *Ultra-violet, Röntgen, and Gamma Rays.*

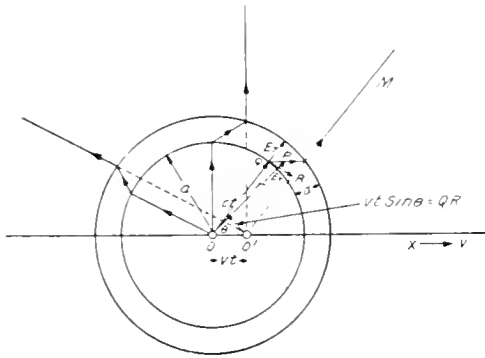
In the region extending from 0 wave-length to that of the lowest visible light rays

are found waves which have been called ultra-violet, Röntgen, and gamma rays. The gamma rays are those produced by Beta particles (electrons) when they suddenly shoot off from radioactive substances. These waves, therefore, are electromagnetic pulses which move out through space, due to the sudden movement given to the Beta particles as they are liberated from the substances. Since Beta particles move with the highest known velocities, it is likely that these rays possess the shortest wave-lengths. For the slower moving gamma rays Rutherford and Andrade⁷ obtained wave-lengths from 0.793×10^{-7} to 1.365×10^{-7} mm. Their position on the spectrum scale is indicated in Fig. 9.

A number of articles have recently appeared in this magazine in connection with Röntgen rays. We need say very little about these, therefore, in this article. It will be well to state, however, that since these rays are produced by the sudden stoppage of electrons within the X-ray tubes, it is safe to assume that these rays are also of an electromagnetic nature and possess wave-lengths somewhat greater than those of the gamma rays. Their position on the spectrum scale is illustrated in Fig. 9. The work of Laue, Friederick, Knipping, W. H. Bragg, W. L. Bragg, C. G. Barkla and others in connection with reflection of Röntgen rays by crystals point to the existence of homogeneous radiations whose wave-lengths correspond to the order of 10^{-7} or 10^{-8} mm. which is about one ten-thousandth that of ordinary light.

Ultra-violet rays are those whose wave-lengths come immediately below those of the visible spectrum. These waves are produced by means of an electric spark between zinc, cadmium, aluminum, and probably other metallic electrodes. The ultra-violet light from electric sparks between the first two metals is strong, while that between the third one is weak, and is easily absorbed in a few centimeters of air. No doubt other metals produce these rays, but they are so feeble that one finds difficulty in detecting them. Ultra-violet rays are also produced by burning magnesium, and in the elective arc strong ultra-violet rays are found. These rays, coming from the sun, are nearly all absorbed by the earth's atmosphere before they reach the earth. Since these rays are so easily absorbed by various substances, it is difficult to learn much about them. The shorter waves are more easily absorbed than the longer ones, so that the minimum wave-

length yet measured is in the neighborhood of 0.00010 mm. Quartz becomes opaque to these ultra-violet waves at about 0.00015 mm., fluorite allows one to reach 0.00012 mm., air is opaque at about 0.0002 mm. and with a concave reflecting grating, Lyman



Uniformly Moving Electron Suddenly Stopped at O.

Fig. 10

succeeded in reaching 0.000103 mm. As to what will be done with the reflection of Röntgen rays by crystals, we are not able to state.

Many of the effects produced by the ultra-violet rays are also produced by Röntgen rays and gamma rays, both of which we have seen to be of an electromagnetic nature. All three of these kinds of waves are photographically active and cause fluorescence. Light waves appear to be of an electromagnetic origin. The ultra-violet rays are observed in electric discharges, so that it is not at all unlikely that these rays are also of an electromagnetic character. The position of these rays in the spectrum is indicated in Fig. 9. We may consider them resulting from the movements of electrons whose lines of force produce the effects observed in connection with these rays. We shall now take up that part of the article dealing with the energy involved in these electromagnetic waves.

V. ENERGY CONSIDERATIONS

Thus far we have said nothing whatsoever about the energy in these electromagnetic waves. I should like, therefore, to devote a short time to an elementary consideration of this important phase of electromagnetic radiation. In the first place, if oscillations are set up in one system, these oscillations, under the proper conditions, set up secondary oscillations in another system some distance

away. That is, the energy in the first system manifests itself in the second one, and therefore, energy disappears in the first and reappears in the second. Consequently (since energy is conservative), this energy must be transmitted through that intervening space in some manner. Since we know that there are electromagnetic waves in the surrounding space, it is quite evident that these waves are waves of electromagnetic energy, or radiant energy as it is more frequently called.

In order to understand more fully the energy conditions which exist in these electromagnetic waves, we may consider it in the following manner: Imagine an electron moving through space with a velocity (v) small compared with the velocity of light so that the electric field around it is uniform for all practical purposes. Suppose the electron is suddenly stopped in a time (T). Considering just one line of force OM (Fig. 10), we can see that after a time (t) has elapsed after stoppage, it is only the parts of the lines of force which are inside a sphere whose radius in ct (c being the velocity of light) which have been stopped. The lines of force outside this sphere will be in the same position as if the electron had not stopped; i.e.,—they would be in the position corresponding to the position (O') occupied by the electron after the time (t) after stoppage. Inside the sphere of radius ct ($t-T$) the lines of force are at rest; outside the sphere of radius ct , the lines of force are moving forward with a velocity (v). Since the lines of force must remain continuous, there is within these two spheres a tangential electric and magnetic force moving outwards with the velocity of light. The state of affairs is as represented in Fig. 10.

Now let us calculate the values of the electric and magnetic forces at a point (P) within the spherical shell. Let (d) equal the thickness of the shell and (r) equal the distance $OP=ct$ (for our purpose), and θ the angle POX . It is clear that the tangential electric force in the shell is zero in the direction of motion and maximum in the direction perpendicular to the motion. It is also clear that we are concerned only with the tangential component of the electric force in the shell for this only is effective in the radiation. Let then (E_T) and (E_r) equal the tangential and radial electric forces respectively. From the geometry of the figure we have:

$$\frac{E_T}{E_r} = \frac{QR}{d} = \frac{vt \sin \theta}{d}$$

or

$$E_T = E_r = \frac{vt \sin \theta}{d} \tag{1}$$

now

$$E_r = \frac{e}{OP^2}$$

so that

$$E_T = \frac{cvt \sin \theta}{OP^2 d}$$

but $OP = ct$

Hence

$$E_T = \frac{cv \sin \theta}{cd \overline{OP}} \tag{2}$$

Dividing equation (2) by (1), we have

$$\frac{\text{Tangential electric force after stoppage}}{\text{Electric force before stoppage}} = \frac{\overline{OP} v \sin \theta}{cd} \tag{3}$$

As (d) is very small compared with (OP) , this ratio is very large. Thus the stoppage of the electron causes a thin shell of intense electric force to travel outward with the velocity of light. But we have seen⁸ that $H = V\vec{E}$ and since $V = c$, the velocity of light, we have from equation (2):

$$H = \frac{ev \sin \theta}{\overline{OP} d} \tag{4}$$

Since H before stoppage was⁹ $\frac{ev \sin \theta}{\overline{OP}^2}$

We have

$$\frac{\text{Tangential magnetic force after stoppage}}{\text{Magnetic force before stoppage}} = \frac{\frac{ev \sin \theta}{\overline{OP} d}}{\frac{ev \sin \theta}{\overline{OP}^2}}$$

$$\frac{\text{Tangential magnetic force after stoppage}}{\text{Magnetic force before stoppage}} = \frac{\overline{OP}}{d} \tag{5}$$

which shows that there is accompanying the pulse of intense electric force one of intense magnetic force, both being propagated through space at the velocity of light. The equations (3) and (5) show that the electric and magnetic forces outside the shell and the electric force within the inside of the inner shell are extremely small compared with these values within the shell. These same equations hold for any other pulse which follows or precedes the one which we have considered, as would be the case in an electric oscillating system of any kind.

It is interesting to determine the total electromagnetic energy in one of these pulses and to see how much of the kinetic energy of the electron is radiated away by its sudden stoppage. In this determination we are concerned only with (E_T) and (H) after stoppage as given by equations (2) and (4) respectively. The total electromagnetic energy (ϵ) in one

of the pulses which surround the electron is given by the integral

$$\epsilon = \frac{1}{8\pi} \iiint (E_T^2 + H^2) dv \tag{6}$$

This integral was derived by Maxwell in his electromagnetic theory, and has already been made use of by the author¹⁰ in this series on Electrophysics. The integration of this equation is to extend over the volume occupied by one pulse. If (a) is the distance out to the pulse and (d) the thickness of the pulse, then the integration extends from (a) to $(a+d)$. Proceeding in the same manner as illustrated on pp. 123-124 of the author's first article in the Feb., 1915, issue of the REVIEW, we obtain for the total electric energy (ϵ_E) and the total magnetic energy (ϵ_M) in the pulse.

$$\epsilon_E = \frac{1}{8\pi} \int_0^\pi \int_0^{(a+d)} \frac{e^2 v^2 \sin^2 \theta}{d^2 r^2} \times 2\pi r^2 \sin \theta d\theta dr \tag{7}$$

and

$$\epsilon_M = \frac{1}{8\pi} \int_0^\pi \int_0^{(a+d)} \frac{e^2 v^2 \sin^2 \theta}{d^2 r^2} \times 2\pi r^2 \sin \theta d\theta dr \tag{8}$$

Equations (7) and (8) reduce respectively to

$$\epsilon_E = \frac{e^2 v^2}{4c^2 d^2} \int_0^\pi \int_0^{(a+d)} \sin^3 \theta d\theta dr \tag{9}$$

and

$$\epsilon_M = \frac{e^2 v^2}{4d^2} \int_0^\pi \int_0^{(a+d)} \sin^3 \theta d\theta dr \tag{10}$$

Integrating equations (9) and (10) we obtain

$$\epsilon_E = \frac{e^2 v^2}{3c^2 d} \tag{11}$$

and

$$\epsilon_M = \frac{e^2 v^2}{3d} \tag{12}$$

Equation (11) is in C.G.S. electrostatic units, while (12) is in C.G.S. electromagnetic units. Eliminating c^2 in the former equation, we have (ϵ_E) in C.G.S. electromagnetic units. It is then seen that the total electric and magnetic energies in one pulse are equal to each other, a thing that should be true now.

$$\epsilon = \epsilon_E + \epsilon_M \tag{13}$$

or

$$\epsilon = \frac{e^2 v^2}{3d} + \frac{e^2 v^2}{3d} \tag{14}$$

$$\epsilon = \frac{2e^2 v^2}{3d} \tag{15}$$

Equation (15) shows us that the electromagnetic energy radiated away is greatest

when the thickness (d) of the shell is least. If (d) equals $\frac{4e^2}{3m}$ (which we have seen¹¹ to be equal to the diameter of the electron by assuming its mass to be wholly electromagnetic), then equation (15) becomes:

$$\epsilon = \frac{2e^2v^2}{3 \times \frac{4e^2}{3m}}$$

or

$$\epsilon = \frac{1}{2}mv^2 \tag{16}$$

which is the whole of the kinetic energy possessed by the electron before stoppage. Hence, if the electron can be stopped quickly enough to make the thickness of the shell equal its diameter, then all the energy is radiated away. If the electron is simply accelerated, positively or negatively, electromagnetic energy is radiated away. When oscillations are set up in a charged wire, like an antenna, then energy will be radiated away in accordance with this principle. For any given frequency of these oscillations, the more abrupt the reversals of current, the greater will be the radiated energy. Since it is impossible to obtain an antenna of a 100 per cent radiative efficiency, it is clear that the thinness of the shell of electromagnetic energy never attains a value as low as indicated above.

VI. EFFECT OF FREQUENCY ON ELECTRICAL MEASUREMENTS

We have seen that the wave-lengths of what we have called electromagnetic waves extend from almost zero to infinity. This corresponds to frequencies ranging from very large values (perhaps 10^{20}) to zero. Can we imagine what the electrical properties of various dielectrics would be when they were tested over such a wide range of frequencies? The discussion of this question is entirely out of the scope of this article, yet I should like to call attention to a few facts relating to this important subject.

The first point is that pertaining to the measurements of dielectric constants. In section IV-C we stated that Maxwell proved that the velocity of electromagnetic waves through transparent media was equal to $\frac{1}{\sqrt{\mu K}}$; K and μ being the dielectric constant and the magnetic permeability respectively of any particular medium. Since we arbitrarily take $\mu = K = 1$ for free space, then

the ratio of the velocity of these waves in free space to that in any transparent medium is:

$$n = \sqrt{\mu K} \tag{17}$$

Now, for all transparent media μ is practically unity. Hence,

$$n = \sqrt{K} \tag{18}$$

Now, (n) is called the refractive index of a medium, and it is seen to be equal to the square root of the dielectric constant of that medium. If this relation were exactly true, it would afford a means of obtaining the dielectric constant of many materials for electromagnetic waves of exceedingly high frequency. At the present time the dielectric constants of materials are measured for steady or relatively low frequency electromotive forces. It becomes of interest to investigate the dielectric constants for very high frequencies, corresponding to that of very short electric waves or ordinary light and infra red rays. The refractive indices for many substances measured at frequencies corresponding to light (about 10^{15}) give values for (n^2) which are very nearly equal to (K) as measured by electromotive forces of ordinary frequencies¹². In these cases we are to conclude that the dielectric constants do not change appreciably with frequency. This furnishes an admirable proof of Maxwell's Electromagnetic Theory. This law is found not to hold for many other substances. For example, the dielectric constants of water and alcohol are about 80 and 25 respectively for the low frequencies, but the refractive indices for these substances vary considerably with frequency as indicated by the following table¹³ of (n^2).

WATER: $K = 80$		
Wave-length	n^2	Authority
0.00059 mm.	1.78
0.082 mm.	1.98	Rubens
5.0 cm.	78.0	Cole
60.0 cm.	75.6	Drude
600.0 cm.	79.2	Cole

ALCOHOL: $K = 25$		
Wave-length	n^2	Authority
0.00059 mm.	1.88
0.108 mm.	1.96	Rubens
4.0 mm.	5.02	Lampa
5.0 cm.	10.24	Cole
60.0 cm.	22.5	Drude
259.0 cm.	27.4	Cole

This table shows us that n^2 does not equal K for water and alcohol over the whole range of frequency recorded. For wave-lengths above 5 cm. it will be seen that Maxwell's law holds very nicely for water, but for the shorter wave-lengths the discrepancy is quite large provided we assume $K=80$ to hold for very short waves. We have no right to assume that $K=80$ for short waves for if we could measure it, we would in all probability find it equal to (n^2) . The sudden change in the value of the dielectric constant for water is found in the unknown region to the right in Fig. 9. The values of (n^2) for alcohol show a consistent decrease with increasing frequency. This same change is to be looked for in the values for (K) for alcohol—the value $K=25$ being one that corresponds to some particular frequency. We are inclined to believe, therefore, that the variations from Maxwell's law simply mean that the values for the dielectric constants have not been investigated over a sufficient range of conditions (including frequency) to know much about them.

Generally speaking then, we may say that the dielectric constants are independent of or decrease with increasing frequency. This means that the capacities of various substances remain constant or decrease as the frequency increases, other things being the same. The above table giving values of (n^2) for water and alcohol would lead us to believe that the dielectric strength of a dielectric consisting of water and air would experience an abrupt increase in the region of wave-lengths corresponding to the sudden change in (n^2) ; in the case of alcohol and air we should expect a gradual increase in the dielectric strength rather than an abrupt one. Of course, other peculiarities enter and tend to nullify these effects. A further discussion of this subject would lead us into a consideration of these other effects, a thing we wish to avoid in this article.

VII. SUMMARY AND CONCLUSIONS

In the present article we have dealt entirely with the free electromagnetic waves, and have shown how these waves are produced by assuming the existence of electric lines of force. These lines of force can be treated as physical realities and are as much a part of electricity as the electric charges them-

selves. A number of examples were discussed showing the connection between the movements of electrons and the production of these electromagnetic waves. Various kinds of electromagnetic waves were discussed, and the positions of the spectrum occupied by them were illustrated by means of Fig. 9. It has been shown that we are justified in considering light waves, infra red rays, gamma rays, ultra-violet rays, and Röntgen rays of an electromagnetic origin arising from the movements of electrons and their lines of electric force. The electromagnetic waves were shown to carry a considerable amount of radiant energy in the pulses, and intense electric and magnetic fields existed within these. Mathematical expressions were obtained for the values of the electric and magnetic energy in each pulse sent out into space by an oscillating electron. A short discussion was given on the effects of frequency on electrical measurements with special reference to Maxwell's law.

REFERENCES

- (1) See article by the Author on "Effect of Dielectric Spark Lag on Spark Gaps," *GENERAL ELECTRIC REVIEW*, July, 1913, pp. 514-518.
- (2) (a) Faraday's "Experimental Researches on Electricity" vol. 3, ser. 29, articles 3273, 3297 and 3299.
Faraday's Physical Lines of Magnetic Force" and "Thoughts on Ray Vibration." *Phil. Mag.*, ser 3, vol. 28, 1846.
- (b) J. J. Thomson, "Electricity and Matter." p. 63.
- (c) J. J. Thomson, "Material Nature of Lines of Force," *Phil. Mag.*, ser. 6, vol. 19, p. 301, Feb., 1910.
- (d) J. A. Fleming, *Phil. Mag.*, ser. 6, vol. 19, p. 301, 1910.
- (3) Oliver Heaviside's "Electromagnetic Theory" vol. 1, p. 56.
- (4) J. A. Fleming, "Principles of Electric Wave Telegraphy" p. 408.
- (5) W. S. Franklin, "Electric Waves" p. 210.
- (6) Hertz, "Electric Waves" (Jones' Translation) pp. 137-150.
- (7) Rutherford and Andrade, "Wave-length of Soft Gamma Rays from Radium," *Phil. Mag.*, vol. 27, pp. 854-868, 1914.
- (8) Oliver Heaviside, *Loc. Cit.* (3).
- (9) J. P. Minton "Cathode Rays and their Properties." *GENERAL ELECTRIC REVIEW*, Feb., 1915, equation (1), p. 123.
- (10) J. P. Minton, *Loc. Cit.* (9), equations (1) and (2) p. 123; also *Loc. Cit.* (1), pp. 517-518.
- (11) J. P. Minton, *Loc. Cit.* (9), equation (7) p. 125.
- (12) J. A. Fleming, *Loc. Cit.* (4), see tables p. 355.
- (13) David Owen, "Recent Physical Research," Table III, p. 128.

THE HIGH-TENSION TEST

(PITTSFIELD WORKS, GENERAL ELECTRIC COMPANY)

By WM. P. WOODWARD

TRANSFORMER DEPARTMENT, GENERAL ELECTRIC COMPANY

The following article describes what is probably the most complete high-tension testing installation in the world. Some of the features of the installation that are treated in the article are the building in which it is housed, the source of the power supply, the equipment of transformers and controlling and measuring devices. The conclusion points out the need for such a completely equipped test and names some of the benefits that are derived from one.—EDITOR.

Power systems are growing in size, in complexity, and in voltage. Their growth is made possible by the transformer. The design of transformers involves constant research and their manufacture requires special and elaborate testing arrangements.

An establishment which has been devoted to this work since the time when the transformer first became a factor in electric systems, and whose growth has been commensurate with the importance of its work, has recently been newly housed and equipped and is unique in its size and completeness.

In a building devoted exclusively to the purpose there are three complete high-tension testing sets, any one of which would, in itself, be a notable feature of any electrical laboratory.

The building is a modern structure of steel with a brick facing and a concrete floor, and is absolutely fireproof. Inside it measures 82 ft. wide, 121 ft. long, and 57 ft. high, with a clear height of 47 ft. and a crane clearance above the floor of 40 ft. There are no columns and the space is absolutely clear. A capacious pit 9 ft. deep gives a total crane clearance of 49 ft. Ready entrance is had through two large doors, and two spurs of the factory railroad enter the building. The doors do not open directly into the outside air but open into another building which houses the Commercial Transformer Testing Department. Thus the entrance of a car with machinery does not introduce a blast of outside air and does not affect the temperature of the room.

Abundant daylight is supplied by windows which occupy practically all of the north and east walls of the building; and at night the building is brilliantly illuminated by mazda lamps, hung near the ceiling above the crane runway.

When a test involving the observation of corona or other optical effects is in progress, the building can be made absolutely dark at any time of day by closing over the windows a series of steel shutters which can be easily and quickly manipulated.

Each of the three testing sets consists essentially of a high-tension transformer,



Fig. 1. Five Minute Negative Exposure of Two Oil-Filled Porcelain Leads in Multiple at 175,000 Volts. The Resistance in Series with Lead on Left, 260,000 Ohms in Series with Lead on Right

with regulating outfit and the necessary spark-gaps, condensers, resistances, and reactances. In the 750,000-volt outfit the principal unit is a 500-kv-a., 750,000-volt, 60-cycle transformer of the oil-insulated, self-cooled, core type with a low-voltage

winding arranged for a series-multiple connection. Cylindrical low-voltage coils and disc high-voltage coils are used. The high-voltage bushings are oil filled. The transformer may be operated grounded or ungrounded, as may be found necessary for the various tests.

The control apparatus is mounted on an elevated platform 20 ft. above the floor, which location enables a commanding view to be had over all the testing room. This



Fig. 2. Four Minute Exposure of a High-Tension Lead at 350,000 Volts



Fig. 3. An Instantaneous Photograph of a 353,000-Volt Arc Produced from a 300,000-Volt Testing Transformer by Conversion Between Terminals 43 Inches Apart. Total Length of Arc about 20 Feet

apparatus is composed of the necessary field rheostats and measuring instruments and is so arranged that the operator can observe everything which occurs while a test is in progress. Control is obtained by means of rheostats in both the motor and the generator fields, so that the frequency as well as the voltage is completely under the control of the operator. There is sufficient resistance in the generator field circuit to permit starting a test at about 25 per cent of its final value. The voltage is then increased by cutting out field resistance in small steps so that,

gaps of various sizes. Both classes of gaps have a rigid base and a micrometer adjustment from zero to the full capacity of the transformer. The needle-point gap is of the conventional type and needs no special description. Its base and parts are of generous size, and give excellent rigidity for accurate centering and setting. The sphere-gap consists of two spheres heavily and rigidly mounted, with micrometer adjustments. The spheres of the largest gap are 75 cm. in diameter ($29\frac{1}{2}$ inches).

There is a large bank of condensers, and a

due to the reactance of the generator and the slow building up of its field, the voltage increases in a smooth curve. This avoids the disturbances that would occur if the voltage should be increased by cutting in turns of a regulating transformer (directly attached to the testing set) whose steps, however small, would be abrupt.

Both needle-point and spherical-spark gaps are available, but the burden of the testing work at present is being carried on by sphere-

variable inductance having a range from 0.005 henrys to 0.750 henrys.

Conveniently near the transformer is an oil tank built of concrete. It is arranged

largely below the floor level, and extends above the floor only a sufficient distance to afford facility in work. Such tests as require immersion in oil are carried out in this tank which has a capacity of 36,000 gal. An oil dryer and filter is permanently installed at the tank; and there are facilities for completely emptying when necessary for cleaning or other purposes. To maintain a uniform temperature of the oil, or to change the temperature to any desired degree, a heater is provided.

The entire testing set is enclosed by a high steel netting barricade, the entrances of which are closed by safety doors electrically connected to the controlling apparatus so that when the door is opened the primary circuit is broken, thus "deadening" the entire test which makes it impossible for any one to enter the enclosure while voltage is on.

Similar to the 750,000-volt testing set is a 300-kv-a., 300,000-volt set, which is provided with the same facilities and is surrounded by the same precautions.

The high-frequency, high-voltage testing set gives 250,000 volts at 250,000 cycles. This frequency is obtained by means of a combination of gap, condenser, and transformer with adjusted time constant. A sine wave, 60-cycle current is used as the fundamental.

In addition to these high-voltage sets, there are several testing sets of lower voltage but of equal completeness and usefulness. One of these is for 30,000 volts and another is for 10,000 volts, each with complete control arrangements and with excellent facilities for such research and investigation as can be made within its range.

The generators are specially designed for high-voltage testing service and are so arranged as to give practically a true sine wave at any load, frequency, and power-factor. The armatures are stationary and are so wound that they may be used at full kv-a. capacity at one-quarter, one-half or full voltage, and at three-quarters kv-a. capacity at three-quarters voltage. The alternators are driven by variable-speed, separately-excited, direct-current motors which can be supplied with line voltages varying from 110 volts to 550 volts so that a complete range of frequency may be obtained. Two of these generators are of 500 kv-a. each and smaller units are arranged for use with the smaller sets, each being of sufficient size to prevent a change of wave form at the low power-factor loads of this kind of service.



Fig 4 Photograph of a High Tension Lead Flash Over at 400,000 Volts

PRACTICAL EXPERIENCE IN THE OPERATION OF ELECTRIC MACHINERY

PART VIII (Nos. 41 TO 46 INC.)

BY E. C. PARIHAM

CONSTRUCTION DEPARTMENT, GENERAL ELECTRIC
COMPANY

(41) CAPACITY CURRENT

Capacity current here refers to the current that flows when an e.m.f. is applied to a circuit that is open in the ordinary understanding of the word *open* as applied to a circuit. A capacity current is due to the condenser effect incident to the fact that, in any system of insulated conductors, the air may serve as the dielectric of an actual condenser in which certain conductors serve as the positive plates and other conductors (or the earth) serve as the negative plates.

In the case of applying a continuous e.m.f., the capacity current or charging current takes the form of a single impulse in one direction, for as soon as the conductors become charged all current flow ceases.

When an alternating e.m.f. is applied, however, the capacity current must reverse as often as does the e.m.f.; therefore, it takes the form of an alternating current. Its value may rise very considerably under certain line conditions. If the line constants are favorable, the "banking up" effect of the surging current may very much increase the measurable e.m.f.; just as water-hammer in pipes may increase the water pressure therein.

In a particular installation the capacity of a high-tension transmission system was such that when closing the station switches upon the open external line (before the field of the alternator exciter could be brought up) both the station current and voltage were observed to be so large that it was necessary to open the oil switches. Owing to the capacity current and its undesirable effects, it was thoroughly unsatisfactory to close the station switches until several transformers had been connected across the transmission line at the distant end, thereby introducing an inductance to overcome the effect of the capacity.

(42) MISAPPLICATION OF DEVICES

Misapplication of electrical devices may be traced to either of two sources: They may

By means of the exceptional testing facilities afforded by the elaborate and complete equipment of this research and commercial laboratory, each advance step in transformer design and construction has been made the subject of exhaustive and practiced investigation. The results have produced a symmetry of insulation design that no other means can obtain. Every part of the transformer is continually and systematically investigated with a view to added excellence and strength; and new and improved methods and materials are continually being evolved. Tests are made on full-size working models, on sections of transformers, and on complete transformers, in accordance with the demand of the subject under consideration. In this way the turn insulation, the insulation between coils, and that to ground have been so developed that each is proportional directly to the demand made upon it.

Varnishes, and other plastics, and the textiles are here commercially tested in advance of their application to machinery, thus insuring uniform quality and strength. They are also experimentally tested here with a view to improving their inherent qualities. This line of investigation has resulted in the production of a very strong and uniform line of varnishes, compounds, and fabrics which by means of the High Tension Testing Department is constantly kept under the eye of experts.

All the insulation which is used, even that for the lowest voltage commercial apparatus, is subjected to a careful high-voltage test before it is assembled in the machine and again after the machine is complete when it is tested as a whole. This obviates the possibility of a defective piece of material, which may be found in a lot otherwise excellent, ever reaching a place in a machine.

It is true, some sort of a transformer can be made by the time-honored method of "hit or miss" but the efficient, sturdy machine that carries the burden of big plants and that saves the pennies which add into dollars for the small user can only be the result of evolution. This truly scientific tool combines the ideas evolved from the experience of the manufacturer and the ideas evolved from the experience of the user, after they have been tried out in such a fully equipped laboratory as the one described.

In this way there has been developed a line of transformers that is uniformly and admittedly superior to any that are not the result of such development.

have been wrongly selected in the first place, or they may have been thoughtlessly shifted from one duty to another by the operator. In either case the result is the same—unsatisfactory operation. While the following may sound like hypothetically stated generalities intended to cover possibilities, too often they exist as trouble brewing actualities that are not covered at all.

(1) Direct-current, shunt-wound motors should not be applied to duties that require abnormal starting torque. (They are designed to develop torque only after the connected load is up to speed.) An efficient shunt-wound motor is characteristically a constant-speed motor, because its field current is independent of the armature current excepting insofar as abnormal armature current may pull down the applied voltage, by producing an excessive line drop. Furthermore, this feature of independence precludes the field from exerting on the armature current any limiting influence proportional to it. Therefore, the current required to start heavy loads is abnormal.

(2) Direct-current, compound-wound motors should not be applied where the duties call for constant speed and moderate starting torque. A differential connection of the shunt and series windings, in order to get automatic speed regulation, is likely to produce an unstable condition, unless the machine was designed with that automatic feature in view. With the fields cumulatively connected, as they generally are, the speed variation per ampere increase in load is greater than with the corresponding shunt-wound motor, because the latter has no series turns to strengthen the field when the load increases. If only a compound-wound motor is available and constant speed is desired, the compound winding may be cut out and the motor operated as a shunt motor. If both abnormal starting torque and constant speed are essential, a compound-wound motor may be so arranged as to start with its series field cumulatively connected, and, after the motor is up to speed, the series field may be cut out and the motor operated as a shunt motor.

(3) Series motors are characteristically variable-speed motors, because load changes affect their field strength directly. On constant potential circuits, their speed cannot be held constant unless the connected load is constant, and on light load racing results.

(4) Squirrel-cage induction motors should not be applied to duties in which range and flexibility in speed control are essential. The

speed control is generally limited to that which can be obtainable by varying a resistance that is connected into the supply mains. Since the torque varies as the square of the applied voltage and since the variations in the voltage applied to the motor itself are much greater than the external variations in the supply voltage, this method of speed control produces instability. For a strong starting torque per ampere and good speed control, the slip-ring motor with external resistor is better.

(5) Induction motors of the internal resistor type should not be applied to loads of great inertia. Since the space available for an internal resistor is limited and its heat storage capacity is comparatively small, the resistor is very liable to be damaged if the motor is applied to heavy starting duty. The field for the resistor type of motor is similar to that of the squirrel-cage motor, which it can replace to advantage where lights are operated on the same circuit, and where it is desirable to minimize the voltage fluctuations incident to starting a motor.

(43) MISLEADING DEFLECTIONS

The indications of some of the forms of ground detector used on alternating current circuits depend upon the fact that current will flow through a condenser which is connected to a source of alternating e.m.f. although the condenser does not metallically close the circuit of which it is a part. This fact explains why alternating current and alternating-current instruments may give very misleading results when used for measuring insulation resistance between conductors that include appreciable capacity. (A capacity current through the instrument will produce a deflection that may indicate low insulation resistance when, as a matter of fact, the insulation resistance may be very high.)

An operator who installed a two-phase, 240-volt generator became alarmed because with the machine at normal voltage he was able to get a 40-volt deflection by applying the voltmeter terminals to legs that belonged to different phases. The deflection was due to the fact that the conductors of the two-phase windings, in conjunction with the intervening insulation, acted as a condenser that charged and discharged through the voltmeter. A test made with a direct-current voltmeter and voltage from the 140 volt exciter indicated the insulation to be perfect insofar as an e.m.f. of 140 volts could indicate.

A later application of a "megger" showed the insulation between phases to exceed 20 megohms.

It is easy to imagine how a repairman, unfamiliar with this characteristic of alternating current, might become alarmed at getting a large deflection between the phases of a machine that he had just repaired. Wherever there is an alternator, the direct-current exciter should be used to furnish the voltage for carrying out the insulation tests.

(44) REACTOR STARTING-BOX TROUBLE

The reactor starting boxes that are used on very small alternating-current motors are so connected, in conjunction with a three-phase winding on the stator, that a part of the reactance is used to produce a current phase displacement, hence a rotation of the magnetism, and a part is used as a choke coil by means of which the motor speed is regulated. Where motors are so controlled, the greatest torque and highest speed are obtainable on the first notch. This arrangement is used to insure that the motor, when under variable voltage conditions, will always have sufficient torque to start and to make certain that the controller will not be left on a notch on which the motor might fail to start should the voltage be low. Under such a condition, the current flowing might be insufficient to melt a fuse but sufficient to injure the motor or the reactance. When this connection is employed, a lower speed can be secured after the motor has been started by advancing the controller to a notch on which some of the reactance is cut into the circuit.

One of these outfits had been applied to the exhausting of smoke from a restaurant the proprietor of which complained that the motor sometimes would start and sometimes it would not and that occasionally the reactor starting box would get very hot. Inspection and tests indicated that the motor and the controller were in good condition in all respects, and the motor started promptly each of several times that the inspector tried it. The voltage was above normal and the inspector was assured that the lights always burned as brightly as they were burning then.

It began to look as if the inspector would have to leave things exactly as he had found them, when the operator made the remark, in substance, that sometimes when he would go to start the motor he would find it already running backward and he wished to inquire if it was safe to try to start it under this

condition. This information was the clue to the trouble. The motor was installed in a window the location of which was such that at times the outside wind blew against the fan with sufficient force to retard its motion and overload the motor, or to prevent the motor from being started from rest. The installing of a wind shield to prevent the wind from blowing directly against the fan permanently relieved the situation for nothing more was ever heard of the matter.

Had the hotel proprietor not indirectly suggested the trouble, the unit would have probably been rejected as unsatisfactory, unless the inspector had happened to visit the plant when the wind was blowing against the fan.

(45) IMPROVISED COMMUTATING WINDING

A correctly proportioned commutating-pole winding neutralizes the distorting effect of armature reaction and thereby produces commutation of a high quality that could not be obtained otherwise except at a much greater first cost. If the commutating poles are either too weak or too strong, the commutation will not be satisfactory. Should there be reason to suspect that the commutating winding is of improper strength, the suspicion can be affirmed or can be disproved experimentally. To test for excessive commutating-pole strength, it is customary to shunt the commutating-pole windings with a resistance and to vary the amount of current passing through the windings by varying this shunt resistance. If there can be found any shunting value that gives satisfactory commutation, the commutating coils as wound are too strong; and, in order to get sparkless operation, the commutating winding must be permanently shunted to the extent indicated by the experimental shunt.

In a certain instance, the experimental shunting of the commutating winding made the sparking much worse, thereby indicating that the commutating field was too weak. The electrician in charge then wound one turn around the outside of each commutating coil, taking care that alternate turns were wound reversely, and connected them in series with each other and with the existing commutating winding. Upon putting on a load the brushes sparked even worse than they did before the extra turns were installed, because these extra turns as a whole had been so connected as to oppose the regular commutating winding. After reversing the experimental wind-

ing as a whole, commutation became about perfect. Success on the first trial was a case of exceedingly good luck, for in many cases the addition of one turn per pole would have made the commutating field too strong, consequently it would have been necessary to experimentally determine the value of a shunt to be used with the improvised part of the commutating winding.

On standard lines of motors and generators, if the factory regulations in regard to the brush setting are observed, commutating-field shunts will seldom be required except on large units.

(46) INSTRUMENT CONNECTIONS WRONG

The primary and the secondary currents of a transformer are in phase opposition. The magnetic lines of force due to the secondary current thread through the core in the direction opposite to that of the magnetic lines due to the primary current. A tendency to reduce the core flux is thereby exerted. This tendency to lessen the core flux of a constant-potential transformer results in decreasing the primary counter e.m.f. and in increasing the primary current, the increased current restoring the flux practically to its original value. With current transformers, however, the weakening of the core flux by the secondary current cannot materially affect the value of the primary current, because that value is determined by the external load of the unit, i.e., the current which the current transformer is being used to measure. This condition is the ideal one, for no measuring device should appreciably affect the value of the quantity that is being measured.

If the secondary terminals of a constant-potential transformer are short-circuited, the heavy secondary current will, by neutralizing the primary flux, cause a flow of primary current so great that the primary fuses or breakers will open. When the terminals of a current transformer are short-circuited, the resultant weakening of the flux cannot affect the primary current. It does, however, decrease the number of moving lines upon

which depends the value of the secondary e.m.f. In well-designed current transformers this automatic regulation of the secondary e.m.f. is such as to maintain a practically constant secondary current (for a given value of primary current) between the limits of short-circuited secondary and the secondary resistance corresponding to the maximum instrument capacity of the transformer. Of course if the primary current changes, the secondary current changes accordingly, otherwise the connected instruments would not follow the changing conditions. The primary flux of necessity always exceeds the secondary flux which is due to it; therefore variations in the primary current, due to changes in the load that is being measured, simply alters the extent to which the primary flux prevails. The volume of the moving flux is thereby changed and with it the secondary e.m.f. and the secondary current.

The preceding explanation was suggested by the conditions disclosed upon investigating an operator's complaint that although his alternator was only partly loaded its exciter was giving commutation trouble and difficulty was experienced in maintaining the engine speed.

As a matter of fact, the alternator was carrying a heavy overload. The ammeter was indicating only about one-half the actual current flow, because in connecting the ammeter and a wattmeter to the same current transformer the current coils of the two instruments had been connected in parallel with each other, instead of in series with each other. As the transformer secondary current was of practically the same value that it would have been had the instrument coils been connected in series, each instrument coil was getting approximately only one-half of the current that it should have received. Therefore, when the ammeter indicated that the alternator was carrying three-quarters load, it was really carrying 50 per cent overload.

After connecting the instrument coils in series, the meter indications became correct, and they disclosed the true state of affairs. Incidentally, the exciter was carrying much more load than its guarantee specified.

NOTES ON THE ACTIVITIES OF THE A. I. E. E.

Annual Convention

The 32nd Annual Convention of the American Institute of Electrical Engineers will be held at Deer Park, Maryland, June 29, 30, July 1, 2, 1915. The Convention Headquarters will be at the Deer Park Hotel.

The following papers will be presented:

The Electric Strength of Air-V1, by J. B. Whitehead.

The Reluctance of Some Irregular Magnetic Fields, by John F. H. Douglas.

The Measurements of Dielectric Losses with the Cathode Ray Tube, by John P. Minton.

Irregular Wave Forms; the Significance of Form Factor, Distortion Factor and Other Factors, by Frederick Bedell.

Classification of Alternating Current Motors, by Val A. Fynn.

Alternating Current Commutator Motor Classification and Nomenclature, by Frederick Creedy.

Short Circuits on Alternators, by Comfort A. Adams.

Electricity in Grain Elevators, by H. E. Stafford.

Fields of Motor Application (Topical Discussion), by D. B. Rushmore.

The Effective Illumination of Streets, by Preston S. Millar.

Systems of Street Illumination, by Chas. P. Steinmetz.

Construction and Maintenance Costs of Overhead Contact Systems, by E. J. Amberg and Ferdinand Zogbaum.

The Contact System of the Butte, Anaconda and Pacific Railway, by J. B. Cox.

Third Rail and Trolley System of the West Jersey and Seashore Railroad, by J. V. B. Duer.

Top Contact Unprotected Contact Rail for 600-Volt Traction System, by Chas. H. Jones.

Under-running Third Rail Conductors, by Edwin B. Katte.

Phase Angle of Current Transformers, by Chester L. Dawes.

Instrument Transformers, by Chas. L. Fortescue.

The Induction Watthour Meter, by V. L. Hollister.

Economic Operation of Electric Ovens, by Percy W. Gumaer.

Class Rates for Electric Light and Power Systems, by Frank G. Baum.

LYNN SECTION

Telephone Problems, by J. G. Patterson

On Wednesday, March 17th, Mr. J. G. Patterson of the Engineering Staff of the New England Telephone Company talked on *Telephone Problems*. Mr. Patterson presented many details to illustrate the immensity of the telephone plant in the country. The entire Bell system represents an investment of between \$800,000,000 and \$900,000,000. There is a total of 16,000,000 miles of line. The New England division owns about 500,000 instruments out of a total of 8,000,000.

Since the first commercial service of 40 years ago there have been in use 53 types of receivers and 73 types of transmitters. Line materials and equipment present some of the largest problems. The demands of underground service have recently resulted in the development of cables only $2\frac{5}{8}$ in. diameter containing 900 circuits, 1800 wires, and some spares whose capacity can be further increased by phantoming.

The high price of tin in recent years led to the substitution of antimony for tin in the lead alloy for cable sheaths, which resulted in a very great saving. Details of cord and jack construction have received the minutest study. All these items must be brought up to standard throughout the entire system in order to make possible unrestricted communication over the long toll lines.

Mr. Patterson discussed the subject of "phantoming" and loading telephone lines. Numerous lantern slides were used to illustrate the lecture, of which those relating to the Boston-Washington underground circuit and the New York-San Francisco line were of particular interest. The latter line consists throughout of at least four wires, making three talking circuits including the phantom.

Present Developments in X-ray Work, by Dr.

W. P. Davey

On March 17th, Dr. W. P. Davey of the Schenectady Research Laboratory gave a most interesting talk on X-rays, abundantly illustrated by lantern slides.

The speaker defined and outlined the relations of electrons, alpha particles, cathode streams, alpha rays, beta rays, gamma rays, etc., and gave figures to illustrate the numerical magnitude of the quantities involved. The general phenomena of radiation were discussed.

The sudden stopping of the electrons of the cathode stream when they strike the target rise to primary X-rays. The vibration of the electrons belonging to the atoms of which the target is composed produce characteristic X-rays. These characteristic X-rays are only excited if the velocity of the cathode stream is sufficiently high. It takes 1200 volts to induce the characteristic radiation in the aluminum, 11,000 volts for copper, and about 95,000 volts for tungsten. The penetrating power of the rays increases with the voltage necessary to produce them.

With a series of slides the history of the development of the X-ray tube, which culminated in the production of the Coolidge tube, was shown.

In the Coolidge tube the performance is entirely under control—in marked contrast with the older forms of tube. The temperature of the filament cathode determines the volume of the radiation, while the potential between cathode and anode determines the penetrating power of the rays.

After this a series of slides was shown illustrating the application of X-rays to medical, botanical, industrial, and purely scientific problems. Some of this work has already been described in articles in the REVIEW. During the talk a Coolidge tube was passed around the audience for examination.

PITTSFIELD SECTION

Leakage Reactance and Short Circuits, by
Professor C. A. Adams

Professor C. A. Adams, of Harvard University, gave a talk to the Section on March 11th, on *The Leakage Reactance of Synchronous Alternators and Its Relation to Sudden Short-Circuits*.

Prof. Adams developed a very interesting theory of the distribution of the reactance in alternators and its effect on the voltage and current at short-circuit. The theory was substantiated by a number of oscillograms showing single-phase and three-phase short-circuits. A method of decreasing by resistance the time during which the excess current persists was outlined. The subject will be presented in greater detail in a paper by Professor Adams to be given at the Annual Convention of the A.I.E.E. in June.

Bureau of Statistics, by Dr. P. G. Agnew

On April 1st, Dr. P. G. Agnew, Assistant Physicist of the Bureau of Standards, gave an illustrated lecture on the recent work of

the Electrical Division of the Bureau. He described in general terms the precision instruments in use; the care of the standard weights and measures; the routine tests carried on by the Bureau for the Government, and for private individuals and firms, etc. An outline was given of the recent work of the Bureau in establishing standards of e.m.f., resistance, and illumination; of the work done on the effect of barometric pressure on heating, etc.

The Bureau has recently co-operated with the navy in establishing methods of ranging-finding, and is working on a standard safety code in co-operation with the Electrical Manufacturers, Public Service Commissions and Electrical Societies. Altogether the great and increasing value of the Bureau in the economic life of the country was emphasized.

April 22nd, *The Educational and Advertising Value of Motion Pictures*, by Mr. C. F. Batcholts.

April 29th, *The Physical Chemistry of the Blood*, by Dr. W. R. Whitney.

These papers were outlined in a previous issue of the REVIEW.

SCHENECTADY SECTION

Problems in Transformer Design, by Mr. G. Faccioli

On April 6th, Mr. G. Faccioli, Assistant Engineer of the Transformer Department, General Electric Company, delivered a very interesting talk in the auditorium of the Edison Club on *Problems in Transformer Design*.

Mr. Faccioli stated that engineers as a rule believe that the transformer is an easy piece of apparatus to design, thinking this to be the case because there are no moving parts. In improperly designed transformers, tons of stress might exist, due to the attraction and repulsion between the coils, but with properly designed transformers, these stresses can be reduced considerably and thoroughly taken care of by means of the mechanical strength of the parts involved. Substantially all the important conditions involved can be worked out mathematically and this in a very simple way. The mechanical stresses can be calculated very accurately and the results checked by experiment.

Among the operating conditions about which the designing engineer must concern

himself, Mr. Faccioli mentioned high voltage, high current and high frequency. He discussed the question of switching high voltage lines on the high potential side and a number of interesting points were brought out in connection with high frequency transients on the transmission line. He described the effect of such transients very clearly and simply, and presented the matter of magnetic forces and transients in such a way that the audience could easily follow him. Mr. Faccioli's paper was discussed by Messrs. F. W. Peek and D. B. Rushmore.

Driving a Ship's Propellers, by W. L. R. Emmet

On March 30th, Mr. W. L. R. Emmet, Consulting Engineer of the General Electric Company, gave a talk on *Driving a Ship's Propellers* before the joint meeting of the Schenectady Section of the A.I.E.E. and the Eastern New York Section of the N.E.L.A. The meeting had the largest attendance of the season and brought out a great deal of discussion from members of both sections. An outline of the address follows:

It was shown that the turbine type of engine is best suited to high speed and large powers. As an illustration, a standard 25,000 kw. unit is run at 1800 r.p.m. and gives efficiencies around 75 per cent (Rankine cycle), while the turbines on the *Lusitania*, of about the same horse power, run at only 180 r.p.m. and give an efficiency of 53 per cent, an increase in steam consumption of over 15 per cent.

The propeller on the other hand has practically opposite characteristics and gives its best efficiency at very slow speed; for instance, the propeller on the *Lusitania* showed an efficiency of only 55 per cent at 180 r.p.m., whereas the efficiency could have been raised to 65 per cent had the propeller speed been considerably lower. Some sort of speed reduction must therefore be introduced between the turbine and the propeller.

The U. S. Collier *Jupiter*, which is the first large vessel to be equipped with electric drive, is a government collier of 20,000 tons displacement, 542 ft. long and 65 ft. beam, having a rated speed of 14 knots, at which speed the propellers operate at 110 r.p.m. The generating unit used is a standard Curtis turbine driving a two-pole, 5450 kv-a., 1990 r.p.m. 2300 volt alternator. This generator supplies current to two Form M 2750 horse power, 110 r.p.m. 2300 volt induction motors.

The combined weight of all the electric driving machinery in this boat is 156 tons, which is only 55 per cent of the weight of the reciprocating engine equipment used in her sister ship, the *Cyclops*.

On her trials the *Jupiter* made 15 knots, at which speed she consumed 7200 h.p. with a water rate of 11.1 lb. per brake h.p. delivered to the propeller shaft, the exact value as estimated by Mr. Emmet before the machinery was built.

The collier has now been in operation for about two years and gone through all kinds of weather. She has been a perfect success from the start, and her coal records show a saving of about 25 per cent over any other boat of her size in the navy.

The *Jupiter* is not the type of vessel which will show the greatest improvement with electric drive, but the method is best suited to large war vessels where economy at lower cruising speeds is of greater importance than at maximum speed, and it also lends itself very advantageously to driving large ocean liners. The *Jupiter* was simply taken as a practical demonstration of the suitability of electric drive, all in view of obtaining its use for the propulsion of a large warship, and so satisfied were the officers of the Navy department after the *Jupiter's* two years of operation that it has been decided that electric propulsion shall be used on the new battleship *California*, now being built at the New York Navy Yard.

By the use of one or both generators, with the combination of either the slow or high speed connections of the motors, the economy will only vary one pound between the speeds of 12 knots and maximum speed. In case one engine room should be disabled, the ship could still maintain about 85 per cent of full speed. When the bids from the New York navy yard for the complete ship were compared, the electric propelling equipment as offered by the General Electric Company showed a saving to the Government of \$160,000 over direct turbine drive as proposed by the regular specifications.

In turbine installations on ocean liners the small space required in the engine room as compared with methods now in use, the weight of the electric propelling machinery, which would be less than half that of reciprocating engines now used, and the saving in fuel, which would alone pay for the equipment inside of two years are important factors.

The talk was concluded by a description of the method of gearing used by Sir Charles Parsons in England, and the methods proposed by the Westinghouse Company. Mr. Emmet also described the type of gearing which the General Electric Company is now experimenting with, and gave some very interesting figures as to its possibilities and limitations, and compared figures as to economy.

The paper was discussed by Messrs. D. B. Rushmore, Wm. Baum, C. L. Perry, J. R. Werth, Eskil Berg and others.

Lectures for the Near Future

The program for the Section includes the following lectures to be delivered in the auditorium of the Edison Club:

April 20th, Philip Torchio, General Electrical Engineer of the New York Edison Company, will talk on electric supply in large cities.

May 18th, E. B. Raymond, formerly General Superintendent of the Schenectady Works, General Electric Company, now Vice President of the Pittsburg Glass Co., on plate glass.

June 1st, Professor Elihu Thompson. The subject of this paper will be announced later.

FROM THE CONSULTING ENGINEERING DEPARTMENT OF THE
GENERAL ELECTRIC COMPANY

NOTES ON THE NOBLE GASES (Continued)

Neon

After Raleigh and Ramsay had succeeded in extracting argon from atmospheric air in 1894, as previously described, they discovered that their product contained minute traces of yet other unknown gases. Owing to the fact that all gases have different boiling points when they are condensed into the liquid state by intense cold and high pressure, Ramsay was eventually able to isolate the various elemental components, which existed in minute quantity in the crude argon, by refined methods of fractional distillation. One of the new elemental gases thus obtained was Neon, so named from the Greek word "neos" meaning "new." Its atomic (and molecular) weight is 20.2, ($O_2 = 32$) for like all of the other noble gases, it is believed to be monatomic and also without chemical affinity, as it forms no compounds with other elements.

Neon can be ionized and thus made a conductor of electricity more readily than any other elemental gas. It is, therefore, extremely sensitive to the influence of high frequency electric oscillations, and vacuum tubes containing neon can also be operated at a lower potential than is required for tubes that are charged with other gases. When excited by electricity it glows with a bright orange-red color, which becomes very brilliant under conditions of high current density.

Neon vacuum tubes have been developed and used to a considerable extent in Europe, and especially in France, where this gas has been obtainable in larger quantities than elsewhere during the process of liquifying air for the production of liquid oxygen. The eminent French scientist, George Claude, has made these vacuum tubes in a great variety of sizes and shapes, some being adapted purely for illuminating purposes, while others are manufactured in the form of attractive advertising signs, etc. Owing to the readiness with which neon can be made to conduct electricity and the extreme brilliancy of its luminescence (as before

stated), the lighting efficiency of these vacuum tubes is said to compare favorably with many modern illuminants. *La Revue Elec.* (Nov. 24, 1912) states that under good working conditions, "the specific consumption is about 0.7 watt per candle-power, including transformer losses."

The spectrum of neon lies entirely within the limits of red, orange and yellow, showing no green, blue or violet lines, so that its combined rays produce a beautiful orange colored light, which—when compared directly with ordinary artificial illumination—appears inclined to red, but when seen by itself, presents a pleasing golden orange hue.

The extremely small amount of neon which exists in the atmosphere, viz., about 15 volumes in each 1,000,000 volumes of air, and the difficulties attending its extraction in purity therefrom has hitherto been a serious bar to its more general use for commercial purposes, and it is only where liquid air is made in large quantities that neon can be produced at anything approaching a moderate cost.

The many interesting and valuable features which this gas possesses warrants the hope, however, that it may eventually become more easily obtainable.

Krypton and Xenon

The two remaining members of this interesting group of noble gases exist in the atmosphere in such almost infinitesimal quantities that they have only hitherto been available for refined academic examination. Krypton takes its name from the Greek word "Kryptos," signifying "hidden," and it is stated that 1,000,000 volumes of air contain only 0.5 volume of Krypton, while Xenon, named from the Greek "Xenos," meaning "stranger," is yet more rare, only about 0.006 volume of this gas being found in every 1,000,000 volumes of air. Both of the above gases show characteristic spectra, by which their presence in exceedingly minute amounts can be made visible. The atomic (and molecular) weight of Krypton is 82.92, and that of Xenon 130.22, based on $O_2 = 32$.

W. S. ANDREWS

QUESTION AND ANSWER SECTION

The purpose of this department of the REVIEW is two-fold.

First, it enables all subscribers to avail themselves of the consulting service of a highly specialized corps of engineering experts, or of such other authority as the problem may require. This service provides for answers by mail with as little delay as possible of such questions as come within the scope of the REVIEW.

Second, it publishes for the benefit of all REVIEW readers questions and answers of general interest and of educational value. When the original question deals with only one phase of an interesting subject, the editor may feel warranted in discussing allied questions so as to provide a more complete treatment of the whole subject.

To avoid the possibility of an incorrect or incomplete answer, the querist should be particularly careful to include sufficient data to permit of an intelligent understanding of the situation. Address letters of inquiry to the Editor, Question and Answer Section, General Electric Review, Schenectady, N. Y.

INDUCTION MOTOR: ROTOR-BAR INSULATION REPAIR

(137) An examination of a 40 h.p., squirrel-cage, bolted end-ring induction motor, which had been in service for some time, was made because it ran at only 80 per cent of its normal speed. The investigation revealed the fact that the rotor-bar insulation was charred and the winding grounded to the core. The stator was uninjured and the motor, with the exception of the rotor-bar insulation, appeared to be in good condition. Since the frequency and voltage of the supply were both normal and the motor was not overloaded at the time it was assumed that the decrease in speed was accountable to this damaged insulation and consequently the bars were withdrawn, reinsulated, and replaced. After this repair had been effected the motor resumed running at normal speed.

The answer to question No. 126 of the Question and Answer Section of the *Review* states definitely that a squirrel-cage induction motor's characteristics are the same whether rotor-bar insulation is present or absent.

This case of unequal motor speeds before and after reinsulating the rotor bars would seem to contradict Answer No. 126; or else some other influence was responsible for the action. Kindly give an explanation.

The particular instance, described in the question, is only one of a number in which the renewing of charred rotor-bar insulation in a "slow-running" squirrel-cage induction motor has been given credit, by the operator, for bringing the motor's speed back to normal. On first consideration, it might be natural to assume that the increase in speed was the result of repairing the defective insulation. As stated, however, in Answer No. 126, the electrical properties of a squirrel-cage motor are, for practical considerations, independent of the rotor-bar insulation, i.e., they will be the same regardless of whether insulation is used or not used around the rotor bars. *The truth of this fact has been proved conclusively by comparative tests.*

The action bringing about the restoration of normal speed must have been a lowering of the rotor resistance, which took place at the time the reinsulating was done. (The speed of a standard induction motor running at normal frequency and voltage, and constant load, will be altered only by a change in the rotor resistance.)

A permanent increase in the rotor resistance of a bolted end-ring motor is likely to be brought about

if the motor is loaded to the point where the rotor is heated excessively. The increase of resistance takes place at the surface contacts between the bars and the end-rings.

The fact that the rotor-bar insulation of the motor under consideration was found to be charred shows that the bars and end rings themselves must have been very hot at some time. As the spring washers, that are under the screws which hold the bars and end-rings in contact, will lose their springiness at a temperature which is considerably below the charring point of the bar insulation, the decrease in the motor's speed was undoubtedly due to the fact that the joints between the bars and rings lost their integrity at the time the spring washers lost their temper.

When the motor was reassembled, after placing new insulation around the bars, the contact joints were undoubtedly cleaned and new spring washers used. This decreased the rotor resistance to normal and was the cause of the motor's resuming normal running speed. If the defective spring washers had been replaced in repairing this motor instead of substituting new ones, as should have been done, the speed would undoubtedly have increased to normal, because the surface joints would have been brought into tight contact when reassembling. The use of defective spring washers is to be condemned, however, because the expansion and contraction of the copper on heating and cooling will soon loosen the joints, at which time the decrease in motor speed will recur.

In case, therefore, that a bolted end ring (or even a soldered end-ring) squirrel-cage motor is found to be running at far below full-load speed under normal load, frequency and voltage, the condition of the bar and end-ring joints will altogether likely be found to be defective and these poor contacts must be repaired. If investigation at the same time reveals the fact that the rotor-bar insulation is charred, but still offers a secure mechanical support for the bars, the damaged insulation need not be renewed. The insulation was placed there in the first place for the purpose of mechanical packing, not for electrical insulation.

In the most up-to-date squirrel-cage motors this packing, misnamed "insulation," has been dispensed with because of the adoption of welded end-rings. Machines of this type are immune from poor contact troubles in the rotor, because the welded joints assure a perfect contact at all temperatures. Also, since no packing is used, there is none to char and burn out thereby possibly allowing the bars to become loose.

A.E.A.

(138) The following are the data of an underground transmission line:

Ducts: 3½ in. Orangeburg fiber laid in concrete on 6-in. centers, two ducts wide, seven high. The outside dimensions of the concrete (cross-section through the ducts) are 17 in. wide and 44 in. deep; these do not include the substantial concrete footing at the bottom. The surrounding ground is on non-conducting blast-furnace slag. Large manholes occur at every 200 ft.

Cables: Three-conductor, 5000-volt, cambric-insulated, lead-covered, carrying three-phase current at 25 cycles and 2300 volts.

250,000 cir. mil	600 ft. long
250,000 cir. mil	800 ft. long
300,000 cir. mil	800 ft. long
300,000 cir. mil	1600 ft. long
1/0	1200 ft. long
4/0	1200 ft. long
No. 4	1200 ft. long

a) What is the maximum current that can be carried in the cables without overheating them?

b) What would be the proper amount of watts loss to allow in these cables if the cost of generating is 0.9 cents per kw-hr?

(a) The maximum currents recommended for the cables are as follows:

250,000 cir. mil.	250 amp. per conductor
300,000 cir. mil.	285 amp. per conductor
1 0	140 amp. per conductor
4 0	220 amp. per conductor
No. 4	74 amp. per conductor

It would not be possible, however, to run all of these cables at full load at the same time in a duct structure of the sort described.

The above current ratings are based on a soil temperature of 20 deg. C. With a lower earth temperature the currents could be increased, but with a higher one they must be decreased.

(b) It may be stated that, in general, it is questionable whether in ordinary conditions in summer the total watts lost per foot of duct structure should exceed 40, if the cables are to be kept at a reasonable temperature. (See paper by L. E. Inlay in A.I.E.E. Proceedings, Feb., 1915, p. 263.)

It will be impossible to state what should be the allowable watt loss in the cable installation described unless the number of hours per day that the cables operate is known, i.e., without having the load curve of the cable.

For instance, the watts lost per duct-foot in the 250,000 cir. mil cable at 250 amp. are approximately nine. If this load continues 24 hours per day, 365 days per year, the cost of energy wasted would be \$0.63 per foot of cable. On a basis of 10 hours per day it would be \$0.22, and for a duration of five hours per day, \$0.11. If the first were the operating condition, cables as large as three-conductor 500,000 cir. mil would be justified, whereas, if the load were carried for an average of only five hours per day a three-conductor 300,000 cir. mil cable would be approximately the most economical. These figures were arrived at by adding together the cost of cable and conduit, and allowing 10 per cent of this valuation for interest and depreciation, and then balancing this result against the cost of the energy losses.

W.S.C.

TRANSMISSION LINE: SAG AND SIZE OF CONDUCTOR

(139) Please furnish formulae, or references to them, which can be applied to the computing of:

- 1) The sag in transmission conductors.
- 2) The size of conductor for three-phase lines.

(1) In the A.I.E.E. Proceedings for 1911 there are three articles which give formulae and tables for computing sag in transmission lines. These papers are:

"Solution to Problems in Sags and Spans," June, p. 1111, W. L. Robertson.

"Sag Calculations for Suspended Wires," June, p. 1131, P. H. Thomas.

"Mechanical and Electrical Characteristics of Transmission Lines," July, p. 1379, H. Pender and H. F. Thomson."

Any of the methods recommended therein will be found to be reliable, and they are described in far more detail than could be attempted in the limited space of these columns.

(2) In the GENERAL ELECTRIC REVIEW, June, 1913, there appeared an article, on page 430, "Practical Calculations of Long Distance Transmission Line Characteristics," by F. W. Peek, Jr., which clearly describes the manner of calculating the size of conductors for three-phase transmission.

F.W.P.

DIRECT-CURRENT GENERATORS: HIGH VOLTAGE

(140) (a) What is the highest voltage for which commercial direct-current generators are designed and used today?

(b) What is the principal limitation that would be encountered in designing a generator of still higher voltage?

(a) So far as we know, 1500 volts is the highest direct-current voltage that is derived from a single commutator and regularly supplied for commercial service in America (Brush arc-lighting circuits excepted).

Voltages of this magnitude are restricted to use in railway circuits.

There are today commercially successful railway systems operating on 1200 volts derived from units of one 1200-volt generator (for example: Southern Traction Co., Dallas, Texas); 1500 volts derived from units of one 1500-volt generator (for example: Portland, Eugene & Eastern Railway, Portland, Oregon); and 2400 volts derived from units of two 1200-volt generators in series (for example: The Butte, Anaconda & Pacific Ry.)

In a short time the Chicago, Milwaukee & St. Paul R. R. electrification will be in operation at 3000 volts derived from units of two 1500-volt generators in series.

(b) The greatest difficulty in developing the design for a high-voltage direct-current generator is the overcoming of the tendency to flash at the commutator. To secure the usual factor of safety against flashing, it is necessary to design a high-voltage machine to run at a lower speed than a moderate-voltage machine for a given number of poles; also, it is necessary to use as high a surface speed as permissible.

J.L.B.

GENERAL ELECTRIC REVIEW

JUNE, 1915



A Special Number
on
The Electrical Industries

GENERAL ELECTRIC REVIEW

A MONTHLY MAGAZINE FOR ENGINEERS

Manager, M. P. RICE

Editor, JOHN R. HEWETT

Associate Editor, B. M. EOFF
Assistant Editor, E. C. SANDERS

Subscription Rates: United States and Mexico, \$2.00 per year; Canada, \$2.25 per year; Foreign, \$2.50 per year; payable in advance. Remit by post-office or express money orders, bank checks or drafts, made payable to the *General Electric Review*, Schenectady, N. Y.

Entered as second-class matter, March 26, 1912, at the post-office at Schenectady, N. Y., under the Act of March, 1879.

VOL. XVIII., No. 6

Copyright, 1915
by General Electric Company

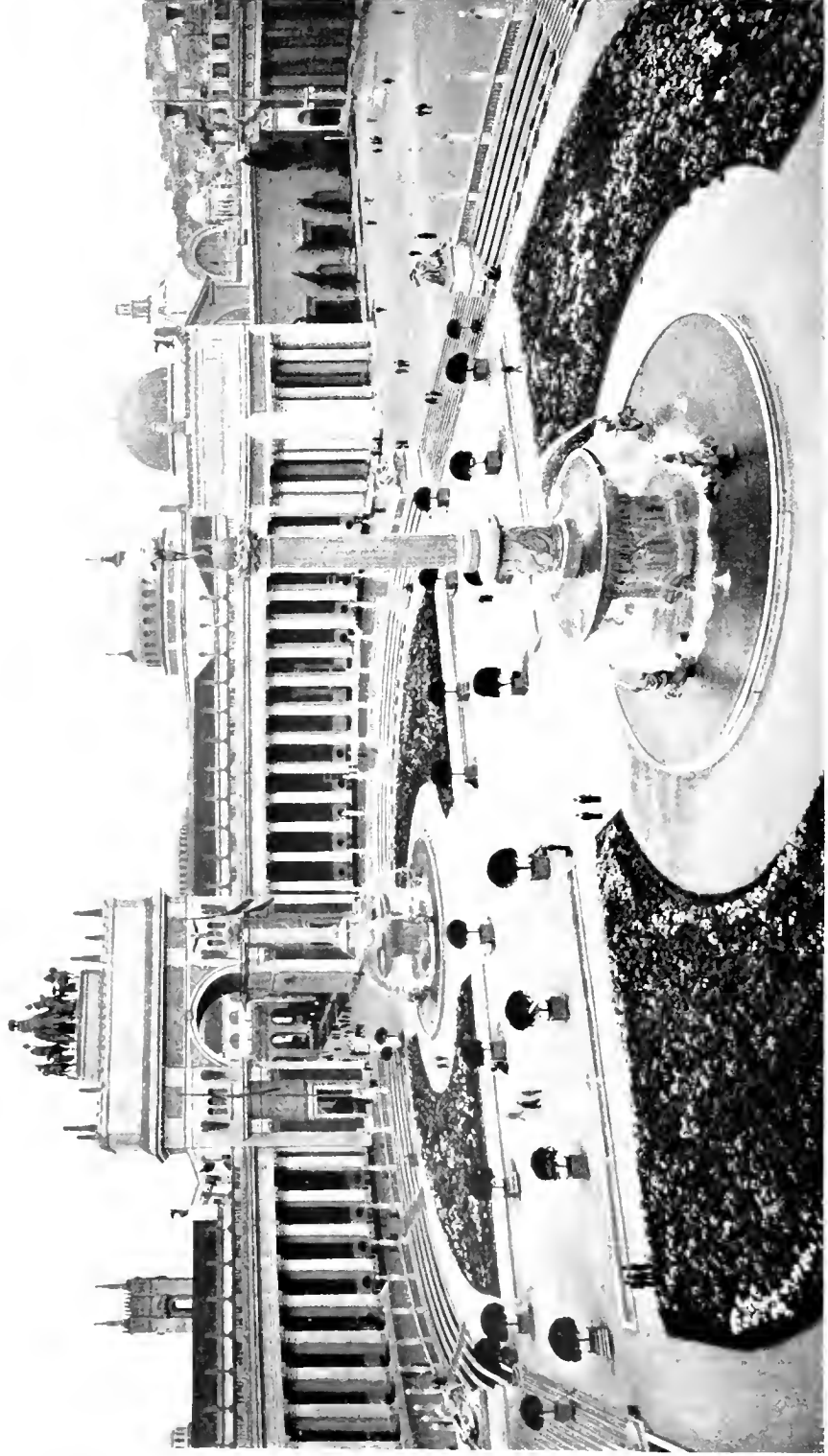
JUNE, 1915

CONTENTS

	PAGE
Frontispiece	414
Editorial: The Paths of Progress	415
Industrial Research	416
BY L. A. HAWKINS	
The Electric Power Industry	427
BY DAVID B. RUSHMORE	
A Brief Review of the Electric Lighting Industry	439
BY C. W. STONE	
A Review of Electric Railways	444
BY W. B. POTTER AND G. H. HILL	
Electric Transmission of Power	454
BY R. E. ARGERSINGER	
Some Industrial Applications of Electricity	460
BY A. R. BUSH	
Electricity in Agriculture	483
BY C. J. ROHRER	
The Electric Lamp Industry	497
BY G. F. MORRISON	

CONTENTS—Continued

	PAGE
Electricity in Marine Work	504
BY MAXWELL W. DAY	
Electric Heating and Heating Appliances	523
BY C. P. RANDOLPH	
The Use of Electricity in Mining Work	527
BY DAVID B. RUSHMORE	
Electric Power in the Textile Industry	540
BY C. A. CHASE	
Electricity in the Automobile Industry	550
BY FRED M. KIMBALL	
“Supplies”: Devices and Appliances for the Distribution, Control and Utilization of Electricity	553
BY S. H. BLAKE	
The Subdivision of Power as Solved by the Small Motor	555
BY R. E. BARKER AND H. R. JOHNSON	
The General Electric Company's Exhibits at the Panama-Pacific International Exposition	561
BY G. W. HALL	
The “Home Electrical” at the Panama-Pacific International Exposition	572
BY DON. CAMERON SHAFER	
Illumination of the Panama-Pacific International Exposition	579
BY W. D'A. RYAN	
Notes on the Activities of the A.I.E.E.	594
From the Consulting Engineering Department of the General Electric Company	596



Court of the Universe, Panama-Pacific Exposition, showing the Fountains of the Rising and the Setting Sun. These fountains are approximately 95 ft. high and are equipped with 1500-watt incandescent lamps having a combined candle-power of approximately 500,000

GENERAL ELECTRIC

REVIEW

THE PATHS OF PROGRESS

The electrical industries have grown to such huge proportions since their comparatively recent conception that a complete review of them would be quite impossible. But in this special issue we attempt a review of some of the most notable electrical industries in such space as is available in a single issue of a magazine.

We have now got to a stage in our development that any further progress beyond a mere multiplication of apparatus and devices and a logical increase in the capacity of individual units must depend more and more upon industrial research. That the importance of this phase of our work is recognized is evidenced by the activities of many of our greatest industrial concerns. Scientific progress depends upon research work and the industries, and very specially the electrical industries, must depend in an ever increasing degree on science. It is, therefore, a matter of great satisfaction to note that research work on an extended scale is carried out by organizations that are primarily devoting their energies to manufacture. A most notable example of this is to be found in the first article of this issue.

The generation, transmission, distribution and application of electric power have, during the last quarter of a century, made wonderful changes in our mode of conducting commercial activities and our future progress seems largely to depend upon developing our natural power resources and upon their economical use. It is due to the fact that electrical energy can be generated, transmitted, distributed and applied more efficiently, and therefore more economically, than any other form of energy that electricity holds its present enviable position, and further it is because electricity can be so conveniently converted to heat, light and mechanical power and can be held under such perfect control that it

seems destined to supplant all other modes of operation.

Older methods have given way to electrical methods, in the vast majority of cases, on purely economic grounds and it is of special interest to note that many modern industries have been made economic possibilities only by the adoption of electricity in one way or another to meet their particular requirements. It is to a broad extension of such applications that we look to much progress in the future, and it would seem that the electro-chemical industries are likely to prove a most active field for such developments. What other new fields are open to development by the application of electrical methods must of necessity be a matter of speculation, but we believe that such fields are enormous.

The consistent and persistent growth of the electrical industries that are already well established is one of the wonders of the age. Some of the curves that we publish in this review show a progress, and a continuation of a rate of progress, that is truly astonishing and brings one very forcibly to realize that the facilities for generating and distributing electrical energy show no signs of over-reaching the demands. For some years past we have recognized that the increase in facilities for rapid transit in our large cities cannot keep pace with the demands. Greater and ever greater facilities are imperative, and it seems that the same lesson is to be learned about the other industrial applications of electricity.

We should naturally wish to make editorial comment on some of the more comprehensive articles that appear in this issue, but neither time nor space will permit. The one essential feature that is of vital importance is to be found recorded in the review of each industry, namely, that the progress which has been enormous, is being maintained and that the future possibilities seem limitless.

INDUSTRIAL RESEARCH

By L. A. HAWKINS

ENGINEER, RESEARCH LABORATORY, GENERAL ELECTRIC COMPANY

The author shows that science and industry have dropped the old prejudices that have existed between them, have joined hands and are working mutually for our progress. He touches on the influence of science on industrial progress abroad, especially in Germany, and cites some notable research developments in this country. A considerable part of the article is devoted to a description of the splendid new research laboratory of the General Electric Company and to the work that has been accomplished there.—EDITOR.

Industrial research is a relatively new thing. It means the co-operation of business and science for their mutual advantage. Not so very many years ago such co-operation would have been unthinkable. To the average business man, the scientist seemed a rather futile fellow whose putterings with test tubes had little more practical value than the researches of a classical scholar in the Greek Dative, while the man of science, like his classical brother, looked with some contempt on the sordidness of trade, talked of "pure" science, as something nobler than "applied" science, and felt that he was losing caste if he permitted his work to suffer contact with "commercialism."

Happily for both business and science, those ideas are now dead—as dead as witchcraft, or the divine right of kings. Repeated object lessons have taught the business man that nearly every marked advance in science has resulted, sooner or later, directly or indirectly, in important effects on industry, while the increasing dependence of modern life on its complex industrial organization has forced the scientist to realize that in benefiting industry he is contributing efficiently to the welfare of mankind, which is, and always must be, the chief aim of all work that is worth while.

The result of this awakening was that business resolved to domesticate science, and that science graciously accepted the home, with all modern improvements, which was offered her. Thus arose the research laboratory of the large industrial corporation.

Though such laboratories have been in existence relatively few years, they have already proved their value. They have been a potent factor in Germany's wonderful commercial development.

The extent to which research has permeated, and made itself an essential part of, German industry is clearly revealed in the address delivered by Dr. Carl Duisberg before the Eighth International Congress of Applied

Chemistry, entitled, "The Latest Achievements and Problems of the Chemical Industry." The scope of the paper is almost co-extensive with industry itself. Production of power, refrigeration, the manufacture of quartz, steel, special alloys of most diverse properties, acids and other reagents, tin, rare metals, and coal tar products including explosives, dyestuffs, and medicinal drugs, chemotherapy, or the treatment of infectious diseases by chemical means, the production of synthetic perfumes, artificial silk, cinematograph films, non-inflammable celluloid and its applications, including patent leather, artificial leather, insulation, enamels, etc., and synthetic rubber,—each of these is cited to illustrate notable recent achievements of chemical research.

The coal tar dye industry is built entirely on chemical research. Dr. B. C. Hesse, in the *Journal of Industrial Chemistry*, Dec., 1914, estimates the annual production of dyes in Germany at \$68,222,846, more than eleven times the production in Great Britain and about eighteen times the production in the United States. In explanation of this fact he quotes a prominent German chemist as saying, in part, "In no country on earth are those branches of the chemical industry which demand versatility of thought, and particularly a large body of scientifically trained employees, so well developed as with us."

Germany was the first country to perceive the enormous monetary value of organized industrial research, and great have been the rewards of her foresight.

We, in this country, have been late in starting, but progress has been rapid and the results important. An article by Mr. A. D. Little in the *Journal of Industrial and Engineering Chemistry*, Oct., 1913, entitled "Industrial Research in America," is an impressive exposition of the extent to which organized science has already become a business asset in the United States. For

instances, he cites the DuPont Powder Co., employing 250 trained chemists, with a laboratory comprising 76 buildings spread over 60 acres, which estimates that its laboratory yields an annual profit of \$1,000,000, the world famous Edison laboratories with their multifarious important products; the automobile industry, in which one tire manufacturer spends \$100,000 a year on his laboratory; the Bausch & Lomb Optical Co.; the Eastman Kodak Co.; the electro-chemical industries at Niagara Falls; the metallurgical

laboratory with a capable staff is an expensive matter, and the financial returns are seldom immediate. Years of costly failure must often precede success, and not even then is success always possible. But in the end, industrial research, if wisely organized and efficiently conducted, does pay, and both the corporation and the public benefit.

The extent and quality of the equipment required by an industrial laboratory, and the character of the work that may profitably be



Fig. 1. Research Laboratory Building

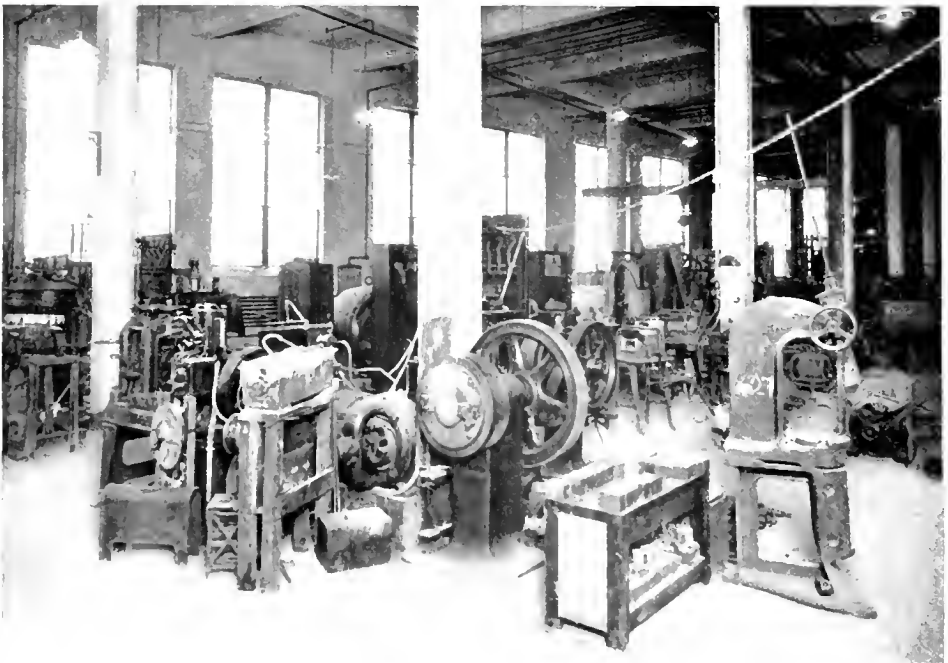
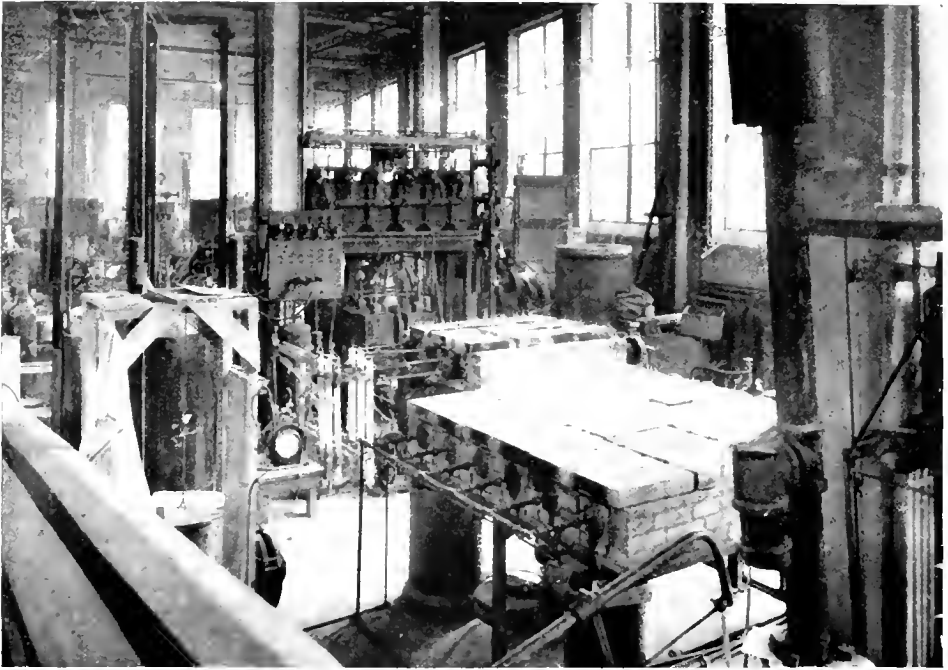
industries, etc., all investing largely in organized research and all reaping profits from their investments.

In all this work, the public benefits, whether by new devices capable of new results, by more efficient apparatus, by better materials, by cheaper goods, or by increase of scientific knowledge. Indeed one of the important advantages the public derives from the existence of the big industrial corporation is the result of industrial research, made possible only by large aggregations of capital, controlled by far-sighted, broad-minded, men; for the maintenance of a well equipped

undertaken, of course vary considerably in different branches of manufacture, but, in a general way, the part that such a laboratory may play in a modern manufacturing plant may be illustrated by a description of one such institution.

The research laboratory of the General Electric Company, started on a small scale 14 years ago, has grown to be one of the largest of its kind, and its work has given it a wide reputation.

Its present staff of 150 employees is now located in the modern seven-story building, shown in Fig. 1, and occupies the greater



Figs. 2 and 3. Furnace Room



Fig. 4. Library

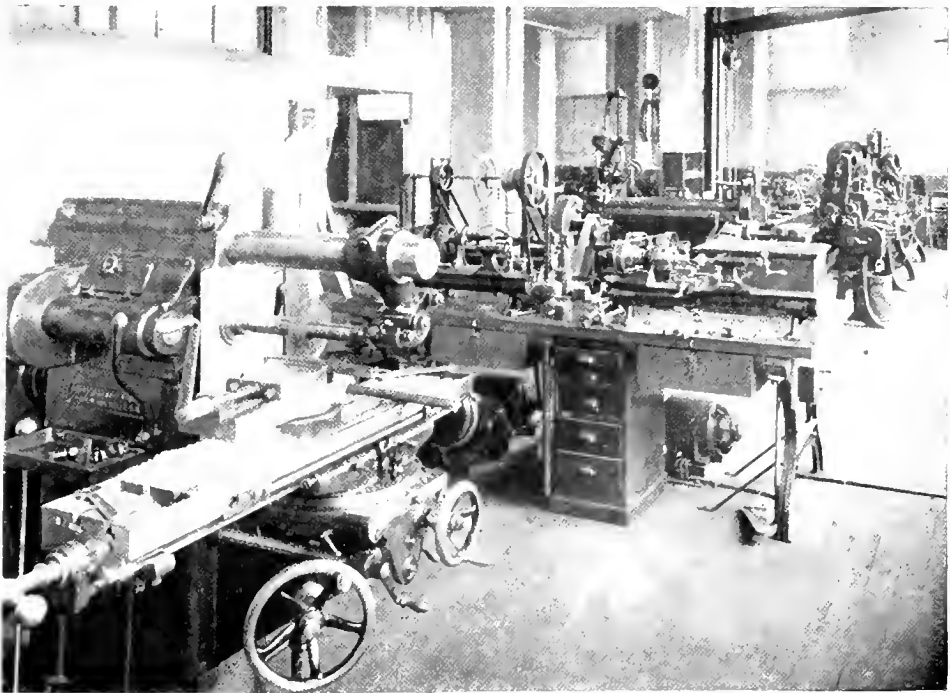


Fig. 5. Machine Shop

part of four floors and the basement, a floor space of 66,500 sq ft.

In the basement are the laboratory power plant and chemical storeroom. Power is supplied from outside at 250 volts, d.c., three-wire system, and at 40 cycles, three-phase, 120 volts. In the laboratory power plant are 16 machines which deliver power at different voltages, and at frequencies ranging from 25 up to 2000 cycles. Through transformers, currents as high as 12,000 amperes, and voltages up to 200,000 may be obtained. A switch-board comprising 28 transfer sections makes it possible to connect any machine to any one of the 118 delivery panels distributed through the laboratory. In the power plant there are also a liquid air machine, an air compressor, and two vacuum pumps, one two-cylinder, 12 in. by 12 in. and the other three-cylinder, 8 in. by 10 in.

All wiring and piping are carried in horizontal ducts 8 ft. by 5 ft. running above the corridors through the laboratory. There are 35 miles of wire, ranging in size from No. 6 up to 2000 c.m. The building is piped throughout with city water, river water, illuminating gas, compressed air, vacuum, high pressure hydrogen, low pressure hydrogen, oxygen, high pressure steam, and for vacuum cleaning. Distilled water may be delivered by gravity to any room, and 250 motors, 80 transformers, and 60 vacuum pumps are distributed through the building.

In a one-story addition, shown in Figs. 2 and 3, are located a number of furnaces, including a porcelain kiln, a frit furnace, two pot furnaces, three calorizing furnaces, two brush firing furnaces, all gas heated, and two large vacuum furnaces, electrically heated. There is also a furnace for argon purification. Disk grinders, crushers, a pulverizer, two large sets of rolls, 5 in. by 8 in., and four smaller sets, eight swaging machines, ten punches, and a 60-ton hydraulic press are installed. The larger electric furnaces of the laboratory, including a two-ton arc furnace, are in a separate building.

The calorizing furnaces, just mentioned, are used for giving to metal parts the heat-proofing treatment, the results of which were described in the *GENERAL ELECTRIC REVIEW*, October, 1914. The argon furnace purifies argon gas for use in experimental incandescent lamps.

On the first floor of the laboratory are offices, the library of 1400 volumes, shown in Fig. 4, three experimental rooms used for X-ray investigations, and the machine shop,

part of which is shown in Fig. 5. The equipment of this shop includes a milling machine, a lathe, 20 in. by 16 in., two smaller engine lathes, four bench lathes, a shaper, a radial drill, two drill presses, a sensitive drill, a forge, a band saw and sharpener, and 100 linear ft. of bench space.

The second floor is occupied by research work on insulation, by production work on the Coolidge X-ray tube, and by the carpenter shop. The equipment for the insulation work includes a paint grinder, barrel mixers, compound mixers, electric drying ovens, a vacuum impregnating machine, a hydraulic press with steam attachment, a 60,000-volt set for testing dielectric strength, and apparatus for measuring insulation resistance hot and cold.

Views of two of the rooms devoted to insulation work are shown in Figs. 6 and 7.

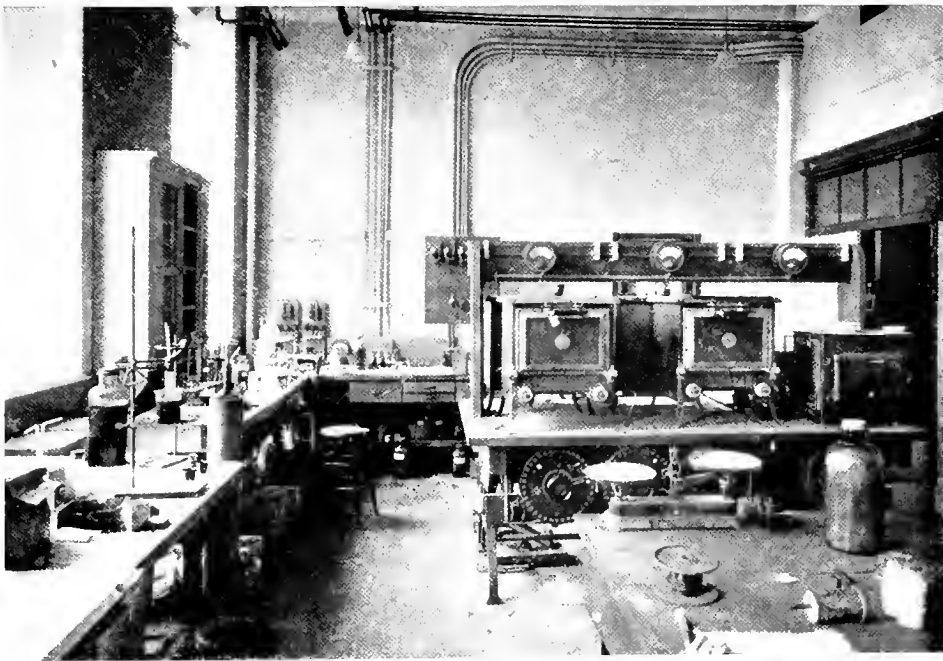
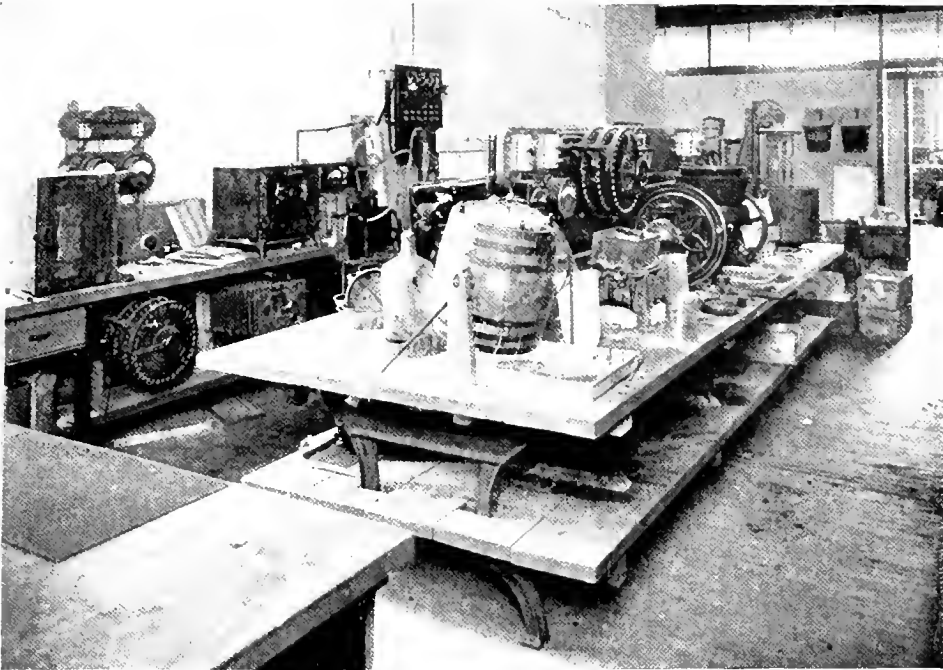
Because of the importance of insulation in electrical apparatus, the laboratory continuously devotes much time to it. Many new molded compounds have been produced, improving and reducing the cost of countless devices. Improvements have been made in varnished cloth, enamels, and other standard insulations, and new types of insulation have been developed, such as the mineral insulation used in the sheath wire now in production for heating devices.

So much has been published lately on the Coolidge X-ray tube that it needs no description here. It is manufactured entirely in the laboratory. The equipment for production and experimental work comprises a Waite and Bartlett machine, a Snook-Röntgen machine, a Scheidel-Western machine, a large static machine, a Waite and Bartlett table for fluoroscopic work, a stereoscopic display frame, a Scheidel X-ray coil, a Kelley-Koett tube stand, two Kny-Scheerer interrupters, six exhaust ovens, three of which are shown in Fig. 8, equipped with Gaede molecular pumps, two Arsem vacuum furnaces, and a tungsten tube furnace.

In addition to the Coolidge tubes, the laboratory manufactures targets for the standard type of tube, comprising a tungsten disk embedded in a copper block.

The analytical laboratory shown in Fig. 9 is on the third floor. The work tables are covered with glazed roofing tile. There are two double hoods, a work table equipped for electrolytic work, and a draft-proof balance room, shown at the right of the figure.

On this same floor is the work on transformer steel and other alloys, with an equip-



Figs. 6 and 7. Two of the Rooms for Insulation Work

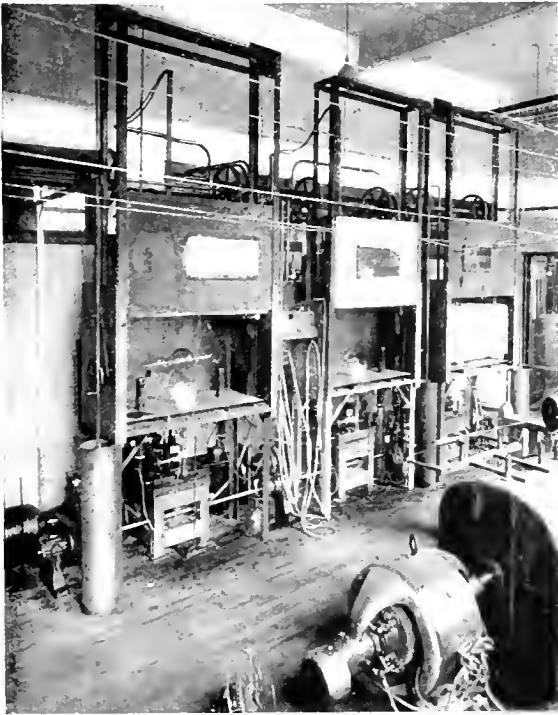


Fig. 8. Exhaust Ovens for Coolidge X-Ray Tubes

ment comprising a set of small electric furnaces for making alloys, eight small electric annealing furnaces, two vacuum furnaces, three melting furnaces, a set of rolls, a potentiometer and Wheatstone bridge, a Burrows permeability apparatus, storage batteries, a photomicrography outfit, and chemical balances. Even a slight decrease in transformer core loss is of great importance because of the enormous aggregate of transformers in use, most of which have their supply voltage on them twenty-four hours a day, so that their core loss is a continuous waste. For this reason continuous research on transformer steel seems justified, even though the results seem small. As for the other work on alloys, there are always demands for new characteristics, mechanical, electrical, or chemical, so that hundreds of special alloys have been made and tested in the laboratory. Also composite metals have been developed, such as "Binel metal," that is, steel coated with a thin layer of Monel, the natural copper-nickel alloy which stands high temperatures with very little oxidation, and composite wire for special purposes, such as gold-coated tungsten and molybdenum as a substitute for platinum in dental work.



Fig. 9. Analytical Laboratory

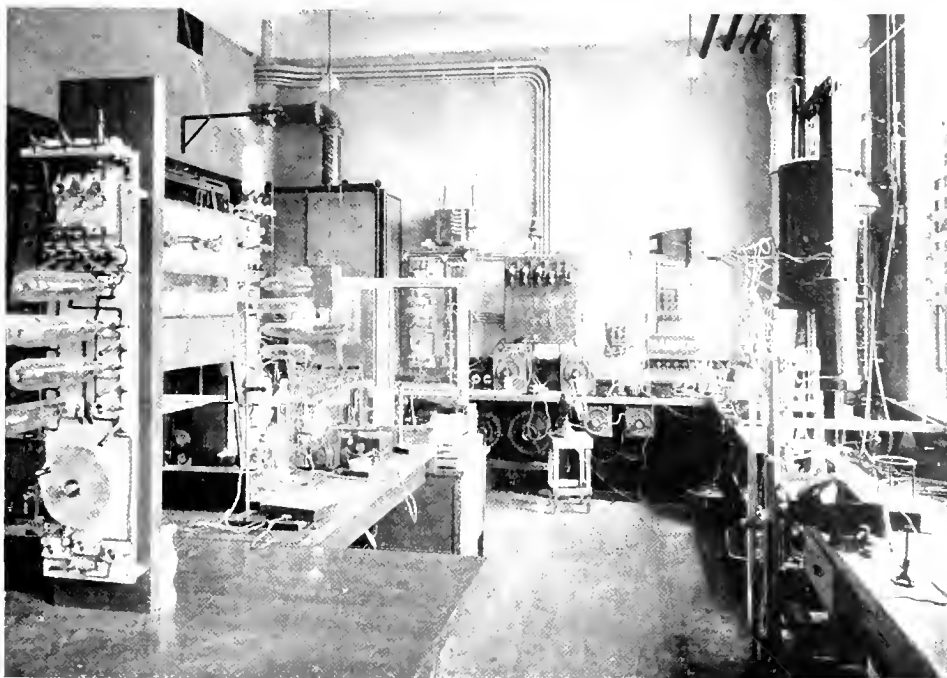


Fig. 10. One of the Rooms for Lamp Experiments

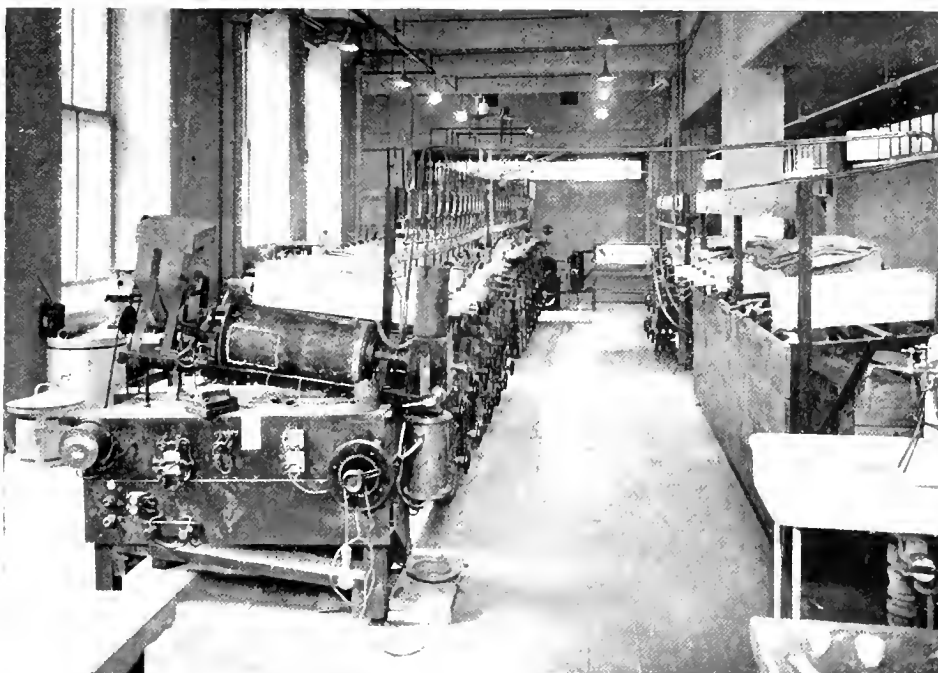


Fig. 11. Tungsten Reduction Furnaces

On the same floor are diamond drilling and jewel polishing machines, and apparatus for testing motor and generator brushes. The quality of the brush has so great an effect on the operation of direct current motors and generators that the laboratory has given much time to developing new grades of brushes better suited to the various machines than any grade formerly on the market. In this way they have made it possible to clean up a number of complaints on motor operation, and in other cases to improve the operation or to lower maintenance costs.

The lamp work is located on the fourth floor. From its beginning, the laboratory has devoted a large part of its efforts to the improvement of incandescent lamps, and has originated the metallized carbon filament lamp, the drawn wire tungsten lamp, and the gas-filled lamp, thereby gradually sextupling incandescent lamp efficiency. If one stops to compare the status of incandescent lighting fifteen years ago with what it is today, and considers how much of the phenomenal advance has been due to those three developments, he will need no argument to convince him that the research laboratory in the electrical industry has justified its existence.

The laboratory equipment for lamp work comprises a small but complete factory for lamp manufacture with a maximum capacity of about 100 lamps per day. There are four large and four smaller exhaust ovens of standard type, three special ovens for special exhaust, a Thomson welding machine, three sets of apparatus for making arced joints, one for pinched joints, two filament winding machines, two different types of apparatus for making pure nitrogen, from air and hydrogen, and from tank nitrogen and ammonium carbonate, respectively, apparatus for purifying argon, and a gas density balance. For testing lamps there are three Lummer-Brodhun prism photometers, two portable photometers, one flicker photometer, one Lummer-Brodhun precision photometer, and an optical pyrometer for filament temperatures calibrated up to the melting point of tungsten, 3450 deg. K. A storage battery, 30 amperes, 170 volts, is used for the photometric work. The life test has a capacity of 60 kw. and facilities are provided for obtaining voltages from 0 to 250 in one-quarter-volt steps. A Tirrell regulator maintains constant voltage on the busbars. Additional circuits are provided for "shop tests" of 120 volts a.c., and 125 and 250 volts d.c., and also an outdoor series circuit of 6.6 amperes equipped

with compensators for the high current series lamps.

A color booth for studying color values of glasses, apparatus for studying residual gases in vacuum lamps, and apparatus for photographing filaments while burning, are included in the equipment.

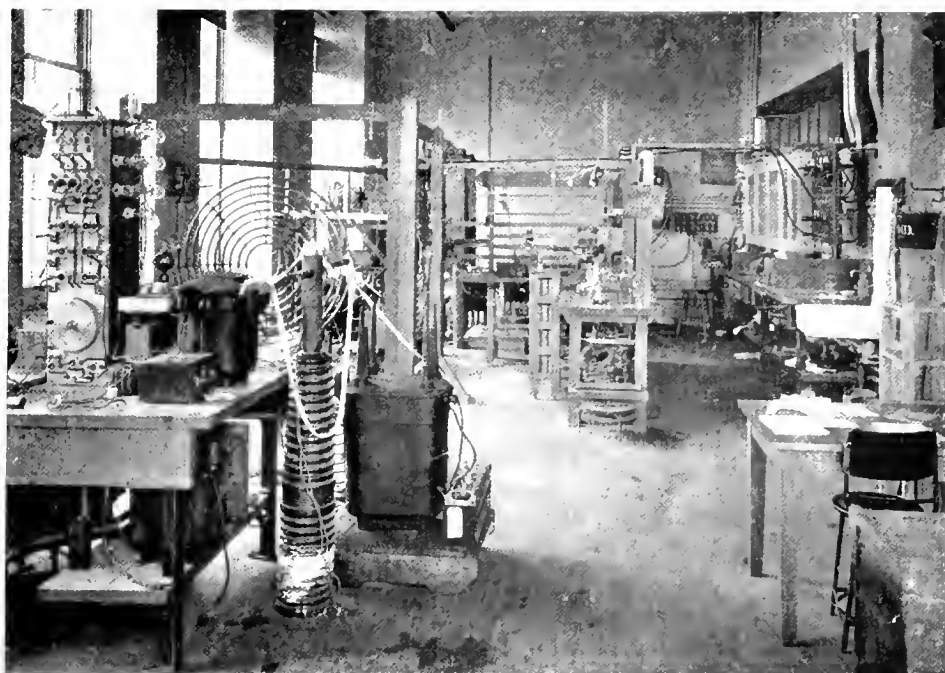
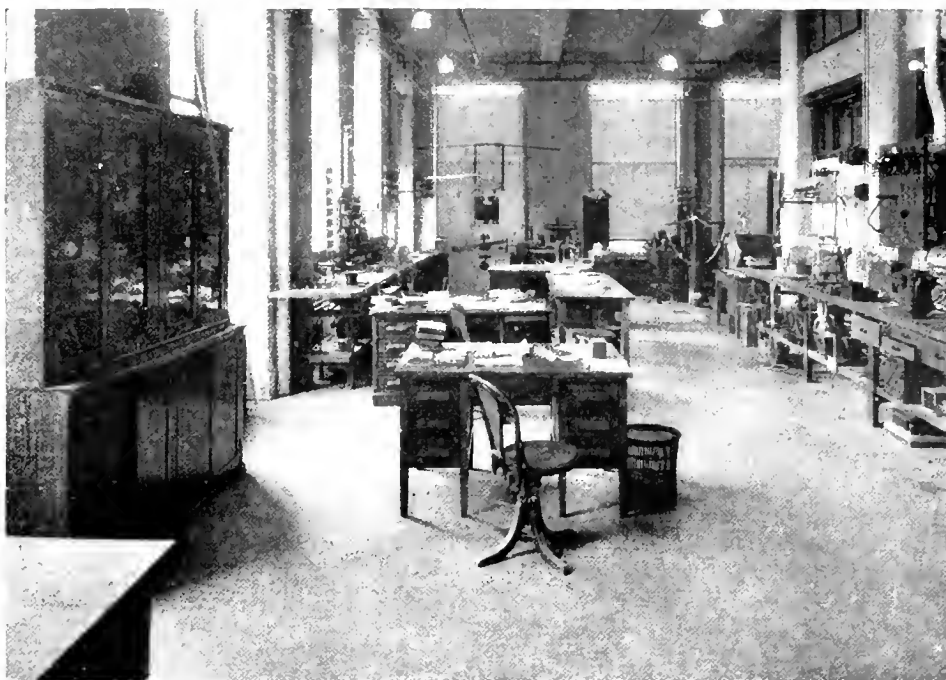
One of the experimental rooms for lamp work is shown in Fig. 10.

There is a photographic dark room on this floor.

Part of this floor is devoted to production work, including a room for chemical purification of tungsten oxide, a battery of electrically heated hydrogen furnaces, shown in Fig. 11, for oxide reduction, with a capacity of 50 lb. of metal a day, and a room for the assembly and grinding of tungsten contacts for use in spark coils, magnetos, relays, etc. One large room, of which two views are shown in Figs. 12 and 13, is devoted to the study of phenomena in very high vacuum. This work has thrown much light on the characteristics of the electron emission from hot filaments under various conditions, and the results have been published in recent papers by Dr. Langmuir.* The phenomena of pure electron emission, resulting from operating a hot tungsten filament in a vacuum so high that there is not sufficient residual gas to produce ionization, have been utilized in the Coolidge X-ray tube and in the high voltage rectifier known as the Kenotron, described by Dr. Dushman in the *GENERAL ELECTRIC REVIEW*, March, 1915. A number of improvements in wireless transmission also have been made possible by this investigation. For this wireless work a smaller room has been fitted up as a sending and receiving station, and an antenna, over 800 ft. long, composed of two wires spaced 16 ft. apart, has been strung between steel towers on the roofs of the laboratory and another building. Before this large antenna had been erected, wireless telephonic communication between the Schenectady and Pittsfield plants had been successfully obtained, and wireless messages received from Berlin, San Francisco, and Honolulu.

The laboratory is continually conducting researches of a purely scientific nature and publishing the results, in an endeavor to contribute its share to the progress of scientific thought, which is rapidly enlarging, modifying, and clarifying our conceptions of the fundamental things underlying all physical sciences. These investigations may be initiated because of their scientific interest,

*See *GENERAL ELECTRIC REVIEW*, May, 1915.



Figs. 12 and 13. Room for Vacuum Tube Experiments

without any definite practical object in view, but it has been already said that every marked advance in science has resulted sooner or later, directly or indirectly, in important effects on industry, and these laboratory investigations have certainly nearly always had these practical results. The study of electron emission, and the various practical utilizations of the principles discovered, is a case in point. The gas-filled lamp, now known as the Mazda C, had its origin in the results of an academic study of the laws governing the loss of heat in small wires, coupled with the results of an investigation of the evaporation of tungsten. The metallized filament lamp resulted from experiments with a high-temperature vacuum furnace. In none of these cases was the practical result foreseen when the research that made them possible was started.

It should not be supposed, however, that all the important achievements of the laboratory have been thus brought about. Many of them, of which drawn tungsten wire is a notable example, were the result of persistent and resourceful effort directed from the beginning toward a perfectly definite goal. Other examples are the sheath wire, with mineral insulation, now in production for heating devices, the magnetite electrode for luminous arcs, and the commercial development of the mercury arc rectifier.

Of course, even in those cases where unforeseen practical results are made possible by the new insight into fundamentals, gained from purely scientific research, they seldom first appear in fully developed form, like Athena sprung from the brain of Zeus, but much work, inventive and experimental, specifically directed to the end in view, is usually necessary before that end is reached.

A third kind of work which constantly requires the attention of the laboratory and occasionally demands the full application of its resources, is that which arises from the specific problems of factory production, such as the improvement of processes, the location of hidden troubles, and the development of new or better materials. Much of the work on insulations and alloys falls within this class, together with countless special investigations, each of which may be the work of a few hours or may extend over months or even years.

The General Electric Company maintains other laboratories than the one described. There are laboratories at the Lynn and Pittsfield plants, which specialize on the

production problems of those works. There are lamp development laboratories at Harrison and Cleveland which develop and standardize new processes, materials, and lamp designs, for the lamp factories. There is the physical laboratory at Cleveland, which conducts researches of a highly scientific order in the physical and physiological aspects of light and illumination. There is the Illuminating Laboratory at Schenectady, devoted to illuminating engineering, the selection of the best lighting unit and the best method of utilizing it for a given lighting system. There is the Consulting Engineering Department Laboratory devoted to general and special engineering problems and particularly to the investigation of high tension phenomena. There is the Testing Laboratory, investigating and testing the physical and chemical properties of materials. There is the Standardizing Laboratory, in charge of the standardization of all instruments, developing new instruments, like the oscillograph, and investigating and developing test methods. In addition to the activities of all these laboratories, the various engineering departments conduct many special tests which they are specially equipped for handling and investigations which sometimes amount to research work of a higher order. Research in general, however is delegated to the Research Laboratory, which was organized and equipped for that purpose.

By this description of the equipment and work of a single laboratory, we have tried to indicate the nature and function of industrial research, to show how science and industry may mutually profit by close co-operation. We believe the subject is timely. The great war is forcing us in this country to analyze, as never before, our industrial position in the world, to consider how far our industries are, or may be made, independent of foreign supplies, and to what extent we are prepared to take advantage of the new markets, cut off from their past source of supply and turning naturally to us to fill their wants. Our introspection shows us lacking in two essentials, financial and technical. The financial difficulties, our lack of the necessary banking facilities and system of commercial credits in foreign lands, will surely not be beyond the ability of our banking houses and business men to handle, now that they have been brought face to face with the necessity for action, for neither in wealth nor in business ability need we feel incompetent to accomplish what other nations have done.

On the technical side, we find our lack is not so much of raw materials, but of the organized science on which so many of Germany's industries and so much of her product is based. It is not that our business men are deficient in power to organize—all the world knows the contrary—nor are we lacking in men of great technical ability. The means are all at hand. There has simply been a tardiness in the recognition of the need for just this kind of organization, the need of

extensive industrial research, adequately equipped and financed, not only in our existing industries but in the new ones which should and will spring from our present necessities. With our unequaled wealth of raw materials, we need only a more thorough organized co-operation of the American business man and the American scientist to insure the technical independence and commercial supremacy of this country.

THE ELECTRIC POWER INDUSTRY

BY DAVID B. RUSHMORE

CHIEF ENGINEER, POWER AND MINING DEPARTMENT, GENERAL ELECTRIC COMPANY

The author gives a great deal of information in the form of vital statistics on this all-important subject. He shows how modern tendencies in the operation of public utilities are leading to the economical generation and distribution of energy by the centralization of the generating apparatus in large power houses. Statistics showing the use of energy in the mining, railway and manufacturing industries are given. "Water-power," generating equipment, and transmission are also considered in detail.—EDITOR.

The development of our industrial life is necessarily dependent upon the manufacture of power and our ability to utilize it in such forms that it can be substituted for the physical work of man.

Electricity is the most convenient form in which energy can be transmitted and distributed. It is not in itself a source of energy, but is obtained, either directly or indirectly, by transformation from energy in either a chemical or mechanical form, and in all practical cases is again transformed before being utilized.

Primary Power

Statistics have never been compiled giving accurately the total mechanical horse power used in the United States. The following estimate may, however, be considered to be fairly close to the actual conditions, and it is safe to place the present value at approximately 150 million horse power, or 1.5 horse power per capita for the entire population.

	H. P.
Manufacturers.....	25,000,000
Central stations.....	8,000,000
Isolated plants.....	4,250,000
Street and electric railways.....	4,000,000
Steam railroads.....	50,000,000
Steam and naval vessels.....	5,000,000
Mines and quarries.....	6,000,000
Flour, grist and saw mills.....	1,250,000
Irrigation.....	500,000
Automobiles.....	25,000,000
Horses and mules.....	25,000,000
TOTAL.....	154,000,000

A great many inferences, deductions and conclusions may be based on these figures, and ought to serve a great variety of useful purposes. The fact that already animal power forms only one-sixth of our national motive power is a rather startling fact, but in view of its average inefficiency there is nothing alarming about it. The horse will long be with us, but the question is obviously how much more we can do without it. If the 25 or possibly 30 million horses and mules now used in farm work were displaced by mechanical power 100 million acres of cultivated land would be released for human requirements, and it is safe to attribute the high cost of living to a very great extent to the very low efficiency of farm labor as compared to the higher efficiency in other industries whose rapid growth will continue to make even greater demands upon the farm productivity. The use of electricity on our farms is therefore sure to be greatly increased, and that this is becoming generally recognized by our central station interests is clearly demonstrated by the extensive network of transmission and distributing circuits which are being built and extended to cover the vast rural districts all over the country.

Public Utilities

The importance of these utilities as an economic factor and as daily necessities is indicated by the volume of their business.



MAP OF SOUTHERN INTERCONNECTED HIGH-TENSION TRANSMISSION SYSTEMS

FIG. 1

This has been estimated by a competent authority for the year 1913, as follows:

TABLE II

Electrical manufacturing	\$375,000,000
Electric railways	650,000,000
Central stations	450,000,000
Gas	200,000,000
Telephone service	350,000,000
Telegraph service	85,000,000
Isolated plants	125,000,000
Miscellaneous	125,000,000
TOTAL	\$2,360,000,000

As the art of production, distribution and application has progressed, these utilities have become primary necessities of modern civilization.

Central Stations

Public utilities are necessarily always undergoing very great changes. There is now a strong tendency toward consolidation with a view of concentrating the power supply for all uses in a large territory from one system. So, for example, a supply company in a large city expands so as to embrace the whole district around it, and the service given originally within a small area is unified over hundreds of square miles. In other cases the properties in a given territory are merged and brought under one management. This is strikingly illustrated by one large public service company in the middle west where nearly 100 communities were originally supplied by about 50 separate generating stations. These have now been shut down and four modern stations will ultimately furnish all the power needed for this service.

The inter-connection of hydro-electric transmission systems is also a step in the right direction, as demonstrated in our southern states where half a dozen large systems are tied together, furnishing power to each other on an "inter-change" contract basis. The advantages of this are obvious. The peak loads of the different systems may not coincide, the minimum stream flow may occur at different times on the different watersheds, common steam reserve stations may be used, and in general the operation may be so improved that a most efficient and reliable service can be rendered to the customers of all the systems so tied together.

In some cases groups of established systems although located in vastly different localities may be brought together under one holding company, and to the creation of such companies may in many instances be attributed the high-class service and financial success of

our small and medium-size light and power systems. The economies due to a central management, the benefits of the best technical and expert advice applied even to the smallest central station, the cumulative effect of active up-to-date new-business campaigns at every point, all have contributed to an improved and cheaper service to the consumer, and without the facilities of such a control they could exist only in the larger communities. Another very important advantage is the great problem of financing all these undertakings and providing funds for extensions to meet the ever-growing demand of the public for electric service. It is possibly in providing ready financial facilities for these purposes that the holding company performs its most important function.

In order to give the people the best service and the lowest rates all public utilities must of necessity be natural monopolies, and the public service regulation is a recognition by the state of the essentially monopolistic character of these enterprises. The favorable showing of virtual monopolies in reducing the cost of electric power is due mainly to a reduction in the capital expenses, lower operating costs and in no less degree to the reduced risk to the investor. By effective safeguards and a well-considered policy of public control the electric securities have become one of the most desirable investments, and there is every indication that efficient public service regulation will make possible even further reductions in the cost of electric power production of public service utilities.

The rapid growth in central electric light and power stations, as taken from the latest census report, is shown in Table III.

Aside from the growth in the number of stations the striking features of this table are the relatively larger increase in the kilowatt capacity per station, while the cost of construction and equipment remains practically the same. That this cost has not been materially reduced is no doubt due to the increased cost of the distributing and transmission lines, which form an important part of the total cost of the system.

It is also of interest to note that the percentage increase in the use of water power for the period of 1902 to 1912 was 463 per cent, as compared to 254 per cent for steam power. On the other hand, gas power increased 811 per cent, but this is not of any great importance as the horse power capacity of the gas engines installed at the beginning of the above period was very small.

Outputs of Large Generating Systems

The *Electrical World* in its issue for March 27th contained the accompanying very interesting Table IV, giving statistics for 1914 on the outputs, peak load and load factor of the largest generating systems of the country. Three of the companies in the list are in Canada, although a large part of the output is exported across the border into the United States. The combined output of the 36 companies listed is approximately 12,000,000,000 kw-hr. Of these, approximately two-thirds was generated from water power. In the census report for 1912, Table III, the total output of the 5221 central stations of the country was 11,502,963,006 kw-hr.; the total

horse power of steam engines and steam turbines 4,946,532, and the total horse power of waterwheels 2,471,081. It would appear, therefore, that over half the electrical energy generated by the central stations of the country is obtained from waterwheel-driven units.

Street and Electric Railways

In no other field has the application of electric power been more startling than for our street railway systems. Table V gives a comparative summary of the street and electric railways in this country for the period of 1890-1912, and it is seen how completely the electric drive has superseded the older methods.

TABLE III
CENTRAL ELECTRIC LIGHT AND POWER STATIONS

	1912	1907	1902	Per cent of increase, 1902-1912
Number of stations*	5,221	4,714	3,620	44.2
Commercial	3,659	3,462	2,805	30.4
Municipal	1,562	1,252	815	91.7
Total income	\$302,115,599	\$175,642,338	\$85,700,605	252.5
Light, heat, and power, including free service	\$286,980,858	\$169,614,691	\$84,186,605	240.9
All other sources	\$15,134,741	\$6,027,647	\$1,514,000	899.7
Total expenses, including salaries and wages	\$234,419,478	\$134,196,911	\$68,081,375	244.3
Total number of persons employed	79,335	47,632	30,326	161.6
Total horse power	7,528,648	4,098,188	1,845,048	308.0
Steam engines and steam turbines:				
Number	7,844	8,054	6,295	24.6
Horse power	4,946,532	2,693,273	1,394,395	254.6
Waterwheels:				
Number	2,933	2,481	1,390	111.0
Horse power	2,471,081	1,349,087	438,472	463.6
Gas and oil engines:				
Number	1,116	463	165	576.4
Horse power	111,035	55,828	12,181	811.5
Kilowatt capacity of dynamos	5,134,689	2,709,225	1,212,235	323.6
Kilowatt capacity per station	983	574	334	194.3
Cost of construction and equipment	\$2,175,678,266	\$1,096,913,622	\$504,740,352	331.4
Cost per kilowatt capacity	\$425	\$404	\$416	
Output of stations, kilowatt-hours	11,502,963,006	5,862,276,737	2,507,051,115	358.8
Estimated number of lamps wired for service:				
Arc	505,395	562,795	385,698	31.0
In incandescent and other varieties	76,507,142	41,876,332	18,194,044	320.5
Stationary motors served:				
Number	435,473	167,184	101,064	330.9
Horse power capacity	4,130,619	1,649,026	438,005	843.1

* The term "station" as here used may represent a single electric station or a number of stations operated under the same ownership.

The plant equipment and output of the power stations for street and electric railways are given in Table VI. It shows the number of companies having power plants, the number and capacity of the primary power units, the electric generators and dynamos, and the subsidiary apparatus by kind, and the quantity of current generated and purchased.

In 1912, 50.8 per cent of the street and electric railways had their own power plant equipments as compared with 61 per cent in 1907 and 70.6 per cent in 1902. In other

words, the number of operating companies without power plant equipments, purchasing their power, has increased from 240, or 29.4 per cent of the total number in 1902, to 480, or 49.2 per cent of the total number in 1912.

Mining Industry

The advantages of using electric power for mining operations are now fully recognized and almost all new mines are being equipped for electric drive, and a very large number of old ones are changing over to this system.

TABLE IV
DATA ON LARGE GENERATING SYSTEMS

System	Peak Load in Kw.	Date of Peak Load	Yearly Output in Kw-hr.	Yearly Load-Factor, per cent
Commonwealth Edison Company.....	306,200	Dec. 15	1,114,130,000	43.6
Niagara Falls Power Company.....	131,520	Jan. 5	906,513,620	78.7
Ontario Power Company.....	130,500	Sept. 23	781,664,400	68.4
New York Edison and United Companies.....	229,787	Dec. 23	719,193,535	35.7
Hydraulic Power Company.....	87,457	Mar. 27	703,105,872	91.7
Pacific Gas & Electric Company.....	124,000	Oct. 29	658,298,000	60.6
Public Service Electric Company.....	123,539	Dec. 23	430,818,532	39.8
Shawinigan Water & Power Company.....	85,000	July 7	430,000,000	58.0
Montana Power Company.....	61,000	July 21	402,663,369	75.0
Mississippi River Power Company.....	73,700	Nov. 16	356,578,000	55.6
Duquesne Light Company.....	72,000	Dec. 21	315,210,796	50.0
Great Western Power Company.....	56,300	Dec. 9	315,000,000	64.0
Detroit Edison Company.....	83,300	Dec. 15	313,718,600	43.0
Puget Sound Traction, Light & Power Company.....	67,200	Dec. 17	299,622,508	50.9
Pacific Light & Power Corporation.....	70,565	Sept. 17	292,545,094	47.37
Southern California Edison Company.....	53,835	Dec. 24	288,549,532	61.1
Utah Power & Light Company.....	47,048	July 9	287,792,765	70.0
Pennsylvania Water & Power Company.....	74,000	Dec. 17	277,200,000	42.5
Philadelphia Electric Company.....	77,728	Dec. 1	250,697,952	36.8
Toronto Power Company.....	72,000	Dec. 4	236,328,680	37.5
Tennessee Power Company.....	47,600	Dec. 11	228,504,650	54.8
Electric Company of Missouri.....	52,528	Nov. 18	228,209,988	49.78
Boston Edison Company.....	65,342	Dec. 21	194,137,400	34.0
Union Electric Light & Power Company.....	51,072	Dec. 7	189,677,593	42.4
Portland (Ore.) Railway, Light & Power Company.....	44,315	Jan. 2	184,766,149	47.7
Washington Water Power Company.....	29,641	Dec. 29	169,691,800	65.4
Wisconsin Edison Company.....	44,124	Dec. 22	159,665,804	36.2
Brooklyn Edison Company.....	49,300	Dec. 9	153,946,900	35.6
Georgia Railway & Power Company.....	44,320	Oct. 28	145,684,800	37.5
Sierra & San Francisco Power Company.....	40,080	Jan. 6	179,444,960	51.2
Great Northern Power Company.....	30,400	Nov. 13	136,733,810	52.0
Rochester Railway & Light Company.....	28,500	Dec. 16	123,850,785	49.6
New England Power Company.....	35,000	Dec. 15	120,000,000	39.0
Minneapolis General Electric Company.....	27,955	Dec. 7	110,346,460	45.06
†Alabama Power Company.....	23,500	Dec. 22	55,837,740	27.1

*Southern Power Company.....

† Main Station began operations April 14.

* No data received, estimated.

GENERAL ELECTRIC REVIEW

TABLE V
STREET AND ELECTRIC RAILWAYS IN UNITED STATES

	1912	1907	1902	1890
Miles of tracks	41,064.82	34,381.51	22,576.99	8,123.02
Operated by				
Electricity	40,808.39	34,037.64	21,901.53	1,261.97
Cable	56.41	61.71	240.69	488.31
Animal power	57.42	136.11	259.10	5,661.44
Steam	76.34	105.06	169.61	711.30
Gasoline motor	66.16	40.99		

TABLE VI
PLANT EQUIPMENT AND OUTPUT OF STREET AND ELECTRIC RAILWAY
POWER STATIONS: 1912, 1907, AND 1902

	1912	1907	1902
Number of operating companies	975	945	817
Number of companies with power-plant equipments	495	576	577
Primary power:			
Number of units	2,695	3,637	2,811
Horse power, rated capacity	3,665,051	2,519,823	1,359,285
Steam power—			
Number of units	2,264	3,368	2,637
Horse power	3,169,554	2,411,527	1,308,207
Engines—			
Number	1,802	3,116	
Horse power	1,706,754	1,876,123	
Turbines—			
Number	462	252	
Horse power	1,462,800	535,404	
Gas and oil engines			
Number	48	41	15
Horse power	24,190	16,335	1,925
Waterwheels and turbines—			
Number	383	228	159
Horse power	471,307	91,961	49,153
Dynamics—			
Number	2,797	3,124	3,302
Kilowatt capacity	2,508,066	1,723,416	898,362
Direct current—			
Number	1,642	2,192	2,861
Kilowatt capacity	769,875	941,502	725,346
Alternating and polyphase current—			
Number	1,155	932	441
Kilowatt capacity	1,738,191	781,914	173,016
Subsidiary equipment:			
Rotary converters and motor-generator sets—			
Number	2,840	1,862	441
Kilowatt capacity	1,637,260	942,232	160,053
Batteries—			
Number	183	134	104
Kilowatt capacity	24,807	17,046	13,666
Storage batteries, number of cells	31,059	63,694	40,477
Transformers—			
Number	8,436	5,274	1,657
Kilowatt capacity	2,357,397	1,133,161	212,569
Auxiliary generators—			
Number	144	311	71
Kilowatt capacity	12,227	19,152	3,763
Output of stations and current purchased, kilowatt-hours			
for year:			
Generated	6,052,699,008	4,759,130,100	2,261,484,397
Purchased	2,967,318,781		

Not only does this reduce the cost of working, but it also offers a much safer and more reliable operation. The use of electricity eliminates the necessity for long lines of steam and air piping, which are expensive to install and maintain and with which the danger of breakdown and the difficulty of obtaining the necessary working pressures increase with every extension of the service. For these conditions electricity substitutes a simple and thoroughly flexible system of transmitting power by means of conductors which can be easily run and rapidly extended to meet the frequent changes which are involved in the progress of the development. The flexibility of motor drive renders possible the use of

While the primary power increased about 85 per cent, the application of electric motors for manufacturing industries alone increased close to 900 per cent.

Figures are not available giving the present amount of power used in the manufacturing industry, but a conservative estimate would probably place the total primary power at 25,000,000 horse power and the electric motors at over 10,000,000 horse power.

Water power was used more extensively than steam in the manufacturing industry prior to 1870. Since that time, however, it declined steadily, while the use of steam power increased, reaching a maximum of about 87 per cent in 1900. There has since

TABLE VII
POWER USED IN MANUFACTURING INDUSTRIES

	1870	1880	1890	1899	1901	1909
Primary power, total	2,346,142	3,410,837	5,939,086	10,097,893	13,487,707	18,680,776
Owned, total			5,850,515	9,778,418	12,854,805	16,808,106
Steam	1,215,711	2,185,458	4,581,595	8,139,579	10,825,348	14,202,137
Gas			8,930	134,742	289,423	754,083
Water	1,130,431	1,225,379	1,255,206	1,454,112	1,647,880	1,822,593
Other			4,784	49,985	92,154	29,293
Rented, total			88,571	319,475	632,902	1,872,670
Electric				182,562	441,589	1,749,031
Other			88,571	136,913	191,313	123,639
Electric motors, total			15,569	492,936	1,592,475	4,817,140
Run by own power				310,374	1,150,886	3,068,109
Run by rented power				182,562	441,589	1,749,031

portable machinery, and additions to, or changes in the location of existing machines can easily be arranged for without interfering in any way with the operation of the remainder of the equipment.

Statistical figures relating to the power used in this important industry are given in the article on "The Use of Electricity in Mining Work" on page 527 of this issue of the REVIEW.

Manufacturing Industries

Table VII shows for all industries combined the horse power of engines and motors employed by manufacturing concerns for the period from 1870 to 1909. The figures for the total primary power exclude duplication and represent the primary power of engines, waterwheels, etc., owned by the manufacturing establishments themselves plus the electric and other power purchased from outside concerns.

Especially striking is the increased use of electric motor applications during this period.

been a marked falling off in the percentage of directly applied steam power and this has been due to the rapid introduction of electric power. The increased use of the electric motor for driving industrial machinery has been phenomenal and this is again best illustrated by a reference to the census report.

The curves in Fig. 1 show the approximate percentage relation that steam, water and gas power bear to the total in the three principal industry—central stations, electric railways and manufacturing.

Water Powers

The total developed water power in the United States does not exceed six million horse power, while many times this amount are at present available for an economical development. The surveys and examinations necessary to a thorough and accurate report of the water power resources of the United States have never been completed. While in certain parts of the country they are fairly

well known, in other parts the information is very incomplete.

An endeavor has been made to determine the maximum power that might be produced if all the practical storage facilities on the drainage areas were utilized. Surveys on many of the basins make possible a fairly

and on the assumption that the water power per square mile is approximately 14 horse power. This value has been found to be the average of a number of investigations in European countries. For Australia, however, this value is entirely too high, and three horse power per square mile has been assumed.

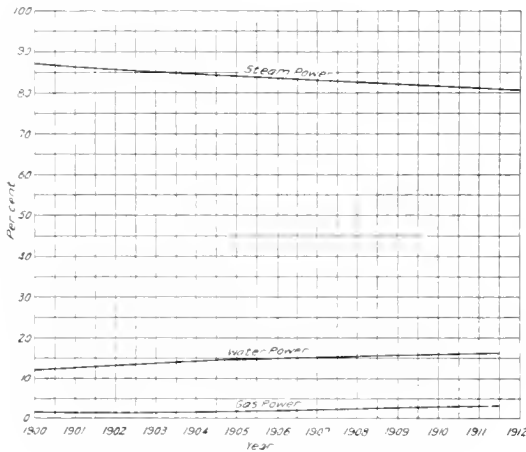


Fig. 2. Curves showing Steam, Water, and Gas Power, in percentage of total for years 1900 to 1912 inclusive

close estimate, but inasmuch as fully three-fourths of the country has not been surveyed in a manner suitable for this purpose, only rough estimates can be given for the entire area. It may, however, be assumed with confidence, with all practicable storage sites utilized and the water properly applied, there might be established eventually in the country a total water power installation of at least 100 million horse power and possibly 150 million. It should, however, not be assumed that all this power is economically available today. Much of it, indeed, would be too costly in development to render it of commercial importance under the present condition of the market and the price of fuel power. It represents, on the other hand, the maximum possibilities in the day when our fuel shall have become so exhausted that the price thereof for production of power is prohibitive, and the people of the country shall be driven to the use of all the water power that can reasonably be produced by the streams.

An endeavor has also been made to estimate the total water powers of the world, the results being given in Table VIII. The values are based on the area of the different continents

TABLE VIII

WATER POWERS OF THE WORLD

Continent	Area in Square Miles	Horse Power
Africa	11,513,579	161,190,116
America, North	8,037,714	112,527,996
America, South	6,851,306	95,918,284
Asia	17,057,666	238,807,324
Australia	3,456,290	10,368,870
Europe	3,754,282	52,559,948
		<u>671,372,538</u>

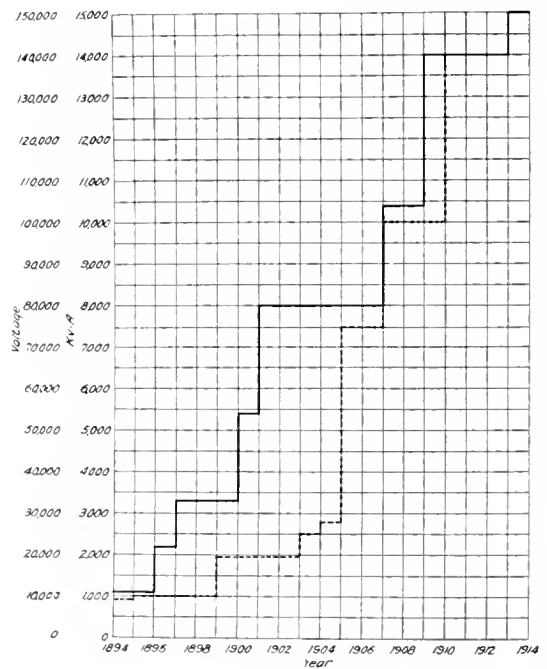


Fig. 3. Curves showing Transformer Development

It is thus seen that the total water powers of the world represent nearly 700 million horse power. This vast amount can, however, not be economically developed at the present time, but the tabulation merely shows the possibilities that may in the future be derived from this natural source.

Electric Power Service

The quantity and quality are the principal elements which determine the value of an electric power service, and while the quantity can readily be measured, there is no standard of quality. It is generally a very difficult matter to determine what under given conditions is good service and whether the quality of the service that has been specified is actually rendered. An absolutely reliable service can of course be obtained but at a very high cost which is justified in only very rare cases. In general, the more reliable the service is the more it must cost, due to the superior construction required and to the increased investment for emergency apparatus, etc. The question therefore always arises: What degree of reliability is justified under certain conditions and what is the real value of such service? It is evident that it varies very widely for different industries.

Generating Equipments

For the generation of electric power the steam turbine and the waterwheel stand foremost, and it is an astonishing rate at which the size as well as the efficiency of these generating units have increased of late. A 35,000-kw. steam turbine unit is now nearing completion and is the largest single turbine built up to the present, although there is every indication that the 50,000-kw. mark will be reached before very long. Hydro-electric turbine units are now also built for capacities up to 17,500 kw. and a large number of notable water power installations have been recently completed or are under construction. Among these may be mentioned the 200,000-h.p. development of the Mississippi River Power Company at Keokuk, Iowa; the Big Creek Developments of the Pacific Light & Power Company, California, and many others.

The type now generally adopted for the Curtis turbine consists of one double wheel followed by a number of wheels having single rows; the number of these depending upon speed, size and efficiency required. In units above 20,000 kw., the turbine is divided into two parts: one high pressure and one low pressure. The low pressure is made double-flow in order that the highest efficiency may be obtained with vacuum as high as 29 in. The high-pressure and the low-pressure parts are both connected to the same shaft and one generator is used, there being no advantage whatsoever in splitting the units up into two parts running at two different speeds. The single row construction, now generally

adopted, requires a higher bucket speed than on the older construction, having two rows of buckets throughout the machine, but at the same time it gives considerably higher efficiencies and in addition permits utilizing efficiently the best vacuum obtainable, which is of the greatest importance, particularly at such installations where the natural conditions permit a good vacuum. As the vacuum is of the greatest importance in turbine installations, the benefit of same should be given careful consideration, and, in judging two different types of turbines, the one that is able to efficiently utilize the best vacuum is far superior to another one that is unable to do so. A turbine designed for 29-in. vacuum is very much larger and more expensive to build than one designed for 28 in., or, putting it another way, the turbine designed for 29 in. is capable of rating up at least 25 per cent at a vacuum of 28 in.

Large Curtis turbines of recent design show not only a performance representing the maximum turbine efficiency so far obtained, but also that the highest value is closely sustained over the greater part of the load range of the machine. The advantage of this where machines are frequently required to operate over considerable variations in load, is apparent. In fact, the useful capacity of a turbine is determined by the shape of its load-water rate curve rather than by an arbitrary rating assigned to it by the manufacturer. In general, any turbine can be made to carry a load considerably in excess of the most economical load, either by permitting congestion of steam in the low-pressure end, or by by-passing live steam to buckets operating at intermediate pressure. This practice is only justified to a limited extent. That is, an increase of a few per cent in steam consumption at the maximum load, over that of the most economical point, is permissible, in order to insure good light load economy. But where a small machine is given a very large arbitrary rating, and the maximum load secured at the sacrifice of economy at high loads, the actual useful capacity is not the maximum rating assigned to the machine, but some lower value, determined by the economical range beyond the best point. The best practice is therefore to so rate turbines that the steam consumption of the machine at its maximum continuous rated load will not differ greatly from that at the point of highest economy.

Hydraulic turbine design has also passed through a stage of wonderful development

during the past few years and remarkable progress has been made toward bringing the turbine to a high state of perfection. Ten years ago it was considered a notable achievement to obtain a turbine with an efficiency as high as 82 per cent, while today a maximum value of 93.7 per cent has been secured. This remarkable increase in efficiency is by no means entirely due to superior runner design. As a matter of fact, the improvements in the design of wheel-casings, wicket gates, draft chests and draft tubes have increased the efficiency of the turbine as much as the more efficient runners.

One of the most notable deviations from the old practice of the multi-runner turbines has been the general adoption of the single-runner, vertical-shaft turbine for low and

and requirements of the prime movers themselves.

Probably the most obvious change in the design of waterwheel-driven generators of recent years, and the most important from a commercial standpoint, is the large increase in kv-a. output now obtained from a given size of frame. In 1909 and earlier, it was common practice of purchasers to require a regulation of from 5 to 8 per cent at unity power-factor. At the present time common requirements for regulation are about double these figures.

This change has resulted mainly from two causes, viz.:

First: The doing away with hand control and the more general use of automatic voltage regulators.



Fig. 4. Cedars Rapids Manufacturing & Power Company on the St. Lawrence River at Cedars Rapids, Canada. Exterior View of Power House with Transformer and Switch House on the Left

medium heads. This change in the type of unit has been made possible by recent progress in the design and development of high-capacity runners. Thus, for a given head and speed it is now possible to secure from a runner a greater output than was possible a few years ago, or, conversely, for a given head and capacity it is possible to operate the more recently designed runners at a much higher rotational speed than was the case with runners designed a few years ago. This increase in the capacity of runners has been secured without sacrifice of maximum efficiency and with only a small sacrifice in the efficiency at fractional loads.

The development of generators driven by different types of prime movers must necessarily also keep step with the development

Second: The necessity of a higher value of inherent reactance as generators were built in increasing capacities, due to the destructive effects of short circuits with the low values of reactance formerly used.

This sacrifice of inherent regulation and the desirability of high inherent reactance enables the designer to obtain from a definite frame a very greatly increased kv-a. output, this amounting to as much as from 15 to 30 per cent over the old rating.

Even with the high values of the present day alternating-current generators, it is often insufficient where a large number of machines of great kv-a. output are connected to a common bus, in which case it frequently becomes necessary to resort to external reactances connected either in the generator

leads or the bus in order to limit the rush of current resulting from a short circuit.

Considerable improvements have been made in insulating materials and in the development of suitable insulation for withstanding higher temperatures than were permissible in the past. Similarly, the life of high potential coils has been greatly lengthened by providing protection against the destructive effects of corona. The use of so-called "temperature coils" has also become very general, these being small suitably shaped coils of insulated wire imbedded in the armature windings of the machine for determining the temperature rise by the increase of resistance of the coils.

Considerable attention has of late been given to the ventilation of generators and the cleaning of the air. With the advent of very slow speed machines with low peripheral velocities, where fans attached to the rotor cannot be effectively used, it has become necessary to resort in certain cases to special

passages of the generators. The use of either method of circulation depends largely upon the generators and the power house design, and the best arrangement must be worked out for each individual case.



Fig. 6. Massena Substation of the Aluminum Company of America, containing eighteen 2500-kw. 360/500-volt Synchronous Converters. Power supplied from Cedars Rapids Manufacturing & Power Company

Transmission

The high-voltage transmission system has undergone an evolution from the single transmission line with a power station at one end and with a receiving circuit at the other, until it is more nearly a high-voltage distributing system into which network are fed a number of steam and hydro-electric power stations, and from which at various points are tapped off distributing systems of lower voltage which feed local communities, many of which secondary systems extend over a very considerable area.

For the transmission and distribution of electric energy the voltage continues to rise as the distance and the amount of power to be transmitted increases, and this in turn presents new problems of design and construction. This involves mainly the transformers, the line structure and the switching equipment.

As long as the transmission voltage and the capacity of the generating stations were moderate, no serious operating difficulties were experienced. With the introduction of transmission pressures of 100,000 volts and above, and with the concentration of enormous amounts of power in our modern power stations, problems arose which were solved only after very painstaking investigations and great expense. So, for example, have the transformer interruptions been reduced to a



Fig. 5. Interior of Cedars Rapids Power House. Present equipment, nine 10,000 kv-a., 136-pole, 55.6 r.p.m., three-phase, 6600-volt generators. Ultimate equipment, eighteen similar units

ventilating arrangements in order to carry away the heat generated. This may take the form of large ducts leading air in from the outside of the building to the generator pit, depending on the fan effect of the generator rotor for circulation, or motor-driven blowers may be used for forcing the air through the

minimum by embodying designs which will make them safely withstand the excessive voltages which may be set up in the system under transient conditions, while on the other hand they are now capable of withstanding the severe mechanical stresses imposed on the windings under short-circuit conditions.



Fig. 7. A Substation and Outside Equipment of the Utah Power and Light Co.



Fig. 8. Another view of the Outside Equipment of the Substation shown in Fig. 7

The curves in Fig. 2 illustrate the astonishing increase in the development of transformers, both as regards capacity and voltage. So, for example, are core type transformers now built in sizes up to 7500 kv-a., while single-phase, shell-type transformers have been built in sizes of 8333 kv-a.

Another notable feature in the transformer development is the combination self-cooled, water-cooled type, consisting of an ordinary water-cooled transformer placed in a corrugated or pipe radiating tank. It may thus be designed for normal operation with water circulated through the cooling coils, while it may also be safely operated at 50 per cent of normal load without the circulation of water and without exceeding its specified temperature rise. On the other hand, this transformer may be designed for normal operation as a self-cooled unit, and be pro-

vided with the necessary cooling coils which, when utilized, permit operation efficiently at 50 per cent above the normal capacity.

On account of its exposed position the transmission line continues to be the weakest link in a high-tension transmission system and even the failure of a single insulator may cause a complete shut-down of the entire system. While very great and encouraging improvements have of late been made in the design of insulators and in the methods of testing for weeding out the defective units, it can, however, not as yet be said that the insulator problem is solved.

The question of regulation of large high-voltage systems involves a number of difficulties not encountered in low-voltage work. In the latter case the energy loss is generally the limiting factor and the regulation can often be improved by installing larger conductors, which at the same time will reduce the line loss. With high-voltage systems the gain of doing so is very slight and other means must be resorted to for keeping the regulation within commercial limits. The effect of the inductance and capacity of the line causes the voltage to vary within very wide limits from full to no load. At no load the large capacity current causes a rise of voltage from the generating station to the receiving end, while at full load the lagging inductive current taken by the load, in general, more than offsets the effect of the capacity current and causes a drop of voltage from the generating station to the receiving end. It is evident then that by installing a synchronous condenser at the receiving end, and taking advantage of the characteristics of this machine, the receiving voltage can be kept constant at a determined value by adjusting the synchronous condenser field, causing the condenser to draw a lagging current from the line at no load and a leading current at full load.

The engineering problems in connection with the operation of these high-voltage systems are very largely those which have to do with preventing interruptions to service, and which isolate and localize the electrical disturbances before they can become of a general nature. This involves itself not only into the general design of the apparatus and transmission lines but also to a careful study of the best system of connections and switching equipment. Reliability and continuity of service are the main considerations, but besides this the protection of apparatus from injury should be very carefully considered.

One of the greatest difficulties involved in this work has been the problem of determining the exact nature of the disturbances, both in kind and magnitude, to which the line and apparatus is subjected, and while the many interesting and valuable investigations which have been made have brought forth much light, more still remains to be accomplished.

On some systems where a careful and detailed study has been made of the problem

of properly relaying the transmission lines, very great improvement has been made. It seems, however, almost impossible to so arrange a system as to prevent a vicious lightning stroke from doing any damage, but experience has proven that it is possible to so relay the system that such an interruption becomes merely local in character and that the supply of power is not in any way disturbed.

A BRIEF REVIEW OF THE ELECTRIC LIGHTING INDUSTRY

By C. W. STONE

MANAGER, LIGHTING DEPARTMENT, GENERAL ELECTRIC COMPANY

The author makes a rapid review of the early stages of the lighting industry noting many historical facts and then recites some of our modern developments. He shows our rate of progress up to the present and tells of the many different directions in which we may expect future developments leading to higher efficiencies in the generation and distribution of electrical energy.—EDITOR.

The electric lighting industry, so-called, has grown so rapidly and has expanded in so many directions that it will be possible to point out only a few of the factors which have contributed to its growth.

The industry, considered as such, may well be called one of our infant industries from the point of years since its inception, but from the point of view of its magnitude it is probable that no single industry is of such vast importance to modern civilization. It is no longer a scientific toy or luxury, but is a vital necessity to our present progress and will become more so as we advance.

The Gramme dynamo completed in 1871 is usually referred to as being the first type of machine to be used commercially for arc lighting, but other work had been done with other forms of machines which were fully as successful. Progress in Europe was rapid in the earlier days, but the greatest progress later was on our own continent. Probably the first commercial arc system installed in this country was in Cleveland in 1879. Immediately after this other systems were installed both in this country and in European countries.

In the earlier days the problems of successful lighting were many. It was not only a problem of building machines for the production of the electricity, but instruments, switch, etc., had to be developed, no continuous lengths of copper wire were available, and in fact the engineer was confronted

with the most difficult problem possible. Everything had to be invented, but the interest was so great that many inventors were attracted and the financiers were liberal in their support, which resulted naturally in very rapid advance.

Most of the early work was on the development of arc machines and arc lamps, and it was about 1883 that companies were formed to take contracts for lighting city streets. The price being about \$1.00 per lamp per night. Many difficulties arose, such as poor and crooked carbons, poor and thick globes, unskilled labor for the construction of both lamps and machines and their operation.

It was soon recognized that the arc system was the best suited for special lighting and particularly for out-of-door work. Mr. Edison then experimented with the development of the incandescent lamp and after many experiments success was reached.

The history of this type of lamp has been described so many times that it is unnecessary to describe it here except to point out the date of the starting of the first commercial station for this type of lighting at Appleton, Wis., in August, 1882, the total capacity of the station being for two hundred and fifty 10-c-p. lamps.

At this time the systems for arc and incandescent lighting were wide apart. Arc lighting, due to its fundamental characteristics, was suitable for outdoor service

lighting, especially in stores and manufacturing plants, while the incandescent system with its low-voltage circuits and small lamps was naturally limited to small areas and indoor service. These two systems of lighting, each with its own admirers, naturally led to rivalry and competition. At the same time, new schemes and contrivances were developed that would bridge the gap existing between the series and multiple system in service; while some of these were quite ingenious, they only proved temporary and gradually paved the way for the introduction of our modern alternating-current system, which perhaps more than any other factor has helped to develop a uniform electric illumination and power transmission. The alternating-current system began to receive prominent attention about 1883 and in the fall of 1885 the first regular alternating-current system was installed at Buffalo, N. Y., when current was generated at 500 volts and stepped up to 3000 volts for transmission, after which it was stepped down to 100 volts for service. Even this installation was crude in a good many respects.

The development of the polyphase generator, which was the next step, permitted the development of the polyphase induction motor with its high starting torque and rugged simple construction.

From this time the growth of the central station was rapid. The value of a day load was soon apparent, campaigns were immediately inaugurated to develop power applications. This resulted in the rapid increase in the size of the central station and created a demand for larger generating units. This demand later brought about the rapid development of the steam turbine. The first large units, 5000 kw., were built in 1900, and the capacities have steadily increased until today turbines are in operation of 30,000 kw. capacity, and 50,000-kw. machines will probably be built within a short time.

It is not in steam turbines alone that this increase has appeared. There are in operation today waterwheel-driven generators of over 17,500 kw. continuous capacity. With the increasing demand for electric service and the development of larger waterwheel-driven alternators the water power companies have gone farther back into the mountains for their water power sites until we now find such stations 250 miles or more from their distributing centers and operating transmission lines at 150,000 volts.

In the control apparatus the development of the oil switch has kept pace with the increase in capacity and voltage until today the oil switch not only breaks a potential of 150,000, but will withstand line disturbances of three times this value.

Before the introduction of electricity, manual labor was almost supreme because the mechanical devices in service were usually so crude that they required almost constant attention for successful operation. During this period many wonderful inventions were nevertheless perfected, but their requirements were for very special conditions of necessity to meet a particular requirement without having direct bearing on the welfare of the entire community.

The introduction of the central station for the general distribution of electricity on the other hand marked a decided step in the advancement of civilization, because through this medium it has been possible to generate power at a cost so low and in such convenient form that it is rapidly displacing all other forms of power.

During the early stages of progress central stations were developed mainly for lighting purposes and, like all new business enterprises, the greatest activity was developed in communities of sufficient size to plainly warrant the expense. The outcome of all these years of development has finally resulted in the successful installation of about 8000 electric lighting plants in continental United States.

The tendency in the past has been the building of a central station for each locality, but this idea is being gradually replaced by the more economical system of distribution, namely, the generation of large quantities of energy at some central point or the consolidation of several central stations and distributing the energy at high potentials to other communities where it is again distributed at safe voltages for various purposes; for instance a large city plant expands so as to include all the district around it and service originally limited to a small area is unified over a considerable territory. In other cases the individual properties in a territory are merged and brought under one management, while other instances occur where unrelated public service companies widely dissociated in various states are placed under one control and management. This system of development has now progressed until the electric properties have merged their interests in other utility properties, such

as the gas and street railway systems. The relative economic advantage of this method of operating must receive universal approval because it is of direct interest to each individual and has a direct bearing on the low price of electric energy.

One of the most important advantages of this method of operating is the utilization of the diversity factor which is one of the primary elements in determining a low price for electric service. The station must be designed to carry the maximum demand, but the cost of the power will depend upon its average 24 hours' demand.

The utilization of electrical energy in a modern city home has reached such a stage that it is now used not only for lighting, but for heating, cooking, cleaning, refrigerating, operating mechanical drive such as fans, washing machines, etc., and almost every other conceivable purpose. In a similar manner everything in which man is interested has been benefited and the rapid development of electricity along diversified lines has added immeasurably to the progress of civilization. In medicine and surgery it has proved of inestimable value. Today we have the Röntgen ray which is of great assistance to surgeons in locating various troubles in the organs of the body, thus simplifying the necessary operation and greatly reducing the time required, and in some cases making it possible to avoid operating.

The X-ray is now being successfully used in metallurgical research, as by its use faults in metal substances can be shown. Electricity is also used for cauterizing wounds in the purification of air and water by the ultra violet ray. The moving picture was made possible by the development of the high powered arc lamp.

These benefits are by no means confined to the city because the central station with its great network of distribution is in a position to furnish electric energy to the farmer, who, if progressive, is today able to enjoy the same pleasures as his city neighbor, and in addition can accomplish a greater amount of work than heretofore in less time and at a smaller cost. Another important direct benefit is that it does away with practically all the old drudgeries usually found about the farm.

The technical growth of this industry has brought out many interesting problems tending to reduce to a minimum the overhead operating and distribution charges, so that electrical energy may be produced and

delivered at the lowest possible cost. The details involved are numerous and complicated even from the proper handling of the coal for the boilers to the delivery of energy to the lamp filaments in the home.

In attempting to prophesy the future of an industry one naturally looks to the past for guidance, although in this age of scientific investigation and discoveries there are possibilities of such radical changes as may upset all prophecies based on past conditions.

It is interesting to note, however, that in the last 20 years the increase in magnitude of the central station industry has been at the rate of about 15 per cent per year or doubling itself every five years. If lighting alone is considered, although the point of saturation is far from being reached, we should not anticipate a continuation of increase at this rate. The central stations are, however, making every effort to increase their output and diversify their load by use of current for every conceivable purpose and a reasonable rate of increase in load will be continued and possibly be increased.

Hand to hand with the growth of the industry has gone a reduction of the cost of lighting and of power, both of these movements being related to each other reciprocally as cause and effect.

It is to be expected that the reduction in cost of electricity will be continued as new discoveries and improved methods of generation, distribution and conversion are adopted, although as the theoretical limits are approached, the decrease in cost will not be so rapid as it has been in the past.

Generation

With the improvement in load factors and the increase in size of generating units and generating plants and systems, it is to be expected that improvements and refinements in the various generating station operations will be made. Some of these possibilities are as follows: The utilization of a greater temperature range in the thermal cycle, as by higher degrees of super-heat, the increased use of economizers, etc. One very important improvement already in sight is the mercury boiler and mercury turbine worked out by Emmet. In this development coal is used in a special boiler evaporating mercury. The mercury vapor is expanded to a high vacuum in passing through a turbine producing power, the condenser for the mercury serving also as a steam producer whence steam is carried to steam turbines, thus the mercury

is worked through the thermal cycle from about 700 deg. F. to 400 deg. F., the steam working through a cycle from 400 deg. F. down to 70 deg. or 80 deg. F. The addition of the mercury cycle to the steam cycle enables us to produce from 35 to 50 per cent more power from a pound of coal than is at present produced by the most efficient steam generating stations.

For small and moderate sized plants the high efficiencies shown by internal combustion engines, particularly of the Diesel type, will probably produce an extension of the use of such machines as soon as improvements of design and standardization of manufacture sufficiently reduce the initial and maintenance cost.

The design of internal combustion turbines is a field having large possibilities but surrounded by apparently insuperable difficulties, to which a solution may possibly be found in the future.

Engineers are turning their attention to methods of utilizing all of the heat generated by fuel, and along this line efforts have been made to utilize the heat of exhaust from the heat of internal combustion engines. A notable example of this is to be seen in the Ford factory.

Distribution

There is a considerable field for improvement in methods of distribution. Developments of the past few years show an increased tendency to connect together a number of generating stations into a network and these stations may be steam stations or hydraulic, or more frequently both. The extension of this network supplied from numbers of central stations will undoubtedly increase. We already have transmission and distribution networks covering several states and the future will probably see the whole country covered by distribution networks connected together by transmission lines, just as the steam railroads have been interconnected. Improved methods of protecting these networks from lightning, high frequency, short circuits, etc., will be developed.

Our knowledge of properties of insulating materials is as yet imperfect. Investigation and discoveries will probably produce considerable improvement in the insulation of conductors and thus allow the use of higher temperatures and higher voltages tending towards reduced losses and economy of investment in the distribution system.

Substations

There has been a steady reduction in the weight, size and cost of electrical apparatus for substation use, enabling the central stations to make considerable increases in the kilowatts per square foot or floor space. These changes have been brought about by improvements in design, economizing in material and the use of increased speeds. It seems likely that some progress will still be made along these lines but there is not very much room for improvement unless new types of apparatus are developed. Such new types as various kinds of rectifiers are being studied and may prove useful in the future.

The automatic operation or the remote control of substations has proved successful in initial installations, both in lighting and railway work. The constant demand for economy in operation is likely to extend to the use of this class of substation.

Lighting

Vast improvements have been made in the past few years in incandescent and arc lamps. The former are now approaching limits fixed by the temperature of melting point of tungsten and other of the most refractory metals. There is no limit, however, to the temperature of incandescent gases, hence the arc lamp offers a field for improvement limited only by the present methods.

A still greater field for improvement is a possibility of the production of light without heat. At present in all of our lighting most of the energy applied to the lamp goes into heat, only a small amount is turned into light. For instance, in the half-watt gas filled Mazda lamp, which works at about 0.62 watts per spherical candle-power, the luminous efficiency is about 3.3 per cent, that is to say, only 3.3 per cent of the energy applied to the lamp is put into the production of light, the remaining 96.7 per cent being dissipated as heat. The most efficient arc lamp has about 5 per cent luminous efficiency. Thus we see that in spite of the great progress that has been made, there is still a vast field for improvement in the transformation of electricity into light, and so offering a field for improvement greater than any of the other steps in the generation and distribution of electricity and its conversion into light.

In conclusion, I quote an interesting article that appeared in the *Brush Electric Light Paper* of March, 1882, which not only

represents the spirit of the times then but now with regard to the possibilities of electric service.

"The progress of electric illumination seems to be on the advance all over the world. In London two miles of streets are now lighted by the Brush and Siemens systems. In New York the Brush Electric Illuminating Company has just received the contract to light Union and Madison squares, Broadway and Fifth avenue, from Fourteenth to Thirty-Fourth streets and Fourteenth and Thirty-fourth streets, between Broadway and Fifth avenue. A new style of street lamps will be used, more like the common street gas lamp. It will be larger and covered with ground glass setting fifteen feet above the ground, instead of twenty-five feet, as now. But the most important change will be the manner of lighting Madison and Union squares. This will be done on the same plan as is now in successful operation at Akron, Ohio. Columns will be erected in the center of the squares; on the top of each of these columns will be suspended six electric lights of 6000 candle-power each, or 36,000 candle-power in all, eighteen times more powerful than the regular Brush light, such as is now being used in Scollay Square. This experiment will be watched with great interest here in Boston, for few cities have so fine large parks situated in the heart of a city as the Common and Public Garden, and it is only a question of time when these places will be lighted by electricity.

"The opposition to electric lighting is very strong, and some parties even object to have the wires carried over their roofs, fearing they will be set on fire or exploded. The Brush Electric Lighting Company of Boston, to be on the safe side, use nothing but insulated wires, so that if they touch

any other wire no trouble will come from it. The contract for the New York street lighting was as low as gas; and this fact has astonished the gas companies very much, as they have always claimed it cost double; and several of the companies, as well as the newspapers, claim that it cannot be done at a profit, and the low price was given as an advertisement. This would be foolish, when the New York Brush Company have all they can do to supply the demand for lights. They have six stations now fitted up and will add more as soon as they can get machines from Cleveland. They have had a good chance to thoroughly test what it costs to generate the power which runs the electric machines; and in one point in particular the Brush Company have shown more judgment than some of the other electric companies. They use the cheaper grades of fuel, and have adopted the most approved methods of burning it; so that from a ton of coal screenings they get as much power as others get from a ton of the highest cost fuel. This gives from 25 to 50 cent economy. In this country, the principal companies before the public are the Brush, Edison and Maxim. The Brush is on the voltaic arc system, and the other two on the incandescent. The latter will be used for indoor lighting. They claim to furnish lights as cheap as gas; but this is a subject that will be required to be proved, as they also admit that they furnish seven lights to a horse power; or, allowing that each incandescent light is the same as gas, 16 candles, this will furnish 112 candle lights to each horse power. It costs less than a horse power to furnish a single Brush light of 2000 candle-power, and a dynamo machine of 40 lights takes only 33 horse power to run it. On this basis neither the Brush Company nor the gas companies have anything to fear from Edison or Maxim."

A REVIEW OF ELECTRIC RAILWAYS

BY W. B. POTTER AND G. H. HILL

CHIEF ENGINEER AND ASSISTANT ENGINEER, RAILWAY AND TRACTION DEPARTMENT,
GENERAL ELECTRIC COMPANY

The authors in making a rapid review of electric railways show the growth of the industry by a series of curves which are self-explanatory and which show a rate of progress and a continuation of progress that is quite astonishing. They tell many interesting and instructive facts from their own experience and give some valuable information on the early development of electric railway apparatus.—EDITOR.

It has become axiomatic that improved means of transportation creates traffic possibilities which may have been wholly unfelt and unappreciated. From the very beginning of rail transportation, this feature has been much in evidence and the possibilities for the creation of traffic have continuously exceeded the most optimistic predictions.

Following the initial success of the steam locomotive, the establishment and extension of railroad facilities throughout the country seem to have become the chief interest in the national industrial life. Although we

After the extensive exploitation of steam railroads there was plenty of enthusiasm as to the possibilities of electric propulsion for city cars, but the possibilities of electric motor cars were not appreciated and even the most optimistic failed to realize how rapid would be the growth of electric railways or how soon they would rank with the steam railroad as a necessity to the traveling public. In 1890 there was scarcely more than 1000 miles of electric railways in the United States. From this time up to the present

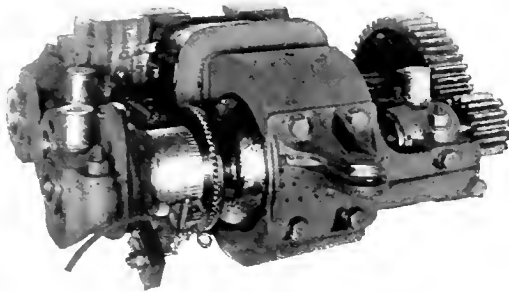


Fig. 1. Type F-30 Railway Motor Built in 1889

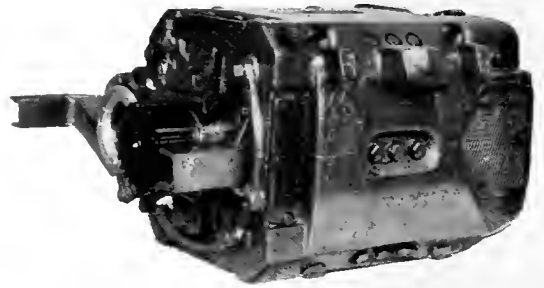


Fig. 2. GE-248 Railway Motor Built for New York Municipal Railway Corporation—1914. Hourly rating 160 h.p. Provided with multiple fan ventilation

may not today appreciate the inconvenience and tediousness of travel by stage and horses, there is little to wonder at the popular interest in this railroad development and the extent to which the resources of individuals, municipalities and even the Federal Government were all devoted to the subject of railroad extension.

The inception of electric railway transportation had for its object a more economical and practical means of street railway transportation in large cities, where horse cars had become insufficient and cable railways and steam elevated trains were unable to successfully meet the requirements.

the mileage of electric railways has steadily increased at the rate of about 2000 miles per year.

The mileage of steam railroads has increased at the rate of about 6000 miles each year for a number of years past, and during this period there have been many consolidations of the original smaller companies into large trunk line systems which may range from 5000 to 12,000 miles of track. A similar consolidation of what were originally independent railways has taken place among many of the electric railway lines, some of these consolidations now having a mileage of over 1000 miles of track.

During the first few years of electric railway development the progress was slow but convincing, despite the novelty of the equipment and some skepticism as to the reliability of electrical apparatus as then constructed. It was obvious from the first that the electric motor car fulfilled the requirements of short haul traffic better than any existing method. Increase in the mileage equipped and improvements in the apparatus both contributed to inspire confidence, and commencing with the Sprague Road at Richmond in 1888, the real development began in 1889 with the general adoption of electric service by the West End Railway,

American enterprise. Certain factors in the then existing lines of transportation, particularly the headway between trains in steam service, was not favorable to the development of interurban travel such as has resulted from the more easily accessible and more frequent headway provided by the interurban motor car.

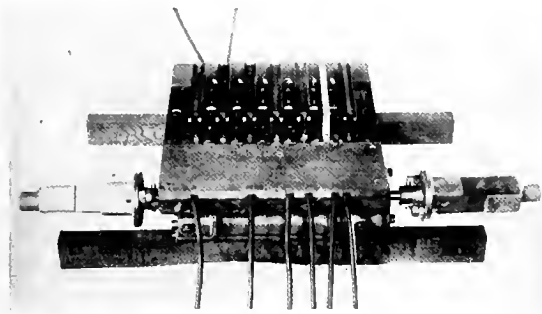


Fig. 3. Original Type of Series Parallel Controller, Form J, built in 1892 for installation beneath the car platform

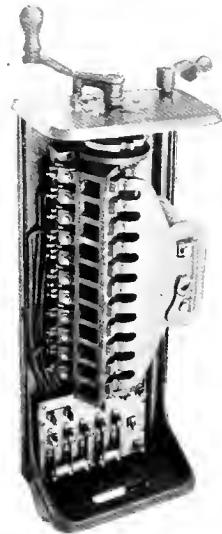


Fig. 4. Type E, Original Series Parallel Platform Controller—1892

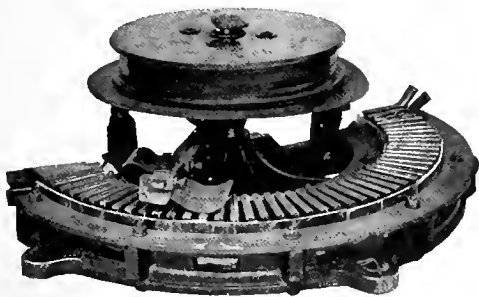


Fig. 5. Type 51 Rheostat for Resistance Control—1888

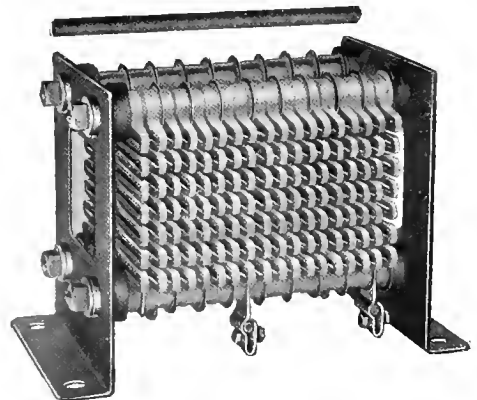


Fig. 6. Type RG Cast Grid Rheostat—1913

Boston. The interurban lines followed as a natural course, earlier instances being merely the joining of outlying extensions from the more populous centers. The real interurban development began in the early '90's and was particularly, for a number of years, an

The first application of electric power to heavy service and the first successful substitution of the electric locomotive for the steam locomotive was in the Baltimore and Ohio tunnel, Baltimore, 1895. Some doubt was expressed at that time, by those more familiar

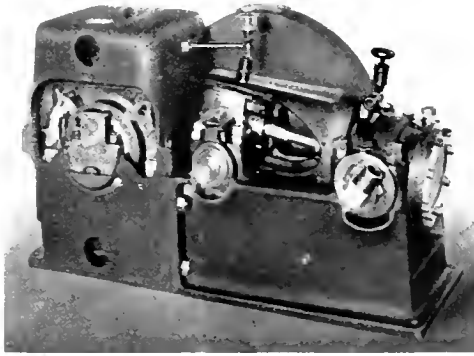


Fig. 7. Early Type of Motor-driven Air Compressor—1893

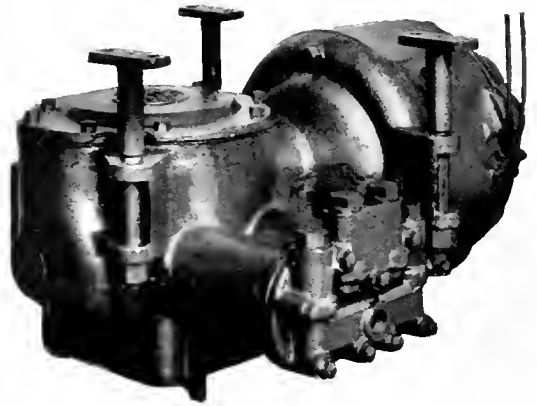


Fig. 8. Latest Type of Motor-driven Air Compressor—1913

with the steam locomotive, as to the ability of an electric locomotive to start a heavy train. Such evidence as slipping the drivers even with sufficient weight on driving wheels as would ensure handling the train with a steam locomotive was not regarded as conclusive. This point, so far as the Baltimore and Ohio was concerned, was settled to the satisfaction of their engineers in the early period of operation. One of their officials who was doubtful of this point desired a

demonstration, and during acceleration of a heavy train he mistook careful handling on the part of the engineer as being necessary to the protection of the locomotive. He instructed the engineer to "open up," which the engineer did after brief remonstrance, knowing what was likely to happen, and so effectually as to pull the end out of a box car loaded with oats in bulk. Needless to say, there was no further question as to whether the locomotive could pull. In this connection,

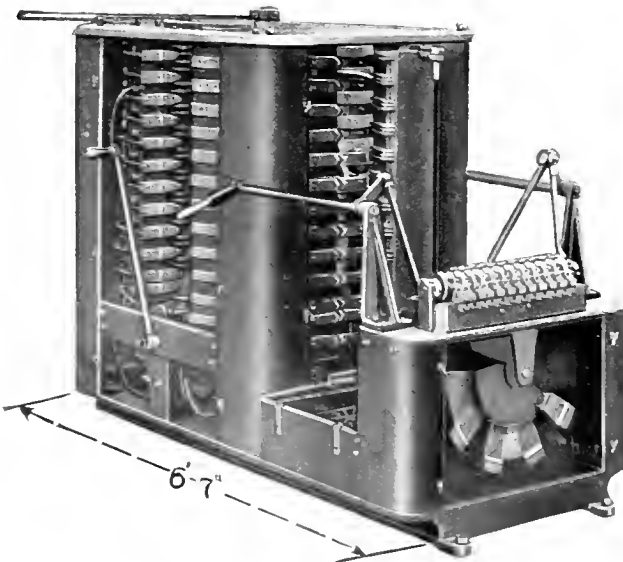


Fig. 9. Cylinder Type Controller built for early B & O locomotives—1896

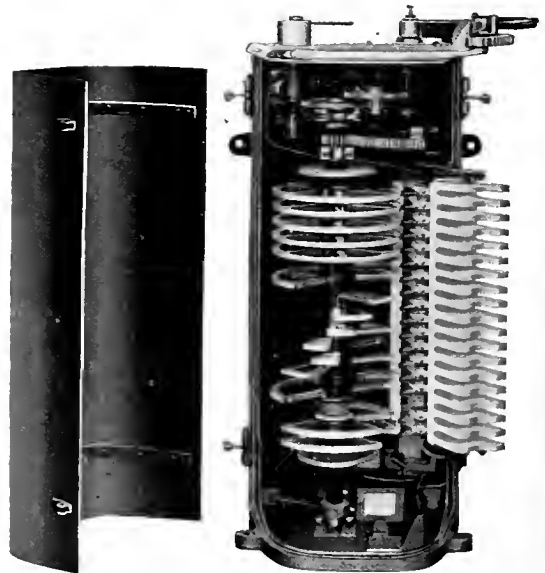


Fig. 10. Master Controller for Butte, Anaconda & Pacific Locomotive—1913

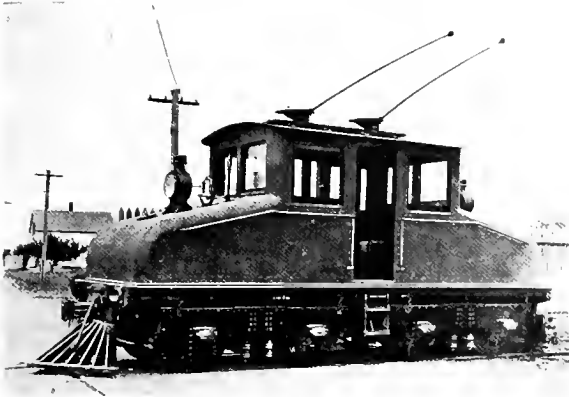


Fig. 11. 40-Ton Electric Locomotive Built in 1894 for Cayadutta Electric Railroad, now a part of the Fonda, Johnstown & Gloversville R.R.

a well known American artist, who had looked over one of the New York Central locomotives, remarked that it was all very impressive, but that he would like to be shown where the electric power was hitched to the driving wheels. Being shown the air gap between the armature and the motor field and told that the hitch was across that

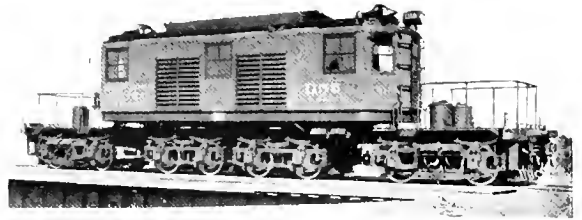


Fig. 12. Latest Type N.Y.C. Passenger Locomotive—1914
Total weight 133 tons—eight bipolar gearless motors with a total of 2640 h.p.

space and as invisible as the air, he pondered a few moments, and then expressed the opinion that it was "hypnotism."

While not at first appreciated it was early realized that the electric car required more than the nominal two horse power of the ordinary horse car. More rapid acceleration, faster schedules and heavier cars soon demonstrated that nothing less than two 10-h.p. motors would answer, and for the earlier successful railways two 15-h.p. motors came to be the accepted standard. Increase in the requirements led to the use, in about 1895, of two 25-h.p. motors. This was

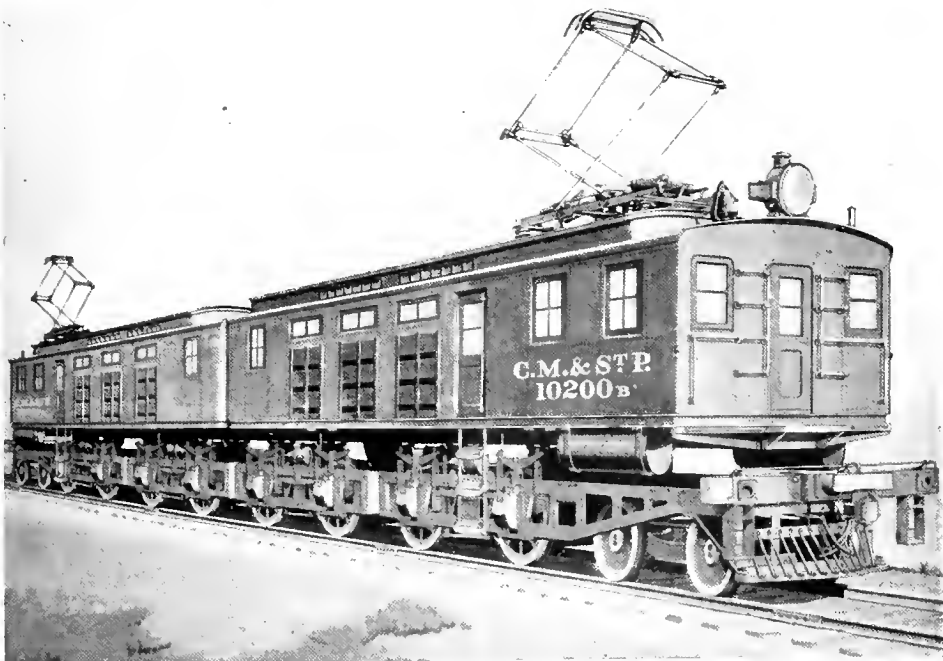


Fig. 13. Chicago, Milwaukee & St. Paul Electric Locomotive, 21 of which are now under construction. Locomotive is equipped with eight motors, totaling 3440 h.p.
Total weight 260 tons



Fig. 14. Early Panel Switchboard—1892

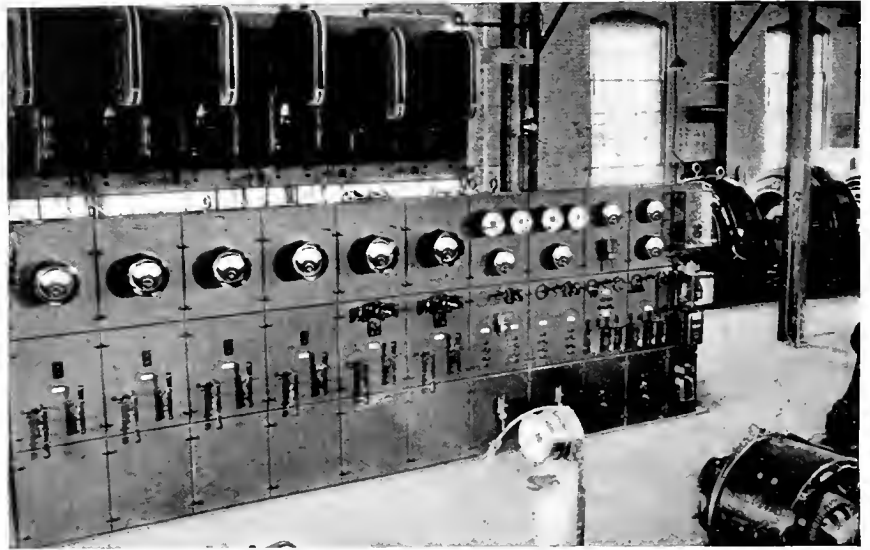


Fig. 15. Butte, Anaconda & Pacific Switchboard—1913

followed by four motor equipments of the same h.p., while today four 40-h.p. motor equipments are in very general use.

After a brief and somewhat trying period, during which motors were placed in every conceivable position, and with belt, rope, chain and bevel gear drive tried and discarded, the mounting of motors directly on the axle with spur gear drive soon became

the established arrangement. Of all electrical apparatus more is required of a railway motor under severe limitations than in any other service. For railway work the motor is limited in width by the gauge, in height by the clearances below and above, and in length by the wheel base.

The first railway motor to be widely used was the Thomson-Houston F-30 rated at

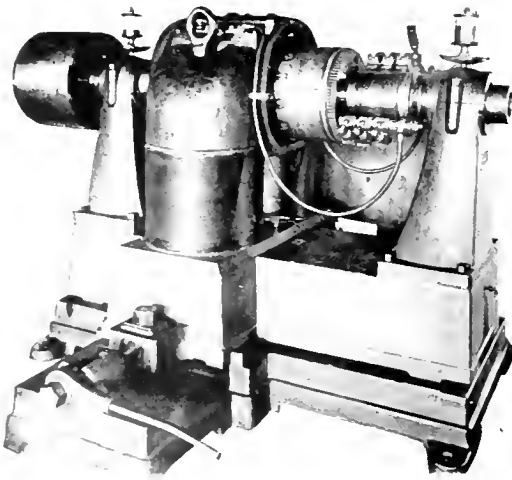


Fig. 16. No. 25 Railway Generator afterward designated D-62, Rating 62 kw.—1888

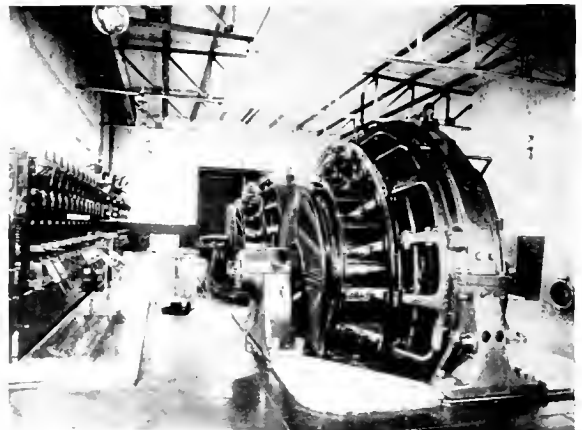


Fig. 17. 4000-kw. Synchronous Converters installed for the Chicago Surface Lines—1914. Campbell Ave. and Homer Street substation

15 h.p. The control consisted of a single reversing switch for both motors, a rheostatic control, the resistance being semi-circular in form with an arm driven by a wire cable from a handle on the platform, moving over contacts interspersed between the resistance plates. One of the earlier improvements was to substitute a double reversing switch to better equalize the work between the motors. The double reversing switch introduced the new feature that if thrown to reverse when the car was moving, one of the motors reacting on the other as a series generator would stop the car without current from the

difficulty experienced in effecting the motor combinations the rheostatic control was continued until 1892. In the meantime there were many unsuccessful attempts to build a series parallel controller. Success finally followed the realization that a series motor would demagnetize its own field when short circuited on itself. The "J" controller was the first in which this electrical connection was used and was the first series parallel controller to be used in regular service. This particular controller was designed for installation beneath the car body and was driven from a handle on the platform by means of

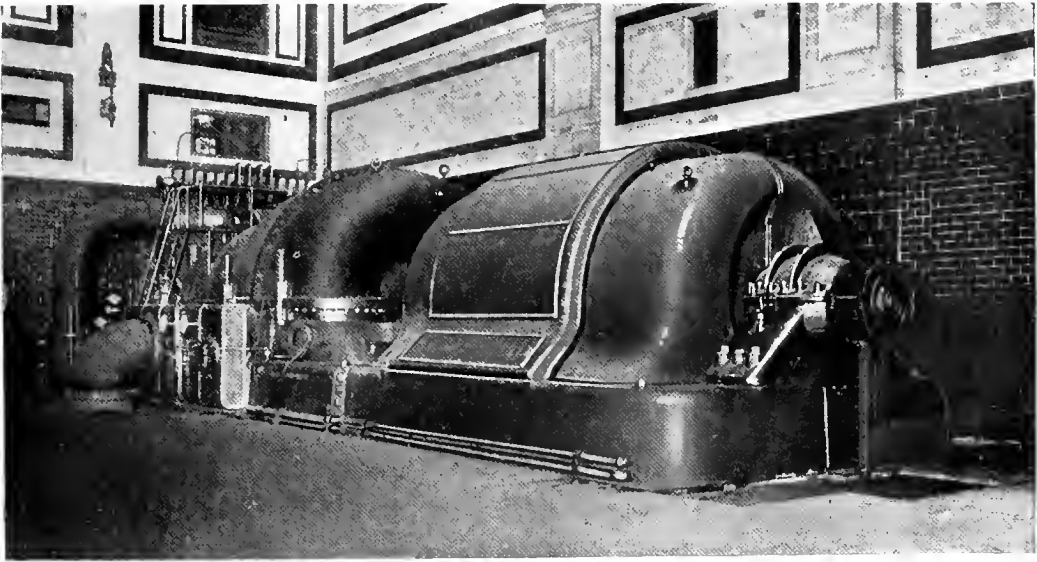


Fig. 18. 30,000-kw. Turbo-generator, New York Edison Company—1915

trolley. This led one superintendent to protest against the use of the double switch, for as he reasoned, if in the reverse position it would stop the car without current from the trolley, if thrown to the forward direction, it must certainly drive the car, and he considered it unsafe to operate an equipment that, despite the brakes, would run by itself with no connection to the power house. Upon investigation the cause of his apprehension in this particular case proved to be the existence of an air gap between the wheels and brake shoes due to defective brake mechanism.

The advantages of series parallel control of the motors, as saving 20 to 30 per cent in energy and permitting efficient running at half speed were realized, but because of the

shafting, bevel gears and gimble joints. This method of drive was a study in "lost motion" as those who had experience with it will remember.

It was soon obvious that the operating handle should be directly attached to the controller shaft and preferable that the controller should be on the platform as had been the practice with a number of rheostatic controllers.

Following the "J" controllers were first the "E" and then the "K" controllers. The latter, designed in 1893, has with little change since that date been the almost universal series parallel controller as used on the platform.

There is probably no feature of an electric railway equipment on which so many

improvements have been suggested as the device for collecting current, nor any feature on which so many of the suggestions have proven unsuccessful. The simple trolley pole and wheel, both because of its simplicity and its capacity for collecting current far

seem today an absurd device. Such a collector was not without its unexpected danger, as an instance of which, at the top of a long grade, one of these collectors breaking away from the car ran to the foot of the hill on the wires, and jumping off at a curve, landed on a passing team. On this same railway these collectors were afterwards replaced with trolley poles of oak, 4 in. by 4 in. at the butt. Needless to add, these trolley poles stayed with the car and incidentally collected at times a considerable proportion of the overhead construction.

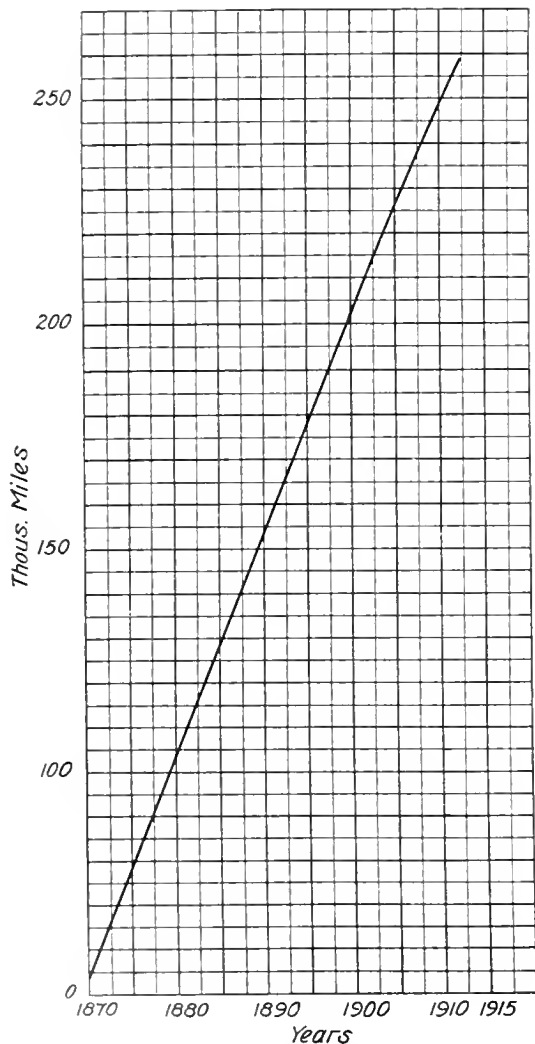


Fig. 19. Growth of Steam Railroads in United States. Total operated mileage single-track basis—1870 to 1912

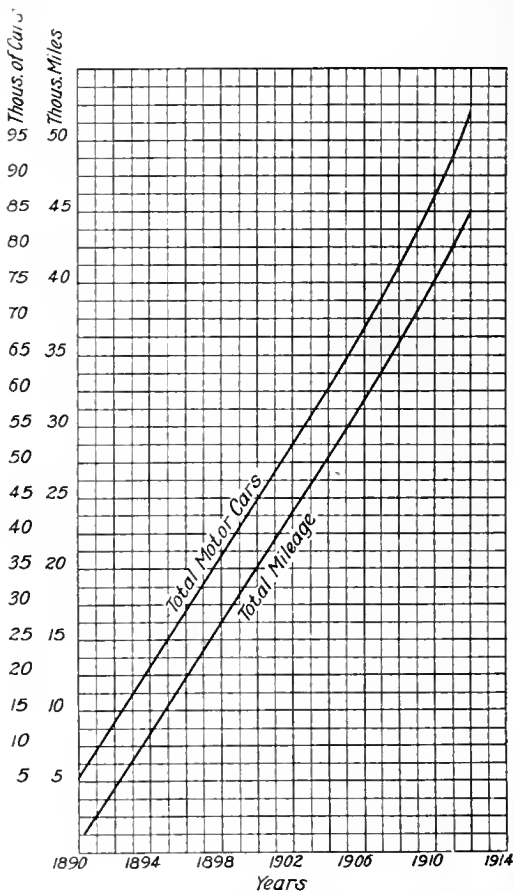


Fig. 20. Growth of Electric Railways in United States. Total single-track mileage and total motor cars—1890 to 1912

beyond what was originally anticipated, bids fair to remain the standard device.

Collecting current by means of a 50-lb. four-wheel carriage running on top of a double trolley wire and towed by the car through a flexible conducting cable, would

For collecting current exceeding the capacity of the trolley wheel the third rail was a natural recourse, although in the Baltimore and Ohio tunnel installation the original conductor was a catenary construction carrying two "Z" bars, within which

the collecting shoe slid, being driven by a tongue projecting through a slot between the bars. It was a sort of suspended third rail, but in service, owing to the drip in the tunnel the inner contact surface became covered with a semi-insulating deposit. The result was an arcing at the contact surface which proved extraordinarily destructive to the collecting shoe. During early trials of the locomotives, before means were provided for keeping the surface reasonably clean, it was not unusual for 10 to 15 pounds of metal to be melted off the shoe during a single trip through the tunnel.

with overhead construction rather than third rail.

One of the early railway generators, which was very generally used, was known as the D-62, the frame resembling the letter D in outline, 62 being the kw. rating. Until within recent years a large number of these machines have remained in regular service in an annex to what was the Central Power Station, West End Railway, Boston.

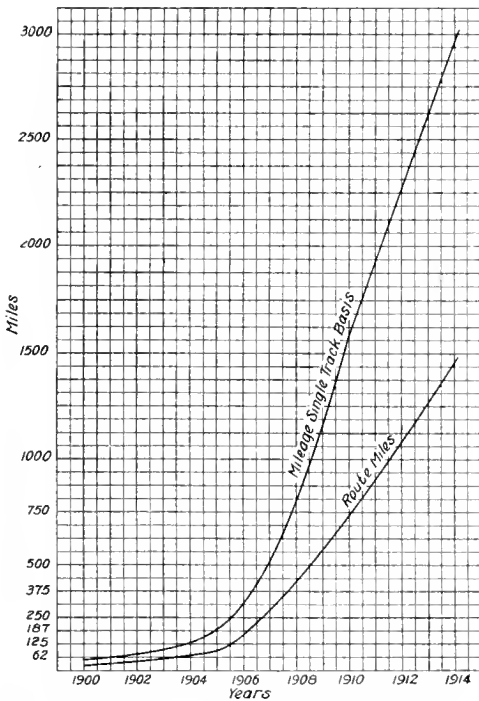


Fig. 21. Growth of Steam Railroad Electrification. Total route miles and total electrified mileage single-track basis—1900 to 1915

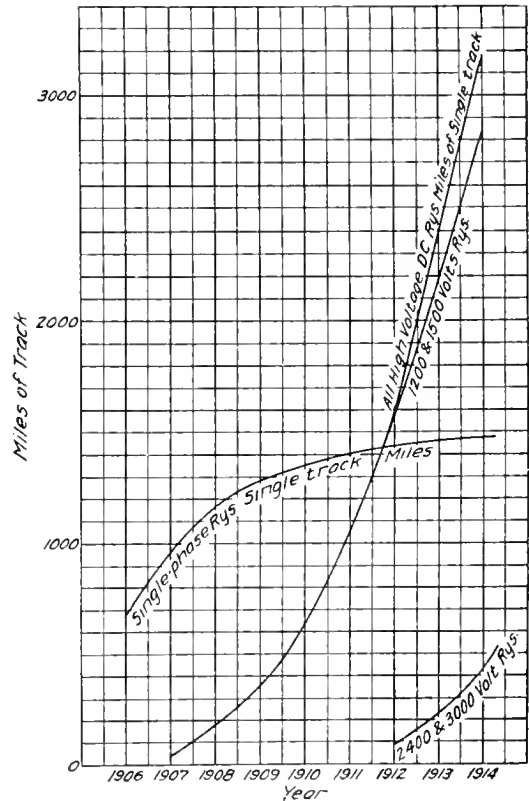


Fig. 22. Growth of High-voltage Direct-current and Single-phase Railways. Total mileage single-track basis—1906 to 1915

Within possible requirements there is practically no limit to the current that can be collected from a third rail, 5000 to 6000 amperes not being unusual in service like the New York Central. With higher d-c. voltages requiring less current there is less necessity for use of a third rail, as with a pantograph collector from 2000 to 3000 amperes can be collected without difficulty from an overhead catenary, and it seems probable that much of the heavy railway development will be

A very different machine, though honors are even, is the modern rotary converter of 4000 kw. which is typical of the substation apparatus through which so many of the present railways obtain their power.

The earlier generators were belt-driven and at the time of proposing generators direct connected to the engine, which was about 1892, there was considerable discussion as to whether this combination would prove reliable under short circuits and the varying require-

ments of railway service. In view of the earlier experience of flying belts and the later experience with direct connection, it seems strange there should ever have been any question. The modern steam turbine of many thousand kilowatts is an advance hardly dreamed of in the earlier days of small reciprocating engines, small turbines and abortive attempts to build rotary engines.

In some of the early work on switchboards, for what were then large power stations, plans were made to use compressed air to extinguish the arc in the automatic circuit breaker, as

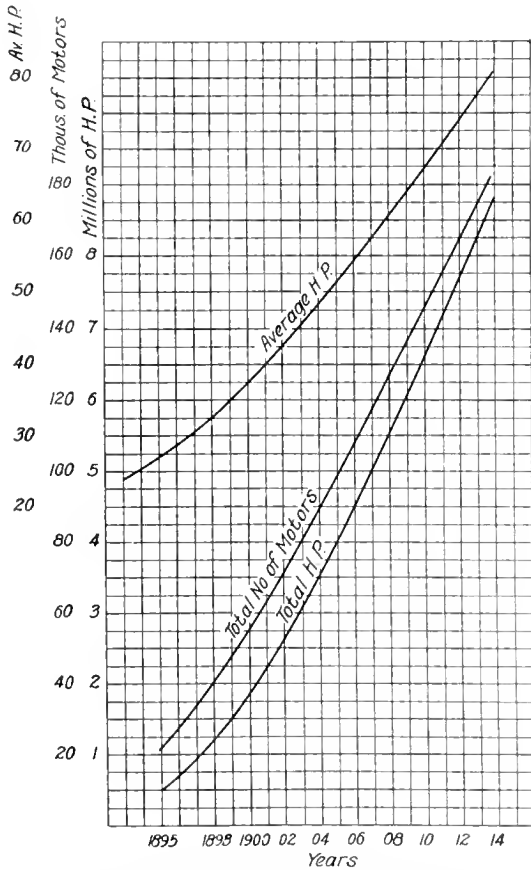


Fig. 23. Growth of G-E Railway Motor Sales. Total orders averaged for five-year periods. Total motors, total horse power and average horse power—1893 to 1915

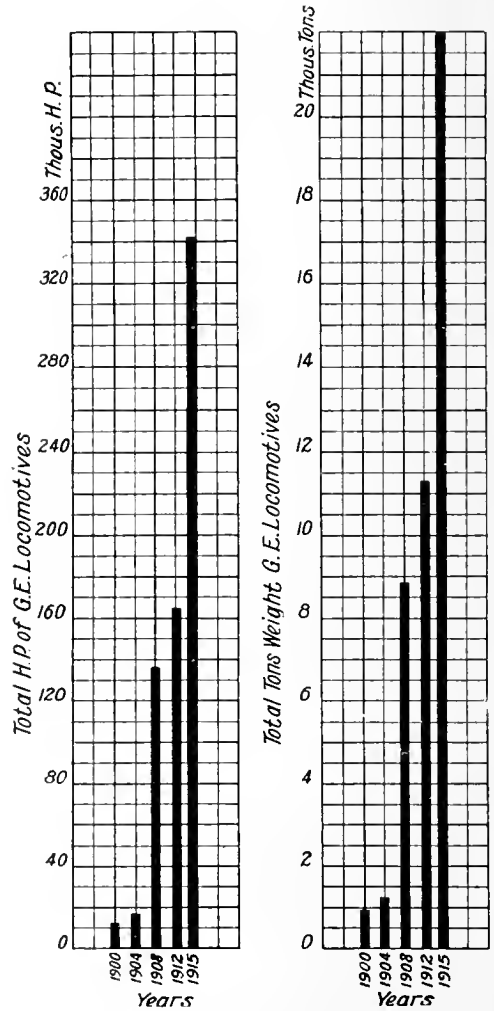


Fig. 24. Growth of G-E Electric Locomotive Sales. Total tons on driving axes and total h.p. hourly rating—1900 to 1915

The earlier station switchboards were built up on a wooden framework, not unlike a high board fence, to which the instruments were fastened, the main circuit connections being usually a No. 0 bare copper wire.

Panel switchboards of slate or marble were first used in 1892 and resulted in established standards which have changed but little except in the instrument and detail of connections.

there was some doubt whether the magnetic blowout would prove effective in handling several thousand kilowatts. A few tests soon demonstrated that the magnetic blowout was all sufficient.

The steam locomotives as a motive power for railway purposes consist essentially of a boiler and engine; and, while this combination permits many variations in arrangement, a general design was early established from

which there has been little departure in the essential features of the mechanical design.

The general arrangement of the motor car equipment naturally served as a model for the earlier electric locomotives, and with some modifications in design of the cab, the mounting of the motor directly on the driving axle and the use of swivel trucks, bids fair to continue as the preferred design of electric locomotives where conditions are favorable.

Many methods of drive with side rods and combinations of gearing and side rods have been tried, and while some of them have the merit of allowing greater latitude in design of the electrical equipment, it seems probable that but few of these methods will survive.

For very high speed service in which the armature speed would be same as the driving wheel, the gearless motor is well adapted, and as arranged on the New York Central locomotives offers the further advantage of a very simple mechanical design. Multiple unit operation, of which the Interboro in New York is the most prominent example, has extended the use of motor cars into a field that could otherwise be handled only by very large electric locomotives.

Whatever the earlier development of electric railways may have lacked in magnitude

they more than made up for in the experience gained.

It is impossible to cover a review of electric railways in so short a space as is available, so the writers have touched on some few of the interesting features as met with in their own experience, and for much of our modern development work would refer the reader to the November, 1913, and November 1914, issues of the REVIEW.

A very considerable part of the real development of electric railways is told in the curves which accompany this article. The growth of both steam and electric railways will astonish many as it is hard to believe that such a constant progress is possible in so vast an industry. That these curves should resolve themselves into straight lines is no less gratifying than it is surprising. The growth of steam railroad electrification is no less satisfactory and emphasizes the fact that this most important part of the industry is showing more vitality than is generally supposed. The curves depicting the relative growth of high tension direct current and single-phase railways speak a whole chapter of the history of electric railroad development more eloquently than could be done in many pages of text.

ELECTRIC TRANSMISSION OF POWER

BY R. E. ARGERSINGER

POWER AND MINING ENGINEERING DEPARTMENT, GENERAL ELECTRIC COMPANY

The author traces the early history of the electric transmission of power by citing some of the most notable early installations and mentioning their most interesting features. Many of the early troubles that had to be overcome are recorded; and the reader will be able to trace the development of much of our modern apparatus and appliances to the work done in overcoming these difficulties and in meeting the constantly increasing voltage of transmission.—EDITOR.

The development of electric power transmission, as distinguished from power distribution, has occurred chiefly within the last 25 years. There were, previous to 1890, a number of direct-current systems, used largely for railway or lighting service within the limits of the municipalities which they served and in many cases these systems carried power for some considerable distance. Direct current, however, has only been considered seriously as a means of power transmission in connection with the so-called "Thury" or series system, which has reached its highest development in Europe, and which was used for the oldest commercial electric transmission scheme. The first installation of this character was that at Genoa, installed in 1889, transmitting approximately 1300 h.p. for a total distance of about 75 miles at 14,000 volts. This type of system has never been used in this country, and even in Europe has not attained very great popularity as something less than 20 installations have been put in since the original one in 1889, although it has been considered many times in competition with alternating-current systems. This is due principally to the complications introduced by the necessity of running a number of direct-current machines in series to obtain the required line voltage and the difficulty and expense of designing high-voltage direct-current apparatus. Further, the system does not afford a convenient means for tapping off small amounts of power at different points. The highest voltage so far used with the Thury system is 57,600, with a total transmission distance of 224 miles. It has been given considerable study from time to time by American engineers, since the absence of inductive effects in the line proper, when using direct current, make it peculiarly attractive for high-voltage, long-distance work. Comparisons, however, have usually failed to show sufficient advantage to warrant the complications in station apparatus necessary for its use.

The real development, therefore, of electric power transmission has been made with the alternating-current system. It is interesting to note that the first dynamo machine built was an a-c. machine, but due to the difficulties experienced with regulation of the lamps using a-c. solenoids, direct-current apparatus was more generally used, and it was not until the late eighties that single-phase alternating-current machines began to be produced for commercial service. The advantages of this type of apparatus were quickly realized, especially the ease with which high voltages could be obtained for transmission purposes, thus making possible the development of water powers remote from markets for driving alternating-current generators.

In 1890 the Willamette Falls Electric Company installed two 300-h.p. Victor wheels belted to 4000-volt, single-phase generators, and transmitted power 13 miles to Portland, Oregon, for lighting purposes. This was the first real power transmission in this country, and so far as the writer knows, the first alternating-current transmission in the world. Its successful completion and operation was followed quickly by the installation of a second system by the Telluride Power Company in 1891, transmitting at 3000 volts about three miles and operating a 100-h.p. synchronous motor. The importance of this new instrument for economic progress was called to the attention of the engineering world by the famous transmission installed in connection with the Frankfort Exhibition in 1891, when power was carried a distance of approximately 100 miles at 30,000 volts. This was the first three-phase transmission and its advantages were quickly realized. In 1892, however, another single-phase transmission plant was installed in California and delivered power to Pomona, approximately 13 miles distant and about 29 miles to San Bernardino. The voltage at the beginning of operation was 5000, which was higher than

any previously used commercially, but on February 16, 1893, this was raised to 10,000 volts, and on May 2, 1893, by connecting their transmission lines all in series, 120 kilowatts was carried 42 miles with a transmission efficiency of 60 per cent, at that time a great achievement and an indication of the possibilities of electric transmission of power.

These early single-phase plants had considerable difficulty in starting the synchronous motors which were used at the receiving end. This was done in some cases by using four transmission wires, over two of which direct current would be passed from the exciter in the generating station to the exciter in the receiving station, bringing the latter up to speed as a motor and consequently speeding up the main synchronous motor to which it was belted. When the latter was up to speed it would be thrown on the main a-c. lines, its exciter cut off from the other two lines and connected to the synchronous motor field while the two sets of transmission wires were then put in parallel, carrying the alternating-current supply.

The Willamette installation was the first a-c. transmission supplying power for lighting—that at Telluride was the first supplying

the high operation costs incident to the generation of power from high priced coal. Transformer design was still in its infancy as shown by the fact that the Willamette

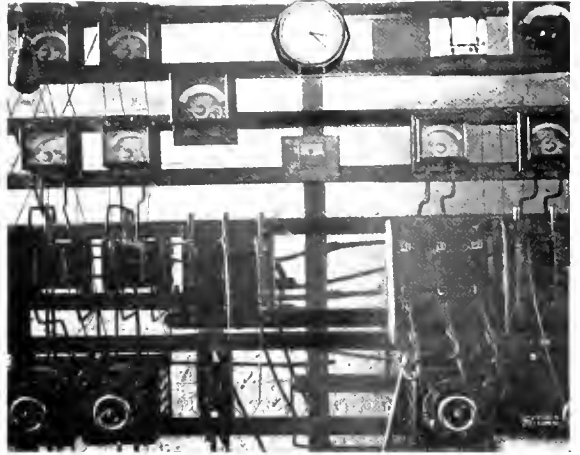


Fig. 2. Switchboard in the Redlands, California, Power Station

Company used 10 transformers in series to step down from 4000 to 1100 volts and the Pomona transmission at 10,000 volts was made possible by connecting 20 units in series.

The advantages of polyphase transmission were so apparent that a three-phase plant was put into operation in 1893 at Redlands, California, carrying 250 kw. $7\frac{1}{2}$ miles at 2500 volts, and this was quickly followed by three other plants, one at Taftsville, Conn., one at Hartford, Conn. and one at Concord, N. H., built for three-phase operation, and an additional plant at Pittsfield, Mass., designed for two-phase operation. All five of these polyphase plants were in operation in January, 1894. The Taftsville plant, although used partially for industrial power, also delivered power to a street railway system from an a-c. transmission, for the first time.

Even at the low voltages used with these transmissions, much trouble was experienced in connection with the insulation of the line, due to the fact that insulator design had been given no study and sufficient experience had not been accumulated to show the characteristics of a suitable insulator for transmission purposes. An occurrence on the transmission line from the Taftsville plant illustrates some of the operating difficulties at that time. Due to a combination of circumstances, trouble occurred at one particular point in

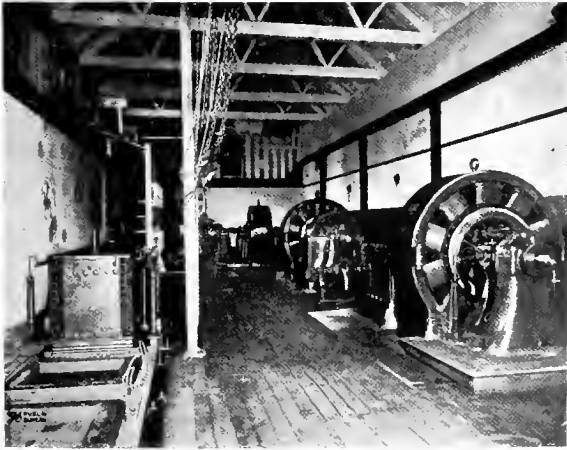


Fig. 1. Power Station at Redlands, California, put in Operation in 1893. This was the initial three-phase transmission system in this country

industrial power. It is worthy of note that the Telluride installation made possible the profitable operation of mines which otherwise must have been shut down, as they were at that time on the verge of bankruptcy due to

the line where arcs continually broke over the supporting insulators. This line supplied power to the street railway and to a cotton mill containing 1700 looms. As the service was very important a man was stationed on a pile of earth close to the arcing insulators and by throwing lumps of dirt at the insulator when it flashed over and thus destroying the arc, the service was maintained on the line for an entire afternoon. This might be cited as the first use of an arc extinguisher.

Troubles due to weather conditions, lightning discharges, etc., made it evident that some protective features were desirable in

however, considerable discussion in regard to the relative advantages of synchronous and induction motors, but the latter finally established its position. In this connection it is interesting to note that Dr. Duncan in 1896 pointed out the great advantage of the synchronous motor in correcting power-factor, and also called attention to the possibilities of its use purely as a synchronous condenser—a feature which has since made possible the voltage regulation of long lines.

The rapid growth of transmission systems after 1894 showed the need of an experimental



Fig. 3. 9000 Kv-a. Generators, Mississippi River Power Company, Keokuk, Iowa

connection with the transmission lines, and in 1893 Mr. A. J. Wurts introduced the non-arcing metal gap arrester. Mr. Wurts also showed by previous experiments in 1892 the protective value of the ground wire paralleling the transmission line.

The difficulties with single-phase motors concentrated the attention of investigators on the development of a three-phase machine and resulted, about this time, in the introduction of the well known induction motor. Its wide range of application, its ability to stand hard service and its ease of handling, were so quickly recognized that a tremendous impetus was given to the development of power for industrial purposes. There was,

determination of many questions of insulation and operation, and in 1895-6 the Telluride Power Company conducted a long series of investigations, using transmission voltages up to 50,000, which resulted in a considerable addition to the accumulated data regarding alternating-current transmission. It is interesting to note that in the comparative tests made at that time with glass and porcelain insulators, the results showed glass to be preferable, although slightly more expensive. In commercial use, however, the glass insulators of that period gave a great deal of trouble owing to unequal expansion when exposed to the sun's rays. It is possible that these difficulties may have been due to

improper annealing, or to improper composition in material used.

Since the first three-phase transmission in 1893, it has been recognized that this system is most suitable for the purpose and the development since that time has been along the line of constantly increasing voltage. The table given herewith shows from the best data in the writer's possession the steps of the increase of transmission voltages as they have occurred. As far as the writer has been able to find, no previous attempt has been made to tabulate these voltages in this form and criticism of any possible inaccuracies would be gladly welcomed.

The rise in voltage was rapid and the increased spacing necessary to obtain sufficient clearances made the construction of wooden pole lines more and more difficult. The Guanajuato Power Company in 1903 put into service the first transmission line carried on steel towers and their success in using such supporting structures led other companies to quickly follow their example. Incidentally, it might be noted that this Guanajuato line was at first built without a ground wire, but after carefully observing the results of operation under this condition a ground wire was added and it was found that the number of disturbances was very materially decreased. The protective value of a ground wire has always been the subject of discussion. Opinion today seems to favor the use of at least one such wire and some companies use two or even three grounded wires strung at the top of the towers and

grounded to each. In some cases interruptions have been caused by mechanical interference between ground and power wires owing to improper spacing or relative sags, but careful line construction should, in general, prevent such difficulties.

As transmission voltages became greater the difficulties with protective equipment also became more and more complicated. The multigap arresters, in common use, gave a great deal of trouble and although expensive were easily destroyed. This condition caused the development of the aluminum cell arrester, which was brought out in 1906 and has since practically superseded for general purposes all other types. Some criticism of this arrester was made to the effect that dangerous surges were caused by the charging arcs. The introduction of charging resistances and short circuiting strips for horn gaps has eliminated any such dangers as may have been incident to its use. Practically no multigap arresters have been used above 60,000 volts, and in fact, 60,000 volts has come to be recognized as a sort of turning point in line construction. This line voltage represents about the limit of use of pin insulators and a study of the possibilities brought out the suspension insulator in 1906-7. The use of an insulator of this type removed many of the mechanical limitations of construction of transmission lines and its influence was quickly seen in the upward swing of transmission voltage. In 1908 the AuSable Electric Company operated one of their transmission lines at 110,000 volts and

In Operation	No. Phases	Line Voltage	Line Length Miles	Company
1890	1	4,000	13	Willamette Falls Elec. Co., Portland, Ore.
1891	1	3,000	3	Telluride Pwr. Co., Ames, Colo.
1891	3	30,000	100	Lauffen to Frankfort, Germany (Experimental)
1892	1	5,000	28	San Antonio Lt. & Pwr. Co., Pomona, Cal.
1893	1	10,000	28	San Antonio Lt. & Pwr. Co., Pomona, Cal.
1893	3	2,500	7 $\frac{1}{2}$	Redlands Elec. Lt. & Pwr. Co., Redlands, Cal.
1894	3	11,500	22	Sacramento Elec., Gas & Rwy. Co., Sacramento, Cal.
1895	3	19,000	35	San Joaquin Elec. Lt. & Pwr. Co., Cal.
1896	3	25,000	40	Pioneer Elec. Pwr. Co., Utah
1897	3	40,000	55	Telluride Pwr. Co., Provo, Utah
1901	3	57,000	65	Missouri River Pwr. Co., Butte, Mont.
1903	3	60,000	104	Guanajuato Pwr. & Elec. Co., Mexico
1906	3	72,000	66	AuSable Elec. Co., Grand Rapids, Mich.
1907	3	75,000	117	So. Calif. Edison Co., Los Angeles, Cal.
* 1908	3	110,000	35	AuSable Elec. Co., Grand Rapids, Mich.
1909	3	100,000	152	Colorado Pwr. Co., Denver, Colo.
1910	3	110,000	135	Hydro-Elec. Pwr. Commission of Ontario
* 1912	3	140,000	240	AuSable Elec. Co., Cooke, Mich.
1913	3	150,000	240	Pacific Lt. & Pwr. Co., Los Angeles, Cal.

* Voltage after some time reduced.

in 1909-10 a number of systems were put into operation at voltages from 100,000 to 110,000. The difficulties in mechanical construction of lines with the flexible support given by the suspension insulator resulted in a great deal

insulator breakdowns acted as relief valves, but with the improvement of line insulation the station apparatus became relatively weaker as shown by the increase in reported failures. As apparatus has improved the trouble



Fig. 4. Control Board and Switchboards of the Keokuk Hydro-Electric Power Station

of line trouble from the crossing of wires, and made necessary increased spacings with a considerable increase in the size of supporting structures. This increase in line troubles was reflected in a great increase in troubles with transformers to which the lines were connected. It called attention to the influence of the inductance and capacity of long lines in setting up dangerous surges in the system, and resulted in a thorough study of the effect of high frequency and transient phenomena on apparatus design and construction. The result of all of this experience has been felt in the greatly improved transformers which are now available, designed with a thorough appreciation of the tremendous stress from both high voltage and high current to which they may be subjected in long distance transmission work. It is quite probable also that some of the recent failures of line insulators have been due to this increase of insulation strength of apparatus connected to the circuits. The surges appearing on transmission systems must be dissipated or discharged in some way. In the early days the weak point was the line and the

has been thrown back on the line with a consequent increase in insulator damage so that the study of the insulation problem has been transferred to the line insulator and investigators are now considering the various factors of operation and manufacture which affect its characteristics. There seems to be a growing feeling that the line insulation must be increased and that it must be designed with reference to the over-voltages to which it may be subjected. If such a program were carried out it would necessitate insulation with respect to local conditions of altitude, climate, frequency of lightning and sleet storms, length of line, etc., and of course to some extent the character of, and methods

of operating the apparatus connected to the circuits rather than with respect to normal line voltage. It would mean also an increase in strength of apparatus insulation to prevent its acting as a relatively weak discharge path. Such insulation would mean a material increase in development costs and undoubtedly would prevent the construction of many transmission enterprises, particularly those of comparatively small size and low voltage. It is necessary, however, to improve such details of insulator design and manufacture as experience has shown to be faulty, and assuming that this will be accomplished, another increase in apparatus troubles must be prevented by the further development of protective devices. The aluminum cell arrester, while it marked a great step in advance, will not protect against high frequency low-voltage disturbances and the development of apparatus to supplement the action of the aluminum cell presents probably the most important problem connected with electrical transmission today. It is known that certain combinations of resistance, reactance and capacity will absorb high-

voltage and high-frequency surges, but a successful combination of these elements has not as yet been practically worked out.

One of the spectacular developments in connection with high-voltage work was brought out in 1909 in the introduction of the outdoor substation. The use of high-voltage equipment in buildings with the difficulties of insulation encountered in carrying high-voltage conductors through walls and in obtaining the necessary space for their installation emphasized the advantage of placing such equipment out-of-doors where space is not restricted and where walls need not be pierced. The operation of high-voltage equipment exposed to the weather is being watched with great interest, and apparently offers no insurmountable difficulties.

The improvement in the art of transformer manufacture has so much increased the feeling of security in connection with their operation that the operator now sees nothing alarming in units of much greater size than would have been considered good practice some years ago. This together with the high cost of high-voltage switching equipment and its installation, has led to a marked change in the arrangement of stations. Where it was formerly widely the practice to install transformers as part of the generator circuit, paralleling all circuits in a high-tension bus, it now seems preferable to arrange transformer banks as part of the transmission line, thus cutting down the number of high-tension circuits and, consequently, the number of high-tension switches and insulators, decreasing the cost of transformers per kilowatt and decreasing considerably the amount of automatic high-tension switching that is necessary. Investigations on many lines have shown the dangerous rises in voltage set up by the operation of automatic high-tension switches and their elimination is very desirable. Further, the reduction in high-voltage apparatus reduces the amount of exposed material in case it is desirable to put the high-voltage apparatus out-of-doors.

In general, high-voltage transmission has been used in connection with water power developments, and consequently the development of the art of waterwheel construction has had a very marked influence on the development of electric transmission of power. Many of the early transmissions were installed at water power sites where high heads were available and the impulse type of wheel was

used. The tendency has been to develop the highest heads first, assuming, of course, that they were equally near suitable power markets. The marked improvement in waterwheel design in the last few years has been reflected in the development of some of our largest hydro-electric plants, such as those at Keokuk and Cedars Rapids. Without the introduction of the single runner turbine unit of high specific speed, such developments would have had prohibitive cost due to the great number of units required to develop the equivalent amount of power. The difference in construction can be readily seen by comparing some of the older plants using two or even three runners on the same waterwheel shaft, as opposed to the single-runner wheels in the Keokuk and in the Cedars Rapids installations.

The standards of service required from transmission systems are constantly becoming higher and the voltage regulation is a problem of continually increasing importance. In the system having long lines at high voltage, apparently the only solution is the use of synchronous condensers for regulation at the substation in the manner which has been so carefully worked by the Pacific Light & Power Company in Los Angeles, and the Utah Power and Light Company in Salt Lake City. It appears at first thought a very expensive proposition to install machines of 7500 or 10,000 kv-a. to run without actual energy output, but the influence of machines of this character in reducing troubles on the system from sudden rises in voltage, is undoubtedly sufficient to more than pay for their cost, to say nothing of the very greatly improved service which can be given by systems so regulated.

The tendency in operating modern systems is to interconnect various water power stations, thereby increasing reliability and permitting more economical use of water. In the South, for instance, the lines of the Southern Power Co., Yadkin River Power Co., Carolina Power & Light Co., Georgia Power Co., Columbus Power Co., Central Georgia Power Co., Tennessee Power Co., and Chattanooga and Tennessee Power Co. are all connected and tie together some 34 generating stations aggregating approximately 450,000 horse power and this has been done about 20 years after the Redlands 7 $\frac{1}{2}$ -mile, 250-kw. plant was, after careful consideration, attempted.

SOME INDUSTRIAL APPLICATIONS OF ELECTRICITY

By A. R. BUSH

MANAGER, POWER AND MINING DEPARTMENT, GENERAL ELECTRIC COMPANY

It would be impossible to write a complete article on this inexhaustible subject, but the author shows in a most interesting manner the application of electricity to some two dozen industries, pointing out the particular conditions in each which make the electric motor an economic factor. A large part of the story is told in pictures, and our limits as to their number have been governed only by the space available.—EDITOR.

The three principal creative divisions of industrial enterprise have been given as "industries producing from the earth," "manufacturing," and "public service." The first two divisions are the ones which we wish to discuss briefly as being greatly influenced by the use of the electric motor. The production from the earth—which includes agriculture and mining as being the most important—is becoming year by year more dependent upon the application of electricity.

Arid lands of the west have been made productive, as now the electric motor controls the flow of water over vast territories and proper irrigation has made possible larger crops and reduced failures. In mining, whether metal, or coal, one big problem is the safe and rapid handling of materials. The electric locomotive, the electric hoist, the motor-driven pump and fan are essential for the safety of mine operators, and for keeping down the cost of production.

Manufacturing is the barometer which indicates the improvement or decline in the condition of commercial affairs. The ease with which a manufacturing concern can adjust itself to varying conditions of production may be the one factor which brings about success.

The operation of a machine, whether it is a drill in a machine shop, a turret lathe in an automobile factory, a loom in a textile mill or a beater in a pulp mill, costs money. This cost of operation depends on the first cost of the machine or interest on the investment, the cost of power to run it, the cost of repairs, the value of the floor space which it occupies—which may be considered as rent. All of these factors may be summed up in a word, and expressed as wages paid a machine.

This wage is entirely independent of the wage paid the operator and in many cases may exceed many times that of the workman. This is mentioned to emphasize the fact that the question of choosing a proper machine and arranging to supply it economically with power is often of more importance than the selection of its operator.

It can be safely stated that not an industry exists in the country which has not been influenced by the introduction of the electric motor.

The number of employees of the electric central station companies which are classified among public utilities, show an increase of about 165 per cent for the 10 years previous to 1912 while the average output per employee in kilowatt-hours increased about 50 per cent. This means an increase in the size of the stations and in the efficiency of operation.

Automobile Factories

The phenomenal growth of the automobile industry has been dependent to a large degree on the use and dependability of the electric motor. Manufacturing plants were built with a certain capacity but in many cases the demand for the machines has gone far beyond the expectation of the promoters. This demand made additional factories and equipment necessary. In some cases assembling plants were required which were entirely separate from the main factory. These changes and additions without the electric motor would have been very expensive if not prohibitive, but with it they were not only possible but the silent workman came to the rescue and helped put into place the brick, steel and concrete necessary for the building itself. A separate article is published in this issue dealing with electricity in the automobile industry.

Bakeries

Present day conditions make it necessary for every baker to maintain a high standard of cleanliness. It is difficult to obtain this condition where overhead belting and shafting are depended upon to transmit energy. The amount of power required in many instances is not sufficient to allow an economical power plant so here again the electric motor has come to the rescue.

Human hands need not touch the products necessary to make a loaf of bread. The flour is sifted, blended and measured auto-

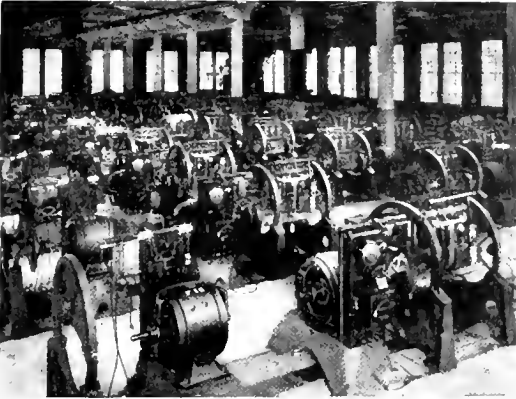


Fig. 1. Block Test, Dynamometer Room. Automobile Factory

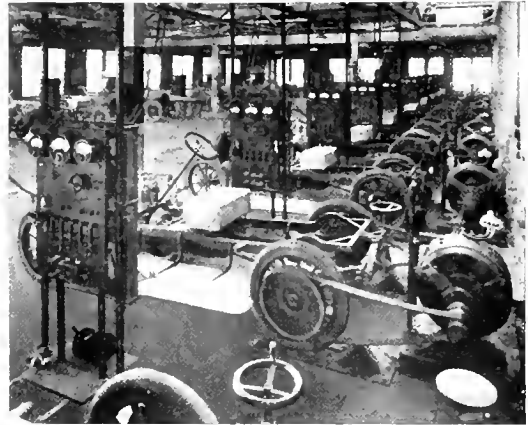


Fig. 2. Chassis Test Room. Automobile Factory

matically and dropped into motor-driven dough mixers from which the dough may be dumped into rising troughs. Then the dough divider cuts it into loaves and a motor-driven belt conveyor takes it to the loaf rounder. After a short stay in the proving box it goes through the motor-driven molding machine and after the time required to "rise" in the pan the bread is ready for baking.

The electric motor has done the work, and a better and more uniform product is the result.

Breweries

In a brewery you have a condition where many widely scattered small motors are necessary. For mechanical transmission long lines of shafting, innumerable belts of all sizes and other mechanical appliances are used, and the application of power may be required in a building adjoining the power house making a long steam pipe necessary, all of these are sources of constant loss.

By using an electric motor the proper power may be applied at the bucket conveyor

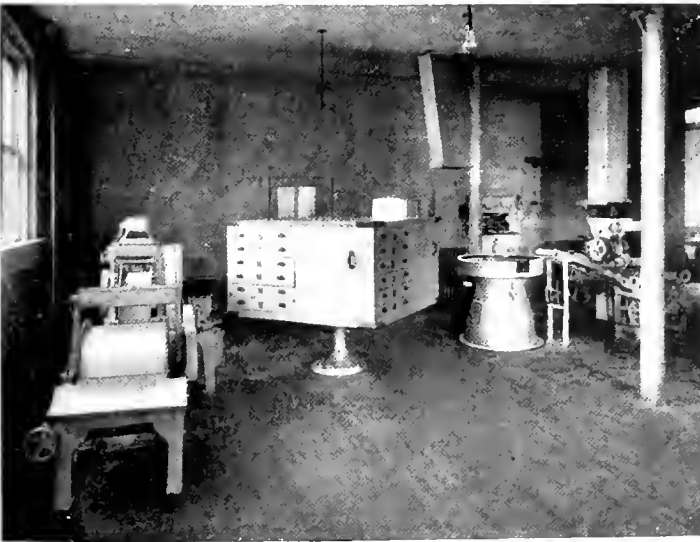


Fig. 3. Motor-driven Bakery



Fig. 4. 5-h.p., 60-cycle, 220-volt, Three phase, 1200-r.p.m. Motor Driving Flour Sifter

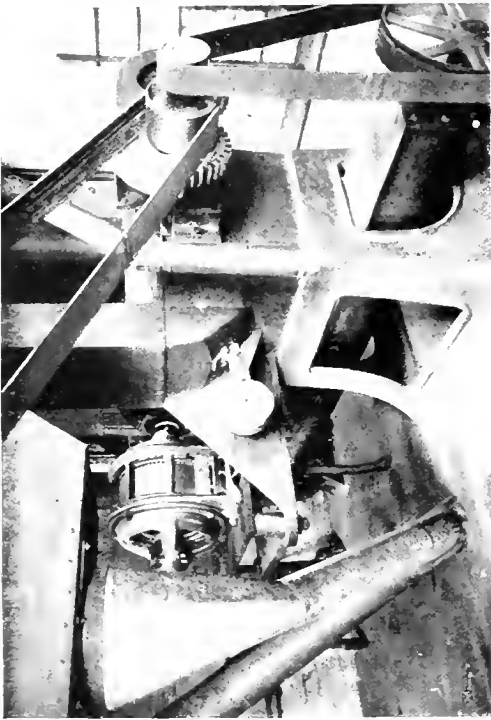


Fig. 6. 7½-h.p., 550-volt, Form K, Induction Motor Geared to Malt Cleaning and Rolling Mill in a Brewery, Capacity 100 bushels per hour

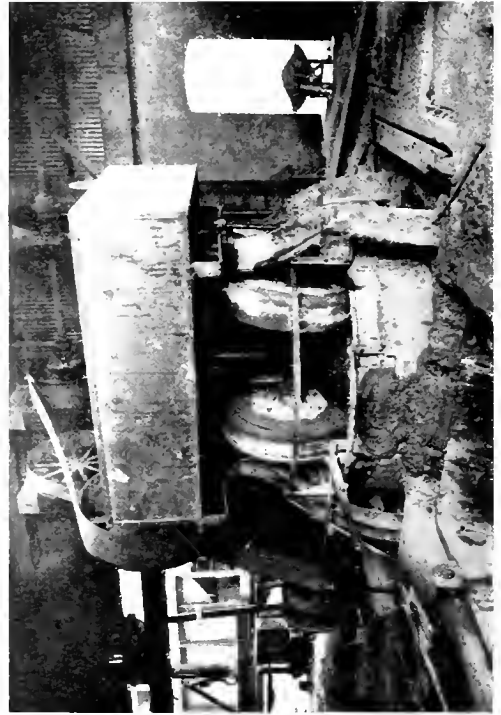


Fig. 8. Clay Mixer Operated by 40-h.p., 750-r.p.m., Form K, 440-volt Motor

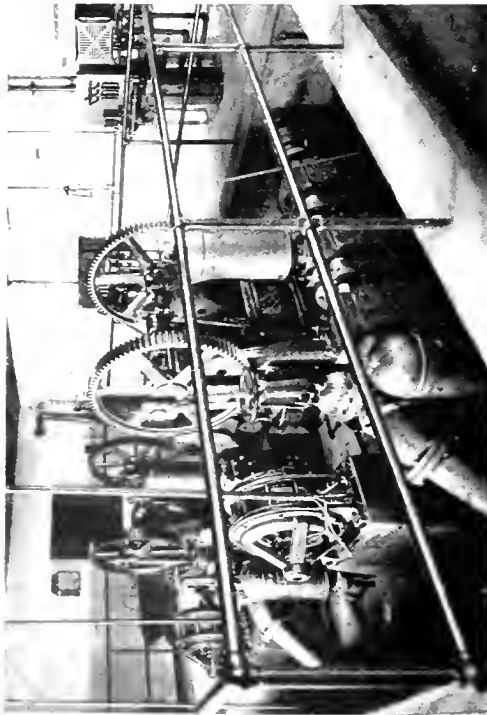


Fig. 5. Two 45-h.p., 740-r.p.m., Form M, 440-volt Induction Motors Driving Triplex Water Pumps in a Brewery

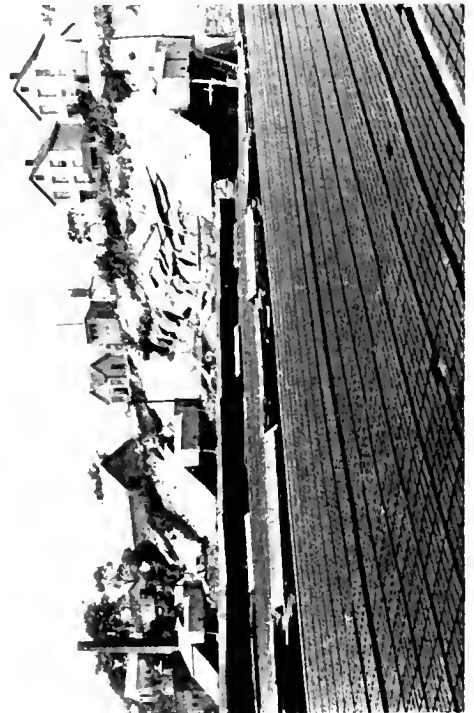


Fig. 7. Brick Plant at East Kingston, N. Y.

for handling the malt and at the worm conveyor for taking the malt to the brew house or mill. The mash tub, which is often located on the second or third story of the building, is brought under perfect control and it is here that the quality of beer may be greatly varied.

The pumps for wort and water can be started at the moment of demand. All of these applications have a profitable influence with the brewer. Comparatively large motors are necessary for operating the ammonia

the heavy motor-driven rolls of the dry-pans, mixed at the pug mill, cut into proper shapes, and then conveyed by belt to the represser where the green bricks are subjected to heavy pressure, and prepared for drying.

On account of the nature of the material and the machinery necessary it is usually desirable to have all these operations performed on the ground floor, therefore considerable space is required. The eliminating of long heavy shafting, bearings, and belts, usually unprotected from the flying dirt, and

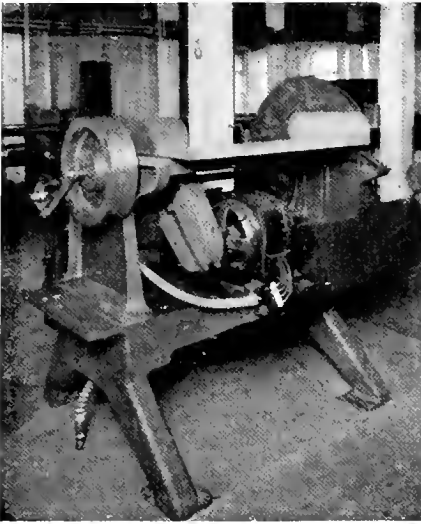


Fig. 9. Dried Beef Slicing Machine Driven by Induction Motor in a Cannery

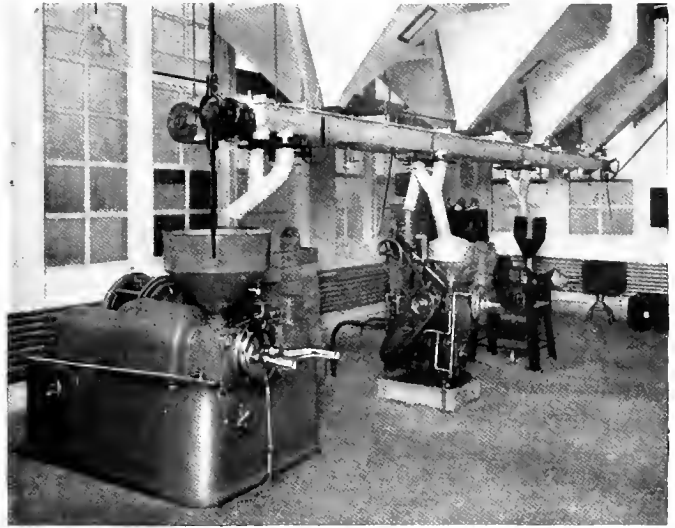


Fig. 10. Peanut Butter Machines Driven by Induction Motors in a Cannery

compressor for refrigeration, and even here the demand for power varies with the season, making the motor-driven compressor a desirable feature of a modern brewery.

Brick and Clay

The manufacture of brick and tile is probably the oldest of all industries. Many plants have been in successful operation long before the possibilities of the electric motor were known.

The territory served by the central power stations has, however, increased to such an extent that the clay worker has found at his door a source of power which cheapens the manufacture of his product.

The up-to-date brick plant finds use for a variety of motor applications. The clay and shale is excavated by an electrically operated shovel, hauled to the stock piles by an industrial type of electric locomotive, crushed by

the use of a motor close to its work can only result in a greater production and a more uniform product.

Canneries

The secret of preserving food in its natural state was discovered, rather than invented, about 120 years ago, and now we have reached the point where the world could not dispense with canned food.

The industry has developed to such an extent that over \$200,000,000 is represented in its annual output, and the past ten years has shown an increase of approximately 60 per cent. The number of canneries necessary to take care of the various food products at the proper time has made the element of time of great importance. The electric motor is now recognized as a time saver. Many classes of machines are used for handling different products and a change of use depend-

ent upon the season, becomes an easy matter with the motor-operated machines.

Sanitation is the most important factor and the elimination of shafting, belts or any moving element which can catch and distribute dust is of great importance to the canner of high class goods.

In the early history of the industry the public was carefully excluded from the plant for fear that trade secrets would be obtained. The public sentiment of today has changed all this so that the canner now realizes the advertising value of a clean, airy, well lighted motor-operated plant and invites the consumer of his wares to inspect the place where the food products are preserved and made ready for distribution.



Fig. 11. 50-h.p., 500-r.p.m., Form K, 25-cycle, 550-volt Motor Driving Ball Mills in Plant

where trouble might develop, and take all the necessary precautions to avoid delays is of the utmost importance. All of this can be accomplished with the electric motor.

Cotton Gins and Cotton Seed Oil

The value of the cotton seed products is now second in importance in the cotton growing states, being exceeded only by the cotton mill itself. For every pound of cotton produced there is an average of two pounds of seed. Not many years ago the seed was considered worthless and burned. It is physically composed of lint, hull, oil and meal, all of which products find a ready market.

The average sized gin is one having six 70-saw gins, and with the baling press and the



Fig. 12. 75-h.p., 500-r.p.m., Form K, 25-cycle, 550-volt Induction Motor Belted to Fuller Mills in Crusher House for Cement

Cement Plants

It is interesting to note that the rapid development of the cement industry from less than a million barrels to over 90,000,000 barrels annually began with the development of the electric motor. The advantages of electric drive were so apparent that soon the building of a mechanically operated mill was not seriously considered, but on the contrary the old plants were changed over and during the past two years no less than five mechanically driven mills have changed to electric drive, and an equal number of new plants which have been established have all adopted electric drive. The price of Portland cement, notwithstanding its enormous use, has made economics in production necessary.

To keep the machinery operating at a predetermined and economical speed is a great factor. Then again to be able to definitely locate the point of maximum load

necessary suction apparatus requires about 80 horse power and will bale 60 to 70 bales of 500 pounds each per day. In the oil mill steam is required for cooking, but since the hulls can be sold for feed and central station power is available for operating the motors, it is found economical to use coal as fuel for cooking. The operations, as in the gins, are conducted in unison, no storage facilities being provided between the various stages makes reliable power essential. The elimination of shafting, belts, etc., avoid interruptions in service.

Another advantage of motor drive which is of great importance is the reduction of fire risk.

The presence of excessive amounts of inflammable lint and dust connected with the various linting and cleaning operations makes the use of the induction motor one of the best forms of insurance.

The power requirements for the oil mill can be taken for various sized mills as about $2\frac{1}{2}$ h.p. per ton of seed per 24 hours.

Farming

To the ordinary farmer the use of electricity is gradually working from what he considered an expensive luxury to a necessity. The telephone was probably the entering wedge and its use has emphasized to him more than any other electrical device the value of time. The desire for better light was the next step and it is no uncommon sight to find the small farmer of New England, as well as the ranch owner of the West, reading his newspaper with the aid of the electric light.

life which grows in the soil, the three principal elements in commercial fertilizers being nitrogen, phosphoric acid and potash. These elements are best handled by being combined with other elements known as "fillers" such as water, fat, lime, soda, magnesium, sand, etc.

To combine these elements the problems of mining, conveying, grinding, mixing, bagging, weighing, etc., are involved, all of which require power. The fertilizer manufacturers realize that it is to their advantage to put their products into the hands of the farmer at as reasonable a price as possible, so that the latter may show a good margin of profit between his increased crop and the amount of

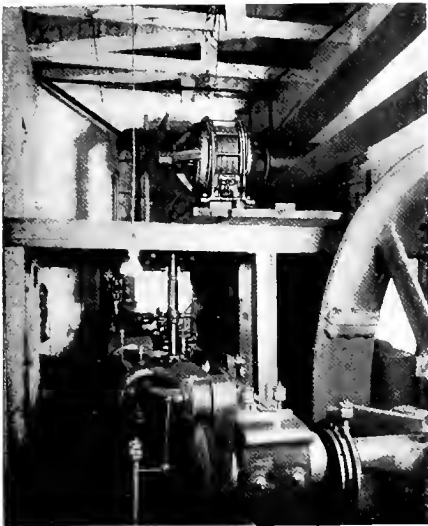


Fig. 13. 100-h.p., 720-r.p.m., 2200-volt Motor Driving Linters, Rolls and Presses in Cotton Seed Oil Mills (Note Motor has replaced Steam Engine)



Fig. 14. 35-h.p., 1800-r.p.m. Motor Driving Cake Mills in Cotton Seed Oil Plant

Then came the power problems such as operating the cream separator, sawing the winter's supply of wood, grinding feed for the stock, cutting corn for the silo, and threshing the grain, and to the housewife the turning of the washing machines and wringer. The development of water power and the extension of lines from the central station has brought the power to the farm so that with the aid of the electric motor, sometimes called the "electric hired man," work which at one time was considered drudgery can now be performed efficiently and quickly.

Fertilizer Factory and Phosphate Mine

The function of the fertilizer factory is to furnish food for the soil or rather for the plant

his fertilizer bill. The greater this difference, the more fertilizer will be bought. One important economical factor in fertilizer manufacturing is the electric motor.

In the mining of phosphate rock, the mineral source for phosphoric acid, which is so extensively carried on in Florida, large motor-driven hydraulic pumps are used for washing out the pebbles. Electric locomotives and motor-driven conveyors are employed for handling the material to the drying bins. The phosphate rock must be distributed to the various fertilizer plants, the same as coal from the mines must be distributed to the central station, and here again the electric-driven hoisting and conveying machinery plays its part.

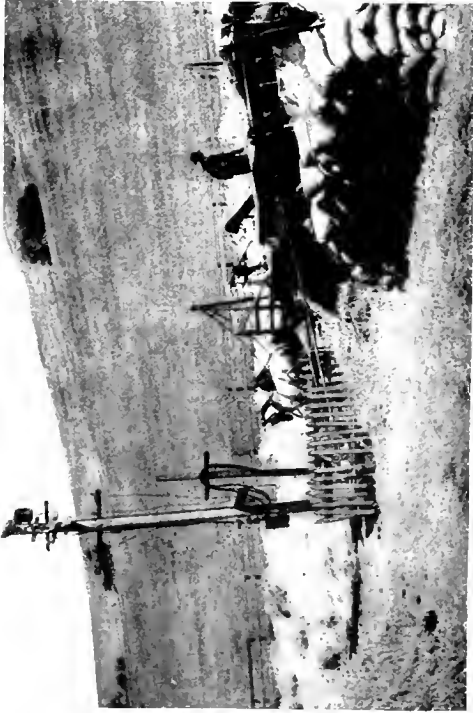


Fig. 16. 30-h.p. Motor Driving Thresher on the Ranch

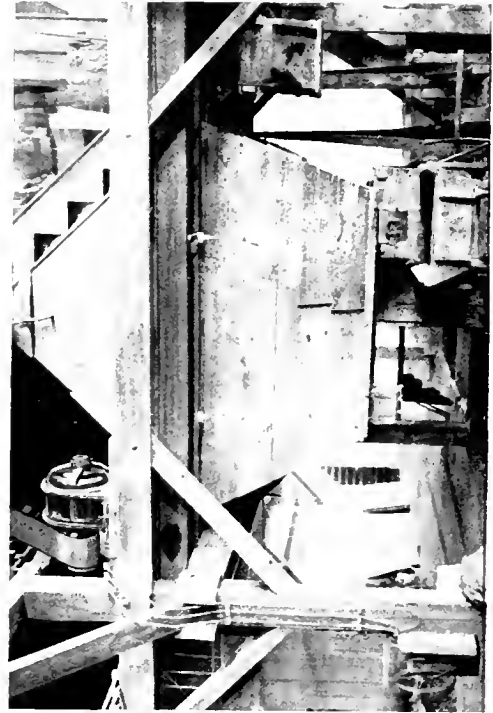


Fig. 18. 20-h.p. Induction Motor Driving Bagging Machine in Fertilizer Plant

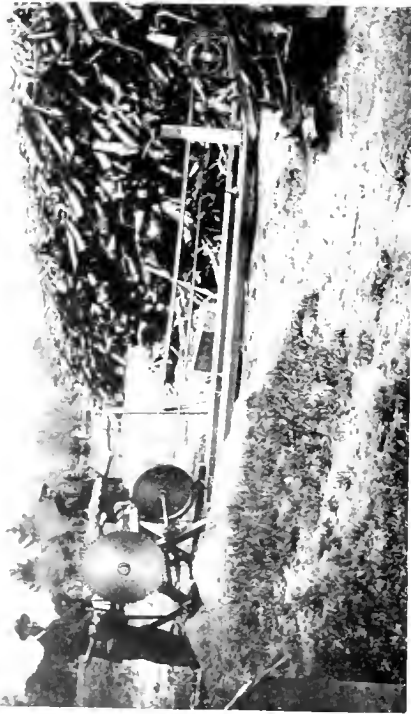


Fig. 15. 5 h.p., Three phase Induction Motor Operating Wood Saw on the Farm



Fig. 17. 100-h.p., 1800-r.p.m., Form K Motor Direct Connected to Centrifugal Fire Pump in Fertilizer Plant

The grinding mills are similar to those used in the cement industry where the induction motor has shown its worth. So on through the mixing and bagging operations where tons of materials are handled daily by the ever willing and untiring electric motor.

The best testimony as to the influence of electricity in this industry is given by the city of Baltimore, where without exception all new fertilizer factories erected within the last five years have chosen electric drive and central-station service. The horse power in

question of fire hazard must be considered. The accumulation of fine dust which is easily ignited cannot be obviated. The mill which requires shafting with long belts extending from floor to floor affords many means for the ignition of this dust either by hot bearings or the friction of the belts due to the lapping at the sides of the openings through the floor. Instances may be cited where steam mills in our large cities have been burned, to be rebuilt and equipped entirely with electric motors. The squirrel cage induction motor



Fig. 19. 200-h.p., Three-phase, 60-cycle, 440-volt, 360-r.p.m., Form P, Three-bearing Motor Driving Bolters and Purifiers in Flour Mill

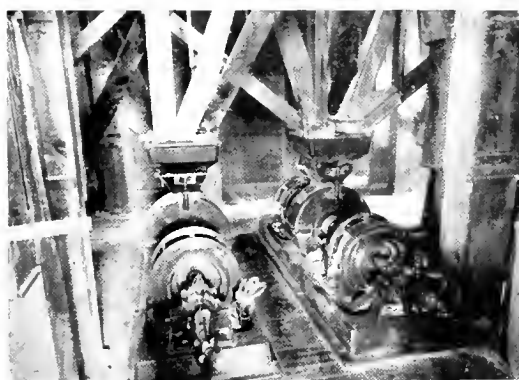


Fig. 20. Two 20-h.p., 1800-r.p.m., 440-volt, Form K Motors Driving 24-in. Double End Attrition Mill

motors has increased here during this period over 450 per cent.

Flour and Feed Mills and Grain Elevators

The first flour mill built in New England was naturally waterwheel-driven. For a long time this form of power dominated, then came the steam-driven mill or possibly the combined water and steam plant, the latter form of power being used in the summer during low-water period. Now we find the electrically operated grain elevator and flour mill, a simple, natural evolution in power application. The strictly water operated mills at the present time probably do not exceed 25 per cent of the total in number, while the percentage in total flour and feed output is far below this rate. The handling of grain at the elevator is naturally intermittent but the power must be available at any time and must be reliable. The electric motor meets the requirements especially where central station power is available, and statistics show that electrically operated elevators are rapidly increasing. In the flour or feed mill the

cannot spark and the controlling devices are installed in enclosed cases with all wiring in conduits, this obviating the chances of fire and greatly reducing the fire hazard.

Garment Manufacturers

Clothing manufacturers are beginning to appreciate that every dollar spent for electric current is the best investment for power. Clean aisles in the garment factories in New York are required by law; this means the elimination of all floor belt boxes. More machines can be operated with the same expense for power by using motors, thus reducing the cost of production. This item is specially important where high rents must be paid.

The motor may be installed underneath the table or at one end where the work table is extended and thus save 12 to 16 square feet of floor space for every motor used. Each machine may be driven at its best productive speed and this speed kept constant. Waste is reduced on account of steadier operating conditions and freedom from oil drips. The

reduction of fire risk is also an important consideration as well as improved ventilation and better distribution of light. The demand for output has high peaks due to rush orders and the electric motor is best suited to meet this demand.

Two and one-half horse power is required to operate from 30 to 36 sewing machines. Sponging and refinishing of the cloth is done with motor-driven machines, and electric-driven cloth cutters are extensively used.

Ice and Refrigeration

Although electric motors have been used quite extensively in handling natural ice by operating conveyors and in some instances

five times the January load. The motor-operated ice plant can be located near the center of distribution, thus reducing transportation expense and wastage; but the most important point from the consumer's standpoint is the removal of the possibility of contamination due to oil from the steam-operated plant and obnoxious foreign matter often found in natural ice.

Irrigation

Irrigation may be considered crop insurance. The average rainfall in a certain district may be sufficient to take care of the crop, but it is not always safe to be guided by this figure.

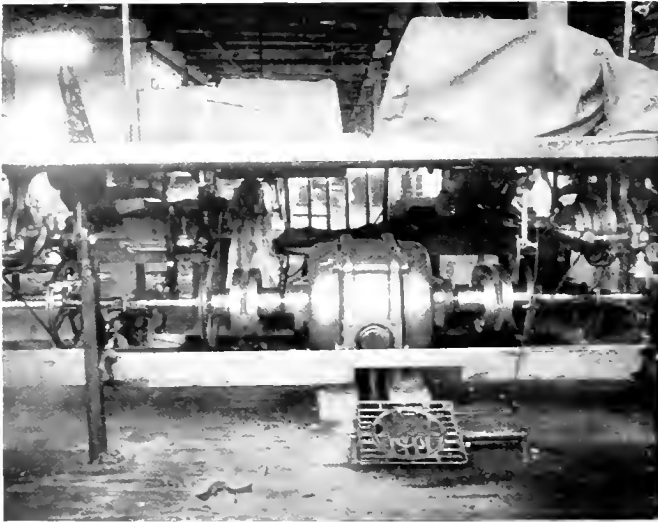


Fig. 21. 3-h.p., 220-volt, 60-cycle, Three-phase Motor Driving Sewing Machine Table



Fig. 22. 3-h.p., 1500-r.p.m., Motors Driving 20 Heavy Woolen Garment Sewing Machines

cutters, the large field is in the manufacture of artificial ice. To within about four years the steam-operated ice plant held a monopoly of the field. This was due to the fact that distilled water was used and the greater part of this distillate was obtained from the exhaust from the engines. With the recent use of multiple-effect evaporators in connection with the distilled water plants; and the introduction of the raw water system of ice making, electricity has entered the field and become an important factor in ice making. The fact that this industry is virtually a summer load, and comes at a time when the lighting load is low, made the business attractive to the central station manager. Instances are known where the July load is approximately

The rain may not be properly distributed, and may come at the time when the crop least needs it. The problem then is to be able to put water on your fields in exactly the right quantity and at the right times during the growing season. Ditch irrigation is limited by the contour of the land, and good land may lie idle because it cannot be reached by ditch water. The use of electrically operated centrifugal pumps and the extension of electric power lines throughout the country has enabled the farmer and ranchman to buy this crop insurance at a very reasonable rate, and, unlike the ordinary forms of insurance, actual annual profits may be shown. The little attention required, and the dependable operation of the electric-driven pump coupled

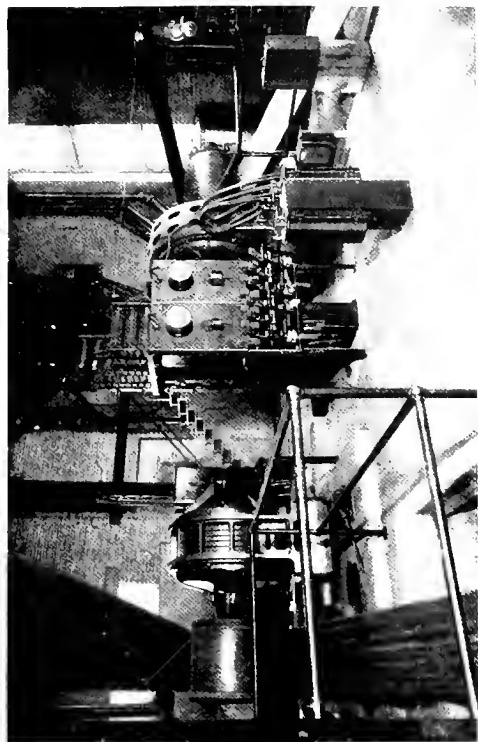


Fig. 24. 150-h.p. Motor and 300-h.p. Motor, Form M, 220-volt, 60-cycle, 500-r.p.m. Driving Ice Machine

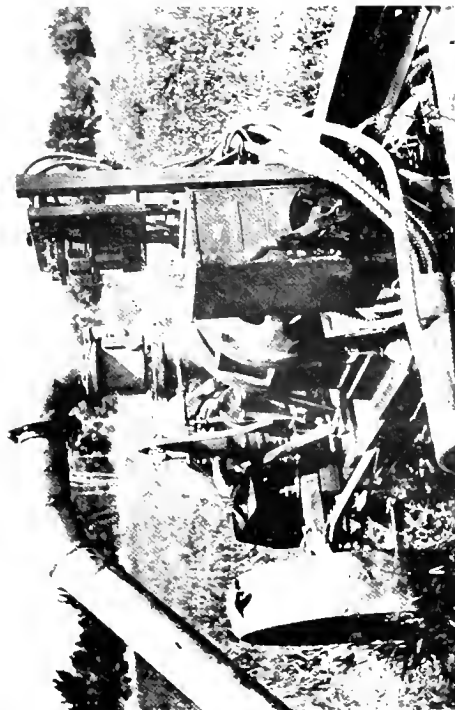


Fig. 26. 10-h.p. Motor Direct Connected to 5-in. Centrifugal Irrigation Pump



Fig. 23. 3-h.p., 1500-r.p.m., Form K, 220-volt Induction Motor Operating Ice Cutting Saw

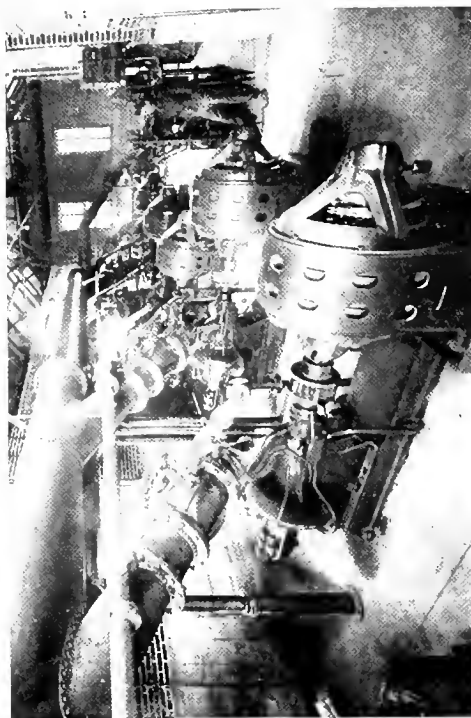


Fig. 25. General View of Pumping Equipment of Payette Oregon Slope Irrigation Company



Fig. 28. 60-in. Plate Shears in Universal Plate Mill, Each Operated by a 150-h.p., 500-r.p.m., Form K, 220-volt Motor

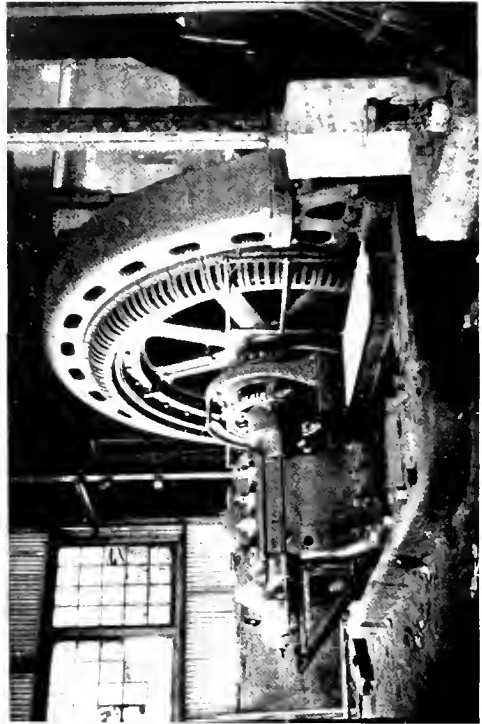


Fig. 30. 1000-h.p., 83.3-r.p.m., Form M, 2200-volt Induction Motor Direct Connected to a Two-stand, 20-in. Sheet Bar Mill

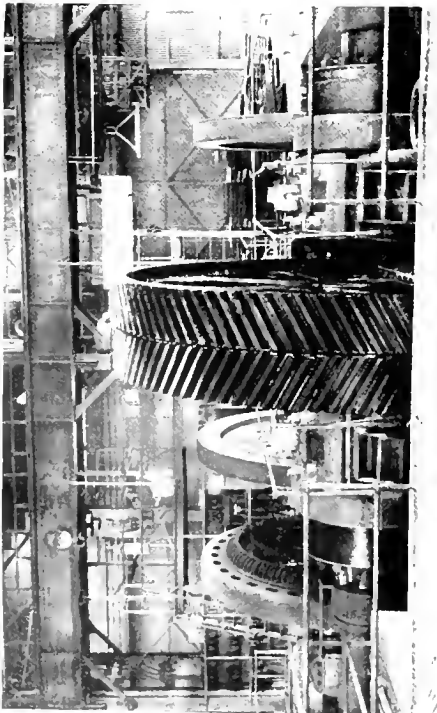


Fig. 27. 1400-h.p., 240 r.p.m. Motor and Control with Flywheels and Gear Driving 28-in. Sheet Mill



Fig. 29. Reheating Furnaces in 60-in. Universal Plate Mill. Each Furnace Door is Operated by a 5-h.p., 750-r.p.m., 220-volt, Form K Motor

with the comparatively small cost of operation has made the working of even small tracts of land profitable.

Here as in many other industrial applications of electricity, the assured increased production has brought about success. Poor crops usually mean general depression in a country, while good crops foretell prosperity.

Iron and Steel Mills

The application of electricity to the iron and steel industry has undoubtedly been the subject of more discussion than any other industrial line in the country. This is not to be wondered at when you consider that the economical production of iron and steel, either in the shape of ingots or manufactured products is a matter of national importance.

In the majority of applications the question was readily solved on the basis of cheaper power, but for many years the electric motor was kept away from the main roll drive for fear that it was not capable of doing the work.

The motor has now demonstrated its ability to handle the main rolls so now in all power applications of the mill it has to compete with other forms of power primarily on the basis of economy. On account of the large power units required with the overloads which must be taken care of, the question of handling sufficient steam at anything like an economical basis is a very serious problem. While it is probably true that a great many improvements are yet to be made in the application of motors and control in the industry, it is equally true that no new mill can be built today and operated on a competitive basis without the use of electricity.

Lumber and Wood Working

The most modern and largest lumber mills in the country have adopted electric drive; this fact is significant. The mills handling cedar, hemlock and fir of the Northwest as well as the yellow pine mills of the South have demonstrated the value of the electric motor as a money-saving factor in the industry.

One large steam-operated saw mill was destroyed about four years ago by fire which originated from a hot bearing. On the site of the old mill has been built a complete electrically operated mill and every modern device has been installed with a view of increasing the production and reducing the fire hazard. Some of these mills require as many as 300 alternating-current motors, which gives some idea as to the extent and completeness of the electrical equipment.

The high speed machinery in a planing mill, such as profilers, surfacers, matchers, moulders, rip saws, cut-off saws and band re-saws, are well adapted for individual motor drive. The output of these machines is dependent to a large extent on the speed, therefore the maintenance of the proper speed is of importance. In practice it is found that shaft-driven machines vary in speed from 10 to 20 per cent from no load to full load. This has a marked effect upon the output, especially for power fed machines. By the use of the individual induction motor slippage is eliminated and production maintained. An official of a large lumber and shingle mill was recently asked why he installed electric motors; his answer is typical and well worth considering: "First, a large saving in the mill frame as we reduced it to one story in height and used much lighter construction. Second, the power plant detached from the saw mill allowing lath mill, picking table and hog house to be separated from the saw mill, reducing the fire hazard very materially. Third, a large reduction in noise and in expense in annual overhauling. Fourth, more continuous operation, as each individual drive has a limit of concentrated power, which in a shaft-driven mill is sufficient to either break up machines or burn the belt when any machine becomes blocked. Fifth, a very large reduction in power required, not over one-third of what the shaft-and-belt-driven mill would take. This last claim may seem too large, but when a large saw mill is all belted up there is a multiplication of transmissions which waste an enormous amount of power. In fact, it is well known among millmen that very large shaft-and-belt-driven mills are extremely difficult to keep in running order even with a small army of experienced millwrights, and are subject to long shut-downs on serious breaks."

Mining

The problem to improve the conditions under which men must labor is being studied by every large corporation through the United States. The man who works underground has a hard lot, but electric lights now show him the way without consuming his very breath, and with the use of the electric-driven coal cutter, locomotive, pump, fan and hoist, the miner's work is more easily performed with less risk to life and limb.

The ever increasing demand for electrical equipment for mines, whether in the coal fields or the metal mining districts, is suf-

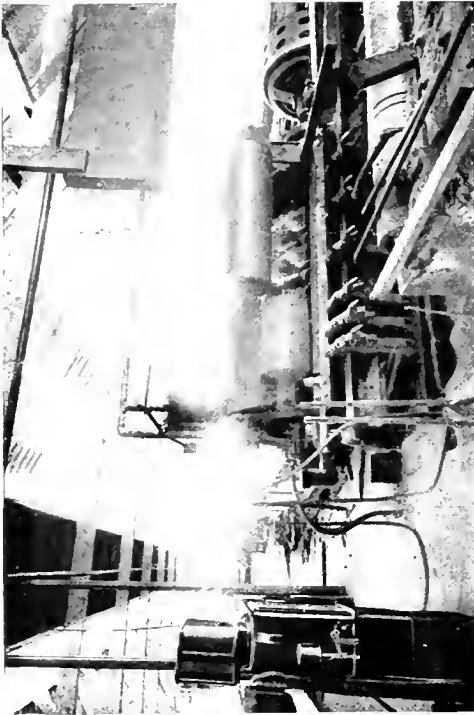


Fig. 32. 200-h.p., 1200-r.p.m., 220-volt, Form K Motor Direct Driving 12-ft. by 72-in. Edger in Lumber Mill

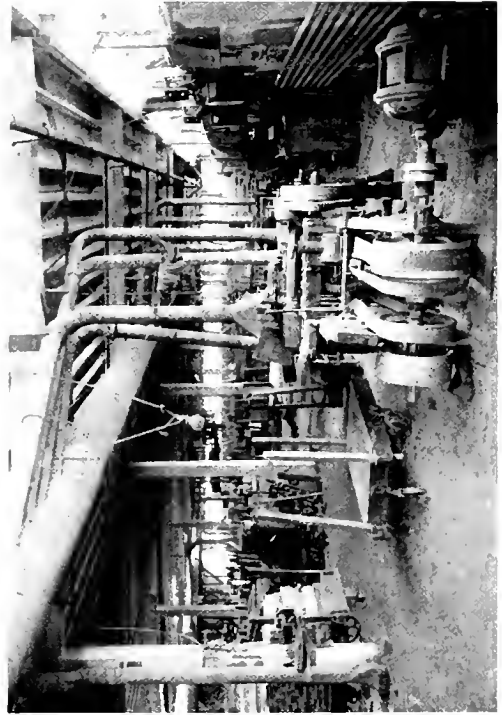


Fig. 34. 25-h.p., 1200-r.p.m., 220-volt Motor Driving Four-sided Moulder in Furniture Plant



Fig. 31. 150-h.p., 600-r.p.m., 550-volt Induction Motor Operating an Electric Logging Outfit

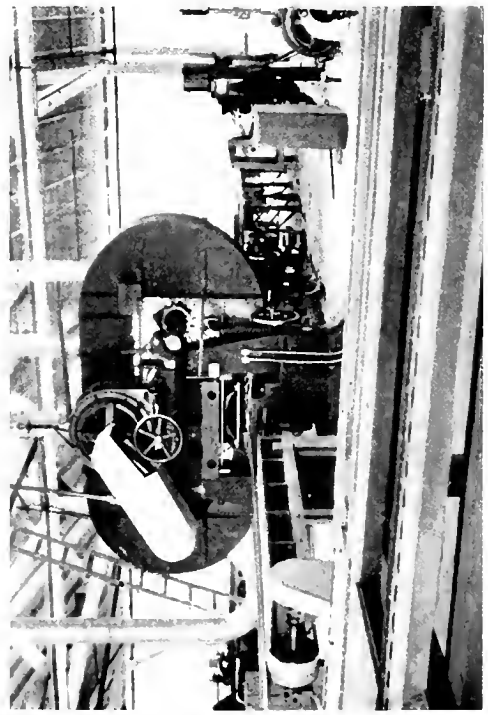


Fig. 33. 35-h.p., 900-r.p.m., Form K, 440-volt Induction Motor Driving Resaw End of Combination Matcher. Resaw Motor Mounted on Resaw in Lumber Mill



Fig. 36. Coal Mine Fan House from Above

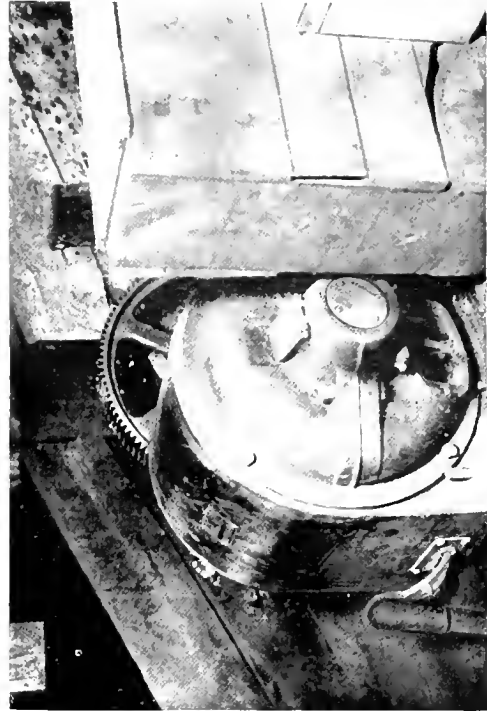


Fig. 38. 25-h.p., 900-r.p.m., 440-volt, Three-phase, Form K Mining Type Induction Motor Installed on Coal Crusher

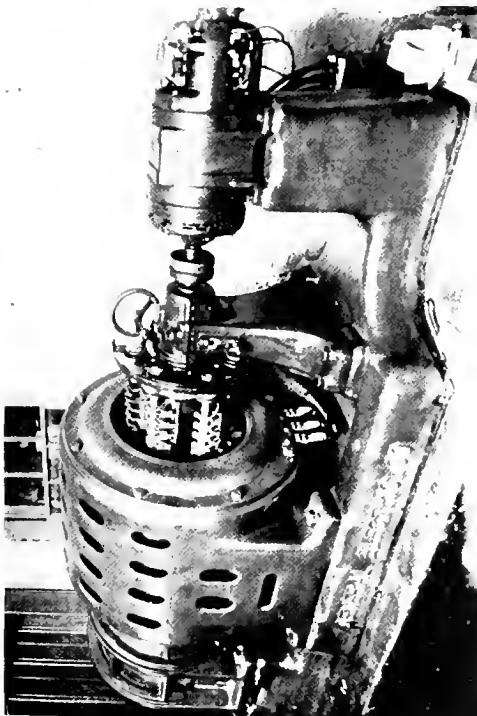


Fig. 35. Regulating Set for 250-h.p. Fan Motor at a Coal Mine Consisting of 70-kv-a. Commutator Motor for 25 per cent Speed Regulation

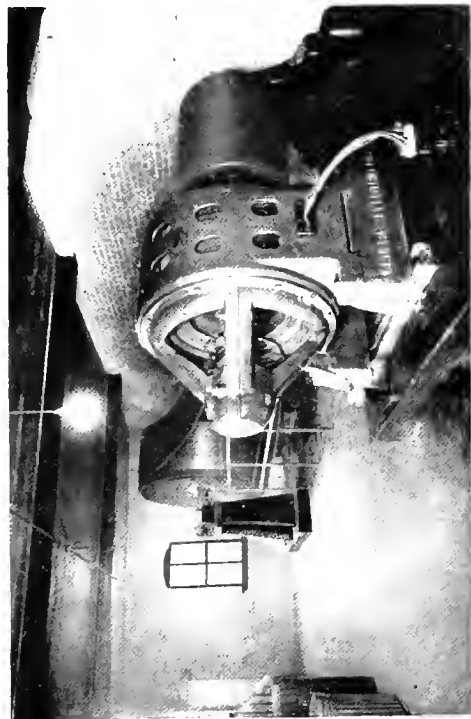


Fig. 37. 250-h.p., 450-r.p.m., Motor Driving Ventilating Fan for Coal Mine, 25 per cent Speed Control with Regulating Set shown in Fig. 35

ficient evidence of its great influence in the industry. To remove economically 10 tons of water from a coal mine for every ton of coal produced is one of the tasks set for the motor-driven pump, and the work is being performed on a paying basis. The emergency demands on the operator are reduced by electric automatic devices in the form of signals, cutouts, etc., and in the case of hoisting equipment entirely automatic operation is made possible. The kw-hr. required per ton of coal mined of course varies widely due to the length of haulage, the grade, and the amount of air necessary for the fans to deliver to the mine, the amount of pumping necessary, etc. Tests have been made in the Pocahontas coal fields where the electric



Fig. 39. Motor-operated Wells in Kern River Oil Fields, Bakersfield, Cal.

as cheap as it could possibly be obtained, no transportation charges being added. The field may be considered limited as compared with other industrial activities but a few reasons showing the success of the motor may not be out of place. The motor does not necessarily work faster than the steam engine but it eliminates delays, and in that way increases production. Operating expenses are decreased as no boiler feed water is required, and the cost of oil and attendance is less. Power bills stop when the work stops. Greater safety of operation is obtained as the motor cannot run away if a hoist line breaks. Fire risks are reduced and operating conditions can be measured by the current consumption. It was only after exhaustive tests in the

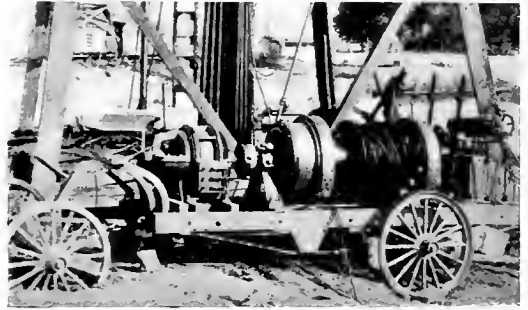


Fig. 40. Portable Hoist Driven by 20-h.p., 1200-r.p.m., Form M, 440-volt Motor, Kern River Oil Fields of California, Bakersfield, Cal.

power per ton of coal mined shows results varying from 1.7 to 6 kw-hr.

It is safe to say, however, that the figures from one mine cannot safely be used for determining the requirements of another mine even with the same tonnage output. But it was not until the introduction of electricity that actual cost of power requirements were determined. In the mining of metals such as gold, silver, copper, lead, tin and zinc, stories could be written for each. Suffice it to say that the power problems peculiar to each kind of mining have been solved successfully with the result of larger productions at a less cost. A separate article is published in this issue dealing with electricity in mining.

Oil Well Drilling and Pumping

The use of the electric motor for drilling and pumping oil wells is of more than ordinary interest. The steam engine was well established in the work; the fuel was right at hand,

California oil fields and after actual economies were shown that the electric motor was standardized for this work.

Pulp and Paper Mills

The centralization of the power generating apparatus and the proper distribution of the necessary power has made the adoption of electricity desirable in pulp and paper mills. As a matter of fact, paper mill engineers were among the first to adopt electric drive on a large scale and at the present time over 200,000 horse power in motors are in service.

The motor-driven jordan is not new but the question of the longitudinal adjustment has prevented some of the older installations from being changed over. The recent introduction of a telescoping coupling has, however, helped to solve the problem, so that now the mechanically-driven jordan is being equipped with a motor at a nominal cost and without sacrificing the old machine.

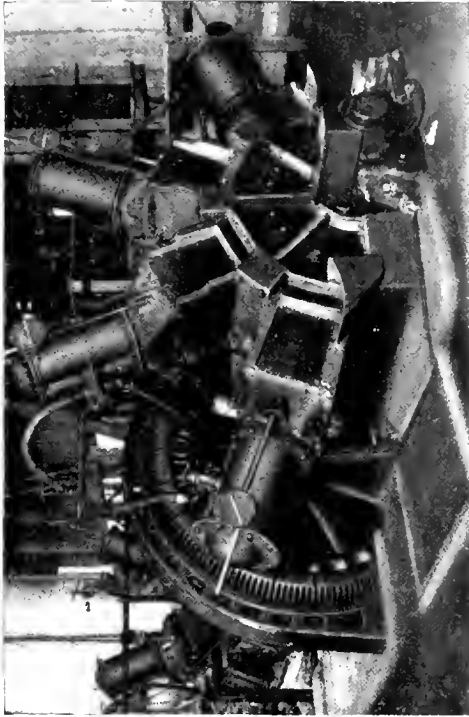


Fig. 42. Two 1200-h.p., 240-r.p.m., 440-volt Motors, Each Motor Direct Connected to Two Four-pocket Grinders in Pulp Mill

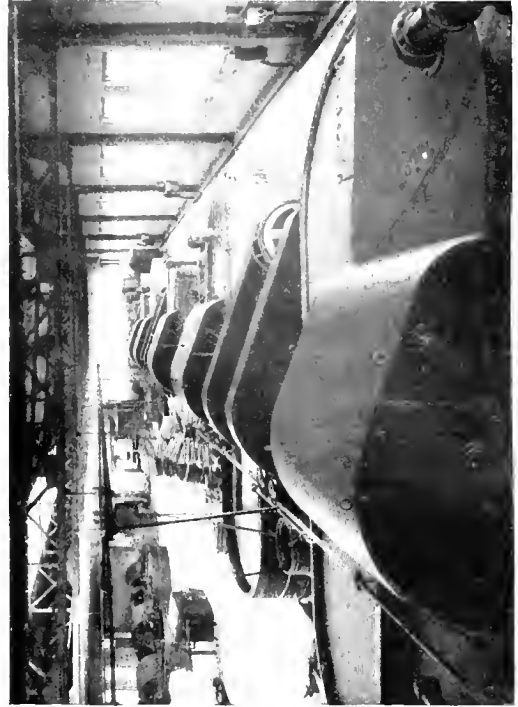


Fig. 44. Group of Six 100-h.p., 480-r.p.m., Type M, 550-volt Motors Each Driving Two Beaters in Pulp Mill



Fig. 41. Two Paper Machines, Capacity 150 Miles of Wrapping Paper 13 ft. wide each per day. Winders driven by 40-h.p., 480-r.p.m., Type M, 40-cycle Motors, and Wet Ends driven by two 75-h.p., 480-r.p.m., Form L, 550-volt Motors

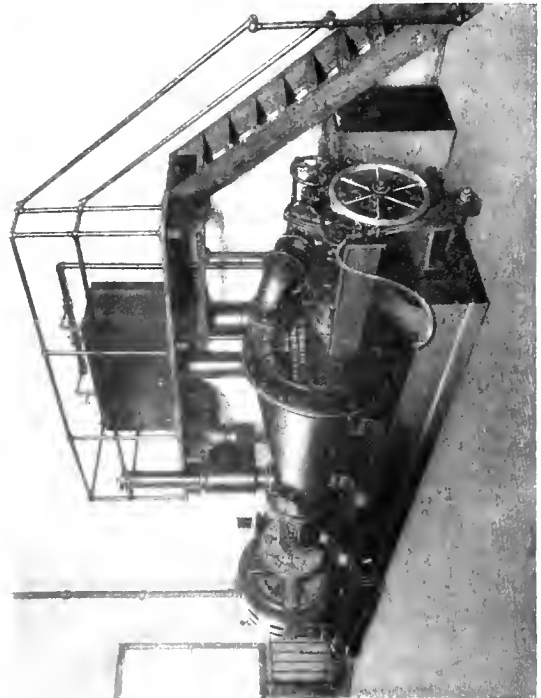


Fig. 43. 225-h.p., 343-r.p.m., Form L, Motor Driving Jordan in Paper Mill



Fig. 45. 30-h.p., 900-r.p.m., Form K, 60-cycle, 220-volt Induction Motor Driving Battery of Sausage Chopping Machines



Fig. 46. 20-h.p., 1200-r.p.m., 220-volt, Form K Motor, Direct Connected to Meat Cutter with 40-in. Bowl, 200 Pounds Capacity

While the question of power distribution was perhaps the main reason for the use of the electric motor, the economical application of the motor to the driven machine is probably of no less importance.

The motor-driven pulp grinder is allowing the pulp manufacturer to purchase his power,

or as in some cases utilize a water power development which is situated some distance from the paper mill, without making a separate pulp mill necessary. The advantages of individual drive are again shown in the beater room where the beaters are driven in pairs. The elimination of shafting and belts in the



Fig. 47. 25-h.p., 1000-r.p.m. and 10-h.p., 750-r.p.m., 220-volt Motors Driving Vacuum Pump, Meat Chopper, Hasher and Corn Beef Filler



Fig. 48. Induction Motor Driving Meat Hashers in Packing Plant

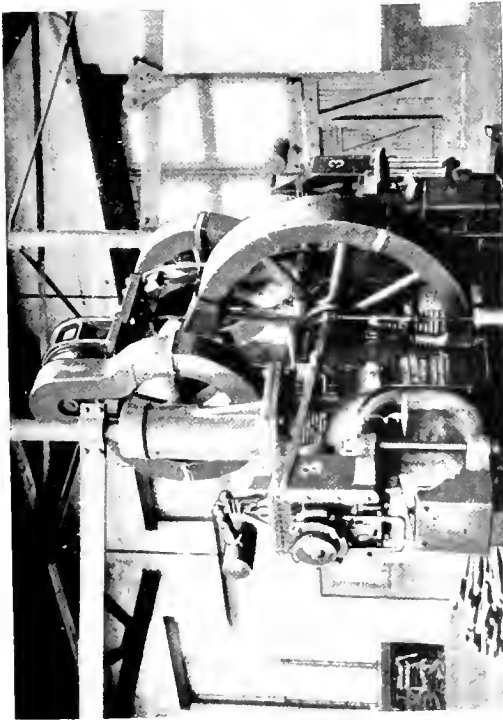


Fig. 49. 10-h.p., 550-volt, 750-r.p.m., Form K Motor Driving Shear and Punch in Railroad Shop

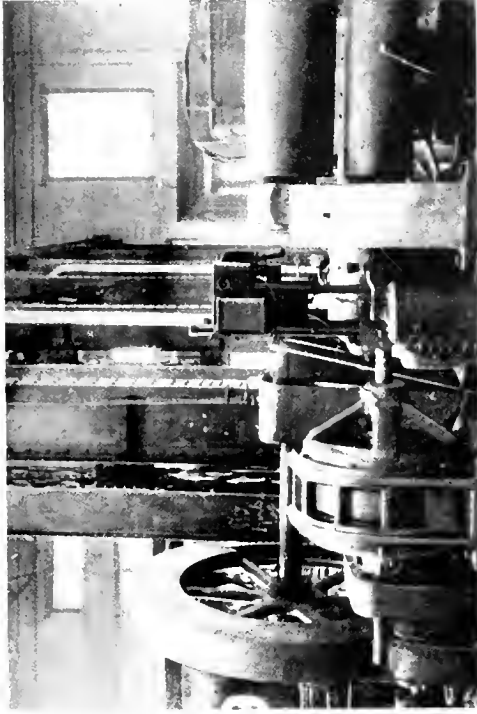


Fig. 50. 35-h.p., 550-volt, 750-r.p.m., Form M Motor Driving 15-ft. Beading Rolls in Railroad Shop

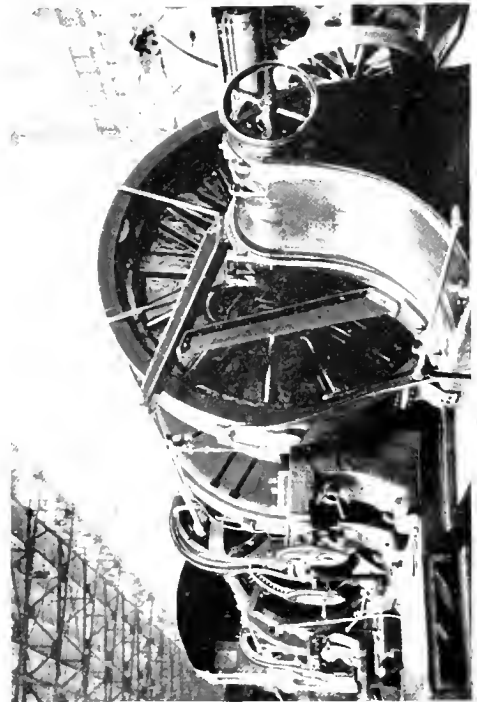


Fig. 51. Two 50-h.p., 230-volt, 500 1000-r.p.m. Direct-current Motors Driving Two Locomotive Driving Wheel Lathes in Railroad Shop

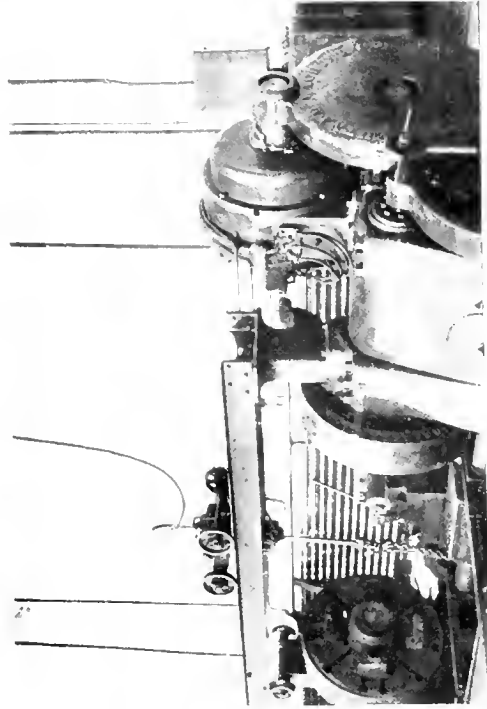


Fig. 52. 5-h.p., 230-volt, 500, 1000-r.p.m. Direct-current Motors Driving 42-in. Car Wheel Lathe in Railroad Shop

beater room basement is of some importance, and economies are secured by being able to repair one set without in any way affecting production of the other sets.

The fact that electric motors are not universally used on paper machines does not mean that the mechanical speed changing devices and variable speed engine are entirely satisfactory.

The steam demand for paper mills varies greatly, depending on the class of product turned out and the method employed. But the demand is present for motor-driven paper machines and a large number of successful installations are in operation.

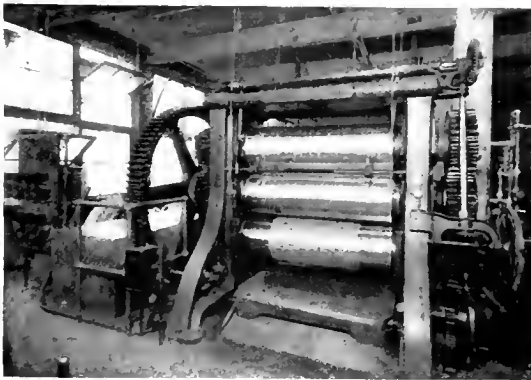


Fig. 53. 40-h.p., 400 800 r.p.m., 220-volt Direct-current Motor Driving a 22- by 60-in. Rubber Calender

Packing Plants

The preparation and packing of meats is done on a large scale by a comparatively few companies. Great quantities of steam and hot water are required, but nevertheless the electric motor is found in every department of the packing plant. In hog killing it is not uncommon to find the hog lifted from the pen by a motor-driven wheel, which starts him on his trolley journey, ending completely dressed ready for the refrigerator. Meat packing is a line of work where the essential requirement is to keep things moving. The processes involved are comparatively few as regards power applications, but the dependability of the electric motor has made its use indispensable.

The competition is so keen that nothing is allowed to waste. The hair cleaning department requires motors, and the dust removed from the hair is worth over \$40 per ton. The operation of the fertilizer mill, where many by-products are turned into money, depends upon the electric motor.

Artificial refrigeration has been one of the most important factors in building up the year round packing business as it is now conducted, and the motor-driven refrigerating equipment is now firmly established in the industry.

Railroad Shops

The influence of electricity on the transportation problems of the country is well known. On one side of the innumerable trolley and steam roads we find the manufacturing plants, on the other side the repair shops. It is the latter which comes under the direct control and deeply concerns the operating department of a railroad system.

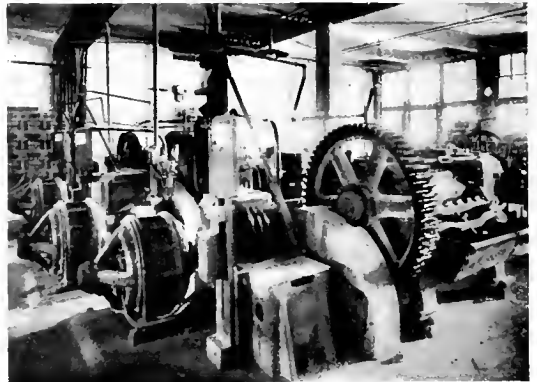


Fig. 54. 40-h.p., 720-r.p.m., Form M, 440-volt Alternating-current Motor Driving a 10- by 36-in. Rubber Refiner

Car wheels must be made true, boiler flues must be kept tight and a thousand and one repairs must be taken care of efficiently and without delay.

Various classes of metal and woodworking machinery are necessary such as shears, punch presses, lathes, boring mills, planers, cold metal saws, milling machines, arc welding apparatus, etc. The growing tendency on the part of steam railroads is to purchase electrical energy for the operation of the repair shops, and of course this means the application of the electric motor.

Better light and the "safety first" ideas in a railroad shop are just as essential as in the ordinary machine shop, shoe factory or textile mill.

Rubber Mills

The transformation of crude rubber to sheets, tubes, rods and molded sections for commercial use requires comparatively heavy machinery and considerable power. The processes of washing, masticating, mixing, refin-



Fig. 56. 50-h.p., Form L, 220-volt Induction Motor Driving 33 Staking Machines in Tannery

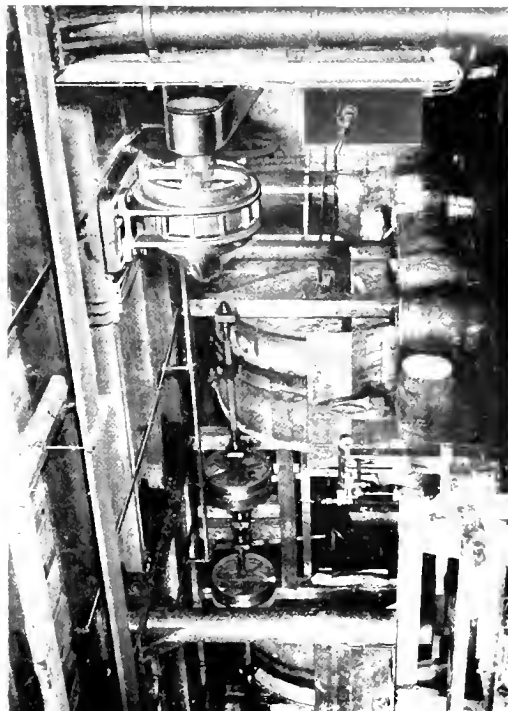


Fig. 58. 75-h.p., 220-volt, Form L Induction Motor Driving 11 Drums in Tannery

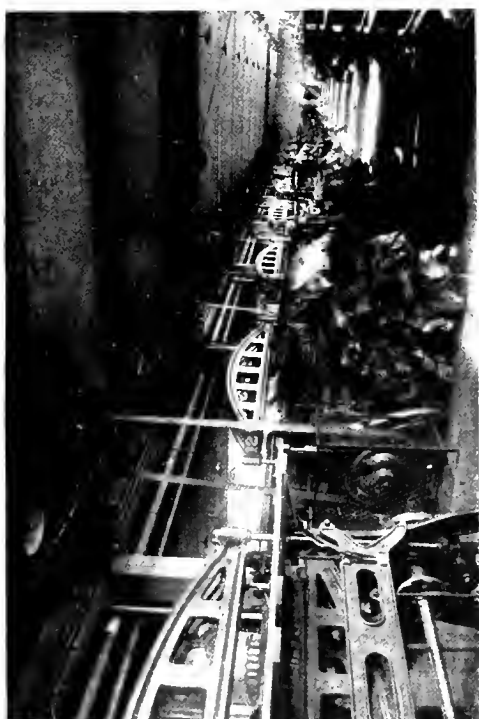


Fig. 55. 10-h.p. Induction Motor Driving a Group of Five Sole Leather Cutting Machines



Fig. 57. 5-h.p. Induction Motor Driving 12 Niggerheads and Four Pullovers in Leasing Room

ing, warming and calendering require mills consisting of two, three or more rolls depending on the operation. The load is variable, as in the case of a three-roll washer 30 h.p. may be the average, with a peak load of 100 h.p. The mixing mill may have an average load of 55 h.p. with a maximum of 120 h.p. The advantages in the use of electric motors are due to the fact that the various machines, each requiring considerable power, can be operated independently.

Heavy overloads must be taken care of and at the same time protective devices must be furnished to avoid the breakage of the rolls due to clogging. The question of individual or group drive is dependent upon factory conditions.

The polyphase squirrel cage motor is especially suited to carry the high peak loads and is most commonly used, except for the calenders where a four-to-one speed range is sometimes required, in which case an adjustable speed direct current motor is used.

Shoe Factories and Tanneries

The material decrease in the unit cost of production is one of the principal advantages attending the use of electricity in shoe factories. The actual reduction of operating cost is not, however, as important as the increased production possible with the same labor and equipment. As a fair example, the cost of power for making a pair of shoes may be taken as one cent. The entire elimination of the power item is not as important as an increased production of 10 per cent in the number of shoes turned out. Shoe factories are generally spread over large areas and a long shaft driven by a reciprocating engine often shows a 10 per cent speed variation at the end farthest from the prime mover. The slipping of belts between engine and driven machines frequently results in 10 to 20 per cent loss of speed in the latter. The steadiness of electric drive with a constant angular velocity not only increases production, but increases the useful life of the driven machinery and greatly reduces wastage. Where electric drive is used the routing of material and good lighting conditions can be the determining factors for location of machinery. Corners which could not be used with mechanical drive become productive. Weak points in the long chain of production may be readily strengthened without disturbing other parts of the factory.

The tanning industry is usually closely associated with the manufacture of shoes

although it is a separate industry and furnishes material to a great variety of manufacturing concerns. The tanner, however, has recognized the advantage of the electric drive as some concerns are using motors by the hundreds, and others who originally use steam engines have re-equipped throughout with modern electrically-driven machinery.

Sugar

In all probability Cuba holds the distinction of being the pioneer in applying alternating current on a large scale to sugar mills, but now we find successful electrically operated plants in other cane growing countries.

The conditions in this industry are interesting from the fact that steam is necessary for cooking, evaporation, etc., while on the other hand conveyors, pumps, etc., are more economically operated electrically than by small steam engines. The crushing rolls for breaking up the cane have in the past been operated by large steam engines but now we have one or two instances where motors are doing this work successfully.

The steam turbine will undoubtedly help solve the problem of furnishing the power sufficient for crushing and operating auxiliary apparatus and at the same time make available sufficient steam for cooking and evaporating. The annual overhauling expense of an ordinary sugar mill is greatly reduced where electric drive is used and the depreciation item is not as big a factor.

In the beet sugar industry the electric motor plays an important part. The success of the beet crop is often dependent upon rain at the proper time. If a dry season is experienced irrigation is necessary and made possible by the motor-driven pump.

The season is comparatively short, rarely over three and one-half months, but when the "campaign" is on, continuous operation of the factory 24 hours per day is necessary; the shutdown of but a few hours means serious loss.

The use of motors for the conveyors, washers, slicers, mixers, granulators, crystalizers and centrifugals has been found to increase production and reduce to a minimum the possibility of delays and shutdowns.

The "centrifugal" is considered one of the most important machines in sugar making, and the operating conditions the most severe, due to the inertia of the load and the cycle of operation. For individual motor drive the peak load is approximately eight times the

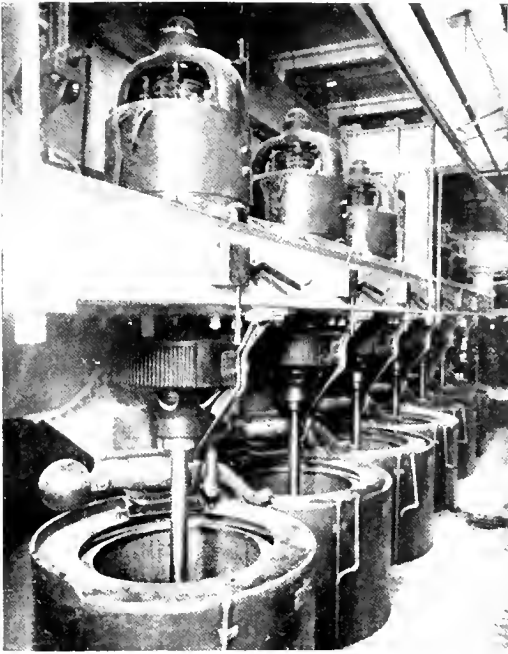


Fig. 59. 40-in. Weston Centrifugal Direct Connected to 20-h.p., 850/1000-r.p.m., 230-volt Direct-current Motor in a Sugar Refinery



Fig. 60. 30-h.p. Induction Motor Driving Cane Hoist in Sugar Mill

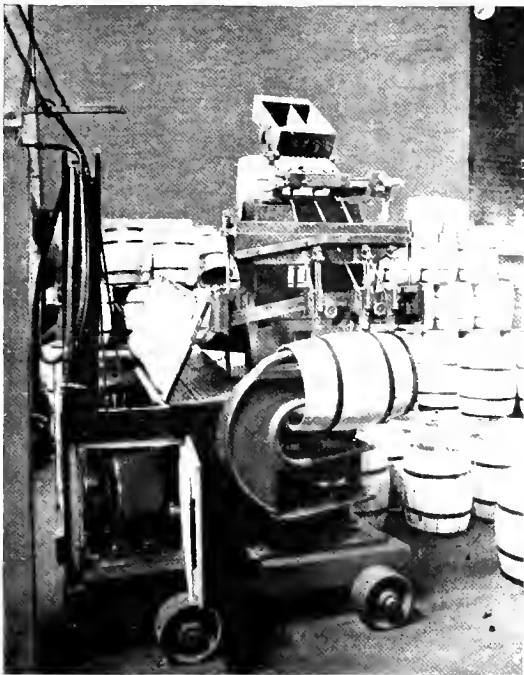


Fig. 61. Motor-driven Portable Machine for Nailing Hoops on Barrels in Cooper Shop

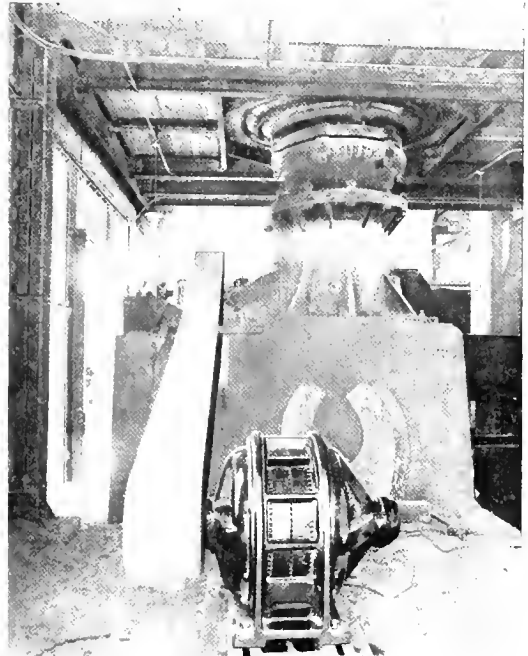


Fig. 62. 50-h.p., 900-r.p.m., Form K, 440-volt Induction Motor Driving Crusher



Fig. 63. 200-h.p., 1200-r.p.m., Form K, 2200-volt Induction Motor Driving a Seven-saw 12- by 72-in. Edger in Lumber Mill

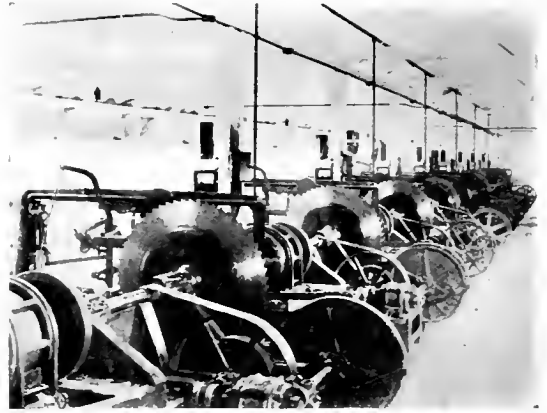


Fig. 64. Ten Upright Shingle Machines Each Driven by One 20-h.p., 1800-r.p.m. and One 3-h.p., 1800-r.p.m., Three-phase, 60-cycle, 440-volt Induction Motor

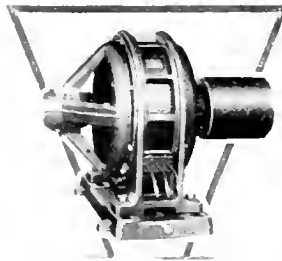
normal running load and the cycle approximately three minutes depending upon the grade of sugar. But even here the electric motor is doing the work.

When you come to the refinery, the advantages of electric drive are so well established that a general discussion is unnecessary.

Conclusion

The discussion of the industrial application of electricity might be extended to the chemical works, paint factories, gas works, ore treating plants, publishing houses, textile mills, tobacco factories, iron and brass foundries, machine shops, quarries, watch making, problems of freight handling and so on until the complete list of industrial activity is exhausted. In each the electric motor is found lightening the burdens of mankind and performing its duty in the most careful and economical manner.

No mention has been made of the various types of electric motors or the complete systems of control available for industrial use, and it is thoroughly understood that no one type is suitable for all requirements. The few applications briefly discussed have been made only after a careful engineering study of the character of work to be performed, the conditions under which the motor must work, the cycle of operation, etc. It is thoroughly understood that a motor with its control devices to operate a reversing planer equipment in a machine shop must be designed with entirely different characteristics from the motor best suited for operating a tippie in a coal mine. Each individual application must be studied. The direct-current motor will probably always have a demand in the industrial field, but in the large majority of cases the alternating-current motor has taken the lead.



Industry's Master Workman



ELECTRICITY IN AGRICULTURE

By CARL J. ROHRER

AGRICULTURAL SPECIALIST, LIGHTING DEPARTMENT, GENERAL ELECTRIC COMPANY

The application of electricity to agriculture is bound to be greatly extended in the next few decades and therefore a review of what has been accomplished is of value. The author goes quite fully into some of the most important phases of this work; the problem of getting the electric energy to the farmers is among the many important things dealt with.—EDITOR.

Fifteen years ago an electric installation on a farm was a rarity, ten years ago it was still thought to be a great novelty and not until about five years later did the farmer begin to seriously consider the many advantages of electricity. Since that time, however, the farmer's change in attitude has been rapid and today he is an enthusiastic advocate of electric light and power. Almost every

expect them to lead in this particular line. Austria-Hungary has a population of 196 per square mile, France 191, Germany 312 and Italy 313. All of these countries have from six to ten times our population per unit area and agriculture is practised in its most intensive state. There, very exhaustive studies have been made as to the possibility of agricultural electrical development. Numerous



Fig. 1. German Exhibit showing Motor-driven Ensilage Cutter

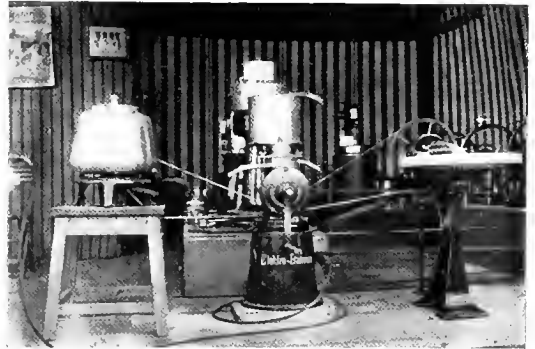


Fig. 2. Dairy Section of a Foreign Exhibit

farmer who is not using electricity at the present time is laying plans to do so as soon as his financial condition permits. This is conclusively proven by the fact that our various agricultural colleges are being flooded with inquiries on this subject. So heavy has the pressure become that classes are being organized and bulletins prepared.

This rapid change is really to be considered remarkable when one stops to reflect that our present population is only about 31 persons per square mile and that only about 50 per cent of these live in the rural districts.

In Europe, especially in Germany, the electrification of the farm has reached a very pronounced stage of development. However, Europe's population is so much greater per square mile that one would naturally

exhibits have been held to educate the rural population and every government has established experiment stations where new farm apparatus of all kinds has been tested and tried out under the supervision of competent government officials. If found wanting the facts are so given and the machine is not recommended, with the consequent result that only suitable apparatus is purchased by the farmer.

A large number of small central stations have been established in the rural districts of Germany supplying light and power to a few small towns and the rural population of the vicinity. Many of the German farmers carry on other industries in connection with their farm work because it enables them to keep their help busy when work is slack or the



Fig. 4. Exhibit Hydro-Electric Commission, Dairy Section



Fig. 6. Exhibit Hydro-Electric Commission, Motor-operated Water Systems and Milking Machines Exhibit of the Province of Ontario

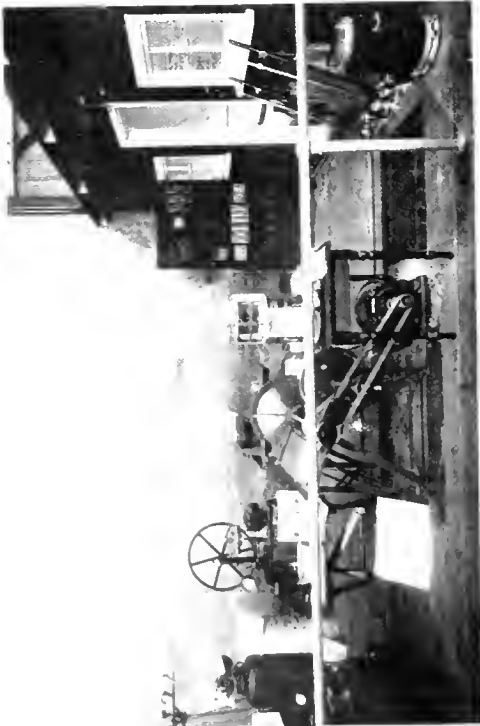


Fig. 3. Exhibit Hydro-Electric Commission of Electrically-driven Wood Saws and Pumps



Fig. 5. Exhibit Hydro-Electric Commission, Electrically-operated Farm Machines Exhibit of the Hydro-Electric Commission of the Province of Ontario

weather unfavorable for labor in the field. This is a type of intensive agriculture which is rarely practised in this country.

In Europe many of the farm machines are supplied by their manufacturers equipped with suitable electric motors. Feed grinders and ensilage cutters with direct connected motors are just as common in Germany as motor-driven lathes and planers in the United States.

Perhaps the most advanced step made by Europe has been in the way of electric plowing. France, Germany and Italy all have made a very large number of experiments to determine the adaptability of electricity for plowing and such outfits have been put in actual production by European manufacturers. Germany has a considerable number of such plowing equipments in actual operation.

Two systems of electric plowing are in common use. In both systems the general appearance of the plow is the same, it being constructed in such a way as to enable it to operate while traveling in either direction.

In one the current is supplied to the plow by means of a two-conductor trolley. A heavy chain is stretched across the field and securely anchored at each end. This chain passes around a drum mounted on the plow, the drum in turn being driven by the electric motor. The anchor wagons to which the chain is attached at each end of the field automatically move forward as the plow travels back and forth across the field.



Fig. 7. Motor-driven Grain Cleaners and Graders, European Exhibit

The other system requires two large trucks, one at each end of the field, upon each of which are mounted an electric motor and cable drum. The plow is drawn back and forth by means of a cable attached to each end of the plow and to the drums. This equipment, however, is more expensive to operate as it

requires at least three men and a duplicate system of motors and winding drums.

A complete plowing equipment of the truck and cable type capable of drawing five or six 14-in. plows across a field 1300 ft. wide will cost in the neighborhood of \$15,000. This outfit is complete in every detail and includes

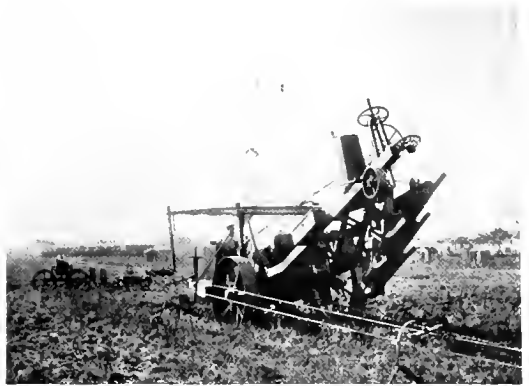


Fig. 8. Electric Plow of the Chain and Trolley Type

two 75-h.p. motors, transformers, switches, plows, cables and trucks. A complete equipment of the above capacity using a chain and trolley and one 75-h.p. motor will cost approximately \$10,500.

Little or no experimentation has been made in this country to develop a suitable electrical plowing equipment, primarily because electrical transmission systems are not available and also because of the low cost of coal and fuel oils. A fortune awaits the man who will develop and put into practical operation an electrical plowing outfit which will be reasonable in first cost and economical in operation.

In 1905 the government of the Province of Ontario, Canada, created what is known as "The Hydro-Electric Commission." This Commission was primarily appointed to develop, control and operate the water powers belonging to the Province. In 1911 the Provincial Legislature passed a law, the object of which was to enable the Commission to distribute electrical energy to the residents of the rural districts. An extensive campaign of education was conducted consisting of meetings and exhibits throughout the Province.

In addition, a number of demonstration farms have been completely equipped. The result has been that a large number of farmers have signed power and lighting contracts; however, no definite figures are available as

to the actual number of farmers signing such agreements.

In the United States the application of electricity to the farm is advancing, as is shown by the enormous increase in the number of isolated plant manufacturers, there being about 200 of such concerns at the present



Fig. 9. Portable Motor and Six-Inch Centrifugal Pump for Irrigating Forty Acres of Alfalfa in California

time. This coupled with the fact that central stations are supplying at present between 50,000 and 75,000 strictly rural customers gives some idea of the possibilities of rural development.

Electricity at the present time can be advantageously applied to over 125 various uses on the farm. Electric applications even in their simplest form bring great advantages to the farmer not only in economy but because they eliminate to a very large extent the drudgery of farm life.

The hard work and the long hours of work have made the farm labor problem a serious one. It is so serious in fact that many farmers instead of trying to get efficient labor have turned their farms over to tenants or else seeded their land to grass and pastured their stock. Electricity perhaps as much as any other one factor will tend to alleviate or minimize these conditions and make it easier to secure farm labor by checking the migration of our young men to the city. It will also make possible the more economical performance of farm operations by shortening the time required and lessening the cost which will in turn enable the farmer to pay higher wages for shorter hours of work.

Perhaps the greatest progress in the rural field has been in the application of electric

motors for irrigation and for the reclamation of land. In our western sections, irrigation is absolutely necessary in order to produce crops of any appreciable size and in many localities it is impossible for vegetation to exist without the artificial application of water.

The gravity system is perhaps the one most extensively used in the west; however, it has two serious disadvantages—namely, the inability of the farmer to get his quota of water any time he desires and also the impossibility of irrigating any land situated at a level higher than the canal itself. To overcome these difficulties suitable pumping equipments have been installed, the water being secured from underground supplies or from rivers, lakes and canals.

Steam, gasolene and distillate engines, as well as electric motors, have been installed by the thousand in this territory. The area under irrigation by pumping in 1909 amounted to 500,000 acres, the horse power required being 243,500 h.p. Conservative estimates show that these figures have been at least doubled since the taking of the 1910 census.

The United States government and the various state agricultural experiment stations have spent thousands of dollars in experimental work to determine the proper amounts of water necessary for crops in the various sections of the country. The government has also assisted in financing the great irrigation projects.

As in the case of all other farm operations, labor is scarce and any mechanical device which will eliminate the necessity of such labor, unless such device is very expensive, will be welcome with open arms by the farmer. While steam, gasolene and distillate engines as prime movers cut the labor cost to a considerable extent, they are in no way comparable to the saving brought about by the use of electric motors. In the arid regions, where a large amount of water is required it is often necessary to operate pumping plants 24 hours a day for a month at a time and in many cases six months. The engine-driven plants require an operator to be in practically constant attendance, while in the case of the motor-driven plant a casual inspection every two or three days will suffice. This difference in the amount of attendance required means a considerable monetary saving in the course of a year.

The extended use of electrically driven irrigation plants is a comparatively new proposition, most of them having been

installed in the last seven or eight years. Perhaps the greatest development has been made in California, where one company alone has approximately 9000 farms using electric power.

This power company derives a gross income of approximately \$500,000 per year from motor-driven irrigation plants. Several other companies in California have from 2000 to 7000 farmers on their lines. The amount of irrigation load has been such that even in the case of the very large companies, the peak load has been shifted from the evening hours of the winter months where it ordinarily comes to the daylight hours of the summer months.

The rural load of many of the smaller power companies consists of as much as 60 per cent of the total. One company especially has an ideal combination in the way of load, as it consists of railway, lighting and irrigation pumping with a yearly load factor of approximately 60 per cent. During the height of the irrigation season, the peak load comes on at about nine o'clock in the morning with another peak almost as high as four o'clock in the afternoon. The minimum load is at four a.m. being approximately one-third of the morning peak. This company's load factor during the summer months is approximately 70 per cent.

Another California central station has a rural load amounting to 33 per cent of the total, another 50 per cent, while in the case of a third it amounts to 67 per cent. The rural connected load in motors in California is at least 130,000 h.p., most of this being for irrigation.

While California is the leading state as far as irrigation is concerned, Washington, Oregon, Colorado, New Mexico, Utah and Arizona all have large numbers of farmers using electric motors. The states of Washington and Oregon alone have at least 5000 h.p. in electric pumping motors.

This is in reality only a very small percentage of the prospective business, when one stops to realize that California has 88,000 farms, Arizona 9000, New Mexico 35,000, Oregon 45,000, Utah 21,000, Colorado 46,000 and Washington 56,000 farms. Probably 50 to 75 per cent of these farms can use irrigation to advantage.

From these figures it can be readily seen that the field for irrigation is by no means exhausted and that the possibilities for irrigation load are still very great.

It is perhaps the common impression that irrigation is not usually practised except in

our far western states; however, this is not the case. There are to be found a considerable number of reclamation projects in the south and in the Mississippi valley, where motor-driven pumps are used, the apparatus being so arranged that water can be pumped in

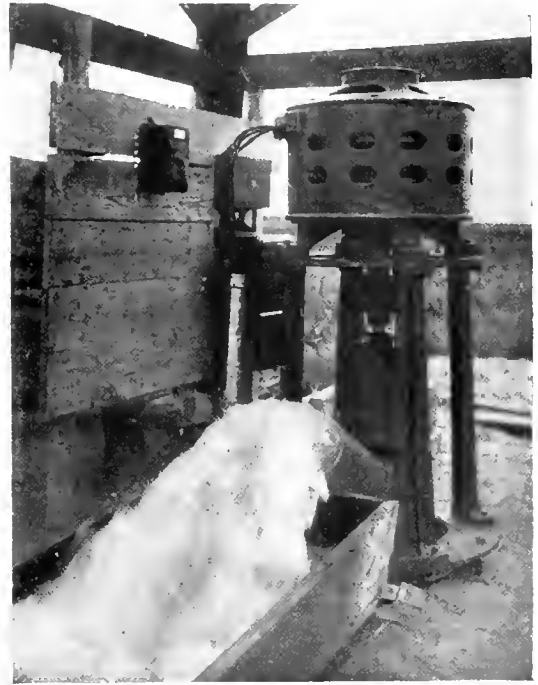


Fig. 10. 35-h.p. G-E Induction Motor Operating 1600-gallon Pump

either direction. During the flood periods the water is pumped into the river or lake, while during the dry season the water is pumped from the river or lake back upon the land.

Rice irrigation is also of considerable importance as the 1909 census shows that there were about 1900 pumping plants in use in Arkansas, Louisiana and Texas aggregating 118,000 h.p. and capable of delivering 9,500,000 gallons of water per minute. If these pumps operated 24 hours a day for one week, they would cover 270 sq. miles of land two in. deep.

There is also another field in the humid sections of the United States for the application of water by artificial methods—namely, the truck and market garden. In some sections of the east, this has reached a very considerable stage of development.

It is a peculiar, but well established fact, that when irrigation is inaugurated in a truck or market garden region, the prices

obtained by the farmers using such irrigation are so much greater that the other truck and market gardeners in that vicinity have been compelled to install irrigation or else accept lower prices for their produce. This is due to the greater quantity and better quality of the products obtained under irrigation, coupled



Fig. 11. 35-h.p. G-E Induction Motor Driving a Pump
Delivering 2000 Gallons per Minute,
Irrigating 160 Acres of Alfalfa

with the irrigation farmer's ability to market his crops earlier, thus getting the cream of the market.

The United States Weather Bureau reports show that almost every summer there are considerable periods of time when a condition of drought exists—namely, less than one inch of rainfall in any 15-day period. These droughts sometimes last for a month or six weeks, completely exhausting the supply of moisture in the soil and causing a decided shrinkage in the quantity, and producing a very inferior quality of product, which must be sold at low prices.

The system of irrigation mainly used for supplying water in the humid sections is almost exclusively of the overhead type, or what is commonly known as the sprinkler system. By this method water is applied under considerable pressure in order to deliver it to the plants in the form of a fine spray. The pressure ordinarily used is from 40 to 50 lb. per sq. in. at the nozzles; this means that a large amount of energy will be required to drive the pump as it must work against a head of from 90 to 115 ft. plus the vertical elevation of the pipes above the water in the well together with the friction loss in the pipes themselves.

Motors for this kind of irrigation are not usually run continuously, ordinarily they are

installed in such capacities that they will operate from three to eight hours per day depending on the amount of rainfall. One to one and one-half inches of water per week is ordinarily considered sufficient to grow good crops; if the rainfall drops below this the additional water is supplied by irrigation. Unless the season is very wet, the plants are usually sprinkled for a short period once a day—either in the early morning or late in the evening—as this has been found to materially aid their growth.

The use of this type of irrigation equipment requires a considerable outlay of money, the piping, pumping equipment, etc., making the installation cost from \$100 to \$150 per acre.

The results obtained, however, have been very satisfactory, and the increase in the quantity and quality of product has made it a paying proposition even when the additional cost of such systems has been considered.

There is a large amount of land in the vicinity of all our large cities devoted to the raising of such crops, and in view of the severe competition in this particular phase of agriculture it will be absolutely necessary in the future for this class of farmers to install pumping equipments in order to successfully compete with those using irrigation. Already many of the more progressive market gardeners have taken advantage of the additional benefits derived and are using motors of from 5 to 25 h.p. to operate pumping equipments.

The load is ideal from a central station standpoint, in that it is exclusively a summer load and rarely if ever interferes with the lighting peak. Those companies who have such customers on their lines have found that this is very good business providing only short line extensions are required. If necessary to run long lines the business is not desirable unless the farmer consents to pay part of the first cost.

In the mind of the farmer lighting is naturally the first consideration and, therefore, the conveniences derived from electric lights are of almost inestimable value from his standpoint. Ordinarily the farmer considers that the lighting of the house and the proper illumination of the barns is the first and of primary importance; however, after these lights have been installed and their value fully realized, the next step is usually the installation of a number of lamps around the farm lots, situated at such points as to give most satisfactory results.

Of principal importance, however, is the very material reduction of fire risk, great losses each year being caused by lamps and lanterns together with the habit of using matches as a source of momentary light.

The amount of work required of the farmer's wife is usually large to say the least and, therefore, any conveniences or labor saving devices are of great assistance in performing the household duties. A good system of domestic water supply, saving hundreds of steps during the course of a day, is an example, for such a system with an electric motor drive and equipped with an automatic starting and stopping device requires practically no attention and pays for itself many times in the saving of actual labor.

It is really remarkable what can be accomplished in the average farm home with the aid of a small motor of $\frac{1}{8}$ - or $\frac{1}{4}$ -h.p. capacity. In a large number of instances a motor has been installed at some convenient point in the kitchen or pantry and belted to a line shaft having a number of pulleys of various diam-

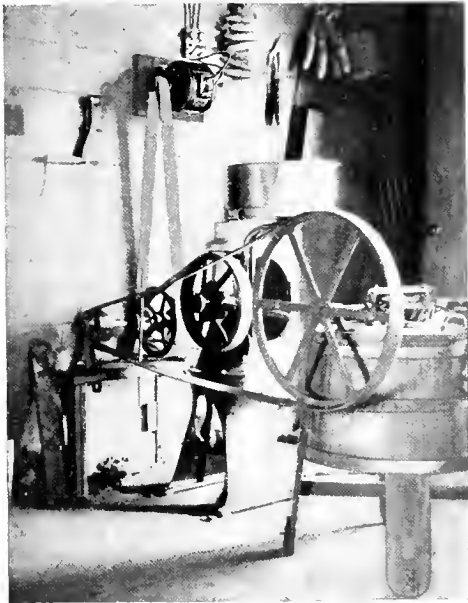


Fig. 12. Motor-Driven Washing Machine and Cream Separator

eters. On a suitable base has been mounted a number of clamps convenient for holding the different machines used in the kitchen.

In one particular instance, this outfit consisted of a coffee grinder, flour sifter, meat grinder, bread mixer, egg beater and buffer

and grinder. Furthermore the motor was mounted in such a manner that it could be easily removed and used to operate the washing machine, churn and sewing machine.

For instance, the washing machine was located in the basement, the churning was done on the back porch in summer and in the

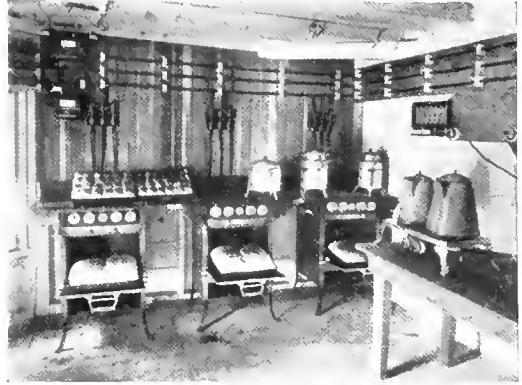


Fig. 13. Electric Kitchen Installed at Headquarters Ranch, California

kitchen in the winter, while the sewing machine was equipped with clamps for holding the motor. In the case of the washing machine, the wringer was also arranged to enable it to be operated by power.

All the necessary equipment for transmitting the power was designed and installed by the farmer himself. The whole outfit took very little room and represented a comparatively small initial investment. This particular instance is not an isolated case, as investigation will show that there are hundreds of such installations, perhaps not quite so complete as to details, but still serving the needs of a definite case.

Electric vacuum cleaners which can be operated from the lighting circuit are also in considerable demand, as they are great labor savers and easily transportable from one room to the other.

An electric fan in the kitchen on a hot summer's day is a piece of electrical equipment which is very much appreciated by the housewife.

Of the heating devices, the electric iron is almost in universal use wherever electricity is available, especially during the summer months, as it enables the housewife to do her ironing in the coolest and most convenient place. The various other heating devices are not so popular, although there are a considerable number of heating pads, hot water

heaters, toasters, hot plates and coffee percolators in use.

Perhaps the most important of the applications of electric drive is that of pumping water for both domestic and general farm purposes. An electrically driven pumping equipment makes an ideal water system.



Fig. 14. Cream Separator Driven by $\frac{1}{2}$ -h.p. Motor

In many instances it is necessary that the pump be situated a considerable distance from the buildings. In such cases the starting equipment can be installed at this central point and the motor even though a half mile away may be started and stopped at will, or it can be made to operate automatically. A motor-driven water system is not expensive to operate and the first cost is no greater than a similar installation using some other source of power.

With the ever increasing population in our country, the land has become well occupied and it is becoming almost a necessity that a system of water supply be secured which is independent of the running streams, due to the fact that the water of such streams may easily carry a contagious disease to the farm animals causing a very serious property loss.

Hog cholera and foot and mouth disease are two of the most serious diseases at the present time which can be easily transmitted in this manner. Much of the loss from infectious

diseases among farm animals has been directly traced to the running stream and the farmer may easily pay the cost of an installation of an adequate water system from the loss which he would occasion by the spread of disease among his herds. This danger has resulted in a very material increase in the number of such plants installed.

The cream separator at the present time has come into almost universal use, and when power-driven the saving in labor is quite appreciable. For instance, it has been found that an electrically driven separator of 500 lb. capacity per hour, even if only 200 lb. of milk is separated each day will show a saving of \$10 per year after all expenses are considered. In addition there will be an actual saving in labor of at least 24 minutes per day or over two weeks' time during the year. This 24 minutes per day can be used to advantage in doing other chores such as washing the milk pails, etc., thus lessening the chore period by that amount. A farmer separating 500 lb. of milk per day would save in actual cash \$35 a year, this amount being left as profit after depreciation, interest, labor and power are charged against the operation. There will also be available for other work during each day a period of one hour or 36 working days of 10 hours each which is a very considerable item to the average farmer.

One of the principal advantages tending to promote the use of the electric motor is its simplicity. No other source of power can compare with it in this respect. The horse must be fed and cared for, the gas engine must be adjusted, the steam engine requires a licensed engineer, but the motor needs only an occasional oiling.

Portability is another feature of the motor, it weighing only two-sevenths as much as a gas engine of the same capacity. A 5-h.p. motor will weigh 340 lb. and can be easily transported from one building to another. This is of sufficient size to operate small feed grinders, corn shellers, fanning mills, grain elevators, concrete mixers, alfalfa mills, grain graders, hay cutters, etc.

When the central stations first tried the installation of portable equipments, it was difficult if not impossible for the farmer to change the motor from one point of use to another. This meant that a representative of the central station must make a trip to disconnect and reconnect the motor to the lines. However, a few simple instructions have been found sufficient to eliminate this inconvenience and ordinarily motors are now

changed from one place to another without difficulty. Several hundred feet of armored cable are usually kept ready, this being used in case it is necessary to install the motor some distance from the nearest outlet box.

It is really remarkable the number of things which can be accomplished with one or two motors about the average farm. On rainy days they are used to grind feed clean and grade grain, shell corn, etc., and at other times to operate concrete mixers, grain elevators, wood saws, etc.

Actual experience has demonstrated that a farm of average size requires about four motors as follows— a $\frac{1}{8}$ - or $\frac{1}{4}$ -h.p. for the house, a 1-h.p. motor for the small farm machines, a 5-h.p. for machines of intermediate size and a 15- or 20-h.p. motor for the heavier farm machinery.

In the past the tendency has been to have the threshing, corn shelling, baling and ensilage cutting done by a custom machine, i.e., a machine owned and operated by a crew of men separate and distinct from the farmer's own organization. Indications point to the fact that this system is rapidly going out of use, the general tendency at the present time being for the farmer to buy a small equipment and operate it with his own help. For instance, in the past a threshing equipment consisted of a grain separator with a 32- or 36-in. cylinder, necessitating a large traction engine and a very considerable force of men to keep the outfit in constant operation.

The president of one of the large threshing machine manufacturing companies made a statement not long ago to the effect that the demand is rapidly shifting towards the smaller machines. The reason for this is attributed to the fact that the farmer can do his own threshing with the assistance of but two or three neighbors, whereas with the old system it required the combination of from 10 to 20 farmers and from 25 to 35 men to keep the machine in motion. The result was that one or two weeks' time was required to complete the threshing. If any breakage occurred, it meant the loss of at least a half day for the whole force. Another disadvantage, especially during a rainy summer was that someone had to have his threshing done last and would in all probability suffer a considerable loss due to damage from the weather.

With the new arrangement, the work can go on without the loss occasioned by the old system and in addition any postponement of the work does not necessitate the replanning of work of the whole neighborhood. The

points mentioned also hold true for ensilage cutters, hay balers and clover hullers; however, the force of men required in this case is not so large as in the previous illustration. This change also means a larger market for small sized equipments of all kinds and furthermore it means that one or two farmers will



Fig. 15. Threshing by Electric Power

now combine and purchase a portable motor and transformer of sufficient capacity to operate these machines. This was impossible before, because the large equipments required from 75 to 100 h.p. to operate them, now 35 h.p. is usually the maximum needed.

A 15- or 20- or even a 35-h.p. motor can be easily transported together with a suitable transformer from one farm to another. Formerly it was necessary for a representative of the central station to disconnect and reconnect the transformer whenever such a change was made; at present, however, an armored cable is used having at one end suitable leads equipped with hooks. These hooks can be hung over the transmission wires or removed with perfect safety by the farmer.

In some cases a flat charge of from \$5 to \$10 a day is made for the electricity, but usually a meter is installed on the secondary side of the transformer, the current used being paid for at the regular rates. Such an outfit is very flexible as it eliminates the core loss of the transformer when not in use and in addition gives the central station a very good summer day load.

Instead of using horses to draw the hay into the mow the farmer now uses a power hay hoist. This is readily adaptable to electric drive, the motor being belted to the hoist. With these hoists all operations are controlled from the load and of course this can be readily accomplished in the case of motor drive.

In the potato-growing regions of the United States motor-driven potato sorters have come into considerable use. Motors are also of value in the apple industry for driving belt conveyors and apple wipers.

The newspapers and magazines have perhaps published more articles describing the



Fig. 16. 250-Egg Electric Incubator

remarkable results obtained by stimulating plants electrically than any other one farm subject. However, the facts of the case are that the whole matter is still in the experimental stage and while results have been obtained they have not been conclusive and furthermore their value from a practical standpoint is still very much in doubt. The United States government has been investigating this subject and finds that, while the plants show beneficial effects, these are not sufficient to warrant the use of this application on a commercial scale.

This lack of results may be due to the fact that the action of the electric current on the metabolism of the plant is not fully understood and it may be that further investigation will bring out important discoveries which will make such applications practicable; however, at the present time nothing of commercial value has been developed.

Another innovation in the way of electric drive has been its application to compressed air spraying equipments for the protection of orchards and truck gardens from the injurious ravages of insects and beetles. The outfit consists of a motor-driven air compressor which supplies air at a pressure of some 200 or 300 lb. per sq. in. All equipments including the mixing tanks are located at a central point. The spraying carts are equipped with two tanks, one for the spray liquid and the other for the compressed air.

The two tanks are interconnected at the bottom through a pipe containing a reducing valve, thus giving a constant pressure in the liquid tank of 100 lb. per sq. in., which is the best pressure to use for spraying purposes. The compressed air entering at the bottom of the liquid tank also serves to keep the spraying liquid agitated and prevents the solid constituents from settling to the bottom.

This equipment, while costing a little more, weighs less and requires practically no mechanical skill. The man at the mixing station can mix the liquids, the motor operating automatically when air is needed.

The farm shop is not complete without electrical equipment, a small motor being very convenient to drive small saws, grind stones, emery wheels and forge blowers. An electric portable drill is quite popular, as it enables repairs to be made on machinery in other buildings without tearing the machine down and taking the part to the repair shop. The electric soldering iron is another handy device, as its convenience in attaching to any lamp socket makes it available for use wherever there is electric current.

Electric hot water heaters find many applications, about the farm, especially in cases of sickness among the farm animals, as they make a supply of hot water available in all the farm buildings. In several instances they have been used as paint buckets to keep paint warm while painting buildings.

These, however, are not the only applications of electricity for the electric vehicle must be considered. At the present time there is a great deal of agitation tending towards the installation of hard roads throughout the various states. In the east remarkable progress has already been made in this direction. With the advent of these hard roads, the use of the electric vehicle will be appreciably increased. A number are already being used in the East for the marketing of farm products. Due to its simplicity and reliability it is safe and unexcelled as a convenient method of transportation for the farmer's wife for it enables her to do the family marketing and attend to her social duties in a manner never before possible. For this reason it will ultimately be the principal means of transportation for the feminine members of the farmer's household.

A review of the applications of electricity to agriculture would not be complete without a few words concerning a gasoline-electric harvester manufactured and used in California.

This machine cuts, threshes and recleans the grain in the field all in one operation. The outfit consists of an 80-h.p. six-cylinder gasoline tractor and a combined harvester cutting a swath 35 ft. wide and having a capacity of 2200 bushels of grain per day. Upon the tractor is mounted a 20-kw. generator driven by the tractor engine. A 25-h.p. motor operates the moving parts of the harvester such as the cylinder, sickle, conveyors, recleaners, etc.

The principal advantage of this equipment lies in its efficiency over the old method of driving by power derived through traction.

1 $\frac{2}{3}$ per cent have milking machines.
 12 per cent are now prospective customers for such machines.
 60 per cent have fanning mills.
 20 per cent have silos.
 3.3 per cent have ensilage cutters.
 9.5 per cent have threshing machines.
 45 per cent have gas engines.
 10 per cent have steam tractors.
 20 per cent have feed grinders.
 5 per cent have hay balers.

The above figures are from investigations made in 1913 and there is every reason to believe that all percentages have been

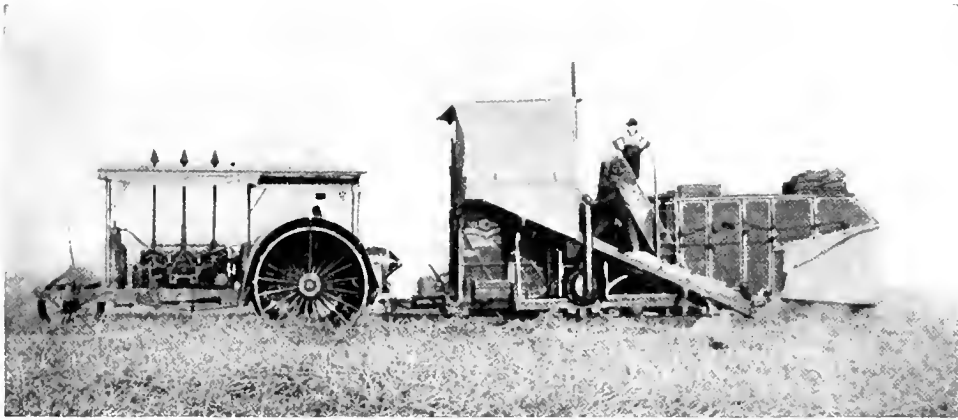


Fig. 17. Gasolene Electric Harvester

Other advantages are flexibility, light weight and lower operating cost. The cost per acre with this machine averages 80 cents against \$2.50 for a horse-drawn harvester and \$3 per acre where a stationary thresher is used.

Some idea of the possibilities of rural development may be gained from data obtained by a number of farm papers by means of circular letters addressed to their subscribers, who total some 400,000. The following figures give the approximate percentage of subscribers using the various types of machines to which electric motors can be applied:

64 per cent have washing machines.
 15 per cent of these machines are power-driven.
 96 per cent have sewing machines.
 65 per cent have cream separators.
 80 per cent have pumps.
 6.2 per cent have water systems with power pumps.
 33 per cent have incubators.

increased by purchases during the last year and a half.

For instance, these investigations show that over 50 per cent of the farmers were planning to buy and install water systems requiring a power pump. As the number of farmers having power-driven machinery increases, the field for electric motors and for electric power will also increase in proportion.

Many of the central station companies throughout the United States have taken considerable interest in the farmer as a prospective customer and a large amount of experimentation is now under way in order to determine what revenue may be expected from such installations and the most satisfactory method of financing them.

This is not a surprising fact when one stops to reflect that only a comparatively few years ago considerable doubt existed in the minds of electrical engineers and central station managers as to whether or not the residential lighting customer was a profitable proposition.

The same thing was true of the various applications of power. However, most of the difficulties of city distribution have reached a satisfactory solution and today it is generally agreed that city lighting and power is very desirable business. The same difficulties are now being considered in the distribution of electric current to the farms and rural communities.

It should be also remembered that the problem of rural service requires special treatment and should, therefore, be considered as a separate and distinct branch of the central station industry.

Progress, however, will not be extremely rapid due to the large number of questions

are some ten other small villages scattered throughout the county, the largest of which has a population of 1900 with eight or nine others having a population of approximately 500 to 700. As the revenue from such small towns is comparatively small, the principal returns will have to ultimately be derived from the rural inhabitants.

The president of this company is also a contractor of very considerable importance in his own state and he feels convinced that his company can gradually make the necessary extensions and that they will pay a reasonable profit on the investment.

The prominence of this man in the business world is such that the result of his endeavors



Fig. 18. Demonstration Car of the Pacific Gas & Electric Co.

which yet remain to be settled by experimentation.

As an isolated illustration, a central station company in the middle west proposes to cover the county in which it is situated with a network of transmission lines. The county has an area of about 400 square miles and a population of 27,000 or 67 persons per square mile, the largest town having 5000 inhabitants. This county has a rural population of 13,500, this figure excluding all towns of over 100 inhabitants. This means a rural population of 33.5 persons per square mile. At the present time only a small area of this county is being supplied with electric current; however, extensions are rapidly being made and the ultimate plan is to completely cover the whole territory with transmission lines. There

in this line will have considerable weight with a number of other central stations, who are awaiting results before venturing into the business on such an extended scale.

From the preceding figures, coupled with the fact that the United States has only about one-sixth of the population per square mile that is found in Europe (or rather was found in Europe), it can easily be seen that the rural electrification in this country is really in its infancy.

A number of companies, however, have already conducted extensive educational campaigns, the most prominent of these being the Pacific Gas & Electric Company, the Edison Electric Illuminating Company of Boston and the Pacific Power & Light Company. All have made exhibits showing the various

applications of electric light and power to the farm. While the immediate results obtained have not been especially encouraging, the officers of these companies are convinced that this educational work will ultimately result in a large amount of new business.

Ordinarily, from a central station standpoint, farm lighting alone is not profitable, as power applications are the deciding factor which swings the balance from loss to profit. The average city customer installs the necessary number of lights, buys a flatiron and a few other devices and the limit in revenue from this source has been reached. The farmer on the other hand keeps finding new

Other companies make the farmers build all the supply lines, furnishing power and light at a nominal rate, the lines remaining in the customer's possession. Others follow the same principle, but refund a certain percentage each year in electric current. Then if the line is a paying proposition this refund continues until the title of the lines ultimately comes into the possession of the central station.

Still other companies require at least four customers per mile with a guarantee of a certain monthly minimum. In addition a connection charge is made which covers the cost of the poles and their erection and some-

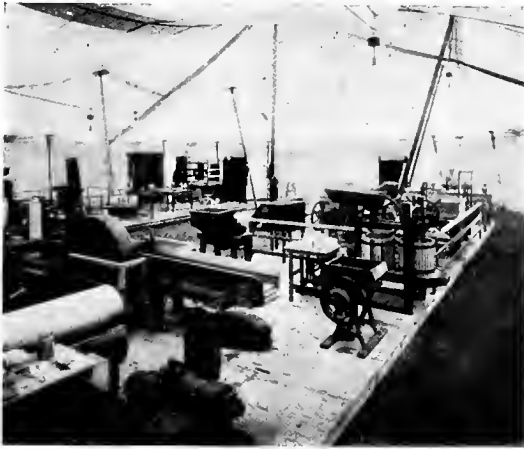


Fig. 19. Exhibit Farm of Edison Light & Power Company

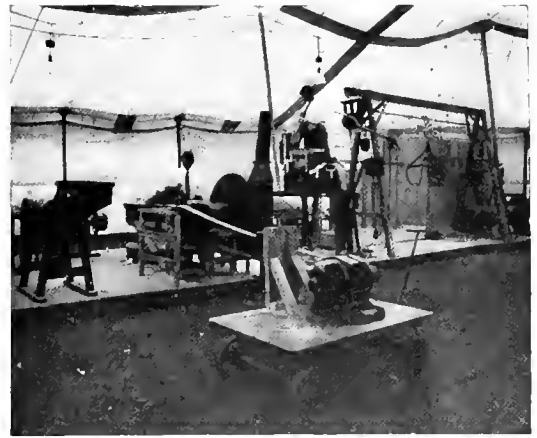


Fig. 20. Exhibit Farm of Edison Light & Power Company

things to do with electricity, and the farm load even though the number of customers remains constant increases each year through the addition of motors and various other devices.

The power situation is one which the isolated plant cannot economically meet except where water is available, or under such special conditions as the presence of cheap natural gas. Until such time as central station power can be made available, the gas engine must be the farmer's only alternative.

The principal problems for the central station are those of rates and first cost. Various systems are now being tried out throughout the country with varying degrees of success. Some companies build their own lines and consequently must charge a high rate which will be unsatisfactory from the farmer's point of view as it practically limits him to the use of electricity for lighting and absolutely discourages the use of power.

times even the transformer is added to the charge where lines are especially costly.

A variation of this consists of a connection charge with an alternative clause allowing the farmers to haul and erect the poles under the supervision of a competent foreman. This latter method has been found to be very satisfactory, as the farmer counts his time as a very small item and, in the majority of cases, he is more than willing to do this work because it enables him to get electric service without a large outlay of actual cash.

Sometimes the customer gets a refund in current running over a series of years or else all current consumed over a certain amount goes to apply on the refund. A service charge as a rule has been found to be unsatisfactory and should be avoided whenever possible.

By far the larger percentage of central stations who have been assisted by the farmers in erecting their lines are more than

pleased with their farm business and this method is becoming more and more the accepted practice among central stations. For it very materially reduces the first cost of such extensions and in addition gives both the farmer and the central station time to develop the consumption of electric current to such an extent that, by the time the complete cost of the line has been refunded, the farmer is using enough electricity to pay interest and depreciation on the investment and still leave a fair margin of profit.

No central station company need expect the farm business to pay from the very first, for the farmer must be educated to the many and varied uses of electric current before he really becomes a paying customer and the only way in which he can be educated successfully is through actual experience.

The character of the farm load makes it desirable business from the central station

standpoint, in that it is "off-peak." The lighting peak very rarely corresponds with those of the city customers and the power load comes on almost exclusively during the daylight hours, being heaviest during the summer months.

Very little can be expected from this type of business, unless an aggressive educational campaign is carried on. Progress will not be rapid until the pioneer central stations in this branch of the industry have given this new field a thorough test and proven conclusively that it can be made a financial success.

The writer's observation has been that those central stations who have had farmers on their lines for a considerable period are as a rule quite enthusiastic concerning the possibilities of this business. However, there is a great deal yet to be accomplished and this can only be done by the active co-operation of both the manufacturer and the central station.

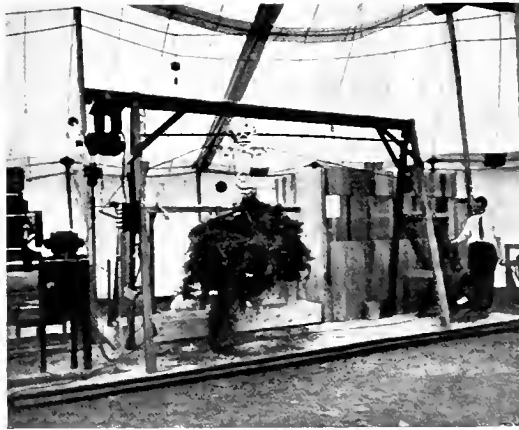


Fig. 21. Exhibit Farm of Edison Light & Power Company

THE ELECTRIC LAMP INDUSTRY

BY G. F. MORRISON

MANAGER OF WORKS, EDISON LAMP WORKS, GENERAL ELECTRIC COMPANY

As the author points out, electric lighting was the motive causing a demand for electric generating and distributing apparatus, and while current is not generated for this sole purpose today the field of the electric lamp is responsible for an enormous consumption of electricity. The following article is therefore of great interest as it is essentially a review of the development, manufacture, efficiency, and cost of the various types of electric lamp from the time of the first successful production by Mr. Edison up to the present day.—EDITOR.

The lamp occupies a place by itself in the electric industry; no other electric appliance or piece of apparatus affords a parallel to it. All original generating and distributing equipments were developed in order to supply current for the operation of electric lamps, either arc or incandescent. The Brush Electric Company, the Edison Company, and the Thomson-Houston Company were all organized exclusively for the exploitation of systems of lighting. Similarly, all the early central station electric companies were founded solely to supply lighting service, and this purpose is still implied in their names. The different systems of distribution were evolved and the voltages adopted with the lamp requirements as the determining factor.

Later came the electric railway, hundreds of electric motor applications, electric heating, and many other minor uses of electricity; so that despite the remarkable growth of the electric lamp industry, the lamp does not today occupy so commanding a position as a current consumer as formerly. Notwithstanding this fact, the public still comes into more intimate touch with the lamp than with any other electric device, and gives more thought to its adaptation. In no other manner in which it serves our needs is electric service so rigorously judged or so highly regarded by the people.

The arc and incandescent lamps were contemporaneously developed as practical lighting equipments, the arc being slightly in advance. The arc lamp was a high power, efficient illuminant, suitable for the lighting of city streets, and the incandescent lamp, though less efficient, was available as a small unit, such as was required for interior lighting—it was safe, convenient and adaptable.

One of the early problems of designing engineers, which even yet has to be solved, is the "divisibility of the arc," or the attempt to produce efficient arcs as small units. Both illuminants have progressed side by side, an

improvement in one being nearly always quickly followed by some corresponding improvement in the other. Other illuminants have come and gone, but these two still divide the field much as formerly, except that in recent years the incandescent lamp has begun to be an important factor in street lighting. It is interesting to note that, despite the wonderful improvements as the result of persistent research and engineering development, the lamps of today, the magnetite arc and the Mazda incandescent lamp, are fundamentally very similar to their original prototypes. One point in illustration is that the screw base which Mr. Edison devised in connection with the early incandescent lamps is now used as the standard throughout the greater part of the world, having predominated over all other types. No essential improvements have been made in this base, and it is practically certain that no other design would have met all requirements so well.

A review of some of the important developments that have marked the progress of the incandescent lamp may be of interest.

Quantity

In 1881, 35,000 incandescent lamps, mostly of 16 candle-power, were manufactured in this country. In 1914 the number per year had increased to over 110,000,000, the average candle-power of which was somewhat higher. The world's production during 1914 was about 250,000,000 lamps. The growth since the start has been a steady one, remarkably free from abnormal years. The lamp is a necessity and its market is so little affected by hard times or business depression that it has often been called the "bread and butter" of the electrical business. This remarkable growth has required a continual enlargement of manufacturing facilities, beginning with the small shop where Mr. Edison made his first successful incandescent lamp (Fig. 1)

and extending to the large groups of factories now located all over the country.

The magnitude of the industry is indicated by the fact that the different divisions of the General Electric Company manufacturing



Fig. 1. Shop in which Edison Developed His First Incandescent Lamp

incandescent lamps are located in 12 cities, and employ 65 acres of floor space.

Development of Types

In 1881 the 16-c-p., 110-watt carbon filament lamp was practically the only size and type made. A few 55-volt, 8-c-p. lamps were made, but these were comparatively unimportant and soon passed away. Later, 10-, 20- and 32-c-p., and then 100-c-p. lamps were made in small quantities. About the year 1886 a three-ampere series street lamp for operation on 1000-volt direct-current circuits was developed, and shortly afterward a few styles for alternating-current series circuits up to 10 amperes were introduced; but the series carbon lamp was never important in street lighting.

Miniature lamps for decorative effects appeared about 1886, the first lamps of this kind being made for operation from low-voltage batteries. Later, 110-volt lamps of many shapes and sizes, including round bulb and imitation candle lamps, were produced in increasing numbers. Among these may be noted the Christmas tree lamps, which were modeled to represent colored fruits, flowers, animals, etc. The number of types of miniature lamps was greatly augmented when the tungsten filament made them practicable for automobile lighting and flashlight use; so that in the year 1914 about 12,000,000 minia-

ture lamps were sold. While today much of the sign lighting employs standard or large focus-type lamps, small long-burning sign lamps are extensively employed for outlining the letters and designs of signs, building fronts, etc. Since the perfection of processes for drawing tungsten wire of very small diameter, the low-voltage sign lamps are giving way to 110-volt lamps. About 3,000,000 Mazda sign lamps were sold in 1914.

The tungsten filament, introduced commercially in 1907 and followed in 1911 by the drawn tungsten wire filament, not only effected remarkable increases in efficiency, but very greatly extended the range of sizes and types. Carbon lamps larger than 32-c-p. were never very successful, while the small sizes were very inefficient. With the tungsten filament both larger and smaller lamps than those practicable with carbon are successful. The tiny "grain of wheat" surgical lamp, of almost immeasurably low candle-power, which is used to illuminate the stomach in critical

Percent Various Classes Incandescent Lamps Sold from 1905-1914 Total Number Lamps for Year = 100%

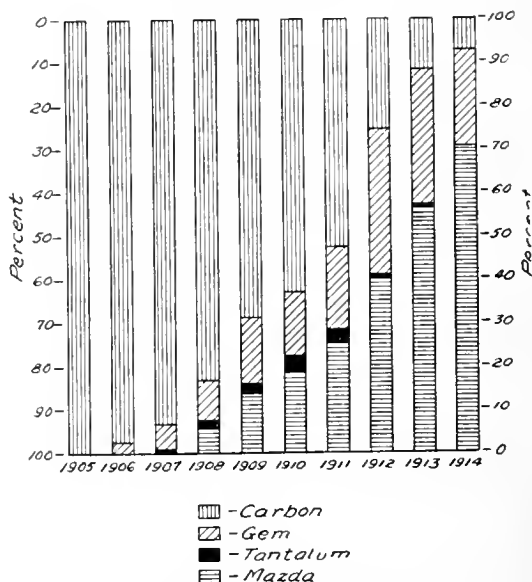


Fig. 2. Per Cent Various Classes Incandescent Lamps Sold from 1905 to 1914. Total Number of Lamps for Year 100 Per Cent

operations, now marks the lower limit. A considerable number of lamps of 1000 c-p. and larger are now sold, and special lamps giving 5000 c-p. have been made. The indications are that the high power limit will

be determined by the commercial demand and not by limitations in design. The number of lamps of the different types sold per year from 1905 to 1914 inclusive, expressed in percentages, are shown in Fig. 2. In the first year for which figures are given practically all the incandescent lamps were of the carbon type, while in 1914, 70 per cent of all incandescent lamps sold in this country were Mazda.

One of the outcomes of the use of ductile tungsten wire filaments is the focus type lamp. The effectiveness of a parabolic searchlight or of a projecting lens system depends upon the so-called "point source" of light, in which all the light emanates from the nearest practicable approximation of a dimensionless point. It is possible to wind a ductile filament into a very small space, and therefore the usefulness and possibilities of incandescent searchlights, headlights, stereopticon lamps, etc., have been very greatly increased.

During 1914 a radically new type of lamp was put in production. These lamps employ an inert gas instead of a vacuum within the bulb. They are made in both the series and multiple types, and in the high power sizes have efficiencies which not long ago were almost inconceivable. They are known as Mazda C lamps.

Therefore this new principle has made it possible to extend the range of sizes to include the highest power lamps for which there is any commercial demand, and today standard multiple Mazda C lamps cover a range from 100 to 1000 watts. Practically all of the series incandescent lamps up to and including the 1000-c-p. units are made in this type, and much higher power lamps, both multiple and series, have been produced successfully.

Series lamps up to and including 600-c-p. are made for direct operation on the 6.6 and 7.5-amp. circuits, fed from constant current transformers. The 400, 600 and 1000-c-p. units are made for operation on the same circuits, with a compensator or transformer at each lamp to step up the current through the lamp to 20 amp. (in the 400-c-p. the current is stepped up to 15 amp.). Thus it is practicable to effectively operate all sizes on the same circuit.

The great variety of lamp fixtures, housings, reflectors, globes, etc., that have been produced to give various distribution of light with the Mazda lamp, has given us a greater flexibility of lighting systems than were ever before attainable.

Efficiency

Mr. Edison's first commercial lamps operated at eight to the horse power and, while not so rated, actually consumed 5.8 watts per candle-power. Subsequent developments

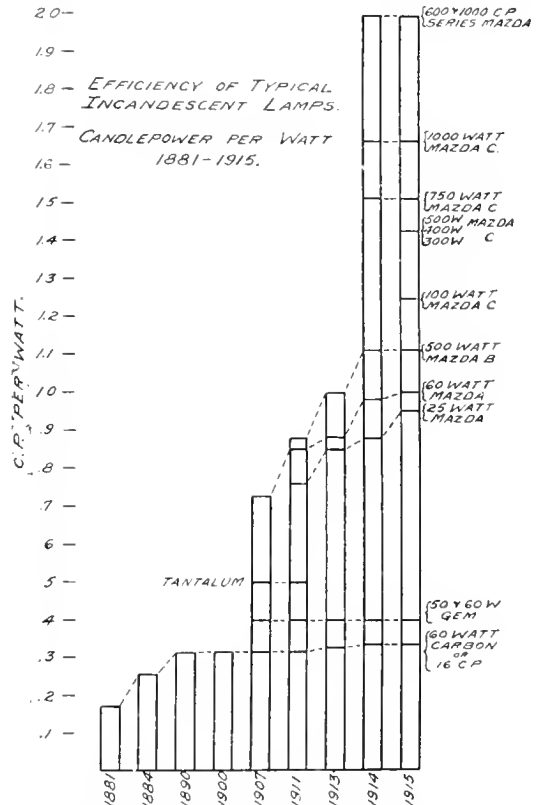


Fig. 3. Efficiency of Typical Incandescent Lamps. Candle-Power per Watt, 1881-1915

lowered the consumption to 3.1 watts per candle-power. The many years of extensive investigation has not shown the possibilities of improving the efficiency of the carbon lamp any further.

The metallized carbon filament or Gem lamp, which appeared in 1905, operated at 2.5 watts per candle-power. In the light of later developments these lamps seem relatively inefficient, but at the time this gain in efficiency over the carbon lamp was considered large, and, in fact, was great in comparison with corresponding improvements in other types of electrical apparatus.

The tantalum lamp, which appeared in 1906, was made in a few sizes between 20 and 60 watts, and operated at two watts per candle-power. It represented a considerable advance in efficiency, but was followed so

closely by the tungsten filament lamp that it did not have an opportunity of taking an important place in the industry. The tantalum lamp is now obsolete. Its greatest influence was in connection with lamp develop-

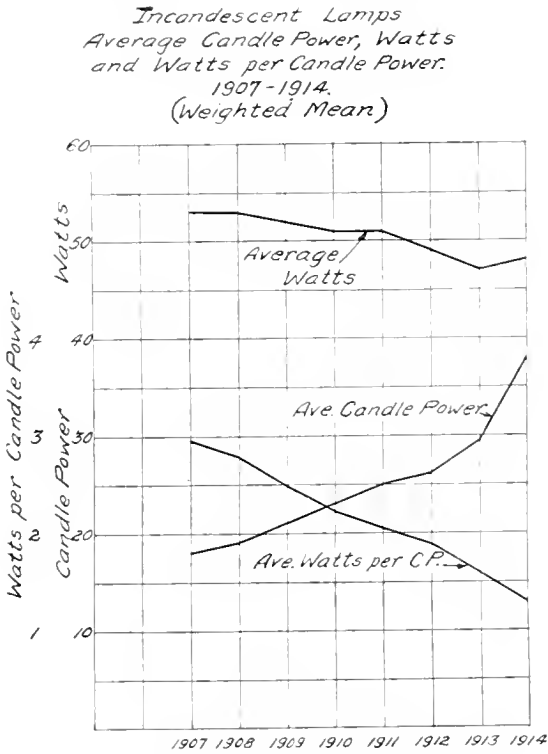


Fig. 4. Incandescent Lamps. Average Candle-power, Watts and Watts per Candle-power, 1907-1914. (Weighted Mean)

ment. It undoubtedly advanced lamp manufacture in bringing out the importance of the metal filament.

In 1907 the tungsten filament came on the market, with an immediate jump to 1.25 watts per candle, since which time efficiencies have increased steadily, reaching the highest point in the non-vacuum lamps.

At present, vacuum Mazda lamps range in efficiency around one watt per candle-power, those of 100 watts or above having a slightly better efficiency; while with the non-vacuum, or Mazda C lamps, the low consumption of one-half watt per candle is commercially realized in certain sizes and types, with double the useful burning life that is obtained with the 3.1-watt carbon filament lamp. The efficiency of the Mazda C lamp, which is largely a function of the current, varies throughout the line, the higher current lamps being the more efficient. The 100-watt multiple Mazda

C lamp is slightly more efficient than the corresponding vacuum lamp. Smaller sizes are not made, since under present conditions they would have no advantage over the vacuum type. The advance in efficiency as indicated in candle-power per watt for a few typical lamps is shown graphically in Fig. 3.

Fig. 4 shows the average candle-power, watts and watts per candle of all lamps for the different years since 1907. A slight falling off in the average wattage will be noted, due to the rapidly increasing efficiency. The increase in wattage for 1914 is due to the high power Mazda C lamps. Perhaps the most interesting features brought out by these curves are the rapid increases in candle-power and efficiency, which very nearly correspond.

Another illustration of the remarkable advance in lamps and other electric apparatus is shown in Fig. 5. In the early days of the electric art, lighting generators were rated in the number of 16-c.p. lamps which they could supply. Such a rating today would, of

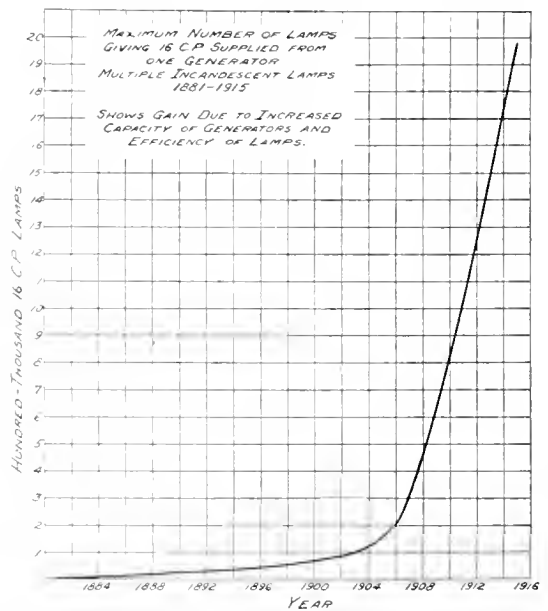


Fig. 5. Maximum Number of Lamps Giving 16 Candle-power Supplied from one Generator. Multiple Incandescent Lamps, 1881-1915. Shows Gain Due to Increased Capacity of Generators and Efficiency of Lamps

course, be impracticable, but the curve shows how remarkably the capacity has increased, owing to the increased efficiency of lamps and the increased size of generators. Had the chart taken into account the efficiency now

obtainable with the 1000-watt Mazda lamps, the equivalent multiple of 16 c-p. obtainable with a single generator during 1914 would have been over twice as great.

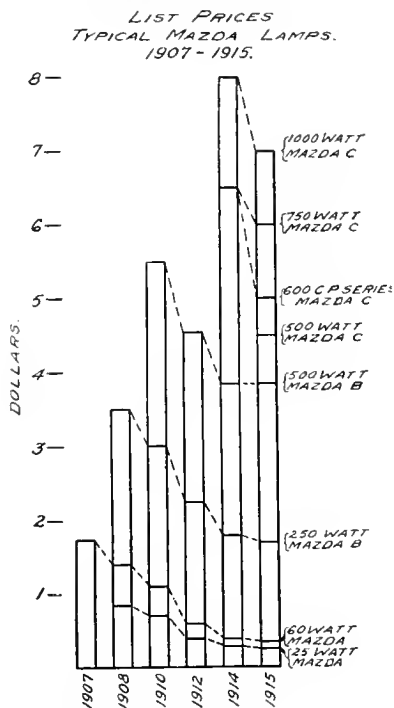


Fig. 6. List Prices Typical Mazda Lamps, 1907-1915

Manufacture

In the early years of the industry it was necessary to employ much skilled labor. All the glass work was done by experienced glass blowers, who received high wages. Through constant study and experimenting, processes have been developed and special machines designed and built, so that better and more uniform work is performed by the unskilled operator than was formerly possible by the best skilled labor. Furthermore, in spite of the large number of types, the number of lamps made per operator is now several times what it was 25 years ago. Practically all the lamp making machinery used in the world has been developed in the American lamp factories and the laboratories of the General Electric Company.

The carbon filament incandescent lamp was developed by Thomas Alva Edison. The production of a practical commercial lamp involved a world-wide search for materials, and comprehensive experimental investigations which would have discouraged any but

the most persistent. The improvement of the incandescent lamp has been the object of more extensive exhaustive study than almost any other article of commerce. In the year 1914 about 60,000 incandescent lamps were destroyed in the life tests of the General Electric Company's engineering organizations, to determine the value of proposed variations of construction. And when we consider that a lamp throughout its life consumes in electric current several times its cost, we obtain some idea of the cost of this one element of invisible service by which the lamp has been brought to its present state of perfection.

Of recent years the scientific development of the lamp has been carried on in the research laboratory at Schenectady, where an organized force of specialists, both chemists and physicists, are engaged in research and develop-

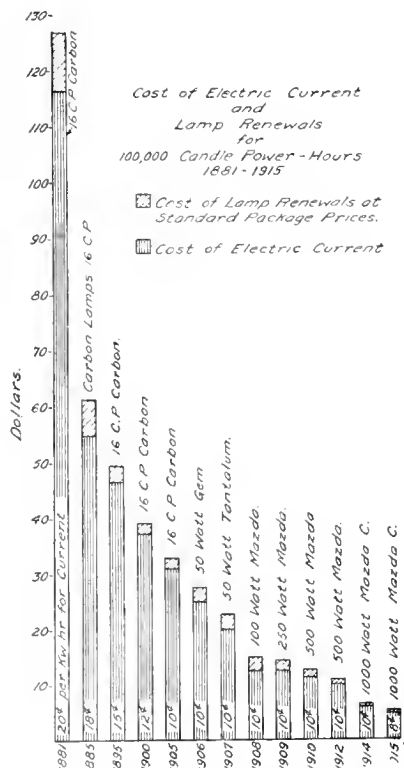


Fig. 7. Cost of Electric Current and Lamp Renewals for 100,000 Candle-power Hours, 1881-1915

ment. The drawn tungsten filament and the gas-filled principle are among the notable inventions made in this laboratory. Such inventions are applied to the practical conditions of lamp manufacture for various

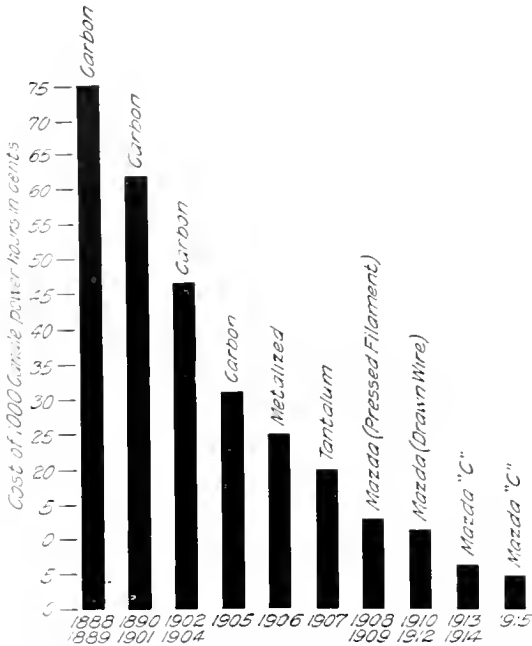


Fig. 8. Decrease in the Cost of Electric Light in New York City, Resulting from Improvements in the Efficiency of Incandescent Lamps and from Reductions in the Rates Charged for Electrical Energy

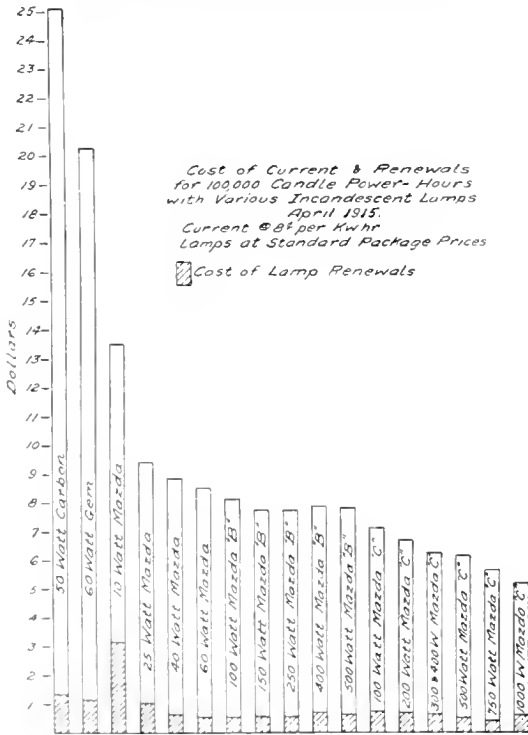


Fig. 10. Cost of Current and Renewals for 100,000 Candle-Power Hours with Various Incandescent Lamps, April, 1915. Current at 8 Cents per Kw-hr. Lamps at Standard Package Prices

types and sizes of lamps by the lamp engineering departments, which, with their developmental laboratories, stand between the research laboratory and the lamp factories. In this highly organized industry many factories are required, each of which makes only a few types of lamps. Each factory receives full detailed instructions from the engineering department.

Cost

The increasing number of lamps, together with the many improvements in manufacturing methods, has resulted in steadily decreasing costs, which in turn have resulted in remarkable reductions in lamp prices. In addition, the increased efficiency of lamps and gradual reduction in the cost of electric current have combined to very materially lessen the cost of electric light. These tendencies are shown in Figs. 6 to 8.

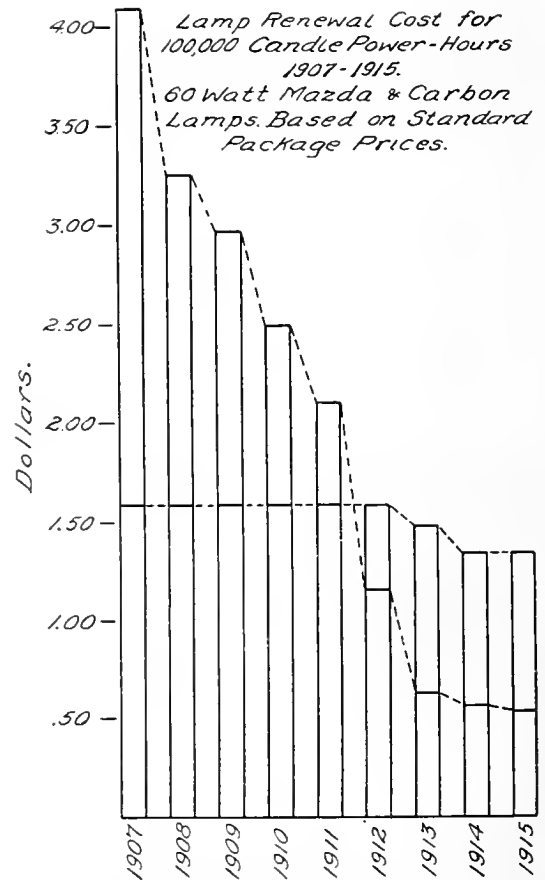


Fig. 9. Lamp Renewal Cost for 100,000 Candle-Power Hours 1907-1915. 60-Watt Mazda and Carbon Lamps. Based on Standard Package Prices

Fig. 6 shows the reduction in price since their standardization of a few typical Mazda lamps.

In Fig. 7 are shown costs from 1881 to date, of current and lamp renewals for producing 100,000 candle-power-hours with the most economical form of incandescent lamp available, as indicated.

While the summation of these values does not necessarily give the total cost of producing light, it makes a very interesting comparison and fairly well indicates the rate of decrease in lighting costs as the result of the increased efficiency of lamps, increased life of lamps, reduction in cost of lamps per candle-power, and lastly the reduced cost of electric current.

How much of this is due to lamp economies is apparent when we note that, with the assumed price of current in 1914 as 40 per cent of that for 1881, the cost of current and renewals is only 5 per cent of the original cost.

As a practical illustration of this point, Fig. 8 showing the cost of 100 candle-power-hours in New York City at the maximum rate

charged, is presented through the courtesy of the New York Edison Company.

The first tungsten filament lamps were used because of their current economy, and in spite of the higher renewal cost. Now, even with the moderate size lamps, the lamp renewal cost alone usually figures less per candle-power-hour than the carbon lamp. This fact was brought out by a comparison of the renewal cost of 60-watt Mazda and carbon lamps, as shown in Fig. 9.

Fig. 10 shows the variation of lighting costs between the different types of multiple lamps available at the present time. In this chart the cost of lamp renewals is indicated by the ruled sections, the cost of current by the clear sections, and the consumption is shown by the total height of the ordinates.

It is not safe to make definite predictions for the future, but the tendencies indicated by the various curves are significant, especially as the increasing appreciation of electric light is furnishing incentive to the manufacturers to extend their efforts in producing the most perfect lamps possible.

ELECTRICITY IN MARINE WORK

BY MAXWELL W. DAY

ENGINEER MARINE DEPARTMENT, GENERAL ELECTRIC COMPANY

The applications of electricity on land have increased so rapidly in scope and in number that they are now solidly established and are regarded as being thoroughly indispensable. On shipboard the applications are not as numerous or various as on land, because maritime conditions have not demanded them. Nevertheless, most readers of this comprehensive article will doubtlessly be surprised to learn through it of the already extensive use to which electricity is put in marine work.—EDITOR.

The use of electric generators on shipboard was at first limited to supplying lights and searchlights and required comparatively small installations, but the advantage of electric operation of mechanical auxiliaries was soon recognized and with the *Kearsage* and *Kentucky* battleships, which were launched in 1898, the extended use of electrically driven auxiliaries began. Previous to this, electric motors had been used in small numbers for ammunition hoists and for turning two of the turrets of the cruiser *Brooklyn*, which was launched in 1895. Equipments for similar purposes had been installed in Europe at about the same time, but the *Kearsage* and *Kentucky* were the first in which the advantages of electrical operation were more fully considered. Besides the large number of electrical auxiliaries on the *Kearsage* and *Kentucky* several others have been added on the later vessels until now the electrical plant of a modern battleship is large and complicated, including the lighting, many kinds of signaling devices and a large variety of motor-driven auxiliaries. For commercial work electricity is used to a much smaller extent, but on the transatlantic liners large electric plants are used, which include a large number of motor-driven machines.

Because of moisture, special construction is used; both on account of securing water-tightness and resistance to corrosion and due to the rolling of the ship, the bearings are specially designed to prevent the oil from being spilt out or water being taken in.

Generating Plant

The generating plant varies in size from about 2 kw. on very small vessels to 800 kw. on large passenger steamers, and 1500 kw. on some of the largest battleships.

For the small generating sets reciprocating steam engines direct connected to the generators are generally used; for the intermediate sizes either reciprocating engines or steam turbines, and for the large sizes steam turbines.

The reciprocating sets are required to be as compact and light as is consistent with good design and enclosed engines with

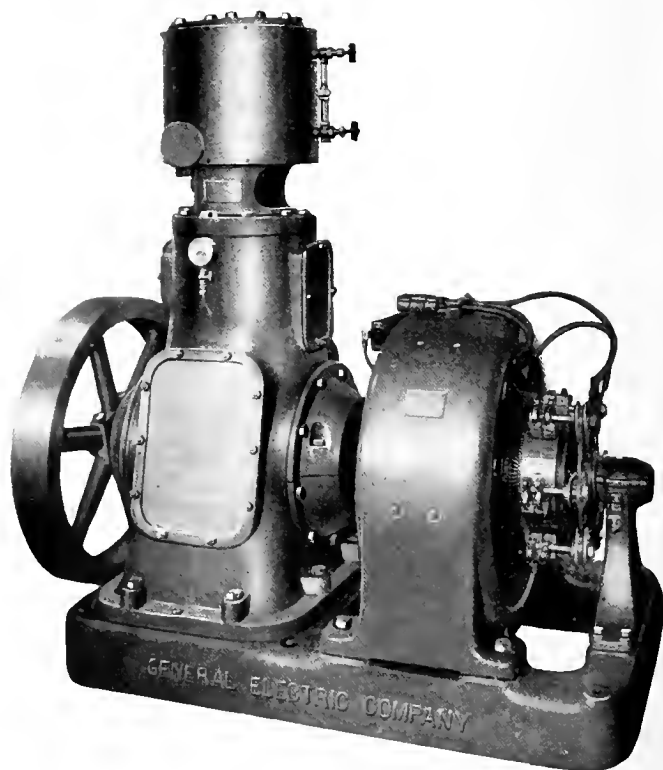


Fig. 1. Generating Set with 9-in. by 7-in. Forced Lubrication Engine

forced lubrication are recommended. Absolute reliability, durability of wearing parts, ready accessibility, and freedom from vibration are important requirements.

Fig. 1 illustrates a reciprocating generating set with 9-in. by 7-in. engine using forced

lubrication, its rating is 25 kw. 400 r.p.m. 110 volts to 125 volts. The internal construction is shown in Fig. 2. This set has a single cylinder with a piston valve; the governor enclosed in crank case, and an oil pump, driven by an eccentric, distributing oil to the various bearings. For navy use these sets are required to run without lubrication in the steam spaces in order to avoid oil in the boilers and special provision is made to prevent the oil being carried by the piston rod into the cylinder. These sets

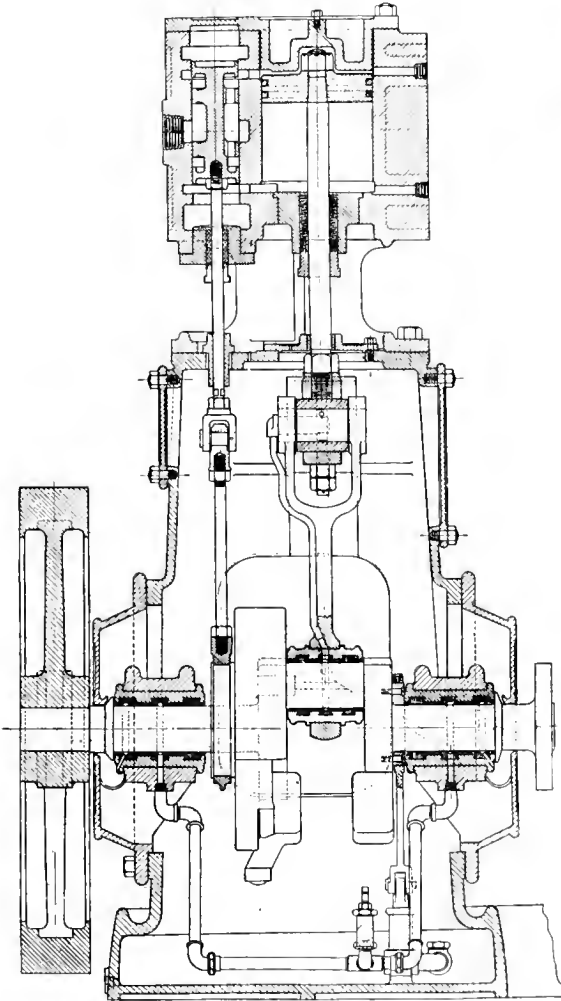


Fig. 2. Sectional View of Steam Engine showing Lubricating Mechanism

may be operated either condensing or non-condensing. The governor is of the Rites inertia type designed for close regulation. The single cylinder sets are built in various sizes up to 50 or 60 kw.

In order to obtain a better steam economy, tandem or cross-compound sets are sometimes used, especially in the larger sizes. While reciprocating sets are largely employed on commercial vessels, most naval vessels are

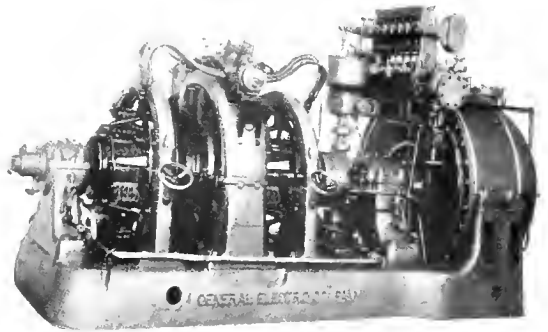


Fig. 3. 300-Kw. Turbo-Generator

equipped with turbo-generating sets on account of compactness, weight, and better steam economy in the larger sizes. The turbine sets are built in sizes from 5 to 375 kw.

Fig. 3 shows a 300-kw. set as frequently used on naval vessels, operating at 125 volts, 1500 r.p.m. and at 200 lb. steam pressure, condensing. On account of the large amount of current these generators are provided with two commutators, but for 250 volts only one commutator is used as in the case of the 375-kw. generating set for the Argentine dreadnoughts.

The turbines for the sets shown are of the Curtis type and are provided with a sensitive governor designed for close regulation. The generators are compound wound adjusted for flat compounding and are provided with commutating poles. The saving in weight by the use of turbines is shown by a comparison of the 25-kw. navy set the permissible weight of which is 4300 lb. in the case of the turbo set, and 7300 lb. for a reciprocating, 25-kw. set running at 400 r.p.m.

The governing is accomplished by different methods in the various types and sizes. In the smaller sizes a centrifugal governor of the throttling type controls the supply of steam but in the larger sizes groups of nozzles are provided with individual valves and the governor is so arranged, either by mechanical or hydraulic means, that the proper number of valves are opened to give the required supply of steam as this gives a better steam economy than to admit throttled steam to all of the nozzles. In the case of the hydraulic

governor a small pilot valve is operated by a centrifugal governor which controls the supply of oil under pressure to a cylinder, the piston of which operates a cam shaft, each cam controlling one of the valves. On light loads

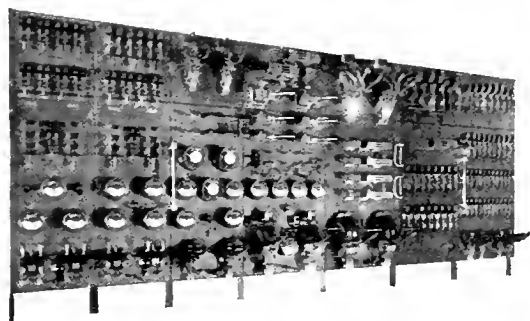


Fig. 4. Generator and Distribution Switchboard

most of the valves are closed, one valve may be wide open and the next valve partly open. As the load increases the cam shaft is rotated by means of the hydraulic device and more valves are opened.

With the mechanical type of governor the valves are either entirely open or entirely closed. On light loads most of the valves are closed, one may be entirely opened and the next one intermittently opened and closed. Thus, if the load requires but slightly more steam than that furnished by one valve, the next valve may be open a short portion of the time and closed a greater portion of the time, but if the load requires nearly as much steam as two valves supply, the second will be open a large portion of the time and closed a short portion of the time.

The oil is fed to the bearings under pressure from a pump which also supplies the oil for operating the governor when hydraulic governor is used. The bearings are cooled either by a pipe carrying water in the bearings themselves, or by carrying the oil through a cooler.

The large sets are usually operated condensing but provision is usually made for non-condensing operation. On some small naval vessels using small turbines the sets are frequently furnished for non-condensing operation and the steam is discharged into the feed water heater at considerable pressure above atmosphere, and if required an auxiliary hand valve is used to give the increased flow of steam.

It is the practice in large war vessels to provide four generators, two in each of two

separate dynamo rooms. This is considered desirable for military reasons, as the disablement of one dynamo room will not put the entire electric plant out of commission.

Switchboards

In some plants the generator and feeder panels are combined into one switchboard, but in the largest vessels the generator switchboards are sometimes separate from the distribution feeder switchboard.

Fig. 4 shows the front view and Fig. 5 shows the back view of a distribution switchboard installed on a modern battleship. The center panel is the generator panel and receives the current from two generators and contains the instruments, circuit breakers, and switches for connecting either or both generators to the busbars of the switchboard. The feeder circuits of large capacity are led out through circuit breakers, while the smaller circuits are provided with double-pole fused switches.

According to American practice the switchboard panels are of slate mounted on rigid angle iron supports and sometimes cushioned with rubber to prevent breakage. In Europe many of the switchboards are made of steel with the switches and instruments insulated from it. In this country the generators are generally run in parallel while in foreign countries the practice differs, some boards being arranged on a selective system, so that certain circuits can be put on one of the generators but no two generators are operated in parallel.

In addition to the main switchboards as shown, smaller boards are frequently used in various parts of the ship for distributing the current to motors and other auxiliaries in the vicinity, and cabinets are frequently provided with several small switches for controlling the various lighting circuits.

Cables

On account of moisture the cables and the fittings to which they are connected are designed with special reference to moisture resisting qualities. The cables are insulated with a high grade of rubber protected by suitable braid, and in some cases by lead and steel armor also. It was formerly the practice in war vessels to install cables very extensively in metal conduits but in recent years the use of leaded cables protected with steel braided armor has been adopted and is now being quite extensively used. This latter type of cable is convenient for instal-

lation and is fairly flexible, so that it can be readily made to conform to the places in which it is to be installed. Where cables are carried through watertight bulkheads, watertight stuffing tubes are used. These cables are usually attached to the bulkhead or decks by means of metal cleats or bands, and where it is necessary to cross beams, they are carried through holes drilled near the neutral axis.

For commercial work unarmored cable is frequently carried through wooden moldings, especially in places where a neat appearance is desired, but in foreign countries the leaded and armored cable is extensively used for merchant work, as well as for the navy.

It is American practice to make all the circuits double-pole, but in Europe a large number of merchant vessels are equipped with the single-wire system, in which the ship itself is used as a common return for all circuits. This method very much simplifies the switchboard, as there is only one switch to each feeder and reduces the amount of cable to about one-half.

Wiring Fittings

Various junction boxes and switches are required, which are of watertight construction and consist of boxes made of composition material supplied with stuffing tubes or in the case of conduit with tapped holes for the reception of the conduit, and the cover is made watertight by a rubber gasket. The covers in some cases are fastened with screws and in some cases are threaded so as to be screwed into place. In Germany boxes with a hinged cover closed by a lever and cams are frequently used and this quick closing device has recently been used to some extent on vessels built in the United States. Some of these boxes are provided with a lock so that they cannot be opened by unauthorized persons.

Lighting Fixtures

The various fixtures for the lamps are of special design on account of the watertightness required, the vibration of the ship and for protection from external injuries.

Lamps in exposed places are covered by glass globes made watertight in the fixture and the globes are protected by a guard. Lamps in magazines require extra careful protection and special enclosing cases for the lamps are provided for this purpose. A large number of portable lamps are used as well as cargo lamps provided with reflectors and specially protected lamps are used for divers.

On warships a special battle circuit is provided independent from the general illumination and in some foreign ships blue lamps are used for this purpose. Incandescent lamps are employed for nearly all of this work,

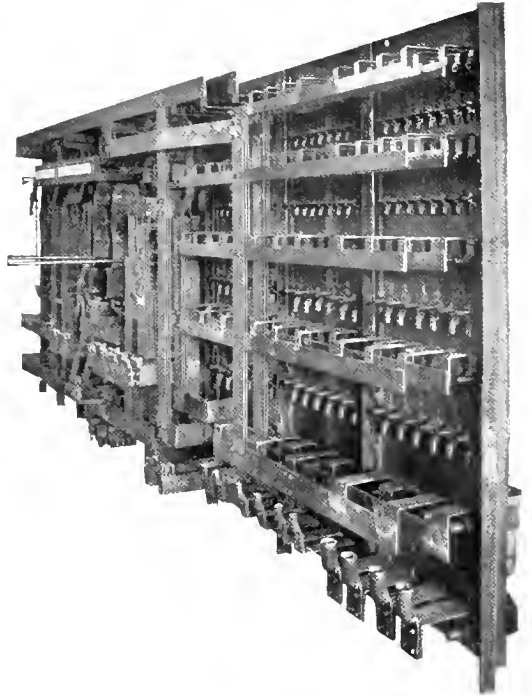


Fig. 5. Generator and Distribution Switchboard, Back View

but in a few open spaces, such as the engine rooms, use has been made of enclosed arc lamps.

Signaling and Interior Communication Devices

The various signal lamps required by ships at anchor or under way are electrically lighted and the circuits for these are carried through a special telltale board which will give an indication if any of these lamps are out. For signaling from ship to ship a night signal set is provided on warships, consisting of four double lanterns, one-half red and one-half white, hung on a wire cable from the mast and a specially designed keyboard is provided with different push buttons corresponding to different letters of the alphabet or other desired signals. By pressing one of these push buttons a combination of lights is shown, consisting of a certain number of white, a certain number of red, or a combina-

tion of white and red which can be seen from other vessels.

A single white light at the top of the mast is also used for this purpose and the light can be worked by a telegraph key, thus making the dots and dashes of the Morse, or other similar code.

For communication inside of the ship various systems are in use. The communication from the bridge to the engine room, steering flat, and for other similar purposes, is very largely carried on by means of mechanically operated telegraphs or by speaking tubes, or by electric telephones, but the electric signal method is coming into use more and more and is at present quite extensively used on foreign vessels. For the operation of these systems various synchronous devices are used so that by turning a lever or indicating arm in the pilot house or central station a similar signal is shown in the engine room or in the steering flat, and when this is answered from those stations an indicator at the sending station shows that the signal has been received. A revolution indicator is often attached to each propeller shaft. In many cases this consists of a small generator driven by the shaft, which operates a voltmeter or frequency indicator in the pilot house, so that the speed of each screw can be readily noted. The engine room telegraph indicates at what speed the ship should be run in either direction.

In some cases fire room timing devices are used to indicate the time and order of firing the different boilers. This apparatus is operated by a clock or similar device which can be set at a predetermined rate of firing. This insures regular and careful firing of the entire steam plant.

The rudder telegraph is used in case there is any disarrangement of the regular steering apparatus when it becomes necessary to transmit the orders for the movement of the rudder to the steering flat itself. Also rudder indicators are used which show in the pilot house the position of the rudder in degrees either side of the midline.

Where power-operated, watertight bulkhead doors are used, an indicator is provided to show at the pilot house or other convenient location whether the different doors are closed or open. The use of all of these various devices operated by electricity is not by any means universal, but the largest and best passenger ships are very largely equipped with this apparatus. On warships the transmission of orders for the ordnance is of very great

importance and electrical arrangements are made for transmitting the range and deflection of the various guns, so that they can be pointed properly and orders given when the gun should be fired. Lights are provided for illuminating the sights of the guns and the firing of the fuses is done electrically by current from storage batteries, or static transformers supplied by special alternating current generators or rotary converters.

The turrets are also provided with danger zone indicators to give warning when the turret is turned so far that it might interfere with another turret or with some other part of the ship's structure.

Another important class of apparatus of this character consists of the telephone, call-bell, and fire alarm systems which differ from land installations in being made thoroughly watertight and in many cases a specially designed loud speaking telephone is used.

On some vessels an alarm system is provided by which an alarm bell will be sounded by closing a switch on the bridge when a man falls overboard, so that life buoys can be immediately thrown out and in some cases the electric circuit is arranged to automatically release the life buoy and drop it into the water.

One of the most important systems of signaling used on shipboard is the radio telegraph, and this has become so important that it has been the subject of International Conferences and National Regulations.

This apparatus usually consists of one or more motor-generator sets, even as large as 10 kw. in some of the largest vessels, giving a range of transmission of many hundred miles. With the motor-generator is supplied a suitable switchboard for starting the motor-generator set, and for making necessary connections to the other parts of the apparatus.

One of the most recent applications of electricity for marine purposes is its use for submarine signaling. The early history of submarine signaling includes the development of submarine bells for sending out the signals from a buoy or light-ship, and the development of electrical apparatus for receiving these signals on board ships. The more recent development has been that in which the apparatus for sending out the signals electrically has been perfected by Prof. R. A. Fessenden.

This device, manufactured by the Submarine Signal Company of Boston is essentially a large telephone diaphragm submerged either

by hanging it over the side of the ship or by actually including it in the ship's skin. This large telephone transmitter, called the "oscillator," delivers powerful impulses to the surrounding water, and in order to make these impulses, when received, readily audible, a frequency of approximately 500 cycles per second is used.

The diaphragm of the oscillator is set in motion by the interaction of currents induced in a copper tube, with a constant magnetic flux passing through this tube. The tube is mechanically fastened to the diaphragm itself. The 500-cycle alternating current is passed through windings around a stationary core inside the tube, while the electromagnet producing the constant magnetic flux is concentric with, and outside of, the tube.

The signal is sent out by making and breaking the alternating current passing around the core, and of course in any one signal there are many impulses of a frequency of 500 in each direction per second imparted to the water. On reaching a distant receiver, which may be an exact duplicate of the oscillator, or a much smaller diaphragm, these impulses are used to effect changes of current in an ordinary telephone receiver and hence made audible at the receiving end.

By using an arrangement of two or more of these oscillators, as one on either side of the ship, means are provided for giving the exact location of a ship, inasmuch as a receiving vessel can change its course until the strength of signals received are equal in both receivers, when it will be known that the sending vessel or station is dead ahead.

The apparatus for supplying the 500-cycle current may be a motor-generator set of the ordinary type. However, a dynamotor has been developed which fulfills the requirements while weighing less than a motor-generator set and having considerably smaller dimensions. This dynamotor consists of a d-c. armature of the ordinary type, revolving in a d-c. field. In slots in the pole faces of the d-c. field the alternating winding is placed and by means of the variation in magnetic flux caused by the teeth of the d-c. armature the 500-cycle current is generated in this winding. This type of construction allows the use of the ordinary motor frames and most of the other standard parts of motors.

The inherent feature of the dynamotor, that the voltage and frequency can not be varied independently, is not objectionable for its use with the oscillator described above; as this oscillator has a power-factor of

practically unity, the voltage regulation of the dynamotor is very good.

Up to the present time the navy department has been the most active in applying the oscillator to its ships, but it seems that

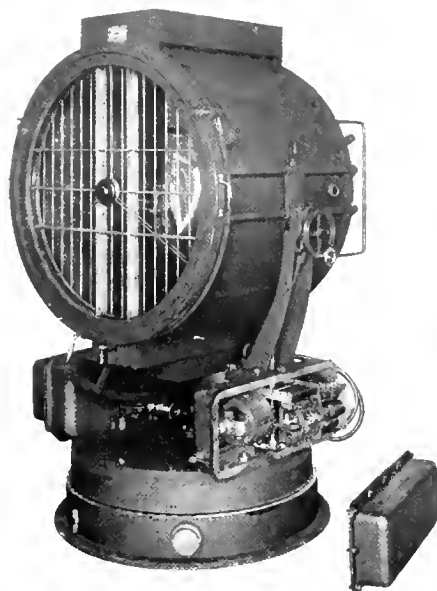


Fig. 6. 36-Inch Electrically Controlled Searchlight

the time is not far distant when merchant vessels, as well as naval vessels, will be equipped with this apparatus.

The general design of the apparatus supplied, such as the dynamotor and control equipment, must, of course, conform to the usual requirements of apparatus used on board ship.

Searchlights

Practically all war vessels, and many commercial vessels are equipped with searchlights. The number of these lights on some large war vessels has been as high as 16, but in many only four are used. For the large vessels these usually have mirrors of 36-in. in diameter. The mirror is made of glass carefully ground to a parabolic shape and silvered on the back surface. This mirror is enclosed in a large barrel which also contains the lamp. Fig. 6 shows a view of a 36-in. electrically controlled searchlight. The barrel is mounted on trunnions carried on two side arms which are supported from a revolving turn-table, this turn-table being supported on a fixed base. Small searchlights are controlled by hand and large searchlights either by hand or electrically. In the electrically

controlled searchlight a controller is located in a suitable place and connected, by a cable containing several wires, to the controller cable plug in the base of the searchlight. The controller may be made portable and can be carried around to any convenient location which can be reached by the flexible cable connecting it to the searchlight.

In some forms of controller two small handwheels are provided and the searchlight will turn around the turn-table in a horizontal direction as long as the horizontal handwheel of the controller is turned, and a certain number of revolutions of the controller handwheel corresponds to a definite number of degrees of movement of the searchlight. In a similar way the rotation of the vertical handwheel of the controller will cause the searchlight to move up or down a definite number of degrees corresponding to the amount of rotation of the controller handwheel. These movements are accomplished by small motors located in the turn-table and controlled by a synchronous controller operated electrically from the main controller. By turning the handwheel of the controller a small amount, electric connection is made to the small motor in the searchlight and after it has turned the searchlight to an amount corresponding to the movement of the controller handwheel, the current is automatically cut off and the searchlight stops. By continuing the motion of the handwheel the searchlight will continue to move.

Disengaging clutches are provided by which the electric control can be disconnected and then the searchlight can be moved by handwheels located on the side arms, as shown in the illustration.

The front of the barrel is provided with a glass cover consisting of vertical strips. These narrow strips are less subject to breaking on account of the heat of the lamp and to the mechanical vibration of the ship than would be the case with a solid disk of glass.

In many cases these lights are provided with a shutter usually of the iris type, somewhat similar to those used in cameras, so that when it is desired to shut off the light for military reasons without disconnecting the current supply, the shutter can be readily closed.

Searchlights can be readily used for signaling at sea by throwing the beam at a high elevation and then interrupting it and breaking it up in dots and dashes by a quick closing shutter, usually of the Venetian blind type.

The lamp consists of two carbons located horizontally with the negative carbon toward the mirror. This allows the light from the positive crater to be thrown against the mirror from which it is reflected forward in a nearly parallel beam. The negative carbon and its support should be made as small as practicable in order to prevent, as far as possible, obstruction of the light from the positive carbon.

If the light were to issue from a point the beam would be cylindrical, but inasmuch as the crater of the positive carbon has an appreciable diameter the beam is thrown out in a diverging cone, the angle of which is quite small and depends upon the relation of the diameter of the crater to the focal length of the mirror.

The lamp mechanism is located at the bottom of the barrel and contains two upright supports to carry the carbons. These supports are moved toward each other as the carbons burn away, either by means of a small motor or by a magnet operating through a ratchet on a screw. The operation of the motor or of the magnet depends principally upon the voltage of the arc which increases as the carbons burn away.

An electric device is also provided for striking the two carbons together and immediately pulling them a short distance apart to start the arc when the current is turned on the searchlight. The voltage of the arc varies from 45 to 65 in various sizes but the lamps will burn very unsteadily if supplied with a constant potential of this amount, and it is therefore necessary to operate the searchlights at a higher voltage—not less than 80—using a steadying rheostat in the circuit. It is customary to operate the searchlights at 110 to 125 volts, corresponding to the voltage of the lighting system of the vessel, and of course, a considerable amount of energy is dissipated in heat from this rheostat. Arrangements are provided to disconnect the electric control of the arc and use hand adjustment if desired.

For the purpose of properly observing the condition of the arc a small side sight is provided, consisting of a hole in the side of the barrel covered by a colored glass which allows the operator to look directly at the arc.

In order to avoid the loss of energy in the rheostat, especially on vessels of 220 volts, motor-generators or compensators have been built which furnish current to the searchlight with a drooping characteristic of voltage instead of a constant potential. With this

design of generator the voltage will drop very considerably in case of an abnormal increase of current and will rise considerably in case of a reduction of current. In this way the current can be turned on the searchlight with the carbons in contact without obtaining a dangerous rush of current and this current will immediately pull the carbons into the proper condition for operating; but few of these have been installed in the United States. A compensator using one armature has been used to some extent in England and motor-generators either of this type without a rheostat or of a constant potential type with a rheostat, have been used considerably in Germany.

Many of the German type are constructed so that the shaft is vertical and can be readily supported from the deck above, and in this way take up but little valuable space.

In some vessels using a 250-volt generating plant, a balancer set has been used, consisting of two 125-volt dynamos direct connected. These are connected in series across the 250-volt lights and a neutral is taken out between them giving 125 volts on each side. In this arrangement some of the searchlights are connected on one side of the circuit and the rest of them are connected on the other. This method was used on the Argentine dreadnoughts built in this country. These ships were each provided with 12 searchlights 43.3-in. diameter and one of 13.8-in. diameter for signaling, all made by the Siemens-Schuckert Works.

A special type of searchlight has been built for vessels making use of the Suez Canal. These lights have special diverging glass strips which deflect the light to each side and leave a dark space ahead. This is done in order to light both banks of the canal without blinding the pilots of approaching vessels.

Cooking and Heating

The very convenient control of electric heaters has led to their use for heating staterooms, and several vessels have been equipped with a large number of electric ovens and ranges. These cooking devices have the advantages of cleanliness, safety and convenience of operation, besides obtaining a uniform and very satisfactory product.

Power Equipment

By far the greatest amount of electric energy is used for the operation of the various auxiliary machines. The advantage of electric operation of auxiliaries is due largely to the

simplicity of control, the small amount of attention required, and the avoidance of heavy steam pipes with consequent condensation of steam and the heating of living spaces. The electric apparatus is also ready to operate as soon as the switches are closed and it is not necessary to warm up the apparatus and get rid of the water of condensation.

The use of electric auxiliary machinery is very much more extensive on war vessels than on commercial vessels, as on these ships convenience and reliability of operation are considered of greater importance than the first cost.

Steering Gear

The largest electric equipment on a large ship is the steering gear, although very few ships make use of electricity for operating this gear. This apparatus has received attention from electrical engineers for many years, and various systems have been designed both in Europe and the United States. In some of these in the smaller sizes, magnetic clutches have been proposed which connect the motor to the rudder mechanism for either direction of motion as desired. On others, motors have been operated by rheostats in the circuit or by controlling the field of a special generator supplying current to the steering motor. Several of the latter type operating on the Pfatischer system have been used on Russian war vessels and on several American commercial vessels. This system is controlled on the Wheatstone bridge principle. A suitable rheostat connected to the two mains is operated by the steering wheel and another similar rheostat is operated by the rudder mechanism. The line connecting the two switch arms is taken to the field of a small exciter and the armature current from the exciter is taken to the field of a generator which may be driven either by a steam engine or an electric motor. The armature current of this generator is taken to the armature of the steering motor. When the steering wheel and the rudder are both in the midship position the switch arms connect the middle points of the two rheostats, in which case the Wheatstone bridge is balanced and no current passes through the field of the exciter.

When the steering wheel is moved to one side the switch arm is moved from the rheostat contacts toward one main line and current now passes through the field of the exciter. This produces a current in the steering motor which moves the rudder. This movement

of the rudder actuates the switch arm of its rheostat toward the same line toward which the steering wheel has moved the other switch arm, and when the rudder has moved to a position corresponding to the position of the steering wheel, the Wheatstone bridge is again balanced, no current passes through the exciter field, and the steering motor is brought to rest.

This method provides a follow-up device and the method of steering is the same as used with the steam gear in which a definite movement of the steering wheel results in a corresponding movement of the rudder.

When it is desired to move the rudder in the other direction, the steering wheel switch arm is moved toward the other main line and current now passes through the exciter field opposite to the previous direction, and the polarity of the generator and consequently the direction of rotation of the motor is reversed.

The steering gear motor is shunt wound and excited by the same circuit that supplies current to the rudder rheostat.

Some of the United States cruisers have been provided with a rheostatic system in which the steering motor is fed directly from the ship's mains without the use of a separate generator and the motor is reversed, started, and controlled in speed by means of a contactor control panel, the secondary circuits of which are controlled by the steering controller or switch.

One of these equipments was provided with a follow-up device so that a definite movement of the steering wheel would result in a definite movement of the rudder, but it has been found more satisfactory to dispense with the follow-up device and operate the contactor control panel by means of two-speed master switches in the pilot house and other steering stations. In this system a movement of the switch lever to the first point in either direction will cause the motor to turn the rudder in that direction as long as the switch lever is held in that position unless the lever is kept in this position until the rudder reaches the limit of its motion, when an automatic limit switch cuts off the current and stops the motor.

In this position of the switch lever, the motor operates at a comparatively low speed but if the switch lever be turned to the second position the motor will operate at full speed.

Some large vessels have been equipped with this system each making use of a 150-h.p. motor, designed to move the rudder from

hardover to hardover,—an angle of 70 deg. in about 40 sec., where the steam steering gear is required to make this movement in 20 sec. Two of these equipments were provided with non-follow-up control as mentioned above, and two others were provided with a follow-up control. This controller contained a cylinder driven by planetary gearing, one set of gears being connected to the rudder mechanism and the other set being operated by the hydraulic telemotor or a Hanscom drum used with the steam steering gear. By this arrangement a certain movement of the steering wheel moves the controller cylinder in the desired direction, and as the rudder itself is moved by the motor, the controller is turned off and the motor stopped, so that the total movement of the rudder corresponds to the total movement of the steering wheel.

On a later vessel, where the electric gear is required to make this movement in 20 sec., two 150-h.p. motors are used, so arranged that they may be connected either in series or parallel.

Another arrangement making use of a separate motor-generator working on the Ward Leonard principle has been adopted for several of the latest vessels. This system avoids the use of a large number of contactors for controlling, and makes the requirements on the power station less severe as the load is applied more gradually.

The equipment for moving and controlling the rudder under the Ward Leonard non-follow-up system consists of a steering gear motor connected to the rudder by means of the mechanical arrangements generally used with steam engine, a motor-generator set, controlling panel, steering stands, selective switch and limit switch. The speed of the steering gear motor is controlled by varying the field strength of the generator, as is usual with the Ward Leonard system.

In these equipments, this motor was rated 350 h.p., with 700 h.p. for short intervals, at a speed of 250 r.p.m. at 250 volts. In order to decrease the power required at extreme loads, this motor is provided with a series field in series with the armature of the driving motor on the motor-generator set. In this way the torque per ampere of the steering gear motor is increased with the load. As the voltage on the armature of the motor is reversed to reverse the direction of rotation, it is not possible to put this series field in series with the armature in the usual manner. To accentuate the same increase of torque per ampere, on very extreme overloads the shunt

field of this motor is increased by means of a relay.

The motor-generator set used with the above motor has a generator rated at 290 kw. at a speed of 1000 r.p.m., when it delivers 250 volts to the steering gear motor. The driving motor takes its power from the ship's mains at 120 or 230 volts. The generator is provided with a differential compound wound winding, so that at extreme overloads the voltage on the generator will be reduced in order to reduce the power demanded of the ship's generating equipment. Also, the driving motor is arranged with a drooping speed characteristic in order that the kinetic energy stored in its armature may be utilized under the heavy load conditions.

The controlling panel contains the necessary contactors for starting the motor-generator set as well as an ammeter to show the input into the driving motor. It also contains the necessary switches, the relay for strengthening the steering gear motor shunt field and an overload relay for limiting such overloads as would otherwise injure the apparatus.

In order to notify the attendant in case the set should be shut down, due to failure of voltage, a circuit is arranged to ring a bell on such failure of voltage. The motor-generator set is also protected from excessive speed by means of a speed limiting device on its shaft.

The selective switch is simply a device for connecting the various controlling circuits to the particular steering stand which it is desired to use at any time. In the equipment described there are four of these steering

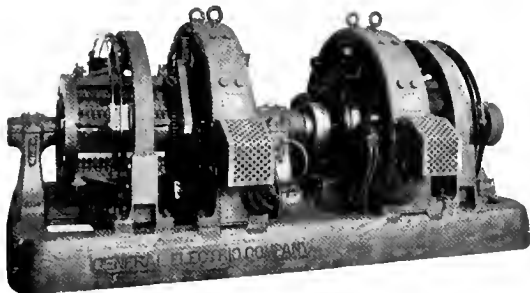


Fig. 7. Steering Gear Motor-Generator Set

stands; one on the bridge, the conning tower, the central station and in the steering gear room.

The steering stands are of watertight construction, made of non-magnetic materials

in order not to influence the magnetic compasses and they provide three speed positions in each direction; in the first the field of the generator is excited to give a low voltage for slow speed of the steering gear motor, the

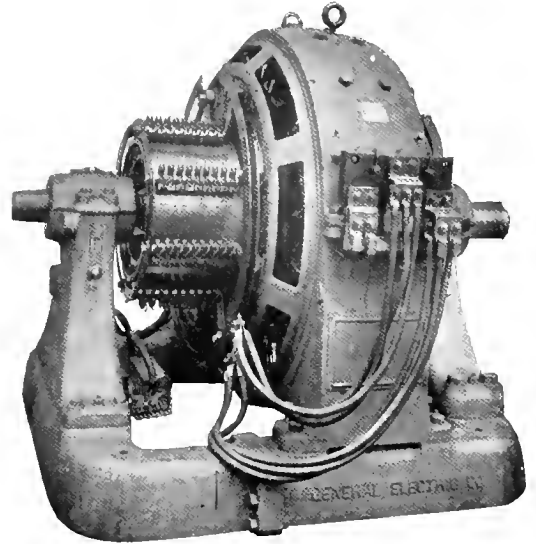


Fig. 8. Steering Gear Motor

next step strengthens the field and the last fully excites it.

The excitation for the generator is carried through the limit switch, which is operated by the steering gear in case of over-travel in order to cut off the power under such conditions. This is accomplished without interfering with the return motion after the voltage is reversed at the steering stand.

This system is primarily designed to meet the same quick movement of rudder as is accomplished by the steam engine and yet to hold the demand on the power plant of the ship down to a reasonable value by means of using high speeds at light loads and storing energy in the rotating element of the motor-generator set to be removed at heavy loads.

Figs. 7, 8 and 9 show the motor-generator set, steering gear motor, and control panel of one of these equipments.

The use of internal combustion engines for propelling vessels is leading to a more extensive use of electric auxiliaries and several of these vessels have been equipped with an English system of steering gear, in which an oil pump is operated continuously by means of an electric motor. The displacement of the pump and the volume and direction of oil

delivered can be changed by suitable connections from the pilot house. The oil is delivered into two cylinders operating plungers or pistons which move the rudder. This apparatus is said to give very satisfactory

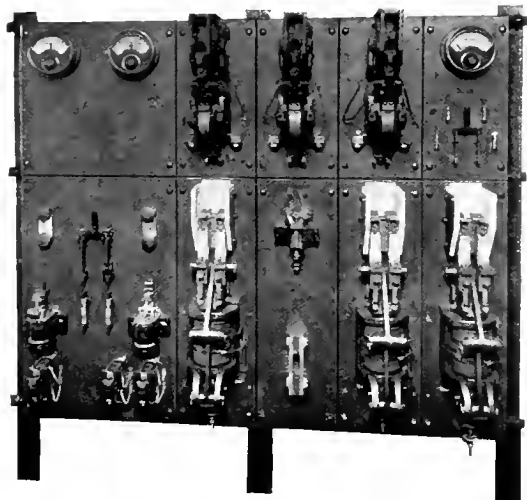


Fig. 9. Steering Gear Panel

results and inasmuch as the apparatus can be arranged to deliver large volumes of oil when the rudder moves easily and small volumes of oil when the rudder requires a large amount of torque, a motor of moderate horse power is sufficient.

Anchor Windlass

It is only quite recently that electricity has been applied to the equipment used for raising anchors, and naval vessels have been foremost in its use.

The requirements of an anchor windlass are rather peculiar for an electrical equipment to meet, inasmuch as provision must be made for such conditions as arise when the anchor becomes fouled or stuck in the mud. In this case it is not sufficient to provide the usual overload device, which would disconnect the electrical equipment from the source of power, but the current must be limited to a safe value and the motor or motors allowed to stall under these conditions in order that the tension may be maintained in the anchor chain and the equipment be left so that it will immediately start on the removal of the overload as is the case with a steam windlass.

In the case of the Argentine battleships the anchor windlass equipment acts only as an auxiliary to the steam windlass and is

designed to function at one-third the normal speed of the latter.

The outfit consists of a 100-h.p. 475-r.p.m. compound wound, commutating field motor of the semi-enclosed type equipped with a disk brake; two watertight, drum type, reversing master controllers, one mounted in the windlass room and one mounted on the weather deck; a contactor panel, containing the accelerating contactors, step-back relay, overload relay, double-pole single-throw disconnecting switch, a single-throw testing switch and a low voltage relay, and the starting resistance. The control is semi-automatic; i.e., the first three speeds are controlled by the master controller but beyond that the current limit relays on the contactors will prevent them from closing until the current in each preceding one has been reduced to a predetermined amount, regardless of the position of the controller cylinder. The step-back relay will open the contactors in case the load should be increased beyond that for which the step-back relay has been set and will introduce all of the starting resistance, except one section, thereby reducing the current to a safe overload on the motor. When the overload is removed, the step-back relay automatically closes, the contactors close and in this way produce the effect mentioned above. The overload relay is intended to operate only in cases of extreme overload, such as produced by abnormal conditions, and completely disconnects the armature from the power supply.

The above equipment is, of course, designed to operate on a constant potential system and hence requires a great amount of rheostat occupying considerable space.

For five of the recent American battleships quite a different system has been designed. Two of these equipments have already been completed, although no ship tests have been made up to date. The requirements to be met are that two anchors, weighing about 20,000 lb. each and 60 fathoms of chain on each shall be raised and lowered simultaneously at a rate of six fathoms per minute. This chain weighs approximately 600 lb. per fathom.

Two electric motors of 175-h.p. rating for one hour and an overload capacity of 350 h.p. for 10 minutes each, running at a full load speed of 230 r.p.m., 230 volts, are coupled on either end of a worm shaft in such a manner that either one or both motors may be operated. These motors are compound

wound and supplied with commutating fields and a disk brake. Each worm meshes with a worm wheel connected to a vertical shaft, which is carried through various decks from the windlass room to the upper deck, where it is connected to the wildcat engaging with the anchor chain.

The Ward Leonard system of control is used, whereby the voltage on one of the two generators connected to the turbines in the forward dynamo room is varied by means of its field excitation, the generator armature being directly connected to either one or both of the two motors, as occasion requires.

Referring to Fig. 10, showing the front view of the control panel, it will be noted that there are three sections, the one on

The large contactors are used for the lowering connections and the relays are provided in order to slow down the motors and limit the current in case of severe overload and are so arranged that the normal connections are restored and the motors brought up to the speed for which the controller is set after the overload is removed.

The motor is similar to the steering gear motor shown in Fig. 8.

Boat Cranes

The method of boat handling varies in different classes of vessels and in different countries. On commercial vessels boats are usually lowered by means of davits, but on

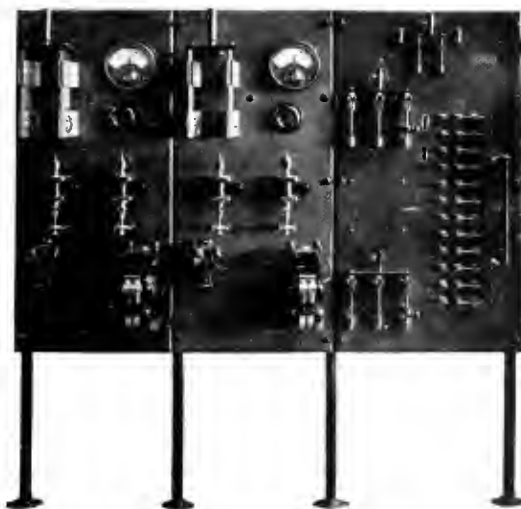


Fig. 10. Anchor Windlass Panel—Ward Leonard Control

the left and the center being in duplicate. These contain a double-pole single-throw line switch for connecting a motor to the generator; an ammeter; field rheostat; two relays; a small and a large contactor. The right-hand section contains a double-pole single-throw fused control switch; two triple-pole single-throw field switches and a multi-pole double-throw control switch. The double-pole single-throw control switch supplies all the control circuits, while each triple-pole switch supplies the field and brake circuits of one motor, so that when only one is used, it is not necessary to have the field and brake of the other connected. The multiple double-throw switch is used to connect the control circuits to either one of the controllers. One of these controllers is placed in the windlass room and the other on the weather deck.

warships some form of boat crane or boat boom is generally used.

The first electric boat cranes in this country were installed on the *Kearsage* and *Kentucky*, each ship having two cranes operated by 50-h.p. motors and two cranes operated by 20-h.p. motors. These motors were shunt wound in order to provide a convenient means for electrical control in lowering. As the boats will drive the crane in lowering, the ordinary system of rheostatic control is not sufficient.

The conditions for hoisting are simple and an ordinary rheostatic drum controller was provided but, in lowering, the rheostat was connected directly across the line, which allowed sufficient power being delivered to the cranes to lower the empty hook or to start the boat downward but the rheostat

being connected in parallel with the armature prevented the motor from acquiring an excessive speed.

The shunt motor, however, runs at practically constant speed irrespective of the load,

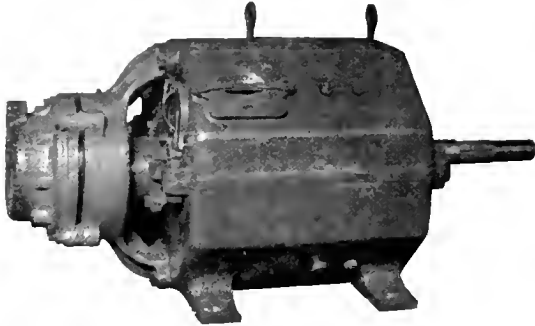


Fig. 11. Boat Crane Motor

and therefore the empty hook could be moved but little faster than the heaviest boat. This led to waste of time and it is also desirable for picking up the boat in a seaway that the empty hook should be moved quickly. On the next vessels equipped with electric boat cranes, series motors were used, and an automatic mechanical lowering brake was provided similar to those used on land cranes, so arranged that the brake would be inoperative in raising the boat but would not allow the boat to run away in lowering. This always requires a moderate amount of power to be delivered to the crane in order to lower the boat, but on account of the complication and heating of this automatic brake, electric lowering systems have been developed in which the principle of dynamic braking is used, in lowering in a method somewhat similar to that originally used on the *Kearsage* and *Kentucky*, but the motors are series or compound wound.

The system used on most of the recent vessels is a German invention and makes use of compound motors with the connections so arranged that in raising the boat plain rheostatic control is used, but in lowering, except at the highest speed, the entire rheostat and the series field are connected in series with each other between the two main lines and the armature is connected in parallel with the series field and a portion of the regulating rheostat.

When the controller is turned to lower a boat, the shunt winding is energized from the main line, and the current received from the main line through the regulating rheostat passes partly through the armature and

partly through the series field. As soon as the motor begins to lower and drive the motor as a generator, the current delivered by the motor armature passes through a portion of the rheostat and through the series field. The hoisting motors, see Fig. 11, are usually of 50-h.p. capacity and are required to lift a load of 40,000 lb. at 20 ft. per minute, and to lift the empty hook at over 60 ft. per minute. This higher speed is obtained by cutting out the series field on the high speed position only when raising light loads, and the motor then operates as a plain shunt motor. The apparatus is so designed that in lowering a heavy boat, it is impossible to lose control by opening of the circuit breaker.

The cranes are also rotated so as to place the boat in the proper place on deck. The motors for this purpose are frequently of 50 h.p. and both shunt and compound wound motors have been used. These require a special rheostat connection, somewhat similar to that used in lowering, so that the crane will be under control when the ship is heeled over and it must permit of ready starting and stopping without causing the boat to swing.

Many of these cranes have been built to revolve with the complete mechanism, in which case flexible connections are required to bring the current to the crane, but in later types the boom is rotated about a fixed pillar and the hoisting cable is carried down from the center of the pillar to the hoist mechanism located on the lower deck, in which case the motors do not revolve with the cranes but the hoisting cable twists in the pillar as the boom is rotated.

On many foreign ships a swinging boom is used, supported from a stationary pillar, although the construction is considerably different from that used in the United States. The controllers for both hoisting and rotating motors are usually combined in one frame. For the early cranes these were of the regular rheostatic type in which the full current passed through the fingers of the controller, but later types make use of small master controllers at the crane which control contactors on a switchboard panel generally located below the deck. The hoisting motors are provided with electric brakes of sufficient strength to hold the load when the current is turned off. Circuit breakers or overload relays are provided to open the circuit in case of an excessive load, in which case the mechanical brake is set and the load prevented from dropping. A rheostatic controller is shown in Fig. 12.

Winches

Most of the winches for handling cargo on commercial ships are steam operated, but those on warships are generally operated by electricity. These are used for taking coal and cargo aboard and vary in number from three to seven on various large vessels. Some of the earlier ones were provided with drums and winch heads but the later ones are provided with winch heads only and a portion of them have compound gearing so that by changing a clutch they may be able to lift a moderate load at high speed or a heavy load at low speed. Winches now generally supplied have a capacity of 5000 lb. at 200 ft. per minute with the simple gearing and 20,000 lb. at 50 ft. per minute with compound gearing.

Formerly these winches were provided with a rheostatic cylinder controller and an enclosed rheostat mounted on the bedplate of the winch itself, but in later practice a small master controller is mounted on the winch and the contactor panel and rheostats are located below the deck. The motor itself is located above deck and is therefore of watertight construction, the same as the boat crane motor shown in Fig. 11.

Fig. 13 shows a deck winch controller of the rheostatic cylinder type. Fig. 14 shows a complete deck winch.

Coaling winches are also provided on many vessels but have been frequently operated by steam. A few vessels have been equipped

being located below decks is semi-enclosed, and is of particularly rugged construction on account of the excessive loads that may occur at times.

On some foreign vessels, small individual electrically operated winches are provided



Fig. 13. Deckwinch Controller

having a winch head on each side and located at convenient places on the deck. These are also readily separated into different parts so that they may be stowed below when the ship is cleared for action.

Coaling at sea apparatus has been operated electrically on several vessels, especially in the Russian navy. For this purpose a special design of electric hoist is installed either on the battleship or on the collier. The collier is towed at some distance behind the battleship and a conveyor line is carried from mast to mast on which bags of coal are carried from the collier to the battleship. Special arrangements are provided for keeping this line tight as the distance between the two vessels varies slightly in a rough seaway. The bags of coal are raised by a hoist to the mast head of the collier and then fastened quickly to the conveyor rope which is kept in motion by a special coaling-at-sea hoist, and a slipping clutch or other suitable arrangement is provided which will take up the slack in this conveyor cable or pay out more cable as circumstances may require.

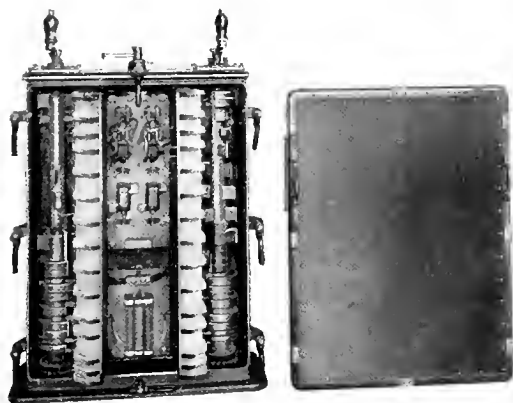


Fig. 12. Rheostatic Controller for Boat Crane

with 150-h.p. motors driving a line shaft connected by bevel gearing to vertical winch heads above the deck. A 150-h.p. motor for this purpose is shown in Fig. 15. This motor

Ventilation

On account of the large number of people living in a small space where natural ventilation cannot be used, artificial ventilation of vessels is very important. This was formerly

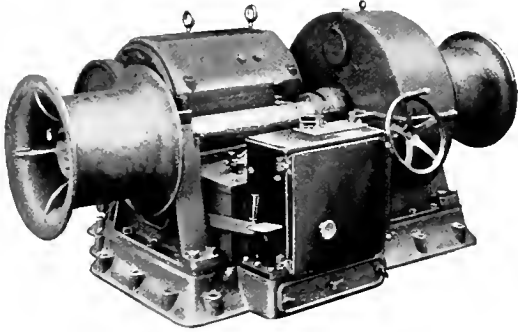


Fig. 14. Deckwinch

accomplished by steam-driven fans but electric fans have shown a great superiority and the equipment of the modern battleship may contain more than 60 electrically operated fans delivering a combined volume of more than 400,000 cu. ft. per minute. These fans are used either for furnishing fresh air to the various compartments, taking it from a ventilator above the deck or for exhausting impure air from the compartments and discharging it through ventilators.

The fan wheels are usually carried on the end of the armature shaft and the fans usually receive air from one side only, being connected to the inlet pipe and discharging it through sheet metal ducts in the various compartments, where the air is required for the supply system, and for the exhaust system these ducts lead from the various compartments combining into a large duct which leads to the inlet of the fan.

These fans are not only used for ventilation but for heating and cooling air and in these cases thermo-tanks or similar heating and cooling coils are used. For heating, the pipes are steam-heated, dampers being provided to by-pass a portion or all of the air around the heaters when the heat is not required. By the use of water these thermo-tanks become coolers and humidifiers, and the temperature can be made comfortable in hot climates.

Frequently the casing of the fan is bolted directly to the sub-base of the motor but for navy work convertible sets of special design are generally used and the fan casing can be bolted to the motor supports at various angles, so that any desired direction of

discharge can be used without building the fan specially for that direction. Motors are usually of the open construction, but where located in exposed places, enclosed water-tight motors are frequently employed, as shown in Fig. 16.

For state-rooms desk and bracket fans play an important part and some of the larger battleships are furnished with as many as 135 of these.

For temporary ventilation of compartments where men may be working, portable ventilation sets, delivering about 400 cu. ft. of air per minute and furnished with flexible hose, are used; 18 being supplied on recent battleships.

Electric operation has also been applied to fans for supplying the forced draft for the boilers both on commercial and naval vessels, see Fig. 17. These vary from 20 to 40 h.p. and from 15,000 to 28,000 cu. ft. per minute. These motors are usually of the enclosed type and are located near the tops of the boilers, sometimes in passage ways near the uptakes and sometimes in special compartments located just above the fire room. These fans take air from both sides and deliver it below into the enclosed fire room, producing a pressure of about 2 in. water gauge. The earlier ones were furnished with hand-operated dial controllers but later types have been furnished with contactor controlling panels, the master controllers for which are



Fig. 15. Cooling Winch Motor

located in the fire rooms. Several of the most recent battleships are provided with fans driven by steam turbines which permit a greater range of control than the electric sets and are somewhat lighter. This particu-

larly applies to oil burning vessels, where the air pressure, and consequently the speed of the fans is higher than in the case of coal burning vessels. On torpedo boat destroyers these turbine-driven forced draft fans are usually of vertical construction. Fig. 18 shows the forced draft motor with special provision for cooling.

Power Doors

On a large number of vessels many of the watertight doors are operated by electric motors. These equipments are provided with local control at the door by which the door can be readily opened or closed, and an emergency station on the bridge is connected to all doors so that in case of danger all of the doors can be closed within a few seconds by operating the emergency controller. These motors vary in size from $\frac{3}{4}$ to 1.2 h.p. They are arranged with automatic devices so that if a bunker door should be clogged with coal, when the emergency controller is operated, the door will close as far as the coal will allow it and after the coal has been removed or washed out by the water, the door will automatically complete the closing operation.

Pumps

The Russian battleship *Retvizan* and cruiser *Variag* built for the Russian Government at the Cramp shipyard at Philadelphia contained several electrical devices not in common use in the United States at that time, some of

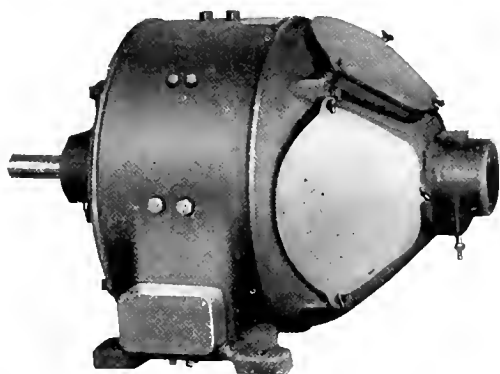


Fig. 16. Watertight Motor

which have been incorporated in United States practice since. These include electrically driven pumps. The Russian battleship had four 54-kw. vertical motors driving centrifugal pumps for drainage purposes and two

similar equipments of 18-kw. capacity. The cruiser was provided with three of the large and two of the small pumps. Several years later similar pumps were introduced in United States vessels. These vary somewhat in

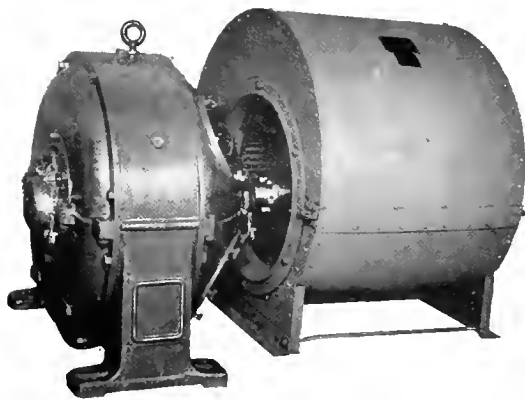


Fig. 17. MP-6-30-h.p., 620/775-r.p.m., 120-volt Motor Direct Connected to Sirocco Fan

capacity, speed and power in the different vessels, but the following applies to some of the most recent vessels:

- Six main drainage pumps of 3000 gallons per minute against 35-ft. head.
- One secondary drainage pump, 750 gallons per minute against 35-lb. head.
- Two flushing pumps, 500 gallons per minute against 50-ft. head.
- Two fresh water pumps, 200 gallons per minute against 35-lb. pressure.

All of these pumps are of the centrifugal type. The main drainage pumps are vertical and are installed in the fire rooms, the motor being supported several decks above and connected by a shaft about 25 ft. long. On account of the possible deflection of bulkheads, due to the pressure of water when the compartments are flooded, special provision is made for supporting the bearings of this intermediate shaft. The motors are of the semi-enclosed type. The motors for the other pumps are watertight, enclosed and of horizontal construction and in some cases provided with ball bearings. The frames are split for convenience in disassembling on shipboard.

The control equipments consist of a contactor panel controlled by a master switch, which in some cases is located at the pump. On some vessels drum type controllers have been installed, providing also field control of the speed of the motor, although usually

compound wound motors without speed control are used.

The horse power of the recent equipments varies from 50 h.p. main drainage pump to 14 h.p. for the flushing and fresh water pumps.

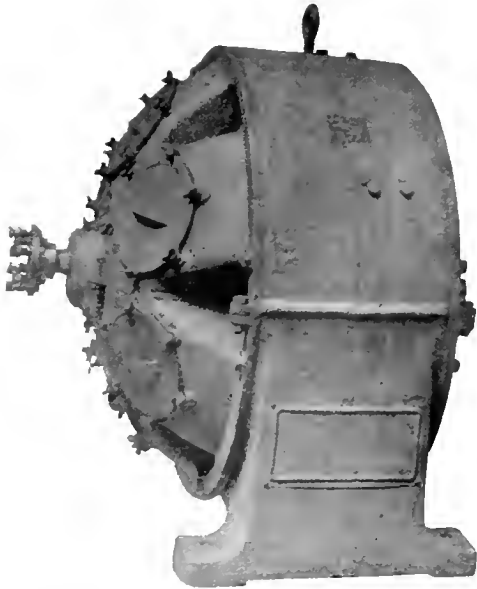


Fig. 18. Type MP-6-32 H.P., 725 930 R.P.M., 120-Volt Totally Enclosed Forced Draft Motors, U.S.S. "Nevada"

Fig. 19 shows a 70-h.p. main drainage pump motor for the Argentine dreadnoughts. Fig. 20 the rheostatic drum controller with field control and Fig. 21 the secondary drainage pump motor for the same vessels. This motor, which differs from the usual construction, is enclosed but provided with a fan on the armature shaft and has an air inlet at the commutator end and a discharge at the other end.

Ammunition Equipments

The handling of ammunition, the serving and pointing of guns, is accomplished electrically. For the broadside secondary battery the ammunition is carried by endless conveyors driven by electric motors and then is carried up to the guns themselves by means of endless chain conveyors. Both of these systems are operated by motors running continuously and the supply of ammunition delivered to the guns is controlled by the quantity delivered to the conveyors or chain hoists.

For the turret guns the ammunition is usually hoisted by means of a car or hook attached to a wire rope and after each shell

is hoisted to the gun the motor is reversed and the hook or car returned for another load. Electric motors operating by various methods have been used for turning the turrets and elevating and depressing the guns.

As these classes of apparatus, as well as the various signaling devices for transmitting orders for operating the guns, are purely of a military character and do not in any way represent commercial practice, no further details will be given.

Gyroscopic Compass

An interesting development of recent years is the gyroscopic compass. One form which has been used considerably has been developed in Germany and another in the United States. These compasses are entirely independent of the earth's magnetism and are not affected in any way by the steel structure of the ship. The directive effort depends upon the reaction of the earth's rotation upon a small flywheel revolving at high speed. The wheel is driven by an induction motor the current for which is furnished by a motor-generator set having a generator of comparatively high frequency.



Fig. 19. Main Drainage Pump Motors

The master compass is located in the lower part of the ship, where it is well protected, and connecting wires are taken to several secondary compasses in convenient locations, which show the readings of the master compass.

Sounding Machines

Good results have been obtained from sounding machines operated by electric motors. This apparatus consists of a small electric hoist containing a drum upon which is wound the line which carries the sounding lead. In lowering the lead the drum is uncoupled from the motor and is controlled by hand by means of a brake. An indicator connected with the drum shows the length of the line that has been let out. When it is desired to raise the lead, the drum is clutched to the motor, which winds up the line.

Ship Propulsion

The electric propulsion of vessels has interested engineers for several years. At the Columbian Exposition in Chicago a large number of launches were propelled electrically. Aside from these the first boats of importance in the United States to be equipped were two fire boats for the City of Chicago. These boats had two 600-h.p. turbines direct connected to 200-kw. generators and centrifugal pumps. When the boats were being propelled the pumps ran

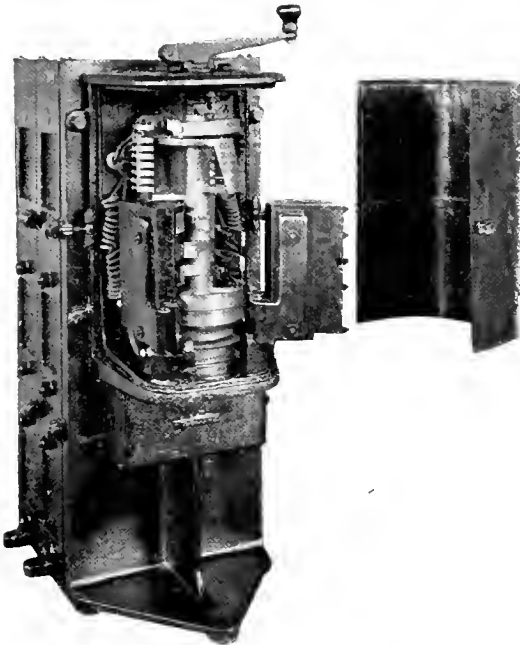


Fig. 20 Controller for Main Pump Motor

idle and the two generators furnished power to two 250-h.p. 200-r.p.m. motors driving twin screws. These equipments operate with direct current on the Ward Leonard system, controllers being located both in the pilot

house and the engine room. The control of these boats is very satisfactory and it is possible to maneuver them without using the rudder.

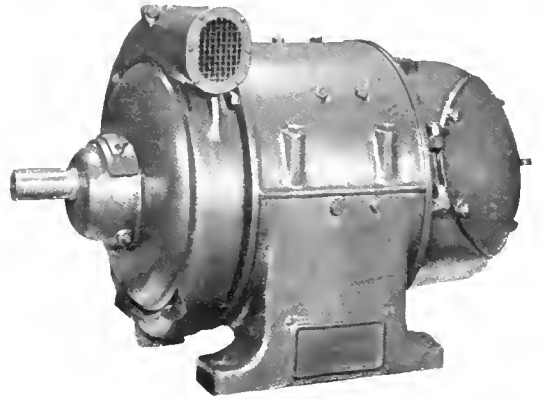


Fig. 21. Secondary Drainage Pump Motor

A few boats have been equipped, in Europe, with internal combustion engines driving generators which furnish current for motors which drive the propellers and in addition magnetic clutches are provided by which the propeller shafts can be coupled directly to the engines. In this system the electrical operation is used for maneuvering the boat, going ahead slowly and backing, but for full speed ahead, the clutch is used and the electrical connections are opened.

Considerable attention has been given to electric propulsion in England, making use of alternating current, and the *Tynemount* equipped with this system is operating on the Great Lakes.

The first large propelling equipment was installed on the U. S. collier *Jupiter*. In this vessel one steam turbo-generator furnishes current for two induction motors driving twin screws. The speed is controlled by adjusting the governor of the turbine and reversal is accomplished by reversing the electrical connections.

The battleship *California* is to be provided with electric propelling apparatus, consisting of two turbo-generators supplying power for four 7500-h.p. induction motors. These motors are provided with a two-speed winding, the slow speed winding being used at ship speeds less than 15 knots, and the high speed winding at higher speeds. Between these points the speed of the motors is controlled by the speed of the turbines. For full power, each turbine supplies two motors

and for moderate speeds one turbine supplies power for all four motors.

Various articles concerning electric propulsion have been published in the technical press and therefore no complete details are given here.

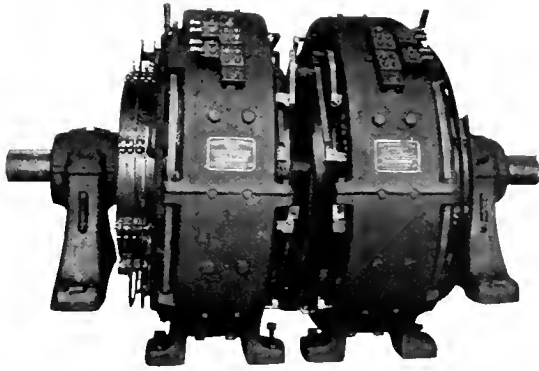


Fig. 22. Propeller Motors

Miscellaneous

In addition to the various equipments which have been described somewhat in detail, there are a large number of other auxiliary apparatus operated electrically. These consist of the laundry machinery, galley appliances, and machine tools, of which a considerable number are used especially on large warships or on special repair ships.

Electric refrigerating apparatus has been adopted in many cases where electric motors are used to drive the compressors instead of steam.

Elevators are used for the fire rooms in warships, and for the general use of passengers on passenger ships.

Submarines

At the present time submarine design is undergoing a radical change, but of those built in recent years many are from 150 to 200 ft. long and have a surface displacement of from 400 to 650 tons. These boats have a surface speed of approximately 14 sea miles per hour and a submerged speed of approximately 10 sea miles per hour. The surface cruising radius varies from 2500 to 4500 miles. The submerged radius is about 150 miles.

The electrical equipment comprises propeller motors operated from 220-volt storage batteries and several small motors for the auxiliaries.

When operating the boat on the surface, a Diesel type of heavy oil engine is direct connected to the propeller through friction

clutches and through the propeller-motor armature shaft, which forms an integral part of the propeller shaft.

The Diesel engine is used for surface propulsion only, on account of the difficulty of supplying air for combustion purposes when submerged. When operating submerged, the propeller motors are connected across the battery and the clutch between the engine and motor is disengaged.

The motors are of the shunt wound type and with fields separately excited from a 110-volt source; i.e., across half of the storage battery. These motors are of the open type and, as the inside diameter of the boat is approximately 10 ft., these motors are designed for the smallest diameter possible, and where the output and speed necessitates the furnishing of a machine having a diameter beyond the allowable limits it is customary to supply two machines having armatures mounted upon a common shaft, as shown in the accompanying illustration, Fig. 22, which shows two motors, each rated 150 h.p., having a full field speed of 125 r.p.m. and a weak field speed of 250 r.p.m., the speed control being accomplished by means of field rheostats.

Another scheme sometimes used, which will permit of furnishing machines having the smallest possible diameter, is to have the motors connected as shown in the above illustration but totally enclosing same and mounting between the two machines a ventilating fan, the intake of this fan being through the openings in the lower half of the commutator end shields.

The storage batteries have a range of from 246 volts to 200 volts over the discharging period. These batteries are charged by throwing out the clutch between the propeller motors and the propeller proper and driving the motors as generators by means of the Diesel oil engines.

All submarines have two propeller shafts and the equipment above described is always furnished in duplicate.

The control of the motors consists of contactor panels enclosed in a watertight case, the operation of which is controlled by two drum type master controllers mounted side by side and so arranged that they can be operated together by one handle through gearing, or this gearing can be thrown out of mesh and the two controllers operated independently. The field rheostat for speed control is mounted on a small panel immediately above the drum controllers and is hand-operated.

THE USE OF ELECTRICITY IN MINING WORK

By DAVID B. RUSHMORE

CHIEF ENGINEER, POWER AND MINING DEPARTMENT, GENERAL ELECTRIC COMPANY

The author shows the broad scope of work included in the term "mining" and gives statistics to indicate the magnitude of the industry. The importance of the application of electricity to mining work as set forth by the author should be of special interest to those connected with the industry.—EDITOR.

Economic activities are divisible into the following general classification:

1. Hunting and fishing.
2. Lumbering and forestry.
3. Mining.
4. Agriculture.
5. Manufacturing.
6. Transportation.
7. Merchandizing.
8. Distribution.
9. Miscellaneous.

The objects of these are to furnish food, shelter, clothing and incidentals to the ultimate consumer.

The mining industry draws upon natural resources and deposits in order to furnish fuel, building and structural material, precious stones and metals, and the raw materials for many manufacturing processes. The principal products of the mining industry are as follows:

Fuels: Anthracite and bituminous coal, petroleum, natural gas and peat.

Metals: Iron, copper, precious metals, lead, zinc, quick-silver, manganese and tungstone.

Structural Materials: Limestone, granite, sandstone, marble, slate, traprock and blue-stone.

Miscellaneous: Asbestos, asphaltum and bituminous rock, barytes, bauxite, buhrstones and millstones, clay, corundum and emery, feldspar, fluorspar, Fuller's earth, garnet, graphite, grindstones, gypsum, infusorial earth and tripoli, magnesite, marl, mica, mineral pigments, monazite and zircon, oilstones, scythestones and whetstones, phosphate rock, precious stones, pumice, pyrite, quartz, sulphur, talc and soapstone.

The mining industry is world-wide and as old as civilization. The man-power of early mining operations had distinct limitations with regard to possible depth, cost and output, and while modern machinery and appliances have made it possible to operate formerly

unprofitable mines, new discoveries and improvements in mining methods are to be continually expected.

The number of men employed in the mining industry in the United States and the division of occupation are approximately as follows:

EXTRACTION OF MINERALS.....	964,824
Foremen, overseers, and inspectors.....	2,338
Foremen and overseers.....	22,142
Inspectors.....	1,196
Operators, officials, and managers.....	25,234
Managers.....	9,798
Officials.....	1,149
Operators.....	14,287
Coal mine operatives.....	613,924
Copper mine operatives.....	39,270
Gold and silver mine operatives.....	55,436
Iron mine operatives.....	49,603
Operatives in other and not specified mines.....	47,252
Lead and zinc mine operatives.....	19,486
All other mine operatives.....	27,766
Quarry operatives.....	80,840
Oil, gas, and salt well operatives.....	29,927
Oil and gas well operatives.....	25,562
Salt well and works operatives.....	4,365

The table on page 538 also gives some important figures regarding the mining industry in the United States and the power utilized.

Mineral, coal, oil and other natural deposits occur over considerable areas much larger than individual mines, which results in the condition known as mining camps such as are found at Butte, Cobalt, Bingham Canyon, the Coeur d'Alenes, the various anthracite developments, the Messabe Range, and in the various oil fields of Pennsylvania, California and Texas.

Due to the fact that a large number of mines in one locality have use for power and that in each mine the machinery is separated by considerable distances, the use of electricity as a means of transmission and application of power has very decided advantages. In fact, the age is passed when advocacy of

electrification of mines has to be put forward as regards new developments. The replacement of antiquated machinery in mines which have been worked well on toward exhaustion

invested in a separate power plant which must be written off during the life of the mine. Thus we find in such places as South Africa, Cobalt, Butte, etc., that the power for the whole mining district is supplied from one or more central source. In the case of hydro-electric power, or transmission over some distance from steam plants, precautions against service interruptions must be given careful attention, but the present state of the art regarding power transmission work is such as to remove any question of great hazard.

The best system, frequency, phase and voltage for mining work is usually dependent largely upon the particular power systems which are available for use in these districts. The life of most mines is now sufficiently great to warrant the development and extension of hydro-electric or

steam power systems to these territories, and there is almost invariably a supply of three-phase electrical energy at 25, 60 or some intermediate frequency.

An interesting similarity exists between the transmission of electric energy and the transportation of commodities. Energy may be transmitted electrically or transported mechanically as is done with coal and oil. Every industry has its waste products and economy is best obtained where these are utilized. In the preparation of commercial sizes of coal there is obtained from the breakers and crushers a refuse known as culm which is unmarketable and which at present has no commercial value except as it may be made into briquettes.

In connection with the use of electricity in coal mines it is therefore interesting to consider the economical use of this by-product or waste coal in commercial form. The best and largest development of the kind in this country is that of the Lehigh Navigation Electric Company at Hauto, Pa. The refuse from preparing the marketable coal of the Lehigh Coal & Navigation Company is sufficient, it is estimated, to supply continuously a power house of 100,000 kw. rated capacity, 30,000 of which have been installed

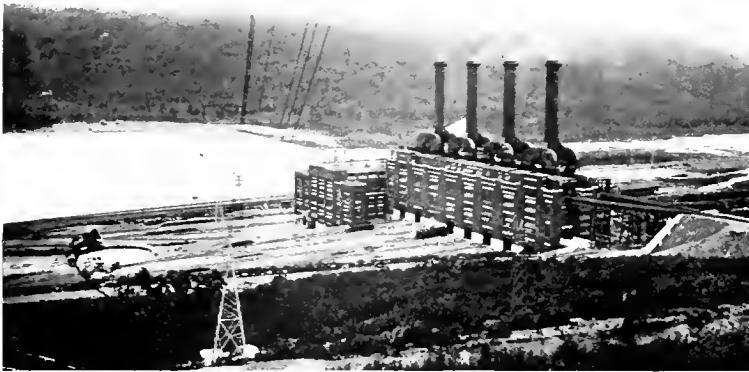


Fig. 1. Power Station of Lehigh Navigation Electric Co., at Hauto, Pa.

is, however, an economic problem which does not always admit of the introduction of electrical apparatus at such a late period.

The principal reasons for the use of electricity in mines are:

1. The possibility of saving in capital and in organization activities by the purchase of power.
2. Efficiency and economy.
3. Convenience.
4. Flexibility.
5. Ease of extensions.
6. Safety.
7. Saving in space.

It also very frequently happens that mining camps are possessed of poor conditions for supplying condensing water, and such water as exists is frequently of an acid nature, which adds to the desirability of supplying power from a central station which can be located under the best of conditions.

The question as to whether mines should generate or purchase their power is one which arises where the camps are small and where mines may be somewhat isolated. Profits in power companies are usually small compared with what they should be in mining operations and therefore the capital should be much better utilized in the mining work than when

in the initial development. This power is used for its own mining operations and also sold to neighboring industries as well as to the public utilities which are accessible. Other developments, both in this country and Europe, have been and are being made to sell not only the refuse coal but also the output of the mine as a whole in this way. Especially noteworthy are the many studies which have thus been made with regard to the possibility of utilizing the culm piles of Pennsylvania in this manner, but the burning of the finest coal dust alone has not yet met with complete success. In certain coal fields in Virginia reached by the Appalachian Power Company, the method of handling coal, on the other hand, is such that a high priced market exists for it all, and therefore makes desirable the purchase of hydro-electric power for coal mining work apparently something of an anomaly.

The principal operations in mining have to do with the handling of material in bulk, while other factors are incidental, such as arrangement for handling men, pumping water, supplying power, illumination and ventilation, as well as considerations of safety.

Mining conditions are highly special and reliable information on the details of mining costs and power consumption are not to be had. Methods of accounting in mining



Fig. 2. Electric Shovel

work are yet to be standardized, and until they are available figures can be used for comparison only when the specific factors are known which are necessary for their interpretation.

The kind of mining operations varies greatly even in one field, such as gold mining for example, where we have the panning and hydraulic mining of California, the dredging

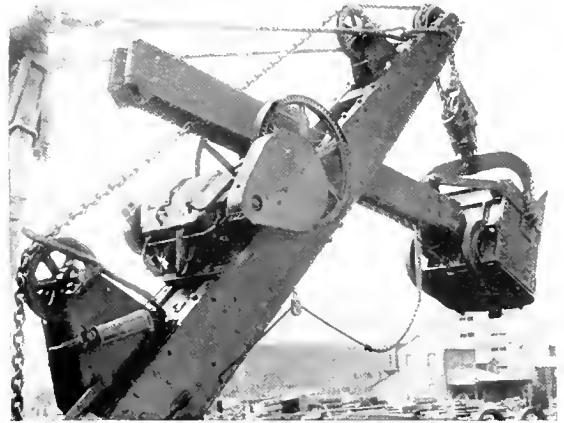


Fig. 3. Crowding Motor and Controller on a 65-Ton Electric Shovel Equipped with Four 550-Volt Series Direct-current Motors

of Alaskan rivers, and the working at extreme depths of the mines on the Rand in South Africa, all to obtain the same metal.

The general power applications in mining work to which electricity is applicable are in connection with the following machines and work:

- Strippers, shovels and various forms of excavating machinery.
- Dredges and monitors.
- Drills, coal cutters, etc..
- Mining locomotives.
- Hoists.
- Pumps.
- Air compressors.
- Mine fans.
- Coal crushers and washeries, etc.
- Magnetic ore separators.
- Signal and telephone systems.
- Lighting and illumination.

The various power applications in mining work and in the auxiliary work of reduction often carried on in the vicinity of mines can be accomplished by a number of different types of motors, although generally some specific form is most suited to each particular case.

Shovels

On account of its simplicity, reliability and economy the electric shovel is being used more

and more in places where current is available. In mining work it may be used for stripping over-burden or for excavating the ore itself and loading it on the railroad cars. These shovels must be exceedingly powerful and carefully designed to successfully withstand the severe shocks and strains incident to the strenuous conditions under which they must operate. Due to the absence of the steam boiler equipment less attendance is required, while the inefficiency of small engine and boiler equipments is fully appreciated. The electric control is very simple and, with motor drive, power is consumed only while operating, resulting in a high efficiency.

The duty cycle of a shovel is very short, varying from about 20 to 30 seconds, while the cycles of the individual motors are even shorter. This necessitates rapid acceleration and frequent reversals of the motors, which for that reason must be of a very rugged design. Their inertia should, of course, also be as low as possible, and it is therefore common practice to equip at least the hoist with two motors, each of one-half the total required power capacity. In this manner the power consumption during acceleration is considerably reduced.

Electric shovels are, as a rule, equipped with three or four motors; one or two for the hoist, one for the swing and one for the boom. The two hoisting motors are located at the back of the main machinery, and longitudinally in relation to the car frame, one on each side, and transmit their power to an intermediate hoisting shaft through bevel gears. This intermediate shaft gears direct into the hoisting drum shaft which carries the drum on which the hoisting chain is wound, this drum being provided with friction and check bands for controlling the hoisting and lowering of the dipper. The friction band is operated by means of an air set ram, while the check band is operated by foot.

The swinging motor is geared to the swinging drum through a system of spur gearing, this drum carrying two cables, one on either end, which lead forward and pass around the swinging circle connecting directly to the boom. This motor is provided with a brake which, however, is used only in case of an emergency.

The boom or crowding motor for controlling the dipper handle, is located on the boom and geared to the shipper shaft which carries two pinions which engage with the racking of the handle. The control for all of these motors is placed at the rear of the machine, and the

arrangement of machinery is practically the same as on the steam units.

The motors are provided with automatic control, which is particularly adapted to this class of work, as the acceleration is automatically taken care of by the contactors, and the master controller, being light, provides free and easy operation. In addition to the series contactors for the hoisting and crowding control, jamming relays are used, which limit the current flowing to the motors to a safe amount, but do not cut the motors out of circuit in case they are stalled or overloaded. No jamming relay is provided with the swinging motor, as it is protected by the circuit breaker.

The reversing master controllers for the hoisting and swinging motors are placed at the forward end of the cab, while the controller for the crowding motor is placed on the boom.

The motors may be either of the alternating-current slip-ring or the direct-current series-wound type. It is, however, generally conceded that the direct-current series motor is superior to the alternating-current motor for shovel work. The characteristics of the series motor closely resemble the steam engine, which is giving very satisfactory service as far as the actual working condition is concerned. The power supply is, however, generally alternating current, and the direct-current equipment must therefore include a motor-generator set, but nevertheless it has proven cheaper than the alternating current.

H. W. Rogers in the Transactions of the A.I.M.E. gives the power consumption for a 120-ton electric shovel as:

0.241 kw-hrs. per cubic yard for direct current

0.273 kw-hrs. per cubic yard for alternating current.

His paper also includes the following table giving comparative costs between steam and electric shovels of the same capacity:

	ELECTRIC		
	STEAM	Direct Current	Equivalent Alternating Current
Interest at 6 per cent.	\$5.20	\$7.75	\$10.85
Depreciation at 4 $\frac{1}{2}$ per cent.	4.03	6.00	8.43
Repairs at 15 per cent.	13.00		
Repairs at 9 per cent.		11.63	16.28
Labor (3 shifts)	90.75	63.75	63.75
Total Cost (3 shifts)	\$112.98	\$89.13	\$99.31

The foregoing table gives the costs for three eight-hour shifts, during each of which it is estimated that 2970 cubic yards of material are excavated. It is assumed, however, that owing to weather conditions, delays, etc., the shovel-working year consists of 150 days.

Dredges

A considerable part of the gold mined in the United States is now recovered by motor-driven dredges. Steam power is, of course, still used to the greatest extent, but with the rapid extension of the Western hydro-electric transmission systems cheap power can now be obtained in many mining districts. It is, however, not only the cheaper power which has made the electrically-operated dredge superior to the steam-operated dredge. Experience has proven that they are more reliable and operations are thus less interrupted, while the larger sizes which have recently been built would have hardly been possible if a steam equipment had been used.

The following table gives the production of gold by dredges in California for the years 1898-1910:

1898	\$18,847	1905	\$3,276,141
1899	133,812	1906	5,098,354
1900	200,369	1907	5,065,437
1901	471,934	1908	6,536,089
1902	801,295	1909	7,382,950
1903	1,488,566	1910	7,550,254
1904	2,187,038		

The number of electrically-driven dredges in operation in the United States at the beginning of the year 1913 is given in the following table:

Feather River	34
Yuba River	14
Folsom River	15
Bear River	1
Toulume	1
Clear Creek	1
Clamath	1
Jenny Lind	2
Montana	5
Scott Valley	1
Colorado	3
Mew Mexico	1
Idaho	3
Oregon	1
Dawson	10
Forty Mile Creek	4
Stewart River	1
Nome	2
Frazer River	4
Total	104

It is safe to say that since the above tabulation was made at least a dozen more dredges have been put into operation.

There are three kinds of dredges in use, viz: dipper, suction and bucket dredges, of which the latter type is most commonly used. It is usually of the continuous chain, close



Fig. 4. Electrically-operated Gold Dredge

connected bucket type, varying in capacity from 3 to 16 cubic feet per bucket and with a bucket speed of from 50 to 75 feet per minute. The machinery of a gold dredge consists of the digger or bucket line, revolving screens, sluice tables and boxes, stacker for carrying the tailings, high and low pressure pumps.

Dredge motors are mostly of the alternating-current class, the variable speed type being required for the operation of the bucket line as well as for the winch by which the dredge is kept in place or moved about. All the other motors are of the constant speed type, with the screen and stacker motors usually phase-wound. When a dredging operation is commenced in a new locality the load is usually light at first and the buckets may be operated at maximum speed. As the depth increases and the soil becomes harder the load increases and the buckets do not fill so easily, so that a reduced speed is required.

Bucket line motors vary in size from 75 to 400 horse power, winch and stacker motors from 15 to 50 horse power, and screen and pump motors from 25 to 150 horse power.

The power is transmitted to the dredges by means of armored cable, carried on floats, and if the transmission can be economically carried out at 2300 volts, the motors are usually wound for this voltage. For higher transmission pressures step-down transformers are, however, provided on the dredge and the pressure reduced to a motor voltage of 440.

The cost of operation varies from approximately 2.3 cents per cubic yard for a 13 cu. ft. dredge to 7.5 cents for a 3 cu. ft. dredge,

the power cost being 0.5 and 1.5 cents respectively.

Coal Cutters

The production of bituminous coal by coal-cutting machines in the United States dates

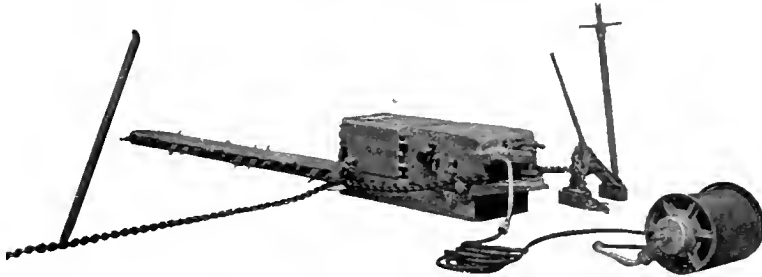


Fig. 5. Sullivan "Ironclad" Electric-driven Continuous Cutting Coal Mining Machine in Position to Cut Across the Coal Face under its Own Power. Object at right is cable reel; equipped with 30 h.p. General Electric motor, direct-current

commercially from 1891, when a little over 500 of such machines were in use cutting somewhat over six million tons of coal, or 6.7 per cent of the entire output. In 1912 over two hundred million tons, or 47 per cent of the total production, were mined by coal cutters, of which over 15,000 were then in use.

The actual mining operation consists in undercutting the coal seam and blasting down the mass by a small charge of powder so as not to break up the coal in too small pieces. The undercutting was formerly, and is still to a great extent, done by compressed air punchers. These are, however, being rapidly superseded by electrically-driven chain cutters. The first of these was the breast type in which the cutter bar is fed into the coal seam to its full length, after which it has to be withdrawn and moved sideways and again anchored before a new cut can be made. This type is now becoming more and more obsolete and is giving place to the continuous cutting machine, which may be either of the long- or short-wall type depending how the cutting is to be done. This machine has many advantages over the breast type. The machine is entirely self-propelling and after the bar has been fed under the coal at one end of the wall it cuts its way across the face to the other side continuously, and the economy in time is obvious. Besides this, it requires much less space, which is of importance as it permits the props to be set up very close to the working face, thus greatly increasing the safety.

Modern coal cutters are now being equipped with either direct or alternating-current motors, which are designed to meet the various mining laws of the country. The motors may be changed readily from the open to the enclosed type, or to the flame-proof pattern, by alterations which may readily be made in the field. This is of great value in many mines, where to begin with there may be no indication of gas. Later on as the development advances, gas is encountered, necessitating a gas-proof machine.

The motors are rated about 30 horse power for one hour, totally enclosed, or for three hours continuously at the same load with open construction.

The average load when cutting coal with continuous-cutting machines is from 12 to 20 horse power for an average period of 30 minutes, depending on the hardness of the coal and the feed of the machine.

The direct-current motor is of the multi-polar, compound wound type, the voltage being 250 or 500, and the alternating-current motor is of the squirrel-cage type, wound for 220, 440 or 550 volts, and 25 or 60 cycles, as desired.



Fig. 6. Electric Rock Drill in Operation in Coal Mine

Locomotives

The mine-haulage problem is one of the most important features of the mining industry. This is of course obvious, when it is

realized that the aggregate amount of ore, coal and waste rock handled in the mines of this country during a single year is in excess of one billion tons.

It is now a fully established fact that animal haulage is not economical for mine service, and while in most mines the mechanical drive has long ago superseded the same as far as the main haulage system is concerned, it is now also being rapidly superseded for the gathering service.

Mining locomotives may be of the compressed air, the gasoline or the electric type. Of these, the latter has so many advantages that in the majority of installations it is the only one being considered, and is now accepted as the standard type for mining service.

Although alternating current locomotives are used occasionally, most mining locomotives are of the direct current two-motor trolley type, with series and parallel control. In this manner it is possible to obtain a very efficient speed regulation, the motors being connected in series for low speeds. Thus for a given load with the motors in series, the current consumption is only half of what would be required by a single-motor locomotive. The motors are of the series-wound commutating pole type, equipped with ball bearings.

The load which a locomotive is capable of hauling depends on the weight of the locomotive, the adhesion between the driving wheels and the track, the frictional resistance of the trailing load and the curvature and gradients of the track.

Mining locomotives are rated according to their weight in tons, the drawbar pull on level track being approximately 20 per cent of the weight. Experience has shown that

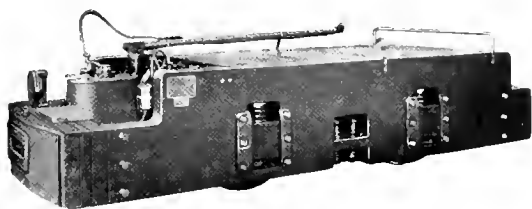


Fig. 7. Fifteen-Ton Mine Locomotive

for cast iron wheels this coefficient of adhesion may be safely assumed for clean dry rails. The maximum drawbar pull is generally 25 per cent greater.

Two-motor locomotives are built in sizes from 4 to 20 tons. For larger sizes six-wheel

three-motor locomotives may be used where the curves are not too sharp, and where these would not be objectionable. This type of locomotive has the advantage of better distributing the weight, so that lighter rails may be used than for a two-motor locomotive of the same weight. To obtain greater capacity it is also possible to connect two two-motor locomotives in tandem in such a manner that all the four motors may be controlled from one controller. Such locomotives may also be operated singly as independent units.

Locomotives used for gathering are generally of a smaller capacity than those used for the main haulage. In order to obviate the use of trolley wires in the entries, these locomotives are often equipped with cable reels, containing several hundred feet of cable the outer end of which can be connected to the trolley wire in the main entries, and through which power may be fed to the locomotive when it enters the working rooms. The cable reel is motor operated and automatically controlled in such a manner as to keep the cable taut and rewind the same when the locomotive returns.

Some gathering locomotives are also in addition provided with hoist drums to be used for steep grades. When so equipped, the locomotive can be blocked on the track in the entries, and by means of the hoist cable the cars can be hauled up or lowered on the steep grades to and from the working face of the rooms. When so equipped, there is hardly any haulage problem that the locomotive can not take care of.

There has also been a steady increased demand for the storage-battery type of locomotive for gathering work, these being built in sizes from 3 to 7 tons. Most of these are of the straight storage battery type, but a limited number have, in addition, been equipped so that they can be operated from a trolley wire when in the main headings. By means of a small self-contained motor-generator set the battery may then also be automatically charged, while the locomotive is running on the trolley.

Hoists

Electric mine hoists were first developed in Europe and their use there had become universal before the mining interests in this country were ready to adopt them. After a campaign of education lasting over several years their adoption in this country came with unusual rapidity, and now it is only

under exceptional circumstances that any other kind of hoist would be considered. In the meantime, however, the large electrification of hoists in South Africa was carried on, in part by one American electrical company, and the largest hoists in the world installed there were designed by American engineers.

Due to the natural conditions of mining the work of hoisting is not evenly divided over the twenty-four hours, but is usually concentrated during two or more periods of the day when the ore is brought to the surface with the greatest rapidity. At certain hours

adapted for hoist work. The current is obtained from a shunt-wound direct-current generator driven by a direct-coupled induction motor, where the source of supply is alternating, as is almost invariably the case. Both the hoist motor as well as the direct-current generator are separately excited, the exciting current being obtained from an exciter direct connected to the motor-generator set. The control of the hoist motor is then effected by regulating and reversing the exciting current of the generator, thus varying the voltage impressed upon the motor terminals.

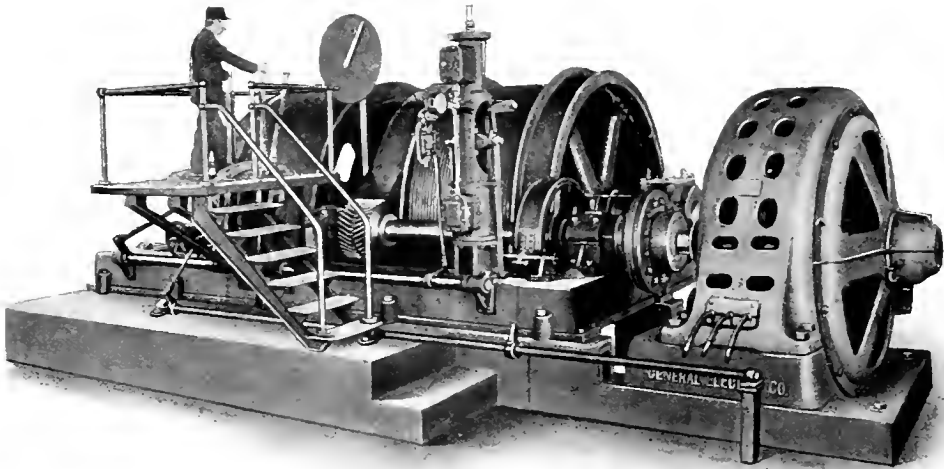


Fig. 8. Mine Hoist Driven by a 700-h.p., 300-r.p.m., 3300-volt Induction Motor

of the day, also, men are lowered or raised from the mine shaft, and at still other hours the work of repairing and lowering timber, etc., into the mine is carried on. The load on the hoist over a complete cycle is naturally of a very fluctuating character and possesses a sharp peak over a few seconds of time. Where the hoisting of a group of mines is done simultaneously a peak of considerable magnitude, lasting over several hours, can be expected. The latter can be taken care of to some considerable extent where the mines come under the same management or where an understanding is reached to prevent too great overlapping.

Mine hoists may be driven either by direct or alternating-current motors. The characteristics of slow-speed shunt-wound direct-current motors make this type admirably

Induction motors for driving hoists are usually of the phase-wound type, the speed control being accomplished by inserting or cutting out resistance in the secondary circuit, liquid rheostats being used for larger equipments.

Where the terms of the power contract are such as to penalize peaks in the demand, a smoothing out of the energy demand on the main system is important and it can be accomplished in a variety of ways. A large number of such systems have been proposed with many ingenious arrangements of storage batteries, flywheel equalizing sets, etc., but as usual where simplicity is greatly to be desired a few of these have been found to possess the most desirable characteristics.

With direct-current equipments as above described, the simplest and, when properly

applied, the most satisfactory method is by adding a flywheel to the motor-generator set. The use of flywheels is, of course, limited to an acceleration of comparatively short duration, and to permit the wheel to take care of the peaks the speed of the set must be varied according to the load fluctuations, i.e., when the peak comes on the set must be slowed down, and vice versa. This is done by inserting resistance in the secondary circuit of the phase-wound induction motor driving the set and this is automatically accomplished by what is known as a slip-regulator.

With the induction motor-driven hoists the peaks may be equalized by means of flywheel

There are two classes of mine pumps in general use, the plunger and the centrifugal. The former is essentially a slow speed machine and is less affected by gritty water. It is extensively used for portable pumps, which collect the water in a centrally located sump from which it may be pumped by large centrifugal pumps during periods when the other mine load is light. The centrifugal pump is a high speed machine, being operated at speeds as high as 3500 revolutions per minute. Consequently the motor drive is very efficient.

Plunger pumps may be driven by shunt or compound-wound direct-current motors or by squirrel cage and phase-wound induction

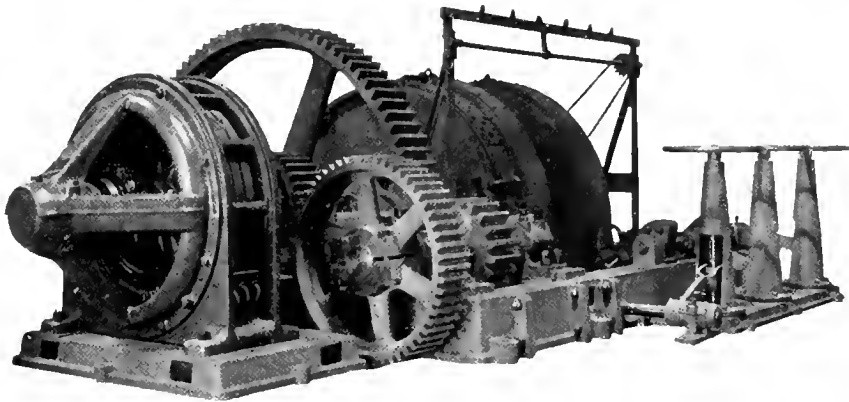


Fig. 9. Ten Thousand Pound Single-driven Electric Hoist with Handwheel Operated Clutch and Two Handwheel Operated Handbrakes for Incline Hoisting, Equipped with a General Electric 160-h.p., 450-r.p.m., three-phase, 60-cycle, 440-volt Induction Motor and Built for the Panther Coal Company, Castle Gate, by the Denver Engineering Works Company

motor balancers. These consist of a direct-current motor driving a flywheel, the motor being separately excited by a direct-connected exciter. The set is then connected to the supply mains through a rotary converter or motor-generator set. The speed of the balancer set is then varied by regulating the motor field, which is automatically done by a regulator actuated by the line current.

The development of hoists which will automatically load, dump and operate is a new feature, and the recent installation of the Inspiration Copper Company is novel in this respect.

Pumps

Pumping is an essential part in the operation of almost every mine, and this problem has been greatly simplified with the introduction of the electric drive.

motors, the latter being used when it is essential to reduce the starting current to a minimum. Synchronous motors are also well adapted for driving reciprocating pumps, but due consideration must be given to the starting torque required.

Centrifugal pumps may be driven by shunt-wound, squirrel cage or phase-wound motors, while synchronous motors are not as well adapted for this class of pumps on account of their high speed.

A notable example of a large and very satisfactory centrifugal mine pump installation is that installed for the Calumet & Hecla Mining Company in Michigan. It consists of five eight-inch, six-stage horizontal pumps built by the I. P. Morris Company. Each pump, which is driven by a 300 horse power General Electric Company direct-connected induction motor, is designed to deliver water

at the rate of 1,440,000 gallons per 24 hours, against a head of 755 feet at a speed of 1460 r.p.m. The water is collected in a sump

mainly is used for draining flooded mines. As these pumps are apt to be entirely submerged, the motors must be specially built

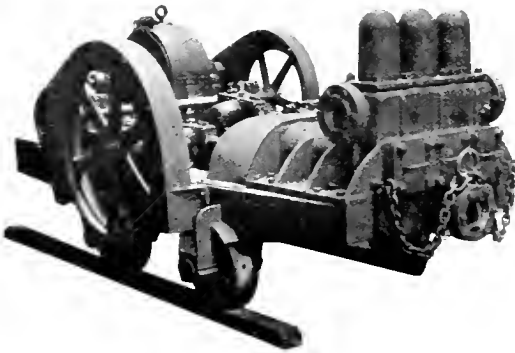


Fig. 10. Portable Mine Pump, Manufactured by Goulds' Manufacturing Co.

holding over 1,000,000 gallons, and this sump is located over 3000 feet below the surface of the ground, and the water is relayed to the surface by means of four pumps. Each of the four pump rooms contains a wooden tank, which receives the discharge water of the pump below it, and furnishes the supply for the unit on its level.

Among other pumps used for mining work may be mentioned the sinking pump, which

to withstand such severe service, while in their selection consideration must be given



Fig. 11. Mine Sinking Pump, Manufactured by Goulds' Manufacturing Co.

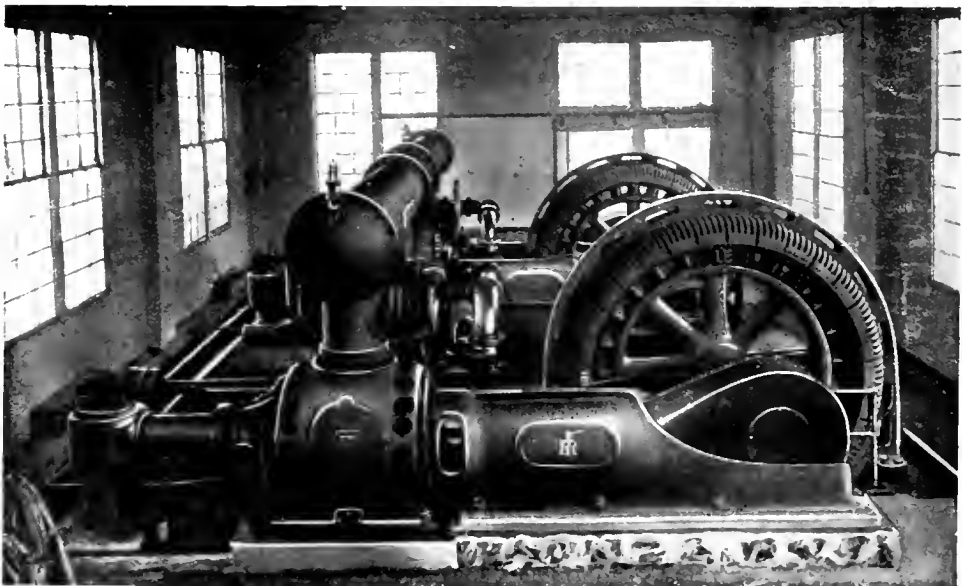


Fig. 12. Air Compressors Each Direct-driven by 450-kv-a., 6000-volt, 125-r.p.m. Synchronous Motor. Buffalo, Rochester and Pittsburg Coal and Iron Company, Punxsutawney, Pa.

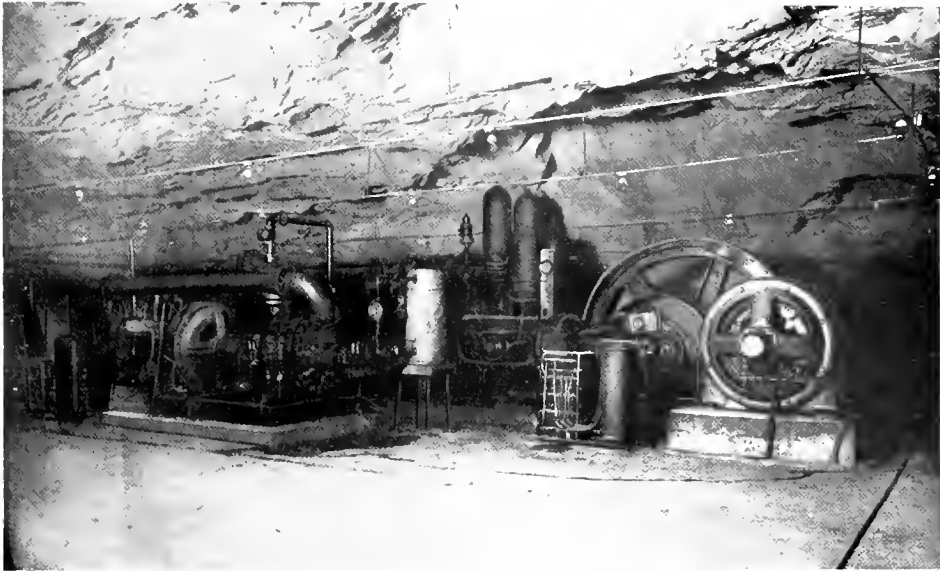


Fig. 13. One 1000-Gallon-per-minute Plunger Pump Driven by a 350-h.p. Induction Motor and One 1000-Gallon Centrifugal Pump Driven by a 400-h.p. Induction Motor. Lift 1000 ft. Pump; Installed at the Gwinn Mine of the Cleveland Cliffs Iron Co. The centrifugal pump is used as spare

to the variation in the head against which the pump has to operate.

Fans

In most deep mines it is just as important to provide a fresh air supply as it is to keep it

State laws and adequate ventilation is compulsory. In this country five hundred and ten million tons of coal were mined last year,

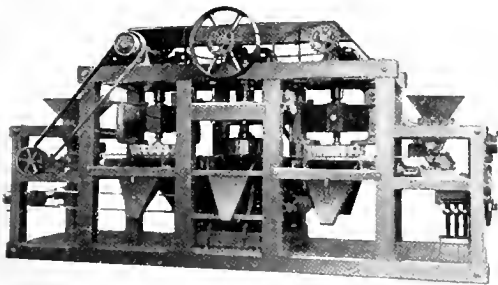


Fig. 14. Magnetic Separator, Manufactured by Dings Electro-Magnetic Separator Company, Milwaukee, Wis.

free from water, as upon a good ventilation depends to the greatest extent the efficiency of the working force. Coal mining takes place under conditions pretty well covered by



Fig. 15. Electric Lamp Equipment

and under average conditions the amount of air supplied to a mine per 24 hours weighs from two to three times as much as the coal

MINING STATISTICS FOR 1909
CONTINENTAL UNITED STATES

	Total All Industries	Coal Anthracite	Coal Bituminous	Petroleum and Natural Gas	Iron	Copper	Zinc and Lead	PRECIOUS METALS		Structural Materials (Granite, Mar- ble, Slate, Etc.)
								Placer Mining		
								Deep Mines		
Number of Operators	23,664	198	3,541	8,053	196	174	1,010	4,682	810	1,020
Number of Mines, Quarries, Oil and Gas Wells	143,688	429	6,068	106,418	501	381	1,213	11,197	1,072	
Persons Engaged in Indus- tries	1,166,918	178,331	593,142	61,089	55,980	56,057	21,891	58,208	6,208	101,181
Proprietors and Firm Members	33,691	188	3,748	16,120	81	79	2,070	5,146	1,103	4,153
Firm Members Doing Manual Labor	10,299	72	1,718	2,174	36	12	1,199	1,832	776	1,832
Skilled Employees	46,475	1,318	19,220	6,387	2,916	3,129	882	3,818	338	4,691
Wage Earners	1,086,782	173,825	570,171	11,282	52,963	53,849	21,939	19,214	4,767	92,637
Capital	\$3,662,527,064	\$246,950,806	\$1,071,599,748	\$697,431,811	\$305,586,736	\$312,970,073	\$63,722,646	\$676,839,197	\$60,203,141	\$133,581,324
Expenses of Operation and Development	1,074,191,429	139,587,968	396,655,893	142,683,027	74,934,131	108,579,464	24,694,749	80,085,766	7,316,908	63,765,977
Salaries	655,584,467	97,084,561	316,279,081	35,552,612	33,471,978	53,661,368	11,675,878	46,659,319	3,394,743	41,888,139
Supplies and Materials	35,878,478	4,593,461	21,853,568	7,458,579	3,423,992	3,806,466	1,111,779	5,794,478	181,833	5,162,675
Fuel and Rent of Power	599,705,989	92,491,097	294,325,516	28,091,033	30,047,986	49,858,102	10,564,099	19,951,841	2,912,910	39,725,464
Royalties and Rent of Mines	213,607,486	23,563,696	10,663,377	5,177,654	12,835,310	34,483,213	6,822,275	25,570,152	2,339,582	8,855,122
Contract Work	46,503,412	3,195,789	7,512,081	1,643,117	4,715,463	13,399,270	2,424,885	6,056,401	681,821	3,487,366
Miscellaneous	61,151,926	7,981,639	12,086,088	21,347,500	15,210,335	1,789,656	2,303,382	1,231,005	112,716	1,439,546
Value of Products	\$1,238,410,322	\$149,180,471	\$427,962,461	\$185,416,684	\$106,947,082	\$134,616,987	\$31,363,091	\$83,885,928	\$10,237,252	\$75,992,908
Primary Power, H. P.	4,649,910	678,698	1,230,010	1,230,546	350,005	380,712	114,045	260,190	32,279	304,917
Steam	3,840,923	676,516	1,202,039	754,720	329,784	397,796	97,363	110,630	3,042	258,856
Gas and Oil	528,264	722	2,329	475,666	3,091	2,325	13,113	17,430	681	9,476
Water	114,629	1,410	348	12,665	12,665	18,005	69	27,328	9,668	8,473
Purchased	216,103	1,310	25,294	160	4,165	32,386	3,468	74,773	18,888	30,352
Electric Motors, Total H. P.	723,727	47,498	354,832	8,749	27,397	79,610	15,576	91,880	29,300	48,182
Number oper. by Pur- chased Power	5,070	32	840	6	55	822	63	1,954	481	681
Horse Power oper. by Purchased Power	216,103	1,410	25,294	160	4,465	52,586	3,468	74,773	18,888	30,352
Number oper. by Gen- erated Power	14,342	1,152	9,720	455	345	549	363	624	39	609
Horse Power oper. by Generated Power	507,624	46,088	329,538	8,589	22,842	27,024	12,108	17,107	1,412	17,830

taken out in the same time, and this will give an idea of the tremendous field of this application.

Most mine fans are of the centrifugal type and the electric drive is about the only economical and satisfactory method of operation, and as an uninterrupted service is of utmost importance, the motors should preferably be direct-connected to the fan.

Some mine managers consider it good practice to provide less ventilation at nights and during holidays on account of the proper saving which this method renders possible. For this reason it is often advantageous to

vary the speed of mine fans. With direct current this is readily taken care of by shunt motors with field or armature control or a combination of the two.

For alternating current the speed regulation can be obtained by means of phase-wound slip-ring motors with rheostat control, but this method is of course not very efficient. For this reason a-c. speed control by means of multi-speed windings, dynamic regulation and brush shifting is now being used more and more, and is giving very satisfactory service, under the particular conditions for which they are intended.

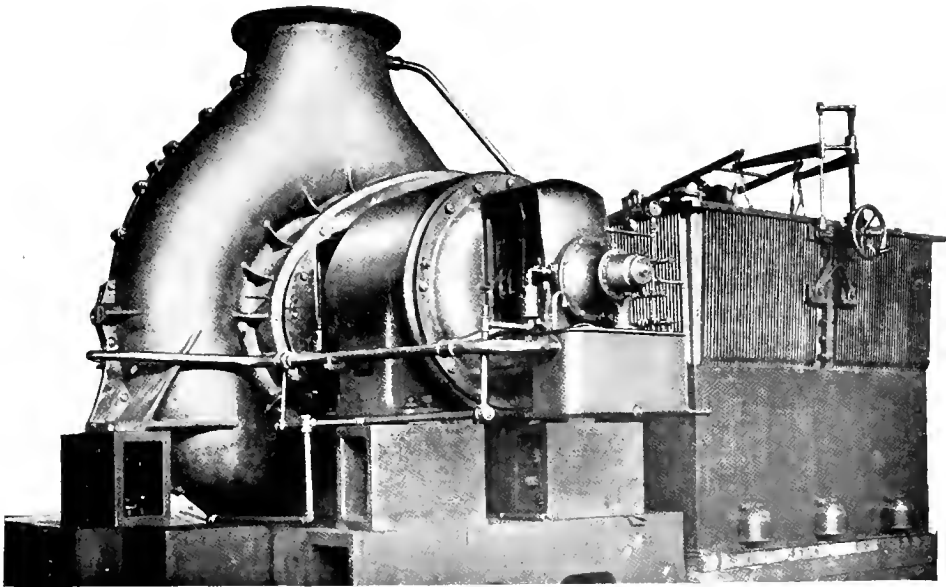


Fig. 16. Air Compressor Driven by a 375-h.p., 3500-r.p.m., 6600-volt Induction Motor

ELECTRIC POWER IN THE TEXTILE INDUSTRY

By C. A. CHASE

MILL POWER DEPARTMENT, GENERAL ELECTRIC COMPANY, BOSTON

Electric drive when applied to textile machinery has resulted in the same high degree of success that has been attained by its application in other industries. The early history of the introduction of electric drive in textile mills is interestingly narrated in the first part of the following article. The body of the article is devoted to an exposition of the general merits of individual "motor drive," an explanation of why this type of drive is preferable to "group drive," and a conservative but attractive series of statements about the highly creditable past performances of "motor drive" and the excellent prospects for growth in future application.—EDITOR.

General

The advent of the electric motor may be said to have marked the beginning of a new epoch in the development of the textile industry of this country. The importance of the part played by electric power in this development is evidenced by the fact that, although the electric motor, in any form, has been available for industrial use for less than thirty years, and the induction motor for only twenty-three years, the textile mills of this country are using them today to the extent

to either locate elsewhere or supplement the water power with one or several steam engine installations. Steam engine driven mills were constantly confronted with the necessity of either increasing the capacity of existing installations and struggling with the problem of mechanical power transmission or adding isolated engines at great expense in first cost, decreasing the economy of their plant with its increased operating and maintenance charges. The timely arrival of the electric motor is well shown by a few typical examples



Fig. 1. First Induction Motor Used in Textile Mill. Picker Room, Columbia Mills Company, Columbia, S. C.

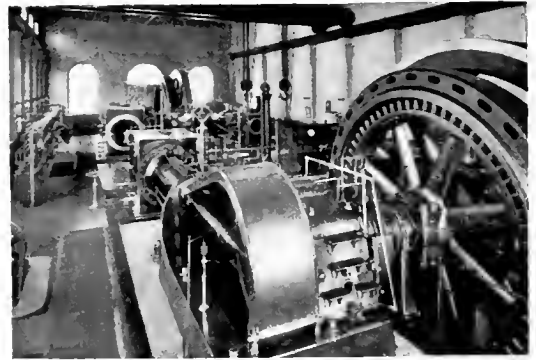


Fig. 2. First Direct Connected Spinning Frame Motors in Textile Mill. Anderson Cotton Mills, Anderson, S. C.

of about 750,000 h.p., or about one-third of all the power required in the textile industry.

Before the electric motor afforded a solution of the power transmission problem, most textile mills, like other industries requiring a large amount of power, grew up around the various water power sites of the East and South. Some, not so fortunate in location, were driven by steam engines which multiplied in number with the growth of each such mill. In many cases the growth of the mills soon outstripped the existing or possible water power development, making it necessary

of electric power installations in mills located on the Merrimack River.

Lawrence, Mass., with approximately 60,000 h.p. of motors in its textile mills, leads all other cities in the world in the utilization of electric power in this industry; The textile mills of Lowell, Mass., use about 38,000 h.p. of motors; and Manchester, N. H., has approximately 31,000 h.p. of motors in its textile mills.

The phenomenal growth of the textile industry in North Carolina, South Carolina and Georgia has been in a large measure due

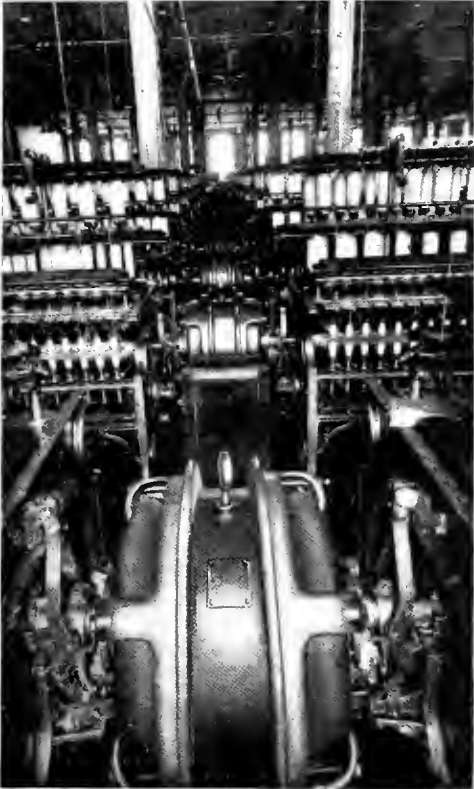


Fig. 3. First Engine-driven, Three-phase Generator in Textile Mill. Lancaster Mills, Clinton, Mass.

to the introduction of electric power, by means of which mills, located with reference to other

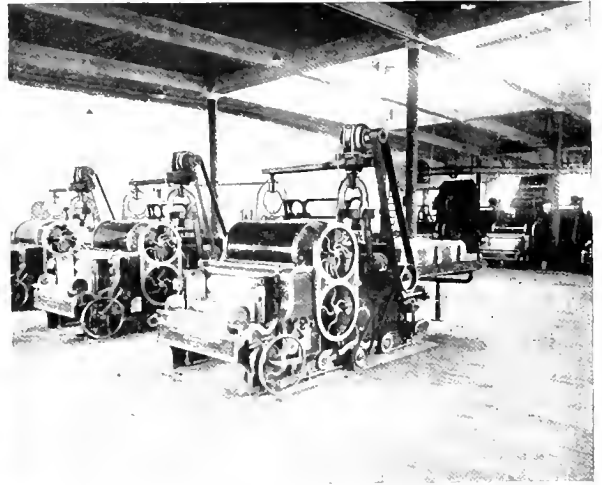


Fig. 5. Individual Motors Driving Finisher Pickers. Erlanger Cotton Mills, Lexington, N. C.

advantages, such as labor, material, shipping facilities, etc., have been able to utilize the energy of the large and numerous water powers of those states.

Historical

It is always interesting and instructive to review the beginning of any new industrial development and in the introduction of electric power to the textile mills of this country there are found a number of noteworthy and significant incidents. The first textile mill in the world to adopt the electric drive throughout was the Columbia Mills Company, Columbia, S. C.

At that time no textile mill in this country or abroad had attempted to drive its machinery by motors and such a radical departure from contemporary practice shows the remarkable courage and foresight on the part of the Columbia Mills Company, its engineers and the manufacturer of the electrical equipment. It is also of interest to note that, of the three electrical manufacturers which tendered propositions, two recommended the continuous current system with a large motor for driving each



Fig. 4. Typical Group Drive in Picker Room

floor of the mill. One manufacturer recommended the polyphase induction motor, then but a few months on the market, and their recommendations as to the power system as well as to subdivision of motor units, were finally accepted. It is scarcely surprising that one prominent manufacturer termed this installation "A most hazardous and dangerous experiment."

The motor installation consisted of seventeen 65 h.p. motors inverted and suspended from the ceiling, in most cases the shaft was extended and provided with two pulleys at each end of the motor, and in some cases the motor shaft was directly coupled to a line of shafting. It should be noted that the type of motor selected and all the various details of installation have ever since been followed by practically all textile mills using what became to be known as the "group system" in applying electric power. Fig. 1 shows the first induction motor used in a textile mill. This motor, and sixteen similar units, were put into service early in 1894, and are still in constant use.

The advantages obtained by the subdivision of power units were soon apparent, and in 1897 the first direct connected spinning motors were installed in the Anderson Cotton Mills, Anderson, S. C., the original installation consisting of forty-two induction motors, each mounted between two spinning frames and connected to the cylinder shafts by friction clutches. These motors are shown in Fig. 3, and, while this form of drive is no longer used, they are interesting as the "progenitors" of the modern individual spinning frame motor.

Previous to 1898 generators for supplying current to motors in textile mills had been driven either by waterwheels or by steam engines by means of belts or ropes, and little consideration had been given to the possibilities of direct connecting large polyphase generators to reciprocating steam engines. The first installation of this character was made at the Lancaster Mills, Clinton, Mass., in 1898. In 1899 another unit of larger capacity was installed in the same power house, as shown in Fig. 2. In this mill, as well as in the case of all previous electric power installations, motors had been used to replace the existing mechanical system. In 1899, however, The Olympia Mills, Columbia, S. C., built the first new mill using electric power throughout with steam engines as prime movers. Direct connected engine-generator units have, however, been rapidly



Fig. 6. Finisher Picker Driven by Direct Connected Motor. Edwards Manufacturing Company, Augusta, Maine



Fig. 7. Typical Group Drive in Card Room

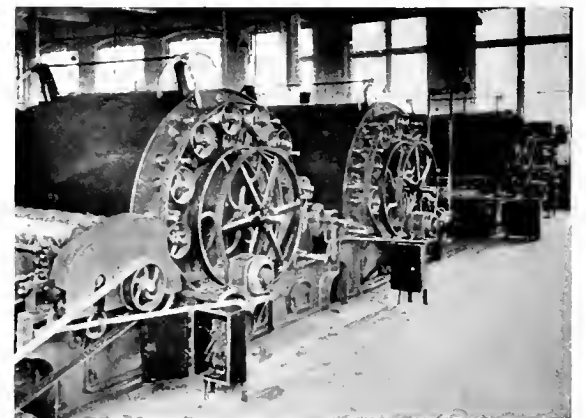


Fig. 8. Individual Motors Driving Cards. Boston Duck Company, Bondsville, Mass.

superseded or supplemented by steam turbo-generators of which approximately 275,000 h.p. are today in operation in the textile mills of this country.

Past and Present Practice in Application of Motors

Electric drive was first used in textile mills as a convenient method of solving transmission problems which, due to local conditions, were either very difficult or impractical of solution by means of the mechanical drive. Also, since the electric drive was at first used for the most part for replacing or supplementing the mechanical drive in old mills, it is only logical that the "group drive" motor, permitting the utilization of the countershafting already installed, should have been used. Furthermore, the most important advantages obtainable from the electric drive were little understood, even by its strongest advocates, and the high cost and relatively low efficiency of the small motors available at that period naturally tended to perpetuate the "group drive" for more than a decade. Even during the past five years, one large mill using about 7500 h.p. in "group drive" motors chose this system for an additional new mill requiring 3000 h.p. The "group drive" still has a few strong adherents, but



Fig. 9. Two Frame Drive, Intermediate Roving Frames. Nyanza Mills, Woonsocket, R. I.

the most progressive textile manufacturers and textile mill engineers are coming to understand, for reasons given in paragraphs to follow, that they cannot afford to use any system other than that which employs a

suitable individual motor for nearly every textile machine in their mills.

The "group drive" is, therefore, now being rapidly superseded by the "motor drive," a term which it is desired to strongly empha-

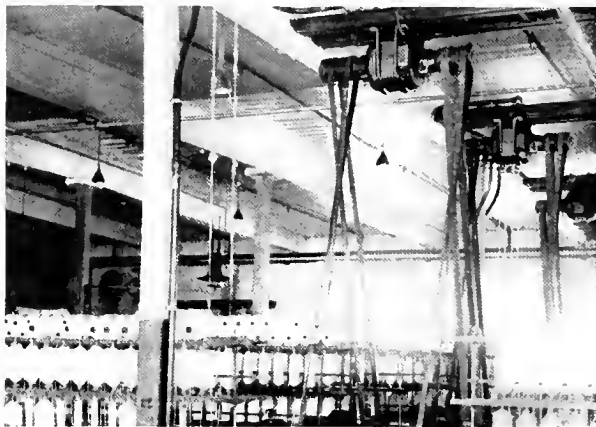


Fig. 10. Four-frame Drive, Speeders. Sterling Cotton Mills, Franklinton, N. C.



Fig. 11. Typical Group Drive in Ring Spinning Room

size in the scope of this brief article. In this connection it is of interest to note that ten years ago the average size of motors installed in the textile mills of this country was about 75 h.p., while today it is less than 16 h.p. In two new prominent southern mills, using respectively 2200 h.p. and 1900 h.p. in motors, the average size of motor is in one case 1.49 h.p. and in the other 1.46 h.p.

The most notable progress in the application of electric power has been made by mills devoted to the manufacture of cotton goods. This may perhaps be attributed to the fact that the first installations were made in cotton mills, and that those most interested in this new development were more closely

identified with that branch of the industry. The silk, worsted and woolen industries, however, have not been far behind in the use of motors, and have led the way in the application of individual loom motors. A silk mill



Fig. 12. Four-frame Drive, Spinning Frames. Lancaster Mills, Clinton, Mass.

in New England was the first to use individual loom motors, importing them from England in 1901. The illustrations of motor installations in this article represent some typical "group drives" and a few examples of the modern tendency toward the "motor drive."

Reasons for "Motor Drive"

"Motor drive" of textile machinery is of great direct value; 1st, to the mill operative; 2nd, to the mill product and, 3rd, to the mill stockholder. Anything that is of benefit to the operative or the product is, of course, indirectly of benefit to the mill stockholder also, but the subdivision given necessitates a broader consideration more in accord with the merits of the subject.

The operative is benefited by the better conditions of light and ventilation always secured by "motor drive." Shafting and belting not only cut off a large amount of daylight illumination but also seriously interfere with the proper distribution of either the natural or artificial lighting of textile machinery. Furthermore, dust and lint, always

present to a greater or less extent, is kept in constant circulation by belts and pulleys and the problem of supplying pure air for the operators is much more difficult than when "motor drive" is used and shafting and belting eliminated. No one familiar with textile mill conditions will fail to agree with these statements and a glance at Figs. 19 and 20 will make it still more apparent.

The operative is further benefited by the better conditions of safety secured by "motor drive." The "Safety first" movement has justly received a great amount of attention during the past few years and in the future it is certain to be an important consideration of the textile industry. Fig. 31 shows what has happened to a section of countershafting in a textile mill. The insurance companies are prompt in recognizing the proper relation between "motor drive" and the "Safety

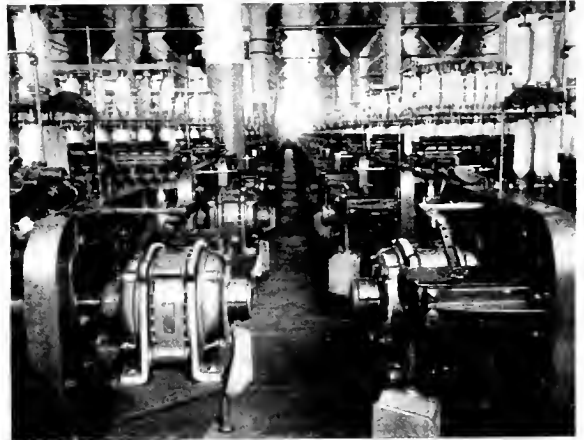


Fig. 13. Motors Direct Connected to Spinning Frames. Erlanger Cotton Mills, Lexington, N. C.

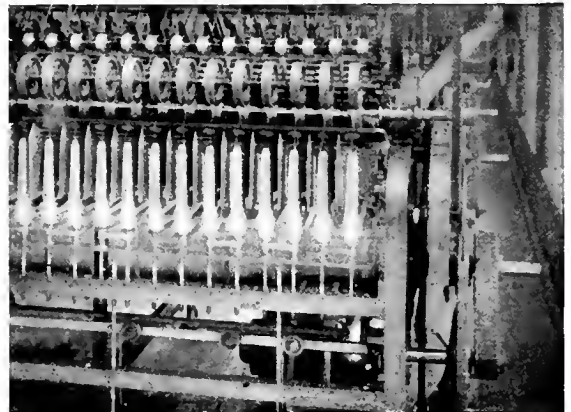


Fig. 14. Chain Drive with Motor Installed Under Spinning Frame. Arlington Mills, Lawrence, Mass.

first" movement. A recent issue of *The Travelers Standard* contained an article entitled "Accident Prevention in Weave Rooms," from which the following quotation

operated by "motor drive." This point will be brought out more clearly in the discussion of benefits to the products of the mill and to the mill stockholders.



Fig. 15. Individual Motors Geared to Spinning Frames. Riverside and Dan River Cotton Mills, Danville, Va.

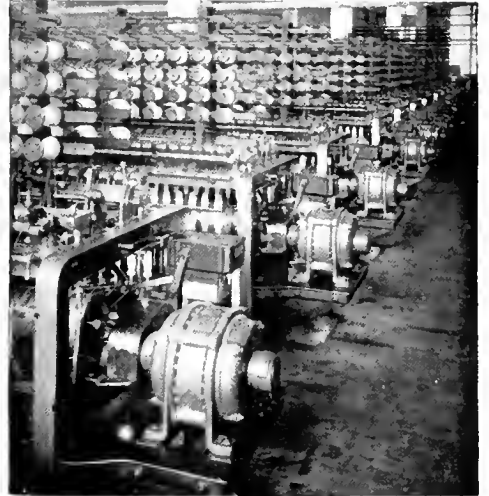


Fig. 16. Individual Motors Geared to Twisters. Dunean Mills, Greenville, S. C.

is taken: "From the safety standpoint there are a number of admirable features connected with the use of individual electric motors. Belting dangers are avoided and long lines of shafting are eliminated." As an example of

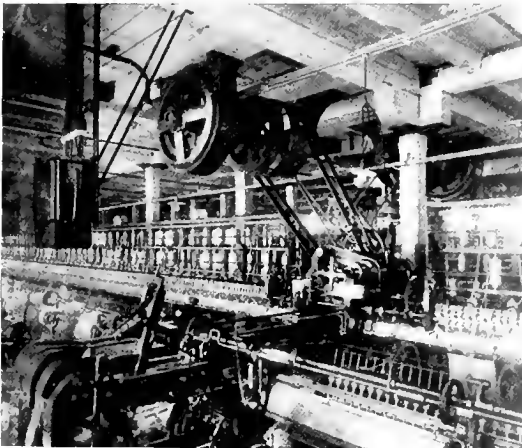


Fig. 17. First Special Individual Mule Motors in Textile Mills. Saxony Worsted Mills, Newton, Mass.

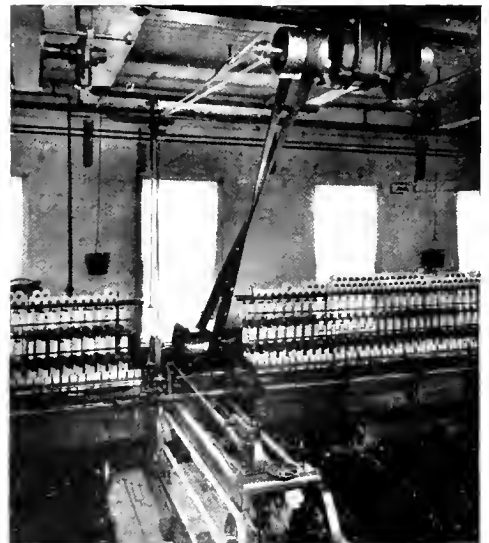


Fig. 18. Special Individual Mule Motor. Otis Company, Ware, Mass.

loom motor installation the above mentioned article contains a cut which is reproduced in Fig. 32.

Finally the operator is benefited by the increased earning capacity of the machinery

The mill product is directly benefited by the better general conditions of cleanliness always secured by "motor drive." While this benefit applies to every branch of the textile industry, it is of special importance in the

case of costly fabrics, such as are produced in the silk industry. The dripping of oil from overhead shafting, even where neither care nor expense has been spared to prevent it, is a constant menace to textile mill product.



Fig. 19. Weave Room Operated by Mechanical Drive

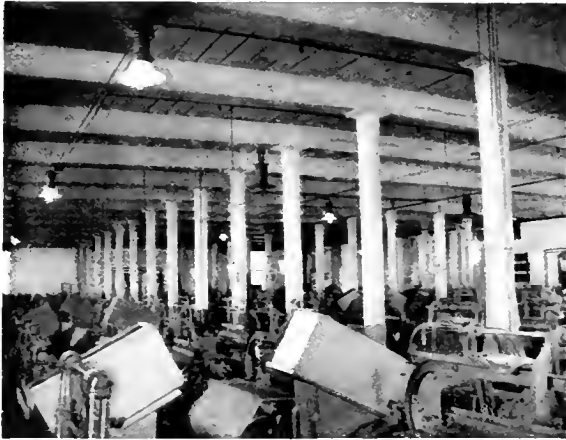


Fig. 20. Appearance of Weave Room Shown in Fig. 19 After Installation of Individual Loom Motors

A more serious matter, however, is the constant circulation of dust, fly, and other foreign matter, caused by the pulleys, belts and overhead shafting. In the cotton industry the importance of keeping the roving and the yarn free from such material is well known and in the silk industry, involving delicate and costly fabrics and where much of the silk is dyed in the skein, the item of strictest cleanliness in all the processes and the prevention of damage to product from foreign matter of any sort is regarded as of the highest

importance. The efficiency or earning capacity of nearly all the preparatory machinery of a textile mill can be widely varied by giving it more or less care in the way of keeping it clean. It is logical, then, that the "motor drive," by eliminating shafting, belting and pulleys and giving better conditions of cleanliness, must be of much benefit to the mill product. Furthermore, there have been many cases where manufacturers have acknowledged securing a much better quality of product due to the easily controlled and steady speed afforded by the "motor drive."

"Motor drive" is of benefit to the mill stockholder, indirectly because of all the before mentioned benefits and, directly because it secures for him a maximum return from a given amount of money invested. "Motor drive" of textile machinery increases its earning capacity and gives the stockholder a two-fold profit, that is, a profit due to decreased cost of production and an added profit on the increased output. A few of the more conservative of the textile machine builders and textile manufacturers are still



Fig. 21. Loom Motors. Dunean Mills, Greenville, S.C.

apparently doubtful about the increased production claimed for the "motor drive." It is a well established fact, however, and there is nothing at all mysterious about it. Almost all textile machinery has a maximum productive speed at which it should be operated under certain conditions in order to

secure the best results in both quantity and quality of product. If operated below the proper speed there is a loss in production. If operated above the proper speed there will be a loss in production due to poor quality, breakages, etc. In the case of power transmission by shafting and belting entirely, or only in part, as in the case of "group drive" with motors, it is absolutely impossible to maintain a definite speed on any large group of machinery. Some belts will slip more than others, all will slip more or less under changes of load and changes in atmospheric conditions, with the result that in a large spinning room or weave room a variation of 10 per cent in the speed of machines supposed to operate at the same speed is not uncommon. It is also well known that in practically every mill driven by shafting and belting, due to the trouble and expense of changing pulleys, much of the machinery is constantly operated at speeds which will not permit the best results in production. When such machinery is driven by suitable individual motors each

is found that the individual motor not only makes a "sweeter" drive and cuts down the expense of machine upkeep but also maintains a higher average speed and consequently gives an increase in production. In long lines

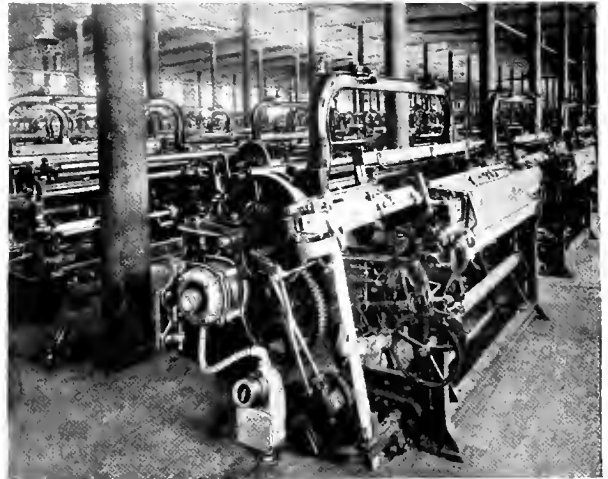


Fig. 22. Loom Motors. Erlanger Cotton Mills, Lexington, N. C.

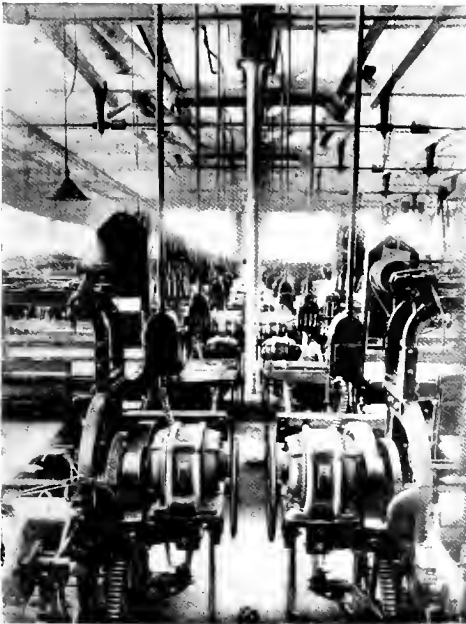


Fig. 24. Individual Drive of Silk Looms. Stewart Silk Company, Easton, Pa.

machine may be constantly operated at its maximum productive speed and maximum earning capacity.

In the case of textile machinery which has heavy reciprocating parts or a very irregular duty cycle, such as the mule and the loom, it

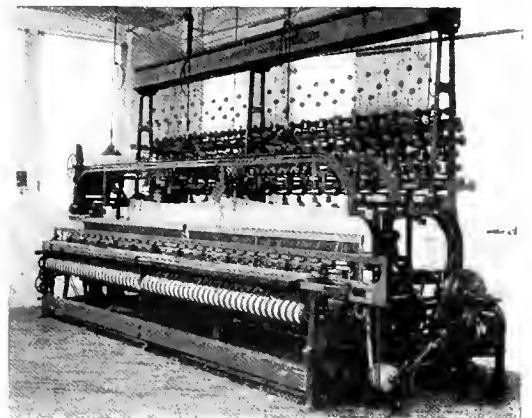


Fig. 23. Motor Driving Ribbon Loom. Macungie Silk Co., Macungie, Pa.

of shafting there is also often present torsional disturbances, due to slippage of belts, changes in load, etc. Such disturbances are often very apparent and serious in the case of belt driven looms and especially so if the looms are weaving wide delicate fabrics. A typical example of such trouble occurred recently in the mill of a well known silk manufacturer. A group of belt driven 92-inch looms weaving crepe-de-chine had been producing a very

unsatisfactory quality of goods. Individual loom motors were installed and the effect of the steady rotative speed was immediately apparent. The manufacturer soon discovered that he could raise the speed of these looms



Fig. 25. Motor-driven Embroidery Machine. E.[Neufer Embroidery Factory, Jersey City, N. J.

and is now securing from them a perfect product with an increase of 18 per cent in the loom output. Narrower looms in the same mill when changed over to individual drive also showed a remarkable increase in production and the manufacturer confidently expects still better results after he has had more experience with "motor drive." It is a significant fact that this manufacturer has changed over his entire plant from belt drive to "motor drive" and estimates that the overall production which has a yearly value of \$2,000,000 has been increased 15 per cent thereby.

It is the universal experience of manufacturers who have used loom motors that the steady rotative speed, together with the inherent flexibility of such motors, permits the operating and maintaining of much higher loom speeds than any other form of loom drive. Many worsted and woolen manufacturers admit 10 per cent more production from their motor-driven looms. For a number of years after the loom motor had proved its value in the silk, woolen and worsted industries it was not considered a commercial

proposition for cotton looms, the product of which is, relatively, of much less value per yard. It is of interest to note that today several thousand loom motors are operating cotton looms in various sections of the country.

It should also be noted that, contrary to the popular impression, the "motor drive" with its many small units does not mean a greater transmission loss than the "group drive" with its few large motors. The small motors especially designed for textile mill

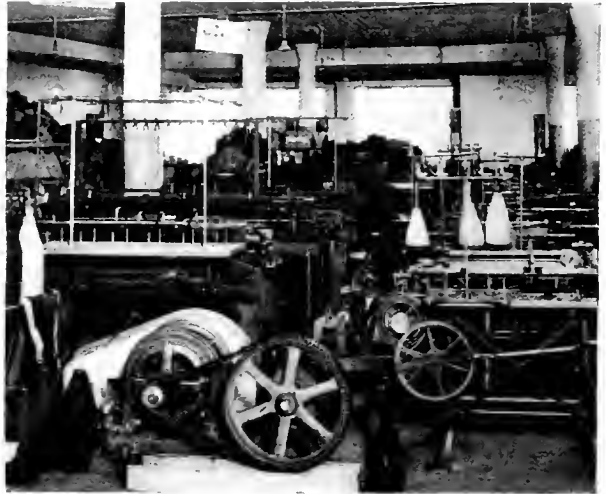


Fig. 26. Induction Motor Driving Eight Full Automatic Sweater Machines. F. A. Patrick Knitting Factory, Duluth, Minn.

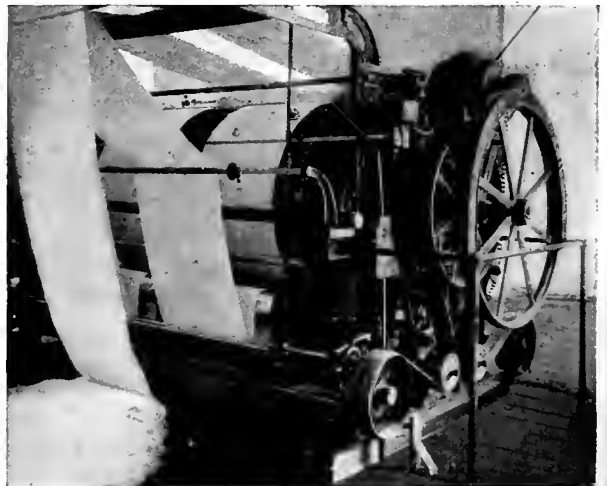


Fig. 27. Enclosed Induction Motor Geared to Napping Machine. Tremont & Suffolk Mills, Lowell, Mass.

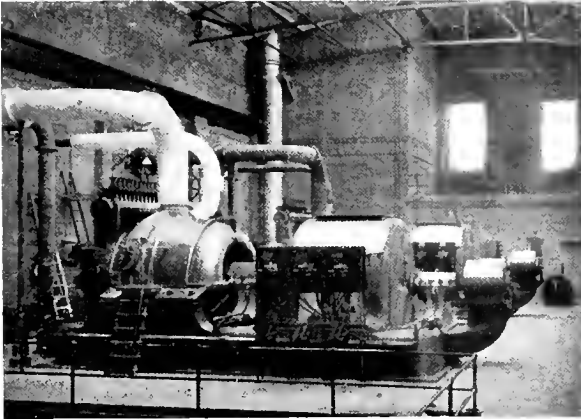


Fig. 28. Two 2500-kw. Turbo-Generators. Ayer Mill, American Woolen Co., Lawrence, Mass.

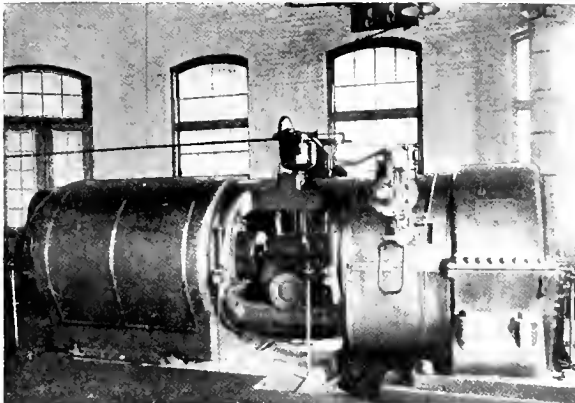


Fig. 29. 1250-kw., 3600-r.p.m., 600-volt, Mixed Pressure Turbine, Riverside Division, Riverside & Dan River Cotton Mills

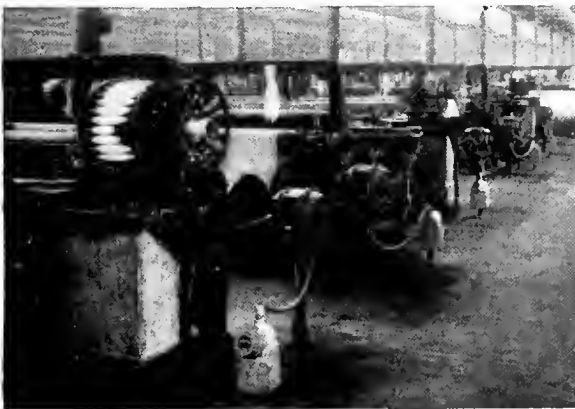


Fig. 30. Enclosed Continuous Running Loom Motors, Geared to Automatic Broad Sheetting Loom. Naumkeag Steam Cotton Co., Salem, Mass.

service are of high efficiency and, in practically any given case, it can be shown that their efficiency is much greater than the overall efficiency of the large group motors plus the necessary countershafting and belts.



Fig. 31. What Has Happened to Countershafting in a Cotton Mill. The Safety First Movement is Always Advanced by "Motor Drive"

In a cotton mill the spinning process consumes a much larger amount of power than any other department, in some cases being from 50 per cent to 60 per cent of the total power required by the mill. In this process the value of "motor drive" has been strongly demonstrated. The increase in production which may be obtained by changing over a spinning room from mechanical drive or "group drive" to "motor drive" depends, of course, to a large extent upon the layout and condition of the mechanical transmission. In one typical case of two mills, only a few miles apart, operated under the same management and spinning the same yarns, the spinning frames in one mill being driven by the "group drive" and in the other by individual motors, a comparative test was made and the results showed that the "motor drive" frames were producing over 12 per cent more yarn per spindle. Under the usual mill conditions, using as a basis of comparison the production of spinning frames operated by "group drive" from large motors, it is safe to assume an increase of production of 5 per cent with the

four-frame drive and 10 per cent with individual motors. A still further increase in production may be obtained with varying speed spinning motors, used for some years abroad and now available of domestic manufacture.

Thus far in this discussion the constant speed motor has, for the most part, been considered. Many kinds of textile machinery in the bleaching, dyeing, finishing and printing processes require variable speeds, which, to a large extent in the past has been secured by the use of small non-condensing individual steam engines or various sorts of more or less uneconomical speed changing transmission devices. Individual variable speed motors for such machinery always greatly improve the economy of drive, while the flexibility in speed and the facility of its control give a

large increase of product. One printworks which changed its machinery from steam engine to "motor drive" acknowledged an increase in production of 33 per cent. Other machinery, such as slubbers and roving frames, the speeds of which are sometimes regulated by changing pulleys, can be operated at greatly increased economical output by the application of suitable individual variable speed motors available for that purpose.

In the light of results which are today being secured from "motor drive," it is confidently predicted that, before the next five years have passed, no new mill of considerable size, regardless of the primary source of its power, will utilize any other form of drive other than a suitable individual motor for practically each and every textile machine.

ELECTRICITY IN THE AUTOMOBILE INDUSTRY

BY FRED M. KIMBALL

MANAGER, SMALL MOTOR DEPARTMENT, GENERAL ELECTRIC COMPANY

The present article deals with the use of electricity in the automobile industry—in the manufacture and testing of automobiles, and in the numerous electrical accessories which have added so much to the comfort of the automobilist, as well as its application to the electric vehicle itself.—EDITOR.

That the use of electricity and electrical accessories has come to play an exceedingly important part in the automobile industry is emphatically manifest to those who have had the opportunity of visiting our larger automobile factories, as well as to those who are at all familiar with the construction and equipment of the modern automobile.

Not only has electricity been very largely employed to facilitate improvements in numberless manufacturing operations employed in the construction and assembly of motor vehicles, but through the use of recently perfected electrical appliances, the final testing of the complete automobile, whether gas or electric, has been very much expedited and simplified, as well as rendered far more accurate and reliable than could be attained by the use of the strictly mechanical methods upon which manufacturers were formerly obliged to depend.

Furthermore, electricity has made possible the adoption and use of almost numberless accessories in the equipment of the automobile, which contribute enormously to the

comfort and pleasure of those who employ this form of vehicle either for business or for recreation.

In considering the various uses of electricity in the automobile industry, we naturally turn at first to its employment in manufacturing operations. Here we find the power required by the great factories occupying acres of floor area supplied either by a central, privately owned generating station, or as is not infrequently the case, by special circuits from the city plant. The enormous areas covered by these establishments make the distribution of power throughout the plant most unsatisfactory from nearly every viewpoint when shafting and belts are largely employed.

Furthermore, the efficiency of transmission when long lines of heavy shafting and many belts are employed is comparatively low, and the average annual productive capacity of the machinery at the ends of these transmission lines is materially below normal. Hence, when such plants are electrified, the machines and machine tools are usually disposed of in

small compact groups, or driven by individual motors, thus largely improving efficiency of power transmission and assuring highest and most constant productive speeds of the machinery employed.

It has been truly said that as a result of the intensive developmental work carried on by electrical designers and engineers during the past decade, there is now available an electric motor for every service, a controller for every motor, and an engineer who is an expert in the selection and application of the motor drive for every variety of manufacturing requirement. In the equipment of a plant like those herein referred to, the motors are usually selected with the utmost care to meet the particular requirements of machines or tools which they are to drive. Hence, motors varying widely in size and characteristics and method of control will nearly always be found in the equipment of the most modern plants.

The elimination of such transmitting devices as heavy shafting, hangers, pulleys and belts, which interfere with adequate lighting and proper ventilation and produce and distribute dust and dirt and constitute a latent source of danger to employees, and the substitution of the unobtrusive, clean, safe, and easily installed electric conductors and motors contribute in no small degree to the maintenance of hygienic conditions and consequently to the efficiency of the workman. As all millwrights know, it is difficult to maintain the alignment of long lengths of shafting, and equally difficult to maintain suitable tension on the belts of a mechanical transmission drive under the varying conditions of heat, cold, moisture and dryness. Hence, it results that extensive systems of transmission employing shafting and belting are always relatively uneconomical in operation and maintenance, and irrespective of how carefully the adjustment of such systems is effected periodically, or at what expenditure of time and labor, their condition begins to deteriorate the moment after adjustment is completed.

The loss of power in such transmission systems may be so great—especially if the tools are widely scattered, the supports for the shafting not rigid, or the condition of the belt and pulleys neglected—that only a comparatively small portion, sometimes as little as 25 or 30 per cent, of the total power generated is finally utilized in useful productive work.

When the electric motor is employed, even in group drive, the distributing shafts are

comparatively short and of small diameter. Speeds are fairly high and belts moderately small and light; hence, highest efficiency in power supply. Inasmuch as the motor will maintain its speed under all reasonable conditions of load in virtual synchronism with the speed of the supplying generators, which are usually driven by the most perfect engines or turbines and constantly attended by capable men, the speed variations are small and the maximum productive capacity of the machines driven by them maintained at all times.

Furthermore, the power losses in the electrical conductors and the motors themselves are comparatively negligible, and of course no shafting or mechanical transmission supplying any machines need be operated when the machine itself is not doing useful work. The electric motor lends itself particularly to use in body shops where many woodworking machines are employed, the cutters of which must be run at high peripheral speeds to produce satisfactory work, and as the ideal conditions for motor drive contemplate the use of fairly high speeds, the electric motor, either direct connected or supplying its power to the machine spindles through one short belt, finds in this application its ideal employment.

Suitably designed motors are also largely employed for direct connection to lathes, milling machines, shapers, boring mills and similar machinery, while small separate groups of drills, screw machines, grinders and tools of kindred type can each be operated by single motors to great advantage.

A large number of interesting special electrical applications are also to be found in these factories which do not require the use of motors. Such are electric welding, brazing, electroplating, the tempering of tools and dies, and in some of the most modern shops, the melting of small quantities of high grade steel in electric furnaces.

“Running in” the engine and transmission drive of the gas car is effected speedily and very effectively by driving the mechanism for a suitable length of time by an electric motor, this being a great improvement over the former method and expense of this operation under the engine's own power.

Almost from the first, electricity has been employed for ignition purposes in gas cars, and although in the earlier cars the current was produced from primary batteries, in modern cars it is almost universally obtained from magnetos or the storage batteries which form part of the central station plant of the

best types of automobiles. The advantages of the electric light for automobiles were early recognized, and secondary batteries charged from external sources were to some extent used for this purpose. It soon became apparent, however, that the service given by the secondary battery alone was not adequate nor sufficiently reliable, and the attention of inventors was focused on the production of a central station plant which would be light enough in weight, compact enough in bulk, large enough in capacity, and cheap enough in cost, to permit its installation on an automobile chassis, and efficient enough in operation to permit its being driven from the main engine without unduly detracting from the motive power. Extraordinary progress has been made within five years in the design of such plants, and as perfection has been approached, more and more uses have been found for the current thus made available.

Not only are cars provided with electric side, head and tail lights, but they are started by the electric motor, and in the more luxurious cars, heating units are provided in limousine bodies for tempering the air; dome and side lights for interior illumination; and provision made for semi-portable trouble lamps, projectors or search lights, the beam from which can be thrown in any direction by a simple turn of the chauffeur's hand. In addition, heating units may be employed for preparing lunches or similar purposes, and in a few cases, the gear shifting is accomplished electrically, as is to some extent electric braking and steering.

In case of the electric vehicle, the driving power is entirely supplied by an electric motor, taking its current from a storage battery mounted under the body of the car. In the design and construction of these motors, the batteries which supply them with current, and the mechanisms by which they are controlled, extraordinary ingenuity and resourcefulness has been shown in so utilizing material that the maximum of motive power and dependability with highest efficiency may be secured with minimum weight and bulk.

The use of the electric motor for vehicular purposes seems to be expanding more rapidly in the field served by commercial vehicles than in the field served by pleasure vehicles at the moment, for wagons ranging in load

capacity from 750 lb. to 10 tons are becoming common, especially in our principal cities. Many of these large trucks are equipped with electrically operated winches and hoists, these latter being most convenient in the service of those who handle and transport heavy machinery, building material, coal, safes, and similar loads. The pleasure vehicle occupies a field particularly its own, and is admirable for use by ladies in shopping, calling, for the theater, opera, and pleasure riding in our parks, and along our magnificent boulevards. Doubtless with further standardization and lower cost, which will follow increased production, its use will be still further enlarged, for it has the undeniable advantages of simplicity in construction, low cost of maintenance and ease of operation in the service to which it is best adapted.

In the garage we find electrically operated air pumps, portable polishing and buffing wheels for cleaning the bright work of automobiles, as well as electrically operated lathes and other machine tools, forges and pumps necessitated in the conduct of a modern repair shop.

The mercury arc rectifier and motor driven generator are indispensable adjuncts in charging, maintaining and conditioning the storage batteries used for starting and lighting gas cars, and for lighting and propulsion on electric cars. Although the electric vulcanizer for repairing rubber tires seems to be the handiest and safest device which has been brought out for the use of small garages or individual car owners, it has not thus far secured the market that its value should command.

Among other ingenious and valuable electrical applications are the electrically operated speedometers, horns and other warning signals, as well as the ingenious rear-end signals which enable the chauffeur to indicate on an illuminated panel at the back of his vehicle, his intention of turning to the right, to the left, proceeding straight ahead, or stopping.

Altogether, electricity and its applications are now indispensable adjuncts to the automobile industry and its product, and their contribution to safety, comfort and the enjoyment of motoring constitute a factor of the very first importance in the estimation of owners and operators alike.

“SUPPLIES”

DEVICES AND APPLIANCES FOR THE DISTRIBUTION, CONTROL AND UTILIZATION OF ELECTRICITY

By S. H. BLAKE

CHIEF ENGINEER, SUPPLY DEPARTMENT, GENERAL ELECTRIC COMPANY

The term “supplies” as used in the electrical industry today is a very much misunderstood word, and therefore the present article is welcome as explaining its modern significance. The magnitude of the supply business will astonish many of our readers. The author deals with many aspects of this varied business and shows the important position it holds in the electrical industry.—EDITOR.

The term “supplies” is commonly accepted as the name for that class of material that is necessarily carried in the storeroom for current and emergency needs. Thus in every line of activity—at home, in the office, hotel, store, or warehouse, on shipboard, in all industrial plants, railroad shops, garages, banks, hospitals, schools, colleges, public buildings, etc.—certain quantities of materials, tools, utensils, repair parts and what not of the kind that are constantly consumed, or that fail from time to time due to wear and tear, are held in reserve for use as occasion requires. Such “supplies” are generally thought of as being relatively small in size and of infinite variety.

In the electrical industry the term “supplies” has come to have a very important and far reaching significance as it embraces various complete lines of appliances and many kinds and types of electrical devices. Electrical apparatus is grouped by its application into such classifications as lighting, power and railway. None of this apparatus becomes of service, however, except through the medium of intermediary and auxiliary means. Thus certain appliances such as wires and cable, switches, instruments, meters, cutouts and kindred devices for the distribution and control of electricity are necessary to gain any benefit from the operation of a generator by transmitting its energy to where it can be used. The electric motor is equally dependent on such agencies to receive current, as likewise is the railway for its particular requirements. Those accessories, therefore, which find application in common in all the so-called departments of the electrical industry and those other devices that aid in the utilization of electric energy for useful purposes, but that do not fall into any particular class division, all group themselves under the category of “electrical supplies” and constitute a very large separate class division or department that is handled commercially, at least, as a single line of goods. These vary in size, for example, from a 150,000-volt

lightning arrester to a fuse plug, and from a 200-kw. transformer to a three-watt All-Nite-Lite outfit, but the same description holds good with respect to their infinite variety. Furthermore, articles classed as “supplies” are ever increasing in number and diversity as from day to day and year to year electricity finds novel and more extended applications.

There is, however, no hard and fast rule as to what supplies comprise. Commercial expediency and the natural growth of the electrical business have been potent factors in determining such classification for each manufacturing company and what has grown to be considered “supply” material with one concern is sometimes associated in another company with a completely different division of apparatus.

In the earliest days of electric lighting a “system” consisted of an arc-lighting dynamo and from one to four arc lamps. No ammeters or voltmeters were available and wiring methods and materials, judged from present day standards, were of the crudest sort. It is not unlikely, however, that there was a tendency even at that time for the business to divide itself into departments, namely “apparatus” consisting of primary articles initially sold, and “supplies” comprising wire, line material, repair parts, etc. As time went on the number of arc lamps that could be operated from one machine was gradually increased and additional auxiliary supply devices such as instruments, lightning arresters, insulators, weatherproof wire, switches, etc., were added to the necessary equipment for a lighting plant. Then came constant potential d-c. generators and incandescent lamps with new classes of supplies in the way of lamp sockets, interior wiring devices, ammeters and low-voltage voltmeters, while incandescent lamps involved such radically different manufacturing and selling problems as to require segregation as a separate division of the industry. The introduction of the d-c. motor for railway and power work quite

naturally was the beginning of another specific department, and brought rheostats, circuit breakers, railway line material, rail bonds, etc., into the "supply" line.

The successful commercial development of alternating-current apparatus brought transformers first for lighting circuits and later for power purposes into the field of "supplies" and also a-c. instruments of all kinds, current and potential transformers and oil switches. The change from the "flat rate" method of charging customers for electric service to the use of meters for actually measuring the current consumed added watt-hour, maximum demand and such metering devices for both a-c. and d-c. The enclosed arc lamp first proved popular for a-c. and d-c. constant potential connection either for interior use or for out of doors, and later was used very extensively for series alternating street lighting in connection with constant current transformers. Considerable numbers of series enclosed d-c. lamps were also installed for operation from 6.6-ampere arc machines. This complete line of appliances comprising lamps, transformers, panel boards, special switches, hanger cutouts, mast arms, suspension hangers, etc., are naturally considered as supply material. Since then, by the introduction of the magnetite system there have also been added to the above line series rectifiers, magnetite and copper electrodes, ornamental pole lamps and all the various auxiliary devices necessary for its successful operation. Series incandescent street lights operated by means of constant current transformers or reactance regulators have become an important branch of supplies and involve the use of special sockets, fixtures, individual compensators and transformers, group transformers, film cutouts, brackets, etc.

The wonderful growth of the use of electric motors for power applications in the industries has required the development of a very comprehensive line of motor control devices.

Other additions to supplies were generator, voltage and feeder regulators, designed respectively to maintain constant voltage at the station and at the center of distribution on long feeders, which became necessary as refinements in service were required and the territories served grew more extensive. The requirements of modern lighting, railway and hydro-electric transmission systems involve the use of a great variety of lightning arresters and protective devices covering the whole ranges of a-c. and d-c. operating voltages and conditions.

From year to year the demands for wire and cable, wiring devices, meters, instruments, transformers, switches, line material, etc., have steadily increased until the production requirements for these staple articles have reached enormous amounts and must continue to expand in unison with the growth of the electrical industry as a whole, which of late years has been at the rate of about 20 per cent per year except in times of depression.

Besides the many and varied appliances above mentioned there are certain others sold as supplies that to the layman represent electricity materialized into utility form. Such articles are fan motors, heating devices, X-ray tubes, multiple rectifiers, transformer specialties, electric furnaces, mine lamps, ozonators, mercury lamps, headlights, sign flood lamps, etc.

It is a simple statement of fact to say that no electrical installation, whatever its purpose, can be made without using supply materials. Instruments, rheostats and switches and sometimes regulators and transformers must be used in the generating stations; switches, lightning arresters, protective devices and sometimes transformers and feeder regulators on the transmission lines; and all the different kinds of appliances enumerated and more too for providing, installing, metering, operating and controlling the connected load. The multitude of electrical utility appliances that are among the many devices of the supply line are, like incandescent lamps and motors, the means by which comforts, conveniences and safeguards are introduced into our lives, at home and abroad, and efficiency and economy into our industrial undertakings. The arc lamp helps to make our streets as safe at night as by day. Industrially it is used for the lighting of yards, docks and large interiors in many plants, and is also used for blue printing, silver printing, photo-engraving and enlarging. High-candle-power carbon arcs and sometimes mercury arcs are utilized in large numbers for furnishing the very brilliant illumination necessary for the taking of moving picture films. Heating devices in great variety are very convenient and useful for cooking, heating and ironing in the hotel and home and find many industrial applications such as drying various materials, baking paint and enamel, aiding chemical processes, vulcanizing rubber, etc. The multiple rectifier serves to charge the pleasure vehicle at home and the motor truck at the industrial plant. The transformer is equally useful in house or factory furnishing the

proper voltage for light and power. Transformer specialties of the bell-ringing and All-Nite-Lite types also have wide useful applications in both fields. Electrical ozonators are used to aid ventilation, and industrially for destroying disagreeable odors, while greatly concentrated ozone is useful as a strong oxidizing agent in chemical processes and for the sterilization of water. Electric resistance furnaces are of great service industrially for securing the proper temperature for melting metals, reducing ores, etc.. Thus we could elaborate to almost any extent, for electricity has come to contribute so much to our present day life that it is difficult to realize, and impossible in a few lines to describe, its many benefits. It

is no wonder that the aggregate sales of electrical supply material of the nature outlined in this article, has grown in thirty years to be over \$100,000,000 a year, in this country alone, and in the large electrical manufacturing concerns such material comprises about a third of the total amount of goods produced.

No reference has been made in this paper to telephone, telegraph, fire alarm, electric elevator, and signal accessories, and such novelties as flash lamps, annunciators, electric bells, buzzers and gongs, toys, burglar alarms, automobile attachments of electrical nature and a thousand and one other contrivances, the total yearly sales of which will run into many millions of dollars.

THE SUBDIVISION OF POWER AS SOLVED BY THE SMALL MOTOR

By R. E. BARKER AND H. R. JOHNSON

SMALL MOTOR DEPARTMENT, GENERAL ELECTRIC COMPANY

Only in very few instances is the total outgoing power of a power plant consumed intact. Efficiency in power supply demands large generating units and "low friction" transmission; value in utility requires that the total power generated be subdivided in order that portions can be used simultaneously at different machines. This subdivision of mechanical power by purely mechanical means—gearing, shafting, belting, etc.—has always been clumsy and inefficient. The substance of the following article comprises a general description of the admirable manner in which mechanical power can be subdivided through the medium of the electric generator and electric motor.—EDITOR.

From the beginning of time man has seen the manifestations of power about him in countless forms, and practically all development in the material world has come from his ever increasing efforts to obtain and control power for supplementing and aiding the work of human hands. Following the invention of the steam engine the use of power increased at an astonishing rate and, as larger and larger units were built, so more and more study was given to methods and means of subdividing the power thereby rendered available. Research along mechanical lines has produced many ingenious solutions of the problem; some of which were generally satisfactory and have survived, while many others, not proving practicable, have been relegated to oblivion. Meantime the progressive demands for more efficient and convenient methods of subdividing power have become more and more insistent and the Twentieth Century brought with it the electric motor, which at once took pre-eminently first place as a means of economical and adaptable power distribution.

When Michael Faraday made the discovery of the principles of electro-magnetic induction, a new field was opened for investigation and many were the experiments made as a result thereof. Invention followed invention, until, after a time, the electric dynamo was

announced and its reversible action discovered. This action whereby a dynamo electric machine may transform electrical into mechanical energy or vice versa is of the greatest importance as upon it is based the efficient conversion of power which every electric motor illustrates. Within about a century after Watt's invention of the steam engine, the direct current dynamo and motor were in commercial use and the principle of the polyphase induction motor demonstrated.

To interest the users of power in any system of subdivision employing electric motors was at first not an easy task, but by diligent effort backed by strong belief in the correctness of the basic principles involved the pioneers in the field of electric motor manufacture and application developed a business which has become of the first importance.

Although the rapid progress of the electric drive as applied to the most diverse requirements is generally appreciated, it may be of interest to fix numerically, by reference to published statistics, the position held by the electric motor. Census figures available up to 1909 show that, out of a total of 18,680,000 horse power employed in the factory class of manufacturing establishments in the United States, 4,817,000 horse power or 25.8 per cent

was applied through the intermediary of the electric motor. If it may be permitted to introduce a present day estimate based on the records of previous years, the total horse power now used is probably about 25,650,000, of which 11,000,000 or 42.9 per cent utilize electric motors. When we consider, first, that the figures quoted above do not include certain industries using motors in large numbers—for example, mining, transportation, etc.—second, that the electric motor is a power transforming device and not a primary source of energy, and finally, that the commercial, as distinguished from the experimental stage of the motor business dates back not more than a score of years, the position now held by electric power is of striking significance.

This eager application of small motors by nearly every class of trade and manufacturing industry must be accepted as irrefutable proof that in point of reliability, simplicity, usefulness and adaptability, the electric motor possesses attributes solely its own.

Regarding the quality of the present day electric motor, one cannot presume to say that the future discoveries or evolutionary progress may not cause it to appear in comparison crude, unwieldy and inefficient. Nevertheless the improvements which have been made thus far in its brief history are to be regarded with justifiable pride. Compared with the early bipolar designs with horseshoe magnet frames, pedestal bearings, sight feed oil cups, unprotected vital parts, etc., direct current motors of today are incomparably superior in compactness, symmetry, unified construction, mechanical protection to the windings or other current carrying parts, and in the countless detail refinements which go to make the near approach to mechanical and electrical perfection.

Simplicity has always been a marked feature of the electric motor as contrasted with other power producers. It is unnecessary to detail the marked reduction in the number of working parts of an electric motor when compared with the steam or internal combustion engine. The elements of compactness, ruggedness and simplicity combine inherently and to their greatest extent in the modern electric motor.

The claim of the electric motor to a place in the front rank of useful apparatus rests upon its economy and reliability in both small and great sizes, more effective application of power, insuring increased production and improved operating conditions.

The call for "intensified production" has rapidly increased the use of power-driven machinery in every line of manufacture, and the average decrease in size of motor used plainly indicates that larger quantities of motors in smaller sizes are being employed.

Individual efficiency has been greatly enhanced through the universal use of the electric motor, while a large share of the drudgery heretofore connected with many occupations has met with permanent banishment. For the work of the baker, blacksmith, butcher, cobbler, grocer, job printer, etc., as well as for the home, farm, laboratory or private shop, the electric motor and central station service readily and completely solve the power supply problem, giving high grade service with small initial investment combined with an operating cost usually much lower than could be obtained from an individual generating plant of equivalent capacity. This result is very largely due to the ease and economy with which electric power can be subdivided to suit widely differing demands.

While the cost of installation and maintenance as well as the loss of power in friction strictly limit the distance that can be served by mechanical transmission from a single source, the introduction of electricity as a power transmitting medium coupled with its easy subdivision, has multiplied many times the radius which can be served economically by a single generating station.

The result in all thriving communities has been the establishment of highly organized, efficiently operated central stations capable of successfully competing with the best practice in large isolated power plants. Generally speaking, we find that, not far beyond the economical limit at which the consumer can afford to take his power from the central station, comes the factory plant whose machinery is so distributed that electric transmission is again seriously to be considered. In fact, in a community adequately served by the central station, there will be found few plants, and those only under exceptional conditions, that should not ultimately adopt electric drive using purchased power.

Of the many strong claims already established for the electric motor as an indispensable factor in modern industry, one of the best arguments in a large number of cases is not only the greater economy of generation made possible by larger centralized units, nor yet the salvage of power formerly lost in friction of mechanical transmission, but

the highly developed and superior operating characteristics of the electric motor itself, which directly or indirectly contributes to increased production with the same machinery and personnel.

Increased production with motor drive may be due to one or more of the following causes: elimination of slipping belts and slowing down of engines under heavy loads, thus making possible the maintenance of maximum productive speeds, and fewer interruptions to service due to broken or thrown belts, broken shafting, overheated bearings, repairs to boilers, etc. With efficiently subdivided motor drive the crippling of a single motor will, at worst, put only one machine or restricted group of machines out of business. The electric motor is conceded to be the most rugged and reliable driving unit in use at the present time, and the service given by central stations skillfully operated, with their reserve equipment, makes failure of power during working hours a remote possibility.

The increased sense of personal safety due to the elimination of belts, shafting and couplings, and the better lighting and ventilation that result from electrification, is also an important contribution to the working efficiency of the working force.

Convenience in the sequence of operations and general arrangement, absence of delays in starting, stopping and regulating the speed of machines through properly planned electric drive and control, effect very marked increases in production, particularly in the case of certain machines, for example: lathes and boring mills, due to the ease with which maximum cutting speeds at different working diameters may be regulated; printing presses, due to absolute and centralized control; electric reversing equipment of planers, shapers and slotters, allowing uniform acceleration and retardation at the start and finish of the stroke. There are also a large variety of miscellaneous machines which can be run at the correct speed through the use of adjustable or multi-speed motors, thus avoiding delays incident to the employment of cone pulleys or change gears.

It is safe to say that in almost any factory, where production is pushed energetically, the output per employee attendant upon machinery may be increased 5 to 15 per cent by the introduction of approved arrangements of electric drive. In the case of certain automatic or semi-automatic machines and controls, made possible only since motor drive was adopted, production is often increased 50

per cent or more. In general, the cost of *power and fuel* is only 2.5 to 5 per cent of the value *added* or created by the manufacturing process, while wages (exclusive of clerks and salaried help) vary between 30 and 50 per cent of the total manufacturing cost. These figures show why a large majority of manufacturing industries profit very substantially by the use of electric power, since a marked increase in the *cost for power* is justified if thereby the major item of wage expense be reduced.

In addition to the foregoing there are numerous attendant advantages to be gained by the adoption of electric drive. By way of illustration, a few of these advantages may be briefly mentioned.

Small expense required to provide power at out of the way places.

Electric transmission is practically unhampered by distances intervening between buildings or the character of the existing installation; e.g., presence of tanks, vats, etc., better light and circulation of air; less dust, dirt and noise; reduction of accident risk; less expensive building construction; free overhead space for cranes; ideal freedom in arrangement of machinery, due to flexible nature of power conductors; accurate means of checking power requirements of individual machines or departments.

The electric motor in some one of its many well standardized types is capable of driving either by belting, gear, chain or direct connection, practically any and every type of machine devised for power drive. A list of such everyday uses of electric motors would form a fairly complete catalogue of our diversified present-day trades and manufacturing industries, and of the labor saving machinery used by them.

The only limit to the possible economical uses of the electric motor is to be found in a limited class of portable and semi-portable machinery operating over unrestricted areas, such as traction engines, automobiles, contractors' machinery, etc. Even in a large proportion of such cases the problem of power supply may often be solved by storage batteries, portable generating sets or by service lines from the source of electric supply, employing flexible cables or temporary overhead construction to the point of application.

Perfection in the design and application of standard and special types of electric motors have made practicable the development of many devices where the obstacle of securing an effective driving element had

previously baffled inventive ingenuity. Again, machines which were operated in a crude and clumsy fashion by steam, compressed air, or other inefficient means, have been rendered practicable and efficient solely through the use of the electric motor. The compactness of the electric motor and the flexibility of power supply and control have led to the design of machine tools and other machines so that the motive power becomes an integral part of a comprehensive scheme rather than a scantily considered auxiliary. The natural *adaptability* of the electric motor will perhaps be most forcibly illustrated by a few examples of the kind of application just referred to:

Power-driven portable vacuum cleaners replacing the rotary brush carpet sweeper.

Domestic washers and sewing machines, formerly operated by manual or foot power. These devices are not only conveniently and cheaply run by electric motor but have been greatly improved under the stimulus of a motive power at once light, compact, durable, and free from complication and operative difficulties.

Chipping and riveting hammers, drills for wood, metal and rock, formerly depending for power upon compressed air or steam supplied through pipes or hose, may now receive power by flexible electric cable without losses by leakage, condensation, plugging out or pipe "kinking."

Convenient desk, wall and ceiling fans have come into common use only since the development of suitable electric motors.

Numerous types of hoisting apparatus, ranging from the portable engine-driven hoist to the largest traveling crane, find the perfect means of operation through electric motors.

The use of portable slotters for heavy machine work is rendered feasible by the ease with which power can be brought by flexible conductors from conveniently located outlets.

Electric starting motors have practically superseded compressed air or mechanical devices as a means of starting vehicle, stationary and marine engines.

The electric motor with its highly developed control accessories makes possible the independent and automatic functioning of different parts of such machines as turret lathes, boring mills and screw machines.

The inherently high rotative speed of electric motors has permitted the efficient redesign of many types of machinery, and

has given great impetus to the development of centrifugal fans and pumps, whose normally efficient speeds are particularly suitable for direct connection to electric motors.

Motors especially designed with extra heavy frames for steel mill service, having practically fireproof insulation and complete mechanical protection for interior parts, are equally suitable for numerous other classes of work where extremely rough usage or high temperatures must be met. The application of electric motors to the various special uses required in mines affords a good example of adapting the driven device, even in the smaller sizes, to very special conditions of installation and service.

Standard adjustable speed motors equipped with control apparatus specially designed for printing establishments not only permit delicate and positive speed adjustment but, by means of extremely low speeds, "jogging" control and stop buttons, save a great deal of time and reduce the personal risk in preliminary or "make-ready" operations.

The incorporation of electric motors into the mechanical structure of the driven machine is also well exemplified by specially designed back geared alternating current motors for driving Linotype machines, and by small head stock motors for woodworking lathes in which a hollow motor shaft actually serves to carry the lathe face plate.

Fairly complete lines of vertical motors provide for quiet and positive drive of vertical centrifugal pumps, and also simplify the driving arrangements to vertical shafts and spindles of numerous other machines, such as surface grinders, centrifuges, etc.

In the foregoing, the history of the electric motor and the subdivision of power as solved by electric energy has been sketched but briefly and without attempt to cover more than the smallest fraction of the uses to which the ubiquitous motor is and can be applied with a success as pre-eminent as universal. If it be considered that the present radius of action and effectiveness of the submarine has been made possible solely by the use of electric energy, that the propulsion of the largest ocean going ships by electric motors bids fair to be the greatest marine engineering development of the near future, that the problem of trunk line transportation as well as the "short haul" will ultimately be solved electrically, we will still fall short of realizing the far reaching effect which electric power exerts over the industrial, social and economic life of humanity.

THE
GENERAL ELECTRIC COMPANY
AT THE
PANAMA-PACIFIC
INTERNATIONAL EXPOSITION



Night View showing the Entrance to the Court of Flowers. Italian Towers on the right and the Tower of Jewels on the left.
This View also shows the 5- and 7-light Luminous Arc Banner Standard

THE GENERAL ELECTRIC COMPANY'S EXHIBITS AT THE PANAMA-PACIFIC INTERNATIONAL EXPOSITION

BY GEORGE WEED HALL

ADVERTISING DEPARTMENT, GENERAL ELECTRIC COMPANY

This article together with the one that follows tells of the General Electric Company's exhibits at the Exposition. The illumination of the Exposition is dealt with in detail by Mr Ryan in a separate article. Those parts of the present article dealing with the exhibits should form a useful record for those interested in this subject.—EDITOR.

Beginning with the first active operations toward creating that stupendous undertaking, the Panama-Pacific International Exposition at San Francisco, which transcends in many ways all previous world's fairs, the General Electric Company has been prominently identified with achieving the success of many of its great features. That this splendid exposition was practically ready on time is due in large measure to the service rendered by electricity. As the Exposition stands today, it may be said from many standpoints to be a tribute to the progress and efficiency of the electrical industry.

The Exposition is in a broad sense an exposition of the greatness of electricity! And the glory of the Exposition is the electric illumination at night. At the very inception of the Exposition idea, this was the initial factor considered that should contribute to proud achievement.

The General Electric Company was consulted, and Mr. W. D'Arcy Ryan, the Company's Illuminating Engineer was specially commissioned at the request of the Exposition officials to create a new form of exposition lighting. A considerable appropriation was made by the General Electric Company to defray the cost of the preliminary work, and Mr. Ryan and his corps of assistants were loaned to San Francisco to devise new and beautiful effects in illumination.

Mr. Ryan was made Chief of Illumination, being given *carte blanche* to create a new night grandeur. Over two years ago he and his staff began the great work of designing a

scheme of illumination that would complement the brilliant plans of the architects and of Mr. Jules Guerin, Chief of Color. The Exposition was to be a wealth of soft, blending colors by day, transformed into beautiful harmony at night by a magnificence of glowing flood-lighting. These plans have been most effectively realized by the cooperation of Mr. G. L. Bayley, Chief of the Mechanical and Electrical Department of the Exposition. The designs for the lighting effects were worked out in the Illuminating Laboratories of the General Electric Company. Here were conceived the famous Exposition jewels, the glory of the Tower of Jewels; the great batteries of searchlights that light



Fig. 1. Palace of Manufactures

this tower and all the grand exhibition palaces; the magnificent heraldic banners that diffuse the wealth of light from powerful arc lamps along the main avenues of the Exposition; the mammoth "scintillator," whose rays

flood the sky; the ever-varied display of fireworks that draws throngs to the Marina and the yacht harbor several nights a week; the smoke bombs in variegated colors and the wonderful, soft flood-lighting of all the beauti-



Fig. 2. "Mazda Service" Research Laboratory Exhibit of the General Electric Company, from the South, Palace of Manufactures



Fig. 3. "Mazda Service" Research Laboratory Exhibit of the General Electric Company, from the East, Palace of Manufactures

ful architectural triumphs. At night the hills of San Francisco are darkened with crowds eager to view the marvelous burst of this aura of light from a proper perspective.

Tuesday, April 13th, a special day, was celebrated in honor of Mr. Ryan, with appropriate ceremonies, followed at night by a brilliant illumination display. The program was carried out in the evening in the Court of Honor, and a tribute was paid to Mr. Ryan for his contribution to the Exposition, and to the General Electric Company for its co-

operation. At the conclusion of his remarks, President Moore of the Exposition Company presented Mr. Ryan with a handsome bronze plaque as a material expression of his appreciation.

It is generally acknowledged that the illumination surpasses anything of the kind hitherto undertaken. Viewing it for the first time, the spectator finds an analysis of it as difficult as an analysis of the emotions it inspires. Opinion is spontaneously expressed that one has not really seen the Exposition until the night fairyland bursts into view. The illumination is best described by its originator and the reader is therefore referred to the article by Mr. Ryan in this issue.

Visitors at the Exposition are also much impressed with the "Home Electrical," one of the exhibits of the General Electric Company in the Palace of Manufactures. Homes equipped with electric appliances for domestic uses are not entirely new. It is several years since electrically-operated devices were first introduced into the home. Other model homes, electrically equipped, have been exhibited at various times; but now that many of these devices have become well known through use, the "Home Electrical" at the Exposition is not so much the object of public curiosity as it is of genuine interest and investigation to learn what are the newest applications of electricity in the home.

Judging from the crowds that throng the "Home Electrical," it is one of the most popular exhibits. Situated in that portion of the building immediately adjoining the Court of Flowers and the Court of Abundance, this full-sized home, thoroughly modern, and of simple Spanish-California bungalow design of moderate cost, is complete in every detail, ready for occupancy. Electricity heats, lights and cools it, and performs the household duties from cooking to sweeping. Each of these applications of electricity is now part of the life of innumerable American homes. The "Home Electrical" is fully described in an article by Mr. Don Cameron Shafer in this issue.

We who are so intimately associated with the manifestations of electricity, the most flexible and efficient form of energy, do not marvel at its accomplishments. We sometimes fail to reflect on the scope of its activities until they are measured by some striking contrast. The "Home Electrical" typifies electricity in its relation to the finer things of life. Yet as easily as it adds comfort to the home, it will gouge out huge, yawning

excavations; lift and transport mighty timbers and steel structural members, and pour concrete for great architectural piles. Electricity was chosen to do most of the rough work during the construction period at the Exposition. Time and economy were vital factors in building the Jewel City, and it was determined to have this great undertaking finished in its entirety when the grounds were formally opened. The temporary lighting during these early operations, including that for plastering and carpenter work in the buildings at night, was generally furnished by various types of lamps of General Electric Company manufacture. Electricity not only lighted, but was largely instrumental in building the Exposition.

Motors manufactured by the General Electric Company were used very extensively for power application during these building operations. They ranged in size all the way from fractional horsepower machines to those of 50 and 60 horsepower. The variety of service for which they were used serves to illustrate the almost unlimited flexibility of electric power. Saw-tables, planers and sanders, electrically driven, worked timbers and lumber into shape; electrically-operated concrete mixers and plaster mixers poured tons of concrete and stucco, the latter being applied with electric cement guns. The pumps that furnished gallons of water for mixing and other purposes were electric-driven, as were air compressors for riveting; drills, milling machines and boring mills cutting iron and steel members and shapes; derricks, hoists and conveyors lifting tons of material of all kinds, and trucks transporting raw and finished products of every description to the centers of activity on the grounds where needed.

While the general work of building the Exposition proper was going on, electricity also assisted in various ways in placing and constructing the exhibits of other manufacturers. After installation, the successful display and operation of many of these exhibits is now possible only through the application of electricity as power, heat or light. But before referring to this phase of the subject, we wish to call attention to the very interesting display of the General Electric Company in the large courtyard of the "Home Electrical." This forms a part of the "Home Electrical" exhibit, although it is in a certain sense apart from it. The two combined exhibits cover a total of some 6100 sq. ft. of area.

The courtyard is enclosed with a low concrete wall having a front entrance gate of ornamental design leading into the roadway between the Mazda research exhibit and the garage, and one opening from the side into the

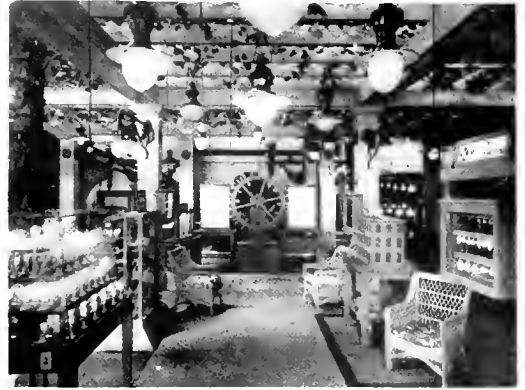


Fig. 4. Commercial Lamp Exhibit, General Electric Company in Pergola, Palace of Manufactures



Fig. 5. Section of Wall and Roof of House showing how Wiring and Wiring Devices are Installed, Exhibit of General Electric Company, Palace of Manufactures

spacious pergola at the rear of the garage. The courtyard is decorated with growing palm trees attractively arranged to group the different classes of exhibits. Glistening through the palm trees back in the distance is a large display sign of the universally recognized G-E monogram mounted high on the wall. This is made up of the famous jewels similar to those on the Tower of Jewels, and is illuminated by projection from searchlights mounted on the house roof, in the same manner as the general scheme of flood-lighting from concealed sources of buildings and groups of statuary about the grounds.

Entering the courtyard through the front gate, the first exhibit at the right is the "Mazda Service" research laboratory display. This exhibit emphasizes strongly the famous "Mazda Service," which has come to

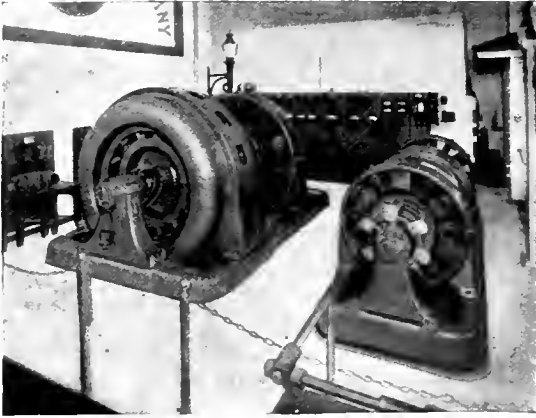


Fig. 6. Interior of one of the Substations for the General Lighting System throughout the Exhibition Grounds, in the Exhibit of the General Electric Company, Palace of Manufactures

signify the greatest factor in the progress of the science of incandescent electric lighting. Here for the first time the public has an opportunity to observe the interesting phases of the development of the Mazda lamp from the early stages. Visitors may listen to instructive and entertaining talks by laboratory experts, explaining the painstaking work and methods that enter into the perfection of these wonderful lamps.

Mounted on special display boards are raw materials, parts in process of construction and finished parts; tungsten ore, ground ore, oxide metal and wire; tungsten contacts; tungsten block, rods and wire; molybdenum sheet, rods and wire; various types of brushes and contacts; copper coated iron wire, compensator, aluminum coated copper wire, alumina dies, calorized samples, moulded compounds; tungsten tube, copper clamp for tungsten tube, binel metal, sheath wire, iron crystals, section of a sheath wire unit, therm-enamel coated copper wire; Coolidge tube anode and cathode, X-ray targets; tungsten steel tool and a typical shaving turned off with the tool; compensator lamp, carbon lamp, gem lamp, Mazda tungsten lamp and gas-filled compensator lamp, etc.

There is an apparatus to show the strength of tungsten wire; another to show the magnified image of a lamp filament; spark inter-

rupter, to show tungsten contacts in operation; Coolidge X-ray tube and battery, to show the filament in the tube lighted; lamp mounts, to show the flexibility of Mazda lamp filaments; copper castings and X-ray photographs, to show the value of the X-ray tube for discovering imperfections in castings; photometer, to show how the candle-power of lamps may be determined; various insulation materials; apparatus to show the tone of iron and tungsten wire; nitrogen apparatus, to show a typical nitrogen purifying installation; argon apparatus in miniature, to show how argon is manufactured; samples of pure metallic boron and a boron regulator, a lamp outfit used particularly to regulate car lighting; large incandescent lamps, to show the maximum amount of light in a minimum sized bulb; "lightning bug" display, whose efficiency in producing "cold light" scientists are striving to approach and still maintain the proper color for an illuminant.

The commercial incandescent lamp exhibit of the General Electric Company is arranged in an Italian pergola at the left of the research exhibit. The pergola, of spacious design, extends from the garage back to the hotel kitchen, and has a wing running to the side entrance gate. This display comprises all sizes and types of Mazda lamps, from the "grain of wheat" to the large 1000-watt gas-filled lamps.

The lamps are grouped in specially constructed cabinets, the multiple lamps and street series lamps being wired and lighted. Flashlight, electric vehicle and automobile lamps are simply displayed in an appropriate case. A case in which are shown the different steps in the production of drawn tungsten wire and a model illustrating the manufacture of the Mazda lamp are interesting. The latter is a miniature lamp factory, in which each part of the lamp appears from the roof in the order of its assembly, the machine operation of putting the parts together being indicated, until the series is complete and a lamp is entirely assembled and lighted. There are transparencies giving relative data on the cost of living and the cost of electric lighting, etc.

A motor-driven, lamp-testing machine attracts attention, as does also a shadow-box exhibiting a facsimile of the original Edison lamp and the present Mazda lamp. There are also some interesting object-lesson devices. A lamp bumper about 6 ft. tall is arranged to permit a Mazda lamp to fall between baffle plates, striking from side to side until it

reaches the bottom, where it lights and is automatically carried up again for another trip. The toughness of drawn tungsten wire is obvious. Another "toy" is a large grandfather's clock. The pendulum compartment is glass-enclosed. On one side one lone penny falls down, striking baffles as it goes; while on the other side, three pennies make a similar trip. The three pennies illustrate the cost of electric light from an old style carbon lamp and the "loner" represents the cost of the same amount of light from the modern Mazda lamp. These and other devices demonstrate simply the advantages of using Mazda lamps, which are the only incandescent lamps used by the Exposition.

When the high-efficiency, high candle-power Mazda lamps for series and multiple circuits were introduced, the new conditions under which they operate required the design of an entirely new line of fixtures to screen the intense brilliancy, to provide proper ventilation for the high temperatures, to bring the light center to the correct location and to provide an individual compensator to increase the current. In the pergola there is a complete display of the new Novalux fixtures and accessories that have been designed for this purpose. This includes pendant units, street system brackets, ornamental street units, etc. There are also concentric reflectors with prismatic refractor, concentric reflectors with opal diffuser, ornamental lamp posts, etc.

In the corner of the courtyard adjoining the pergola is a rather interesting exhibit of miscellaneous products. Among these are a great many electrically-operated devices for the home, such as washing machines, vacuum

cleaners, heating devices, cooking utensils, etc., the products of several different manufacturers and driven by G-E motors. These appliances are demonstrated in the "Home Electrical" on different days, and

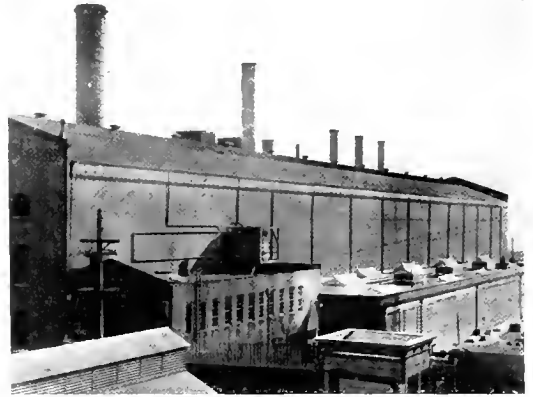


Fig. 7. Exterior of Station "A" of the Pacific Gas & Electric Co., San Francisco, showing New Switch House

employed in turn to do the work in the house. Here are also many industrial electric devices for heating, light and power, including projectors similar to those lighting the grounds, a lightning arrester display, fabroil gears and pinions, oil tempering bath, glue pots, soldering irons, drills, chippers, riveters, toy transformers, fractional horsepower and larger motors, motor-generator set, crane motor, vibrating rectifier, switchboard, controllers, rheostats, circuit breakers, voltmeters and ammeters,



Fig. 8. Palace of Transportation on the Marina

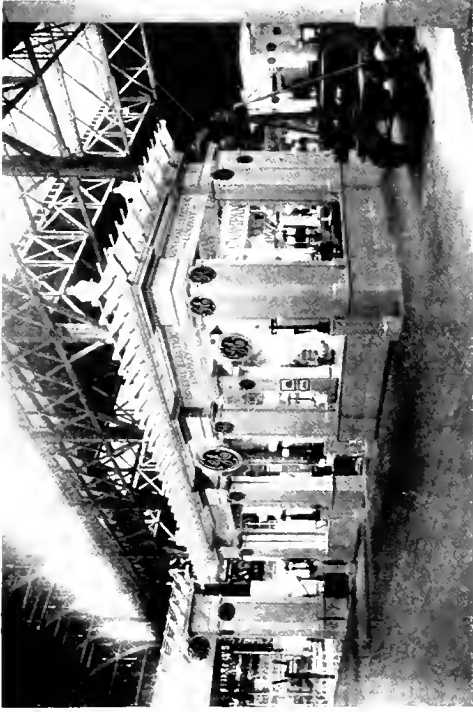


Fig. 10. Reception Room in the Transportation Exhibit of the General Electric Company, Palace of Transportation



Fig. 12. Butte, Anaconda & Pacific Electric Locomotive in the Transportation Exhibit of the General Electric Company, Palace of Transportation



Fig. 9. Looking Down on the Transportation Exhibit of the General Electric Company, Palace of Transportation



Fig. 11. Group of Five Locomotives in the Transportation Exhibit of the General Electric Company, Palace of Transportation

oil switches, a wire and cable panel, wiring devices, etc.

Perhaps one of the most instructive exhibits in this display is a room adjoining the hotel kitchen, in which all types of interior wiring and wiring devices for homes and public buildings are shown installed. These are mounted in unfinished sections of the wall and roof to make plain how this work should be done, and the display includes even a doorbell, buzzer and telephone wiring. Plugs, sockets, receptacles, switches—everything of interest to the building trade—form part of this display.

We reach the hotel kitchen next, just back of the pergola. This is a complete model kitchen for a medium sized hotel, and is arranged in a building of the same attractive style of architecture as the "Home Electrical." The entire cooking equipment is electrical. One side of the building is removed to allow better observation, all the equipment being installed and connected up for operation to permit demonstrations. There is a hotel range, broiler, bake oven, toaster, vegetable paring machine, coffee urn, steam table with electric circulation water heater, etc. An electrically-driven fan, reversible for exhaust or ventilating, maintains a wholesome atmosphere. The room is lighted by two 100-watt, bowl frosted Mazda lamps with Holophane prismatic reflectors. The kitchen has a sanitary brick floor.

Worthy of particular attention in the courtyard is the substation room, situated back of the "Home Electrical," at the left of the pergola. This is in operation and is one of the substations furnishing current for the general lighting and ornamental illumination for the Exposition grounds. It is operated by the Exposition Company, but was left open to the public at the request of the General Electric Company, to form part of its exhibit. It is fitted up as a model substation with tile flooring. One side is enclosed by the "Home Electrical" wall and the adjoining end by the transformer room. The front side and end are enclosed by brass railing and brass chain, and are outlined with six ornamental luminous arc lamps, which light the exhibit. A number of ornamental luminous arc lamps are also employed for lighting avenues on the Exposition grounds. The remaining sections of the courtyard are lighted by Mazda lamps. In fact, this entire exhibit is one of the few at the Exposition artificially illuminated in the daytime. All exhibit palaces are closed at night.

The equipment in this substation consists of G-E apparatus and comprises a 1000-kw. motor-generator set, 250-kw. balancer set, transformers, switchboard and the necessary feeder circuits. The motor-generator set is composed of a 1000-kw., 275-volt, shunt wound, d-c. generator, direct-connected to a 1400-kv-a., three-phase, 60-cycle synchronous motor. Excitation for the motor is obtained from the busses supplied by the generators of the balancer set. The set is started from the d-c. end. The balancer is a three-unit set, consisting of two 125-kw., 125-volt, shunt wound, d-c. generators, direct connected to a 375-h.p., 2400-volt, two-phase, 60-cycle, induction motor started through self-contained compensators. There are two 125-kw., 125/2400-volt, three-phase two-phase, step-down transformers, the induction motor being connected directly to the secondary through the compensator. The apparatus is controlled by a nine-panel switchboard.

Specially constructed racks and benches are employed in connection with this exhibit, on which are mounted 1-h.p., 2-h.p., 5-h.p. and 10-h.p. motors for industrial purposes, for both alternating current and direct current. They are connected up with instruments, arranged for operating under load similar to actual service and serve to demonstrate the different types of controlling devices. An indicating recording-integrating flow meter, installed in the boiler room of the Horticultural Palace, is measuring the actual steam consumption.

As we might naturally infer, electricity runs the Exposition, and we should here call attention to its source. Nearly all this electric energy is generated by apparatus manufactured by the General Electric Company. This is supplied entirely by the Pacific Gas & Electric Company, largely from the city stations of the company in San Francisco. The principal generating plant is "Station A," which has a total capacity of 53,500 kw. and in which are installed three large Curtis steam turbo-generator units, two of 15,000 kw. and one of 12,000 kw., in addition to five smaller machines. Considerable quantities of G-E apparatus, devices and accessories used throughout the Exposition by contractors and exhibitors were secured through the Pacific Gas & Electric Company and the Pacific States Electric Company, acting as distributors.

We shall now proceed to the most extensive exhibit of the General Electric Company, the Transportation Exhibit, which is located

in the Palace of Transportation adjacent to the Court of the Universe. This exhibit covers a total of over 9000 sq. ft., of which some 7735 sq. ft. are used for the apparatus display and the remainder for trackage



Fig. 13. Ghirardelli Chocolate Shop and Factory in the Amusement Zone

extending along Avenue C from the main west entrance. The entire exhibit is of the open type, not fenced in or enclosed. The displays are grouped and arranged particularly to permit free inspection, as they are largely operative and are designed to be broadly educational. The exhibit is brilliantly illuminated by Mazda lamps in Novalux ornamental units mounted on statuary bronze standards. At the entrance is an inviting reception room of pergola design.

The exhibit comprises electric locomotives for various classes of service from underground mine haulage to heavy steam railroad electrification; railway motors and all kinds of apparatus for electric railways, representing the latest developments in modern city and interurban electric service; signal accessory electric devices; electric apparatus and equipment for railway shops; electric illumination for cars, shops, etc. All essential parts of electric traction are demonstrated in operation.

A most impressive exhibit is the electric locomotives, of which five different types are included. The Butte, Anaconda & Pacific locomotive, occupying the central space of

the group, is one of four units that have recently been built for this road and is a duplicate of the original seventeen units put into service in 1913. These are the first direct current electric locomotives for operation at 2400 volts ever built. Each unit weighs 80 tons. Two are, however, coupled together for freight service to form a locomotive weighing 160 tons. The combination freight locomotives are hauling main line trains of 4600 tons at a speed of 16 miles per hour against the ruling grade of 0.3 per cent, and at 21 miles per hour on level tangent track. The two passenger locomotives, operating as single units on this system, are geared for a maximum speed of 45 miles per hour on level tangent track.

The freight traffic on this road consists largely of the transportation of copper ore from the mines at Butte to the smelters at Anaconda. The initial electrical equipment was intended for handling annually about 5,000,000 tons of ore, besides a large amount of mine supplies and an extensive freight and passenger service consisting of eight trains per day between the terminal cities. On account of diverting about 3000 tons of ore per day from the smelters at Great Falls to those at Anaconda, an increase of approximately 25 per cent is anticipated in the tonnage to be hauled during this year, necessitating the four additional locomotives. Based on six months of steam and electric operation, a comparison shows a total net saving for the latter of more than 20 per cent on the investment or total cost of the electrification, with an increase in tonnage per train of 33 per cent, a decrease in the number of trains of 25 per cent, and a saving of 30 per cent in the time required per trip. This electrification includes about 26 miles of main line, or with yards and sidings a total of approximately 90 miles on a single track basis.

A 60-ton electric locomotive of the type standard for interurban freight and passenger service and heavy switching duty is also shown. This machine is designed for operation at both 600 and 1200 volts direct current. The cab is of all-steel construction and is divided into three sections, the central operating cab containing the controller and other apparatus that should be within immediate reach of the engineer, and the two end steeply-back cabs containing the auxiliary electrical apparatus. The motor equipment consists of four GE-251 commutating pole motors, one mounted on each axle. They are arranged for forced ventilation from a blower in the cab. The

well-known type M multiple unit control is used and combined straight and automatic air brakes are provided. The trucks are of the equalized type and conform to MCB standards. There is also an industrial 16-ton, all-steel, electric locomotive of similar design with steep-back end cabs for light freight and yard switching service. It is equipped with two 600-volt, commutating pole, ventilated motors.

The electric mining locomotives consist of a large 20-ton trolley type equipped with three motors and a six-ton combination trolley and storage battery locomotive equipped with two motors, all of the commutating pole type. The latter is so arranged that it may be operated on the storage batteries for gathering beyond the point where the trolley wire extends, the batteries being recharged from a small charging set mounted in the locomotive and operating on the trolley voltage, thus obviating the necessity of laying up the locomotive while charging or changing the battery.

The General Electric Company has adopted the commutating pole ventilated type of motor as standard for practically all multiple unit railway equipments. Motors of this construction have a greatly increased service capacity when compared with motors of the closed type and same hourly rating, because of the positive circulation of air that is maintained throughout the interior by the system of self-ventilation. The motors displayed embrace GE-200, 203, 201, 222 and 247, all 600-volt motors of 40, 50, 65, 140 and 35 h.p. respectively; types GE-233 and 240, 600/1200-volt motors of 75 and 85 h.p. respectively; GE-239, 140-h.p., 2400-volt motor; and a GE-246, 60-h.p., 600-volt motor in section, with partially-wound armature and partially-insulated field coils, to show the manner of construction.

There is a storage battery truck crane for loading, unloading and carrying articles weighing up to one ton, for use in industrial plants, warehouses, on docks, etc., as well as for hauling loaded trailers, "spotting" freight cars, etc. Another industrial truck, a storage battery platform truck, designed to run inside of freight cars, has come into extensive use for freight and package handling, express, warehouse and other service. A portable air compressor set for use around factories is shown, the compressor being fitted with a glass cover and the interior illuminated to show the operation. This same type CP-27 air compressor is employed with

air brake systems, one of which is mounted on a rack in the same manner as it is installed on a car, with all the valves and accessories for combined straight and automatic operation.

A most interesting feature of the traction exhibit is the two single-end type MK control equipments, each mounted on a separate rack in the usual manner of installing for service. The exhibition racks, which represent the complete underframing and equipment for a two-car train, are placed end to end with control jumpers and air brake hose connections for train operation. Each control equipment consists of a master controller, contactor box, etc., completely wired for the actual operation of two GE-247 motors, which are mounted on a truck beneath the rack. These equipments also include complete straight and automatic air brakes, with CP-27 air compressor, governor, valves, etc. The motor trucks are equipped with third rail shoes. The entire arrangement permits operation to be demonstrated either as a single car or two-car train on multiple-unit control. Illuminated diagrams connected with the control system indicate by lighted lines the connections of the motor circuit at each step on the controller.

Another working exhibition rack contains a complete type M multiple unit control designed for three-speed operation in city service. The motor circuit connections at each step are also similarly shown. The controller exhibit includes the standard K-35, K-36, K-51 and K-201 types. The last named controller is designed for three running positions and is suitable for frequent stop city service. A complete assortment of line material is grouped on a large frame, many of the devices being arranged in the same manner as when installed in actual service.

A large number of separate valves, contactors, governors, fuse boxes, rheostats, switches, lightning arresters and other devices entering into car equipment form part of the exhibit. Forged steel treated gears, cast steel split and solid gears, and pressed steel gear cases for city, suburban and interurban service are shown, as well as several grades of forged steel treated pinions and pinion pullers. A display of railway lamps demonstrates effectively systems of car lighting with modern Mazda lamps. Automobile lamps and accessories are also included. Shadow boxes and photometric curves demonstrate the relative value of the illuminating units. There is



Fig. 14. "Panama Canal" in the Amusement Zone



Fig. 15. "Creation" in the Amusement Zone

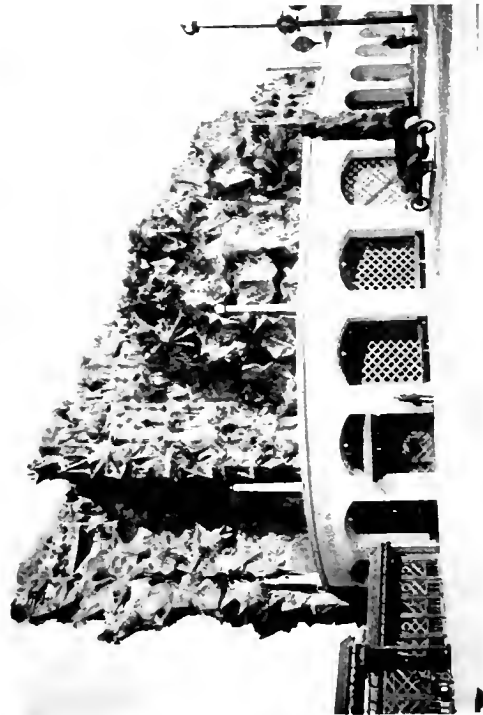


Fig. 16. "Yellowstone Park" in the Amusement Zone



Fig. 17. "London to the South Pole" in the Amusement Zone

also a complete line of incandescent and luminous arc headlamps with semaphore lenses and parabolic reflectors, for city, suburban and interurban service.

The line of signal accessories includes transformers, vacuum and multigap lightning arresters, switchboards, instruments, etc. Other interesting apparatus are a 50-kw. motor-generator, a mercury arc rectifier of the standard type for battery charging, an electric arc welding outfit, a new high frequency oscillator shown in operation testing insulators, a full line of insulators, the "Genemotor" the new self-starting and lighting system for Ford cars, a new multi-recorder for switchboards for automatically keeping a record of the time of manipulation of the various switches, a complete line of circuit breakers, etc. Meriting particular attention is the model of the Panama electric towing locomotive, an entirely new design of machine, of which the General Electric Company supplied forty for towing vessels through the Panama Canal locks. A model of one of these "electric mules," as they are popularly called, is also included in the Government exhibit.

A most attractive and instructive feature of the exhibit is the several hundred illustrations which a stereomotorgraph projects automatically on a large translucent screen. These illustrations, of which there are several hundred, cover the range of modern traction developments. They are made from actual photographs taken in various parts of the country and show important applications of recent railway equipment in city, interurban and heavy electrification service, as well as many typical installations of new apparatus in large power plants and substations.

While the illumination of the Exposition signalizes beyond all else to the average mind the greatness of electrical achievements, and while the exhibits of the General Electric Company have attracted exceptional attention from the public, especially the "Home Electrical," the representation of this Company is by no means confined to its own displays. Evidence of its activities and the almost unlimited diversity of the application of its products in industrial and social development may be said to permeate the entire Exposition. Many of the machines and devices displayed by a very large number of exhibitors in various buildings are operated by its

motors and apparatus, loaned to exhibitors. A large number of sales of apparatus were also made, particularly in the Amusement Zone, mention of which is made below.

The application of G-E motors by other exhibitors at the Exposition includes the operation of pumps, clutches, hoists, derricks, machine tools, silk machinery, glove machinery, refrigerating machinery, elevators, cotton mill machinery, dairy machinery, flour mill machinery, shoe machinery, dredging machinery, optical equipment, dentists' tools, electric trucks, lumbering machinery, woodworking machinery, steel and iron mill equipment, etc. In fact, so extensive is the application of electric power in evidence, we are impressed that electricity is coming more and more to do the world's work.

But before we leave the Exposition, we also find electricity "at play." Every one that visits the Exposition takes in the novelties of the Amusement Zone, or simply "The Zone," as it is popularly called. Here there is a very large representation of General Electric Company apparatus. Machines and devices driven by this company's motors are installed in numerous concessions, including the Ghirardelli chocolate making plant, the miniature working representation of the Panama Canal, Bowls of Joy, Marine Restaurant, Orange Blossom candy factory, Creation, Frankfurter Inn, Neptune's Daughters, Forty-nine Camp, Zone Café, Yellowstone Park, Desmond Supply Company, London to South Pole, Jester Palace, Joy Wheel, Alt Nurnburg, Shooting Galleries, etc. The concessions on "The Zone" are generally lighted on the interior and outline lighted on the exterior by Mazda lamps, as are also the streets and avenues in this section.

The Exposition in its entirety is not only a beautiful vision, but will leave a lasting impression of its greatness and grandeur on the many thousands of visitors. It is a fitting and adequate expression of the opening of the new gateway to the East and the West, the Panama Canal. And the one impression of newness in expositions, a prominent difference that charms and lingers long with the visitor, is the combined decorative and lighting feature, a modern esthetic achievement, which has been so well termed "a new symphony in color."

THE HOME ELECTRICAL AT THE PANAMA-PACIFIC INTERNATIONAL EXPOSITION

By DON. CAMERON SHAFER
GENERAL ELECTRIC COMPANY

For the purpose of demonstrating that electricity can easily and inexpensively be applied to reduce the drudgery of housework in a home and to secure those conveniences which would be appreciated by all its members, the General Electric Company is maintaining a full-size, fully furnished model house in the Palace of Manufactures at San Francisco. This article describes the arrangement of the exhibit, its furnishings, and the electric lighting, heating and power appliances.—EDITOR.

If it be true that the attainment of popularity is the final test of successful advertising then the Home Electrical, which is but a part of the General Electric Company's exhibit at the Panama-Pacific International Exposition at San Francisco, is one of the most effective publicity ventures at the exhibition. It is certain that this thoroughly modern home, where electric energy is converted into light, power and heat to perform many of the most important household tasks, has proven far

fashion and with a long columned portico along two sides. There is also a small enclosed patio, or garden, in the rear. The interior arrangement provides for a large and comfortable living room, an attractive dining room with a breakfast alcove, a bedroom with a nursery and a bathroom adjoining, a sewing room, a kitchen with auxiliary refrigeration room and laundry. In connection with the house there are also an electric garage, a workshop and a small creamery. Every



Fig. 1 The "Home Electrical" Exhibit of the General Electric Company in the Palace of Manufactures

more attractive to the visiting public than any other exhibit in the great Manufacturer's Building.

The construction of this complete house within the Manufacturer's Palace is an engineering novelty which has added materially to the attractiveness of this special exhibit. The home is a California mission bungalow in design, built of gray stucco, roofed with red tile in the picturesque Spanish

room is completely furnished and attractively decorated, all in excellent taste, and yet entirely within the means of an average family.

Here at the very beginning it should be said that the Home Electrical is in no sense of the word an exhibition "stunt" designed merely to demonstrate the wonders which electricity can be made to do in the modern home. It is not the purpose of this house to

astonish the visitors, or to astound them with numerous bewildering and amazing electrical performances which savor of the magical. It is in every way a modern house and every application of electricity therein is aimed to lessen the work of housekeeping and to remove the drudgery of housework. Not a single electrical convenience is shown but what would be entirely suitable for the average family and well within the means of anyone in moderate circumstances. Visitors have often remarked with surprise that the electrical equipment is so simple that anyone can operate it without any previous study or knowledge of electrical matters.

Approaching the Home Electrical one is agreeably surprised to find that the house number is an electric transparency, and the portico, or veranda, is lighted with Mazda

lamps in ornamental porch fixtures. The lamps are enclosed in six-inch light opal globes with close ceiling type fixtures. The doors are equipped with electric bells which announce your presence to the servants.

Entering the house one steps into a spacious and appropriately furnished living room approximately 13 by 19 feet. It is furnished in mahogany and the color scheme is a mulberry tone, with draperies, wall paper, lighting fixtures, rugs, etc., in perfect harmony. The woodwork is finished in fumed oak. The illumination of this room is of the very latest and approved system of semi-direct lighting from hanging Holophane "Calla" bowl fixtures, the 60-watt amber dipped Mazda lamps being hidden from the eye while the light is distributed by reflection from the walls and tinted ceiling to all parts of the room. The

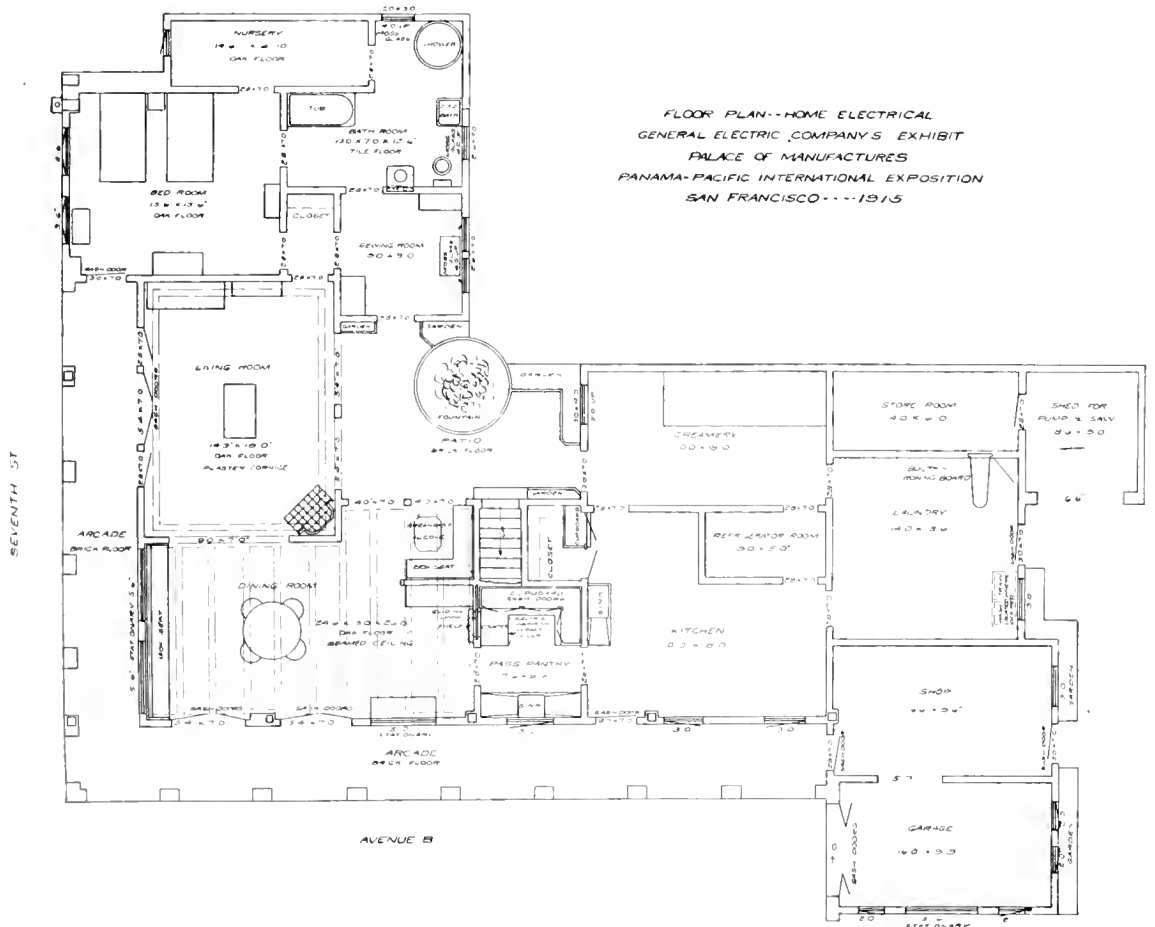


Fig. 2. Floor Plan of the "Home Electrical" Exhibit

lamps are controlled from wall push switches located at convenient points. Three-way push switch controls are located at the porch entrance and also between the living room and the dining room. There is also a small lamp for the desk and a handsome table



Fig. 3. Living Room in the "Home Electrical" Exhibit

lamp. A telephone on a suitable stand connects with local and long distance lines and with the inter-house phone to every room, an electric convenience which saves many steps in the course of a day. An electric fireplace of the four-bulb luminous radiator type furnishes both warmth and a pleasing glow in addition to the regular three-kilowatt electric heater. One of the most novel electrical devices in the house is to be found in this room—an electric piano player, which appears to be more satisfactory to the music lover than the ordinary piano players.

Adjoining the living room, after the bungalow fashion, is the dining room, in soft blue tones and black walnut furniture. Draperies, curtains, rugs, wall paper—all harmonize to the blue tone. It is completely furnished with a table of the pedestal type, chairs, tea wagon, buffet, china closet, and with the necessary linen, silverware and china. This room is also lighted by Mazda lamps in ornamental fixtures which provide direct illumination through tinted shades which harmonize with the color scheme. It is heated with an electric heater and the air is kept constantly stirred and refreshed by a small oscillating electric fan located on the wall. It is in this room that the

visitor is first impressed with the versatility of the electric energy drawn from the house wiring, it is converted into light, heat and power to operate the lamps, the heating and cooking devices and the electric fan. The dining room is equipped with electric heating and cooking devices for the preparation of lunches and light refreshments such as are so acceptable late in the evening after the theater or on Sunday evening. Among the devices may be noted a domestic toaster, an electric coffee pot, a tea samovar, a disk stove for general cooking; a uni-set, a uni-set chafing dish for preparing hot soups or desserts and a radiant grill for broiling, toasting, preparing eggs, etc. In fact, if desired, a very substantial meal can be cooked right on the dining room table. Another electrical feature is the warming closet at the entrance to the butler's pantry where the food is kept hot between courses. To the right of the dining room is the breakfast alcove, very cosily arranged and also equipped for "table cooking." This breakfast nook is finished in a blue tone and looks out upon a vine covered patio, upon ferns and flowers and a little green yard wherein sparkles an electric fountain. This early morning meal is cooked before your very eyes, just as you want it,



Fig. 4. Breakfast Nook in the "Home Electrical" Exhibit

from coffee to toast and bacon and eggs, and even more if you are hungry for sausages and cakes.

Between the dining room and the kitchen is the butler's pantry, approximately seven by nine feet in size. Here are installed a combination butler's sink and dish-washer for cleaning the light and valuable wares. On

a shelf there is a disk stove for making dressing and sauces, and a small electrically driven buffer for polishing nickel and silver pieces. On the wall is the annunciator of the door bell system which signals information to the maid or butler.

Interest naturally centers about the kitchen of the home because this is the housewife's workshop, and the entire housework revolves around this important room with its three-meals-a-day and the necessary labor of preparation and cleaning up afterwards. And it is but natural that here electricity should find its greatest field of usefulness. The dirty, insufferably hot, heat-wasting coal range; the stuffy, odorous and dangerous gas stove, have been replaced with a modern, sanitary domestic electric range of the latest design. The type R-3 range is a substantial affair capable of the largest family dinner. Both oven and boiler are placed high enough so the contents may be watched without stooping. This range uses ordinary cooking utensils and embodies many features of the so-called fireless cooker, such as insulated steam compartments and specially heat-insulated oven and hot plates. The broiler is combined with the oven and broils by radiant heat above the meat. The range is

At the snap of a switch the stove is ready to cook, at any degree of heat required, and at the pressure of a finger the heat is gone until it is wanted again.

Suitable electric lamps are located to give an even distribution of light about the kitchen,



Fig. 6. Bed Room in the "Home Electrical" Exhibit

and especially over the stove, work table, sink and other centers of activity. The unpleasant odors of cooking are no longer noticed as a household ozonator and exhaust fan combine to quickly remove them and keep the air in the kitchen pure and fresh. Should the day be chilly, a portable air heater can be put into service by inserting a small wall plug. The kitchen, all white enamel, is furnished with a kitchen cabinet, sink and drain, combination work and power table, chairs and all the necessary pots, pans and cooking utensils otherwise than the electrical devices. In addition to the range there are also an electric grill, a two-pint percolator coffee pot, a toaster and a small water heater.

The electric refrigerating system is a constant source of interest. While the visitors cannot all understand how this little mechanical device keeps the refrigerator at any predetermined temperature they do appreciate its convenience and labor saving factors. The refrigerator proper is located in the kitchen, handy to the kitchen cabinet, but the motor-driven ammonia compression tanks, etc., are located in an adjoining refrigerating room. The refrigerator is lighted by electricity, an improvement worthy of note, and small cubes of ice may also be obtained from



Fig. 5. Kitchen in the "Home Electrical" Exhibit

equipped with five hot plates, or grids, with three degrees of heat. The convenience of such an electric range is easily appreciated by the woman visitor. No fires have to be built or tended, no coal to lift and carry, no soot, no ashes, no dirty stove to clean. Practically no heat is radiated out into the room to make the kitchen a place of torment in hot weather.

this machine if desired. With this may be mentioned the electrically driven ice cream freezer for ices and creams. A connection with the inter-house phone for saving steps is the final kitchen convenience.



Fig. 7. Laundry in the "Home Electrical" Exhibit

The bedroom is finished in a pleasing gray tone with old rose furnishings. The furniture is Kaiser gray oak, including the two beds, the dressing table, the dresser, the chiffonier, the chairs, etc. The color scheme is carried out by including rugs, curtains and wall paper, of a deep red tone.

This room contains many electrical conveniences and articles for the toilet, including an electric massage vibrator, electric curling iron, hair dryer, and boudoir lamps. There is a physician's heating pad to take the place of the old fashioned hot water bag and a small electric water heater in case of sickness. The bedroom is heated by electricity in chilly weather and cooled with an electric fan when the nights are too warm. There is a connection for the vacuum cleaner when electric energy is required to do the sweeping and dusting, to clean the rugs, curtains and furniture. The room is also provided with a telephone connection to all parts of the house to save unnecessary steps.

The burglar switch located in the bedroom cannot fail to interest the nervous and timid. In the middle of the night, at the warning of any suspicious noise in the house, one has

but to reach out and turn this switch and instantly every room in the house will blaze with light. Once on the lamps cannot be turned off except from the master switch. It has been proven that a flood of light is the best guardian of any home and a sure method of frightening away intruders.

Near the bedroom is the nursery with its electric toys and an electrical device at the window to keep the room supplied with fresh air without dangerous drafts. This room is finished in white enamel and provided with two systems of lighting, flashed on alternately at intervals of half a minute by means of a sign flasher, to demonstrate both methods. The first method consists of indirect lighting units on the ceiling with "eye comfort" fixtures equipped with 60-watt clear Mazda lamps. The second method consists of bracket lights provided with pull sockets, and

equipped with two All-Nite-Lite outfits. It is furnished with a small white bed, a small chair and rocker, toys, etc. The curtains and rugs are blue. The nursery is heated by electricity with a twin-glower radiator and



Fig. 8. Shed for the Stationary Vacuum Cleaning Outfit and High Pressure Pumping System in Connection with the "Home Electrical" Exhibit

there is an electric uni-set nursery outfit for preparing medicine, food, etc. An electric heating pad is also provided to warm up cold hands and toes or for use in case of sickness.

The bathroom, of white tile and spotless porcelain, in addition to a complete set of bathroom fittings is equipped with such electrical conveniences as a hot water cup for shaving purposes, and various other uses, an electric radiator in case the room should be chilly in the early morning, an electric vibrator and a hair dryer. There is the usual bathroom equipment including shower, tiled floor, white chair and stool. Curtains and shades are white and the window glass is frosted. An overhead lighting unit with 60-watt Mazda lamps furnishes illumination. In addition the mirror is lighted from either side by white side wall brackets with pull sockets. An exhaust fan serves as a ventilator and draws the steam from the hot water out of the room. The fan, with an ozonator, prevents impure or vitiated air. The hot water for the bathroom is drawn from the hot water tank in the kitchen in the usual manner.

The sewing room is also a point of special interest with its electrical appliances for sewing, pressing and dressmaking. The electrically driven sewing machine is controlled by the foot treadle and is so nicely adjusted that it can be stopped in the middle of a

threads and scraps of cloth. A connection to the interhouse phone saves many steps in tending to various household duties during sewing hours. A small air heater and a fan keep the room warm and comfortable at all



Fig. 10. Creamery in the "Home Electrical" Exhibit

seasons. The furniture includes a sewing table and cabinet, rugs, curtains, etc.

Anyone who has ever done a family washing, or ever turned a washing machine, can appreciate the electric laundry where the little motor does all the hard work. This little device, no larger than an ordinary flower pot, runs the washing machine, washes and rinses the clothes, and turns the wringer, all without the slightest effort. An electrically driven mangle makes ironing easy as all the large pieces and many of the smaller ones can be ironed very quickly with this machine. The laundry is 13 by 13 feet in size. It is lighted from a ceiling fixture equipped with an enameled steel reflector. The equipment includes stationary tubs, drying cabinet, chairs, etc. A double eight-inch hot plate is used for boiling the clothes. Electric flat-irons in four sizes, three, six, eight and twelve pounds respectively, are used for smoothing, pressing and ironing in accordance with the demands of the work. A collapsible ironing board folds into a shallow closet and the flatiron switches are equipped with pilot lights to indicate whether or not the current has been turned off when the work is done. If wash day be hot and sultry an exhaust fan removes all steam and heated air and maintains a comfortable working temperature. An air heater is ready to be "plugged in" when the day is cold.

Inasmuch as many homes are not located where they can enjoy a civic water system provision has been made in the shed for a



Fig. 9. Garage in the "Home Electrical" Exhibit

stitch. The motor will run the sewing machine all day for a few cents' worth of electricity and remove entirely the drudgery of sewing. A three- and a six-pound electric iron are located on a convenient board and a small portable vacuum cleaner is used to pick up

constant water pressure all over the house, where a well is the source of supply. This is an automatic air pressure system connected to the water supply which keeps the pressure constant at any desired point. Both the air and water pumps are driven by a tiny electric motor, controlled by a pressure switch. When enough water has been used to lower the tank pressure to a certain predetermined point the switch starts up the motor. When enough pressure has been secured the little switch shuts off the current and stops the motor. In this way a constant supply of water is secured automatically, day or night from any well or spring.

Men and boys handy with all kinds of tools can appreciate the electric workshop which is equipped for any ordinary repair or construction work, with a workbench, bench type drill press, chipping hammer, electric riveter, and grindstone. Then there is a buffing outfit, saw table, bench type lathe, melting pot, all electrically operated. Handy little electric soldering irons and an electric glue-pot aid in repairing of leaky utensils or broken wood-work. An air heater of sturdy build and generous capacity is ready at all times to insure comfort in the shop.

In connection with the Home Electrical is the modern electric garage where a light electric coupé is kept automatically charged and ready for service. The car batteries are charged through the aid of a mercury arc rectifier which changes the alternating current of the lighting service into direct current for battery charging. This charging is entirely automatic and the batteries for car lighting are charged by a small vibrator. A small portable search lamp, which can be operated on any electrically lighted car, is used for examination of any part of the car, and a portable electric tire pump complete the car equipment. Connections are made to the inter-house phone in both garage and work-shop. An air heater is also installed in the garage.

Many visitors to the Home Electrical will be from rural communities and they will wish to see the electric dairy which is equipped with an electrically driven cream separator, bottle washer and churn to reduce manual labor to an absolute minimum. In conjunction with these appliances is an automatic refrigerator and milk cooler, operating to keep the cooling chamber at the proper temperature. Any time that the temperature varies from the desired point the thermostat control operates the motor switch and starts the flow of cooling solution through the pipes. When the temperature has dropped to the proper point, the thermostat control again operates to stop the motor.

The second floor of the Home Electrical is finished off into a suitable office for the transaction of such business as may be necessary in connection with such a large exhibit.

The success of the Home Electrical is due to the impression it leaves with the casual visitor that the electric light wires are a source of energy not restricted to illumination but which can also be used as heat and power to banish drudgery and hard work from the home. The devices shown are for the most part inexpensive to purchase and cost but a few cents a day to operate.

In conclusion it should be stated that this exhibit, which is conducted entirely by the General Electric Company, is co-operative to the extent that it comprises a very complete display of household devices operated by the Company's motors but manufactured by other concerns, many of whom have no other representation at the exposition. The purpose of this exhibit is more educational than commercial, inasmuch as it effectively demonstrates to every visitor the value of electricity in the home and proves that the electric labor saving devices and conveniences shown therein are inexpensive and within the reach of all.

ILLUMINATION OF THE PANAMA-PACIFIC INTERNATIONAL EXPOSITION

BY W. D'A. RYAN

CHIEF OF ILLUMINATION

The text of this article, together with the illustrations that accompany it, will give the reader an idea of the wonderful illuminating effects that have been achieved at the Panama-Pacific International Exhibition. Special interest is attached to this contribution, as its author was responsible for the work he describes.
—EDITOR.

The illumination of the Panama-Pacific International Exposition is a development in the art of illumination made possible by the science of lighting which grew up under the name of illuminating engineering and had its inception at the Thomson-Houston plant of the General Electric Company at Lynn, Massachusetts, nearly twenty years ago.

While in charge of the expert course, the writer came closely in contact with the development of the Thomson '93 arc lamps which in various ornamental forms were designed for alternating and direct current series and multiple circuits. The enclosed arcs soon made their appearance and these lamps added to the existing lighting sources suggested the necessity of a careful scientific study in the selection, location, reflectoring and globing of the various units to obtain maximum results at minimum cost for industrial use, store and street lighting, and other purposes.

That illuminating engineering was to form such an important specialized branch of electrical engineering was not at first recognized, but after considerable progress had been made in this particular field the title of Illuminating Engineer became generally acknowledged. From that time on the development has been very rapid. New photometers, luximeters, and luminometers were built for laboratory and field work. Lumichromoscopes were designed for studying effects of different lights on various colored materials, diffusers made their appearance, scientific glassware and reflectors swept over the land, extensive laboratory and field tests were made and the development became general.

Many papers were read at conventions, colleges and elsewhere to stimulate public interest in the importance of the work. Contemporaries entered the field, scientific journals gave considerable space to the subject and publications, such as the *Illuminating Engineer* and *Good Lighting*, devoting their entire space to illuminating engineering,

were published in this country and abroad. An Illuminating Engineering Society was formed in the United States and this action was quickly followed in England. The membership was made up of engineers, lighting specialists, architects, decorators, oculists, glass manufacturers, fixture designers, psychologists and others. Valuable contributions were received from many sources and the general interest created thereby.

Today the General Electric Company has Illuminating Engineering Laboratories, commercial, experimental or developmental at Schenectady, Cleveland, Harrison and Lynn. In New York, Boston, Chicago and many other cities proficient illuminating engineers are doing excellent work and practically every large manufacturer of lighting units or appurtenances has either an illuminating engineering department or an associated illuminating engineer.

In lighting propositions involving special effects or treatment, it has become the practice to employ an illuminating engineer in addition to the electrical engineer. It was therefore natural that when the Panama-Pacific International Exposition decided that its illumination should possess features of novelty to correspond with its general policy it recognized the necessity of establishing a department of illuminating engineering in addition to the electrical and mechanical department, which came under the direction of Mr. G. L. Bayley, as Chief.

Mr. Bayley's application to the General Electric Company resulted in the writer's appearing before Mr. H. D. H. Connick, director of works, and the architectural commission in August, 1912, to consider the preparation of lighting plans along original lines. Three months later a scheme and scope was presented to the architectural commission and the writer was officially appointed "Chief of Illumination" in charge of the illuminating and spectacular effects, also the design of lighting standards and fixtures and

the selection of the glass for the buildings and various lighting units.

The General Electric Company as a further contribution to the Exposition agreed to maintain a branch of the illuminating engineering laboratory at the Exposition for this purpose and in addition to the writer the organization consisted of Mr. A. F. Dickerson, first assistant; Mr. J. W. Gosling, decorative designer; Mr. J. W. Shaffer, chief draftsman; Mr. H. E. Mahan, illuminating engineer, and Mr. E. J. Edwards, illuminating engineer representing the laboratory of the National Lamp Works at Cleveland.

Supplementing this organization we had the assistance of the entire illuminating engineering force at Schenectady under the direction of Major R. H. Ryan, where tests were run on luminous arcs, Mazda lamps, gas arcs, searchlights, glassware and various devices entering into the illuminating effects. As a result, for the first time in history the lighting of an International Exposition was completely designed and charted before the buildings were erected.

No fundamental changes were made except in one instance where, due to a difference of opinion existing between some of the architects and the writer, as to the relative height and mass of the nine-light standards in the daylight picture, the night effect was unfortunately sacrificed.

The general results obtained are due in a great measure to the support of Mr. H. D. H. Connick, director of works, and Mr. G. L. Bayley and his excellent electrical and mechanical organization. We also enjoyed the co-operation of and assistance from the chiefs of all departments, architects, designers, sculptors, modelers and others too numerous to mention in this article.

A detailed description of the lighting in a limited space is, of course, impossible, and it is the purpose of this article to convey a general idea of the effects rather than the means employed to produce them.

The illumination of the Exposition marks an epoch in the science of lighting and the art of illumination. Like many other features of the Exposition, the illumination is highly educational in character and emphasizes more than anything that has gone before the result of concentrated study in the best uses and application of artificial light.

Previous exposition buildings have, in the main, been used as a background on which to display lamps. The art of outlining, notably the effects obtained at the Pan-

American Exposition at Buffalo, could probably not be surpassed. This method of illumination has, however, been extended to amusement parks throughout the world and is now commonplace. Its particular disadvantage is that it suppresses the architecture which becomes secondary and it is practically impossible to obtain a variety of effects, so that the Exposition from every point of view presents more or less similarity. Furthermore, the glare from so many exposed sources particularly when assembled on light colored buildings causes eye strain. Prior to the opening night of the Exposition, there were many who maintained that the public would not be attracted except by the glare of exposed sources and great brilliancy, which was analogous to saying that the masses could be attracted only by one form of lighting. The results obtained, however, clearly disproved this theory.

The lighting effects are radical, daring and in every sense new, the fundamental features of which consist primarily of masked lighting diffused upon softly illuminated facades emphasized by strongly illuminated towers, and minarets in beautiful color tones.

The direct source is completely screened in the main vistas and the "behind the scenes" effects are minimized to a few locations and are nowhere offensive.

Furnishing wonderful contrast to the soft illumination of the palaces, with their high lights and shadows, we have the zone, or amusement section with all the glare of the bizarre, giving the visitor an opportunity to contrast the light of the present with the illumination of the future. As we pass from the Zone with its blaze of lights, we enter a pleasing field of enticement or carnival spirit. We are first impressed with the beautiful colors of the heraldic shields on which is written the early history of the Pacific Ocean and California. Behind these banners are luminous arc lamps in clusters of two, three, five, seven and nine, ranging in height from 25 to 55 feet. We look from the semi-shadow upon beautiful vistas and the Guerin colors which fascinate in the daytime are even more entrancing by night. The lawns and shrubbery surrounding the buildings and the trees with their wonderful shadows appear in magnificent relief against the soft background of the palaces and the "Tower of Jewels" with its 102,000 "Nova-gems," or so-called exposition jewels, standing mysteriously against the starry blue-black canopy of the night, surpassing the dreams of Aladdin.

As we enter the "Court of Abundance" from the east, with its masked shell standards strongly illuminating the cornice lines and gradually fading to twilight in the foreground, we are impressed with the feeling of mystery analogous to the prime conception of the architect's wonderful creation. Soft radiant energy is everywhere; lights and shadows abound, fire spits from the mouths of serpents into the flaming gas cauldrons and sends its flickering rays over the composite Spanish-Gothic-Oriental grandeur. Mysterious vapors rise from steam-electric cauldrons and also from the beautiful central fountain group symbolizing the Earth in formation. The cloister lanterns and the snow-crystal standards give a warm amber glow to the whole court and the organ tower is carried in the same tone by colored searchlight rays.

Passing through the "Venetian Court," we enter the "Court of the Universe," where the illumination reaches a climax in dignity, thoroughly in keeping with the grandeur of the court, where an area of nearly half a million square feet is illuminated by two fountains, rising 95 feet above the level of the sunken gardens, one symbolizing the rising sun and the other the setting sun.

The shaft and ball surmounting each fountain is glazed in heavy opal glass which is coated on the outside in imitation of travertine stone so that by day they do not in any sense suggest the idea of being light sources. Mazda lamps installed in these two columns give a combined initial mean spherical candle-power of approximately 500,000 and yet the intrinsic brilliancy is so low that the fountains are free from disagreeable glare and the great colonnades are bathed in a soft radiance. For relief lighting three Mazda lamps are placed in specially designed cup reflectors located in the central flute to the rear of each column. This brings out the Pompeian red walls and the cerulean blue ceilings with their golden stars and at the same time the sources are so thoroughly concealed that their location cannot be detected from any point in the court.

The perimeter of the "Sunken Garden" is marked by balustrade standards of unique design consisting of Atlantes supporting urns in which are placed Mazda lamps of relatively low candle-power. The function of these lights is purely decorative.

The great arches are carried by concealed lamps, red on one side and pale yellow on the other, thereby preserving the curvature and the relief of the surface decorations. The

balustrade of this court, 70 feet above the sunken garden, is surmounted by 90 seraphic figures with jeweled heads. These are cross lighted by 180 Mazda searchlights, the demarcation of the beams being blended out by the light from the fountains of the rising and the setting sun.

Passing through the Venetian Court to the west, we enter the "Court of the Four Seasons," classically grand. We are now in a field of illumination in perfect harmony with the surroundings, suggesting peace and quiet. The high current luminous arcs mounted in pairs on 25-ft. standards masked by Greek banners are wonderfully pleasing in this setting. The white light on the columns causes them to stand out in semi-silhouette against the warmly illuminated niches with their cascades of falling water, and the placid central pool reflects in marvelous beauty scenes of enchantment.

Having reviewed in order illuminations mysterious, grand and peaceful, we emerge from the West Court upon lighting classical and sublime, the magnificent Palace of Fine Arts bathed in triple moonlight and casting reflections in the lagoon impossible to describe. The effect is produced by searchlights on the roofs of the Palaces of Food Products and Education supplemented by concealed lighting in the rear cornice soffits of the colonnade.

You have only passed through the central, east and west axis of the Exposition. There are many more marvels to be seen. If you wish to study the art of illumination you could visit the Exposition every evening throughout the year and still find detail studies of interest. For instance, did you ever see artificial illumination in competition with daylight? On certain occasions the projectors flood-light the towers before the sun goes down. If you are fortunate enough to be present, take up a position in the northwest section of the "Court of the Universe" and watch the marvelous effect of the "Tower of Jewels" as the daylight vanishes and the artificial illumination rises above the deepening shadows of the night. The prismatic colors of the jewels intensify and the tower itself becomes a vision of beauty never to be forgotten.

The South Garden may very properly be called the fairy-land of the Exposition at night. When the lights are first turned on, the five great towers are bathed in ruby tones and they appear with the iridescence of red hot metal. This gradually fades to delicate

rose as the flood-light from the arc projectors converts the exterior of the towers into soft Italian marble. The combination of the projected arc light (white) and the concealed Mazda light (ruby) produces shadows of a wonderful quality. Each flag along the parapet walls has its individual projector which converts it into a veritable sheet of flame.

As a primary line of color the heraldic shields and cartouche lamp standards produce a wonderful effect against the travertine walls bathed in soft radiance from the luminous arcs which also bring out the color of the flowers and lawns and create pleasing shadows in the palms and other tropical foliage. This is supported by a secondary effect in the decorative Mazda standards along the "Avenue of Palms" and throughout the garden. A finishing touch is added by the effect of life within created by the warm orange light emanating from all the Exposition windows supported by red light in the towers, minarets and pylon lanterns.

To the west we have the enormous glass dome of the Palace of Horticulture converted into an astronomical sphere with its revolving spots, rings and comets appearing and disappearing above and below the horizon and changing colors as they swing through their orbits. The action is not mechanical, but astronomical.

To the east, we have the "Festival Hall" flood-lighted by luminous arcs and accentuated by orange and rose lights from the corner pavilions, windows, and lantern surmounting the dome, all reflected in the adjacent lagoon and possessing a distinctive charm which will long remain in the memory.

Purely spectacular effects have been confined to the scintillator at the entrance of the yacht harbor. This consists of 48 36-in. projectors having a combined projected candle-power of over 2,600,000,000. This battery is manned by a detachment of United States Marines.

A modern express locomotive with 81-in. drivers is used to furnish steam for the various fireless fireworks effects known as "Fairy Feathers," "Sun-Burst," "Chromatic Wheels," "Plumes of Paradise," "Devil's Fan," etc. The locomotive is arranged so that the wheels can be driven at a speed of 50 or 60 miles per hour under brake, thereby producing great volumes of steam and smoke, which, when illuminated with various colors, produces a wonderful spectacle.

The aurora borealis created by the searchlights reaches from the Golden Gate to

Sausalito and extends for miles in every direction. The production of "Scotch Plaids" in the sky and the "Birth of Color," the weird "Ghost Dance," "Fighting Serpents," the "Spook's Parade" and many other effects are fascinating.

Additional features consist of ground mines, salvos of shells producing "Flags of All Nations," grotesque figures and artificial clouds for the purpose of creating midnight sunsets.

Over 300 scintillator effects have been worked out and this feature of the illumination is subject to wide variation. Atmospheric conditions have a great influence upon the general lighting effects; for instance, on still nights the reflections in the lagoons reach a climax, particularly the Palace of Fine Arts as viewed from Administration Avenue; the facades of the Education and Food Products Palaces as seen in the waters through the colonnade of the Palace of Fine Arts; the Palaces of Horticulture and Festival Hall from their respective lagoons in the South Garden; the colonnades and the Nova-gems on the heads of the seraphic figures, and the "Tower of Jewels" as reflected in the water mirror located in the North Arm of the "Court of the Universe."

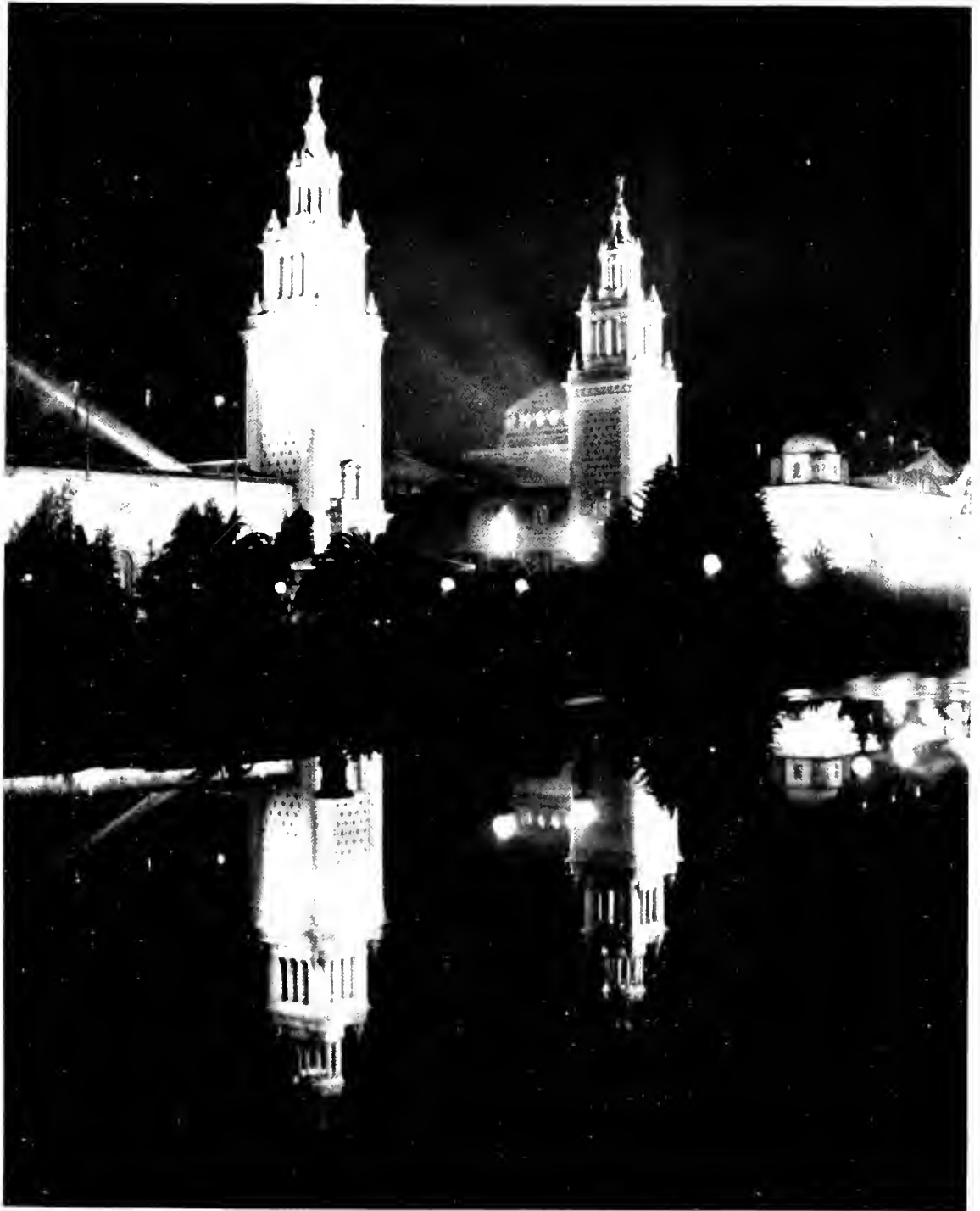
On windy nights the flags and jewels are at their best. On foggy nights wonderful beam effects are produced over the Exposition impossible at other times. When the wind is blowing over the land the scintillator display is different from nights when the wind is blowing across the Bay. A further variety is introduced in the action of the smoke and steam on calm nights.

On the evening of St. Patrick's Day all the searchlights were screened with green; not only the towers but every flag in the Exposition took on a new aspect.

Orange in various shades was the prevailing color for the evening of Orange Day and on the ninth anniversary of the burning of San Francisco the Exposition was bathed in red, with a strikingly realistic demonstration of the burning of the "Tower of Jewels."

High pressure gas lighting plays an important part in street lighting in the foreign and state sections; low pressure gas for emergency purposes, and gas flambeaux for special effects.

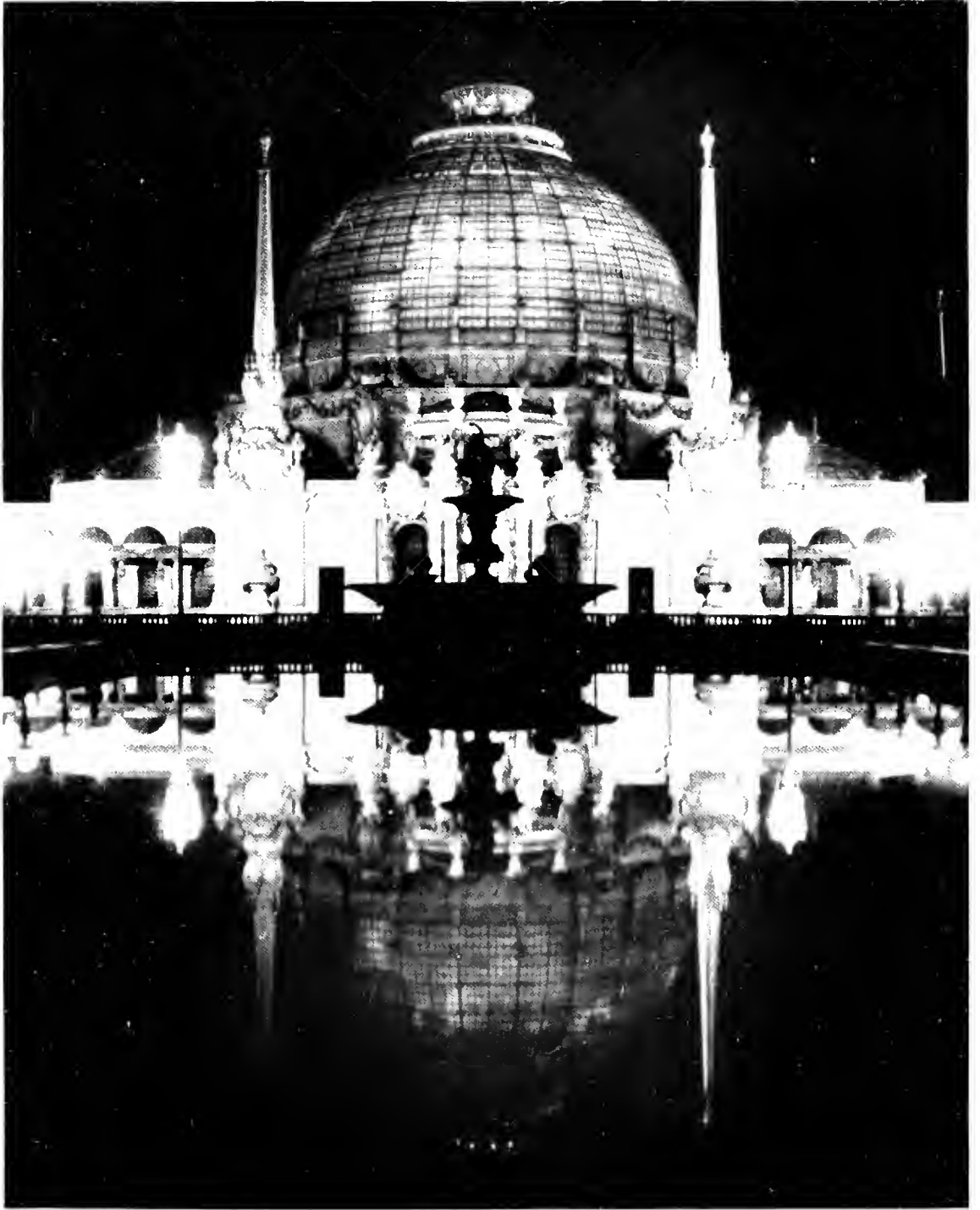
The accompanying illustrations suggest some idea of the illumination, but the addition of color is absolutely necessary to convey anything approaching a correct impression of the night pictures of the Exposition.



Reflection of the Italian Towers of the Court of Flowers in the East Lagoon of the South Garden



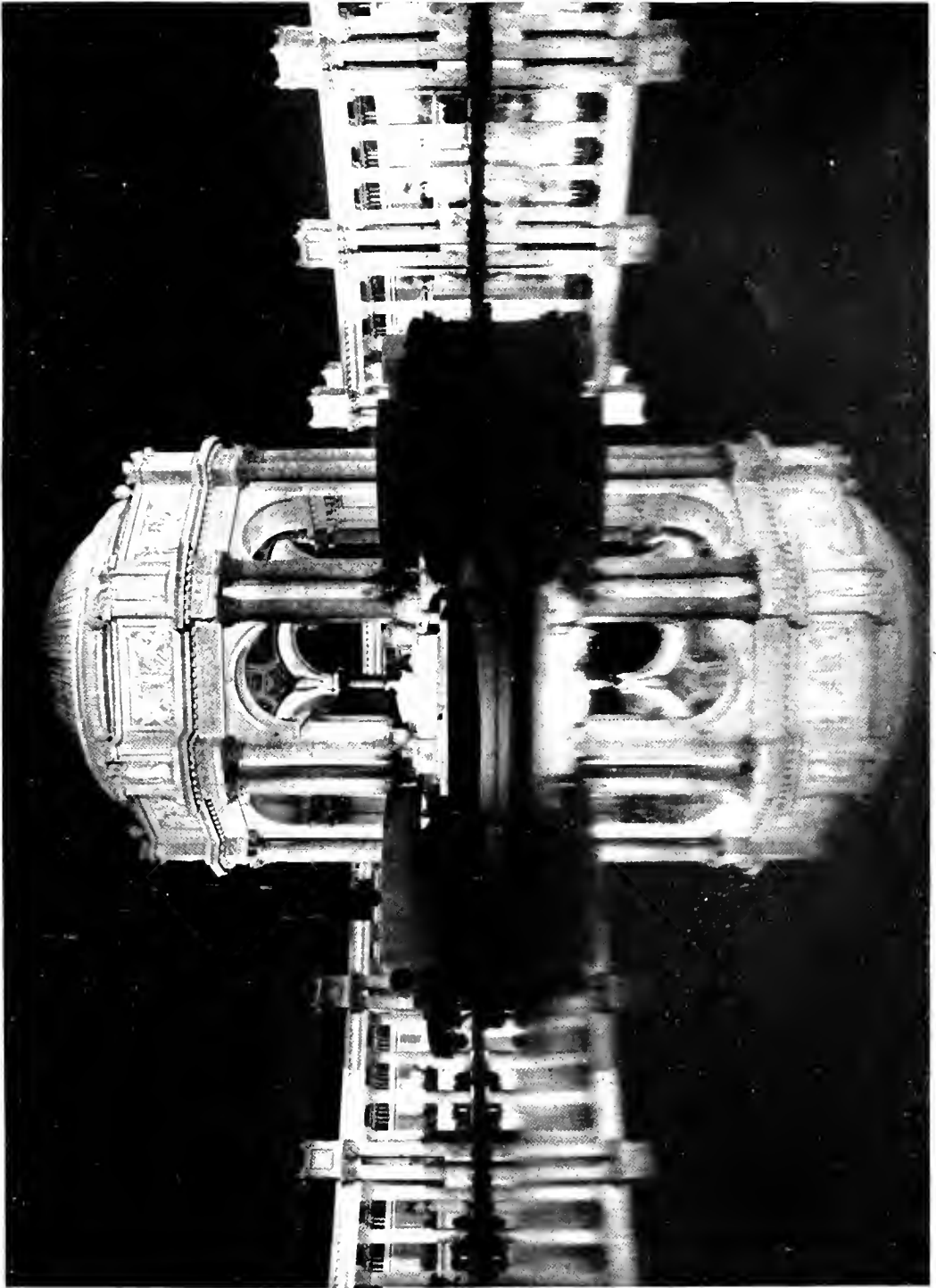
Reflection of the Tower of Jewels in the West Lagoon of the South Garden



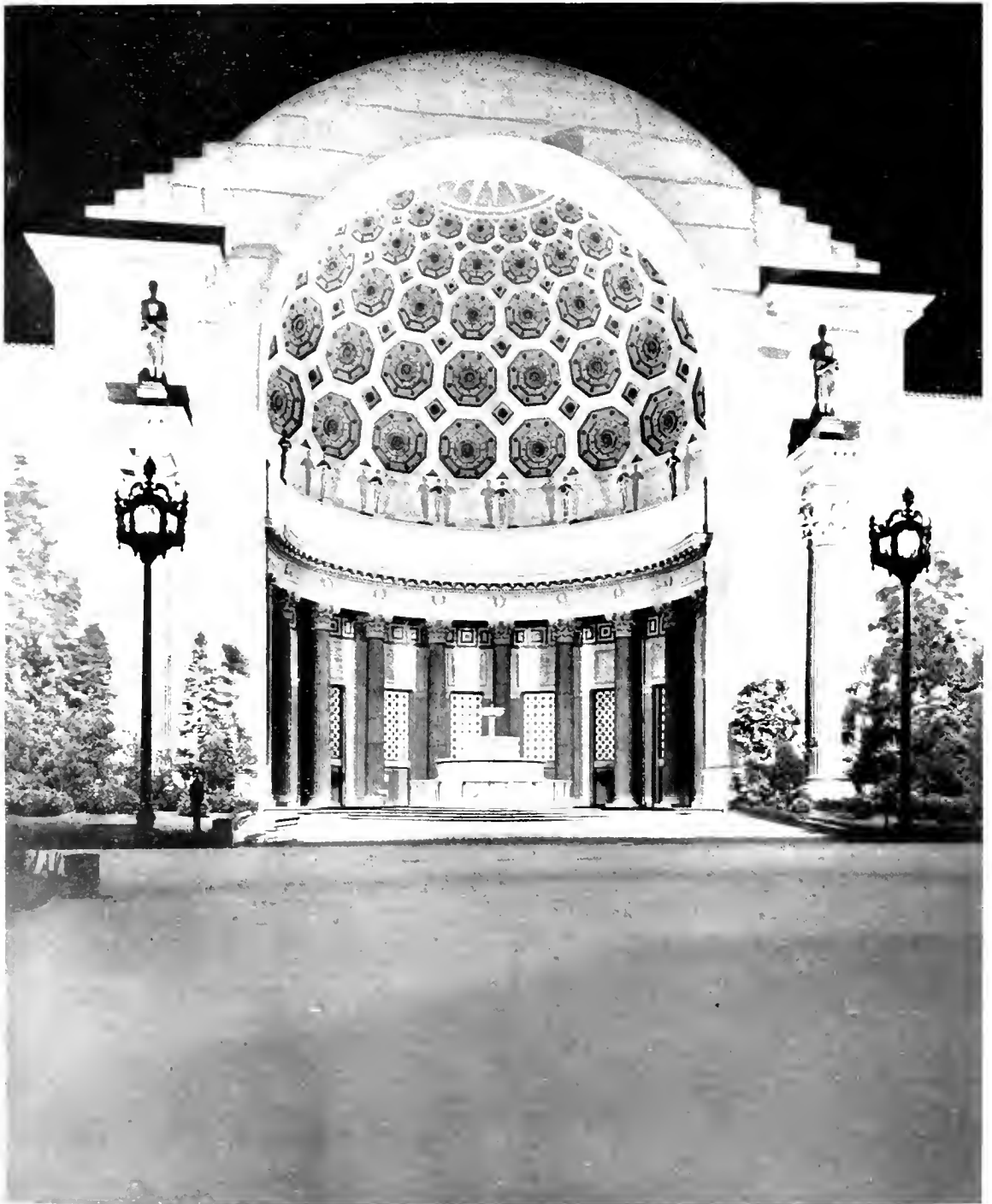
Palace of Horticulture as Reflected in the West Lagoon of the South Garden



The Court of the Four Seasons



Rotunda and Colonnade of the Palace of Fine Arts



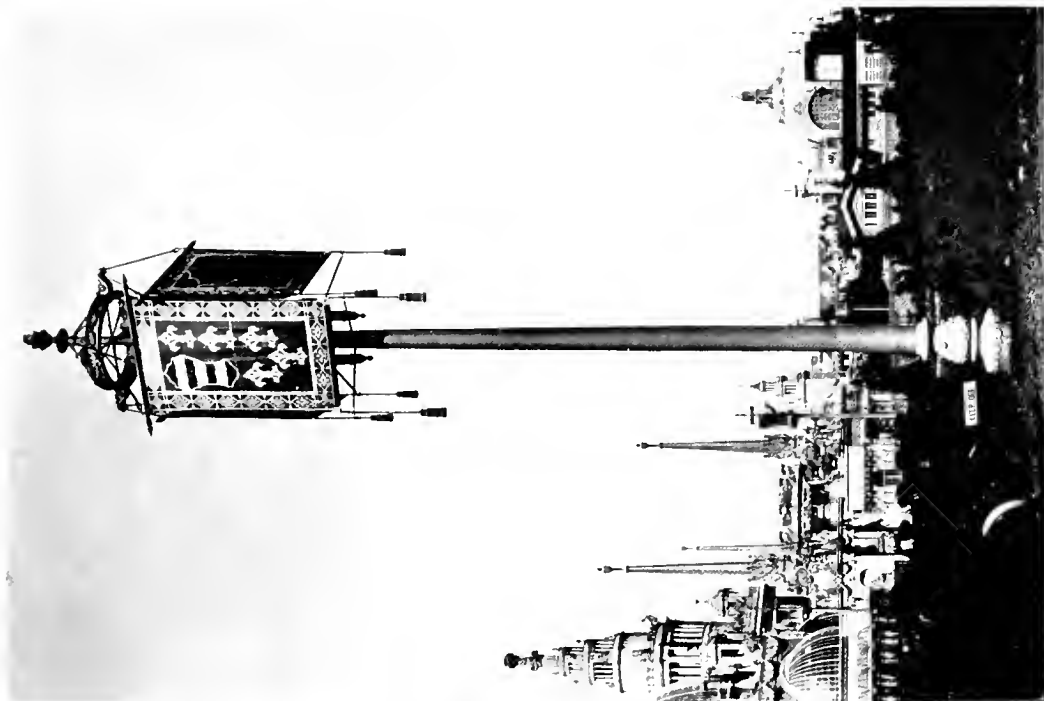
West Entrance to Food Products Palace showing 35 ft. 3-light Luminous Arc Cartouche Standards



Entrance to Varied Industries Building Lighted by 3-light Luminous Arc Cartouche Standards



Reflection of Festival Hall in the East Lagoon of the South Gardens



Banner Standard for G-E Ornamental Luminous Arc Lamps



G-E Ornamental Luminous Arc Lamp Standard. Lamps Equipped with Leaded Glass Shades



Fountain of Energy and 21-light Mazda Lamp Standard at the Entrance to the South Gardens



Decorative Mazda Standard and Lantern, Court of Flowers

* NOTES ON THE ACTIVITIES OF THE A.I.E.E.

Institute Meetings

The annual convention will be held at Deer Park, Md., from June 29th to July 2nd. The Panama-Pacific convention will take place in San Francisco on September 16th and 17th. At the Directors' Meeting recently in New York, upon the recommendation of the Meetings and Papers Committee, authority has been granted to hold an Institute Meeting at Philadelphia on October 11th under the auspices of the Philadelphia Section, and also a meeting at St. Louis under the auspices of the St. Louis Section. The exact date of the latter is to be announced later.

Specifications for Testing Porcelain Insulators

For a long time there has been a great demand for a set of specifications to cover the inspection and testing of high tension line insulators. Under the auspices of the Transmission Committee, a great many very interesting papers have been contributed in the past year or so on the general subject. The scope of these papers has included practically all the information available about the operation and manufacture of insulators, and the transmission committee have now added to this important work by preparing a set of specifications which can be used as a model or skeleton in the preparation of specifications covering the inspecting and testing of high tension insulators.

SCHENECTADY SECTION**Electric Supply in Large Cities**

On April 20th, Mr. Philip Torchio, Chief Electrical Engineer of the New York Edison Company, gave a very interesting talk on the subject of *Electric Supply in Large Cities*. A large number of carefully prepared lantern slides were used to illustrate the various points brought out.

Mr. Torchio pointed out that most large cities depend for electrical power on steam generation, and that modern practice is illustrated by a study of installations here and abroad. He then took up the question of the coal pile, and proceeded from this point to a complete analysis of the subject.

A number of slides were shown, illustrating the various methods of coal storage, coal conveying and ash handling. Mr. Torchio stated that large coal storages ensured a constant supply of coal, even when the regular

delivery from the mines is interrupted. He pointed out that coal handling apparatus was necessary to supply the boilers with fuel, and showed a number of lantern slides illustrating the various types of coal conveyors.

Several methods of ash handling were discussed, and it was stated that the removal of ashes by vacuum is accomplished successfully in England, and that the success of the system requires crushing of the clinkers in ashes entering the vacuum pipe. The Paris stations utilize the ashes with the addition of 10 per cent hydraulic cement for making bricks.

Some American and foreign practices were discussed and illustrated with regard to boilers, stokers, etc. Water tube boilers of different designs are generally prevalent, and stokers reduce the boiler room operating cost. Superheaters are used up to 300 deg. F., and economizers are generally used abroad and will probably come more into use in this country. Cinder catchers have been installed in New York to overcome objectionable conditions to neighbors.

The Évase stack system to create induced draft is very efficient and extensively used in German and French installations. The economic operation of a boiler room requires a carefully organized system of tests.

With regard to some of the accessories of a boiler, it was stated that steel valves and fittings for steam piping are considered essential for superheated steam. The pipe run should be as short as possible to reduce cost and heat loss.

Electrically driven pumps for boiler feed and condensers are generally used abroad where economizers are used for the heating of the boiler feed water. Exhausting the steam of auxiliaries into the low pressure element of the turbine has also given good results. Surface condensers for turbines are universally used.

The new Paris station is equipped with 10,000- and 15,000-kw. turbo-generators, each with a direct connected exciter, and a separate generator is used to supply the electrically driven auxiliaries. Air filters are used for generators abroad, while air washers are coming into use in this country. Acoustic frames in the air ducts are used in New York to eliminate noise from turbo-generators. Exciters are steam-driven, water-driven and turbine-driven, respectively, depending upon local conditions, but exciter bus batteries

*The Lynn and Pittsfield Sections have closed for the season.

are now generally considered essential for very large plants.

In this country, parallel operation prevails for the generators in a single station as well as that between those in several stations. Abroad, however, the tendency is to sectionalize. The two methods of operation call for different arrangement of busses and switch-board connections. Protective reactors are generally adopted in this country and are rapidly gaining favor abroad. A number of lantern slides illustrating various station arrangements, particularly those used by the New York Edison system, were shown.

As regards underground distribution, it was stated that lead covered cables cannot be safely used for high tension wiring without special precautions, and favored braided cables on insulators as an ideal layout.

The grounding of the neutral should be designed to confine the grounding current to the minimum necessary to obtain prevention of an arcing ground and prompt disconnection of the feeder when a ground develops. Transmission cables in ducts are more adapted to American conditions than armored cables in earth, and the operation of feeders to a substation is either in multiple or independent, the latter giving greater protection.

Characteristic direct current distributing systems include substations with rotary converters, stand-by batteries giving full substation output for about 10 minutes, regulation of feeder pressure by different sets of busses operated at different voltages, and pressure wires for each feeder from the junction box. Concentric cables are preferable for feeders, and neutral feeders and mains should be single conductor cables. A network of mains should be connected solid with provisions for sectionalizing, if ever necessary.

This gives maximum efficiency of regulation. An interesting fact is that the old Edison tubes installed many years ago are doing today just as full duty as the more modern cable layouts.

Alternating current distribution includes substations with main transformers, and distributing feeders with automatic regulators on each feeder. The practice of alternating current distribution abroad is the ring system; in America, the independent feeder circuit. Progress has been made, however, in tying together different feeders, either normally or automatically, in cases of emergency. Distributing transformers are placed in manholes, vaults or kiosks.

Character of service includes ordinary commercial business service supplied from low tension distributing and regulated systems, and the bulk business service supplied as untransformed current for the construction of public works, railways or railroads, pumping stations, etc. Some of the larger contracts being fulfilled by his Company were mentioned by way of illustration. Such developments forecast the passing of the small station and portend the day of the unified system of large central stations supplying all the needs of the community.

Mr. Torchio's paper was discussed by Messrs. W. L. R. Emmet, A. H. Kreusi, H. R. Summerhayes and others. Mr. Emmet, in particular, paid Mr. Torchio a high tribute, pointing out that Mr. Torchio had gained for himself a most creditable reputation. He said that he himself had been in the central station business from its beginning, and was, therefore, in a position to appreciate just how much Mr. Torchio had done, and how very valuable this work had been to the central station profession.

FROM THE CONSULTING ENGINEERING DEPARTMENT OF THE
GENERAL ELECTRIC COMPANY

COMPENSATORS FOR MAZDA C LAMPS

For constructive reasons and to obtain the advantage of a higher efficiency, the 0.5 watt per candle high current gas-filled lamp is desirable for street lighting purposes. Since the majority of the series systems are either 6.6 or 7.5 amperes, it has been necessary to

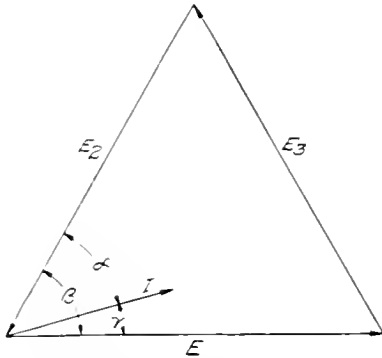


Fig. 1. Vector Relations showing Use of an Independent Phase for Power-Factor Determination

employ a compensator to transform the current to 15 or 20 amperes as the case may require. In addition to this, these compensators are designed to perform two other functions.

By selecting the proper flux density and arranging the primary and secondary coils in separate groups, the leakage flux increases rapidly as the line current tends to rise above normal; the result is that the power-factor falls off. Thus, for current excesses caused either by the short circuiting of a section of the series loop or by primary voltage surges, the compensator has the same effect as an added series reactance. This in turn protects the lamp against injurious excess currents, thus increasing the reliability of the system as a whole. For an increase of 50 per cent line current the lamp current increases approximately 23 per cent, while the reactance increases from 1.68 ohms normal to 3.97 ohms at 50 per cent line current.

The same compensator may be used for constant potential series operation where the proper number of lamps in series are connected directly across a constant potential supply. For this class of work the compensators must not only transform current, but must possess inherent regulating character-

istics by fulfilling the requirements of a variable reactance voltage and consequently maintaining practically constant impedance of the circuit. This is accomplished by designing the device for a definite open circuit flux density, that is, as the lamps burn out the open circuit voltage of the compensator decreases as the current wave becomes more and more distorted, due to the saturation in the magnetic circuit. The present type C compensators are designed to meet the requirements of either constant current or constant potential operation and will in either case protect the lamp against excess currents.

Determination of Power-Factor

The loaded compensator taking only a few hundred watts has a high power-factor, and since the variation of the cosine with the angle is not rapid when the power-factor is near unity an error of even two or three watts in reading the meter will introduce an appreciable error in the final result. For example at 6.6 amperes 50 volts 320 watts the calculated power-factor is 97 per cent, while if 323 watts were read a value about 1 per cent higher would be indicated.

If, however, a voltage having a phase relation of about 45 deg. to the current be used, small errors will not be magnified as in the above case, since here the cosine varies rapidly with change of angle. This method is simple and accurate, and has an additional advantage in that the potential coil currents are in an independent phase and can not possibly enter as disturbing elements in current reading.

Referring to Fig. 1 the method of applying the above may be more clearly seen. The lamp circuit is supplied with power from the phase indicated by E , but in order to determine α it is necessary to connect the potential coil across E_2 while the current coil is connected in series with that part of the circuit through which the current I passes. Measurements of E_2 , W_2 , and I are recorded.

$$W_2 = E_2 I \cos \alpha.$$

$$\cos \alpha = \frac{W_2}{E_2 I}$$

$$\beta = 60 \text{ deg. since } E_2 = E_3 = E.$$

$$\gamma = \beta - \alpha.$$

$$\gamma = 60 - \alpha.$$

$$\cos \gamma = \text{Power-factor of compensator.}$$

H. D. BROWN

GENERAL ELECTRIC REVIEW

A MONTHLY MAGAZINE FOR ENGINEERS

Manager, M. P. RICE

Editor, JOHN R. HEWETT

Associate Editor, B. M. EOFF
Assistant Editor, E. C. SANDERS

Subscription Rates: United States and Mexico, \$2.00 per year; Canada, \$2.25 per year; Foreign, \$2.50 per year; payable in advance. Remit by post-office or express (money orders, bank checks or drafts, made payable to the *General Electric Review*, Schenectady, N. Y.)

Entered as second-class matter, March 26, 1912, at the post-office at Schenectady, N. Y., under the Act of March, 1879.

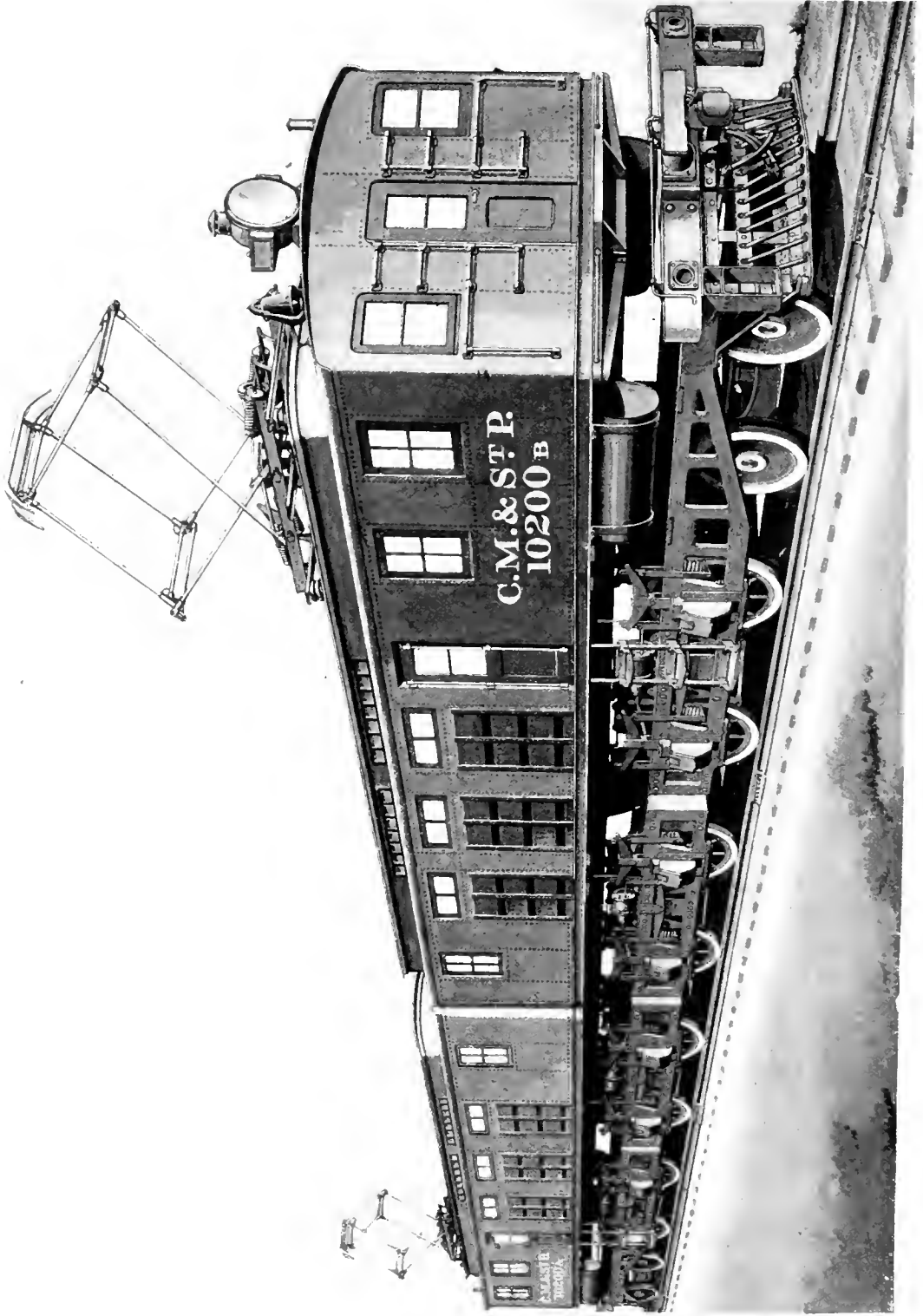
VOL. XVIII., No. 7

Copyright, 1915
by General Electric Company

JULY, 1915

CONTENTS

	PAGE
Frontispiece	598
Editorial: The Paths of Progress	599
The Chicago, Milwaukee & St. Paul Locomotives	600
BY A. H. ARMSTRONG	
The Jitney Problem	604
BY J. C. THIRLWALL	
The Periodic Law	614
BY DR. SAUL DUSHMAN	
Test for Dirt in an Air Supply	622
BY SANFORD A. MOSS	
X-Rays, Part III	625
BY DR. WHEELER P. DAVEY	
Ball Bearings in Electric Motors	631
BY FREDERICK H. POOR	
Electrophysics: Some Characteristics of Cathode Ray Tubes	636
BY J. P. MINTON	
High-Voltage Direct-Current Substation Machinery	641
BY E. S. JOHNSON	
The 1500-Volt Electrification of the Chicago, Milwaukee & St. Paul Railway	644
BY W. D. BEARCE	
Some Recent Developments in Switchboard Apparatus	646
BY E. H. BECKERT	
The Small Consumer--A Problem	657
BY A. D. DUDLEY	
Modern Street Lighting with Mazda Lamps	659
BY H. A. TINSON	
Practical Experience in the Operation of Electrical Machinery, Part IX	666
The Wrong Shunt Ratio; Repulsion Motor Heating; Variable-Speed Motor on an Inertia Load; Service Voltage too Low	
BY E. C. PARHAM	
From the Consulting Engineering Department of the General Electric Company	669
Question and Answer Section	670
In Memoriam--John P. Judge	672



Chicago, Milwaukee & St. Paul Locomotive, 260 tons, equipped with eight motors totalling 3440 h.p.

GENERAL ELECTRIC REVIEW

THE PATHS OF PROGRESS

We publish in this issue an article on the "Jitney Problem," and while this particular problem is of great interest at the immediate present, it is the general fundamental principle underlying this discussion that is of greatest importance.

The problem is being met in various ways in different localities, but roughly speaking, one of two ways is generally adopted. One is by attempting to meet this form of competition by competitive service; the other is by legislation.

Prior to the time when the people undertook the regulation and control of Public Utilities by the creation of Public Service Commissions under statute in the several States, competition was generally looked upon as being the only means of obtaining better service and lower charges. The unsoundness of this principle, however, as applied to Public Service Corporations, which are usually natural monopolies, led to the creation of Public Service Commissions and an attempt to secure the desired improvement in service under government direction.

Generally speaking Public Service Commissions have recognized that Public Service Corporations, like street railways, should have protection from competition, and their decisions in cases arising throughout the United States show a consistent effort to prevent the economic waste resulting from sporadic competition. Public Service Corporations today are operating under regulations which no longer leave them free to meet such competition as they could prior to the creation of the Public Service Commissions and they are operating under Government regulation upon a basis which can only be profitable if they are reasonably protected. When a street railway can be compelled to extend its lines into sparsely settled districts, it obviously should be protected in its revenues in more densely populated sections.

At the time Public Service Commissions first came into existence in 1907 it was contemplated that the only competition to be avoided was that of other similarly operated companies—the steam railroad should be protected from a new parallel steam railroad serving the same territory—a street railway

should be protected from another street railway operating through the same streets or in the same general territory. While the legislatures have generally been inactive concerning the jitney problem the general trend is to extend the power of the Public Service Commissions either to place such competitors as the jitney buses under the same regulations and restrictions as are now imposed upon their competitors or to eliminate entirely such competition in accordance with the more modern policy of the States. If jitney buses are to enter the field of public service they should be required to give the same class of service as their competitors, and to accept the same responsibility as regards accidents, proper equipment, hours of service, area of service, etc.

The theory upon which Public Service Commission Laws are based is that a commission of men familiar with Public Service questions and with the conditions under which Public Service Corporations operate is in the best position to determine whether it is for public welfare to have competition or a regulated monopoly in each instance. With this in view commissions are empowered to subpoena witnesses, hold hearings, and to determine upon all the available evidence whether the public convenience and necessity requires any change or extension in a particular service, and if so, whether it can be best obtained from the Public Service Companies already in the field, or whether a new interest should be admitted to serve the public. Before a new corporation or individual can come into the field and before an existing one can materially extend its activities, a favorable decision by the commission is required with an order that it is to the public convenience and necessity to permit the new company to operate as it desires. This would seem the logical solution of the "Jitney Problem" from the standpoint of legislation.

The popularity of the jitney buses in many localities may be a passing craze or it may indicate a desire on the part of the public for a quicker service at short intervals. Some railway companies may find it desirable to meet this requirement by a lighter type of equipment operated under shorter headways.

THE CHICAGO, MILWAUKEE & ST. PAUL LOCOMOTIVES

By A. H. ARMSTRONG

ASSISTANT ENGINEER, RAILWAY AND TRACTION DEPARTMENT, GENERAL ELECTRIC COMPANY

The author gives a great deal of valuable data on these most interesting locomotives. Among the points which will attract special attention are the regenerative control, the large continuous capacity of the motors, and the novel form of current collectors. The comparison given between these locomotives and the Mallet engine emphasizes the size and hauling capacity of the electric locomotives. This article appeared in the *Electric Railway Journal* of June 5, 1915.—EDITOR.

The flexibility in design and operation of the electric locomotive afforded by the use of electric motors renders this type of motive power especially well suited to the hauling of trains, either high speed passenger or slow speed freight. In fact the electric locomotive possesses inherent qualifications for haulage service that are becoming more fully appreciated as constituting the fundamental reasons for bringing about the change from steam to electricity, and interest in any new projected electrification therefore largely centers in the characteristics of the locomotives proposed. Work has progressed upon the Chicago, Milwaukee & St. Paul locomotives at the Schenectady and Erie Works of the General Electric Company to such an extent as to make available certain facts as to the construction and capacity that are of especial interest owing to the magnitude of the problems involved in this extensive electrification.

The general data applying to the St. Paul freight locomotives are as follows:

Type of locomotive.....	3000 volts direct current
Length over all.....	112 ft.
Total wheel base.....	103 ft.
Rigid wheel base.....	10 ft. 6 in.
Total weight.....	520,000 lb.
Weight on drivers.....	400,000 lb.
Weight on driving axle.....	50,000 lb.
Weight on guiding axle.....	30,000 lb.
Diameter of driving wheel.....	52 in.
Diameter of guiding wheel.....	36 in.
Number of driving motors.....	8
Total output (continuous rating).....	3000 h.p.
Total output (1 hour rating).....	3430 h.p.
Tractive effort (continuous rating).....	71,000 lb.
Per cent of weight on drivers.....	17.75
Speed at this tractive effort at 3000 volts.....	15.75 m.p.h.
Tractive effort (1 hour rating).....	85,000 lb.
Per cent of weight upon drivers.....	21.2
Speed at this tractive effort at 3000 volts.....	15.25 m.p.h.

A very exhaustive series of tests have just been completed upon the first sample motor built at Schenectady which have demonstrated that it has ample capacity to meet the

heavy demands that will be placed upon it under service operating conditions. The motors are wound for 1500 volts and connected two in series for 3000 volts. The power axles are driven by twin gears, in this respect being similar to the drive on the Great Northern, Detroit Tunnel, Baltimore & Ohio and Butte, Anaconda & Pacific, except that springs are used in the axle gears. On account of the high voltage for which the motors are wound, the commutator width is small, thus allowing more space for armature iron and copper, with the result that the motor has a continuous capacity of 375 h.p. In fact special interest attaches to the large continuous capacity of the St. Paul locomotive as this is the first instance where such a liberal motor capacity has been required and provided for, and it should be noted that this large capacity is secured in an axle motor without departing from well known and thoroughly tried out forms of construction.

A study of the train dispatcher's sheet covering performance on mountain grade divisions of our steam railways discloses the fact that it is general practice to assign such a trailing tonnage to a locomotive on ruling grade as to demand a tractive effort at the driver rims equivalent to approximately 18 to 19 per cent of the weight upon the drivers. In other words, steam practice calls for a locomotive which can operate for long periods at a coefficient of adhesion of 18 to 19 per cent, leaving the difference between this value and the slipping point of the drivers as a sufficient margin with which to start on ruling gradients. Under like track conditions, the uniform torque of the electric motor should make available some 10 per cent more tractive effort than is possible with the reciprocating drive of the steam locomotive having the same weight upon the drivers. Until sufficient operating experience is available, however, to prove that an electric locomotive can be rated at 20 per cent coefficient of adhesion, it seems reasonable to

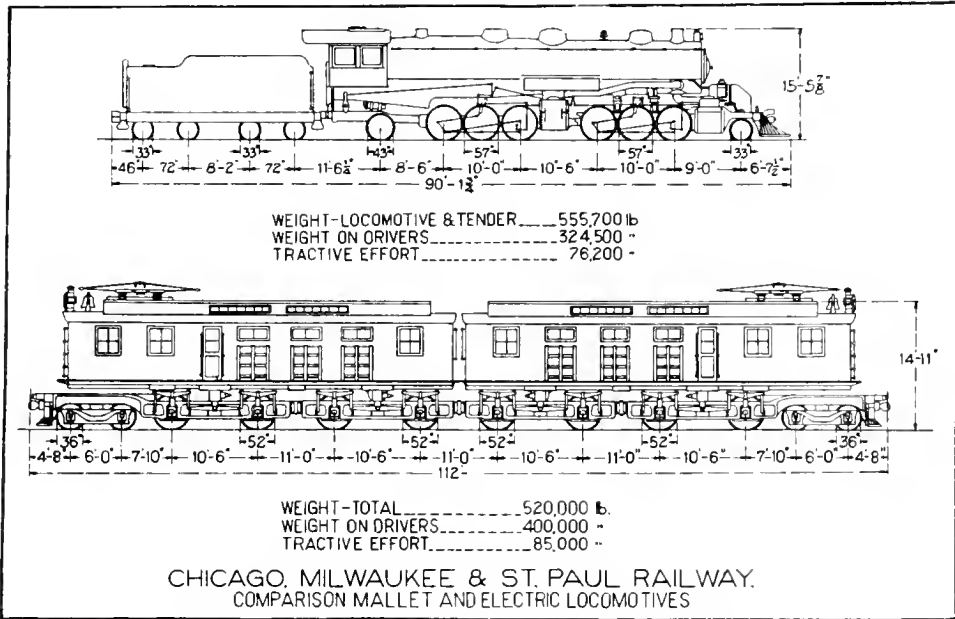


Fig. 1. Diagram of the Mallet Locomotive which has been used on the C. M. & St. P. Ry., and of the electric locomotive which is replacing the Mallet type on that road



Fig. 2. C. M. & St. P. 3000-volt Direct-current Locomotive, total weight, 260 tons eight motors, total capacity 3440 H.P.

adhere to the present steam practice of a somewhat lower value. The St. Paul locomotive, therefore, with its continuous motor capacity of 17.75 per cent and a one hour rating of 21.2 per cent of weight on drivers

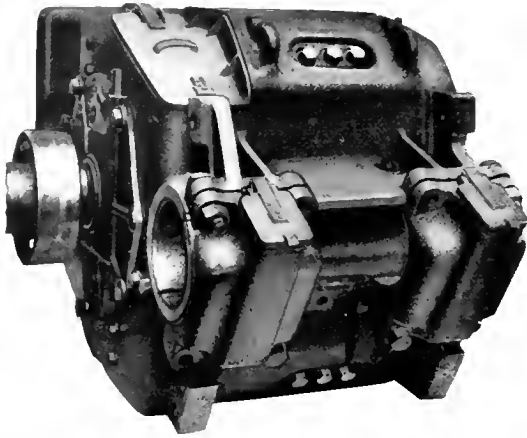


Fig. 3. One of the eight direct-current motors used on a C. M. & St. P. locomotive

gives ample assurance of ability to handle its assigned tonnage under all service conditions.

The St. Paul freight locomotive is guaranteed to have a hauling capacity of 2500 tons trailing load on all gradients up to 1 per cent, and its heaviest duty will be to haul this load from Lombard to Summit over the Belt Mountains, a distance of 49 miles with a ruling grade of 1 per cent and an average grade of 0.7 per cent over the entire distance. Including the locomotive of 260 tons, the gross train weight of 2760 tons will require a tractive effort of approximately 72,000 lb. on the 1 per cent ruling grade, based upon a train resistance of 6 lb. per ton. This practically corresponds to the continuous rating of the locomotive as tabulated herein and brings out the interesting fact that these locomotives are so proportioned as to motor capacity that they cannot be abused under normal service operation.

The necessity of rating main line electric locomotives upon a practically continuous basis is still further emphasized in the case of the St. Paul locomotives by the introduction of electric regenerative braking. The heavy demands upon the motors when operating up grade may be nearly duplicated during the following down grade running when regenerating, thus giving small chance for the time element of the motor heating to

enter as a factor in proportioning its capacity for such exacting service. A 2 per cent grade requires a motor output of 46 lb. per ton up grade and gives 34 lb. per ton motor input down grade. Making due allowance for internal locomotive losses, it is evident that the motor output when operating as a generator down grade will approximate 60 per cent of its input when hauling the same train up a 2 per cent gradient, hence, the need of making provision for a practically continuous motor capacity in the St. Paul locomotives in order to meet the service requirements of the broken profile over which they are designed to operate.

It is interesting to compare the relative capacity of the new electric locomotives and the Mallet engines they will replace.

COMPARISON MALLET AND ELECTRIC LOCOMOTIVES

	Mallet	Electric
Total weight.....	555,700 lb.	520,000 lb.
Weight on drivers.....	324,500 lb.	400,000 lb.
Rated tractive effort.....	76,200 lb.	85,000 lb.
Per cent of weight on drivers.....	23.5%	21.2%
Rated tonnage 1 per cent grade.....	1,800 tons	2,500 tons
Tractive effort for above tonnage.....	54,000 lb.	71,700 lb.
Coefficient of adhesion...	16.7%	17.7%
Wheels per guiding truck	2	4
Weight per driving axle...	54,000 lb.	50,000 lb.
Total weight on one rigid wheel base truck.....	162,000 lb.	100,000 lb.

Under favorable conditions the Mallet engine can haul 2000 tons on 1 per cent grade, thus bringing its tractive effort up to 59,000 lb. and the coefficient of adhesion on its drivers up to 18.3 per cent. The electric locomotive weighs 94 per cent of the combined weight of Mallet engine and tender and has a tonnage rating 23½ per cent greater based upon using the same coefficient of adhesion in each case, that is 17.9 per cent. This comparison indicates that the electric locomotive has a hauling capacity one-third greater than the steam engine and tender of the same total weight, has less weight per axle, is provided with four-wheel guiding truck in place of two-wheel, requires no turn table, as it operates equally well in either direction, and finally, eliminates the necessity for stopping to take on coal and water.

The same type of locomotive is used for both freight and passenger service, the only difference between the two being the gear ratio, which is 4.56 for freight and 2.45 for passenger service. This interchangeability of all parts of the freight and passenger locomotive and the adoption of one uniform type for all classes of service should be reflected later in the low cost of maintenance of the locomotive as well as prove of great benefit in the economical handling of the traffic. For facility in shop repairs, the locomotive is constructed in halves, and in fact each half can be provided with draft gear in place of the articulated joint and operated singly in service up to its capacity. One passenger locomotive will haul a trailing load of 800 tons over all gradients of the road without assistance except upon the 2 per cent grade section over the main divide of the Rocky Mountains. Even on this grade a 600-ton train can be hauled without assistance. This illustrates the exacting nature of mountain railroading which demands in this instance that the passenger locomotives shall have the necessary motor capacity and smooth running qualities to successfully haul an 800-ton train at 60 miles per hour on level track and also operate over 20 miles of 2 per cent up grade. Add to this the regenerative braking feature and steam heaters for train heating, and the broad nature of the problem of designing an electric locomotive for main line mountain service becomes very apparent. The locomotive superstructure contains space for two oil fired steam heaters together with ample provision for storage of oil and water. All passenger locomotives and a certain number of freight locomotives intended as reserve passenger units will be equipped with heater boilers.

A departure from the roller current collector of the Butte locomotive has been made in the St. Paul locomotives as the result of numerous experiments made upon the test tracks at Schenectady and Erie. These tests indicate that a double pan collector bearing against twin conductor trolley wires is capable of taking off a current of 2000 amperes at speeds as high as 60 miles per hour. This is several times the demand upon one collector of the St. Paul locomotives and the double pan was adopted in place of the roller collector although the latter has been giving excellent results, reaching a life of nearly 30,000 miles in the passenger service of the Butte, Anaconda & Pacific Railway.

Provision has been made in the control to enable two locomotives to be run together in multiple unit, but the enormous starting effort of two such locomotives, 240,000 lb. tractive effort at 30 per cent coefficient of

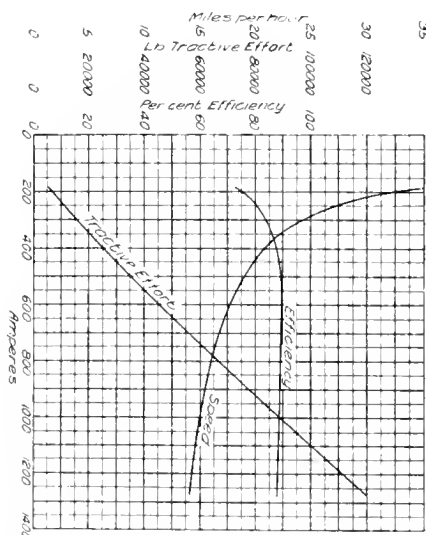


Fig. 4. Characteristic curves of a C. M. & St. P. freight locomotive. Direct current, 3000 volts; Gear ratio 4.56; Diameter drivers 52 inches

adhesion, makes such a combination of use only when it acts as a pusher on the rear of a train. The motors and starting resistances are designed to permit of a starting effort of 120,000 lb. being maintained on one locomotive for a period of five minutes without destructive heating and in this connection the thermal capacity of the heavy slow speed motors will be of great assistance.

The first completed St. Paul locomotive will probably be placed upon the test tracks at Erie during September and shipment of these locomotives commenced soon thereafter. The construction work upon trolley and substations of the first engine division between Three Forks and Deer Lodge has been so far completed as to give promise of being finished and ready for the trial runs of the locomotives as soon as they are received this fall. Ample provision has been made for power and transmission line facilities by the Montana Power Company, so that electrical operation of the Chicago, Milwaukee & St. Paul Railway should soon be an accomplished fact.

THE JITNEY PROBLEM

By J. C. THIRLWALL

RAILWAY AND TRACTION ENGINEERING DEPARTMENT, GENERAL ELECTRIC COMPANY

In the first part of this article the author analyzes the jitney problem insofar as it affects the street railway companies, and considers ways and means of meeting this competition. The second portion is devoted to a study of the economies that are made possible by the use of lighter cars. The results of a comprehensive investigation of these economies are given in four tables.—EDITOR.

PART I: THE STATUS OF THE JITNEY, APRIL, 1915

A trip was made by the writer during March and April last, which included visits to a large number of the leading cities and electric railways in Texas, Louisiana, Alabama, Tennessee, Arkansas, Kentucky and Ohio. More than twenty roads were visited and the question of jitney competition discussed with the chief operating officials of each, and the following paragraphs give a consensus of their opinions on the main points of discussion.*

1st. The jitney car or bus is making serious inroads into the revenues of the railway companies operating in eight out of the 19 cities visited. In two places, city ordinances regulating all common carriers had prevented their advent. In some other cities, excessive grades and poor pavements prevent any extensive use of automobiles, and in others the local officials attributed their freedom from competition to the frequency of their schedules and the high character of their service or to other purely local causes.

2d. Various methods of meeting the jitney competition have been adopted; operators in general are endeavoring to secure proper regulation either through the state legislatures or city councils; some had cut down their schedules and expenses; others had increased their service. The latter method appeared to be most effective in meeting jitney competition.

3d. Without regulation by state or city, the number of jitneys in service in a city appears to pass through a period of very rapid growth, followed by a decrease. This is due to several reasons. As a novelty, when the first machines appear, the riding in them is very heavy and they carry good loads all day long. There is a good profit in the business at this stage which attracts so many

drivers that their average daily receipts drop very sharply, even though the total number of people riding in them is large enough to seriously curtail the railroad's revenues. Moreover, as the novelty of the new form of transportation wears off, as accidents increase, and as people find that they are being crowded as much or more in the jitneys as in the street cars, many passengers return to the railway. Further, the maintenance on the average small automobile, within two or three months of running 150 to 200 miles a day, becomes excessive. All these reasons combine to cause a large number of drivers to drop out, and their number usually exceeds that of fresh recruits.

But as the total number of machines decreases, the average daily earnings of those remaining tend to again increase until a point is reached where the driver can ordinarily make a profit over his costs for fuel and repairs which is sufficient to support himself and in some instances to cover the depreciation on his car.

4th. Without city or state regulation, the number of machines tends to become nearly stationary at this stage, or to decrease very slowly.

5th. The total earnings of the jitneys are considerably in excess of what the railways lose to them. They carry in pleasant weather many pleasure riders and, due to the frequency of their service, many people who would walk short distances rather than wait for a street car. The number of such riders is considerable. Moreover, they frequently charge more than five cents, particularly when operating late at night, or when asked to deliver passengers at some point off their regular routes.

6th. The larger busses, seating from 10 to 30 people, have made little headway, as yet, compared to the small five- or seven-passenger car.

*This, of course, represents conditions existent early in the spring of 1915, and many changes may have occurred before this article is published.

7th. It appears certain that even with strict regulation some autos will remain in the business, but probably at a rate of fare amounting to more than five cents, and probably only in the higher class residential sections.

8th. If regulation, particularly as to furnish bonds to guarantee settlement of accident claims, is enforced, all but a small proportion of the jitneys will disappear.

9th. The difficulty of depending upon regulation to meet this competition lies in a fairly general public sentiment against putting the individual under the same restrictions as a corporation. In many places where regulation has been proposed after the advent of the jitney, a strong protest has developed against it, on the part of many newspapers and a considerable part of the public, and in at least two cities an attempt has been made to submit the matter to a referendum vote. These factors have in general prevented the adoption or enforcement of any real regulatory measures.

10th. There are three other means of meeting the situation, until regulation can be obtained.

(a) To decrease service and cut down operating costs. This, it is realized, will simply give the jitneys a better chance, but would be adopted to bring most forcibly to the attention of the city authorities the need of protecting the railway company's interest.

(b) To put on a larger number of jitney cars or busses, to run in competition with the privately owned jitneys, and to either force the others out by giving lower fares, or, to compel regulation by the character of the competition. It is realized that this would be simply an emergency measure, that the operation of these cars would be at a loss, and that their success in driving other jitneys from business would terminate in a heavy loss on the machines which would then become useless to the operators.

(c) To increase the service on lines subject to jitney competition, and to cut down headways, with the idea of taking back sufficient passengers from the jitneys so that the narrow margin of profit to their drivers now existing would be entirely wiped out, or where they are operating at cost or less, that they would the quicker realize the hopelessness of continuing in the business.

11th. There was a wide diversity of opinion as to the merits of these schemes, but the big majority of operators declare the first scheme suicidal, in that it enables the jitneys

to make a very much greater revenue, and increases still further the complaints of dissatisfied patrons.

The second scheme was also generally considered a dangerous experiment, and likely to lead to trouble with the public besides being extremely expensive and probably not very effective.

The third scheme was almost unanimously agreed to as being the logical move, but the opinions were almost equally unanimous that it would involve too great expense, both in the purchase of new cars, and in the costs of operation, especially platform wages. It was further thought by most officials that, if adopted as a means to eliminate competition, they would be compelled to maintain such service after the competition passed, thus permanently increasing expenses.

12th. It was, however, agreed that if such a measure were to be adopted, a different type of equipment from what has been purchased by most roads during the past few years would be a necessity, and that power and maintenance cost would have to be radically cut if platform wages should be appreciably increased.

13th. This led to the question of one-man cars. Nearly every operator asserted that there were certain lines in every city where one man operation would be feasible, and that on nearly all lines such operation would be entirely practicable during many hours of the day. On the other hand, nearly every road is compelled, either by the terms of its charter or by state or city laws, to have two men on each car. However, the use of prepayment cars and the education of the public in nearly every city to this system has automatically relieved the conductor of most of his duties, and it is believed that very little delay would result from the motorman collecting fares and issuing transfers. In Lexington, Ky., the rear doors have already been closed off, the conductors are located at the front platform, and no trouble has been occasioned thereby.

But nearly everyone believed that before the change to one-man operation could be made, a long period of discussion and of agitation with city councils and state legislatures would be necessary.

14th. Almost every operator stated that if two men per car are to be used, the cost of operation will increase even with extremely light weight cars, if headways are materially shortened, and there is a very general feeling that this increase would not be made up by increased receipts. A number of operators,

however, do not agree with this, saying that headways of 10 to 15 minutes apart lose a very large proportion of short riders.

15th. Assuming the use of smaller, light weight cars, however, as a future standard, nearly all were agreed on the following: such cars would have to be of a comfortable easy riding type, which means cross seats, and prohibits the use of the short wheel base rigid single truck. The latter point was also emphasized by the general impression that cars on such trucks could not be successfully operated in trains.

PART II: OPERATING ECONOMIES MADE POSSIBLE BY THE USE OF LIGHT CARS

The invasion of the street railway field by the jitney automobile busses, during the past six months, brought to the attention of the railway manager more urgently than ever before the vital necessity for reducing his operating expenses. In the case of many roads, indeed, it has become a question of one of three things; a radical decrease in operating costs, an increase in fares, or a receivership. To increase fares, except by some such means as the Milwaukee zone system, is an absolute impossibility for the average city system, under the present feeling of the public and legislatures. Indeed, it is becoming more and more difficult to prevent radical cuts in the rate of fare, either through being compelled to sell tickets at three or four cents, or by compulsory extension of lines or of transfer privileges.

The foregoing analysis of the jitney situation indicates that the majority of operators do not feel very confident that their interests will be adequately protected by legislation against unfair competition; before tremendous losses have been incurred. There is also a fairly general agreement that what success has attended the operation of jitneys is because they are a novelty and because they meet a popular demand for quicker and more frequent service. Most operators will further agree that the railways are not securing all of the traffic possible, and that a considerable increase in receipts could be secured by providing shorter headways and faster schedules, but that they are forced to compromise between the service which the public demands (and which they cannot afford to supply under existing conditions), and what they could most economically furnish, but which the public will not tolerate.

The use of radial trucks with relatively long wheel base was favored by a few; most operators questioned their use on short radii curves.

Low wheels, preferably 24 in., were favored by nearly all.

Center entrance cars were not thought desirable by most operators.

The use of multiple unit control, if cars of a seating capacity of about 30 were used, was considered a necessity by nearly all operators, in the larger cities, to care for rush hour conditions, both as a measure of platform economy and to relieve downtown congestion.

Under these conditions, it logically follows that on most roads, if it were possible to operate faster schedules and to greatly reduce headways without a material increase in the operating expenses, it would be hailed with equal joy by the operators and the public. It cannot be done by the automobile; there is no question of doubt, in spite of the claims of individuals, that with the typical small machine the platform costs per passenger handled and the costs of power are so much higher than on railway cars that they cannot compete on even terms. With the larger busses there appears to be a greater difference of opinion. But even with these, all experience in this country has shown that they cannot be made to pay against a properly managed electric railway; and when brought down to the simplest terms it is again the well known story of the wastefulness of small scattered power plants as compared with the large central station. An individual may operate his own automobile for short distances on city streets and, by working from 12 to 15 hours per day and making his own repairs and replacements, make a bare living from his machine after paying for fuel, tires and depreciation. A company attempting to operate such machines, however, could not secure his services for anywhere near the amount he is content to work for while he is operating independently. These facts are so self-evident that with very few exceptions operators have dismissed the idea of employing the gasoline car.

To put into service a greater number of electric cars of the present standard type, as a temporary measure, in order to meet jitney competition by cutting down the average daily receipts of each private car and thus hasten

the inevitable conclusion of its driver that he cannot make a living in the service, would probably be effective in ending competition. But most operators fear that this would result in ordinances compelling them to maintain such service after the passing of the auto, and that the increased cost of the additional service would not be offset by correspondingly increased revenues, since platform wages, power, and maintenance charges would all advance, and at the same time the first cost of such cars would considerably increase the capital account.

The question then arises; Can the car building companies and the manufacturers of electric car equipment design and furnish cars of a type acceptable to the public, but which will combine the qualities of light weight and strength to such a degree that the savings in power and in maintenance secured by their operation would offset the additional platform expense where more of these are used? The advance in car body and truck design, and the introduction during the past year of the low-wheel motor makes it possible to answer "yes" to this inquiry.

The Third Avenue Railway Company in New York was one of the first companies, so far as the writer recalls, to utilize this feature, and in their cars the weight per seated passenger was cut to approximately 650 lb. as compared with weights of 800 to 900 lb. in the typical double-truck cars purchased by most urban systems during the past two or three years. The seating capacity of their cars is 42; for many medium sized cities, a smaller number of seats would be ample during all hours of the day, except for one or two trips in the rush hours.

Approximately the same weight per passenger was secured in the latest cars put into service in New Orleans, which seat 52 and weigh less than 35,000 lb. This latter car, if mounted on 24-in. wheels, using smaller motors, and taking advantage of other improvements which have lately been developed, could be brought down to about 30,000 lb.

A still further advance has been suggested by a well known car designer, who has laid out a single-end, one-man truckless car, which seating 29 would weigh but 9000 lb. and a double-end car seating 32 and weighing about 12,000 lb.

Four of the former cars would provide as many seats as five of the usual city type, and with a 30 per cent reduction in weight. Three of the second type could replace two of the standard size and weigh 50 per cent less.

Either one offers considerable economies, both in first cost and in power and maintenance. The reduction in power consumption, especially in the peak load during rush hours, would be a measure of immense economy. The reduced wear and tear on tracks, roadbed, and special work would be even more marked. Reduced current means less wear on trolley wires. Reduction in brakeshoe and wheel wear is of course obvious.

The importance of weight reduction is so well known that a figure of five cents per lb. per year is commonly accepted as the saving which can be secured in city service by any cutting of weights on the cars. If this is true, the substitution of 12,000-lb. cars for cars weighing 36,000 or 40,000 lb., even when more of the smaller ones are operated during rush hours, would save the operator from \$1100 to \$1700 per car annually. On the other side of the ledger is only the increased expense of platform operation for four or five hours daily, which would not amount to more than \$300 or \$400 per car annually.

There are, of course, other objections; first, many operators say that the public will not stand for the return to single-truck cars, with their bumping and swaying. To this the car designer replies that, by the use of a radial truck, wheel bases can be lengthened to a point where the riding qualities of the single-truck approximate those of the double-truck. He will also refer to the English coaches, with the pedestals and journal boxes mounted beneath long elliptic springs, giving a cushion effect equal to that of the automobile. Cross seats can of course be as easily provided as in any larger car. With these improvements, the objection of discomfort to passengers is removed.

The objection is also made that additional units on the street during the evening rush hours mean excessive congestion, slow movement and more accidents. In many cities this would be a severe handicap. Where rush hour headways are four, five or six minutes, and only single cars used, it would not be burdensome. Where they are less, and particularly where two-car trains are already required, it would involve the use of multiple unit control, and the operation of three- or four-car trains, to prevent an excessive number of units upon the street. In smaller cities, two-car trains, using platform control and jumpers, would not involve excessive complications, and might provide an increased seating capacity without shortening of headways.

But where rush hour congestion is really severe, and train operation not desired, a car of large seating capacity is essential. The 52-passenger car mentioned previously, run singly, will give a distinct saving during the periods of maximum travel, both in power and in platform wage, over ordinary equipments, and a reduction in platform cost over the small car which will offset its greater power cost unless power rates are unusually high.

i.e. to determine which will leave the net revenues in the best condition, based on all costs of operation under typical conditions, becomes in order.

In the tabulated data herewith appended a comparison is made between the assumed costs and revenues on two lines, one in Texas, and one in Alabama. In both cities, the performance of the standard type of equipment is contrasted with that of the

TABLE 1
LARGE RAILWAY, LIGHT & POWER COMPANY IN ALABAMA

Typical Line—Distance 8.78 miles round trip.

A—Present cars—56,000 lb., seat 48; pull trailers 33,000 lb., seating 60.
B—Suggested cars—30,000 lb., seat 52.
C—Suggested cars—12,000 lb., seat 32.

	A	B	C
Headway 14 hours	9 mins.	9 mins.	9 mins.
Headway 4 hours	6 mins.	6 mins.	6 mins.
Running time 14 hours	54 mins.	54 mins.	54 mins.
Running time 4 hours	60 mins.	60 mins.	60 mins.
Cars required 14 hours	6	6	6
Cars required 4 hours	10-2-car	10-2-car	10-3-car
Seats per hour 14 hours	320	347	214
Seats per hour 4 hours	1080	1040	960
Car miles per day	1520	1520	1870
Operating Costs per Day			
Platform wages	\$72.00	\$72.00	\$82.00
Maintenance and depreciation	53.00	45.60	46.75
Power	33.75	20.90	11.60
Other transportation and general	74.50	74.50	74.50
	\$233.55	\$213.00	\$214.85
Transportation revenue	350.00	350.00	350.00
Net	116.45	137.00	135.15
Cost of cars	\$30,000.00	\$100,000.00	\$78,000.00
Annual saving		7,500.00	6,825.00
Increase would pay on this		7.5 per cent	8.7 per cent

Above figures are based on present operating costs and revenues with power and maintenance reductions as indicated in "Discussion of Data" sheet.

One-man car operation, also, would have a much better chance of success in the smaller towns and cities than in larger places, and the smaller the car the easier it would be to use but one man.

All these things mean that local causes would govern the selection of the particular size of car that would have to be purchased, and that some operators would prefer the large capacity car and others the small car, regardless of their theoretical efficiency or relative cost of operation. A comparison, however, made from a purely economical viewpoint,

suggested light weight cars. In the first, a small number of cars purchased in the past three years are somewhat lighter in weight than the ones used in the present calculations, but the latter represents the greater part of the existing equipment. In both places, the majority of all cars are of the size and weight shown.

On the Texas road, power costs are fairly normal and rush hour congestion is not so excessive as to require the use of trains, nor of trailers during rush hours. Medium sized cars of fairly light weight have handled traffic

satisfactorily. The greatest handicap here has been a very high number of stops per mile, combined with slippery rail conditions during a great part of the year, which has resulted in extremely slow schedules on many lines. The frequency of stops in spite of slow speed has meant unusually high power costs. The other city has large factory crowds to handle, and has extreme congestion of traffic during the rush hours, necessitating

paring what these are now with the two other types of cars, the assumption in each case being that an equal number of cars are run during the lighter hours of the day when the average load is usually less than 30 in all cities, and that the same number of seats will be furnished during rush hours by each type.

Tables II and IV make the same comparisons on the basis of improved service, or shorter headways. All data is based on two-men per

TABLE II
LARGE RAILWAY, LIGHT & POWER COMPANY IN ALABAMA

	A	B	C
Operating Data on Basis of Improved Service			
Headway 14 hours.....	6 mins.	6 mins.	6 mins.
Headway 4 hours.....	4 mins.	4 mins.	3.5 mins.
Running time 14 hours.....	48 mins.	48 mins.	48 mins.
Running time 4 hours.....	56 mins.	56 mins.	56 mins.
Cars required 14 hours.....	8	8	8
Cars required 4 hours.....	6-2-car 8-1-car	6-2-car 8-1-car	16-2-car
Seats per hour 14 hours.....	480	520	320
Seats per hour 4 hours.....	1155	1115	1100
Car miles per day.....	2010	2010	2465
Daily Operating Costs			
Platform wages.....	\$90.00	\$90.00	\$104.00
Maintenance and depreciation.....	70.00	60.30	61.75
Power.....	64.10	27.70	14.95
General.....	74.30	74.30	74.30
	\$280.90	\$252.30	\$255.00
Assume 20 per cent increase in revenue.....	420.00	420.00	420.00
Net.....	\$139.10	\$167.70	\$165.00
Increase over present.....	22.65	51.25	48.55
Annual increase.....	\$8,250.00	\$18,700.00	\$17,700.00
Cost of new cars.....	*\$120,000.00	\$100,000.00	\$83,000.00
Increase would pay on this.....	7 per cent	18.7 per cent	21.2 per cent

* All motor cars of present type.

large capacity two-car trains at present. The stops, however, are comparatively infrequent due to long city blocks, schedule speeds are high, and power consumption is relatively low. The cost of power is also unusually low here. These causes combine to make the platform wage item much larger in proportion to the power cost than it is in most cities.

In both cities, the railroads have been hard hit by the jitney competition. In both, the substitution of lighter cars and operation of shorter headways would seem to offer a solution of the difficulty.

Tables I and III represent existing service schedules, headways, costs and receipts, com-

car except one column in Table IV. This is inserted merely as an indication of the further economies made possible by one-man operation.

In the foregoing figures (Tables I and II), platform wages are taken at 50 cents per hour for single cars and at 75 cents per hour for two-car trains.

Maintenance and depreciation of equipment and way is taken at 3.5 cents per car mile with heavy equipment, at 3 cents per mile with the medium weight cars, and at 2.4 cents per mile for the small cars.

Power costs are figured at 0.55 cents per kw-hr., and on a basis of 4.5 kw-hr. per car mile for the large cars and 3.5 kw-hr. per car

mile during trailer operation. The type B cars are figured at 2.5 kw-hr. per car mile and the small cars at 1.1 kw-hr. per car mile. Variations from these figures, due to total causes, such as low voltage, improper handling of the equipment, etc., would not change the relative values.

Miscellaneous traffic expenses and general expenses are totalled at 4.9 cents per car mile

Platform wages are taken at 50 cents per hour for single cars in first three columns, and at 30 cents per hour for the one-man cars; for the two-car trains, at 75 cents per hour.

Maintenance and depreciation of equipment is figured at 4 cents per car mile at present, and at 2.7 cents per car mile with the light weight cars, and at 3.5 cents per car mile with the class B cars.

TABLE III
ELECTRIC RAILWAY COMPANY IN TEXAS

South End Line—distance 5.06 miles round trip.

A—Present cars seat 44, weigh 36,000 lb.
B—Proposed cars seat 52, weigh 30,000 lb.
C—Proposed cars seat 32, weigh 12,000 lb.

	A	B	C	C*
Schedule time 10 hours daily	36 mins.	36 mins.	30 mins.	36 mins.
Schedule time 4 hours daily	40 mins.	40 mins.	32 mins.	40 mins.
Schedule time 4 hours daily	40 mins.	42 mins.	35 mins.	40 mins.
Headway 10 hours daily	12 mins.	12 mins.	10 mins.	12 mins.
Headway 4 hours daily	8 mins.	8 mins.	8 mins.	8 mins.
Headway 4 hours daily	5 mins.	6 mins.	5 mins.	5 mins.
Cars required 10 hours daily	3	3	3	3
Cars required 4 hours daily	5	5	4	5
Cars required 4 hours daily	8	7	3-2-car 4-1-car	3-2-car 5-1-car
Seats per hour 10 hours daily	220	260	192	160
Seats per hour 4 hours daily	230	390	240	240
Seats per hour 4 hours daily	528	520	534	528
Daily mileage	641	606	800	740
Total platform wages, daily	\$41.00	\$39.00	\$40.00	\$28.20
Maintenance and depreciation equipment and way	25.64	21.20	21.60	19.95
Power	19.23	15.20	8.80	8.25
General	30.50	30.50	30.50	30.50
Total operating costs, daily	\$116.37	\$105.90	\$100.90	\$86.90
Transportation receipts	154.00	154.00	154.00	154.00
Net earnings daily	37.63	48.10	53.10	67.10
Annual increase in net		\$3,800.00	\$5,700.00	\$11,000.00
Approximate cost new cars		35,000.00	26,000.00	28,600.00
Increase would pay on this		11 per cent	22 per cent	38 per cent

* One-man operation.

on the present mileage. The actual costs of these two latter items are assumed to be unchanged by the change in car type or by increased mileage.

Transportation revenues are estimated at 23 cents per car mile.

All figures except platform wages and power consumption are based on the average cost of operation for this property in 1914, and the power rate is also taken from their cost sheets. Both wages and power consumption agree closely with the actual averages for all their equipment.

The figures used in Tables III and IV are based on the following assumptions:

Power costs are figured at 1 cent per kw-hr. and on a basis of 3 kw-hr. per car mile for the type A cars, 2.5 kw-hr. for the type B cars, and at 1.1 kw-hr. for the type C cars. Variations from these figures for local causes, such as low voltage, improper handling of the equipment, etc., would not change the relative values.

Miscellaneous traffic expenses and general expenses are taken together at 4.75 cents per car mile on the basis of the present mileage, and the actual costs of these two items are assumed to be unchanged by the use of a different car type, or by increases in mileage.

Transportation revenues are estimated at 24 cents per car mile on the present mileage. All figures, except platform wages and power costs, are based on the average operating statistics for Southern Railways contained in the United States census report of 1912, and both platform and power costs as figured above agree closely with the averages of the census report.

DISCUSSION OF DATA

In the preceding data, slight variations in the actual hourly wage of motorman or conductors would not change the relative values of platform expenses, nor would the result be changed if somewhat different values are assumed for general expense and miscellaneous traffic costs. The two latter items are inherently stable; and would not be increased in any way that is apparent to the writer by a change in the type of equipment, nor by a moderate increase in the number of cars in service.

The two items which might reasonably be questioned are the maintenance and power charges. Assuming that maintenance and depreciation are now 4 cents per car mile (which is the average for Southern roads),

we find from Mr. Doolittle's article in the March issue of the *Aera* that the items which go to make it up are as follows: an average being taken of the East South Central and West South Central data.

	Cents
A—Way structures, superintendence . . .	0.095
B—Maintenance of way	1.315
C—Maintenance of way, electric lines . .	0.330
D—Buildings and structure	0.08
E—Depreciation of way and structures . .	0.15
F—Other operations	0.11
G—Equipment superintendence	0.085
H—Maintenance of power equipment . . .	0.21
I—Maintenance of cars and locomotives .	0.84
J—Maintenance of electrical equipment of cars	0.42
K—Miscellaneous equipment expense . . .	0.115
L—Depreciation of equipment	0.19
M—Other operations	0.115
Total	1.055

Of the above, items A, D, F, G, K and M would probably not be affected, insofar as total expenditures are concerned, but if the mileage made is increased, the cost per car mile for these items would be proportionally

TABLE IV
ELECTRIC RAILWAY COMPANY IN TEXAS
Improved Service, Shorter Headways

	A	B	C	C*
Schedule time 10 hours daily	32 mins.	32 mins.	30 mins.	32 mins.
Schedule time 4 hours daily	35 mins.	35 mins.	35 mins.	35 mins.
Schedule time 4 hours daily	36 mins.	40 mins.	35 mins.	40 mins.
Headway 10 hours daily	8 mins.	8 mins.	7.5 mins.	8 mins.
Headway 4 hours daily	5 mins.	5 mins.	5 mins.	5 mins.
Headway 4 hours daily	4 mins.	5 mins.	3.5 mins.	4 mins.
Cars required 10 hours daily	4	4	4	4
Cars required 4 hours daily	7	7	7	7
Cars required 4 hours daily	9	8	2-2-car 8-1-car	3-2-car 7-1-car
Seats per hour 10 hours daily	330	390	256	240
Seats per hour 4 hours daily	528	624	364	364
Seats per hour 4 hours daily	660	624	656	624
Daily mileage	920	860	1067	1020
Platform wages	\$52.00	\$50.00	\$56.00	\$36.00
Maintenance and depreciation equipment and way . .	36.80	30.10	28.81	27.54
Power	27.60	21.50	11.74	11.22
General	30.50	30.50	30.50	30.50
Total operating cost daily	\$146.90	\$132.10	\$127.05	\$105.26
Assumed 20 per cent increase in revenues	184.80	184.80	184.80	184.80
Net	\$37.90	\$52.70	\$57.75	\$79.54
Increase over present27	15.07	20.12	41.91
Annual increase	98.00	5,500.00	7,300.00	15,300.00
Cost of new cars	\$4,500.00	\$40,000.00	\$31,200.00	\$33,800.00
Increase would pay on this	2 per cent	14 per cent	23.4 per cent	46.6 per cent

* One-man operation.

decreased. The average weight on the road with the small cars would be about one-third of what it is at present, and the actual effect on damage to special work, and to the sub-structure and paving should be reduced proportionally. Rail wear too would be about proportional to the weights; but on the other hand wear and tear due to other traffic and to the elements would not be changed. It seems reasonable therefore to place the figure for light cars at one-half of the present value, or 0.66 cents.

The maintenance of electric lines would also drop as a result of reduced currents at the trolley wheel. This reduction is estimated at 20 per cent, giving a revised figure of 0.264 cents.

Depreciation of way and structures might decrease one-third, and becomes 0.10 cents.

Maintenance of power equipment, due to the greatly decreased load should decrease at least one-third and becomes 0.14 cents.

Car maintenance, due to reduced brakeshoe and wheel wear, and the more modern design of the parts, should be at least 20 per cent less per car mile, or 0.67 cents.

Electric equipment maintenance, due to the more modern design of the equipment should average not over 0.05 cents. This is based on actual records, on many roads, of motors and controllers put out during the past four or five years.

Depreciation of equipment should be somewhat less, due to improved design and better materials, say 0.15 cents.

In this connection, should the present cars be replaced outright by new cars, depreciation charges would of course increase, as the value of the new equipment would have to be added to that of the outstanding value of the old, and a rate set which would wipe out both values within a reasonable period. But if the old cars were retained in service, and used as spares and for rush hour and holiday traffic, they would still be carried in the capital account. This of course would be the logical method, and under these circumstances the greater earning capacity of the new cars in proportion to the capital investment should mean a lower proportion of the gross receipts would have to be set aside for depreciation.

The new total, on these assumptions, becomes 2.63 cents, 60 per cent of the present cost. To be conservative, however, the figure of 2.7 cents has been assumed, a decrease of one-third.

For the type B cars, a figure of 3.5 cents was arrived at by a similar method of estimating.

The biggest item of economy is, of course, in power. Consumptions per car mile are calculated values, and probably agree fairly closely with what is actually taken at present, and the decrease in total power consumption would unquestionably be at the ratios shown. But many operators will not agree that the cost per kilowatt-hour should remain the same under the reduced output as under the heavy load. In the case of a company which sells lighting and commercial power there should be no question of this. The reduced railway load simply releases so many kilowatts which can be sold at a profit elsewhere.

In the case of the railway companies that purchase their power, any reduction in their peak load should mean a decrease in rate as well as paying for less kilowatt-hours, and the combined value of these economies should offset the increased cost per kilowatt-hour of their overhead charges for distribution.

It is the operator, however, who neither buys nor sells power who, often, can see no benefit to himself in power reduction, save in a slightly reduced fuel bill. If the reduction is only a very small percentage of the total output, this is ostensibly correct, provided neither his machines nor lines are overloaded. There would be no immediate reduction in either his overhead or labor costs, and the reduction in fuel and maintenance costs might be negligible. But where the reduction in load amounts to as great a proportion of the total cost as in this instance, or approximately two-thirds, it should be possible to shut down some units, reduce the number of firemen, and make a general reduction in all the costs of operation of the power plant. There would be a distinct reduction in the line losses, which in many instances would act to postpone the installation of additional copper in the distributing system. If these indirect economies did not manifest themselves immediately, they could unquestionably be secured in the long run, by enabling additional service to be supplied without increase in station or line capacity.

The actual cost of power at the station is of course an important factor in this analysis. On the Alabama property it is unusually low. In fact, only a few of the largest railway systems in this country can purchase or produce power for approximately one-half cent per kilowatt-hour; and this of course does not include interest on their plant or on their distribution system. These are of course part of the real cost, but are carried in the fixed charges and not under the operation. The

effect of this low rate, however, combined with schedules which require a comparatively low consumption of power, makes the cost of power a relatively small item on this system, and the extreme rush hour conditions makes the platform account a greater percentage of the total expense than on most roads.

These two reasons, combined, make a car of large seating capacity of more importance to them than one of low power consumption, and the medium-weight car (type B) is unquestionably the most efficient.

On the other hand, under normal rates for power, which have been assumed for Texas, and with schedules which require an unusually high consumption per ton-mile, power charges assume a greater importance. Since there is moreover, here, a more even distribution of traffic throughout the day and less pronounced rush hour peaks, platform wages, while still the largest item, are not so great a part of the total as in some other places. Under these circumstances, the small car, even with two-man operation, appears the more efficient; and with one-man operation the saving would amount to a large sum.

Of the economics of one-man car operation there can be no question. Of the advisability of attempting to operate cars in this manner in any save the smaller cities, there are grave differences of opinion. It seems logical that their use under any heavy condition of traffic would materially slow down schedules. The use of one-man cars is prohibited by law in many communities. If the education of the public in the prepayment of fares and the use of transfer and change making machines obviates the need of a conductor, and the car can be operated as satisfactorily without one, it is obvious that laws will have to be changed to permit of such operation. Such permission would probably be far more easily obtained than an increase in fares. Whether one or two men per car be employed, however, is purely an operating matter; the only way on which it enters into the present paper is that the smaller the car the less the difficulty of single-end one-man operation.

Upon the assumption, though, that in the majority of cities no immediate change in this respect is possible, the other apparent advantages of the smaller cars are so evident that, whether as a means of meeting and fighting other forms of transportation, or simply as a method of securing greater economy under normal operation, it seems perfectly logical to assert that their use will prove decidedly advantageous to the great

many urban railways, and that many others could secure greater efficiency by the use of lighter equipment than they are using.

Certain assumptions have been made as to the effect on transportation revenues of cutting down headways and providing faster schedules. In the case of cities where maximum traction trucks are largely used, both accelerating and braking rates on poor rails are necessarily low as compared to single-truck or to four-motor equipments, and this usually results in slower average schedule speeds than could otherwise be secured, since the schedules have to be laid out with the most adverse conditions in mind. This probably accounts in part for the slow schedule speeds in Table III. Bad rail conditions, due to greasy or muddy tracks, are common here during many months of the year, and rates of acceleration and braking are slower than is usual even with maximum traction equipments. The advantage of the single-truck car in respect to rail adhesion, together with the fact that the use of more cars will decrease the average load per car per trip, and therefore there will be fewer stops made per trip, make it certain the running time at all hours of the day could be materially shortened.

This in itself would prove popular, as passengers object strongly to slow schedules, and especially to the loafing which motormen so often resort to on the lighter trips of the day when with a good rail and few stops they get ahead of schedule. But the most potent factor in promoting the riding habit, and in securing business which is otherwise lost, is a short headway and the running of cars absolutely on time. It is no exaggeration to say that a man who lives not more than two miles from his business will very frequently walk sooner than wait ten minutes for a car, and that the average person who has a mile to go will walk sooner than wait above five minutes. The greater number of riders per capita in the largest cities as compared with smaller communities is due in part to the longer distances between the business and residential sections, but is also very largely brought about by the greater frequency of service in the former places.

If headways of from 6 to 12 minutes were cut one-third, and a faster schedule at the same time offered, it appears reasonably certain that the number of passengers would increase at least 20 per cent. The increased receipts shown in Tables II and IV are based on this assumption. Intermediate cuts in headway should produce increases in receipts of

from 10 to 15 per cent. These figures are, of course, mere guesses, but are the estimates of a considerable number of men, and based largely on their own experience; in other words, is an estimate of the number of rides they take weekly on street cars as compared with the number of times they walk in preference to waiting. Jitneys, of course, catch numbers of such passengers; so do private car owners who see friends walking and pick them up.

In short, to furnish improved service will bring in an increased amount of business, and will at the same time reduce public criticism and hostility, which is the most serious handicap with which most public service corporations have to contend. If it can be done without a prohibitive increase in the costs of operation, it will prove a mutual benefit to the public and operators, and should be the means of placing the electric railways on a firmer financial footing.

THE PERIODIC LAW

BY DR. SAUL DUSHMAN

RESEARCH LABORATORY, GENERAL ELECTRIC COMPANY

For a number of years chemists have been familiar with the Periodic Table of the Elements as arranged by Mendelejeff. With the discovery of the numerous radioactive elements there arose the problem as to their place in this Periodic Table—a problem which has been solved only quite recently. In the present paper the writer discusses the revised arrangement of the elements which is based upon the results of the most recent investigations.—EDITOR.

Historical Introduction*

Ever since the establishment of the atomic theory by Dalton and Berzelius it was felt among chemists that there must be some relation between the atomic weights of the different elements and their properties. It was recognized very early that there exist groups of elements possessing related chemical and physical properties, and one of the earliest attempts to bring out this point is due to Dobereiner. In 1829 he tried to show that "many elements may be arranged in groups of three, in each of which the middle element has an atomic weight equal, or approximately equal to the mean of the atomic weights of the two extremes." As illustrations of this method of arrangement may be mentioned, the following groups: *Li, Na, K*; *Ca, Sr, Ba*; and *Cl, Br, I*.

Passing over briefly the memoirs of Cooke and Beguyer de Chancourtois, we come to the "law of octaves" enunciated by J. A. R. Newlands in 1864. He drew attention to the fact that "the eighth element, starting from a given one, is a kind of repetition of the first, like the eighth note of an octave in music," and thus made the most distinct advance towards a system of classification of the elements that had yet been accomplished.

It is, however, to the Russian chemist, Mendelejeff, that chemistry owes the system

of classification of the elements which is based on the recognition of this fundamental fact: "*that the properties of the elements and the properties and compositions of compounds vary periodically with the atomic weights of the elements.*"

This principle, known as the *Periodic Law*, was enunciated by Mendelejeff in two memoirs published in 1869 and 1871 respectively, and the arrangement of the elements, based on this law, which was finally adopted by him is illustrated in Fig. 1.

While a discussion of this law may be found in almost any text-book on chemistry, a few remarks of a general nature may not be out of place in this connection.

Mendelejeff arranges the elements into series and groups. In each series the order of the elements corresponds to increasing atomic weights, and accompanying this change in atomic weight there is evident a gradual variation in all the properties of both the elements and their compounds. On the other hand, the arrangement in groups exhibits the *periodical recurrence* of elements possessing fairly analogous properties.

The change in valency, as exhibited by the formulæ of the oxides and hydrides is probably one of the most striking facts brought out by the periodic arrangement of the elements.

From the univalent elements like *H, Li, Na*, etc., the valency for oxygen increases regularly until in compounds like *OsO₄*, the

* This section is to a large extent based on Chapter XIII (The Periodic Law) in P. Murr's "History of Chemical Theories in England."

elements exert a valency of eight. The maximum valency for hydrogen appears to be four, and while the valency for oxygen increases from Group I to Group VIII, that for hydrogen decreases in the same manner from Group IV to Group VIII.

The compounds exhibit a gradation in properties quite similar to that exhibited by the elements themselves. Thus Na_2O is strongly basic, MgO less so, Al_2O_3 combines with acids to form salts and with alkali hydrates to form aluminates, that is, it acts as an anhydride of both acids and bases. In SiO_2 we have a weak acid anhydride, while the acids formed from P_2O_5 , SO_3 and Cl_2O_7 range in strength in the same order.

state that the atomic volume is a periodic function of the atomic weight. The specific heats of the elements when plotted as ordinates against the atomic weights show a similar periodicity of maxima and minima, and the same can be stated for other properties.

Application of Periodic Law to Determine Atomic Weights

One of the most important applications of the Periodic Law suggested by Mendelejeff was the determination of atomic weights from the properties of the elements. In other words, he stated as a fundamental axiom that *the atomic weight of any element*

SERIES.	GROUP I. — R'O	GROUP II. — RO	GROUP III. — R'O ³	GROUP IV. — RH ⁴ RO ²	GROUP V. — RH ⁵ R'O ⁵	GROUP VI. — RH ⁶ RO ³	GROUP VII. — RH R'O ⁷	GROUP VIII. — RO ⁸
1	H = 1							
2	Li = 7	Be = 9.4	B = 11	C = 12	N = 14	O = 16	F = 19	
3	Na = 23	Mg = 24	Al = 27.3	Si = 28	P = 31	S = 32	Cl = 35.5	
4	K = 39	Ca = 40	— = 44	Ti = 48	V = 51	Cr = 52	Mn = 55	Fe = 56 Co = 59 Ni = 59 Cu = 63.
5	(Cu = 63)	Zn = 65	— = 68	— = 72	As = 75	Se = 78	Br = 80	
6	Rb = 85	Sr = 87	?Yt = 88	Zr = 90	Nb = 94	Mo = 96	— = 100	Ru = 104 Rh = 104 Pd = 106 Ag = 108
7	(Ag = 108)	Cd = 112	In = 113	Su = 118	Sb = 122	Te = 125?	I = 127	
8	Cs = 133	Ba = 137	?Di = 138	?Ce = 140	—	—	—	
9	(—)	—	—	—	—	—	—	
10	—	—	?Er = 178	?La = 180	Ta = 182	W = 184	—	Os = 195 Ir = 197 Pt = 198 Au = 199
11	(Au = 199)	Hg = 200	Tl = 204	Pb = 207	Bi = 208	—	—	
12	—	—	—	Th = 231	—	U = 240	—	— — — —

Fig. 1. Periodic Table as Arranged by Mendelejeff

Atomic Volume as a Periodic Function of Atomic Weight

Probably the best illustration of the significance of Mendelejeff's Periodic Law can be conveyed by plotting some property of the different elements against the atomic weight. In Fig. 2, which is taken from Holleman's Inorganic Chemistry, the atomic volume (specific gravity divided by atomic weight) has been plotted as ordinate with the atomic weights as abscissæ. It will be observed that elements possessing similar chemical and physical properties occupy similar positions on the curve. In mathematics a periodic function is one which returns to the same value for definite increments of the independent variable. From Fig. 2 it is evident that we can in a similar manner

must determine its properties. He illustrated this conclusion by prophesying in detail the properties of three unknown elements which he named eka-boron, eka-aluminum, and eka-silicon, and to which he assigned the approximate atomic weights 44, 68, and 72, respectively. His predictions were subsequently completely verified by the discovery of the elements scandium (eka-boron), gallium (eka-aluminum) and germanium (eka-silicon).

It must be observed that without the assistance of the Periodic Law the exact determination of the atomic weight of an element, whose compounds are all non-volatile, becomes a matter of extreme difficulty. Thus a chemical analysis of the oxide of indium shows that the element has the

equivalent weight 38, that is, 38 parts by weight of indium are equivalent to 1 part by weight of hydrogen. At the time when Mendelejeff published his papers the atomic weight of this element was taken to be 76 and the formula of the oxide was assumed to be InO . A study of the properties of this oxide and of the metal itself, from the standpoint of the Periodic Law, led Mendelejeff to assign it to Group III, along with *B* and *Al*. Consequently the oxide must have the formula In_2O_3 and the atomic weight must be about 114.

Discrepancies in the Periodic Table

It was already observed by Mendelejeff that a discrepancy exists in the case of tellurium and iodine. According to order of atomic weights iodine should come before tellurium; but even the most superficial investigation of the properties of these elements and of their compounds shows that iodine belongs to the chlorine family, while tellurium closely resembles sulphur and selenium. Mendelejeff therefore argued that the atomic weight of tellurium ought to be smaller; but in spite of the most careful and most elaborate investigations undertaken in this direction, the results have always led to the same conclusion.

Similar discrepancies have been observed in the case of cobalt and nickel, and argon and potassium (see "Rare Earths", page 620). It will be shown in a subsequent section that these discrepancies disappear in the light of the most recent speculations.

Rare Gases in Relation to the Periodic Table

When the existence of the rare gases* was discovered an interesting question arose as to their place in the Periodic Table. As is well known, these gases were found to be absolutely inert chemically, thus differing radically from every other element known up to that time. Consequently they could not be placed in any of the known groups. However, by arranging them in a group to the left of Group I (see Fig. 4) they are shown as a natural transition from the elements of Group VIII to those of Group I.

Rare Earths in Relation to the Periodic Table

The group of elements known as the "rare earths" has presented an exceedingly interesting problem as regards their arrangement in Mendelejeff's system of classification.

* Those who are unfamiliar with the unique properties of the rare gases will find a note on the subject in the GENERAL ELECTRIC REVIEW, March, 1915, p. 226, and May, 1915, p. 408.

The elements of this group and their compounds resemble each other very closely in chemical properties; in fact, it is possible to separate them only because of slight differences in physical properties, such as solubility, melting point, or color; so that the process of isolating a salt of any one of the members of the group is a most laborious process, involving probably over several thousand recrystallizations.

Up to the present the existence of the following elements has been definitely determined:

		ATOMIC WEIGHT
<i>Scandium Group</i>	Scandium	44.1
	Yttrium	88.7
<i>Cerite Earths:</i>	Lanthanum	139.0
	Cerium	140.25
	Præeodymium	140.6
	Neodymium	144.3
	Samarium	150.4
	Europium	152.0
<i>Ytterbium Earths:</i>	Gadolinium	157.3
	Terbium	159.2
	Dysprosium	162.5
	Erbium	167.4
	Thulium	168.5
	Ytterbium	172.0
	Lutecium	174.0

With respect to the first four of the above elements, there has been no doubt as to what place they ought to occupy in the Periodic Table. When scandium was first isolated in 1879 it was recognized immediately as the element eka-boron whose properties had been prophesied by Mendelejeff. The position of yttrium and lanthanum in Group III as analogous elements to aluminum and scandium has also not been questioned. As cerium forms an oxide CeO_2 similar to SnO_2 and its salts resemble those of tin and germanium, it seems equally well established that this element belongs to Group IV.

But up to the present time it has remained quite an open question as to the manner in which the other twelve elements should be arranged. Prof. Meyer has suggested that they should be grouped together in Group III *between* lanthanum and cerium, thus emphasizing the resemblance in chemical properties of the different elements constituting this group. This would, however, place lutetium, with an atomic weight of 174, before cerium whose atomic weight is 140.

In view of the more recent work of Moseley on the high-frequency spectra of the elements, of which further mention will be made, the

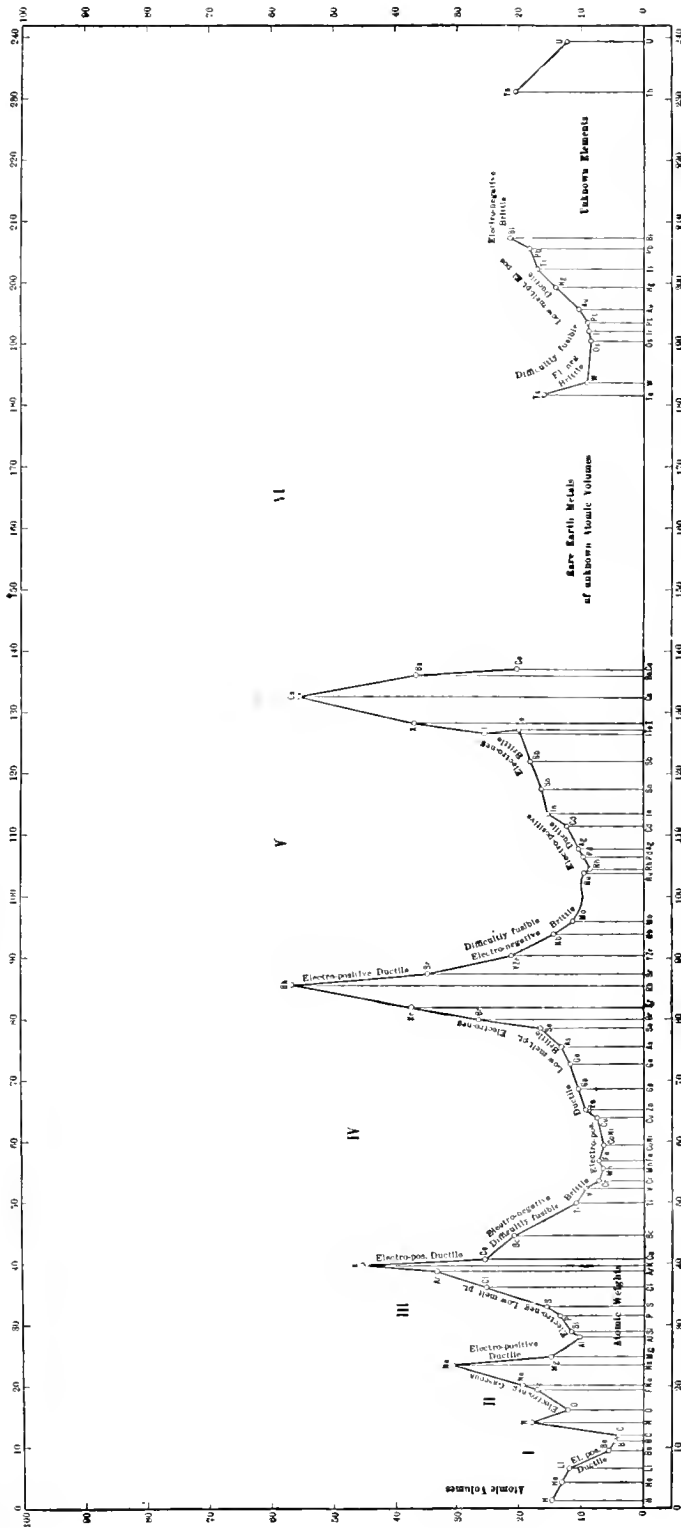


Fig. 2. A Graphical Representation of the Periodic Variation of the Atomic Volumes of the Elements with their Atomic Weights

writer has tentatively arranged the rare earths as indicated in Fig. 4. They are thus made to come in *below* lanthanum and cerium and before tantalum.

Radioactive Elements

The discovery of the radioactive elements has naturally led to the question as to what relationship they bear to the other elements in the Periodic Table. There could be no doubt about the position of elements like radium, thorium, and uranium which could be obtained in large enough quantities to determine their atomic weights and chemical properties, but up to the past year there was a great deal of speculation about the manner in which the other radioactive elements should be arranged, and it was only after an immense amount of careful investigation and ingenious deduction on the part of brilliant physical chemists like Soddy and Fajans that the whole situation was cleared up, and another epoch-making chapter added to the history of the Periodic Law. It is largely with the conclusion reached by these investigators that the present paper is specially concerned.

As is well known, the radioactive elements are characterized by a greater or less instability. After a certain average period of existence, which may range from over a thousand million years, as in the case of uranium (U_1), to a millionth of a second, as in the case of RaC_1 , the atom disintegrates spontaneously and yields an atom which possesses totally distinct properties. The disintegration is detected by the expulsion either of alpha* or of beta† particles. Accompanying the expulsion of beta particles there is also observed in a

* The alpha (α) particle has the same mass as the atom of helium but differs from the latter in possessing two unit positive charges $2\epsilon = 9.54 \times 10^{-10}$ e.s.u.).

† The beta (β) particles correspond in mass and electric charge to the electrons (unit of negative electricity, $\epsilon = 4.77 \times 10^{-10}$ e.s.u.).

number of cases, an emission of gamma rays. These are electromagnetic pulses of extremely short wave length (about 10^{-9} cm.) and are probably due to the bombardment of the atoms of the radioactive substance itself by the *beta* particles.

As a result of the large amount of careful work which has been carried out during the past few years in investigating the relationship between the different radioactive elements and their transformation products it has been concluded that there exist three well defined disintegration series whose starting points are uranium, thorium, and actinium, respectively.

Fig. 3 illustrates diagrammatically the manner in which the members of these series appear to be related.

When mesothorium II disintegrates it yields radiothorium and as a beta particle is expelled during the transformation there is no change in atomic weight. Radiothorium is chemically allied to thorium and non-separable from it. These facts lead to the conclusion that radiothorium belongs to Group IV and mesothorium II must therefore belong to Group III.

Passing to thorium X, we here again come to an element which is chemically similar to radium, thus placing it in Group II. The atom of thorium X expels an alpha particle and yields thorium emanation, a gas which is *inert chemically*, and condenses at low pressures between -120 deg. C. and -150 deg. C. The emanation resembles therefore the rare gases of the argon group.

Thorium emanation is the first member of the group of transformation products that constitute the thorium "active deposit." They are indicated in Fig. 3 as thorium A, B, C₁, C₂ and D.

The diagrams illustrating the actinium and uranium series are self-explanatory. In a general way the three series are quite similar. The most noteworthy feature about these radioactive elements is the fact that individual members of each series appear to be chemically indistinguishable from certain members of the other series. Thus thorium B and

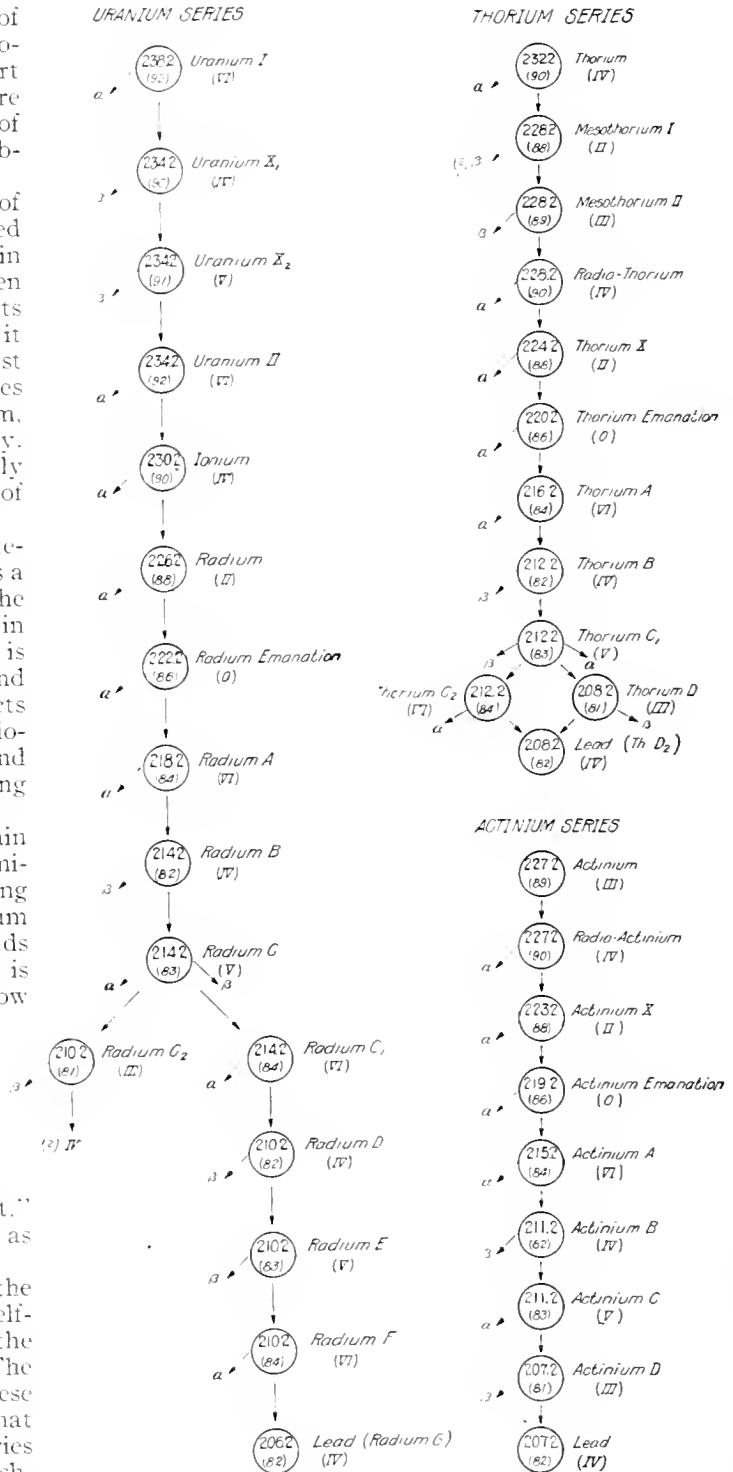


Fig. 3. Method of Disintegration of Radioactive Elements

MENDELEJEFF'S PERIODIC SYSTEM OF THE ELEMENTS

Containing Atomic Weights, Atomic Numbers and Isotopic Radioactive Elements

Group 0	Group 1	Group 2	Group 3	Group 4	Group 5	Group 6	Group 7	Group 8
- - -	E ₂ O - - -	EO - - -	E ₂ O ₃ - - -	EO ₂ EH ₄	E ₂ O ₅ EH ₃	EO ₃ EH ₂	E ₂ O ₇ EH	EO ₄
H ₁	H ^{1.008} (1)	Ca*	R	C (90)	N	O	F	
				Io 230.2 Th 232.2 Ux ₁ 234.2	Ux ₂ 234.2 (91)	U _{II} 234.2 U _I 238.2		

* Be = Gl
† Ch = Nb
‡ Neoytterbium = 173.5

Atomic Weights listed in **Bold** figures.
Atomic Numbers listed in *Italics* in parentheses.

Fig. 4

67812

MENDELEJEFF'S PERIODIC SYSTEM OF THE ELEMENTS

Containing Atomic Weights, Atomic Numbers and Isotopic Radioactive Elements

Group 0	Group 1	Group 2	Group 3	Group 4	Group 5	Group 6	Group 7	Group 8
	E ₂ O	EO	E ₂ O ₃	EO ₂ EH ₄	E ₂ O ₅ EH ₃	EO ₃ EH ₂	E ₂ O ₇ EH	EO ₄
He 4.00 (2)	H 1.008 (1) Li 6.94 (3)	Be* 9.1 (4)	B 11.00 (5)	C 12.00 (6)	N 14.01 (7)	O 16.00 (8)	F 19.0 (9)	
Ne† 20.3 (10)	Na 23.00 (11) K 39.10 (19)	Mg 24.32 (12) Ca 40.07 (20)	Al 27.1 (13) Sc 44.1 (21)	Si 28.3 (14) Ti 48.1 (22)	P 31.04 (16) V 51.0 (23)	S 32.07 (16) Cr 52.0 (24)	Cl 35.46 (17) Mn 54.93 (25)	Fe 55.84 (26) Co 58.97 (27) Ni 58.68 (28)
Kr 83.92 (36)	Rb 85.45 (37) Cs 132.61 (55)	Zn 65.37 (30) Sr 87.63 (38) Ba 137.37 (56)	Ga 69.9 (31) Yt 89.0 (39) La 139.0 (57)	Ge 72.5 (32) Zr 90.6 (40) Ce 140.25 (58)	As 74.96 (33) Nb 92.9 (41) Sb 120.2 (51)	Se 79.2 (34) Mo 96.0 (42) Te 127.5 (52)	Br 79.92 (35) I 126.92 (53)	Ru 101.7 (44) Rh 102.9 (45) Pd 106.7 (46)
Xe 130.3 (54)	Cu 63.57 (29) Ag 107.88 (47) Au 197.2 (79)	Pr 140.6 (59) Gd 137.3 (64) Tm 168.5 (69)	In 114.8 (49) Tl 204.0 (81)	Sa 150.4 (62) Ho 162.5 (67) Lu 174.0 (72)	Sn 119.0 (50) Pb 207.15 (82)	Te 127.5 (52) Ra D 210.2 (83)	I 126.92 (53) Bi 208.0 (84)	Os 190.9 (76) Ir 193.1 (77) Pt 195.2 (78)
Ac Em 219.2 (60)		Th X 234.2 (88) Ra 226.2 (88) MesTh ₁ 228.2 (88)	Ac D 207.2 (87) Th D 206.2 (87) Ra C ₂ 210.2 (87)	Ac B 211.2 (82) Th B 212.2 (82) Th D ₂ 205.2 (82) Ra B 214.2 (82) Ra D ₂ 210.2 (82)	Ac C 211.2 (83) Th C ₁ 212.2 (83) Ra C 214.2 (83)	Ra F 210.2 Ac C ₁ 211.2 Ac A 215.2 Th C ₂ 212.2 Th A 216.2 Ra C ₁ 214.2 Ra A 218.2		
Th Em 230.2 (61)		MesTh ₂ 238.2 (89)	Ac 227.2 (89) MesTh ₂ 238.2 (89)	Rd Ac 227.2 (89) Rd Th 238.2 (89) Io 230.2 (89) Th 232.2 (89) Ux ₁ 234.2 (89)	Ux ₂ 234.2 (91)	U _{II} 235.2 U _I 238.2 (90)		

* Be = OI
† Cb = Rb
‡ Neoytterbium = 173.5

6,82

radium B possess identical chemical properties. If it were not for the difference in period of existence of both substances it would be impossible to differentiate them.

Isotopes

Soddy first drew attention to this and similar cases of radioactive elements that are chemically identical and since they must occupy the same place in the Periodic Table he has designated them *isotopes*. Thus the elements uranium X_1 , ionium, and radio-actinium are isotopic. A similar example is furnished by the three emanations, and by radium and thorium X . A remarkable feature about these isotopes is that although they are chemically the same, they differ in atomic weights. In other words, we have here cases of elements that are absolutely inseparable by all chemical methods so far devised, and yet differ in that respect which has hitherto been taken to be the most important characteristic of an element—its atomic weight.

Soddy's Law of Sequence of Changes

A comprehensive survey of the chemical properties of the different radioactive elements has led Soddy and Fajans independently to an interesting and extremely important generalization which enables them to assign these isotopes to their places in the Periodic Table.

It will be remembered that an alpha particle is a helium atom with two positive charges. By its expulsion, therefore, the atom must lose two positive charges, and the atomic weight must decrease by four units. Similarly, the expulsion of a beta particle means the loss of a negative charge or, what is equivalent, the gain of one positive charge; and since the mass of the beta particle is extremely small compared with that of the atom, there is practically no decrease in atomic weight. Now in the Periodic Table the valency for oxygen, an electro-negative element, increases regularly as we pass from Group 0 to Group VIII, while that for hydrogen, an electro-positive element, decreases, i.e., the electro-positive characteristic increases by one unit for each change in the group number as we pass in any series from left to right. Furthermore, in each group the electro-positive character increases regularly with increasing atomic weight.

These considerations led Soddy and Fajans to this conclusion:

The expulsion of an alpha particle from any radio-active element leads to an element which is two places lower in the Periodic Table (and has an atomic weight which is four units less) while the emission of a beta particle leads to an element which is one place higher up, but has the same atomic weight.

It is possible, therefore, to have elements of the same atomic weight but possessing distinctly different chemical properties, and, on the other hand, since the effect of the emission of one alpha particle may be neutralized by the subsequent emission of two beta particles, it is possible to have two elements which differ in atomic weight by four units (or some multiple of four) and yet exhibit chemically similar properties.

As an illustration, let us consider the Uranium Series. Uranium I belongs to Group VI. By the expulsion of an alpha particle we obtain uranium X_1 , an element of Group IV. This atom in turn disintegrates with the expulsion of a beta particle. Consequently uranium X_2 must belong to Group V. In this manner we can follow the individual changes that lead to the different members of the series, and by means of the generalization of Soddy and Fajans we can not only assign to each element its place in the Periodic Table but also its atomic weight, as has been done in Fig. 3.

This generalization has been of material assistance in elucidating some of the difficult problems in the study of the disintegration series. More than this, it has led to the intensely interesting conclusion that the end product of each of the three radio-active series is an isotope of lead. The results of the most recent work on the atomic weight of lead are in splendid accord with this deduction, as it has been found that lead, which is of radio-active origin, has a slightly lower atomic weight than ordinary lead.*

In a couple of cases the isotope has not been definitely isolated, but there can hardly be any doubt of its existence. Thus, the disintegration product of radium C_2 must be an element of Group IV, but the evidence for its existence is very meager.

Nuclear Theory of Structure of the Atom

All these conclusions are in accord with an interesting theory of atomic structure that was first put forward by Rutherford and elaborated by Bohr, Moseley and Darwin. As this theory has been discussed at great length in connection with another series of

* J. Am. Chem. Soc., 36, 1329, 1914.

articles* we shall limit ourselves here to a few remarks on its essential points.

Stated briefly, this theory assumes the atom to consist of a positively charged nucleus surrounded by a system of electrons which are kept together by attractive forces from the nucleus. "This nucleus is assumed to be the seat of the essential part of the mass of the atom, and to have linear dimensions exceedingly small compared with the linear dimensions of the whole atom."

According to Bohr, the experimental evidence supports the hypothesis that *the nuclear charge of any element corresponds to the position of that element in the series of increasing atomic weights.* The chemical properties of the atom depend upon the magnitude of this nuclear charge; since, however, any given number of electrons may assume different configurations it is possible for two or more elements to exist having the same nuclear charge, but possessing different atomic weights. In other words, the possible existence of isotopes is deduced from Rutherford and Bohr's assumptions.

The atomic weight thus assumes the rôle of a secondary characteristic; the important property of any element is its *nuclear charge*, so that by arranging the elements in order of increasing nuclear charge we ought to obtain a much better approximation to a periodic arrangement of the elements. It so happens that in most cases the order of increasing atomic weight coincides with that of increasing atomic number (nuclear charge), but this need not be so in all cases.

High Frequency Spectra of the Elements

Bohr showed that there must exist a definite relation between the charge on the nucleus and the frequency of the characteristic X-rays emitted by the substance. Moseley, therefore, has measured the wavelengths of the characteristic X-rays emitted by the different elements when these were made anti-cathodes in an X-ray tube and has determined, in this manner, the atomic numbers of all the elements from aluminum, 13, to gold, 79. There appear to be only three elements in this range which have not been discovered by the chemist.

Periodic Table in Present Form

The revised form of Mendelejeff's Periodic Table which has been drawn up in Fig. 4 presents an attempt to embody the most recent results of the different lines of investi-

gation that have been discussed herein. Under each element is given the atomic weight and the atomic number (in brackets). A few remarks about different elements in this table are, however, essential in this connection.

Neon and Meta-Neon. Nebulium

Evidence for the existence of two isotopes of neon has recently been deduced by Prof. J. J. Thomson and Aston. By careful diffusion experiments the latter was able to separate from neon another gas of atomic weight 22, which has been named meta-neon. The two gases differ only in their gravitational properties, but are chemically and spectroscopically identical.

During the past year spectroscopic evidence has been adduced for the existence of a new element nebulium, having an atomic weight of about 3. This element occurs in the spectrum of the nebula of Orion. It is, however, probably too premature to try to speculate about its place in the Periodic Table. There are a number of elements like nebulium for the existence of which we have only spectroscopic evidence and it may be, as has been suggested recently, that these are the proto-elements out of which our terrestrial elements have been built up.

Rare Earths

The case of the rare earths has already been discussed in a previous section. The arrangement shown in Fig. 4 is in accordance with the atomic numbers determined by Moseley in the case of the following elements: Lanthanum, cerium, praseodymium, neodymium, samarium, europium, gadolinium and holmium. The order of atomic numbers in the case of dysprosium and holmium is apparently the reverse of that of the atomic weights. But this case, as well as those of tellurium, iodine; cobalt, nickel; and argon, potassium, no longer appears anomalous when the elements are arranged in order of increasing atomic number rather than that of increasing atomic weight. The atomic weight of neoytterbium has been determined during the past year; it is, however, impossible to state at present what relation it bears to the other elements of the rare earth group.

Radioactive Elements

The radioactive elements have been arranged in groups of isotopes and the atomic numbers are based upon the order of the different elements in the disintegration series

* GENERAL ELECTRIC REVIEW, December, 1914.

(see Fig. 3), assuming the atomic number of lead to be 82.

The atomic weight of actinium and its disintegration products have not been determined. We have therefore adopted the value suggested by Fajans which is about 227. All we can say definitely is that the atomic weight is greater than that of radium and considerably less than that of thorium.

The atomic weights of uranium and radium are based on the following considerations: Firstly, as radium is derived from uranium by the expulsion of three alpha particles, the atomic weights must differ by 3×3.99 units. Secondly, according to the most recent report of the International Committee on Atomic Weights there seem to be valid reasons for accepting a value which is very close to 238.2 for the atomic weight of uranium. The value actually obtained by Hoenigschmid (*Z. Elect.* 20, 452, 1914) varied from 238.09 to 238.18; but the Committee consider the latter value as being the more accurate. The determinations of the atomic weight of radium have yielded results varying from 225.9 to 226.4, and the latter is the value given in the Table of Atomic Weights issued by the International Committee for the present year. However, in view of the above considerations we have used the value 226.2.

The nomenclature of the radioactive elements is based on that of Soddy.* At the time when they were isolated, there was of course no definite knowledge as to their relationships and the result has therefore been rather confusing. Thus the name polonium has been applied to *RaF*, while *U_X2* is also known as brevium. The designation "niton" for radium emanation has

become quite well known. It has, however, been considered advisable to use those names which best convey the relationships of the different elements, and an attempt has been made to carry out this plan in tabulating the isotopes.

Conclusions

Considering the relationships exhibited by the different radioactive elements, one realizes that the dream of the alchemists may not have been as fatuous as has appeared until recently. The concept of an absolutely stable atom must be discarded once for all, and its place is taken by this miniature solar system, as it were, consisting of a central nucleus and one or more rings of electrons. But the nucleus itself is apparently the seat of immense forces, and in spite of its exceedingly infinitesimal dimensions it contains both alpha particles and electrons. Once in a while the nucleus of one of the atoms will spontaneously disintegrate and expel an alpha or beta particle. A new element has been born. What causes these transformations? Can they be controlled? These are questions which only the future can answer. But if we had it in our power to remove two alpha particles from the atom of bismuth or any of its isotopes, not only would the dream of the alchemists be realized, but man would be in possession of such intensely powerful sources of energy that all our coal mines, water-powers, and explosives would become insignificant by comparison.

REFERENCES

1. Pattison Muir—History of Chemical Theories and Laws.
2. F. Soddy.—The Chemistry of the Radio-Elements, Parts I and II.
3. K. Fajans.—Naturwissenschaften, vol. II, 429, 462 (1914).

* The Chemistry of the Radio-Elements.

TEST FOR DIRT IN AN AIR SUPPLY

BY SANFORD A. MOSS

TURBINE DEPARTMENT, LYNN, GENERAL ELECTRIC COMPANY

The dirt carried in suspension in a current of seemingly clean air will amount to a startling quantity if it is collected for a period of time. While many objects inadvertently act as "dust collectors," electrical engineers are primarily interested in preventing electrical machines, cooled by forced draft, from functioning in this manner. Very satisfactory air cleaners have been devised, but the old elaborate methods of testing the amount of dirt in the air supply are both expensive and liable to give inaccurate results. A new method of test, which possesses merits superior to its predecessors, is the subject of description in this article. (In our next issue we hope to publish an article dealing very completely with air cleaning apparatus.)—EDITOR.

Introduction

A simple and comparatively accurate method for determining the amount of dirt in an air stream employs a coarse wire screen which supports a thin film of absorbent cotton.

enormous amount of dirt. The turbine-generator alluded to later in this article draws in about 15,000 cu. ft. of air per minute. If it is assumed, as seems reasonable, that this air contains 0.004 grains of dirt per cu. ft., there will pass through the generator in the course of a year one ton of dirt.

A test screen made as will be described later and put in the air intake of any ordinary turbine-generator will collect a very large amount of dirt in a relatively short time. Such an experiment will probably convince the user of the turbine-generator that he should adopt some means for keeping his air supply clean.

Fig. 2 shows a test screen which was placed in the intake of the turbine-generator later described, before any means were used for cleaning the air. The appearance of this screen, compared with the appearance of an unexposed screen, Fig. 1, shows the uncleanly nature of the air supply. This is probably an extreme case, but nevertheless the experiment mentioned is well worth trying in any usual case.

Old Method of Testing for Dirt

A certain system of testing for the amount of dirt contained in the producer gas that is supplied to engines or for dirt in other similar cases has been used for many years. This same system is also used for the purposes discussed herewith. It, however, requires considerable apparatus and careful manipulation, and the accuracy of the final result is somewhat questionable. In arrangement, the system consists of a small exhauster which sucks a sample of air from a point in the main flow, through a dirt collecting tube, and then through a small gas meter. A small intake tube is provided, say about $\frac{1}{4}$ inch in diameter, which is inserted in the stream. This tube is sometimes led to a chamber wherein is placed some dehydrating agent, such as calcium chloride. Then the sample

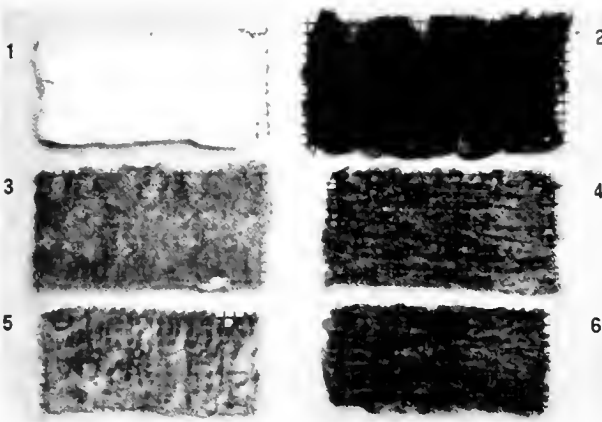


Fig. 1. A Sample of an Unexposed Screen
 Fig. 2. A Screen Exposed for One Week in the Air to a Turbine Generator Without Air Washer
 Fig. 3. A Screen Exposed in Winter for $23\frac{1}{2}$ Hours in the Air to an Air Washer
 Fig. 4. A Screen Exposed for $131\frac{1}{2}$ Hours in the Washed Air from a Defective Washer
 Fig. 5. A Screen Exposed in Summer for 48 Hours in Washed Air
 Fig. 6. A Screen Exposed in Summer for 48 Hours in the Air to an Air Washer

This filter screen is located in the air stream. The method has been used for determining the amount of dirt that is removed by an air washer through which the air passes to a turbine-generator. Cotton screens were exposed in the cleaned and uncleaned air for such periods that each collected about the same amount of dirt. The relative length of the periods gave a good indication of the cleaning power of the air washer.

Dirt in Air

The air supplied to a turbine-generator or to a public room contains what is really an

is passed through another chamber fairly well packed with absorbent cotton. This latter chamber usually consists of glass and is so arranged that it can be readily disconnected from the remainder of the apparatus. Then the sample is led through a gas meter.

The tube containing absorbent cotton is very carefully weighed in a chemical balance before the experiment is begun. The tube is then connected into the pipe line, and the exhauster allowed to suck a sample through the system for an hour or more. The total quantity of gas or air that has passed is read from the gas meter. The cotton-filled collecting tube is then weighed a second time. Sometimes the tube is dried by heating before each weighing. The difference in weight gives the amount of dirt that was collected from the measured amount of gas. This system is open to the following objections:

The apparatus required is expensive. Extraordinary care is required to get accurate results. It is stated that moisture is very difficult to eliminate, and it is quite possible to have moisture on the cotton either before or after the dirt has been collected. This will vitiate the weighing of the amount of dirt. The amount of dirt collected is always very small when compared to the weight of the cotton and vessel so that there may be present the usual errors that develop in obtaining a small difference between two large quantities.

The most serious objection is the question as to whether a fair sample of air can be collected by sucking it into a small tube. In the first place, the end of the small tube usually has a very small area compared with that of the duct through which the main flow is passing so that the sampling tube may unwittingly be placed at a point where there is flowing an amount of dirt above or below the average. This error might be eliminated by moving the tube over all parts of the duct.

Next is the question as to whether dirt and air flow into the end of the tube in the proper ratio. The air flows into the sampling tube in curved stream lines forming a sort of vortex. Do the dirt particles follow these curved stream lines properly, or is there a tendency for a greater or a less than normal percentage of dirt to flow into the vortex? An experiment was made in which sunlight was shining on the dusty air that was sucked into the end of a tube. Many of the dust particles followed curved stream lines to the end of the tube,

but whether the proper ratio of air to dirt was maintained could not be determined from the appearance.

A number of other similar methods, some of them not applicable to the case under dis-



Fig. 7. Test Screen in Uncleaned Air.
A similar screen is placed in the cleaned air beyond the washer

cussion, are described in the *Lancet*, September 20, 1913, page 886. The general conclusion from this paper is that none of the methods known are wholly satisfactory.

Cotton Screen Dirt Test

After considerable investigation of the various methods of testing for dirt, the method herewith discussed was devised and it has proved very satisfactory. Many test screens have been made and have been inserted in air currents carrying various amounts of dirt, in washed and in unwashed air currents, and in washed air currents passing through washers operating at various degrees of efficiency. Satisfactory comparisons have been secured in all cases. No attempt whatever has been made to weigh the dirt collected, as this would probably be quite difficult. The system gives qualitative results with a single screen, or quantita-

tive results by comparison of two screens inserted at different places.

Tests for Cleaning Efficiency of an Air Washer

Many types of air washers are in use for cleaning the air supplied to generators or public halls. These may be any one of four general classes. The most common are the spray washers in which a portion of the conduit is enlarged and subjected to water sprays in various directions which wash the dirt out of corrugated eliminator plates placed just beyond. Abroad, cloth filters are used which consist of large areas of finely woven cotton cloth through which all the air must pass, and the dirt is trapped by the cloth fibers. The area must be very large in order to avoid restriction of the flow. Rotating drums producing a centrifugal effect are also used. These are usually accompanied by some sort of water spray. They are used extensively for cleaning gas and have been applied to cleaning air. Finally, the passage of a current through charged plates, according to the Cottrell system, has been used extensively for purifying smelting fumes and smoke; and this method could of course be applied to cleaning air.

Tests reported herewith show that although such systems remove large amounts of dirt from the air the cleaned air from an air washer is often still somewhat dirty. Similar conclusions have also been reached by Professor Whipple, *Engineering News*, Sept. 18, 1913.

The following is the plan that has been finally adopted for making such tests. Screens are simultaneously inserted in the air current, one in the entrance to the air washer and one in its discharge. The screen in the uncleaned air is allowed to remain for such a length of time that there is an appreciable amount of dirt collected, the time is recorded, and the screen is removed. A second screen is then put in the same place and is left until it is (to the eye) as dirty as the first screen. The time is recorded and the screen replaced by a third one, etc. From time to time the screen in the cleaned air is examined. When it seems (to the eye) as dirty as any one of the set of screens taken from the uncleaned air, the time is recorded and the test is completed. The ratio of the average time of exposure for the screens in the uncleaned air to the time of exposure for the screen in the cleaned air gives the percentage of dirt remaining in the cleaned air.

Tests with a 3500-Kw. Turbine-Generator

Many tests have been made in the case of a 3500-kw. turbine-generator that is installed in the Lynn shop plant of the General Electric Company. This machine has fans installed on the rotor which draw air from an inlet through various passages in the machine and finally discharge it into the atmosphere. These fans pass about 15,000 cu. ft. of air per minute. Near the power-house are coal storage piles. In summer the power-house windows are open which combined with the wind results in a large amount of coal dust being present in the air supplied to the turbine-generator. In winter, the closing of the windows eliminates most of this coal dust. The air supply is drawn from the interior of the power-house at its lower level. There are also nearby a number of auxiliaries which are lubricated with oil. These latter undoubtedly result in a considerable amount of oil vapor entering the turbine-generator. The generator has been examined a number of times and a considerable incrustation of a greasy substance has been disclosed which undoubtedly contains coal dust.

Before any method of cleaning the air was used, a screen was exposed in the inlet conduit for about a week. The final result is shown in Fig. 2. The cotton was wholly covered with a dense black coating. It is quite probable that a screen thus exposed in the air supply to any electrical machine will show a considerable collection of dirt in a comparatively short time.

In order to avoid the risk of the generator burning out due to the accumulation of dirt, a spray system washer was installed. This apparatus collected an enormous amount of dirt. Shortly after the installation but before it was realized how much dirt was being collected, a screen in the water supply, which was supposed to remove the dirt from the water prior to using it again, completely clogged and permitted no water to pass. The screen thereupon broke, destroying of course the value of the apparatus. An improved system for removing the dirt was then installed and various other changes have been made from time to time.

In the course of these experiments the screens shown in Figs. 3, 4, 5 and 6 have been obtained. Fig. 1 shows an unexposed screen for comparison. At first these tests showed that the air washer while removing a considerable amount of dirt also allowed a considerable amount to pass. Successive decreases have been made in the amount of dirt thus

passing. When the amount of dirt became comparatively small the color of the screen exposed in the cleaned air became yellow, while the screen in the uncleaned air was always black or grayish. This has been attributed to the fact that the air washer permitted the passage of a considerable number of oil particles. Thus, when the screens are of different colors it has been suggested that comparison be made by transmitted light.

Preparation of Screens

The testing screens have for a base a section of coarse wire screen of about one-half inch mesh and are from 6 in. by 6 in. to 18 in. by 18 in. One surface of the wires is coated lightly with shellac, and absorbent cotton such as is used for surgical dressings is pressed upon it. After the shellac has dried, the surplus absorbent cotton is peeled off so as to leave a thin uniform film.

X-RAYS

PART III

BY DR. WHEELER P. DAVEY

RESEARCH LABORATORY, GENERAL ELECTRIC COMPANY

This article is the last of a series of three on the physics of X-rays. The first dealt with the nature of the rays, and the second with their properties. This installment gives an elementary explanation of the experimental work which has given support to the theories treated in the initial article, and indicates briefly how these results have been applied in physics, chemistry and crystallography.—EDITOR.

In Part I* of this series it was shown that the electromagnetic theory of X-rays considers characteristic X-rays as being light of very short wave length. It would be reasonable to expect that, if this were so, characteristic X-rays would obey the same laws of diffraction as light waves. The experimental verification of this expectation is one of the most signal vindications of the electromagnetic theory.

Before considering the experiments themselves it will be well to consider the diffraction of ordinary light. Let XX' (Figs. 1, 2, and 3) be a surface opaque to ordinary light, and let B and E be narrow slits. If the two rays of light AB and DE come originally from the same portion of the same source by paths of equal length, then the light-wave at B will be in phase with the light-wave at E . Therefore, B and E will act as exactly similar sources of light. A lens placed at CF will cause the light to appear at the focus as a luminous spot, for the two beams of light will meet in the same phase having traveled equal paths from B and E . If the lens is moved slightly to one side the intensity of the light will be much diminished, for the light from B and E will travel over paths of different lengths. If the lens is moved further to one

side, no light will be seen at the focal spot. But if the lens is moved to a position GH (Fig. 1) such that the difference in path-length is one wave-length, then the two beams once more meet in phase and light is seen. In the same way light may be observed at IJ and KV (Figs. 2 and 3) where the difference in path-length is two and three wave-lengths respectively. The light appearing at CF is usually called an image of the "zero order," that at GH an image of the "first order," etc. The intensity of the light falls off rapidly as the "order" of the image increases, so that only the first few "orders" can be made use of.

An inspection of Figs. 1, 2, and 3 will make it at once evident that, if the angles separating the various orders of images are to be large enough to be measurable with accuracy, the distance d must be comparable with the wave-length of the light used. Thus diffraction gratings intended for use with visible light (wave-lengths in the neighborhood of 10^{-5} centimeters) usually have a grating space d of from 0.002 cm. to 0.0005 cm. Now the wave-length of X-rays is in the neighborhood of 10^{-8} centimeters. It is evidently hopeless to attempt to rule a grating so fine that the lines are only one hundred-millionth of a centimeter apart.

*GENERAL ELECTRIC REVIEW, 1915, April, p. 258.

Haga and Wind* and Walter and Pohl† tried to use a single narrow wedge in the

hope of overcoming this difficulty but they did not achieve much success.

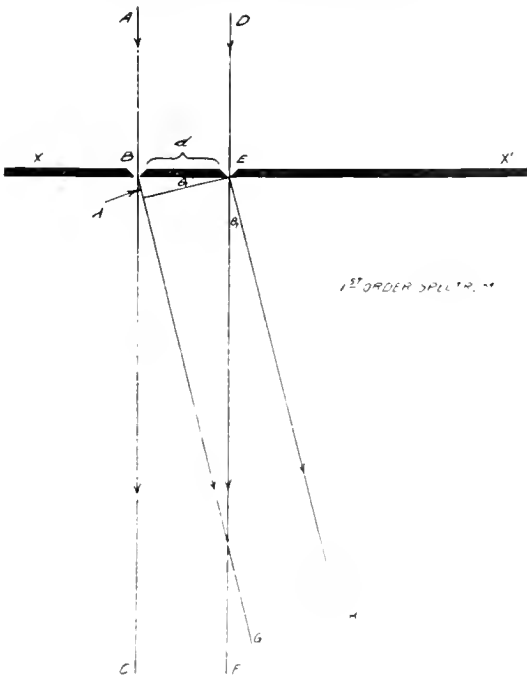


Fig. 1. Diagram showing production of a spectrum of the 1st order

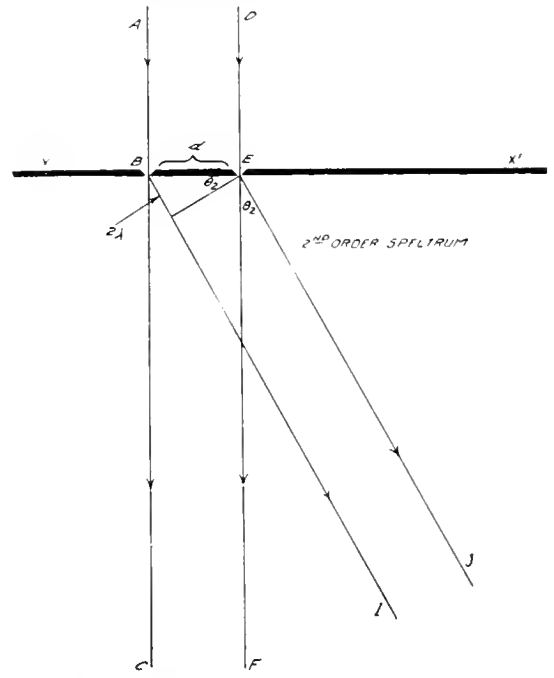


Fig. 2. Diagram showing production of a spectrum of the 2nd order

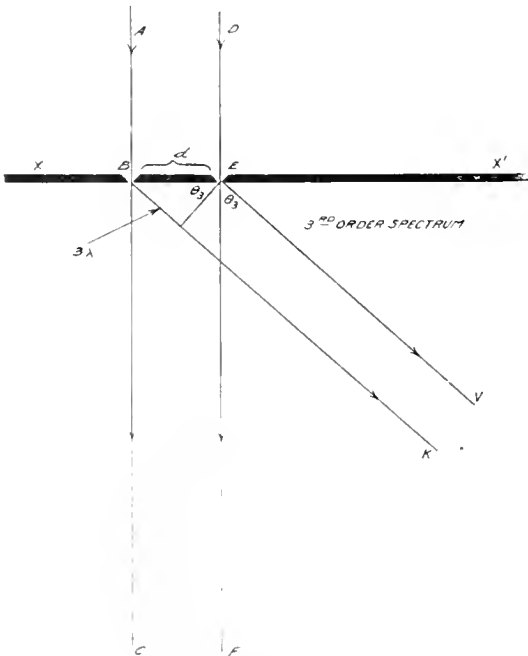


Fig. 3. Diagram showing production of a spectrum of the 3rd order

To Prof. Laue of Munich belongs the credit for the next great step in the diffraction of X-rays. The atoms in a crystal are arranged in a definite systematic formation and their inter-atomic distances are of the same general order of magnitude as the wave-lengths of X-rays, as calculated from theory. Laue,

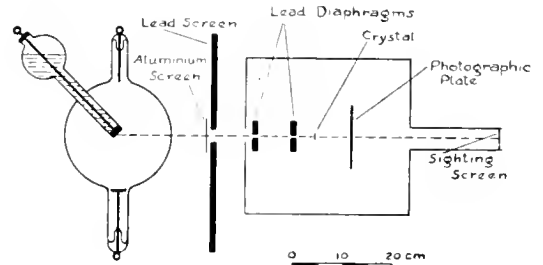


Fig. 4. Diagram of apparatus used by Friedrich Knipping and Laue

therefore, was led to regard a crystal as a ready-made natural diffraction grating for use with X-rays. Such gratings are much more complicated than those used with

* Haga and Wind, Wied. Ann., pp. 884-895, 1899.

† Walter and Pohl, Ann. d. Phys., pp. 715-724, 1968.

ordinary light because of their three-dimensional nature. Friedrich and Knipping* verified experimentally Laue's conjecture. Their apparatus is shown diagrammatically in Fig. 4, and Fig. 5 shows diffraction patterns which they obtained.

It will be noticed from Fig. 4 that Friedrich and Kipping used the crystal as a *transmission* grating. The method was capable of showing that X-rays could be diffracted, but was not

*Friedrich, Knipping and Laue, Ann. d. Phys., pp. 971-1002, 1913.

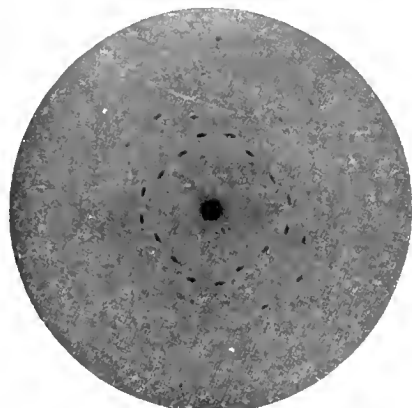


Fig. 5a. Through crystal of Zinc Blend. Rays passed through crystal perpendicular to 100 plane

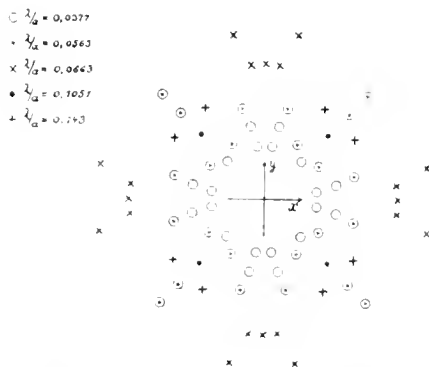


Fig. 5b. Theoretical diagram showing position of possible spots on Fig. 5a

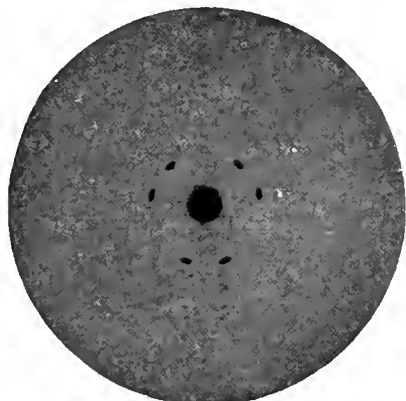


Fig. 5c. Through crystal of Zinc Blend. Rays pass through crystal perpendicular to 111 plane

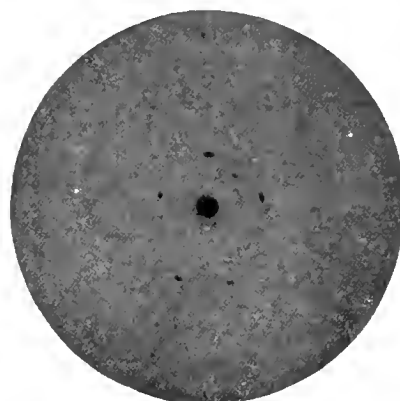


Fig. 5d. Same as Fig. 5c except that the crystal has been slightly rotated



Fig. 5e. Through Copper Sulphate. Rays passed perpendicular to 110 plane

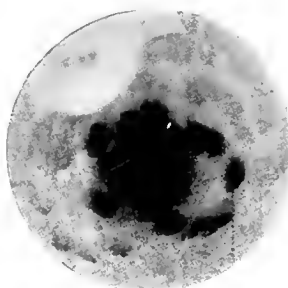


Fig. 5f. Same as Fig. 5e, except that photographic plate is farther from crystal

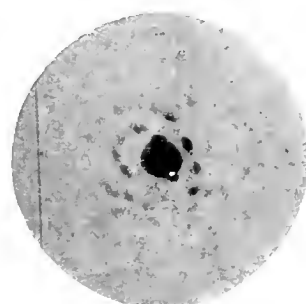


Fig. 5g. Rays passed through powdered Copper Sulphate

Fig. 5. Spectra obtained by Knipping and Laue

well adapted to measuring the wave-length of X-rays nor to a study of crystal structure. W. L. Bragg conceived the idea of using a crystal as a reflection grating (see Fig. 6). This method possesses the advantage that the results are very easy of interpretation, which is evident at once by an inspection of Fig. 7.

The distance MNP is the difference in path-length of the two X-ray beams A_1 and A_2 . If this distance is an exact whole number of

wave-lengths, the two reflected waves are in phase and the wave actually exists. Otherwise, the waves are out of phase and interfere destructively. There are thus only two conditions to be met, (a) the angle of reflection must equal the angle of incidence, (b) the wave-length of the X-rays must be such that it is an exact divisor of the difference in the path-length caused by reflection from the various crystal planes. If the inter-atomic distances and the angles between crystal

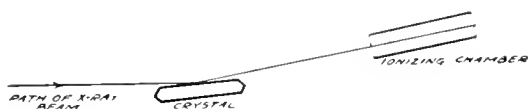


Fig. 6. Arrangement of apparatus used by Bragg

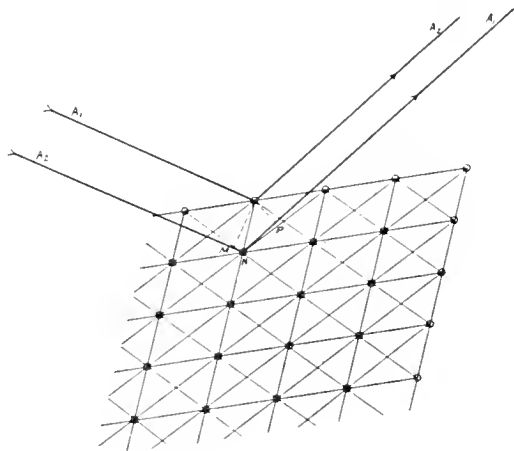
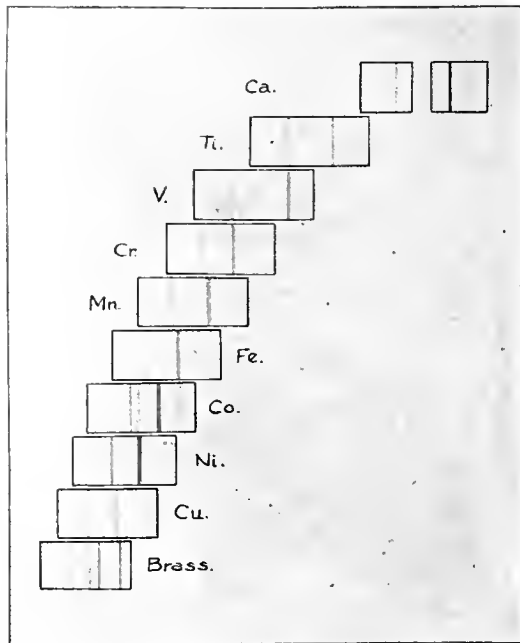


Fig. 7. Diagram showing reflection by atoms in a crystal



→ Increasing Wave Length.

Fig. 10. Spectra obtained using various metals as reflectors

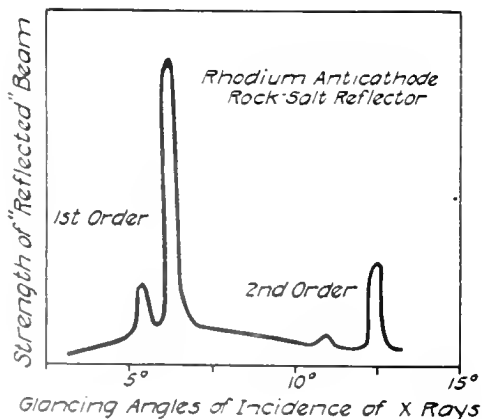
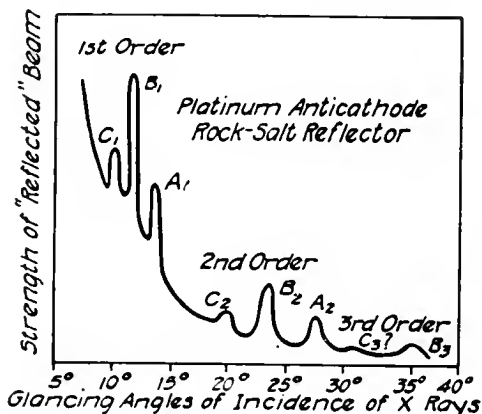


Fig. 8. Spectra obtained by Bragg



planes are known, the wave-length of any X-ray beam may be calculated from the angle at which it will reflect. Conversely, if the wave-length of the rays and the angle at which they reflect from a given crystal face are known, then from the angles between the crystal planes the inter-atomic distances may be calculated.

An attempt has been made in Fig. 7 to show by lines drawn through the atoms that there are many crystal-planes possible in different directions in a single crystal. An inspection of the diagram shows at once that the inter-atomic distance is different for different planes. By examining the various orders of spectra from the various crystal planes, Prof. Bragg has been able to assign a definite arrangement to the atoms of a crystal. Fig. 8 shows two spectra obtained by reflection. Fig. 9 shows the structure of a crystal of a halogen salt of a monovalent metal. The black spots represent metallic atoms, (Na, K, etc.). The white spots represent the halogen (F, Cl, Br, I).

As a result of the work in X-ray spectra, the Mendelejeff table of elements is to be largely replaced by the Rutherford system of atomic numbers (Table I) which is based on the fact that, if the elements are arranged in the order of their atomic weights, the *atomic numbers* are proportional to the reciprocal of the square roots of the wave-lengths of the characteristic X-rays.

A striking instance of the interrelation of the various branches of science is furnished by the work of the physicist in X-rays which has been found useful not only in physics but

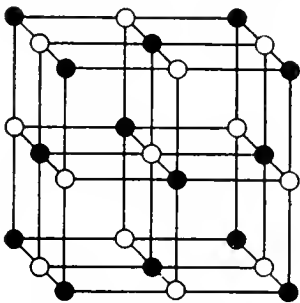


Fig. 9. Arrangement of atoms in a crystal of sodium chloride

also in crystallography and chemistry. The crystallographer is now able to measure in centimeters the distances between the molecules in crystals and is able in many cases to assign a definite structure to them. The

TABLE I
THE RUTHERFORD SYSTEM OF
ATOMIC NUMBERS

Atomic Numbers	Symbol	Atomic Weight	Atomic Numbers	Symbol	Atomic Weight
1	H	1.008	57	La	139.
2	He	3.99	58	Ce	140.25
3	Li	6.94	59	Pr	140.6
4	Be	9.1	60	Nd	144.3
5	B	11.	61		
6	C	12.	62	Sa	150.4
7	N	14.01	63	Eu	152.
8	O	16.	64	Gd	157.3
9	F	19.	65	Tb	159.2
10	Ne	20.2	66	Ho	163.5
11	Na	23.	67	Dy	162.5
12	Mg	24.32	68	Er	167.7
13	Al	27.1	69	Tm _i	
14	Si	28.3	70	Tm _{ii}	
15	P	31.04	71	Yb	172.
16	S	32.07	72	Lu	174.
17	Cl	35.46	73	Ta	181.5
18	A	39.88	74	H'	184.
19	K	39.1	75		
20	Ca	40.07	76	Os	190.9
21	Sc	44.1	77	Ir	193.1
22	Ti	48.1	78	Pt	195.2
23	V	51.	79	Au	197.2
24	Cr	52.	80	Hg	200.6
25	Mn	54.93	81	Tl	204.
26	Fe	55.84	81	RaC ₂	210.
27	Co	58.97	81	AcD	
28	Ni	58.68	81	ThD	208.
29	Cu	63.57	82	Pb	207.1
30	Zn	65.37	82	RaB	214.
31	Ga	69.9	82	RaD	210.
32	Ge	72.5	82	ThB	212.
33	As	74.96	82	AcB	
34	Se	79.2	83	Bi	208.
35	Br	79.92	83	RaC	214.
36	Kr	82.92	83	RaE	210.
37	Rb	85.45	83	AcC	
38	Sr	87.63	83	ThC	212.
39	Yt	89.	84	RaA	218.
40	Zr	90.6	84	RF	210.
41	Nb	93.5	85		
42	Mo	96.	86	Nt	222.
43			87		
44	Ru	101.7	88	Ra	226.
45	Rh	102.9	88	Mes.Th _i	228.
46	Pd	106.7	88	AcX	
47	Ag	107.88	88	ThX	224.
48	Cd	112.4	89	Ac	
49	In	114.8	89	Mes.Th _{ii}	228.
50	Sn	119.	90	Th	232.
51	Sb	120.2	90	Ux	230.5
52	Te	127.5	90	Io	230.5
53	I	126.92	90	RaAc	
54	Xe	130.2	90	Rath	228.
55	Cs	132.81	91	Ux ₂	
56	Ba	137.37	92	U	238.5

chemist now knows that, at least as far as crystals are concerned, there are no such things as molecules in the sense in which the word is ordinarily used in chemistry. The *whole crystal* is a big complex molecule, and

the chemical formula only shows the relative amounts of each element present. It is reasonable to assume that in metals the *crystal* (not the "molecule") is, next to the atom, the unit to be considered. It has even been suggested that it might be possible to use the characteristic X-rays as a means of identifying the various elements, so that a measurement of the wave-length of the characteristic X-rays from a substance would

serve as a qualitative analysis of the substance. Fig. 10 shows in diagram, spectra of the third order obtained by Mosely.* They are so arranged that the scale of wave-lengths of each plate registers with the scale of the plates above and below it. Table II which is of approximate wave-lengths is given for reference.†

* Mosely, Phil. Mag., Dec., pp. 1024-1034, 1913.
† See also GENERAL ELECTRIC REVIEW, 1915, April, p. 263, Table II.

TABLE II
VARIOUS ELEMENTS, THEIR ATOMIC WEIGHTS, AND WAVE-LENGTHS OF THEIR CHARACTERISTIC X-RAYS

Element	Atomic Weight	Wave-Length	Remarks
Calcium	40.1	3.36×10^{-8} cm.	Strong K radiation
		3.09×10^{-8} cm.	Weak radiation
Titanium	48.1	2.76×10^{-8} cm.	Strong K radiation
		2.525×10^{-8} cm.	Weak radiation
Vanadium	51.1	2.52×10^{-8} cm.	Strong K radiation
		2.30×10^{-8} cm.	Weak radiation
Chromium	52.0	2.30×10^{-8} cm.	Strong K radiation
		2.09×10^{-8} cm.	Weak radiation
Manganese	54.9	2.11×10^{-8} cm.	Strong K radiation
		1.92×10^{-8} cm.	Weak radiation
Iron	55.9	1.945×10^{-8} cm.	Strong K radiation
		1.765×10^{-8} cm.	Weak radiation
Cobalt	59.0	1.80×10^{-8} cm.	Strong K radiation
		1.63×10^{-8} cm.	Weak radiation
Nickel	58.7	1.66×10^{-8} cm.	Strong K radiation
		1.505×10^{-8} cm.	Weak radiation
Copper	63.6	1.55×10^{-8} cm.	Strong K radiation
		1.40×10^{-8} cm.	Weak radiation

BALL BEARINGS IN ELECTRIC MOTORS

BY FREDERICK H. POOR

MANAGER SKF BALL BEARING COMPANY

The author has written an interesting article showing the advantages of ball bearings. It is likely that some engineers will not fully agree with him in all of his claims, as it is difficult to make general statements of the kind that can be broadly applied; but that many of his claims are perfectly justified is shown by the increased use of ball bearings. It should be noted that some standard lines of motors manufactured without ball bearings have their bearings sealed against leakage, and therefore this advantage can hardly be claimed as peculiar to ball bearings.—EDITOR.

The motor manufacturer and the motor user have in these days of active competition come to realize the necessity of considering those factors in design and construction which affect cost of maintenance and attention, as well as those which have a bearing on overall mechanical efficiency; and at the same time they cannot afford to overlook features of compactness and reduction in weight, and their resultant effects upon the adaptability of motors to various industrial conditions.

Improvements in electrical characteristics are by no means at a standstill, but in considering them it may be stated that features of mechanical construction taken in detail are receiving a great deal of consideration. As affecting the general progress in motor construction, ball bearings are coming into prominence, and their more general standardization in the electrical industry is assured, both by reason of their extensive employment in various industries, including textile mills, paper mills, flour mills, mines, woodworking plants, street railway service, etc., and the abundant proof of their serviceability under the exacting duties which these industries demand, such as high speeds, heavy loads, dusty mill conditions, and installations subject to neglect and possible abuse at the hands of inexperienced workmen.

As an aspect of this progress we may take for example the use of ball bearings on mining locomotive motors, for here we have operating conditions that are likely to be subject to as little proper attention as will be found anywhere. As indicating a few of the advantages to be derived from the use of ball bearings on this class of motors, a few reports from users of ball bearing mining locomotive motors may be cited. These reports are in reply to a definite series of questions submitted to a large number of mine superintendents. Their reports are as follows:

In reply to a question as to what percentage of time a locomotive with plain bearing armatures is out of service due to the armatures striking the pole pieces, one man gave

as his experience 20 per cent, with a further statement that 30 per cent of these motors give trouble. Another man answered: "We have no plain bearing locomotives—don't want any machinery with plain bearings." A third replied: "Our data are in favor of ball bearings, 50 per cent."

In reply to the question as to how much the total motor repair bill is affected by the use of ball bearings on motor armatures, one man replied 60 per cent and another 50 per cent. A third states: "We are sure there is a large saving."

A third question was put up to the superintendent: "How much have motor failures due to grounds on brush-holders, cables and other parts inside of the motors, been reduced on account of ball bearing armatures?" One electrical engineer said 80 per cent; a general superintendent, 75 per cent.

Analyzing the foregoing replies as a whole we see convincing evidence of, first, decreased maintenance costs and fewer repairs, and second, improvement in motor commutation, a shortening of intervals of motor inspection, freedom from lubrication troubles, etc.

Ball bearings must be lubricated, and in the ball bearing motor construction which has been in service in General Electric mining locomotives for the past two years and a half, a small grease cup within easy access of the operator provides the sole source of lubrication. A half turn a day on the grease cup—possibly a refilling of the cup once a week—is sufficient, because the double row ball bearings are suitably encased within the bearing heads with narrow sealing grooves on each side of the bearings to prevent the leakage of the lubricant into the motor frame. With this protection, little or no overflow into the armature occurs, the commutators are protected against a conducting "slop" of coal dust and oil, and good commutation is maintained.

As affecting maintenance and repairs it should be remembered that in a ball bearing, hardened steel balls roll on hardened steel bearing races, rubbing friction is eliminated,

and accuracy is maintained. Added to this, the self-aligning feature in the SKF ball bearings allows them to accept, without binding, any strains which might otherwise be developed from slight shaft deflection due to the sudden impulses of starting or shock loads. These

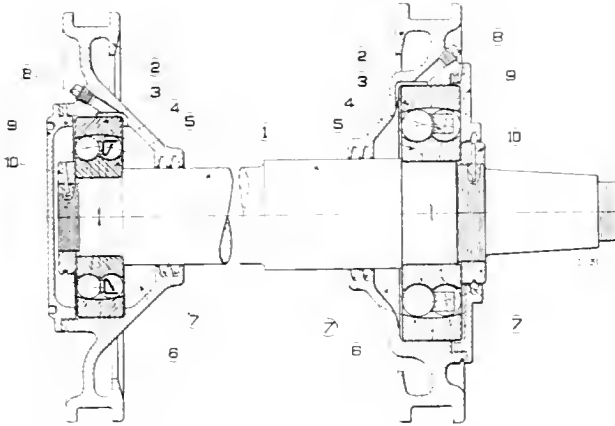


Fig. 1. Mining Motor Heads. 1, Armature Shaft; 2, Motor Bearing Head; 3, Outer Bearing Race; 4, Balls and Retainer; 5, Inner Bearing Race; 6, Lubrication Chamber; 7, Gland to Seal Lubrication Chamber; 8, Grease Feed Pipe; 9, Outside Housing Cap; 10, Lock Nut to hold Inner Race Securely on Shaft

factors insure the maintenance of the motor air gaps and practically eliminate the danger of armatures dropping onto the pole shoes. Their effect upon the accuracy of gear setting and the consequent greater life of the gears is almost as pronounced.

Considering the conditions which surround general industrial applications for induction motors and direct current motors, we find many cases which require compactness. Some motor manufacturers pride themselves on their ability to develop increased horse power out of a given sized standard motor frame. Their ambition is to obtain larger output from a standard unit, a decreased weight per unit of horse power capacity, maximum power in a limited space condition, etc. In striving to achieve these ends, it is well to consider features of mechanical compactness in the bearings, as well as the electrical characteristics which, with a possible stretching of the normal heating limits, permit the motor to be used under exacting space conditions and decreased costs of production.

As compared with a plain bearing, a ball bearing, including a liberal lubricating chamber surrounding it, will occupy approximately one-half to one-third the distance along the shaft required by a babbitt bearing; in some special cases the result being that a ball bearing motor will be as much as 20 per cent shorter than a plain bearing motor of exactly similar characteristics and capacity. This feature is shown diagrammatically in Fig. 3 and further in Figs. 4 and 5, where the plain bearing motor, normally 40 in. overall length, was reduced to 33 in. by the use of ball bearings—a reduction of 18 per cent.

The ball bearing heads are short, compact and rugged, and in installations where space is at a premium, where a consideration of aisle room, floor space, machine arrangement, etc., is necessary, the ball bearing motor goes a long way toward solving the problem. Where conditions of high speeds are to be reckoned with, the designer is confronted with the problem of balancing the allowable bearing pressure per square inch of surface against the surface speed of the shaft in babbitt bearings, i. e., he must seek a compromise between the allowable length of bearings, as opposed to allowable bearing pressures which different methods of lubrication make possible. Oil rings must be used

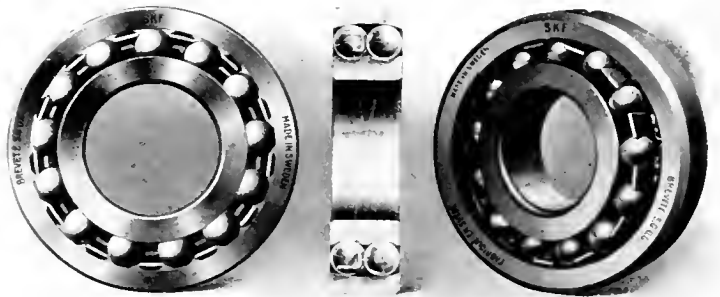


Fig. 2. An SKF Ball Bearing Shown in Normal Sectional and Deflected Positions

for circulation, sometimes chains; in some cases a simple wick will suffice, in others large chambers for waste packing must be provided. These considerations are all based upon the presupposition that bearings in service will be subject to frequent inspection, renewal of

the lubricant, or possibly occasional re-babbiting.

It is true that babbitt bearings as they are at present being furnished in stock motors occasion little complaint from the average motor user, who quite expects to give to them the normal attention now required; but this same user is seeing the constantly increased use of ball bearings on the machines he is using in his shop, on machine tools, on line shafting, grinders, buffers, and machines mentioned previously in classified industries, and is coming to a realization of the material reduction in his shop maintenance costs as a whole which results from their use.

In the flour milling industry, bearings which are sealed against leakage prevent the flour in process from becoming contaminated with oil and they also reduce the risk from fire. As bearing on this last statement, it is of interest to read the report of Mr. John Hoffa, Chairman of the Insurance Committee to the Pennsylvania Millers' State Association, in which he states: "There has been an aggregate fire loss, caused solely by hot boxes in mills and elevators, during the last three years, of over a million dollars."

A similar danger from fire exists in textile mills, where there is frequently an accumulation of oil-soaked lint, etc., around a leaky bearing; and added to this is the possibility of ruining fabrics from dripping oil. In the individual ceiling motor drive or the four-frame drive, where direct connected motors are employed, the possibilities of dripping oil are a constant menace unless the bearings can be sealed against leakage.

In vehicle motors, in motors for grinding rooms, buffing rooms, cement plants or mill installations where an abrasive dust or grit is present, conditions are reversed. Here is a case where abrasive material must be kept out of the bearings in order to prevent rapid wear and the consequent necessity of frequent bearing renewals. Again the bearings must be sealed in some manner.

It is only fair to the ball bearing to examine into how the mounting adapts itself to the conditions we have outlined, and a typical motor mounting will suffice to make the point clear. As will be seen from Fig. 7, the inner race of the ball bearing is securely locked in position against a shoulder on the shaft so that the inner ball race is firmly seated on and forms practically an integral part of the shaft. The outer ball race has a sucking fit in the end shield. On each side of the bearing is a liberal lubricant chamber,

protected against leakage from within or against the intrusion of grit, moisture, etc., from without, by small annular sealing grooves in the end caps adjacent to the shaft on each side. With the lubricant chamber filled with oil to the level of the balls in the lower part of the bearing head, with

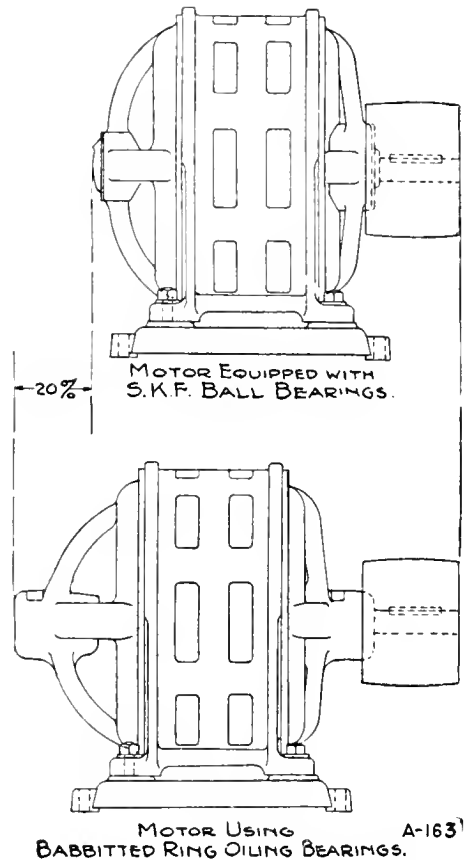


Fig. 3. Comparison of Motor Lengths

a suitable grease, the ball bearing is its own lubricator, without the necessity of oil rings or other auxiliary devices. Alignment is taken care of by the spherically ground surface of the outer bearing race, and a compact, rugged mounting is obtained, free from the inspection of curious and practically proof against neglect. It will further be noted that this arrangement is suited to floor or ceiling use without the necessity of reversal of the motor end shields.

A few words on the selection of the sizes of ball bearings for motors may be of interest. In selecting ball bearings for almost any type

of machine the power normally required for the machine and the speed of the shaft are usually established before the final details of bearings are considered, and with this data available the bearing loads may be pretty closely determined.

Bearings on electric motors are liable to excessive shocks, sometimes vibration, heavy belt loads, and a variety of trying conditions that will vary considerably with the shafting or machines to which the motors are delivering their power. In making bearing selections the designer must take into account the extra strains which occur in the motor, such as those due to vibration (which particularly at great speeds and unbalanced motors can

In mounting the bearings, the inner race should have a tight fit on the shaft and should be permanently seated in a fixed position against the shoulder on the shaft by means of a lock nut or distance piece, the setting being such that the inner race of the bearings forms practically an integral part of the shaft. A driving fit cannot always be relied upon because the continued action of the load on the bearing may tend topeen the shaft, and greater security for the inner bearing race is therefore obtained by locking it securely in position.

When placing the bearing on the shaft, the shaft should be slightly larger than the bore of the bearing in all cases, inasmuch as



Fig. 4. A 40-h.p., 500-r.p.m., 230-volt Shunt Wound Motor equipped with Ball Bearings

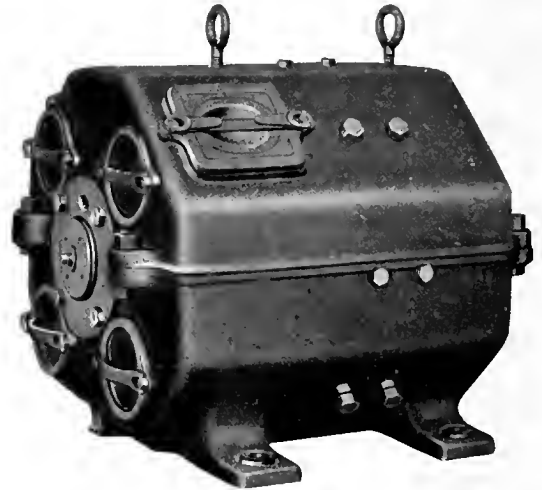


Fig. 5. A 60-h.p., 400-r.p.m., 230-volt Shunt Wound Motor equipped with Ball Bearings

cause a very considerable addition to the load on the bearing), the extra thrust load which may occur if the rotor is not well adjusted in the magnetic field, and the excessive load resulting from unnecessary stretching of belting by inexperienced or careless workmen. Experience has shown that in selecting ball bearings for belt-driven machines the proper bearing capacity may be arrived at by assuming the belt tension to be 350 pounds per inch width of belt, or by adopting a bearing whose rated capacity is approximately five times the predetermined load.

On gear or chain drive, backlash, inaccuracies in machining, and possible conditions of shock which may come from frequent reversals, usually call for ball bearings having a capacity of three times the predetermined load.

the inner race will spring slightly and a good driving fit can thereby be obtained.

The outer races of the bearings should seldom, if ever, be held rigidly in the housing. A slight clearance, i.e., a sucking fit within the housing, will admit of the slow rotation of the outer race when the bearing is in operation, insuring a more perfect distribution of the load over the whole of the outer race, thus obviating any undue fatigue on one section of the outer race while the other section remains entirely unloaded.

As a further requirement for the proper mounting of bearings on the motor it should be pointed out that, where there are several radial bearings on the same shaft, one bearing only should be used to stabilize the shaft against end motion, inasmuch as if an effort is made to fix the outer races of both bearings

against end motion there is immediate danger of cramping, entirely due to difference in expansion of the shaft and the motor frame with changes in temperature, etc.

On direct current motors both bearings may be given lateral freedom in the housing in many cases thereby giving opportunity

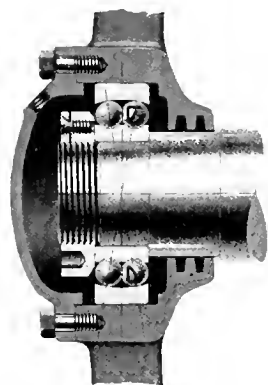


Fig. 6. Sectional View of Ball Bearing Motor Head, showing the Sealing Grooves

for end play and allowing the rotor an opportunity to adjust itself in the magnetic field.

The housing surrounding the bearings should be well tightened to prevent moisture and dirt from getting in, as well as to prevent the escape of the lubricant. The lubricant should actually get down to the bearing, and should be chemically neutral—free from acid, alkali, or other rust-forming constituents.

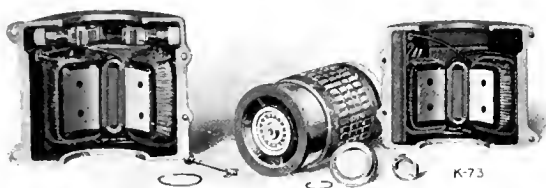


Fig. 8. Mining Locomotive Motor, Disassembled, showing the Ball Bearings

The factors which will in the largest degree affect the successful operation of ball bearings on motors may be briefly summed up as follows:

1. Care in the selection of the bearings. The use of a reasonable judgment, and con-

sultation with the manufacturers of the bearing, who by reason of their experience are competent to give sound advice.

2. Care in mounting. This is a factor which is very largely in the hands of the manufacturer of the motor, for poor machine work on those parts surrounding the bearing,

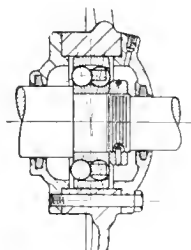


Fig. 7. Mounting of Ball Bearing Induction Motor

either on the shaft or in the bearing housing, must be guarded against; and while this cautionary statement may seem superfluous, it may be stated that there are still a number of ball bearing users who have not yet recognized, or who have not become sufficiently appreciative of, the fact that a high grade ball bearing is an accurately finished, carefully manufactured, and a precise mechanical specialty, and a reasonable effort should be made to finish the parts surrounding the bearing with a proportionate degree of care.

3. The third factor, which is none the less important than the two first, is cleanliness. The casings surrounding the bearings should be free from casting sand; they should be thoroughly cleared of all metal chips from the machine work which is done on to them, and if they are allowed to stand a length of time that will develop rust, this should be thoroughly cleaned out before the bearings are mounted.

As a further precaution, it is well to emphasize the fact that ball bearings are normally packed in a preservative grease, and if they are laid on shop benches, containing dust, filings, or metal chips, before they are installed in the motor, there is grave danger of having this grit work into the bearings in operation.

It is to be recommended, therefore, that the bearings themselves should be thoroughly cleaned out by gasoline or kerosene before they are enclosed in the machine.

ELECTROPHYSICS

PART V

By J. P. MINTON

RESEARCH LABORATORY, PITTSFIELD WORKS, GENERAL ELECTRIC COMPANY

This is the concluding article of this author's series on "Electrophysics." In our next issue we hope to publish an article closely allied with this series by Mr. M. E. Tressler. The present contribution deals with the characteristics of cathode ray tubes under two main headings, viz., their vacuum characteristics and the electrostatic effect near the cathode.—EDITOR.

SOME CHARACTERISTICS OF CATHODE RAY TUBES

Introduction

Although the subject matter of this paper is not strictly electrophysics, yet it is closely related to this field, in that it deals directly with an apparatus with which electrophysical research can be carried out. For this reason, this paper, dealing with some characteristics of cathode ray tubes, will fit in nicely with the series on electrophysics, and with an article on the cathode ray tube and its application, by Mr. M. E. Tressler, which is being prepared for the August issue of the REVIEW.

A number of interesting observations have been made and some valuable information gained concerning the cathode ray tube in the work which this laboratory has conducted along this line. In the present paper only two points will be considered, because these are the most important and reveal some interesting facts regarding cathode ray tubes. These two points will prove of value to those who are engaged in work of this nature. The first of the two subjects to be considered is the vacuum characteristics of cathode ray tubes, and the second one is the electrostatic effects around the cathodes.

I. Vacuum Characteristics

In the literature on this subject, reference is made to trouble encountered with "hardening" and "softening" effects in these tubes. The first is an increase and the second a decrease of vacua in the tubes. The changes in vacua may occur either during the operation of the tubes or at other times. If the vacuum in a tube is originally adjusted to the desired value, then any further changes in the vacuum will be undesirable and in many cases will cause the tube to be unfit for further use. The "hardening" of the vacuum usually occurs with continued use of the tube and generally is of a gradual nature. The "softening" effect, however, is usually quite rapid and always occurs during the operation of the tube. If a tube is operated

heavily so that strong rays are produced, the vacuum may be ruined within five minutes. At other times, a tube may be strongly operated for perhaps an hour or so, or even six or eight hours, and then within a few minutes the pressure will increase sufficiently to make the tube of no further use. It would seem that in the case of "hardening" effects the tube acts as if it were exhausted, while in the case of "softening" effects it would appear that some air was suddenly admitted into the tubes to increase the pressure. Vacuum changes such as these make the cathode ray tubes unreliable and unsatisfactory for use over long periods of time, perhaps several years.

Several suggestions¹ have been made to counteract or eliminate these effects. There are four methods. The first an auxiliary side tube made of platinum, or better still, palladium, through which gas can enter the tube when the metal is heated for a few seconds at red heat. This is referred to in Mr. Tressler's paper. This method allows a reduction in vacuum but it is useless for allowing an increase in it. The second method is an auxiliary side tube containing acid sodium carbonate. This salt liberates a gas when a discharge of electricity takes place through it. Consequently, this auxiliary side tube is provided with an electrode, and by passing a discharge between it and the anode the vacuum is reduced. This scheme, therefore, allows only a reduction in vacuum to be obtained. A third method is to have a side tube connected to the main tube through a stop cock. If the pressure becomes too small, a little gas is admitted from this side tube. Another side tube containing platinum-black, which readily absorbs large quantities of gases, is also connected to the cathode ray tube through a stop cock. If the pressure becomes too great, the platinum-black is allowed to absorb a sufficient quantity of gas to give the desired vacuum. The fourth method

is to have the cathode ray tube connected continually to a suitable exhausting system. The vacuum can then be adjusted at any time to any desired degree.

Evidently, the first two methods of vacuum regulation are unsatisfactory for commercial work. The third scheme is not suitable because slight changes in pressure affect the operation of the tubes greatly, and it is difficult to obtain fine regulation by operating stop cocks. Such a scheme as the third one makes the construction of the tubes more difficult. Likewise, the fourth method is unsatisfactory for it is not expedient to have suitable vacuum pumps installed where it is desired to use the tubes.

These difficulties and objections lead to the belief that, if satisfactory tubes were made, it would be necessary to have them maintain constant vacua of the desired magnitudes under all ordinary conditions of operation. In order to accomplish this, it was necessary to first know why the vacuum changes occurred. After this was known, it would be possible to attempt to eliminate them with some hope of success.

It is known that water vapor and other condensable gases will be adsorbed on the surface of glass. It was reasonable to believe, therefore, that on the inside surface of a cathode ray tube, a thin film of gas adhered very tenaciously to the glass. The same kind of a film would also adhere to the surface of the electrodes, the fluorescent screen, the diaphragm, and any other surface within the tube. In addition to these adsorbed gases, the metal electrodes, glass, etc., would tend to absorb gases. Suppose then, that a tube had been exhausted to the desired vacuum, there would still be both adsorbed and absorbed gases bound up with the glass, electrodes, etc., within the tube. Now, if this gas was liberated from the surfaces either during operation of the tube or at any other time, the pressure would increase and the "softening" effects described above would be observed. On the other hand, if gas from the interior of the tube was removed by absorption or adsorption, then the pressure would decrease and the "hardening" effects would be noticed.

With few exceptions, all the tubes showed pressure-increases when they were operated. Usually these occurred during the first few minutes of operation. In several cases, the tubes were operated heavily for perhaps 15 hours and exhausted at the same time. In this way the liberated gases were removed

from the tubes as rapidly as they were freed. Even this would not stop the "softening" phenomenon and there appeared to be almost an endless supply of gases from out of and off of the surfaces within the tubes. It was found, however, that if the tubes were exhausted three or four hours, at perhaps 350 deg. C., sufficient gases were liberated from the surfaces to maintain constant vacua over long periods of time. One tube has now maintained a constant vacuum for almost two years and there is no indication that it will not maintain this vacuum for a number of years, although it is used almost daily. Not one exception to this rule has been found. Some tubes have been operated about 10 hours continuously with such strong rays that one could not touch the glass around the cathodes without receiving severe burns. Even in these most extreme cases, the vacua remained constant. It may be said, therefore, that when tubes are exhausted in this manner they will maintain constant vacua over long periods of time, thus requiring no regulators of any kind. This improvement is of much value and it insures reliable tubes for experimental purposes.

Several questions now naturally suggest themselves. Some of these are:

Were these vacuum changes due to the portion of the tubes where the discharges occurred or could they be partly due to the large ends of the tubes in which the screens were placed?

Were the vacuum changes of an adsorption nature rather than an absorption one?

Were the changes due to moisture deposited on the surfaces within the tubes?

Regarding the first question, it may be said that the vacuum changes were not due to the large ends of the tubes in which the screens were placed. This was shown to be true because the "softening" effects were observed for small test-tubes containing only a cathode and anode. When these small test-tubes were exhausted at about 350 deg. C., they would maintain a constant vacuum just the same as a regular cathode ray tube would. It seems, therefore, that the discharge will cause a film of gas to partially disengage itself from the surface of the glass and electrodes. This liberated gas will then increase the pressure within the tube. Since the temperature-rise of the glass is not over a degree or so during the time required for "softening," it means that the film is partially liberated by some means other than that of heating effect. It is probably true that the

cause of the "softening" effects is directly due to a mechanical or electrical effect, as a result of the discharge within the tube.

Regarding the second question, it is probably true that the gas is adsorbed to the surfaces within the tubes, rather than absorbed within the electrodes and glass walls. This seems to be the case because of the following observations:

Some tubes were exhausted for several hours at about 350 deg. C. They were then operated strongly for, perhaps, three hours, and the vacua remained perfectly constant. The pressure was then allowed to increase quickly to atmospheric value by allowing ordinary air to enter. After standing in this condition for several hours, they were exhausted at room temperature. Then when they were placed in operation, they would soften within a few minutes, just as though they had never been exhausted at a high temperature. They could again be exhausted at about 350 deg. C., and when operated the vacua would remain constant. Allowing the pressure to increase again to atmospheric value and exhausting at room temperature, the same "softening" effects were observed. Even when the pressure increased to atmospheric value for only a few minutes, the vacua would "soften" as though the tubes had never been exhausted at high temperature. (There has been noted only one exception to this characteristic of cathode ray tubes.) These facts show that the gas if adsorbed to the surfaces within the tubes for absorption would require appreciable time. Adsorption would require only a relatively short time for as soon as the admitted gases come in contact with the surfaces of the glass, electrodes, etc., the gas film would begin to form immediately on the exposed surfaces.

It was next shown that water vapor was not responsible for the "softening" effects, because the above phenomenon occurred either when perfectly dry air or ordinary moist air was admitted into the tubes. It would seem, therefore, that ordinary air will form a thin layer of air, the density of which is much greater than ordinary air, over the surfaces of the glass and electrodes within the tubes. A sufficient quantity of this film should be removed, by exhaustion at about 350 deg. C., to eliminate any tendency for a greater or less film to be formed either during the operation of the tubes or at any other time. If this condition is attained no trouble will be encountered due to vacuum changes within the tubes.

II. Electrostatic Effects near the Cathode

The second point to be considered is that relating to the accumulation of electrostatic charges on the glass surrounding the aluminium cathode. Since the cathode is of a negative potential, it means that the positive ions will be drawn toward the cathode end of the tube. Some of these positive ions will strike the cathode while the others will impinge on the glass surrounding it. These positive ions then cause the glass to receive a positive charge. In addition to this, the negative cathode, which is charged to a high potential, induces a positive charge on the glass surrounding it. These two effects continue so long as the tube is in operation. When the potential difference between the glass and cathode reaches a sufficient amount a discharge will occur between them. Discharges of this nature may start either from the glass or the cathode, but they never extend throughout the distance between the cathode and the glass. The discharges may occur several times a second, once every few minutes, or not at all, depending on the strength of the cathode rays and on the initial conditions of the tube.

Such discharges always cause the cathode ray stream to be unsteady and frequently result in flash-overs within the tube between the cathode and anode. The flash-overs were prevented by the use of high resistances of perhaps 100,000 ohms. High resistance lightning arrester rods are especially suitable for this work, and they should be connected in the cathode lead adjacent to the cathode itself. These resistances not only prevent possible damage to the tube and vacuum, due to the flash-overs, but they also cause the tube to operate much more steadily. They do not, however, prevent discharges from occurring between the cathode and the glass surrounding it. A number of investigators have encountered this difficulty and have tried to eliminate it in various ways. To avoid this trouble, Dr. Zenneck² surrounded the cathode with glass formed into small cups ("Hinterkleidungen") as illustrated in Fig. 1-a. Roschansky³, for the same purpose, placed behind the cathode a metallic screen, and filled the space between this and the glass with ruffled tinfoil leaves. This scheme is illustrated in Fig. 1-b where *S* is the metallic screen and *L* the ruffled tinfoil leaves. Grundelach, in his tube, made the cross section of the cathode almost large enough to fill the tube as illustrated in Fig. 1-c.

A tube, made in Germany of Dr. Zenneck's design, was tried but the glass "Hinterkleidung" did not prevent static discharges between it and the cathode. It did, however, prevent them from occurring between the cathode and the glass wall of the tube. The discharges between the cathode and the glass "Hinterkleidung" caused unsteady rays, and for this reason this scheme is not as advantageous as one would wish. The size, shape and position of the cathode, and the kind of glass used, have a great deal to do with the accumulation of these static charges and, therefore, with the operation of the tubes. For example, a cathode of the size and shape shown in Fig. 1-d gives much trouble on account of the frequency of the static discharges between it and the glass. A cathode of the form shown in Fig. 1-e is the most satisfactory of any tried. This form of cathode yields a fairly uniform field throughout the cross section of the tube and permits no concentration of the field at sharp edges. Concentrated fields, due to sharp edges, are quite effective in producing unsteady cathode rays. Plane cathodes of a disk shape and of large areas, are quite satisfactory: Fig. 1-c represents such a cathode. It was found, however, that none of the schemes, with the possible exception of Roschansky's which has not been tried, would prevent the trouble due to the accumulation of static charges on the glass surrounding the cathode.

In order to avoid this trouble the following scheme of exhaustion was found to produce the desired results. It was noticed that tubes whose vacua "softened" during operation never gave any trouble due to electrostatic charges around the cathode. Tubes which had been exhausted several hours at a high temperature in order to eliminate vacuum changes, were always unsatisfactory because of difficulty with the charges. Since the adsorbed gases are liberated from the glass and electrodes during exhaustion at about 350 deg. C., it would seem that the reason why the charges accumulate during operation of the tubes is on account of a film of gas on the glass surface being necessary for conducting away the charges. If a sufficient film is present on the glass, the charges are apparently conducted to the cathode and there neutralized, but if the film is removed, then the charges accumulate until they are neutralized by discharges between the cathode and glass. This phenomenon occurred with any form of cathode and with any kind of glass tried. The explanation, however, as here

given may not be the correct one. Trouble due to electrostatic charges should not be encountered in a tube whose cathode-end was constructed as shown in Fig. 1-f; *M* is a metallic screen fitting closely to the glass and

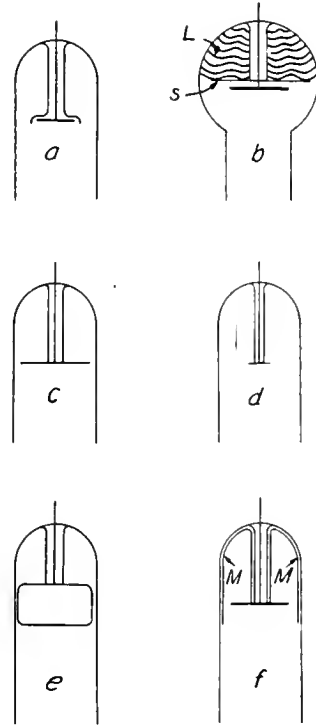


Fig. 1

extending down to the upper surface of the cathode as shown. This construction, however, was not necessary for the following scheme of exhaustion was found to eliminate all trouble of this nature. The idea was to remove a sufficient amount of the film of gas by exhausting the tube at about 350 deg. C., in order to allow a constant vacuum to be maintained, and still leave enough of the film to conduct away the charges, which collect on the glass surface. After some experimenting it was found that if the tube was exhausted at about 350 deg. C. for perhaps half an hour, the vacuum would remain constant during several hours of continuous heavy operation, and no trouble would be experienced on account of charges on the glass surrounding the cathode. Exhaustion at a high temperature for this time was sufficient to avoid vacuum changes over long periods of time. This method of exhaustion has been tried on a

number of experimental tubes and found to be satisfactory. It would appear therefore that why this trouble has been encountered so much, is because the tubes have been exhausted for too long⁴ periods at a high temperature, in order to avoid vacuum changes.

A word may be added as to the effect of the kind of glass on the characteristics of cathode ray tubes considered in the present paper. It may be said that soft glass will give less trouble on account of static discharges than will hard glass. It is also easier to adjust the time of exhaustion at a high temperature, in order to eliminate static discharges around the cathode and still maintain constant vacuum characteristics, with soft glass than it is with hard glass. Soft sodium glass is satisfactory in every way, and it has the advantages of being easily blown and of yielding the characteristic greenish-yellow fluorescence of this glass to help one judge the character of the cathode rays.

REFERENCES

- (a) "A Power Diagram Indicator," by Harris J. Ryan, A.I.E.E., Vol. 30, P. 530, 1911.
- (b) "Apparate und Verfahren zur Aufnahme und Darstellung von Wechselstromkurven und Elektrischen Schwingungen." By H. Hansrath; Helios, Fach-Zeitschrift für Elektrotechnik, Zeite 527, 1914.
- (c) Siehe Z. B., Fortschritte auf dem Gebiets der Röntgenstrahlen, Bd. 18, Heft 2, 1912, Heinz Bauer.
- ² Zenneck—Wied Ann. 69, P. 842, 1899.
- ³ Roschansky—Ann der Phys. 26, P. 281, 1911.
- ⁴ See for example Loc. Cit. 1 (b), P. 527.

CORRECTION TO "ELECTROPHYSICS, PART I"

Mr. Ralph Bown, Instructor in Physics at Cornell University, has kindly called my attention to a slight discrepancy which exists in Fig. 1, Part I, on Electrophysics (see February, 1915, issue of the REVIEW) and which I overlooked in preparing the figure. The quadrants *QQ* should be sufficiently large to give a uniform electric field as far as the screen *S*. The magnetic field should also be uniform over this same distance. The text and equations were based on the assumption of uniform electric and magnetic fields, but, unfortunately, I neglected to say so, although it was what I had in mind. It is to be hoped that this modification in Fig. 1 will eliminate any difficulty anyone may have encountered as a result of this discrepancy.

J. P. M.

HIGH-VOLTAGE DIRECT-CURRENT SUBSTATION MACHINERY

By E. S. JOHNSON

RAILWAY AND TRACTION ENGINEERING DEPARTMENT, GENERAL ELECTRIC COMPANY

The rapidly increasing number of installations of high-voltage direct-current apparatus in railway systems proves the commercial success of that method of operation. As a result, wide-spread interest has been aroused in the design, operation, and characteristics of the equipment. The following article contains very interesting information on the frequency, voltage, current, overload capacity, commutation, influence of short circuits, etc., of the high-voltage direct-current machinery which is being used.—EDITOR.

The idea that the application of 1200 volts or higher voltage direct current to electric railway work constitutes a system radically different from one employing 600 volts, and that the difficulties attending the operation are greater, has been shown to be entirely erroneous.

The design of higher potential direct-current substation machinery follows a logical advance in the design of 600-volt apparatus, not a single good element being discarded or replaced. The one feature that permitted the use of higher voltages was the successful application of the old idea of commutating poles to motors and generators. This has made possible the use of higher voltages per bar and higher commutator speeds, which result in greater output per pound weight, or, as might be better stated, a reduction in the cost per kilowatt capacity.

In the first 1200-volt and 1500-volt installations two 600- or 750-volt machines were connected in series, the fields of both machines generally being connected on the ground side. The design of these machines was identical in every respect with standard 600-volt machines with the exception of the necessary increase in insulation. Experience indicated that the designs then adopted met every condition of operation with marked success, except it was found in a few cases that trouble was experienced by flashing over on those machines in which the brush rigging was supported from the pillow block. In later designs it has been the practice to support the brush rigging from the magnet frame or in some cases from a special yoke attached to the base.

With the exception of 60-cycle synchronous converters, it has become the usual practice in designing substation apparatus (for operation up to and including 1500 volts) to obtain the desired voltage from one machine. Synchronous converters up to a frequency of 35 cycles can be designed to operate at any voltage up to 1500. There are a number of 33 cycle 1200-volt synchronous converters in successful operation, two of the most prominent installations being the 500-kw. machines furnished to the Portland, Oregon,

Railway and the Michigan United Traction Co. The latter machines are insulated for 2400 volts, being operated two in series, and in a number of cases are arranged to supply both 1200 and 2400 volts.

When it is desired to obtain a voltage higher than about 600 volts and not above about 1500 volts direct current from a 60-cycle power transmission system, motor-generator sets are generally used because the desired voltage can be obtained from one machine and the synchronous motor can be arranged to give power-factor correction. Two synchronous converters connected in series, however, give a higher efficiency.

On account of the cost and the construction difficulties of the fields for self-excited generators having a voltage of 1200 or above, it is found advisable to separately excite the machines from a direct-connected 125-volt exciter. Since a separately-excited generator does not automatically drop its voltage on short circuit, the same as a self-excited machine, it is necessary to connect in series with the generator field a resistance that is normally short circuited by a contactor. The contactor is so connected to an attachment on the circuit-breaker that, when the circuit-breaker opens, the contactor also opens and thus the resistance is inserted in the generator field. By this action the voltage at the terminals of the generator is reduced. This arrangement has been used in a great number of cases and has met every requirement for successful operation.

For all voltages higher than about 1500, it is advisable to connect two machines in series when synchronous converters are used on account of the limitations of design; and when motor-generator sets are used on account of the cost. The machines furnished the Butte, Anaconda & Pacific Railroad, and the numerous interurban railways in Michigan, all consist of two 500-kw., 1200-volt generators or synchronous converters connected in series for obtaining 2400 volts. The series fields, commutating fields, and compensating windings of all machines are connected on the ground side. Where two

1200-volt synchronous converters insulated for 2400 volts are connected two in series, the low machine (the one on the ground side) is self-excited and the high machine (the one on the trolley side) is excited from the low machine.

It has been found advisable from a cost standpoint to build all high-voltage direct-current apparatus to carry 200 per cent overload for one minute and sometimes in the case of heavy traction work to design the apparatus to stand 200 per cent overload for five minutes and 100 per cent overload for half an hour. Where direct-current generators are required to stand 200 per cent overload for accelerating a train, it is usual to design them with compensating as well as commutating windings, thus almost entirely neutralizing the armature reaction.

At the time of the general adoption of commutating poles for 600-volt railway apparatus, it was found necessary to use a shunt in multiple with the commutating field windings in order to provide a means of adjustment for obtaining proper commutation. A simple resistance shunt was used with the first machines. With such a resistance shunt, it was found that the machines would either spark very badly or flash over under sudden large variations in load. An elaborate and exhaustive series of tests were made which demonstrated that it was necessary to supply a shunt having inductance as well as resistance in order that the current would divide properly during rapid changes in load as well as when the load was practically constant. Sometimes it is possible to design the commutating field so that a shunt is not required. A small amount of adjustment to obtain proper commutation can be obtained by varying the width of the commutating pole face slightly or by inserting non-magnetic shims between the commutating pole and the magnet frame. The reluctance of the commutating magnetic circuit can be changed by either of these methods.

It is believed that the equalization of the excitation, which will reduce the tendency to flash over on machines having commutating poles, will be obtained by bridging the commutating poles. Recently a big improvement was made in the operation of some commutating-pole synchronous converters by the addition of bridges. These machines are not provided with shunts. As a matter of convenience, it has been found advisable in general operation to supply commutating poles with a shunt winding which is excited directly

from the machine or from the separate source of excitation, so that the commutation of the machine may be adjusted while in operation without being shut down.

Long years of experience have demonstrated that it is not necessary to provide any protection against short circuits, for 600-volt substation apparatus, beyond that given by the inherent impedance of the circuit and the circuit breakers. It is a well known fact that any 600-volt direct-current machine will flash over on short circuit but the resulting damage is not so great but that the machine can again be placed in service after the commutator has been cleaned up. There are no records available which would indicate the frequency with which short circuits occur. In some cases they are very infrequent and in others several occur each day. On a line in which short circuits are liable to occur quite frequently, it has been found that any trouble that has been experienced can generally be eliminated by extending the feeder a short distance from the substation before tapping it to the trolley. One case in particular is known where a substation, located adjacent to a car-barn, was subjected to frequent short circuits due to the peculiar overhead construction and the apparent inefficiency of the car-barn employees. The trouble was entirely eliminated by placing the car-barn circuit on a separate feeder in which was inserted a small amount of resistance.

Due to the greater safety factor in the design of all apparatus for 1200-volt operation, to the care with which the apparatus has been handled, or to the greater inherent impedance of the circuit as compared with 600-volt circuits, short-circuits are of comparatively infrequent occurrence. No records of any great damage being done are available and it is a fact that the writer cannot find that any serious complaints have ever been made of trouble from short circuits on any 1200- or 1500-volt substation apparatus. It has therefore not been found necessary to take special precautions to protect such equipment against short circuits. If trouble did occur, however, the natural step would be to do the same as has been done for 600-volt operation, i.e., to tap the feeder into the trolley system a short distance from the substation. In the initial operation of the 2400-volt Butte Anaconda & Pacific R.R. the switching yards at Anaconda were tied in directly with the main track. On account of the substation being located near the middle

of the yard, short-circuits, which were very frequent, were very severe. The switching tracks were placed on a separate circuit in which the feeder was of considerable length; thus, enough resistance was included to reduce the severity of the short circuits. The operation since has been entirely successful.

The severity of short-circuits depends upon the distance at which they occur from the source of supply, i.e., they depend on the amount of impedance in the circuit. A short-circuit current near the terminals of a machine will amount to about twenty-five times normal current. However, as short-circuits near the terminals are very infrequent (usually taking place at quite some distance from the substation) there is enough impedance in the circuit to reduce the short-circuit current to from 12 to 15 times normal. Such values will do no great amount of damage beyond slightly burning the brush-holders and somewhat blackening the commutator. If short-circuits are very frequent, it would probably be necessary to tap the feeder into the trolley at such a distance from the substation that the current will be limited to eight or ten times normal, as the damage to a machine flashing over at this load would be slight.

Comparison of the short-circuits on 600-volt apparatus with those on 1200- and 1500-volt, shows conclusively that less damage done is to the higher voltage apparatus. The damage seems to be somewhat inversely proportional to the voltage, i.e., it appears that the

damage done varies as the volume of the current which is, of course, independent of the voltage. In general, it might be stated that high voltage apparatus is slightly more susceptible to flashing over than 600-volt apparatus, especially so where one machine is used to obtain 1200 or 1500 volts because, in the design of this apparatus, it is generally necessary to use narrower commutator bars and higher commutator speeds than are used for 600-volt apparatus; thus the flashing distances are shorter. As previously stated, however, the consequences which result from this increased tendency of higher voltage apparatus to flash over need not be seriously considered.

Very serious consideration has been given to the question of introducing reactances in feeder circuits to prevent the current from rising to a greater value than eight or ten times normal before the circuit breaker opens. Calculations and a thorough study of this indicate that the intentional introduction of reactance is not advisable, on account of the excessive cost and the space occupied and because of the inductive kick which would have a tendency to cause the arc to hold across the breaker contacts. It is believed that it would be preferable to introduce into the supply circuit a resistance which will be normally short-circuited by a quick-acting mechanism that will automatically open and place the resistance in circuit before the current reaches a dangerous value.

THE 1500-VOLT ELECTRIFICATION OF THE CHICAGO, MILWAUKEE & ST. PAUL RAILWAY

By W. D. BEARCE

RAILWAY AND TRACTION ENGINEERING DEPARTMENT, GENERAL ELECTRIC COMPANY

The author gives a brief description of the 1500-volt electrification of the terminal line at Great Falls, Montana, which will in all probability ultimately make connection with the 3000-volt installation of the Chicago, Milwaukee & St. Paul Railway. The most interesting features of the substation and locomotive equipment and the overhead line construction are described.—EDITOR.

GREAT FALLS TERMINAL

As a forerunner of the 3000-volt main line electrification, the Chicago, Milwaukee & St. Paul Railway has recently begun electrical operation of the terminal line in the city of Great Falls, Montana. This city is at present the terminal of the new 138-mile feeder line from Lewistown, Montana, connecting with the main line transcontinental division at Harlowton, the eastern terminus of the 3000-volt electrification now under construction. The Great Falls terminal yards are located in the center of the city and are connected by a cross-town line about four miles in length, known as the Valeria Way Line. There are about three miles of additional electrified trackage, making a total of seven miles. The terminal buildings include a large freight house, round house, power plant and passenger station.

The tracks connecting the Falls Yards and the Terminal Yard pass through the business part of the city and it is expected that considerable benefit will be derived from the elimination of steam locomotive smoke from the center of the city as well as a reduction in the cost of train haulage. The traffic includes the transfer of both freight and passenger trains from the Falls Yards to the terminal station as well as switching service in the terminals.

The electrical equipment is of sufficient capacity to take care of 580-ton freight trains operating at about 9½ m.p.h. on the maximum grades of 0.65 per cent. Electric power is supplied by the Great Falls Power Company from the hydro-electric plant at Rainbow Falls, about six miles from the substation. Energy is transmitted at 6600 volts, three-phase, 60 cycles, as generated at the power station.

Substation

The substation equipment is located in the power station operated by the railway company for heating the terminal buildings and includes a two-unit synchronous motor-

generator set with a two-panel switchboard for controlling the alternating and direct-current units. The motor is rated 435 kv-a. (0.8 power-factor), 6600 volts, and operates at 900 r.p.m. Provision is made for starting as an induction motor through a compensator which is operated from the alternating-current panel. The generator is of the commutating pole type, rated 300 kw. at 1500 volts. The set is capable of carrying 200 per cent overload or 900 kw. momentarily. Excitation for the a-c. motor fields and for the shunt fields of the d-c. generator is furnished by a 10-kw., 125-volt direct connected exciter.

The switchboard consists of two natural black slate panels, one controlling the synchronous motor and the other the direct-current generator and feeder. The d-c. panel is of the standard 1500-volt type and carries a remote control, hand-operated switch and circuit breaker mounted between slate barriers at the top of the panel. The motor

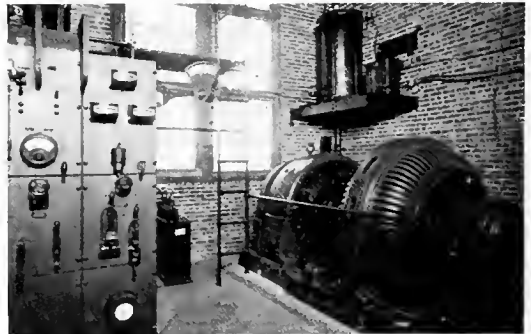


Fig. 1. Part of the 1500-volt Substation Equipment for the Great Falls Electrification of the C. M. & St. P. Ry.

panel contains the usual instruments and starting and operating switches for controlling the motor. An aluminum cell lightning arrester is also installed in the station for protection against electrical storms.

Locomotive

All trains are handled by a standard 50-ton electric locomotive of the steeple cab type designed for slow speed freight and switching service. The running gear consists of two swivel equalized trucks carried on semi-elliptic equalizer springs. The driving wheels are of solid rolled steel, 36 inches in diameter.

The motor equipment includes four GE-207, 750-volt, box frame commutating pole motors insulated for 1500 volts. Each motor has a normal one-hour rating of 79 h.p. at 750 volts, and two motors are connected permanently in series. All motors are ventilated by a blower direct connected to the dynamotor in the cab of the locomotive. The gear reduction is 64/17.

The control equipment is Sprague-General Electric type M, arranged for operation from either end of the cab. There are 10 steps with the motors in series and seven steps in series parallel. Control current for the operation of contactors, lighting and other auxiliary circuits is furnished by a 1500/600-volt dynamotor. A multivane fan carried on an extension of the shaft furnishes air for ventilating the motors.

The current collector is a sliding pantograph similar to that being installed on the main line 3000-volt locomotives. The slide is



Fig. 3. Locomotive shown in Fig. 2 hauling freight train

The compressors are located in the cab of the locomotive convenient for inspection.

A headlight is mounted on each end of the locomotive provided with a concentrated filament type Mazda lamp of about 100 c-p.

As a safety precaution no trolley wire is installed inside of the round house. A connection is made in the cab of the locomotive for applying power to the locomotive through a length of special flexible cable insulated for 2400 volts. A double-throw switch in the locomotive cab allows connection to be made either to the trolley or cable circuit.

Line Construction

The overhead line construction is of the catenary type similar in a general way to that installed on the Butte, Anaconda & Pacific, 2400-volt railroad. Both span and bracket construction are used, depending upon local conditions. Poles are spaced approximately 150 ft. apart on tangent track supporting a 4/0 grooved trolley from a three-point suspension. There is no feeder copper installed.

The work was done by the Electrification Department of the Chicago, Milwaukee & St. Paul Railway, R. Beeuwkes, engineer in charge, under direction of Mr. C. A. Goodnow, assistant to the President. All of the electrical apparatus including locomotive, substation equipment and line material was furnished by the General Electric Company.

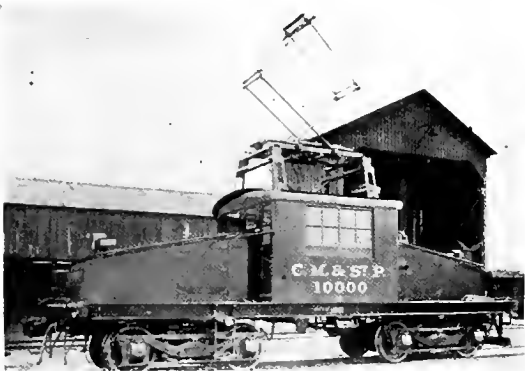


Fig. 2. 1500-volt, 50-ton Locomotive on the Great Falls Electrification

lifted into position by air pressure and is held against the wire by steel coil springs. Provision is made for operating at trolley heights varying from 17 to 25½ ft. above the top of the rail.

SOME RECENT DEVELOPMENTS IN SWITCHBOARD APPARATUS

BY E. H. BECKERT

SWITCHBOARD SALES DEPARTMENT, GENERAL ELECTRIC COMPANY

Control and protective apparatus for electric power systems must of necessity undergo almost constant change in design, owing to the ever higher voltages and larger capacities that are being employed. In some cases a change in existing types will suffice to meet all requirements, while in others entirely new designs are required. This article describes some of the more recent modifications and developments that have been made in switchboard apparatus, including relays, oil switches, circuit breakers and instruments.—EDITOR.

As power and lighting systems become more extensive, and operating voltages climb higher and higher, as generators and generating plants grow in capacity, as new fields are opened for the application of electricity and the old fields are gone over and changes made, it becomes necessary to develop new controlling apparatus or change existing apparatus to meet the new demands. At the same time the buying public are becoming more and more exacting in their requirements in order to properly protect their financial interests and safeguard against accidents.

The following paragraphs give a brief description of some of the most interesting developments in switchboard apparatus which have lately come into existence, as a result of the above conditions and the desire of manufacturers to improve their product along lines indicated by active original research work.

Relays

Probably no branch of switchboard apparatus has experienced more marked advance than that of relays. Selective relays of various sorts have become a necessity in large systems in order to properly protect operator and consumer. It means much to each of these parties to reduce to a minimum the loss due to short circuits, grounds and overloads in different parts of a system, and to insure continuity of service as far as this is possible. Upon the relay devolves this important duty.

On parallel transmission lines, on tie lines between generating stations, and on generator and motor-generator sets operating in parallel, it is often desirable to provide means for automatically cutting out lines or machines in trouble due to a short circuit or ground when a reversal of power is caused, and at the same time not disturb the rest of the system. The reverse power relay in several forms has been developed to take care of this

situation. It is of the dynamometer type with current and potential coils, the arrangement of which is shown in Fig. 1. With energy flowing in the normal direction in the circuit, the contacts are held in the normal position by the pull of the relay, which increases with increase of energy in the normal direction. Consequently, no amount of overload will cause the relay to operate as long as it is not accompanied by a reversal of energy; but the relay may be relied on to operate on a reverse

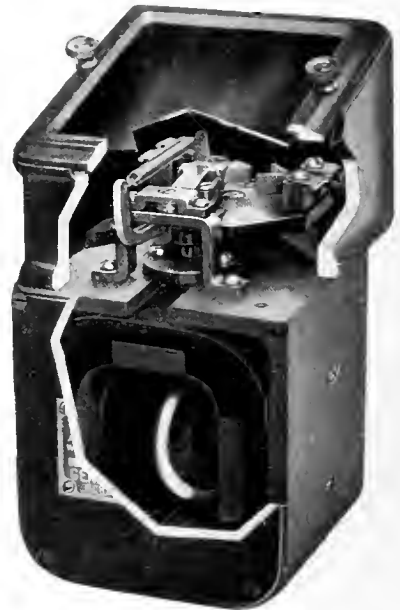


Fig. 1. Reverse Power Relay

power short circuit even though the potential is greatly reduced.

These relays are made in three forms, one (form E) having single-throw circuit closing contacts, another (form E-2) having single-

throw circuit opening contacts, and the third (form E-3) having double-throw contacts and requiring for its operation a pilot wire between stations and a time delay low-voltage relay. The application of the different forms is as follows:

(1) For two generating stations connected by one line, with power normally feeding in either direction. To disconnect this line at both ends in case of trouble on the line, use E-3 at each end of line.

(2) For two generating stations connected by two lines, with power normally feeding in either direction. To disconnect the line in trouble, leaving the other in operation, use E or E-2 at each end of each line, the current coils of the relays being interconnected. The same scheme can be used for more than two lines by using additional relays and properly interconnecting them. (The E-3 connected at each end of each line could also be used, but the arrangement given is less expensive because of the fact that with the E or E-2 no pilot wires between stations are necessary.)

(3) For two or more generators connected to one bus. To disconnect the generator in trouble and not disturb the others, use E or E-2 connected between each generator and bus.

(4) For motor-generator sets or synchronous converters. To prevent pump back, use E or E-2 connected between machine and bus.

(5) For two or more lines from generating station to substation only. To disconnect line in trouble without disturbing others, use E or E-2 at the substation and time limit overload relay at generating station end of line.

Fig. 2 illustrates the connections of the E-3 relay, using a single-phase diagram for simplicity. With energy flowing in the same direction at both ends of the line, all the contacts of the relays will take a uniform position. If the direction of energy should change on the whole line, all contacts would simultaneously reverse, bringing them again to a uniform position. Under these circumstances, the circuits of the low-voltage time

delay relay will be unbroken, and the tripping circuit will therefore be kept open. The time limit feature is added to the low-voltage relays simply to insure sufficient delay to

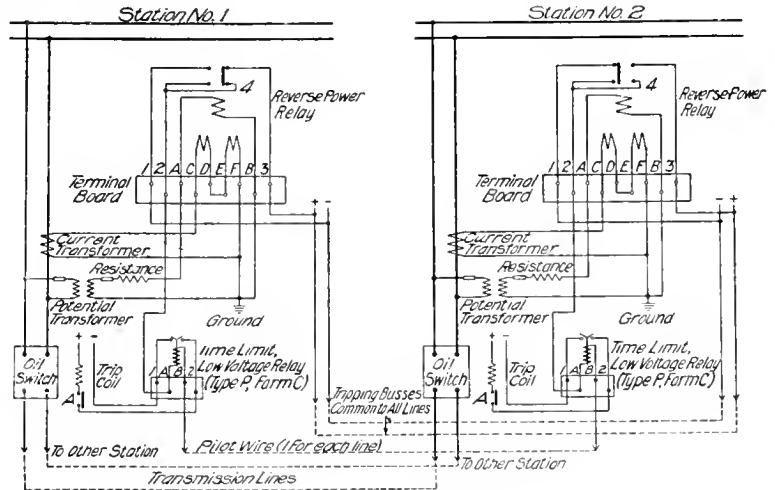


Fig. 2. Connections of E-3 Relay

allow all relay contacts to swing to their proper positions on the occurrence of a normal reversal of energy in the tie line. In case of trouble between stations, causing power to flow from each end of the line, the relay contacts at one end will remain normal, while those at the other end will be thrown to the opposite side. This will open the circuit of the low-voltage relay and cause its contacts to complete the circuit through the tripping coil of the oil switch. The contacts of the relay will remain in the position which caused the oil switch to open on the occurrence of the fault, and must be reset by hand before the next operation. This is made possible by the use of a knurled button at the front of the relay. The relays should be set to operate at some value above normal load on the circuit so that a reversal of power under normal operating conditions will not cause the relay contacts to be operated.

OIL SWITCHES

Improvement in Form H Oil Switches

Recently these oil switches have undergone some structural changes to make the circuit rupturing parts more accessible for inspection, adjustment and repair. Also the cap on the oil vessel as well as the lower oil vessel clamp has been changed to allow metal straps to be bolted between cap and clamp, as is very clearly

shown in Fig. 3. These straps have added greatly to the security with which the caps are fastened in position, a valuable feature when the switch is called upon to open heavy overloads or short circuits.

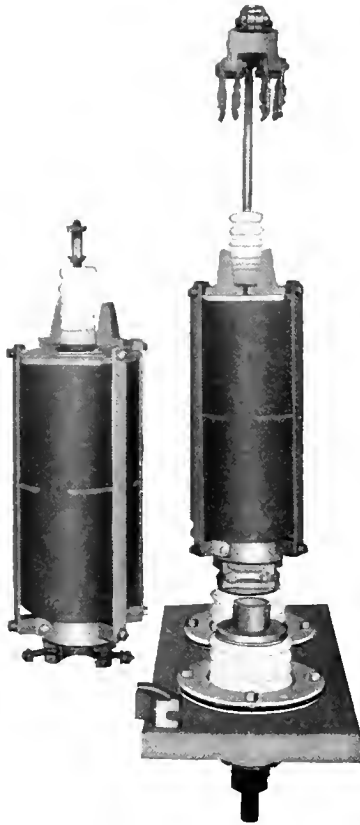


Fig. 3. Oil Vessels of Type F Form H6 Oil Switch showing the easily removable parts

For ready inspection of contacts and oil vessels, switches up to 35,000 volts inclusive are provided with easily removable parts. The construction is shown in Fig. 3, which pictures one pole of the switch with one of the oil vessels, the movable secondary contact and fixed contact being removed. To remove these parts it is necessary, after the switch is opened, to remove the nut at the top of the contact rod, loosen the clamping nut on the crosshead, and push the contact rod down into the oil vessel; then loosen one swing bolt nut on the lower clamp on the oil vessel and remove the unit, consisting of oil vessel and fixed and removable contacts.

In order to supply the trade with a switch which will most nearly suit its needs and

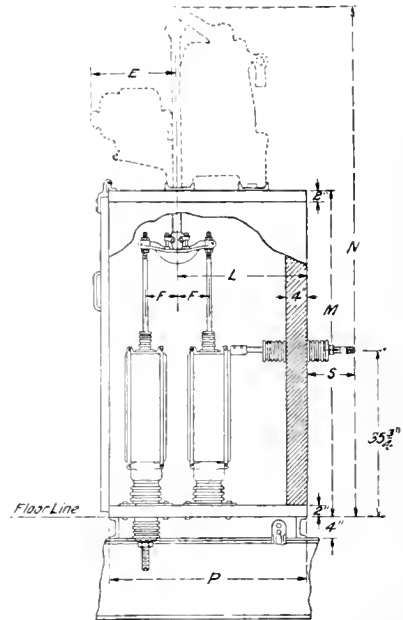


Fig. 4. Bottom and Back Connected Type F Form H3 Oil Switch

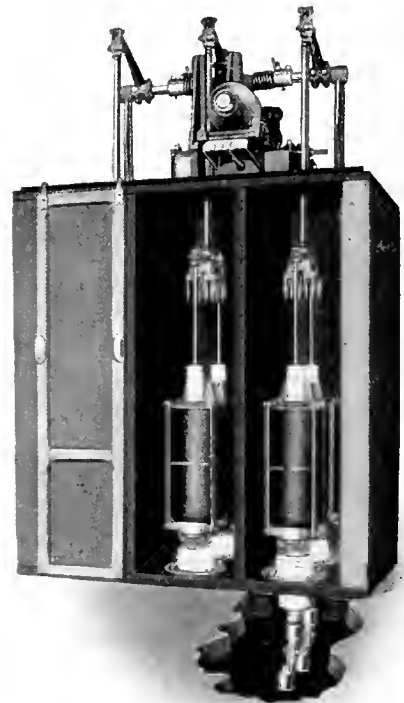


Fig. 5. Type F Form H6 Oil Switch with Poles arranged in parallel

which will give the engineer an opportunity to work out the design of his station to the best advantage, the line of motor-operated oil switches has been extended, so that all 15,000-volt switches may be obtained with studs so arranged that connection can be made at bottom and back, as shown in Fig. 4. The poles of the switch can now be obtained either all arranged in parallel as shown in Fig. 5, or all in tandem as shown in Fig. 6. In the case of the tandem arrangement, switches can be obtained either bottom-connected as shown in Fig. 7, or back-connected as shown in Fig. 8. From the illustrations it is seen that a very complete line is available, and the engineer should have no trouble in choosing something that will fit in with his station arrangement.

Type F Form K26 and KO26

New 45,000-volt and 70,000-volt indoor and outdoor oil switches have been developed which can be mounted on a supporting framework or on the floor as desired (Fig 8a). The framework is provided to allow for the easy removal of oil tanks by means of tank lifters. The indoor and outdoor switches are similar except for the necessary change in bushings. The remaining features are practically the same as in the type F form K21 oil switch, the tanks being slightly larger in size and

the insulation increased. Fig. 8a shows the indoor switch with the first tank entirely removed.



Fig. 8a. 45,000-volt Type F Form K26 Oil Switch

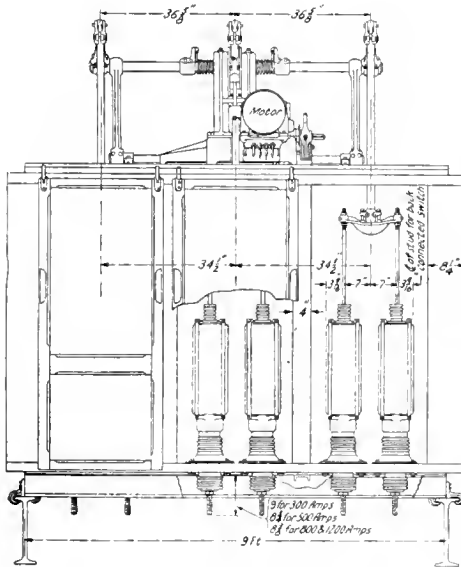


Fig. 6. Type F Form H6 Oil Switch with poles arranged in tandem

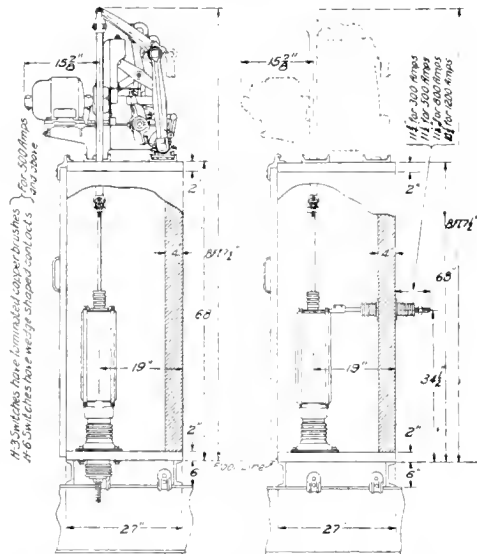


Fig. 7. Type F Form H6 Oil Switch with poles arranged in tandem — bottom connected

Fig. 8. Type F Form H6 Oil Switch with poles arranged in tandem — back connected

Type F Form K25 Oil Switches

Figs. 9 and 10 represent two capacities in a new line of 600-volt oil switches, including the 3000-, 4000- and 5000-ampere sizes. In these switches laminated brushes very similar to those of the larger capacity circuit breakers are used to carry the main current, although the final arc is always broken on auxiliary contacts. In the 3000-ampere switch these brushes are in the oil, while in the larger capacities the brush is above the oil tank and the final break is made on a set of auxiliary contacts under oil.

In all switches the tanks are mounted on a framework, allowing for their easy removal and inspection of internal parts. The 3000-ampere switch may be furnished hand-operated, the others electrically operated only.

Type F Form K24 Oil Switches

A line of K24 switches has also been introduced having rupturing capacities somewhat lower than the K21. These switches are supported on pipe framework and have tanks and contacts similar to those of the K21. They are available in capacities of 300, 500, 800 and 1200 amperes at 15,000 volts, and 300 amperes at 35,000 volts. Fig. 11 shows a 35,000-volt switch of this type.

Tank Lifters

To enable the station attendant to more readily and quickly remove or attach oil switch tanks of the form K switches, the manufacturer has produced several different designs of tank lifters. Figs. 12 and 13 show the construction as applied to the type F form K12 switch.

The device consists of two separate triangular supports, one for each side

of the tank, to the top of which are fastened steel wire cables. These cables pass over pulleys and around a shaft operated by a worm gear. The tank rests upon continuations of the triangular supports bent at right angles to fit over the rim at the bottom of the tank. The pulley shaft is mounted on a casting containing a triangular slot and can be moved forward or backward on an arm which rests

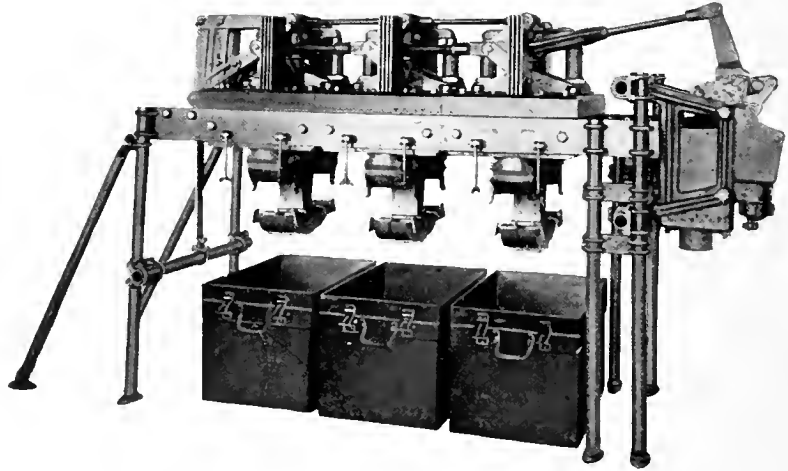


Fig. 9. 3000-amp. 600 volt Type F Form K25 Oil Switch

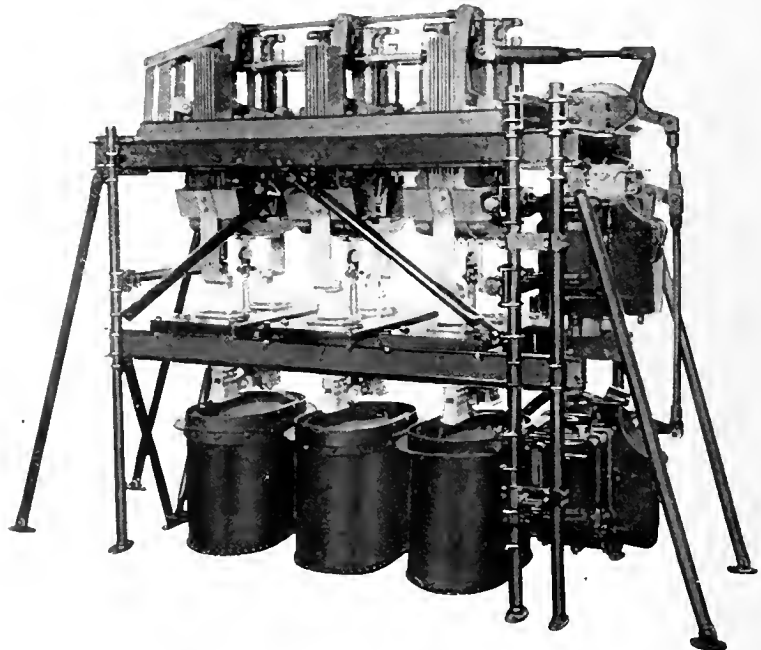


Fig. 10. 4000-amp. 600-volt Type F Form K25 Oil Switch

on the switch frame and also supports the operating shaft, gear and handle.

The raising and lowering of the tank is of course accomplished by turning the handle operating the worm gear. The tank can be lowered to the floor or can be suspended in any intermediate position. The triangular supports are removed from the tank by lifting one end of the tank slightly and sliding the support from underneath.

High Tension Series Trip

Series overload mechanisms which act by direct mechanical means to trip open high tension oil switches have often been the subject of severe criticism on account of the inaccessibility of the working parts. It has been rather dangerous to inspect, clean or adjust the mechanism which is in direct connection with the high-voltage current.

To obviate these difficulties, a scheme has been devised whereby the only portion of the tripping mechanism alive at high potential is a solenoid, constructed so simply and ruggedly that it requires practically no attention. As shown in Fig. 14, the solenoid is supported on a post type insulator, the plunger of the solenoid connecting directly with the releasing mechanism of the oil switch. Change in current setting is affected by means of a calibrating mechanism at the oil switch. The time limit feature is obtained by employing an oil dashpot mounted at the switch. If the switch and mechanism are

grounded, as is always recommended, either the current or time setting can be accomplished, if necessary, while the switch is alive, although

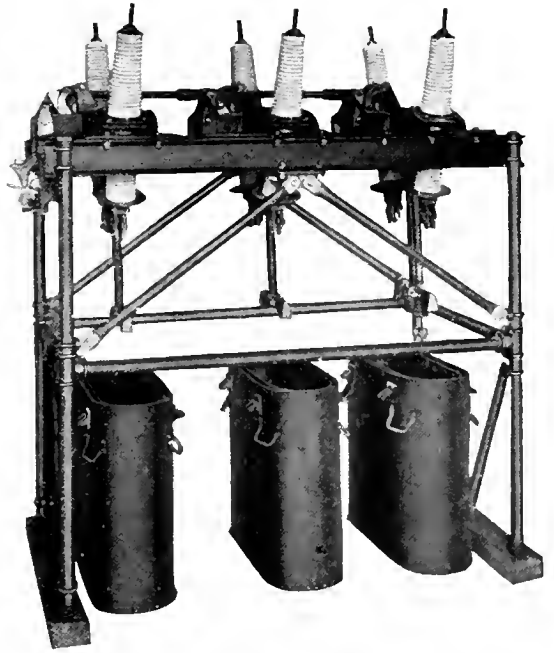


Fig. 11. 300-amp. 35,000-volt Type F Form K24 Oil Switch

it is recommended that the switch be entirely disconnected from the line whenever this is possible.

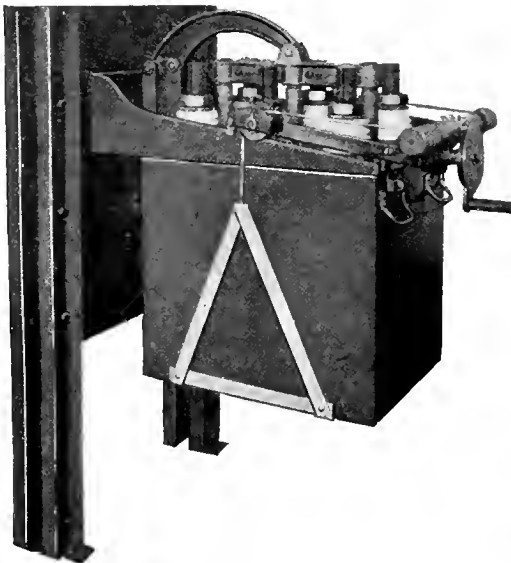


Fig. 12. Tank Lifter in position to lower tank

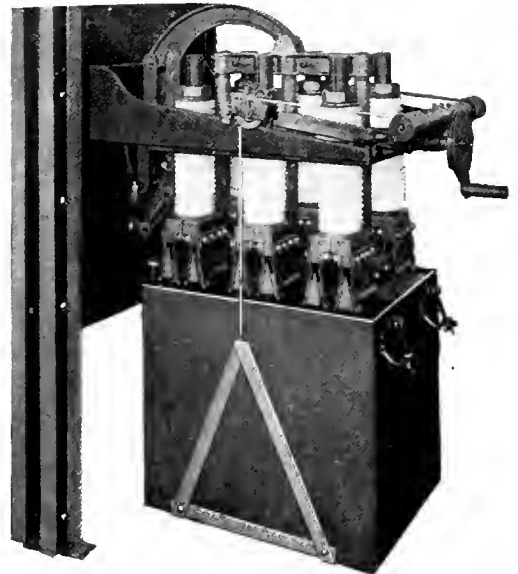


Fig. 13. Oil Tank partly removed by tank lifter

Employing practically the same principles as before, a series overload relay has been designed, the chief difference being that the plunger of the solenoid, instead of acting mechanically upon the tripping mechanism

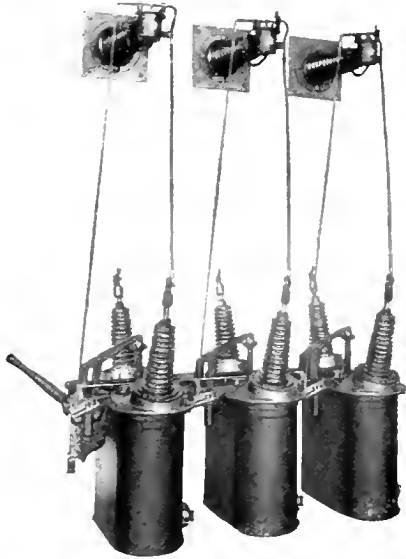


Fig. 14. Time Limit Series Trips on a 35,000-volt Type F Form K21 oil switch

of the switch, closes contacts which in turn complete an auxiliary electrical circuit through the trip coil of the switch.

Type F, Form P4 Oil Switch

Fig. 15 shows one of the latest designs in oil switches for manhole service, having a special bell chamber for entrance leads. This switch is intended for service in locations where there is danger of flooding, and all current-carrying parts are entirely enclosed in a compact cast iron frame oil tank, bell chamber and cover. The leads are carried to and from the switch through bell chambers at the bottom of the frame. This bell chamber is similar to the G-E interior end bells used on incoming lines, and it is so constructed that a triple conductor cable may be brought entirely within the water-proof compartment before the lead sheath is removed. This chamber affords ample room for separating the strands of the cable and connecting them to the switch terminals. The chamber may then be filled with an insulating compound and made entirely water-tight.

The bell chambers, as well as the oil vessel and cover, are made of cast iron and are securely bolted to the cast iron switch

frame. All these joints are made watertight by the use of gaskets, and the switch is tested totally submerged under water for 24 hours.

The operating handle is outside the frame and is of such design that the switch can be operated with a hook. The shaft to which the handle is attached passes through the frame in a water-tight stuffing box. These switches are made single, double, or triple-pole, single-throw, for use on currents up to 10,000 volts. The normal rating is 200 amperes.

LEVER SWITCHES

Automatic Throw Over Switch

A sudden failure of the source of power for the lighting system in the power station is a more or less frequent and troublesome occurrence. To take care of such an emergency and facilitate the reestablishment of normal conditions where apparatus may have been shut down due to the failure of power, a switch for automatically throwing the lights to an auxiliary or reserve source becomes very handy. The switch shown in Fig. 16 accomplishes this result. The device consists

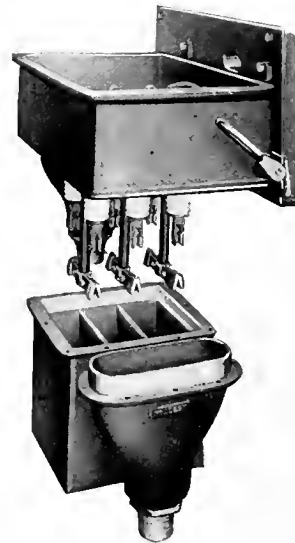


Fig. 15. 10,000-volt 200-amp. Type F Form P4 Oil Switch with special bell chamber

of a special double-throw switch held closed by a latch on one throw against a pair of springs.

To close the lighting circuit with the normal source of power in operation, the switch is thrown in the lower set of contacts and latched

in the closed position by hand. When a failure of the source occurs, a low-voltage release is caused to drop its armature, tripping the latch free from the crossbar above it. The springs on the hinge clips of the switch then quickly force the switch into the upper set of contacts, which are connected to the reserve source of power. At the same time an auxiliary switch at the top is thrown into contact, causing a bell or other indicator to operate to attract the station attendant's notice. After the resumption of normal conditions, the switch must be thrown by hand into the lower contacts and latched.

These switches can be obtained in 100-, 200- and 300-ampere 250-volt capacities, and either double or triple-pole. Besides being valuable in power stations, this switch finds a useful field in the lighting system of large buildings, such as hospitals, office buildings and apartment houses, in which the installation of a storage battery as a reserve source is not likely to be too large an item of expense.

Type L Form D16 Lever Switch

For starting six-phase synchronous converters from the a-c. end, using taps on the power transformers, two triple-pole double-



Fig. 16. Automatic Throw-over Switch

throw lever switches are necessary, the running throw of one switch carrying the full load current of the machine. The capacities of these converters have been steadily increasing,

necessitating larger and larger starting switches, until such a capacity has been reached that it is next to impossible to operate the switches by hand. The split lever con-

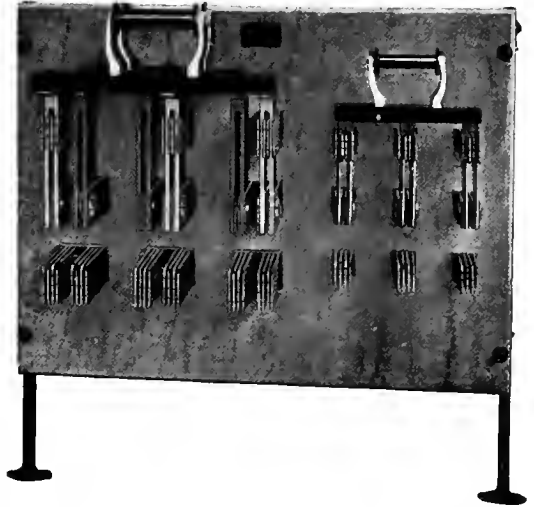


Fig. 17. Synchronous Converter Starting Panel showing split pole lever switch

struction was then resorted to. Fig. 17 shows a starting panel for a six-phase converter, the switch on the left of the panel being of 4000 amperes capacity. It has the crossbars with separate handles, one-half of the blade of each pole being fastened to each crossbar. The upper contacts are connected to the two-thirds taps on the transformers for only a short time, and are arranged to make contact only with that half of the switch which must be thrown first to the lower or running side. Half of the blades readily carry the load until the operator throws over the second section. Large triple-pole switches such as this are easily operated, whereas the alternative would be a much more expensive set of large solenoid operated circuit breakers. Converter starting switches of this construction of 5000 amperes capacity are in use and are operated without difficulty.

CIRCUIT BREAKERS

20,000 Ampere Circuit Breaker

In Fig. 18 is shown a 500-volt d-c. automatic solenoid-operated circuit breaker of 20,000 amperes capacity, a number of which have recently been built. The breaker is operated by two solenoids mounted below the main contacts (which consist of three brushes in one frame), which act in unison. It

will be seen from the illustration that the breaker mechanism to the point where the operating rods from the solenoid are connected, is very similar to the toggle arrangement of the large capacity hand operated

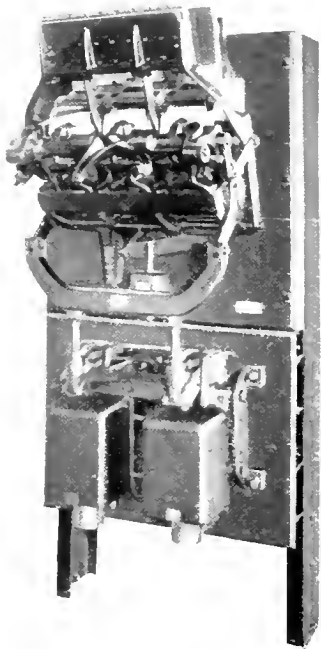


Fig. 18. 20,000-amp. 500-volt Circuit Breaker

breakers. Each solenoid consists of a closing coil only, the automatic tripping of the breaker being accomplished by its overload armature striking the holding-in latch and the tripping of the breaker from the control switch being effected by means of closing the circuit through a shunt trip coil whose plunger strikes the latch. It is possible to close the breaker by hand, using two handles which can be inserted in sockets shown on the illustration. The breaker is supplied with laminated studs.

High Voltage Circuit Breaker

The introduction of 2400-volt direct current in the operation of electric railways has necessitated the design of new apparatus, a problem of some difficulty being the production of an efficient automatic circuit breaker. After considerable experiment and thorough tests the design in Fig. 19 was completed. The construction is similar to the lower-voltage breakers, the chief difference being that the 2400-volt breaker is remote controlled, while the secondary contacts and their adjacent

parts are changed. The carbon break has given way to a magnetic blowout of an unusual design. For the construction of this blowout, two large flat barriers of a non-combustible insulating material form an arc chute and effectually confine the arc in a vertical plane. On the outside of this chute there are iron pole pieces which become magnetized when the breaker opens under load. A strong magnetic field is consequently produced throughout the entire space between these pole pieces. On account of the large magnetized area, the arc from the breaker will be greatly extended and blown out and broken.

This breaker is mounted remote from the panel and operated by a lever on the front of the panel, the breaker being insulated from the lever by a wooden rod. The breaker is also insulated from the base upon which it is mounted by porcelain supports. The illustration shows also the lever switch which is connected in series with the breaker and operated by a lever from the front of the panel.

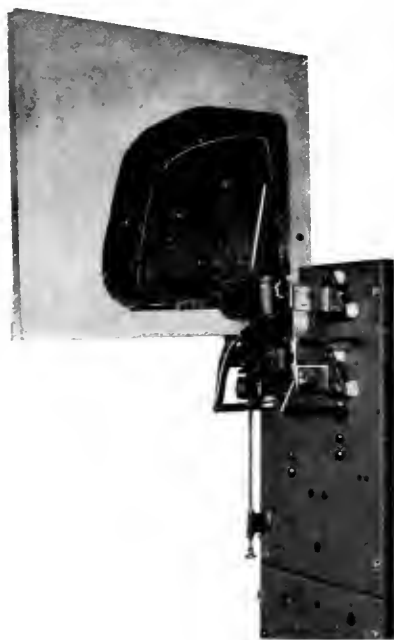


Fig. 19. High Voltage Breaker used on 2400-volt d-c. systems

Laminated Studs

For use on circuits of heavy current capacity, a line of rectangular laminated studs (Fig. 20) has been developed, and it is recommended that they be used on a-c. circuits of 3000-ampere capacity and over, and on d-c. circuits

of 5000 amperes and over. The advantage gained is that the laminations of the connection bar fit in between the laminations of the stud, forming a joint which cannot work loose and making it unnecessary to bend the bar or to tighten a number of large nuts, and at the same time greatly simplifying the arrangement of connection bars at the back of the panel. Studs can be obtained with the laminations arranged in either a vertical or horizontal plane.

INSTRUMENTS

Electrostatic Synchronism Indicator

Synchronizing on high tension lines, while often desirable, has been out of the question because of the excessive cost and space required for installing the necessary potential transformers for a secondary synchronism indicator. A glow synchronism indicator is now available for this purpose on circuits of 13,200 volts and above. The new indicator depends for its operation upon the principle of electrostatic discharge in a vacuum.

The instrument case resembles the ordinary round pattern switchboard instrument. Inside the case are receptacles for holding the special glowers which project through holes in the cover. Connections from the line to the device are made through condensers, which consist of suspension insulators having an insulation equal to that used on the line. Normally the glowers have the appearance of ordinary spherical frosted incandescent lamp bulbs. When, however, there is a proper difference of potential across their

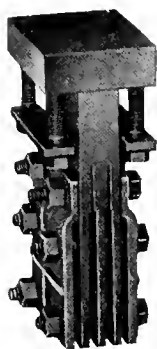


Fig. 20. Laminated Stud for 6000-amp. circuit breaker

terminals they will glow with a reddish hue. When the lines are not in synchronism, the glowers will light up in succession, showing the relative direction of rotation and indicating whether the incoming machine is

running fast or slow. When synchronism is reached there will be no rotating effect, and one glower will be dark while the other two will glow at about half brilliancy. For synchronizing two lines, the instrument is usually



Fig. 21. Electrostatic Synchronism Indicator and disconnecting switches

mounted on a panel with disconnecting switches as shown in Fig. 21. The equipment can be made suitable for any voltage by simply connecting in the proper number of insulators.

Temperature Indicator

It is of great value to know the temperature of certain parts of generator and transformer windings that are inaccessible for thermometer measurements. An instrument known as the temperature indicator has been produced to determine these temperatures. Copper coils of known resistance are placed in the parts whose temperature it is desired to know. The changes in resistance are shown on the scale of the indicator, which is marked in degrees centigrade corresponding to the change in resistance. The instrument itself is a differential voltmeter with three terminals. The connections are such that one of the moving coil windings is in series with a resistance coil which has a zero temperature coefficient and a resistance equal to that of the copper temperature coil, and the other winding is in series with the copper temperature coil. When the temperature of the copper coil rises, the current in that branch of the circuit decreases

and causes a corresponding deflection toward a higher temperature on the scale of the instrument. The reverse is the case when the temperature falls.

Tuned Circuit Frequency Indicator

A frequency indicator with a large angular deflection for each cycle variation becomes a necessity where great accuracy is demanded.

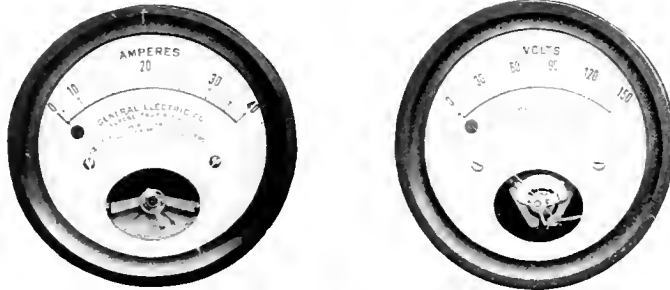


Fig. 22. Alternating-current Ammeter—Direct-current Voltmeter

An instrument known as the tuned circuit frequency indicator has been produced, which admirably fills this requirement with its long scale and large movement of needle for each small change in frequency. This new frequency indicator differs from earlier types principally in that capacity has been added to the resistance and inductance common to nearly all other indicators. The value of the condenser is apparent when it is considered that in instruments of the moving pointer type, the entire operating force is obtained by splitting up the single-phase potential circuit in such a way that a change of frequency affects one portion to a greater extent than the other. Inductance is more impervious to higher frequency, while capacity has an action just the reverse. Therefore, by combining both inductance and capacity in proper proportion, it is possible to obtain an instrument with a much greater movement of armature and pointer for each unit change in frequency than can be had with the older resistance-reactance type.

The tuned circuit frequency indicators are provided with scales approximately six inches in length. Normal frequency is marked at the center, the standard scale markings for a 60-cycle instrument being from 55 to 65 cycles. For special work they can be furnished with a maximum deflection as low as one cycle or as high as 10 cycles each side of normal. The same principle can be applied to the curve-drawing frequency indicator.

Semi-Flush Type Instruments

To fill the demand for an inexpensive instrument for small boards, there has been put into production two new lines, which are known as the semi-flush type (Fig. 22). The two lines comprise ammeters and voltmeters only for direct current and alternating current. As the name implies, these instruments fit into recesses in the panel which receive that

part of the case containing the mechanism, the necessary holes in the panel being $4\frac{1}{2}$ inches in diameter. The d-c. instrument has a D'Arsonval movement and the a-c. is of the inclined coil magnetic-vane design.

Busbar Support

In stations of large capacity special precautions should be taken in supporting buses in compartments, due to the great

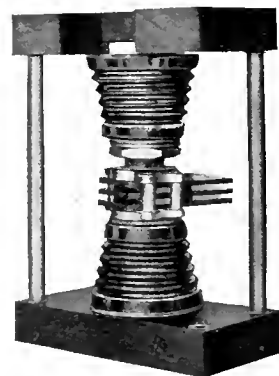


Fig. 23. Busbar Support for Compartments

stresses which are exerted under short circuit conditions. Fig. 23 shows a late design of such a support. It consists of two porcelain insulators, fitted loosely into the horizontal compartment barriers as shown. Two alloy clamps of similar design, held apart by four

brass pillars fitting loosely into holes in the clamps, form the support for the bars. The top clamp has a threaded stud extending into a hollow in the top insulator. By tightening the nut on this stud against the top insulator, the whole support is held firmly in place. By loosening this nut to the limit of its travel against the top clamp, it is possible to lift the top clamp for the reception of new lamina-

tions of bus or to remove the top insulator, there being just enough play to permit it to clear the top stud. Subsequently the remaining parts of the support can be easily removed for repair or inspection. The individual laminations of the bus are separated by fillers, and the number of laminations can be varied at will by using pillars of the proper length.

THE SMALL CONSUMER—A PROBLEM*

BY A. D. DUDLEY

COMMERCIAL AGENT, SYRACUSE LIGHTING CO., SYRACUSE, N. Y.

The small consumer offers a problem that is always present with Central Station managers. In many instances, no adequate return accrues on investments for this class of consumers. Mr. Dudley discusses both gas and electric small consumers and takes up the various phases of these problems.—EDITOR.

The small consumer problem confronts all gas and electric companies and deserves more serious consideration than it has been given in many locations. Both the gas and electric companies are interested in the solution of this problem and, therefore, the subject is treated from both viewpoints.

The small consumer can be divided into two classes:

1. The consumer who is a small user of gas and electricity and by nature of his existence offers little, if any, possibility of development.

2. The consumer whose monthly bill is small because he has never been shown how or through what medium his own gas or electricity could be used to his own advantage (as well as to the Company's).

The most striking example of the first class or the consumer offering little, if any, possibility of development is found in buildings having small offices. Even though electricity is used as much as is needed and in a diversity of ways, the consumption will always of necessity be small and in many cases would be unprofitable without the minimum bill charge which most electric companies are allowed.

In such locations, the consumption of gas is even smaller, in fact, is practically nothing in many instances. The gas meter is retained by the consumer for auxiliary or emergency use and is a burden of expense to the majority of companies for want of a monthly minimum

or meter rental. This condition is without doubt very serious at the present time. A recent analysis of our ledgers disclosed the fact that about ten per cent or some 3000 gas meters yielded us less than 50 cents a month. For the most part, these meters were located in offices and rarely, if ever, were used or in other places where effort to stimulate consumption would be wasted. More serious still is the fact that, as the use of electricity becomes more general, the number of gas meters installed for emergency use will materially increase and some provision whereby the unprofitable consumer can be eliminated, if not imperative, would, to say the least, be most desirable.

Any company that has not already analyzed or classified its ledgers will be surprised at the result. In no other way will the importance of the small consumer problem be brought home more forcibly, and the data thus obtained will give just the material needed to apply practical methods for a remedy.

As a result of our own analysis we found that, in addition to the unprofitable consumers previously named, there were many more consumers who were using gas and electricity in a limited way only; and our total list of small consumers greatly exceeded our expectations. We found, for instance, that 1500 electric consumers were using less than the minimum of \$1.00 per month.

The field offers ample opportunity to increase the yearly revenue and accomplish the desired end of making the small consumer

* Read before the National Electric Light Ass'n and the Empire State Gas & Electric Ass'n, May, 1915.

more profitable. Efforts should be made in this direction as no additional investment is required in the way of line extensions, not even a service meter is needed.

Inspection and maintenance, to a limited extent, will do much to increase the consumption on appliances now in use. A consumer may be a small user because many of his sockets are empty, the oven of the gas range may be out of commission for the want of new linings, and the electric iron may have been laid on the shelf for six months because of a burned-out element or a broken plug. Until our sign flashers were placed under a regular maintenance system for which the consumer gladly pays, signs were frequently out of commission and the consumer constantly irritated. Bringing these matters to the consumer's attention and aiding him to have them remedied will necessarily increase his consumption. In a certain instance an extensive inspection campaign was carried on in a large city and it yielded a material increase in revenue.

Demonstration work is closely allied to inspection work and may well be covered at one and the same time. This work, covered more advantageously by women, extends the use of installed appliances. Many of the pies, cakes and cookies now bought outside would be prepared at home if the cook or housewife understood better the operation of the gas range oven. It is a well known fact that thousands of broiling ovens have never been used for lack of demonstration. The uses of an electric grill are many. With the different fittings of a vacuum cleaner, a variety of work can be done. At the time an appliance is sold, it may be explained fully but a demonstration in the home after the owner has used it very often assures a more continuous use.

More important than maintenance and demonstration is the sale of new appliances. This is the surest way of developing the small consumer. An analysis of this phase of the subject should bring out plans and methods which have been tried and proven effective in the development of the small consumer. The important considerations are as follows:

Are you selling the right appliances and offering wide enough variety? Is your selling plan liberal enough to reach the small consumer? Are your prices right? Have you the right kind of a sales force and are you paying the salesman enough to warrant your expecting a more rapid development than you are getting? These questions are asked to present different views and ideas and to learn how the "other fellow" has been successful in making the small consumer a large one.

Whatever the sales plan adopted, it is vital to know where one stands before he start lest much time and money be wasted. It is not only necessary to know what a small consumer has, it is of greater importance to know what he has not. No industry has a better opportunity to keep in close touch with its consumers. None come in personal contact with them oftener. Granting that to a certain extent the small consumer is unavoidable in our business as well as in every other line, nevertheless we all have more than we should because we allow that condition to exist. The solution may be a matter of maintenance or demonstration; the adoption of an intensive sales plan; the introduction of a new appliance or perhaps only more courteous treatment. In any event, there is no reason why a policy of securing, developing and holding cannot be adopted and followed that will reduce to a minimum the number of small consumers in the territories in which we operate.

MODERN STREET LIGHTING WITH MAZDA LAMPS

By H. A. TINSON

EDISON LAMP WORKS, HARRISON, N. J.

The high efficiency Mazda lamp in the larger sizes is being extensively used for street lighting in the smaller cities and towns, and in the outlying sections of cities of the first class. A number of installations are illustrated and described in this article, and some recommendations are made respecting the spacing and height of units, and the reflector equipment for certain conditions of street lighting.—EDITOR.

Up until the year 1907 very few incandescent lamps were used for street lighting purposes. Those that were employed for this purpose operated at about $3\frac{1}{2}$ watts per mean horizontal candle-power, and could only be obtained in low candle-power sizes. Eight years ago tungsten filament lamps were introduced and these marked the successful application of incandescent lamps to street lighting on a large scale.

The lamps were made to operate at an efficiency about three times that of those hitherto available, i.e., carbon filament lamps. As a consequence of this development, a very large number of incandescent lamps were installed throughout the country. However, owing to the fact that they were commercially produced in sizes up to 350 candle-power only, with the exception of ornamental cluster lighting, they fulfilled the requirements where only relatively low power light sources were needed.

With the introduction of the Mazda tungsten filament lamp in high candle-power sizes last year, a complete change in the field of application of this lamp took place. The results of this new development in street illuminants will undoubtedly be far-reaching, especially as there are likely to be still further improvements in this type of lamp. It should now be quite practicable to light the main highways in the country districts and it might be expected that considerable attention will be given to this class of lighting in the near future.

In this country most street lighting installations are operated on the series system and are controlled by means of a constant-current transformer or regulator. The Mazda lamp, especially in the low candle-power sizes, can be manufactured with a much higher operating efficiency when designed to use a relatively high current at a low potential, and it is therefore particularly suited to series operation. The current values generally adopted follow those originally found most suitable for the enclosed arc lamps, i.e., 6.6 or 7.5

amperes. Mazda series lamps made according to these ratings offer the largest selection in candle-power sizes, which range from 32 to 600. One-thousand-candle-power lamps are made and some even higher have been produced, but as the filaments in these sizes operate at a current of 20 amperes a suitable device at the lamp is used to step up the series line current to this value. In fact, auto or series transformers are commonly used with 400- and 600-candle-power lamps in order to secure higher efficiency.

From the preceding it must not be assumed that a series system is always to be preferred. While series incandescent lamps operate at a higher efficiency than those of the multiple type, there are many other factors to consider before it can be determined whether a series system is to be preferred to a multiple one. The multiple lamps are primarily designed to be used for interior illumination; however, many thousands of them find application in street lighting—notably where Edison direct-current three-wire systems exist, as in the hearts of several of the larger cities.

Fig. 1 illustrates diagrammatically the steps which have been made in the development of the series incandescent lamp during the last 15 years.

As might be supposed, the advent of Mazda lamps in so wide an application to street illumination has necessitated the development of suitable fixtures and apparatus for their use. Thus, there have been recently introduced a large number of lighting units, which may be classified as follows:

- Heavy substantial pendent units for high power lamps.
- Light weight, low cost pendent units for high power lamps.
- Pole top units.
- Open and enclosed units, mostly for low power lamps, used on brackets or center suspensions.

The accessories, such as reflectors, opalescent enclosing globes, refracting globes, auto-

ADVANCES IN EFFICIENCIES OF SERIES INCANDESCENT UNITS
1900 — 1915.

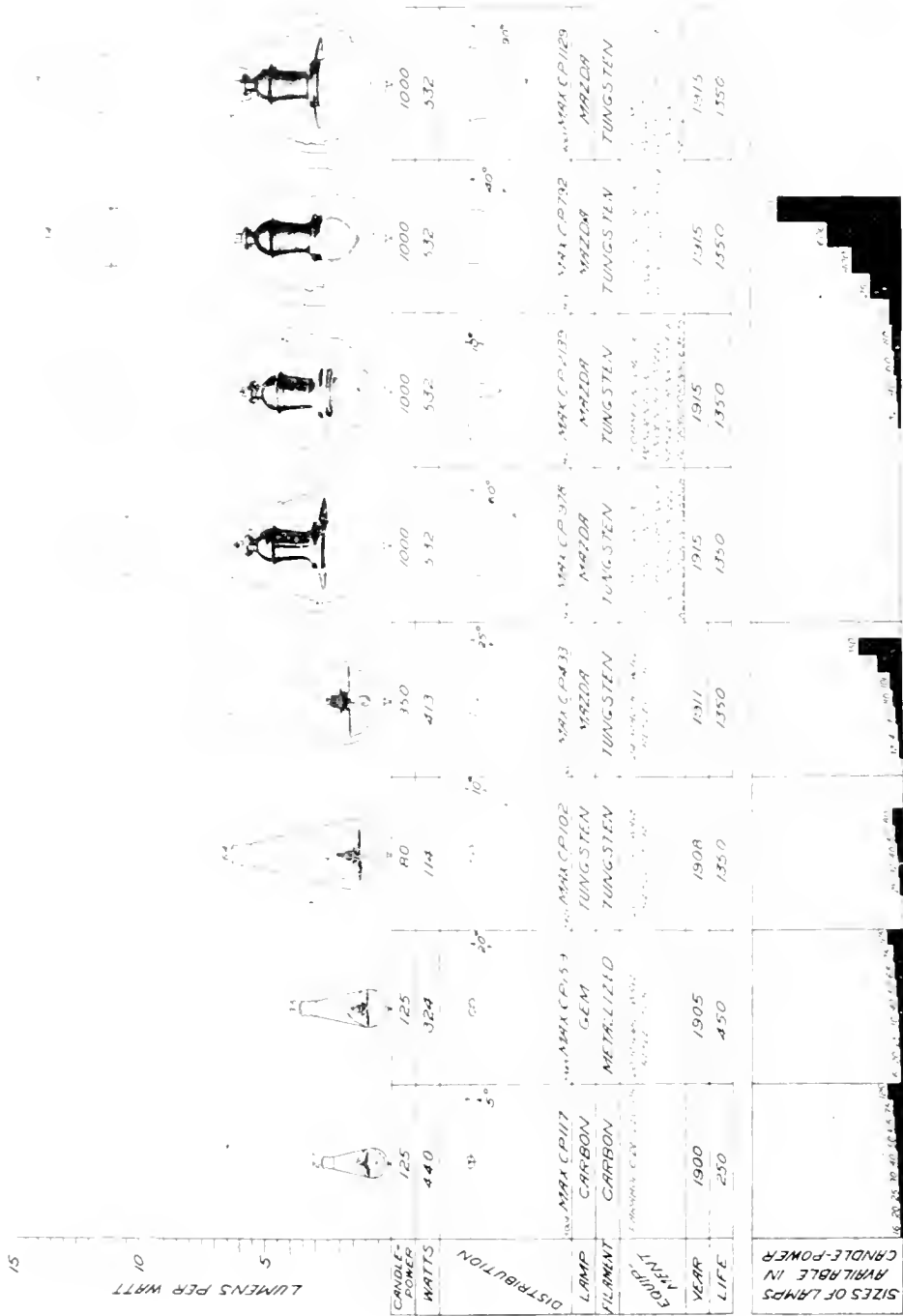


Fig. 1. The Advance in Efficiencies of Series Incandescent Units, 1900-1915

transformers, series transformers, cutouts, sockets, etc., can be obtained in such variety that there is now practically no class of street lighting nor local condition that cannot be adequately provided for when installing Mazda lamps for exterior illumination. The fixtures and other units cover a complete line for use with multiple as well as with series lamps.

Mazda series lamps in sizes up to 250-candle-power, now produced to operate at efficiencies appreciably higher than hitherto attainable, are rapidly replacing the earlier types of lamps. In the new construction and method of mounting the filament, the light source is concentrated and is placed lower in the bulb of the lamp. It therefore becomes desirable to use especially designed fixture and reflector equipments in order to insure the most effective distribution of light.

The low candle-power sizes of lamps find their greatest field of application in the lighting of residential streets and outlying districts. Lamps of the intermediate size (250-candle-power) are very frequently used in the lighting of the main and business areas of small cities and towns. If a suitable reflector and globe equipment is used and the units are properly spaced, this intermediate size of lamp meets the requirements of moderate intensity lighting very well. Figs. 2 and 3 show examples of 100-candle-power and 250-candle-power center suspension units, as used in a small Pennsylvania town. In this particular installation, which is in many respects typical of such a class, the smaller sizes of lamps are used throughout the residential and outlying sections and the 250-candle-power lamps on the principal business streets. All the units are equipped with concentric reflectors and prismatic refractors, so as to distribute the light as uniformly as possible throughout the relatively wide spacings adopted. The spacing of the lamps in this installation is not uniform, due to the irregularity of the street intersec-

tions, the curved roads, and the hilly nature of the streets. The average height of the units is about 18 or 19 feet.

The new sizes of Mazda lamps (400-, 600-, and 1000-candle-power in the series type, and



Fig. 2. Day View of Washington Street, Sellersville, Pa., showing G-E eye suspension fixtures equipped with concentric reflectors, prismatic refractors and 100-c.p. 6.6-amp. series Mazda lamps



Fig. 3. Day View of Main Street, Sellersville, Pa., showing G-E eye suspension fixture equipped with concentric reflector, prismatic refractor and 250-c.p. 6.6-amp. Mazda lamp

300-, 400-, 500-, and 750-watt in the multiple type) are being employed for lighting city streets in many places. In several cities, where high power light sources have been commonly employed in the illumination of both business areas and suburban sections for several years, the older illuminants have been replaced, unit for unit, by high candle-power Mazda lamps with excellent results.

When installing new units, however, an opportunity often occurs to improve the illumination at a small outlay. Suspension heights can sometimes be made more uniform and the spacings more regular. In tree-



Fig. 4. Day View of Street in Carlisle, Pa., showing Novalux pendent units equipped with 600-c.p. 20-amp. Edison Mazda lamps and prismatic refractors



Fig. 5. Night View of Street shown in Fig. 4

covered areas it is frequently advantageous to mount the units lower than those they are replacing. With lower mounting heights smaller lamps should be used with closer spacings. In this manner, the sidewalks can be better illuminated and the lighting much improved in uniformity. Figs. 4 and 5 show day and night views taken in a city illuminated by 600-candle-power Mazda series lamps.

The units used in this case are known as "Novalux Form-2," which are of the pendent type and are equipped with auto-transformers, dome reflectors, and prismatic refractors. The auto-transformers are contained in the housings of the units and are used to step up the line current from 6.6 amperes to 20 amperes.

As will be noted in the night view, Fig. 5, the illumination is of high intensity and is uniform. The spacings of the units are not equal but vary between 300 and 400 feet.

A typical example of the illumination afforded by Mazda units in a large eastern city is shown in Fig. 6. In this case reflectors were not used on account of the relatively narrow spacing (200 feet), the appearance of the unit, and the desire for illumination on the faces of the buildings. The lamps used in these units are of the 400-candle-power 15-ampere type and are mounted 18 feet 6 inches above the sidewalk.

A good example of modern bridge lighting by means of pendent type Mazda units is shown in Fig. 7. These units are equipped with the radial wave type of reflector. The lamps used are of the 300-watt multiple type, are suspended about 16 feet high, and the character of the lighting provided by these units is very satisfactory with the spacings of 120 feet at which they are installed.

The radial wave reflector is quite effective and gives a fairly wide distribution, but as it is used without a diffusing globe it is seldom applicable for use with the higher power lamps. Some installations are now in operation

using this type of equipment with 250-candle-power series lamps and 300-watt multiple lamps.

The ornamental post type of lighting, which originally was introduced through the initiative of business men in many cities, has now developed to very considerable proportions. The demand for such systems of lighting is still unabated but single units are



Fig. 7. Night View of Queensboro Bridge, New York City, lighted with 300-watt multiple type C Edison Mazda lamps in Novalux units with radial wave reflectors



Fig. 9. Night Photograph of Scene shown in Fig. 8.

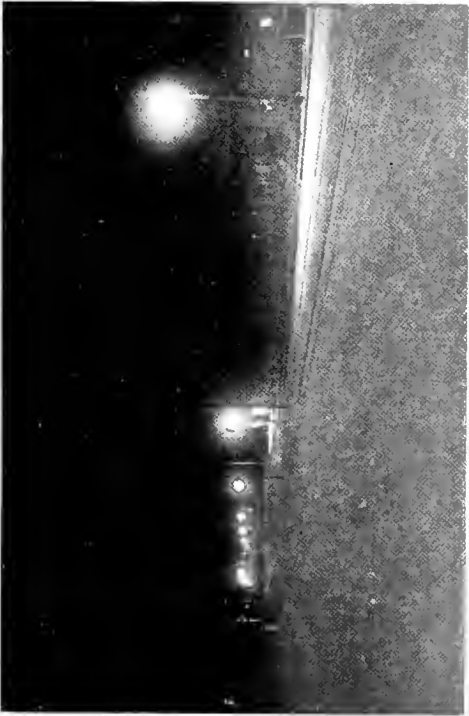


Fig. 6. Night View of Morris Park Ave., Bronx, New York City, lighted with 400-c.p. 15-amp. series type C Edison Mazda lamps in Novalux units

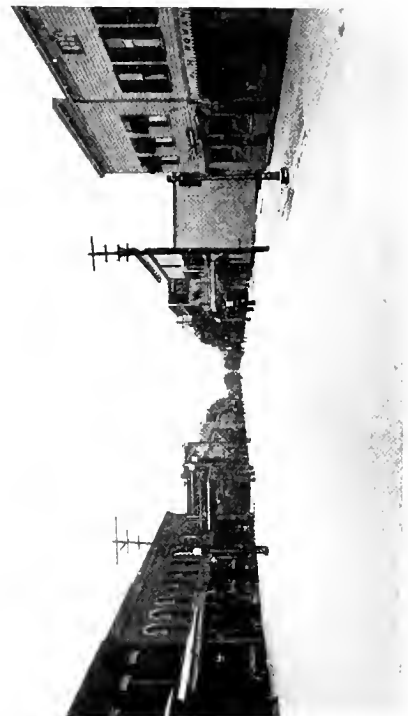


Fig. 8. Dansville, N. Y., 600-c.p., 20-amp. Edison Mazda type C lamp with Novalux units



Fig. 10 Street in Cummag, N. Y., showing illumination by 400 c. p. 15 amp Edison Mazda C lamps with Novalux units



Fig. 11 Kenwood Avenue, Rochester, showing Mazda lighting with concrete lamp poles of the Rochester Railway & Light Company



Fig. 12 Lake Avenue, Rochester, N. Y., showing ornamental post units built by Rochester Railway & Light Company, 1000-c.p., 20 amp. Edison Mazda C lamps



Fig. 13 Lake Avenue, Rochester, N. Y., showing ornamental post units built by Rochester Railway & Light Company, 1000-c.p., 20-amp. Edison Mazda C lamps

now preferred in place of the clusters that so generally were favored before the advent of the high power Mazda lamps.

It is now possible to avoid running the high tension series line to the top of the ornamental post. A small waterproof transformer may be placed either in or near the base of the post to step up the current and also to provide insulation. Even on open circuit, the potential at the socket does not exceed 100 volts with the largest size lamp.

The advantages of the single light unit over the cluster may be briefly summarized as follows:

- (1) Improved appearance in perspective on the street, both by day and by night.
- (2) More effective distribution of the light.
- (3) Large lamps operate at a higher efficiency and give greater brilliancy in appearance.
- (4) Maintenance cost is considerably reduced both in respect to the number of lamps and the enclosing globes.

An up-to-date example of this class of lighting is shown in Figs. 8 and 9. Fig. 8 is a daylight view of a business street in a small town in western New York. The units used are "Novalux Form-5," equipped with auto-transformers and 600-candle-power 20-ampere Mazda lamps operated from a 6.6-ampere series circuit. The mounting height to the center of the globe is 13 feet and the average spacing along one side of the street is 134 feet. The staggered arrangement of posts was adopted and is very satisfactory for this spacing. In this instance the lamps are installed on two circuits, which permits of somewhat more than half the units burning all night and the remainder until midnight. They are so arranged as to provide good illumination at intersecting streets all night. A double circuit is run to each post, so that any particular lamp may be connected either to the all-night or to midnight circuit. The midnight circuit is controlled by a time clock. Fig. 9 illustrates a night view of this installation with all the units burning.

Another example, similar in character to that just described, is shown in Fig. 10. This is in another town in western New York. The average spacing, however, is somewhat

closer, being 100 feet, and four units are placed at each street intersection. There are 74 of these units, using 400-candle-power 15-ampere Mazda lamps operated from a 6.6-ampere series circuit. The mounting height is 13 feet 6 inches and the posts are placed opposite one another. With the closer spacing and lower candle-power lamps in this case, the arrangement is well chosen.

In both the previously described instances the property owners or business men bore a large share of the cost of the installations, the cities and lighting companies co-operating.

The ornamental lighting unit is also becoming popular for the general lighting of residential streets. The Pacific Coast cities have many examples of this class of lighting and many cities in the East are rapidly following suit. The illustrations given in Figs. 11, 12, and 13 are typical of what has been done to beautify the appearance of the avenues of a progressive city in central New York. Fig. 11 depicts a residential street lined with heavy foliage. In this case 100-candle-power Mazda lamps are used, mounted about 10 feet high and enclosed in opalescent globes. The spacing varies according to the character of the streets. The posts are of reinforced concrete and the top fitter is of imitation bronze. Not only is the illumination provided by these units adequate, but it will be noted that the foliage does not obstruct the light from the roadway and sidewalk.

Figs. 12 and 13 show a day and a night view of a main thoroughfare. While it is strictly residential, the street is wide and traffic relatively heavy, so that higher power units are necessary for proper illumination. Mazda lamps of 1000-candle-power are used. They are enclosed in 18-inch opalescent globes, mounted 14 feet 3 inches above the ground. In this particular installation there are 57 of these units spaced about 200 feet apart along the street, in a staggered arrangement.

Space has permitted only brief descriptions of a few installations. In spite of the short time since these new lamps have been available, many installations are already in operation and these have been rendering excellent service.

Thus the Mazda lamp is becoming a more and more important factor in improving all classes of street lighting.

PRACTICAL EXPERIENCE IN THE OPERATION OF ELECTRICAL MACHINERY

PART IX (Nos. 47 TO 50 INC.)

By E. C. PARHAM

CONSTRUCTION DEPARTMENT, GENERAL ELECTRIC COMPANY

47) THE WRONG SHUNT RATIO

Fig. 1 illustrates a method of increasing the capacity of an ammeter so that it can be used to measure currents that exceed its range. The largest copper wire that can be passed through the terminals is drawn through them forming a loop in parallel with the meter. The meter and wire are then used as a single unit, and the value of the current indicated by the meter depends upon the loop length, which can be varied.

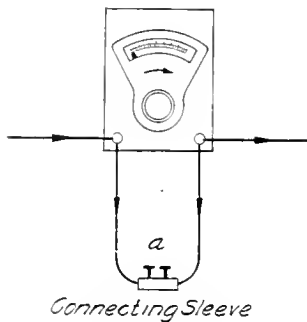


Fig. 1

Using a steady source of current, the calibration of the meter and shunt is carried out as follows: It is desired to read 225 amperes on a 100-ampere ammeter, for example. With only the meter in circuit, adjust the current to 75 amperes; then close the loop through the connector, tightening the screws, and vary the loop length (by drawing one end through a meter terminal) until the reading is 25 amperes. (Each time that an adjustment is made the binding-post screw that is loosened for drawing through the wire must be tightened.) A current of 75 amperes still flows; but, as the meter carries only one-third of the current, the meter reading must be multiplied by three in order to obtain the value of the current in the circuit. With an adjustment for example such that the closing of the loop reduces the meter reading to one-half, each reading must

be multiplied by two in order to get the total current flowing in the circuit.

Station ammeters and shunts are connected in this manner (the meter carrying only a small part of the current) but the dial is marked as if the meter carried all of the current. In portable work, milli-voltmeters are used in conjunction with standard shunts. Such sets have a stated maximum capacity and several taps may be brought out of the shunt as indicated in Fig. 2. The multiplying

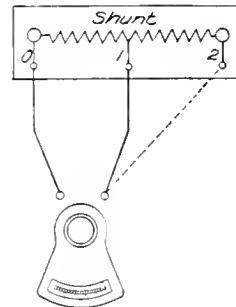


Fig. 2

factor to be used depends upon the tap that is employed. Assuming that tap 1 is so chosen that the meter reads 100 divisions when the current is 100 amperes, the meter then is direct reading and no multiplying factor for the reading should be used. If another tap, for example tap 2, includes twice as much of the resistance of the shunt as tap 1, a line current of 100 amperes will deflect the needle through 200 divisions, and with this connection the actual current will then be but half of that indicated on the meter.

An operator called in an inspector because an exciter apparently was taking about twice the amount of current that it should and still was unable to furnish sufficient exciting current to its alternator to maintain normal alternating voltage. As is so often the case, the exciter had no switchboard ammeter. The operator was using a milli-voltmeter-

shunt combination that he had borrowed. In connecting the milli-voltmeter to the shunt he had used tap 2 instead of tap 1, thereby making the apparent current twice the actual current.

Upon increasing the exciter current, the alternating voltage promptly became normal. Had the tap been one such that the connection would have caused the meter to indicate but half of the current flowing, the result might have been more serious had the operator undertaken to load his exciter according to the indication of the meter.

(48) REPULSION MOTOR HEATING

In Fig. 1, showing the internal connections of a single-phase repulsion-induction motor, the field coils brought to the terminals outside of the motor are the main field coils that correspond to the stator coils of an ordinary induction motor. These connect to the supply lines through a suitable switch. In the actual motor, however, they are divided into pairs and the pairs can be connected in series or in parallel, accordingly as the line voltage may be 220 volts or 440 volts. The inner field coils are wound concentrically with the main field coils and are called compensating field coils because they oppose and neutralize the armature reaction, thereby preventing sparking. The compensating field coils are connected to brushes 3 and 4 and their exciting current is due to the rotation of the armature. Since their polarity is the same as that of the main coils and since

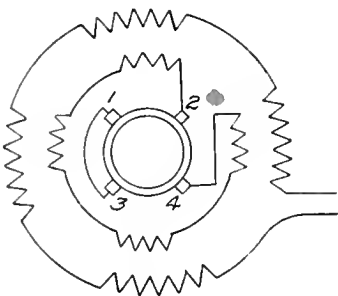


Fig. 3

their effect increases with the armature speed, it is evident that they act to limit the speed at very light loads. The brushes 1 and 2 are short-circuited. These carry the current which, being repelled by the main field, causes the armature to rotate.

An operator complained that his repulsion induction motor was heating too much. An ammeter was connected into the stator circuit and it indicated 30 per cent current overload; notwithstanding this overload, the armature speed was about 200 r.p.m. too high. The brushes sparked very little, but both the brushes and the commutator ran hot. These symptoms suggested a reversed compensating field, which proved to be the case.

Upon reversing the compensating brush leads, every sign of sparking disappeared, the speed decreased about 150 r.p.m., the current decreased from 8 amperes (30 per cent overload) to about $2\frac{1}{2}$ amperes (the amount required for the load carried when the motor was connected properly) and the heating lessened correspondingly.

(49) VARIABLE-SPEED MOTOR ON AN INERTIA LOAD

A variable-speed motor must commute satisfactorily at the comparatively high speed that is incident to a weakened field, and this requirement is sufficiently exacting without imposing severe local conditions to aggravate matters. It was necessary to diagnose a case of bad flashing of a shunt-wound, variable-speed, reversible motor that was connected to a centrifugal drier. The motor was operated from service lines that also supplied several heavy motors which were frequently started and stopped. The flashing did not seem to depend so much upon what the motor itself was doing, as it did upon what was going on in other parts of the plant. The motor would be operating with perfect commutation, when suddenly there would develop a tendency to flash-over between the brush-holders, the brushes would spit a few times, and then the operation would become normal again.

The causes of these irregular actions were about as follows. As long as the motor with its connected load, which had a great deal of inertia, was supplied by a constant line voltage it ran faultlessly; but as soon as the starting of a heavy motor elsewhere pulled down the line voltage, the motor (unable to at once reduce its speed to a value corresponding to the existing voltage) would act as a generator and would "pump" into the line, which additional load thus imposed would slow the centrifugal motor. During the next instant the throwing off of a large motor elsewhere would suddenly raise the line voltage which would cause the slowed motor to

draw a heavy current that would always cause sparking and which would sometimes cause a flash-over. Owing to the fact that the best position of the brushes for a *motor* is not the best position when the machine is operating as a *generator*, a change from motor to generator would alone account for the tendency to flash. Also, it is easy to account for flashing without the generating feature; for assuming a case in which the line voltage was lowered so gradually that the speed of the motor could respond there would then be no generation, but the sudden increase in the line voltage, incident to a sudden decrease in the service load elsewhere in the mill, would cause a flash-over because of the increase in motor current.

Under ordinary conditions the installing of overload devices and of reverse-current devices would have helped matters, but in the plant concerned it was undesirable to do anything that would interfere with the continuous operation of the motor. Should the automatic devices have operated when no one was near, considerable valuable time would be lost. The problem was solved by increasing the amount of copper in the distributing mains and by installing a compensating voltage regulator to over-compound the system for constant voltage at the center of distribution.

(50) SERVICE VOLTAGE TOO LOW

Standard induction motors will operate satisfactorily on voltages that are as much as 10 per cent greater or 10 per cent less than that for which they have been designed. A greater departure than this from the rated voltage is likely to result in unsatisfactory operation, especially if the connected load is such as to require approximately the full rated load of the motor. In practice, induction motors are more often subjected to abusive conditions of low voltage than they are to those of high voltage. When the voltage is abnormally low, unsatisfactory starting characteristics result because the starting power of an induction motor varies as the square of the impressed voltage; in other words, the starting power decreases much more rapidly than does the impressed voltage.

Table I gives the percentages of full-load torque that correspond to given percentages of full impressed line voltage, and also the percentages of torque decrease that cor-

respond to given percentages of decrease in impressed voltage. For example, when the applied voltage is 50 per cent of normal the torque is only 25 per cent of the torque corresponding to full voltage. Looked at in another way, noting columns 3 and 4, a 50 per cent reduction in the applied voltage causes a 75 per cent reduction in the resulting torque. Many specific instances might be cited wherein complaints of unsatisfactory operation of induction motors have been investigated and the source of all the unsatisfactory operation found to be due to abnormally low voltage. Perhaps the most troublesome condition for the operator to detect is that in which a motor promptly starts its connected load for some time after being installed, but later begins to lose its starting power on account of the line or the transformer from which it draws its energy becoming gradually overloaded, as a result of having further devices added from time to time. Where the gradual overloading is due to the addition of other motors in the same service, the operator is more likely to suspect the condition just named, but where the overloading involves several plants that draw their energy from the same transformer, or from the same mains, the cause is not so evident.

TABLE I

Per Cent Normal Voltage	Per Cent Normal Torque	Per Cent Voltage Decrease	Per Cent Torque Decrease
100	100	0	0
90	81	10	19
80	64	20	36
70	49	30	51
60	36	40	64
50	25	50	75
40	16	60	84
30	9	70	90

ERRATA

In the article "Parallel Operation of Alternating-Current Generators," GENERAL ELECTRIC REVIEW, March, 1915, the following changes should be noted:

Page 172, left-hand column, line 16, the word "different" should be "definite."

Page 177, Table I:

Footnote (A) applies to the column headed "Longest Torque Period."

Column C, Oil Engines, line 4, the formula $1.02 \times 10^8 (K + 0.45 P)$ should be $1.02 \times 10^8 (K - 0.45 P)$.

Same column, line 5, the formula $4.8 \times 10^7 (K + 1.12 P)$ should be $4.8 \times 10^7 (K - 1.12 P)$.

Same column, line 2, the formula $2.4 \times 8^* P$ should be $2.4 \times 10^* P$.

**FROM THE CONSULTING ENGINEERING DEPARTMENT OF THE
GENERAL ELECTRIC COMPANY**

**TEMPERATURE COEFFICIENT FORMULAE
FOR COPPER**

In the International Electro Chemical Publication No. 28, "International Standard of Resistance for Copper," published in March, 1914, this rule appears: "At a temperature of 20 deg. C. the 'Constant mass' temperature coefficient of resistance of standard annealed copper, measured between two potential points rigidly fixed to the wire, is $0.00393 = 1/254.45$ per degree Centigrade." Since this rule was written the U. S. Bureau of Standards has used it in Circular No. 31 as a basis of copper wire tables and the rule has been formally standardized in the Standardization Rules of the American Institute of Electrical Engineers, Edition of December 1, 1914. The figure given above should therefore be used in temperature coefficient tables and formulæ. In the 1914 A.I.E.E. rules the necessity of using a change of temperature coefficient for a change of initial temperature is emphasized in Paragraph 178.* The table included in that paragraph shows the increase in the temperature coefficient. The rule applying to the increase follows:

"In the case of resistance measurements, the temperature coefficient of copper shall be deduced from the formulæ $\frac{1}{234.5 \times t}$ " where t is the initial temperature from which measurements are made.

The above formula is a very convenient one, accurate approximations can be secured by its employment, and its natural sequence of numbers allows it to be easily memorized.

For some time approximations have been made by the well-known formula

$$R_h = R_c [1 + \alpha(T_h - T_c)] \quad (1)$$

where

R_h = resistance at the hot or final temperature.

R_c = resistance at the cold or initial temperature.

T_h = hot or final temperature.

α = the temperature coefficient. From 0 deg. C., α has usually been taken as 0.0042, but under the 1914 rules should be taken as 0.00427.

$(T_h - T_c)$, which is the temperature rise, is often expressed as t .

The new values, α , $1/\alpha$ and the standard reference temperatures are as follows:

Temp.	$X = 1/\alpha$	α
0	234.5	0.00427
20	254.5	0.00393
25	259.5	0.00385
40	274.5	0.00364

Standard temperature of reference 20 deg. C.
Ambient temperature for water-cooled machinery 25 deg. C.
Ambient temperature of reference for air 40 deg. C.

For general use it would possibly be better to reconstruct the working formulæ in order to take care of any initial temperature without having to introduce any numerical factor other than the easily remembered 234.5. After revising formula (1) to take care of the varying temperature coefficient for varying initial temperatures, the formula becomes

$$R_h = R_c \left[1 + \frac{T_h - T_c}{234.5 + T_c} \right] \quad (2)$$

or possibly it may be more convenient to memorize in the form

$$R_h = R_c \left[\frac{234.5 + T_h}{234.5 + T_c} \right] \quad (3)$$

If it is desired to find the final temperature for a given resistance we find

$$R_h = \frac{234.5 R_c + T_h R_c}{234.5 + T_c}$$

$$234.5 R_h + T_c R_h = 234.5 R_c + T_h R_c$$

$$T_h = \frac{234.5 R_h - 234.5 R_c + T_c R_h}{R_c}$$

$$= \frac{234.5 (R_h - R_c) + T_c R_h}{R_c} \quad (4)$$

Solving for the initial temperature

$$T_c = \frac{234.5 (R_c - R_h) + T_h R_c}{R_h} \quad (5)$$

and for initial resistance

$$R_c = R_h \left[\frac{234.5 + T_c}{234.5 + T_h} \right] \quad (6)$$

or

$$R_c = R_h \left[1 + \frac{T_c - T_h}{234.5 + T_h} \right] \quad (7)$$

JOHN D. BALL

* It is expected that a revised edition of the "Standardization Rules of the A.I.E.E." will be distributed soon; in this edition the quoted rule will appear unchanged but under a different paragraph number.

QUESTION AND ANSWER SECTION

The purpose of this department of the REVIEW is two-fold.

First, it enables all subscribers to avail themselves of the consulting service of a highly specialized corps of engineering experts, or of such other authority as the problem may require. This service provides for answers by mail with as little delay as possible of such questions as come within the scope of the REVIEW.

Second, it publishes for the benefit of all REVIEW readers questions and answers of general interest and of educational value. When the original question deals with only one phase of an interesting subject, the editor may feel warranted in discussing allied questions so as to provide a more complete treatment of the whole subject.

To avoid the possibility of an incorrect or incomplete answer, the querist should be particularly careful to include sufficient data to permit of an intelligent understanding of the situation. Address letters of inquiry to the Editor, Question and Answer Section, General Electric Review, Schenectady, N. Y.

TEMPERATURE: KELVIN SCALE

141) What is the basis and arrangement of the Kelvin scale of temperature?

At constant pressure a given volume of a perfect gas expands $\frac{1}{273}$ of its volume at 0 deg. C. for each rise of 1 deg. C., and contracts at the same rate for the same decrease of temperature. Consequently, at -273 deg. C. the volume would apparently vanish, if the gas laws were valid at this temperature. For this reason, as well as those based on the second law of thermodynamics, this temperature has been chosen as the zero of the so-called Kelvin or absolute scale. Temperatures on this scale are obtained from the temperatures on the centigrade scale by adding 273, i.e., T (Kelvin) = t (centigrade) + 273. (The more accurate value of absolute zero on the centigrade scale is -273.1 deg., hence in very exact experimental work this value should be used rather than the more commonly employed value -273 .)
E.C.S.

THREE-WIRE SYNCHRONOUS CONVERTER: CONNECTIONS AND UNBALANCED LOAD

142) Referring to diagrams Fig. 1 and Fig. 1-a which appeared in the article "The Edison Three-Wire System," GENERAL ELECTRIC REVIEW, March, 1914, will you please explain the following points?

- 1) Why is it necessary to have the middle point of each transformer connected by a separate switch to neutral?
- 2) What amount of unbalance will the connection described take care of properly?
- 3) Kindly give an explanation of the division of unbalanced current through the transformers as indicated in Fig. 1-a.

1) It is necessary to have the neutral from each transformer on a separate switch to neutral if the synchronous converter is to be started by secondary starting taps on the transformers. This will be clear if one considers that the starting switch, when connected to the half-voltage taps at the time of start, would be short circuited by the neutral switch were this latter switch permanently closed. The usual method of starting from the alternating-current side is by means of $\frac{1}{3}$ and $\frac{2}{3}$ starting taps in the transformer secondary. This would give the same effect as the half-voltage starting, except that there would not be a dead short circuit. Another way to realize the necessity of opening the neutral

is to regard $\frac{1}{3}$ of the secondary of each transformer, or of each phase, considering the transformer as a three-phase unit connected directly across the synchronous converter. If, now, the neutral switch is not open, the synchronous converter is short circuited through $\frac{1}{6}$ of the transformer winding.

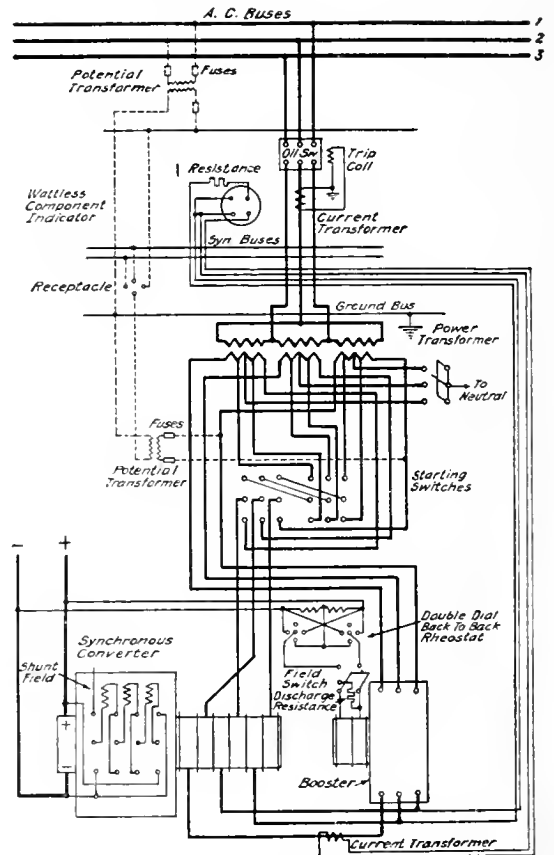


Fig. 1. Complete Diagram of Connections for a Six-Phase Three-Wire Synchronous Converter

(GENERAL ELECTRIC REVIEW, March, 1914)

(2) The amount of unbalancing which this connection will take care of properly depends entirely upon the design of the synchronous converter. With the straight synchronous converter, that is, one having main poles only, an unbalancing in neutral current up to 50 per cent of full load line current is permissible; 25 per cent has been the standard in the past. With a commutating-pole converter the windings on the commutating-poles must necessarily be split, and even under this condition a heavy unbalancing may affect commutation. It is seldom desirable, therefore, to attempt to allow for more than 10 per cent unbalancing unless the converter is especially designed for a

GENERATOR: INPUT AT 70 AND 100 PER CENT POWER-FACTORS

(143) Does a Diesel engine or other prime mover require as much fuel to drive a generator carrying a 500-kv-a. load at 70 per cent power-factor as it uses when the generator is under a load of 500 kv-a. at unity power-factor?

No; more fuel will be required when the generator supplies 500 kv-a. at unity power-factor. The copper loss ($I_a^2 R_a$) in the armature, the core loss, and the friction and windage loss in the generator are about the same for 500 kv-a. at 70 per cent power-factor as at unity power-factor; but the copper loss

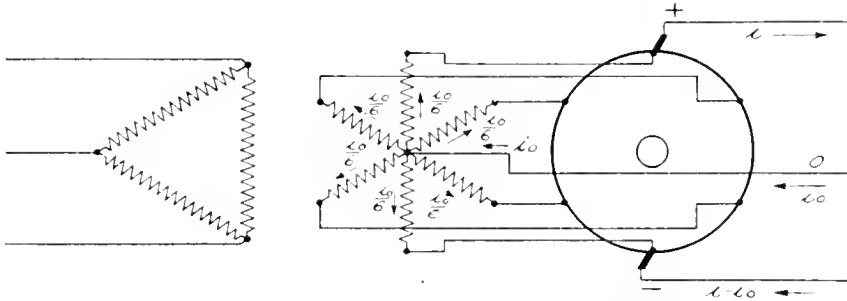


Fig. 1-a. Simplified Diagram of the Connections Shown in Fig. 1

(GENERAL ELECTRIC REVIEW, March, 1914)

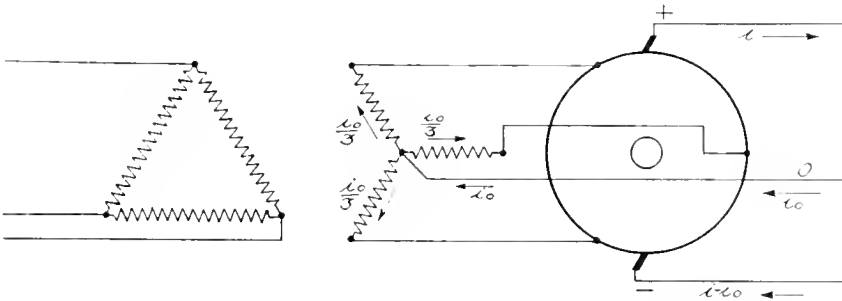


Fig. 2-a. Simplified Diagram of Connections for Using a Three-Phase Core-Type Transformer (Three-Phase Converter)

(GENERAL ELECTRIC REVIEW, March, 1914)

greater percentage. (The above figures are not necessarily guaranteed.)

(3) The current i_0 (Fig. 1-a), returning through the neutral as the result of unbalanced load, will divide into six equal parts as the transformer is connected electrically at six equi-distant points on the converter armature. This is similar to the three-phase connection shown in Fig. 2-a, which was explained in detail in No. 89 of the Question and Answer Section of the same issue of the REVIEW. The principal difference between Fig. 1-a and Fig. 2-a is that in Fig. 2-a the currents in the transformer legs are not neutralized, whereas in Fig. 1-a the currents in any one winding are completely neutralized since they are equal and opposite to each other.

($I_a^2 R_a$) in the field for 70 per cent power-factor operation is greater than that resulting from unity power-factor operation.

If the generating set referred to in the question is of average speed, the total generator loss at 500 kv-a. output at 100 per cent power-factor may be assumed for convenience to be 30 kw. This loss may be reasonably expected to increase to 35 kw. when the generator furnishes 500 kv-a. at 70 per cent power-factor.

Thus the output of the prime mover (the factor determining the fuel consumption) is

$$\text{For 500 kv-a. at 100 per cent p-f: } (500 \times 1.00) + 30 = 530 \text{ kw.}$$

$$\text{For 500 kv-a. at 70 per cent p-f: } (500 \times \frac{70}{100}) + 35 = 385 \text{ kw.}$$

$$(500 \times \frac{70}{100}) + 35 = 385 \text{ kw.}$$

R. H. T.

E. C. S.

IN MEMORIAM

The death of John P. Judge, Manager of the Baltimore Office of the General Electric Company, which occurred on January 26th, marks the passing of an old and valued employee of the Company. Mr. Judge was first associated with the Edison Company in October, 1890, and became an employee of the General Electric Company in November, 1904, at which time he was placed in charge of the power and mining business of the Baltimore territory. For the succeeding eighteen years his activities were responsible



JOHN P. JUDGE

for many of the most notable industrial applications of electricity in that territory, and in November, 1912, he was made acting local manager of the Baltimore office.

Mr. Judge was born in the City of Baltimore, where a large part of his business career was spent. His death, which occurred at the age of sixty-two years, was due to apoplexy. He is survived by his wife, two sons and four daughters. He was actively identified with church and social betterment work, and his business acumen and technical ability were combined with a personality which make his loss keenly regretted among all those who came in personal contact with him throughout the organization.

67-771

GENERAL ELECTRIC REVIEW

A MONTHLY MAGAZINE FOR ENGINEERS

Manager, M. P. RICE

Editor, JOHN R. HEWETT

Associate Editor, B. M. EOFF
Assistant Editor, E. C. SANDERS

Subscription Rates: United States and Mexico, \$2.00 per year; Canada, \$2.25 per year; Foreign, \$2.50 per year, payable in advance. Remit by post-office or express money orders, bank checks or drafts, made payable to the *General Electric Review*, Schenectady, N. Y.

Entered as second-class matter, March 26, 1912, at the post-office at Schenectady, N. Y., under the Act of March, 1879.

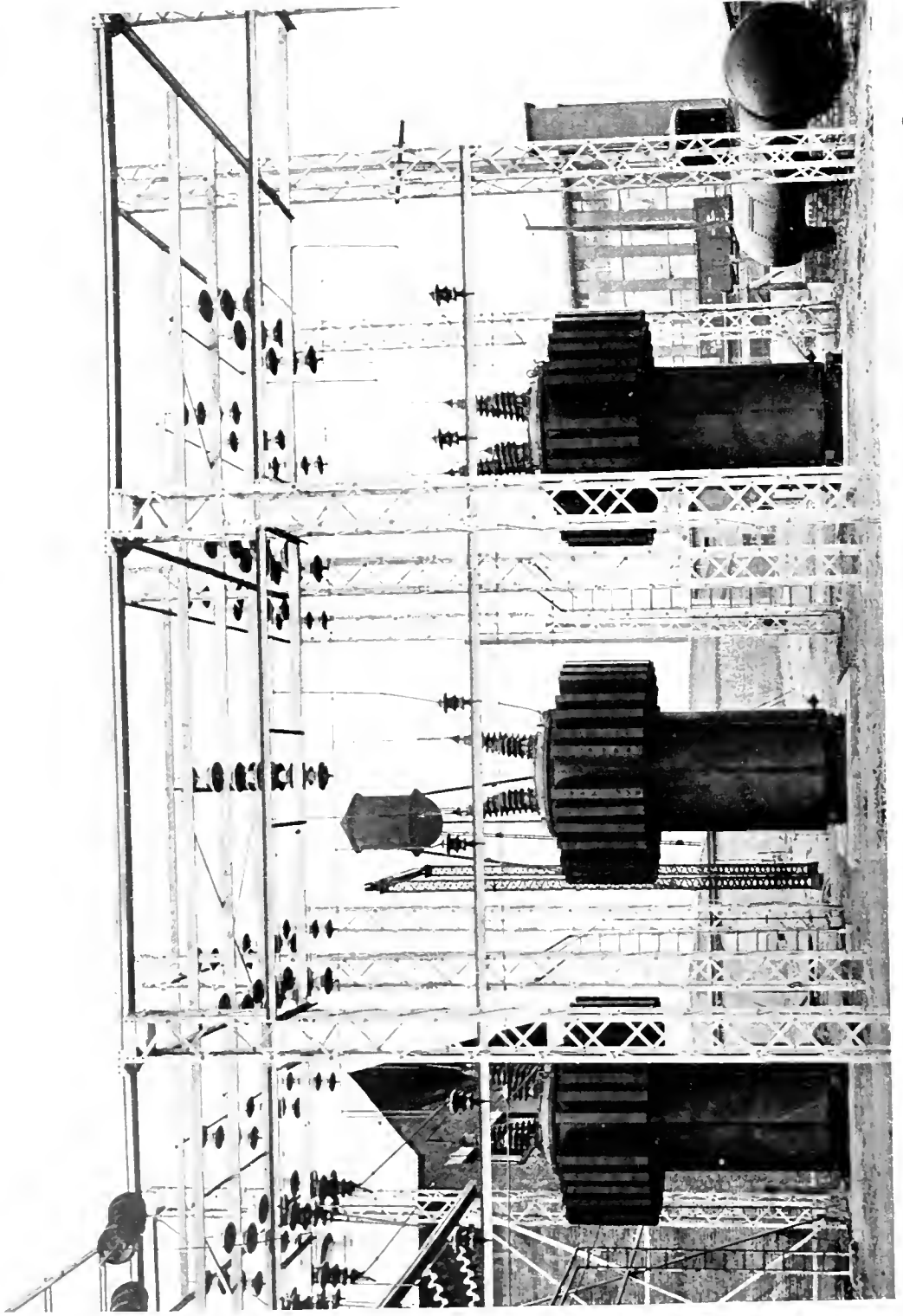
VOL. XVIII., No. 8

Copyright, 1915
by General Electric Company

AUGUST, 1915

CONTENTS

	PAGE
Frontispiece	782
Editorial: The Paths of Progress	783
The Trend of Electrical Development	784
BY PAUL M. LINCOLN	
Economies in Operating Small Cars	790
BY J. F. LAYNG	
Radiography of Metals	795
BY DR. WHEELER P. DAVEY	
Air Cleaning Apparatus for the Ventilation of Generators and Transformers	801
BY WILLIAM BAUM	
The Individual and Corporate Development of Industry	813
BY DR. CHARLES P. STEINMETZ	
The Cathode Ray Tube and Its Application	816
BY M. E. TRESSLER	
Law of Corona and Spark-Over in Oil	821
BY F. W. PEEK, JR.	
The Operation and Rating of the Electric Locomotive	828
BY A. H. ARMSTRONG	
Emergency Transformer Connections	832
BY GEORGE P. ROUX	
Parallel Operation of Frequency Changers	836
BY G. H. RETTEW	
Principal Factors Governing the Choice of Method of Cooling Power Transformers as Related to Their First Cost and Operating Conditions	839
BY W. S. MOODY	
The Contact System of the Butte, Anaconda & Pacific Railway	842
BY J. B. COX	
From the Consulting Engineering Department of the General Electric Company	860
Practical Experience in the Operation of Electrical Machinery, Part X	861
Stations in Series; Parallel Transformers; Transformer Connections	
BY E. C. PARHAM	
Question and Answer Section	863



Three 2000-kv-a., 101,200 volt, self-cooled, radiator type transformers in an outdoor substation of the Southern Power Company.
(See page 839)

GENERAL ELECTRIC

REVIEW

THE PATHS OF PROGRESS

We publish in this issue Mr. Lincoln's presidential address before the American Institute of Electrical Engineers delivered at the recent annual convention held at Deer Park, Md. Those reading this address must be impressed anew with the wonderful achievements of the electrical engineer—The average efficiency of electric generators and motors, when both small and large units are considered, is 90 per cent; large transformers may reach the extraordinarily high efficiency of 99 per cent; and rotary converters can approach 98 per cent efficiency. Such accomplishments are hard to realize and appreciate, but it must be constantly borne in mind that it is these achievements that have given electricity its unique position in the industrial world.

There is still a large margin left for possible improvement in steam prime movers, although the efficiency of large modern steam turbines is something thought quite unattainable but a few years ago. It is apparent from Mr. Lincoln's address that our rate of progress in the future must be slower than in the past, but this statement only refers to progress in attaining higher efficiencies in specific apparatus.

In this connection it is interesting to try to see in what directions we may look for future progress even if we eliminate the possibility of any great new discoveries that may make as radical changes in our industrial life as electricity has made during the last three decades.

We feel that the extension of the application of electricity is inevitable and that this is true both in regard to applications already attempted, with partial or full success, and in a myriad of directions as yet unthought of. That electricity is seriously contemplated for the propulsion of large steamships and that it is already extensively used on self-propelled gas-electric railway cars goes to show that the inherent features of electric control are destined to play a part of ever increasing im-

portance in our future developments. In both of these instances the prime mover is carried as an essential part of the equipment whether electrical apparatus is used or not. Electrical apparatus is an addition which at first sight would appear to complicate matters and to add considerable weight to the equipment; but the addition of the electrical equipment to the mechanical secures such a flexible control of the energy used, and at the same time eliminates large cumbersome mechanical gearing such as speed-changing devices, etc., that the addition of both an electric generator and motor leads to an added efficiency of the whole equipment.

The same general principle with modifications is now being applied to the automobile with every prospect of marked success; and here again we look for wonderful developments which will be entirely due to the recognition of the fact that an electrical link in our chain of energy conversion gives us refinements in the control of energy that enable us to obtain the maximum power at the essential periods, a higher overall efficiency with a minimum total expenditure of energy, and a minimum total weight.

Over and above these opportunities for an advancement in the art of electrical engineering there are the ever attractive fields of electric lighting and electric heating, the limits of which are not at present even contemplated.

It is most interesting to review the past progress as Mr. Lincoln has done in his able address, but it is even a greater fascination to anticipate some of the possibilities of the future. The electrical industries are among the most highly developed of the age and yet the possibilities for the future of these same industries seem to be absolutely limitless. Each step of progress seems to lead us to new possibilities and the electrical engineer is constantly entering new fields and proving that things can be done more economically and more efficiently electrically than by any other means.

THE TREND OF ELECTRICAL DEVELOPMENT

BY PAUL M. LINCOLN

PRESIDENT OF THE AMERICAN INSTITUTE OF ELECTRICAL ENGINEERS

In the presidential address before the American Institute of Electrical Engineers, Mr. Lincoln shows among other things the progress made in the development of electrical machines. The average efficiency of electric generators and motors, including both small and large, is given as 90 per cent, showing clearly that small future progress can be made in this direction. The approach towards perfection is further emphasized by stating the fact that some large transformers have an efficiency of 99 per cent and some rotary converters approach 98 per cent efficiency. A statement of the room left for improvement in the development of water-wheels and in thermo-dynamic engines forms an interesting part of the author's theme. He shows that our rate of progress in the future must be smaller than in the past and substantiates his statements by quoting from Mr. A. E. Kennelly's inaugural address delivered at Omaha in 1898. The author also shows in what direction future progress may be looked for. We believe that our readers will get considerable pleasure from reading this able address.—EDITOR.

An annual address by the President of our Institute is more than a perfunctory affair. It is a constitutional requirement. It is enumerated specifically in our constitution among the duties of the President—"He shall deliver an address at the annual convention."

It has occurred to me that in my address on this occasion it might be well to trace the progress of some of the developments and practices that have marked the path that the electrical engineer has traversed in the past with a view of obtaining some idea possibly as to whither these paths may lead us in the future. Insofar as this method incorporates a review of the past it presents no particular difficulty; but when it involves a prognostication of what a continuation along any particular line of development will finally lead to, it delves somewhat into realms of prophesy. I realize full well that anyone who attempts to deal in prophesy among the inventions and developments of this day and age is running a grave risk, and I therefore do not propose to wander far from what I conceive that the trend of present development will carry us in the future.

In the matter of efficiency, it has always been recognized that electrical apparatus is in a class by itself. Mechanical energy can be converted into electrical by a generator, or vice versa, by a motor at an efficiency ranging up to as high as 97 per cent, or even more in the most favorable cases. I think it is a safe statement to say that the average efficiency by which the conversion of mechanical energy into electrical by generators or electrical energy into mechanical by motors, including all sizes under actual operation conditions, will reach 90 per cent. There are, of course, many cases where the efficiencies are lower than 90 per cent. On the other hand, there are many cases where the conversion is carried on at much higher efficiencies

and I believe that the assumption of 90 per cent as an average figure is not far from the truth. Owing to the fact that the size of the average electrical generator is much greater than that of the average motor and that it is possible to operate the generator at higher average loads than is the case of the motor, it must be apparent that the average efficiency for converting mechanical energy into electrical is higher than the reconversion of this electrical energy back into mechanical. The average generator efficiency is undoubtedly well above 90 per cent while it is doubtful if the average motor reaches so high a figure. However, the general conclusion I would draw from these figures is not modified by this difference between generator and motor. This conclusion which must be apparent to anyone is that no development of a revolutionary character can be looked for in this respect. Our ability to convert mechanical energy into electrical or vice versa has reached so high a value that even if we could obtain perfection itself we could add only a matter of 10 per cent to what we have already accomplished. This conclusion must hold unless the law of conservation of energy is revoked and I am not predicting any suspension of that law.

When we come to deal with the efficiencies by which electrical energy in one form is transformed into electrical energy of another form, efficiencies are found to be still higher. The efficiencies of some of our larger transformers for instance exceed 99 per cent. The rotary converter, in which alternating current is changed into direct, attains efficiencies approaching 98 per cent. It is evident that perfection itself could not add greatly to existing performances and hence nothing revolutionary may be expected along this line in the future.

When we come to consider the prime mover, we find a marvelous improvement

in recent years. Taking up first the water-wheel, the early attempts to develop power at Niagara Falls constitute a significant commentary upon the status of the water-wheel at that time (the late 60's and the early 70's). About this time the building of what is now known as the Schoellkopf Canal at Niagara Falls made available a head of about 215 ft. at the edge of the cliff below the falls on the American side. Of this 215-ft. head these earliest wheels used only some 15 or 20 ft. for some of the least progressive and from there up to possibly 40 or 50 ft. for the more progressive. After passing through the wheels under this head, the water was then discharged at the face of the cliff and fell uselessly for the remainder of the distance, much to the detriment of the scenic beauty of the bank. And not only was it impossible at that time to obtain waterwheels that would work under more than these very limited heads but the efficiencies of such as were used were very far below those attainable now. Today, waterwheels have no limit in head except that imposed by the strength of available materials, and efficiencies ranging up to 90 per cent are expected as matters of course. Improvements in waterwheel design will, of course, continue, but perfection itself would add but a matter of 10 per cent to the best of our modern practice and not to exceed 20 to 25 per cent to the worst. Therefore, in waterwheels, as well as in motor and generator practice, we are approaching the limits set by natural laws almost as closely as human ingenuity can be expected to attain. No startling or record breaking developments need be expected along these lines so long as the law of conversion of energy holds.

In thermo-dynamic engines, too, the last few years have some marvelous improvements. The reciprocating engine of Watt has largely given place in recent years to the steam turbine and the use of the turbine has enabled us to attain efficiencies in thermo-dynamic conversion that were out of the question with the reciprocating engine of Watt. In the thermo-dynamic conversion the law of conservation of energy takes a peculiar form. No conceivable method of thermo-dynamic conservation can begin to transform all the energy contained in a lump of coal, for instance, into dynamic or mechanical form. If the heat contained in the coal is used to heat a fluid used in a thermo-dynamic engine, the maximum mechanical energy that can be taken from that engine

can bear no greater a ratio to the total heat imparted by the fuel to the fluid than the actual range of temperature used in the engine does to the maximum absolute temperature of the fluid as it enters the engine. The efficiency which would result by the use of this ratio of temperature ranges is that which would result if what is known as the "Rankine cycle efficiency" were 100 per cent. Some of the best of our modern steam turbines have attained to as high as 75 per cent—or possibly a little more—of this "Rankine cycle efficiency." In these most perfect engines, therefore, perfection itself would not add more than 25 per cent or such a matter. It should be particularly borne in mind that this statement is true only of the best of modern practice. It is not true that the average of modern practice attains anywhere near this degree of perfection. It is only with prime movers of the largest size and most modern design and construction that so close an approach to the ideal can be attained. As capacity is reduced it becomes rapidly more and more difficult to attain the higher degrees of economy in thermo-dynamic machines. This must always remain one of the potent factors in the economies of power supply. It is, and undoubtedly always will be, one of the fundamental reasons why central station supply of electric service must prevail as against isolated plant supply for the same service. The central station can, of course, use units which are very large in comparison, and can be worked at much higher average loads than must necessarily be the case with an isolated plant.

One means that has been suggested to improve the efficiency of the thermo-dynamic engine is to increase the temperature range through which the working fluid is used. When using water or steam as the fluid in our heat engine, there are certain practical limitations to the temperature range which is available and the temperature range cannot be materially extended over the best of modern practice. The only two ways to extend this temperature range when using steam are to increase the super-heat or increase the pressure. Increasing the super-heat over the best modern practice does not promise results commensurate with the expenditure of heat to obtain this super-heat, since increasing the temperature at one end of the heat cycle simply involves a loss in the efficiency at the other end. There is a rather definite limit to superheating of steam beyond which it is useless to go. Increasing the steam

pressure does promise results, and it is probable that the tendencies for the future will be toward these higher steam pressures.

Another promising method of increasing temperature range is that to which attention has been called during the last year or two by Mr. W. L. R. Emmet of Schenectady. He has called attention to the advantages of using mercury as the working fluid in a heat engine for temperature ranges above those available with steam. After working the mercury through a given temperature range, the heat remaining in the mercury is transferred to water and the steam thus made available is again worked through a lower temperature range. The advantages of this are that the steam is in practically all respects the same as in standard steam turbine practice and the mercury cycle is closely similar to the steam. Additional energy is made available from the same amount of initial heat due to the greater temperature range obtainable by the use of the mercury. The main disadvantage is the poisonous nature of mercury vapor and the difficulty of absolutely preventing its leakage at the high pressures and temperatures of the mercury boiler. These practical difficulties make it too early to predict whether or not this method will work out as a feasible solution of the thermo-dynamic engine problem. However, it can be said that, without some such method or device, the future is apt to bring no revolutionary improvements in thermo-dynamic engines over the best of modern practice. Improvements of course will undoubtedly continue to take place, but it cannot be hoped that the improvements of the future will be of the same revolutionary character as the improvements in the thermo-dynamic engine which have taken place within the last 10 or 15 years. Here again we are approaching so close to the law of conservation of energy that it is safe to make a prediction of this nature.

In the matter of size and capacity of generating units it can safely be said that this is a consideration that will hereafter be fixed by the conditions to be met and not by any inherent limitation in our ability to produce units of any desired outputs. We now have units of 30,000-kw. capacity in service and still larger ones projected, and no limitations of design or material appear of such a nature as to place a stop to further progress along the same line.

At Omaha in June, 1898, the then president of our Institute, Mr. A. E. Kennelly, made

an inaugural address upon the topic, "The Present Status of Electrical Engineering." This address constitutes a very convenient milestone by which to judge our progress since that time, and in this address I will take the liberty of quoting freely from this 1898 address of Past President Kennelly. In the matter of generator sizes, he says, "In 1884 a 50-kw. dynamo was considered a large machine while a 100-kw. Edison steam dynamo was justly called a 'jumbo.' At present the largest size of generator built or building is of 4600-kw. capacity." In the 14 years from 1884 to 1898 the maximum size of generator therefore increased 46-fold, while in the 17 years since that time, the increase has only been about 7-fold. While the increase in capacity therefore has been a marked one, the rate of increase has not been so rapid during the last 17 years as it was in the previous 14 years, a result which naturally might have been anticipated. The future will undoubtedly continue to produce larger and larger capacity machines, the limit as to size being dictated by plant capacity and economic considerations and not by any inability to produce the larger sizes.

In the matter of selling price of such apparatus the following extract from Kennelly in 1898 may be of interest: "The price of dynamos in 1882 was about 20 cents per watt of output while dynamos of similar running speed for comparatively small sizes without switchboards now cost about 2 cents per watt." The speed and size of these units is not mentioned, but it may be said in comparison that nowadays prices are frequently quoted below $\frac{1}{2}$ cent per watt. In this respect again the improvement in the last 17 years has not been so marked as it was in the 14 years previous, a result that is only to be expected. In the next succeeding period it is probable that a still smaller degree of improvement will occur. We are approaching a saturation point in this respect.

It may be well to point out some of the reasons for this approach to saturation in the matter of costs. The two fundamental costs of electrical apparatus are those of labor and material. In regard to the item of labor, I submit that it is safe to predict that the tendency for the future will be for the cost of labor to increase rather than decrease. Economies in the use of labor will undoubtedly take place by the introduction of the methods of scientific management, etc., but these need not be expected to be revolutionary in character so far as cost of apparatus is

concerned. The tendency of the labor item will unquestionably be toward appreciation rather than depreciation.

In regard to the item of material, modern design has approached very close to the physical limits of available materials. Take, for instance, the property of permeability possessed by irons. With higher permeability, making available greater flux densities, the cost of electrical apparatus might be considerably reduced. That the future will bring some improvement in this respect is unquestionable but it is further highly improbable that this improvement will be of such a revolutionary character as to cause any sweeping change in the cost of electrical apparatus.

The hysteresis and eddy current losses that take place in irons and steels that are subjected to varying magnetic fluxes is another of the limits encountered in the design of electrical machines. Marked progress has been made in this respect in recent years. Our modern transformer steels in the matters of losses and iron ageing qualities show a vast improvement over those formerly available. Unfortunately these improvements have so far been accompanied by a decrease in permeability which is highly objectionable in rotating machinery. Unquestionably, further improvements will be made in the magnetic qualities of our irons and steels, but these improvements will probably make no revolutionary change in the costs of electrical apparatus.

The conductivity of copper and other metals is another physical property that sets a limit to the output and cost of our electrical apparatus. Apparently we have reached a definite limit in this respect. The conductivity of the copper of commerce is within an extremely small percentage of that of pure copper and we cannot expect to obtain a higher conductivity in copper than that of purity. There remains, of course, the possibility of using some metal other than copper, but at this present time there is very little promise in that possibility. There is apparently no metal that even approaches the space and cost characteristic of copper that makes it so essential to the construction of electrical apparatus. Aluminum is a competitor only when the volume of the conductor is not an essential element in design, as in transmission lines and the like.

One of the most pressing of our existing limitations to a reduction in cost of electrical apparatus is that fixed by temperature rise.

The output of a piece of electrical apparatus increases with the temperature rise, and the temperature rise in turn is dictated by the point of balance between the rate at which heat is put in and that at which it is taken out. The rate at which heat is put in depends largely upon such physical characteristics as hysteresis and permeability of iron and conductivity of copper, which characteristics are already being crowded to the limit by our modern designs. The rate at which heat is dissipated depends upon the efficiency of the ventilation methods used and in this particular there is a considerable opportunity for improvement. The methods and devices for taking heat out of machines are just as important, when considering temperature rise, as the prevention of heat from entering. While there is unquestionably room for considerable improvement in this particular, there is a question as to whether it will cause any material reduction in the cost of such apparatus. The additional costs of applying the more efficient methods of dissipating heat will go far toward multiplying their tendency toward a reduction of cost.

However, there is one line of development that does promise some reduction in cost, and that is the tendency toward higher operating temperatures. In the past, the maximum operating temperature has been fixed by the disintegrating point of fibrous insulation, and this point has placed a very definite and logical limit to temperature rises in such machines. However, when types of insulation are used which do not have this definite temperature of disintegration, this reason for such a temperature limit disappears. Just how far we can go in apparatus temperatures without exceeding the safe limits of these heat-resisting insulations is as yet problematical. However, a limit to an indefinite extension in this direction is set by the temperature coefficient of copper conductors, the property that causes the resistance to rise with increasing temperature, thereby causing still higher losses and in turn still higher temperatures. If we go high enough, we will reach a point of unstable equilibrium in this temperature rise curve, where the apparatus will literally and automatically "burn out." This point is, of course, far above anything that is projected at the present time, but while we are looking for limits, we might as well recognize that such a one exists.

In the matter of power production, therefore, although we have steadily improved

in the past, both as to costs and as to performance, and although we may expect to continue this steady improvement in the future, we must not expect that these improvements will be of the same revolutionary character as they have been in the past. We can see ahead of us a definite limit beyond which it will be impossible to improve the methods of power production now in use. I do not mean to say that there will be no new or revolutionary methods developed in the future, but so long as we continue to get our power from falling streams and burning coal we need not expect to see the same radical improvements in the future as have distinguished the past. To illustrate my point more fully let us consider the nature of a water power. Water is evaporated by the action of the sun and is carried miles above the earth into the clouds. Here it is precipitated in the form of rain or snow and falls on the earth. The streams carry this water back to the ocean and it is then ready to repeat the cycle. Our existing water powers utilize an almost infinitesimally small part of this water over an almost infinitesimally small part of the total height to which the sun carried it. Insofar as is concerned the water we use over the head through which we use it, we do fairly well, but the part of the sun's energy which we thereby realize is so infinitesimally small that it puts us to shame. Some Westinghouse or Edison of the future will show us how to use the sun's energy directly. The point I wish to make is that the revolutionary improvements in power production methods of the future must come in a fundamental change of method rather than in the continued improvement of existing methods.

So much then for the methods of producing power. In the matter of utilization of power a few comparisons with the past may not be amiss. As indicated early in this address, the modern motor has reached a stage, insofar as efficiency is concerned, such that little improvement may be expected. We are within a comparatively few per cent of perfection in this respect. The progress of the future will undoubtedly come from improvements in methods of application and in this direction the field is inexhaustible. For instance, the problem of applying electrically the large amounts of power which are demanded by our modern railroad trains has not yet received a solution which is satisfactory to all concerned. That the problem will be solved there is no doubt in my mind, but just how,

is a question that I do not propose to discuss in this address. However, this is only one of the many problems that confront the electrical engineer. The devising of methods for the application of electricity to our modern industries constitutes the occupation of no small part of our fraternity; as witness the many pages in our Proceedings that have been occupied during the past years by the activities of the Industrial Power Committee. It is along this line that we may expect much of what the future may have to offer us of a revolutionary character.

In the field of electric lighting there have been developments of importance. After the telegraph, in point of time, the electric light was the first practical application of electricity.

Most of our modern development in electrical engineering has taken its initiative from the supply of electric lighting to our communities. In this matter of electric lighting let me quote again from Kennelly's 1898 address. He says; "The price of a 16-candle-power incandescent lamp 16 years ago was about \$1.00. Now it is about 18 cents. The best lamps at that time, under laboratory conditions, gave about 0.28 mean horizontal British candle-power per watt, and under commercial conditions about 0.20. The highest pressure for which they could then be obtained was about 110 volts. At the present time, lamps are obtainable giving normally 0.4 mean horizontal British candles per watt, while under commercial conditions the average lamp normally develops about 0.25 candle per watt. They can also be obtained (at 0.25 candle per watt) for pressures up to 240 volts, and are frequently installed on 220-volt mains."

Kennelly therefore records an improvement in 16 years of about 50 per cent in cost of lamps to the consumer and about 50 per cent in efficiency. The introduction of the metal filament lamp has enabled us today to record a much greater rate of improvement in efficiency than Kennelly did. He reported an improvement of about 50 per cent in efficiency in the 16 years previous to 1898. In the 17 years since Kennelly wrote, we have improved our maximum efficiency about 1000 per cent, an advance which is truly marvelous. But here is a field where we have a long way to go yet without reaching a possible limit. It is true that the melting point of the now available materials seems to place the limit of lamp efficiency at a point not much higher than that which we have at present. However,

when we come to compare the efficiencies of even our best lamps with that attained by the fire-fly it is evident that we still have a long way to go before we have reached perfection.

In the matter of power transmission, progress during the past few years has been remarkable. In 1898 the record reads: "The electric transmission of the power of falling water is a branch of engineering that has come into service since 1884, and is making rapid strides, owing to the recent successful employment of high voltages and multi-phase alternating currents. It has been estimated that about 150,000 kw. of this class of machinery is installed in the North American continent, commercially transmitting power to various distances up to 85 miles, at various pressures up to 40,000 volts." Since Kennelly wrote, 17 years ago, the maximum transmission voltages have gone up about $3\frac{3}{4}$ times; the maximum then was 40,000 and now is 150,000 volts. The maximum distance of transmission has gone up about $3\frac{1}{2}$ times, 245 miles as against 85, and the installed capacity of water power plants on the North American continent about 9 times, 1,350,000 instead of 150,000 kw. Kennelly also mentions in his record that "insulation testing sets have been made for producing alternating pressures up to 160,000 volts effective." In this respect we can go at least 10 times better than he reported, 1,000,000 volts from transformers having been made available on more than one occasion and in some cases the voltage available from transformers has been pushed even higher. This matter of power transmission is a branch of our industry wherein the progress of the last 17 years since Kennelly made his record has advanced with probably greater rapidity than in any other branch. I feel very sure that the President of our Institute who comes along 17 years hence and compares the then conditions with my record will not be able to claim any such advance as that we may now claim over 1898. This follows because we are approaching some fairly well defined limits in these matters. For instance, in the question of increasing transmission voltages we are close to the corona limit. The appearance of corona in the transmission line means the continual loss of power and therefore corona cannot be tolerated to any appreciable degree. There are, of course, methods of increasing the voltage range somewhat before corona is produced, such as increasing conductor diam-

eter, but it can be readily seen that the limits of such remedies will be reached long before transmission voltages have increased by the same ratio as they have in the past 17 years.

Another limit that we are approaching in the matter of power transmission is the economic one. Transmitted power costs more than that generated at the points of delivery on account of the cost of and the losses in the transmission line. There obviously is a limit to the investment that can be made in transmission lines and still be able to supply power with the same economy as it can be generated upon the ground. This consideration, coupled with the rapid advance in methods of generating power from steam, has in my mind placed an economic limit to the transmission of water power so that we cannot expect any such advances in the future as the past 10 or 15 years have given us. That there will continue to be improvement and advance, no one can doubt, but its rate certainly will be diminished.

Transmission by high voltage direct currents has received some attention of recent years. While there is no question but that the problems of pure transmission are much simplified by the use of direct currents, the accompanying problems of the generation and utilization are so much intensified that nothing is to be gained in this manner. I would predict no material advance for the future in direct current transmission of power unless some means, as yet undeveloped, is found by which its generation and utilization are made easier and safer than is possible at present.

And so we might go on indefinitely and draw comparisons with past practices. Always we find progress; always also we find that the rate of progress is not so high now as it was in previous years. This is but the working out of a natural law. Electricity is no longer the infant that it was formerly pictured, and cannot be expected to continue the rate of growth of the infant. It is attaining the vigor and strength of manhood. It is contrary to natural law that either a child or an industry can have rapidity of growth and at the same time strength and stability of character. Unquestionably the rapidity of our development is not so great now as it was when Kennelly spoke in 1898, and in this respect we are following but a natural law. At the same time, our vocation is acquiring a stability and performance that are absolutely incompatible with the rate of growth that characterized our earlier years.

ECONOMIES IN OPERATING SMALL CARS

By J. F. LAYNG

RAILWAY AND TRACTION ENGINEERING DEPARTMENT, GENERAL ELECTRIC COMPANY

The author first outlines some of the disadvantages under which the modern street railway is operated. He then analyses the expenses of electric railways, dealing specifically with general expenses, power, maintenance of ways and structures, maintenance of equipment and transportation, and shows the influence of weight of car per passenger carried on each of these items. Finally he compares the present type of car seating 48 passengers with a proposed one-man car seating 32 people and emphasizes the economies that could be effected by employing the lighter equipment.—EDITOR.

Railway managers have ever present before them the problem of balancing their expenditures with the receipts in the efforts to attain the proper operating ratio of expense to earnings. Of late years, due to general conditions, this problem has been harder to solve than formerly. It has been almost universally impossible to secure a change in the rate of fare, regardless of the advance in the rate of change in the cost of producing transportation. In past years it was possible to increase the total receipts by fare zones, or by decreasing the transfer privileges, but at the present time, in most cases, the attitude of the public to the public service corporation is that if reduction can be made in the charge for transportation the public is entitled to a reduction, but if for any reason whatever the cost of producing transportation is greater the public usually give the railway companies very little consideration, and generally the statement is made that the management of the property is inefficient.

In nearly all cases for city service the fare unit has remained the same, but it is also true that the average passenger haul is longer and the transfer privileges have had to be extended. The public have been educated to expect more and more from the transportation companies not only in the grade of transportation given, but also they expect a lower rate of fare. In the early days of electric railways, small light weight single-truck cars with longitudinal seats and non-heated cars were looked upon as a luxury, but now the public expect large double-truck cars with comfortable transverse seats, and during the winter time the cars must be kept at a uniform temperature.

To meet the demand of the public and keep down the expense of operation, it is best for city service to run cars at the fastest practicable schedule speeds. With the large double-truck cars, naturally the total weights and weight per seated passenger is increased. These features naturally increase the wear and tear on the track and special work, and also increase the power consumption propor-

tionately. The heavier cars also naturally require heavy roadbed construction with heavy rails, and even with the larger first expenditure for roadbed the heavier cars greatly increased the maintenance of way cost.

The rapid development of the automobile and its continued increased use has greatly cut into the receipts of both the interurban and city roads. During the past two years a large number of managers of interurban properties found the receipts during county and state fairs were greatly reduced when compared with former years. This reduction was attributed almost entirely to the increased use of the automobile.

During mild seasons of the year the automobile is and will probably continue to be a factor to be considered in the receipts of the short hauls of the interurban road. The cost of this method of transportation is higher than that furnished by the electric road, but with the class of person who owns and maintains a machine, even though it costs a little more, providing the expense is not continuous, it is not considered serious, and the pleasure of driving one's own car is considered to cover the difference. To meet this form of competition, many think the only thing to do is to bring to the attention of the automobile users the difference in the cost of the two classes of service, and to make the car service as attractive as possible. The city lines have recently encountered much more serious competition in the jitney. This service has developed almost over-night, and within an incredibly short period of time many railway companies have encountered a competitor that reduced their gross receipts 5 per cent, and in some cases 20 per cent. The jitney as operated at present in most cities follows the lines which have the most traffic. In a city where seven city lines are operated, only two of these lines were having jitney competition. One of the lines during non-rush hours gave a six-minute service, and during the rush hours a three-minute service, the other line gave a 10-minute non-rush hour

and a five-minute rush hour service; the other five lines gave a 15-minute service. With the two lines having the dense traffic the gross receipts dropped 20 per cent. Problems such as this put the railway management in a most serious position. The problem is not confined to any local community, but is a general one encountered from the New England States to the Pacific Coast. The general consensus of opinion regarding the jitney service is that there are three things which influence the public to use them; first, the high schedule speed; second, the novelty of the ride, and third, the direct delivery to the point of destination. It is also generally believed, from the experience of a large number of people, that the jitney service as given at present is not profitable, and that in its present form the service will not continue and is merely a passing fad. However, many believe that some form of the auto bus carrying possibly from 10 to 12 passengers will be worked out, and may prove a really serious competitor for the electric service as it is now given.

The American railway men in the past have proved progressive, ingenious and resourceful. Every problem of maintenance and operation is scientifically studied, and the results of these studies are put into practice. There has been more originality and progress in transportation methods, car design and design of apparatus for this class of work than in any other business we have. With the art in such able hands and with the assistance of the technical press, which reaches us all at regular intervals, there is every reason to feel confident of the practical solution of the problem.

To get a proper perspective as to what is involved, a study of the figures given by the United States Census Bureau for the distribution of expenses of all the electric railways in the United States is of considerable assistance. This table gives the following ratio of costs to operating revenues:

General expense.....	9.53 per cent
Power.....	9.0 per cent
Maintenance of way and structure..	8.17 per cent
Maintenance of equipment.....	7.06 per cent
Transportation.....	24.42 per cent
Total.....	58.18 per cent

In looking over these figures, it is but natural that the largest figures should be selected first for analysis; that is, the cost of conducting transportation, which is 24.42 per cent of the gross receipts. Practically all of this represents expenditures for platform

wages. With the present plan or system of fare collections for the larger cities, and where travel is heavier, there does not seem to be any way of materially reducing these figures. All of the progressive railway companies have studied their local conditions and have in-

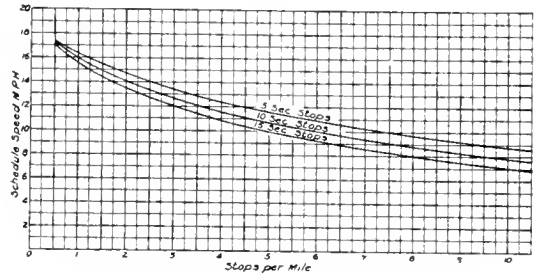


Fig. 1. Typical Schedule Speeds for 20-ton Car Geared for 20 m.p.h. max. speed Acceleration 150 lb. per ton Braking 150 lb. per ton Coasting 20 per cent power on period

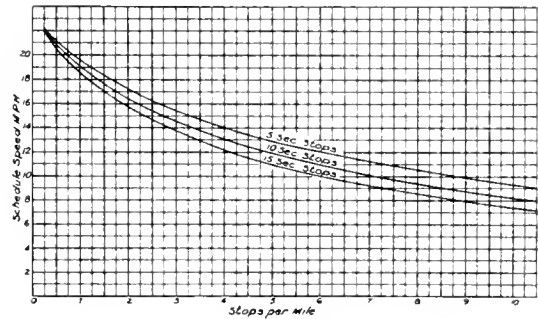


Fig. 2. Typical Schedule Speeds for 20-ton Car Geared for 25 m.p.h. max. speed Acceleration 150 lb. per ton Braking 150 lb. per ton Coasting 20 per cent power on period

creased schedule speeds to the maximum in order to secure the lowest possible platform expense per car mile. Cars have been designed with entrances and exits especially adapted to facilitate rapid loading and unloading, so as to reduce the length of stop to a minimum. In several cities skip-stop service has been inaugurated to cut down the number of stops per car on lines where a large number of stops necessarily have to be made. Curves shown in Figs. 1 and 2 illustrate the effect of increasing the length of stop with different stops per mile with cars geared to a free running speed of 20 and 25 m.p.h. These curves show the highest possible schedule speeds that may be obtained on level track under favorable conditions. When making calculations and considering practical schedules,

it is best to increase the running time by 10 per cent to allow for the naturally slower schedule speed which will be caused by curves, grades, and obstructions by vehicles which are encountered in actual service.

A practical example of what long stops mean can be seen by referring to the schedule speeds. Let us take for example a line having a schedule speed of 12 m.p.h. with six stops per mile and five-second stops. By increasing the length of stop to 15 seconds the schedule speed is reduced to 10 m.p.h. This is a reduction in schedule speed of $16\frac{2}{3}$ per cent. Of course, extending the length of stop to 15 seconds for city service is a larger value than will be found normally, but it illustrates the value of the efforts to keep down the length of stop. By expending energy along this line, we can secure true economies as the increase in schedule speeds obtained in this manner do not require increased power per car-mile and will give us a greater number of car miles per hour. All railway companies have lines on which only one to five cars are operated and give sufficient service, and in some cases the combinations of the running time and distance will not admit of much change in present methods, but the cases where some possible saving cannot be made are comparatively rare.

The length of stops has been discussed at considerable length as it directly affects our problems of fare collection, general car designs and schedule speeds. There are many instances where one-man cars are now successfully used, and there will no doubt be many of these cars in the future. They will probably ultimately be used for practically all service, in cities having a population of 60,000 or less, and in large cities for lines on suburban sections where the traffic is not sufficient to warrant the use of the larger cars such as are used for a heavily congested traffic. In this class of work the light weight one-man car should serve the public equally as well as the larger cars.

With all of our present systems of fare collections, it is necessary for the operator to handle money, and as long as this is true, it would hardly seem practicable to have the cars in the larger cities operated by one man. The additional time which would be consumed by making change and giving transfers would probably prove of too great a handicap. These features with the larger number of cars required would extend schedule speeds and cause obstruction to traffic in the down town section. Therefore, unless we have some

radical change in our fare collection and transfer feature for larger cities the only way to change the traffic expense ratio is by having each car operated so as to run the maximum car miles per hour. However, in a small city and on many suburban feeder lines, large savings are possible with the small car. Those who have made a study of the one-man car deem it advisable to have all the possible safety features, which includes "dead man's release" on the controller, which when the operator's hand is removed from the controller handle, automatically cuts off current from the motors, sands the track, applies the brakes, and when the car comes to a full stop opens the car door.

Again referring to our census figures, we find that the next highest item is power, which constitutes 9 per cent of the total. There are three ways to reduce this figure, which are reducing car weights, slowing down the schedule, and more efficient operation. By more efficient operation is meant savings that can be made by operating at the proper rate of acceleration, maximum coasting, and proper rate of braking. The question of saving power by lengthening the schedules can hardly be considered, as the savings made by this method for city service almost universally are considerably less than is necessary to balance the extra cost of transportation expenses.

For the purpose of the present discussion, it will be assumed that all possible savings are being made by the proper application of power and brakes. This will confine us entirely to the question of car weights. The influence of the actual cost of transporting a given weight varies greatly. Some railway officials say that it is a negligible figure and do not consider that a few hundred pounds more or less on the car affects the cost of operation; while others figure that it costs 30 cents per year to carry an extra pound. The generally accepted figure of five cents per pound per year has a good deal of justification. However, the only tangible figure is that for power. All other elements entering into consideration are more indefinite. Recently an analysis of the service of a large city line where the maximum schedule speeds are operated showed the power consumption at the power house to be 170 watthours per ton-mile, and the average miles for a car owned is 40,000 miles per year. Current costs this company 0.7 cents per kw-hr. It can therefore be seen that for current alone the cost of hauling

one pound per year is 2.38 cents. There are of course other expenses that increase weight, such as larger investment for power supply, feeders and extra cost of the maintenance of right of way, due to the increased weight to be carried.

When considering power alone, savings can be made almost in proportion to reduction in weights of cars.

When the successful storage battery cars were put in operation, a great object lesson in car body and truck construction and electrical design was given to the equipment designers in this country.

One of the next steps was the realization that two-motor equipments will give satisfactory service where grades do not exceed five per cent and where trailer operation is not required. However, there are many American cities where grades exceed five per cent, where two-motor equipments are far from satisfactory.

One of the next greatest advances was made by Mr. P. N. Jones and his assistants when they put 24 in. wheel equipments in service on the Pittsburg Railways. With these cars and other cars of this character which have since been built, the weight per seated passenger was decreased to approximately 600 lb., while the preceding types of cars using four-motor equipments had a weight equal to 900 or 1000 lb. per seated passenger. With the small diameter of wheel smaller truck strains are obtained, which coupled with the less weight of wheel gives us trucks which are roughly speaking $33\frac{1}{3}$ per cent lighter than the trucks which were formerly used for this same class of service. Since the Pittsburg Railways put in service cars with 24 in. wheels, a number of other companies have also purchased the same class of equipment, and all indications now are that an entirely new field of development has been started by the small diameter of wheel. With single truck cars it is possible to have a much longer wheel base with no greater binding in curves than is obtained with a relatively short wheel base with a large diameter of wheel.

Recently the jitney competition has caused operators to again review general car designs to determine if it is feasible to develop a light weight one-man car. Mr. J. M. Bosenbury, Superintendent of Motive Power of the Illinois Traction System, has designed a single end and double-end one-man car; each of these cars seating 30 passengers. The single-end car completely equipped will weigh

10,000 lb. and the double-end car 15,000 lb. These weights are equal to 333 and 500 lb. respectively per seated passenger.

Mr. C. O. Birney of the Stone & Webster Engineering Corporation has designed a single-end one-man car which will weigh completely equipped 9000 lb. and seat 29 passengers, which is equal to 310 lb. per seated passenger.

In some cases these types of cars might advantageously use motors smaller than we are now considering standard for railway service, but if there is a real demand for this class of car, and if it is ultimately believed by the transportation interests that such a car is desirable, the manufacturers of apparatus can be depended upon to supply equipments which will meet the requirements in every respect.

Again referring to the census figures, the next item which we have to consider is 8.17 per cent for maintenance of way and structures. Of course, with very light cars this figure will be reduced, but as the amount of the reduction is difficult of determination, a direct answer could not be given to this question as it would vary greatly with different localities and different conditions.

The next figure from the census report is 7.06 per cent for maintenance of equipment. The maintenance figure would be reduced with the small light weight cars from 10 to 20 per cent.

All that have been discussed previously in this paper have been features which enter into the design of our present cars and those things which may be considered when designing the small one-man car. From a purely engineering standpoint there is not the slightest doubt but that the small light weight one-man car should be used for practically all service. With the small car when compared to larger cars used at present practically the same service can be given with at least 18 per cent less expense; that is, when operating a one-man car and in giving service that is required in many cases.

For a direct comparison of power, with different number of stops per mile and different car weights, a curve showing the energy for an 8-ton and a 20-ton car is shown in Fig. 3. The 20-ton car includes the live load and therefore a four-motor equipment is favoring the larger car to a considerable extent, while the 8-ton car is showing the small one-man car up in as unfavorable a light as could be consistent insofar as power calculations are concerned. In order to help arrive

at an understanding of the advantages and disadvantages of a one-man car, an example has been taken of a line which is 10.6 miles per round trip; the running time for the round trip one hour, with six stops per mile. Platform wages for the two-man car are

power as shown by the curve for a 20-ton car for this service would be 2.9 kw-hr. per car mile at the car, and for the 8-ton car 1.3 kw-hr. The receipts for the present cars are assumed to be 24 cents per car mile.

For the one-man car two grades of service are analyzed, viz.: one in which the headway during the non-rush hour is decreased from the present service of ten minutes to six minutes, and the second in which the interval between cars is left the same as at present, but giving during the rush hours an increased service the same as would be required with the one-man car frequent service.

The above analysis shows the receipts the same for all classes of cars. The smaller cars in both cases give much more frequent service, and it is but natural with this increased service that the receipts should be greater. With the large car the operating ratio of expense to gross receipts is 56.5 per cent while with the small one-man car with cars at six-minute intervals instead of ten-minute service, the operating ratio is 53.5 per cent.

Reviewing the figures of the one-man car giving ten-minute service during the non-rush hours and three-minute service during the rush hours brings out several very prominent facts. The first is that the operating ratio has decreased to 46 per cent. The second is that with this type car more seats per hour can be furnished during the rush hour with 18 per cent decreased expense. Another fact is that during the non-rush hours the larger seating capacity of the larger cars is not

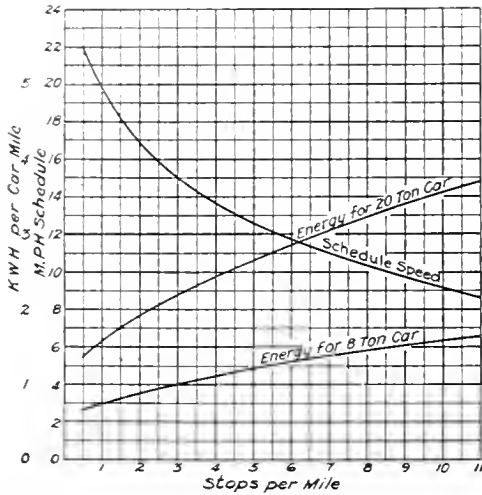


Fig. 3. Curves showing Energy Saving with Light Cars for Various Stops
Free speed 25 m.p.h.
Four-motor, 20-ton car—friction 24 lb. per ton
Two-motor, 8-ton car—friction 30 lb. per ton

taken at 50 cents per hour, for the one-man car 30 cents per hour, and the power is assumed to cost one and one-half cents per kilowatt-hour delivered to the car. The present cars seat 48 passengers and the proposed one-man car seats 32 passengers. The

	Present Car Seating 48	Proposed One-man Car Seating 32	Proposed One-man Car Seating 32
Headway for 14 hours.	10 min.	6 min.	10 min.
Headway for 4 hours.	5 min.	3 min.	3 min.
Running time	60 min.	60 min.	60 min.
Cars required 14 hours.	6	10	6
Cars required 4 hours	12	20	20
Seats per hour 14 hours	288	320	192
Seats per hour 4 hours	576	640	640
Car miles per day	1399.2	2332	1738.4
Power	\$40.57	\$30.31	\$22.60
Platform wages	66.00	66.00	49.20
Maintenance of way 8.17 per cent	27.43	27.43	27.43
Maintenance of equipment 7.06 per cent	23.69	23.69	23.69
General expense 9.53 per cent	32.00	32.00	32.00
Total expense	\$189.69	\$179.43	\$154.92
Receipts at 24 cents per car mile	335.80	335.80	335.80
Ratio of expense to gross receipts, per cent.	56.5	53.5	46

required. In many cities the average load does not require more than 50 per cent of the seating capacity furnished. With the small cars the seating capacity during the non-rush hours is in the proportion to the logical actual requirements and conforms to a natural and proper saving.

It will be noted that expenses for traffic other than platform wages are left the same for the one-man car as for the proposed car as it would hardly seem fair to the small car to do otherwise. It is also assumed that the extra car miles which are made by the small car will offset any savings in maintenance

of equipment and track, and the same proportions of expense have been used as have been found by the average throughout the country.

Certainly it would seem from these figures that in the future many light weight one-man cars will be purchased.

In many cities there are ordinances or rulings of public service commissions which at present prohibit the use of one-man cars, but it is reasonable to assume that when the case is properly presented, and if the light weight car will serve the needs of a community, these restrictions will be removed.

RADIOGRAPHY OF METALS

By DR. WHEELER P. DAVEY

RESEARCH LABORATORY, GENERAL ELECTRIC COMPANY

Previous investigations by the author (insofar as these had been made) demonstrated the practicability of employing X-rays to detect flaws in the interior of metal castings, etc. Naturally, the next steps undertaken were the ascertaining of the limits of this new method of detection, the determination of the direction in which to expect a possible extension of the limits, the derivation of the working formulæ for the work, and the acquisition of the necessary technique for its successful prosecution. In the following article the author describes these latter investigations and records their results.—EDITOR.

In an article in the GENERAL ELECTRIC REVIEW, January, 1915, reference was made to the X-ray examination of a steel casting $\frac{9}{16}$ of an inch thick. Fig. 1 shows one of the radiographs thus obtained. All these radiographs showed plainly the tool marks on the surface of the casting. *All but one* showed peculiar markings which were of such shape as to strongly suggest that they were indeed the pictures of holes in the interior. A cylindrical piece, one inch in diameter, was punched from the casting at a point where the radiograph, shown in Fig. 1, indicated that a blow-hole should be found. (The location of the sample punched out is indicated by a circle.) Fig. 2 is a photograph of the side of the punching and it shows the hole that was found.

Since that article was written it has seemed desirable (1) to obtain data from which the exposure necessary for any thickness of steel could be at once calculated, (2) to find the thickness of the smallest air inclusion which could be radiographed in a given thickness of steel, (3) to find the direction from which to hope for further progress, and (4) to find the technique of radiographing metals.

In order to gain some preliminary data, several pieces of $\frac{1}{2}$ -in. boiler plate were obtained, five by seven inches in size. In

one of these, holes were drilled in such a way that the axis of each hole was midway between the faces of the steel and parallel to those faces. The diameters of these holes are listed in Table I.

TABLE I

Hole Number	Diameter
1	$\frac{1}{4}$ inch
2	$\frac{1}{8}$ inch
3	$\frac{1}{16}$ inch
4	$\frac{1}{32}$ inch
5	$\frac{1}{64}$ inch

Exposures were made on Seed X-ray plates at a distance of 20 inches with Coolidge tube X-117 which was operated on a Scheidel-Western induction coil having a mercury turbine break. The X-ray plate was placed on a sheet of $\frac{1}{8}$ -in. lead. The steel plate was laid on this and a lead cover was placed over the whole in such a manner that the cover and backing made a complete lead-shield for the X-ray plate. (See Fig. 3.) A rectangular hole in the cover allowed such X-rays as were able to penetrate the steel to reach the X-ray plate. This afforded complete protection against secondary rays.

Without such precautions, the effect of secondary rays on the X-ray plate would have been greater than that of the rays used to take the picture. If the steel had been two or three feet square, such precautions would have been unnecessary. By placing the pieces of boiler plate on top of each other any thickness of steel desired could be obtained. Exposures were made at 11-, 13- and 15-in. parallel spark-gap between points. An attempt was made to use a 17-in. spark gap, but was abandoned due to flashing in the tube. The results are tabulated in Table II.

TABLE II

Thickness of Steel in In.	Plate	Spark Gap	Exposure in Milliamperes-minutes	Holes visible
$1\frac{1}{2}$	D	11	7	1-2-3-4-5
	A	13	4	1-2-3-4-5
	B	15	2	1-2-3-4-5
1	E	11	45	1-2-3-4-5
	F	13	19	1-2-3-4-5
	G	15	10	1-2-3-4-5
$1\frac{1}{2}$	H	11	45	1-2-3 very faint
	I	13	30	1-2-3 very faint
	K	13	90	1-2-3 faint
	J	15	30	1-2-3-4-5 very faint
	L	15	60	1-2-3-4-5 faint

This really means, of course, that at 13-in. spark-gap 90 milliampere-minutes is sufficient to enable one to notice the difference in blackening between exposures through $1\frac{7}{16}$ in. and $1\frac{1}{2}$ in. of steel, but is not sufficient to enable one to detect the difference in blackening between exposures through $1\frac{5}{8}$ in. and $1\frac{1}{2}$ in.

These results were necessarily incomplete, since the plates were by no means all of the same density. They served, however, to demonstrate two facts.

(1) With the voltages which can now be used, it is impracticable to radiograph through more than $1\frac{1}{2}$ in. of steel with tungsten target tubes because of the time required.

(2) The use of high voltages does not seem to appreciably reduce the clearness of the picture obtained. (It was to have been expected from published data on scattering in aluminum that enough scattered radiation would have been produced to blur the pictures, but plate *B* apparently shows as good detail as does plate *D*.)

It remained to verify these conclusions by data of a quantitative nature. Seed X-ray plates were therefore exposed under the same conditions as before except that none of the slabs of steel used had been drilled. For each thickness of steel, all the exposures at a given



Fig. 1. Radiograph of a Steel Casting showing Flaw within Casting. The circle shows where a piece was later punched out

spark-gap were made on the same plate. Each plate, then, showed a series of steps which increased in density from one end of the plate to the other. Thickness of steel, spark-gap, and milliampere-minutes were recorded on each plate by means of lead numbers. Data regarding these plates is listed in Table III.

TABLE III

Plate No.	Thickness of Steel	Spark-gap
216	1/2	11 inches
217	1/2	13 inches
218	1/2	15 inches
221	1	11 inches
220	1	13 inches
219	1	15 inches
222	1 1/2	15 inches

A study of these plates showed the following facts. Let $E_{1/2}$ be the exposure in milliampere-minutes necessary to produce a given darkening of the plate through 1/2 inch of steel, and let E_1 and $E_{1 1/2}$ be the exposures necessary to produce the same darkening through 1 inch and 1 1/2 inch respectively. Then at 11-in. gap

$$E_{1/2} : E_1 = 1 : 11$$

At 13-in. gap

$$E_{1/2} : E_1 = 1 : 8$$

At 15-in. gap

$$E_{1/2} : E_1 = E_1 : E_{1 1/2} = 1 : 8$$

Also, through both 1/2 inch and 1 inch of steel

$$E_{13\text{-in. gap}} : E_{11\text{-in. gap}} = 1 : 4$$

and $E_{15\text{-in. gap}} : E_{13\text{-in. gap}} = 2 : 3$

of these conclusions is the more probable, but it is the *effect of the X-rays on the plate* which is of prime importance in this work, so that from a radiographic standpoint we may say that in any case the *effective penetration* of the rays is a little greater at 13-in. gap than at 11-in. gap.

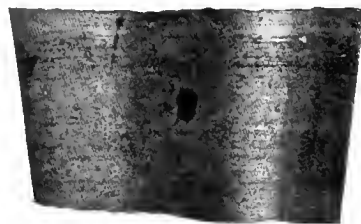


Fig. 2. Ordinary Photograph of one edge of the punching from the plate shown in Fig. 2. Note flaw

In the same way we may conclude that the effective penetration at 15-in. gap is the same as at 13-in. gap. There is, however, a marked decrease in the amount of exposure required as the voltage across the tube (as measured by the spark-gap) is increased. This may be due to one of two causes, *either* the efficiency of transformation from the kinetic energy of the cathode stream into the energy of the X-rays may be greater at high voltages, *or* there may be some peculiarity in the wave-form produced by the induction coil such that a great deal of energy is given off at a voltage corresponding to 13-in. gap when the coil is operated so as to give a maximum voltage corresponding to a 15-in. gap. Investigation

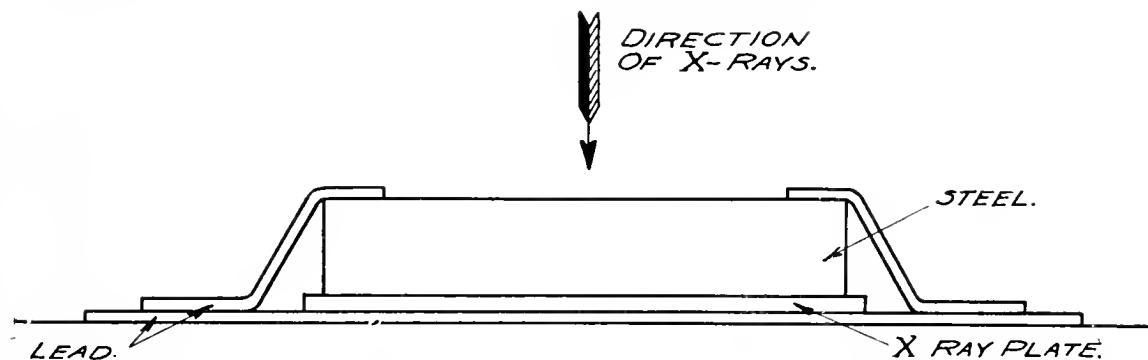


Fig. 3. Diagram of the Method of Preparing Steel Sample, X-ray Plate, Lead Mask and Lead Backing for taking Radiograph

It is at once evident that *either* X-rays from a tungsten target at 13-in. gap are more penetrating than when produced at 11-inch gap, *or* the X-ray plates used are more sensitive to the rays produced at 13-in. gap. There is other evidence to show that the first

work on crystal-reflection of X-rays will serve to decide between the two hypotheses.

From the data at hand, it is easily possible by well known means to construct formulæ for computing the exposure necessary for radiographing steel at various spark gaps.

Let Q_0 be the quantity of X-rays impinging on the steel during the exposure.

Let Q be the quantity of the rays which pass through the steel.

Let x be the thickness of the steel.

Let λ be the coefficient of absorption of the steel. Then, if the X-rays are homogeneous,

$$Q = Q_0 \epsilon^{-\lambda x}$$

Where ϵ is the base of natural logarithms.

Now at 15-in. gap we know that $\frac{E_{1/2}}{E_1} = \frac{E_{1/4}}{E_{1/8}} = 1.8$

Likewise for 15-in. gap

$$\lambda = 4.16 \text{ inches}^{-1} = 1.64 \text{ centimeters}^{-1}$$

Applying the same method for 11-in. gap

$$\lambda = 4.80 \text{ inches}^{-1} = 1.89 \text{ centimeters}^{-1}$$

Now at 15-in. gap and 20-in. distance, 0.8 milliamperere-minutes gives a good exposure through $\frac{1}{2}$ inch of steel. A corresponding darkening would have been produced on a bare (unobstructed) plate by an exposure of 0.1 milliamperere-minutes. This corresponds

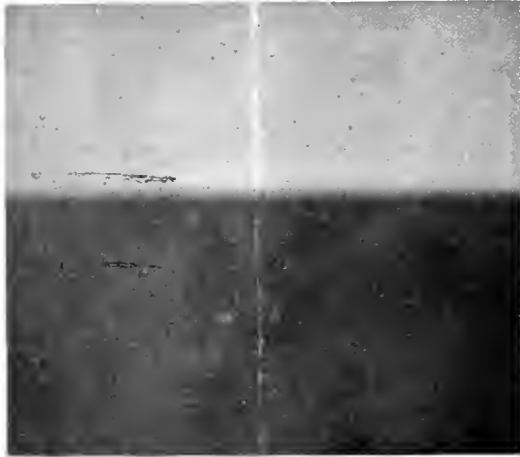


Fig. 4a. Radiograph of Autogenous Weld in Steel. Sample No. 1. Only the surfaces have been welded



Fig. 5a. Radiograph of Autogenous Weld in Steel. Sample No. 2. Holes in center due to metal not being thoroughly fused

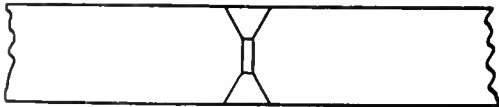


Fig. 4b. Diagram of Section of Weld in Sample No. 1



Fig. 5b. Diagram of Section of Weld of Sample No. 2

The rays given off at 15-in. gap are therefore practically homogeneous. Since $\frac{E_{1/2}}{E_1} = 1.8$ at 13-in. gap, we may assume that these rays are also practically homogeneous. Rays given off at 11-in. gap are still sufficiently homogeneous, after having passed through the first few hundredths of an inch of steel, to allow of being treated as though they were actually homogeneous. Calculations for exposures at 11-in. gap are to be considered as being only good approximations.

For 15-in. gap we have

$$Q/Q_0 = 1/8 = \epsilon^{-x\lambda} = \epsilon^{-1\lambda}$$

$$\log 8 = 1/2 \lambda = 2.079$$

$$\lambda = 4.16 \text{ inches}^{-1} = 1.64 \text{ centimeters}^{-1}$$

to Q in the formula. We may therefore write, since $Q_0 = E$,

$$0.1 = E \epsilon^{-4.16 x}$$

$$10 E = \epsilon^{4.16 x}$$

$$\log \epsilon 10 E = 4.16 x$$

$$\log_{10} 10 E = 1.80 x$$

$$E = 1/10 \log^{-1}_{10} 1.80 x$$

where x is the thickness of the steel in inches or

$$E = 1/10 \log^{-1}_{10} 0.71 x$$

where x is the thickness of the steel in centimeters.

The corresponding formulæ for 13-in. gap are

$$E = 3.20 \log^{-1}_{10} 1.80 x \text{ (} x \text{ in inches)}$$

$$E = 3/20 \log^{-1}_{10} 0.71 x \text{ (} x \text{ in centimeters)}$$

The approximate formulæ for 11-in. gap are

$$E = 3/5 \log^{-1}_{10} 2.09 x (x \text{ in inches})$$

$$E = 3/5 \log^{-1}_{10} 0.82 x (x \text{ in centimeters})$$

It remained to find the thickness of the smallest air-inclusion which could be radiographed in steel at 15-in. gap. For this purpose two plates of steel were taken. The faces were machined flat and in one of them a slot was cut, thus giving a *wedge* of air. The slot and the faces of the steel plates were then

taking of pictures so that the technique of radiography through metals might be worked out.

A record of a single example will suffice. Four samples of autogenous welds in steel were obtained. The welding had been done with an oxy-acetylene flame. The samples were 1/2 inch thick and about 4 inches square, and their faces were fairly rough. Sample No. 1 had only been welded on the surfaces. (See Fig. 4b.) Sample No. 2 had been



Fig. 6a. Radiograph of Autogenous Weld in Steel. Sample No. 3. Weld is porous



Fig. 7a. Radiograph of Autogenous Weld in Steel. Sample No. 4. A good weld



Fig. 6b. Diagram of Section of Weld in Sample No. 3



Fig. 7b. Diagram of Section of Weld in Sample No. 4

ground smooth. When completed, each plate was 5/8 in. thick. The air wedge was 10 inches long, 1 inch wide, and 9/64 inch thick at its thick end. When the two plates were bolted together, the air wedge simulated a blow-hole in a casting. The wedge was then radiographed at 15-in. gap. When the X-ray plates were dry the place was noted at which the outline of the wedge was barely visible. In order to avoid error, only a small portion of the wedge image was viewed at one time, the remainder being blocked off with cardboard.

It was found that an air inclusion 0.021 inch thick could be detected in 1 1/4 inches of steel. In this 5/8 inches, an air inclusion of 0.007 inch could be detected.

Besides the work that has been outlined here in much more has been done in the actual

insufficiently heated so that there was incomplete fusion of the metal at the center. (See Fig. 5b.) In welding sample No. 3 an excess of oxygen had been used in the flame, which caused the presence of oxide on the surface. (See Fig. 6b.) Sample No. 4 was considered to be a good weld. (See Fig. 7b.) One-half of each face of the samples was machined off, so that half the length of the weld was between flat, parallel faces; the other half was left under the original rough surfaces. As a result, one-half of each sample was 1/2 inch thick and the other half was about 3/8 inch thick. Radiographs were taken at 15-in. gap under the conditions described above. Reference to the formula for exposure at 15-in. gap shows that the exposures through the 1/2 inch and 3/8 inch portions were in the ratio of 1

to 1.7. The resulting radiographs are shown in Fig. 4a, 5a, 6a, and 7a.

Fig. 4a shows clearly the unwelded center of sample No. 1 in both portions of the picture. Fig. 5a shows, in both portions of the picture, the holes caused by the metal not having been thoroughly fused at the center. That portion of Fig. 6a which was taken through the machined end of the weld of sample No. 3 would seem to indicate a porous structure. Such a structure was evident during the machining. The portion of the picture taken through the unmachined end of the weld did not show such a structure with certainty. This was to have been expected, as the inequalities in thickness due to the uneven surface were at least as great as those due to porous or frothy structure. Fig. 7a shows that, as far as gross structure is concerned, sample No. 4 was a good weld.

It is of course self-evident that a radiograph gives only the gross structure of the metal,

and gives no information as to the "grain," crystal interlocking at the edge of the weld, etc. A radiograph does, however, give valuable information as to the presence of blow-holes, slag inclusions, porous spots, and defects of like nature which could not be found otherwise except by cutting into the metal. Unfortunately, no fluoroscopic screen now known is sensitive enough for this work, therefore all work in metals must be done radiographically. An inspection of the formulæ that have just been derived demonstrates that, for the present at least, radiography of steel is a commercial possibility only up to thicknesses of $\frac{1}{2}$ inch. For greater thicknesses, the time required is rather great. The big saving in time which is gained by the use of a 15-in. spark-gap instead of a 13-in. gap makes it seem probable that a further increase in the voltage across the tube would allow one to radiograph still greater thicknesses of steel.

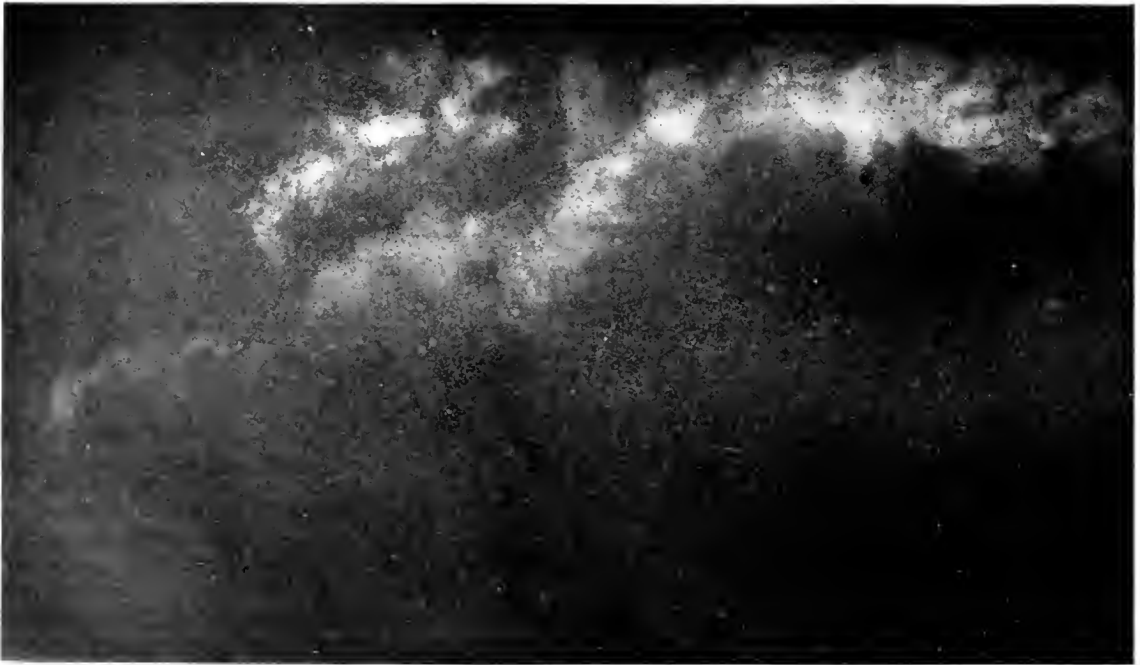


Fig. 8. A radiograph of a steel casting revealing a flaw in the interior of the plate

AIR CLEANING APPARATUS FOR THE VENTILATION OF GENERATORS AND TRANSFORMERS

BY WILLIAM BAUM

GENERAL ELECTRIC COMPANY

In our last issue we published an article on "Tests for Dirt in an Air Supply." We now publish the following comprehensive article on "Air Cleaning Apparatus." The author has gone into this subject so fully that his treatment should be of great value to central station men. Dry air filters, wet surface filters, and air washers of various designs are considered in detail and valuable comparative data and costs of operation are given. This subject is of such live interest at the present time that we hope our article will fill the need expressed by many central station men for such information.—EDITOR.

I. INTRODUCTION

The great importance of cleaning and cooling the air used for the ventilation of turbo-generators and air blast transformers is well recognized.

The use of air for ventilating purposes without any check on its purity results in the rapid accumulation of dirt and oil with the consequent risk of the breakdown of the machine. Further, the accumulation of dirt means rapid deterioration and frequent cleaning; to carry out the cleaning, the machine must be shut down. These considerations brought the question of air purification into prominence.

The following is a study of air cleaning apparatus which has been applied to the ventilation of electrical machinery, and is an attempt to arrive at a definite conclusion as to the relative merits of the various apparatus and their fields of application.

II. DRY SURFACE FILTERS

General

Modern dry surface filters consist of a number of units or boxes suitably arranged and fixed in a framework, the number depending upon the amount of air to be delivered to the generator or transformer. Each unit supports a filtering medium which permits the passage of the air, at the same time obstructing the dust particles held in suspension. In general, air filters should meet the following requirements:

- (a) Complete removal of suspended matter.
- (b) Minimum loss in pressure due to air passing through the clean and soiled filtering medium.
- (c) Minimum dimensions.
- (d) Simple construction with means for convenient removal and cleaning of the filtering medium.
- (e) Durable filtering medium which does not require too frequent removal.
- (f) Minimum fire risk.

In the following paragraphs these requirements are considered in detail:

(a) Complete Removal of Suspended Matter

Manufacturers of dry surface filters guarantee the *complete* removal of suspended matter without giving, however, accurate methods of determining the effectiveness of cleaning. The degree of purification depends upon the density of the woven material which must be kept within reasonable degrees to prevent excessive resistance to the passing air.

(b) Minimum Loss in Pressure Due to Air Passing Through

Fig. 1 relates to a dry surface filter which is installed with a 6000-kw. A. E. G. turbo-generator in the Berlin Electricity Works and shows the resistance of the clean filter and the increase of resistance as a function of the hours of operation.

The filter started at a resistance of 5 m/m (0.197 in.) of water column and rose to 26 m/m (1.02 in.) after 2000 hours of operation. Then the filter was cleaned by means of suction air and the resistance fell to 9 m/m (0.354 in.), rising again to 28 m/m (1.1 in.) after 2820 hours of operation. A second cleaning took place, the resistance falling to 10 m/m (0.394 in.) and rising again to 36 m/m (1.417 in.) after 3600 hours of operation. After a third cleaning, the resistance fell again to 10 m/m (0.394 in.) and, as a maximum of permissible resistance had been reached, the filter medium had to be replaced by a new one after approximately 4000 hours of operation.

The diagram indicates that the air resistance after a cleaning process is always higher than the resistance obtained after a preceding cleaning and it is, therefore, necessary to replace, with each cleaning process, some of the units in order to keep the pressure loss within permissible limits.

c Minimum Dimensions

An effective area of 0.2 square feet is normally required for each cubic foot of air per minute. The required area depends

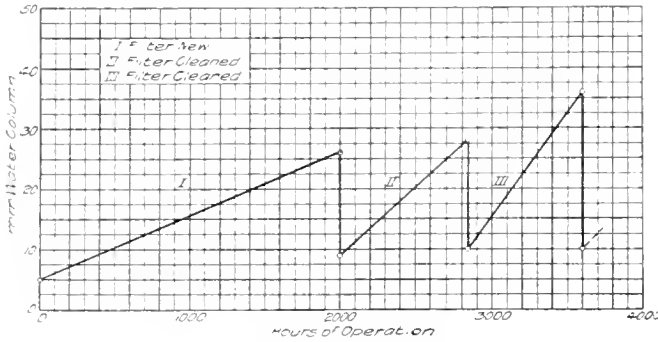


Fig. 1. Diagram showing the Air Resistance of an Air Filter in connection with a 6000-kw. turbine

upon the nature of the filtering medium which is spread on frames of wood or metal in such a manner that a maximum of effective surface is obtained with a minimum of space. The air velocity is in the neighborhood of 6 to 10 feet per minute, according to the amount of dirt in the air.

The filter medium is arranged in zig-zag or in independent pocket form; the latter type is preferable as the individual pocket can be easily removed, cleaned or replaced without interrupting the filtering process. Cotton rope filters require less space than cloth filters.

d Simple Construction with Means for Convenient Removal and Cleaning of the Filter Medium

A great variety of dry surface filters has been designed in Europe and their construction will best be understood by referring to the illustrations in this article. Cleaning takes place by means of compressed air or vacuum. Chemical cleaning cannot be recommended, as practice has shown that the fluffy parts of the filters are destroyed, materially reducing the cleaning effect. Further, the filters shrink and the stretching on the frames becomes difficult. The success of dry filters depends largely upon careful, regular cleaning and handling.

e Durable Filtering Medium which Does Not Require Too Frequent Removal

The life of the filtering medium depends upon the grade of the woven material, the amount of dirt in the air and the general climatic conditions. In very damp localities,

the filter becomes covered with a coat of slime and rapidly loses its cleaning capacity. The filter medium consists usually of a cloth made of cotton flannel or is made up of cotton rope in the form of fluffy strings.

(f) Minimum Fire Risk

If the filtering medium, consisting of a combustible material, catches fire it may cause the complete destruction of the power house. Air filters should always be installed within brick or concrete walls or be surrounded by a strong fence wire. They should be accessible only to conscientious attendants. Where possible, the air should be taken directly from the outside. So-called "fire-proof" filters, consisting of impregnated cotton material, are useless after the cloth is soiled. In the filter manufactured by the "Filterfabrik und Apparate Bau Anstalt" the cotton has a tube shape and is enclosed by wire gauze to prevent the entrance of flames on the Davy lamp principle. Often a sprinkler system is furnished similar to those found in offices and factories. The filter

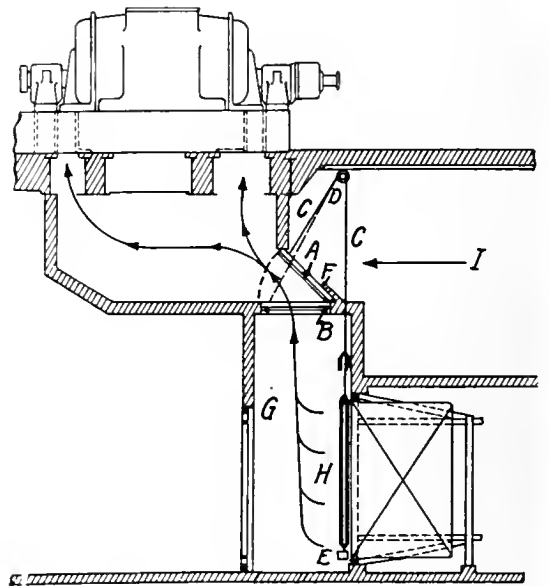


Fig. 2. Trap Door Arrangement in the Air Passages to a Turbine

manufactured by "Le Filtre A. R." is constructed of sheet metal, the only inflammable material being layers of cotton wool which are fastened to those sheets. An efficient precau-

tion is taken by the Allgemeine Elektrizitäts-Gesellschaft in Berlin. A trap door is provided which is kept open by means of a counterweight suspended by a "fuse rope." In case of fire in the filter chamber, the fuse melts (at 60 deg. C.), the weight drops and the door closes, due to its own weight. This arrangement, which protects the power house against destruction by fire, is shown in Fig. 2.

The objections raised against the installation of dry surface filters are the fire risk, inefficiency of purification, frequent cleaning and replacing of the filter medium and the fact that the air passing through the filter cannot be cooled as is the case with air cleaning apparatus of the wet type.

Modern dry surface filters have proven satisfactory in practice and, as will be shown later, there are

certain fields of application where this type can be used with advantage. Table I indicates the extent to which dry filters have been installed in Europe. It will be seen that one

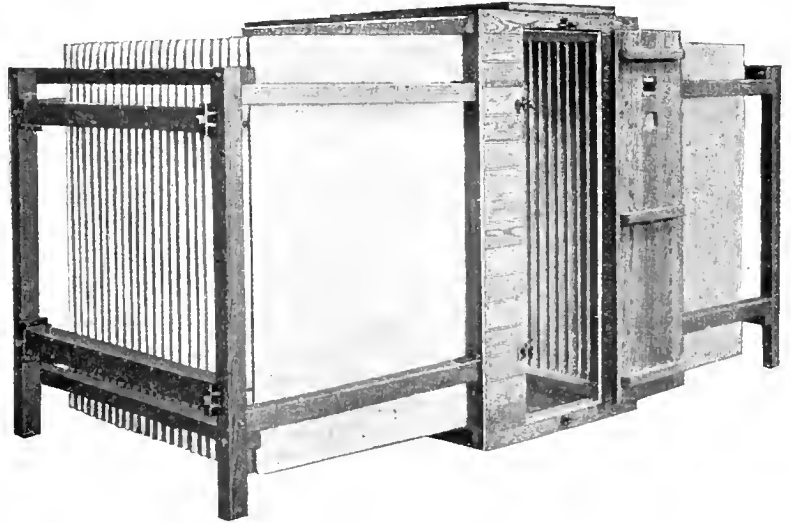


Fig. 3. General View of the Filter of Balcke Manufacture

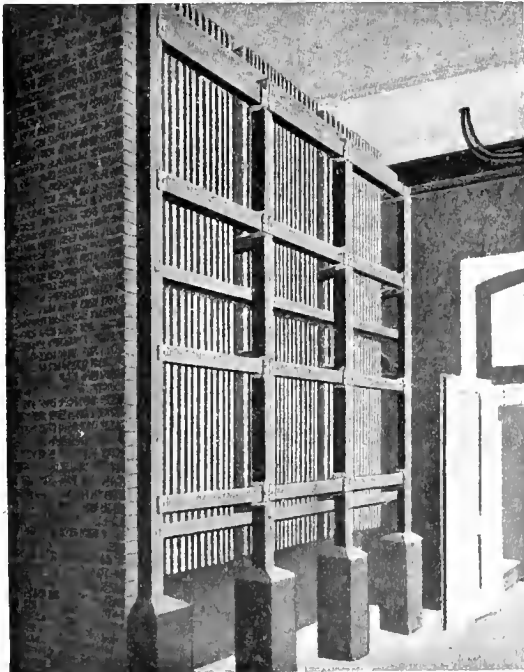


Fig. 4. A Filter of Balcke Manufacture installed in the basement of a power house

company alone installed, in the years 1900-1909, not less than 1264 filters with a total capacity of 16,100,000 cubic feet of air per minute. It can be concluded from this table that dry surface filters are used for the ventilation of comparatively small generators.

BRIEF DESCRIPTIONS

Filter Manufactured by Balcke & Co.

The construction of this filter is shown in Figs. 3 and 4. The filter cloth is arranged in zig-zag pocket form, sewed together at the top and bottom and stretched tightly by means of screws which draw or release the frames as desired. These screws operate through springs of tinned piano wire to avoid rupture of the cloth and to take up unevenness.

Filter Manufactured by the "Deutsche Luft Filter Baugesellschaft"

The design of this filter is very similar to that mentioned above, the cloth being arranged in zig-zag pocket form, and tightened by means of screws. A complete Delbeg filter is shown in Fig. 5, and the arrangement of a walled filter chamber below the floor surface in Fig. 6.

These filters are also furnished with independent pockets as shown in Fig. 7. This

modern design has the advantage that any soiled or damaged pocket can be cleaned or replaced while the filter is at work. This advantage cannot be claimed by the single cloth filter, the cleaning of which is difficult on account of its bulk and weight.

Filter Manufactured by K. Th. Möller

This type has probably found the widest application, and is of the independent pocket design illustrated in Fig. 8. The pockets are secured by means of bolts and nuts.

Filter Manufactured by G. A. Schütz

Details of this filter are shown in Fig. 9, and a general view of the assembly before shipment is given in Fig. 10. One of these filters has been installed in the Lauchhammer station in which each of three 5000-kw. generators require 31,800 cubic feet of air per minute or a total of 95,400 cubic feet. This interesting installation is fully described in the *Zeitschrift des Vereins Deutscher Ingenieure*, 1913, page 272.

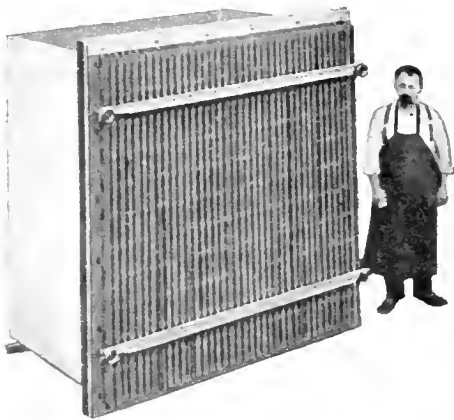


Fig. 5. The Pure Air Side of a Complete Delberg Filter

Filter Manufactured by Dr. Hans Cruse & Co.

The filter medium consists of cotton rope arranged in independent pocket frames in such a manner that the center line between two strings on one frame is covered by the

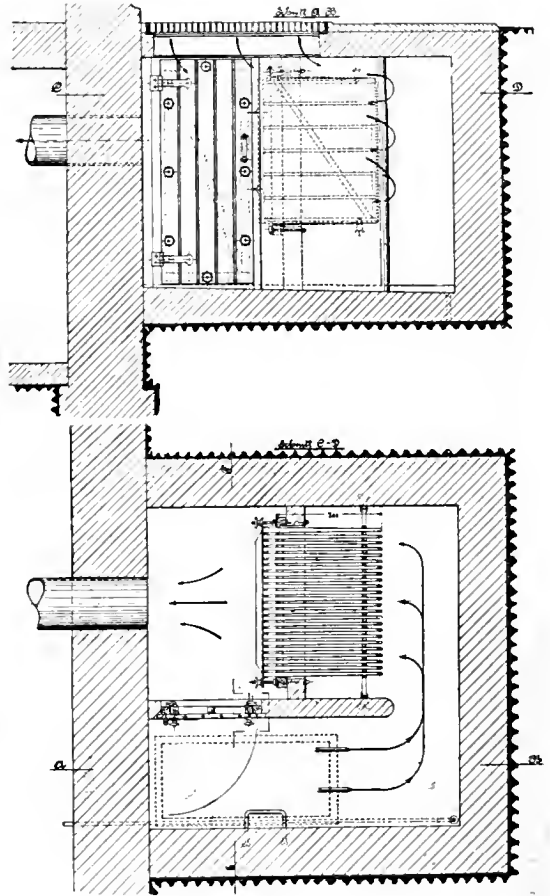


Fig. 6. Diagrams of a Walled Filter Chamber below the floor surface

TABLE No. 1
INSTALLATIONS OF GERMAN DRY SURFACE FILTERS

Name of Manufacturer	No. of Units	Tot. Capacity Cu. Ft. per Minute	Average Capacity per Unit in Cu. Ft. per Min.	Generator Size in Kw. Determined by Assuming Average Requirements of 3.5 Cu. Ft. of Air per Min. for 1 Kw. Output
Balcke	262	1,440,000	5500
Delbeg
Möller 1900-1909	1264	16,100,000	12700	3640
Schütz	257	783,000	3040
Böllinger	100	1,760,000	17600	5030
Haberl

Average Generator Output 4335 kw

center line of a string on the next. A horizontal filter of this type is shown in Fig. 11 and a vertical filter in Fig. 12. The danger of rupture of the filter medium, due to high air pressure, is avoided in this design. The air will always pass through the filter medium, even after the fluffy strings are soiled. This filter, which is also exploited in this country, requires less space than other dry filters.

Filter Manufactured by "Le Filtre A. R."

This apparatus is illustrated in Fig. 13 and is constructed of perforated sheet metal to which the filter medium, consisting of cotton wool, is fastened. The plates are arranged in steel boxes supported by a steel frame. This filter is of French design and is practically incombustible, but has not as yet

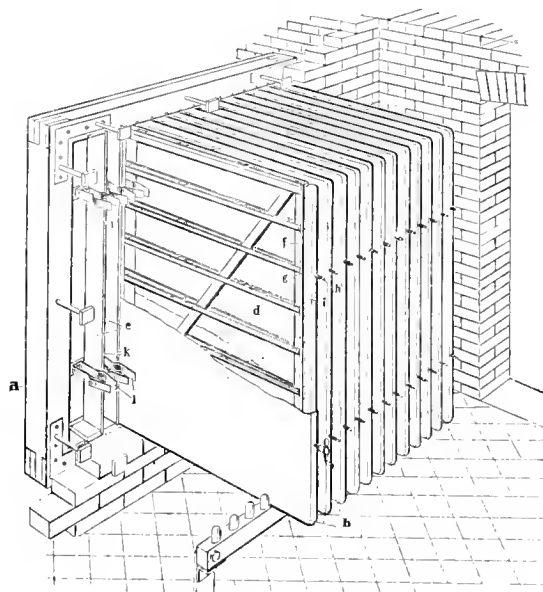


Fig. 7. A Filter with Independent Pockets

On account of the evaporation, the heat in the air is rendered latent and a cooling effect is obtained.

The construction is shown in Fig. 14. The wet surfaces are contained in special drums consisting of a cast iron center on which is wound, spirally, thin galvanized plates or a special cloth. A space of about one-seventh

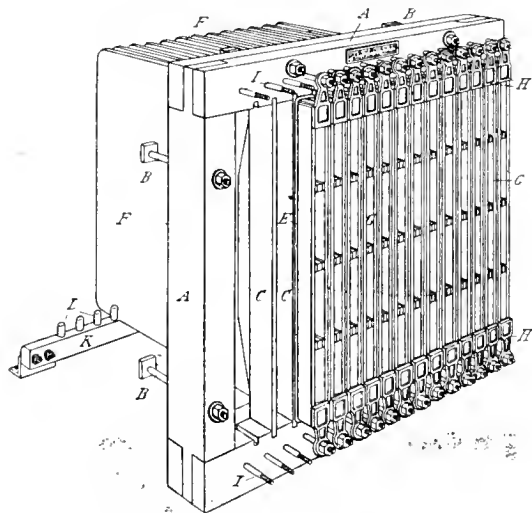


Fig. 8. A Filter of Møller Manufacture

found application for the ventilation of generators, due to its high first cost and heavy maintenance charge.

III. WET SURFACE FILTERS

This class is represented by the "Heenan filter" which is manufactured in England where it has found considerable successful application in connection with the ventilation of generators.

The design is based on the principle of utilizing large wet surfaces for the air to pass through. The wet surfaces take up the dirt in suspension, every particle of the air being thoroughly rubbed against the surfaces, which are washed clean by rotating in water.

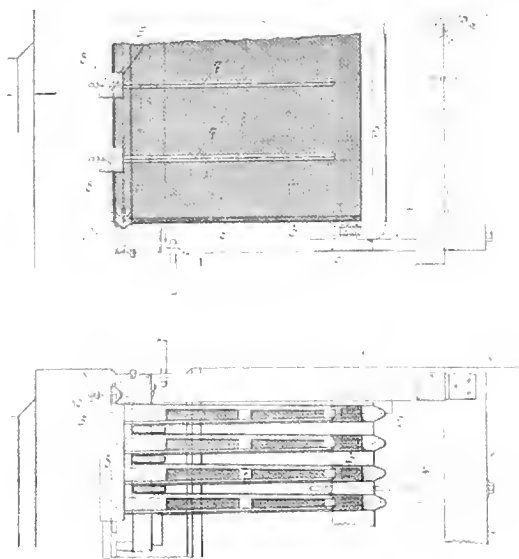


Fig. 9. Two Views of a Filter of Schütz Manufacture

inch is left between each layer for the air to pass through. The drums are driven by electric motors at low speed; the lower part of the drum revolves in a tank of water and the air passes through the upper part.

The advantages claimed and guaranteed for this apparatus are the thorough cleaning

(98 per cent), effective cooling of the air (within 2 deg. of the wet bulb temperature), simplicity of construction, operation and handling, the absence of loose moisture in the air leaving the filter and the small power required to drive the drum. According to a statement by the manufacturer, 49 filters have

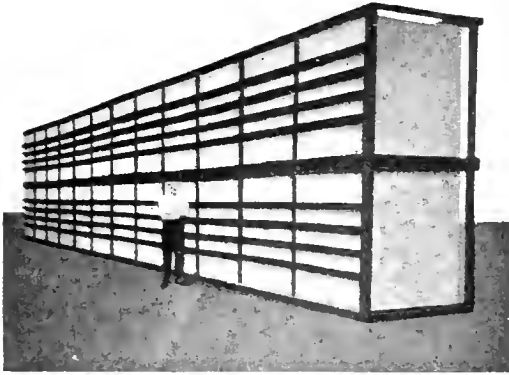


Fig. 10. A Complete Assembled Filter of the Type shown in Fig. 9

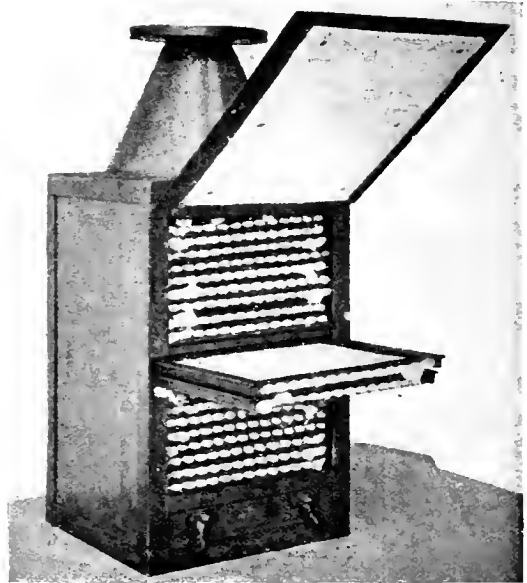


Fig. 11. A Horizontal Filter

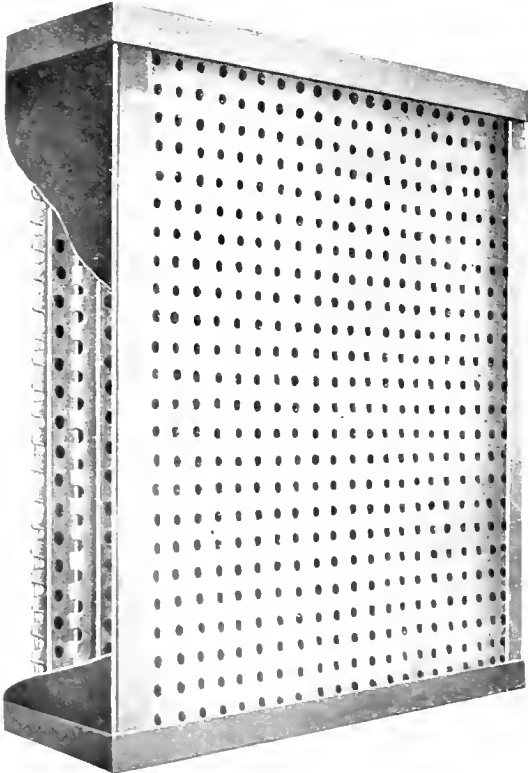


Fig. 13. A Filter of Le Filtre A. R. Manufacture

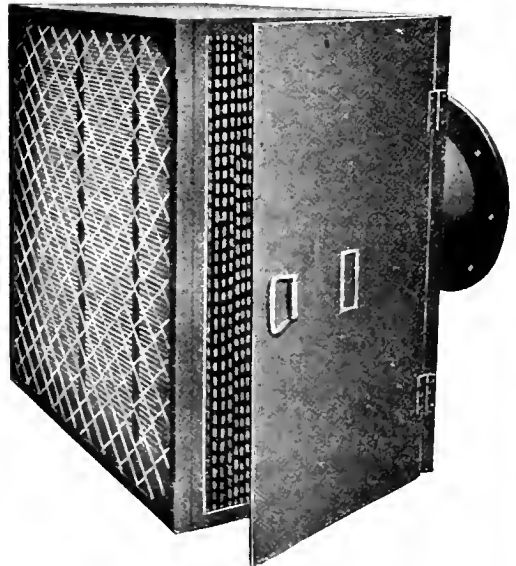


Fig. 12. A Vertical Filter

been installed having a total capacity of 1,258,500 cubic feet of air per minute, and on the basis of 3.5 cubic feet for each kilowatt, an average generator capacity of 7350 kw. would result. This would indicate that wet surface filters are used for larger generators than dry surface filters.

Where the water can be circulated in the system and only enough added to make up for the loss due to evaporation, the temperature of the water and the air in the spray will be within a few degrees of the wet bulb temperature of the air. The following tabulation may serve as an example:

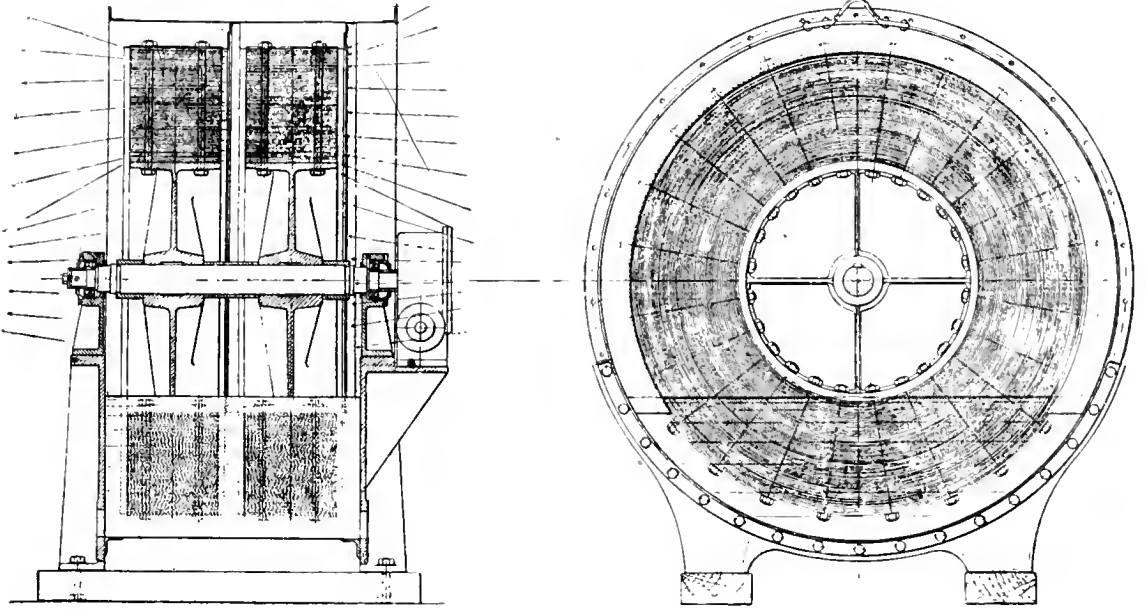


Fig. 14. Diagrams of a Rotary Wet Surface Filter

IV. AIR WASHERS

General

All modern air washers operate upon the same general principle. The air to be cleaned comes into close contact with water in the form of mist or spray. Dirt in suspension is saturated with water whereby its weight is increased. The air leaves the spray and passes between "eliminator plates." The water and wet dirt particles, having greater inertia than the air, strike these plates and are washed down to a settling tank. The air leaves the washer clean and free from unevaporated moisture.

In passing through the spray, the air evaporates water and the temperature of both the water and the air is reduced. The reduction of the air temperature depends upon the humidity of the entering air and the latter is subject to changes in various localities and at different times of the day. If the entering air is saturated, there will be no evaporation and consequently no temperature reduction.

	Temperature of Air Before Entering	Relative Humid. of Entering Air	Theoretical Temp. of Leaving Air	Probable Temp. of Leaving Air
1st example	25 deg. C.	70%	21 deg. C.	22 deg. C.
2d example	35 deg. C.	60%	28 deg. C.	30 deg. C.
3d example	40 deg. C.	50%	30 deg. C.	33 deg. C.

It is evident from these figures that the lower the relative humidity, the greater is the quantity of water evaporated and hence the lower is the resultant air temperature. The cooling effect of air washers can, therefore, be based on the knowledge of the existing atmospheric conditions only.

If the water, instead of being circulated in the system is continually renewed, the air can be cooled to the temperature of the water. If an ample supply of cold water can be obtained without the risk of freezing in winter,

this is the better method of cooling, as it is independent of the humidity of the air.

A general discussion on air washers and the operating conditions, with special reference to the cooling effect, will be found in Edgar Knowlton's article, "Ventilation of Steam Turbine Engine Rooms," which appeared in the *GENERAL ELECTRIC REVIEW*, September, 1913, page 627.

The prime object in the installation of air washers, or as they are often called, humidifiers, is to clean the ventilating air. Advantages due to cooling and consequent greater capacity of generators or transformers are incidental. In hot, dry localities, the cooling effect of humidifiers may be appreciable but the rating of generators or transformers should never be established on this cooling effect on account of the liability of accidental interruption of the air washer and the consequent possibility of dangerous overheating.

It has been claimed that the moisture of the air entering the generator tends to increase the cooling effect as water vapor has a higher specific heat than air. Mr. Knowlton has shown in the above mentioned article that the amount of water vapor, even in a saturated mixture, is too small to have an appreciable effect on the specific heat, the energy absorbed by the saturated air being only $1\frac{1}{2}$ per cent greater than the energy absorbed by perfectly dry air.

As far as practical experience has shown, no insulation troubles have been experienced due to the effect of the saturated air upon generator windings. It is essential that the moist air which comes in contact with the windings be free of entrained water. As a matter of precaution, the sprays should not be started until the generator becomes sufficiently warm to prevent condensation of the moisture; also, the sprays should not be in operation after the generator is shut down.

In some power houses, as for instance in the Delray station of the Detroit Edison Company, air washers are installed on the roof and a fan is provided which draws the air through the washer from which it is discharged into the turbine room. With such an arrangement, an even distribution of the cleaned and cooled air throughout the room is secured. The air leaving the washer is heated to a certain extent by passing over heated surfaces in the turbine room before entering the generator. As a result of this, the air is not in a saturated condition when it comes in contact with the insulation, whereby any effect upon the insulation of the windings

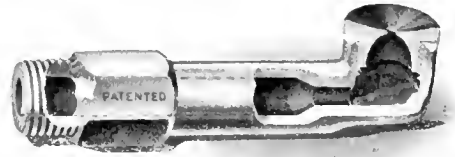


Fig. 15. Sectional View of the Carrier Spray Nozzle

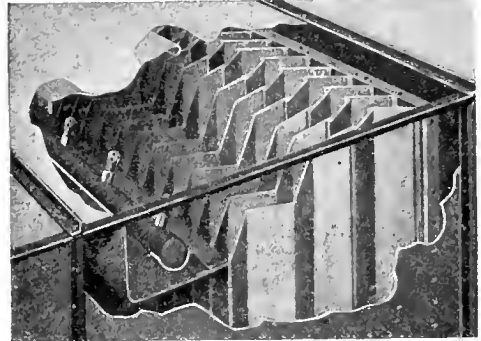


Fig. 16. Sectional View of a Filter showing spray nozzles and eliminators

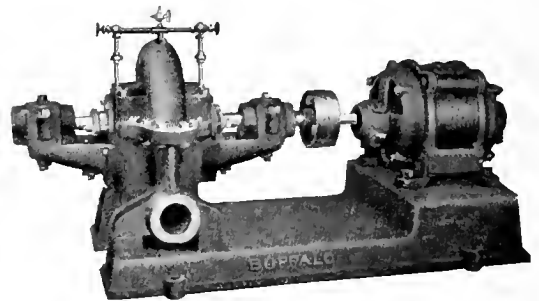


Fig. 17. Motor and Pump furnished for use in connection with the filter of the Carrier Company

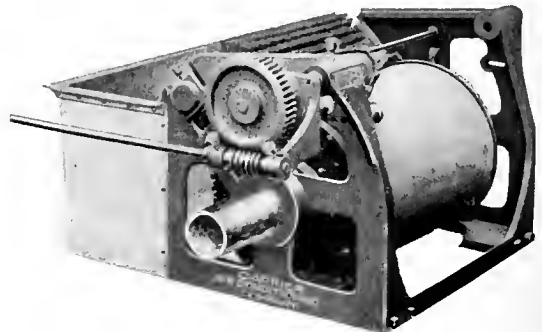


Fig. 18. Self-Cleaning Rotary Strainer used in connection with the filter of the Carrier Company

is eliminated. The cooling effect, of course, is offset as the air is heated before entering the generator. However, the power house has the benefit of the clean cool air. Finished metal parts coming in contact with the moist air corrode quickly.

Air washers operating on cold days in winter may cause thick layers of ice to form on the windows of the power house, but any danger of water freezing can be avoided by drawing the air from the power house through the washer instead of taking it from the outside.

Nozzles, strainer and settling tank should be cleaned once a week.

The velocity of the air passing through the humidifier is from 600 to 750 feet per minute, in rare cases even higher. The pressure developed by the centrifugal pump to force the water through the nozzles is from 25 to 30 lb. per sq. in.

Where the air is directly discharged into the generator, a fan is mounted on the rotor, developing a static pressure of four to ten inches of water, depending on the size of the air passages through the machine. This includes some margin for a drop of pressure in ducts leading to the generator. A drop of 0.5 inch may be allowed through air washers without detriment to the ventilation of the generator.

Manufacturers of air washers usually guarantee a cleaning efficiency of 95 to 98 per cent and a temperature reduction to within 2 deg. of the wet bulb temperature of the entering air.

A number of test methods for determining the effectiveness of cleaning have been proposed, but on account of the different nature of such tests, none have been satisfactory for practical purposes. The American Society of Heating and Ventilating Engineers issued a report in 1914 outlining standard methods for testing air washers. Perhaps the best method which gives fairly good results for practical purposes is described in an article, "Tests for Dirt in an Air Supply," by Sanford A. Moss in the July, 1915, issue of the *GENERAL ELECTRIC REVIEW*. This method relates to cotton covered wire screens which are placed in the inlet and outlet of the humidifiers until both screens appear to have absorbed the same amount of dirt; the ratio of the time exposed giving the efficiency of cleaning.

According to available statistics, 58 air washers have been installed in the United States for the ventilation of generators, giving an average capacity per unit of 36,582

cubic feet of air per minute. Assuming again an average requirement of 3.5 cubic feet of air for each kilowatt generator output, an average generator size of approximately 10,000 kw. results.

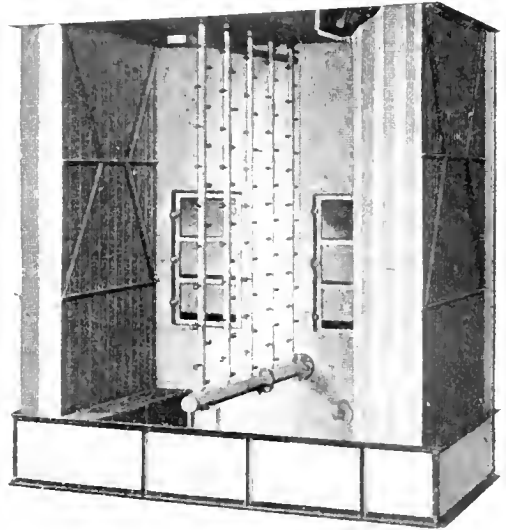


Fig. 19. Interior of a Humidifier of the Carrier Company

It is thus shown that air washers are used for the larger generators, dry surface filters for the smaller, and wet surface filters for medium sizes.

BRIEF DESCRIPTIONS

Air washers consist of the following essential parts:

Spray chamber, spray nozzles and piping, eliminator or baffle plates, strainer, settling tank and water circulating system with pump.

The difference in the various makes is principally in the design and arrangement of the nozzles.

Carrier Air Conditioning Company of America

The Carrier nozzle has a comparatively large discharge opening, ranging from $\frac{1}{16}$ in. to $\frac{3}{32}$ in. and is shown in Fig. 15. The water enters a circular chamber tangentially, receives a whirling motion, and, as it approaches the opening, an increase of velocity is caused by the change in the shape of the passage until it bursts into an atomized spray. This atomizing effect, due to the centrifugal action of the nozzle, is produced by a pressure of 15

lb., per sq. in. and is increased with greater water pressure up to about 40 lb.

The eliminators, shown in Fig. 16, are of galvanized iron or copper, and are to prevent entrained water particles entering the generator or transformer. There is a second arrangement of nozzles on top of the eliminators to keep their surfaces thoroughly wet, thereby adding to the washing of dirt down to the settling tank. The pump, furnished by the Carrier Company, is of the horizontal, split-shell, centrifugal type, and is shown in Fig. 17. A suction screen of No. 20 copper wire, 14-mesh cloth, extends completely across the tank to filter the water. A rotary strainer with a self-cleaning arrangement is furnished to prevent clogging of the nozzles and is shown in Fig. 18.

The apparatus operates normally at an air velocity of 600 feet per minute through the eliminators. The resistance is 0.36 in. of water column. The advantages claimed are the combination of low water pressure, large orifice in the nozzle and the self-cleaning strainer, reducing the attention required for the apparatus. A complete view is shown in Fig. 19.

Spray Engineering Company

The apparatus shown in Fig. 20 differs from the Carrier washer in the design and arrangement of the nozzles. Fig. 21 and 22 illustrate the three parts forming the nozzle and the section showing the direction and flow of water. In passing through, the water is given a rapid, rotating motion and a central driving jet impinges on the rotating water at the orifice and ejects it as a fine spray in a solid conical formation. The fine mist produced by these atomizing nozzles is mixed with the air which is again subjected to the action of cross scrubbing sprays placed beyond the first set of nozzles. The air then passes through a screen and finally through the eliminators. The apparatus is operated under a comparatively high velocity, usually 720 feet per minute. The air resistance is never more than $\frac{1}{4}$ in. The sprays operate at 25 lb. per sq. in.

General Condenser Company

The arrangement of the nozzles is shown in Fig. 23. The water entering the first set of sprays is in the form of mist and is mixed with the incoming air in a horizontal direction. The draft effect of the first set of sprays is

neutralized by the opposing sprays of the second set, the flow of air through the system being maintained by the fan of the generator. The object of this arrangement is to prevent too much moisture and air passing to the eliminators. The pressure at the nozzles is 30 lb. per sq. in. In almost every respect, this apparatus is similar to others already mentioned.

There are a number of other types of air washers manufactured in this country as well as abroad. They have been used extensively for the ventilation of public buildings, textile industries and factories and are now being applied to the ventilation of generators and transformers. All these air washers work upon the same general principle and differ only in details of construction, and particularly in the arrangement and design of

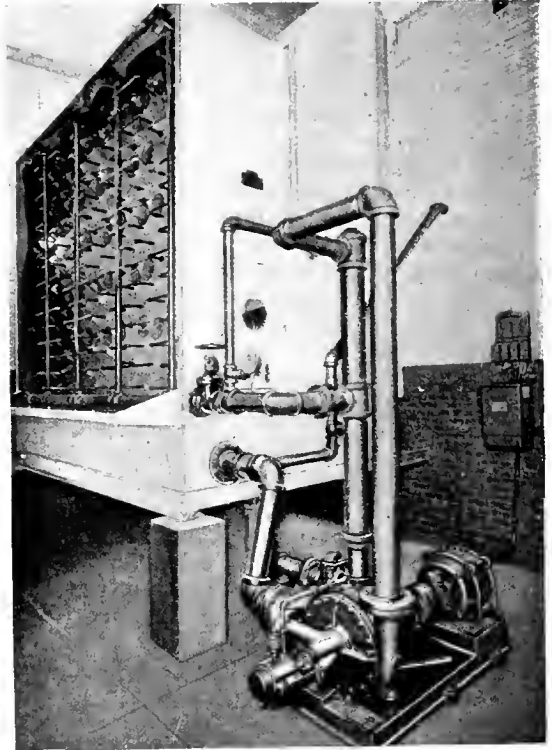


Fig. 20. A Spray Engineering Company filter with Motor and Pump

the nozzles. Among the best known builders of air washers are the American Blower Company, B. F. Sturtevant Company, Stuart W. Cramer and Balcke & Company.

V. COMPARATIVE DATA

A comparison of the approximate space required by the different classes of air cleaning apparatus is shown in Fig. 24, and a comparison of the approximate prices is indicated in Fig. 25. The curves shown in these diagrams are self-explanatory.

There are no operating costs for dry surface filters, but the maintenance charges are comparatively high in the medium sizes and prohibitive in the larger sizes (above 5000 kw.). Expenses for labor and cloth for a 3000-kw. generator requiring 15,000

Table III which is based on the assumption that the cost of water is one cent per 1000 gallons and the cost of electric energy is one cent per kilowatt-hour. The figures given under the heading "operation" are based on the requirements for water consumption and

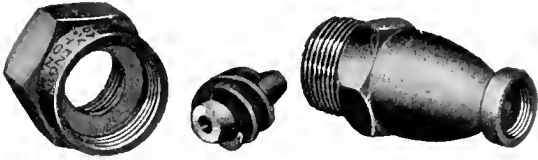


Fig. 21. Exploded View of the Spray Nozzle shown in Fig. 22

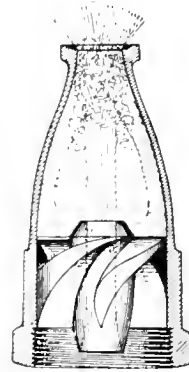


Fig. 22. A Section of a Spray Nozzle. The dotted lines show the direction of water flow

cubic feet of air per minute would be approximately \$400 per year. This expense depends, of course, upon the amount of dirt which the filter has to take up and also upon the dampness of the atmosphere. An air washer of the same capacity necessitates an expense of approximately \$300 per year for operation and maintenance.

Wet surface filters have a very low cost for operation and maintenance as the power required to drive the pump is small and the settling tank needs only occasional cleaning.

An estimate of the cost for operation and maintenance of air washers is given in

driving the pump motor, while the figures under "maintenance" are based on the assumption that the settling tank, screen, strainer and nozzles are cleaned once a week. This work is usually done by the man who also attends to other auxiliaries.

An attempt is made to tabulate in a convenient form the advantages and disadvantages of the three types of air cleaning apparatus in Table IV in which "D" designates dry surface filters, "W" wet surface filters and "A" air washers.

GENERAL CONDENSER CO
AIR WASHER

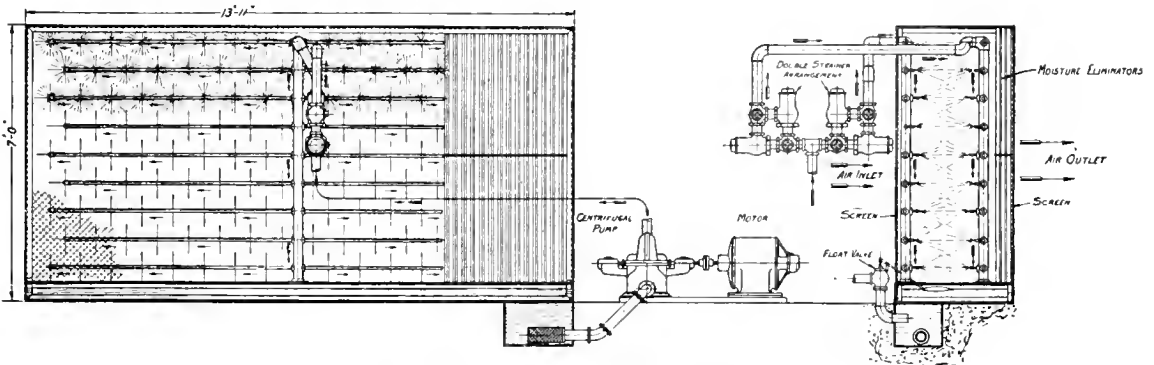


Fig. 23. Complete Diagram of the Air Washer of the General Condenser Company

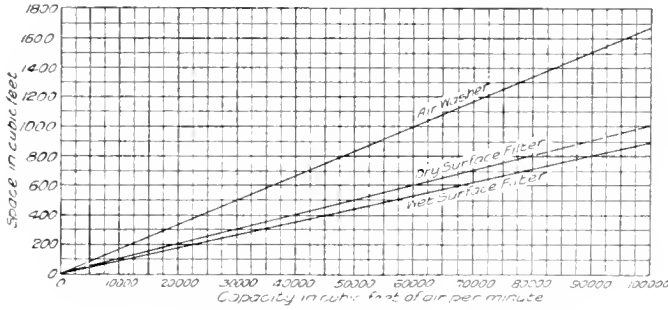


Fig. 24. Curves showing the Approximate Space Required by Air Cleaning Apparatus

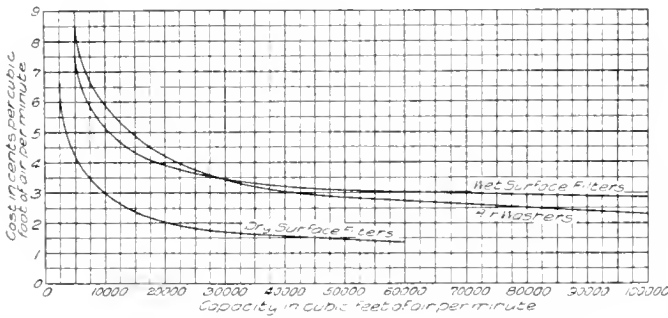


Fig. 25. Curves showing the Approximate Average Prices of Air Cleaning Apparatus

VI. CONCLUSIONS

Dry Surface Filters

For generators up to about 5000 kw., dry surface filters may be recommended on account of their low first cost, and if the air is not too dirty, thereby keeping down the maintenance. Their application is of advantage in dry, cold climates. Dry surface filters require careful attention and handling.

Wet Surface Filters

This type, which has found successful application in England, has not as yet been introduced in this country. Its field of application is for generators of medium size (above 5000 kw.). This interesting apparatus has given satisfaction in various electrical plants in England.

Air Washers

The tendency toward the installation of large turbo-generator units will undoubtedly increase the application of air washers or humidifiers in preference to other types of air cleaning apparatus. In dry, hot localities, the cooling effect of air washers is appreciable. Special precautions are necessary to prevent freezing of the water in winter.

TABLE III
AIR WASHERS

Capacity in Cu. Ft. per Min.	Approx. Yearly Cost of Operation	Approx. Yearly Cost of Maintenance and Cleaning	Yearly Total Cost
7,500	\$165.00	\$45.00	\$210.00
10,000	200.00	50.00	250.00
20,000	300.00	50.00	350.00
30,000	360.00	55.00	415.00
40,000	400.00	60.00	460.00
50,000	500.00	65.00	565.00
60,000	600.00	70.00	670.00
70,000	630.00	75.00	705.00
80,000	720.00	75.00	795.00
90,000	810.00	80.00	890.00
100,000	900.00	80.00	980.00

TABLE IV

Advantages	Type	Disadvantages	Type
Cleaning effect	D W A	Fire risk	D
Cleaning and cooling effect	W A	Possible discharge of free moisture	W A
Low first cost	D	Possible corrosion	W A
Low cost of operation	D W	Water freezing in winter	W A
Low cost of maintenance	W A	Troubles in damp locations	D

THE INDIVIDUAL AND CORPORATE DEVELOPMENT OF INDUSTRY

BY DR. CHARLES P. STEINMETZ

CHIEF CONSULTING ENGINEER, GENERAL ELECTRIC COMPANY

This contribution is of great human interest. The author shows that the growth of the corporation schools and other "welfare work" activities was a natural process of evolution with the change from individualistic to corporate industrial undertakings. He discusses the great problem of education to meet modern industrial needs in an able manner and shows that the industries themselves must give the technical training after the schools have laid the foundations of a general education. The fact that the employee must be in sympathy with the efforts of the employer to get the best cooperative results in all activities designed to better industrial conditions is emphasized. This article was given as the author's presidential address to the National Association of Corporate Schools, at Worcester, Mass.—EDITOR.

During the last generation a radical advance in the efficiency of the industrial system of our country has taken place through the progress from the individualistic production of the days of Lincoln, to the corporate production of today. While the corporation is proving the most powerful and most efficient tool of industrial progress, at the same time some defects have appeared, and have led to the present rather widespread antagonism against the corporation. Nevertheless these defects are not inherent in the nature of the corporation, but are due to its newness and crudeness, which led us to overlook too much the human element in the industrial relation between corporations, employees and public. In the small production of bygone days, personal relations existed between the individual employer and employee, which do not exist in the large corporations, and must be replaced by organized effort. That is, to the financial, administrative and engineering or manufacturing activity must be added a fourth activity, that dealing with the human relation of the corporation with its employees and the public at large, before the corporation can socially justify its existence. The beginning thereof is seen in the so-called "welfare work" in attention to hygiene and safety, profit sharing and service annuities, etc., and in the educational work of the corporation.

Amongst the first corporation schools were the special apprentice courses established by some industries to provide for their specific educational requirements, which could not be supplied by educational institutions nor by practical experience. Such are the student engineers' courses established twenty-five years ago by electrical manufacturing companies. In them college graduates are, by one to two years' training in factory, testing

room and office, fitted for the higher positions in the company. The early corporate development of the electrical industry made this possible, and also made it possible to exert a considerable influence in shaping the curriculum of engineering colleges towards the higher efficiency of the graduates, and the superiority of the electrical industry of the United States is largely due to the educational work carried on in co-operation with the engineering colleges. Similar special apprentice schools have been established by electrical operating companies for the training of station operators, etc.

Intermediate between the special apprentice schools and the general trade apprenticeship are those dealing with new occupations resulting from the corporate development, such as salesmanship, business getting, office work, etc. They represent activities sufficiently broad to be undertaken by public educational institutions, such as business colleges, high school business courses, etc., in co-operation with, or preliminary to the corporation school, and thus form a separate class.

The most serious problem resulting from the corporate development of the industry is, however, the failure of the supply of skilled workmen. In individualistic production, the apprentice or helper learns his trade from his employer, who was skilled in the trade. To some extent this is still the case in some trades. But within the field of the modern corporation, with its subdivisions and increasing specialization of work, very little chance existed for the young man to learn a trade and become a skilled workman. Immigration from Europe for some time supplied skilled workmen. However, European countries have become industrial, and retain their skilled men, and those who immigrate are directed to European colonies, so that the supply by

immigration is vanishing, while the demand of our industries is increasing.

Vocational training thus has become the most important problem of the American industries.

This is realized even more outside of the corporation, by the general public. There it appears as a problem of the parents, to find a suitable occupation for their children, as a problem of the young men and women to find work without getting into a dead alley occupation. Increasingly the general public thus makes the demand on the public schools to provide the vocational training which the industry gave in former times, but which now, in its corporate form, it fails to give. So far, the output of the apprentice courses of corporations is still very small compared with the industrial demand.

The trade apprenticeship courses of corporations, and the industrial education of the public schools, at first appear to be in competition with each other, but in reality the problem of the trade apprenticeship can be solved only by the co-operation of the corporation and the public school, as was proven by the experience in the profession. Once it was customary for a young man to go into an engineering office to learn engineering, into a law office to study law, etc. Experience has eliminated this as giving too narrow and limited knowledge, and the engineering college, the law school or medical school now are the avenues of approach to the profession. But experience also has shown that the graduate of the engineering school is not an engineer, the graduate of the law school or medical school not a lawyer or physician, but merely prepared to enter the practical part of his professional education in the industry, the law office or the hospital. Applying the same to the trades, we see that the practical trade training must be given in the industry by the corporation apprentice course, but the public schools must do the preparatory work.

The field of the corporation school is the industrial training of those fitted for the industry. The field of the public schools is the general education, that is, to supply that minimum amount of knowledge which every intelligent citizen must have before he can specialize in trade or profession, or at least that part of general education which is difficult to acquire afterwards. With increasing civilization, the requirements of general education also have increased. With increasing population density and the growth of

cities, physical development, hygiene and medical supervision become essential parts of public education, and familiarity with the use of the most common industrial tools, such as the hammer, saw, etc., which formerly was acquired in the home, has to be taught by manual training in the schools. This increasing general educational demand on the schools precludes the possibility of industrial training, that is, of teaching a trade, within the limited time of mandatory school attendance, and industrial or vocational training thus must be a continuation of school work, while manual training, giving a general familiarity with the common tools of industry such as every man should possess, belongs to the grades as mandatory subjects. This sharp distinction between manual training and industrial education is not always realized. Industrial training belongs to and can be efficiently accomplished only by the industry, by the corporation apprentice course taking the place of the former individual apprenticeship or by co-operative systems of public schools and corporations; vocational continuation schools, technical high schools, etc., can be of limited usefulness only, but the new field of the public school is to establish an intelligent system of vocational guidance, based on the teacher's familiarity with the pupil's characteristics, and especially on the adaptability and interest shown in manual training, so as to lead the pupils into those trades and professions for which they are adapted, and in which they can find the satisfaction resulting from success.

With the heterogeneous population of our country, where some States maintain fairly good educational systems, many other States practically none, and a large number of immigrants, handicapped by unfamiliarity with the American language, complicating the problem, the general educational work of the public school can not stop at the end of the school age, but must be continued by evening schools, language classes and other educational efforts, and it is the duty of the corporation to see that these educational facilities are provided by the public schools, and to exert its influence on their employees to avail themselves of these educational facilities.

The limitation of the corporation activities in the educational and similar fields necessarily is that given by the limitation of the corporation's purpose—to earn dividends for its stockholders. No human activity can be justified before the stockholders' meeting

which does not show a favorable financial balance, however much the corporation directors may desire philanthropic work. This is often difficult, as the beneficial results are largely intangible, and it must be proven to the satisfaction of the administrative heads of the corporation that these benefits are very real, consist in the better relation between corporations and employees, their higher efficiency and better co-operation, the lesser liability to interference by industrial warfare, etc. Also, we must realize that the right of existence of the corporation is challenged by a considerable part of the public, and self-defense justifies the expense of activities bringing home to the public the benefits which can be derived from corporate industrial organization.

The human activities of the corporations are co-operative with its employees, and the favorable attitude and viewpoint of the employees thus is essential for their success. Herein lies the cause of many of the failures. It is not sufficient for the corporations to undertake such educational and welfare work and other activities as are in the opinion of the corporation managers for the best interest of the employees, but the corporation actions must be such that the employees and their organization take the same viewpoint, otherwise welfare work may be resented as charity, educational work opposed by the suspicion of an ulterior motive hostile to the employee's interest, as an attempt of breaking down their organization, safety regulation as an attempt to evade responsibility, etc.

In the individualistic production of old, employer and employee met on fairly equal terms. With the close organization of numerous employers, as stockholders of the industrial corporations, organization of the employees also appeared, as a matter of course, in the labor unions. Theoretically, the aims of both organizations, the organization of employers as stockholders of the corporation, and the organization of employees as labor unions, are the same: efficiency of industrial production to increase the return on the investment in labor and in capital. Unfortunately, however, the relations between the two organizations have frequently been hostile industrial warfare over the distribution of the returns rather than co-operation for the increase of financial returns of both parties, and as the result, mutual suspicion and antagonism has arisen making efficient co-operation for mutual advantage of corporations and employees

difficult, while the obvious advantage of organization, illustrated in the industrial corporations, necessarily tends to lead to the organization of the employees in some form or another, and any attempt of substituting, for the unions formed by the employees, employees' organizations formed by the corporation, give an apparent justification to suspicion. On the other hand, there always have been and always will be leaders, as the majority of the people prefer to be led, and the natural leaders in the co-operate human activities of the industrial corporations would be the leaders in its other activities, if once the suspicion were removed by evidence that suspicion is not justified any more, and the leadership accepted.

This problem is still unsolved, and is most serious, especially in a democracy, where hostile masses, though incapable to reconstruct, have the power to destroy, and are beginning to use it, as the industrial history of the last ten years has shown.

While under pressure of public opinion, influenced by the dying remnants of former individualistic production, and hostile employees' organization, all political parties profess hostility to the great industrial corporations in the fulminations of the stump speakers or soap-box orator at the street corners, there is nothing in the principles of the great political parties antagonistic to corporate organization of the industries.

The principle of the republican party has always been centralization, that is, to the larger organization belongs what it can do better than the smaller organization. This is the principle of the industrial corporation.

The democratic party has been the party of decentralization, of individualism, and therefore was inherently hostile to the corporations, but industrial laws, more powerful than party doctrines, are forcing it towards centralization, and all the constructive work of the present democratic administration has been unwilling centralization.

The socialistic party can not be antagonistic to the corporation principle, since its ultimate aim, socialistic society, may be expressed as the formation of the industrial corporation of the United States, owned by all the citizens as stockholders.

More serious appears the objection against the industrial corporation, that it destroys the individualistic development, on which all progress, in invention, scientific research, etc., is based, and therefore is hostile to civilization. It is true that in the early days of the new

country, when unlimited natural resources gave everybody a good chance for success, individualistic effort was most efficient for progress. But these times have long passed, and in the world today the fight for existence has become so intense that the individual's energy is wasted in the mere earning of a living, without much chance of development, and it is only in the comparative safety of the industrial corporation, or the educational corporation, the university, that the condi-

tions are favorable for such development of individualism as leads to the world's progress. It is significant that today practically all scientific research, most of the inventive and development work, is done within the industrial corporations or the educational institutions, and very little by the unattached individual, showing that in the corporation is found also the most efficient means of making individual development possible in our present state of civilization.

THE CATHODE RAY TUBE AND ITS APPLICATION

BY M. E. TRESSLER

RESEARCH LABORATORY, PITTSFIELD WORKS, GENERAL ELECTRIC COMPANY

In the first section of the following article the mechanical construction and theory of operation of several of the more successful cathode ray tubes is described. The second section contains a treatment of a subject concerning which but very little has been published, viz., the use of the cathode ray tube as an oscillograph and a wattmeter.—EDITOR.

The cathode ray tube in its simplest form is a glass tube from which the air is exhausted to a vacuum of 4 to 8 microns, i.e., to an air pressure of 0.004 to 0.008 millimeters of mercury.

In one end of the glass tube is a small, flat metal disk which is connected through the cathode. At one side, or in the tube about 15 to 20 cm. away from the cathode, is another metal electrode which is connected through the glass to a terminal on the outside. This is the anode. This is all that is actually required to produce the cathode rays, but in order to make use of them, the rest of the tube must be formed to a particular shape and several parts added.

The diaphragm is usually a glass or metal disk just below the anode which closes the tube with the exception of a small hole in the center of this disk about 0.4 to 0.8 millimeters in diameter. About 35 cm. below the diaphragm is fastened the screen on which the cathode particles strike. This screen is a metal, mica or glass disk coated with some salt which fluoresces when acted upon by the cathode rays. This fluorescence may then be observed visually or it may be photographed.

A sketch of the tube is given in Fig. 1. *C* is the cathode, *A* anode, *D* diaphragm, *S* screen, *R* palladium tube regulator, *F* focusing coil, *Q* quadrants.

The tube is operated as follows: The negative terminal of a high voltage (12,000 to 30,000 volts) direct current generator is connected to the cathode and the positive terminal to the anode, the anode being grounded. The voltage to apply depends upon the vacuum maintained in the tube, the steadiness of operation desired, the position, shape and connection of the focusing coil, the intensity of the magnetic field of the focusing coil and other minor influences. With this voltage applied there is a stream of electrons or negatively charged particles shot from the cathode normal to its surface with a velocity of 5000 to 60,000 miles (8 to 96×10^8 cm.) per second, depending upon the vacuum in the tube and the voltage applied. This discharge of electrons is produced by the electric field between the cathode and anode.

The attenuated gas in the tube is generally understood to consist of a mixture of neutral gas molecules, i.e., molecules where the positive and negative charges are exactly balanced; of gas molecules positively charged because they have lost one or more electrons or negative charges; and of free electrons which have been separated from the gas molecules, these being, of course, negatively charged.

As soon as the electric field is set up the positively charged molecules are attracted toward the cathode and the electrons are

repelled. By the time the positively charged molecules have gotten to the cathode, they have attained sufficient velocity so that the force of the collision bumps off one or more electrons. The positively charged molecules in going to the cathode surface also run against neutral molecules and electrons with sufficient force to separate electrons from the neutral molecules and even to lose electrons themselves. The electrons, being negatively charged and of very much smaller size and mass than the molecules, are repelled with much higher velocity from the cathode than the molecules are attracted. These negative particles from the cathode pass down the tube to the diaphragm where most of them are stopped, except a small beam which passes through the central opening and strikes the fluorescent screen. The diaphragm is grounded so that the charge that would tend to collect on it from the cathode particles is neutralized.

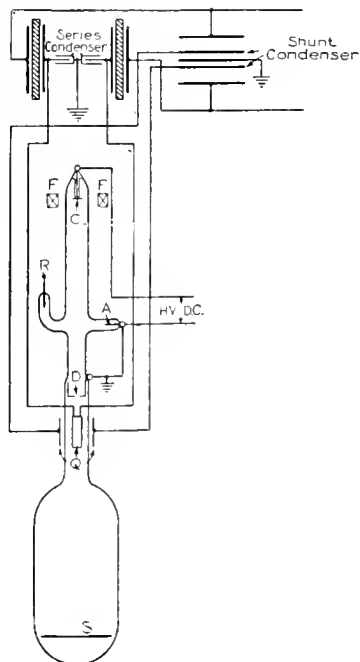


Fig. 1

If the cathode surface was a perfect plane, all of the cathode particles would start normal to this plane, but, as compared with the size of the cathode particles the unevenness of this surface is very large, hence some of the particles start off at an angle other than 90 deg. to the plane of the cathode surface. This tends to make the cathode discharge a

diverging one, but even if this were not the case there would be a spreading out of the discharge, due to the repellant force between negatively electrified particles. This spreading out of the discharge is partially overcome by the focusing coil which gives a longitudinal magnetic field in the direction of the stream of cathode rays, and which tends to concentrate the rays and hence increase the intensity of the beam passing through the opening in the diaphragm.

The palladium tube regulator which is connected opposite the anode is used for regulating the vacuum when there is an increase of vacuum due to a long continued use of the tube at high voltage. The palladium tube is sealed in the glass and closed at its outer end. When heated to a red heat it allows a small amount of gas to pass through, and hence raises the gas pressure inside the tube.

The diaphragm must be made of a sufficiently dense, thick material so that the cathode rays will not pass through it. A platinum diaphragm 0.005 in. (0.127 mm.) thick will allow the cathode particles to pass through it. A brass cup with walls 0.030 in. thick is commonly used and found satisfactory.

The screen in order to be fluorescent is coated with willemite, zinc sulphide or calcium tungstate. The willemite gives a yellowish-green fluorescent light when excited by the cathode rays, which is very bright to the eye but is not very active actinically, i.e., when photographed it does not act rapidly on the photographic plate. The zinc sulphide is said to be very actinic, and is used by a great many experimenters with the cathode ray tube. Calcium tungstate has been found to be the most actinic and best suited for our work thus far. It gives a bluish-white fluorescence which is quite brilliant, both visually and actinically.

Other Methods of Producing Cathode Rays

There are several other forms of cathode ray tubes where the electron or cathode discharge is produced in a different manner. Wehnelt's method of obtaining an electron discharge is to coat a platinum strip with a thin film of lime and then to heat the lime to incandescence by causing an electric current to flow through the platinum strip. He has shown that the incandescent lime emits copious streams of electrons in comparatively weak electric fields. This discharge is also largely due to the bombardment of the hot

lime by the positive ions or gas molecules, but it is also due to the high temperature zone into which these positive ions flow, the electrons being much more readily separated from them. Of course the velocity of the electrons emitted from the hot lime is very much lower than those which are repelled under a very strong electric field.

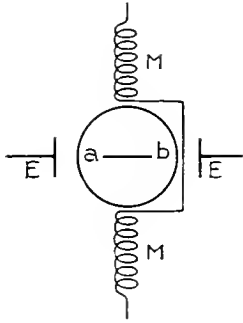


Fig. 2

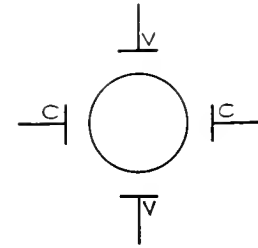


Fig. 2a

The latest and probably the best method of obtaining an electron discharge in a cathode ray tube is by means of the hot tungsten cathode in a very highly exhausted glass tube where the glass and all of the metal parts have been kept in this high vacuum at a high temperature for a sufficient time to get all of the gases out of them.

When the cathode (which in this case is a tungsten wire filament heated to high temperature by an electric current flowing through it) is connected to a high voltage, there is a pure electron discharge from the cathode with no accompanying positive ion bombardment: the tube having been exhausted to such a high vacuum that there is an inappreciable number of positively charged molecules or ions present. In this case the electrons must come from the metal filament itself; the number of electrons, or, in other words, the current flowing depending upon the temperature of the cathode and the voltage applied, and the velocity of the electrons depending upon the voltage only.

Uses

The cathode ray tube in practice has been used as an oscillograph and as a wattmeter for measuring very small amounts of power at low power-factors and high voltages. In order to use it as either one of these instruments it requires some method of deflecting the beam of cathode rays after it has passed through the opening in the diaphragm and before it has

reached the screen. This is accomplished by means of a transverse electric or magnetic field applied a short distance below the diaphragm opening.

The cathode particles carry a certain charge or quantity of negative electricity and hence when an electric field is applied at right angles to the direction of travel of the particles they are deflected parallel to the direction of the field and if a magnetic field is applied they are deflected at right angles to the direction of the field. This is shown in Fig. 2 where the circle is a section of the tube just below the diaphragm and *M* is a set of magnetic quadrants and at *E* a set of electric quadrants. The deflection due to either field is in the line *a-b*.

As accurately as can be measured from photographs, it is found that the deflection of the fluorescent spot on the screen due to the field is directly proportional to the strength of the field; that is, to the voltage applied or to the current through the coil. This is so because the angle through which the beam is deflected is quite small, and therefore the arc of the circle, whose radius is the distance from the quadrants to the screen, through which the spot would travel, is not appreciably different from the distance on the surface of the screen, which is the tangent of the angle. If an alternating voltage is applied, the fluorescent spot vibrates back and forth once per cycle, which makes it appear as a line across the screen.

In order to use it as an oscillograph, it is necessary to have a photographic plate move at right angles to the direction of vibration of the spot which thereby will show the wave shape.

When it is required to use the tube as a wattmeter, two pairs of quadrants at right angles to each other are required; on one pair a voltage proportional to the current flowing in the circuit is impressed and on the other pair a voltage proportional to the total voltage drop across the apparatus under test is applied.

It will be noticed here that we have assumed that an electric field is used for each pair of quadrants, this being more convenient where losses at high voltages and very small currents are being measured.

The voltage for the current quadrants may be obtained from the potential drop over a capacity or resistance in series with the apparatus or material under test. If a capacity is used the area of the figure traced on the screen will be a maximum when the power-

factor is 100 per cent, whereas, when a series resistance is used the area will be a maximum when the power-factor is 0 per cent. The voltage for the voltage quadrants may be obtained through a potential transformer or from a capacity shunted across the line using two plates of this condenser to step down the

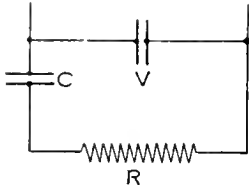


Fig. 3

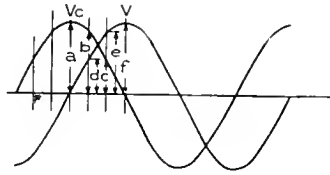


Fig. 4

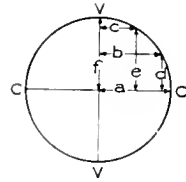


Fig. 5

voltage. The operation as a wattmeter is shown in Figs. 3, 4 and 5.

Assume that it is desired to determine the loss in a high resistance when subjected to high voltage. The voltage drop over a condenser in series with the resistance is used to produce the current deflection when connected to the current quadrants and the voltage drop over a part of a condenser shunted across the

resistance R , depending upon the voltage drop over the condenser C . However, this is not large, as the voltage over the condenser is never greater than 15 per cent of the total voltage across the condenser and loss together.

This slight phase angle is corrected for in determining the true power-factor, by calculating the angular difference due to this series condenser and subtracting it from the measured θ' , where $\cos \theta'$ is the measured power-factor, leaving the angle θ whose cosine would be the true power-factor of the material under test.

Now, if we take the line in which the fluorescent spot vibrates, due to the voltage across the series condenser, as the axis of abscissa, and the line due to the voltage across the shunt condenser as the axis of ordinates, and plot instantaneous values of the two waves in this co-ordinate system, it will be seen that the fluorescent spot traces out a closed figure, Fig. 5, on the screen which will be a circle, ellipse or straight line, depending upon the relative amplitudes of the two voltages and the power-factor of the loss being measured.

In order to know what this loss is in watts, the voltage drop across the series condenser is measured with an electrostatic voltmeter and from the known capacity of this condenser and the frequency and wave shape of the voltage the current flowing in the circuit can be calculated. The current and voltage are now known and it becomes necessary to obtain the power-factor, when the watts can be calculated.

The power-factor is found to be the ratio of the area of the figure as measured, to that of the maximum area which could be obtained with the separate measured deflections. This

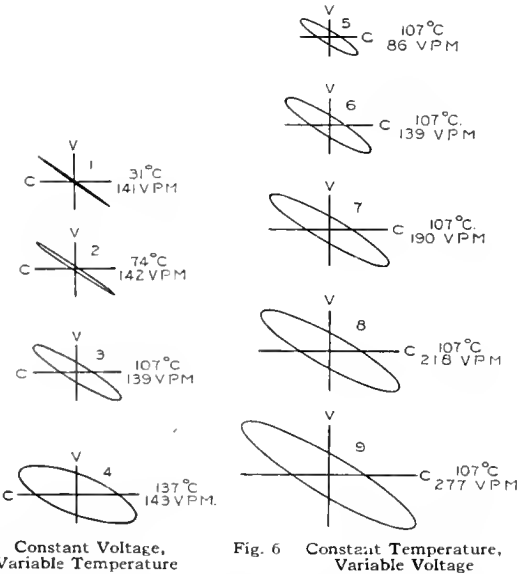


Fig. 6 Constant Temperature, Variable Voltage

Constant Voltage, Variable Temperature

resistance and series condenser is used to produce the voltage deflection when connected to the voltage quadrants, as shown in the circuit of Fig. 1. Taking the simple circuit in Fig. 3, the current in C is in phase with the current in R , but as C is a pure capacity the voltage must be lagging 90 deg. behind the current. This wave is plotted as V_c in Fig. 4.

is determined briefly as follows: The area of the maximum ellipse is πab , where a is the semi-major deflection and b is the semi-minor deflection. The area of the ellipse,

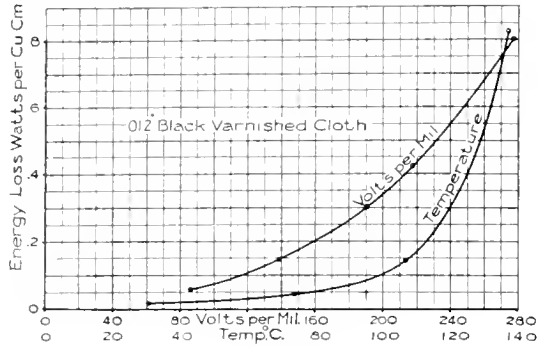


Fig. 7

which measures a loss whose power-factor is $\cos \theta'$, would be $\pi ab \cos \theta'$.

Hence $\frac{\pi ab \cos \theta'}{\pi ab} = \cos \theta'$, or power-factor,

which is the measured area divided by the maximum area calculated from the separate deflections.

With a sine wave in both co-ordinates, the maximum area would be π 4 times the product of the length of the two co-ordinates VV and CC . Then the measured area of the figure divided by the maximum area gives the power-factor. Hence we have measured the voltage, current and power-factor and then can readily calculate the loss.

In Fig. 6 is shown two series of losses; one is the dielectric loss vs. temperature on black varnished cloth at a given constant voltage, and the other is dielectric loss vs. voltage at a given temperature.

The law of variation of dielectric loss in insulations with variation of temperature and voltage has not yet been determined. If the loss were similar to a resistance loss, we would expect that it would vary as the square of the voltage if the temperature could be kept constant. However, there are several factors which enter into the problem, such as the thickness, area, thermal conductivity, specific heat of and the amount of moisture in, the material under test, the size and material of the electrodes, length of time the voltage is applied, etc., that make the calculation quite difficult and unsolved as yet.

LAW OF "CORONA" AND SPARK-OVER IN OIL

By F. W. PEEK, JR.

CONSULTING ENGINEER, GENERAL ELECTRIC COMPANY

The author shows that the mechanism of breakdown in gaseous and liquid insulations is very much the same; the general laws which he has developed for air also apply to oil. These laws may be used in practice in calculating the breakdown voltages in oil. Data on the various properties of oil for 60-cycle, high frequency and impulse voltages are given.—EDITOR.

General Characteristics

The most common liquid insulation is transil oil. Its average characteristics are as follows:*

same as for air excepting the apparent strength is very much higher.

The dielectric strengths of oils are usually compared by noting the spark-over voltage

	Medium	Light
Flashing temperature.....	180 deg.— 190 deg. C.	130 deg.— 140 deg. C.
Burning temperature.....	205 deg.— 215 deg. C.	140 deg.— 150 deg. C.
Freezing point.....	-10 deg.— -15 deg. C.	-15 deg.— -20 deg. C.
Specific gravity at 13.5 deg. C.....	0.865—0.870	0.845—0.850
Viscosity at 40 deg. C. (Saybolt test)	100—110 sec.	40—50 sec.

Various other oils, mineral, animal and vegetable, are insulators. All of these in the pure state have more or less the same order of dielectric strength.

Compounds made by dissolving solids in oil to increase their viscosity are generally

between two parallel brass disks 1.25 cm. in diameter, and 0.5 cm. (0.2 in.) separation. The spark-over voltage for good oils used in the investigation below tests 58.5 kv. maximum in the above gap.

Effect of Moisture

The slightest trace of moisture in oil greatly reduces its dielectric strength. The effect of moisture is shown in Fig. 2, for the standard disk gap (test by Hendricks). Water is held in suspension in oil in minute drops. When voltage is applied these drops are attracted by the dielectric field. Thus they are attracted to the denser portions of the field and may form larger drops by collision. When attracted to, and after touching a metal part, they are immediately repelled. If the field is uniform the drops form in conducting chains along the lines of force. It can be seen that the effect of moisture should vary greatly with the shape of the electrode, and with some shapes the moisture may even be removed from the space between the electrodes by the action of the field, in which case its presence would not be detected by low-voltage breakdowns. In transformers, moisture will generally be attracted to points under greatest stress. The most effective way of removing moisture is by filtration through blotting paper. Dirt in oil may have an effect very similar to moisture and the small conducting particles may be made to bridge between the electrodes by the dielectric field.

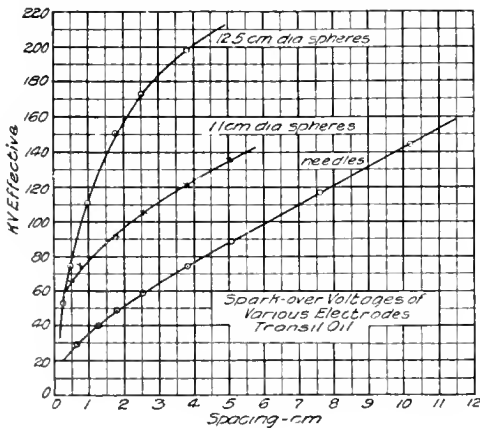


Fig. 1

unreliable unless used dry, e.g., varnish; under the action of the dielectric stress the various dielectrics of different permittivities tend to separate. As in air, there is very little loss in pure oil until local rupture occurs in the form of brush discharge or corona.

Different Electrodes

In Fig. 1 are plotted 60 ~ spark-over curves for different electrodes in good transformer oil. The characteristics are very much the

* Tobey—Dielectric Strength of Oil—A.I.E.E., June, 1910.

Temperature

Temperature over the operating range has very little influence on the strength of oil. The strength increases at the freezing point; this is shown in Fig. 3; the insulation resistance is also shown. The increase

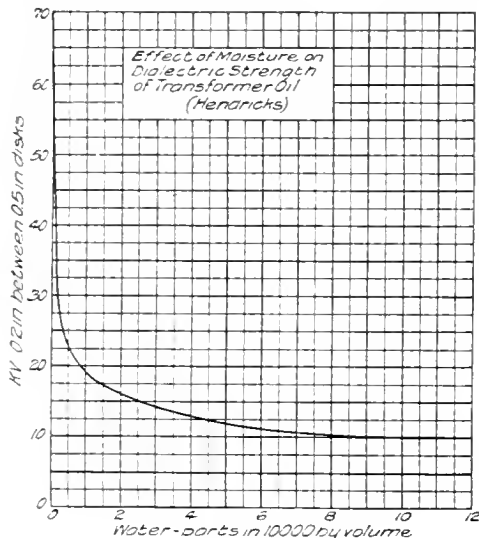


Fig. 2

in strength with temperature seems only apparent and is due partly to the decreasing insulation resistance which allows more current to flow through the oil, which tends to even up the stress, but mostly to the drying out of moisture particles by high temperature. The hump at about 70 deg. increases with poor oil, and decreases as the quality of the oil is improved. The cooling curve is generally higher, as shown in Fig. 3. Evidently moisture and gas have been removed by heating, when the strength decreases with the density. The increase at freezing should be expected, as an actual change in dielectric properties results. For a perfectly dry oil the strength generally actually decreases with increasing temperature or decreasing density.

Spark-over or "Corona" in Oil

A phenomenon similar to corona in gases also takes place in liquid insulations such as oil, due to a tearing apart of the molecules of the oil or occluded gases. It seems probable that occluded gases often take an important part in supplying "initial ionization." (The great effect of moisture must always be kept in mind.) It will later be noted that the strength of oil in bulk is not very much greater than air.

"Corona" in oil is not as steady or definite as in air.* It appears to start quite suddenly and to extend much farther out from the electrode than a corona in air. It is much more difficult to detect the starting point, and unless the conductors are very small and far apart (s/r large) corona does not appear before spark-over. For instance, with an outer cylinder of 3.81 cm. radius and an inner one of 0.0127 cm. radius ($\frac{R}{r} = 300$), the

corona and spark-over voltages are practically the same. (The condition for spark-over before corona, for concentric cylinders of radii R and r , is for an insulation of constant strength $\frac{R}{r} < \epsilon$, ($\epsilon = 2.718$). "Corona" can

never occur when $\frac{R}{r} < \epsilon$. The absence of corona

in oil before spark-over when $\frac{R}{r} < \epsilon$, unless the

wires are very small or far apart, seems to mean that the mechanism or breakdown in oil is very similar to that in air; the apparent strength is greater for small wires. This is because energy is required to start a rupture.† A rupture cannot, therefore, take place at the

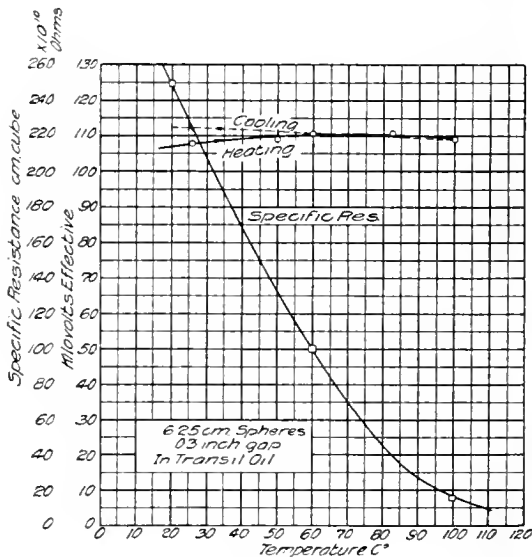


Fig. 3

conductor surface, but the oil must be stressed at or above the breakdown voltage over a finite thickness. Thus, just before "corona"

* Corona may be considered as spark from conductor to space, while spark-over is spark from conductor to conductor.

† Law of Corona I, II, III, A.I.E.E., June, 1911, '12, '13, '14. High Voltage Engineering—Journal Franklin Institute, December, 1913.

occurs, the stress at the wire surface is higher than the rupturing stress; at a finite distance away it is the rupturing stress. This breakdown distance is called the energy distance or rupturing distance. The energy distance is much greater in oil than in air. Thus, as the voltage is increased, "corona" rupture occurs out to the energy distance; this increases r to the condition for spark-over

$$r + \text{energy distance broken down (hence, conducting)} = \frac{R}{r_1} < \epsilon$$

and spark follows. Therefore, the spark-over voltages and corona voltages up to fairly high ratios of $\frac{R}{r}$ are the same, and may be used in determining the strength of oil.

The strength of oil for different sizes of wire from Table IV is plotted in Fig. 4. The curve is similar to that for "corona" in air. Fig. 5 shows that a straight line relation holds approximately between $\frac{1}{\sqrt{r}}$ and g_v . Values are not used when $R/r > 3.5$. Thus, as in the case of air:

$$g_v' = g_o' \left(1 + \frac{a}{\sqrt{r}} \right)$$

$$g_v = 36 \left(1 + \frac{1.2}{\sqrt{r}} \right) \text{ kv/cm. max.}$$

$$g_v = 25.5 \left(1 + \frac{1.2}{\sqrt{r}} \right) \text{ kv/cm. effective sine wave}$$

The electron theory may also be very well applied in agreement with experimental data.

When low potential is applied between two conductors any free ions are set in motion. As the potential and, therefore, the field intensity or gradient is increased, the velocity of the ions increases. At a gradient of $g_o = 36$ kv/cm the velocity of the ions becomes sufficiently great over the mean free path to form other ions by collision with atoms and molecules. This gradient is constant and is called the dielectric strength of oil. When ionic-saturation is reached at any point, the oil becomes conducting and glows, or there is "corona" or spark. When a gradient g_v is reached at the wire surface any free ions are accelerated and produce other ions by collision with molecules, which are in turn accelerated. The ionic density is thus gradually increased by successive collisions until at $1.2\sqrt{r}$ cm. from the wire surface, where $g_o = 36$, ionic saturation is reached, or "corona" starts. The distance $1.2\sqrt{r}$ cm. is, of course, many times greater than the mean free path of the ion, and many collisions must

take place in this distance. Thus for the wire "corona" cannot form when the gradient of g_o is reached at the surface, as at any distance from the surface the gradient is less than g_o ; a finite thickness must be stressed at a gradient of g_o or over or ionic saturation cannot occur.

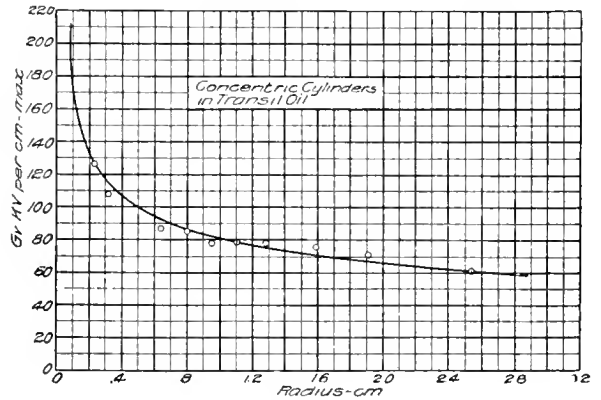


Fig. 4

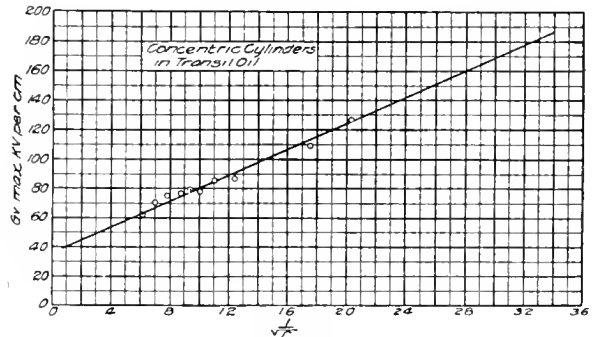


Fig. 5

The gradient at the surface must therefore be increased to g_v so that the gradient a finite distance away from the surface ($1.2\sqrt{r}$ cm.) is g_o . That is, energy is necessary to start corona, as stated above.

When the conductors are placed so close together that the free rupturing or energy storage distance is interfered with, the gradient g_v must be increased in order that ionic saturation may be reached in this limited distance.

The gradient g_v , as with air, should also vary with the density of the oil—that is, with temperature. When initial ionization is caused by occluded gases it is probable that the strength should increase for very high pressure to a greater extent than would be expected by the small increase in density with the increase in pressure.

TABLE I
DIELECTRIC STRENGTH OF TRANSIL OIL—SPARK-OVER BETWEEN SPHERES—60 ~.

Spacing Cm.	RADIUS OF SPHERES, CM.										NEEDLES 0
	0.159		0.555		1.27		3.12		6.25		
	Kv. Max.	Gradient Max. kv/cm	Kv. Max.	Gradient Max. kv/cm	Kv. Max.	Gradient Max. kv/cm	Kv. Max.	Gradient Max. kv/cm	Kv. Max.	Gradient Max. kv/cm	
0.129	44.6	449	48.0	394	47.1	364
0.198	50.5	360
0.264	59.2	365	73.0	333	73.5	310	74.3	288	74.8	289	...
0.322	65.0	360
0.378	71.1	364	90.0	295
0.508	81.0	368	99.0	222	105.0	220	107.0	214	...
0.650	41.6
0.766	89.9	353	106.0	225	117.0	187	128.0	182	132.0	180	...
1.010	97.6	358	112.0	192	146.0	166	159.0	166	...
1.270	104.0	361	116.0	176	157.0	158	171.0	158	177.0	147	57.0
1.780	111.0	384	131.0	171	165.0	143	203.0	137	214.0	130	...
2.540	124.0	416	149.0	174	185.0	130	240.0	122	245.0	110	84.0
3.810	145.0	470	172.0	184	206.0	131	266.0	103	280.0	90	108.0
5.080	168.0	542	191.0	192	231.0	133	124.0
7.620	166.0
10.150	203.0

TABLE II
SPARK-OVER BETWEEN PARALLEL PLATES IN TRANSIL OIL—60 ~.

r Kv. Max.	X Spacing Cm.	g kv/cm Max.	Remarks
34.6	0.254	136.3	
52.3	0.508	102.8	
71.0	0.762	93.0	
113.2	1.27	88.8	
155.5	2.54	61.	
212.	5.08	41.7	
296.	7.62	35.	

10 cm. flat disks 0.5 cm. radius on the edge 25 deg.
58.5 kv. max. oil in 0.5 cm. std. gap.

TABLE III
"CORONA" IN OIL, WIRE AND PLATE—60 ~.
(Distance of Wire from Plate = 16.5 cm.)

Kv. Eff.	Radius Wire Cm.	g : eff. kv. cm	g : max. kv. cm.
50	0.025	278	393
60	0.05	185	262
80	0.0635	201	284
100	0.152	122	173
55	0.00508	615	870

The rupturing distance is $1.2\sqrt{r}$ cm. or almost four times that of air, indicating that a greater amount of energy is required to rupture oil, or a greater number of collisions are necessary before ionic saturation is reached. g_0 and a vary to a considerable extent in oil. The strength of oil or the disruptive gradient, or the gradient required to bring the ions up to sufficient velocity to produce others by collision, seems fairly low. Oil should, therefore, have low strength in bulk (about 36 kv/cm maximum between parallel planes at large spacings), but high apparent strength when subdivided or confined to make use of the large energy distance necessary to rupture.

Spark-over voltages and gradients are given for various sizes of spheres at various spacings in Table I. The characteristics of the curves between gradient and spacing, as shown in Fig. 6, are the same as those for air. When the spacing is so small that it interferes with the rupturing distance, the apparent strength of oil increases. At spacings above this the gradient is constant until the separation is so great that "corona" forms before spark-over.

The rupturing gradient at the constant part of the curve for various sizes of spheres is given in Table V, and is shown in Fig. 7. This may be written

$$g_s = 28.3 \left(1 + \frac{4}{\sqrt{r}} \right) \text{ kv/cm max.}$$

The energy distance is approximately $2\sqrt{r}$.

The spark-over voltages between electrodes for wires where $\frac{S}{r} \gtrsim 10$ or $\frac{R}{r} \gtrsim 5$, and for

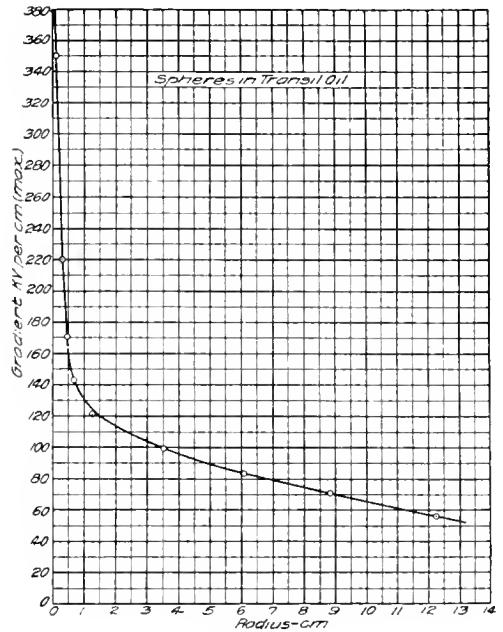


Fig. 7

spheres between $2\sqrt{R}$ and $3R$ spacing on the constant part of the curve, may be calculated by substituting the proper g_s in the voltage formula.

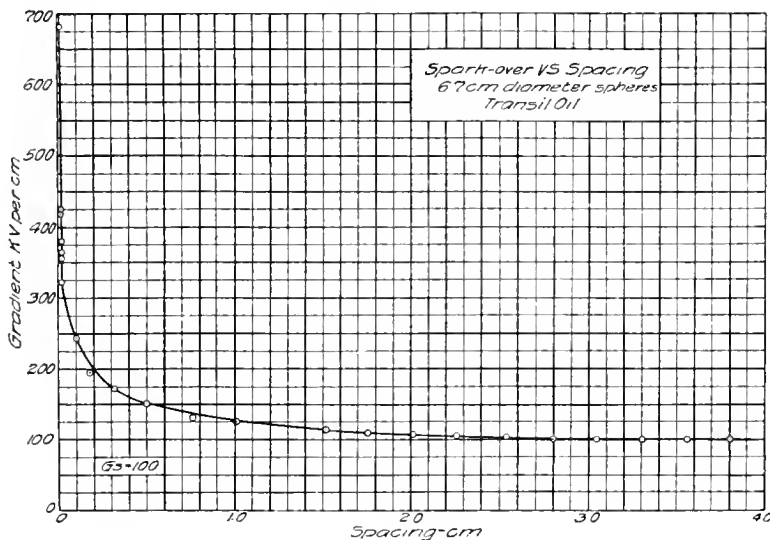


Fig. 6

TABLE IV
SPARK-OVER VOLTAGES FOR TRANSIL OIL CONCENTRIC CYLINDERS—60 ~.

R Cm.	r Cm.	Kv. Eff.	Kv. Max.	$\frac{R}{r}$ Max. kv/cm	$\frac{1}{\sqrt{r}}$	$\frac{R}{r}$	Remarks
3.81	0.032	45.3	64.0	420.0	5.61	120.00	Tests made in dry cylinders with belled ends. Oil between std. disks 0.5 cm. apart tested 58.5 kv. (max.) 25 deg. C.
3.81	0.238	60.0	84.0	127.7	2.05	16.00	
3.81	0.317	60.5	85.5	108.1	1.77	12.00	
3.81	0.635	69.5	98.3	86.3	1.26	6.00	
3.81	0.794	75.0	106.1	85.5	1.12	4.80	
3.81	0.952	73.0	103.2	78.1	1.02	4.00	
3.81	1.111	76.7	108.5	79.4	0.95		
3.81	1.270	76.0	107.5	77.0	0.89	3.00	
3.81	1.587	73.7	104.3	75.1	0.79	2.40	
3.81	1.905	66.3	93.7	70.7	0.72	2.05	
3.81	2.540	45.5	64.3	62.4	0.63	1.57	

TABLE V
SPHERES IN OIL

Radius Cm.	Gradient kv/cm Max.	$\frac{1}{\sqrt{R}}$	Radius Cm.	Gradient kv/cm Max.	$\frac{1}{\sqrt{R}}$
0.159	348	2.51	1.270	120	0.89
0.237	260	2.05	3.120	98	0.56
0.355	222	1.68	6.25	82	0.40
0.555	169	1.35	12.5	56	0.28

Gradient at constant part of the curve. 60 ~. Data from Table I.

TABLE VI
COMPARISON OF 60 CYCLE AND IMPULSE SPARK-OVER IN OIL

Gap	Spacing Cm.	Kv. 60 Cycle Max.	Kv. Impulse Max.
Standard disk.	0.5	56.6	170.
2.0 needles. . .	1 4	50.2 108.	103.3 321.
2.54 cm. spheres.	0.25 1.02	37.2 111.2	117.3 337.

TABLE VIII
COMPARATIVE INSULATION STRENGTH FOR HIGH FREQUENCY IMPULSE,
OSCILLATION AND 60-CYCLE VOLTAGES

Temperature 30 Deg. C.

Transil Oil between Flat Terminals—Square Edge—2.5 Cm. Diameter—0.25 Cm. Space

60 CYCLES*	HIGH FREQUENCY* (ALTERNATOR) 90,000 CYCLES	DAMPED OSCILLATION* TRAIN FREQ. 120 SECONDS 200,000 CYCLES	SINGLE IMPULSE SINE SHAPE CORRESPONDING TO HALF CYCLE OF 200,000 CYCLES
Kv/cm (Max.)	Kv/cm (Max.)	Kv/cm (Max.)	Kv/cm (Max.)
170	67	300	390

* Voltages in columns 1, 2 and 3 brought up to breakdown in few seconds.

Thus,

$$e = g_s r \log_e \frac{R}{r} \text{ concentric cylinder.}$$

$$e = 2 g_s r \log_e \frac{S}{r} \text{ parallel wires, single-phase.}$$

$$e = 1.73 g_s r \log_e \frac{S}{r} \text{ parallel wires, three-phase.}$$

$$e = g_s \frac{X}{f} \text{ for spheres.}$$

The spacings X and s , and the radii R and r , are in cm. f is given below.

$\frac{X}{R}$	f Non-grounded	f One Sphere Grounded
0.1	1.03	1.03
1.0	1.36	1.42
2.0	1.77	1.98
3.0	2.21	2.60
4.0	2.62	3.21

Where the spacings are greater than the upper limit, the voltage calculated is the corona voltage.

In oil, the apparent strength can be improved by limiting the "free energy distance." This can be seen in Tables I and II, where e/X is given for parallel planes, and g_s for spheres. It should be noted that the strength between parallel planes decreases with the spacing. It approaches a constant value of 36 kv/cm. (max.) at about 10 cm. spacing. For the small spacings, where the free energy distance is limited, the apparent rupturing gradient is very high, just as in the case of air. Strengths as high as 700 kv/cm. have been reached.

Permittivity

The permittivity of oil varies with its density and, therefore, with its temperature. It is $2.6 \times$ the specific gravity of oil.

Barriers

The strength of oil may be greatly increased by the use of barriers, by limiting the energy distance. However, if the barriers have a higher permittivity than oil, the stress on the oil may be very greatly increased if the thickness of the barrier is great compared with the oil thickness. In this way the breakdown voltage may be actually decreased

by barriers. Even under this condition, however, there is a great gain, as the water particles and dirt are prevented from lining up, incipient sparks are prevented from developing, etc.

Transient Voltages and High Frequency Voltages

Transient voltages, or impulse voltages of short duration, greatly in excess of the low frequency rupturing voltages may be applied to insulation without rupture. In other words, the rupture of insulation requires not only a sufficiently high voltage, but also a definite minimum amount of energy. This means also that a definite but very small time elapses between the application of voltage and breakdown. This is called the "dielectric spark lag." The rupturing energy seems to be much greater for oil than for air, as indicated by the large energy distance in the gradient equation above. At low frequency a given definite voltage is required to cause rupture during the comparatively unlimited time of application. This voltage is constant until the application is limited to some small but finite time, depending upon the initial ionization, etc., when a higher voltage is required to accomplish the same results in limited time. Such transient voltages of short duration, and impulses of steep wave front, must not be confused with continuously applied high frequency where breakdown will generally take place at lower voltages, due to loss, etc.

In Table VI, the relative breakdown voltages of gaps in oil, at 60 cycles, and for impulse voltages of steep wave front, are given. An impulse voltage much higher than the 60-cycle voltage is required to break down a given gap.

Oil is an excellent insulation in combination with proper barriers. On solid insulations the effect of transient voltages is cumulative. A partial break occurs which is enlarged by each succeeding impulse, until dynamic energy finally follows. With oil, such "cracks" are closed up by new oil immediately.

The comparative strengths of oil for impulse, high frequency, oscillatory and 60-cycle voltages are given in Table VII.

The author wishes to acknowledge indebtedness to Mr. B. L. Stemmons for assistance in making tests.

THE OPERATION AND RATING OF THE ELECTRIC LOCOMOTIVE

BY A. H. ARMSTRONG

ASSISTANT ENGINEER, RAILWAY AND TRACTION DEPARTMENT,
GENERAL ELECTRIC COMPANY

The rating of electric locomotives is a subject on which we need much education. The author who has done so much work in giving rational ratings to electric railway motors in general gives some most useful data in discussing the momentary, one hour and continuous capacity of some notable electric locomotives. Many details of design including those of the locomotives for the Chicago, Milwaukee & St. Paul Railway are discussed. This article is prepared from the author's discussion at the recent meeting of the Institute of Mechanical Engineers in Chicago.—EDITOR.

The present article touches upon the subject of electric locomotive operation, what excuse it has for existence, and draws some few comparisons with the steam locomotive as to its selection and rating.

Commencing with the New York Central locomotive, we have a distinctive type admirably adapted to high speed passenger service. It is designed to deliver a moderate tractive effort at a high speed, the first 47 locomotives of the "S" type giving a tractive effort of 7100 lb. continuously at a speed of 56 miles per hour and a one-hour rating of 20,600 lb. The driving motors, four in number, are thus able to give an output of 2200 h.p. for a period of one hour without overheating. The later "T" type of locomotive, weighing approximately 130 tons, has a capacity of 14,000 lb. tractive effort at a speed of $53\frac{1}{2}$ miles per hour or a continuous motor capacity of approximately 2000 h.p. For the one-hour period the output is 2600 h.p.

Electric railway engineers talk about continuous and one-hour capacities and also about starting tractive effort, and that brings up one point that needs explanation to the steam railroad man; that is, the time element plays a very important part in the determination of the rating of an electric motor. In a steam locomotive the tractive effort or pulling power is determined by the diameter of the piston and the steam pressure behind it, and the locomotive can deliver this tractive effort continuously provided it has sufficient boiler capacity to supply the quantity of steam demanded and the fireman is sufficiently industrious to keep the grate covered which is supposed to have sufficient surface. With the electric locomotive, on the contrary, allowance must be made for the fact that the insulation used deteriorates if heated continuously above a certain amount. It takes a considerable time for the motor to heat up to this dangerous point, thus giving rise to a momentary rating or starting effort, a one-hour rating and a continuous rating, the latter

being the output which the motors can give continuously without injurious heating. In other words, the steam locomotive engineer is concerned in keeping his boiler hot, while the effort of the designer of electric locomotives is to keep his machine cool.

In the early electric locomotive design there was no such thing as continuous rating. The service which it was called upon to perform was of an intermittent character, the runs between stops were short and the designing engineers were concerned mostly with the question of starting or accelerating, tractive effort and commutation. Therefore, the continuous rating of the early motors did not affect its design. With the extension of electrified lines and more especially with the introduction of the electric locomotive on main steam trunk lines, it was found that the motive power was called upon to deliver a continuous output for long periods at a time, and it became necessary to introduce air blown or ventilated motors as well as fire-proof insulation in order to secure the large output required without exceeding the limitations of space and weight imposed by standard gauge and reasonable diameter of wheels, wheel-base and weight per driving wheel. We are therefore designing electric locomotives today suitable for the heaviest class of freight and passenger service. Such locomotives are entering into competition with the steam locomotive with a full appreciation of the phenomenal growth and possibilities of the latter as developed during the past few years, as well as a knowledge of the growth in the demands placed upon the motive power to take care of modern high speed passenger and freight train service.

In designing such electric locomotives the electrical engineer is fully alive to the fact that a steam locomotive has been built weighing 750,000 lb. on drivers and having a total weight of 850,000 lb., and that nearly 90 per cent of the total weight of the locomotive and tender is now rendered available

for tractive purposes by the development of the Mallet principle to include cylinders placed upon the tender itself. It is also known that the tractive effort of these locomotives has increased from the 40,000 lb., of the early "Consolidation" engines weighing 200,000 lb. on the drivers, to values as high as 160,000 lb. for the latest type of Mallet. It is also known that the introduction of the steel passenger car with the need of high sustained speeds of between 60 and 70 miles per hour, calls for the hauling of passenger trains weighing over 1000 tons, and that provision is made in the latest New York Central electric locomotive to take care of 1200 tons at 60 miles an hour. Due appreciation is also paid to the results secured with the combination of superheating and simple engine which has so largely replaced the compound. Also the increased capacity afforded by the use of mechanical pushers, and fire door openings with hand firing, have increased the efficiency of the fireman so that it is now possible for him to throw between 5000 and 6000 lb. of coal per hour where previously 4000 lb. might be considered good performance. Finally it is fully understood that the modern steam locomotive has been so improved as to fuel economy by the introduction of superheating, fire arch and other developments that it is possible to get an indicated horse-power with a consumption of 15 lb. of steam and less than 2 lb. of coal under the best conditions of operation, and that with the use of mechanical stokers or with oil fired boilers, locomotives are in operation giving 3000 indicated horse-power or more.

Fully appreciating the above facts and the magnitude of the problem confronting him, the electric railway engineer nevertheless offers in the modern electric locomotive a type of motive power which can accomplish results in transportation which are not possible to obtain with the steam locomotive as regards tonnage handled, speed on mountain grades and general flexibility and economy in operation. The first large locomotive built was placed in operation on the Baltimore & Ohio Railway in 1895, and it is worthy of note that this was a gearless locomotive and a forerunner of the highly efficient gearless locomotives now in operation upon the New York Central road today. The New York Central locomotive, as developed in the later "T" type, is capable of hauling the heaviest overland passenger trains over any length of track that may be electrically equipped, and withal at a cost for upkeep, including all labor

and material spent in maintenance, of not exceeding $3\frac{1}{2}$ cents per mile run, as is shown by the records of the New York Central during the operation of the past seven years.

The first railroad in this country to adopt electric freight locomotives having large sustained output capacity is the Butte, Anaconda & Pacific Railway. Some three years ago the construction of 92 miles of the total of 114 miles of track was commenced, being completed for freight operation in May of 1913 and for complete freight and passenger operation in October of 1913. There are still four or five steam engines in operation on Butte Hill, but these will be replaced in the near future, so that in a short time the entire road, or 114 miles of track, will be in operation electrically. The one motive inspiring this installation was economy in operation, and preliminary reports indicated that the savings in electric over steam operation should be sufficient to pay something like $18\frac{1}{2}$ per cent upon the capital required to electrify. During the first six months of operation of this road careful detail figures were kept on the cost of electric operation, every item of expense being accounted for, with the result that prorated over the entire fiscal year there was a saving shown of \$240,000 over the cost of steam operation during the previous year with practically the same tonnage handled. The entire first cost of this installation, including all material and labor and contingent expenses as well as interest on money during construction, was approximately \$1,200,000, so that the saving above indicated results in a 20 per cent gross return upon the capital required for electrification. This makes no allowance for the scrap value of more than 20 steam locomotives discarded.

On this road the heaviest class of freight trains are operated electrically, regular operation calling for the movement of from 3500 to 4000 tons behind the locomotives from the Butte Yards to Anaconda, and record has been made of train weights as high as 4500 tons trailing against a gradient of 0.3 per cent. Each locomotive weighs 80 tons, all on drivers, and two such units are coupled together, operated by one engineer and comprise a complete locomotive hauling the above tonnage. At the Butte end there is a gradient of $2\frac{1}{2}$ per cent against the returning empty cars, and at Anaconda a 1.1 per cent grade against which one of the above locomotives hauls 25 cars, or approximately 2000 tons.

This leads up to the subject of the rating of an electric locomotive. The Butte loco-

motive, weighing 80 tons, all on drivers, will give a continuous tractive effort of 26,000 lb. at a speed of approximately $16\frac{1}{2}$ miles per hour at full substation line voltage. This corresponds to $16\frac{1}{4}$ per cent of the weight upon the drivers. Investigation of the locomotive loading regulations on many steam roads operating over ruling grades indicates that it is almost universal practice to assign to a locomotive a trailing load so that the tractive effort at the rim of the drivers, as required on a ruling grade, will be equivalent to approximately 18 to 19 per cent of the weight upon the drivers. In other words, from 18 to 19 per cent coefficient of adhesion between driver and rail is now considered good steam practice, and the electric locomotive rating is closely following this same steam practice. The electric motor, of course, gives a perfectly uniform rotation to the driving wheels, and should thus give something like 10 per cent more tractive effort than the steam locomotive with its reciprocating parts. Continued operation will develop whether this additional 10 per cent tractive effort can be utilized or not. In the meantime steam practice is being followed in the loading of electric locomotives.

In adopting a coefficient of adhesion of 18 or 19 per cent as the basis of determining the tractive effort required on ruling grades, it is evident that there is left for starting purposes the difference between the above coefficient of adhesion and the slipping point of the wheels, whatever that may be, as determined by the condition of the track. Tests on electric locomotives have shown a coefficient of adhesion as high as 35 per cent, or even more under specially favorable conditions, but it is fair to assume a maximum of 30 per cent as available in operation and even 25 per cent may be nearer the average. There is therefore not much difference between the tractive effort required on ruling grades and that required for starting, and in order to be "fool proof" and capable of meeting the exacting demands of the heaviest kind of service, the electric locomotive should be capable of delivering continuously a tractive effort equal to from 16 to 18 per cent coefficient of adhesion of the weight upon its drivers. The Butte locomotive is therefore rated at 26,000 lb. or 16.25 coefficient of adhesion as its continuous output, and this capacity is sufficient to meet all demands of operation on the Butte, Anaconda & Pacific Railway.

Coming now to the latest type of trunk line electric locomotive, the one designed

by the General Electric Company for the Chicago, Milwaukee & St. Paul Railway, this is a direct development of the Butte, Anaconda & Pacific both as to type of locomotive and general system of electrification installed. The weight of the locomotive is 260 tons, of which 400,000 lb. are on the drivers. Each of the eight driving motors has a continuous rating of approximately 400 h.p., making the sustained continuous output of the complete locomotive 3200 h.p. at the rim of the drivers. This locomotive, however, will give a considerably larger output for short periods. For example, it has a capacity of 3600 h.p. for one hour and even greater than this for short periods. The sustained tractive effort is 72,000 lb. at a speed of $15\frac{3}{4}$ miles per hour at full substation line potential. Compare this with the Mallet engine of approximately the same weight now in operation on the St. Paul road and we find that the Mallet has 76,200 lb. tractive effort corresponding to 23.5 per cent coefficient of adhesion, but those of you familiar with the performance of this beast of burden know that it toils painfully at speeds seldom exceeding 7 to 10 miles per hour when operating at its full hauling capacity. It is in this matter of higher speed for the same tractive power that the electric locomotive excels. In fact the question of speed is simply one of cost and expediency, as the horse power output of the electric locomotive can be raised to any value desired without exceeding the limits of track loading.

The St. Paul locomotive, weighing 70 tons, has a capacity to haul a 2500 ton trailing load behind the locomotive on a 1.0 per cent grade at nearly 16 miles per hour without any assisting locomotive. The St. Paul road in Montana and Idaho crosses three mountain ranges, the Belt Mountains, the Rocky Mountains and the Bitter Root Mountains. From Lombard to Summit, in the Belt Mountains, a distance of 49 miles, there is an average gradient of 0.71 per cent and a ruling grade of one per cent against which one locomotive will haul a trailing load of 2500 tons without assistance. Between Piedmont and Donald, a distance of 22 miles to the summit of the Rocky Mountains, there exists a two per cent grade against which two locomotives will haul 2500 tons trailing, the second locomotive being used at the rear of the train as a pusher. A second pusher division exists in crossing the Bitter Root Mountains of Idaho making only two pusher divisions in the 440 miles of electrified road from Avery, Idaho, to Harlowton, Montana.

The general design of the St. Paul locomotive comprises a locomotive divided in halves for facility in shop repairs, each half being identical and equipped with four driving axles and two guiding axles. The design is identical with the Butte locomotive except for the addition of the four-wheel guiding truck at each end of the locomotive, one of the reasons for its introduction being that the same locomotive is thus made available for both passenger and freight service. This does not mean that any locomotive can be used interchangeably at will in both freight and passenger service, but it does mean that all parts of the locomotive are identical whether used for freight or passenger service with the single exception of the gearing between motors and driving axles which has a ratio of 4.56 for freight service and 2.45 for passenger service. This adoption of a uniform type of motive power for all classes of service should result in effecting a great reduction in the cost of maintaining the locomotives of the four engine divisions electrified.

A second type of light locomotive for shifting service may be introduced later, although in this connection arrangements are being made to operate independently, one-half of the locomotive being equipped with draft gear in place of the articulated joint joining the two halves. This will provide a locomotive weighing 130 tons having 200,000 lb. on the drivers and capable of doing one-half the work stated above as the capacity of the combined locomotive; this half locomotive would require turning if used in passenger service, as it has guiding axles at one end only.

The installation on the St. Paul road will use for the first time on such a large scale a principle which should be of the greatest advantage in the operation of mountain grade divisions; that is, the utilization of the motors on the locomotives to brake the train on down grades and return the energy of the descending train back into the trolley. The efficiency of the locomotive, both electrical and mechanical, is nearly 90 per cent as a maximum, not taking into account the minor losses in driving ventilating fans and air compressors. When descending heavy grades, therefore, the reversible feature of the locomotive, permitting it to transform mechanical power received into electrical energy, suggests by this means a considerable reduction in the amount of power required to operate the road. It is probable, however, that a power saving of less than 10 per cent will result from the

regenerative braking feature of the electric locomotives, and the principal advantage resulting from the introduction of the electric brakes will be to relieve brake shoes and wheels from the dangers attending overheating. To those of you who are familiar with the handling of trains on long and heavy down grades this argument will appeal in full force, as it is not an uncommon sight to see brake shoes red hot as a result of sustained application on down grades of long extent.

In conclusion it is well to comment on the suitability of the New York Central gearless type of locomotive for passenger service. This is seen very plainly when the entire absence of mechanical losses in the motor other than the brush friction on the commutator is considered. There are no bearings on the motor of any kind as the armature is mounted directly upon the driving axle and the field structure is part of the frame which is carried upon the journals. The electrical efficiency of the motor and the frictional losses on the commutator, due to the brushes, are therefore the only losses to be considered, and the efficiency of this locomotive in operation is therefore between 93 and 94 per cent. In other words, of the electrical input received at the third rail shoes, from 93 to 94 per cent appears as useful mechanical output at the rim of the drivers. This in itself is a most remarkable performance, but the value of this high efficiency locomotive is rendered more important when it is explained that the maximum efficiency occurs at approximately the free running speed between 50 and 60 miles per hour. In other words, the motor has a drooping efficiency curve, being highest at free running and lowest at overloads or during acceleration, and in this respect being just the reverse of the efficiency curve of geared motors which reach their highest point at practically the one hour load capacity of the motors. The gearless locomotive is therefore particularly adapted to operate on fairly level profiles and could not be utilized to such great advantage on roads like the St. Paul which contains many heavy grades sustained over a long distance. It is very difficult to combine in one structure motors capable of hauling 800 tons trailing over heavy sustained grades, and also have the characteristics required for good operation on level track at 60 miles per hour, and in the St. Paul locomotives recourse to gearing between motor and driving axle appears necessary to secure the greatest all round advantages at the lowest first cost.

EMERGENCY TRANSFORMER CONNECTIONS

By GEORGE P. ROUX

CONSULTING ENGINEER, PHILADELPHIA, PA.

Emergency conditions, to be handled successfully, always require quick thinking and oftentimes ingenious impromptu arrangements. Now while it would be entirely impossible to treat all the many sudden and unexpected conditions that might arise in our various types of apparatus, it is certain that this article will provide engineers and operators with such information as will be of greatest assistance to them when dealing with emergency transformer connections.—EDITOR.

The constantly widening and almost unlimited applications of electrical energy have greatly increased the tasks of the engineer and of the operating man; they are very often confronted with a variety of problems which require almost instant solution. The origin of these emergencies is either accidental, or incidental, and due to the operating features of all systems. In all instances they must be met with prompt action, worthy of the resourcefulness of the electrical engineer.

A very common kind of emergency engineering is found in transformer service where the nature of the installation requires either an unusual voltage or phase transformation not easily obtainable from standard apparatus generally on hand or available on short notice; or else it is an interruption in the service caused by the failure of some special transformer not easily replaceable. In both cases an emergency substitute is absolutely necessary to resume service.

Transformer Taps

Transformers provided with special taps other than the customary regulation taps are not of standard construction and therefore are not readily procurable from stock or from the manufacturer; hence delay and expense in obtaining them.

Special taps are objectionable for different reasons, and to the designer and builder of transformers they are in most cases a source of great inconvenience. Some of the principal objections are:

(1) To locate the tap at the proper point of the winding so that it can be brought out without serious difficulties and without impairing the dielectric strength of the insulation or the internal balance of the apparatus, thus affecting its degree of resistivity to electrostatic and electromagnetic stresses.

(2) The additional expense in construction entailed by special tap provisions is not merely the cost of this extra connection, which in itself would be unimportant, but the expense involved in the special design and in the provisions that must be made to conform

with the standard designs now adopted in all improved types of transformers, which are designed and built for the requirements of the most strenuous services, with the view to insuring continuity and reliability of operation.

(3) The greatest internal stresses occur in a transformer at the extreme ends of its windings, and it is now the general practice to reinforce the insulation at these points, avoiding any taps or connections with the exterior. In most modern types of transformers the voltage regulation taps have been removed toward the region of minimum stresses, or at the center of the windings, as shown in Fig. 1.

It is evident that a special tap brought out near the ends of the windings, as for instance at C, requires an extension of the dielectric reinforcement, or else a sacrifice of insulation at the cost of security. Furthermore, the transformer having its windings connected to the line at C and B will have the balance of its coil CA operating as an auto-transformer open circuited at one end and with a voltage at A in excess of the line voltage by an amount corresponding to the ratio of turns in CA and CB, thus causing an unnecessary strain on the insulation of that part of the winding and the terminal—a condition very objectionable, especially with high voltage transformers.

Transformers with special taps must be avoided as much as possible, except where it



Fig. 1. Location of Transformer Taps

is physically impossible to dispense with such provisions. In the majority of cases it is possible to provide externally for the lack of internal taps to a transformer, and yet secure the same results without incurring the expense and complication of specially constructed

apparatus, a feature more particularly appreciated in the event of emergency connections.

Emergency T-Connection

It is entirely unnecessary to explain here why an 86.6 per cent tap is required in the teaser transformer, and a 50 per cent tap in the main transformer to connect these two pieces of apparatus according to the Scott method of phase transformation: suffice it to say that the Scott connection is used in a great number of cases where voltage and phase transformation are necessary. This method would be used even more were it not for the 86.6 per cent tap required. In many instances two transformers are simply T-connected in the absence of this special tap; the 50 per cent tap being easily obtained from nearly all transformers whose windings consist of at least two coils. An attempt to bring out an emergency 86.6 per cent tap is in most cases fruitless, and no other course seems possible but to use the T-connection. The ill-effects resulting from this connection, such as unbalancing of the secondary voltage and phase angle distortion, are well known and are always a source of trouble and complaint.

Dealing first with the case of a three-phase high voltage power which is to be transformed to two-phase low voltage power, we find that the absence of the 86.6 per cent tap in the teaser transformer gives the conditions shown in Fig. 2; that is, a difference of 13.4 per cent in the voltages of phases A and B. Since we have a difference of voltage of 13.4 per cent between the voltages of each leg of the two-phase system, it is only necessary to

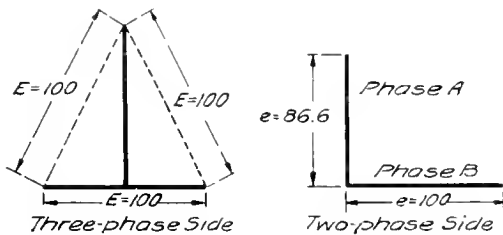


Fig. 2. Phase and Voltage Relation of T-connected Transformers

boost one leg or buck the other to even-up the potential of the phases. The solution of this problem is therefore simplified, and is reduced to the operation of connecting an outside transformer in series with one of the legs, in such a manner as to boost or buck the

voltage to the proper amount, as indicated in Fig. 3.

Assuming for instance that the low voltage two-phase power is 2300 volts, we find 2300 volts across one leg of Fig. 2, but only $2300 \times 0.866 = 1991.8$ volts across the other leg

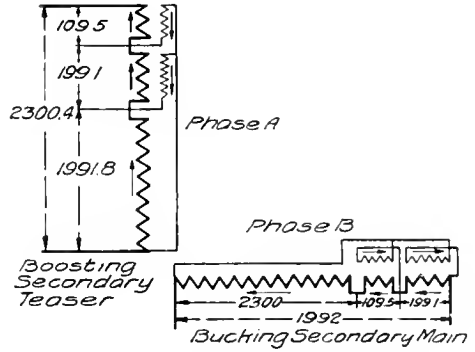


Fig. 3. Connections for Boosting or Bucking

which corresponds to the teaser transformer. By taking two pole-type transformers, one wound for 2200/220 volts and the other for 2200/110 volts with an aggregate kilovolt-ampere capacity equal to at least 13.4 per cent that of transformer A or B and connecting these two transformers with their secondaries in series-boost at the end of transformer A, it will be possible to balance externally the voltage of phase A.

This result is accomplished in this manner: The primary of the first booster, being connected across 1991.8 volts with a ratio of 10 to 1, will boost the voltage through its secondary (in series with A) a value equal to $\frac{1991.8}{10} = 199.18$ volts, or from 1991.8 to 2190.9 volts. The primary of the second booster, being similarly connected across 2190.9 volts, with a ratio of 20 to 1, will again boost the voltage by 109.5 volts, making a total voltage across phase A of 2300.48 volts. The voltage across phase A will then be half a volt higher than that across phase B; that is theoretically, because in practice it will be hardly detectable.

If it is found preferable to buck phase B instead of boosting phase A, the same result of voltage balance will be obtained with the two pole-type transformers if we connect them at the end of transformer B and buck phase B by 308.6 volts, that is, reduce the voltage from 2300 to 1991.4 by reversing the

primary connections of the pole type transformers.

One objection that might be raised to this method by the man of strict accountability is the use of pole-type transformers (which we have selected because they are generally

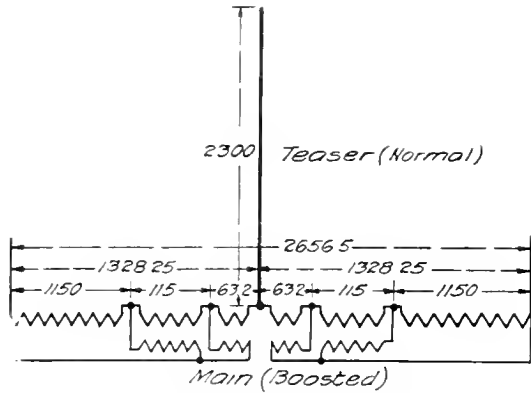


Fig. 4. Equivalent T-connection, Boosting Main

available from stock). on the ground that they will be subjected to a voltage of 2300 on the secondary windings and terminals. To this objection we may state that all 2200-volt transformers of modern design and construction are so built as to withstand continuously a voltage of 5000 across either winding, and between windings, terminals and case, without injury. We may further point out the fact that in our case there will be an inappreciable difference of potential between windings far less than when operating normally.

Where the conditions are reversed; that is, where two-phase high voltage power is to be transformed to three-phase power of lower voltage, another system of connections, shown on Fig. 4, can be used, which will increase the voltage of the main transformer so that the ratio of main to teaser windings will be 100 to 86.6. This connection is somewhat more complicated than the one previously described and consists in splitting in half both the primary and secondary windings of the booster transformers and connecting the teaser to the middle of the secondary winding of the booster. It would be easier to reduce the voltage of the teaser by bucking, again using (in case of 2300-volt distribution) the two pole-type transformers at the end of the teaser winding, as shown in Fig. 5.

For high voltage ratio, the connection shown in Fig. 5 is preferable, because the

extreme ends of the windings of the large transformers are better protected by additional insulation against stresses, and in emergencies of this nature it would be better to connect the bucking transformers between the lower end of the teaser and the middle of the main transformer.

Where, for instance, a high voltage two-phase power is to be transformed to a 6600-volt three-phase power by the connection represented in Fig. 5, the voltage impressed on both main and teaser will be 6600 volts respectively; whereas the voltage of the teaser should be only 5715, or a difference of 885 volts. Two 6600/440-volt transformers, connected with their secondary in series and their primary in parallel but reversed, will reduce the teaser voltage to 5720 volts.

There are of course limitations to the use of these emergency connections when applied to high voltages, and special attention should be given to the matter of stresses imposed on the insulation of the auxiliary transformers in order to avoid accidents.

It will be found, however, that in the majority of cases met with in practice the connections described are of great help, at least for temporary installations. The writer has used these different styles of connections on various occasions with excellent results,

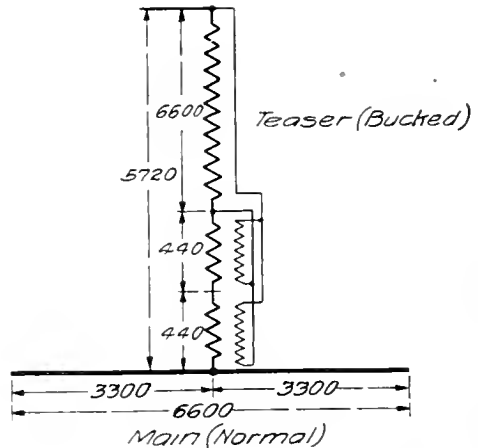


Fig. 5. Equivalent T-connection, Bucking Teaser

and in a few instances for permanent operation now covering a period of three years.

Boosting Line Voltage

Very often it happens that a feeder requires a higher voltage to compensate for an exces-

sive line potential drop, generally due to an increased load, this condition indicating an insufficient cross-section of conductor, but because the additional load is only of a temporary nature, or for some other reasons, it may be policy to increase the voltage of this particular feeder rather than add copper to the line. Pending some ulterior decision regarding an improvement, prompt action involving the least possible expense is necessary.

Immediate relief may be obtained by installing at a convenient point on the line one or more booster transformers of the same type as the transformers in use on the circuit in question, and connected as shown in Fig. 6, which is for a single-phase feeder. Using two

carry in their secondaries the line current to be boosted.

For two-phase and three-phase lines similar connections can be used with equally satisfactory results.

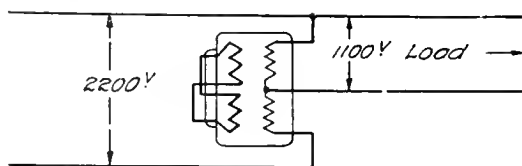


Fig. 7. Step-up or Step-down Compensator Connection for Ratio 1 to 2

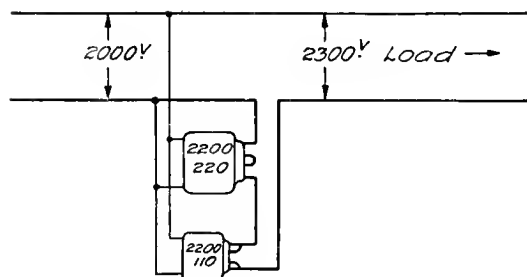


Fig. 6. Connections for Boosting Feeder Voltage

or more booster transformers and adjusting their voltage regulation taps and connections, it is possible to practically boost the line voltage by any value. The capacity of the booster transformers must in all cases be sufficient to

Later, should it become unnecessary to improve the voltage of the feeder, the booster transformers can be removed and used somewhere else, as they are standard transformers.

Transformers can also be used as step-up or step-down compensators, specially for a ratio of 1 to 2. An installation made for such service is shown in Fig. 8. To reduce the impedance between the primary windings, it is advisable to connect the secondary coils in multiple.

A great number of combinations of voltage transformations and adjustments can be effected with single-phase transformers properly connected. Multiphase and multivoltage transformers can also be obtained by special connections. In all cases some preliminary studies must be made of the problem, as several solutions are generally available, and good judgment is essential in making the final selection.

PARALLEL OPERATION OF FREQUENCY CHANGERS

BY G. H. RETTEW

ELECTRICAL ENGINEER, POTOMAC ELECTRIC POWER COMPANY

The author describes the difficulties sometimes met with in synchronizing frequency changer sets. The problem of synchronizing such machines is increased when they are located in different stations. He describes a concrete example of a system where continuous synchronous operation of two stations is only necessary during certain periods, during the greater part of the time the load being carried by a main substation. The author shows how all the difficulties were overcome and describes the successful method adopted.—EDITOR.

This article deals only with that form of frequency changer consisting of synchronous motor direct connected to a revolving field alternator, that being the type generally employed on the larger systems.

Not much difficulty is experienced in the paralleling of alternators driven by any type of engine, waterwheel, or steam turbine, as the problems are well understood and such difficulties as have manifested themselves have been taken care of by proper designs. All of these forms of prime movers have drooping speed characteristics that assist in securing satisfactory parallel operation of the alternators driven by them, and the proper division of load between units is easily secured by regulating the amount of power supplied by the prime movers.

In the operation of frequency changers in parallel, difficulties arise which, while not impossible to overcome, are not generally as well known except to those who have such apparatus in charge. These difficulties are brought about partly by reason of the fact that the motor is of the synchronous type and hence does not have the drooping speed characteristic which is desirable in driving alternators which are to be paralleled, and further by the fact that both the motor and generator must be paralleled. An additional trouble is that the division of load on the generators cannot be accomplished by regulating the power supplied by the driving motor.

The last mentioned difficulty is overcome in modern machines by mounting the stator of either motor or generator in a cradle, thus enabling the operator to give the various units to be paralleled, such relation to their respective revolving fields, and to each other, as will secure the desired division of load. With units of similar characteristics, even though there is considerable difference in capacity, the load may be satisfactorily divided in proportion to the respective capacities.

The paralleling of a unit of this description on the motor end is readily accomplished by starting up through a compensator, but after reaching synchronous speed the generator end may or may not bear the proper relation to

synchronize with another unit which is already carrying load, hence it is necessary to slip poles by reversing the motor field. One or more reversals may be necessary before the proper relation is found.

The synchronizing of the generators without a synchroscope is almost sure to lead to trouble, hence synchroscopes are almost universally used in connection with frequency changers.

It must be borne in mind that, as the load increases on a unit such as we are here dealing with, there will be a corresponding angular displacement of the revolving fields, so that if one machine is carrying a full load and a second one is started, the scope will not show true synchronism even though the proper relation of the two machines has been established. However, there is usually no serious disturbance when two machines are thus thrown together, provided they are in the same station where the resistances of the leads is small, and where automatic feeder voltage regulators are used, such disturbances as there are will usually not be manifest to the consumer.

Where machines are located in different stations, and where it is desirable to parallel over a tie line, additional complications arise due to the fact that the resistance of the tie line tends to lower the synchronizing power of the machines, and due further to the fact that there is a drop in voltage in the tie line. Of course the same conditions are also in evidence that obtain where the machines are in the same station, such as the angular displacement due to load on one or more machines in one station with an incoming machine in another station having no load. These conditions are so difficult to meet that where more than one station has frequency changers, at least one machine in each station is usually kept in service, the tie line only coming into use for transmitting part load from one station to the other in order to hold a high machine load factor, although in event of one machine "kicking off," the tie line would prevent a complete shut down.

The tie lines, where the above practice prevails, must be capable of carrying con-

siderable load, perhaps the equivalent of one machine, or say 500 to 1000 kw. Such tie lines, at 2300 volts operating potential, become rather expensive, particularly as they are usually underground. In addition to the matter of cost, it is not always desirable to keep even one machine in operation in each station.

A concrete example, which however represents the practice of one of the larger systems in this country, will serve to illustrate some of the difficulties referred to, and also to demonstrate a method whereby, with relatively small and inexpensive tie lines, the machine load factor is held quite high, and satisfactory synchronizing is secured. The system employed does not contemplate continuous synchronous operation of two stations, but rather to enable one main station to carry the load, except during the peak, and thus hold a high machine loading factor, and to enable the transfer of load without appreciable effect on the voltage regulation.

Referring to Fig. 1, the two substations containing frequency changers are fed from a common generator bus, some miles away; hence by starting the frequency changers on the motor side through compensators, they must necessarily be properly paralleled on that side. The two substations are practically three miles apart; the tie line is underground, and has a rated safe capacity of 450 kv-a. Owing to the voltage drop it cannot carry more than 200 kv-a.

It should be noted that the four frequency changers in the one station can be readily paralleled, and from one to three machines are always in use, depending on the load.

During the hours from midnight to approximately 5:30 p.m. the load on the smaller of the two stations is about 100 kv-a. and is carried by the larger of the two substations over the tie line, the single unit in the second station being idle. As the evening load starts to come on, this single unit is started, synchronized, and the tie line then cut out. About midnight the tie line is cut in, and the single unit shut down.

With a 1000-kw. unit in operation at the larger station, with nearly full load on it, and with approximately 100 kv-a. passing over the tie line, there was formerly quite a nasty "bump" at the instant when the unit was paralleled with the tie line at the smaller station. As previously explained, the synchroscope would never stand at the true synchronous position due to the fact that the machine or machines at the larger station were loaded

while incoming machine was unloaded, but would stand at an angle of from 30 to 60 degrees fast, indicating that the incoming machine was fast, or ahead, hence when the machine was thrown in there was not only a "bump," but surges, the character and

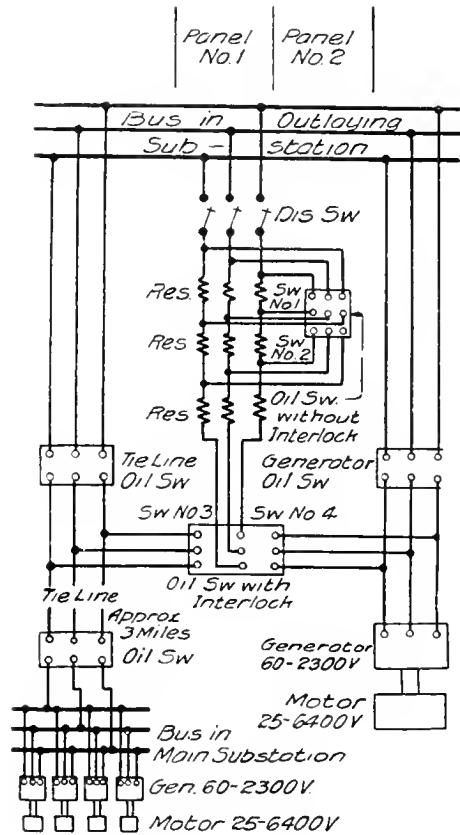


Fig. 1. Diagram showing Two Frequency Changer Substations, a Common Bus, a Tie Line, and Suitable Resistances and Control Switches

extent of which depended on many circumstances, one of which was whether the switch was closed on the peak of the wave or on the increasing side of the wave, or whether on the decreasing side, or at zero.

A very noticeable improvement in the conditions has been made by installing a resistance and suitable control switches, in the station containing the single unit. Referring to the diagram, the disconnecting switches are left closed except when repairs are necessary. The cycle of operations is as follows: Assume the tie line to be carrying the load and it is desired to put the frequency changer on load. Oil switches Nos.

1, 2, 3 and 4 and the generator oil switch must be open. Start the machine and synchronize. Close oil switch No. 4, then No. 1, then No. 2, then generator. Open No. 4, close No. 3, open the tie line switch, and No. 2. open No. 1, open No. 3.

Assume the machine to be carrying the load and it is desired to put the load on the tie line. The tie line switch and Nos. 1, 2, 3 and 4 must be open. Close switch No. 3, then No. 1, then No. 2, then the tie line switch. Open Switch No. 3, close No. 4, open the generator switch, then open No. 2, then No. 1, then No. 4.

true synchronizing position to enable paralleling with little or no "bump."

Practically the same result could be accomplished by putting an artificial load on the incoming machine thus causing a mechanical displacement in it which would bring it back to the correct synchronizing position, and this is virtually what is accomplished by the method described.

The two recording voltmeter charts show the "before and after" results, and demonstrate the value of the method.

The number of operations involved in putting the machine on load, or taking it

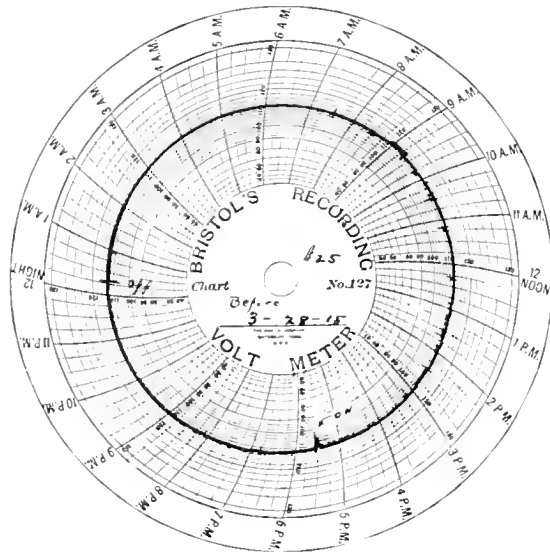


Fig. 2. Recording Voltmeter Chart taken before improvements were made in the substation wiring. Note wide fluctuations at "On" and "Off"

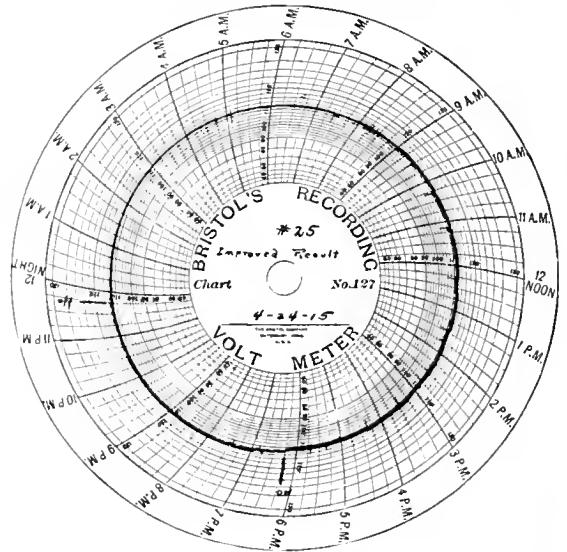


Fig. 3. Recording Voltmeter Chart taken after improvements were made in the substation wiring. Note absence of fluctuation at "On" and "Off"

The effect of these operations is to permit the load to be shifted from the tie line to the machine, or vice versa, in steps having a low enough value to practically eliminate the trouble previously experienced.

Assuming that the tie line is carrying the load and that the machine is synchronized, the synchroscope may stand at, say eight minutes after 12, showing that the incoming machine is approximately 48 degrees ahead. As the resistance is thrown in circuit the incoming machine picks up part of the load and the synchroscope will fall back to say five minutes after 12 position, or 30 degrees. Cutting out another step of resistance will further reduce the angular displacement, and on the last step the synchroscope will be near enough to the

off, is considerable, but as the switches are mounted on adjacent panels it does not cause the operator a great amount of work, and the time involved can be as little as ten seconds. In practice the operator is required to count three between one operation and the next to give the machine time to overcome its inertia, which is considerable, and adjust itself to the new conditions, also to permit the automatic voltage regulators to adjust themselves.

This method of operation has proved reliable and satisfactory and may be of service to others in developing their substations along the same lines, that is, to have one main station with smaller stations carried during the day over relatively inexpensive tie lines, with units at these smaller stations to take up the evening peak.

PRINCIPAL FACTORS GOVERNING THE CHOICE OF METHOD OF COOLING POWER TRANSFORMERS AS RELATED TO THEIR FIRST COST AND OPERATING CONDITIONS

By W. S. MOODY

ENGINEER, TRANSFORMER DEPARTMENT, GENERAL ELECTRIC COMPANY

The author shows in a few concise statements the different methods adopted for cooling transformers and tells the relative merits, the limitations and suitable applications of each. The article is concluded with a few interesting historical facts.—EDITOR.

The continuously increasing demand, during the last few years, for the transmission of energy over greater distances and for the distribution of larger and larger amounts of power, has necessitated the development of a diversity of types of modern power transformers, until they now may be had at practically unlimited voltage and capacity.

In former days certain types were restricted in size, as in the case of air-blast and self-cooled oil-immersed designs, especially the latter. Today, these limits have about disappeared (excepting in the case of the air-blast type which is still limited by voltage) through advanced engineering acquaintance with the laws of heat generation and dissipation, gained by long experience and aided by scientific progress in the art of designing.

Of all the features effective in modifying the design of a static transformer, there is none that so fundamentally affects it in every way as does the method used for cooling, which is also most intimately associated with the first cost of the apparatus and with the conditions of its operation.

The self-cooling, oil-immersed type of transformer is desirable always whenever its cost is not too high, because it has no auxiliary cooling apparatus that requires attention. It is especially applicable, therefore, for substations or where help or water is expensive. The highest commercial voltages can be supplied in this construction.

The cost varies from approximately 20 to 30 per cent more than for water-cooled transformers. The interest on this extra cost must, of course, be balanced against the cost of attendance and auxiliary apparatus for the artificially-cooled types. Oil-cooled transformers should have ample ventilation around and between the units. A variety of tanks is required to cover the whole range in capacity, but their choice is a matter only of efficiency in heat dissipation and mechanical strength and stability.

Water-cooled transformers are very extensively used, owing to their being smaller and

cheaper per unit output than other types, and because until recently self-cooled designs were not available in sizes over 3000 or 4000 kv-a. capacity. Their voltage is limited only by that of the transmission line, and their capacity by transportation facilities.

In considering this type the question of the availability of attendance must be settled. Are attendants required for this particular plant of transformers only or would they be necessary for other apparatus that might be installed there, and if not so needed, will the transformer installation warrant it?

Water-cooled units are practically independent of the cooling effect of the air, particularly so in the larger sizes, and consequently but one form of tank is used, that is, a plain smooth case of sheet steel.

A combination self-cooling and water-cooling design is becoming attractive in many cases, particularly for conditions where long and definite periods of light and heavy load occur, such as in small winter and large summer service.

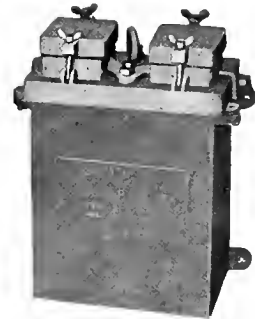


Fig. 1. Probably, the First Oil-immersed, Self-cooled Transformer placed in commercial use (1890)

Such transformers are placed in the regular sheet steel tanks of the self-cooled design, excepting that they have smaller surfaces, and are in addition provided with water cooling coils to take care of the super-load.

Such transformers can easily be designed to carry 50 per cent of the maximum load

without water circulation and not exceed the rated temperature rise. The increase in cost over the water-cooled design is slight and often will be found a good investment when water for cooling has any appreciable value.

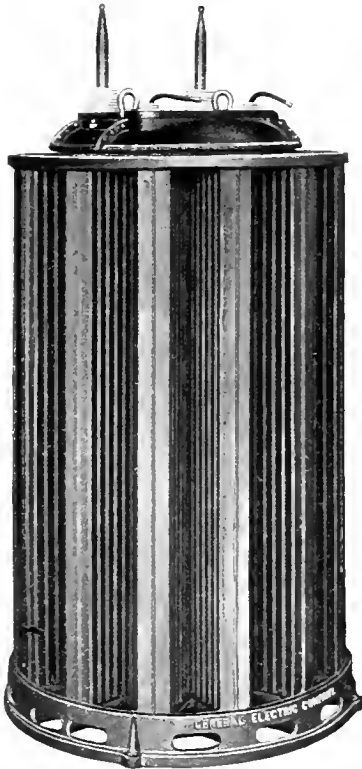


Fig. 2. A 300-kv-a. Transformer Built in 1904. This type of tank has become standard for units of 100 to 1000 kv-a.

Forced oil designs were somewhat popular a few years ago for reasons more academic than real, but have now become essentially obsolete, as there is no saving in the cost of the transformer itself that is not usually offset by the extra expense of auxiliary circulatory apparatus.

Air-blast transformers owe their use to the insurance restrictions and popular objections against large oil-filled units in city districts. Voltages are limited to 35,000 as a maximum, on account of the difficulty in avoiding corona and dielectric heating for potentials above this voltage. While many thousands of kilowatts of such transformers have operated successfully on 30,000- to 35,000-volt circuits for many years, it is advisable to limit

their use to 25,000 volts or less. This type has in general about the same cost as self-cooled oil-immersed designs.

Outdoor transformers with both natural and artificial cooling have now been proved by the experience of the last few years to be entirely successful, even for the highest voltages or capacity, in any type and in any climate. The main difference from the indoor type lies in certain simple details relating to weather-proofness. Precautions against freezing must be taken with water-cooled designs, while the oil-cooled units can withstand cold weather if the oil does not get below -20 deg. C. during idle periods. Air-blast transformers have not as yet been used outdoors, but there is apparently no reason why they could not be.



Fig. 3. The Form of Tanks used for units varying from 1000 to 1500 kv-a

The General Electric Company has always been both active and conservative in its transformer design, and the following brief outline of its practices regarding methods of cooling is one illustration.

In 1890 it made its first commercial installation (probably the first ever made by any manufacturer) of oil-immersed, self-cooled transformers of the form seen in Fig. 1.

In 1893 the first air-blast transformers were designed, and are still in successful operation.

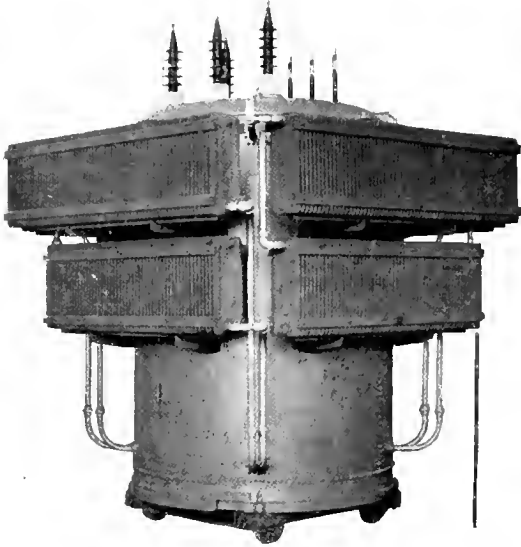


Fig. 4. The Form of Tank and the Radiators used for units greater than 1500 kv-a.

Large self-cooled, oil-immersed designs, requiring tanks having corrugated outlines to give a sufficient radiating surface, were at first made only with cast iron cases. Later on, methods of welding were developed to admit the use of sheet steel cases, in which all seams, as well as joints between sides and base, could be thoroughly welded.

The form of tank shown in Fig. 2 was brought out in 1904 and has been the standard for all manufacturers for self-cooled transformers in sizes from 100 to 1000 kv-a. ever since. That seen in Fig. 3 covers a range from 1000 to 1500 kv-a. The construction set forth in Fig. 4 is used for transformers of from 1500 up to 3000 kv-a. and larger.

As transportation facilities have always been more restricted abroad than here,

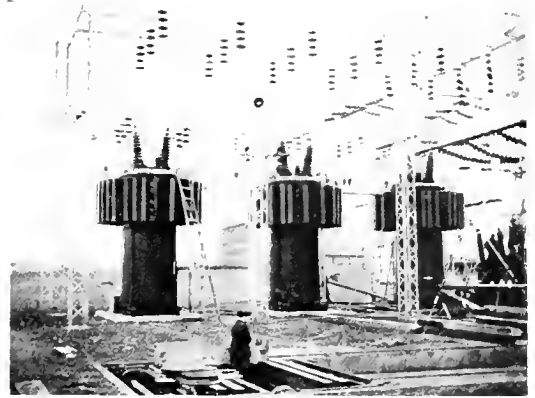


Fig. 5. An outdoor installation of Transformers having tanks of the type shown in Fig. 4.

transformer tanks having detachable radiators were first brought out there; although shipping limits were soon reached here also. It is now some three years since the General Electric Company developed the first tanks of this form used in this country. In Fig. 5 is shown a recent installation of transformers in such tanks, located at one of the "outdoor" substations of the Southern Power Company.

THE CONTACT SYSTEM OF THE BUTTE, ANACONDA & PACIFIC RAILWAY

By J. B. Cox

RAILWAY AND TRACTION ENGINEERING DEPARTMENT, GENERAL ELECTRIC COMPANY

The main divisions of the following comprehensive article on "The Contact System of the Butte, Anaconda & Pacific Railway" cover the following points: Reasons for selecting an overhead system, development of the mechanical details of the pantograph to fulfill the local conditions, method of crossing trolley wires at street railway intersections, sectionalization and layout of trolley wires, costs of material and labor, record of progress during construction period, and difficulties encountered and the means employed in overcoming them.

—EDITOR.

A careful preliminary survey of the general problems involved in the electrification of the Butte, Anaconda & Pacific Railway had made it evident that an overhead contact system was unquestionably advisable; the two predominating reasons were that approximately 60 per cent of the tracks to be electrified consisted of yards and sidings with numerous switches and street crossings, and that a great portion of these tracks were in localities where it would be very difficult to protect against trespass by the public.

An analysis of the general traffic conditions had indicated that a locomotive unit with approximately 80 tons on the drivers and equipped with an aggregate motor capacity of approximately 2400 h.p., for maximum accelerating periods, would be the most economical and best suited to the general service conditions (two such units being operated in multiple as a single locomotive for the heavier freight trains). Such a locomotive would thus frequently have to collect from the trolley from 3000 to 3600 kilowatts, which would mean 6000, 3000 or 2500 amperes at 600, 1200 or 1500 volts respectively.

Trial estimates on the total initial costs and the final operating expenses had indicated that, for the general conditions, direct-current motors operating two in series from a 2400-volt trolley fed from two substations, one located at each end of the line in existing power supply buildings approximately 26 miles apart where no extra attendants would be required, would be expected to yield the most economic results. Higher trolley voltages were considered but were not found to be generally advantageous.

A double-unit locomotive with a capacity as described would, therefore, be required to collect from the 2400-volt trolley during acceleration from 1400 to 1500 amperes or 700 to 750 amperes for each collector, there being one collector for each unit.

While this was known to be well within the capacity of a single 4 0 trolley fed at frequent intervals from both directions, the successful

collection of such a heavy current from a single trolley wire was a more serious problem.

Sliding pantographs of various types had been developed and made to operate fairly successfully for the collection of currents up to 150 or 200 amperes under similar operating conditions, but none had given any hopeful indications of collecting these heavy currents with a reasonably satisfactory life.

Rollers of various kinds had been tried as substitutes for the slider and one of these, made from steel tubing, had been found to give very satisfactory results.

On the whole this type of collector seemed to give the most promising prospect at the time, so that it was chosen for the moving contact device on the locomotives.

A Shelby steel tube 5 inches in diameter and 24 inches long was used for making up the roller. The thickness of this tube when machined inside and outside was approximately $\frac{1}{8}$ inch. Originally, a wooden lining was forced inside the tube, which was expected to hold the tube together until the sparking had called attention to the necessity for its removal, in case the metal wore through.

Removable bearing housings of aluminum were fitted into each end of the tube, two phosphor bronze sleeve bearings being installed in each housing and between these was an oil chamber for containing the lubricant. The complete roller revolved about a $\frac{5}{8}$ in. steel shaft which was fixed at each end by clamps to the pantograph frame.

The completed roller with lining, bearings, and spindle weighed approximately 31 lb., as against about 5 lb. for the corresponding contact element usually adopted for the sliding pantograph.

This comparatively heavy contact device could not be expected to respond so readily or so gently to hard or uneven spots in the trolley wire as the lighter slider. Besides the increase in weight, the rapid revolving of the roller at high speeds would tend to increase the difficulties unless the balance was almost perfect. These difficulties were foreseen from

the beginning, and as it was realized that the weight of the roller could not be materially reduced it was decided to adopt practically the standard pantograph frame with such changes as were necessary for the substitution of the roller and then turn to the trolley line construction with a view toward removing the most serious objections to the roller, i.e., to eliminate the hard or uneven spots in the trolley line which seemed to be its greatest detriment.

The pantograph as originally installed on the locomotives is illustrated in Fig. 1. One such pantograph was mounted on each freight locomotive unit, and two on each passenger unit, though only one pantograph is used at a time. The extra one was to be held as a spare for use in case of trouble, thus avoiding unnecessary delay. All main line freight trains are operated by a double-unit locomotive with both pantographs in contact with the trolley wire. Both pantographs are connected in multiple by means of a bus line run on top of the locomotives, with a jumper connection between the two units.

In case of accident to either pantograph on these trains a single pantograph is capable of collecting the current for both units for the completion of the trip. The operation of this pantograph in service is described in detail later in this article.

In considering what might be done by way of improving the design of the overhead line construction, so as to make it more adaptable to the satisfactory operation of the roller pantograph, evenness and flexibility were recognized as being the qualities most desired. The introduction of catenary construction with hangers at frequent intervals had accomplished much in these directions, especially the first, and gradual improvements had been made toward simplifying and cheapening this type of construction, though perhaps the



Fig. 1. Pantograph Trolley

importance of flexibility had not been fully appreciated until the heavier types of collector became necessary.

Attention was directed to the redesigning of all hangers, pulloffs and other line material which tended to add unevenly distributed

weight or local stiffness to the trolley wire, the result being the development of a new line of this material.

The new hanger was made up of a $\frac{5}{8}$ in. by $\frac{1}{4}$ in. flat strap having a malleable iron ear secured by a $\frac{1}{2}$ in. by $1\frac{1}{2}$ in. carriage bolt.



Fig. 2. 28-in. Trolley Wire Hanger

This hanger allows the greatest possible vertical movement of the trolley wire, or more than the upward pressure of the two pantographs of a double-unit locomotive, operating with a tension of 35 to 40 lb., each against the trolley wire, will normally raise it. No resistance from the messenger wire will be encountered even up to this point, since the loop extends for almost the entire length of the hanger. The hanger is simple in construction and is easily installed, since the loop is merely thrown over the messenger and the two ears carried by the loop strap are secured by the single bolt which at the same time clamps the self-aligning jaws into the groove of the trolley wire.

The design of the jaws gives liberal clearance for the roller and would readily permit the operation of a trolley wheel should such for any reason be desired.

The weight of the complete hanger varied from $14\frac{1}{2}$ oz. in the case of the 8 in. to $13\frac{3}{4}$ lb. for the 28 in. or longest hanger. Fig. 2 illustrates this hanger.

As a very large percentage of the trackage to be electrified is of curve construction varying anywhere from a tangent to 22 deg. curvature, it was necessary to give most careful attention to the design of a new pulloff. The efforts in this direction created an entirely new pulloff by means of which the messenger and trolley wires are held in position by separate clamps. From each clamp runs an individual pulloff wire with a strut between them that maintains the pull parallel to the horizontal plane of the trolley wire. This arrangement allows of a free vertical movement independent of the messenger, see Fig. 3.

The double pulloff used where there was more than one track is shown in Fig. 4. This pulloff, while an improvement in some respects over former designs, was not as satisfactory as the single pulloff, as it proved to be heavier and less flexible than was desired and caused a slight sparking when a single

pantograph passed underneath it at medium speeds. The design has been revised and in future construction will be considerably improved.

Rigid pulloffs, as shown in Fig. 5, were used at some points but were found to be subject to

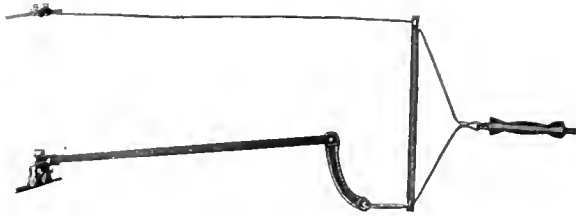


Fig. 3. Flexible Pull Off for Pantograph Collector

much the same objections as the double pulloffs because of the sparking due to similar reasons.

The splicing sleeve is made of sheet steel with a malleable iron removable shoe which gives a smooth underrun for the roller and may be replaced when worn out before the body of the holding member proper is injured.

The wire is securely held, without bending the wire or diminishing its tensile strength, by a drop-forged wedge with sharpened teeth.

Fig. 6 illustrates the form of wedge grip clevis used for dead-ending the trolley and messenger wires. This had double wedges with sharpened teeth similar to that for the splicing sleeve. These are readily installed with a hammer; which fact, together with their low manufacturing cost and ease of adjustment in service, makes their use economical as well as satisfactory.

The question as to the use of wood or steel poles for the supporting structure was not a difficult one owing to the general conditions and the nearness to the best of markets for good Idaho cedar poles which made their use more economical when compared with the cost of steel structures. Some consideration was given to the use of steel structures in some of the yard construction where as many



Fig. 4. Double Flexible Catenary Pull Off

as eight tracks were to be spanned, but even here it was finally decided to use the wooden poles though the general advantages were not so great as on the main line construction. However, steel supporting structures were used on the double track steel trestle running

from the concentrator yards up over the ore storage bins alongside the concentrator buildings. These tracks are approximately $\frac{1}{2}$ mile in length. The steel supporting structure was made up at the smelter and the cost of it is included in Table I.

A further item of unusual character in connection with the trolley line construction was that required for about $\frac{1}{4}$ mile of track alongside a slump pond from which the sediment is taken by means of a drag-line scraper bucket operated from a cableway suspended between two traveling towers mounted on rails on each side of the pond. As the track in question on which empty cars are placed for loading is located inside the area covered by the cableway, a trolley wire over the center of the track would interfere with the loading. It was desirable to use a standard locomotive for the handling of these cars, so the brackets which supported the

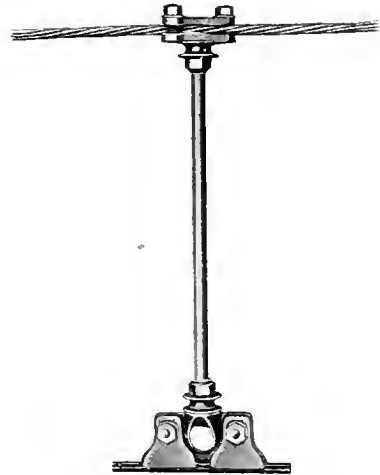


Fig. 5. Rigid Catenary Pull Off

trolley and messenger wire were hinged at the pole and a flexible wire cable, attached to the outer end and passing over a pulley anchored on top of the pole, was connected to a hand-operated windlass by which the brackets are swung upward carrying the trolley line from over the track and clear of the path of the bucket. When the loading is completed the trolley is lowered to the normal position while the loaded cars are removed and replaced by other empties.

The number of poles and costs will be found in Table II.

The matter of insulation was not a serious one as trolley voltage up to 11,000 volts had

been in operation for a number of years and insulation difficulties for such pressures had been met quite satisfactorily. It was therefore simply a question of choice between wood and porcelain, the decision eventually being made in favor of wood as the dry climate in the locality was favorable to its satisfactory service with greater general economy.

The wooden strain insulators used are shown in Fig. 7 and the number employed and the costs are given in Table II.

Insofar as the general plan of trolley construction is concerned no decidedly radical departures from some of the later installations was attempted, but every effort was made to simplify and perfect what had been done before and to adapt the construction to the particular conditions.

A very important item tending toward economy and simplification was the omission of the use of any form of deflector at all special work. Some new departures were made in the manner of arrangement of the trolley wires at these points so as to insure the pantographs picking up and dropping them properly.

At switching points, in ordinary trolley wire construction, frogs are employed to make the trolley junction; and for use with pantographs deflectors are generally required.



Fig. 6. Wedge Grip Clevis



Fig. 7. Wooden Strain Insulator

These deflectors prevent the pantograph, when approaching such a junction toward a trailing switch, from raising its wire above that of the converging track, and thus avoid the damage that would result to either the pantograph or the trolley wire. Instead of

this usual type of construction the trolley and messenger wires which were intended to follow the switching track were started several feet ahead of the switch, from a convenient point for dead-ending, and several inches above the horizontal plane of the



Fig. 8. Pantograph in Contact with Six Trolley Wires at a Switching Point

through wires and then gradually brought down to that plane a short distance ahead of the switching point from where they were gradually carried away following over the switching track. At some points in the yards, where the parallel tracks left the ladder track at close intervals, as many as six sets of wires are in the same horizontal plane and all the trolley wires make contact with the roller simultaneously. See Fig. 8.

This construction has proved entirely satisfactory and there have been no instances of trouble caused by the omission of deflectors. The construction adopted not only lessened the cost of the work but avoided much extra weight at points where the supporting structure was most taxed. Fig. 9 is an illustration of the construction described.

Air section insulation was used at all points where it was practicable and has been found to be advantageous from every point of view. Instead of inserting wooden insulators in the trolley line where sectionalization was desired, the ends of the wires of each section were made to overlap each other the length of a pole spacing. The two sets of wires are carried in approximately the same horizontal plane but about 12 inches apart for a few feet in the middle of the span, from which point the dead ends of the trolley wire are gradually

carried above the path of the collector to its anchorage.

This construction avoids the use of heavy insulators and prevents hard or heavy spots in the line which are destructive to it and the pantograph alike. With this construction there is less objection to subdividing the line into a number of short sections which, with the elasticity provided by wooden poles and catenary suspension, overcomes to a great extent the difficulties arising from contraction and expansion due to changes in temperature.

These sections are passed at full speed without any noticeable effect on the line, or the pantograph, or the least interruption of contact.

Similar construction was used at all anchoring points for both the trolley and messenger and it has been found to be equally satisfactory there. Undoubtedly this type of sectionalizing will become much more general in the future and means will be devised for its adoption at points where it is now found difficult to install properly.

Tests were made by cutting the current off one section and running a locomotive from the live section onto the dead section at slow speed with heavy current to see if the arcing between the pantograph and the live trolley wire would be injurious. The arcing was surprisingly small and not of a nature to do serious harm to either wire or roller. Fig. 10 shows the general method of installation.

The effect of such an operation in the case of the wooden section insulators, used at street railway crossings and other points



Fig. 10. The Arrangement of an Air Section Insulator

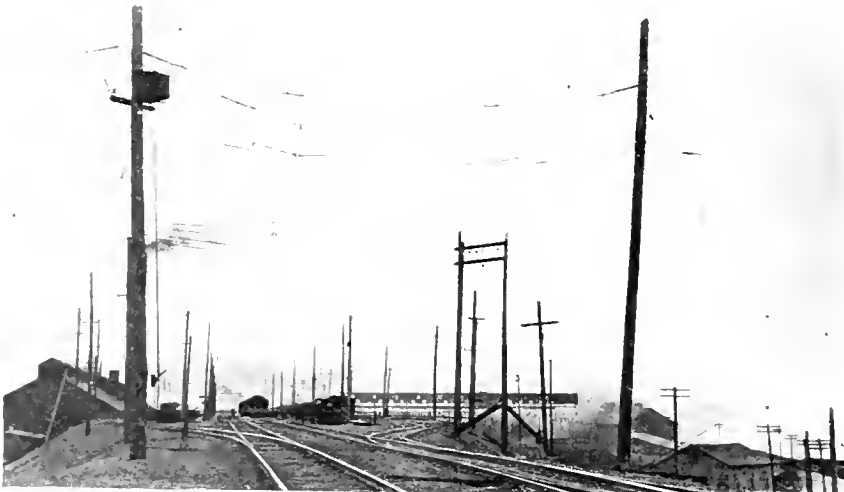


Fig. 9. View of the Contact System at the Stock Bin Yard

where it was not found convenient to install the air type, was quite injurious; and, though such tests were not meant to be given them and the insulators were not expected to stand such treatment repeatedly, some of those located at street crossings where considerable switching was done received the test too frequently and sooner or later broke down under the treatment.

At these street railway crossings it was necessary to use two such insulators about 75 feet apart in the 2400-volt line, the trolley section in between being called the protecting zone. This was made necessary on account of the operation of double-unit locomotives with a trolley of each in use and the two being connected by a bus line.

As the first insulator was usually about 100 feet from the switch and the safety section was not energized until a member of the train crew ran ahead and threw a commutating switch located on a pole near the street crossing (which cut off the commutating section from the normal 600-volt connection and energized it with the 2400-volt current so long as the switch handle was held in the full up position) it frequently happened in the earlier period of electrical operation, before the crews had learned from actual experience the damage that might result, that the member of the crew whose duty it was to run ahead and operate the switch did not get it thrown until the locomotive had passed under the first insulator. As this was often done with the power on the motors, the arcing that occurred when the roller left the live section of the insulator and ran onto the dead section carbonized the wood of the insulator, and the carbonization was extended with each repetition until the insulation was finally insufficient and the insulator had to be replaced. The insulator originally used at these points is shown in Fig. 11. These experiences suggested the advisability of a change in the design of the insulator so as to render the arcing in such instances less destructive. The overlapping metal contact strips which originally were attached directly to the bottom of the wooden insulators were therefore replaced by other strips which were carried out about four inches from the wood insulation, thus making the distance between the strips considerably greater. These strips were attached to the insulators by spring hinges, so as to lessen the blow to both the insulator and pantograph. The insulators were quite an improvement over the original ones but even they were not entirely free from injury when

heavy currents were broken under the conditions heretofore described. Fig. 12 shows the general arrangement of the electrical connections for these street railway crossings.

The Butte, Anaconda & Pacific tracks cross local street railway tracks at six points,

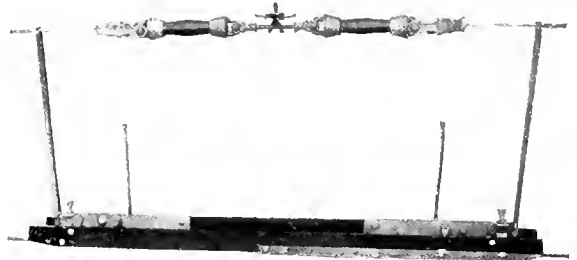


Fig. 11 Section Insulator for a Pantograph Collector as Installed at a Cross Span

four of which are at street level in Butte. Two are at the Anaconda end, but at these, not being street crossings, it was possible to avoid the use of the special switching devices by arranging with the street railway company to coast over the crossing. At two of the crossings in Butte watchmen were permanently employed to operate gates for protecting the traffic. The electrical switches for controlling the crossing at these points were placed on poles near the watchman's tower where he could operate them easily, and they were interlocked with the gates so as to make it impossible to energize the crossing with the 2400-volt current until the gates were closed or to open the gates while the switch was in the 2400-volt position.

Practically no trouble was experienced at these points after the watchmen became accustomed to their new duties, but at the less frequently used crossings where the train crews operated the commutating switches some troubles were experienced with the switches in addition to that already noted with the section insulators. These switches were not expected to open heavy currents for the operators were expected to hold them in until the locomotive had entirely cleared the protecting zone. Occasionally this was not done or to aggravate matters the switch was allowed to only partly open while the locomotive was still in the protecting zone, and when arcing was noticed in the switch box the handle was dropped and the switch badly burned. These commutating switches are shown in Fig. 13. At one point where this trouble occurred a second time, electrically



Fig. 12. General Arrangement of the Electrical Connections at a Street Railway Crossing

operated contactors were placed in series with the ordinary operating switch on both the 2400-volt and 600-volt circuits, the two sets of contactors being so interlocked as to render it impossible for both to be energized at the same time. See Fig. 14.

No further troubles were experienced from this cause after the installation of the contactors. These switches have been redesigned for future installations. After the men had become familiar with the operation of the switches there were very few instances of trouble even with the original switches.

The trolley line was sectionalized at intervals as shown in Fig. 15 which also shows the final feeder arrangement. The sectionalizing switches were placed in asbestos lined wooden boxes and located on trolley poles well out of reach from the ground. An operating lever was located at a convenient point on the pole, and at a suitable distance from the ground for ease in handling. It is provided with a standard track switch padlock so that no extra key is required by trainmen for its operation. The operating handle is connected with the switch blade by a wooden rod which provides adequate insulation.

In addition to the sectionalizing of the main line these switches were used at all yards and at most spurs and transfer tracks to connecting lines, and at such of these points as the service was infrequent the switch was normally left open. Such transfer connections were made with four other railway lines, viz., Great Northern, Northern Pacific, Chicago, Milwaukee & St. Paul, and the Oregon Short Line.

Eleven point suspension with 28 inch deflection was used throughout.

Approximately 10 per cent of the 91 miles of track electrified was bracket construction which was used on nearly all tangent single track. These stretches of tangent track were so short comparatively and the percentage and degree of curvature so great that it was unnecessary to make any special provision for staggering the trolley wire. Approximately 38 of the 91 track miles would be classified as route miles leaving about 53 miles—or roughly 58 per cent—of yards, sidings, spurs, etc.

These 53 miles were made up principally of 8 yards located at Anaconda, East Anaconda, Silver Bow, Rocker, West Butte, and Butte on the main line and the Concentrator Bins, Storage Bins, and Butte Hill Yards on branch lines. Fig. 16 shows in

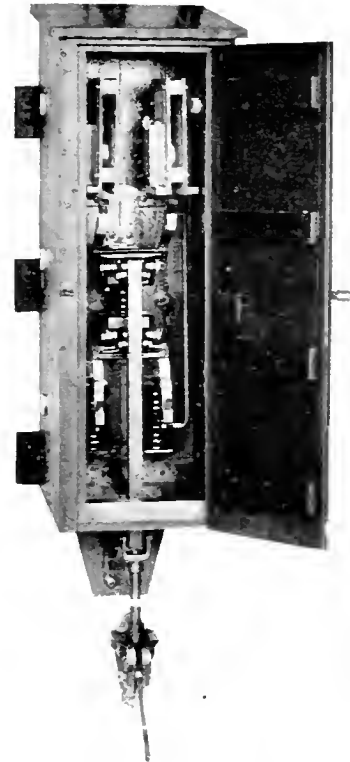


Fig. 13. A Commutating Switch

map form the relative location of these yards and spurs as well as the number and arrangement of the tracks, etc.

The East Anaconda Yards contained 12 tracks (including those of the main line) aggregating approximately 5 miles. These are the largest yards on the system. Eight of these tracks run almost the entire length of the yard which is approximately $\frac{1}{2}$ mile in length. The eight tracks are spanned by double messenger span wires supported from a pole line on each side spaced approximately 110 ft. apart. The details of this construction with dimensions are given in Fig. 17.

At the western end of the yard there are four additional stub end tracks where a third pole line was erected to form the outside support for the wiring. This eight track span construction has stood up well and is quite satisfactory. All the construction in the yards and spurs is of the standard catenary type and entire freedom from any kind of trouble with it would seem to fully justify any additional expense that this may have required.

The construction work was practically completed in October, 1913, though some small extensions were made on Butte Hill in 1914.

Fig. 18 illustrates the form of weekly report that was made to indicate the progress and general condition of the work during construction. As this was the last such report made, it represents practically the completed

construction and indicates how nearly the original estimates correspond with the final results in addition to giving many other details of useful interest relative to the nature of the work.

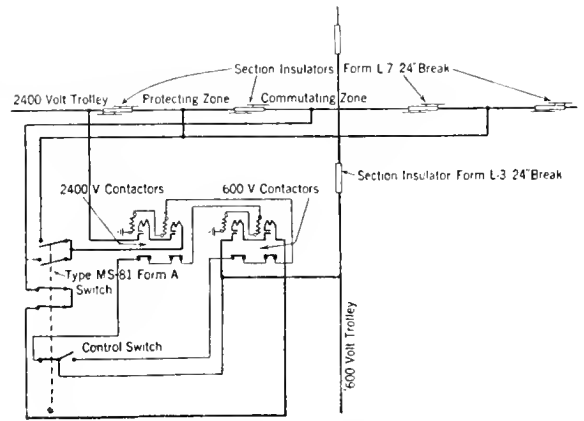


Fig. 14. Diagram of Connections at a 600-volt Street Railway Crossing showing commutating arrangement and protection from 2400-volt System with Electrically Operated Contactors in Series with Regular Commutating Switch

This report was not intended to cover other than the regular construction and, therefore, does not include the entire list of all the items mentioned; some further short extensions were made at a later date.

The total cost of the trolley and feeder system inclusive of bonding and all changes

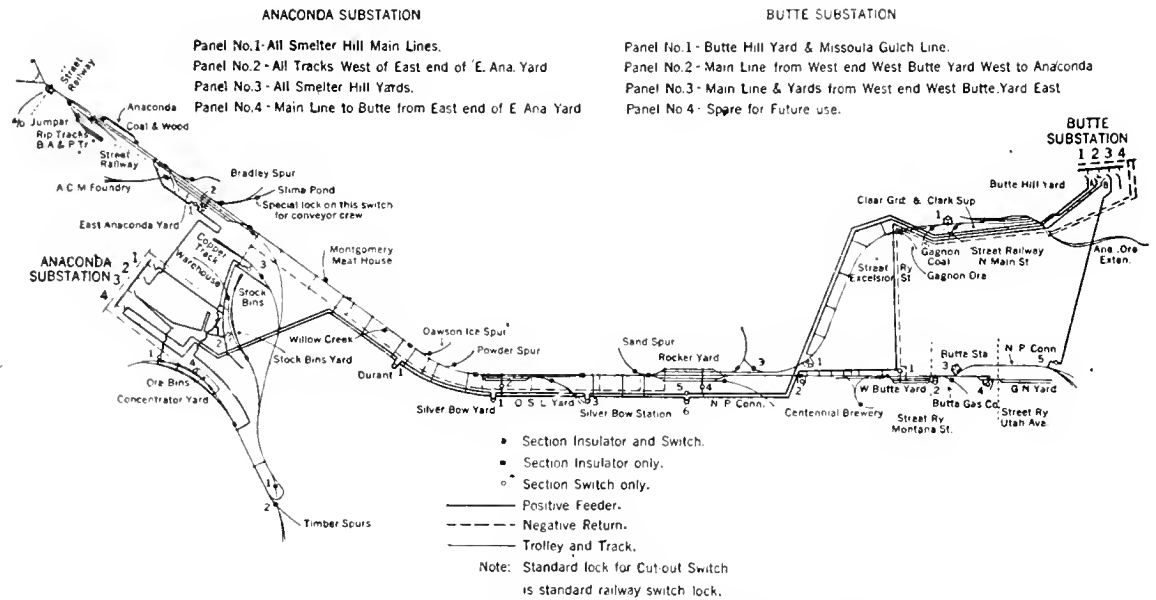


Fig. 15. Diagram Showing Sectionalization of Trolley and Feeder Systems

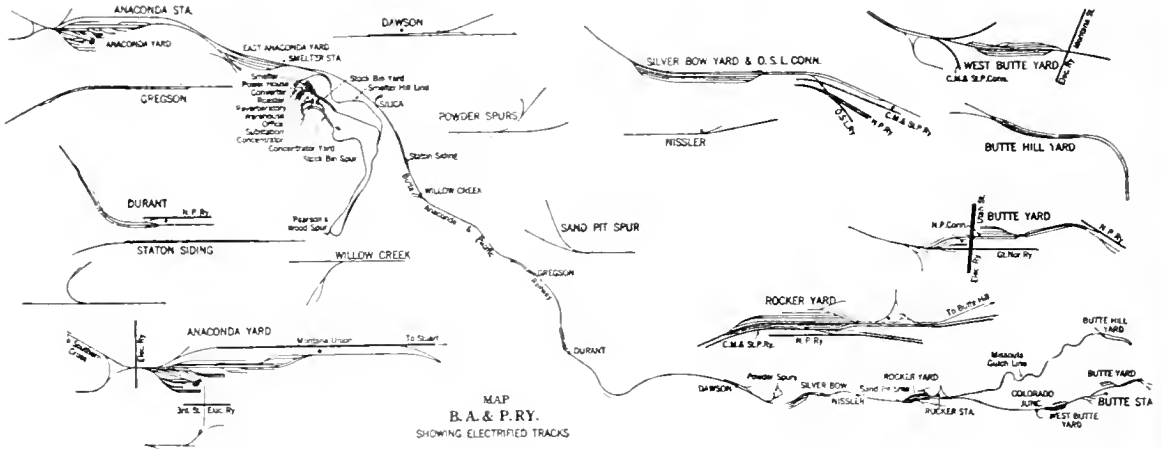


Fig. 16 Diagram of the Electrified Section of the Butte, Anaconda & Pacific Railway

TABLE I
 COST OF DISTRIBUTION SYSTEM
 ELECTRIFICATION OF THE BUTTE, ANACONDA & PACIFIC RAILWAY

	Cost per Item	Cost Per Mile
Labor installing	\$129,027.56	\$1417.89
Feeder copper	89,697.00	985.68
Work train service	64,268.31	706.25
Trolley wire	58,213.60	639.71
Cedar poles	27,739.21	304.83
Galvanized strand wire	26,807.47	294.59
Copper bonds	20,564.20	225.98
Hangers	7,596.27	83.48
Crosby clips	5,396.17	59.30
Wood strain insulators	5,385.22	59.18
Engineering and superintendence	5,289.30	58.12
Tools	3,811.30	41.88
Anchor rods	3,403.73	37.40
Sectionalizing switches	3,097.05	34.03
Injuries and damages, etc.	3,036.56	33.37
Fitting up work cars	2,292.61	25.19
Steel and iron from stock	2,043.87	22.46
Lumber and timbers	2,013.61	22.13
Rental on work cars	1,716.50	18.86
Shop expenses	1,418.59	15.59
Lightning arresters	1,271.02	13.96
Paints and oils	901.32	9.90
Feeder and messenger insulators	842.15	9.25
Cresote and oil	637.00	7.00
Steel bond protectors	570.00	6.26
Splicing sleeves	294.00	3.23
Postage, car-fares, etc.	238.62	2.62
Guards and signs	234.08	2.57
Wedge grips	130.01	1.43
Dynamite and fuses	121.36	1.33
Gasoline, solder, etc.	100.46	1.10
Miscellaneous items	33,629.50	369.55
Total	\$501,787.74	\$5514.15

It is not likely that the average steam road would encounter so many obstacles of this nature in undertaking the electrification of its lines, for seldom would there be found more complications than in this case where the nature of the work (being required for a mining and smelting industry of large magnitude) calls for many varieties of structures and conditions not usually to be encountered in ordinary railway electrifications.

The work was begun in the summer of 1912 and was just reaching a state of efficient organization when the electrical wiremen went on strike tying up the entire work from June to October, about three months of the most favorable part of the year for such work, thus bringing the heavy part of the work in the winter when the weather at times was 20 degrees below zero. During the three months cessation of work the engineering and supervision force was continued at a very low percentage of efficiency and this delay contributed in various other ways to an increase in the cost of the construction.

Some of the items of expense in connection with changes made in existing construction and charged against the distribution system are shown approximately in Table VI. The new telephone lines listed in this tabulation were run on the trolley line poles and were for the purpose of enabling the train crews to communicate with the dispatcher from any locomotive on all of which telephone instruments were installed, together with a standard rod for making electrical connections with the wires at any point along the line.

Table VI is by no means complete, though it gives an indication of the various items represented in the total costs of the system.

Combining eleven pay rolls gives the classification of labor, see Table VII. These eleven payrolls represent the principal items of labor in connection with the erection of the trolley and feeder wires, and are those for the regular forces engaged in this work and charged against account No. 22, Table III.

TABLE II

TABLE SHOWING AMOUNTS AND COSTS OF PRINCIPAL MATERIALS REQUIRED FOR BUTTE, ANACONDA AND PACIFIC DISTRIBUTION SYSTEM

	Total Units	Units Per Mile	Costs Per Unit	Total Cost
Feeder copper, lb.	507,055	5,572	17.69 cents	\$89,697.00
Trolley copper, lb.	343,030	3,770	16.97 cents	58,213.60
Cedar poles	4,869	53.5	566.00 cents	27,739.21
Galvanized steel strand, feet	1,553,750	17,074	1.73 cents	26,807.47
Copper bonds	32,260	355	63.74 cents	20,564.20
Crosby clips	61,911	680	8.72 cents	5,396.17
Wood strain insulators	15,850	175	33.97 cents	5,385.22
Anchor rods	6,123	673	55.57 cents	3,403.73
Splicing sleeves	265	3	111.00 cents	294.00
Wedge grips	680	7.5	19.13 cents	130.01
Total				\$237,630.61

TABLE III

COSTS OF THE ELECTRIFICATION OF THE BUTTE, ANACONDA & PACIFIC RAILWAY CLASSIFIED IN ACCORDANCE WITH INTERSTATE COMMERCE REGULATIONS

Account No. 1—Engineering and superintendence (including general preliminary report)	\$10,937.15
Account No. 12—Roadway tools (used for construction 19 and 22)	3,851.74
Account No. 16—Crossings, fences, guards and signs, mostly for signs	234.08
Account No. 17—Interlocking and signal apparatus, new system required account of electrification	22,367.62
Account No. 19—Poles and fixtures (approximately 91 miles track)	135,263.98
Account No. 22—Distribution system (approximately 91 miles track wired)	357,009.45
Account No. 25—Substation building (existing building used)	191.15
Account No. 31—Electrical Equipment (five 1000-kw. motor-generator sets and 17 loco-	
Account No. 36—motive units)	671,764.78
Account No. 41—Interest	9,975.80
Total	\$1,211,595.75

Time and a half was allowed for all over-time and double time for Sunday work in the case of electrical workers.

Wages and perhaps most materials were somewhat higher in the locality of Butte than in any place east of it or in most places in the western states.

The operation of the overhead system as a whole has been quite satisfactory in every respect for there have been practically no troubles or delays to traffic on account of it. There were two instances of wires slipping in the splicing sleeves due to the wedges not being properly driven up. One of these

instances was in connection with the trolley wire and the other with the messenger. In both cases the results were negligible for, in the first instance, the trolley hangers slid back along the messenger much as the rings hanging a curtain slide along the supporting wire until the tension was evened up, the trolley being held clear of the ground by the messenger; while, in the second instance, the messenger slid back through the loop of the hanger until the tension was relieved but was supported clear of the ground by the trolley wire so that no harm resulted. All that was necessary to remedy the trouble on

TABLE IV
COST OF MAINTENANCE AND DISTRIBUTION SYSTEM, OCTOBER, 1913, TO MARCH, 1915, INCLUSIVE

	POLES AND FIXTURES		TROLLEY		FEEDERS		BONDING		MISCELLANEOUS		TOTAL	TOTAL	
	Labor	Material	Labor	Material	Labor	Material	Labor	Material	Labor	Material	Labor	Material and Labor	
Oct. 1913.....									\$291.85	\$7.50	\$291.85	\$7.50	\$299.35
Nov. 1913.....									431.20	264.47	431.20	264.47	695.67
Dec. 1913.....									426.35	114.74	426.35	114.74	541.09
Jan. 1914.....								\$60.50	390.30	88.72	450.80	88.72	539.52
Feb. 1914.....					\$334.65			65.95	286.25	784.21	686.85	784.21	1471.06
Mar. 1914.....					32.40			64.95	570.55	808.51	667.90	808.51	1476.41
Apr. 1914.....								37.65	313.65	348.95	351.30	348.95	701.25
May 1914.....								40.20	526.75	628.36	566.95	628.36	1195.31
June 1914.....								24.00	473.65	972.08	497.65	972.08	1469.73
July 1914.....	\$599.95	\$14.43	\$449.25		150.95	Cr. 235.64	104.65				1304.80	Cr. 221.21	1082.59
Aug. 1914.....	219.65	15.09	446.50		23.15	320.57	47.40				736.70	335.66	1072.36
Sept. 1914.....	251.50	26.98	98.70	\$9.32		206.25	24.05	\$66.22			374.35	308.77	683.12
Oct. 1914.....	172.10		389.15		26.95	55.86	10.90			367.94	599.10	423.80	1022.90
Nov. 1914.....	105.10	.13	163.30		70.90	4.64	43.10	64.57			384.40	69.34	453.74
Dec. 1914.....	134.90	6.12	103.45	.48	9.20	42.96	30.85	94.54			278.40	144.10	422.50
Jan. 1915.....	115.53		186.95	19.36	49.10		94.90	99.68			446.50	119.04	565.54
Feb. 1915.....	152.95	2.47	135.15	3.08	63.45		45.41	39.20			390.75	218.51	609.26
Mar. 1915.....	163.55	6.58	141.15	.50	67.05	91.04	58.40	66.02			430.15	164.14	594.29
Total 18 months.....	1915.35	71.80	2115.60	32.74	827.70	601.09	746.70	488.58	3710.55	4385.48	9316.00	5579.69	14895.69
Rate per year.....	1276.90	47.86	1410.40	21.83	551.87	400.72	497.80	325.72	2473.70	2923.65	6210.69	3179.79	9930.46
Rate per mile per year	14.03	.48	15.50	.22	6.06	4.40	5.47	3.58	27.18	32.13	68.25	40.88	109.13

TABLE V

	SMELTER HILL SERVICE EAST ANACONDA TO CONCENTRATOR				MAIN LINE SERVICE ROCKER TO EAST ANACONDA		
	Train No. 1	Train No. 2	Train No. 3	Average	Anaconda to Rocker	Rocker to Anaconda	Average
No. of cars in train.....	18	21	25	21.3	64	57	60
Gross wt. tons.....	1420	1580	1910	1633	1335	4150	
Ton-miles, gross.....	9940	11060	13370	11431	26700	83000	54850
Schedule speed.....	16.1	16.2	14.2	15.5	20.1	20.1	20.1
Avg. amperes-total.....	580	583	667	610	366	380	373
Avg. volts.....	2327	2277	2276	2293	2325	2345	2335
Avg. kilowatts.....	1350	1327	1518	1398	852	891	872
Max. amperes.....	860	640	800	767	624	640	632
Maximum volts.....	2456	2419	2456	2444	2475	2435	2455
Max. kilowatts.....	1951	1500	1733	1728	1368	1510	1439
Total kilowatt-hours.....	580	560	746	629	852	654	753
Watt-hours per ton-mile.....	61.4	50.6	55.82	55.02	31.91	7.87	13.73
Minimum volts.....	2250	2119	2100	2156	2175	2175	2175
Max. drop per cent.....	8.4	12.4	14.5	11.8	12.1	10.7	11.4
Avg. drop per cent.....	5.3	5.9	7.3	6.9	6.0	3.6	4.9

both occasions was to pull the parted wire back into position and properly wedge it into the sleeve. There have been two instances of the trolley wire parting due to the improper welding of the metal in manufacture and other similarly negligible instances common to such installations.

TABLE VI

New telephone line on trolley line poles.	\$7,850.64
Changing light, power, telephone and telegraph lines.....	4,273.15
Changing street railway crossings.....	1,546.65
Relocating railway tracks.....	815.90
Raising drip sheds.....	785.54
Changing station platforms.....	693.29
Raising wagon bridges.....	361.52
Total.....	\$16,326.69

The most serious interruption that occurred was originated by the blasting out of some old bridge piles by the section men of a paralleling railway. A fragment of the pile was blown against a telephone wire carrying it across the 2400-volt trolley. This telephone wire ran through the switching board in all the stations along the line, some of which had not then been provided with the proper protecting devices. The result was that the arc set fire to some of the boards and in one, where the operator happened to be temporarily absent at the time, the building was burned setting fire to adjacent poles and parting both the trolley and messenger wires.

At the other stations involved, where the operators were present and could give prompt attention to putting out the arc, no serious damage resulted.

The maintenance men who took charge of the trolley system were put on October 1, 1913, and consisted of a foreman and two linemen who could requisition other assistance

when an occasion demanded it. The cost of maintenance from this date up to and including March 31, 1915, covering the first 18 months operation, is given in Table V.

Beginning with July, 1914, these accounts were kept more in detail. These expenses include some rearrangements of feeder, etc., and the cost of some special instruments for bond testing, and tools. The average cost of maintenance of the distributing system inclusive of the track bonding for the 18 months has been at the rate of \$109.13 per track mile per year.

Taking the last nine months during which the costs were segregated more completely gives the data listed in Table VIII.

To ascertain the rate of wear on the trolley wire, measurements were recently made on the Smelter Hill line where the traffic is heavier than at any other point and where the electric service has been in operation longest (just about two years).

The original diameter of the wire vertically was supposed to average about 0.482 of an inch. The minimum diameter found where the measurements were made was 0.470 of an inch. The average of a number of measurements was 0.475. It is usually considered safe to allow a 4/0 trolley wire to wear down to 0.350 thus allowing a wear of 0.132. If the maximum wear of 0.012 as found for the two years is taken as the average during the useful life of the wire, which is at the rate of 0.006 per year, the wire can be expected to last 22 years. At this portion of the line there has been an average of approximately 50 passages of pantograph rollers per day which for two years would be an aggregate of 36,500 passages or 18,250 per year indicating 3041 passages per thousandth of an inch wear.

TABLE VII

	Days	Avg. Approx. Per Day	Total
Blacksmiths and helper.....	27	\$3.08	\$110.58
Boilermakers and helper.....	26	3.76	97.78
Carpenters and helper.....	17	4.40	75.56
Machinists and helper.....	15	4.33	64.91
Electricians and helper.....	3,580	5.71	20,544.09
Pipefitters and helper.....	2	3.80	7.69
Laborers.....	3,035	3.56	28,611.53
Teamsters.....	35	3.25	106.96
Electrical foremen.....	835	6.35	5,300.62
Foremen.....	665	6.06	4,030.82
Clerks.....	500	3.35	1,670.42
Totals.....	13,737 days	\$4.41 ave.	\$60,620.96

It is perhaps questionable as to whether the first few months wear on the trolley wire would be at the same rate as after the contact surface had become greater. The outside surface of the wire might be slightly harder than the interior and thus the wear be less at the beginning, while on the other hand when the wire is new the contact area with the roller is quite small and the pressure per unit area together with the increased current density might cause more rapid wear. From such data as are at hand, it would appear that the rate of wear on the trolley is greater at the beginning and decreases as the contact area is increased. Extensive tests with a sliding contact, where the operating conditions were varied as to the amount of tension against the trolley wire and current collected, almost invariably indicated that the

spot or groove which rendered the roller unfit for further service (if not detected at an early stage).

This sticking was first due to the imperfect alignment of the clamping jaws which held the ends of the spindle passing through the roller and on which the bushings revolved. As the bearings consisted of four bushings $1\frac{1}{2}$ in. long, being arranged in pairs one at each end with a space of 1 in. between the two bushings of each pair, thus making each lining substantially 4 in. in length, it was possible to clamp the ends of the spindle so tightly as to spring it out of line and cause it to bind in the bushings until it did not revolve with the ordinary friction offered by its contact with the trolley wire. This trouble was overcome by more care in the adjustment of the clamps. A little later the caps in the

TABLE VIII

	Poles and Fixtures	Trolley	Feeder	Bonding	Misc.	Total
Labor.....	\$1915.35	\$2115.60	\$460.75	\$453.45	\$0.00	\$4945.15
Material.....	71.80	32.74	601.09	488.58	367.94	1562.15
Total.....	\$1987.15	\$2148.34	\$1061.84	\$942.03	\$367.94	\$6507.30
Rate per year.....	2649.53	2864.45	1415.79	1256.04	490.59	8676.40
Rate per year per mile of track	29.12	31.48	15.55	13.80	5.39	95.34
Per cent labor.....	96	98	43	48		76
Per cent material.....	4	2	57	52	100	24
Per cent of total.....	31	33	16	15	5	100

rate of wear decreased as the area of contact increased; and there seems no reason to suppose that the same would not be true in the case of the roller collector so that the average life of the trolley wire in this service should not be less than 20 to 25 years.

The roller collectors adopted for the service and described in the beginning of this article have performed their work in general equally as well as had been expected of them, though at the beginning of the electrical operation a number of minor improvements were found desirable. The rollers were operated against the trolley with an upward pressure of approximately 35 lb., the practice being not to readjust so long as the tension was not above 38 or below 33 lb., at the average operating height.

The first difficulties experienced with these rollers was from the sticking of the roller in the bearings, which resulted in their sliding along the trolley wire causing a flat

bearing heads began to loosen until they bound the roller between the clamps and caused them to slide as before. A set screw was provided which prevented the unscrewing of the caps and no more trouble from the sliding of the roller was experienced until extremely cold weather came and heavy frost accumulated on the trolley wire which, on being knocked off by the roller, lodged on top of the $2\frac{1}{2}$ in. iron brace or hooker frame supported underneath the roller (having about $\frac{1}{16}$ in. clearance) piled up and finally clogged the roller causing it to slide with the same results as heretofore.

This difficulty was met by increasing the clearance of both the brace and the roller and inverting the **T** so that the web was on the bottom and thus did not offer so large an area for the collection of the frost.

Another defect that threatened trouble at an early stage was the removable cast iron wearing plates screwed to the pantograph

head at each end of the roller and intended to guide the trolley wire smoothly from the horn onto the roller.

It was found quite difficult to keep this plate in proper alignment with the roller owing to the wearing down of the bushings and the increase in the end play of the roller, which allowed the trolley wire to hang in the gap between the wearing plate and the end of the roller. When this condition was not remedied promptly a groove was soon worn at this point which often made the replacement of the plate necessary and sometimes

m.p.h., the bushings wore out very quickly which allowed the oil to be carried out along the spindle and thrown off. It fell on the roofs of the locomotive and cars and made it necessary to replenish the oil at the beginning of each trip.

When the bushings became worn the roller vibrated considerably, causing more sparking at the contact with the trolley wire and often breaking the truss rods used for bracing the pantograph frame. In some instances these bushings were badly worn before they had made 200 miles.

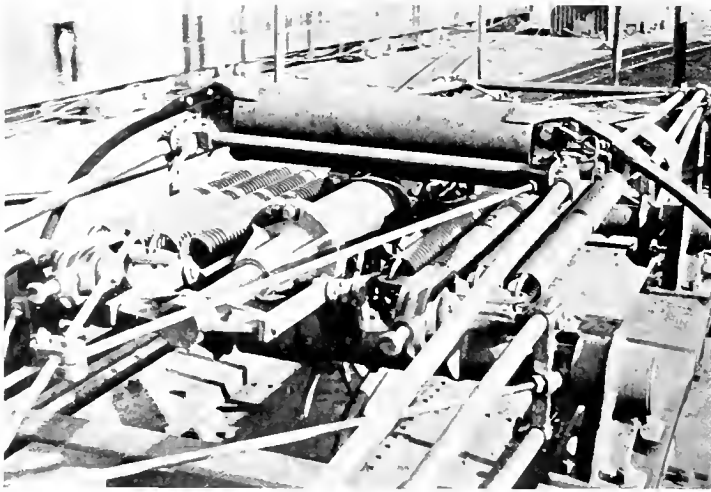


Fig. 19. A Pantograph Folded showing Revised Wear Plate

that of the roller tube as well. This difficulty was removed by the application of a new type of wearing plate which extended out slightly over the roller with a prong on either side gradually dropping below the line of the top of the roller so that the wire passed from one to the other so gradually that there was no point where the wire was inclined to catch. The lower end of this wearing plate extended out over the upper end of the horn in a similar manner and avoided the necessity of such careful fitting as had been required with the old type where butt joints were used. The new wearing plate is shown in Fig. 19.

The sleeve bearings with oil lubrication were fairly satisfactory in the freight service where the average speed was from 15 to 30 miles per hour but when the passenger service was started, requiring a schedule speed of 26 m.p.h. with maximum speeds of 45 to 50

Experiments were made with grease lubrication, which gave promise of good results and which led to some slight modification of the bearings and to a general substitution of grease for oil as a lubricant.

In the meantime tests were being made with Hyatt roller bearings and the results had been so encouraging that it was decided to substitute these for the sleeve bearings in all the rollers as fast as the latter wore out and required to be renewed. Fig. 21 shows their installation in the later rollers designed for this purpose.

The total locomotive miles made by the electric locomotives up to the end of March, 1915, was 927,234. The number of roller tubes received by the Railway Company up to that date was 123 including those that came on the locomotives and extra pantographs bought for spares.

On this data the roller tube stock was as shown in Table IX:

TABLE IX

- 5 new rollers complete in pantographs
- 29 new tubes in stock
- 20 partially used tubes on locomotives
- 10 partially used tubes in stock

Total 64 tubes used and unused, 34 of which are new and 30 partially worn, leaving 59 tubes that have been replaced.

The master mechanic estimates that the 30 partially used tubes are, on the average, about half worn out, on which basis the average miles per roller would be $\frac{927,234}{79} = 11,750$ or supposing that these tubes were two-thirds worn out the average mileage per tube would be $\frac{927,234}{84} = 11,030$ miles.

In this connection it should be noted that eleven of the 59 abandoned tubes were removed before they had been in service many miles on account of the rollers sticking and sliding along the trolley until a groove was cut in them as shown in Fig. 22. Some of

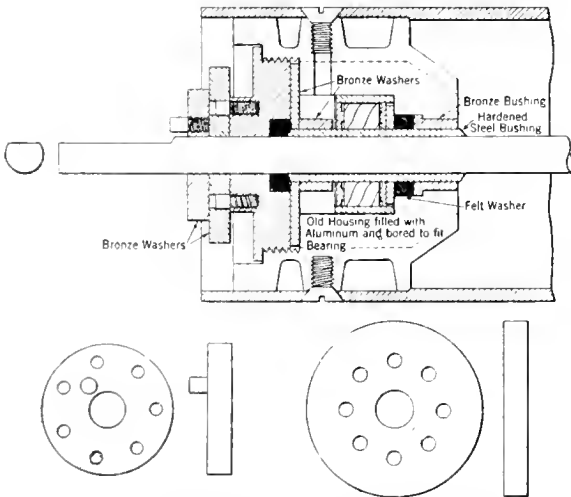


Fig. 20. Original Pantograph Roller Housing Modified and Fitted with Roller Bearing

these tubes were thus injured during the commencement of electrical operations before the defect had all been remedied, but most of them were caused by the frost freezing the roller to the T iron brace underneath, previously mentioned.

A large percentage of the above mileage was made before all the sleeve bearings were replaced by roller bearings or the clearance of the roller above the T iron had been increased.

Comparatively few rollers that were fitted with the roller bearings when new have yet

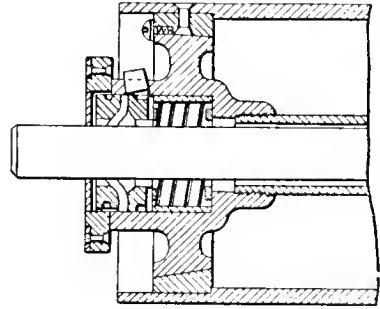


Fig. 21. Latest Type of Pantograph Roller Designed for use with Roller Bearing

had to be replaced. One roller which had been in the passenger service, where the average current collected is not so great as in the case of the freight service, though the speed is considerably higher, ran 26,880 miles before it was replaced. The average mileage of all tubes with roller bearings at the present time is approximately 16,000 miles which indicates that roller bearings are responsible for an increase of about 35 per cent in the average life of the rollers.

The old sleeve bearings with grease lubrication had to be renewed about each 5000 or 6000 miles, thus requiring about two sets of bushings during the life of a tube. The roller bearings after making 26,880 miles were in perfect condition and it is difficult to judge as to what mileage they will make but, from present indications, it is reasonable to expect that they will make at least 100,000 miles per set. It cost approximately \$2.92 in labor and material to renew a set of the old bushings.

The cost of substituting the roller bearings for the bushings was approximately \$2.20 for material and \$2.25 for labor or \$4.45 per roller. It will thus be apparent that the change was even more important from the point of saving in maintenance of bearings than from increased life of the rollers. The roller bearings require comparatively little attention, a small quantity of fresh grease being inserted at each regular inspection of the engine.

The general repairs to the entire pantograph have been likewise affected as the decreased

vibration has stopped almost all pantograph troubles.

The repairs to other parts of the pantograph during the past six months consisted of renewing six wearing plates; the replacing of two horns and one cross bar.



Fig 22. View of Pantograph Rollers showing Injuries that have developed from sliding

The average cost of maintenance of the original pantographs with the sleeve bearings was about \$185 per month or approximately \$3.20 per 1000 locomotive miles.

The present corresponding cost of this maintenance is about \$35 per month or 62 cents per 1000 locomotive miles which shows a decrease of approximately 81 per cent in this item.

It was found in practice that the wooden lining originally pressed inside the tube was unnecessary and this was omitted when the new bearings were installed.

The operation of these roller pantographs is, therefore, considerably more efficient than had originally been expected.

Two 500,000 feeder cables in multiple for the trolley and one 4/0 cable for the track circuits were run on the trolley line poles between the two substations; the other trolley feeder running to the yards which were fed separately or in pairs.

Voltmeter and ammeter readings were taken on a number of trains to ascertain the drop in voltage and energy consumption; a summary of these is given in Table V from which it will be seen that the maximum drop in voltage obtained was 14.5 per cent while the average drop for all readings was 5.6 per cent.

The readings making up the averages given were taken at 30 second intervals for the entire trips on the locomotives in regular service hauling normal trains under average operating conditions and are, therefore, fairly representative of general results. However, there has been a gradual increase in the weight of the trains which might slightly affect the average drop in voltage.



Fig 23. Section of Tangent Track, showing Pantograph Trolley Suspension as sketched in Fig. 17

It may be of interest to note that repair work on the 2400-volt trolley line is done from an ordinary wooden work car without special insulation with full voltage on the line. There has been no serious cases of shock to the workmen.

In wet weather it is not considered safe to work from this car with full potential on the line but there should be little difficulty in constructing a tower car which would make it quite safe under any ordinary conditions.

The writer wishes to thank herein Mr. C. A. Lemmon, Chief Engineer and Mr. C. H. Spengler, Master Mechanic of the Butte, Anaconda & Pacific Railway, Mr. R. E. Wade, (now Ass't Electrical Engineer of the Chicago, Milwaukee & St. Paul) who had personal charge of the construction of the Butte, Anaconda & Pacific distribution system, and Mr. C. J. Hixson and staff for assistance kindly rendered in obtaining the data contained in this article.



Fig. 24. West End of East Anaconda Yard

**FROM THE CONSULTING ENGINEERING DEPARTMENT OF THE
GENERAL ELECTRIC COMPANY**

**A CURSORY ACCOUNT OF THE FIRST
LIGHTNING STORM OF THE SEASON
AS GIVEN BY THE RECORDS OF
THE MULTI-RECORDER**

This information is given to emphasize the importance of making exact records of interruptions and the beneficial effects in avoiding interruption of service which may be obtained therefrom.

The data are taken from a multi-recorder operating on a large transmission system and, in the limited space allotted, it is possible only to give a cursory account of the record of the storm during the first hour.

The first indication of the storm occurred at 4 p.m. when the dense gathering clouds caused it to grow dark. A surge recorder gave the first record on the multi-recorder of a lightning stroke which affected the line 17 minutes and 41 seconds after four o'clock. This surge recorder is a coherer actuated device which is connected to the line through specially arranged condensers so that the surges on the line cause the coherer to operate.

There occurred then no further disturbance for seven minutes when five records were made in nine seconds, showing almost a continuous surge. There was then another interval of twelve minutes of no disturbance and the record of a single instantaneous surge at the end of it.

There was no further disturbance for two minutes but after this time there began a succession of instantaneous surges. There were ten of these records in all, scattered over a minute and a half. The records show that the time between discharges first increased and then decreased. The time between successive discharges was as follows, all given in seconds: 9, 14, 41, 4, 6, 3, 3, 1, 1, and 2. These momentary surges then developed into a continual surge which lasted 17 minutes. During this period of 17 minutes of continual surges there were a number of extra heavy surges which caused four distinct operations of a surge recorder connected to one phase of a parallel line.

It is interesting to note that up to this time no arc had yet occurred between the line and ground. This is known because there is a relay which makes a record of a ground. The surges were apparently caused by the preliminary "spitting" or corona discharge which often precedes the arc-over of a string of insulator disks.

The end of this long succession of surges occurred at four o'clock, 57 minutes, 34 seconds. It was seven minutes before the disturbance recurred. The disturbance then lasted twenty seconds. Apparently it differed somewhat from the previous disturbance in that it brought into operation several times a surge recorder on the adjacent phase of the same line.

There was then another period of no disturbance for one minute and 38 seconds (6 minutes, 14 seconds past 5 p.m.) when an arcing ground took place.

The recorder shows that the oil switch did not open and disconnect the line until eight seconds after the arcing ground took place. This time is too brief to allow of any appreciable number of definite visual observations but the recorder made twelve records. Most of these were of surges, but one record was that of the opening of a circuit breaker which disconnected one transformer of a bank of four that were in service at this time. The surges started some trouble inside the transformer which caused smoke to blow out at one of the leads. It is a favorable comment on the watchfulness of the operator that he switched out this transformer seven seconds after the accidental arcing ground started and one second before the oil switch was opened.

As an answer to the very pertinent question a practical operator might ask "Of what use are these hair-splitting detailed records?" further intermediate records are taken from the multi-recorder.

There were four circuits in operation when the storm first started. Twenty-four minutes and no seconds after the continuous surge ended the recorder shows that three of the circuits were separated from the one in trouble by the opening of a circuit breaker which sectionalized the bus. No interruption occurred on these three circuits. The operator did this two minutes and 16 seconds before the arcing ground took place. There is a parallel circuit to the one on which the arcing ground developed and there was plenty of time to switch on this parallel circuit if it had been free. Unfortunately some mechanical damage had previously been done to this circuit and the linemen were repairing it at the time, otherwise it would have been possible to have avoided entirely an interruption of service by the use of the multi-recorder and its auxiliary devices.

During this one line trouble the recorder had shown to the second of time the passage through the arresters of lightning strokes as they occurred. It had also picked out the circuit and the phase on which the trouble was developing and gave the operator plenty of warning and, as it happened, plenty of time to perform the necessary switching in the station.

If one were asked "Is this apparatus worth while?" the answer is a similar question: "Is it worth while to know when and where trouble occurs and avoid all the interruptions that do not develop instantaneously? Also,

is it worth while to know how troubles occur with the probability of making arrangements to avoid an interruption when troubles of the same kind occur subsequently?"

E. E. F. CREIGHTON.

ERRATA

GENERAL ELECTRIC REVIEW, July, 1915, p. 669, "Temperature Coefficient Formulæ for Copper."

Left-hand column, line 1: "Electro Chemical" should read

"Electrotechnical Commission."

Equation (1): $R_t = R_0 [1 + \alpha (T_t - T_0)]$ should read

$R_t = R_0 [1 + \alpha (T_t - T_0)]$.

Right-hand column, line 15: "any numerical factor" should read "any tabulated values or numerical factor."

PRACTICAL EXPERIENCE IN THE OPERATION OF ELECTRICAL MACHINERY

PART X (Nos. 51 TO 53 INC.)

By E. C. PARHAM

CONSTRUCTION DEPARTMENT, GENERAL ELECTRIC COMPANY

(51) STATIONS IN SERIES

Instances of power stations or of substations operating in parallel are numerous; instances of stations operating in series are comparatively few.

Two electric railroads, the tracks and lines of which abutted at their termini, had initially been operated independently. Later these were merged under a single management and the two developments were converted into a continuous right of way. The trolley wires were made mechanically continuous but electrically they were insulated from each other by means of a section-insulator. One of the insulated sections was supplied from a power-station and the other was fed from a substation having a single 600-volt synchronous converter. One day the converter apparently "blew up." At first the machine appeared to be badly damaged but a complete examination showed it to be in a much better condition, and it was soon qualified for service again.

In the meantime a report was received to the effect that, simultaneously with the trouble of the converter, the generator in the distant power-station had given trouble also, but of a lesser degree because it was larger than the converter. Subsequently it developed that the converter had "come up" with the wrong polarity, thereby placing the opposite ends of the section insulator at a potential difference of about 1200 volts, instead of one of 50 or 100 volts as normally existed.

The first car that ran past the section breaker with its controller on an operating notch had dragged an arc, which resulted in placing the power-station and the substation in series with each other. The resistances of the track, the line, and that of the two machines acted as the only limit to the value of the short-circuit current due to the 1200 volts.

The source of the trouble was a voltmeter of the type that gives a *positive* reading irrespective of whether the current through it is flowing in a positive or in a negative direction. So long as the converter operated independently, its polarity was a matter of no consequence; but if the same voltmeter had been used for paralleling that converter with another, the result might have been much more serious than the one described.

(52) PARALLEL TRANSFORMERS

The secondary coil of a transformer may be considered as a source of voltage in the same manner as the armature of a generator. In either case any number of independent sources supplying independent loads will affect each other only insofar as load excesses or load fluctuations may affect the amount of line drop or may affect the speed of the prime movers upon which the generators or the transformers depend. Where two generators are to supply current to the same circuit, however, certain conditions must be fulfilled or the two units will not divide the total load proportionally. Similarly, if the

secondaries of two transformers are connected to the same service line, the two units require that certain conditions be fulfilled or they will not divide the load proportionally. It is not sufficient that the internal characteristics of the transformers be similar; the external conductors by means of which the trans-

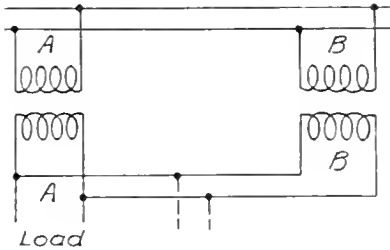


Fig. 1

formers are connected to the load must have resistances that are inversely proportional to the ratings of the respective units, and furthermore there should exist no local conditions capable of greatly modifying the reactance of the external circuit of either secondary.

The full lines in Fig. 1 illustrate an instance where two transformers of equal size, of the same rating, and of similar characteristics failed to divide the total load equally, because the leads from one transformer to the load buses were approximately ten times as long as the corresponding leads of the other transformer. In permanent installation work the matter would have been rectified by placing the two transformers beside each other. The installation under discussion, however, was only temporary; therefore, in order to relieve the condition the load lines were simply shifted to the positions indicated by the dotted lines in the diagram. This change equalized the lengths of the leads.

The main objection to an unequal division of the load is that at the full-load capacity of the heavier loaded unit the lighter loaded one is not fully loaded. This results in an uneconomical investment for a considerable transformer capacity has to be purchased that is not used.

53) TRANSFORMER CONNECTIONS

If a three-phase service voltage is derived from the delta connected secondaries of three single-phase transformers, the secondaries would not be adapted for Y connection to the same service. With the delta connection, the

service voltage equals the voltage per coil; in the case of the Y connection, however, two of the coils connected in vector series add their individual voltages and thereby produce a resultant voltage that is less than the arithmetical sum of the component voltages, but which exceeds the value of the service voltage.

In Fig. 2 a primary voltage of 100 and a 1 to 1 ratio between the primary and the

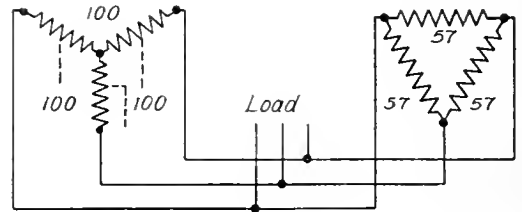


Fig. 2

secondary have been assumed, also the voltage per phase and the voltage per coil have been indicated for several secondary and primary combinations. It will be seen that the service voltage produced by a primary voltage of 100 varies from 173 to 57 according to the connection used. It is of great importance, therefore, to specify the primary and secondary voltage and also the standard connections that are to be used, when ordering single-phase transformers for three-phase service.

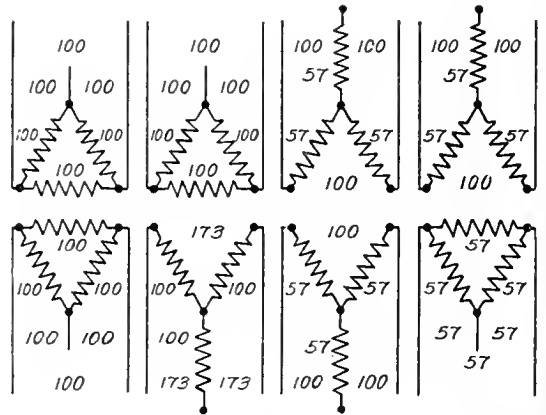


Fig. 3

Fig. 3 illustrates the condition that was found to exist in two sets of transformers which would not operate together but would blow the fuses. The secondary of one was connected in delta and the secondary of the other was connected in Y.

QUESTION AND ANSWER SECTION

The purpose of this department of the REVIEW is two-fold.

First, it enables all subscribers to avail themselves of the consulting service of a highly specialized corps of engineering experts, or of such other authority as the problem may require. This service provides for answers by mail with as little delay as possible of such questions as come within the scope of the REVIEW.

Second, it publishes for the benefit of all REVIEW readers questions and answers of general interest and of educational value. When the original question deals with only one phase of an interesting subject, the editor may feel warranted in discussing allied questions so as to provide a more complete treatment of the whole subject.

To avoid the possibility of an incorrect or incomplete answer, the querist should be particularly careful to include sufficient data to permit of an intelligent understanding of the situation. Address letters of inquiry to the Editor, Question and Answer Section, General Electric Review, Schenectady, New York.

PHASE RELATION AND ROTATION: DETERMINATION

- (144) (a) What is the difference between phase relation and phase rotation?
 (b) Describe a method of testing out both the above with lamps (with and without potential transformers) when a three-phase alternator is to be connected to the bus for the first time.
 (c) What is considered the best method of determining whether a synchroscope is indicating correctly?

(a) The best means of showing the difference between phase relation and phase rotation is to define each.

Phase relation is expressed as the difference in angular-position between the maximum alternating voltage and current in the same circuit or between the alternating voltages in two circuits (or between the currents in those circuits).

First example: The phase relation between the alternating voltage and the current in the same circuit is ordinarily expressed by the value of the angle between the voltage vector and the current vector. For sine waves of current or electromotive force, the phase relation between the voltage and the current determines the available power in a given circuit and the power-factor is equal to the cosine of the angle which represents their difference in phase. In the case of waves of non-sinusoidal form as well as for sine waves the power-factor is the ratio of the available power, as determined by a wattmeter, to the volt-amperes. From the watts and the volt-amperes in the above relations, the cosine of the angle of phase displacement can be determined and from this the angle which expresses the phase relation. The phase angle then refers to the position of two vectors, one of current and one of voltage, each of which would be that corresponding to "equivalent sine waves" by which the actions in the circuit may be represented. It is convenient to regard most circuits as being rendered active by simple sine waves which are the "equivalent sine waves" corresponding to actual conditions. The actual waves are usually more or less complex.

Second example: The phase relation between the alternating voltage (or the current) in one circuit and the corresponding voltage (or current) in another circuit is expressed by the angular distance between the vectors representing them. This phase relation varies from time to time, if the circuits are not synchronized and consequently have frequencies differing to a greater or less degree. If the maximum voltage in circuit *A* is displaced from that of circuit *B* by 60 deg., the phase relation between the voltages is 60 deg. (Phase relation is considered in this sense when synchronizing two lines.)

Phase rotation is that angular direction which in a polyphase system represents progression of the maximum value during a sequence of time. (It will be noted that "phase relation" is a phenomenon considered fixed at any time, and that "phase rotation" is one considered as progressing with

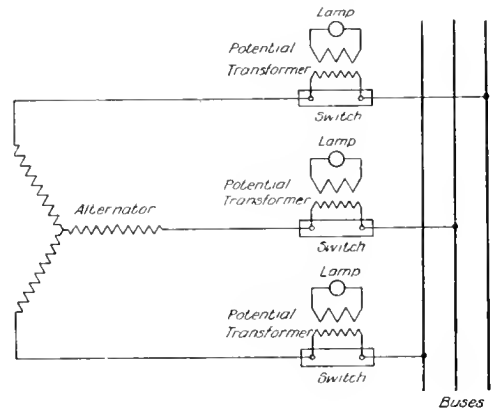


Fig. 1

cyclic speed.) Phase rotation is ordinarily defined as being "clockwise" or "counter-clockwise." The designation which is applicable to a particular case, e.g., in a three-phase line with its conductors located geometrically (at the apexes of an equilateral triangle) is theoretically determined by the observer imagining that he is looking end-on at a cross-section of the line and determining whether the crests, or the valley points, of the current or the electromotive force in the conductors pass from conductor to conductor in a clockwise or in a counter-clockwise direction. (Phase rotation must be considered when synchronizing two lines, and when connecting any polyphase motor for a definite direction of rotation.)

(b) There are two methods of employing lamps for synchronizing an alternator with a bus. These are called the "dark" and the "light" methods. The former is the one customarily used since its connections are the more simple; consequently this method will be described.

Depending upon what would be the value of twice the normal voltage of the alternator connect one lamp, several lamps, or a potential transformer (with a lamp in its secondary circuit), across the terminals of each switch. (Fig. 1 shows the connections for a potential transformer and one lamp per switch.)

Run the alternator at normal speed and excite it to a voltage equal to the bus voltage (measured by voltmeter). Observe the periodic increase and decrease in the brilliance of the lamps.

If the three lamps brighten and darken simultaneously, the *phase rotation* of the voltage in the leads that are brought to one side of the switches is the same as that brought to the other side. If the lighting does not take place simultaneously in all three lamps but assumes a "see-saw" action, the phase rotation of the alternator is unlike that of the bus. To correct this condition it is only necessary to transpose the leads (interchanging two) coming to one side of the switches until the lamps act together (Like phase rotation is necessary, but it is immaterial so far as this general discussion is concerned whether it is clockwise or counter-clockwise.)

Then, increase or decrease the speed of the alternator (whichever is necessary) until the frequency of the light fluctuation decreases. When the periodic variations in the light are very slow, the

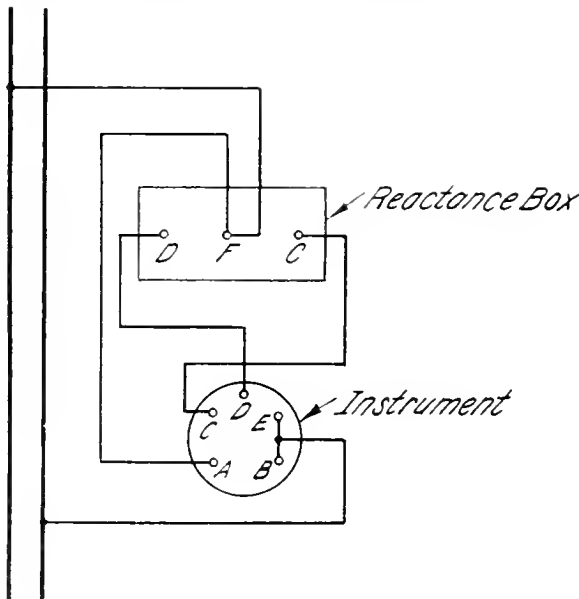


Fig. 2

alternator is running at very nearly the frequency of the bus. At the instant that the three lamps are at the mid-point of the dark period, the phase relation of the alternator voltage to that of the bus is one of coincidence, i.e., the phase relation is zero, and the voltages are in phase. The connecting switches should be closed at this instant and the alternator will be ready to take on load.

If desired, the lamp around one of the switches may be dispensed with after the leads to the switches have been correctly arranged for like phase rotation. (It is the modern practice, however, to install a synchronism indicator rather than to continue to use lamps after the connections to the switches have been properly made.)

(c) The best method for completely testing the accuracy of the connections made to a synchronism indicator is first to connect a set of lamps (or set of potential transformers with lamps if necessary) across the switches as described in the foregoing and shown in Fig. 1. Then observe if the indications of

the synchronism indicator are in accordance with those of the lamps. If they are in coincidence, the indicator is registering correctly. If this is not the case, attention should first be given to checking the wiring to the indicator since it is most probable that the mistake will be found there. If it is only desired to check the location of the needle at synchronism, a test more simple, convenient and accurate than the lamp method will supply this information. Connect the indicator and its reactance box, as shown in Fig. 2, to a single-phase line of the normal voltage for the instrument. If the needle is mounted correctly, it will point to the neutral or synchronism index on the dial; if it does not assume this position, it should be made to do so by changing its setting on the spindle that rotates it. E.C.S.

INDUCTION MOTOR: CHANGE IN NUMBER OF POLES

(145) When it is desired to increase the normal speed of a squirrel-cage induction motor by reconnecting the stator windings to give a fewer number of poles, what are the limiting factors that determine if such a change is possible? If the reconnection is possible what would be the effect on the motor's characteristics?

The principal factors limiting a change in the number of poles of a squirrel-cage induction motor are these:

- (a) The number of turns in series per phase. These must remain the same since the applied voltage is to be unchanged.
- (b) The insulation between the conductors of different phases. Of this there must be sufficient to not reduce the factor of safety against breakdowns after the regrouping of the conductors has been carried out.
- (c) The saturation of the iron. It is often inadvisable to use a magnetic density much higher than normal.

Because the designs of induction motors vary widely with different manufacturers and also in the product of each maker (for the purpose of supplying motors for various types of service), it will be impossible to make other than very general statements regarding the expected change in characteristics of the motor when running at the higher speed. Furthermore, the following statements must not be expected to hold true when the number of poles has been decreased sufficiently to raise the normal speed more than say 25 per cent.

After the reconnection,

- (a) The normal speed will be equal to approximately the original normal speed times the original number of poles divided by the new number of poles.
- (b) There will be a somewhat higher torque per pole exerted, due to the slightly increased flux per pole that arises from the shortened pole pitch, so that the total motor torque might be expected to be decreased but little by the change.
- (c) The running-light current will be slightly lowered.
- (d) The starting torque will probably be slightly decreased.
- (e) The power-factor might be expected to be somewhat higher.
- (f) When the power-factor is higher the rating of the motor can be increased about in proportion to the square root of the increase in speed with the same heating.
- (g) The efficiency will be practically the same as before the change. A.E.A.

GENERAL ELECTRIC REVIEW

A MONTHLY MAGAZINE FOR ENGINEERS

Manager, M. P. RICE

Editor, JOHN R. HEWETT

Associate Editor, B. M. EOFF
Assistant Editor, E. C. SANDERS

Subscription Rates: United States and Mexico, \$2.00 per year; Canada, \$2.25 per year; Foreign, \$2.50 per year, payable in advance. Remit by post-office or express money orders, bank checks or drafts, made payable to the *General Electric Review*, Schenectady, N. Y.

Entered as second-class matter, March 26, 1912, at the post-office at Schenectady, N. Y., under the Act of March, 1879.

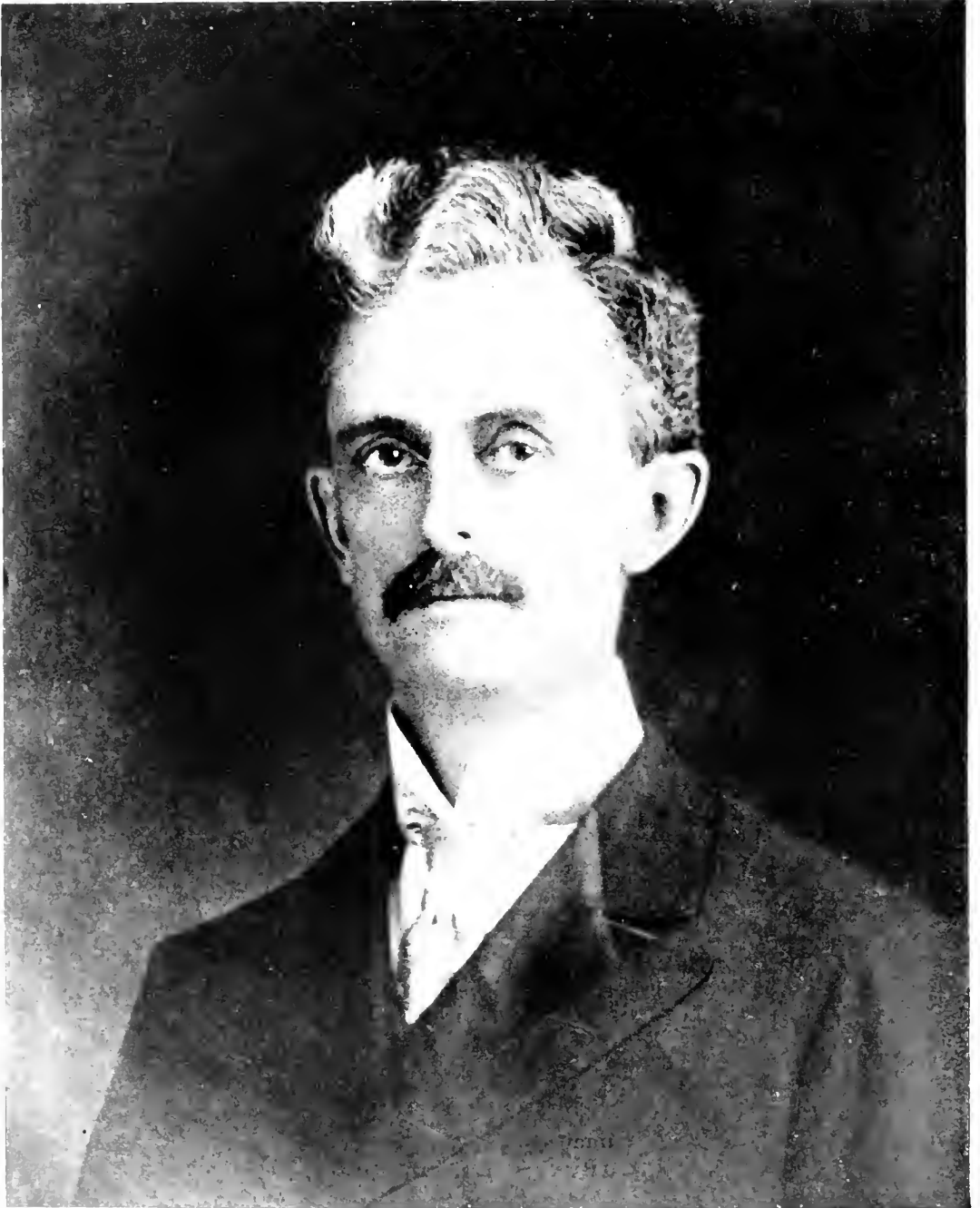
VOL. XVIII., No. 9

Copyright, 1915
by General Electric Company

SEPTEMBER, 1915

CONTENTS

	PAGE
Frontispiece: Dr. Fred S. Pearson	866
Editorial: The Paths of Progress	867
The Relation of Research to the Progress of Manufacturing Industries	868
BY DR. W. R. WHITNEY	
The 45,000-kw. Synchronous Converter Substation of the Aluminum Company of America at Massena Springs, N. Y.	873
BY J. L. BURNHAM AND R. C. MUIR	
Protective Coatings for Metal	878
BY H. B. C. ALLISON	
The Iron-cobalt Alloy, Fe ₂ Co, and its Magnetic Properties	881
BY TRYGVE D. YENSEN	
Control and Protection of Electric Systems	887
BY CHARLES P. STEINMETZ	
Current Supply for Motion Picture Machines	895
BY H. R. JOHNSON	
Proper Construction of Earth Connections	904
BY G. H. RETTEW	
Methods of Removing the Armature from Box Frame Railway Motors	908
BY J. L. BOOTH	
A Ten-to-one Ratio for Comparing Precision Resistance Standards	915
BY C. A. HOXIE	
Some Problems in Burning Powdered Coal, Part I	920
BY ARTHUR S. MANN	
A Review of the N.E.L.A. Lamp Committee Report	925
BY G. F. MORRISON	
Practical Experience in the Operation of Electrical Machinery, Part XI	928
Field Connection Error; Motor Would Not Start; Adjusting Single-phase Motor Clutches	
BY E. C. PARHAM	
In Memoriam: Dr. and Mrs. F. S. Pearson	930
From the Consulting Engineering Department of the General Electric Company	934
Question and Answer Section	935



THE LATE DR. F. S. PEARSON

On page 930 we publish a memorial to Dr. and Mrs. Pearson, who were lost with the sinking of the Lusitania, on May 7, 1915

GENERAL ELECTRIC

REVIEW

THE PATHS OF PROGRESS

We publish in this issue a memorial tribute to a great American engineer who has left behind him monuments which will testify for long years to come of his usefulness to mankind. The contemplation of such a man and especially of his life's work must make many a seriously minded man wonder wherein lay his special power to accomplish so much in the brief span of human life. No amount of energy, unless perpetually guided by a fixed purpose, can account for such a career. Energy is often misguided. No amount of specialized study will lead to such results. The lives of many most learned men are sadly lacking in accomplishments that benefit mankind and lead us further along the paths of progress. The secret does not lie in the physical strength of the body or in stature, this is too apparent to need comment or qualification. We know of many men that left the world the gainer by their lives through thinking great thoughts and recording these for the benefit and guidance of the world at large, but these are literary men. An engineer can never become great by writings, however eloquent, and it is with the abstract greatness of an engineer that we are particularly interested.

This greatness cannot be traced to energy alone, nor to the material body which is matter, but must be traced to the greatest attribute of life—mind. The energy and matter are both essential parts of the manifestation of greatness, but each is equally impotent of accomplishing results unless perpetually guided and controlled by the mind.

The more we contemplate the greatness of an engineer who converts nature's forces and materials to the use of mankind, the more fully we realize that there are but three fundamental essentials that we can consider—mind, energy and matter. That these three must work in harmony we think is apparent. Of these three essentials the mind must ever

be the greatest. A great man need have no greater store of energy than one of lesser caliber, and stature is of still less importance, but a great and active mind he must have.

Tracing backward from the accomplished work to the source from which it emanates we are forced to a realization of the fact that each great engineering work must first have originated in a thought and that it is by thoughts, properly controlled and tempered by an imagination which can produce results, and that can guide both physical energy and materials, or matter, that great men become great.

Again a great man with great thoughts would hardly be reckoned great if his thoughts guided and controlled physical energy and matter alone. The genius of most great men must be attributed to the additional faculty of, by thoughts, controlling or guiding the minds of other men. Indeed it seems that the highest function of the great mind is to influence and guide the thoughts of other men less gifted. And so the function of the great engineer, and in fact, of all great men in all walks of life, is to guide and control mind, energy and matter, and their success in this direction is a measure of their greatness.

Of course, there are many who attribute success to luck and who think that most successful careers are the playthings of fortune, and that all that is essential is to be a mediocre man, in the right place at the right time. Some also seem to think that most men might be great if opportunity had presented itself, but we are rather inclined to think that more men fail to become great by not taking the opportunities when they present themselves than are kept back in the ranks of mediocrity by lack of opportunity. For—

“There is a tide in the affairs of men
Which, taken at the flood, leads on to fortune;
Omitted, all the voyage of their life
Is bound in shallows and in miseries.”

THE RELATION OF RESEARCH TO THE PROGRESS OF MANUFACTURING INDUSTRIES

BY DR. W. R. WHITNEY

DIRECTOR OF THE RESEARCH LABORATORY, GENERAL ELECTRIC COMPANY

The author shows the great value of a knowledge of every fact concerning nature. A knowledge of the most trivial fact has often led to developments of most vital importance. He shows that utility is the prime factor of modern research work, but that purely academical research has led to some of our greatest developments. The spread of scientific knowledge is traced to the publications of scientific societies and it is pointed out that some of the best work has been done by poorly paid services. The whole address demonstrates clearly that the nation that is to advance commercially must do so by the aid of scientific knowledge. This address appeared in *The Annals of the American Academy of Political and Social Science*, Philadelphia, May, 1915.

—EDITOR.

We humans can never quite appreciate the incredible applicability and utility of new facts of nature. We are repeatedly shown by our experience, but each new example only augments our stock of wonderment or bewilderment. A very few months ago a certain well-known scientific investigator (Lord Rayleigh) found a slight difference in the density of nitrogen taken from air and nitrogen derived from other sources. He felt obliged to know about this little difference. In co-operation with Sir William Ramsay, he discovered argon. This was present in the atmospheric nitrogen and had always escaped detection. It formed less than one per cent of the air. It was discovered to be entirely inert and chemically inactive. This was an apparent promise of great chemical uselessness. At that time it was also exceedingly difficult to separate it from the air, and except for its scientific interest, it seemed destined to be left inactive. Newly discovered methods of liquefying air and of combining nitrogen for fertilizer, as in the cyanamid process, have just made the argon available commercially. Other pure scientific research had shown the value of such a gas in incandescent lamps, and it is just at this time being used to produce the most efficient incandescent lamps of our knowledge. It was the recently discovered differences between this gas and other gases which made this lamp possible. When its existence and properties were known, its application was relatively simple and easy.

Our American people are quick to see the value of new things where value exists. They are given, in this era, to actively utilizing every scheme which means better health, greater safety, greater pleasures, greater profits, and greater economies. We can hardly conceive of a people devoting their lives to inactivity and idleness. To better living conditions, to improve and extend manufacturing industries, and to conserve

resources is quite generally the life aim of our ablest men.

A nation or a race does not stand still. It either advances or falls behind its neighbors. Knowing more has been the means of every nation's advance.

Research is a convenient word which covers the pioneer work upon which advances are founded. It is significant that as life becomes more and more complex, it is ever less possible for advances to be made by accident or by the designs of an individual working for short periods on different subjects. The day of that inventor is past who discovers an animal carrying a new hide, who modifies the shoe machinery or devises a new button or button-hole. Each of these and a thousand other such details are now the fertile fields in which groups of trained experts are at work. We want shoes badly and there are many of us. We want them to wear well, even to the enamel on the brass eyelets. The fact that we are collectively willing to pay hundreds of thousands, or even millions of dollars for some slight improvement in a shoe or additional economy in the manufacture, indicates not only that we are many, but that we want actively every possible improvement and economy.

A Benvenuto Cellini lived and left the impression that he did all the work of an army of artists, inventors, soldiers, politicians, murderers, and—I may as well add—biographers. Besides his autobiography, he wrote books on the goldsmith art, sculpture and bronze, foundry practice, architecture, and poetry. There are none extant like him.

A Franklin wrote equally advanced discourses on electricity, on coal stoves, on the recently united states of America which he represented, on economy, on philosophy, and many other subjects. We have few Franklins and Cellinis to day.

Today the research chemist, with his analytical methods, the metallographist, with his microscope, the physicist with his pyrom-

eter, the mechanical engineer with his tensile strength apparatus, and the coke, gas, oil and electric furnace experts are each separately working on the still wonderfully complex cast iron of which a stove is made. Certainly they will not be satisfied, nor will we, the people, be satisfied, with any final state, so long as we can conceive of a better one. Iron must cast better, must rust less, be stronger, be permanent in the grate bar, be cheaper, keep an unaltered color, and so on.

The entire work involved in developing such new devices and processes may be called research, but there is a part of it which deserves more careful attention than the rest. This part is sometimes called pure research. Most people mean by this term the search after new knowledge, without reference to its utility. Others mean the search for new and useless knowledge. There certainly are searchers after new truth who do not wish to see the usefulness of their disclosures. But facts of nature or true principles of science live forever and are sure to be useful. The attempt at worship of pure research for its own sake, as is often done, is merely the tipping backward of those who wish to stand erect, unbent by sordid aims in their search after truth.

Bergson points out that the essential object of science is to enlarge our influence over things. He says:

"Science may be speculative in its form, disinterested in its immediate ends; in other words, we may give it as long a credit as it wants. But however long the day of reckoning may be put off, some time or other payment must be made. It is always then, in short, practical utility that science has in view."

A fair example of scientific research lies in the history of our talking at a distance. First, we called out as loudly as we could and the strongest voice was the best telephone. The use of some new knowledge which was not immediately or obviously connected with the voice was later put to use, and a tin or iron pipe was used for short distances as a speaking tube. After this idea was disclosed, plumbers, tinsmiths, or pipe fitters could do the rest. Then, later, the possible application of formerly entirely undreamt of principles to the increase of the speaking distance was tried. Those to which I refer were the electromagnetic principles which, in short, produced the telephone transmitter and receiver. These changed the short, thick pipe into a long, thin wire. I regret that I cannot go into detail to point out the extended researches which, without the

slightest premonition of telephony, had to be made before the knowledge was at hand to enable Bell to contribute his part. Joseph Henry, for example, studying in the basement of an Albany school, had to wind wires with insulation and study the properties of the magnet, and this had to be followed by the studies of many others for half a century. To the early art, in the pipe stage, the telephone wire may have looked merely like a more refined pipe of the same material, but it was not. There were entirely new, and what I may call remote, principles, brought into play and added to the metal of the pipe. These were discovered by patient scientific research of the highest order. The outcome could not have been foreseen from any knowledge of pipes or piping. In a practical treatment of the subject of Research and the Industries, this point must be made clear. The final gathering of the fruits of the labor of research often seems as little anticipated by the real planting done by search for new knowledge, as the picking of the fruit of a tree seems anticipated by burying a seed in the ground. Nevertheless, the developments are the same in the two cases. It may be for this reason that the President of the Carnegie Institution, in his 1914 report, referred to the work of the Institution in the words:

"The general reader must take it for granted (provisionally, at least) that these investigations are in the main worth undertaking . . . for in proportion as such investigations are fundamental, and hence worth carrying on, they will be difficult of exposition and more difficult of comprehension."

Of the lines of activity of that Institution, the farmer sees value in the studies in heredity in cattle, but wonders why anyone should want to synthesize rocks; the glass maker who sees value in the geophysics work, wonders why the sun spot work is of use, while the naturalist* says: "The sublime ideas of infinity of space and time, and the beauty of the simple laws of planetary motion, have had a value to mankind far transcending that of any so-called practical application of stellar science." Thus, those who have had the broadest comprehension have generally most highly valued pure research.

So we are now in our day apparently seeing our telephone wire grow finer and longer. Talking from New York to San Francisco is a thing of every day commercial experience. This, in turn, was due not alone to the use

* R. G. Harrison, President of the American Society of Naturalists, Philadelphia, 1913.

of longer wire or lower resistance or more delicate instruments (what Bacon calls an increase in the efficient), but involved new, remote ideas, the result of research. Such is the Pupin loading coil, for example, which has made long distance telephony possible. We are also aware that to all appearances the telephone wire is now being drawn so fine that it is altogether disappearing, and wireless telephony is an accomplished fact. This becomes possible not through finer wire drawing, but by the application of *newly discovered laws or principles of nature*. It was not even done by those who were most industrious in construction of telephones, any more than the tin speaking tube was really displaced by the tinsmith. The work was done by those already trained scientific investigators, who were learning new facts of physics or electricity which, at some stage of their work, seemed applicable to telephonic use. This new work, this pioneer obtaining of facts which never revert to the undiscovered state, constitutes research.

Our government, among others, has schemes for the promotion of research. One of them is the patent law. If a discoverer will disclose his discovery to the public, he may exercise a monopoly of it for seventeen years. In some cases this is very encouraging, but it seems to have at least one serious defect. The discovery, besides being new, must be, at the same time, useful. With many great discoveries this is not the case. It may seem ridiculous to favor useless discoveries, but it is quite the reverse. The thing to encourage is the search and finding of new facts, principles, laws, and habits of nature; i.e., additions to our knowledge without reference to immediate value. These are the surest guarantees of ultimate utility. The process of making knowledge useful is not half so difficult nor so rare as is the production of the knowledge itself. But the rewards usually go to the man who shows us the utility. For this reason we must plan better ways of encouraging scientific research. To emphasize this is the only object of this paper. It is being done to some extent. Many of those, living and succeeding under our system of advance, have realized the way the seeds have first to be sown. They have usually selected some special field where the utility to be expected from newly disclosed facts would be of greatest public good. In this spirit have been established many of those research institutions which are devoted to the health of the people, the cure of disease, etc. These are starts

in the right direction and are naturally made where the need is most painful.

Of a little more remote benefit is such research work as is being carried out by the Research Corporation, from whose minutes the following abstract was made:

"This far-sighted and patriotic conception found its realization through the 'Research Corporation' which for administrative reasons was substituted for the Smithsonian Institution as the custodian of Dr. Cottrell's endowment. The objects of the Research Corporation as stated in its Charter are:

"'To provide means for the advancement and extension of technical and scientific investigation, research and experimentation by contributing the net earnings of the corporation, over and above such sum or sums as may be reserved or retained and held as an endowment fund or working capital, to the Smithsonian Institution, and such other scientific and educational institutions and societies as the Board of Directors may from time to time select in order to enable such institutions and societies to conduct such investigations, research and experimentation.'

"Organized in 1912 as a stock corporation but precluded by its charter from paying dividends and capitalized by a group of gentlemen desirous of furthering Dr. Cottrell's objects, without personal profit, the Research Corporation undertook and successfully accomplished the installation of the Cottrell processes in various industries throughout the country, with the result that in two years' operation its surplus has provided the capital of twenty thousand dollars required by its charter, and a fund of over one hundred thousand dollars for scientific research."

A few such steps as this one would soon build up a fund of new knowledge. I think it is safe to say that most of our new knowledge of physical, chemical, and electrical phenomena has come to us through the publications of various scientific societies. The work was largely done as a by-product of poorly paid services in colleges and universities of the world. Let me illustrate this point. The general field of colloid chemistry is open for investigation. There is surely no more fertile field. It touches all the reactions of living organisms and most of those of organic and inorganic chemistry, from the growth of cells through immunity to disease in animals, to the decay of metals, from the coloring of glass and dyeing of fabrics, to the production of a river delta

or the manufacture of an automobile tire. It is being largely done as the by-product or hobby of a few teachers in their spare time. As the principles governing this part of chemistry are made known, the applications in useful processes will be rapid, but there are many men ready to perform the latter operation compared to the few who are making known the laws involved. For every investigator who might point out from his experiments the possibility that the antitoxic action of immunized blood serum might lie in the magnitude of the electric charges on the colloids concerned in the reactions, there are hundreds of others who will ably test the hypothesis when it is advanced. For every chemist whose experiments go to clarify the laws of tensile strength and the wear and friction of colloidal materials, for example, there are hundreds who will test his conclusions in new aero-metals and automobile tires. We in this country are particularly active in putting the "useful" into the invention, but we are less active in the study for the "new." For this reason it is necessary to encourage research of the advanced type. Anyone who has followed the subject knows that, during the past ten or more years, the amount of research work in connection with the industries has greatly increased. Large manufacturing companies in many lines have groups of men who devote all their time to advancing the methods of manufacture by more or less pure research. They are never expected to become part of the production department, but are always kept on the exploring line in laboratories. There are now research laboratories connected with almost every art and profession. The American canners and the American dentists have them, as well as the companies making powder and shot, and those making armor plates. There are laboratories devoted to research on paper and others on paint, some working on cements and others on soils, some on gas lights and others on electric lights, some on fertilizers, others on sterilizers, and some on almost everything. They could all use more knowledge to advantage if they could get it. If there were no way to increase the rate of our acquisition of knowledge, then this argument would be useless, but we have had a lesson from Germany during the past forty years which shows one way of increasing the world's stock of knowledge. It is by encouraged or endowed research. Germany did it through her universities. Every year there were turned out one or two

thousand men with the degree of doctor of philosophy. This meant that each one had done a couple of years' research work and, in most cases, freely published it. The stock of investigators in the country was rapidly increased. The industries and the arts felt the effects. In 1912 there were 1703 of these doctorates conferred there, 705 were on science and 355 in chemistry. How could such a country stand still in industry? Last March, Lord Haldane, addressing a teachers' meeting in London, said:

"We are behind the level which has been reached by several of our competitors, a level which will put us in peril. We cannot dissociate national progress from the basis of knowledge, even when it comes to the question of making money."

This conclusion is only a year old, but it is being proved.

In addition to the very helpful and important university methods of Germany, there should continue in America, beyond what is done by government laboratories and bureaus, the natural extension of the ideas exemplified by the cancer research laboratories and hospitals, the Rockefeller Institute for Medical Research, the Carnegie Institution, the Smithsonian undertakings and others.

Here also a start has been made in such work as Dr. Duncan inaugurated in the Mellon Research Laboratory at Pittsburgh and at the University of Kansas, in the very recent Brush endowed fellowships at the Nela Park laboratories, and in the Mayo brothers endowment at the University of Minnesota.

Dr. Woodward, President of the Carnegie Institution, has recently said: "Successful research requires neither any peculiar conformity nor any peculiar deformity of mind. It requires rather peculiar normality and unusual patience and industry." This certainly applies as well to the researches of an Edison, devoting his life to the immediate utilities, as to the abstract researches of the mathematician. It is for this reason that research ought to and does succeed in its applications in the case of many industries. In the industrial research laboratories, normality, patience and industry are apt to be encouraged. Interruptions are there at a minimum. Equipment, power, facilities and the rest are made a matter of some one's business. On the other hand the universities and colleges, which are forced to combine with short hours and short years the teaching of science and the methods and habits of research, are still our foremost organized

research institutions. It seems possible that manufacturing companies may offer in the future nearly as great assistance to the increase of useful knowledge. Co-operation between laboratories of research in universities and industries has already been the subject of considerable study. There is a committee of one hundred of the American Association for the Advancement of Science which was appointed to encourage it. Naturally, with so great an undertaking, the progress may be slow. It is certainly possible for industrial laboratories to economically add to scientific knowledge and to grow in the process. This fact is being recognized.

It is unfortunately true that most of what we may call the new knowledge in physical science of the past decade has had to cross the Atlantic for us. No one knows this better than those Americans who make the most use of it. The fundamental knowledge behind almost every utility which Yankee ingenuity has assisted, grew on older soil than ours. The list is almost discouraging to an American. The encouraging view to take is that we have it within our power to force the future to write different history. It is unfortunately quite safe to predict, for example, that just as most of our technical advances of the past can be traced to early fundamental discoveries in academic fields in Europe, so also we will have to see here future applications of still more modern European scientific thought. A wonderful list of useful results, processes, products, conveniences, cures and economies are sure to be produced by applications of the new knowledge of such things as radium, X-rays, wireless waves, electrons, crystal structure, atomic numbers, canal rays, none of which were "made in U. S. A."

In physical science there is but little chance that our country will do its full share for years to come. If the wisdom of attempting it, rather than confining attention to short-sighted application of research to pressing commercial problems can be gradually recognized, the future is assured. It is surely the duty of our American research laboratories to contribute effectively in the advance of knowledge, and particularly is this true of those richly endowed with men, new materials and appliances.

And so I return to the cardinal point in any suitable consideration of research in its relation to our industries. Search for new knowledge is the insurance for the future of the industries. Many of them will later be

manufacturing things not even conceivable today. The past has proved it. Most of the present products will, like the ox-yoke and flail of our grandfathers, be replaced in our factories by utilities more fitting to our new needs and less exhaustive of our energies and assets. This change is practically continuous. Technical complacency is like the mercuric chloride tablet taken internally—it means a lingering suicide. The incandescent lamp business will serve me for illustration, because I am more familiar with it than with others. I have seen whole factories entirely overhauled a number of times in the past few years, in order to make the newest lamps. Not only have entire floors of complicated and expensive machines for making carbon lamps been thrown out and new machinery for making metal filament lamps installed, but before packing cases containing new machines could be opened and unpacked in the factory they have been thrown out as useless, as the advance from squirted metal filaments to drawn wire filaments proved the better way. Before the limit of factory efficiency on vacuum lamps could be reached, the introduction of nitrogen into the lamps brought the factories an entirely new factor, and now, before the consumers have more than commenced to feel the effects of the nitrogen-tungsten lamps, the manufacture of argon and its introduction into the incandescent lamp becomes a reality. If the research laboratories which discovered the means for bringing about these changes, with their corresponding economies, could tax the consuming public a cent for every dollar thus saved to the public, the laboratories would receive over a million dollars a year to spend for further research. This is not written in a spirit of dissatisfaction at all, but rather to point out what is probably true in many fields. The people are the ones most interested in research, though they may not know it. It is easier seen in therapeutic and curative research, but even there the more ignorant fail to realize the great lasting value of such work.

Bacon wrote:

"For man, being the minister and interpreter of nature, acts and understands so far as he has observed of the order, the works and mind of nature, and can proceed no further: for no power is able to loose or break the chain of causes, nor is nature to be conquered by submission: whence those twin intentions, human knowledge and human power, are really coincident; and the greatest hindrance to workers is the ignorance of causes."

THE 45,000-KW. SYNCHRONOUS CONVERTER SUBSTATION OF THE ALUMINUM COMPANY OF AMERICA AT MASSENA SPRINGS, N. Y.

By J. L. BURNHAM

DIRECT CURRENT ENGINEERING DEPARTMENT, GENERAL ELECTRIC COMPANY

AND R. C. MUIR

POWER AND MINING ENGINEERING DEPARTMENT, GENERAL ELECTRIC COMPANY

The installation described in this article is of special interest for the large kilowatt rating of the individual units and the large total capacity coupled with the extraordinarily high amperage distinguish it from any we have previously described. The authors give many interesting details concerning the construction and operation of the synchronous converters, transformers, and circuit breakers, in addition to other important data.—EDITOR.

The cost of electrical energy represents such a small part of the total cost of manufacture in most industrial products, that a factory location favorable to raw products and the market is often more important than a location where cheap power can be obtained. In the reduction of aluminum, however, each pound produced represents an energy consumption of approximately 15 kw-hr., which makes it essential to locate the reduction plant where electrical energy can be obtained at a very low figure. For this reason the Aluminum Company of America first located one of their large plants at Massena Springs, New York, where a hydro-electric development of considerable size was possible. As soon as the full capacity of this development was utilized arrangements were made with the Cedars Rapids Manufacturing and Power Company for the provision of an additional 60,000 h.p. from a large development on the St. Lawrence River, about fifty miles distant. The Cedars plant was completed and put in operation the first week in January, 1915, and since that time power has been transmitted to the receiving substation at Massena.

The receiving substation at Massena is particularly noteworthy in that it is the largest rotary converter substation in existence; the synchronous converters are the largest 60-cycle units ever built, the transformers involved unusual construction difficulties, the combined ampere rating of the circuit breakers totals over one-half million amperes and the arrangement of apparatus from the incoming high tension lines to the outgoing pot lines is unique in many ways. The design has been carried out with one predominant idea, directness of connections. The current passes through the station in practically a straight line, the apparatus being arranged in the following order, starting from the high tension buses: disconnecting switches, oil switches, transformers, alter-

nating current circuit breakers, synchronous converters, direct current circuit breakers, direct current busses, pot line circuit breakers.

The substation is composed of two parallel buildings separated by a court 30 ft. wide and connected only by the walls at the end and a passageway at the center. One building contains the high voltage transformers and oil switches and the other contains the synchronous converters, circuit breakers and controlling switchboard.

Incoming Lines

The voltage is stepped up at Cedars from 6600 volts by two 24,000-kv-a. banks of transformers connected delta-delta.

Power is transmitted at 110,000 volts, three-phase, 60 cycles over a single steel tower double-circuit transmission line. Each circuit consists of three aluminum cables of 500,000 c.m. with a steel core of 114,110 c.m. A 7-strand, $\frac{1}{2}$ -in. galvanized steel grounding cable is also supported by the towers. The insulators are of the 10-in. disk suspension type, seven units being used on the top and bottom cross arms of the suspension towers and eight units at all other attachments.

Electrolytic lightning arresters are installed in the yard adjacent to the substation. The ends of the transmission lines are anchored on the roof, one at each end of the substation. Connections are dropped down to cross wires supported by strain insulators between the two buildings and from there entrance is made through wall entrance bushings into the transformer room.

High Voltage Connections and Switches

The following description can probably be followed more easily by referring to the one-line diagram of connections shown in Fig. 1 and to the photograph of the high tension room shown in Fig. 2. The incoming lines, one at each end of the transformer room, pass

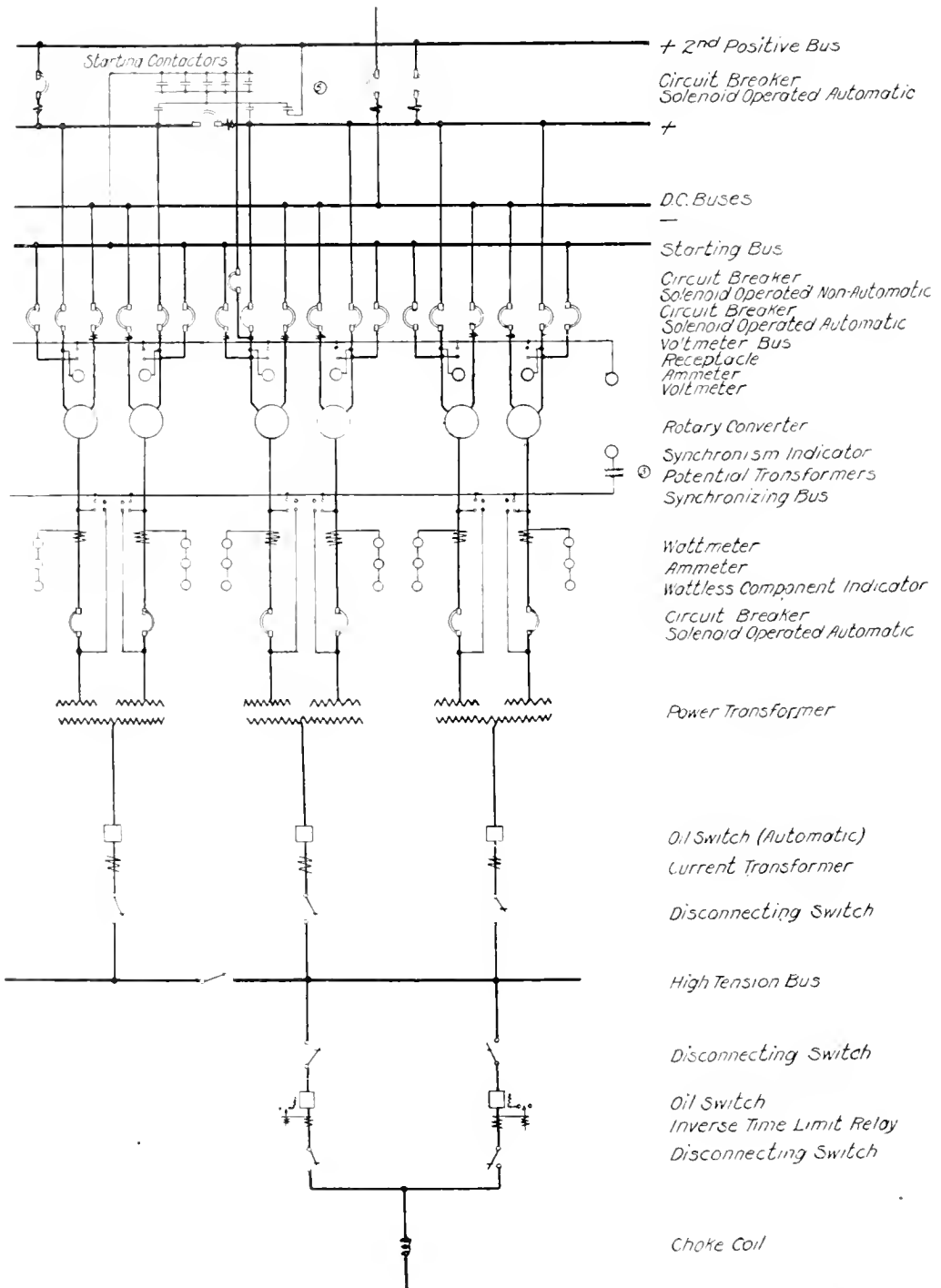


Fig. 1. A One-line Diagram of the Connections for three transformers and six converters in the substation. The connections for the other machines are similar

through choke coils and then through parallel disconnecting switches, oil switches, and disconnecting switches to the high tension bus. Parallel switches are used simply to guard against interruptions, either switch being of sufficient capacity to carry the full load of the line.

The high tension bus is composed of aluminum rods supported from the ceiling by suspension insulators. It runs the full length of the station but provisions are made between transformers 2 and 3, 4 and 5, 5 and 6, and 7 and 9 to open the bus by means of disconnecting switches. The disconnecting switches are all arranged to be operated from the floor, the three poles opening simultaneously. A sectionalizing oil switch is also placed between transformers 5 and 6.

The high tension connections to the transformers are made in a rather novel way. The connections first pass from the high tension bus through a disconnecting switch mounted on the wall then out over the transformer to an oil switch mounted on steel framework and wheels (located adjacent to the transformer) and thence to the transformer leads. The object in mounting the oil switches on an elevated framework was to keep all high tension connections a considerable distance above ground, to shorten the connections, to make the arrangement compact and to facilitate repairs. The minimum clearance between the high tension connections is 4 feet 7 inches, the same distance as is allowed between the high tension transformer terminal and the connection passing from the disconnecting switch to the high tension oil switch.

The oil switches are solenoid operated and are controlled from the benchboard in the machine room. Inverse time limit relays, which operate from bushing type current transformers, are provided for all of the high voltage switches.

Transformers

There are nine transformers, each rated 5000 kv-a., with a 40 deg. C. temperature

rise. They are 110,000-volt "Y" connected (ungrounded) units with three-phase primaries, with two secondary windings each of 377 volts, and with six-phase diametrical connections. The high tension winding is furnished with taps so that with a potential

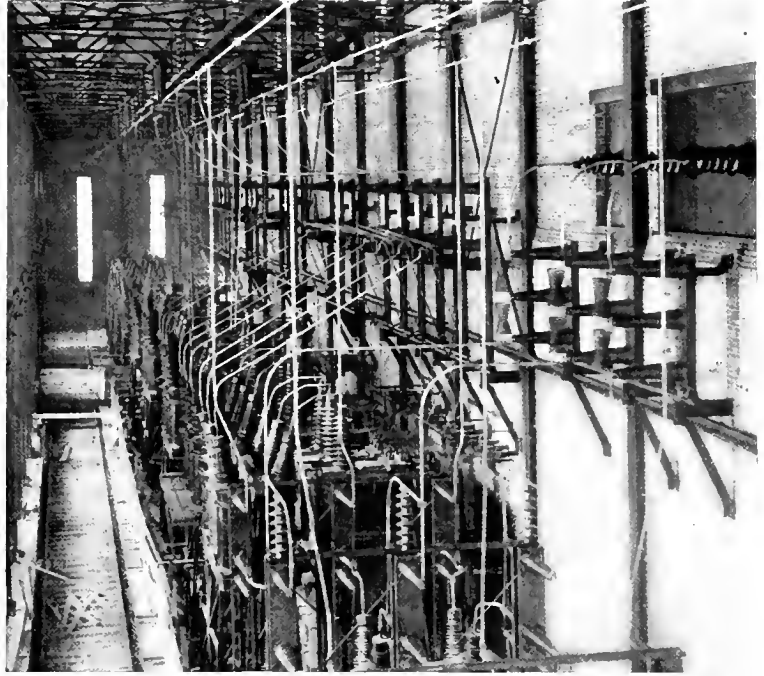


Fig. 2. General View of the High-Tension Room showing transformers, oil switches, and 110,000-volt connections

of 110,000 volts there can be obtained on the total low voltage winding the following voltages: 396, 377, 366 and 356 volts.

Each of the twelve low voltage connections have a normal current carrying capacity of 2210 amperes and the problem of bringing out the necessary connections involved many difficulties in the design and construction of the transformers. It was impossible to arrange the connections inside the transformer in such a manner as to provide convenient connections to the rotary converters, therefore, a system of copper bar cross connections were provided just outside each transformer, whereby all the leads could be run directly to the converters without further crossing. The fact that it required a ton of copper to make these bar connections for each transformer gives some idea of the difficulties involved.

The transformers are of the shell type, water-cooled. A central oiling system is

provided from which the transformers and oil switches can be filled with filtered oil. Provisions are made for draining the transformers and oil switches to the central reservoirs, a complete system of piping being installed in passageways under the floor.

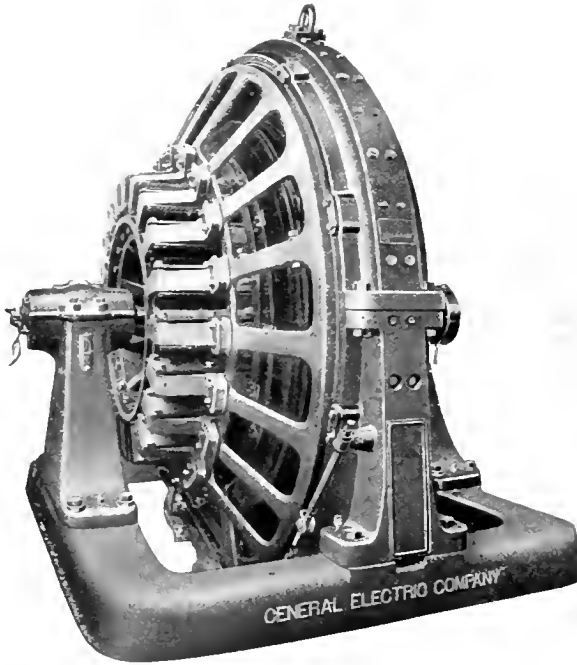


Fig. 3. The Direct-Current End of One of the 2500-kw. Synchronous Converters used in the substation

Synchronous Converters

The illustration on the cover of this issue of the REVIEW shows the interior of the synchronous converter room, with seventeen of the eighteen 2500-kw. machines in operation.

Not many years ago the 60-cycle rotary converter attained a reputation for sensitiveness in operation which was usually manifested by flashing at the commutator. Pulsation and alternating or direct current line disturbances frequently caused flash-overs and shut-downs. These troubles have now been practically eliminated by better line construction and protective devices and by the more uniform speeds of prime movers, as well as by improvements in the design of the rotary converter.

This largest installation of synchronous converters thoroughly establishes the reliability of the 60-cycle converter operating under reasonably good conditions.

Each of the eighteen units is rated at 2500 kw., at 500 to 525 volts. They will

operate at 5000 amperes with the voltages reduced to 300. With a higher temperature rise, they will carry 3125 kw. continuously, giving a total station output of 56,250 kw.

As the load is held continuously at the rating for long periods, all parts were more liberally designed, to insure low heating and good commutation, than would be necessary for usual services with lower load factors.

On account of the large amount of energy available on short circuit, which might be caused by errors in operation, etc., the protection of the commutator and its brush rigging was made unusually complete. Each brush-holder is fitted on the trailing side with a moulded asbestos piece to prevent burning in case of such accidents as would cause flashing. The leading side of each group of brushes is protected by a one-piece barrier and another barrier, extending entirely around the commutator next to the armature, completes the enclosure of all the brush-holders.



Fig. 4. The Direct-Current Ends of the Converters as installed, showing the moulded asbestos pieces on the brush-holders

A severe short circuit with flashing has occurred without any damage by burning to the brush-holders or other parts.

Fig. 3 shows the barriers on the trailing side of the groups of brushes and the one extending around the commutator next to

the armature. Fig. 4 shows the moulded asbestos protection on each brush-holder.

In other respects the construction is standard for 60-cycle commutating pole converters. The balance of the armature circuits is assured by the use of equalizers that connect to every slot of the winding. The construction of the equalizers, which are mounted on the collector side of the armature, is shown in Fig. 5. It will be seen that they are supported by U-bolts, which take all of the strain and are adjustable for any shrinkage of insulation. The dampers in the pole faces are of grid construction with copper rods passing through the pole face close to the surface. The through rods are accurately fitted on a taper into the side bars to insure a permanently good contact. The brushes on both the commutator and collector rings are self-lubricating and thus greatly reduce the labor of operation. Two of the machines are provided with a brush

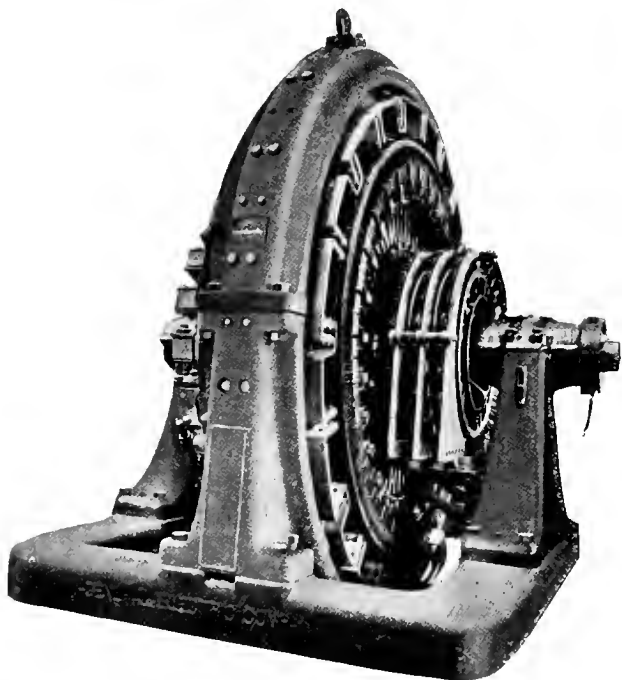


Fig. 5. The Alternating-Current End of the Converter shown in Fig. 3

raising device in order that the brushes may be quickly raised to avoid sparking when starting from the alternating current side. The other sixteen machines are always started as direct current motors and synchronized.

Circuit Breakers

The alternating current circuit breakers are located along the transformer house side of the synchronous converter room and the direct current breakers are located along the pot house side of the room, as is shown in the cover illustration.

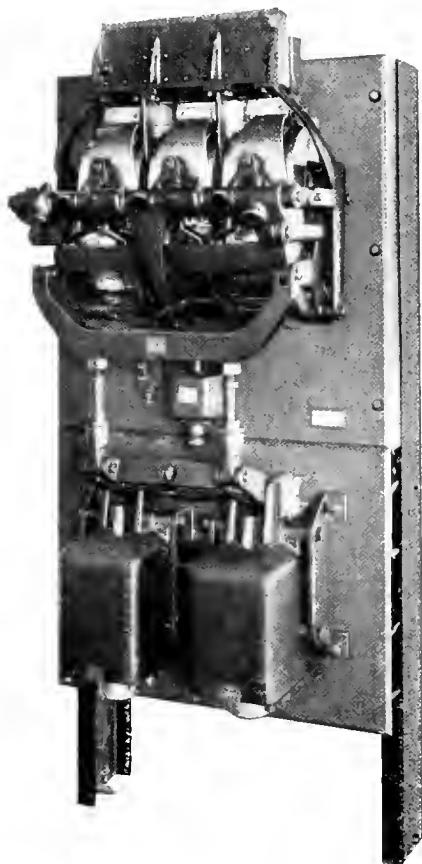


Fig. 6. One of the 20,000-ampere Direct Current Circuit Breakers that are installed in the substation

The alternating current breakers are three-pole units of 2300 amperes capacity and the direct current breakers are of 1000, 5000, 10,000 and 20,000 amperes capacity; the various breakers being used for starting, running, bus section-alizing and pot lines respectively. All the breakers are solenoid-operated, designed for 500 volts and are rated at their normal continuous current carrying capacity. On overloads the breakers open automatically by means of a direct acting trip which releases the locking latch when the plunger of the

tripping coil is raised. The 5000-ampere positive breakers are also equipped with reverse current relays.

Fig. 6 shows one of the 20,000-ampere breakers. It represents the most recent construction for solenoid-operated breakers of unusually large capacity. The compactness and neatness are especially noticeable.

Switchboard

All the switches and circuit breakers are controlled from a gallery type of benchboard located in the center of the machine room on the transformer house side.

The synchronous converters are started automatically from the direct current side and then synchronized across the alternating current circuit breakers. A starting bus and two automatic starting panels are provided for this purpose.

Control wires are all run in iron conduits directly to the various switches. The control circuit is fed by a small storage battery.

Two 35-kw. motor-generator sets, one alternating current driven and the other direct current driven, are provided for charging the battery. These sets are provided with automatic starters and are started from the main control board.

While there is nothing unusual about this benchboard, except its size, it is thoroughly modern and in keeping with the remainder of the apparatus.

The engineering and construction was carried out under the supervision of the engineers of the Aluminum Company of America and the apparatus was furnished by the General Electric Company, Schenectady, N. Y.

In view of the size and importance of the undertaking, it is particularly gratifying to those concerned that the substation was completed and started up on schedule time and has since operated continuously in regular service in a most satisfactory manner.

PROTECTIVE COATINGS FOR METAL

By H. B. C. ALLISON

RESEARCH LABORATORY, GENERAL ELECTRIC COMPANY

The author has compiled a very valuable resumé of the most effective processes of forming protective coatings for metals. Each process is dealt with in such a brief and concise manner that will make this contribution particularly useful for the purpose of reference.—EDITOR.

Introduction

This brief review of some of the processes at present in use for protecting metals from oxidation will be confined to two types: firstly, that in which the metal itself is made more resistant, usually by some chemical treatment; and secondly, that in which another metal is used as a surface coating.

In the first instance a coating is formed which must possess the following properties, if it is to be successful: It must be homogeneous, continuous, resistant to attack by acids or alkali, firmly attached to the base metal and must have a similar expansion coefficient. The ideal metal coating should also be homogeneous and continuous, but should be strongly electropositive to the base metal and should form electropositive alloys with it, so that in case of oxidation the coating will be attacked and the base metal protected.

As iron is the metal most commonly used as the base, the processes chosen will be those used for its protection, although some may be applicable to other metals.

Protection by Oxide Coatings

It was known for a considerable time before any process was devised that the black or magnetic oxide formed on iron, under certain conditions, was a very fair protective coating. Attempts to control and improve this coating have led to a number of patented processes, of which two may be taken as typical.

Bower-Barff Process

The pieces to be treated are heated to a temperature of 900 deg. C. in a closed retort. When this temperature has been reached, superheated steam is admitted for 20 minutes and a coating consisting of a mixture of red and black oxides is formed. Producer gas is then substituted for the steam and allowed to act for the same length of time. After cooling somewhat, the pieces are oiled and a smooth, green-back coating is produced, which affords efficient protection from sea water, acid fumes, etc., and will stand a wide variation in temperature.

Gesner Process

This is a further development of the above process. The pieces to be treated are maintained at 600 deg. C. for 20 minutes, after which steam at low pressure is let in at intervals for 30 minutes. The steam, on entering, passes through a red hot pipe at the base of the retort, and is thus partially decomposed into hydrogen and oxygen. After this treatment a small quantity of naphtha or hydrocarbon oil is introduced and allowed to act for 15 minutes to reduce any red oxide, and also to carbonize the surface. The coating is said to be a compound of iron, hydrogen and carbon, and analyses have shown that a minimum of 2 per cent hydrogen is present.

It is an improvement on the Bower-Barff process in that the danger of warping, due to high temperature, is removed, the size of the piece is practically unaltered, and the tendency to scale is much less.

Both of these processes are quite expensive, but users have usually found the protection afforded of sufficient benefit to warrant the added expense.

Protection by Chemical Means

There is one process which may be of interest in this connection, known after its inventor as "Coslettizing."

The pieces to be coated are first cleaned as usual, either by pickling or sand blasting, and are then placed in a boiling water solution of phosphoric acid, in which iron or zinc filings are always present. The period of treatment is from one-half to three hours, depending on the thickness of the coating desired. After drying, the pieces are usually oiled. By this treatment a very slight amount of the surface of the article is converted into certain phosphates of iron, but most of the coating comes from the solution itself.

This coating has been found to be particularly useful in the tropics, and is used in one instance for typewriters. It is not a complicated process or an expensive one and the finish is very durable. It is, however, subject to patent restrictions.

Protection by Another Metal

The agent used in the majority of cases for protecting iron is the metal zinc. Zinc is strongly electropositive to iron and so are its alloys, if free from impurities. It is also readily available and may be applied by a number of processes.

Hot Galvanizing

The oldest process is that of hot galvanizing, which consists simply of cleaning the piece, coating with a suitable flux and then dipping in the molten zinc. The piece is usually wiped after this to improve the coating. This process has the disadvantages of limiting the thickness of the coat, of plugging any small holes, of the composition of the coating being variable, and the possibility of including injurious and corrosive substances in the coating, which may cause early failure.

Lohman Process

A modification of this process is known as the Lohman process. After cleaning, the article to be coated is dipped in the Lohman bath, which is a solution of hydrochloric acid, mercuric chloride and ammonium chloride; it is then dried before immersing in the molten metal, which may be any one or a mixture of a number of metals such as lead, zinc, and tin. The chief point in its favor seems to be that the junction between the iron and the protective alloy is kept free from all oxide, and, therefore, the alloy will fill all the pores and no corroding agent can be included.

It is claimed by its backers that a graduated alloy is formed so that the protective coating cannot be completely broken through except by breaking the sheet itself.

Cold Galvanizing

Another process which is being used more and more as it is improved is that of wet galvanizing or electroplating. In this case the article to be coated is suspended as a cathode in a suitable bath and is subject to easy control. It provides a coating of high purity and uniform thickness in general, but recesses and corners cause some trouble. It is liable to be more or less porous and may contain acid which will eventually cause failure. In both of these processes, hot or cold, the coating does not become intimately connected with the base metal through deep alloying.

Sherardizing

The latest process of this type is sherardizing, and it is undoubtedly the most perfect as a protection. The object to be sherardized is placed in an iron drum which is filled with a mixture of finely powdered zinc and zinc oxide, in varying proportions, and is heated in a reducing or inert atmosphere for a period of time, the length of which depends on the

thickness of coating desired. The coating so obtained consists of four protective layers. Next to the pure iron is an alloy "C," rich in iron, upon which is another definite alloy "B," containing more zinc. Then there is a layer containing a number of more or less unknown alloys, and finally a layer of pure zinc. This makes a coating which is not easily broken down and which is continuous. The principal objections to its use are the high temperature to which the piece must be subjected and the increase in size which may be caused.

The theory which has been advanced to explain this process is interesting in that it may be considered as a distillation process. The zinc dust which is obtained from the zinc smelters is said to be in a state of unstable equilibrium, so that in contact with the hot iron it undergoes a change tending to restore it to the normal condition. During this change some of it alloys with the iron, thereby lowering the vapor pressure for zinc in that region. A slow distillation then begins from the zinc nearest the object to the object itself. As the alloy becomes richer in zinc the difference in vapor pressure becomes less and less and then finally becomes zero. This is found to be the case in practice. The deposition becomes slower as the time is extended.

Calorizing

This recently developed process makes use of aluminum as the protective metal and is of particular advantage in preventing oxidation at high temperatures. The protective action is due to the oxide formed by the action of heat on the protecting metal, rather than to any electrolytic relations between the aluminum and the base.

It has been found very useful in the case of iron utensils subject to direct contact with flames at temperatures up to 1000 deg. C. and also in the case of boiler tubes, for the life is increased many times by this treatment and the saving in the cost of replacements is much greater than the additional initial cost of calorizing.

Schoop Process

One of the most recent processes, and one of the most promising, is the Schoop process. This is applicable to the deposition of metals or alloys on any sort of an object. The apparatus consists of a pistol into which the coating metal is fed as a wire. It passes through a straightening and centering device into the nozzle, where it is fed through a

burner whose temperature may be regulated from 700 deg. to 2000 deg. F. The molten metal is carried a short distance by the gas current and is suddenly caught by a powerful blast of compressed air which shoots it out of the nozzle with a velocity of 3000 feet per second, directly on the object to be coated, which is held a short distance away. The coating is homogeneous, continuous, and of any desired depth, and is also exceedingly intimate.

The following explanation of the theory is given by the inventor:

"The theory is that the gaseous medium used is much larger in volume at any moment than the drop it has pulverized and is carrying, and the gas is expanding so rapidly that its temperature is far lower than that of the spray. A rapid exchange of heat, therefore, takes place between them, which consolidates the molten particles and gives them a temperature far below the melting point. If the particles arrived in a liquid state at the base with the observed velocity of 3000 feet per second, they would simply splash on the surface and largely rebound. As a matter of fact they impact and inter-penetrate freely, and the later bombarding particles unite with the earlier ones to form homogeneous compact bodies. In accounting for the observed action of the Schoop spray at the receiving base, it is supposed that the cooled particles of the metal, just before impinging with great velocity on a hard surface, are in an abnormal physical condition. Due to the heat of collision they pass directly into a vapor which condenses and solidifies on the relatively cold receiving body, penetrating by osmotic pressure the superficial pores of the base when an affinity for the latter exists, and otherwise driven in by the pressure behind it. In either case it condenses and solidifies after penetration, and is effectively dovetailed into the base. The hammering and bombardment of the solidified first coat by the minute succeeding particles is practically a process of cold working. The entrained particles liquidify and solidify so rapidly that the metal has not time to return to its natural crystallized state."

In conclusion it should be stated that there are many other processes in use which could not be mentioned in a brief review of this type. Those processes outlined were chosen as representative of the various different means used to obtain the desired protection because of their prominence, or of some new feature which they contain.

THE IRON-COBALT ALLOY, Fe_2Co , AND ITS MAGNETIC PROPERTIES

BY TRYGVE D. YENSEN

ENGINEERING EXPERIMENT STATION, UNIVERSITY OF ILLINOIS

The author first briefly refers to the work of earlier investigators in preparing pure iron and iron cobalt and in testing these substances. He next describes the preparation and testing of his own samples, and records by tables and a summary the conclusions derived from the tests, viz., the magnetic properties and apparent usefulness of the iron-cobalt alloy.—EDITOR.

During the last four years experiments have been carried on by the writer in the Engineering Experiment Station of the University of Illinois on the magnetic properties of pure iron and iron alloys¹. Electrolytically refined iron has formed the basis of these experiments, and, in order to prevent contamination, the melting has been done in a vacuum furnace. On account of the high permeability and low hysteresis loss obtained by the vacuum method of melting, it was suggested to the writer by Dr. Jacob Kunz that an iron-cobalt alloy of the composition Fe_2Co , melted in vacuo, might show some interesting properties. This alloy was produced by Dr. P. Weiss² of Zurich in 1912, who found that it had a saturation value of magnetization 10 per cent higher than that of pure iron. Previous to that time the magnetic properties of iron in intense fields had been investigated by Ewing and Low³, Du Bois⁴, Gumlich⁵, and by Hadfield and Hopkinson⁶. The intensity of saturation, I_s , obtained by these investigators for pure iron ranged from 1680 to 1750, and, until Weiss produced his Fe_2Co alloy, it was generally accepted that no alloy had a higher saturation value than pure iron.

This article gives the results obtained for pure iron and for the alloy, Fe_2Co , melted and annealed in vacuo. For the sake of comparison a sample of Fe_2Co , obtained from Dr. P. Weiss, was tested both in the original state as forged, and after being remelted in vacuo. Furthermore, the following commercial grades of iron were tested and the data included here:

1. Ordinary cold rolled steel
2. Standard transformer steel
3. 4 per cent silicon steel
4. Swedish charcoal iron.

Numbers 2 and 3 were received from the manufacturers and had received their standard heat treatment.

The results include the magnetic properties in low, medium and intense fields, the electrical resistance, the mechanical properties, chemical analysis and microstructures.

Materials, Apparatus and Methods

As already mentioned, the iron for this investigation consisted of doubly refined electrolytic iron containing 0.02–0.03 per cent impurities. The melting was done in an Arsem type vacuum furnace, capable of melting 600 grams of iron at a pressure of 0.5 mm. of mercury. The charge was left in the furnace until cold, and the resulting ingots were then forged into rods $\frac{1}{2}$ in. in diameter. From these rods the test pieces were machined into the proper form.

The magnetic testing in low and medium fields was done by means of the Burrows compensated double bar and yoke method using rods 14 in. (35.5 cm.) long and 0.392 in. (0.966 cm.) in diameter.* The saturation values were obtained by Dr. E. W. Williams of the Physics Department. He employed for this purpose an electromagnet with conical pole pieces between which a field of 10,000 gilberts per cm. could be obtained. The test pieces consisted of ellipsoids about 1 cm. long. After testing as forged the magnetic test pieces were annealed at 900 deg. C., and then at 1100 deg. C. The annealing was done in a vacuum furnace to prevent oxidation.

Results

The results of the investigation are shown in the following tables and figures. In Table I

* For details regarding the magnetic testing as well as other matters concerning the investigation the reader is referred to Bulletins Nos. 72 and 77 of the Engineering Experiment Station of the University of Illinois.

No. 1 Magnetic and Other Properties of Electrolytic Iron Melted in Vacuo, ¹Bulletins Nos. 72 and 74, Engineering Experiment Station, University of Illinois, 1914.

No. 2 The Effect of Boron upon the Magnetic and Other Properties of Electrolytic Iron Melted in Vacuo, Bulletin No. 77, 1915.

²Compt. Rend. 156, 1970-72, 1913.

³Proc. Royal Soc. 42, p. 200, 1887.

⁴Phil. Trans. 180A, p. 221, 1889.

⁵Phil. Mag. 29, p. 293, 1890.

⁶Elektrotech. Zeitschr. 30, p. 1065, 1909.

⁷Journ. Inst. Elect. Engrs., Dec., 1910.

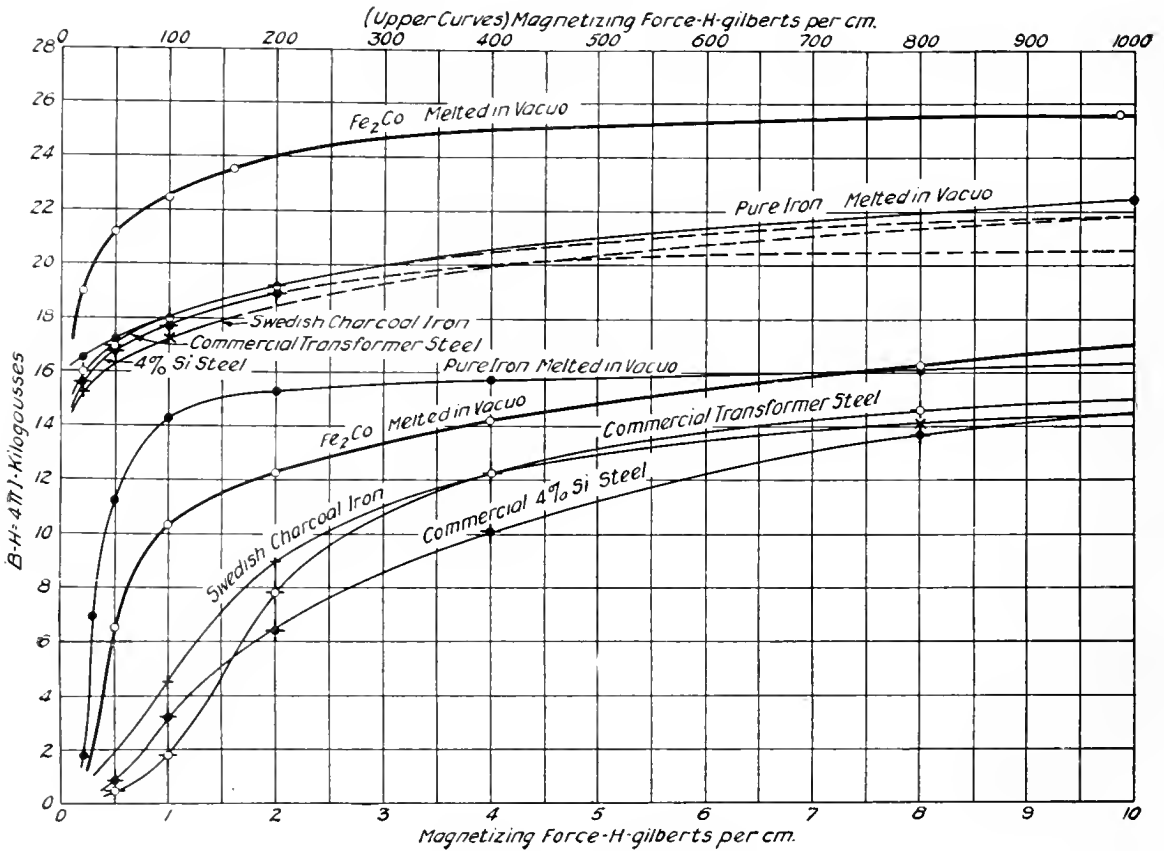


Fig. 1. Magnetization Curves for Various Grades of Iron and Iron Alloys. Annealed

the various specimens are listed, together with the chemical analysis in case this was made. These specimens did not all receive the complete set of tests, however, because test pieces were lacking in some cases. The iron-cobalt alloys, although forging and machining readily, were quite brittle when cold, and on that account the rod forged from specimen No. 3Co01 broke in the lathe due to the carelessness of the machinist. This specimen, therefore, could not be used for magnetic tests in low and medium fields. The only specimens for which complete sets of tests were obtained are the pure iron specimen—which is an average representative of a large number—and specimen No. 3Co02, but suffi-

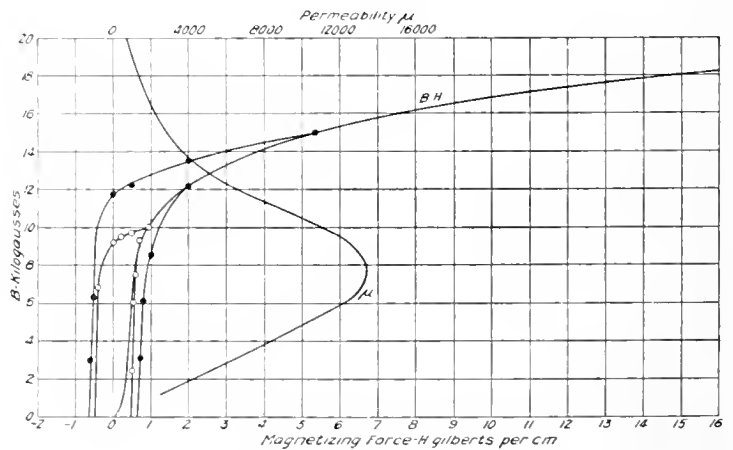


Fig. 2a. Hysteresis Loops and Permeability Curve for Iron-Cobalt (Fe₂Co) Melted in Vacuo. Annealed at 900 deg. C.

cient data are available for the rest to allow definite conclusions to be drawn.

TABLE 1

SPECIMENS TESTED

- Electrolytic iron, melted in vacuo, C—0.01 per cent. Si—0.01 per cent.
- No. 3Co01, iron-cobalt, melted in vacuo, at a pressure of about 3.0 mm. Hg. Co—33.36 per cent.
- No. 3Co02, iron-cobalt, melted in vacuo, at a pressure of about 1.0 mm. Hg. Co—33.33 per cent.
- No. 3Co03, iron-cobalt, melted in vacuo, at a pressure of about 0.5 mm. Hg.
- Iron-cobalt, forged from a casting obtained from Dr. P. Weiss.
- Same as above, remelted in vacuo at a pressure of 0.5 mm. Hg.

COMMERCIAL GRADES

- Cold rolled steel
- Standard transformer steel of commercially high permeability
- 4 per cent silicon steel for transformer cores
- Swedish charcoal iron C—0.163 per cent, Si—0.032 per cent, S—0.0002 per cent.

The magnetic properties are shown in Tables 2 and 3 and in Figs. 1 and 2. The magnetic properties in the forged state are not included, as they are of interest merely to show the vast improvement obtained by annealing*. The electrical resistance is recorded in Table 4, and the results of the mechanical tests are given in Table 5. Figs. 3 to 5 inclusive show the microstructure of some of the specimens tested.

Discussion of Results

From the chemical analysis it appears that the iron-cobalt alloys contain 33.33 per cent cobalt and may thus be said to conform quite closely to the formula Fe_2Co .

Before discussing further the iron-cobalt alloy, it may be of interest first to give some attention to the pure iron specimen with which it is compared. In the results published by the writer about a year ago on pure iron melted in vacuo, 19,000 was given as the

* The reader who is particularly interested in this phase of the investigation is referred to Bulletin No. 72 of the Engineering Experiment Station of the University of Illinois.

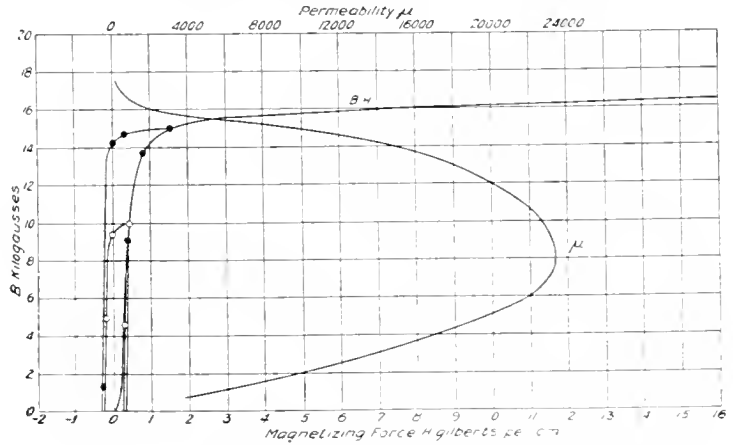


Fig. 2b. Hysteresis Loops and Permeability Curve for Pure Iron Melted in Vacuo, Annealed at 900 deg. C.

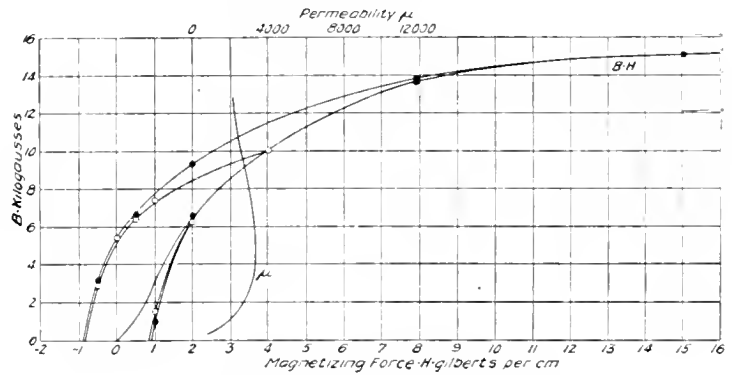


Fig. 2c. Hysteresis Loops and Permeability Curve for Commercial 4 per cent Silicon Steel, Annealed

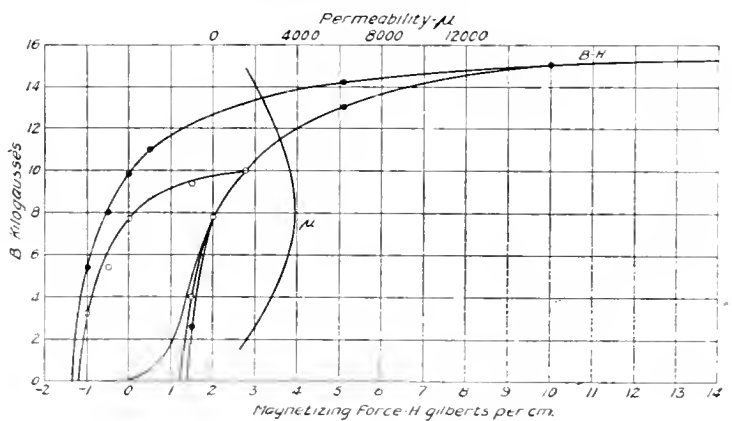


Fig. 2d. Hysteresis Loops and Permeability Curves for Commercial Transformer Steel, Annealed

maximum permeability obtained. By improved apparatus and refined methods of testing, this figure, instead of being an exception, has been shown to be below the average

TABLE 2
 I_s —SATURATION INTENSITY OF MAGNETIZATION

Specimen	As Forged	Annealed at 900 deg. C.	Annealed at 1100 deg. C.
Pure iron—melted in vacuo ¹	1798	1803	1803
Fe ₂ Co—No. 3Co01—melted in vacuo ¹	1977	1967	1967
Fe ₂ Co—No. 3Co02—melted in vacuo ²	2036	2039	2039
Fe ₂ Co—No. 3Co03—melted in vacuo ³	2057	2048	2048
Fe ₂ Co—obtained from Weiss	1977		
Same, remelted in vacuo ³	2038		
	As rolled		
Cold rolled steel	1750		

¹At a pressure of about 3.0 mm. Hg.

²At a pressure of about 1.0 mm. Hg.

³At a pressure of about 0.5 mm. Hg.

TABLE 3
 MAGNETIC PROPERTIES

Specimen	Maximum Permeability	Density for Maximum Permeability Gauss/cm	HYSTERESIS LOSS ERGS PER CC. PER CYCLE		COERCIVE FORCE GILBERTS PER CM.		RETENTIVITY GAUSSSES		Heat treatment
			for $B_{max} = 10000$	for $B_{max} = 15000$	for $B_{max} = 10000$	for $B_{max} = 15000$	for $B_{max} = 10000$	for $B_{max} = 15000$	
			Pure iron—melted in vacuo	22,800	10,000	820	1,700	0.27	
Fe ₂ Co—melted in vacuo	13,200	8,000	1,460	3,200	0.48	0.65	9,100	12,000	
COMMERCIAL GRADES									
Standard transformer steel	3,850	7,000	3,320	5,910	1.20	1.33	7,700	9,900	Received manufacturer's standard heat treatment
4% silicon steel	3,400	4,000	2,260	3,030	0.88	0.88	5,400	5,400	
Swedish charcoal iron	4,850	6,500	2,490	4,530	0.88	0.95	6,900	8,000	Annealed at 900 deg. C.
Pure iron—melted in vacuo	24,300	8,500	686	1,655	0.22	0.26	9,300	13,000	Annealed at 1100 deg. C.
Fe ₂ Co—melted in vacuo	8,800	8,000	2,230	4,400	0.75	1.00	9,300	12,300	

TABLE 4
 ELECTRICAL RESISTANCE
 Microhms per CC. at 20 Deg. C.

Specimen	As Forged	Annealed at 900 deg. C.	Annealed at 1100 deg. C.	Remarks
Pure iron—melted in vacuo	9.90	9.85		
Fe ₂ Co—No. 3Co02—melted in vacuo	9.55	10.15	10.10	
Fe ₂ Co—No. 3Co03—melted in vacuo	9.25	9.72	9.60	
COMMERCIAL GRADES				
Standard transformer steel		11.00		Received manufacturer's standard heat treatment
4% silicon steel		51.00		
Swedish charcoal iron		10.57		

TABLE 5
 RESULTS OF MECHANICAL TESTS

Specimen	AS FORGED				ANNEALED				Reduction of Area %	Remarks	
	Stress at Yield Point lbs/sq. in.	Ultimate Stress lbs/sq. in.	Elongation %		Stress at Yield Point lbs/sq. in.	Ultimate Stress lbs/sq. in.	Elongation %				
			1	2			1	2			
Pure iron—melted in vacuo	40,600	42,630	5.5	32.0	71.0	16,100	35,500	25.0	49.0	78.0	Av'ge for several spec.
Fe ₂ Co—No. 3Co01—melted in vacuo	73,400	97,500	< 1.0	3.0	3.0	30,800	30,800	< 1.0	< 1.0	< 1.0	
Fe ₂ Co—No. 3Co02—melted in vacuo						29,450	29,450	< 1.0	< 1.0	< 1.0	
Swedish charcoal iron	—	40,000		36.0	57.0						As cut from plate

1. Elongation before specimen has commenced to "neck."

2. Ultimate elongation.

as obtained today. The magnetization curve and hysteresis loop for pure iron as shown in Fig. 1 and Fig. 2b, represent average results recently obtained, giving a maximum permeability of 23,000 at a flux density of 8000 gauss. The hysteresis loss for $B_{max} = 10,000$ and 15,000 is 764 and 1610 ergs per cc. per cycle, respectively.

With regard to the saturation values, it is seen from Table 2 that the results obtained in this investigation show that the iron-cobalt alloy, Fe_2Co , has a saturation value about 13 per cent higher than that of pure iron, irrespective of the method of melting. However, the saturation values both for pure iron and for the iron-cobalt alloy are raised about 3 per cent by melting the substances in vacuo. While the saturation value is primarily of scientific interest, Fig. 1 shows that the iron-cobalt alloy may be of practical importance in the electrical industry. While its magnetization curve is 13 per cent above that for pure iron at saturation, it is 25 per cent higher in medium fields, such as $H = 50$ to $H = 200$. It crosses the pure iron curve at $H = 7.5$ and remains below at lower densities. However, its maximum permeability is 13,500, which is much higher than is obtained for the best grades of transformer iron at the present time. Its hysteresis loss, too, is as low as or lower than that in commercial grades of iron. Its chief importance, however, lies in its high magnetic permeability at high densities. An increase here of 25 per cent,



Fig. 3a. Pure Iron, Melted in Vacuo. As forged. 50 diam.

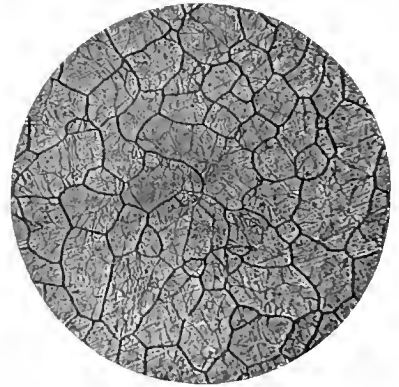


Fig. 3b. Pure Iron, Melted in Vacuo. Annealed. 50 diam.



Fig. 4a. Iron-Cobalt, Fe_2Co , No. 3 Co01, Melted in Vacuo. As forged. 50 diam.



Fig. 4b. Iron-Cobalt, Fe_2Co , No. 3 Co01, Melted in Vacuo. Annealed. 50 diam.



Fig. 5a. Iron-Cobalt, Fe_2Co , No. 3 Co02, Melted in Vacuo. As forged. 50 diam.



Fig. 5b. Iron-Cobalt, Fe_2Co , No. 3 Co02, Melted in Vacuo. Annealed. 50 diam.

when coupled with a low hysteresis loss, is a highly desirable characteristic, for instance,

for the teeth of the armatures of dynamo machinery, where the density is always very high. Without going into detail, a few considerations will make this apparent. By increasing the density in the teeth 25 per cent—which is allowable by using the Fe_2Co alloy—the armature may be shortened a corresponding amount. As the increased density in the teeth necessarily means an increase in the density of the air gap, the latter may be shortened so as to keep the field ampere turns for the air gap and the teeth the same as before. Furthermore, the inside diameter of the armature core may be increased so as to give a smaller core cross-section. The shortening of the armature also shortens the pole pieces and if a high permeability alloy is used in the field magnetic circuit as well as in the armature, the cross section of the field core and yoke may also be reduced. From the above reasoning it follows that the armature, besides requiring less iron, will also require less copper; and the field spools, while containing the same number of ampere turns as before, will also require less copper. The total reduction of iron and copper may thus amount to as much as 25 per cent each. Passing from the amount of material needed to the energy losses in the machine, it is readily seen that the I^2R loss is reduced in direct proportion to the reduction in copper used. Furthermore, as the hysteresis loss is lower per pound for the Fe_2Co alloy than for ordinary iron, and as the eddy current loss is about the same, the total core loss should be considerably less than with ordinary iron, in spite of the increased density. Thus, it would appear possible with this iron-cobalt alloy to construct dynamo-machinery considerably lighter than at present, and with a higher efficiency.

The mechanical properties of this iron-cobalt alloy, as seen from Table 5, are not particularly advantageous. In the forged state, while rather brittle, it is considerably stronger in tension than pure iron. After being annealed at 900 deg. C., however, its tensile strength has decreased to about one-third, and it is even more brittle than in the forged state. It may be that the alloy could be annealed at a lower temperature than 900 deg. C., and retain some of the strength that it exhibits in the forged state, at the same time acquiring the magnetic properties obtainable by annealing 900 deg.

The electrical resistance of the Fe_2Co alloy, as seen from Table 4, is about the same as for pure iron, and makes the alloy unsuitable

for use in places where the eddy current loss is of chief importance.

Annealing the Fe_2Co alloy at 1100 deg. C, as seen from Tables 2 and 3, reduces the permeability and increases the hysteresis loss considerably, although the saturation value remains the same as before.

Summary and Conclusions

The results set forth in the previous pages relating to the iron-cobalt alloy, Fe_2Co , may be summarized as follows:

1. The iron-cobalt alloy, Fe_2Co , has a saturation value of magnetization 13 per cent higher than that of pure iron. However, the values for the vacuum product, both for pure iron and for the Fe_2Co alloy, are about 3 per cent higher than for the corresponding grades melted under ordinary conditions.

2. When melted in vacuo its maximum permeability is above 13,000 at a density of 8000 gauss. While this is considerably lower than the maximum permeability found for pure iron, melted in vacuo, its permeability in medium fields such as $H=50$ to $H=200$ is 25 per cent higher than that for pure iron or for commercial grades of iron.

3. Its hysteresis loss at densities of 10,000 gauss or below is considerably less than for the best grade of commercial transformer iron. At densities of 15,000 or above the hysteresis loss is about the same as for this commercial iron, at the same densities.

4. Its specific electrical resistance is about 10 microhms, or about the same as for pure iron.

5. Mechanically it is brittle but fairly strong. Annealed, the ultimate tensile strength of the Fe_2Co alloy and of the pure iron is about the same, while in the forged state the alloy is more than twice as strong as pure iron.

In this iron-cobalt alloy, Fe_2Co , is thus found a substance that is suitable for use in places where the magnetic density is very high, such as armature teeth of dynamo machinery. While its electrical resistance is low, there is reason to believe that this may be raised by the addition of other alloying elements.

The cost of cobalt prohibits the general use of this alloy at the present time, but there are indications that the price of cobalt will be less in the future.

It is the writer's intention before long to make a more systematic study of the iron-cobalt series, as it may reveal alloys with

even more desirable properties than the ones recorded in this article.

In conclusion the writer wishes to acknowledge his indebtedness to Dr. Jacob Kunz for suggesting the possibilities of the investiga-

tion, to Dr. Elmer H. Williams for the saturation values of magnetization, to Professor E. H. Waldo for criticizing the manuscript, and to Mr. W. A. Gatward for assistance with the magnetic testing.

CONTROL AND PROTECTION OF ELECTRIC SYSTEMS

BY CHARLES PROTEUS STEINMETZ

CHIEF CONSULTING ENGINEER, GENERAL ELECTRIC COMPANY

We have from time to time published quite a number of articles dealing with the many problems involved in the Control and Protection of Electric Circuits, but none covers the complete subject so fully as the present paper. The clearness and simplicity with which the subject is handled are typical of the author; meters, transformers, circuit-breakers, reactances, grounds and short circuits, arcing-grounds, time-limit devices, relays, lightning, surges, impulses and stationary waves are all taken into consideration. This paper was presented before a joint meeting of the Electrical Section of the Franklin Institute and the Philadelphia Section of the A.I.E.E.—EDITOR.

When the first commercial electric circuit issued from a station the problem of control and of protection arose. It was a simple problem at first: an ammeter and voltmeter to measure current and voltage; a knife-blade switch to send the current into the desired path, or withdraw it; the fuse to open the circuit in emergencies; and if the wires became crossed and fuse and switch failed, generator and engines stopped and not much harm was done.

With the extension of the circuits into the suburbs some lightning troubles were felt and led to the introduction of lightning arresters—in the early days based mainly on hope and trust in providence rather, as very little was known of lightning phenomena.

Since these days, less than a generation ago, enormous changes have taken place, and the electric systems have increased in size, in voltage, and in extension.

Where 100-horse-power machines were large once, now steam turbine alternators of 40,000 horse power and more are in commercial operation. The steam engine has made room for the steam turbine, and the steam turbine does not stop when the wires are crossed and a short circuit occurs, and the momentum of the turbine disks, revolving at velocities of 300 to 400 miles per hour, can supply ample energy for the destruction of any part of the system.

Feeders of 10,000 horse power or more, generators of 40,000 horse power have to be controlled by switching: an attempt to open such a circuit by the knife-blade switch of old would lead to the destruction of the switch—and probably its operator.

Instead of small machines operating separately on independent circuits, huge

generators now feed in parallel into the system of busbars, on which is concentrated all the power of the station or the group of stations which are tied together. Numerous stations and systems of interconnected stations of 100,000 to a quarter million horse power and over are in operation, and the half-million horse power mark has been reached.

Anywhere on the busbars of the station or in the feeders near the station there is available, destructively in case of an accident, as a short circuit, not only the entire power of the station, or perhaps half a million horse power, but the far greater power which the station generators can give momentarily.

Short-circuit currents of forty to fifty times normal full load current may momentarily flow from some turbo-alternators, representing ten and more times full load power.

Such a station, or group of closely interconnected stations, of half a million horse power full load capacity, may momentarily send into a short circuit at the busbars over five million horse power. This is the power of Niagara: for Niagara is estimated variously at from 5,000,000 to 15,000,000 horse power.

It is obvious that no switch or circuit breaker can be built to safely open such power, to suddenly stop Niagara, especially when considering that many hundreds of feeders issue from the busbars, that in any one of these feeders a short circuit in the cable may let loose the power of the entire system, and every feeder thus requires such a circuit breaker.

With half a million horse power station capacity, a momentary overload capacity ten times as high, assuming that we could

build a circuit breaker to open this short circuit power as quickly as in three to four cycles, or one-eighth second: this would require to dissipate in the circuit breaker the energy of over 200,000,000 foot-pounds—the destructive energy of 1000 tons dropping from a height of 100 feet. This is about the energy of a projectile of 2000 pounds weight leaving the cannon at the velocity of 2500 feet per second. It is the destructive energy of two heavy railway trains, of 400 tons each, going at sixty miles per hour, and meeting in head-on collision. It is the energy of the explosion of thirty pounds of dynamite.

Equally great has been the increase of voltage: where once 2000 volts were high-voltage distribution, in circuits of a few miles length, now circuits of hundreds of miles length are in operation at voltages of 100,000 to 150,000. Such voltages jump toward any object for over a foot distance, and will maintain arcs of practically unlimited distance; that is, with 100,000 volts and practically unlimited power back of it, an arc can extend for hundreds of feet. Thus no simple switch will open such voltages under power.

Transmission systems at high voltages have been interconnected with each other into networks, which spread and extend, and already today often represent thousands of miles of interconnected high-voltage lines, covering tens of thousands of square miles, and picking up every lightning, every atmospheric disturbance within this entire area.

Thus the lightning protection also has become a far larger problem than in the small circuits of old.

But far greater than the energy of any lightning stroke is the energy stored as magnetic field surrounding the conductors, as dielectric field radiating from the conductors of these big transmission systems, and if this internal energy of the system is set surging, its effects are far more destructive than those of lightning, and the effects may not be merely momentary, as those of lightning, but continual, as machine energy continually replaces the stored internal energy which causes the destructive surge.

And, in addition hereto, far greater reliability and continuity of service is today demanded from the electric systems than was in the early days, and that at a lower cost of electric energy; and it must be remembered that, with the increasing cost of living, electricity is one of the few commodities which has steadily decreased in price.

The foremost problem of control of electric systems thus is that of controlling enormous powers; the foremost problem of protection is that against self-destruction by its own power.

Current and voltage have grown beyond the values for which instruments can be built, and *current transformers* and *voltmeter transformers* are interposed between the circuit and the instruments measuring it. With the general introduction of parallel operation, *power-factor indicators* are required to insure the division of load without excessive waste currents; *frequency indicators* and *synchronizing devices* to safely connect machines into the system.

With hundreds of feeders radiating from the generating station, the office of the load dispatcher has become essential, and the necessity of keeping exact records of all operations and of all accidents and incidents is of the greatest importance. Automatic recording devices thus have been developed, as the *multi-recorder*, to record, within fractional seconds, all important events, as opening and closing of switches, starting and stopping of generators, surges, lightning disturbances, etc. Such automatic devices afford a valuable check on the operating staff, but more important still is their record in emergencies, where a number of things happen almost at once, where the attention of the operators is detracted from accurate observation by the necessity of action, and the record thus could be made only afterwards from memory, which is not very accurate in such a period of excitement. It is just in such abnormal conditions where the most complete and accurate record is of greatest importance, to enable the engineers to determine with certainty what happened and why it happened, so as to take steps to guard against its recurrence.

Oil circuit breakers have been developed, which can safely and without disturbance close and open the feeder circuits of over 10,000 horse power, the generator circuits of 40,000 horse power and more, with an ample margin of overload capacity. In these the circuit is opened under oil with such mechanical arrangement of contacts and oil vessel that in the moment of circuit opening the current is extinguished at the end of a half wave by the rapid expansion and chilling of the oil vapor which is produced by the opening arc, and which in the first moment is under high compression, due to the momentum of the oil, which has to be set in motion.

The most serious danger, in the growth of electric systems, was, however, the possibility of self-destruction by the power let loose under the short circuit, and there were anxious years for the operators and managers of these large electric systems before the industry devised the means of safely controlling unlimited power. More than once, when a serious short circuit occurred and a disaster was averted only by luck, the system was cut into two or three sections and these operated independently, to limit the power. But when months passed without further accidents, invariably, due to the requirements of economy and reliability of operation, the sections came together again and parallel operation of the entire system was restored.

This, the most serious problem of the high-power electric system, was solved by the development of the *power limiting reactances*.

In the generator leads, between generators and busbars, are inserted reactances, capable of standing enormous overloads, of a size sufficiently small not to interfere with the normal flow of power at full load or any overload which the generator may be called upon, but large enough to materially limit the generator current and power at short circuit. Usually the *generator reactances* limit the momentary short-circuit current to about ten to twelve times full-load current; that is, the momentary short-circuit power to about two and one-half times full-load power. This solved the problem for medium-sized stations. Thus in a 60,000-horse power station, instead of a possible short-circuit power of over half a million horse power, the power is limited to 150,000 horse power.

However, even with generator reactances, with increasing size of station, the power which may be let loose under short circuit becomes large beyond control; with a 400,000-horse power station, with generator power limiting reactances, a million horse power may still be concentrated at a short circuit.

Busbar reactances then were introduced; that is, the busbars divided into sections by reactances sufficiently small not to interfere with the interchange of power along the busbars, and thereby retaining the advantage of parallel operation, but large enough to limit the flow of power, which, in case of a short circuit on one busbar section, can flow into it from the adjoining sections.

With such reactances in the busbars and in the tie feeders between the stations, the system is divided into sections of about 60,000 horse power each. A short circuit then can

seriously involve one busbar section only, and the destructive power of a short circuit is limited to that of one section, plus the limited power which can flow from the two adjoining sections, a total of 150,000 to 200,000 horse power, and this is within the emergency limit of the modern oil circuit breaker of moderate size. It still represents a terrific energy, nearly 10,000,000 foot-pounds, and is a severe strain on the circuit breaker.

These busbar reactances permit an unlimited extension of the system, and the short circuit on a section of a half-million-horse power system is no more severe than a short circuit on a 100,000-horse power system, and there is now no limitation to the future increase to electric systems of many millions of horse power capacity, operating in parallel on one set of busbars.

With hundreds of feeders radiating from the busbars, the probability of a short circuit in feeders is far greater than in the busbars, and a material advantage, therefore, is given by *feeder reactances*; that is, reactance interposed between the feeder or a group of feeders and the busbars, so that a short circuit in the feeder is still more limited than a short circuit in the busbars.

By the development of generator reactances, busbar reactances, and feeder reactances, the problem of the power control of large systems for protection against self-destruction by short circuit has been solved and unlimited extension of systems without any increase of danger has been made possible, and experience has shown that after the introduction of such power-limiting reactances dead short circuits have occurred at the busbars of very large systems without even interfering with the operation of most of the synchronous apparatus on the system.

Not all three classes of reactances are always necessary: in systems of moderate size busbar reactances may not yet be needed. In low-head water-power plants, with slow-speed multipolar alternators of inherently limited short-circuit current, generator reactances may be unnecessary and only busbar reactances required. Such, for instance, is the case at the Keokuk plant on the Mississippi River. Again, with a perfect system of generator and busbar reactances, feeder reactances may be dispensed with—though they are even then an advantage.

In high-voltage transmission networks, even of very high power, power-limiting reactances sometimes may not be required or

are less essential. With a considerable number of medium-sized water-power plants feeding into a transmission system, the power of each individual generating station may not be sufficient to give destructive values under short circuit, and the impedance of the lines between the generating stations may be sufficient to limit the power which can feed into the short circuit at one station. In transmission networks, therefore, power-limiting reactances are necessary only in very large generating stations, such as the Keokuk station, or where several fairly large stations are close together, and also, as generator reactances, in turbo-alternators connected into the system as steam reserve.

To cut off a disabled line or feeder with the voltages and powers of our modern systems is beyond the capacity of the fuse or simple blade switch, and automatic oil circuit breakers are generally used. However, the problem has become more difficult by the increasing demand for reliability and continuity of service.

The two main sources of troubles in lines and cables are *grounds* and *short circuits* between phases. In transmission lines a ground on one phase is the most frequent trouble, and short circuits are rare except in lines in which the design was faulty, or reliability had been sacrificed to cheapness, and the spacing between conductors chosen too small, so that they swing together during wind storms, etc. A short circuit is far more serious than a ground, as in the former the current is limited only by the generator capacity, while with a ground the current has no return—except if the neutral is grounded, and then over the resistance of the neutral—and the current, and with it the shock on the system, is therefore very much less, especially if safeguards against the occurrence of high frequency by *arcing grounds* are installed. In a well-designed transmission line a short circuit usually occurs only as the result of two simultaneous grounds. A ground on one conductor, however, raises the voltage against ground of the other two phases, from the Y voltage to the delta voltage of the system, and thereby increases the strain on the insulation of the other two phases. It thus either introduces the danger of a second ground, causing a short circuit, or requires a higher grade of insulation.

This has led to two methods of operation of transmission systems. In one the neutral of the transformers is grounded, frequently

through a resistance where the resistance of the ground is not high enough to limit the current. Then a ground on one phase is a partial short circuit to the neutral, and causes a large current to flow, and thereby opens the automatic breakers and cuts off the circuit before the ground has developed to a short circuit. However, this method, the "*grounded Y system*," means a shutdown at every ground, every flashover of an insulator by lightning, etc. In the other the neutral of the system is not grounded, the insulation of the circuit being made good enough to safely stand the increased strain put on it by a ground on one phase, and by an *arcing ground suppressor*, etc., care is taken not to continue an arcing ground—leading to high frequency disturbances—but convert it into a metallic ground. In this case, the "*isolated delta system*," service can be maintained on the circuit, even if one phase grounds, until arrangements are made to take care of the load, or the fault found and remedied, and the continuity of service thus is not interfered with. However, the cost of line construction is higher, due to the better insulation required. The relation between grounded Y and isolated delta thus is that of cheapness *versus* reliability and continuity of operation, and, as a rule, we find grounded Y systems where lowest cost of development is considered essential and occasional interruption of service not considered objectionable, while the isolated delta is generally preferred in systems in which reliability and continuity of service are considered as of first importance, such as in the extension across the country of the great Metropolitan Edison systems—systems which are proud of their record that the voltage has not been off their busbars for ten years or more.

Different are the conditions in underground cable systems. In a cable the three conductors are so close together that a ground on one conductor quickly reaches the other conductors and becomes a short circuit. A grounded cable, therefore, cannot be kept in service, but has to be cut out as promptly as possible. In these systems it therefore is customary to ground the neutral through a resistance sufficiently low, in case of a ground on one conductor of a cable, to allow sufficient current to flow to open the circuit breaker and cut off the cable, but sufficiently high not to give a severe shock on the system. Or, where grounding of the neutral is considered undesirable, an arrangement of relays is made to give the same effect. With under-

ground cables such cutting off of a disabled feeder does not interfere with the continuity of service, as a number of feeder cables are always used in multiple for every important substation.

However, the problem of cutting off a disabled feeder by the operation of the circuit breaker, due to the large current taken by the grounded feeder, is not so simple. Assuming that three cables feed in multiple into a substation, and one of these feeders grounds: a large current then flows from the generating station into this cable to ground, and the circuit breaker at the generator end of this feeder opens. This, however, does not stop the current rush, but a large current still flows through the damaged cables into the ground, coming back from the substation, and flows to the substation from the generating station through the two parallel feeders, which are undamaged; that is, short-circuit current feeds back through these two cables over the substation, and these two cables also open their overload circuit breakers, cutting off and thereby shutting down the substation. If the substation is connected by tie feeders to adjoining substations, current feeds back into the faulty cable over these tie feeders from adjoining substations, and these tie feeders, and the cables feeding the adjoining substations from the generating station, open their circuit breakers by overload, and in this manner a ground in one cable may shut down a number of substations, possibly the entire system. *Time-limit devices* in the circuit breakers are insufficient to protect against such extended shutdowns resulting from a single fault in a cable. A permanent time-limit is not permissible in large systems, as with a dead short circuit the circuit breakers must open instantly before extensive damage is done by the large power of the short circuit. Therefore, so-called "*inverse time-limit*" circuit breakers are generally used; that is, circuit breakers in which the time limit of their operation decreases with increasing overload. Such circuit breakers would first cut off the cable carrying the greatest excess current—that is, the faulty cable—and then those of less excess current; but, as with the cutting off of the faulty cable—at both ends—the excess current stops, other cables should not be interfered with. However, the inverse time-limit circuit breaker necessarily must be practically instantaneous under short circuit, and therefore, while the time limit discriminates between 100 or 200 or 300 per cent overload, it cannot

discriminate between short circuits of various severity; that is, not only the faulty cable, but its parallel undamaged cable, and the tie cables to other substations, etc., would open, and, while the extent of the shutdown would be somewhat limited, it is still far beyond the extent permitted by reliability of service.

Thus devices become necessary to select a disabled feeder and cut it out without cutting off its parallel feeders or the tie feeders to the substation served by the faulty feeder, regardless of what excess currents these may carry. This is a problem which has not yet been completely solved.

As the result, in general in high-power systems of high standard of reliability the radial system of substation supply is used; that is, each substation is fed by a separate set of cables, and the substations are not interconnected into a network by a system of tie feeders. This radial system, however, is materially less economical in feeder copper than the interconnected network, since the radial system requires for each substation a feeder capacity equal to the maximum power demand of the individual substation, while in the network, by cross-feeding between the substations, the feeder capacity is reduced to that required by the average maximum demand of the substations.

To avoid a shutdown of the substation by a fault in one of its feeders, the different feeders of the same substation are not connected in parallel in the substation, but feed separate translating devices, as transformers and converters, and are paralleled in the substation only on the secondary side of transformer or converter. In case of a faulty feeder, the current feeding back into the fault over the other feeders of the same substation, therefore, has to pass through two sets of translating devices, and this limits it sufficiently to allow the time limit relay of the circuit breakers to operate and cut out the faulty feeder without opening the other feeders; that is, without shutting down the substation.

However, the economic disadvantage of the radical system remains, and an effective *selective feeder relay*, which could be relied upon to pick out the faulty feeder and no other, would offer material advantages.

Such a selective device is afforded by the use of *pilot cables*. Each cable or feeder is duplicated by a smaller low-voltage, three-phase cable, which joins the secondaries of current transformers connected into the two

ends of the main cable. If the main cable is undamaged, the same current comes out of it as flows into it, and the connections to the pilot cable are such that in this case the secondary currents would be in opposition; that is, neutralize each other. If, however, the main cable grounds, current flows into it from both sides, the secondary currents in the pilot cable then add, and the current flowing in the pilot cable operates the relay which opens the circuit breaker. This arrangement is very perfect in operation, capable of cutting out the damaged cable whether feeder cable or tie cable, without interfering with any other cable, but it has the formidable disadvantage of doubling the number of cables required in the system, and, while the pilot cables are small and of low voltage, they occupy room in the underground ducts which carry the electric circuits in American cities. Thus this method of control by pilot cable is, due to its high cost of installation, very little used in this country.

Another method is that of the "*split conductor*" cable. Every cable conductor is made of two parts, of which the one surrounds the other concentrically, with some insulation between them. Normally there is no potential difference between the inner and the outer half of the conductor, as they are connected with each other at the ends of the cable. If, however, a ground occurs on the cable, this ground can at first reach only the outer half of the conductor, and a potential difference and current appears between the inner and outer half of the conductor and operates the circuit breakers, through a relay connected between the two halves of the conductor, at either end of the cable.

This method also works very satisfactorily, but has the same economic disadvantage, though to a lesser degree than the method of pilot cables, in that the split conductor cable is materially larger and more expensive than the standard cable. It is therefore used to a limited extent only.

The usual method of taking care of the problem, at least in most cases, is by the so-called "*reverse power relay*," also wrongly called "*reverse current relay*."

When a cable grounds, the current at its end reverses; that is, flows into the cable ("*feeding back*") instead of coming out of it. However, this reversal of current by itself can do nothing, as it is an alternating current, and as such has no direction of its own, but only a relative direction to other alternating waves, as that of the voltage. Installing then

a wattmeter relay at the end of the cable—that is, a relay operated by the action of two coils upon each other, the one coil energized by the current, the other by the voltage: if the current reverses, the voltage remaining the same, the pull of the relay reverses, and thereby closes the operating circuit, which opens the circuit breaker which disconnects the cable.

Such reverse power relay operates perfectly so long as there is any voltage for the reverse current to act upon. If, however, a short circuit occurs at or close to the substation, the voltage vanishes, and with it the reverse power relay loses its pull. To guard against this, the installation of reactances is recommended between cables and substations to give a sufficient voltage drop to operate the relay. However, this is an additional complication.

The reverse power relay is not adapted to guard tie feeders between stations, as in these the current reverses in direction with the change of the distribution of load between the substations.

Thus the reverse power relay does not make the operation of interconnected networks of substations possible, but in the radical system of operation, which is generally used, it is the only device which is generally available economically, and is very satisfactory, with the only exception—which must be realized—that it cannot operate where there is no voltage left.

In overhead transmission systems and networks the problems of selectivity are essentially the same as in underground cable systems, except that in interconnected networks of distributed generating power the high impedance of the lines often gives an automatic partial selectivity, which cannot exist with the low impedance of cable systems.

Interference by *lightning* with high-potential transmission lines has rather decreased with increasing line voltage, and this is very fortunate when considering the enormous extent of these systems and the resulting certainty of lightning effects. In the present high-potential transmission lines voltages have been reached comparable with the voltage of lightning disturbances; possibly not with the voltage of the direct lightning stroke—but direct strokes into lines are rare—but few lightning-induced voltages reach beyond the insulation strength of modern high-voltage lines. In 100,000-volt lines the insulators are tested for one minute at 200,000 to 250,000 volts, and stand

momentarily, for the very short time of lightning, over half a million volts. Thus it is rare that lightning flashes over or punctures the suspension insulators of our very high-voltage transmission systems. A flashover, with the grounded Y system, shuts down the circuit, often without any damage, while with the isolated delta system it may not even shut down the circuit, but is taken care of by the protective device against flashovers, the arcing ground suppressor in the station. Most lightning voltages incapable of destroying the line insulation run along the line until their energy is dissipated or they reach a station, and there they often do serious damage. The most important problem of lightning protection thus has become the rapid damping out of line disturbances caused by lightning, so as to make them harmless before they reach the station. The most effective method heretofore is the overhead ground wire. By its screening effect it lowers the voltage which lightning can induce in the line, but far more important is its powerful damping effect on the line disturbance, the travelling wave caused by lightning, which runs towards the station. As short-circuited secondary to the line wire, the ground wire absorbs and dissipates in its resistance the energy of the travelling wave, and causes it to die out at a rate several times more rapid than is the case in a line which is not protected by ground wire.

Far more destructive than the energy of lightning may be the *internal energy* of the system. While a lightning stroke may amount to millions of horse power, at a duration of a millionth of a second, this means only thousands of foot-pounds. In a transmission network of thousands of miles extent a surge of the system may amount to many thousands of horse power. But even a surge of a hundred horse power only is liable to be very destructive, as it may be continual, the generator power continually replenishing the surge energy, and a hundred horse power, during one hour, means 200,000,000 foot-pounds.

Thus the foremost problem is again the protection of the system against destruction by its internal energy, and lightning is dangerous mainly by letting loose the internal energy.

Against damage by breakdown to ground, by over-voltages, effective and complete protection is given by the *aluminum cell lightning arrester*, so that the problem of over-voltage protection resolves into the

economic question, how far the cost of lightning arresters is warranted by the elimination of the danger of breakdown to ground.

Impulses, high-frequency oscillations, and stationary waves are the most common other dangers.

An *impulse* is an electrical effect in which voltage and current rise rapidly—with a “steep wave front”—and then gradually taper down and die out. Such impulses are produced by switching operation, by flash over the insulators, by induction from lightning flashes, etc. The danger from impulse voltages lies in the local piling up of voltage due to its steep wave front. Thus, for instance, when a switch is closed and 100,000 volts put onto a line at the moment of closing the switch, 100,000 volts suddenly appear in the line at the switch, while perhaps five feet away the line voltage is still zero. Gradually—with the velocity of light, or 188,000 miles per second—the voltage spreads over the line as an impulse. Suppose now such impulse reaches the terminals of a transformer near the source of the impulse, where its wave front is till very steep. When the full impulse voltage reaches the first transformer turn the second transformer turn is still at zero voltage, and the full voltage of 100,000 comes on the insulation between the first two turns. While the transformer winding is insulated to stand 200,000 volts to ground for one minute, and momentarily still much higher voltage, normally the voltage between adjacent turns may be only ten volts, and with all the extra insulation between the end turns, even if we make this insulation to stand 1000 times the voltage to which it is normally exposed, it would be far below standing 100,000 volts. Thus the danger from impulses is that they produce voltages across small parts of the circuit, single turns or coils, which are often many thousand times the normal voltage existing in this part of the circuit; thus they may be far below the total circuit voltage, and thus would not discharge over the over-voltage protective devices or “lightning arresters.”

Fortunately such steep waves fronts rapidly flatten out in the progress of the wave along the circuit, so that their danger is largely limited to the immediate neighborhood of the origin of the impulse.

Assuming now that we would, by a condenser in shunt to the circuit, bypass the energy of the impulse for only one-millionth

of a second. During one-millionth of a second the impulse travels about 1000 feet, and such a very small condenser would flatten the wave front to 1000 foot length. With such a flattened wave of 1000 foot front, before full voltage appears at the transformer terminals, the beginnings of the impulse is passed over ten or more turns, and the impulse voltage thus distributes over the insulation of a number of turns, and no difficulty exists to give the end turns an extra insulation sufficient to stand the voltage.

The foremost cases of high-frequency oscillations are spark discharges from the line, arcing grounds, etc. Their danger also is the piling up of voltage in reactive devices, such as current transformers, end turns of power transformers, etc. While a current transformer may take only a few volts at the normal frequency of sixty cycles, at 10,000 times this frequency it would take 10,000 times the voltage, and then break down between turns and between terminals. Inductance to reflect the high-frequency oscillation back into the line—which can stand it—with shunted capacity, and a non-inductive, or preferably, a capacity bipath to the inductive device such as the aluminum cell, offers protection against the danger from high-frequency oscillations. The best guard against interference by high-frequency oscillations is, however, to avoid all causes which may produce them, and the foremost cause is the arc. Thus arcs, arcing grounds, spark discharges, open-air switches, etc., should be carefully avoided in transmission systems, as introducing the dangers of high-frequency disturbances. This is to a large extent a designing problem.

In apparatus capable of electric oscillation—that is, apparatus of high inductance, considerable capacity, but very low energy

losses, such as high-potential transformer windings—under certain conditions *stationary waves* may occur; that is, high-frequency impulses or oscillations, coming from the outside, built up by resonance to higher and higher voltages. Such stationary high-frequency waves are extremely destructive, as their energy is practically unlimited; is given by the low-frequency power of the system. Their frequencies usually are fairly low, between 10,000 and 100,000 cycles, and therefore it is more difficult to deal with them than with the oscillations of many hundred thousands or millions of cycles.

The best protection against them is not to allow them to build up. This is done by designing the apparatus so as to give the least ability to stationary oscillations, and by dissipating their energy, and thereby limiting their voltage, by shunted resistance. To avoid excessive waste of power in such shunted dissipating resistances, a condenser of moderate capacity is connected in series with them. Such condensers practically cut off the flow of power at the low machine frequency, but permit the flow of large currents through them into the dissipating resistance at the much higher frequencies of the standing waves.

In considering the protection of modern electrical systems it must be realized that the various sources and kinds of interference or danger require correspondingly different protective devices: it would be just as unreasonable to expect a standard type of "lightning arrester" to protect an electric system against all possible troubles as it would be to call for a single-standard "safety device" which would protect a railway train against all possible dangers, from a broken rail or a washout of the roadbed to a collision or a boiler explosion.

CURRENT SUPPLY FOR MOTION PICTURE MACHINES

By H. R. JOHNSON

SMALL MOTOR DEPARTMENT, GENERAL ELECTRIC COMPANY

The popularity of motion picture displays has increased at a phenomenal rate. In contradiction to the early predictions that this form of entertainment would be short-lived, the "movies" have secured a permanent place in our list of public amusements. While this solidarity of establishment is largely due to the efforts of the producers, there are grave doubts that motion pictures would have remained in public favor had not great improvements been made in the projecting apparatus. The following is a comprehensive article that furnishes data on the present-day illumination and operation requirements of projection and describes the commercial electrical apparatus that fulfills these requirements.—EDITOR.

The cinematograph or moving picture exhibition has apparently permanently established itself as a part of our national life. This is evinced not only by the ever increasing number of show houses offering moving pictures as the principal form of entertainment but, even more surely, by the ever widening scope and variety of subjects presented. The popularity of moving pictures did not decline, as was sometimes predicted, as soon as the mere novelty of pictures in motion ceased to be a strong attraction, because the producers have realized and met their opportunity to adequately present a class of spectacular and news subjects scarcely attempted or possible hitherto, for which this new art is a peculiarly valuable medium.

Improving standards in the matter of seating accommodations, attendance, music, ventilation, and projection have kept pace with the increasing popularity of this form of entertainment. The day of shadowy, jumpy projection is passing; and, as the business of motion picture exhibiting settles down to a solid and permanent basis, the development of standard electrical equipment to meet the varied conditions of operation is the next logical step.

Developmental Steps

It may be interesting to trace very briefly the history of electric apparatus for supplying and controlling the current used in the projecting arc. It is essential to remember that the voltage required for direct current carbon arcs is approximately 55 volts, and for alternating current arcs approximately 33 volts; the current of course depends upon the amount of light demanded, the actual amperes required for the same illumination being three to four times as great with alternating as with direct current. It should also be remembered that the carbon arc is characteristically subject to sudden and extreme variations of current when operated directly from a constant potential circuit. When a sufficient resistance (or reactance) is connected in series with the arc, satisfactory

stability can be obtained because the change in voltage drop over the resistance tends to instantly counteract any variation in the current. With a sensibly constant potential supply circuit, the direct current arc requires sufficient steadying resistance to give a voltage drop of at least 15 to 20 volts which makes the required supply voltage about 70 to 75 volts. If the supply voltage has a sufficiently drooping characteristic, due to the special design of the generator, no steadying resistance will be needed and a normal voltage of 55 is sufficient.

The first installations naturally took their current directly from commercial alternating or direct current power circuits, using adjustable resistances or reactances to reduce the standard line voltage to that required at the arc. More than enough such resistance or reactance to give the necessary stabilizing effect was required for voltage reduction, so that the results were quite satisfactory in that respect. When direct current circuits of voltages higher than 110 had to be used, the waste of power was tremendous and the heat generated in the grids made the operating rooms very uncomfortable in warm weather.

The excess voltage of alternating-current circuits was cut down with much less loss by means of reactances; but the use of alternating current was strictly limited by the candle-power that could be obtained from a current of 60 to 70 amperes and also it was rather unsatisfactory on account of the color of the light produced. The economy of the alternating current projector was soon further improved by the development of adjustable voltage transformers, such as the alternating current "Compensarc."

With the growing demand for better and more brilliant projection a means was required for economically converting alternating current, often the only kind available, into direct current. This demand was early met in a very satisfactory manner by the standard moving picture rectifier outfit.

The rectifier well combines the principal advantages of both alternating and direct

current, i.e., better quality of light, smaller current in the arc, economical reduction and regulation of voltage by means of transformer, compensator, or reactance. In addition to a good efficiency, the absence of moving parts, noise or vibration and the fact that it may be neglected for long periods as far as oiling, cleaning, etc., are concerned have contributed to the popularity of the mercury-arc rectifier. The rectifier may be made to start automatically by simply bringing the arc-lamp carbons together for an instant and then separating them the required distance. In this way the rectifier runs only during the operating time of the arc, and all losses due to running idle are

that have been mentioned are shown approximately in Fig. 5.

Optical System of the Projector

Before considering in greater detail the performance, characteristics, and choice of sizes of the compensator, or other apparatus used for supplying current to the projecting lantern, it will be interesting to briefly discuss the fundamental conditions and requirements to be met. Fig. 1 shows diagrammatically the optical arrangement of a typical projection apparatus.

The arc is so placed that the maximum intensity of light shall be directed upon the condenser lens, which in turn concentrates

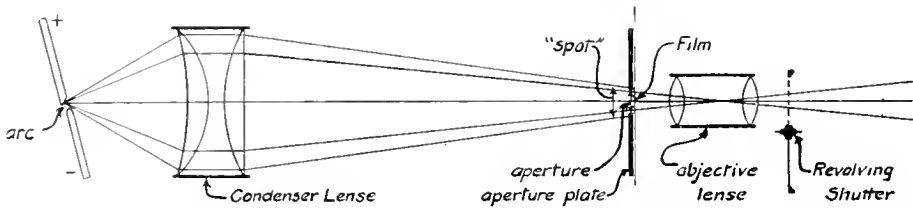


Fig. 1. Diagram of the Optical Arrangement of a Typical Motion Picture Projection Apparatus

eliminated. Due to the small space occupied and to the entire absence of vibration, the rectifier can be installed in almost any convenient space without the necessity of providing a special foundation.

Dynamo-electric alternating to direct current translating devices, e.g., motor-generator sets, and rotary converters, have always been close competitors of the rectifier, and many operators claim for them the advantages of better quality (whiter) light and greater freedom from interruptions in service. A more important advantage of the motor-generator or the rotary-converter is the ability to provide a single machine whose characteristics will permit a second arc to be started and warmed up without interfering with the continuous projection of a picture. This is especially desirable in the higher class establishments where successive pictures are dissolved into one another. Most equipments, however, are handicapped in the matter of economy because of the usual necessity for using continuously a certain amount of ballast resistance. In the specially designed generators used with the a-c.—d-c. and d-c.—d-c. compensators, this handicap is overcome and the efficiency is fully as good as that of the rectifier.

The essential points in the comparison between the economy of the different devices

the rays which it receives into a very intense beam or "spot" that slightly overlaps the opening in the aperture plate. Each picture in the film pauses for an instant, directly beyond this rectangular "aperture," which defines the illuminated area of the film and so fixes the outline of the picture thrown upon the screen. An image of the intensely illuminated section of film is magnified and reproduced upon the screen by the objective lens.

Aside from technical problems in the construction of film handling mechanisms, lenses, and shutters, the fundamental requirement for satisfactory projection is to secure an illumination on (or more exactly reflection from) the screen of good chromatic quality with a suitable minimum intensity. This required intensity of screen illumination is most conveniently considered in terms of the horizontal candle-power of the electric arc, or other light source. It is to be remembered that the results depend upon:

- (1) The size of the picture.
- (2) The density or tinting of the film.
- (3) The kind of screen surface.
- (4) The ratio between periods of darkness and light caused by the action of the shutter.
- (5) The size and quality of the condenser lens and its consequent ability to use a larger or smaller fraction of the available light flux.

(6) To a less extent upon such factors as the size of "spot" run, size and position of carbons, amount and arrangement of house lighting, etc.

Size of Screen

First in importance in determining the amount of light required is the size of the screen to be illuminated in square feet. One can readily appreciate that with a certain quantity of light available at the arc, the intensity at the screen will decrease in exactly inverse ratio to the area over which it is dispersed—in other words, the larger the surface for a given amount of light available, the thinner it must be spread.

Since the number of square feet surface may vary rapidly with changes in dimensions, the effect in illumination is very marked. For example, a 12 by 9 foot screen represents an area of 108 square feet which is approximately one-half that of a screen with only a two-foot wider margin, that is, a 16 by 12 foot screen which has an area of 192 square feet. For the same light available at the arc, the two screens would have an illumination intensity in the ratio of 1 to 0.56.

Although there are no set dimensions for projection screens, the actual proportions of the illuminated area are fixed by the shape of the "aperture" of the projection machine which is ordinarily $\frac{15}{16}$ inches wide by $\frac{11}{16}$ inches high. Accordingly, the width of the picture will always bear a ratio to the height of 15 to 11. When the picture is spoken of in one dimension only, the width is meant. Probably the most common size is a 12-foot wide picture, which is considered "life size." In a small hall a picture as narrow as 9 feet is sometimes used. With a hall of seating capacity from 1000 to 1500, the picture is usually 12 to 16 feet wide; with a still larger seating capacity it may be necessary to run a picture as much as 18 to 22 feet wide. About 20 or 22 feet is the limiting width, however, since all defects in the film are magnified in like proportion and a larger picture will have a general fuzzy outline. The 12 by 9 foot or "life size" picture, appears clear and fairly satisfactory, although rather small, at a seating distance of 75 to 100 feet from the screen.

Another factor that tends to keep down the size of pictures is the increasing use of expensive screen surfaces. As a rule mirror screens are not over 12 to 16 feet wide. Also there are optical troubles with pictures whose width runs more than a quarter of the

projection distance, e. g., the necessary wide-angle lens gives a distortion at the edge of the picture that cannot be corrected.

Density of Film

There is a marked difference in the density of the films supplied by various manufacturers. Pictures taken outdoors in a Western atmosphere where the air is particularly clear, or in interiors with light backgrounds taken with artificial illumination rich in actinic value, will as a rule require considerably less light for proper projection than will pictures taken in a smoky humid atmosphere. The various brands of films vary widely in density; some films due to the use of heavy backgrounds and silhouette lighting effects are very dense requiring a considerable increase in the current at the arc, while other films are of the exact opposite type being so thin that the current at the arc must be cut down to keep from bleaching the detail from the picture. Alternating thin and dense sections of film to secure the effect of moonlight, cloudy or bright atmosphere, smoke, etc., do not necessarily need to be corrected by altering the arc adjustment. It is evident that projecting outfits must be provided with a light powerful enough for the densest make of ordinary black and white films. Tinted films, or the use of color screens as in the Kinemacolor machines, may require two or three times as much light as the ordinary film.

Screen Surface

Screens for motion-picture projection may be roughly divided into four classes: Plain muslin, plaster, semi-reflecting and mirror screens.

The plain muslin screen requires the largest amount of light for proper brilliancy of projection, due to the low reflecting value of its surface. At one time used only by the cheap traveling show or vaudeville house in which pictures were a minor part of the program, the muslin screen has been found to give exceptionally soft, artistic pictures, rich in detail and free from harsh contrasty black and white effects, so that it is now found in some of the most pretentious theaters, in spite of the high current required at the arc. Sometimes the muslin surface is slightly starched, which tends to reduce the light required, but it more often presents a plain freshly laundered white surface.

Plaster screens, usually coated with calcimine or a flat paint preparation, are found

in all classes of moving picture theaters. They require somewhat less projected light than a muslin screen to secure the same brilliancy. The present tendency, largely due to the increasing size of theaters, is toward a plaster finished screen of some kind which will combine the softness and pleasing detail of the muslin screen with reflecting qualities that reduce the high current consumption of the arc.

Semi-reflecting metallic screens such as mirroride, radium, gold-fiber, etc., give rather harsh, contrasty pictures but these require considerably less light for a given brilliancy than either the muslin or the plaster screen. The characteristics of these screens vary between those of the plaster and the mirror types.

Mirror screens are the most economical of current for a given brilliancy, but the sizes are at present limited to 18 feet and their use is further limited by the high initial cost, particularly in the larger sizes.

The comparative degrees of illumination required by the different classes of screens in order to produce approximately equivalent brilliancy of illumination at various observation angles are recorded in Table I, taking the plain muslin surface as the standard of comparison.

TABLE I

Material	REQUIRED ILLUMINATION FOR OBSERVATION ANGLES		
	15 Deg.	45 Deg.	60 Deg.
White muslin.....	100	107	110
Magnesium oxide.....	73		88
Plaster of paris.....	77	83	94
White lead.....	83		93
Century white.....	82		90
Zinc paint.....	87		96
Aluminum paint on card.....	35		408
Zeiss metallic screen, smooth..	54		526
Mirror screen.....	37		

Shutter Motion

In the operation of the projecting mechanism, a revolving shutter cuts off all light from the screen from the instant just before the film starts to move from one position to the next until the film has come to rest in that next position. The interval of movement of the film in ordinary projectors occupies approximately one-sixth of the complete cycle, there being, on the average, a new

picture shown every one-sixteenth of a second. It has been found that if the alternations of light and darkness take place too slowly, or in other words if the intervals of darkness are too far apart, the eye catches an impression of "flicker." To prevent this effect from becoming noticeable, ordinary shutters have two or three "wings" instead of one which introduce one or two extra dark intervals during the time the film is actually at rest and the picture is being projected. The two-wing shutter is still largely used where 60-cycle alternating current is supplied to the arc, and also by a few managers who prefer to economize on current at the expense of a slight impression of flicker. The tendency to flicker is increased by more brilliant projection whether by improved types of screens or by increased illumination, hence the present tendency to standardize the three-wing shutter. The three-wing shutter cuts off approximately 50 per cent of the light, whereas the two-wing shutter cuts off only about 35 per cent; the type of shutter must therefore be considered in choosing the capacity of the illuminant required.

Lenses

Although the size and focal length of the condenser lens might theoretically have a very important effect upon the amount of light required at the arc, it is believed that the differences between ordinary outfits in this respect are not nearly as important as are several other factors in respect to which no standardization can be effected, as for instance the management of the arc, the size and setting of the carbons, the arc voltage, the size of "spot," etc.

Size of "Spot"

As already explained, the function of the condenser lens is to concentrate all the light that it receives into an intense and fairly uniform beam, which covers the opening in the aperture plate, Fig. 1. The usual condenser, being an uncorrected lens, possesses a certain amount of chromatic aberration (tendency to separate light into the primary colors). This fault occurs largely at the edge of the "spot"; and therefore the beam is always spread enough so that the light delivered to the aperture shall be substantially pure white in quality. The larger the spot, within certain limits, the purer and more uniform will be the quality of the illumination on the screen. In practice, this size is determined by making the spot just large

enough to prevent any noticeable weakness in the illumination at the corners of the picture, so that any variation in the size of the spot (and consequently waste of light at the aperture) is usually not very great.

Distance

It is the general consensus of opinion that, within the ordinary limits of 50 to 150 feet, the distance from the screen to the projector, or the "throw," has no direct effect on the quantity of light required.

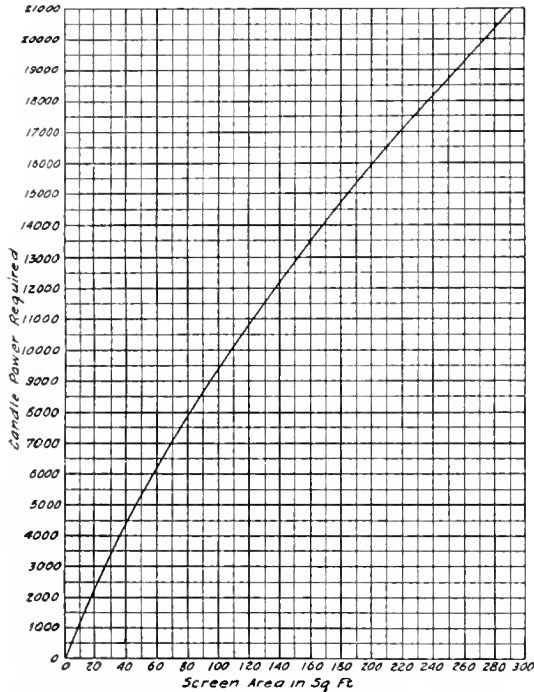


Fig. 2. Curve showing the Candle-power Required for Various Size Plain Muslin Screens. Black and white film

House Lighting

An important factor in determining the required brilliancy of the screen illumination is the amount and arrangement of the house lighting. The present tendency is more and more to have the auditorium lighting sufficient for patrons to readily see their way about and even to read programs while pictures are being shown. Although any stray light from this source which falls upon the screen makes necessary a considerably more brilliant projection, it has been found that by carefully screening auxiliary light sources a surprisingly good general illumination can be maintained without materially interfering with the exhibition of the pictures.

Size and Setting of Carbons

The actual amount of light obtained from the arc depends to a great extent upon the kind, size, and setting of the carbons. Each make of projection carbons has its good qualities and, in the hands of operators familiar with the particular brands, will give good results. While most operators use two cored carbons of the same size for a direct current arc, others prefer using a smaller solid carbon for the negative. Probably the most common combination, and one that will give

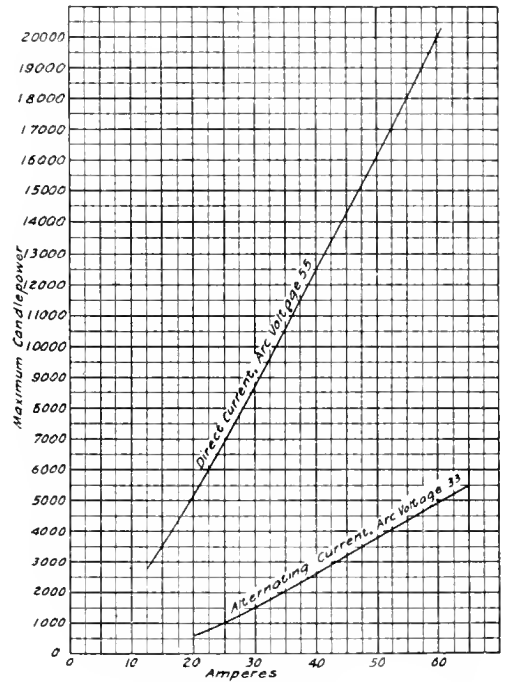


Fig. 3. Curve showing the Candle-power of Projection Arcs for Different Arc Currents

good results, is two $\frac{5}{8}$ -inch cored carbons for 25 to 40 amperes and two $\frac{3}{4}$ -inch cored carbons for 40 to 60 amperes. The most satisfactory setting is to incline the carbons backward about 15 to 30 degrees, which brings the white-hot crater of the upper carbon directly opposite the condenser. The upper carbon is generally pulled back from $\frac{1}{16}$ -inch to $\frac{3}{16}$ -inch behind the lower carbon, which forces the crater away from the back edge of the upper carbon. The carbons should be separated to a sufficient distance so that the negative carbon cannot cast a shadow due to its being in front of the crater. Ordinarily the length of the arc will be approximately $\frac{3}{8}$ -inch to $\frac{1}{2}$ -inch.

Required Candle-power

Assuming the use of a plain muslin screen, a three-wing shutter, and other average conditions, it is believed that the required horizontal candle-power delivered by the arc for different size pictures will be approxi-

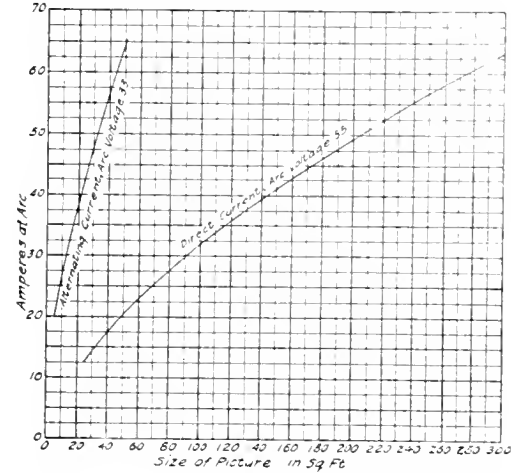


Fig. 4. Curves showing Relation Between Size of Picture and Necessary Arc Current

mately in accordance with the curve given in Fig. 2. Theoretically, the required candle-power should increase in direct ratio to the screen area; it appears, however, that in practice the larger pictures do not require quite so great a brilliancy of illumination. In using the curve in Fig. 2 it is particularly necessary to make due allowances for the kind of screen surface and the ratio of area of dark and light sectors in the shutter. A two-wing shutter is almost always used with an alternating current arc. The expression "maximum candle-power" refers to the candle-power measured toward the lens, which should be the direction of maximum intensity.

Required Current Supply

The curve in Fig. 3 shows the approximate maximum candle-power of direct and alternating arcs for different arc currents when using the arrangement of carbons previously described. Fig. 4 combines in a more convenient form the data shown in Figs. 2 and 3. The current from a mercury-arc rectifier may be considered as giving practically the same candle-power as that obtained from ordinary continuous-current sources. Alternating current is much inferior on account of the reddish quality of light

obtained and the high current required for a given intensity of illumination.

Summarizing the foregoing, 35 amperes direct current is usually great enough for a 12-foot picture, and an obtainable range of 30 to 50 amperes at the lamp will meet all except extreme conditions.

Dissolving

When one picture is to immediately follow another in the program it becomes necessary, in order to avoid a delay of several minutes, to have a second machine ready to start at the instant the first stops. By this means the delay may be cut down to a very few seconds. It is generally considered necessary, however, to warm up the second arc for 3 to 5 minutes before showing the picture, thus giving it time to become steady. Moreover, in the better class of show houses, it is coming to be the accepted method of operation to "dissolve" one moving picture or stereopticon view into another, thus eliminating all delay. This necessitates the use of ballast resistances when the second arc is struck and while the two are operating in parallel, as well as extra switching equipment, rheostats, etc., the arrangements varying considerably with different apparatus.

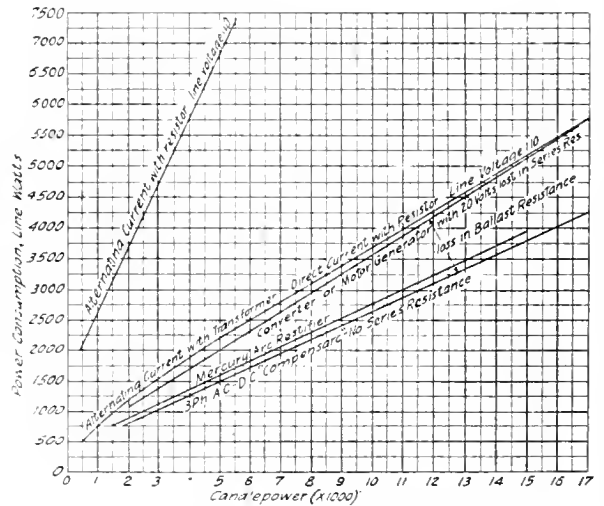


Fig. 5. Curves Comparing the Approximate Economy of Different Methods of Current Supply

Apparatus for Moving Picture Houses

A complete line of standard apparatus suitable for practically all requirements of large or small moving picture establishments has been developed and placed on the market. It includes the alternating-current "compensator"

sarc" (transformer) for operating an alternating-current arc from a lighting circuit; the d.c.—d.c. and a.c.—d.c. "compensars" (motor-generator sets) for obtaining perfectly regulated direct current from commercial lighting or power circuits, of any voltage or frequency, alternating or direct current; the mercury arc rectifier for obtaining approximately continuous current from single-phase commercial circuits; the "Transport-arc" (spot-light transformer) for alternating current; a spot-light, as well as efficient transformers for low-voltage sign or house lighting.

A-C.—D-C. and D-C.—D-C. Compensars

The d.c.—d.c. compensare is built in three sizes, viz., 35, 50 and 75 amperes for one lamp only; or, with proper switching arrangements, the 50-ampere outfit can be used for the operation of two 35-ampere lamps alternately, and the 75-ampere outfit for two 50-ampere lamps where two picture machines are used to obtain a dissolving effect upon the screen. These sets are of the two-bearing construction and have their armatures electrically interconnected in such

a way as to give an improved operating efficiency. The volt-ampere characteristics of the generator end are similar to those of the a.c.—d.c. compensare.

A.c.—d.c. compensars are built for operation on single-, two-, or three-phase commer-

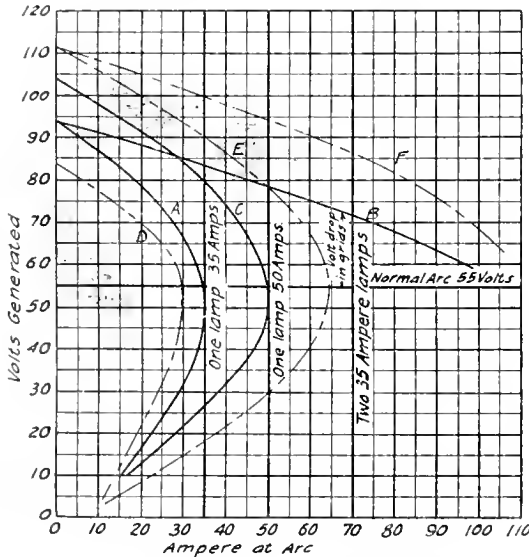


Fig. 6. Typical Volt-ampere Characteristic Curves of a "Compensarc" for Two 35-amp. Lamps Alternately

- A—Normal operation, one 35-amp. lamp, change-over switch closed.
- B—Normal operation, two 35-amp. lamps in use for short period, change-over switch open, grid resistance in circuit.
- C—Normal operation, compensarc connected for one 50-amp. lamp.
- D—Minimum load, field rheostat all in, change-over switch closed.
- E—Maximum load, field rheostat all out, change-over switch closed.
- F—Maximum load, same as "E" except change-over switch open.

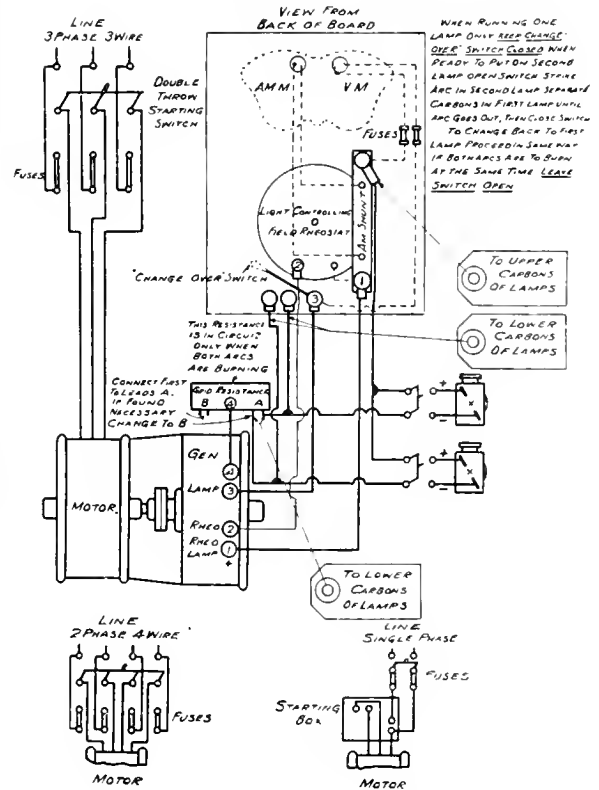


Fig. 7. Diagram of Connections for a Two-lamp A-c.—D-c. Compensarc

cial power circuits, and in three ratings, as follows:—35 amperes, one lamp; two 35-ampere lamps alternately, or one 50-ampere lamp; two 50-ampere lamps alternately or one 75-ampere lamp. The generators are specially designed machines and have a high armature reaction. The two-lamp (alternately) machines are equipped with a series-field winding so arranged that, for a short period of time, two lamps can be carried simultaneously while generating the additional voltage consumed by the necessary steadying resistance. This allows the second lamp to be heated up and prepared for use while the first picture is being shown, thus the second reel may be dissolved into the first.

Fig. 6 shows the volt-ampere characteristics of the two 35-ampere lamp (alternately) set, the corresponding wiring con-

nections are shown in Fig. 7. It will be noted that, when one lamp is being run and the change over switch is closed, no ballast resistance grids are used, thus securing the best possible economy; and the rapid change of voltage with a slight variation of the

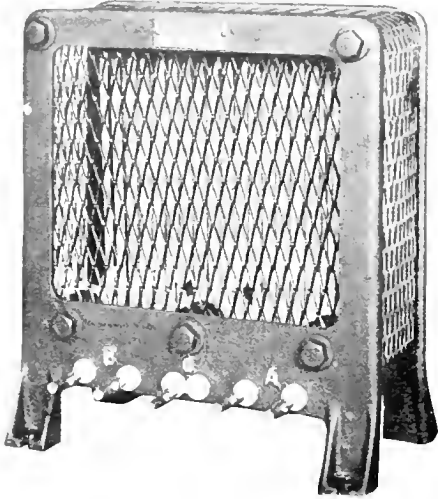


Fig. 8. The Ballast Resistance Grid Used with an A-c.—D-c. Compensarc for Two Lamps Alternately

current results in maintaining an extremely steady and elastic arc that will not rupture even though the carbons are fed very irregularly. The grid steadying resistance is used only when changing from one arc to the other and during a brief period for warming up the second arc while running the first machine. The voltage drop through this resistance prevents the first arc from being put out at the instant the second is struck. It should be particularly noted that, with the change-over switch closed, it is impossible to overload the generator at any particular rheostat setting, since the voltage drops "over the bend" and the machine protects itself from injury when the carbons are brought together or "struck." The comparatively low current on short-circuit makes these sets much superior to ordinary constant potential circuits with which, even though a series resistance is used, "striking" the arc results in a very high rush of current that often blows fuses or destroys the "crater" of the positive tip (thus resulting in poor illumination until a new crater is formed).

Figs. 8 and 9 show the compact, self-contained grid rheostat and control panel developed for use with the two-lamp (alternately) a-c.—d-c. compensarc set. Fig. 10

illustrates the simplicity and compactness of the generating set itself, as well as the specially designed control panel and arrangement of a typical one-lamp installation for a small theater.

The mercury-arc rectifier has been in use in moving picture theaters and elsewhere for so many years that a description of it seems hardly necessary. The rectifiers are built in three current capacities, viz., 30, 40, and 60 amperes, and they are interchangeable on either 110 or 220 volts. Rectifiers are made for various frequencies, the 60-cycle rectifiers being satisfactory for 50 cycles and above, the 25-cycle rectifiers being suited to frequencies up to 50 cycles. A rectifier is shown in Fig. 11. This is one of the latest type; it is equipped with a dial switch for regulating the current without any loss in resistance



Fig. 9. The Control Panel Used with an A-c.—D-c. Compensarc for Two Lamps Alternately

and with two link connections just below the triple-pole switch for connecting to 110 volts (in position shown) or on the two outside binding posts for 220 volts. The rectifier can be furnished either with or without an ammeter, or with an ammeter and a volt-

meter. All rectifiers are equipped with a triple-pole, double-throw switch, so that in case of trouble with the rectifier the switch can be immediately thrown to the lower position and the arc operated from the rectifier as an alternating-current compensarc.

balance against relative power consumption, maintenance cost and convenient regulation, while duly considering portability, class and patronage of the house, daily hours of operation, etc.

The curves in Fig. 5 give an approximate comparison of the power consumption of different apparatus and arrangements for supplying current. Different makes of the same class of apparatus naturally vary slightly in efficiency. Single-phase, a-c.—d-c. compen-

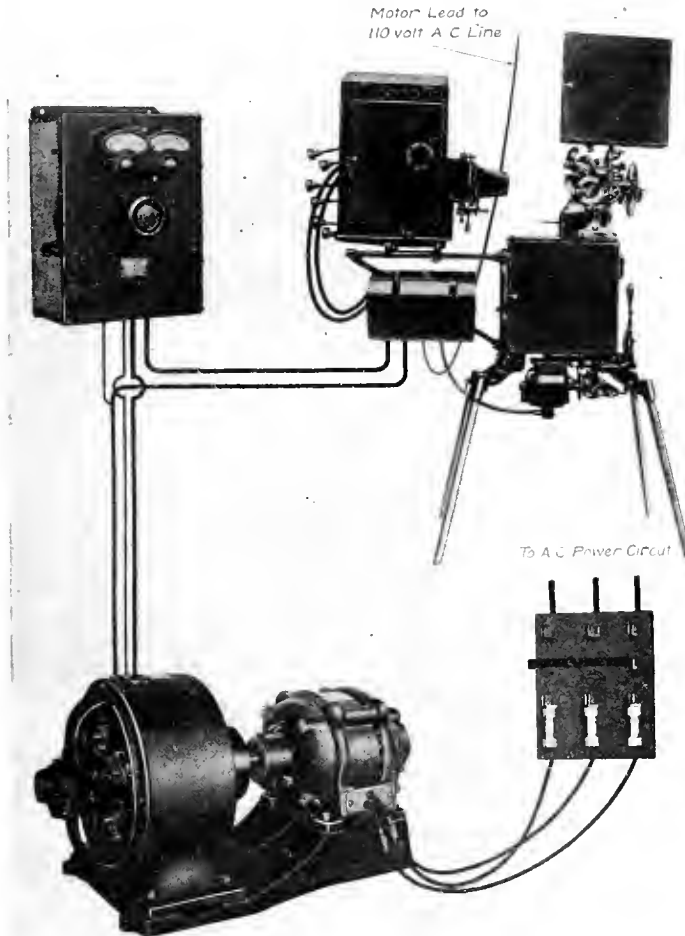


Fig. 10. Diagram showing Installation Arrangement for a One-lamp A-c.—D-c. Compensarc

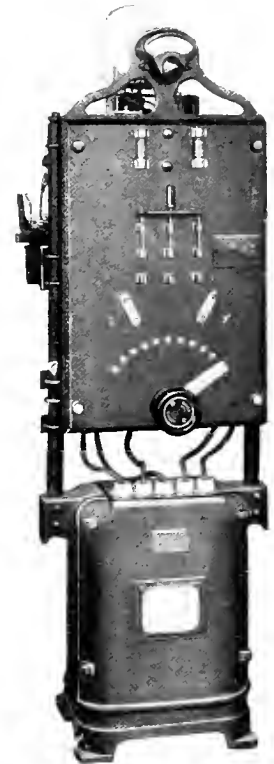


Fig. 11. A Single-phase Mercury Arc Rectifier Equipped with Dial Switch and Change-over Switch

An additional feature which is just beginning to be used with the rectifier is an auxiliary equipment whereby two pictures can be faded one into the other by a very simple and almost automatic process.

Each of the previously described methods of current supply has its own peculiar field of usefulness. The use of alternating current often saves a great deal in first cost of installation. Between the different sources of direct current, initial investment must be set in the

sarcs have a slightly poorer and d-c.—d-c. compensarcs a slightly better efficiency than indicated by the curve. Although a small synchronous converter might be expected to have a better efficiency than a motor-generator set for supplying direct current, those available at present apparently have not; and, furthermore, the specially designed "Compensarc" is one of the few types of direct-current apparatus that has the necessary characteristics to maintain a steady

arc without the use of ballast resistance, even when running only one lamp at a time. Other generators and converters require various amounts of series resistance, consuming from 5 to 20 volts in order to secure the necessary stability. It will be noted that this is a particularly important point because, as shown by the curves, any

economy of power to be secured by the motor-generator or converter, as compared with current taken directly from a lighting circuit using the cheaper series resistance or transformer, depends largely upon the ability to dispense with ballast resistances during the period of normal or one-lamp operation.

PROPER CONSTRUCTION OF EARTH CONNECTIONS

BY G. H. RETTEW

ELECTRICAL ENGINEER, POTOMAC ELECTRIC POWER CO.

The necessity that ground connections be of permanently low resistance is obvious; yet most engineers give but meager attention to the construction and periodic testing of these protective connections. As the result of an extensive investigation, which included the resistance measurement of grounds, the author cooperating with the Bureau of Standards learned that many ground connections are of such high resistance as to entirely vitiate their worth as a protection. The development of a permanently effective and cheap type of ground connection constituted the remainder of the investigation, the results of which with tests form the basis of the following article.—EDITOR.

Those grounds, or earth connections, which are installed for protective purposes are important as by such means danger to life and property is materially reduced, hence any method of constructing such grounds which reduces the resistance is worthy of study.

Grounds are used for the neutrals of transformer secondaries, for lightning arresters, for cases and frames of apparatus, and for the neutrals of transmission systems, and, while all operating companies do not use grounds for all of these purposes, they all must necessarily use them to some extent at least.

On account of this wide usage it would naturally be supposed that the best methods of making effective grounds would have been the subject of much study and experiment by the engineering and construction departments of the companies using and installing grounds, but it is surprising how little attention has been paid to this important matter. In fact little information is available to assist those companies who do not have an engineering force to study such problems, and many engineers have neglected to make a study of this supposedly unimportant detail.

It is hoped that this article will be of some assistance to those who are not informed on the subject, and to those operating companies who have not given the matter the consideration it rightfully deserves.

Something like three years ago the attention of the writer was called to this matter by certain occurrences on the system of one of the largest companies in this country. Upon investigation it was learned that a

number of different forms of earth connections were in use, but none of these forms had been standardized and in fact no tests were recorded to show the effectiveness of any of the large number of grounds that were in use.

A test was accordingly made of different forms of earthing devices, such as plates, cones, rods, and pipes of various sizes, the conclusion being finally reached that pipes were the most desirable form owing to the fact that they can be readily driven to a sufficient depth to reach permanent moisture, while plates or cones require considerable excavation and resulting cost. No ground of any form is effective unless placed at a depth of seven feet or more, hence the value of a deep driven pipe.

A test was then made of 100 grounds of different forms, in scattered locations, and of various ages, *the average resistance being found to be approximately 200 ohms*. It is quite certain that these grounds were installed with average care and under approximately the same conditions that obtain in other cities, and thus we conclude that, where the matter has not been made the subject of investigation, the same conditions would exist, or even worse conditions found. It is needless to state that an earth connection having a resistance of 200 ohms is of no value in protecting transformer secondary mains in event of a leak from the primary, hence any manager who does not definitely know the resistance of his grounds would do well to investigate. Even a lightning arrester connected to such a ground is of doubtful value, so there is more than one reason for careful construction.

Having finally determined on using pipe grounds, tests were made of different sizes, and of the same size driven to different depths. It was finally decided that a single 3/4-in. galvanized pipe driven ten feet would meet the requirements, except at power houses or substations at which points a number of such pipes in multiple are to be used.

The first 250 such grounds which were installed showed an average resistance of 15.68 ohms. Each of these had a mate driven nearby and the test was made by means of a 2300, 115-230-volt transformer of 2.5-kw. capacity, this being carried on the tool wagon. Temporary connections were made to 2300-volt lines, current was passed into the two grounds in series with an ammeter in circuit, the drop of potential taken, and the resistance of two grounds in series was calculated. The resistance of each of the two grounds was assumed to be equal to that of the other, hence the resistance of the permanent ground was taken at half the resultant resistance of the two in series. Some thousands of these pipe grounds are now in use, hundreds of older types having been replaced, or reinforced by a new one installed close thereto and the two connected together. During the progress of such work it was not unusual to blow a primary transformer fuse when a new ground was connected in, and an investigation would disclose a ground on the interior wiring, the resistance of which in series with the poor ground would not permit enough current to flow to blow even a 6-ampere branch fuse; however, it would cause some meter registration, and the constant flow of even a small amount of current would tend to bake out the ground and make it just so much worse.

During the latter part of 1914, the Bureau of Standards, in connection with a comprehensive investigation of the subject of earthing and earth connections, co-operated with the writer in making tests of grounds of the form referred to in order to determine not only the effectiveness at the time of installation but also to ascertain what deterioration, if any, took place with lapse of time. This investigation is still in progress. For the purpose of the tests just mentioned five standard grounds were installed by men regularly engaged in line work, no effort being made to secure better results than in regular practice. These were located as shown in Fig. 1. The numbers shown are used for identification purposes in the tables and descriptive matter which follow, much

of which is taken directly from notes on the tests which were submitted by the Bureau of Standards.

The measurements were made in various combinations by means of ammeters and voltmeters at 110, 220, and 1100 volts, the

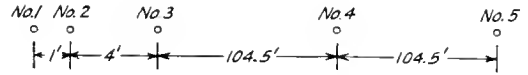


Fig. 1

first measurements being made immediately after the grounds were installed, that is, before the soil had a chance to settle and pack around the pipes, and before the electrolytic agent which is part of the pipe form of ground had a chance to diffuse through the surrounding soil.

The result of first test is shown in Table I:

TABLE I
TEST AUGUST 15, 1914, 110 VOLTS

Number of Grounds in Series	Resistance of Grounds in Series	Calculated Resistance of Each Ground
1 and 2	12.2 ohms	No. 1 - 12.4 ohms
1 and 3	21.4 ohms	No. 2 - 11.2 ohms
3 and 4	23.1 ohms	No. 3 - 15.4 ohms
2 and 4	18.7 ohms	No. 4 - 7.6 ohms
1 and 4	20.0 ohms	No. 5 - 16.7 ohms
3 and 5	32.1 ohms	
2 and 5	28.0 ohms	
1 and 5	29.1 ohms	
4 and 5	24.3 ohms	

It should be noted that the resistance between two earth connections increases to a maximum as they are moved apart, the maximum being reached at from 6 to 10 feet. This is shown to some extent by the measured resistance between No. 1 and No. 2 in Table I, which is 12.2 ohms, although the sum of the individual resistances is 23.6 ohms.

The method by which the individual resistance was calculated may be of interest;

Nos. 1 and 2 being so close together, it was thought preferable to calculate Nos. 3, 4 and 5 individually, and later to calculate Nos. 1 and 2 by testing in series with one of the others whose resistance had been found.

From Table I it may be noted that

- Resistance of No. 3 + No. 4 = 23.1 ohms
- Resistance of No. 3 + No. 5 = 32.1 ohms
- Resistance of No. 4 + No. 5 = 24.3 ohms

If we substitute $X-Y-Z$ respectively for 3-4-5, then

$$X+Z=32.1$$

$$X+Y=23.1$$

$$Z-Y=9.0$$

$$Y+Z=24.3$$

$$2Z=33.3$$

$Z=16.65$ or 16.7 as per Table I. Z being No. 5.

Having thus determined Nos. 3, 4 and 5, Nos. 1 and 2 were tested against those already known and their resistance determined.

The same tests as indicated by Table I, which was based on 110 volts pressure, were repeated using both 220 and 1100 volts. *At the higher voltages the resistances were almost uniformly less than when tested at 110 volts, probably due to the fact that the temperature of the earth was raised by the quite considerable amount of energy consumed.*

It should be here noted that 1100 volts was impressed directly on Nos. 1, 4 and 5, immediately after first test, and continued for a sufficient length of time to thoroughly bake them out, the idea being to determine whether this would permanently impair their effectiveness.

On November 18th, the tests were repeated, this being three months after the first test.

The result of the resistance measurements is shown by Table II, from which it may be noted that the baking had not caused permanent impairment, but on the other hand that the resistance had materially decreased.

TABLE II

TEST NOVEMBER 18, 1914, 230 VOLTS

Number of Grounds in Series	Resistance of Grounds in Series	Calculated Resistance of Each Ground
1 and 2	2.8 ohms	No. 1- 6.42 ohms
1 and 3	6.2 ohms	No. 2- 6.50 ohms
1 and 4	10.25 ohms	No. 3- 8.80 ohms
1 and 5	17.8 ohms	No. 4- 3.83 ohms
2 and 4	10.3 ohms	No. 5- 11.39 ohms
2 and 5	17.9 ohms	
3 and 4	12.7 ohms	
3 and 5	20.2 ohms	
4 and 5	15.2 ohms	

After this test Nos. 1 and 5 were baked out by impressing 1100 volts on them for 40 minutes. The average current during this period was 60 amperes, or roughly 66 kw.

A third test was made March 4, 1915, the results appearing in Table III. For a week or ten days prior to this test there had been no rain, consequently the ground was rather dry. The resistances were, however, quite low, in fact much lower than is generally considered necessary, although a ground for the protection of life or property cannot be too low in resistance. In any event there is not manifest any deterioration such as might have been expected, particularly after the grounds had been baked out on more than one occasion.

TABLE III

TEST MARCH 4, 1915, 230 VOLTS

Number of Grounds in Series	Resistance of Grounds in Series	Calculated Resistance of Each Ground
1 and 2	7.52 ohms	No. 1-8.72 ohms
1 and 3	11.24 ohms	No. 2-8.08 ohms
3 and 2	9.26 ohms	No. 3-8.96 ohms
2 and 4	15.88 ohms	No. 4-7.78 ohms
1 and 4	16.46 ohms	No. 5-9.89 ohms
3 and 4	16.78 ohms	
1 and 5	18.66 ohms	
2 and 5	17.96 ohms	
3 and 5	18.81 ohms	
4 and 5	17.68 ohms	

Feeling that earth connections of this form are highly desirable, as they are of low resistance, easy to install, do not require expert workmen, are apparently permanent, and moreover are relatively inexpensive, there is appended a complete description of the methods which have been standardized for the particular system with which the writer is connected:

A 2-in. pipe is driven 5 feet deep and then pulled out; the hole thus formed is then filled with rock salt; a piece of $\frac{3}{4}$ -in. galvanized iron pipe 12 feet long is then driven through the 5 feet of salt and 5 feet further into the ground; the hammering naturally batters the top of the pipe, which is then cut off and threaded, and an additional length of 10 feet, more or less, screwed on. As grounds of this character are usually placed at the base of poles, it is necessary to locate the pipe 18 inches or 2 feet from the pole so that the three-wheel pipe cutter and the stock can be operated. A trench is dug from the pipe to the pole, the pipe is bent into the trench, and the projecting length cleated to the pole. This brings the top of the pipe approximately 10 feet above ground; it is cleated at intervals as it passes up the pole to a brass coupling.

The brass coupling is specially made for the purpose and is readily obtainable on the market. It is similar to an ordinary pipe coupling except that a lug is cast on the side and drilled to receive the wire, which is sweated in. This method is far superior to using a cap on top of the pipe, as the coupling being open permits rain to enter the pipe and thus get down where it effectively increases the conductivity of the soil, for quite a large quantity of salt is inside the pipe and the entrance of water gradually dissolves this and permits this excellent electrolytic agent to permeate the soil.

The salt is an essential feature of any low resistance earth connection; or at least some electrolytic agent is necessary, salt being preferable as it has little or no destructive action on the pipe.

Experience with this form of ground has demonstrated that it is durable, as after three years' use the pipes show little or no deterioration. The majority are painted to harmonize with the pole and this undoubtedly assists in preserving the pipe at the ground line.

In concluding it might be well to note that the wire need not be carried down into or through the pipe. The writer has frequently seen weather-proof wire carried through a protecting pipe to an earthing device, which was intended to carry off charges induced by lightning. The reactance of the pipe to high frequencies when surrounding a conductor is considerable, and in some cases the charge will jump from the wire through the insulation to the top of the pipe, the insulation being frayed out by the discharge. Such a ground is not only lacking in protective power but is actually a source of danger.

The pipe ground as described has as little reactance as any form that could be placed in practical use, as well as having the other desirable characteristics which have been set forth.

It is believed that the Bureau of Standards, at the conclusion of its investigation, will publish a treatise on the subject of "Earthing and Earth Connections"; if so, it will doubtless be a valuable addition to the present knowledge of the subject.

METHODS OF REMOVING THE ARMATURE FROM BOX FRAME RAILWAY MOTORS

By J. L. Booth

RAILWAY MOTOR ENGINEERING DEPARTMENT, GENERAL ELECTRIC COMPANY

We hope to be able to publish a number of articles dealing with some of the more important features of car barn practice. This first article after showing the advantage of the box frame design of railway motor describes several different methods of removing armatures from such motors of different capacities. The illustrations are especially valuable as showing the processes in great detail.—EDITOR.

The box type of frame for railway motors was originally developed in order to meet the demand for motors capable of giving the large outputs required for heavy service on interurban, elevated and subway lines. In addition to possessing many advantages from

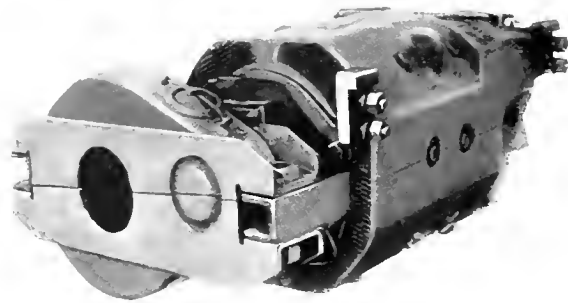


Fig. 1. Small Light-Weight Motor with box frame for small wheel cars

a mechanical point of view, it enables the designer to obtain a considerable increase in capacity for a given weight and space, when compared with the split frame. As the advantages of this type of frame became more widely known and recognized among operating engineers, the demand for box frames increased until at the present time they are being used for motors of all sizes from the largest to the smallest, and have almost entirely superseded the split frame. From 80 to 90 per cent of the railway motors now being made are of the box frame type, and many of the most recent designs of motors are being built with this type of frame only.

Advantages of the Box Frame

For a given space and weight, a larger output can be obtained than with a split frame, or for a given output the motor can be made both smaller and lighter. It also possesses greater structural strength and durability, and there is less chance of breakdowns due to the mechanical failure of parts of the machine, or the breakage of bolts. The lower half of malleable iron gear cases may be supported in a more substantial manner

rendering them better able to withstand the severe stresses to which they are frequently subjected. The elimination of the joint in the frame, in addition to giving an unbroken magnetic circuit, prevents oil from working into the interior of the motor from the axle bearings, which is always liable to occur through the joint in a split frame.

From the absence of this joint, which is usually horizontal, a greater freedom of design is generally obtained for the armature, pole pieces, and coils, and for the same reason a better axle preparation and design of axle bearing housings is made possible.

With a ventilated motor, in which air is drawn through the frame and armature core, a greater space is available in the frame for the passage of the cooling air around the field coils. This allows unrestricted ventilation with a corresponding increase in the service capacity of the motor. Better protection is afforded to the field coil connections which, in the box frame motor, are all inside the frame. By removing the motor from the truck repairs are effected, bearings seated and connections made under favorable conditions to insure good workmanship, while with the

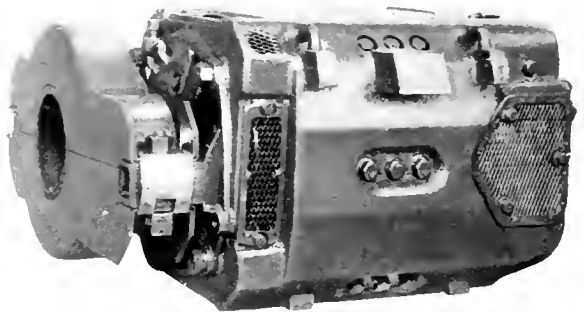


Fig. 2. 160-H.P. Motor with box type of frame

split frame the work is often done from the pit in a cramped position and under poor lighting and working conditions.

There are also a fewer number of parts which are liable to work on each other and which ultimately require liners to take up

wear. This together with the increased reliability of the box frame motor gives a low maintenance cost.

A typical example of a small box frame motor is shown in Fig. 1. This motor has been especially developed for use with light cars having small wheel trucks. It is built in the box frame type only and although of 35 h.p. rating weighs only about 1500 lb. Even in this size of motor it is possible to provide openings, both on the top and suspension side of the motor, of sufficient size to permit the thorough inspection of the commutator and brush-holders.

A larger motor is shown in Fig. 2. This motor which rates at 160 h.p. weighs, complete with all parts, approximately 5720 lb.

Methods of Removing Armatures

When the box frame was first advocated it was felt by some operating engineers that the necessity of dismounting the motor from the truck in order to remove the armature, for repairs, would take so much time and keep a car out of service so long that the cost of repairs would largely offset the advantages of the box frame. Experience, however, has shown this not to be so, and by the provision of various simple appliances to facilitate the removal of armatures, repairs to box frame motors are today being executed just as rapidly as with split frames. Indeed, in the opinion of some operating engineers of roads where both types are in operation, inspection and repairs can be effected in less time with the box frame, due to the superior working conditions which exist when the motor is off the truck. In many cases the time necessary to have an armature "on the floor" after the car has been run in has been cut down to something very small, and the systematic inspection of motors at regular intervals of time or of distance run is materially reducing the cost of maintenance and repairs. It has been urged that for small roads operating single-truck cars, and not provided with the equipment for easily lifting the car body from the truck, the split frame can be more easily handled and should be used. The removal of the box frame motor, however, without taking out the truck from under the car, presents no great difficulty and is recommended for this type of car. The axle caps and bolts are first removed and the gear case taken down. The motor is then supported from the pit by a jack bearing against the center of the motor frame. The suspension bolts are next taken out (if of the bolted bar

type) and the suspension bar unbolted from the truck. The motor may then be raised by the jack and moved away from the axle sufficiently far to allow the portion of the axle bearing housing that projects over the axle to clear it. The motor may then be

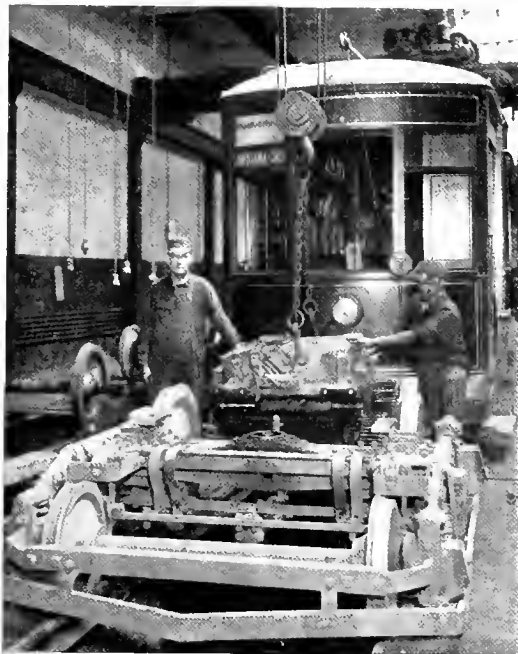


Fig. 3. Removing a 65-H.P. Box Frame Motor from the Truck. This operation takes fifteen minutes to perform

lowered into the pit. If preferred, the axle may be used as a fulcrum and the motor swung down around the axle until the bearing housings are clear. In any case, the motors generally used on single-truck cars are small, and the weight to be handled is not great. No elaborate equipment is required for removing a truck from a double-truck car. In most car barns, two pairs of chain blocks can be arranged to lift one end of the car while the truck is being removed, and it is not necessary to send the car to the main shops for the removal of an armature. Some examples are given here of the methods employed on various roads. Figs. 3, 4 and 5 show how GE-242 motors are being handled on a large system in the middle west. This motor is rated at 65 h.p. on 600 volts, and weighs with gear, gear case, pinion and axle linings approximately 3045 lb. The truck is run out from under the car, and the suspension bolts, gear

case, axle caps and linings removed, the dust guard coming away with the axle caps.

The motor is then lifted out by means of the bails and an ordinary pair of chain slings (see Fig. 3). The four bolts securing the pinion end frame head are next removed and the head started by jack screws.

A lever, having a collar at one end which fits over and is clamped to the pinion, is used to support one end of the armature which is then pulled out sufficiently far to enable a

wide lifting strap to be placed in position as shown in Fig. 4. The length of the bearing at the commutator end is sufficient to support that end of the armature until the lifting strap is in place.

By bearing down on the end of the lever, the weight of the armature can be balanced while being removed from the frame. Fig. 5 shows the armature clear of the frame, with the man's weight still on the lever, balancing the armature in the sling.



Fig. 4. Removing Armature from a 65-H.P. Box Frame Motor. Lifting strap in position. From the time the motor is off the truck until the armature is on the floor is twenty minutes

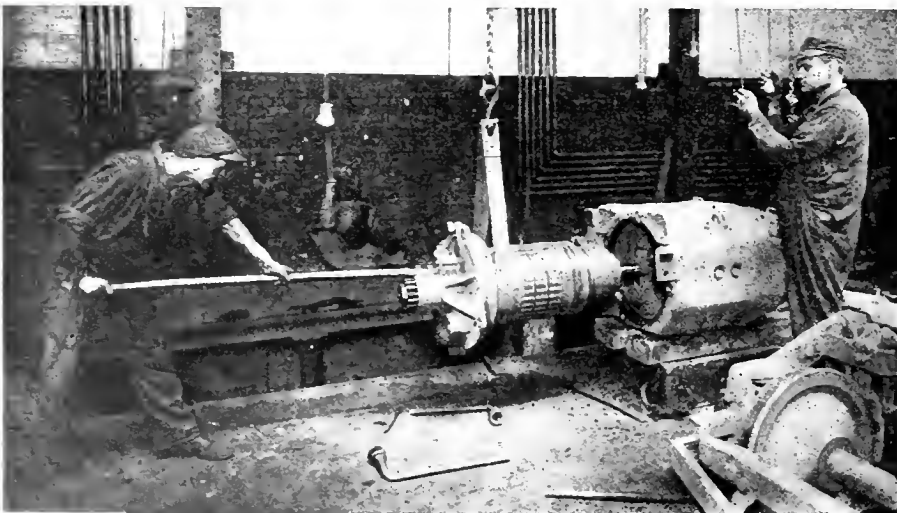


Fig. 5. Armature of a 65-H P. Motor Removed. Man's weight on lever balances weight of armature. To replace armature and remount motor on truck takes twenty-five minutes

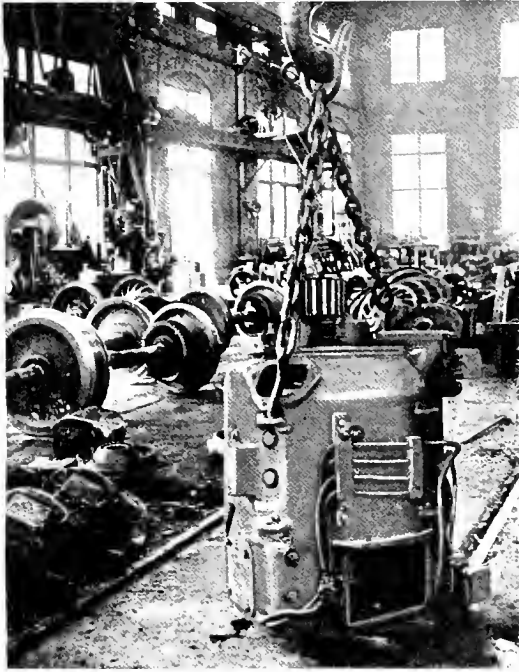


Fig. 6. A 140-H.P. Box Frame Motor removed from truck and turned on end preparatory to lifting out armature

It will be noticed that the pinion has not been removed, and that it is only necessary to

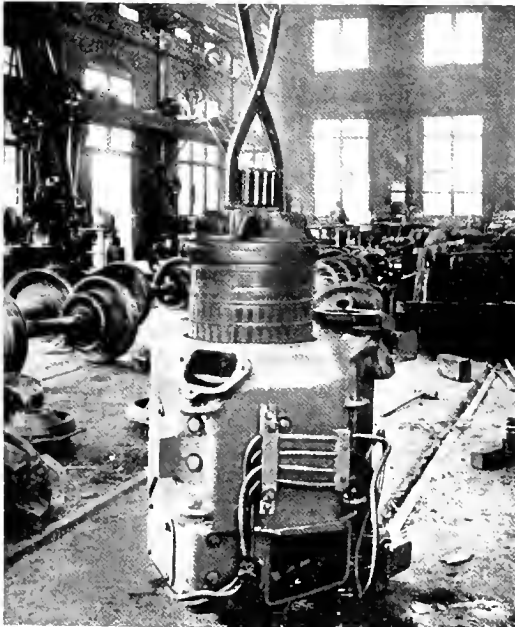


Fig. 7. Lifting out Armature of a 140-H.P. Box Frame Motor with scissors-like clamps which fit under pinion

remove the four bolts in the pinion end armature head, also that in this method, which avoids turning the motor on end, it is not necessary to remove the oil from the oil boxes.

The time necessary to remove and replace an armature after the truck has been taken out from under the car body is as follows:

To perform the first operation, that is, the removal of the axle caps and suspension bolts and raising the motor frame from the truck, takes 15 minutes.

The second operation, covering the removal of frame head bolts, forcing off frame head,

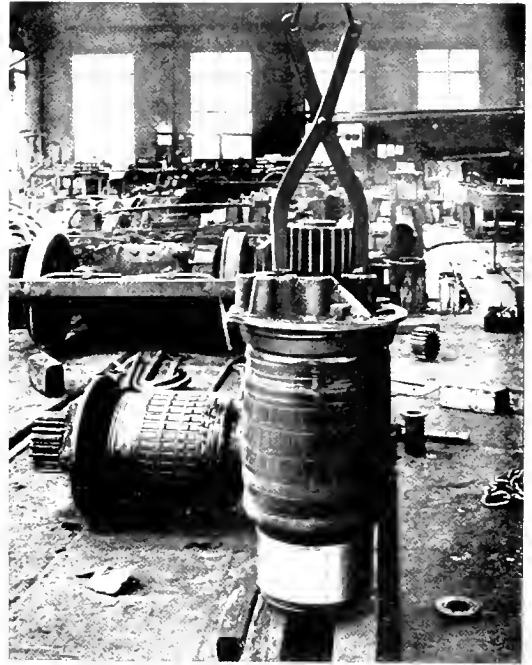


Fig. 8. The clamps are replaced by a light chain before laying the armature flat on the ground

clamping lever to pinion, placing lifting strap in position, removing armature and laying it on floor, requires 20 minutes.

The third operation, picking up armature, replacing it in shell, bolting up frame head, lifting motor and placing it on truck ready for service, takes 25 minutes.

This makes a total time of one hour from the time the truck is taken from under the car, until the motor is remounted and the truck ready to be replaced under the car body. This is, however, an average time and, under extraordinary circumstances, the work could and has been done in 45 minutes.



Fig. 9. Removing an armature by means of an extension of the armature shaft supported by a roller in a bracket bolted to the frame

Handling a Large Motor

Photographs are reproduced in Figs. 6, 7 and 8 showing the method adopted by another road for removing the armature from GE-222 motors. This is a 140-h.p. motor weighing complete with all parts 4260 lb. In this case, the motor is turned on end, after having been removed from the truck by slings in the usual manner. To turn the motor on end, the air intake pipe is removed, and a sling with hooks is attached to one of the bails on the motor frame, and to an eye bolt screwed into one of the axle cap bolt holes. For removing the armature the chain slings for taking the motor out of the truck, and for turning it on end, are replaced by scissors-like clamps which fit under the pinion teeth. The armature is then withdrawn, and stood vertically on blocks, while the clamps are replaced by a light chain before laying the armature flat on the ground.

A road operating a large number of GE-200 box frame motors is using an extension of the armature shaft to support one end while the latter is being dismounted. The pinion end frame head is removed, and the head at the commutator end replaced by a malleable iron bracket which fits the bore of the frame and is held in place by two tap bolts. This bracket carries a machined roller of such a diameter that the extension of the armature shaft, see Fig. 9, is kept in the center of the frame. This extension is a steel tube machined on the inside to just slip over the armature shaft. The shaft at the other end is supported

by an oak pole 3 inches in diameter having a steel tube at one end of it that fits over the armature shaft. The armature is moved out

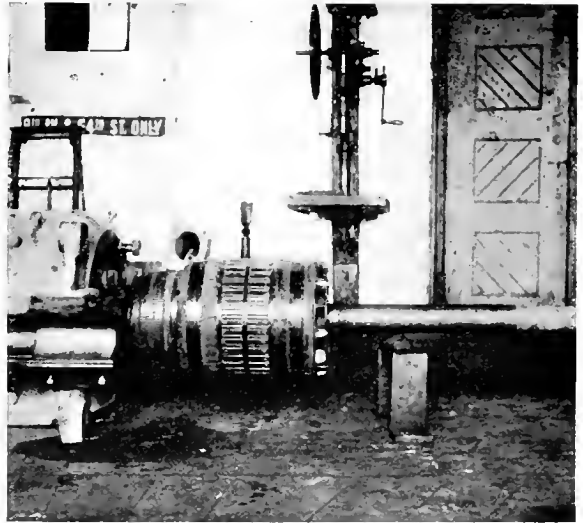


Fig. 10. The other end of shaft than that shown in Fig. 9 supported by an oak pole with a steel tube fitting over the shaft

horizontally and is supported at one end by the roller until it is clear of the frame.

Two somewhat similar methods are in use on another road for handling GE-210 motors. In one case the frame is stationary and the armature moved. An iron pipe having one

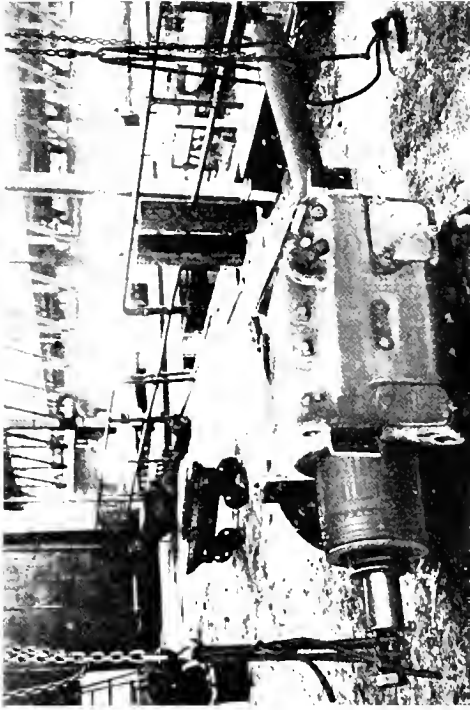


Fig. 12. One end of armature supported by a tube fitting over the armature shaft



Fig. 14. The armature is supported by jacks which can be readily adjusted to take the weight of the armature off the pole pieces



Fig. 11. An armature removed by overhead crane. Frame is stationary and armature is moved out horizontally

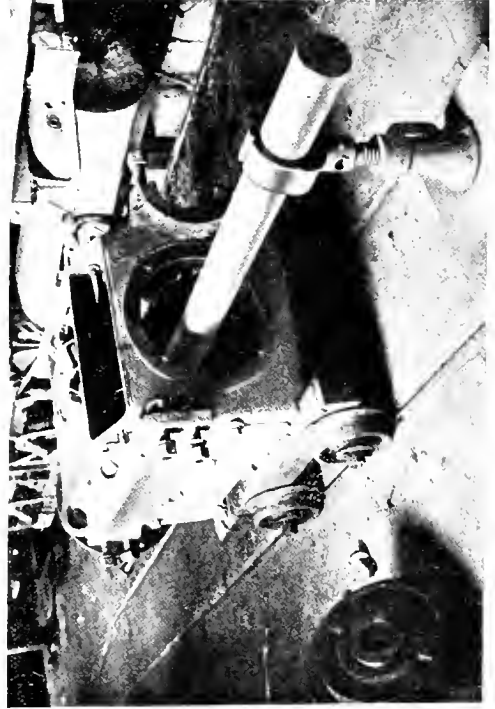


Fig. 13. The armature is held stationary and frame is moved horizontally on a truck

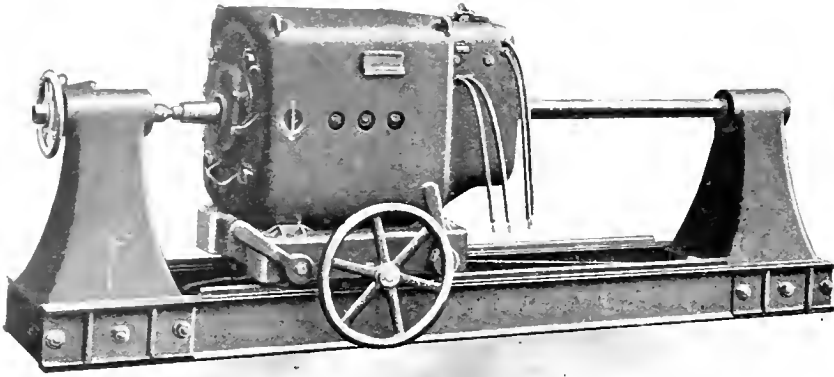


Fig. 15. A special machine for removing armatures from Box Frame Motors. Motor in place

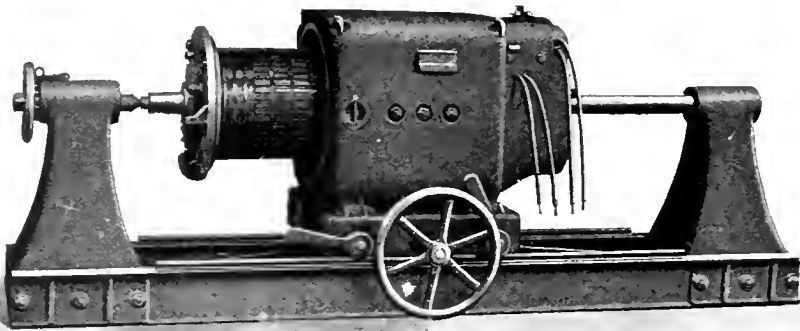


Fig. 16. Frame-head bolts withdrawn and frame moved partially along the bed of the machine by means of the handwheel

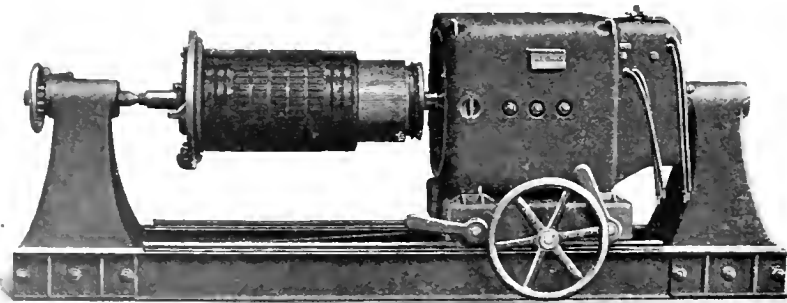


Fig. 17. Armature clear of frame and in a convenient position for examination and for effecting minor repairs

end bushed with brass, to avoid injury to the armature shaft, is used to support one end of the shaft. The armature is lifted by slings and moved out of the frame horizontally by an overhead traveller, see Figs. 11 and 12. The illustrations show the pinion and pinion end frame head removed from the shaft, though this is not actually necessary for the removal of the armature.

With the second method in use on this road, the armature is held stationary and the frame moved. Figs. 13 and 14 show this. The armature is supported by jacks, a bushed pipe being used at one end as before. The jacks can be readily adjusted to take the weight of the armature off the pole pieces, and the truck with the frame is moved along until the armature is clear.

This method is similar to that employed with the special machine shown in Figs. 15, 16 and 17. Although this involves the use of a special tool, it is simple and inexpensive to make and has many advantages.

The machine consists of a pair of centers, one of which is adjustable, mounted on a base which may be either a casting or built of channel bars. By using a long center instead of the pipe fitting over the armature shaft, the removal of the commutator frame head is avoided.

The table may be moved along the base by means of a hand wheel, and each of the supports on which the motor rests can be adjusted vertically by a lever.

The motor is supported by the machined bosses on the bottom of the frame. The method of removing the armature is made evident by the photographs. It is unnecessary to remove the oil from the armature bearing oil boxes, and the armature and frame are in a very convenient position for inspection and making minor repairs.

These examples illustrate some of the means employed for the removal of armatures from box frame motors. Other appliances may be used where better suited to individual shops.

A TEN-TO-ONE RATIO FOR COMPARING PRECISION RESISTANCE STANDARDS

By C. A. HOXIE

STANDARDIZING LABORATORY, GENERAL ELECTRIC COMPANY

The main object of this article is to describe a method of establishing a ten-to-one ratio by which precision resistance standards of either higher or lower denomination than the standard of reference may be compared with practically the same accuracy as those of equal nominal value.—EDITOR.

A piece of apparatus (which will be described later) for accurately determining a ratio of ten-to-one (Fig. 1), together with a bridge designed for the comparison of precision standards (Fig. 2), has been recently built and is now in use at the Standardizing Laboratory of the General Electric Company at Schenectady. This ten-to-one ratio is a modified form of a similar device in use at the Bureau of Standards at Washington to check the accuracy of another ratio with which their precision standards are compared.

The modification consists of an arrangement by which an adjustment of the special ratio set may be made, thus permitting a direct comparison of the standards.

The determination of the relative values of resistances having the same nominal value presents small difficulties compared with those encountered when the ratio is 10:1.

One of the first methods that might occur to us would be to form the ratio arms of eleven units that have been adjusted to an equal value, ten in one arm and one in the other; or to place the ten in parallel, using the odd one for the high side. But this, although employed for several years, is not entirely satisfactory, owing to the fact that there is no convenient way of checking the resulting measurements by interchanging the ratio coils.

We can, however, establish a ten-to-one ratio that possesses this advantage and puts it very nearly on a par with the even ratio method as to accuracy.

In the ordinary commercial electrical instruments the accuracy required is seldom greater than 0.1 per cent; but where such instruments of precision as potentiometers and resistance standards are manufactured

the resistances should be known to within 0.01 per cent.

The standard of reference is the international ohm, defined as that resistance offered to an unvarying electric current by a column of mercury at the temperature of

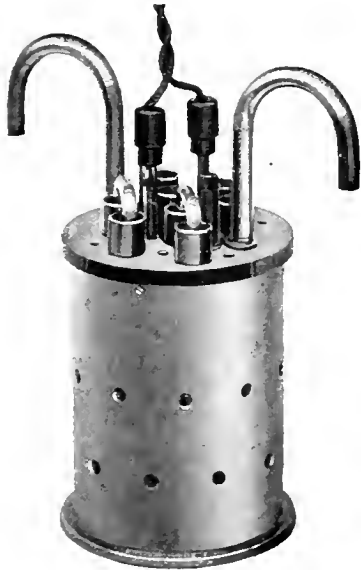


Fig. 1. Ten-to-One Ratio used in Connection with Precision Resistance Bridge

melting ice, 14.4521 grams in mass, of constant cross sectional area and of a length of 106.3 centimeters.

The results of several determinations of this value by different physicists, together with the comparison with wire standards, have agreed to within about two parts in 100,000 (0.002 per cent). If we add to this an estimated change of not more than 0.002 per cent in the reference wire standards, it probably would be difficult to certify to the absolute value nearer than about five parts in 100,000. Relative values, however, between suitably constructed standards under favorable conditions can be determined to within one or two parts in a million.

There can be obtained resistance standards of approved design constructed of resistance material which will not vary more than 30 parts in a million per degree C. and adjusted

to within 0.01 per cent of its nominal value. These standards are provided with heavy copper terminals projecting beyond the case by which they can be supported in mercury cups.

Having one of these standards, it is possible by means of a suitable precision bridge to determine the relative value of other standards.

In order to explain in the simplest way the 10:1 ratio, it seems advisable to refer in detail to a 1:1 comparison carried out according to ordinary well known means.

Let the standard S , Fig. 3, and a resistance of the same nominal value to be compared S_1 be placed in two adjacent arms of a Wheatstone bridge and a set of even ratio coils, A and B , form the other two arms. If now the ratio coils and the resistance S_1 be adjusted until the bridge is balanced and this balance be not disturbed by a reversal of the relative position of the ratio coils, it is evident that $A = B$ and $S_1 = S$. The adjustment of the arms S and S_1 may be accomplished by shunting one or the other, depending on which is the higher, with a comparatively high resistance a . If then the ratio coils are equal and the standard S be the one shunted to obtain a balance;

$$S_1 = \frac{aS}{a+S} \text{ or if } S_1, \text{ then } S_1 = \frac{aS}{a-S}$$

In practice A seldom equals B exactly, but it can be shown that if A differs from B not

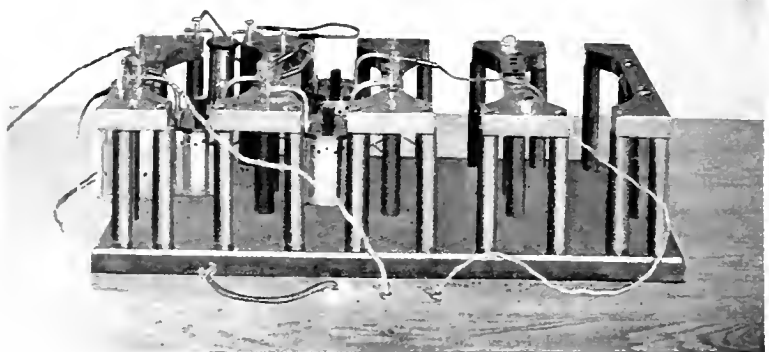


Fig. 2. Precision Bridge for Comparison of Resistance Standards

more than 0.1 per cent, the value of S obtained by taking the mean of two measurements, one with A and B in their normal position and one with their positions reversed, will not be affected by this difference more than one part in a million. This error in the result, however,

varies as the square of the difference between A and B . For example, if A differs from B 1 per cent, the result would be in error about one part in 10,000, or 100 times that of the first case.

Example 1. Let $A = 100$ ohms and $B = 99.9$ ohms (0.1 per cent lower) S and $S_1 = 1$ ohm each. In order to balance the bridge, if arranged as shown in Fig. 3, the shunt a

would equal $\frac{1 \times .999}{1 - .999} = 999$ ohms.

Result obtained from 1st reading

$$= S_1 = \frac{aS}{a - S} = \frac{999 \times 1}{999 - 1} = 1.001002.$$

Result obtained from 2nd reading

$$= S_1 = \frac{aS}{a + S} = \frac{999 \times 1}{999 + 1} = 0.999.$$

Mean of 1st and 2nd

$$= \frac{1.001002 + 0.999}{2} = 1.000001.$$

When the 2nd measurement was made the positions of A and B were reversed and S was shunted to balance the bridge.

Example 2. In this case let B be 1 per cent lower than A . $A = 100$ ohms, $B = 99.$, a would equal 99 ohms. 1st reading,

$$S_1 = \frac{99 \times 1}{99 - 1} = 1.010204.$$

2nd reading, $S_1 = \frac{99 \times 1}{99 + 1} = 0.99.$

Mean of 1st and 2nd =

$$\frac{1.010204 + 0.99}{2} = 1.000102.$$

In the first case the error in the final result was one part in a million; in the second, one part in 10,000, one hundred times that of the first.

The principal objection to this method of shunting the standard of reference, S , or the standard being compared, S_1 , in order to balance the bridge, is the very large range of shunt values that are required. For example, if the nominal value of the standards were 10 ohms each, it would require a shunt of one million ohms if only a reduction of one part in 100,000 were necessary; and if 100-ohm standards are being compared, ten times this shunt value, or ten megohms, are required to obtain the same result, while on the other hand one ohm shunted across a standard of 0.0001 ohm would only reduce its value one part in 10,000.

For this reason it is better to shunt a portion of the ratio coils A or B . If the

nominal value of A and B is 100 ohms, let this portion be, say one ohm. If this part be selected to within an accuracy of 0.2 per cent, the resulting calculated value of the reduction in A or B due to the shunt will be in error not more than two parts in a million, if this reduction be not more than 0.05 per cent of the

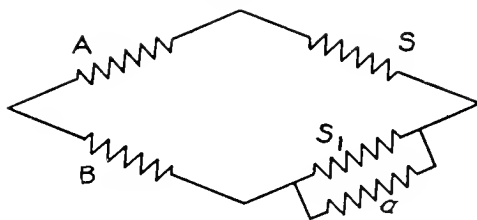


Fig. 3

total, which will seldom be the case when comparing precision standards.

For example, let the ratio coils equal 100 ohms each and the shunted portion, γ , equal 1.002 ohms; let the reduction in the ratio coil be 0.05 per cent, which in this case would be 0.05 ohm. In order to make this reduction,

the shunt $a = \frac{\gamma(\gamma - C)}{\gamma - (\gamma - C)}$ when $C =$ amount of reduction. Substituting,

$$\frac{1.002 \times (1.002 - 0.05)}{1.002 - (1.002 - 0.05)}$$

$= 19.07$ ohms = resistance of shunt. This value shunted across exactly 1 ohm would

reduce it $1 - \frac{19.07 \times 1}{19.07 + 1} = 0.04983$ ohm instead

of 0.05 as in the first case—a difference of only 0.00017 ohm, which is less than two parts in a million when A and $B = 100$ ohms.

The shunting resistance under these conditions would not exceed 10,000 ohms to show a change of one part in a million, nor lower than 20 ohms to reduce the ratio 0.05 per cent, the resistance of this shunt being independent of the nominal value of the standards under comparison.

In the foregoing we have dealt entirely with comparing resistances of the same nominal values, determining the accuracy of our ratio by a reversal of position.

In order to establish a 10:1 ratio we may select a suitable resistance, the value which need only be known approximately, and by intercomparison as before described adjust six others to the same value. Place three of these in parallel and adjust a seventh unit to the resultant value. We have now six units

of equal resistance and one that is one third of this.

If we now form two adjacent arms of a bridge by placing in each arm three of the six units in series, arranged so that either group of three can be connected in parallel,

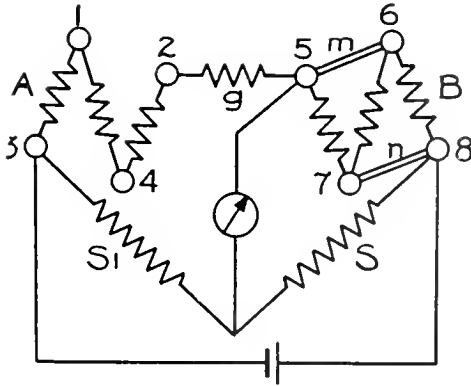


Fig. 4

a nine-to-one ratio can be established. This is the ideal condition, as the ratio can be reversed by simply placing the groups of these in parallel first on one side and then the other, of course leaving the units on the opposite side in series. In this case there will be an actual reversal of the relative position of the standards under comparison with respect to the resistance units forming the ten to one ratio, thereby obtaining a check equal to that of the even ratio condition.

(NOTE.—The parallel or series condition is made possible by assembling the seven coils in a suitable case and connecting the terminals of each to mercury cups located on the top, which can be joined by copper links of negligible resistance. (See Fig. 1.)

But unfortunately it is not a nine-to-one but a ten-to-one ratio that is required, which makes the problem somewhat more complicated.

However, by adding another resistance we can produce a ten-to-one condition that will still permit of a check that will assure very nearly the same accuracy in the final result.

If we connect the unit "g" that was adjusted to $\frac{1}{3}$ the resistance of the others, between the two groups as shown in Fig. 4 and place the three units in the B arm in parallel by links *m* and *n*, the resistance of the A arm will equal ten times that of B, and reversing these conditions by removing the links from 5—6 and 7—8 and placing them across 1—2 and 3—4 and changing the galvanometer connection from

5 to 2 will result in making B ten times that of A, provided all the resistances have been adjusted correctly.

This arrangement permits of a check on the accuracy by taking the mean of two measurements, as in the case of the even ratio condition, one with the relative positions of S and S₁ reversed with respect to the resistances forming the A and B arms (with the exception of the portion g, which will always be on the higher side of the ratio). For this reason any error in the value of g will cause an error equal to one-tenth of this in the final result. Therefore a check should be made to determine the relative value of g with respect to the mean value of the two groups of three in A and B, in order to be able to apply the necessary correction.

This check can easily be made by letting S and S₁ form an even ratio (Fig. 4) and placing a copper link of negligible resistance from 2 to 3, leaving the galvanometer connection at 5 and the coils in B in parallel.

After noting the difference in per cent between g and the coils in B, reverse the conditions (being careful to reverse the relative position of S and S₁ also) and compare g with the coils in the A arm. The mean of these two results will be the per cent that g is different from the mean value of the two groups; one-tenth of this difference being the correction that should be applied to the arm containing g when comparisons of ten to one ratio are made. This relative value of g can readily be determined to within one part in 100,000; then by applying this correction the measurement will not be affected by more than one part in a million.

It can be shown as was the case with the even ratio condition that the relative value of the six other resistances forming the A and B arms can be in error 0.1 per cent without affecting the final result more than one part in a million if the mean of two comparisons of a standard having a normal value of ten times, or one tenth that of the standard of reference, be taken, letting A form the high and B the low side in one, and with these conditions reversed in another as before described. This added to the estimated error introduced by the resistance g amounts to about two or three parts in a million.

In order to balance the bridge in the even ratio condition it was convenient to shunt a small portion of the A or B side, depending on which was the higher with respect to S and S₁.

In the ten to one ratio the only portion that permits of adjustment in this manner is

the resistance g , which is always on the high side. If, however, g is left about 0.5 per cent high (which is equal to 0.05 per cent of the total value of the arm) and a suitable portion be shunted until it is correct when compared with the remaining coils in A and B , as before described, it is evident that a balance can be obtained if the relative value of the standard being compared varies not more than 0.05 per cent either way from the standard of reference.

To illustrate, let the resistance forming g be a little larger than its true value. Select a small portion γ , across which can be shunted a variable resistance a . Compare the resistance g with the remaining coils in both A and B , adjusting in each case its resistance by the shunt a . If a_1 be the mean of the two shunt values required to bring the bridge to balance,

then $\gamma - \frac{a_1 \gamma}{a_1 + \gamma}$ will equal the amount that the

resistance g exceeds that of its true value. For example, we will take some actual data obtained in the Standardizing Laboratory in connection with the ten-to-one ratio now in use. The coils of equal resistance that form the large part of the A and B arms were adjusted to 150 ohms each. The values of

g were $\frac{150}{3} = 50$ ohms. The high side was then equal to $(150 \times 3) + 50 = 500$ ohms, and

the low side $\frac{150}{3} = 50$ ohms.

The resistance of the coil g was made approximately 0.5 per cent large. The portion γ , across which a variable resistance a was shunted, was adjusted carefully to 15 ohms.

When comparing g with the three coils in parallel on the A side, it was necessary in order to obtain a balance to shunt γ with 945 or 961 ohms, depending on the relative positions of S and S_1 (S and S_1 in this case equaled approximately 100 ohms each), the mean of which was 953 ohms. When comparing g with the B side, the shunt values were 942 and 958, the mean being 950 ohms.

The mean of the two means was $\frac{953 + 950}{2} =$

951.5 ohms. Let this = a' : then the amount that the resistance g exceeded that of its true

value = $\gamma - \frac{a_1 \gamma}{2 + \gamma} = 15 - \frac{951.5 \times 15}{951.5 + 15} = 0.2328$

ohms. Therefore under these conditions, when making ten to one comparisons if less than 951.5 ohms is required for a balance, the resistance of the high side is smaller than ten times that of the low side, or vice versa. This is, of course, strictly true only when the coils on the A side exactly equal in value those in the B arm. For this reason a mean of two measurements made under reverse conditions should be taken. If this is done, practically the same accuracy should be obtained as with the even ratio measurements, i.e., within two or three parts in a million. This, of course, only refers to relative values.

For example, let a standard S_1 having a nominal value of 100 ohms be compared with a standard S of 10.0012 ohms.

Let the value of the shunt necessary to secure a balance be 875 ohms and under the reverse conditions 878 ohms.

In the first measurement the reduction of the 15 ohms by the shunt of 875 ohms

$$= 15 - \frac{875 \times 15}{875 + 15} = 0.2528 \text{ ohm,}$$

$500 - (0.2528 - 0.2328) = 499.9800$, which is 40 parts in a million low.

In the second measurement the reduction

$$= 15 - \frac{878 \times 15}{878 - 15} = 0.2518 \text{ ohm,}$$

$500 - (0.2518 - 0.2328) = 499.9810$, which is 38 parts in a million low.

The results obtained from the first reading

$$S_1 = (10 \times 10.0012) - 0.0040 = 100.0080 \text{ ohms.}$$

The results obtained from the second reading

$$S_1 = (10 \times 10.0012) - 0.0038 = 100.0082 \text{ ohms.}$$

The mean of the first and the second = 100.0081 ohms = the true relative resistance of S_1 .

It has not been the intention of the writer to discuss the merits of the different bridge methods best adapted for the various resistance values under comparison.

In this article only the Wheatstone bridge was mentioned, but the principles brought out apply equally well to other types. In fact, the general practice is to employ the Kelvin double bridge for all comparisons or measurements of precision standards of ten ohms or less, using the Wheatstone bridge for all resistances over that value.

SOME PROBLEMS IN BURNING POWDERED COAL

PART I

BY ARTHUR S. MANN

GENERAL ELECTRIC COMPANY, SCHENECTADY, N. Y.

The author writes from a wide experience in this most interesting subject; this experience has been gained first hand from his experimental work at the Schenectady plant of the General Electric Company. In the present article he deals in considerable detail with the apparatus employed and includes data on the nature and behavior of powdered coal. We hope to publish in our next issue a report of the tests made.—EDITOR.

Powdered coal has been burned for years. It is more difficult to burn it beneath a boiler than it is in a forge furnace or in a cement kiln.

It seems simple enough to drop coal down a pipe by a screw feed, to pick it up with a cross current of air which carries it along to a furnace; and it is simple, provided the rules are obeyed. But such a plan is not very economical; the mixture is not good and some of the coal is long in burning; the fire may do the work required of it if there is room, but it will not give a high initial temperature; it will not have completed its burning in fifteen inches or so, perhaps not in fifteen feet.

Coal acts like other dust. Some of it is picked up on an eight-mile breeze but it will not stay in suspension at that speed: double the velocity to 1500 feet per minute and most of it will stay up, though 2000 feet is none too high for general work.

It is not good practice to send such a current at such a speed into a furnace. The combustion of carbon compounds is best at high temperature; the sooner it is over the better, and it requires a perfect mixture. A particle of coal speeding along parallel with an air stream has no inducement to mix with 10,000 air volume units, which it must have for its combustion. Such stream lines should be broken up.

A Burner

There are many ways of stirring things up. In one case we let the stream make a sharp turn with fair results: but more than one turn is needed and such turns take up room. One general rule may be stated: it is easier to make the mixture (it must be done in one-third second or less) if all those ten thousand volumes are not put in at once. Two, three, even five divisions are much better if the quantities are great. A pail of meal and water is better intermingled if the meal is added in small quantities; time is lost if all of both elements are brought together at once.

A device which is being used successfully to perfect a mixture and at the same time reduce high velocities is shown in Fig. 1. It consists of a cast iron cylindrical box eight inches in diameter with five openings beside its discharge mouth. Either opening *S* or *T* is used for coal and its primary air, or carrying air (40 to 60 cubic feet per pound of dust). Either *X* or *Y* is used for the combustion air and sometimes air is admitted at the end *U*. The first four of these openings are tangential, causing the currents to take irregular spiral forms, and they are used for short burning.

For an ordinary forge furnace, say five by four feet, *S*, *Y* and *U* will be piped up. A fire is started by using combustion air through *Y* alone, for through its use a short complete mixture can be dropped right upon burning kindling, and so long as this arrangement is preserved the high heat will be near the tuyere, and perhaps twelve inches in front of it. It sometimes happens that with short work it is not necessary that a furnace be hot all over and fuel will be saved if there be a high local temperature only. If a complete and uniform heat is wanted additional combustion air is admitted at *U* and there is an immediate change in the character of fire. The flame is no longer local: the mixture is not so good and burning calls for more time. Coal that can find adequate air near the tuyere burns there; other coal waits till it finds air, and there is a long flame in consequence. By manipulating the air valves at *Y* and *U* the range of regulation is great and it is possible to make a very long flame, even thirty feet under certain conditions. The same is true of an oil fire. If mixtures are only poor enough and oil is sent from the burner in chunks large enough, a flame of great length is attainable; it is only requisite that the fuel and air travel in parallel streams, whatever the nature of a suspended fuel. Such long flames are not economical; good mixture gives good economy. It must be remembered that the velocity of the stream passing along the axis of the burner must not be low enough to drop the coal, so a burner

must not be too large if a short fire is wanted. When two air streams (as at S and Y) rotating in counter directions meet, the rotation becomes nil and the axial speed must be enough to keep the coal in suspension and preserve the mixture already made.

It will be noted that the rotary motion within this burner is just the motion used in a centrifugal separator to draw moisture out of steam, or in a dust collector to separate air from solids. In these devices either the body diameter is large enough to keep the two elements apart, or baffles are provided to trap the heavier material. Then there are separate and guarded outlets for the two components, all of which are not true of the burner. That the device does produce a mixture is shown in its operation; for even when openings S and X are used, causing both sets of air to swirl in the same direction, the flame is only about twenty-four inches long, and as the combustion air at X is reduced and the air at U increased, the flame length is increased and combustion becomes slower, showing a less perfect mixture. Some of our furnaces are piped in just that way and though the range is not so great it is ample for most forging work.

600 turns per minute, or more if required. With so wide a speed control it is possible to carry a fire that shows just a visible red: by a simple movement of a rheostat handle this same fire will spring up vigorously and shortly give a heat high enough for any forge work.

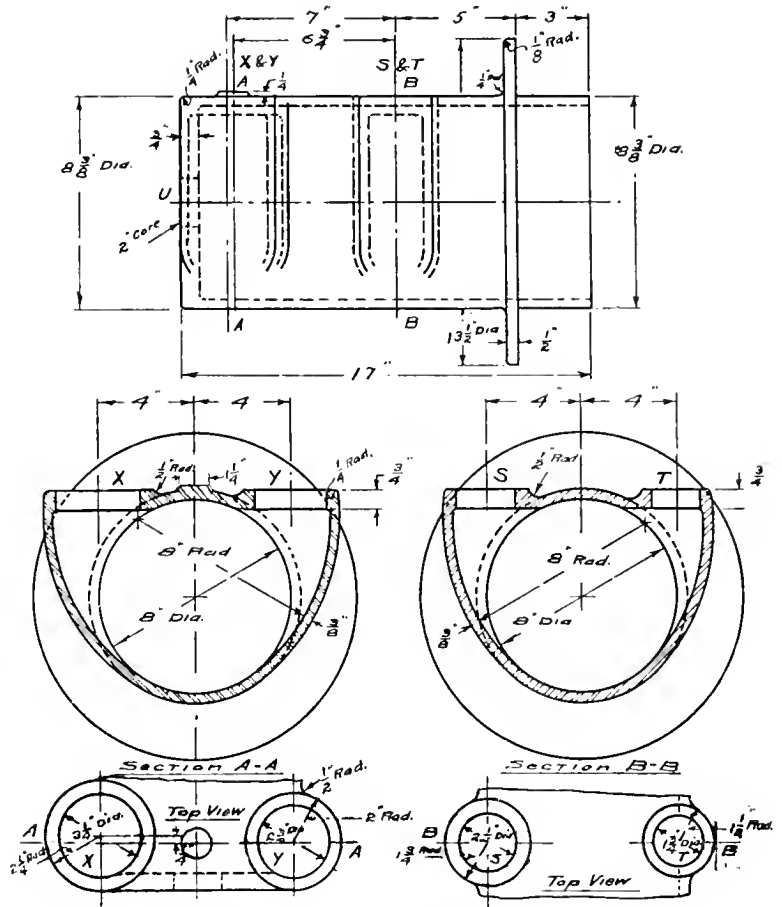


Fig. 1. Elevation and Sectional Drawings of an 8-inch Powdered Coal Burner

A Feeder

While there are several designs of feeders in use and no doubt many more are to be invented, we have found that a simple screw will answer every purpose. The feeder draws coal from a supply tank and delivers it in definite amounts to a cavity in which it can be picked up by the primary or carrying air; and therefore more than one speed is required. In the plant under consideration the feeder is driven by a little motor which can turn at 1800 r.p.m., 600 r.p.m., or any intermediate speed, and is geared down only once. We therefore made a screw that will feed at 300 or

There is a feature of the plain screw feed that makes it very convenient in many situations; viz., it can stand a little back pressure so that discharge distances may be long. In the installation under consideration the coal is being fed across a shop, that is, the supply tank with its feeders and motors is fixed to the shop wall, out of the way. A two-inch pipe is led along underground for 90 feet or more, then up to a furnace and its burner. The distance could be much greater, even a few hundred feet, and the control would be just as convenient and exact because the switch and rheostat are located

at the side of the furnace, and the operator has no occasion to come over to the supply tank. In all these long transmissions there will be a little back pressure at the screw. Primary air is introduced on the eductive principle, using the fitting shown in Fig. 2.

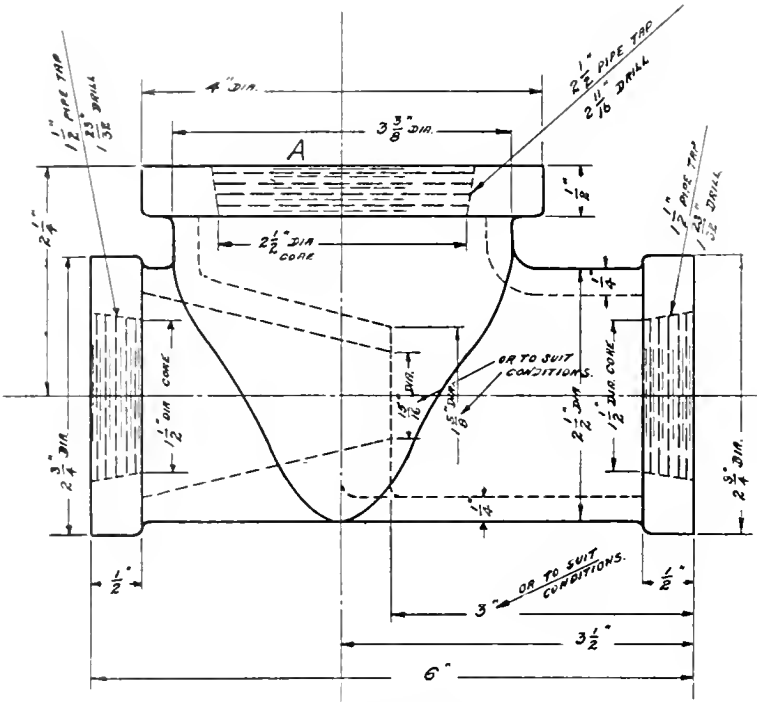


Fig. 2. The Special Pipe Tee in which the powdered coal is picked up by the primary air

finger fast enough to carry a moderate fire) there are times when considerable power is required. Normally the coal is light and fluffy, but under certain conditions of long standing coal can pack so tightly that no mechanical device can move within it.

The screw is cut in a lathe with spaces proportioned to the quantity required. A 2 1/2-in. diameter screw, as shown, will feed 700 pounds per hour, and with slight modification much more. The bottom of the thread is tapered so that after the screw has taken its bite the volume increases as a threadful advances, and the flow to the pipe is free and easy in consequence.

The weight of a cubic foot of coal may be anything from 20 lb. to 50 lb. As coal lies on a feeder screw it will not reach 20 lb. per foot. When delivered by a conveyor screw to a tank seven feet deep and measured immediately it weighs 31 1/2 pounds per foot. In 24 hours it will reach 35 pounds, and increases in density till in six weeks without jarring, it will weigh 38 1/2 pounds. Now these changes will take place in a container with smooth sides, or in one with a diameter equal to half its depth. In a piece of 6-in. vertical pipe 10 ft. 6 in. long, it was found that there was little settlement in two months. The pressure in the tanks, however, is computed at 35 pounds. Sometimes the coal flows as freely as a liquid and will spread out its top surface nearly level in the tank. At other times it

won't even flow down hill, though it always moves freely enough unless it has stopped for 48 hours or longer.

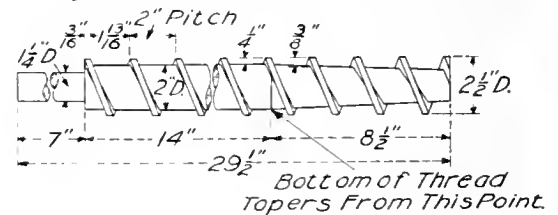


Fig. 3. The Feeder Screw

The resistances on the discharge side increase with distance. If the distance is short, we have a negative pressure in the pipe leading from the end of the screw to the opening A, see Fig. 2. Eight inches of vacuum, by water column, is easily attainable. As the discharge distance increases with addition of elbows and crooks this vacuum falls and we may have even five inches pressure. A plain screw is little affected by these changes, for the throat fit at A Fig. 4 is machined and gives a certain force to the coal. We have, however, so proportioned our long transmission that static pressure is usually negative, say one inch or so.

The screw and its feeder box are shown in Figs. 3 and 4 respectively. While usually only a small amount of power is needed to turn the screw it can be turned with the

This tendency to pack and clog is due to the physical arrangement of the particles through

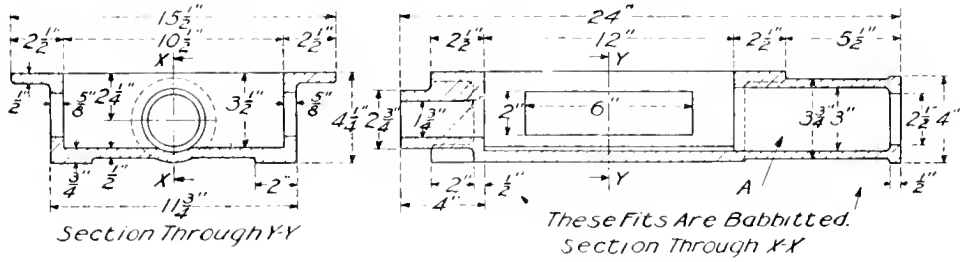


Fig. 4. The Feeder Box in which the feeder screw is located

settlement rather than to moisture. The powder will absorb microscopic water, but it cannot be made wet by throwing water upon it. We tried to make a paste once by using sticks to stir and squeeze the coal into the water; but it did not work. The only way that we could make a mixture was to take a little of each between thumb and finger and knead the two together. After the game was over we left our playthings in the sun. In a

day or so the water had evaporated, leaving our coal clean and dry.

It isn't hard to dry the coal to one-half per cent moisture or less, but there is always some small portion that contains moisture in excess. It is a little surprising to find an eight-ton bin of coal that has been nicely dried dripping with water twelve hours afterwards; but it does so, and it is not an uncommon thing to find a pulverizer frozen

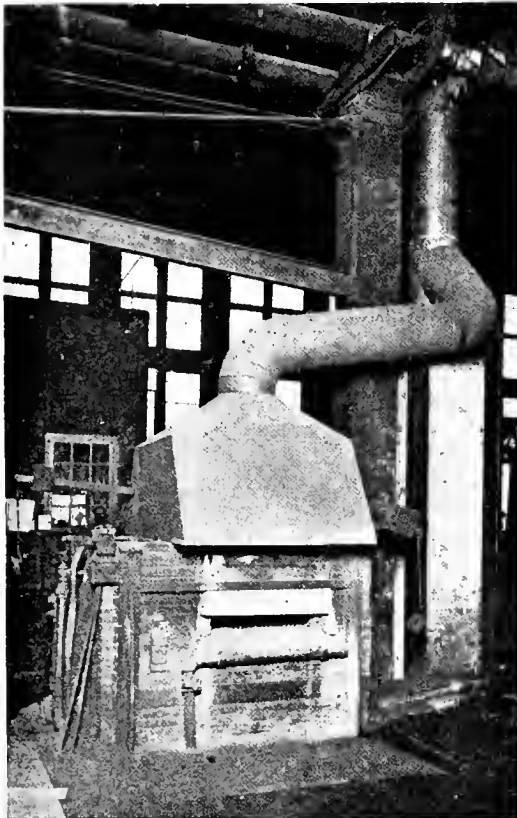


Fig. 5. A Front View of a Forging Furnace that uses powdered coal for fuel



Fig. 6. View of a Forging Furnace similarly equipped to that shown in Fig. 5

up with this water in the morning. The source of such water is not hard to find. When coal is in a dryer it is hot and so is its contained air. The air is saturated with moisture at the temperature of the dryer and when the coal and air cool the moisture is precipitated, and in cold weather makes its presence felt. It thus appears that coal cannot be made thoroughly dry through the agency of heat.

A Furnace

A question often asked is: Can I use my present oil furnace for a powdered coal furnace? The answer is yes, in the average case, though the writer believes it will pay to rebuild a furnace when its fuel is changed. As a rule two oil burners, if they be of the

If all gases are allowed to escape in this way, the heat distribution is not perfect, and therefore we like a chimney vent at an appropriate point. It is good practice to run this chimney up through the roof over each furnace and to cut into a 45 deg. Y to which the hood vent is attached and in which an upward draft is induced by the chimney draft. Figs. 5 and 6 are photographs of such connections. It pays to provide a nicely fitted damper which can be adjusted with precision: if the damper works on a screw thread the tips can be moved 1/50-inch, though such a fine adjustment is not needed. It also pays to preheat the combustion air. The saving in fuel greatly exceeds that represented by the heat imparted to this air. It was found that a saving of 35 per cent was secured in one

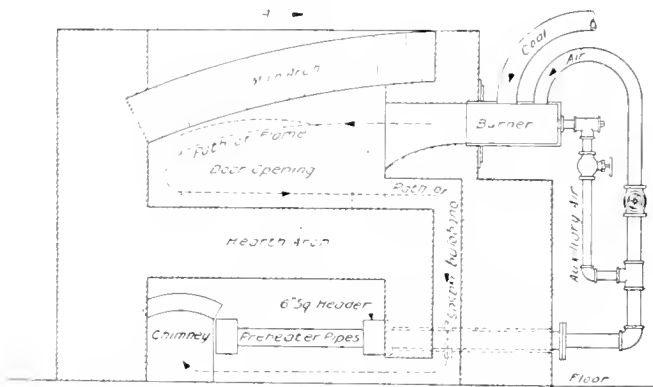


Fig. 7

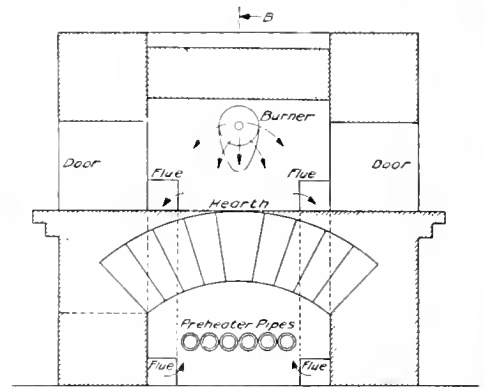


Fig. 8

Sectional Drawings of a Forging Furnace that burns powdered coal

atomizing type, are required on an average furnace. An oil burner of the globular type needs a combustion chamber of some sort. A coal furnace needs but one burner and calls for no combustion chamber. In every other respect the coal furnace is more complex than its oil counterpart. An oil fire makes no visible smoke and there is little or no odor from its products of combustion, so there is no reason why there should be a chimney or in many cases even a furnace vent. Flame and hot gases can be brought up to and passed out of the door, keeping the fronts hot. A coal fire yields no black or colored smoke, though the gases contain some small particles of white ash, but it does have a decided and disagreeable odor. It is better then to provide a hood over the furnace door, enveloping it, if heat is wanted right at the door as it is in most forge work, and this hood must have an outdoor vent.

case with air heated to 334 deg. C. while the heat contained in the combustion air was only 16 per cent of that in the coal. Only a moderate air temperature was used, as it is preferable to install only such surface as can be readily cleaned, and the low temperature prevents burning out the preheating surface. It is good practice to allow 15 feet of surface in a furnace that burns 100 pounds of coal per hour, with an inside temperature of 1355 deg. C.

The preheater is made of 3-in. cast iron soil pipe, six lengths being rusted into a header at either end and placed beneath the hearth in the path of the waste gases.

Two vertical sections of a furnace in the Schenectady Works are shown in Figs. 7 and 8. The hearth is 43 inches long and 24 inches deep though this same design is being used for furnaces having twice the area.

(To be Continued)

A REVIEW OF THE N.E.L.A. LAMP COMMITTEE REPORT

By G. F. MORRISON

EDISON LAMP WORKS, HARRISON, N. J.

The report of the lamp committee of the N.E.L.A. is always looked forward to with great interest by the lighting industry. This year the committee has rendered a particularly interesting report and throughout the year has kept the members of the electric lighting industry informed on developments and progress in the incandescent lamp field. The increase in the number of gas filled lamps manufactured is significant as showing the rapidity with which research work is leading to industrial results.—EDITOR.

The comprehensive report presented at the San Francisco Convention is an excellent record of the present status of the incandescent lamp with relation to the central station business. It is enhanced with numerous illustrations, curves, diagrams and tabulations, giving data not elsewhere available. As might be expected, in view of the rapidly increasing use of the Mazda C lamps, a considerable portion of the report is devoted to their development and application, especial attention being given to the question of providing suitable fixture equipment. Besides following out and bringing up to date the report of last year, it contributes much new and important information in line with the broadening policy of the Committee.

The lamp sales for 1914 fell a little below those of the preceding year, being slightly less than 100,000,000. The trend toward the use of the Mazda lamp continues to increase, so that 70 per cent of all lamps sold were of the Mazda type as against 56 per cent for 1913. In the same period, the sales of Gem lamps decreased from 31 to 22 per cent and the carbon from 12 to 7 per cent. Fig. 1.

The distribution of lamp sales among the various sizes shows that about 41 per cent of all multiple Mazda lamps were of the 25-watt size or below; 27 per cent were of the 40-watt size; 17 per cent were of the 60-watt size; and 6 per cent were of the 100-watt size.

Notwithstanding the recent extensive use of low wattage lamps, the average candle-power of all incandescent lamps sold annually during the last eight years has risen from 18 to 38.2, while the average wattage has only fallen from 53 to 48. Especially during the past year the high power lamps have been influential in raising these averages.

The falling off in the sales of Gem lamps and the irregularity of the demand as predicted last year by the Committee made it seem necessary to warn the member companies to anticipate their requirements, on account of the impracticability of furnishing such lamps in large quantities on short notice. For a similar reason, together with the tendency of the demand toward a few

particular voltages, it has been necessary to broaden the voltage limits of lamp specifications.

“Development work on the incandescent lamp has been principally along the lines of increasing the number of sizes of Mazda lamps

Domestic Incandescent Lamp Sales
1907-1914

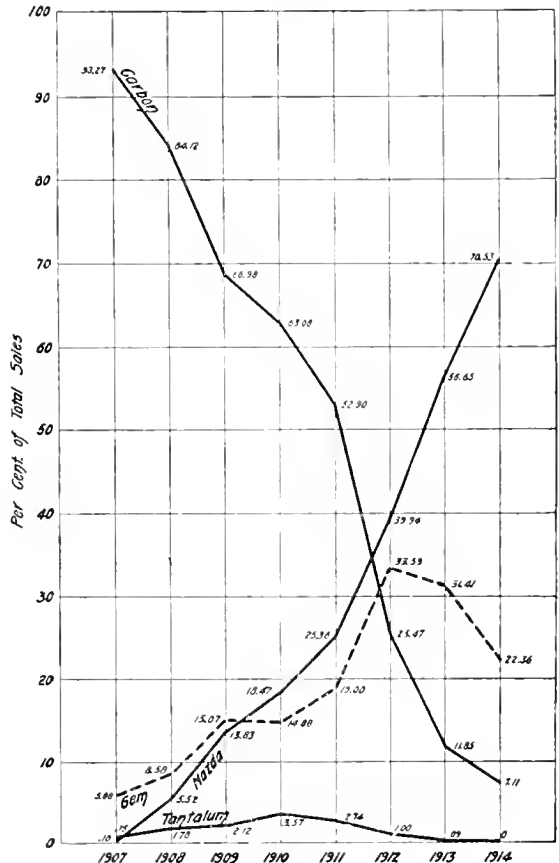


Fig. 1

available, embodying the gas-filled principle. Lamps of this type will be referred to as Mazda C lamps to distinguish them from vacuum lamps. They are now made for multiple service in the following sizes: 100, 200, 300, 400, 500, 750 and 1000 watts. All of

these lamps are primarily unit illuminants, that is, it is customary to use them in individual reflectors, and your Committee emphasizes the importance of seeing to it, so far as may be possible, that these lamps are introduced and used as unit illuminants.

"The popularity of lamps embodying the gas-filled principle is illustrated by the fact that in the neighborhood of a million were sold during 1914.

lamps designed for operation in an inverted position (tipup) but such lamps must be ordered specially for this purpose."

In order to secure the best result, it is important that lamps be used in suitable fixtures which for the high power lamps should provide ample ventilation, and for outdoor service protect the bulbs from moisture. Rule No. 35 of the National Electric Code prescribes the conditions to be

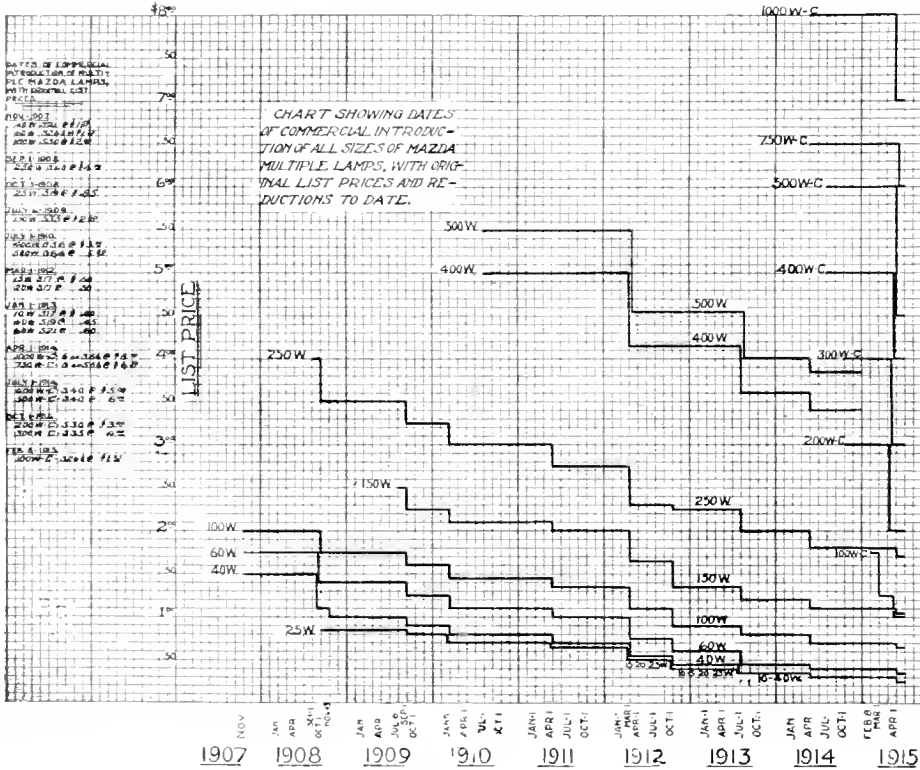


Fig. 2

"Improvements in these lamps have been principally along the lines of securing a more uniform product * * * *

"The principal change in their design has been to adopt a new line of bulbs in all standard sizes, with the exception of the low candle-power street series. The new bulbs are pear-shaped with extended glass necks * * * .

"It is customary to insert a mica disk deflector between the stem and the filament of this lamp, thereby deflecting hot gases from the glass seals and base.

"The usual practice in the design of these lamps is to construct them for but one position of burning, namely, tipdown. Manufacturers are, however, in a position to supply

met by fixtures and installations. A list of the principal types of fixtures and reflectors indicates the classes of service for which each is suited.

In connection with the greater economic value of the Mazda C street series lamps over the vacuum type or Mazda B, it should be noted that the 60-c-p. Mazda C consumes slightly less wattage than the 40-c-p. Mazda B, and but little more than the 32-c-p. The Committee recommends the policy, as generally adopted by the larger companies, of substituting the 60-c-p. Mazda C for the old 40-c-p. and 32-c-p. sizes and thus standardizing it as a minimum size. Likewise in the higher powers it recommends replacing

the 80-c.p. with the 100-c.p. Mazda C, and the 200-c.p. with the 250-c.p. Mazda C.

“Last year it was stated that the practice of introducing chemicals to delay the discoloration of the bulb of the Mazda B lamp had been extended to include the 40- and 25-watt sizes. This practice has been still further extended to include 20-, 15- and 10-watt lamps and has permitted the operation of all vacuum lamps at higher efficiencies with improved maintained candle-power.” These improvements in quality have resulted

decreased 60 per cent and the cost of electric light 85 per cent.

This economy, together with the increasing range of sizes, not only makes it desirable to intensify the use of incandescent lighting in present fields, but opens up many new applications which may be exploited with profit to the central station. Some of the important classes of lighting worthy of such attention are the semi-indirect and indirect lighting of large interiors, the lighting of photographic studios, lighting of streets,

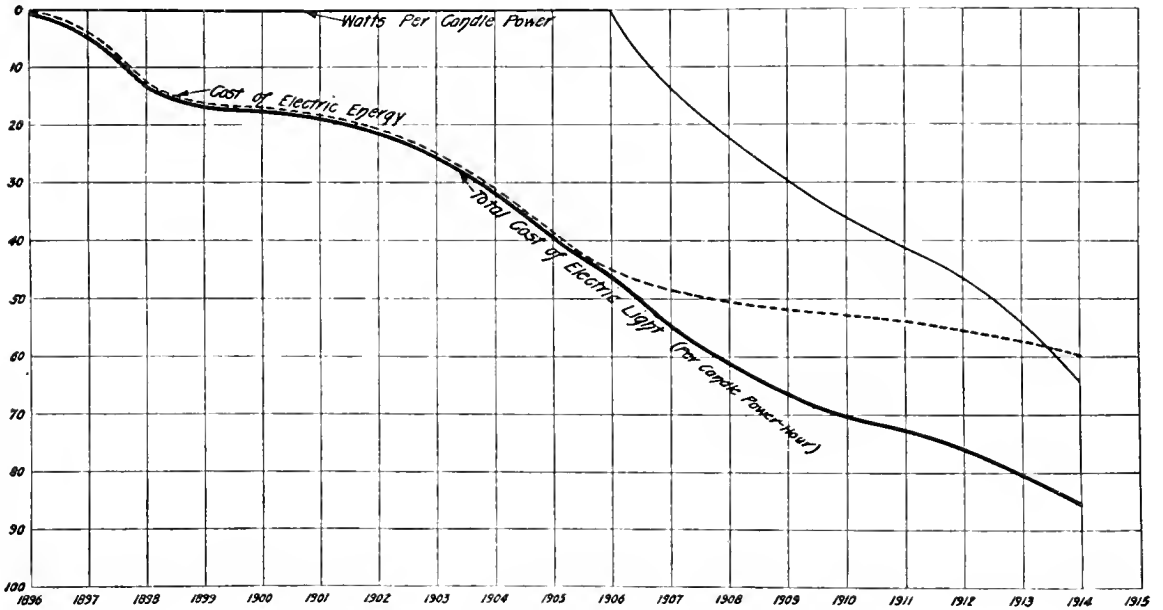


Fig. 3. Curves showing Decrease in Cost of Electric Light

in increases of from 7 to 10 per cent in the efficiencies of sizes below 150 watts.

A table shows the improvements in efficiency of each size of Mazda lamp since its introduction, while a chart which is here reproduced as Fig. 2 indicates the very considerable price reductions which have been made in the corresponding period. These reflect the remarkable strides made in the manufacture of lamps since the introduction of the tungsten filament, both as to the quality of lamps and the economy of manufacture. From Fig. 3 it will be seen that since 1896 the cost of electric energy has

bridges, parks, etc., and the lighting of outdoor areas for athletic events such as tennis courts, court golf and trap shooting.

The new focusing type of Mazda C lamps (concentrated filaments) also opens up new uses for electric current. Prominent among these are the flood lighting of building fronts, billboards, etc., which are very desirable loads to the central station on account of their excellent load factors. The focusing type lamps are also used to advantage in stereopticons, spot lights and small moving picture machines.

In regard to lamp policy, the Committee urges the member companies to maintain supervision of the size, quality and rating of lamps used on their circuits. This is becoming more and more important, as inferior tungsten filament lamps, both in vacuum and gas-filled types, are making their

appearance on the market in increasing numbers. Their use is likely to result in unsatisfactory service and a disadvantage to the lighting industry. Appended to the report are the series of articles published during the year in the Association Bulletin under the auspices of the Lamp Committee.

PRACTICAL EXPERIENCE IN THE OPERATION OF ELECTRICAL MACHINERY

PART XI (Nos. 54 TO 56 INS.)

By E. C. PARHAM

CONSTRUCTION DEPARTMENT, GENERAL ELECTRIC COMPANY

(54) FIELD CONNECTION ERROR

Single-phase repulsion-induction motors vary in the number and in the disposition of their brushes according to the size of the motor, according to the number of poles, and according to whether the motor is reversible, is of variable speed, or is of variable speed and reversible also. Irrespective of the type, every repulsion-induction motor has at least two sets of brushes—one set of energy brushes and one set of compensating brushes.

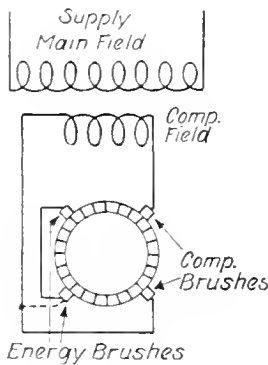


Fig. 1

On the constant-speed motors the energy brushes are short-circuited within the motor and the compensating brushes are connected directly to the compensating field winding which is an extra field winding, one purpose of which is to limit the speed of the armature at light loads. The speed limiting property depends on the fact that an increase in armature speed increases the e.m.f. available at the compensating brushes, therefore the compensating field current becomes stronger.

The circuits of a constant-speed repulsion-induction motor are indicated in Fig. 1. Since the rotation of the armature is due to the current of the energy circuit, if that circuit is opened, for example, by a poor contact, the armature cannot rotate. Furthermore, since the speed is limited by the compensating field, which concurs in direction with the main field, if the compensating field circuit is opened or is reversed not only will the armature speed be higher for a given load condition but the current will be correspondingly high at all load values because the counter e.m.f. of the armature will be lower.

The full lines in the diagram indicate the correct connection, the dotted line indicates an incorrect connection that caused heating, sparking, and high speed of a repulsion-induction motor that was applied to driving a printing machine. The trouble was caused by the fact that the operator when reversing the direction of rotation of the armature by shifting all the brushes to the opposite running mark, had not followed the instructions properly. He reversed the compensating field terminals correctly but instead of fastening both of the field leads onto the compensating brushes again, he connected one of them to a compensating brush and the other to an energy brush.

(55) MOTOR WOULD NOT START

When a motor fails to start on closing the starter and there is no evidence of current flowing, a "dead" line or an open-circuit is suggested; if there is an evidence of current flowing, a short-circuit or a wrong connection is generally sought. In the case of a polyphase

motor, however, symptoms are not as well defined because current may flow in one phase and not in the others. If a polyphase motor does not start but simply hums when voltage is applied, it is reasonable to assume that only one of its phases is energized.

An operator installed a three-phase induction motor to operate a "skull-cracker" in an iron foundry. The motor ran continuously but the skull-cracker was operated by means of a clutch. On applying voltage for the first time, the motor started but ran in the wrong direction. Two of the stator leads were then reversed, after which the motor just hummed instead of starting. On throwing the compensator to the running position, the fuses blew. The renewal of the fuses and restoration of the stator leads to their original connection did not correct matters. On removing the bottom and front of the compensator to look at the contacts, it was noticed that one of the three coils showed no evidence of heating. The switch was then opened and a magneto used for ringing from the fuses to the bottom contacts 1, 2, 3, 4, 5 and 6. With the switch on either side, the bell rang from fuses *a* and *b* to contacts 2 and 3, respectively, but fuse *c* would ring to contact 6 only when the compensator switch was on the running side.

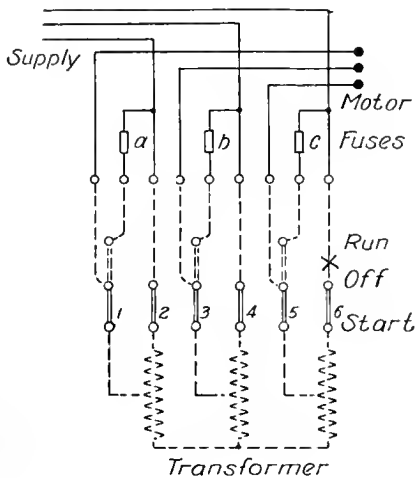


Fig. 2

The compensator was then disassembled and a burned off flexible wire was located at the place marked with a cross in Fig. 2. The wire did not appear to be parted because its insulation held the ends in line. Most of the strands had been parted for a long time but

three of them showed recent burning. This explained why the motor had started once and why it could not be started again.

From the diagram it will be seen that the 2, 4 and 6 contacts rang to the fuses with the compensator on the running side, because in this position the starting wires to the bottom fingers are by-passed by the paths that lead through the fuses, the switch, the transformer taps, and the upper sections of the coils.

(56) ADJUSTING SINGLE-PHASE MOTOR CLUTCHES

On one very successful type of self-starting single-phase induction motor, the armature core is free to turn on the armature shaft up to a certain predetermined speed, at which value the centrifugal force causes clutch fingers, that are integral with the core, to engage a clutch shell that is integral with the shaft. The shaft and its connected load are then started and accelerated to practically synchronous speed. The speed at which the clutch members engage is adjustable by means of springs that oppose the effort caused by centrifugal force. The advantage of this construction lies in the fact that the limited torque afforded by split-phase starting devices is not required to start the connected load.

The clutch springs are usually so adjusted as to permit the centrifugal force to overcome the opposing clutch tension at about two-thirds synchronous speed. At this speed value, the momentum of the core together with the rapidly increasing single-phase synchronizing effort of the motor will be sufficient to start the connected load and bring it to speed, unless the connected load has a great inertia such as that due to a flywheel, for example. If under conditions of great inertia or of low voltage the clutch is adjusted to throw in too soon, the motor will not have acquired sufficient synchronizing power at the time that it is required to take up the connected load. Under this condition the core will either partially slow down or it will stop entirely in accordance as to whether the starter is on the starting notch or is on the running notch. The obtaining of the correct clutch adjustment for particular loads is a matter of trial, adjustment and trial again. The standard factory adjustments will cover most of the operating conditions ordinarily met, but occasionally the adjustments must be modified to suit local special conditions.

IN MEMORIAM

DR. AND MRS. F. S. PEARSON

It is always difficult to write a befitting eulogy of a great man whom we admire and respect, and the task is harder when, as in the case of Dr. Pearson, his activities have extended back almost into another generation, and his energy has been of such a versatile nature as to lead him to many widely distant fields of activities. There are some few men whose energy and genius seem to lead to their being considered rather as citizens of the whole world than as belonging to any one particular nation. Such was the case with Dr. Pearson, for while his early activities were confined largely to the United States, latterly he undertook many great schemes in foreign countries, notably in Mexico, South America and Spain, and he drew upon the financial resources of England, France and Belgium to carry out his many ambitious undertakings.

Dr. Pearson was first and foremost an engineer in the fullest and best sense of the word; he was a builder, a constructor, a man who carried through great schemes to a successful conclusion; he was one who met many different kinds of difficulties and obstacles, both technical and financial, and overcame them all. His whole life was spent in converting the forces of nature to the useful service of man.

Both Dr. and Mrs. Pearson were lost in the most tragic of modern disasters—the destruction of the *Lusitania* by a submarine on the high seas on May 7, 1915—a disaster that shocked and horrified the whole civilized world as none other has done in the memory of man. It is not our intention, though, to dwell upon this tragedy, but rather to try to give our readers some conception of the work, life and character of Dr. Pearson. Perhaps the best way that we can accomplish this purpose is to quote, in extenso, from some of the addresses made by his friends at the memorial service held in New York on June 23, 1915.

On this occasion Dr. E. W. Rice, Jr., said:

I first made the acquaintance of Dr. Fred S. Pearson over 25 years ago in connection with the electrification of the West End Street Railway of Boston.

I have a very distinct recollection of the strong and altogether favorable impression which he immediately made upon me. He was the engineer

of the Street Railway Company, and the Thomson-Houston Company, with which I was connected, furnished the electrical apparatus.

The problems presented were new, difficult and without precedence for guidance. Courage, perseverance, versatility and optimism were in constant demand, the situation was frequently critical, but Dr. Pearson's confidence in the ultimate success of the enterprise never flagged for a single instant.

He had a ready solution for every difficulty, a courage that was contagious, and optimism not blind to immediate shortcomings but nevertheless full of the vision of the more perfect future.

He showed at this early date those qualities which characterized his whole after life. While tremendous energy was the dominant note in his character, he was also patient, studious and practical, careful but bold, painstaking enough in details which seemed important, yet possessed with a breadth of view that encompassed the whole problem.

After the successful electrification of the street car system of Boston he came to Brooklyn, and as engineer was responsible for the introduction of the electric street cars of that city, designing and erecting in connection therewith what was then the largest and most modern of electric power stations.

He then turned his attention to New York City. The problem presented here was exceedingly difficult because the overhead trolley was not permitted. It was due to his courage and engineering ability that the underground conduit or trolley was brought into successful operation in this city; it still remains practically as he left it.

In connection with this work in New York, he designed and erected the 96th Street power house of what was then the Metropolitan Street Railway Company. This was the first of New York's mammoth power houses, and was at the time (1896) the largest in the country, with a total generating capacity of 70,000 horse power. It remained for some years a model for the guidance of the rapidly expanding industry.

During this period his services were in great demand as consulting engineer for many electrical enterprises in Providence, Toronto, Montreal, Niagara Falls, Winnipeg and other places.

His health failed after such tremendous exertions and it was necessary to seek rest, but after a short vacation he resumed his strenuous life. From this time on his interest was largely in foreign countries.

In Mexico, he built up the great engineering works which supply the City of Mexico with light and power. In Sao Paulo, Brazil, he developed a similar enterprise, and again as the result of his labors in Rio de Janeiro, Brazil, it is said, that "in place of several lines of mule cars, an antiquated gas plant and a telephone service where one could walk to the one he desired to talk with quicker than telephone, Rio de Janeiro now enjoys the highest type of modern electric railway service unexcelled anywhere in the United States or Europe, an electric lighting system which makes it the best lighted city in the world, a new and modern gas plant and a regular Bell telephone service which is now being extended all over the United States of Brazil."

Between frequent trips to Brazil and Mexico he found time to plan and superintend the hydraulic installation of the Electrical Development Company at Niagara Falls, a plant of 160,000 horse power, supplying electric light and power to the city of Toronto 100 miles away.

His last great enterprise is located in Spain and involves the building of works for the utilization of the water power of the Ebro river and the supply of such power to the city of Barcelona for the operation of electric lights, general power and the city tramways. This great enterprise he had nearly completed at the time when the war burst upon the world and interrupted his work because of the general dislocation of finances.

Dr. Pearson then returned to this city and we were glad to renew our friendship of so many years. I was again impressed by his splendid courage and quiet defiance of misfortune. Anarchy in Mexico had for the time paralyzed his great creation in that country and the European war had forced a sudden stoppage of the Barcelona enterprise, but with his characteristic energy and ability he soon succeeded in overcoming all obstacles and arranged the necessary finances to give assurance that his latest enterprise would soon go ahead to a final and successful completion.

I have only mentioned a few of his achievements in electrical engineering, but as is well known his energy and activity were so great that he found time to engineer and direct many other important enterprises entirely outside the electrical field, such as mining and railroading, lumbering and irrigation, and as if these were not enough he found leisure to indulge his love of nature by developing and managing a beautiful estate of thousands of acres in the hill country of western Massachusetts.

While Dr. Pearson was a loyal American he was in every sense a citizen of the world; his work kept him abroad much of the time and he was equally at home in England and Spain, in Mexico and Brazil, as in the United States.

The features of Dr. Pearson's personality, which appealed to all those who met him, were his great energy and activity, as ceaseless as the running water of the many rivers he so loved to turn to useful purposes; his thoroughness which permitted no necessary detail to be neglected and which led him to personally visit and study at first hand the site of every water power or other engineering project in which he was interested, no matter where located. This was perhaps one of the reasons for his success and the secret of the astounding amount of work accomplished because it enabled him to go ahead at full speed with that confidence which follows a definite and accurate knowledge of the road to be traveled.

He also possessed to an extraordinary degree a mind capable not only of conceiving the largest plans but the courage and optimism to put such plans into execution and the ability to interest the necessary financial assistance.

He was always leading his profession in the demands which he made upon the manufacturers for increase in size of engine, dynamo or transformer, for the highest practical efficiency, for the highest operating pressure; in fact, he was always pushing everything and everybody to the limit, and yet his judgment was so well balanced that I cannot remember a single instance of failure of any of his engineering works in any important part. His work was permanent and reliable, and eminently practical and successful.

In a very real and literal sense his works are his monuments; in the mountains of Brazil, on the plateau of Mexico, at Necaxa, and on the Ebro river in Spain, are solid concrete dams and electrical power houses, great and permanent engineering structures created by his genius and energy for the perpetual service of man. It is said that Cæsar dammed the rivers of Spain for the purpose of war to enable him to destroy his enemies; Pearson dammed the same rivers for the purpose of peace, to save life and to make it better worth living.

In the entire course of his busy life, in which he had the most complicated business and engineering relations with numberless men of many types, professions and nationalities, and involving financial obligations of millions of dollars, there was never any question as to his absolute honesty and integrity, not only of word and deed but of that uprightness of mind which permits no deception of itself and which makes straight thinking and honest dealing with others a matter of second nature.

I have tried very hard to keep my thoughts from contemplating the tragic ending of this benefactor of his own country and of the people of foreign lands, but it is impossible, I cannot keep it out of my mind. We, his friends, cannot help thinking of the frightful needless sacrifice of such a valuable life, cut off in the prime of its vigor and usefulness. He was actually engaged on an errand of peace when he met his tragic fate. He was then on his way to England to help complete arrangements which would start anew the wheels of industry and give employment to thousands of men.

It is impossible to think of his sacrifice and that of the sweet and noble partner of his life, and those other unoffending men, women and innocent babes without feelings of horror.

If, as we hope, the aroused conscience of the civilized world, acting through our country, succeeds in restoring the practices of humane civilization, then his sacrifice and that of so many others may not have been wholly in vain.

Whatever may happen, however, we, his friends, have the solace that although cut off in his prime, Dr. Pearson had lived a great life, that this work was so well done that the industries which he established will live on, that many of his incomplete plans will be taken up and continued by others who have been stimulated by his example and inspired by his personality. He will continue to live in the hearts of his friends as long as they live, and we may all take comfort and inspiration from our belief that this world is and will continue to be a better world as the result of his life and work.

Mr. C. A. Coffin, who was unable to be present at the service, communicated the following tribute:

It is with a certain sad satisfaction that I am able to send you my personal tribute to the memory of my friend of many years, Dr. Fred S. Pearson. It is with deep regret that I am unable to be present at the memorial service in honor of him and his wife.

I came into close personal and business relations with Dr. Pearson some thirty years ago, and during all the intervening time I have never ceased to hold him in high and affectionate regard. His ability, his openness and frankness, his loyalty, his simplicity and truth, his untiring industry and earnestness, were striking attributes of a most unusual

character, which won for him universal esteem and admiration.

In his untimely death, all those associated with him must feel his loss as a personal sorrow. For myself, it is as if a warm and cheerful light had been extinguished, because of which the world in which we move became darker. One of the finest spirits in the brotherhood of men has been taken from us, but we shall ever cherish his memory as an uncommon and lasting heritage.

Professor Elihu Thomson wrote as follows:

I can only say now that I always had the highest esteem for Dr. Pearson. He was an example of a very able engineer, of great courage, always ready to act up to his convictions. He was such a man as was needed in the early inception of street railway electrification on a large scale, such as the West End Street Railway system in Boston. He was engaged in this work when we first met. His great ability, altogether exceptional, and his personal earnestness and integrity always impressed me. His quiet modesty was not the least of his qualities. Those who were privileged to know him as a friend must deeply mourn his loss and deplore the circumstances which brought to an untimely end the work of a great man; for that he was a truly great man is shown simply by the list of activities in which his talent was demanded.

He shrank from no task, however formidable, which fell upon him and achieved remarkable success due to hard work and unflinching devotion. I am glad of the opportunity to testify to his great worth but with all others of his friends deeply mourn his loss.

Mr. W. B. Potter's tribute was:

Our lives are not unlike a road which, day by day, we build into the wilderness of a far country. We seek only to build, and only at the last call from labor are our hands withdrawn—whither the road leads and how constructed is a mark of the builder, and its route and foundation are an inheritance to those who follow after.

Dr. Pearson was a builder of roads and of men, a pioneer in undertaking, an engineer of construction and a master of opportunity.

His work will endure and his example long be an inspiration to other workers in the world's welfare. He brightened many of the world's dark places and eased the weary travel of multitudes. But he will no longer direct and guide, and why it thus should be, only in the infinite wisdom of God is the answer. He was, with all, a man among men and with whom it was a privilege to be a friend. The loss is more than ours, but to those of us who knew Dr. Pearson, there is an intimate realization of one who has gone before.

Professor William L. Hooper, who knew Dr. Pearson from his early manhood gave the following address:

It is my privilege to speak of Dr. Pearson as one who knew him well during his early manhood and who had watched his subsequent career with keenest interest and with profound admiration.

We became friends in the Spring of 1883 when I began to teach in, and he was to about graduate from Tufts College; and during the succeeding

three years, while he was Walker Special Instructor in Mathematics, we taught and sometimes worked together.

Even in his college days young Pearson displayed that restless, tireless energy, that love of work for work's sake, that has always seemed to me his chief and distinguishing characteristic. Though, of course, an excellent student, he was not content to follow tamely the lead of his professors, but was impelled to gambol by the wayside. First we saw him absorbed in chemistry, then buried in philosophy, and again delving into the mysteries of Hamilton's quaternions and the higher mathematics. And, strange to say, each thing that he touched he seemed to absorb and master as though endowed by nature with special aptitudes in that one branch of learning. I have never known another with Dr. Pearson's versatility of intellect.

As a teacher he is remembered by his former pupils in various ways. To his more brilliant students he was a delight and an inspiration; the more slothful remember only an illuminated mist that their dimmer vision could not penetrate. It soon became apparent that the career of a college professor, which some of us had predicted for him, offered an entirely insufficient field for his superabundant activity; for before his term as Walker Instructor had expired, he was already engaged in a number of commercial enterprises. Then or shortly afterwards he visited and investigated mining enterprises in Texas and Brazil. He was one of the founders of the Somerville Electric Light Company in Massachusetts; he assisted in organizing companies in Woburn, Massachusetts; Halifax, Nova Scotia, and elsewhere.

The first field adequate for the display of Dr. Pearson's genius was presented when Henry M. Whitney having consolidated the various street railway companies of Boston and vicinity, called upon him in 1888 to take charge of the electrification of the West End Street Railway. Hardly anyone then, and few even now, can fully appreciate all that was involved in that undertaking. It had been shown that cars could be successfully propelled by electric motors; in several places a few cars were being so run; but a great system of electric traction had as yet to be created. Among the problems he met and solved in the West End were those of adequate insulation for overhead construction, better track construction and bonding, better engines and larger generators, improved switchboard equipment, and the prevention of electrolysis in underground pipes and cables. Some years ago the late George Westinghouse stated that the specifications for the first large West End generators marked an epoch in the development of the dynamo. Mr. Whitney once said to me that in the electrification of the West End no difficulty ever arose, and difficulties were the common experience, for which Dr. Pearson did not soon devise an effective remedy.

Dr. Pearson found in the West End electrification the crude beginnings of an experiment; he left it with two large power houses well advanced in construction and equipment, a thousand cars in successful operation, and the plans for the complete electrification of the road nearly finished.

As I have already said, cars had been run by electricity before, but here was the first great system of electric traction the world had ever seen and for years afterwards the West End was the model for all who sought to equip electric railways.

I leave to another better qualified than I the task of speaking of Dr. Pearson's subsequent professional

career, but I cannot let pass this opportunity of paying my tribute of affectionate admiration to the characters of Dr. Pearson and his devoted wife.

With Mrs. Pearson I was never intimately acquainted, but I knew her well enough to appreciate that she was a loving and devoted wife, his constant companion on his travels, watching over him and guarding him as a mother does her child. To her devotion and self sacrifice it seems to me the Doctor owed the strength that enabled his not too robust frame to be sustained under the strain of his Herculean labors.

I have spoken of Dr. Pearson's indomitable energy and his versatility of intellect. To these must be added a wonderful power of imagination, not merely the susceptible imagination of the poet or the artist, though he had that too, but the constructive, the creative imagination of the scientist. This power of picturing in his mind a whole complicated course of events and seeing clearly what the ultimate outcome should be accounted for an audacity of execution that frequently astounded others. This power of imagination and audacity in execution are well illustrated in the Necaxa Hydraulic Development in Mexico. Who but a Pearson could have seen in the brooks of Northern Puebla the possibility of a great power generation? Who but he would have had the courage to undertake its realization?

One of the qualities that most endeared the Doctor to others was his simple, kindly manner and entire absence of ostentation. He was always ready to receive a suggestion and if that suggestion seemed to him to possess merit he was ready to adopt it. Coupled with this kindly disposition was an almost too ready confidence in the faith, good intentions and ability of others. This confidence generally was well bestowed, but I have sometimes thought that had it always been deserved the Doctor's troubles and perplexities would have been reduced. Like a thread of gold through a fabric of sober hue ran a keen sense of Yankee humor, which sometimes even in the midst of grave and

mighty transactions would set the table in a roar. His humor, however, was never low, never vicious; it left no sting.

To Dr. Pearson's untiring energy and impartial appreciation, to his tremendous grasp of principles and mastery of details, to his wonderful memory and vivid imagination, to his versatility, his kindly disposition, and his faith in others were due the immediate source of his successes, the unswerving loyalty and devotion of his staff. Without such loyalty and devotion it would have been impossible for any man to have conducted such great and widely scattered enterprises.

Dr. Pearson's name will always occupy a high place in the history of engineering. One of the world's great engineers has said of him, and still another has said to me, that Dr. Fred Stark Pearson was the world's greatest engineer.

We believe that the above tributes to Dr. Pearson's memory by some few of his many friends and admirers express better than anything that we could write the admiration and affection with which he was esteemed, and give a better idea of his genius and of his work than any short compilation that we might make from them. But in concluding there is one thought which we wish to express—that it is upon just such men as Dr. Pearson, who have their genius fortified with courage and indefatigable energy, that the progress of nations depends—it is by such men that empires have been founded, and we feel that we, one and all of us, benefit by their work. Dr. Pearson was a great American—and America mourns his loss, as does the rest of the civilized world that knew him through his works.

FROM THE CONSULTING ENGINEERING DEPARTMENT OF THE
GENERAL ELECTRIC COMPANY

HIGH FREQUENCY

The term "high frequency" is at present very loosely used; under it are generally included high frequency voltage from an alternator, oscillations with varying unknown damping factors and train frequencies, steep wave-front impulses of various unknown shapes, etc. The effects of these on insulation are naturally not the same. There are, consequently, many apparent discrepancies resulting from the "same" cause—"high frequency." In "high-frequency" tests the wave shape has not been exactly known.

In the following table is a comparison of the breakdown values of oiled pressboard insulation for known continuously applied and transient voltages.

The same general relative effects also occur in air and oil. Such data has already been given.† Oil, and especially air, are however not affected to as great an extent by continuously applied high frequency. The total range in puncture voltage in the data given is 10 to 1. By reducing the damping and increasing the train frequency, the effect of oscillatory voltage may be made to approach that due to high frequency. At high frequency the losses are very great and puncture results from heating or even burning. The high puncture voltage for the impulse is due to the limited time of application. The effect of impulse voltages higher than the 60-cycle puncture voltage is cumulative; each one locally "cracks" or "shatters" the

BREAKDOWN VALUES OF OILED PRESSBOARD

60 CYCLES KV. (MAXIMUM)		HIGH FREQUENCY (ALTERNATOR) 90,000 CYCLES (KV. MAXIMUM)		DAMPED OSCILLATION 200,000 CYCLES (TRAIN FREQUENCY 120 PER SECOND) (KV. MAXIMUM)		SINGLE IMPULSE CORRESPONDING TO SINGLE HALF CYCLE OF 200,000 CYCLE SINE WAVE (KV. MAXIMUM)	Thickness Cm.
Time of Application		Time of Application		Time of Application		Time of Application	
Rapidly * App.	One Minute	Rapidly App.	One Minute	Rapidly App.	One Minute	Single Impulse	
89	87	24	18	95	73	180	0.25
200	185	30	20	210	120	...	0.50

* Brought rapidly up to breakdown value in a few seconds.

An examination of these data shows that the impulse puncture voltage is approximately double the 60-cycle puncture voltage, while the high-frequency (alternator) puncture voltage is only about 30 per cent of the 60-cycle voltage. These data are sufficient to emphasize the importance of knowing the exact conditions under which tests are made.

insulation. The puncture voltage may be 180 kv. for one impulse and 95 kv. for a thousand impulses. This, to a certain extent, is shown in the table above by the single impulse puncture voltage and the damped oscillation puncture voltage. The damping is so high that the oscillation roughly represents a single impulse. There were approximately 1000 oscillations in the "rapidly applied" damped oscillation test; the damping and train frequency were such that appreciable heating did not result.

† A.I.E.E., June, 1913—Discussion by author at Detroit.
F. W. Peek, Jr.—"The Law of Corona and Spark-over in Oil." GENERAL ELECTRIC REVIEW, August, 1915.
F. W. Peek, Jr.—"Dielectric Phenomena in High-Voltage Engineering."

F. W. PEEK, JR.

QUESTION AND ANSWER SECTION

The purpose of this department of the REVIEW is two-fold.

First, it enables all subscribers to avail themselves of the consulting service of a highly specialized corps of engineering experts, or of such other authority as the problem may require. This service provides for answers by mail with as little delay as possible of such questions as come within the scope of the REVIEW.

Second, it publishes for the benefit of all REVIEW readers questions and answers of general interest and of educational value. When the original question deals with only one phase of an interesting subject, the editor may feel warranted in discussing allied questions so as to provide a more complete treatment of the whole subject.

To avoid the possibility of an incorrect or incomplete answer, the querist should be particularly careful to include sufficient data to permit of an intelligent understanding of the situation. Address letters of inquiry to the Editor, Question and Answer Section, General Electric Review, Schenectady, New York.

REACTANCE COILS: PRACTICABILITY FOR SEGREGATING TROUBLE

(146) The accompanying "one-line" diagram (Fig. 1) represents the layout of the alternating-current distributing circuits of a direct-current trolley railway system. Two nominally independent high-tension lines connect the stations. If a short circuit takes place on one of these lines, say on line No. 1 at $y-z$ (1) it is found that all the connected lines feed into the fault, which opens all the breakers back to the main station. Could not reactance coils be designed so that, when placed one in each station bus between the tapping points of lines No. 1 and No. 2, (at the points marked $-X-$), they would prevent the good line from feeding sufficient current into the faulty one to cause trouble? If such an installation is possible, the stations, in the event of a short circuit crippling one line, could continue to draw power from the other line which might suffice until the damaged line could be placed in service again.

Commenting upon the proposed scheme of inserting reactance coils in the bus at the generating station and at each substation, it should first be said that such reactances could be arranged to take care of the conditions mentioned. That is, short circuits in certain lines could be prevented from affecting lines in tandem with them, which are arranged on the other side of the bus reactance.

bus at both ends of the reactances are liable to fall out of step.

(3) The system as a whole will be benefited but very little by having short circuits paralyze one side of the system all the way back to the main station, even if the other side is left in good working order.

Continuity of service, as it is understood at the present time, demands that a disturbance of any one line be localized and that only the line in trouble be cut out (this without affecting any of the other lines either in parallel or in series with it).

The whole situation is one that should be met not by the introduction of additional new devices, such as reactances, but by a change in existing arrangements. The selection and distribution of relays on the various transmission lines, as described, denote rather an old-fashioned practice. Unfortunately, in the past, very little attention was frequently given to the selection of relays, with the result that it was impossible in a great many cases to localize trouble and confine it to its own circuit. Instead of disturbances being limited to the circuit of the line in which they started, they were not prevented from running back throughout the whole network and opening up circuit-breaker after circuit-breaker, through which they passed on their way to the main source of power. Only recently has there been developed a regular fine art in diagnosing the characteristic needs of each

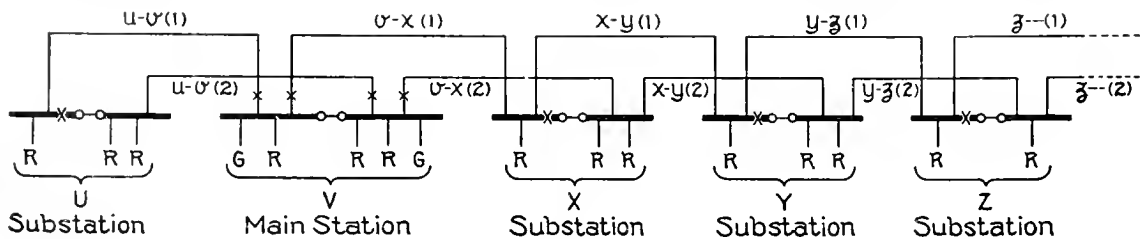


Fig. 1

R = Rotary Converter; G = Generator; -O-O- = Bus Switch; -X- Proposed Reactance.
 Transmission lines No. 1 B. and S., three-phase, Y-connected, neutral grounded.
 Lines $u-v$ (1) and (2) are protected at U by instantaneous relay on middle leg only.
 Lines $u-v$ (1) and (2) are protected at V by time-limit relay on all three legs.
 Lines $v-x$ (1) and (2) are protected at V by time limit relay on all three legs.
 Lines $v-x$ (1) and (2) are protected at X by instantaneous relay on middle leg only.
 Lines $x-y$ (1) and (2) are protected at X by instantaneous relay on all three legs.
 Lines $x-y$ (1) and (2) are protected at Y by instantaneous relay on middle leg only.
 Lines $y-z$ (1) and (2) are protected at Y by instantaneous relay on all three legs.
 Lines $y-z$ (1) and (2) are protected at Z by instantaneous relay on middle leg only.

However, the use of reactances has the following objections:

- (1) Considerable expense.
- (2) Bus reactances always have the disadvantage that synchronous apparatus connected to the

individual circuit in order to fit it with relays sympathetic only to those troubles starting within their own radius, and not to be affected by outside disturbances, no matter how near nor how great.

It is easy enough to equip a power system such as that described with a line of relays, which will combine reliability of operation with dependable selective action, so that the trouble referred to will be eliminated; that is, to prevent short circuits from going back to the main station and throwing out of commission every station between it and the seat of the trouble. The main features of such a scheme would be to employ reverse-power relays at the incoming ends and selective time-limit relays at the outgoing ends of the lines, the time element increasing the nearer the relays are to the main station. D.B.

HARMONICS: DEFINITION AND TEST

1471. What is a harmonic current?

What designates it as being of the first, second, or third, etc., degree?

How can its presence be detected?

"A harmonic current (or harmonic electromotive force) is a current the value of which, at each instant of time, is proportional to the sine or the cosine of an angle that is increasing at a constant rate."* In practical work, an alternating voltage or current is seldom a simple harmonic function of time for it contains one or more of the so-called "higher harmonics." In fact, an alternating wave of even very irregular shape may be resolved into several component waves which act according to the harmonic law. The wave having the greatest length (lowest frequency) is generally called the "fundamental" or "first harmonic," and all the others are referred to it. A wave having a periodicity or frequency twice as great as the fundamental is called the "second harmonic"; one having a frequency three times as great is the "third harmonic," etc.

A simple means of obtaining an indication of the presence or the absence of higher harmonics in an alternating voltage wave is to place an electrostatic condenser of accurately known capacity in the circuit and measure its charging current. If the measured value is greater than that calculated from the formula

$$\text{Current} = 2 \times \text{frequency} \times \text{capacity} \times \text{e.m.f.}$$

it can be safely assumed that the voltage wave contains harmonics higher than the fundamental frequency.

The best method of testing waves for higher harmonics (although somewhat more elaborate than that just described) is based upon the use of an oscillograph. This method, in addition to furnishing positive and accurate data, possesses the following advantages over the condenser method; it is equally applicable to examining current waves; and, besides merely indicating the presence or the absence of higher harmonics, it permits the number and degree of all the harmonic waves that may be present to be determined. The scheme consists of taking an oscillogram of the wave, enlarging the

photograph, and subjecting it to some method of analysis. There are several of these methods, a simple one being described in Bedell's "Direct and Alternating Current Manual," Chapter 11. Another is the so-called "point-to-point" method. This and other methods of wave analysis are described in Karapetoff's "Experimental Electrical Engineering," Vol. II, Chapter 31. S.T.

* From "Elements of Electrical Engineering" by Franklin and Esty.

CABLES: CARRYING CAPACITY

(148) We have an underground, 60-cycle, 6600-volt, three-phase line 85 feet long, between generators and their oil switches made up of nine, 500,000 cir. mil, cambric-insulated, lead-covered cables laid in groups of three in fiber ducts. The three cables of each group are connected in parallel with each other, comprising one leg of the three-phase line, and are drawn into one duct. It was impossible to use three equivalent single-conductor cables because of sharp bends in the ducts. The current per phase varies from 1000 to 1250 amperes and is often higher for short periods.

(a) What is the approximate cable loss?

(b) What would be a reasonable temperature rise to expect?

(c) What is the eddy current loss in the lead covering of the cables?

(d) Would the loss be increased or decreased if the cables were reconnected so as to have a cable per phase in each duct, i.e., have three-phase current in each duct?

(e) Assuming it to have been possible to have used only three single-conductor cables (instead of nine, three per phase) of equivalent section and with the same thickness of lead sheath would the loss have been decreased?

(a) The loss would be approximately 10 watts per duct foot.

(b) The loss given in (a) would be expected to cause a rise in the cables of 30 to 40 deg. C. above the temperature of the floor or surrounding earth.

(c) We know of no recent tests that have been made of the eddy-current loss in the lead sheath of alternating-current cables. Early ones have shown, however, that it is small compared to the I^2R loss, and in single-conductor cables carrying 60-cycle alternating current (when the lead on the different legs of the circuit is insulated so that there are no cross currents between the sheaths) the lead loss is about 10 per cent of the I^2R loss.

(d) The loss would be greater.

(e) It is doubtful if alteration in the arrangement of the lead covering would cause any further change in the losses than to slightly increase the skin effect due to the greater diameter of the cable. W.S.C.

AN OMISSION

Through oversight we failed to give credit to the American Institute of Electrical Engineers for the article, The Contact System of the Butte, Anaconda and Pacific Railway System, by J. B. Cox, published in our August issue. This was a paper presented at the Annual Convention of the A.I.E.E., Deer Park, Md., June 29, 1915.

INSERTION

July REVIEW, *The Periodic Law*, page 618. Following third paragraph read: We shall consider the thorium series as typical of the three series. The atom of thorium disintegrates with the expulsion of an alpha (α) particle and yields Mesothorium I. The radiation emitted during the transition from Mesothorium I to II is extremely weak; but a study of the properties of the other members of the series leads to the conclusion that these radiations are most probably beta (β) particles of very low penetrating power.

GENERAL ELECTRIC REVIEW

A MONTHLY MAGAZINE FOR ENGINEERS

Manager, M. P. RICE

Editor, JOHN R. HEWETT

Associate Editor, B. M. EOFF
Assistant Editor, E. C. SANDERS

Subscription Rates: United States and Mexico, \$2.00 per year; Canada, \$2.25 per year; Foreign, \$2.50 per year; payable in advance. Remit by post-office or express money orders, bank checks or drafts, made payable to the *General Electric Review*, Schenectady, N. Y.

Entered as second-class matter, March 26, 1912, at the post-office at Schenectady, N. Y., under the Act of March, 1879.

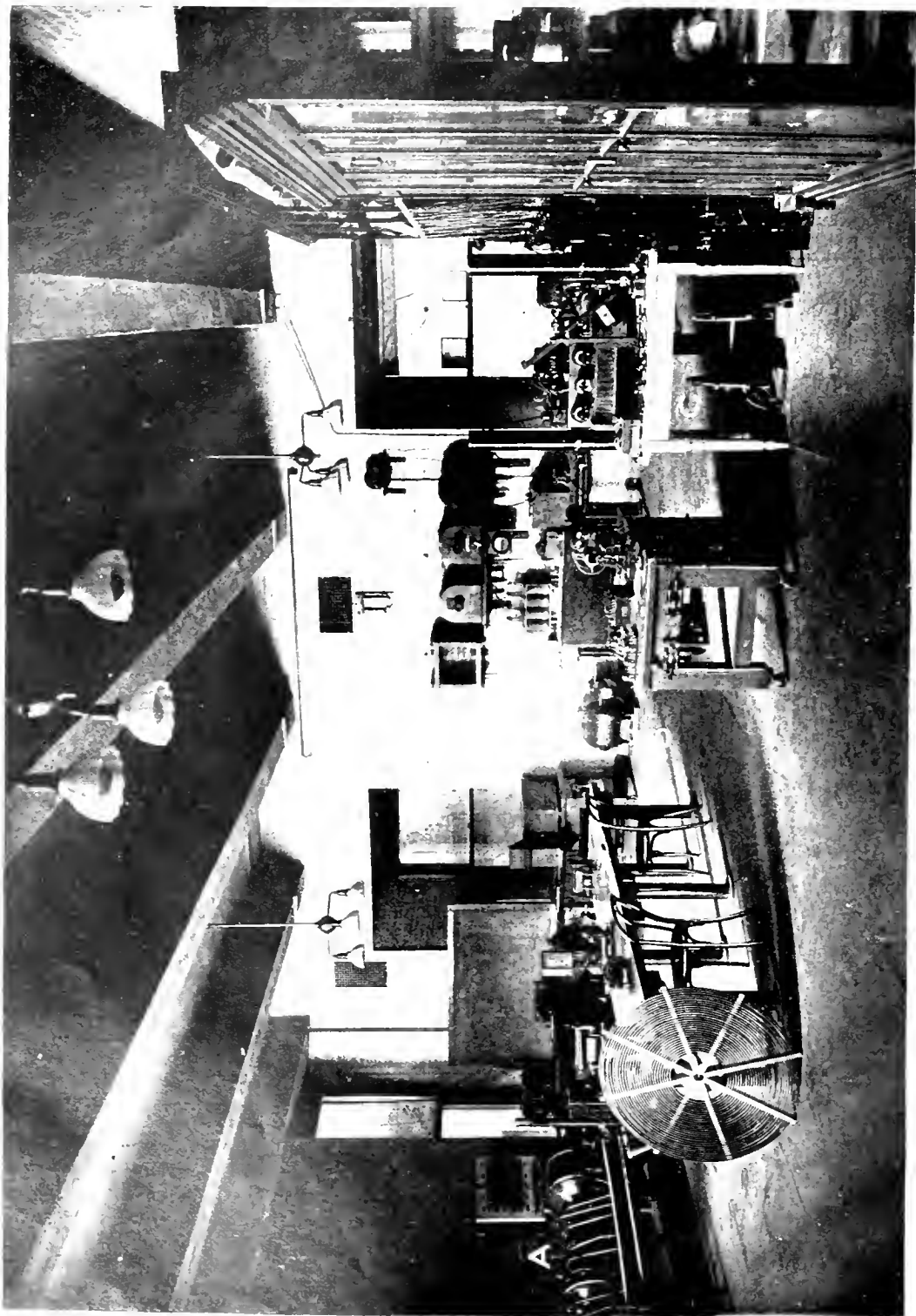
VOL. XVIII., No. 10

Copyright, 1915
by General Electric Company

OCTOBER, 1915

CONTENTS

	PAGE
Frontispiece	938
Editorial: The Paths of Progress	939
The New Advanced Course in Electrical Engineering at Columbia University	940
BY W. I. SLICHTER	
Power Consumption of Railway Motors	944
BY H. L. ANDREWS AND J. C. THIRLWALL	
The Kinetic Theory of Gases, Part I	952
BY DR. SAUL DUSHMAN	
Some Problems in Burning Powdered Coal, Part II	959
BY ARTHUR S. MANN	
The Theory of Lubrication, Part I.	966
BY L. UBBELOHDE	
Translated from <i>Petroleum</i> by HELEN R. HOSMER	
Relation Between Car Operation and Power Consumption	973
BY J. F. LAYNG	
Automatic Railway Substations	976
BY CASSIUS M. DAVIS	
Protection and Control of Industrial Electric Power	979
BY DR. CHARLES P. STEINMETZ	
Sprague-General Electric PC Control	985
BY C. J. AXTELL	
General Notes on Grounding	991
BY H. M. WOLF	
The Volume Resistivity and Surface Resistivity of Insulating Materials	996
BY HARVEY L. CURTIS, PH. D.	
Water Rheostats	1001
BY N. L. REA	
Practical Experience in the Operation of Electrical Machinery, Part XII	1003
Crane Troubles; Motor Stopped and Reversed; Unstable Voltage	
BY E. C. PARHAM	
History of the Schenectady Section of the A.I.E.E.	1006
BY S. M. CREGO	
From the Consulting Engineering Department of the General Electric Company	1008



Radio Engineering Laboratory of Columbia University. A, Alexanderson High Frequency Generating Set; B, Standard Sending Outfit; C, A New Special Highly Sensitive Receiving Apparatus; and D, Connection to the Antenna through the Window

GENERAL ELECTRIC

REVIEW

THE PATHS OF PROGRESS

In the issue of the REVIEW which appears about the time that the American Electric Railway Association hold their annual convention we usually try to publish some material that will be of special interest to electric railway men. So in this issue we publish several articles on railway subjects, one of which is written to show the possibilities of securing greater economies by studying every detail which enters into schedule making and the proper selection of equipment. Such a study is timely. Electric railways in common with all other public services are finding it increasingly harder to balance the ratio between receipts and expenditures in a manner that will give satisfaction to the stock holders. With the constantly increasing demands of the public for better, and incidentally more expensive service, the earning power of the railways is being reduced rather than increased and at the same time, through too numerous regulations, the responsibilities of the operating companies are being enlarged rather than curtailed.

During the past year the electric railways throughout the country have had to face the jitney problem which has materially added to their embarrassment, and while some relief may possibly be looked for from legislation—which should protect as well as regulate—the problem of lost traffic caused by privately owned cars other than jitneys is more likely to increase than to decrease.

In addition to these problems it must be borne in mind that all, or almost all railways are operating under unfavorable conditions. They have to provide facilities that could be operated profitably if the load were uniform over the entire 24 hours, but in most instances conditions compel them to operate at a very poor load factor. Handicapped by such conditions, profitable operation, if possible at all, is only to be attained by a scientific study of every factor entering into the industry.

Three main factors enter into every industry—labor, energy and material. The

cost of labor is steadily increasing and for many reasons it is not susceptible of the same close regulation as the other two factors. The cost of electrical energy has steadily decreased during the last quarter century. For these reasons it is profitable to substitute electrical energy for human energy wherever possible on a railway system and to adopt labor saving devices wherever such are possible consistent with safety. That this factor is recognized is evident by the very extensive adoption of electrical apparatus in railroad shops, car barns, etc.

The third factor, material, which among many other items in railway undertakings includes power house, substation and car equipments, has also been considerably reduced in price during recent years; and coincident with this decrease in cost there have been far reaching improvements in efficiency and adaptability to service requirements.

The manufacturers of electrical apparatus and the operators of electric railways jointly have done wonders in producing cheap transportation, and undoubtedly improvements in apparatus and economies in operating methods will be effected in the future as they have been in the past; but it would seem that there must be some limit as to how much transportation can be sold at a profit to the public for a nickel.

The operating companies and the manufacturers have called to their aid in the fight for the production of cheaper and ever cheaper transportation all that engineering skill and a scientific knowledge can provide, but on the last analysis there must be some limit to the character as well as to the amount of service that can be given for a nickel. When this limit has been reached it seems only reasonable to suppose that the public will have to pay more for the transportation they are receiving, and whether the operating companies will earn more substantial returns by being permitted to institute a zone system of fares or some such scheme must be left for the future to determine.

THE NEW ADVANCED COURSE IN ELECTRICAL ENGINEERING AT COLUMBIA UNIVERSITY

By W. I. SLICHTER

HEAD OF DEPARTMENT OF ELECTRICAL ENGINEERING, COLUMBIA UNIVERSITY

As an answer to the mooted question, "How many years are required to furnish the most serviceable college engineering education?" Columbia University is about to make a departure from the previously existing four-year standard. The reason for this change has been the conclusion on the part of the management that the average four-year course, because of an insufficiency of time, does not allow of following a curriculum that is well balanced between cultural and technical studies. The tendency has ever been to minimize the time devoted to the study of broad cultural subjects and to utilize this for the further pursuit of specialized technical subjects.—EDITOR.

In September of this year all the engineering courses at Columbia University will be placed on a graduate basis, that is, will require a college course before admission. This is the first instance in this country of an educational institution putting its engineering work on a graduate basis; but in making this change the engineering school is only following the example of the schools of Law and Medicine. Thus the three professional schools at Columbia—law, medicine and engineering are placed on the same basis.

The Engineering School at Columbia, being a part of a large university having a very large teaching staff including specialists and authorities in almost every branch of human knowledge, has an advantage in intellectual resources not possessed by independent technical schools which only teach engineering subjects. To make the best use of these resources the faculty of Columbia has arranged the new advanced courses in engineering with the object of furnishing a training which will produce engineers of broad and liberal education, capable of filling the highest positions in the professions and in society.

The system of instruction in engineering in the technical schools of this country has for many years past consisted uniformly of four years of technical training beginning immediately upon the student's completion of a high school course. It is attempted in these four years to give the prospective engineers a reasonable amount of general or cultural education, such as English and another modern language, philosophy, political economy and as much science and professional training as the time allows.

Some institutions realized that it was impossible to accomplish much in the professional line if the general subjects were given as completely as they should be, and have recognized this by giving only a bachelor's degree, and not the professional degree. Others have included a more thorough technical training and given a professional degree, but it has been pretty generally

recognized that these graduates were lacking in some very important qualifications, particularly the ability to express their ideas in speech and writing in a clear and forceful manner, and partly in the broad attitude of mind which comes from a good liberal education in the humanities.

The professions of law and medicine have had the same experience and the more important law and medical schools have recognized this and met the difficulty by requiring a college education and a bachelor's degree for admission to the professional school. This broad qualification (a bachelor's degree) does very well as a preliminary for the education of a lawyer or a doctor, as all that is required is a mental training that has developed the intellectual powers, but as a preparation for an engineering career this preliminary work must include a definite amount of training in mathematics, physics and chemistry, which are as necessary to the engineer as tools are necessary to a carpenter or a mechanic.

For this reason the preliminary collegiate education of those men anticipating a graduate engineering course must be carefully planned to include a proper amount of these fundamentals and a reasonable amount of cultural courses such as English, history, philosophy, economics and foreign languages as given in most colleges. The equivalent of three years of this work is specified for entrance to the Columbia School of Engineering, and whether this is increased to cover the requirements for a bachelor's degree depends upon the tastes or resources of the student.

The course, therefore, consists of three years spent in any college giving these fundamental scientific subjects (and most colleges offer these courses but do not require them) and three years professional work at Columbia. During these six years it is possible to obtain by extra work (as at Columbia College) both the B.S. degree and the E.E. degree, although the former is not necessary.

By this arrangement a student is expected to begin his preparation for professional study at an age one or two years earlier than he would for the standard four year technical course, and as a result he will finish possibly at the same age or one year later than with the old four year course. Thus the change from four years to six years does not mean that the student will be two years older when he graduates but that the School of Engineering will endeavor to direct his training two years earlier. For economy of the student's time it is desirable that he should decide on the scientific career earlier in life, although he need not decide any earlier on which branch of engineering he desires to follow.

Object of the Course

The objects of the advanced professional course are: First, by means of a study of applied science to cultivate judgment in the student by teaching him to analyze problems and reason from cause to effect; second, to give a broad engineering education which will be of value in any line of activity whether electrical or other branch of engineering or even in commercial work; and third, to give the student a preparation in the specialized knowledge of one profession in order that he may immediately understand practices and methods, and thus the sooner be of value to an employer, and eventually master the more complex problems which would qualify him as a specialist in Electrical Engineering.

Preparation for the Course

The requirements for entrance into the first year of the new advanced course are briefly as follows:

Mathematics. Algebra through determinants, complex numbers, the theory of equations and partial fractions. Analytical Geometry through conic sections and the elements of three dimensional geometry. Calculus, differential and integral.

Physics. Heat, Light, Electricity and Magnetism, with one year of laboratory work. Mechanics, through harmonic motion, resonance, hydrostatics and coplanar statics.

Chemistry. General chemistry and qualitative analysis.

Drafting. Engineering drafting, topography and descriptive geometry.

Surveying. Theory of plane surveying and triangulation.

General Cultural. English, History, Philosophy, Economics, Mineralogy and two modern languages.

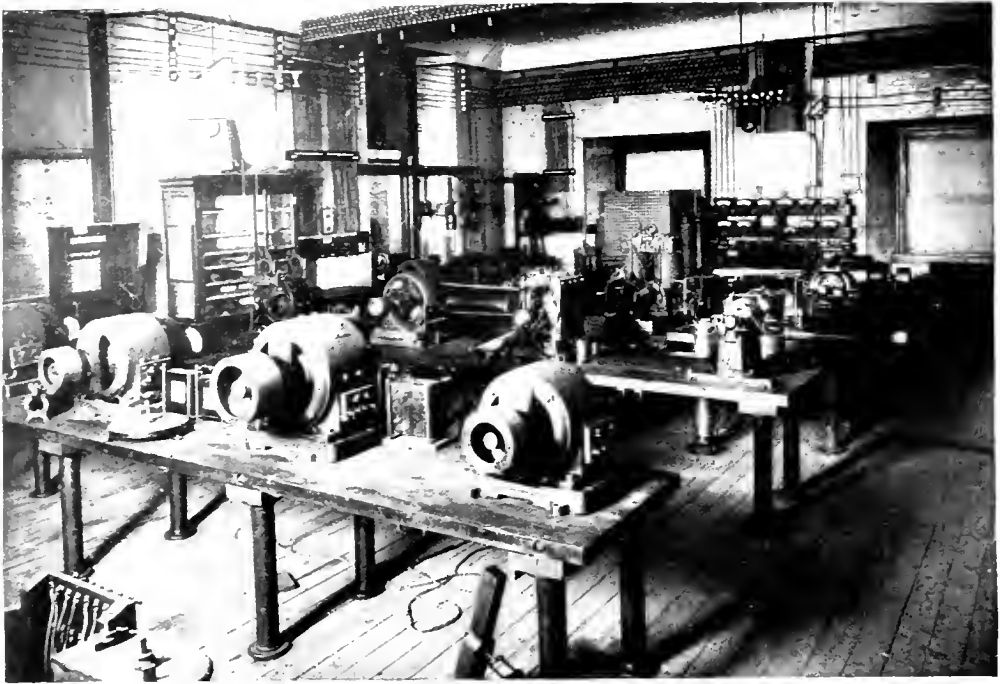
A special course has been arranged in Columbia College in which a student may complete this work in three years after leaving high school. On the completion of a small amount of extra work (about 15 per cent more in time) in electives, such as advanced English or modern languages, the student will obtain the degree of B.S. This extra work may be done any time during the six years and the first year of the advanced course is arranged so that he may have an opportunity then.

Description of the Professional Course

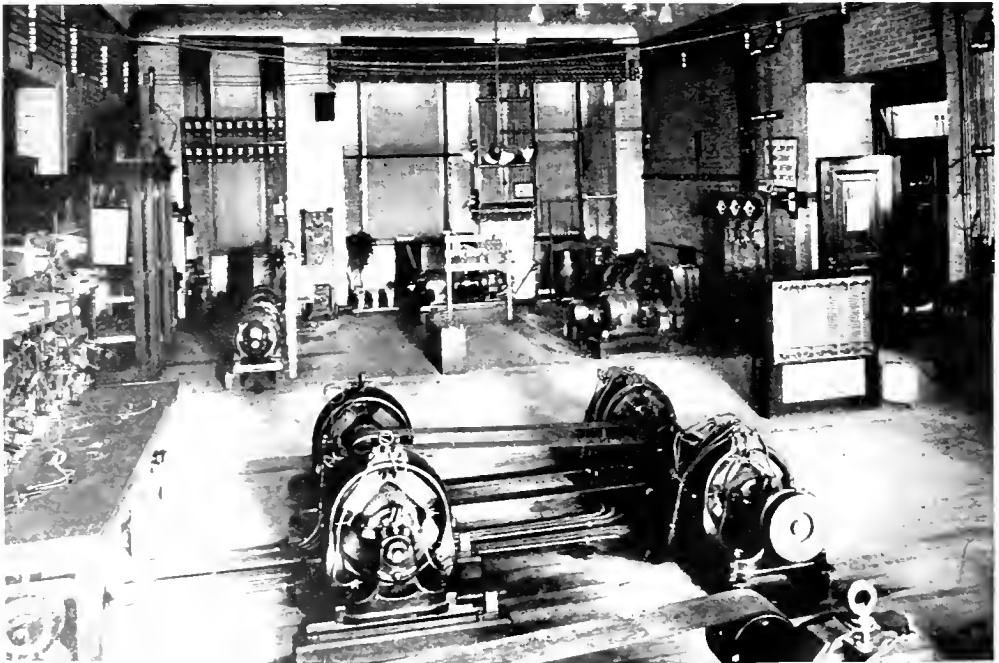
The advanced course in Electrical Engineering comprises, in addition to the electrical subjects, a group of studies in civil, mechanical and chemical engineering and metallurgy, in order that the graduate will be primarily an all-round broad engineer, and along with this general engineering education a little less than half the total time is devoted to purely electrical subjects. The student of electrical engineering will spend 46 per cent of his working time for three years on electrical subjects, 27 per cent on mechanical engineering subjects, 10 per cent on chemistry, 9 per cent on physics, and the balance, 18 per cent, on miscellaneous subjects.

The courses in electrical engineering, in accordance with the established policy of the department, are designed to teach the principles rather than the details. They may be divided into three general classes, theoretical, technical and practical. The theoretical courses are given mostly by the Department of Electro Mechanics of which Dr. M. I. Pupin is the head. These courses give the student an insight into the application of mathematics to the fundamental principles of electrical phenomena. These courses are usually the most difficult for the student but are of the greatest importance as they are not easily acquired after leaving college. There is at least one of these courses in each term throughout the whole three years.

Closely in parallel with the theoretical courses are the technical courses which point out the application of the principles laid down in the theoretical courses and show the use of those principles. They are intended to familiarize the student with the terms, practices, instruments and appliances of the profession by a description of the apparatus, a discussion of their principles and a description of their operating characteristics and applications. Problems are given in these courses which involve a concrete application



View in the Direct Current Machine Laboratory at Columbia University



View in Standardizing and Instrument Laboratory at Columbia University

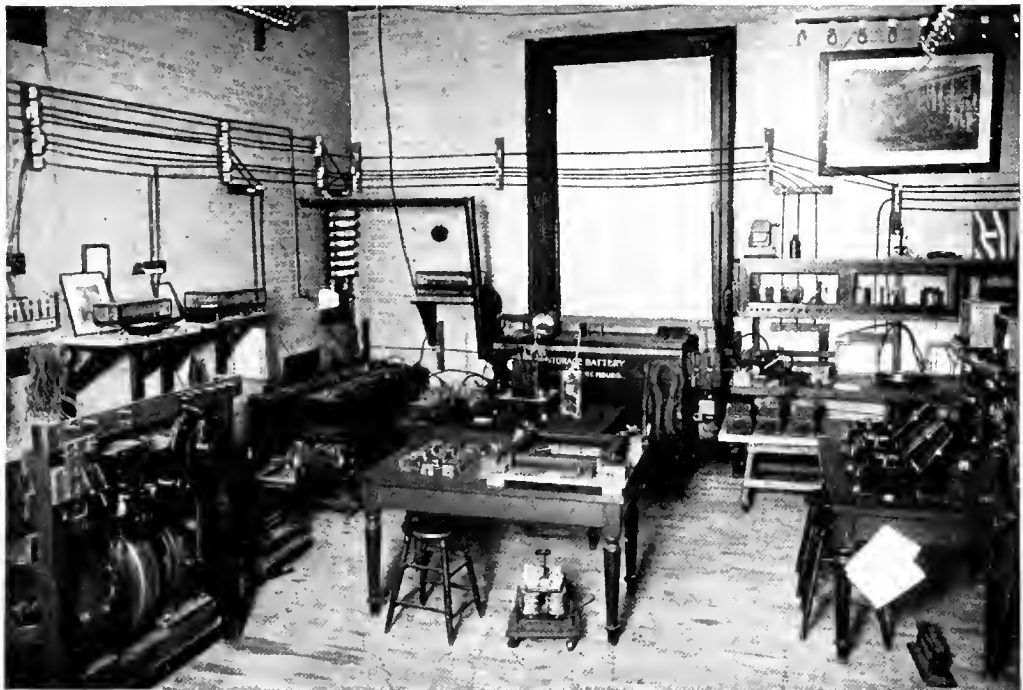
of the principles learned. Of this class of courses are electrical machinery in the first graduate year, alternating current engineering and electrical communication in the second year, and alternating current machinery, applications of electric motors and electric railways in the final year.

The practical courses are those of the laboratory and drafting room which are in their chronological sequence: direct current laboratory, design of direct current machinery, standardizing laboratory, photometric laboratory, alternating current laboratory and design of alternating current machinery. These courses are always preceded by a preliminary lecture and are arranged in parallel with lecture courses treating the same subjects in detail. Among the various experiments performed and investigations undertaken in these courses are the following which are of more than ordinary interest: Testing and location of faults on a generator; complete tests on a railway motor equipment; parallel operation of alternating current generators as operated in power stations, including measurement of all variables such as circulating current, power-factor and phase shift; complete tests of polyphase circuits, including the study and measurement of

upper harmonic currents and voltages in various connections; practical experience in the use of curve-tracing apparatus, such as the ondograph and oscillograph for the study of transient phenomena in alternating and direct current circuits; adjustment of radio telegraphy apparatus; calibration and standardization of instruments; measurement of the distribution of light and the economy of different forms of lamps; the design of a direct current generator and motor and of an alternating current generator, motor and transformer. These practical courses serve to keep up the students' interest in the theoretical courses as well as to teach their own particular lessons.

In addition provision is made for each student to spend eight weeks during one summer at actual work in the shops of one of several large manufacturing concerns with whom arrangements have been made. Here the student will obtain a practical experience of great value and his time will be efficiently used as each group will be under the careful supervision of an instructor assigned to the purpose.

The Department of Electrical Engineering of Columbia acts as electrical laboratories and consulting engineer to the government



View in the Alternating Current Machine Laboratory at Columbia University

of the City of New York, which involves the investigation of many live questions and the testing of many new pieces of apparatus. This gives students a touch with the actual work of the profession while they are still at their studies.

Columbia has granted the degree of E.E. to 394 men in the 25 years that that degree has been granted. Of these many have of their own accord availed themselves of an optional seven year course, comprising three years in the college and four years in the engineering school for which they were granted both the Bachelor's and Engineer's degrees. These men have generally shown

a marked superiority over the regular four year men and this noticeable difference has been in part the reason for the change about to go into effect.

For the past two years a graduate course in electrical and mechanical engineering has been given at Columbia to officers of the U. S. Navy. The men were assigned to this course by the Navy Department after graduation from Annapolis and five or six years active service at sea. These classes have averaged about eighteen men a year and the men chosen were those who had given evidence of a particular fitness for and interest in the engineering side of naval work.

POWER CONSUMPTION OF RAILWAY MOTORS

BY H. L. ANDREWS AND J. C. THIRLWALL

RAILWAY AND TRACTION ENGINEERING DEPARTMENT, GENERAL ELECTRIC COMPANY

The authors deal with a subject that is of great importance to all those interested in operating electric railways. They show that operating economies may be secured by selecting the equipment best suited to the service and by designing schedules on a scientific basis. The characteristics of the motor, weight of car and equipment, the adoption of two or four motor equipments, frequency of stops, amount of coasting, gear ratio, rate of accelerating and rate of braking, and the type of control are all considered in their relation to power consumption and their general effect on operation. The curves included in the article add greatly to its value.—EDITOR.

The increasing cost of electric railway operation, due to higher wages of employees and the general advance in the price of materials and supplies, makes it more and more imperative that the operators look for economies in every direction where it is practicable to secure them. On every road the cost of power is one of the major items of expense, running from 10 to 20 per cent of the entire cost of operation in city service and averaging about 17 per cent of the total. Of this, by far the greater part is consumed by the car motors. Any material decrease that can be secured in this item, either by the use of more efficient equipment or by better methods of operation will be of material assistance in keeping the ratio between expenditures and receipts down to a point where a profit can be shown.

It is the purpose of this article to point out the essential factors entering into the power consumption of the motive equipment of electric cars, and to indicate where economies can be secured either in existing equipments or those that may be purchased in the future. To move a car of given weight a certain number of miles per hour on a level track requires the application of a certain definite amount of power through its motors. The obvious

factors which determine the minimum energy necessary to make any schedule are: the weight of the car plus its load; the distance to be covered and the time in which the run is to be made; the number of stops and their average duration; and the number of slow-downs. Given these, and an approximate curve of the car's resistance, it is a simple mathematical calculation to determine what average kilowatt input is the least that will do the work. The effect of grades and of curves on the power consumption can also be accurately determined if a correct profile and contour of the line is available.

But in actual service, these minimum values are always considerably exceeded, due in part to the equipment itself and in part to the way in which the car is handled. In addition to the factors mentioned above, there are several others which modify the power calculation. These are: the characteristics of the motor used; the diameter of the car wheels; the gear ratio; the scheme of control; the amount of coasting ordinarily done by motormen; and the rates of acceleration and of braking employed.

A number of curves have been plotted to illustrate the effect of these various factors on the power; that is, what variations in each

factor may be looked for and what can be done to secure the greatest efficiency in operation.

Characteristics of Motors Used in Calculation

Comparisons of power consumptions of two equipments are affected by the relative shapes of speed curves and the relative values of motor efficiencies. In order to eliminate any effect of the shape of speed curves or motor efficiencies in this comparison, the motors used were selected with identical speed curves and efficiencies. Motor "A" in Fig. 1 is a standard motor, rating 35 h.p. on 600 volts. Motor "B," which is a 65-h.p. machine on 600 volts, is assumed to have the same speed and the same efficiencies as motor "A" at a current input corresponding to the increased duty imposed on the motor.

Motor "A" requires 73 amperes for acceleration of a 32,000-lb. car at 1.5 m.p.h.p.s., and at this input has a speed of 11.2 m.p.h., a tractive effort of 1315 lb. and an efficiency of 79.5 per cent. In order to accelerate the 42,000-lb. car with the "B" motor there is required 1711 lb. tractive effort, and, as the car must be accelerated to the same speed as the lighter car with motor "A,"

By using these characteristics, the time spent on the controller and the speed on the last point of the controller is the same in each case, and the motor efficiencies are the same for the relative duty imposed on each motor.

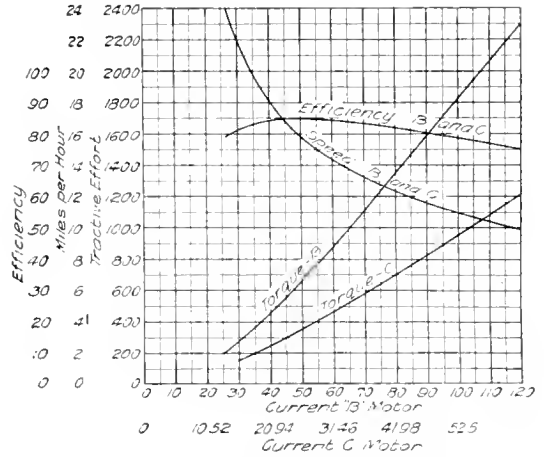


Fig. 2. Characteristic Curves of G.E. Railway Motors on 500 volts with 30-in. wheels

The characteristic curves given in Fig. 1 were used for the calculations illustrated in Figs. 4 and 5.

In making the calculations in Fig. 6 the characteristics given in Fig. 2 were used. These characteristics were obtained in the same manner described above and give the same speed and the same motor efficiencies.

Car Friction and Coasting Friction

The car friction and coasting friction used in these calculations are taken from the curves shown in Fig. 3.

The values of friction used in plotting these curves were obtained from numerous tests made on cars of approximately the weights assumed, and represent an average of the friction values obtained throughout the country.

Weight

Figs. 4 and 5 illustrate the effect of a difference in weight alone on the current and power values. Fig. 4 is based on a schedule of 9.9 m.p.h. making 7 stops per mile of 10 seconds each, and Fig. 5 is based on a schedule of 16.75 m.p.h. making 1.8 10-second stops per mile. In both figures cars weighing 32,000 lb. and 42,000 lb. are considered.

The motors are properly geared for the cycle of duty assumed and perform the schedule with a reasonable amount of coasting.

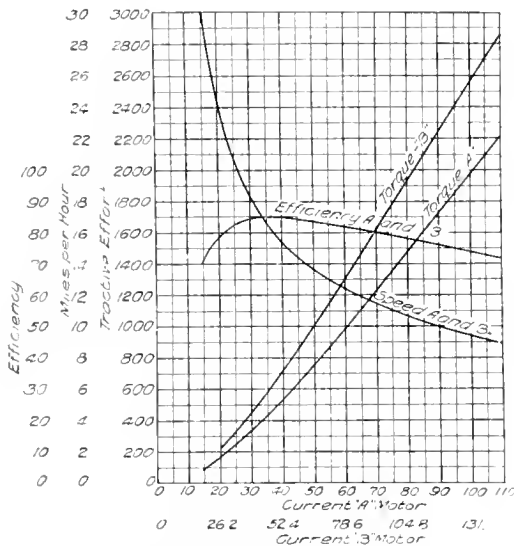


Fig. 1. Characteristic Curves of G.E. Railway Motors on 500 volts with 30-in. wheels

the 1711-lb. torque point must be obtained at 11.2 m.p.h. and the motor efficiency must be the same. It is then a simple calculation to obtain the new current scale for the "B" motor and to calculate a new torque curve using the new current scale.

In Fig. 4 it will be noted that the speed time curves practically coincide, the slightly higher speed of the heavier weight car being due to a lower car friction. The current curve is considerably higher for the "B" motor and the 42,000-lb. car. The 32,000-lb. car is

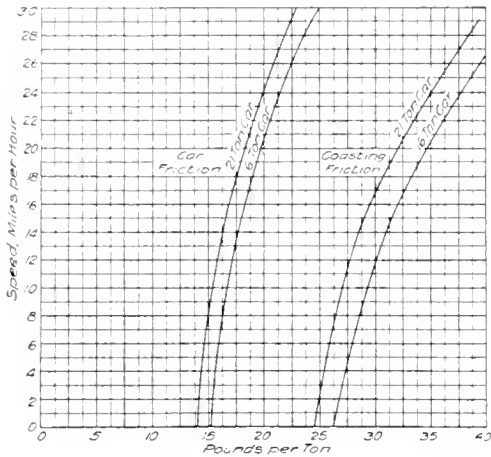


Fig. 3. Car Friction and Coasting Friction Curves for 16-ton and 21-ton Cars

23.8 per cent lighter than the other; and its power consumption per car mile is 2.185 kw-hr. as against 2.795 kw-hr. for the heavier car, or a saving of 21.8 per cent. In other

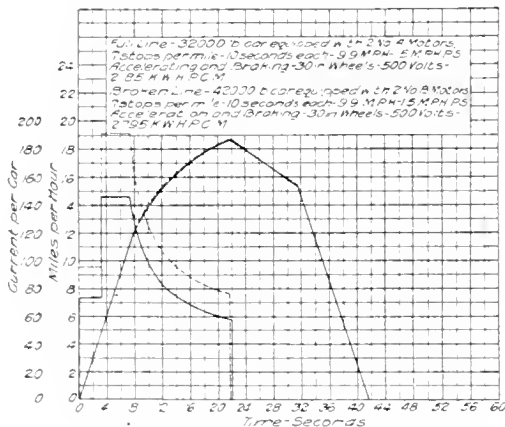


Fig. 4. Speed-time and Current-time Curves illustrating the Effect of Weight on Energy Consumption

words, the difference in power is nearly in direct proportion to the difference in weight. The efficiency of the lighter car, due to difference in car friction being lower than that of the heavier car, accounts for the energy not varying in direct proportion.

In Fig. 5, making 1.8 stops per mile, the relative power values per car-mile become 1.585 kw-hr. for the heavier car and 1.27 kw-hr. for the lighter car, or, a difference of 19.8 per cent. The savings due to weight reductions are therefore of greater relative importance in frequent stop city service than in infrequent stop suburban or interurban service. The total saving is also greater. For instance, the city cars would run 178 miles in an 18-hour day and the suburban car 297 miles. The reduction in power of 0.61 kw-hr. per car mile with the city car equals 108 kw-hr. per car daily, while the saving of 0.315 kw-hr. per car mile in the suburban run equals 93 kw-hr. per car daily. In interurban

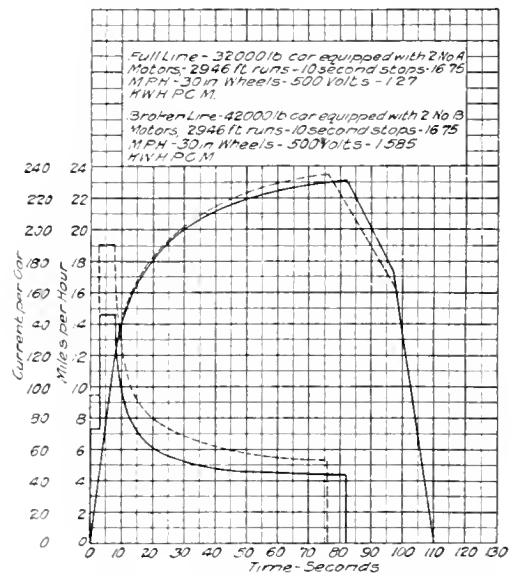


Fig. 5. Speed-time and Current-time Curves illustrating the Effect of Weight on Energy Consumption

service, with stops of one per mile to one in ten miles, the saving becomes even less.

Two- or Four-Motor Equipments

Aside from questions of traction on excessive grades, or when pulling trailers, or other local conditions, the selection of a four-motor equipment instead of a two-motor equipment for city cars is inadvisable. Under ordinary conditions of single-car operation rates of acceleration and braking as high as passenger comfort will permit can be secured with a two-motor equipment and with an appreciable reduction in weight. There are in service today, in cities all over the country, cars which weigh 44,000 lb. or more equipped with four GE-80 or four W-101 motors. The

electrical equipment on these cars weighs approximately 13,000 lb. If this same car were equipped with two motors of recent design, of sufficient capacity to do the same work as the GE-80 or W-101 motors, a saving in weight of 6000 lb. could be made. If maximum traction trucks were used, a further reduction of 3000 lb. could be made, or a total reduction of 9000 lb., with two motors and maximum traction trucks.

Considering motors of recent design in each case, the saving in weight is less and with the weight of car assumed would amount to 2110 lb., i.e., between a modern four-motor and a two-motor equipment.

Fig. 6 illustrates the power differences inherent in two-motor vs. four-motor equipment.

The two-motor equipment will take 2.795 kw-hr. per car-mile and the four-motor equipment 2.935 kw-hr. per car-mile, or, a reduction in power of approximately 4.76 per cent. On the basis of 40,000 car-miles per year, the two-motor equipment would take 5600 kw-hr. less than the four-motor equipment annually. This comparison is made on the same schedule and stops as in Fig. 4. The cars assumed in each case are the same—the car with two motors weighing

“C” equipment. This difference in weight amounts to 4.78 per cent which indicates that the reduction in power varies directly with the weight. Since there is very little difference in car weight, the car efficiencies are approximately the same.

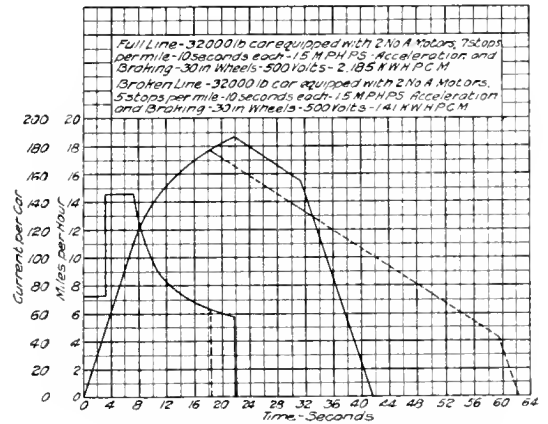


Fig. 7. Speed-time and Current-time Curves illustrating the Effect of Stops on Energy Consumption

In Figs. 4, 5 and 6 the power consumption is given at the car on the basis of 500 volts. At the station, due to line losses, the relative values would be 20 per cent to 25 per cent higher, and the savings due to weight would be correspondingly increased.

When allowance is made for the difference which exists between maximum traction trucks and the M.C.B. type, the total power reduction of two-motor over four-motor equipments would be close to 17,000 kw-hr. per car per year. This is a considerable item and would on most roads save the company at least \$1.50 per car annually.

Frequency of Stops

For any given schedule speed, power will vary with the number of stops in the run, Figs. 4 and 5 show that even with a considerably faster schedule speed a car making but 1.8 stops per mile requires only about 57 per cent as much energy as one making seven stops per mile. To reduce stops in city service to two or less per mile would be impracticable. To bring them down to five per mile by the use of the skip-stop plan is in many cases feasible.

Fig. 7 illustrates the savings made possible by such a change. With the same car making 9.9 m.p.h. in each case, the power drops from 2.185 kw-hr. per car mile to 1.41 kw-hr., a

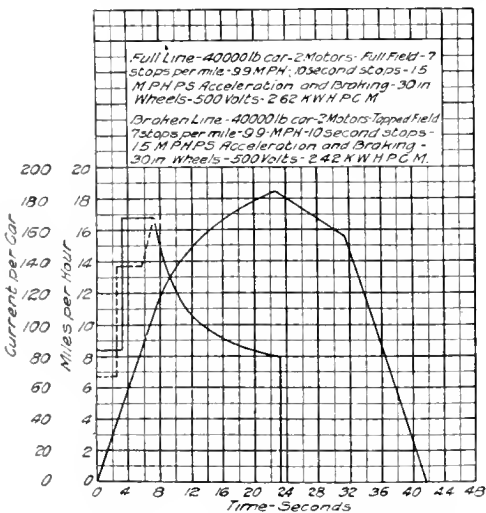


Fig. 6. Speed-time and Current-time Curves illustrating the Effect of Two-motor Equipment vs. Four-motor Equipment on Energy Consumption

42,000 lb. complete, and the car with four motors weighing 44,110 lb. complete—the difference in weight of the two cars being due entirely to the difference in weight of a two-motor “B” equipment and a four-motor

decrease of 35 per cent. Of course, in practice the excessive amount of coasting shown here for the five stop run would probably not be obtained, but this would permit of a faster schedule being run, thus reducing the number of cars required and still leave a lower power load on the station.

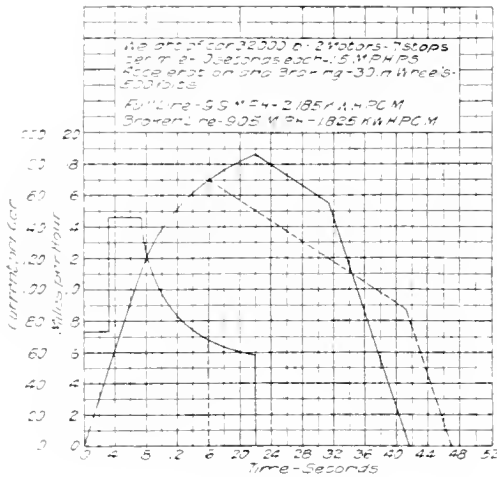


Fig. 8. Speed-time and Current-time Curves illustrating the Effect of Schedule on Power Consumption

Slowdowns will affect power in the same manner as stops, the effect depending upon the number of slowdowns and the speed to which the slowdown is made.

Coasting and Schedule Speed

Fig. 8 illustrates the effect of coasting on schedules and on power consumption. The weight of car, stops and motor equipment are the same as used in Fig. 4. When coasting the short distance the equipment makes a schedule of 9.9 m.p.h. and has an energy consumption of 2.185 kw-hr. per car mile. When coasting the longer distance the schedule drops to 9.05 m.p.h. and the equipment has an energy consumption per car mile of 1.825 kw-hr.

It is pointed out that by holding the power on for the longer period the schedule is increased 9.39 per cent, while the power consumption is increased 19.72 per cent. The increased schedule obtained is only approximately 50 per cent of the increase in energy.

To secure the greatest economies in operation, both the foregoing factors should be considered, in connection with the headways which are used. There is no object in increasing schedule speeds at the expense of power unless the increased speed enables a reduction

in the number of cars required on the given run, and thereby a reduction in platform expense can be secured. That is, assume a line 6 miles in length, with a schedule speed of 8 m.p.h. and with 15-minute headways. The round trip time is 90 minutes and 6 cars are required. To increase the speed to anything less than 9.6 m.p.h. (which would cut the round trip time to 75 minutes and allow 5 cars to be used instead of 6) would be worse than useless to the operator. If, however, by decreasing stops or by faster running the speed can be brought up to 9.6 m.p.h., a saving of over \$3000 annually could be made in platform wages which would more than offset the increased power cost.

Gear Ratio and Wheel Diameter

Gear ratio and wheel diameters have the same effect on the speed of a car and consequently on its energy consumption. A change in gear ratio is equivalent to a change in wheel diameter.

Fig. 9 illustrates the effect of a change in gear ratio on the energy consumption of the car. The car, schedule and motor equipment used is the same as used in Fig. 4, the only change made being in the gear ratio.

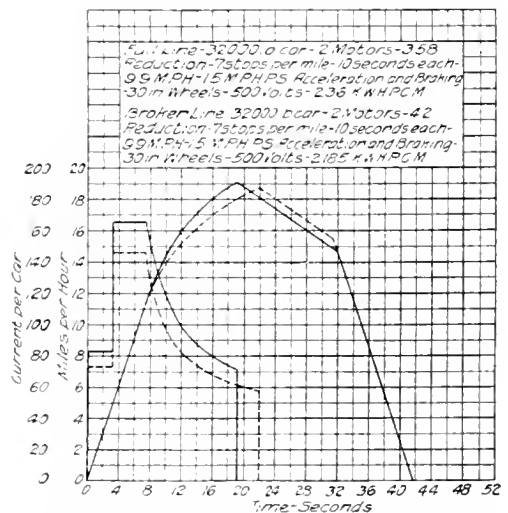


Fig. 9. Speed-time and Current-time Curves illustrating the Effect of Gear Ratio on Energy Consumption

The higher speed gearing gives a free running speed of 25 m.p.h. and an energy consumption per car mile of 2.36 kw-hr. The lower speed gearing gives a free running speed of 23 m.p.h. and an energy consumption of 2.185 kw-hr. per car mile, or, a reduction of

7.42 per cent in power. On the basis of an 18-hour day the car will make 178 miles per day, equalling a saving of 31.2 kw-hr. per car per day. This power consumption is at the car and due to line losses would be 20 per cent to 25 per cent higher at the station. This comparison is made with a 15-tooth pinion against a 17-tooth pinion on 30 in. wheels. There are, however, many equipments in the country running on a schedule very nearly the same as that assumed and using a 22-tooth pinion on 33 in. wheels, which would give a free running speed of over 33 m.p.h. In this case the saving in energy for the lower speed gearing would be much higher than given above.

Rate of Acceleration and Braking

The rate of acceleration and braking influences to a large extent the power consumption of a given weight car. With a moderately low rate of acceleration, i.e., one m.p.h.p.s., it requires a much longer time on the controller than with a higher rate, i.e., 1.5 m.p.h.p.s., which is an average rate throughout the country for city service.

In frequent stop service where rheostatic losses and losses during acceleration are a large percentage of the total, it is essential

is the same as used in Fig. 4, but the schedule has been decreased to 8.5 m.p.h.

With one m.p.h.p.s. acceleration and braking, there is required 12.8 seconds for acceleration. During this time the average current input per car is 114 amperes, or 1460 ampere-seconds. The energy consumption per car-mile for this rate of acceleration and braking is 2.27 kw-hr. With the rate of acceleration and braking increased to 1.5 m.p.h.p.s., the time required for acceleration is decreased to 7.46 seconds. The average ampere input per car is increased to 146 during this time, but the ampere-seconds are decreased to 1090. The energy consumption per car mile is decreased to 1.853 kw-hr. a reduction of 18.35 per cent, 13.4 per cent of which is saved during acceleration.

Schemes of Control

The most economical control from a power standpoint is dependent upon the class of service in which the equipment is to be used.

Tapped field control shows a slight saving in energy in frequent stop city service. In congested districts where the stops per mile are very frequent, the saving will be higher than in suburban or interurban service where the stops per mile are less frequent. The saving in power with tapped field control is accomplished by the use of a slower speed motor, or a slower speed gearing during acceleration, which decreases the time and current during acceleration. With frequent stop city service where the time on the controller is a comparatively large proportion of the total time, this saving will become greater. As the length of the run increases and the percentage of time on rheostats to total time decreases, the saving in energy will become less.

In a mixed city and interurban service where an equipment must run at low speeds in the city and comparatively high speeds in the interurban portion, a tapped field equipment can sometimes be used advantageously. The low speed in full field position permits making the city service without resorting to running on resistance points, while the tapped field position gives what is equivalent to a change in gear ratio for the higher speed interurban running. An equipment of this kind, however, is used for flexibility only and not from any energy standpoint.

It is obvious that an equipment properly geared for a given service should not have a higher speed when running on tapped field than a full field equipment of the proper speed

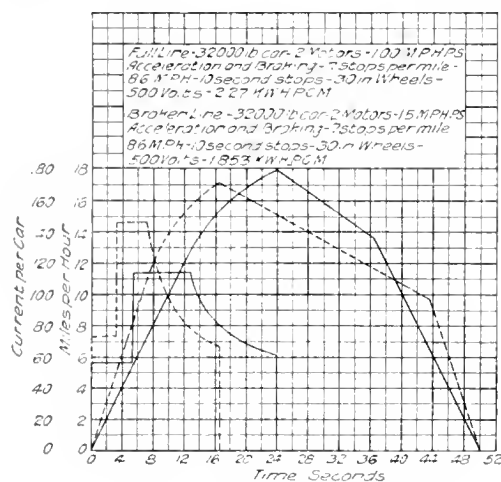


Fig. 10. Speed-time and Current-time Curves illustrating the Effect of Rates of Acceleration and Braking on Current Consumption

for low energy consumption that the rate of acceleration and braking be as high as permissible without discomfort to passengers.

Fig. 10 illustrates the effect of low acceleration and braking on the power consumption. The weight of car, stops and equipment used

for the service. The equipments used for this comparison were selected with this point in mind and have the characteristics as shown in Fig. 11. The characteristics of the full field motor and of the tapped field motor on tapped field are identical. The tapped field

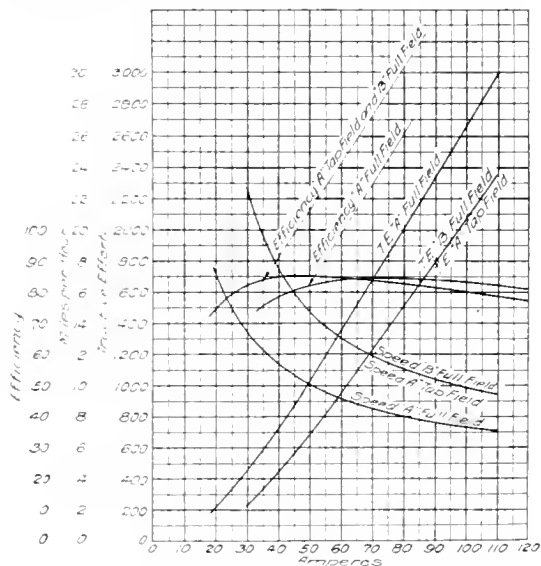


Fig. 11. Characteristic Curves of G.E. Railway Motors on 500 volts with 30-in. wheels

A—Tapped Field Motor; B—Full Field Motor

motor does, however, have a lower speed and corresponding higher torque for the full field. By using these motors any saving due to different speed motors or different shape speed curves is eliminated and the saving in energy shown is due entirely to the use of the tapped field permitting lower current inputs and shorter time during acceleration.

Tests have been made by a number of operators between cars using tapped field control and other cars using ordinary control, where there were inherent differences in motor characteristics, needlessly high speed gear ratios, greater weight, or a combination of all these factors operating to the disadvantage of the full field equipment. Reports of such tests have led in some cases to an exaggerated idea of the inherent value of tapped field control.

Fig. 12 illustrates the effect of tapped field on energy consumption. The speed time curves coincide and each equipment does the same amount of coasting and dissipates the same amount of energy in the brakeshoes. The cycle assumed is 9.9 m.p.h. with 7 ten-second stops per mile. The weight of car is assumed as 40,000 lb. complete.

The tapped field equipment requires an energy consumption per car mile of 2.42 kw-hr. while the full field equipment has an energy consumption of 2.62 kw-hr. per car mile, or, a reduction in energy of 0.2 kw-hr. per car mile, equivalent to 7.63 per cent. From the current time curves it will be noted that all the saving in current is made during acceleration and that as the percentage of time on the controller to the total time decreases, the percentage saving in current and in power will decrease, or, as the length of run increases the saving in power will decrease.

Three speed control for four-motor equipments affords a small power reduction due to the elimination of a large part of the rheostats and of the time spent on resistance. This saving will not exceed 5 per cent of the total in frequent stop city service and will be much less in infrequent stop suburban or interurban service.

Handling of the Equipment

Probably the most important point for a road to consider, when power reductions are sought, is in the handling of its cars by the

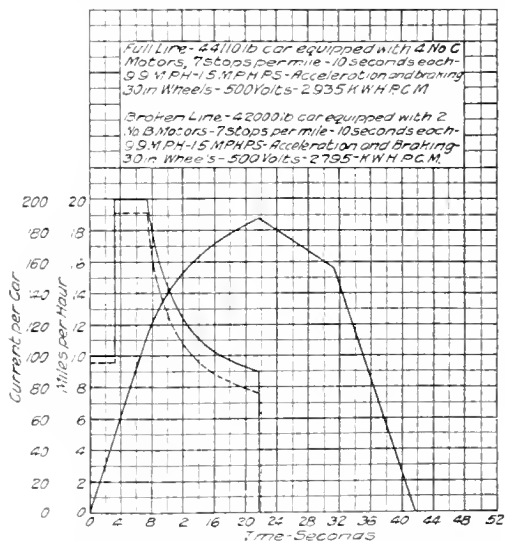


Fig. 12. Speed-time and Current-time Curves illustrating the Effect of Tapped Field vs. Full Field Control of Energy

motormen. The growing use of coasting clocks, and of car watt-hour meters or ampere-hour meters is a proof of the value of their records in demonstrating what a tremendous difference there is between the methods of operation of different men; many roads

without any change in equipment or schedules have reduced their power consumption from 10 to 20 per cent or more, simply by proper instruction of motormen. Without such instruction and supervision, the average man is apt to either overrun his schedules, in order to increase his layover time at a terminal, to run an excessive amount of time on resistance points or to use extremely slow rates of acceleration or of braking.

This last point is very common. So much motor and controller trouble in the earlier days of electric operation was attributed to "fast feeding" that it became a fetish on most roads to instruct motormen to notch up their controller at a very slow rate, and rates of acceleration of 1 m.p.h.p.s. or less became and are still very common. This never was good practice, and with motors designed within the past ten years, particularly those having commutating poles, rates of acceleration up to 2 m.p.h.p.s. would in many cases impose no injurious strains on the machines. But the result was, in a very large proportion of cases, that, due to the slow rate of acceleration, unnecessarily high free running speeds were required to make the schedules, as shown in Fig. 10. This led to a wide adoption of higher speed gearing than was advisable, with the result of high power costs and to a large extent high maintenance due to overloading of the motors, thus defeat-

ing the very object which the operators sought to obtain by the slow feeding. There is hardly an urban railway of any size in this country on which a large proportion of their motors do not have improper gear ratios for the service performed. Some roads have experimented with slower speed ratios and then abandoned the idea because the motormen, not being instructed to accelerate faster, complained that the cars were slow, after the change was made.

A very frequent occurrence and one hard to prevent, except by some form of graphic record on the car, or exceptionally close supervision, is for motormen to seek to obtain a layover at a terminal where none is listed, or to increase the length of his nominal layover, by fast running. This is very common practice, and results in a power increase such as is illustrated in Fig. 8.

In conclusion, it is strongly recommended that roads, seeking economies in their operating costs to meet the conditions of reduced earnings so universally prevalent, devote some time to the study of their power, bearing the points in mind which are touched on above, and we venture to say that they will find the manufacturers of their electrical equipments glad to co-operate with them both in making such investigations and suggesting remedies for wrong conditions found.

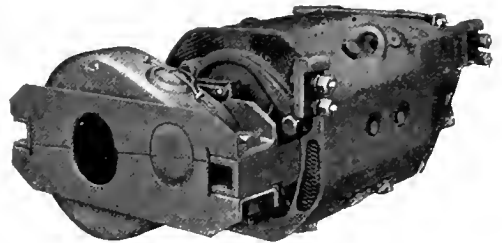
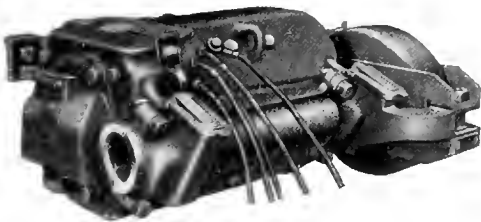


Fig. 13. Photographs of the 600-volt, 35 h.p. Railway Motor upon which the calculations in this article were based

THE KINETIC THEORY OF GASES

PART I

BY DR. SAUL DUSHMAN

RESEARCH LABORATORY, GENERAL ELECTRIC COMPANY

The kinetic theory of gases has often been referred to in the REVIEW. The following article is the first of a series in which the author elucidates this theory in an elementary manner, and discusses the principal conclusions that have been deduced from it and their bearing upon different problems in physics and chemistry.—EDITOR.

Atoms and Molecules

A consideration of the composition and properties of substances and of the changes which they undergo has led to the view that matter is discontinuous. According to this view all substances are regarded as consisting of atoms and molecules. The latter are the ultimate units of the physicist, while the chemist, seeking a representation of the manner in which the elements combine to form different substances, conceives the molecule as consisting of still smaller units—the atoms.

Various phenomena, such as evaporation, solution and diffusion and the behavior of gases in general, lead to the assumption that the molecules of gases and liquids are in constant motion. The evolution of this idea along the line of applying the laws of ordinary mechanics to the molecules in the gaseous and liquid states has led to a number of interesting and very important generalizations that are comprised under the heading of "Kinetic Theory of Gases."

Kinetic Theory

According to this theory the molecules of a gas when in a diffused state are assumed to be in constant motion in all directions, and except in more condensed states the molecules are so far apart that they exert no attractive or repulsive forces whatever on one another. Furthermore, the collisions of these molecules with one another or with any enclosing wall are assumed to be perfectly *elastic*; that is, there is no loss of energy of motion in such encounters, merely the directions and relative velocities are altered.

Since the total energy of a given mass of gas is proportional to the temperature, it follows that the average energy per molecule is proportional to the temperature only, and heat added to a mass of gas is used up in increasing this average molecular energy.

Fundamental Laws of Gases

The first essential of any theory of gases must be the possibility of readily deducing from this theory the simple laws which govern the behavior of gases. The laws of Boyle, Gay-Lussac and Avogadro may be combined in one statement by the formula:

$$P V = n R T \quad (1)$$

Here P indicates the pressure at the absolute temperature T of a mass of gas occupying a volume V ; n denotes the number of mols,* that is, it corresponds to the mass divided by the molecular weight; and R is a *universal* constant which has the same value for all gases.

If $n = 1$, V denotes the molar volume, or volume occupied by the molecular weight in grams of any gas at pressure P and temperature T .

The value of the constant R is derived from experimentally determined values of V , the volume of 1 mol of an ideal gas at given values of P and T . In this article we shall consider as *normal pressure*, a pressure of 1 megabar. This is a much more logical unit than the conventional 760 mm. of mercury, and its use as standard is being adopted in all recent publications.

By definition, 1 megabar is equal to 10^6 dynes per square centimeter, and corresponds pretty closely to 750 mm. mercury at 0 deg. C., latitude 45 deg., and sea-level.†

At $T = 273.1$ (0 deg. C.) and $P = 10^6$ dynes per cm^2 , $V = 22,708 \text{ cm}^3$.

Hence, $R = 83.15 \times 10^6$ ergs per deg.

Since 4.184×10^7 ergs = 1 calorie (mean calorie)

$R = 1.988$ cal. per deg.

* The molecular weight in grams is known as a "mol."

† The approximation is correct to 1 part in 5000. The conventional unit, 760 mm. mercury at 0 deg. C. = 1.0132×10^6 dynes per cm^2 .

Velocity of Molecules

We shall now consider the meaning of the term "pressure" from the point of view of the kinetic theory, and then show that this interpretation leads to a method of calculating the molecular velocities.

A gas exerts pressure on the enclosing walls because of the impact of molecules on these walls. Since the gas suffers no loss of energy through exerting pressure on the solid wall of its enclosure, it follows that each molecule is thrown back from the wall with the same speed with which it struck it, but in the reverse direction, that is, the impacts are perfectly elastic.

Suppose a molecule of mass, m , to approach the wall with velocity G . Since the molecule rebounds with the same speed, the change of momentum per impact is $2 mG$. If n_o molecules strike unit area in unit time with an average velocity G , the total impulse exerted on the unit area per unit time is $2 m n_o G$. But the pressure is defined as the rate at which momentum is imparted to a unit area of surface.

Hence,

$$2m n_o G = P \tag{2a}$$

It now remains to calculate n_o . Let n denote the number of molecules per unit volume. It is evident that at any instant we can consider the molecules as moving in six directions corresponding to the six faces of a cube. Since the velocity of the molecules is G , it follows that, on the average, $\frac{n}{6} G$ molecules will cross unit area in unit time. Equation (2a) therefore becomes

$$P = \frac{1}{3} m n G^2 \tag{2b}$$

From equation (2b) it is possible to deduce the three fundamental laws of gases that have been mentioned.

Since the product mn corresponds to the density, it follows that at constant temperature the pressure varies directly as the density, or inversely as the volume. This is known as Boyle's law.

Again, from equation (2b) it will be seen that the kinetic energy of the molecules in a volume V is:

$$\frac{1}{2} mn G^2 V = \frac{3}{2} PV \tag{3a}$$

Now we know that if we mix two different gases that were previously at the same temperature there will be no change in tempera-

ture; this holds for all temperatures. Consequently, the average kinetic energy of the molecules ($\frac{1}{2} mG^2$) must be the same for all gases at the same temperature and must increase at the same rate for all gases. We can therefore define temperature in terms of the kinetic energy of a gas. If we write

$$\frac{1}{2} mn G^2 V = \frac{3}{2} RT \tag{3b}$$

where R is a constant, it immediately follows that

$$PV = RT$$

which is the law of Gay-Lussac.

Lastly, let us consider equal volumes of any two different gases at the same pressure and temperature. Since P and V are the same for each, and $\frac{1}{2} mG^2$ is constant at constant temperature, it follows that n must be the same for both gases. That is, *equal volumes of all gases at the same temperature and pressure contain an equal number of molecules.* This was stated as a fundamental principle by Avogadro in 1811, but it took chemists about fifty years to understand its full import.

TABLE I
THE MEAN VELOCITY OF MOLECULES OF DIFFERENT GASES AT 0 DEG. C. AND ROOM TEMPERATURE (20 DEG. C.)

Formula of Gas	Molecular Weight	MEAN VELOCITY $\times 10^{-3}$ CM. SEC. ⁻¹	
		at 0 deg. C.	at 20 deg. C.
H_2	2.016	1.838	1.904
O_2	32.00	0.4613	0.4778
N_2	28.02	0.4928	0.5106
<i>Air</i>	28.96	0.4849	0.5023
<i>Hg</i>	200.6	0.1842	0.1908
CO_2	44.0	0.3933	0.4076
H_2O	18.016	0.6148	0.6368
A	39.88	0.4133	0.4282
NH_3	17.02	0.6328	0.6554
CO	28.00	0.4933	0.5109

If we let V denote the volume corresponding to the molecular weight, the value of the constant R is that defined on page 952. Instead of mnV we can write M , the molecular weight, and (3b) becomes

$$\frac{1}{2} MG^2 = \frac{3}{2} RT \tag{3c}$$

Equation (3c) enables us to calculate the so-called *mean velocity* of the molecules. Substituting for R the value given above, we can write equation (3c) in the form:

$$G = \sqrt{3 \times 83.15 \times 10^6 \times \frac{T}{M}} = 15,800 \sqrt{\frac{T}{M}} \text{ cm. sec.}^{-1} \tag{3d}$$

In Table I are given the values of G at 0 deg. C. and 20 deg. C. for some of the more common gases.

Application to Efflux of Gases

An evident consequence of the last equation is the law that, at constant temperature, the rates of flow of different gases through a narrow opening must vary inversely as the square roots of their molecular weights. This law was confirmed experimentally by Graham and has been applied to determine molecular weights in a number of cases where no other method could be used. The case of the radio-active emanations and still more recently the isolation of meta-neon, a gas of molecular weight 22, which is an isotope of neon, furnish interesting applications of the relation between rate of efflux and molecular weight.

Ratio of Specific Rates at Constant Pressure and Constant Volume

One of the most important deductions in the kinetic theory of gases is that regarding the specific heats of gases.

According to the kinetic theory we conceive a gas to be constituted of molecules which are in constant agitation and we furthermore assume that these molecules are constituted of atoms which may be more or less rigidly held together. Energy added to the gas may therefore be absorbed in the following operations:

(1) In overcoming the external forces when the gas performs work during expansion.

(2) In increasing the translational kinetic energy of the molecules.

(3) In increasing the rotational energy of the atoms in the molecules.

(4) In increasing the energy of vibration of the atoms.*

(5) In overcoming attractive forces between the molecules.

In a "perfect" gas there are no attractive or repulsive forces between the molecules, and the gas obeys Boyle's law rigidly†. For the present therefore we shall neglect the term in the specific heat due to this cause.

Let C_v denote the specific heat at constant volume and C_p that at constant pressure, both being referred to the molecular weight as the unit of mass.

The heat absorbed in raising the temperature of the gas at constant volume from T_1 to T_2 is $C_v (T_2 - T_1)$. The increase in translational energy of the molecules as deduced from equation (3b) is

$$E_t = \frac{1}{2} M (G_2^2 - G_1^2) \\ = \frac{3}{2} R (T_2 - T_1).$$

We shall denote the energy absorbed in the other ways by E_r . We can therefore write,

$$C_v (T_2 - T_1) = \frac{3}{2} R (T_2 - T_1) + E_r \quad (4a)$$

During expansion at constant pressure, the gas performs work. Therefore,

$$C_p (T_2 - T_1) = \frac{3}{2} R (T_2 - T_1) + E_r + P(V_2 - V_1) \\ = \frac{3}{2} R (T_2 - T_1) + E_r + R(T_2 - T_1) \quad (4b)$$

Now in the case of monatomic gases, where we can reasonably assume that the atoms possess the simplest possible structure, it is actually found that

$$C_v = \frac{3}{2} R \text{ and } C_p/C_v = \frac{5}{3}.$$

This leads to the conclusion that for such gases there is no absorption of energy in any other manner than in the form of increased translational energy of the molecules.

On the other hand, the fact that for polyatomic gases C_p/C_v is less than 1.667 indicates that in the case of these gases heat is absorbed in increasing both the rotational and vibrational energy of the molecules.

Table II shows that in case of monatomic gases the relations

$$C_v = \frac{3}{2} R = 2.982 \text{ cal.} \\ C_p = \frac{5}{2} R = 4.970 \text{ cal.} \quad (5a)$$

are in splendid accord with the results of experimental observations.

Degrees of Freedom. Specific Heats of Polyatomic Gases

According to the principles of dynamics, any velocity can always be resolved into three component velocities in directions at right angles to each other, so that the sum of the squares of the component velocities is equal to the square of the resolved velocity. We can therefore consider any swarm of molecules as constituted of three streams which are travelling at any instant in directions at right angles to each other. On the average, there will be just as many molecules travelling in one direction as the other and, since the kinetic energy is proportional to the square of the velocity, it follows that *the average kinetic energy of the molecules for each of the three directions of motion is $\frac{1}{2} R T$, that is, 0.994 T cal. per gram molecular weight.*

* This phase of the subject will be discussed later.
† At high pressures and very low temperatures all gases deviate to a large extent from the laws of a "perfect" gas. By making certain assumptions regarding the nature of the forces acting between the molecules, Van der Waal has deduced an equation which is in good accord with the observed data. A further discussion of this equation will be found in the second article of this series.

Now let us consider two different gases in temperature equilibrium, one of these gases being monatomic and the other diatomic. From the laws of dynamics, it can be deduced that under these conditions the energy resolved along each of the three directions of motion must be the same for each gas; furthermore, the same considerations show that if the molecules of the diatomic gas possess a rotational energy, due to the rotation of their atoms about an axis perpendicular to the line joining their centers, *the average rotational energy must also be equal to $\frac{1}{2} R T$ for each of the degrees of freedom of rotation.* Now if we assume that the two atoms constituting the diatomic molecule are at a fixed distance from each other and are capable of rotating only on an axis perpendicular to the line joining their centers, we limit their rotational motion to *two directions.* We thus conclude that for diatomic gases,

$$\begin{aligned} C_p &= 5 \frac{1}{2} R = 4.970 \text{ cal.} \\ C_p &= 7 \frac{1}{2} R = 6.958 \text{ cal.} \\ C_p/C_v &= 1.40 \end{aligned} \quad (5b)$$

This conclusion is also in good accord with the experimental data, as shown in Table II. Maxwell and Boltzmann deduced these conclusions as particular cases of a more generalized conclusion which they stated as follows:

The average energy content of any system of molecules or atoms is always equal to $\frac{1}{2} R T$ for each degree of freedom.

This is known as the *Principle of Equipartition of Energy.* It is true that the principle

has been shown to be not quite as valid as was originally thought to be the case*; but, nevertheless, the generalization remains as one of the most important deductions of the classical theory of gases.

For triatomic and more complex gases the calculation of C_v becomes quite difficult, but we can conclude this much as certain, that C_p/C_v must be less than 1.40.

It is, however, necessary to point out some respects in which the original form of the kinetic theory has failed to account for some of the actually observed facts.

The specific heats are found to vary with the temperature, while according to the above considerations they should remain constant. This has led not only to a lengthy discussion among physicists as to the validity of the principle of equipartition, but has also led to various attempts to modify the classical theory in such a manner as to account for the new observations.

The absorption spectra of gases in the infra-red region led to the suggestion that the molecules probably possess a certain amount of vibrational energy due to oscillations of the atoms about mean positions of equilibrium. At ordinary temperatures this is negligible but, as the temperature increases, the atoms begin to vibrate with greater and greater amplitudes until at a high temperature they break apart, i.e., the molecule dissociates.

* See "Recent Views on Matter and Energy," GENERAL ELECTRIC REVIEW, Sept., 1914, where the author has discussed this question at greater length.

TABLE II

SPECIFIC HEATS AT CONSTANT PRESSURE AND CONSTANT VOLUME

Gas	C_p		C_v		C_p/C_v	
	Temp.	Value	Temp.	Value (4)	Temp.	Value
A { Hg He	20-30	4.908 (1)	0	2.98	0	1.667 (1)
			0	2.976	310	1.667 (1) 1.63 (1)
H ₂	16	6.860 (2)	0	4.76	16	1.407 (2)
N ₂	20	6.983 (2)	0	4.95	20	1.400 (2)
O ₂	20	6.980 (2)	0	4.96	20	1.399 (2)
CO	18	7.606 (2)	0	4.95	18	1.398 (2)
CO ₂	20	8.889 (1)	0	6.60	0	1.315 (3)
H ₂ O	100	8.374 (1)	0	6.16	100	1.305 (1)
NH ₃	23-100	8.84 (1)	0	6.60	0	1.317 (3)

(1) Kaye & Laby, Physical Constants, pp. 58-9.

(2) Scheele & Heuse, J. Chem. Soc. 103, 11, 183-4.

(3) Jellinek, Lehrbuch d. Physik. Chem. I, 1, 191, etc.

(4) Eucken, Phys. 14, 324, (1914).

By bringing in the additional assumption that the energy from the hot source is absorbed by the molecules, in multiples of a unit amount which is proportional to the frequency of vibration*, N. Bjerrum has been able to account quantitatively for a number of the discrepancies that have been hitherto observed†.

The theory of energy quanta has been applied not only to the vibrational energy but also to the rotational and even translational energies, and it looks at present as if these views will be able to account for all the variations in the specific heats over the range of temperatures 250 deg. C. to 2000 deg. C.

Maxwell's Distribution Law of Velocities

Equation (3c) shows that the value G of the velocity of the molecules may be defined to be such that it corresponds to the mean energy of the molecules which strike against the wall. In other words, "with this equalized distribution of velocities the gaseous medium retains the same energy and exerts the same pressure as with its actual unequal distribution."

It is evident that even if all the molecules in a given volume actually possessed the same velocity at any initial instant, the constantly occurring collisions between them would disturb this equal distribution of velocities and a non-uniform distribution would be established.

Can we calculate the distribution of velocities amongst an infinitely large swarm of molecules? Maxwell showed that the laws of probability could be applied to answer this problem and the result at which he arrived is known as the law of distribution of velocities. It may be stated as follows:

"The possible values which the components of the molecular velocities can assume are distributed among the molecules in question according to the same law as the possible errors of observation are (by the method of least squares) distributed among the observations."‡

The curve shown in Fig. 1 represents graphically the distribution of velocities among a large number of molecules which

have a given mean velocity. The equation of this curve is

$$Y = \frac{4}{\sqrt{\pi}} x^2 e^{-x^2} \tag{6}$$

where Y denotes the probability of a velocity whose magnitude is x , the most probable velocity being taken as unity.

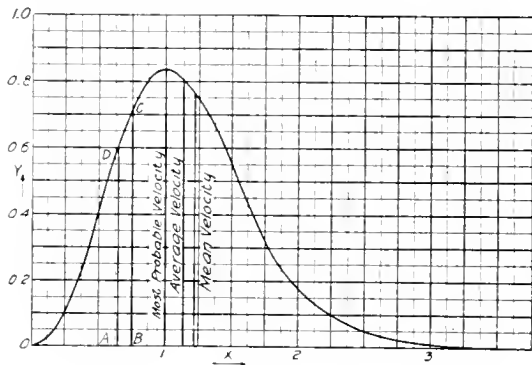


Fig. 1

The most probable velocity is usually denoted by Π' . The value of the mean velocity, G , is greater than Π' , while the value of average (arithmetical) velocity which is denoted by Ω , lies between G and Π' . The distinction between G and Ω is analogous in certain respects to the difference between the readings of alternating current and direct current meters on a pulsating direct current circuit (such as is obtained by rectifying an alternating current without introducing inductance or capacity). The alternating current meter reads the root mean square value of the current, corresponding to G in our velocity diagram, while the direct current meter reads the average value of the current, corresponding to Ω .

The curve in Fig. 1 may also be interpreted as follows: Consider the molecules with velocities ranging between OA and OB , the total fraction of the molecules which will have velocities in this range is given by the area under the curve which is comprised between the ordinates AD and BC .

Relation between W , G and Ω

From the equation of the curve in Fig. 1, it can readily be shown that

$$G = \Pi' \sqrt{3/2} = 1.225 \Pi' \tag{7}$$

and

$$\Omega = \Pi' \sqrt{4/\pi} = 1.128 \Pi' \tag{8}$$

* This is the fundamental assumption of the theory of energy quanta. If ν denotes the frequency of vibration, the energy is absorbed by the oscillating atoms in multiples of the unit quantum $h\nu$ where h is a universal constant. See "Recent Views on Matter and Energy," GENERAL ELECTRIC REVIEW, Sept., 1914. The value of ν is derived from measurements of the absorption spectrum in the infra-red.

† Z. F. Elektrochemie, 17, 731 (1912).

‡ Meyer, Kinetic Theory of Gases, p. 44.

Substituting for G from equation (3c) it follows that:

$$\Omega = \sqrt{\frac{8}{\pi}} \frac{RT}{M} \quad (9)$$

The ordinates corresponding to each of these values of the velocity of molecules have been indicated in Fig. 1. Table III gives the values of Ω in centimeters per second for different gases at various temperatures.

Importance of Ω in the Consideration of Evaporation and Kinetics of Chemical Reactions

It was shown by Meyer* that the number of molecules of a gas at rest as a whole which in unit time strike unit area of the enclosing

tion leads to the results $\omega = 13.8$ g. per sq. cm. per second.

While equation (10a) has been more or less familiar to physicists ever since its deduction by Meyer, it remained for Dr. Irving Langmuir to point out its importance in the consideration of rates of evaporation and of the kinetics of heterogeneous gas reactions.

We shall quote from the paper on "The Vapor Pressure of Metallic Tungsten."†

"Let us consider a surface of metal in equilibrium with its saturated vapor. According to the kinetic theory we look upon the equilibrium as a balance between the rate of evaporation and rate of condensation. That

TABLE III
VALUES OF THE AVERAGE (ARITHMETICAL) VELOCITY

Gas	M	$\Omega \times 10^{-3}$ AT T =					
		273	293	373	1000	1500	2000
H_2	2.016	1.696	1.755	1.980	3.241	3.970	4.583
NH_3	17.02	0.583	0.604	0.681	1.115	1.367	1.577
H_2O	18.016	0.566	0.587	0.662	1.084	1.317	1.533
CO	28.00	0.454	0.471	0.531	0.870	1.065	1.230
N_2	28.02	0.454	0.471	0.531	0.869	1.064	1.229
<i>Air</i>	28.96	0.447	0.463	0.522	0.855	1.047	1.209
O_2	32.00	0.425	0.440	0.497	0.813	0.996	1.150
<i>I</i>	39.88	0.381	0.395	0.445	0.729	0.892	1.030
CO_2	44.00	0.362	0.376	0.434	0.694	0.850	0.981
<i>Mo</i>	96.0				0.463	0.575	0.664
<i>W</i>	184.0				0.339	0.416	0.480
<i>Hg</i>	200.6	0.170	0.176	0.199	0.325	0.398	0.459

wall is $\frac{1}{4} n \Omega$, where n denotes the number of molecules per unit volume. (This is the signification to be attached to n in the remainder of this article.)

Denoting the mass of gas that strikes unit area per unit time by ω , it follows that

$$\begin{aligned} \omega &= \frac{1}{4} n m \Omega \\ &= \frac{1}{4} \rho \Omega \end{aligned} \quad (10a)$$

where ρ denotes the density of the gas. Since

$$\begin{aligned} \rho &= \frac{M}{V} = \frac{MP}{RT} \\ \omega &= \frac{1}{4} \cdot \frac{MP}{RT} \Omega \end{aligned} \quad (10b)$$

Substituting for Ω the value deduced in equation (7) above, and also the value of R ,

$$\omega = 43.74 \times 10^{-6} \sqrt{M/T} \cdot P \quad (10c)$$

Here ω is expressed in grams per square cm. per second, and P is in bars.

For air at normal pressure ($P = 10^6$ bars) and room temperature ($T = 293$), this equa-

is, we conceive of these two processes going on simultaneously at equal rates.

"At temperatures so low that the vapor pressure of a substance does not exceed a millimeter, we may consider that the actual rate of evaporation of a substance is independent of the presence of vapor around it. That is, the rate of evaporation in a high vacuum is the same as the rate of evaporation in presence of saturated vapor. Similarly we may consider that the rate of condensation is determined only by the pressure of the vapor."

It is therefore possible, according to Langmuir, to apply equation (10) to calculate the vapor pressure of a metal like tungsten in vacuum from the observed rate of evaporation (loss of weight at constant temperature).

Thus, at a temperature of 2800 deg. K., the observed value of ω , the loss in weight of a tungsten filament is 0.43×10^{-6} gms. per

* Meyer, Kinetic Theory, p. 83.

† Phys. Rev., 2, 329, 1913.

square cm. per second. Substituting in equation (10c) we find for P , the value, 28.6×10^{-6} mms. of mercury, or 38.1×10^{-3} bar.

In this manner Langmuir and Mackay have obtained the vapor pressure curves of the metals tungsten, molybdenum and platinum over a large range of temperatures.

The application of the same considerations to the study of chemical reactions between gases and heated filaments has also been productive of intensely interesting and important results.*

One of the simplest cases is that of the dissociation of hydrogen into atoms.†

Measurements of the heat lost by convection from tungsten wires heated in hydrogen showed that the losses increased at an abnormally high rate when extremely high temperatures were reached. In explanation of this it was suggested by Langmuir that the increased loss is due to the heat absorbed in the dissociation of hydrogen molecules as they strike the filament, and a comparison of the actual results with the deductions based on this hypothesis has led to a striking confirmation of the latter.

Of special interest is the application of equation (10) to the calculation of the heat of dissociation of hydrogen molecules.

At extremely low pressures the rate at which hydrogen molecules strike the surface of the tungsten may be calculated by means of equation (10), and knowing the heat loss from the surface, the energy carried away by each molecule may be determined. Now at very high temperatures the heat loss tends to reach a constant value. Hence, if it be assumed that under these conditions every hydrogen molecule which strikes the filament becomes dissociated, then those experiments must lead to a direct determination of the heat absorbed in the dissociation of hydrogen molecules. That is, it is possible by applying equation (10) to the observed results on the heat losses from tungsten wires in hydrogen

at low pressures to calculate a lower limit for the heat of the reaction:



Another interesting illustration is the reaction between oxygen gas at very low pressures and a heated tungsten filament in a lamp bulb. The tungsten is attacked and forms the oxide, $H'O_3$. At sufficiently high temperatures, this oxide volatilizes; the molecules of $H'O_3$ travel directly to the walls of the bulb and condense there, so that the surface of the filament remains clean. Now the rate at which oxygen molecules strike the surface can be calculated by means of equation (10). When we compare this with the rate at which the filament is actually attacked, we find that only a fraction of all the molecules that strike the filament react with it.

The value of this fraction in the case of the reaction between oxygen and tungsten varies from 0.00033 at 800 deg. C. to 0.15 at 2500 deg. C. In other words, at the latter temperature, about one out of every seven molecules of oxygen that strike the surface of the tungsten react with it. It would take us beyond the scope of the present paper to discuss the interesting conclusions which Langmuir deduces from this result; but it may be pointed out in what respect such calculations are of importance.

There is no doubt that the chemistry of the future will be largely a study of the actual mechanism of chemical reactions. The chemistry of the past has been distinguished by the applications of the first and second laws of thermodynamics. But such applications, no matter how brilliant the success attained, have necessarily been limited to systems in equilibrium. When, however, we come to consider the kinetics of chemical reactions, all such considerations fail; the kinetic theory in its manifold applications is the only means by which we can hope to attain a better understanding of this phase of chemical reactions and manifestly the simplest conditions for such a study are present when we are dealing with very low pressures where we can, as it were, follow up the history of each individual molecule.

(To be Continued)

* The work in this field has been summarized by Dr. Langmuir himself in a paper presented at the New York Section of the American Chemical Society, March 5, 1915, on the occasion of his receiving the Nichols medal. (Chemical Reactions at Low Pressures, Journ. Am. Chem. Soc. 37, 1139).

† Journ. Am. Chem. Soc. 37, 417 (1915)

SOME PROBLEMS IN BURNING POWDERED COAL

PART II

BY ARTHUR S. MANN

GENERAL ELECTRIC COMPANY, SCHENECTADY, N. Y.

In Part I of this article, which was published in the September REVIEW, the author describes a highly successful system which he has developed for burning powdered coal and illustrates its application to firing furnaces. In the present installment he narrates how the same equipment has been applied to firing boilers and, in addition to stating the peculiarities in burning powdered coal, he includes the records of tests on forging furnaces and boilers which demonstrate the value of this type of firing.—EDITOR.

Furnace linings have been burned out by powdered coal fires. Sometimes a wall looks as the rocks in a turbulent stream after ages of wearing. You can see where the brick has been cut away, and it was all done in a few weeks. Coal may be awful in its action, but it need not be. A hot stream of coal and air driven at high speed against a wall will cut it out. A low fusing point brick is melted down: a refractory brick is cut away mechanically. We have cut away carborundum brick by misdirecting a fire which did not approach the melting temperature of the brick. But such action is unnecessary. Except at the burning tuyere brick need not meet a destructive flame, and the tuyere itself can be so shaped that repairs are minor and infrequent. The remedy is to avoid high velocity along the brickwork. If a wall must take the full force of a current, we protect it with loose brick or pass a current of combustion air along its face, which both deflects and protects. An arch can always be treated in this way. Some of the combustion air is cut off from a burner and sent along on top and over it. The total volume of air used is not increased and a reducing fire can still be carried; heat distribution is noticeably good.

The designing and building of furnaces is an undertaking that calls for engineering skill. Speeds, volumes and currents must all be considered; sizes and areas influence heat generation and distribution; the position of egress ports, if many, may defeat the purpose of a furnace. To be sure, all the elements at hand involve only the simple laws of nature and the problems are susceptible of simple mathematical solution. But it will not do to build a furnace in a haphazard way—apply a burner somewhere and if it does not work squirt in enough fuel to make it work. Perhaps there is no fuel so sensitive to correct use as coal dust.

Some fuels can be burned without care on the part of an operator: gas is one and oil

virtually another. There is no economy in such ways, but the furnace is undeniably hot. We recall an instance where an oil man wanted a really good fire and had no oil to waste. He watched that fire all the time and kept it right; if he eased off his oil a trifle he cut down his air too and did not forget to look at the chimney, top and bottom. Such work always pays, whatever a fuel may be.

Powdered coal is not a fuel that can be left for half a day to itself while the fireman goes to grind his knife and pare his apple. We have fires that run all day with no change in adjustment whatever, but somebody always knows they are right and the fire is looked at every half hour or so. There is always slag and some fine ash forming: it is well to know where these are going. On the other hand a wrong adjustment of either coal or air makes itself apparent. Powdered coal burns best with 200 cu. ft. of air for each pound. It can burn, and burn clearly, with 160 ft. and even less, but the extra air pays. As the supply exceeds 200 ft. efficiency begins to fall. There is even a noticeable loss at 208 ft. The eye cannot discriminate between a 200 ft. and a 208 ft. fire, but it can recognize a 250 ft., or even a 220 ft. blaze. There is a marked change in its appearance and unless a cutting fire is really wanted, there is no excuse for such bad mixtures.

This is not true of other fuels. Coal on a grate is not doing its best at 200 feet, and it takes a remarkably close observer to note the difference with a 240 ft. fire. With oil this is even more pronounced. It is the usual thing to find an oil fire with air greatly in excess, and the fact not known. The average operator will not even try to find out whether he is wrong, for in order to do so he must reduce his air little by little till things go wrong, and all that takes time. Firemen are not paid to save fuel. The powdered coal fire begins to spark and wheeze when it has too much air.

An interesting problem in furnace construction presented itself eighteen months ago

It was desired to heat certain metals very slowly and uniformly, the furnace to be charged when cold, that is, at room temperature, and brought up to 900 deg. C. in six hours, the rate of temperature rise not to exceed 200 deg. C. per hour at any time. After reaching 900 deg. the heat was to be held for the rest of the day. Perhaps this can be done with other fuels but it was done very easily with powdered coal, and there would have been no trouble in holding a temperature increase of 20 deg. per hour had it been

and the five cold ones put in. The hot billets were dropped in a tank of cold water and kept there till they were stone cold. So these charges were heated alternately all day. Fuel was weighed, furnace temperatures were measured, and in order to allow for the metal burned away it was weighed at beginning and close of trial to give an average. The procedure in boiler testing was followed as closely as possible with these two differences; the furnaces were cold when a trial began and not all the metal was heated that

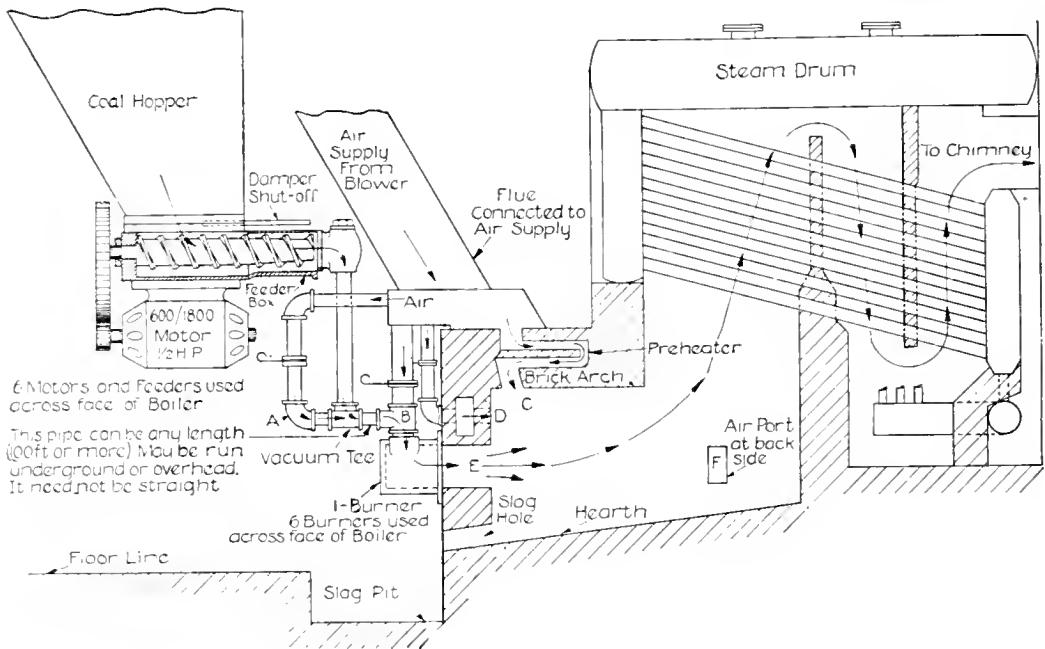


Fig. 9. A diagrammatic longitudinal section of a boiler and powdered coal burning equipment

required. This was true of the first hour too, which, by the way, presents the greatest difficulty.

It may be of interest to note the results of trials upon furnaces built to heat metal for forging purposes. There is no standard of comparison as there is in the case of a boiler trial, so we had to make one. We had eleven billets 4 in. square and about 20 in. long weighing approximately 91 lb. each, which were to be melted down for scrap. The two furnaces selected could each heat one-half of them at a charge, five at one time and six at the next, so the hearth was covered to 50 per cent of its area and 4 in. deep. As soon as six of these billets were heated to a smart forging temperature just short of dripping they were hauled out

could have been heated. If each charge had been twice as great the output per pound of fuel and the working efficiency would have been nearly twice as large for only about 10 per cent of the fuel in a furnace goes toward heating the charge; one quarter of the rest goes to heat up brickwork and the balance goes out the chimney.

Table I gives results of these trials. The first was upon No. 4 furnace with cold combustion air and coal dust for fuel; the second upon No. 0 furnace with hot air and coal dust. The third trial was with oil on No. 0 furnace. No. 4 furnace is somewhat larger in area than No. 0. The first and the second trials may be compared to show effect of preheating air; the second and third to show input of coal and oil.

The temperature of the heated air was apparently higher in the case of coal than in that of oil; but all the air was preheated for oil, while primary air, or say 25 per cent of the air for coal, was not heated at all. In any event the same air heater and same furnace were used in the two cases.

The heats in this class of work are unquestionably better with coal. They were noticeably brighter and softer; to express the difference as a forgesmith would, it is stated that coal heat is more penetrating, and in a given furnace more work can be done, and more fuel can be well burned with coal than with oil. Columns 2 and 3, Table I, show a 10 per cent greater output with coal than with oil. It can be noted, however, that efficiencies are virtually the same, less than three-tenths of one per cent difference. We have found the same thing true in comparing coke with oil in a large oven, and in general it may be stated that efficiencies will be equal if fuel is properly burned, and this will cover coal upon a grate too. If burning conditions are right, if fires are carefully and intelligently watched, efficiencies will be high and will be essentially equal. When fires are not understood, when conditions are wrong and results poor, there is no use in trying to draw conclusions from a trial. The speed of two race horses cannot be gauged by a trial when they are half starved. If a fire beneath a boiler cannot turn 75 per cent of itself into steam, have 75 per cent efficiency, either the operator is untrained or

the burning arrangements are wrong. A skillful man will obtain better than 75 per cent.

Some time ago we fitted up a boiler furnace to burn coal dust. It was a single 474 horsepower (10 sq. ft. rating) unit that had been fitted with an extension front, making a 4-ft. Dutch oven, for burning oil. We used the same oven, the same front, for a coal furnace, but the internal arrangements were made quite different. Fig. 9 shows a longitudinal section of this furnace, Fig. 14 is a photograph of the front, and the illustration on the cover of this issue shows the front and side. Fig. 11 is a diagram of the front.

The same feeders and same driving gear are used as those shown in Figs. 3 and 4. In order to perfect mixtures and to supply both air and coal in small quantities, six burners and six feeders were used. Air is admitted at six separate ports, that is, each particle of coal encounters six air currents before it passes on to the heating surface, and every air current is pointed across, or at an angle to the burning current, to make the stirring action perfect. In consequence combustion is virtually complete in eight feet of travel even with 200 per cent or more load. Five hundred and twenty pounds per front foot of furnace has been burned with only seven feet between header and floor line. The boiler has carried 265 per cent load long enough to show that such loads are possible, and 220 per cent or more can be carried indefinitely, for there are no cleaning periods.

TABLE I
RESULTS OF FORGE FURNACE TRIALS

	No. 4 Furnace	No. 0 Furnace	No. 0 Furnace
Kind of fuel	Powdered Coal	Powdered Coal	Fuel Oil
Duration of trial	7 30/60 hr.	7 37/60 hr.	7 34/60 hr.
Temperature of furnace at start	Cold 16 hr.	Cold 16 hr.	Cold 16 hr.
Temperature of furnace at finish	1370 deg. C.	1355 deg. C.	1350 deg. C.
Average furnace temperature	1300 deg. C.	1301 deg. C.	1270 deg. C.
Time to end of first heat, including bringing up furnace	94 min.	85 min.	98 min.
Number of heats	8	10	9
Average time each heat, neglecting first	51 min.	41 min.	44 min.
Temperature combustion air	16 deg. C.	334 deg. C.	240 deg. C.
B.t.u. per lb. fuel	14000	14000	19400
Total fuel, including kindling	1042	790 lb.	518 lb.
Total steel heated	4288	5015	4563 lb.
HOURLY QUANTITIES			
Pounds steel heated per hour	573	659	604
Pounds fuel per hour	139	104	69.5
ECONOMIC RESULTS			
Pounds steel per pound of fuel	4.11	6.35	8.83
B.t.u. per lb. steel in fuel	3406	2203	2196

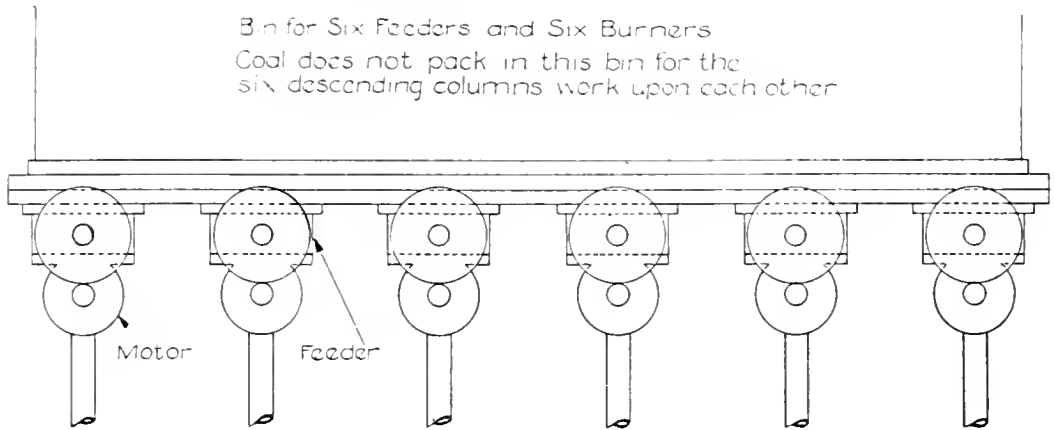


Fig. 10. Diagram of the powdered coal bin, feeders and motors on a boiler front

The six burners across our furnace front are so arranged that the air currents issuing from them revolve in counter direction with respect to each pair. The diagram, Fig. 12, shows this relationship and the currents act as do a train of toothed gears at the tuyere mouth and so tend to preserve a path of travel normal to the general gas current. These swirling masses proceed a little way only, when they meet with air from the arch ports. Fig. 13 shows this movement. The swirls move onward in a corkscrew path, and are met with hot air from A. The result is the curve D, and the whole volume follows the path and can be seen plainly at lighter loads making its turn beneath the arch. There are six curves like D, one for each burner, and each curve is a corkscrew at least part way.

The side wall currents help to prolong the mixing action.

One difficulty presents itself in burning powder that is not met in burning coal by usual processes. Powder is burned in suspension, and as it travels at 40 or 50 ft. per second it must be consumed in one-sixth second or so. If it isn't, it will not be completely oxidized. During this brief time interval there is only one-fifth pound burning, even at heaviest loads, and at no instant is there a greater quantity of coal on fire. With a grate no coal particle must burn in a short time, the average time for all particles being half an hour, for there is a ton and a half or so on the grate burning slowly. This seeming disability really works to the good of powdered coal.

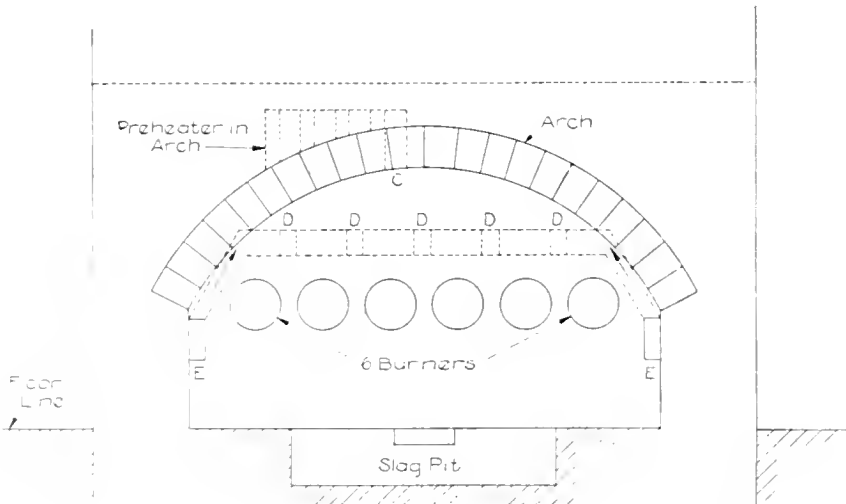


Fig. 11. Diagram of a boiler front showing location of burners and air passages

When the morning for starting a first fire beneath this boiler arrived, an armful of kindling was placed at the mouth of one burner and lighted; then secondary air was admitted at this burner followed by primary air. A switch started a motor and its feeder

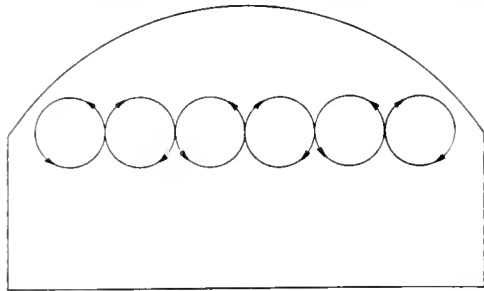


Fig. 12. Diagram showing the direction of rotation of the powdered coal and air as they leave the burners

sending down coal; a puff of smoke and the fire was going. The next burner caught from the first and so two more, making four in all, were set at work. The memorandum taken at the time was:

- 8:26 a.m. light fire, four burners $\frac{2}{3}$ on
- 8:33 a.m. 10 lb. pressure
- 8:46 a.m. 140 lb. pressure

At 8:46 a.m. the fireman checked his coal feed and went up overhead to open the stop valve, and in two more minutes our boiler had load.

This fire was started in a new cold furnace beneath a boiler full of cold water. With half the coal-burning capacity in use, pressure was up in twenty minutes.

Our first boiler trial gave us 68 per cent efficiency with 131 per cent load. Efficiencies are calculated by dividing heat in steam by heat in coal (laboratory test) that produced it. That is, if we had 10 lb. equivalent evaporation per pound coal and 14,000 coal we multiply 10 by 966 and divide product by 14,000,

giving 69 per cent efficiency. Successive trials gave the results shown in Table II.

Since the last and best trial the boiler has given as good or better efficiencies for a week at a time including coal for all purposes, with railroad weights for coal, the fire being put out at 5 p.m. and kindled fresh at 7:30 a.m. every day.

The earlier experiments show nothing remarkable in economy, but in the beginning we knew neither how much air to admit nor where best to admit it. We worked in the dark till we made experiment No. 5, when our observations began to coordinate. Nos. 7 and 8 taught us much, but we had to make some mistakes before we brought out No. 11, and this is not final. We can do better with

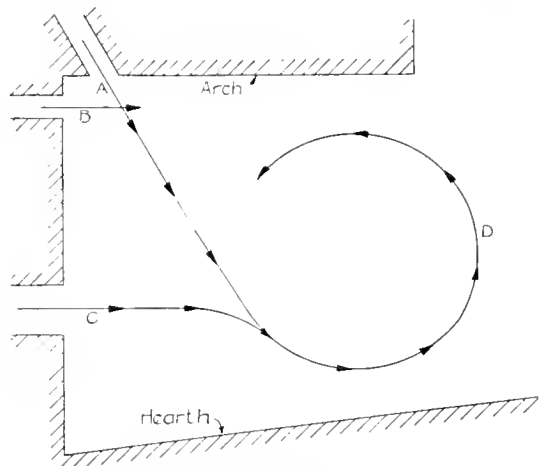


Fig. 13. Diagram showing the path of the powdered coal and air currents immediately after entering boiler

less air, though perhaps there are some fires not giving 75.7 per cent efficiency with 205 per cent load.

We experimented chiefly with air dampers, noting air volumes, flue temperatures and color of smoke. Each air supply has its

TABLE II
RESULTS OF BOILER TRIALS

	1	2	3	4	5	6	7	8	9	10	11
Load percentage.....	131	186	212	119	97	136	154	154	141	164	205
Efficiency per cent.....	68	63.8	65.8	68	71.8	65.5	71	69.4	66.1	63.7	75.7
Air per lb. coal c.f.....	210	178	150	190	250	181	200	226	216	168	208
Flue temperature.....	559	684	786	583	568	652	693	685	628	678	724

dampers, and these were adjusted independently. With a given coal feed, if it was found that changing points of application of air enabled us to reduce air volumes, with an accompanying rise in flue temperature with no smoke, we concluded we were making an improvement.

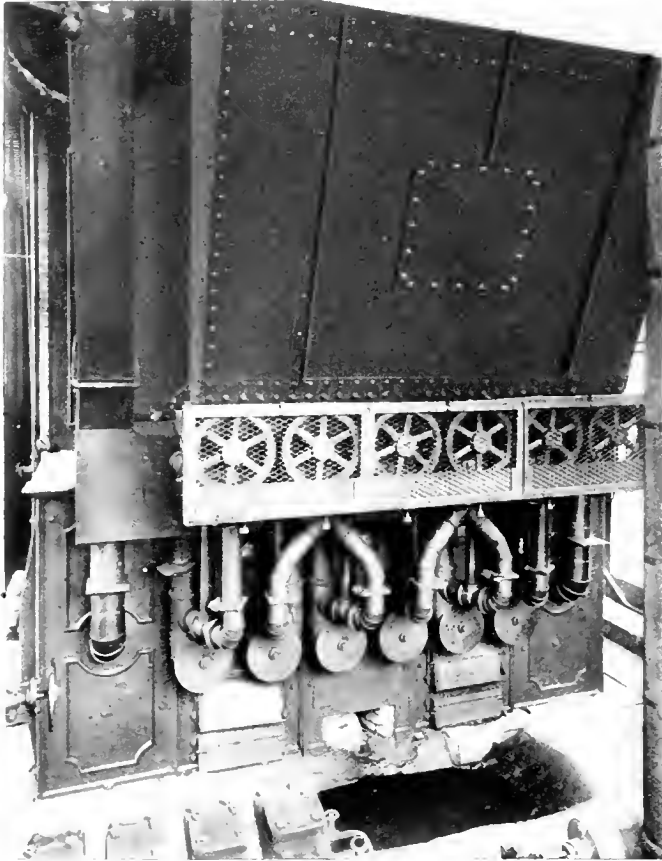


Fig. 14. Front view of a boiler equipped with powdered coal burning apparatus

In this way we found it best to admit as little air at *A* and *B* as possible, a lot at *C*, some at *D*, and a little at *E* (*F* is used only on heaviest loads, that is above 210 per cent). In general it may be stated that as the air supply departs from 200 cubic feet per pound of coal efficiency falls.

We have supplied the operator with some gauges which give him the heights of water column for a definite air volume. Each gauge is marked with its number of coal notches on feeder rheostats, for example, 16-20-21 and so on. He then makes the water

column fit his coal feed. Dampers are marked and results are definite.

It is to be observed that measuring air volume is much better than measuring CO_2 in chimney gases. Two hundred feet of air gives a CO_2 of about 15.3 per cent; 208 feet gives 14.7 per cent, and this small change (which no CO_2 apparatus can be sure of) gives a marked change in evaporation. The same change in air volume makes our water column move $\frac{1}{4}$ in. Furthermore, the fireman knows of any change here instantly. He measures it and he measures all the air. The CO_2 content is judged from a minute sample and is half an hour behind the time.

It will pay to so arrange air piping on any boiler that air volumes can be measured instantly, and this is true whether a chimney or a fan produces the draft. A nozzle plug is used in the pipe, though perhaps a Pitot tube might do; however, the nozzle plug acts well and it is liked. If a fireman sees his water column go up he knows that a hole is coming in his fire and he knows it right away. This knowledge would be of more value to him than any other information of the sort he could have.

We are for the present conducting no more boiler trials. Those already recorded point the way to improvement. There is enough heat in flue gases to warrant the placing of heating surface in its path. Everything in the shape of tar has been burned out of the fuel, so we are putting about 600 ft. of $1\frac{1}{4}$ in. tubing in the breeching and will send feed water through it. The stack is clear. All soot drops in the gas chambers long before reaching the stack, so that all troubles commonly met with on this surface are absent. More trials will be conducted when this addition is ready.

There are three difficulties to be overcome in burning powdered coal, which are greater as quantities and temperatures are greater. These are slag, ash and burned brickwork. None of these are serious with light loads, say 140 per cent or less, but heavy loads are so easily and economically carried that the three problems call for care in designing furnaces. Furnace temperatures are high; 2700 deg. F. or more is not uncommon and most of the ash will slag when hot. We aimed to slag as

much as possible, for it can be drawn off at intervals. Fine ash passes on among the tubes. The slag weighs 5.72 per cent, and the soot 3.41 per cent of the coal that made it. This coal gives 11.26 per cent ash in the laboratory, so that 2 per cent must have gone out the stack. This 2 per cent is a very fine white powder, scarcely visible at the chimney top. The slag (114 lb. per ton) contains no carbon whatever. For a moderate load, say 180 per cent, it is drawn out once during the day to a concrete pit containing water. The pit is cleaned out with pick and shovel the next morning. This is not the easiest way to handle slag. If there were a cellar beneath the boiler room there would be less labor, but even as it is the work is not difficult. Water in the pit is essential, however.

With heavy loads some particles of slag travel with the gas current and cling to the first cold surface they meet—the bottom row of tubes. If this slag is allowed to accumulate, say for ten hours, it will choke off enough of the gas passage to make reduction of load necessary. This seemed a great difficulty at first, but it has been overcome. It can be blown off with a steam jet once during the forenoon and again in the afternoon for heavy loads. It does not call for much time and is not laborious. However, we have greatly improved this condition by admitting a little steam at the inlet end of the passages. This steam travels with the hot air, mingling with it and altering the character of the fire; it makes slag run more freely, softening and decreasing the quantity that clings to the tubes. We have found that 145 lb. per hour is enough for 160 per cent load, or 24,000 lb. of steam per hour.

It pays to blow tubes once a day and we follow that practice. Most of the soot goes over through the second pass and drops nicely in the back chamber. The bottom of that chamber has been paved giving it a pitch, with tile pipe leading to a pit, and all this material is washed out every second day by merely opening a valve. The soot, however, is a loss for 60 per cent of it is carbon; that is, 60 per cent of 3.41 per cent or 2 per cent of our coal is unburned. The soot is light and fluffy, weighing 18 lb. per cubic

foot but we have found no good use for it thus far.

Other losses are not great. Radiation from the furnace is small, for the furnace is virtually surrounded with air passages and heat that gets into them is returned to the furnace. These air passages, and the deflecting air currents *C*, *D*, *E* and *F* do much toward protecting furnace walls. We have burned out one arch, melted it down from nine inches to four inches when it fell, but it stood up nearly six months. It did not run every day with heavy load and did not run nights at all; but it was made of common fire bricks which are not intended for high temperatures. The new arch is of better material, costing \$37.00 per thousand. We may find it will pay to use carborundum.

Somebody will ask how much it costs to make powdered coal. The answer is that it depends upon how much is made. Coal has to be crushed, elevated, dried and distributed, whatever burning system is used. There are two elevations and the pulverizing additional for powdered coal. So the question of real interest is how much more does it cost to make and burn pulverized coal than it costs to make and burn coal by the usual process. Our pulverizer is small, and the cost with motor installed was about \$1000 per ton pulverized per day. If it were to run only five hours per day, leaving ample time for repairs, fixed charges come to about 7c. per ton, allowing 10 per cent per year.

Our current costs, in cents per ton, are as follows: Driving dryer, 1.95; two elevations, 0.77; pulverizing, 14.8; which makes 17.52c. per short ton for current and 24.52c. including fixed charges. This total is reduced by a third with larger pulverizers.

The pulverizer calls for some attention, but it is in the coal house with other machinery and whatever labor it needs is more than made up in decreased labor of firing. Our blower at the furnace gives a pressure of three ounces, which is ample, so that 25c. per ton is all that can be charged against pulverized coal. We have not run long enough to say what the repairs will be, but our two years have shown that they are nominal, at least no greater than is met with in all coal-handling machinery.

THE THEORY OF LUBRICATION

By L. ÜBBELOHDE

Translated for the GENERAL ELECTRIC REVIEW from *Petroleum*

By HELEN R. HOSMER

RESEARCH LABORATORY, GENERAL ELECTRIC COMPANY

PART I

This article is the first installment of a valuable and exhaustive treatise on the subject of "Lubrication." The present section deals with the fundamental physical principles and its subdivisions treat of the subjects—capillarity, general characteristics of friction, definitions, physical and technical units and the interrelation of these, external friction, and the characteristics of oil. The following installments will take up the "Laws of Friction in Lubricated Machine Bearings" and the "Failure of Oil Testing Machines."—EDITOR.

In the following article are briefly recorded the results of investigations, some of them completed years ago, upon the important problems of friction in lubricated machine parts and the testing of lubricants. Time has been lacking to publish this material in detail, as was originally intended.

I. FUNDAMENTAL PHYSICAL PRINCIPLES

Before entering upon a consideration of the phenomena of lubrication, there are several underlying principles, such as capillarity and friction between solid bodies, and within fluids, which may well be recalled.

(a) Capillarity

It should be noted in the first place that the wetting of a journal and bearing and the angle of contact due to surface tension are the factors controlling the lubricating power of a fluid. The phenomena of capillarity thus enter directly into the problem under consideration.

Oil forms a thin layer between a bearing and journal, the action of which may be studied as follows: If a drop of oil be placed upon a watch glass and a second glass, slightly more curving, be laid upon it, the oil layer between the glasses may be made as thin as desired by pressure. But if this experiment be repeated with mercury, it will be found very difficult to retain this fluid between the glasses, for it tends constantly to slip out at some point from the narrow space, allowing air to enter from the other side.

In explanation of this behavior let us consider the surface tensions at a and b (Fig. 1), and assume that by chance the mercury is not evenly distributed about the narrowest constriction, so that the space at b is somewhat narrower than at a . Since at both places the liquid-solid angles of contact are approximately equal, there must be at b a smaller radius of curvature, and therefore a sharper curve than at a . Consequently the surface presses harder upon the liquid at b and the meniscus at b pushes the mercury to

the left, overbalancing the surface tension at a^2 , until the narrow space is free from mercury.

With a liquid such as oil, which wets the walls, the converse phenomena appear. In Fig. 2 the more curved surface at b sucks the oil drop to the right until it is distributed uniformly about the narrow space.

A wetting fluid always seeks the narrowest space, and with a force, under certain conditions, sufficient to prevent the coming in contact of the two surfaces. If there are air bubbles in the fluid they will behave in the opposite sense from the fluid itself; in oil they will move toward the place where the layer is thickest, in mercury toward the narrowest point.

As the force of capillarity becomes very great in very thin layers, on account of the small radius of curvature, it follows that if a non-wetting fluid be used for a lubricant, one can never be sure that there is any present between the bearing surfaces at the points where they approach most closely. The contrary condition is much more to be expected, and this is indeed the reason why fluids which do not wet are unsuited for lubrication; no power can retain them between the rubbing surfaces³.

It is the general impression that water is not applicable to the lubricating of machine bearings. This is to be traced back to the fact that tests have been made with bearings which had not previously been completely freed from fat, and so water would not wet them. The conclusion should be corrected. However, there is never any demand in practice for so thin a lubricant⁴.

(1) See introduction to "Tabellen zum Englerschen Viscosimeter," S. Hirzel, Leipzig, Absatz 4.

(2) This manifestation of surface-tension in non-wetting fluids, which can be appropriately termed "abhorrence of narrow spaces" is turned to account in mercury joint packing. The mercury will not flow, in spite of gas pressure, into the extremely narrow spaces between the ground and packed surfaces.

(3) Not even in pressure lubrication by means of especially constructed pumps, unless extremely high pressures be used.

(4) I have known of instances where water was used for lubrication, but in these cases the bearing consisted of a wooden bracket. Such bearings are the "Sternbuch" bearing, or the outside bearing of a ship's propeller. The lubrication of metal bearings with emulsions of oil and water (soap solutions) will not be considered here.

(b) General Characteristics of Friction between Solid Bodies and in Fluids

(1) Definition of Friction

Although there are many good contributions on the subject of friction, one who has kept track of the publications upon the subject of the testing of lubricants will not consider a repetition of the general laws superfluous, as preliminary to a consideration of the subject of the internal friction of fluids.

By the simple term "friction" is always understood a force (which the engineer therefore measures in kilograms), which we shall always denote in the course of this article by R . A related term is frictional work A (measured in meter kilograms) which equals the frictional force times the distance over which it is overcome. A third term is frictional power, L , which is the frictional work per unit of time (measured in meter kilograms per second, horse power, kilowatts, or calories per hour).

$$\text{Therefore } A = R s \quad (1)$$

$$\text{and } L = \frac{A}{T} = R \frac{s}{T} = R v \quad (2)$$

where T denotes time and v the velocity of the rubbing bodies. The frictional power is obtained by multiplying the frictional force by the velocity. There are also in use the further expressions "specific frictional work" a , and "specific frictional power" l , meaning the total frictional work A or frictional power L divided by the size of the surfaces in contact. These values may be measured in m. at. (meter atmospheres) and in m. at. sec.

All frictional phenomena are accompanied by the production of heat, that is, the temperature of the rubbing bodies rises until as much heat is given off per second by conduction and radiation as is produced. It is said that the bearing has then reached constant temperature.

From these considerations it appears that frictional work and frictional heat are identical, and hence the terms are often used interchangeably. It is specially to be noted that the frictional work is usually expressed as meter kilograms, but the frictional heat as calories.

(2) Friction of Solid Bodies (Dry Friction)

Under the designation friction is understood, for the case of solid bodies, that force which must be applied to the sliding bodies in order to maintain them in uniform motion.

The dry friction of solid bodies is expressed by the law of Coulomb

$$R = \mu N$$

where N equals the force pressing the bodies together and μ a constant dependent upon the nature of the rubbing surfaces.

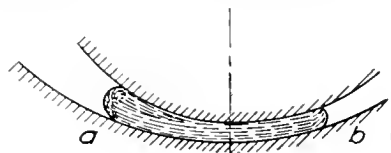


Fig. 1

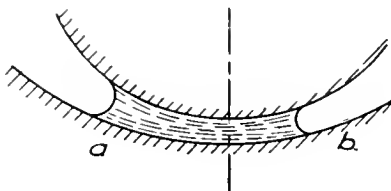


Fig. 2

(3) Friction in Fluids

(a) Viscosity or Internal Friction

Of far greater importance for lubricated bearings than dry friction is the internal friction of the lubricating oil, so that for one who would make a thorough investigation of the conditions of bearing friction an absolutely clear understanding of the laws of fluid friction is indispensable.

Newton stated several laws applying to fluid friction which are expressed by the formula:

$$R = \eta f \frac{dv}{du} \quad (3)$$

Here R is the frictional force (in dynes) which is necessary to shove over each other two fluid layers of f cm² surface separated from each other by du centimeters at the rate of dv centimeters per second; η is the viscosity of the fluid. (See below.)

In connection with Newton's law it should be stated that the coefficient η , which according to Newton should depend only upon the fluid and the temperature, is also influenced to a slight extent by the pressure⁵ and free surface.⁶ Neither of these effects need be

⁽⁵⁾ Warburg and von Babo, Wied. Ann. 17, 290, 1882; see also the graphical representation in work of R. Biel, Forschung a.d. Geb. d. Ing.-Wes. 44, 5, 1907; other articles upon the effect of pressure: Rontgen, Wied. Ann. 22, 510, 1884; Cohen, Wied. Ann. 45, 666, 1892; G. Tammann, Wied. Ann. 69, 771, 1899; Hauser, Diss., Stuttgart 1900, Beibl. 1900, p-1253; Drudes Ann. 5, 597, 1901.

⁽⁶⁾ Plateau, Mém. de l'Acad. de Belg. 1843-63; Statique des liquides soumis aux seules forces moléculaires; Gand et Paris 1873, T. 2, p-261 ff; Pogg. Ann. 17, 604, 1861; see also Plateau, Pogg. Ann. 147, 44, 1870; see also: Stables and Wilson, Phil. Mag. 15, 406-1883; Beibl. 7, 884.

taken into consideration, however, in general in connection with bearings. Only in the case of very thin layers of lubricant (insufficient lubrication) would the effect of adhesion upon the density of the oil become significant. This condition will not be gone into here.

The present day theory of the friction of lubricated machine parts is based upon Newton's law, whose mathematical expression is free from error only under the condition that the sliding of the separate fluid layers consists of pure translation, that is, when there is no eddy. Such eddy occurs under otherwise similar conditions with higher velocities, wider tubes, or lower viscosities. The expression "critical velocity" is used to indicate that velocity at which under the conditions existent the straight line movement just ceases and the circular motion begins. It would take us beyond the limits of this paper to discuss the matter further here. When, as the result of exceeding the critical velocity, eddy movement sets in, it produces a greater resistance, and the effect is to give η a higher value in the quoted formula.

(α) DETERMINATION OF VISCOSITY IN THE SYSTEM OF UNITS USED IN PHYSICS

The absolute value of the viscosity can be determined from the amounts flowing through capillary tubes, by the formula:

$$\eta = \frac{\pi p r^4 t}{8 l V} \quad (4)$$

where p = the pressure necessary to overcome the resistance, l and r are the length and radius of the capillary tube, V the volume of liquid which has flowed out, and t the time of flow.

This viscosity has, then, the dimensions $\text{cm}^{-1} \text{g sec}^{-1}$ (c.g.s. system) and can be called the absolute viscosity. Frequently the viscosity is referred to that of water at $\theta^\circ = 1$, and the value thus obtained is called the specific viscosity. The absolute viscosity of water at $\theta^\circ = 0.01797$ c.m.⁻¹g sec.⁻¹. The value of the specific viscosity multiplied by 0.01797 gives, therefore, the value for the absolute viscosity.

(β) TECHNICAL UNITS

Besides the units of measure used in physics there are employed for technical purposes other systems, which, in contrast to the above, are derived from certain conventional testing machines. These units differ, therefore, from those used in physics, not alone in that they have a different fundamental unit (as, for instance, do absolute viscosity and specific

viscosity) but the numerical values themselves are:

1. Not proportional to the viscosity (i.e., an oil of the Engler number 2 is not twice as viscous as one with the number 1).

2. Not always comparable among themselves.

3. Not capable of being referred back directly to the c.g.s. system. See under (γ).

Nevertheless the easy manipulation of the technical testing apparatus entirely justifies its use. But the technical units must not be used in hydrodynamic or hydraulic computations. This would, and indeed has, already led to grave errors. (See below.) For such cases the methods given under (γ) may be used for conversion into absolute values.

The types of conventional apparatus are many, and only the principal ones will be named, such as the Engler, the Saybolt (America), the Redwood (England), and the Barbey (France) viscosimeters. In Germany the Engler viscosimeter is used exclusively for testing lubricants, and the same instrument is also much used in other European countries. The so-called "Engler numbers" or "Engler degrees" are defined as the ratio of the time taken for the discharge of 200 cc. of oil to that taken by the same amount of water at $20^\circ = 1$, using this particular apparatus under the specified conditions. The values thus obtained average $\frac{1}{4}$ to $\frac{1}{5}$ the specific viscosities as defined above. The relation is, however, entirely different below 5 of the Engler scale, and is very dependent upon the specific gravity of the oil (see formula 6). Engler expressly pointed out that the relative values obtained from the viscosimeter are dependent upon the adjustment; hence they have no absolute definition.

(γ) COMPUTATION CONNECTING THE PHYSICAL AND THE TECHNICAL SYSTEMS OF UNITS

An easily applicable relation between these two systems of units has been worked out by Ubbelohde², giving the following formula, which is derived theoretically but has been experimentally confirmed. Using this, the so-called viscosity factor can be calculated from the Engler degrees.

$$Z = 4.072 E - \frac{3.513}{E} \quad (5)$$

Here E is Engler degrees and Z the viscosity factor. The viscosity factor of Ubbelohde

² Ubbelohde, Tabellen zum Englerschen Viskosimeter, Leipzig 1907.

approaches very closely to the specific viscosity (see formula 6) and can be used as a technical value. With the aid of the viscosity factor there can be determined:

1. The specific viscosity from the formula $z = Z s$ (6)

2. The absolute viscosity in the c.g.s. system from the formula $\eta = Z s$
 $0.01797 \text{ cm.}^{-1} \text{ g sec.}^{-1}$ (7)

In these formulæ s is the specific weight of the fluid at the temperature of the experiment and the numerical factor 0.01797 is the viscosity of water at 0° in the c.g.s. system.

Fig. 3 represents in a rough way the relation of the specific viscosities at the various densities of the oil to the Engler numbers. However, as it is impossible from such a table to get the specific gravity corresponding to a certain Engler value with sufficient accuracy, a table has been drawn up, with the help of the above mentioned formulæ, for the Engler viscosimeter³ from which may be obtained with great accuracy the viscosity factors corresponding to all Engler values. (For further information concerning this, see introduction to the table.)

The viscosity factor is of special value for international use, as it makes possible the comparison of the results from all technical viscosimeters, as soon as the relation of each to the viscosity factor has been established, as has already been done for the Engler viscosimeter. The national section of the International Petroleum Commission (Karlsruhe in Baden) is at this time occupied in the preparation of the necessary tables⁴. In conclusion it may be suggested that the viscosities of oils be given as viscosity factors, whereby two advantages will be obtained:

1. The value can be determined upon any viscosimeter at choice.

2. The values obtained are very nearly proportional to the real viscosities and can be recomputed directly into specific or absolute viscosities by means of the formulæ given above.

(b) External Friction

Having explained the methods for the determination of viscosity, we will return to the problem of the friction of lubricated machine parts.

Besides the internal friction (or viscosity) of the fluid, there must be taken into consideration its "external friction," that is, the friction between the fluid and the bounding solid bodies. Concerning this latter phenom-

enon there is still a division of opinion, and among non-physicists, a great deal of confusion.

It has been supposed that the outer layer of fluid, which is in immediate contact with the solid boundary, does not cling thereto,

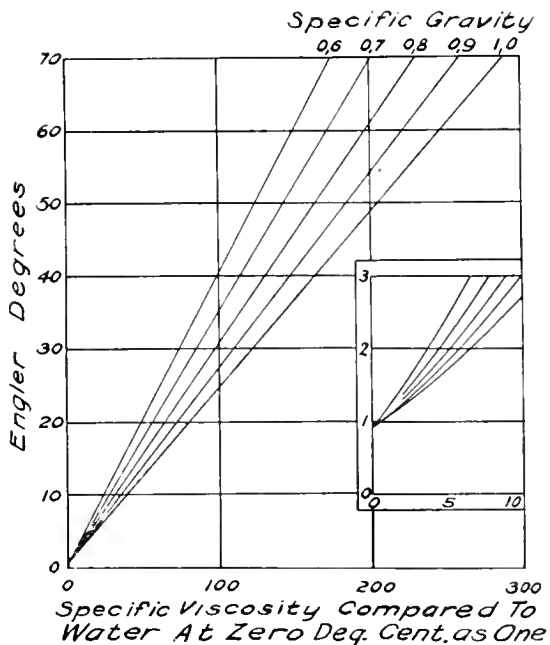


Fig. 3

but slides, and the friction which opposes this movement, with certain materials, is proportional to the velocity of sliding, and hence can be expressed by the equation:

$$R = \lambda f v_0 \tag{8}$$

in which v_0 is the sliding velocity, λ is an experimental coefficient, the "coefficient of external friction," corresponding to η and dependent, besides the material of the boundary, only upon the nature of the fluid and the temperature.

From experiments upon the flow of liquids from capillary tubes of different diameters it can be shown, however, that the fluid immedi-

(³) See (9). See also R.v. Mises, "Ueber den Englerschen Flüssigkeitsmesser," Phys. Ztscher. 12, 812-814, 1911; the author cannot have been acquainted with the "Tabellen."

(⁴) See Ubbelohde, "Die Internationale Petroleumkommission," Zeitschr. Petroleum 7, 398, (1912). Also Dr. W. Meissner "Internationale Vereinheitlichung der Zähigkeitsbestimmungen," Zeitschr. Petroleum 7, 405, (1912). Also the report of Committee D upon lubricating oils. (Chairman: A. H. Gill of the American Society for Testing Materials) contains comparative data on the time of flow of the following viscosimeters: Saybolt, Saybolt Universal, Redwood and Engler; the investigations can not, however, be considered as finished and will not be described in more detail here, as within a short time the standardization will be given out by the Intern. Petroleum-Kommission in Karlsruhe (Drugs, Oils, and Paints 26, Nos. 6 and 7, 1910; Petroleum Berlin 6, 2029 1911).

ately against the wall has an infinitely small velocity, or, in other words, clings to it.

The opinion has been repeatedly expressed that when a fluid does not wet the solid surface, sliding will be more likely to occur. Poiseuille expected, on the other hand, to find that for the flow of mercury through glass capillary tubes his experimental formula (formula 4) would no longer hold. Careful investigations by Warburg¹⁰, however, showed that even in the case of mercury and glass no slipping occurred. Moreover, water clings, whether it wets or not. Coyette performed an experiment in 1890 in which water flowed through paraffin capillaries, and assuming adhesion obtained a very accurate value for η .

Yet more convincing perhaps, is a fact which I happened upon. During the above mentioned determination of specific viscosity of oils, a glass capillary was used for a long time in testing mineral and fatty oils, and when with it the water value was again tested, the water would not wet it, in spite of careful cleaning with benzol, alcohol, and ether, but, upon removing the pressure, would still form a convex head in the capillary. A test of the flow, carried out in spite of this condition, gave exactly the same value as was found earlier, when the water was wetting the capillary. For confirmation, the test was repeated, after wetting had been produced by cleansing most carefully with nitric acid. But this time also, as in a fourth test in which again there was no wetting, exactly the same time for flow was obtained. The following table gives the observations:

TABLE I

No. Expt.	TIME FOR FLOW IN SEC. (WATER AT 20°, P = 60 G CM ²)	
	Wetting	Not Wetting
1	510.8	
2		510.9
3	510.6	
4		510.5
5		510.4
6	510.4	
Average	510.6	510.6

The variation of the single observations is very small, and shows no dependence of the time of flow upon the circumstance of wetting or non-wetting of the capillary by the water. The mean values agree exactly.

From all these facts concerning external friction, it can be assumed, at least so long as no investigations indicate the contrary, that the external friction is independent of the degree of wetting and also of the angle of contact, and that all fluids adhere to all

solid substances, and that hence the external friction can be taken as infinitely great. Under these conditions, in the derivation of the hydrodynamic resistance in lubricated machine bearings the external resistance should be neglected. Hence only the viscosity appears as a constant of the lubricant, in the formula in Section II¹¹. That wetting, however, is of the greatest importance in another respect, in connection with lubricating phenomena, and is to a certain extent a necessary condition has already been shown above.

(4) Other Characteristics of Oils, Alleged to be of Especial Concern to the Subject of Lubrication

The recently derived laws of friction in lubricated machine bearings take into account, as a constant of the lubricant, only the viscosity or internal friction, and this is generally recognized as correct by the physicists of today. In the voluminous literature concerning methods of lubrication and its relation to the characteristics of oils originating in other circles are to be found, however, a number of other characteristics of lubricating oils of alleged importance. There appear such terms as lubricating power, lubricity, durability, layer forming power, adhesion, etc., but without especially clear definition of the characteristics named. In general, however, the external friction discussed above plays a part in the definition. The obscurity is increased to a superfluous degree by the fact that very erroneous conceptions exist concerning well defined terms such as internal friction, surface tension, wetting and the like. This all but inscrutable confusion will only be mentioned, for it is impossible here to clear up all of these errors.

But for just this reason it seems desirable to prove, with the aid of a well known experimental investigation, that for the behavior of lubricating oil between bearing and journal only the viscosity of the lubricating oil is of significance. Work has been done by Klaudy, from which, up to this time, quite the opposite conclusion has been drawn.

The apparatus used by Klaudy was of the following form: Into a vessel filled with the lubricant to be tested, so arranged that it can be heated, and furnished at the top with a ring neck 44 mm. high and 40 mm. internal diameter, can be sunk a freely moving piston weighted with iron weights, the diameter of the piston being several hundredths of a millimeter less than the bore of the ring. At each test 100 cc. of lubricating oil is pressed

⁽¹⁰⁾ Warburg, Pogg. Ann. 140, 367, 1870.

⁽¹¹⁾ Section II will appear in the next installment of this article.

out through the narrow ring channel, and the time is measured which is necessary for the flowing out of this amount with a known thickness of layer, temperature, and weight

on the piston. This time is divided by that observed for water under the same conditions, and this gives a value called the "capillary viscosity" for that thickness of

TABLE II

1 Material	2 VALUES DETERMINED BY KLAUDY			3 VALUES CALCULATED BY UBBELOHDE			
	Capillary Viscosity k	Engler Degrees E^2	Adhesion Factor $a = \frac{k}{E}$	Sp. G. γ in g./cu.cm ³	Sp. Viscosity σ^*	Variations	
						$k_2 : k_1^3$	$\sigma : k^4$
<i>a</i> at 20 deg. C.							
1. Ether.....	0.15-0.21	1.40†	0.11-0.15	0.72	0.23†	1.40	1.09
2. Benzine.....	0.31-0.46	0.94**	0.33-0.49	0.7		1.48	1.0***
3. Methyl alcohol.....	0.41-0.57	0.94	0.43-0.60	0.80	0.59†	1.39	1.03
4. Benzol.....	0.47-0.71	0.94	0.50-0.75	0.884	0.646†	1.51	1
5. Toluol.....	0.39-0.76	0.98	0.39-0.77	0.88	0.58†	1.95	1
6. Cumol.....	0.62-0.89	0.98	0.63-0.91	1	0.7	1.43	1
7. Chloroform.....	0.39-0.53	1.00†	0.39-0.53	1.49	0.56†	1.36	1.06
8. Pyridin.....	0.69-1.06	1.00	0.69-1.06	1.00	1.00	1.54	1
9. Xylol††.....	0.45-0.68	1.00†	0.45-0.68	0.87	0.61†	1.51	1
10. Water.....	1	1	1	1	1		
11. Soap, 68 g/l.....	1.35-1.53	1.00	1.42-1.61‡				
12. Salt solution 174 g/l.....	1.27-1.61	1.00	1.27-1.61	1.13	1.1	1.27	1
13. Petroleum.....	1.17-1.53	1.08	1.05-1.46	0.8	1.6	1.31	1
14. Ethyl alcohol.....	1.20-1.59	1.10	1.09-1.45	0.79	1.8	1.33	1
15. Amyl alcohol.....	3.31-3.69	1.30	2.55-3.04	0.81	3.8	1.11	1.03
16. Aniline.....	4.16-4.50	1.40†	2.97-3.21	1.03	4.45†	1.18	1
17. Gas oil.....	9.99-13.7	2.21	4.52-6.18	0.83	.11	1.37	1
18. Velocite.....	13.3-15.0	2.80	4.75-6.32	0.82	.15	1.13	1
19. Vacuum oil (Floridsdorf).....	15.5-20.3	3.10	5.00-6.50	0.85	.16	1.31	1
20. Cleaning oil.....	18.7-22.2	3.50	5.35-6.35	0.85	.20	1.19	1
21. Spindle oil (Wagenmann).....	37.5-42.5	5.80	6.47-7.32	0.89	.37	1.13	0.96
22. Arctic.....	54.7-66.9	8.40	6.51-7.96	0.90	.55	1.22	1
23. Spindle oil II. (Floridsdorf).....	65.4-86.0	9.00	7.26-9.56	0.90	.58	1.32	0.89
24. Olive oil.....	74.0-83.8	10.5	7.04-7.98	0.90	.68	1.13	0.92
25. Spindle oil I. (Floridsdorf).....	53.9-77.3	10.7	5.03-7.22	0.90	.70	1.43	1
26. Arachisöl.....	71.6-91.5	10.9	6.63-8.39	0.91	.72	1.28	1
27. Bakuöl III. (Floridsdorf).....	93.2-124	12.6	7.39-8.95	0.91	.83	1.33	0.89
28. Rüböl.....	75.9-181	12.7	5.98-7.99	0.91	.84	2.38	1
29. Knochenöl.....	87.3-112	13.0	6.71-8.58	0.91	.86	1.27	0.99
30. Etna.....	134-139	16.7	8.00-8.40	0.92	1.11	1.04	0.83
31. Vulkanöl.....	171-231	21.0	8.14-11.00	0.92	1.41	1.35	0.83
32. Glycerine.....	206-250	23.5	8.81-10.66	1.24	2.11	1.22	1
33. Transmission oil (Wagenmann).....	138-213	24.2	5.70-8.79	0.92	1.63	1.54	1
34. Bakuöl II. (Floridsdorf).....	140-193	27.5	5.06-7.03	0.92	1.84	1.38	1
35. Bakuöl I. (Floridsdorf).....	233-381	35.7	6.52-10.68	0.92	2.40	1.64	1
36. Russian Petroleum.....	248-405	43.0	5.77-10.41	0.92	2.88	1.63	1
<i>b</i> at 50 deg. C.							
37. Cylinder oil (Floridsdorf).....	574-757	18.9	30.40-40.06	0.90	218	1.32	0.38‡
<i>c</i> at 75 deg. C.							
38. Paraffine.....	9.94-13.8	1.30	7.65-10.62	0.9	11	1.39	1
39. Pressed tallow.....	45.0-59.4	2.90	15.80-20.50	0.9	45	1.32	1
40. Vaseline.....	163-174	9.06	18.02-19.80	0.9	151	1.06	0.93
41. Natural wool fat.....	355-602	9.68	36.70-62.20	0.89	164	1.70	0.46‡
42. Valvoline.....	317-419	10.0	31.70-31.90	0.9	172	1.32	0.54‡

† Round numbers. At a layer thickness of 0.03 to 0.075 mm.

‡ Round numbers.

* Referred to water at the same temperature as that of the liquids in column 1.

** In the article quoted this is given as 9.94, apparently a misprint.

*** This number is the ratio of the given Engler value (0.94) to that obtained by recalculating the nearest capillary viscosity to specific viscosity. This procedure is necessitated by the fact that for such thin fluid substances almost identical Engler values are obtained for liquids which in reality have very different viscosities (see also in this connection "Tabellen Zum Englerschen Viskosimeter" by Ubbelohde).

† These viscosities, as well as the values for ether, chloroform, xylol, and aniline, are taken from Landolt-Bornstein's tables, since the Engler viscosities given in Table II for the former appeared to be incorrect, and viscosities cannot be deduced from the Engler values for such thin fluids as the latter. (See my article "Die Zähigkeit des Leucht petroleums und ein Apparat zu ihrer Bestimmung," Zeitschrift "Petroleum" IV, Nr 15.)

†† The viscosity given is that for metazyxol.

‡ Capillary viscosities of column 2.

§ Specific viscosity computed from the nearest capillary viscosity.

layer. Four different sizes of piston inserted within the bronze ring determine four different layer thicknesses, 0.03, 0.04, 0.05, and 0.075 mm.¹² The pressure can be increased up to two atmospheres above normal, and the temperature to 100 deg. C. and a bronze piston may be substituted for the steel.

The investigation shows that this capillary viscosity does not agree with the Engler viscosity (Engler degrees), but is sixty times as large for many fluids, and a tenth as large for others. This fact led Klaudy to the natural but erroneous impression that he was dealing with a new property of the lubricant which he, in accord with the conception then in vogue, connected with the effect of the walls upon the fluid. As in general the capillary viscosity was considerably greater for viscous lubricants than for non-viscous, and as this difference far exceeded and so masked the variations mentioned above in the Engler viscosity (Engler degrees), it seemed desirable to distinguish between them. For this purpose, the measured capillary viscosity was divided by the Engler viscosity, and the result, which should accentuate this wall effect and reduce that of viscosity, was called the "adhesion factor."

In controversion of this line of reasoning should be mentioned the following facts:

It is evident that the conditions under which the fluid flows out between the piston and the ring neck are such that the time consumed by the flow of a specified volume under a certain pressure is exactly proportional to the viscosity of the fluid.

Therefore, the above determined "capillary viscosity" is nothing more than the viscosity of the fluid in question referred to the viscosity of water at the same temperature. This may be proved as follows:

In Table II are brought together capillary viscosities and specific viscosities (arranged in the order of increasing viscosity), the latter having been determined in the following manner: In Klaudy's work were given, besides the capillary viscosities, the Engler degree of each of the fluids investigated. For each of these Engler measurements I have taken from the tables supplied with the Engler viscosimeter the corresponding viscosity factor (see above), and using the specific gravities in column 5 of Table II have computed by equation (6) the specific viscosity (referred to water at $0^{\circ}=1$). In

order to refer the specific viscosities to that of water at the temperature of the test, they were divided by the specific viscosity of water at the experimental temperature, the latter having been also reduced to 0 deg., and the quotients thus obtained, which therefore are identical with the capillary viscosities k of column 2, according to my assertion, are recorded in column 6 of the table.

To make the variations existing yet more apparent, I have added columns 7 and 8. Column 7 contains the ratio of the values of k given by Klaudy, which ratio must theoretically always equal 1, and whose variation from 1 is sufficiently explained by experimental error, as is shown below. Column 8 similarly contains the ratio of the specific viscosity ε to the capillary viscosity. When the former lies between the two given values of the last, the ratio is taken as 1, otherwise it is divided by that of k which comes nearest to it.

In considering columns 2 and 3, it must not be overlooked that the Engler measure and the capillary viscosity are not identical. Hence the values of a in column 4 differ markedly from unity. On the other hand, the values of ε in column 6 accord decidedly better with k . This is especially easy to see in column 8, whose numbers show no noteworthy variation from unity; only a few fluids appearing, as it were, to form an exception. In general, the values in column 8 differ from unity less than do those in column 7, which indicates that the specific viscosities agree better with Klaudy's capillary viscosities than do the latter among themselves.

In other words, if, in place of the Engler numbers of Klaudy, the specific viscosities be substituted, the adhesion factor disappears wholly. All the phenomena are therefore explained completely by the specific viscosity of the lubricant. That the specific viscosity was not substituted by Klaudy is easily explained by the fact that at that time it was not recognized that such extremely great differences existed between the Engler numbers and the specific viscosities. This was first shown by the computation of Engler degrees over into specific viscosity. This explains the above error in connection with the adhesion factor. According to the new interpretation, the work of Klaudy acquires very positive value, in that it shows experimentally, by means of an apparatus similar to the common journal bearing, that no specific property of the lubricant, beyond the viscosity, is of significance in considering the behavior of oil between bushing and journal.

(To be Continued)

¹² See Bericht über die Ziele und den Stand der Arbeiten des Schmiermaterialkomitees im Niederösterreichischen Gewerbeverein in Wien vom 11. Dezember, 1899. Also Allgemeine Oesterreichische Chemiker- und Techniker-Zeitung 26, No. 12, 1898, and 17, No. 11, 1899.

RELATION BETWEEN CAR OPERATION AND POWER CONSUMPTION

By J. F. LAYNG

RAILWAY AND TRACTION ENGINEERING DEPARTMENT, GENERAL ELECTRIC COMPANY

The results of a series of tests are shown graphically in this article to illustrate the saving in power which can be effected by increasing the amount of coasting for a given length of run. With a set of assumed constants the difference in energy consumption is shown for varying rates of acceleration, varying rates of braking, varying duration of stops and, finally, varying schedule speeds. It is evident that appreciable savings in power consumption can be made by giving the motormen proper and uniform instructions.—EDITOR.

Since the early days of electric railroading it has been known that in test runs there are great differences between power used, even when the conditions of service are the same. With the same car over the same route, with the same number and length of stops, the power consumption will vary more than 30 per cent when operated by different motormen. This is a case where the difference between individuals is strongly emphasized. It is also recognized that with the same motorman on different days the power used will vary greatly. If he feels strong and in a good humor the motorman accelerates fast and saves power, but if he feels otherwise he will accelerate slowly and consequently waste power in starting resistors. Weather conditions, of course, will cause variation in the amount of power used, but with reference to the remarks just made, it is assumed that weather conditions are normal. The difference in power consumption in the different runs is caused by the relative amount of coasting and rate of braking by the different men. The maximum amount of coasting is obtained when a car is accelerated at a maximum rate and decelerated at a maximum rate. When a car is accelerated rapidly instead of slowly, the starting resistor is in use for a proportionately shorter length of time and consequently the difference in the energy consumption is transferred from rheostatic losses to useful work.

A few years ago there were a number of investigations made to determine some systematic method of securing the maximum coasting at all times, and as a result the coasting clock was designed and is now very extensively used throughout the country.

Two other methods that have been used in a number of instances to obtain the maximum coasting consist in employing wattmeters and ampere-hour meters. With these two instruments it is of course necessary to make proper allowance for the difference in the weight of cars when making an analysis. Recently there has been considerable data published regarding the methods of obtaining

the maximum amount of coasting, and it would therefore seem advisable to make an analysis of the fundamentals which will illustrate in curve form just what can be expected in energy savings by accelerating and decelerating as rapidly as possible.

To illustrate these points, calculations and curves have been made on cars weighing 18 tons complete with load, and equipped with two motors. It is assumed that the car is geared to have a free running speed of 22 m.p.h., a 1000 ft. run, a schedule speed of 10.65 m.p.h., 7-second stops, and 20 lb. per ton friction. As has been previously stated, with maximum rates of acceleration and deceleration the maximum amount of coasting is obtained. The curves shown in Fig. 1

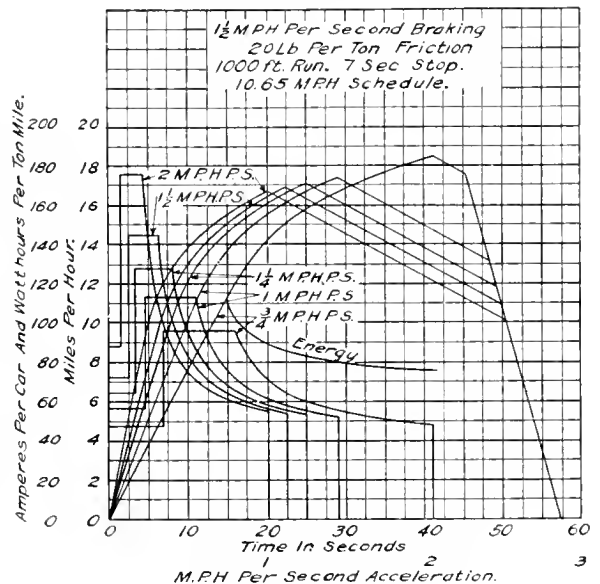


Fig. 1. Decrease in Energy as Rate of Acceleration is Increased

illustrate the amount of power which will be required per ton mile when accelerating at different rates, that is, $\frac{3}{4}$, 1, $1\frac{1}{4}$, $1\frac{1}{2}$ and 2 m.p.h.p.s. The amounts of current are also plotted on these curves.

A study of the amounts of energy required for the different rates of acceleration is very interesting. When accelerating at $1\frac{1}{2}$ m.p.h.p.s., it is found that the power consumption is 110 watthours per ton mile. When accelerating at 1 m.p.h.p.s. this is reduced to 90 watt-

of accelerating at $1\frac{1}{2}$ m.p.h.p.s. The rates of deceleration chosen are 0.825, 1, $1\frac{1}{2}$ and 2 m.p.h.p.s. The additional amount of coasting which is obtained will enable current to be cut off from the motors sooner than when braking at some relatively lower rate, and a greater amount of coasting will be obtained. The energy required for the different rates of deceleration are respectively 100, 85, 79 and 76 watthours per ton mile. The difference between 100 watthours per ton mile and 85 watthours per ton mile is 15 per cent, and the difference between the other values are 7.5 per cent and 4 per cent respectively. It will therefore be seen that the difference between decelerating at the most rapid rate on the curve and the lower rate on the curve gives a saving of 24 per cent in energy. The difference in accelerating from the lower to the higher rate, as shown in Fig. 1, gives a saving of 31 per cent. These values when considered separately can actually be obtained, but there are points between the lowest rate of acceleration and the lowest rate of braking where the lines cross.

It is generally accepted that the proper rate of acceleration and braking is in the neighborhood of $1\frac{1}{2}$ m.p.h.p.s. However, there are some cities in the United States where, due to exceptional conditions, it is deemed advisable to accelerate and decelerate at 2 m.p.h.p.s. This of course gives the highest possible schedule speeds, which of necessity give the largest number of car miles per hour which can be obtained, and in this manner the greatest use of a car is obtainable. It has also long been recognized that by carefully following up the motorman's instruction with the assistance of coasting clocks, ampere-hour meters or wattmeters, the motorman will realize the advantages which will accrue from coasting, and in this way great savings will be made in power, brake shoes, and wheels. Coasting records also show whether it is possible to decrease the number of cars on a given line, and give a direct indication of how much leeway there is in schedules. There are other ways in which power can be saved, that is, by decreasing the length of stop and also slightly extending the schedule speeds. Analysis of many conditions will show that in some cases by very slightly extending the running

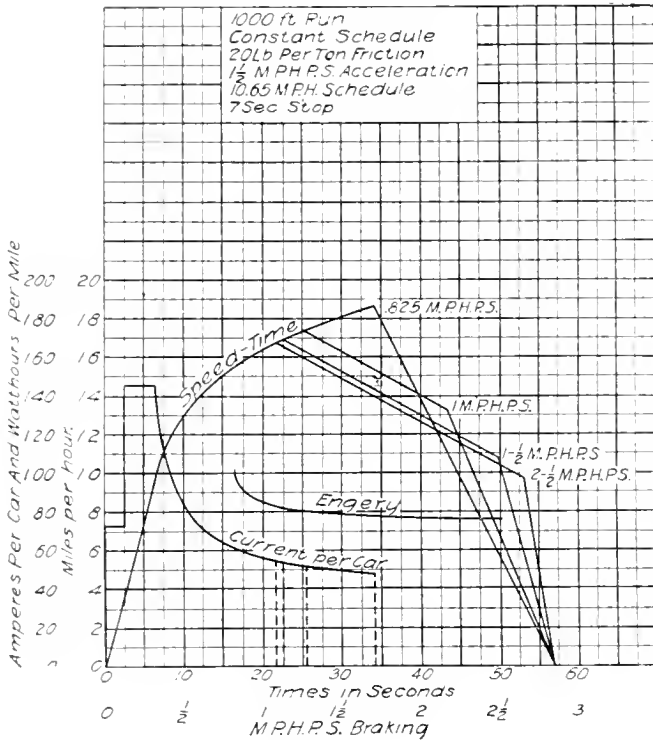


Fig. 2. Decrease in Energy Consumption as Rate of Braking is Increased

hours per ton mile. and when accelerating at $1\frac{1}{4}$, $1\frac{1}{2}$ and 2 m.p.h.p.s. the energy required will be 83, 79, and 76 watthours per ton mile respectively. The difference in energy saving is considerably less between the higher rates of acceleration than between the extremely low rates; it will be noticed that the difference between the 110 watthours and 90 watthours is 19 per cent, while the difference between 90, 83, 79 and 76 will be 7, 5, and 3.8 per cent, respectively. Therefore it will be appreciated that while there is some considerable saving between accelerating at $1\frac{1}{2}$ m.p.h.p.s. and 2 m.p.h.p.s. still at the same time the saving is considerably less than in rates of acceleration lower than this value.

Fig. 2 has been made to illustrate the value of braking or decelerating at different rates, and is based on the same data as given in Fig. 1. This curve is made up on the basis

time considerable power can be saved. Fig. 3 illustrates the amount of power which can be saved when making the same schedule as has been previously outlined in Figs. 1 and 2. With 4, 8 and 12 second stops the energy required to propel the car will be 74, 81, and 105 wattohours per ton mile respectively, which shows a saving in energy of 22.8 per cent between the 8 second and 12 second stop. To maintain the same schedule with a 12.3 second stop will require 41.8 per cent additional energy when compared with a 4 second stop.

Fig. 4 illustrates what can be done by extending the schedule speeds. With an actual running time of 52 seconds, 115 wattohours per ton mile are required. By extending the actual running time of this run to 53 seconds, there is a power saving of 22½ per cent. Of course, it is not practicable to operate a schedule with absolutely no coasting, such as the 52 second run, but these figures illustrate the value of a small working leeway in running time. It will be noted that the actual running time, not including stop, is extended to 80 seconds, and that the energy is reduced to 54 wattohours per ton mile, but the schedule has been reduced from 11.7

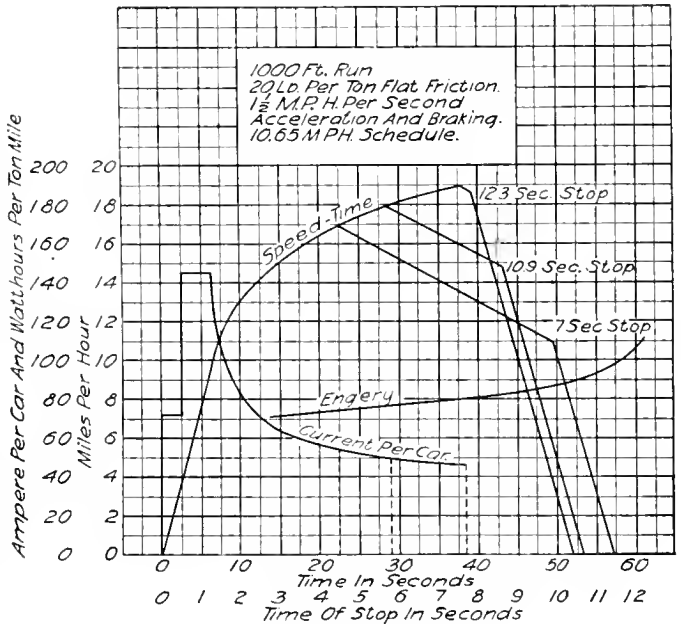


Fig. 3. Increase of Energy Consumption for a given Run and Schedule as the Time of Stop is Increased

m.p.h. to 7.8 m.p.h. when considering the entire range which is covered by the curve. The last two sets of curves which have just been discussed are entirely separate from the first two curves. The first curves illustrate certain fixed conditions with reference to

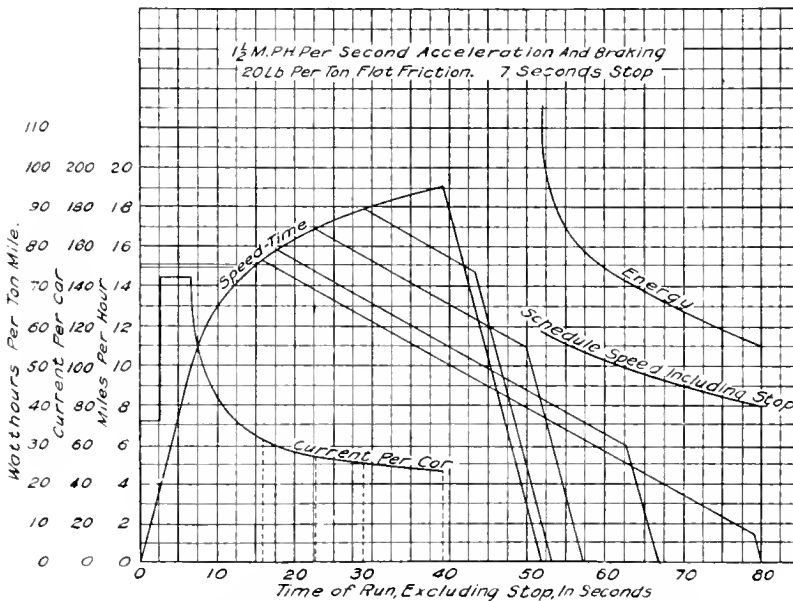


Fig. 4. Decrease in Energy Consumption, Current Input, and Schedule Speed by Increasing the Coasting in a 1000 ft. Run

schedule speed, length of run and length of stop, while the last two curves assume the operating conditions to be changed, that is, by changing the length of stop or extending the schedule speed.

After reviewing the four series of curves given, there can be but two conclusions, viz.: the effort to keep track of power consumption and to instruct the motorman is a very profitable undertaking, and that there is as much reason for following up and keeping tab of the energy used by individual motor-

men as there is for keeping record of any other expenditures on the property. By keeping these records and following them up properly, savings in power of 20 to 25 per cent can reasonably be expected. In many cases a study of the local conditions will show how schedules can be slightly rearranged and either less cars used for a given service, or the running time can be very slightly extended and the power savings made which are illustrated in the curves of Fig. 4.

AUTOMATIC RAILWAY SUBSTATIONS

By CASSIUS M. DAVIS

RAILWAY AND TRACTION ENGINEERING DEPARTMENT, GENERAL ELECTRIC COMPANY

The present article revives an old subject that has been food for thought and fuel for inventions for a number of years. Many engineers have been cognizant of the financial possibilities of the automatic substation, but few have considered it very practical. The author points out that such railway substations are a commercial possibility and that several are or are about to be placed in regular operation on interurban systems. He shows what reductions in operating expenses may be made and discusses the fields of application.

—EDITOR.

General Remarks

Automatic substations have been proposed a great many times and a large number of schemes have been devised, some of them dating back many years, but it is only recently that the question has assumed any commercial significance. This is due largely to the willingness of the management of the Elgin & Belvidere Electric Railway to install automatic equipment on their system near Chicago. This road, in endeavoring to reduce the operating expenses to a minimum, thought it advisable to adopt some method not only of operating the substations without attendants but of operating them in such a manner that would practically eliminate the light load and no-load losses in the apparatus.

A scheme of automatic operation was devised and an experimental installation put in service about December 1, 1914. This equipment worked so satisfactorily that the Elgin & Belvidere Electric Railway decided to equip all three of its railway substations for automatic operation. These have since been placed in commission.

The forerunner of the automatic substation was the remote-controlled substation, notably the type installed on the Edison System in the city of Detroit. In the remote controlled substation, the equipment operates without an attendant but the starting up and shutting down is controlled manually from a distant

point. The automatic substation, on the other hand, starts up and shuts down without attention on the part of any operator, and then only when the load conditions require its service. The function of the remote-controlled substation is to reduce the expense of attendants. That of the automatic substation is to not only reduce the expense of attendants but to eliminate light load and no-load losses.

Saving in Operating Expenses

The first saving which can be secured by automatic control is the item of expense for attendants. The regular operators can be replaced by a few inspectors. It is estimated that a road operating, say, four substations could eliminate the day and night operators in each substation and in their place employ one day inspector and one night inspector for all substations whose duty would be merely looking after the equipment, keeping it in proper adjustment, oiling, polishing commutators, cleaning, etc.

The saving that can be made in power is quite appreciable; this depends upon the number of units per substation necessary to carry the maximum load and upon the frequency of the train service on the road. The saving will of course become greater the less frequent the train service.

As an example of the saving which might be possible, the following may be of interest.

	Hand Operation	Automatic Operation
Headway between trains	120 min.	120 min.
Number of substations	4	4
Capacity of each substation	300 kw.	300 kw.
Actual time machines operate per day	18 hr.	7 hr.
No load losses per substation	12 kw.	—
No load energy losses per day per substation	132 kw-hr.	—
Cost of energy at substation	1c. per kw-hr.	1c. per kw-hr.
Value of energy saved per day per substation	—	\$1.32
Value of energy saved per year per substation	—	\$482.00
Number of operators or inspectors	8	2
Wages of each operator or inspector per month	\$65.00	\$65.00
Total wages per year	\$6240.00	\$1560.00
Value of wages saved per year	—	\$4680.00
Value of energy saved per year	—	\$1928.00
Total saving per year	—	\$6608.00

It should be understood that the above figures are not based on the actual operation of any road. They are based, however, on conservative assumptions such as would apply to a road operating cars on an infrequent schedule.

The significant fact brought out in the preceding tabulation is that over \$1600.00 per substation can be saved *per year*. This amount would pay for a large part of the automatic apparatus during the first year. The automatic feature should therefore appeal strongly to many operating companies.

Where cars are run under shorter headway the saving would not be quite so large but even then it is possible to secure a marked economy during the early morning and late evening when fewer trains are running. During these hours the substation may be shut down for a considerable portion of the time.

When the cars run under such short headway as to require the continuous operation of some of the substation equipment, an appreciable reduction can be secured by the automatic operation of other machines in the substation, which are required only during the rush hours. For example, it is common practice during the morning and evening peaks to operate additional units for a period of two or three hours. It is seldom, however, that the additional machines are needed continuously during this time; therefore all machines in the station operate at partial load and consequent poor efficiency. As a definite example of this condition we may take the case of a substation containing two 300 kw. converters, one of which is in continuous operation from 6 a.m. until 2:30 the next morning, and the other machine from 6 to 7:45 a.m. and again from 3:45 to 9:30 p.m. The service assumed on the road calls for trains each way every half hour with extra cars during the morning and evening rush hours. Under this condition it is estimated that the first machine when running

alone operates at no load for a period of 3.4 hours. The no-load loss of the converter and transformers is approximately 12 kw. Therefore, the energy loss per day is approximately 41 kw-hr. or a total of 14,965 kw-hr. per year, which at 1 cent per kw-hr. means approximately \$150 per year. During the time the two machines are operating it is estimated that there is no load on either machine for a period of 18 minutes per day which represents a no-load loss of approximately \$15 per year. Furthermore, during the time the two machines are operating, it is estimated from a typical load curve that the second machine could be shut down a total of at least two hours when it is not required to carry load peaks. The no-load losses during this time would amount to 24 kw-hr. per day, which represents approximately \$88 a year at 1 cent per kw-hr. This station could therefore save at least \$253 per year in power alone. There would also be a slight additional saving during the time when the two machines are running, due to the fact that under automatic operation when two machines were necessary, both would be operating at a high efficiency.

In addition to the saving in power and expense for operators, the maintenance charges on the substation equipment should be materially reduced.

Scheme of Operation

As mentioned earlier, there are a variety of ways by which automatic operation can be accomplished. The scheme which has been placed in operation on the Elgin & Belvidere line represents the latest application and this has been the basis for other equipments about to be placed in operation.

The station is started up when the potential on the trolley falls to 450 volts, or below. This low voltage causes a contact-making voltmeter to close various relay circuits which start a motor-driven drum controller.

The contact fingers and segments on the drum controller energize the operating coils of the starting and running alternating current switches, the field switch, and the direct current line switch. As soon as the converter reaches full speed and full voltage the drum controller comes to rest, and the station then operates until the current which it supplies to the trolley circuit falls below some predetermined value at which time a current relay drops out and shuts down the station.*

One novel feature which has been introduced is a series resistance placed between the positive brush of the armature and the bus, which is automatically cut into circuit at predetermined overloads. This resistance has the effect of limiting the output of the substation and thereby obviates the necessity for providing a means for repeatedly closing the feeder and direct current converter circuit-breakers for the purpose of "trying out" the circuit as is done in hand operation.

It is possible to modify the equipment to accomplish practically any desired result. For example, the Elgin & Belvidere equipment will start up on a dead trolley. Where this feature is not desirable, it can be arranged to start only when the trolley voltage comes between certain specified limits; or, the station may be made to start when the current at some part of the system reaches a certain value. It may be made to start by means of a clock mechanism at certain definite times; or, it can be made to start its initial operation each day from some remote point by means of pilot wires, or upon the excitation of the incoming transmission line, etc. In fact, there are an almost unlimited number of arrangements which can be made to suit practically every operating condition.

Field of Application

The chief object of installing automatic substations is to eliminate the light load and no-load losses, to reduce the number or to largely eliminate substation operators (and therewith the expense of their wages), and, incidentally, to lower the substation maintenance costs.

On railway systems where the service is so frequent as to require the continuous operation of part of the substation equipment, it is usually possible to improve the load-factor, and therewith the station efficiency, by so arranging the apparatus that additional equipment is cut in only when the load conditions require it. It is common practice in a substation containing, say, two converter

or motor-generator equipments to keep one machine running throughout the entire working day and to start up and shut down the other machine at specified times. The second machine is usually operated for an hour or two in the morning and again three or four hours in the late afternoon and evening. During both the morning and evening rush hours the load conditions are usually such as to require the second machine only for intervals of a few minutes, or at most half an hour at a time, and during the remainder of the time the second machine as well as the first are operating under reduced load and low efficiency conditions.

A material saving should be possible, under the conditions that have been outlined, by making the second machine automatic in its operation. During the early morning and late evening hours the infrequent schedule usually requires the first machine only a portion of the time, and therefore a saving can be made by having the first machine also automatically controlled.

In a station having two machines, both automatically controlled, it is very easy to provide a change-over switch which will cause No. 1 machine to operate continuously and No. 2 machine to carry the overloads for one day, and then No. 2 machine to operate continuously and No. 1 machine to take the overloads on the next day. This switch could be thrown by the inspector while making his regular rounds.

It is possible to carry out the automatic features for stations having any number of machines which would automatically be cut in and out to take care of fluctuating load conditions.

The field where automatic operation seems particularly applicable is in connection with railway substations located at or near the ends of main or branch lines, and especially on branch lines feeding summer resorts and picnic grounds. Such substations carry their heaviest load for a few hours in the morning and evening and very light loads during the remainder of the day. The advantage of automatic operation in such locations is so obvious as to need no further discussion.

It may be said in general that the automatic operation of substations will produce the most efficient results where hand operation is least efficient.

While the discussion in this article has been applied more particularly to railway work, it should be borne in mind that equally attractive results may be obtained in lighting and power substations.

* For a detailed description of this equipment see a paper by Allen and Taylor in Proc. A.I.E.E., September, 1915.

PROTECTION AND CONTROL OF INDUSTRIAL ELECTRIC POWER*

BY DR. CHARLES P. STEINMETZ

CHIEF CONSULTING ENGINEER, GENERAL ELECTRIC COMPANY

This article considers briefly the disturbances that the modern high tension transmission system, with its distribution system, is subject to, such as destructive current rushes on short circuit, lightning strokes, and high frequency surges, and the devices that have been produced to protect the system against each, such as power limiting reactances, the aluminum cell lightning arrester, and high frequency energy absorbing choke coils. Some interesting information derived from the operation of the multi-recorder is also given.—EDITOR.

For industrial power application, from the small isolated motor to the huge steel plant, electric energy offers advantages over all other forms of energy, which are leading to its rapidly extending use. The foremost advantages of electric power are the high efficiency and the simplicity of its conversion into any other form of power, so that in most cases no special skill of the operator of electric devices is required; and the possibility of almost unlimited transmission and distribution at high efficiency and reliability, which permits concentrating the power generation in one station and subdividing the power applications by attaching the motor directly to the driven machine, thus eliminating mechanical transmission losses.

The concentration of the power generation in one large station—which very often is interconnected, for reserve, with the network of electric trunk lines, rapidly spreading over the country—introduced two serious problems, not existing before. At any place of the wide ramification of the distribution system, the entire power of the system is available and may be let loose destructively in case of accident, and any accident anywhere in the wide extent of the system may involve the whole system and shut down the entire plant. The two problems thus are: to limit the power, which may be let loose destructively by an accident in any part of the system, without interfering with the normal flow of power, and to protect the system against being involved by any accident in any part of it.

For this purpose, switches, fuses and circuit breakers, either automatic or hand operated, have been developed to cut off any disabled apparatus. However, they solve the problem to a limited extent only, for, no matter how quick acting switches, fuses and circuit breakers may be, they operate only after the concentration of power at the place of accident, and in a very high power system much of the damage has then already been done, and furthermore, these devices also are limited in capacity and fail, or have

to be built of a commercially impracticable size if they have to deal with the concentrated power of a large system. The problem thus became, by power limitation inherent in the system, to eliminate the possibility of a dangerous power concentration at a place of accident, rather than to permit it to occur and then attempt to open the circuit at unlimited power.

This power limitation is accomplished by reactance in the generator circuits. Slow speed steam engine or gas engine driven generators usually have sufficient inherent reactance to limit their power under short circuit; but not so in steam turbine alternators. The latter thus either have to be specially designed for high internal reactance—which makes them larger and less efficient—or reactors are inserted into the generator leads. Experience has shown that the most economical method is to build the generators with as high internal reactance as feasible, without interference with economical design, and to add the rest of the limiting reactance in the generator leads.

As the safety of the system from self-destruction depends on the absolute reliability of these power limiting reactances, any attempt to economize in them is greatly to be deprecated. They should be able to stand enormous overloads without danger of self destruction by heat or mechanical forces; the distance between the turns should be large and no metal near them, to escape danger from short circuit by high frequency; and they should not contain any inflammable material. Fig. 1 shows an illustration of such a power limiting reactance, consisting of bare copper wire cast into concrete, with the layers arranged V shaped, so as to give maximum distance between the extreme turns of successive layers.

In very large power plants with numerous generators feeding into the busbars, power limitation in the generators still gives a dangerous power concentration in the busbars, and then power limiting reactances are used also for sectionalizing the busbars. Such busbar reactances are designed so as to practically limit a short circuit on the bus-

*A paper read before the Association of Iron and Steel Electrical Engineers, Detroit, Mich., Sept., 9, 1915.

bars to the section on which it occurs, without under normal operation interfering with the power transfer along the busbars, required by parallel operation.

Still further the power concentration in the system is limited by feeder reactances, and as

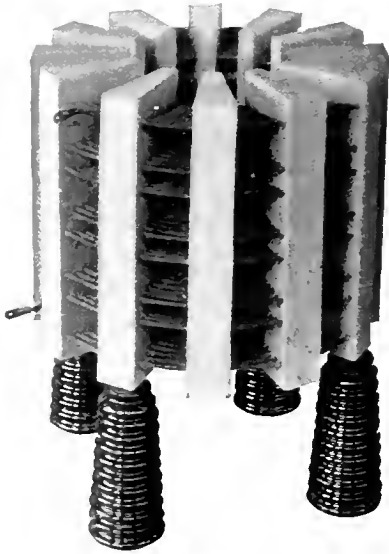


Fig. 1. "Cast in Concrete" Power Limiting Reactance

short circuits in the feeders are more frequent than in the busbars or generators, feeder reactances are of material assistance, though not essential if the power is limited by generator and busbar reactances.

In transmission and distribution circuits, whether overhead lines or underground cables, two or more lines are used in multiple to all the more important distribution centers, so that with one line out of service from a ground or short circuit, the others maintain the service. This requires selective cut-out devices. With a short circuit on one feeder, excess currents would flow also in all parallel feeders to the substation, from there feeding back into the disabled feeder, and overload circuit breakers would thus shut down the good feeders as well as the disabled one. Thus selective devices are necessary which do not open the undamaged feeders, even if overloaded. The most satisfactory type of such devices is the reverse power relay. The alternating waves have no direction of their own, thus there is no reversal of current when feeding back into a disabled feeder, as would be the case in a direct current circuit. But the direction, or phase of the current

with regard to the voltage, that is, the power, reverses in feeding back, and a wattmeter relay thus is selective. Its limitation, however, is that it depends on the voltage, and while usually built so as to operate on very low voltage, if by a dead short circuit near the end of the feeder the voltage entirely vanishes, the relay fails. Other methods, based on the use of pilot wires, of split conductor cables, etc., have been devised which are operative under all conditions, but are of limited application due to their complication and corresponding cost.

In a similar manner, where a number of transformers are connected in parallel between high and low tension busbars, in case of one transformer being disabled, it is disconnected without interfering with the others, though the others feed back into the disabled one: a relay is energized by primary and secondary current so that the two currents neutralize each other's action as long as they are proportional to the ratio of transformation. Such a relay would not operate from any overload, but would be operated if there were a short circuit in the transformer, which would disturb the ratio of primary to secondary current. The same interlocking relay between the primary and secondary of a transformer also discriminates between the transformer and line, that is, in case of a short in a circuit consisting of a line and transformer, it shows whether the fault is in the transformer or in the line connected to it.

Whenever overhead lines of any appreciable extent exist in the system, troubles from atmospheric disturbances such as lightning may be expected. These consist of over voltages, of high frequency discharges and of impulses. But even without any overhead lines exposed to lightning, in any extensive system, the same class of phenomena of over voltage, impulse or high frequency not infrequently occur, produced in the system by internal disturbances such as arcing grounds, spark discharges, switching, connecting and disconnecting lines and transformers, etc., and these internal disturbances, while usually of lower voltage than lightning, often are recurrent, that is, repeat continually for minutes, hours and even days, and then may be far more destructive than lightning. Against over voltages, experience has proven as the most satisfactory protection the aluminum cell lightning arrester in the station, together with high insulation of the line. Photographs of such an aluminum cell arrester are given in Figs. 2 and 3. Abnormal

frequencies may vary from a few hundred cycles, in some arcing grounds, up to millions of cycles in spark discharges over insulators. The most dangerous frequencies, however, seem to lie between 10,000 and 100,000 cycles, as these are sufficiently high to give destructive voltages across inductive parts of the circuit, such as current transformers, regulators, end turns of generators and transformers etc., and sufficiently low to have considerable power behind them: the energy of a high frequency discharge in a system usually is the lower the higher the frequency, and as the resonance frequency of high potential transformer windings usually is within this range the aluminum cell lightning arresters can not protect against high frequency, unless the high frequency voltage is so high as to jump the arrester gap, which is rarely the case. In the transmission line, the most effective protection is the overhead ground wire. This, as short circuited secondary, rapidly dissipates the high frequency energy and thereby localizes the disturbance, and relieves the station, that is, the high frequency energy is dissipated in the line, and little if any reaches the station. A small reactance at the entrance of the station affords considerable protection against high

by the switching arc, etc., the choke coil as a barrier reflects it back into the station, where it may build up to destructive voltages, from stationary oscillations in apparatus capable thereof, such as transformer high potential coils. The danger introduced by

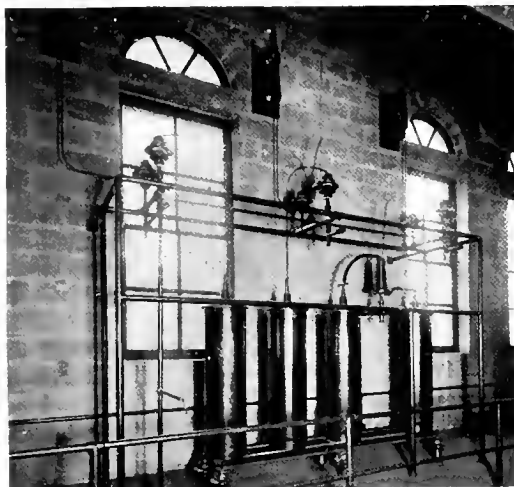


Fig. 2. Three-phase 44,000-volt Lightning Arrester Installation

frequency entering it from the line, by reflecting the high frequency back into the line, where the line insulation can stand it. Such a lightning protective choke coil, however, introduces a considerable danger, for if the high frequency discharge is produced in the station,

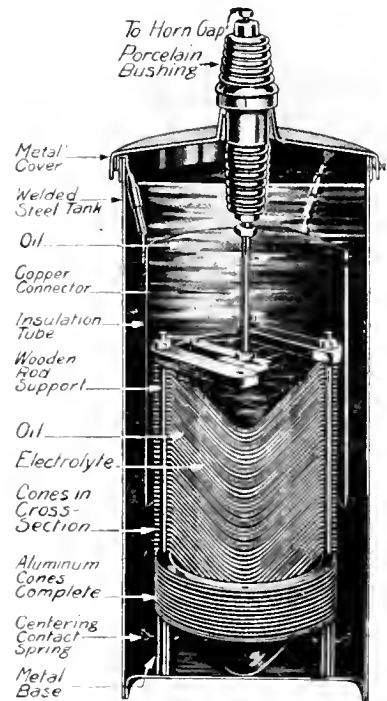


Fig. 3. Cross-section of a Tank of Cells for a 25,000-volt Aluminum Lightning Arrester

the lightning protective choke coil, of reflecting the high frequency back into the station, is eliminated by retaining the barrier action given by its reactance, but instead of reflecting the high frequency energy, cause it to dissipate this energy. Such a coil, having a moderate inductance and capable of dissipating considerable high frequency energy—without consuming appreciable energy at normal line frequency—is illustrated in Fig. 4. By energy absorption, it greatly reduces the energy of the reflected wave, and thereby guards against building up by resonance, to stationary waves.

Coming now beyond the line and the step-down transformer into the receiving circuit, to the control and protection of the motors and other apparatus, which are the purpose of the power system, we are in the field of industrial power applications, which is vastly

beyond the possibility of even a general review within the limits of this article.

First class installations, high insulation and effective controlling and protective devices are the requirements of efficient and reliable, and therefore economical operation.

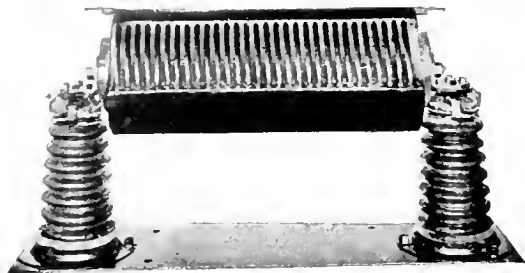


Fig. 4. Choke Coil for Dissipating Energy of High Frequency Surges

However, they are only half the requirement, and equally important is the operating staff. This is not always realized, and some first class installations give rather unsatisfactory operation, due to false economy in the selection of the operating staff, while some rather poor installations give good service. A proof of this we see occasionally, when one of the large high class central station organizations acquire some second rate local plant: even before any reconstruction is made, the improvement of service by the high quality of the operating staff often is marked.

Reliable and economic operation thus depends on a first class operating staff. It requires system and organization of the operating staff, and requires that accurate records be taken of all operations and all occurrences in the system, not only to control the reliability of the individual operators, but more still is this important in those cases where unusual incidents occur, as in emergencies and in case of accidents. Reliable and complete records then are essential to get the exact facts, find what happened and how it happened, so as to guard against its recurrence. This, however, requires automatic records. In the operation of the system, we use automatic devices as far as possible. Equally then, in recording the operation, automatic devices are essential for the completeness and reliability of the records. This at present is done to a limited extent only: we have a few curve-drawing voltmeters and ammeters, etc., but in the record of switching operation, etc., we rely on the operator's notes. The result is, that when any accident or other emergency occurs, the record as a

rule is practically worthless: when a number of circuit breakers open rapidly after each other, practically simultaneously, lightning arresters discharge, and the generators and other apparatus require the operator's immediate attention, it is impossible to observe accurately all the occurrences, still less the sequence of incidents, and their exact time, and records can be taken only after the trouble is over, from memory, and during the time of excitement memory is an entirely unreliable guide. This is the reason why so little is known of the nature and cause of troubles in electric systems; in most cases, we have to so largely guess what happened, and how it happened, that it is remarkable that we have advanced so far in our knowledge.



Fig. 5. Fifty-point Multi Recorder

Automatic records of all the operations and occurrences in a larger electrical system thus are of most valuable assistance in securing the safety and reliability of operation, and for discovering the causes of many troubles before they have led to the loss of apparatus.

Such an automatic recording device has been developed by Professor Creighton in the multi-recorder, shown in Figs. 5 and 6. It has been described in *Human Accuracy: Multi-Recorder for Lightning Phenomena and Switches*, by Prof. E. E. F. Creighton, H. E. Nichols and P. E. Hosegood, Trans. A. I. E. E., Vol. XXXI-1912 pp. 825-849.

The multi-recorder essentially consists of a number of stamps—in the usual size 50—operated by clockwork and printing the time, within fraction of seconds, of the event to which they are relayed. Thus some of the "points" may be connected to the switches and circuit breakers, and record the opening and closing of these switches, others record lightning discharges, or excess currents, etc.; in short, the time of anything whatever may be recorded, by connecting it by a proper

As illustration, the following records may be given:

1. The following report was made by the inspector of the multi-recorder, in a high power system feeding a railway converter substation:

"We got a very interesting record Friday, December 18th, at 11:29:31 p.m. One of the rotaries at the X street substation arced over and its oil switch blew open, showering everything near with oil.

"The operator at the power house claimed he threw no switches at that time. X street could find no cause of the trouble. All trolleys were OK and no short on any of the feeders.

"Immediately after the trouble the oil switch at the power house on the X street line was carefully inspected. It was closed

2P 1 50 85	1 2 3 4 5 6 - 8 9 10 11 - 13 - 15 - 17 - 19 -	21 - 23 - 25 26 27 28 - 31 - 33 - 34 - 37 - 39 40 -
2P 1 49 46	1 - - 4 5 6 - 8 9 10 11 - 13 - 15 - 17 - 19 -	21 - 23 - 25 26 27 28 - 31 - 33 - 34 - 37 - 39 40 -
2P 1 49 37	1 - - 4 5 6 - 8 9 10 11 - 13 - 15 - 17 - 19 -	21 - 23 - 25 26 27 28 - 31 - 33 - 34 - 37 - 39 40 -
2P 1 49 33	1 - - 4 5 6 - 8 9 10 11 - - - 15 - 17 - 19 -	21 - 23 - 25 26 27 28 - 31 - 33 - 34 - 37 - 39 40 -
2P 1 49 01	1 2 - 4 5 6 - 8 9 10 11 - - - 15 - 17 - 19 -	21 - 23 - 25 26 27 28 - 31 - 33 - 34 - 37 - 39 40 -
2P 1 48 44	1 2 - 4 - 6 - 8 9 10 11 - - - 15 - 17 - 19 -	21 - 23 - 25 26 27 28 - 31 - 33 - 34 - 37 - 39 40 -
2P 1 49 20	1 2 - 4 - 6 - 8 9 10 11 - 13 - 15 - 17 - 19 -	21 22 23 - 25 26 - 28 - 30 31 - 33 - 34 - 37 - 39 40 -
2P 1 48 05	1 2 3 4 - 6 - 8 9 10 11 - 13 - 15 - 17 - 19 -	21 22 23 - 25 26 - 28 - 30 31 - 33 - 34 - 37 - 39 40 -
2P 1 48 09	1 2 3 - - 6 - 8 9 10 11 - 13 - 15 - 17 - 19 -	21 22 23 - 25 26 - 28 - 30 31 - 33 - 34 - 37 - 39 40 -
2P 1 48 09	1 2 - - - 6 - 8 9 10 11 - 13 - 15 - 17 - 19 -	21 22 23 - 25 26 - 28 - 30 31 - 33 - 34 - 37 - 39 40 -
2P 1 48 05	1 - - - - 6 - 8 9 10 11 - 13 - 15 - 17 - 19 -	21 22 23 - 25 26 - 28 - 30 31 - 33 - 34 - 37 - 39 40 -
2P 1 47 58	- - - - - 6 - 8 9 10 11 - 13 - 15 - 17 - 19 -	21 22 23 - 25 26 - 28 - 30 31 - 33 - 34 - 37 - 39 40 -
2P 1 47 45	- - - - - 6 - 8 - 10 11 - 13 - 15 - 17 - 19 -	21 22 23 - 25 26 - 28 - 30 31 - 33 - 34 - 37 - 39 40 -
2P 1 47 36	- - - - - 6 - 8 - 10 11 - 13 - 15 - 17 - 19 -	21 22 23 - 25 26 - 28 - 30 31 - 33 - 34 - 37 - 39 40 -
2P 1 47 27	- - - - - 6 - 8 - 10 11 - 13 - 15 - 17 - 19 -	21 22 23 - 25 26 - 28 - 30 31 - 33 - 34 - 37 - 39 40 -
2P 1 47 24	- - - - - 6 - 8 - 10 11 - 13 - 15 - 17 - 19 -	21 - 23 - 25 26 - 28 - 30 31 - 33 - 34 - 37 - 39 40 -

Fig. 6. Record Sheet made by a 50-point Multi Recorder showing four records made in one second

relay to the multi-recorder. By using one of the 50 points to record standard time, the events in different stations, hundreds of miles apart, may be compared with each other in their exact sequence within a second, by the multi-recorders.

At present, multi-recorders are used to record the following events, through relays devised for the purpose:

Opening and closing of switches and circuit breakers.

Recording when lines are made alive, and when killed.

Recording grounds or short circuits, on which line, and on which phase of the line they occur.

Excess currents.

High frequency in lines, in which line and which phase.

Lightning discharges over the arresters, which line and which phase.

Operation of protective devices.

Approach of thunderstorms, etc.

and in perfect condition. This left the whole matter in the dark. When inspecting the multi-recorder record the following morning, I saw that X street line No. 4 was taken off at 11:29:30 p.m. and thrown back on at 11:29:31 p.m. This was shown on the record as contact No. 7, which is located on the H₃ 500-amp. 10,000-volt oil switch on X street line No. 4, opening and closing as shown above.

"I inquired the cause and was told they thought perhaps it was blown open due to the overload caused by a rotary at X street arcing over, as the two incidents were simultaneous.

"I then looked at the multi-recorder record to see if the excess current relay on X street line No. 4 had operated before the oil switch had blown and found that it had not, but operated when the oil switch was thrown back in. This seemed to prove quite conclusively that the oil switch was opened at the power house, causing X street to fall out of

phase and then closed. This of course would account for the trouble. This is also borne out in another way. The oil switch at the power house is set to trip out at about three or four times the current required to open the oil switch at X street or the excess current relay. Since the excess current relay failed to operate before the oil switch at the power house opened, it is evident the switch did not open due to overload.

"Since, after the trouble was over, the oil switch at the power house was found closed and the operator claimed to know nothing of its operation, we would never have known of its operation had it not been for the multi-recorder.

"As fortunately no material damage was done by the incident, the matter was not further followed up."

2. Another record of the same system, operating a large steam turbine plant in parallel with a hydraulic station over a long

distance transmission line, is given in the following report:

"One incident showed the utility of the multi-recorder. At 3:04:10 the discharge alarm recorded a lightning stroke. Several observers saw the transmission line No. 2 arc over; whether from line to line or line to ground could not be accurately told, although the supposition is that it occurred between the upmost line and the middle one on the first tower across the canal. The operator has standing orders to clear the board in a contingency like this. He waited, however, over two minutes as the electrostatic relays showed the line was energized from the steam turbine station until 3:06:24. Just 8 seconds later the water power station came on—if the operator had been just a little bit slower the system would probably have been badly bumped."

3. As the record of the disturbances caused by a thunderstorm in a large 100,000-volt

Date and Time	MR. Cont. No. X = closed - = open	MR. No.	Probable Cause of Operation
May 4, p.m.			
There was a thunderstorm over toward X that caused a very severe bump on the 100-kv. lines.			
2:25:00	11, 16, 20, 22X 31 - 41, 42, 43, 45X	2 2 2	Lightning struck line No. 2 grounding same, causing the excess current relays in ground leg of transformer, contacts, 41, 42, 43 and 45 and high frequency relays 11, 20, 22 to operate on line No. 3 due to the very high induced voltage or may be from direct stroke on line and No. 16 high frequency relay on phase 3 of line No. 2.
2:25:01	11, 20, 22, 33 -	2	
2:25:01	16, 32 - 41, 42, 43, 45 -	2 2	
May 4, 1915, p.m.			
Voltage was pulled down so low the electrostatic relays on line No. 2 (contacts No. 31, 32, 33) dropped open. Horn gaps to lightning arrester did not arc over at this time.			
May 4, p.m.			
2:25:02	11, 12, 16, 20 22, 23, 26X	2 2	A heavy surge came at this time arcing over horn gap to both the live line No. 2 and the dead line 3. This was a single heavy surge lasting only a part of one second.
2:25:02	11, 12, 16, 20 22, 23, 26 -	2 2	
2:25:11	45, 46, 47 -	1	Line oil switch on line No. 2 opened. Due to switching off line
2:25:12	16X	2	No. 2.
2:25:12	16 -	2	
2:25:13	45, 46, 47X 16, 23X 31, 32, 33X	1 2 2	Put line No. 2 back on 100 kv. bus. Horn gap to lightning arrester arced over on line No. 2 and high frequency relay on phase 3 operated. When voltage came on the line electrostatic relays picked up instantly as shown by 31, 32, 33 closing in the same $\frac{1}{4}$ second that the line was charged.
2:25:15	13X	2	It seems there was some stray high frequency going to ground on phase 3. This coherer is about 300 ft. from the roof where arc was, and would hardly work at all due to wireless I'm quite sure.
2:25:15	13 -	2	
2:25:16	16, 23 -	2	Horn gap arced over continuously for 3 seconds as shown by contacts 16 and 23 remaining closed from 2:25:13 to 2:25:16. Lines now seem to be OK, again.

transmission system, the following report on the operation of the multi-recorder is given. The system contains two multi-recorders located in the hydraulic generating system, and connected to show the operation of all the switches, line voltage, excess current, lightning arrester and high frequency absorber operation, high frequency disturbances in lines and in stations.

"(The data in the table do not include the regular switch operation, which also were recorded, but are omitted here.)

"It is interesting to note that 53 different things occurred and were recorded in their

sequence, within 16 seconds. Fortunately, possibly due to the protection afforded by the high frequency absorber, no damage was done to any apparatus. We can realize how utterly impossible it would be, even for a large and well trained operating staff, to observe and record some 50 different occurrences, together with the sequence in which they occurred, within 16 seconds, or even a small fraction of them, and how difficult, if not hopeless, it therefore would be without the multi-recorder, if any damage had occurred, to ascertain the exact cause and protect against its recurrence."

SPRAGUE-GENERAL ELECTRIC PC CONTROL

(THE ELECTRO-PNEUMATIC SYSTEM)

By C. J. AXTELL

RAILWAY EQUIPMENT ENGINEERING DEPARTMENT, GENERAL ELECTRIC COMPANY

A detailed description of the mechanical construction and pneumatic operation of this new type of car and train control forms the body of the following article. This system of control combines elements which give extreme simplicity in operation and compactness in design which particularly adapts it to the many varying conditions of wheel diameter and minimum space requirements.—EDITOR.

Probably few, if any, branches of electrical engineering have developed more rapidly during the past few years than the electric railway. This is particularly true in the large cities where the demands for rapid transit facilities are constantly ahead of the facilities provided. Not only a greater carrying capacity of cars and trains is required, but also an increased schedule speed is demanded. These increases tax the equipment; not only to care for the additional load imposed by the car service, but, also to operate upon a system on which the power station and distributing lines have grown to tremendous proportions. Such demands necessitate control equipments on cars to handle the increased capacity, to be capable of opening heavy overloads and even short-circuits under the above conditions and to provide for a reliability that has never before been obtained, while at the same time the cost of maintenance must be kept at a minimum. Due to the present day tendencies in car design to lower the car floor, to use small wheels, etc., the space available underneath a car for control equipments has been growing smaller instead of larger.

It is to meet these conditions that a new type of control, known as the Sprague-General Electric Type PC Control, has been developed and recently placed upon the market. This system of control embodies

all the essential characteristics for the simple and satisfactory operation of electric railway cars either singly or in train. The complete control of the car movement is possible from any car in the train, the equipments operating on the well-known multiple-unit principle, viz., all main or motor controllers on the train operate synchronously, their movement being governed by the master controller. The control equipment for a car consists essentially of a main or motor controller, a master controller, and motor resistor, together with such auxiliary apparatus as is common to all car equipments.

The principal piece of apparatus is the main or motor controller. Exterior views of a typical controller are shown in Figs. 1 and 2, and the front and rear views with covers removed are shown in Figs. 3 and 4. The particular controller shown in these illustrations is suitable for operating two 220 h.p., 600-volt, tap-field motors. One hundred and twenty-four of these controllers will shortly be in use for operating trains on the lines of the Interborough Rapid Transit Company, New York.

The controller contains in one box the line breaker, the overload relay, the contactor elements for making the various motor and resistor connections, the reverser, and the operating mechanisms. The line breaker

elements, of which there are two in the equipment illustrated, are electro-pneumatically operated contactors provided with extremely powerful magnetic blowouts. The power for operating these line breakers is obtained from the compressed air supply

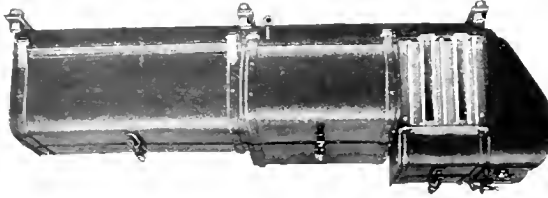


Fig. 1. Type PC Motor Controller.
Front view with covers

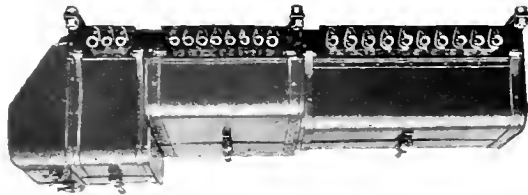


Fig. 2. Type PC Motor Controller.
Rear view with covers

of the air-brake system. Air admitted through a small magnet valve to a cylinder located underneath the operating mechanism, forces up an air piston and closes the main contacts of the line breaker element against a powerful spring. These line breaker elements function to open the motor circuits under all normal conditions as well as under overload conditions. This possesses the advantage of rupturing all arcs in that part of the equipment particularly designed for such service; which part was formerly used as a circuit-breaker, opening only under overload or short-circuit conditions. Extensive investigation and development has recently been made to produce the most efficient magnetic blowout, the results of which have been incorporated in this new control both in the line breaker and in the contactor units. The current carrying parts of these line breakers are similar to those used on the contactors of the Sprague-General Electric type "M" control and consist essentially of a main contact, series coil with magnetic blowout, and arc chute. Fig. 5 shows a partially disassembled view of one of these breakers. The construction of the element in a unit form and the assembly of it on a moulded compound base makes the removal or replacement of any element very simple, for it is only required to detach the two cable

terminals and loosen the two nuts holding the unit in position. The operating levers are so designed that the contact tips when closing and opening are given a "wipe" or rolling motion which prevents them from "freezing" or welding together.

Included as a part of the main controller is an overload relay consisting of a series coil through which passes the line current taken by the car, an armature that operates contacts in the control circuits of that equipment, and a mechanical latch having an electrical reset. This latch is arranged to hold the relay in an open position, in case it is tripped by an overload current, until the reset coil is energized by a small switch in the motorman's compartment. The armature of the relay is held in the normal position, that is, with the contacts closed, by means of a tension spring, which spring also affords a means of calibrating and setting the relay to trip at any desired overload current value, depending upon the equipment and service conditions.

The reverser used on this type of controller is, like the line breakers and main contactor units, operated electro-pneumatically. The form of reverser is that of the well-known cylinder type such as has been used for many years on the standard "K" type of platform controller. On account of the severe service and increased capacity of motors, which this controller is designed to handle, the parts of the reverser must be very large and rugged which is made possible by locating them under the car body. The operating mechanism of the reverser consists of two air cylinders with a magnet valve directly attached to each cylinder. The pistons of the air cylinders are connected to an arm on the shaft of the reverse cylinder that carries the contact segments. The energizing of one of the reverser magnet valves admits air to its cylinder and rocks the reverse cylinder to the opposite or reverse position. Control fingers, as well as the main current fingers, are also placed upon the reverse cylinder, the function of which is to commutate the control circuits as the reverser is thrown. The control circuit energizing the reverse magnet valve passes through an interlock on the control cylinder of the cam shaft, which connection is made only on the "off" position of the main controller, thus positively preventing the throwing of the reverser until power is cut off from the motor circuit. After one of the magnet valves of the reverser is energized and the reverse cylinder thrown over to the reverse position, the control fingers on this cylinder transfer

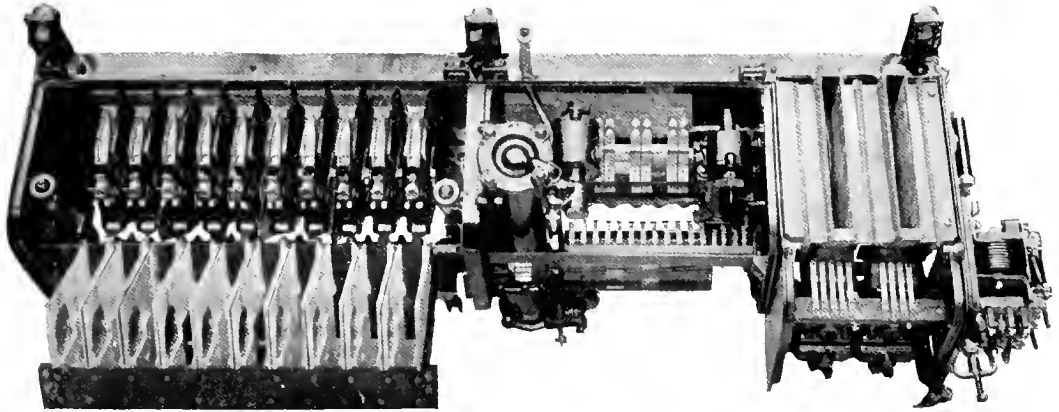


Fig. 3. Type PC Motor Controller. Front view with arc-chute unit swung down

this control circuit from the magnet valve of the reverser to that of the line breaker. This transfer of control circuits gives the safety feature of insuring that the reverser is thrown to its final position before the line breaker magnets can be energized and any current applied to the motors. It also cuts off the air from the reverser air cylinder, as the air pressure is required only for throwing and not for maintaining the reverser in position.

The fourth and principal part of the main controller consists of the cam operated contactors or magnetic blowout switches which function in the proper sequence to make the series and parallel connections of the motors and to cut out the resistance sections used to accelerate the car. These contactors are constructed very similarly to, but smaller in size than, the line breaker elements for they are not required to have as great an arc rupturing capacity as the line breaker. They are, however, of sufficient capacity to open

the motor circuit, even under abnormal conditions, if for any reason the line breaker should fail to do so. One of the contactor units without arc chute is shown in Fig. 6.

The arc chute for the entire group of contactor elements is made up as a unit, that is, the individual arc chutes are rigidly fastened together and are hinged on the lower side, the construction being similar to that of the platform type of controller. By simply loosening two spring thumb nuts, the entire arc chute can be lowered as shown in Fig. 3, thereby affording free access for inspection or repair of the moving parts of the contactor units. In any method of connecting up the motors and resistors of the control equipment certain of the contactors, due to their location in the circuit, operate under more severe conditions than others, which causes a greater burning of the tips and arc chutes. In the arc chute of such contactors there is introduced a small auxiliary arc chute to

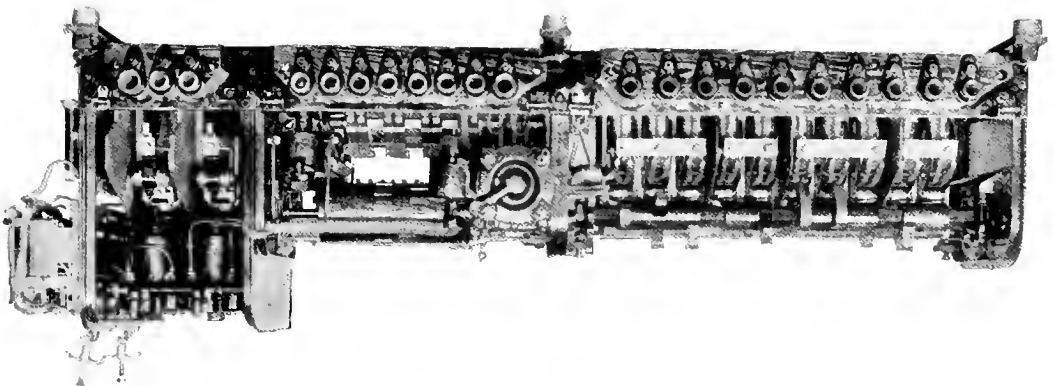


Fig. 4. Type PC Motor Controller. Rear view with covers removed

take this burning. This arc chute is reversible and is readily renewable, it being easily detached in a few seconds without tools and without disturbing any other part of the contactor.

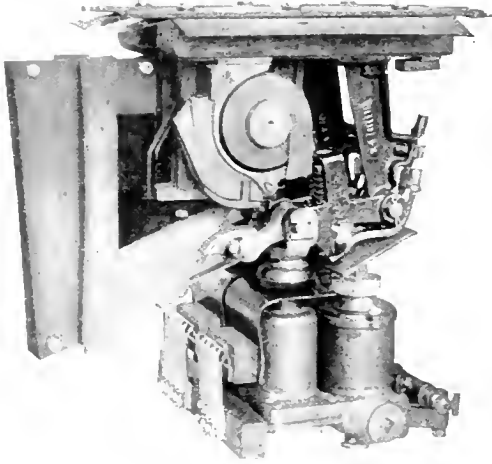


Fig. 5. Line Breaker, with One Arc Chute Removed, for PC Motor Controller

The movement of these contactor units is effected by means of cams mounted upon a rotating shaft which is located underneath the contactors and which bears upon the rollers of the contact levers. The construction is illustrated in Fig. 4. This shaft is rotated by a pinion and rack, the rack being actuated by the piston of two air cylinders. The air pressure against the piston of the "on" cylinder tends to rotate the cam shaft to give full parallel connections of the motors, while the air admitted to the "off" cylinder produces a rotation in the opposite direction. To each air cylinder is attached a magnet valve which governs the admission of air to that cylinder. The magnet valve attached to the "off" cylinder is so arranged that when the valve is in the normal or unenergized position the "off" cylinder is charged with air from the supply reservoir, and when this valve is energized the cylinder is connected to the atmosphere. The magnet valve governing the "on" cylinder has the reversed function, that is, when in the normal or deenergized position it connects the cylinder to atmosphere while in the energized position it admits air to the cylinder. It will thus be seen that when neither of these magnet valves are energized the air pressure will be against the piston of the "off" cylinder only, which will turn the cam shaft to the

"off" position. In order to advance the cam shaft through the successive steps of the control, it is necessary to first energize the "on" magnet and to admit air to the "on" cylinder. This equalizes the pressure in both cylinders, and the advancement of the cam shaft is then obtained by reducing the air pressure in the "off" cylinder. As this reduction is governed by the magnet valve, it follows that the entire control of this cam shaft from the first series to the last parallel position of the motors is obtained by the energizing or deenergizing of a single valve.

On the cam shaft is also mounted a control cylinder with the segments and fingers necessary to make the required control connections for each step, and to insure the proper functioning of the line breaker elements, the reverser, and the cam operated contactors. No interlocks are used on the contactor units themselves, as in the case of other multiple unit controls; this control cylinder takes the place of such interlocks and thus gives not only a much less complicated control connection but a greatly reduced number of parts. Fig. 7 shows the control and motor circuit connection for an equipment suitable for four, 130 h.p., 600-volt motors. This controller gives five series and four parallel steps and is operated by nine control wires in the train line. The connections shown are for a hand control but, by the addition of a series relay in one of the motor circuits and one finger on the control cylinder of the main controller, the equipment can be made automatic with current limit. This series relay opens up the control

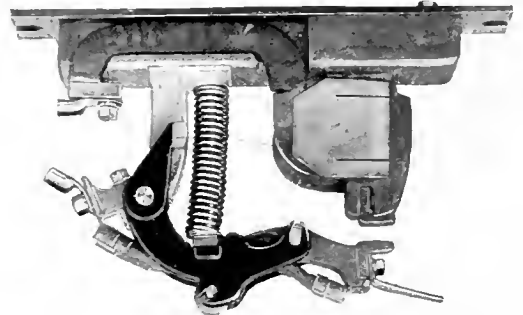


Fig. 6. Contactor Unit for PC Motor Controller

circuit of the "off" magnet, thus preventing the "notching up" of the motor controller when the motor current is above a pre-determined value.

The master controller is provided with a "slip ring" attachment which closes the

trolley circuit to the control when the master controller is moved from the "off" to the first position. This contact remains closed with any forward movement of the master controller handle, but it immediately opens if the handle is turned backward and it cannot be closed again without returning the handle to the "off" position and again advancing.

Line breaker element No. 1 is so interlocked that it can close only when the cam controller is in the "off" position, and the cam controller cannot advance from the "off" position to the first position until this element No. 1 is closed. Therefore, the control has been made, as far as possible, proof against abuse, improper, or unsafe operation.

The control current required to operate the magnet valves is approximately 0.3 amperes per car on a 600-volt circuit. Only a part of the energy represented by the above current is used in operating the magnet valves; consequently, the control is particularly adapted for use where the control current is to be taken from a small battery on the car.

A prominent feature of this control is that the sequence of operation of these contactors is positive as they are closed by the cam and opened by a stiff spring. This feature effectively eliminates the trouble found in using individually operated contactors, viz., that due to the time lag of opening and closing which varies with the electrical connections, voltage, air pressure, etc. This controller has also the advantage of insuring that, regardless of the rapidity with which the motorman

advances the master controller handle, the main controller must advance through all the successive steps exactly the same as does a drum controller, which not only protects the motors from abnormal rushes of current but also avoids improper circuits in the controller itself.

This type of control contains, therefore, in one piece of apparatus what was formerly located in three separate boxes, that is, the circuit breaker, the contactors, and the reverser. As will be seen from Fig. 2, all the conduit inlets are at the back, the cables going into the box and directly to the terminals thus eliminating much of the interior wiring that was necessary on former types of equipments. The cable inlets are located on a hard wood strip to insulate the box from the conduit, as it is recommended that the controller be insulated from the grounded framework of the car. Due to the combination of these pieces of apparatus in a single box, this new type of control equipment is considerably lighter in weight than other types of multiple-unit control of equal capacity, and occupies much less space under the car.

This control system is applied to either two or four-motor equipments for 600-volt or higher voltage systems, and for motors of any capacity. It is also applicable where tap-field motors are used. When used on a line of higher potential than 600 volts, a dynamotor is not required as the small amount of energy necessary for operating the control magnets can be obtained by the use of a control resistor.

GENERAL NOTES ON GROUNDING

By H. M. WOLF

CAPITAL ELECTRIC COMPANY, SALT LAKE CITY

This article, which treats of the subject of grounds in a strictly practical manner, contains information which should be very useful to those engineers who are concerned with grounded circuits. The author after describing the various types of grounds, discusses their relative merits, the proper methods of installation, the effects of various soil conditions, and the different methods of applying electrical tests.—EDITOR.

This article will deal only with the practical side of grounding, i. e., the making and testing of grounds; the history or necessity for grounding will not be discussed. It has been the general practice to make use of treated surface grounds, i. e., ground elements placed only a few feet in the earth and then treated with some sort of solution, usually salt water.

The writer has attacked the grounding problem from a different angle, and the following are the different types of grounds arranged in what he believes to be the order of their relative importance. The series is arranged on the basis that the most satisfactory ground is the one that gives the best results with the least expense and trouble.

(1) Grounds to water systems, where proper conditions permit, are the cheapest and best type. (These will be discussed later in the article.)

(2) Grounds located at a permanent water depth.

(3) Grounds located at a permanent moisture depth.

(4) Treated surface grounds.

(5) Untreated surface grounds.

Relative Value of Different Types of Grounds

It has been truly remarked that a poor ground is worse than none; and an untreated surface ground is absolutely worthless in most cases, for the contact resistance is too high, varying possibly from 12 ohms where the permanent water strata is close to the surface to 250 ohms in dry season where water is not close to the surface.

Omitting, for the time being, consideration of grounds to water systems, there remains the choice between the ground placed at permanent water or permanent moisture depth and the treated surface ground. The ground element placed at permanent water or moisture depth will be under uniform conditions throughout the year, and will require no upkeep or testing until sufficient years have elapsed to wear away the pipe. The ground element placed at permanent water depth will offer a constant resistance of from 12 to 20 ohms, and the ground element

placed at permanent moisture depth will cause a resistance of from 18 to 40 ohms. The cost of placing these ground elements will vary over a wide range, depending upon the depth to which the pipe must be driven and upon the nature of the soil; but an average cost for placing about 800 of these grounds at a possible average depth of 27 feet, under varying soil conditions, was about \$5.00. This figure includes labor and material, and placing wire on the pole, and testing the resistance of the ground.

When a pipe is placed at permanent water or moisture depth, the current discharged to the ground cannot dry out the earth surrounding the pipe because of the excess amount of moisture present; but with the treated surface grounds, where the soil is dry, it is possible for the current to dry out the soil surrounding the pipe, thereby causing a rise in the contact resistance.

The treated surface ground is subject to varying qualities as a ground; and it requires systematic and regular testing until the variables can be determined and the conditions of maintenance and upkeep standardized for each kind of soil. The life of the pipe is shorter where grounds are treated than where they are not treated, and it is believed that the difference in life is quite noticeable. To maintain a reasonably constant contact resistance, one ground will require more salt than another and will require the replacement of the salt more often than another, due to differences in the compactness of the soil and the amount of moisture it contains. A heavy rainfall with a loose earth soil will wash a considerable quantity of salt away from the ground element; and, when the soil again dries out, the contact resistance will show an appreciable increase. The change of the seasons will affect the contact resistance due to the fact that frozen soil is of higher resistance than that which is not frozen. For this reason it is desirable to sink surface ground elements to a depth of at least 8 or 10 feet; a greater depth will be productive of good results. These ground contacts might vary in resistance from 1 to 5 to 40 ohms, and

even up to 250 ohms if not kept properly salted.

Proper Grounding

For ordinary grounding purposes it is believed that a ground contact resistance of not more than 20 ohms is satisfactory; but lower contact resistances are desirable in connection with abnormally heavy currents or large station equipments. The average contact resistance where one pipe is placed at permanent water depth is between 12 and 20 ohms, depending upon the size of the ground element, its depth in the ground, and more especially upon the kind or nature of the soil. If the necessary expense is justified, this resistance can be lowered to one ohm or even less by placing additional ground elements in multiple or by treating the earth directly surrounding the ground element with solutions to increase its conductivity.

It is generally conceded that the earth has no resistance except the contact resistance which is generally taken as the resistance between the ground element and the earth directly surrounding the ground element.

The grounding problem then resolves itself into one question, that of what is the allowable ohmic resistance of contact. This will be determined by the requirements of the particular case and the cost of obtaining the desired results under the existing soil conditions.

It would seem apparent from the data already given that a satisfactory ground could be obtained at any place under any soil conditions, but this is not always possible. Where rock is within a few inches or a few feet of the surface, or where the soil is of boulders as in old river beds, it is impossible to get low contact resistances and a wire will have to be run to some point where a proper ground can be made.

The earth crust is made up of rises and depressions in the stratified layers of soil and these depressions are generally filled with loose soil which, from all outward appearances, seems to offer a satisfactory ground; and in many instances seepage water is held in these depressions. These conditions sometimes give satisfactory grounds, but it is necessary to test to another ground sufficiently removed to determine the actual grounding value of such an earth contact.

The following facts are generally agreed upon by those having made extensive ground tests.

(1) Assuming a uniform soil and moisture condition, the contact resistance is not materially lowered by increasing the depth of the pipe in the ground after the pipe has reached a depth of about 8 feet. Placing the pipe 16 feet deep, instead of 8 feet, would likely lower the contact resistance only 6 to 12 per cent.

(2) The size of the pipe to be used should be determined from the mechanical conditions of driving and the possible saving due to the longer life of a larger pipe, but not from the difference in contact resistance due to increased surface, for doubling the size of the pipe gives only 6 to 12 per cent lower contact resistance.

(3) Driving pipes near together, say a few inches or a foot apart, is equivalent to driving one pipe of the larger size; pipes driven not less than 6 feet apart, when connected in multiple, will give a combined resistance inversely proportional to the number of pipes placed.

(4) Ground elements can be tested with either direct or alternating current with equal accuracy, for there is no inductive or capacity effects introduced.

Peculiarities of Special Interest

There are no doubt many peculiarities connected with the process of grounding. The following have come to the writer's attention and are of interest:

(1) When testing three grounds by algebraic applications of three equations with three unknown quantities, it is noted that if one of the contact resistances is very high with respect to the other two, say five or more times as high, the values determined by the equation may be in error possibly 2 to 5 per cent. The writer's belief is that while the resistance of the earth is generally not considered, the earth does have a resistance and the difference in values is due to the resultant obtained by combining the earth's resistance with the sum of the contact resistances of the elements under test.

It is the belief of the writer that the earth has a specific resistance, which depends upon the nature of the soil, but that the resistance is constant for different amperages unless the contact is of such a nature that the increased current can dry out the moisture in the soil and change the nature of the surrounding earth.

(2) If two pipes are driven into the earth within a few feet of each other, either of the

pipes will show a lowering of its contact resistance of from 2 to 5 per cent due to the presence of the other pipe which is not electrically connected in any way with the pipe tested. This apparently is due to the auxiliary pipe tending to tie the earth together between the upper and lower strata and offering a point of increased current density.

Relative Value of Copper Plates and Iron Pipes

Copper Plates

- (1) Costly to place at any great depth.
- (2) Cost of placing copper plates 6 or 8 feet is greater than cost of placing iron pipes to the same depth, and the cost of the copper itself is greater than the cost of the pipe.
- (3) Have a short life in the ground.*
- (4) Large contact surfaces are readily obtainable with copper plates, but increased surface within closely defined areas gives but little decrease in contact resistances.

Iron Pipes

- (1) Easy and cheap to place, even to a considerable depth.
- (2) Comparatively long life in the ground—galvanized pipe will last from 10 to 25 years, possibly average 15 to 18 years.
- (3) Satisfies all the requirements of a good ground element.

Value of Charcoal or Coke

Charcoal or coke has no value where ground elements are placed at permanent water or permanent moisture depth, as they are not of especially low resistance and only serve to hold moisture. With treated surface grounds the charcoal or coke serves a useful purpose when placed around the ground element. Probably the best results can be obtained by using charcoal or coke of about one inch size and, after mixing it liberally with some sort of loamy soil, filling it in about the ground element to a depth of possibly 6 or 8 inches. The use of charcoal or coke with an untreated ground is not productive of good results, and it does not materially add to the value of the untreated surface ground.

Water Systems for Grounding Purposes

Where the water system is of metal pipe, this usually offers a very satisfactory grounding medium, under certain restrictions; but, where the mains are of wooden pipe and only

the laterals or services are iron, the water system should not be used as a ground.

The restrictions that were referred to are as follows: First, where a water system is to be used as the ground, the attachment should be to one of the main pipes and it should be made by means of an iron band or clamp fitted around the pipe so that local electrical action will not take place between the copper fastening wire and the water main but between the wire and the clamp. Second, the copper or iron wire running from the pole to the water main should be encased in a galvanized iron pipe to (a) mechanically protect the wire from being broken, and (b) in the case of copper wire being used, to increase the life of the copper by offering a more electro-positive surface than the copper. Third, an emergency ground element of reasonable grounding quality should be placed so that the opening of the water mains at any point will not relieve the circuit of a ground or endanger the workman on the mains.

Soil Conditions and the Type of Ground

Assuming that it is desired to place a ground element, the procedure should be as follows:

First, determine insofar as is possible these features concerning the character of the soil; its depth, formations at different depths, depth to either surface or live water, different height of surface or live water at different seasons of the year, and the amount and depth of permanent moisture. It is surprising how much information there can be obtained on these subjects as the result of effort in asking a few questions and making a small amount of careful observation. There are usually wells in most places that give considerable data; then, also, well drillers and city or county engineers are usually more or less liberally supplied with data along this line.

The writer has made considerable use of a 5-inch diameter auger post-hole digger and has drilled holes 30 and 40 feet deep to study the soil conditions. This is not a tedious process by any means for holes have been drilled 20 feet deep in one hour, and the information obtained was readily applicable to other locations which saved considerable time in placing grounds elsewhere.

It is recommended that the intention of driving a pipe to a permanent water depth be held until it is satisfactorily shown that this cannot be done. If permanent

* There are still some adherents to the use of copper plates. To those it is suggested that a piece of iron be buried with the copper, as the iron (being more electro-positive than the copper) will eat away before the copper will begin to depreciate.

water is readily obtainable, a pipe can be driven to the necessary depth in most cases without difficulty.

As the result of investigating the soil as just described one will also have determined, by the amount of moisture near the impervious stratified layers, whether a permanent moisture ground is possible in case there is an absence of abundant water. If sufficient moisture be found at 12 feet or deeper, a satisfactory ground can be made by driving a pipe to this depth; and, if the contact resistance of one pipe is too high, a second pipe can be placed (not closer than 6 feet) and tied-in in multiple with the first pipe, which combination gives one-half of the resistance first obtained.

Careful investigations have indicated that it is usually possible to place a pipe to permanent water or permanent moisture depth; but assume that in this case neither of these could be accomplished. The investigation already made will give sufficient data to determine whether a treated surface ground would secure the proper results, but it is safe to say that a treated surface ground would be satisfactory if the soil was of loose earth formation. At least it would be worth while to place this ground and make the necessary tests, as the cost would be small and the experience very valuable.

Several small towns, where solid rock varied from a few inches to a few feet from the surface, would necessitate a common ground system with the ground elements specially and advantageously placed; perhaps wells or other open water sources might be available.

Placing Ground Elements

Driving a pipe to permanent water or moisture depth offers unusual difficulties only when a considerable depth must be reached. The general practice is to drive the pipe with a hammer, the lineman swinging the hammer from the pole; but the writer has made up a special hammering ram by attaching a guide pipe to a weight and operating the device by means of a rope through a pulley attached to the top of the pole or a cross-arm. A complete hammer of this kind can be made up for about \$8.00 and will prove a great saving in time and labor. A 50-lb. hammer is used with $\frac{3}{4}$ -inch pipe for all grounding purposes, except for special soil conditions where the $\frac{3}{4}$ -inch pipe bends too easily and a $1\frac{1}{4}$ -inch pipe is used. This latter is driven with a 100-lb. hammer. This standard has

been arbitrarily chosen and has given good results.

Where a pipe longer than 80 feet is to be placed, it will be necessary to couple lengths of pipe together and this coupling is liable to prove bothersome. Considerable difficulty has been experienced from pipes breaking at the coupling, until a proper standard was developed which made the joint stronger than the pipe itself. Many grounds 30 to 35 feet deep have been placed, quite a number 40 to 50 feet deep, and one 60 feet deep. Undoubtedly, under favorable conditions, pipes can be driven to 100 feet depth.

In placing treated surface grounds, it is recommended that a hole about 8 inches in diameter be drilled to at least 8 or 10 feet depth, and if possible to 15 feet depth. A galvanized iron pipe not smaller than 1 inch diameter (preferably $1\frac{1}{4}$ or $1\frac{1}{2}$ inches in diameter) should be placed in the center of this hole and a mixture of charcoal or coke with loamy soil tamped in about this pipe for at least 6 feet in height. The rest of the hole can be filled with the earth that was removed. To treat the pipe with salt, pour a liberal amount of salt water around the pipe and, after the ground has dried out on the surface, sprinkle a reasonable amount of salt on the ground in a ring about the pipe, allowing possibly 18 or 24 inches clearance from the pipe to protect it from a concentrated chemical action at the surface. The salt will then be carried into the ground with the rainfall and will maintain a low resistance contact. The salt will have to be replenished from time to time and tests should be made to determine the average varying conditions, from which a practice can be established in accordance with the requirements.

Testing Grounds

Algebraic Method

The most accurate method of determining the value of a ground is to measure its contact resistance in ohms. This can best be done by applying the algebra of three equations with three unknown quantities, which is a very simple process. It is necessary to have three ground elements to make this test, but the resistance need not be the same; so that two pipes can be driven temporarily into the ground and removed after the test is made.

Because of the accuracy and ease of application, this method is strongly recommended for all experimental and standardizing testing purposes.

Ammeter Test with Two Grounds

It is a common practice to test, with an ammeter, the current flow between two pipes, and take a voltage reading across the pipes at the same time. This method is accurate only when the pipes are of the same resistance. If the two pipes are of equal ground qualities, each is responsible for one-half of the total resistance of the circuit; but if the grounds are not of the same value, it is absolutely impossible to determine what is the resistance of each.

Fuse Test

It has been established as a standard in some localities that a satisfactory ground will cause the blowing of a 5-ampere fuse. Tests of fuses have shown that a 5-ampere will sometimes melt at from 7 to 8 amperes in 5 minutes with a room temperature of about 70 degrees Fahr. The fuses were 24 inches long and were supported horizontally on small metal contacts. In other tests a 5-ampere fuse carried 12 amperes indefinitely without warming up perceptibly to the hand.

It is evident that the range of variation of melting point of a fuse is wide and 25 amperes may perhaps be required to blow a 5-ampere fuse instantly. It is believed that the point at which a fuse will blow instantly can be standardized within close limits, but that the time limit at which a fuse will be melted cannot be standardized due to the radiation of heat which is dependent upon several factors that are usually uncontrollable.

Assume two pipe grounds under test, each having 12 ohms contact resistance, or a combined resistance of 24 ohms. At 110 volts, 110 divided by 24 equals 4.6 amperes which will not even melt the 5-ampere fuse.

Assume one pipe of 12 ohms contact resistance against a water system ground of say one ohm resistance. At 110 volts, 110 divided by 13 equals 8.5 amperes which would require some little time to melt the fuse; perhaps it would not melt at all.

These tests were made with open string fuses, but later tests were made with enclosed fuses. The results, however, were not satisfactory owing to the time factor. If it is possible to make up a fuse that will blow instantly within well defined limits, a fuse that is rated at 5 amperes will prove of value.

Because of the inability to blow 5-ampere fuses on 110-volt circuits, and to avoid the time element, the writer made 5-ampere fuse tests with the primary distributing voltages,

1100, 2300 and 6600 volts. As a matter of economy, the tests were made between two independent and permanent grounds, rather than to cause the placing of a temporary ground at great cost for testing only. This made the testing cost but a very small per cent of the total cost of securing satisfactory grounds. The distance between the grounds was usually not less than $\frac{1}{4}$ mile which insured good grounding.

General Testing Practice

The depth to water should be known and the pipe driven to the desired depth. In such cases it is only necessary to know that the pipe is intact and that it has not broken at a coupling. This can be readily determined by running a wire down the pipe to the distance the pipe was driven. If the pipe point has been flattened, but not welded, water will rise in the pipe and the end of the wire should show moisture.

Assuming any given resistance between two grounds, a given capacity fuse will act within closely defined limits of performance under any similar tests (if the fuse is blown instantly) and a standard practice can be established for different voltages so that the fuse will blow with about the same amount of force. When testing with a 5-ampere fuse about 24 inches long on 2300-volt circuits, the fuse had to be completely destroyed to prove the ground to be satisfactory. On 6600-volt tests, a 2-ampere fuse was put in series with a 5-ampere fuse, and if the 5-ampere fuse blew it did so with considerable force which showed that the rush of current was great and the ground was satisfactory.

To test a pipe while driving it, connect one side of a 110-volt circuit to a well (if one is nearby or if not to a pipe temporarily driven in the earth), connect the other side of the 110-volt circuit to an ammeter so arranged that contact can be made at will from the ammeter to the pipe being driven. When the pipe is started into the ground the ammeter will show a deflection which will be very small but which will increase as the pipe is driven into the earth, until a certain fixed point is reached. This will be the greatest deflection that will be read until thoroughly wet soil is reached, when the deflection will show a marked increase suddenly. The pipe should then be driven four to eight feet farther. This method has been used with excellent results in determining water depth.

THE VOLUME RESISTIVITY AND SURFACE RESISTIVITY OF INSULATING MATERIALS

BY HARVEY L. CURTIS, PH. D.

ASSOCIATE PHYSICIST, BUREAU OF STANDARDS, WASHINGTON, D. C.

After naming the factors which affect the volume resistivity and the surface resistivity of an insulating material, the author describes the influences which these factors exert. Then he furnishes tables listing the values of resistivity for a large number of the more common insulators and gives an example of the method for applying these data to calculating practical problems.—EDITOR.

It has long been known that the insulation resistance between two conductors which are insulated by a solid dielectric depends upon leakage over the surface of the insulator as well as conduction through the material. Very little quantitative data has been published, however, by which the resistance of the two paths can be computed in any given case. To procure more data upon this subject, different kinds of solid insulating materials (mostly hard rubber substitutes) have been collected and their surface and volume resistivity measured under different conditions of temperature, humidity, and applied voltage.

The volume resistivity, ρ , of a material is the resistance between two opposite faces of a centimeter cube of the material. It may be expressed by the equation $\rho = \frac{RA}{l}$ where R is the resistance in ohms of a specimen of uniform cross-section A and length l . To measure the resistivity of the insulators a specimen approximately $10 \times 10 \times 1$ cm. was employed. This was floated upon mercury, and three short concentric copper tubes were placed on the upper surface. Sufficient mercury was then poured into the inner tube and between the two outer tubes to cover the bottom, while the two inner tubes were carefully insulated from each other. The resistance was measured between the mercury on which the specimen floated and the mercury in the inner tube. The outer ring of mercury was maintained at the same potential as that in the inner tube and hence served as a guard ring to prevent leakage over the surface.

The volume resistivity of a material may depend upon its temperature, upon the applied voltage, and upon the amount of moisture absorbed by the material. The resistivity decreases with increasing temperature. The resistivity of most materials at 30 deg. C. is from one-half to one-third of the resistivity at 20 deg. Most materials show no change in resistance with change in the voltage until

the breakdown voltage is approached. However, if a porous material such as marble or slate has water absorbed in its pores the resistance will decrease with increasing voltage at comparatively low voltage. With 50 volts it is often found to be two or three times that with 500 volts. Most materials do not absorb enough moisture from the air to change the volume resistivity appreciably, but with porous materials such as marble, slate and unglazed porcelain, the absorption of moisture is sometimes sufficient to make the resistance in very humid air only one one-hundredth of that in very dry air.

Values for the volume resistivity of various materials are given in Table I. These are, in most cases, the mean of the measurements upon two or more samples. They were taken at 22 deg. C., using 200 volts. The measurements were made when the samples were dry.

The leakage over the surface of insulators is best determined by measurements of the surface resistance. The surface resistivity σ is the resistance between two opposite edges of a square centimeter of the film of water or other liquid which is condensed on the surface of the material. It may be expressed by the equation

$$\sigma = \frac{R' b}{l}$$

where R' is the resistance of a film of length l and breadth b . While for purposes of definition it is desirable to use a square centimeter, yet the equation shows that the size of the square is immaterial, since the resistance of a square inch or a square foot of a uniform film is the same as the resistance of a square centimeter.

There is no method by which the surface resistance alone can be measured. If two long metal strips are pressed upon the surface of a thick slab of insulating material so that their inner surfaces are one centimeter apart, the resistance per unit length of the strips due to the flow of current through the material is about three times the volume resistivity. Since this is in parallel with the surface

resistance, the total resistance T is given by the formula

$$\frac{1}{T} = \frac{1}{\sigma} + \frac{1}{3\rho} \therefore \sigma = \frac{3\rho T}{3\rho - T} = T \left[1 + \frac{T}{3\rho} + \left(\frac{T}{3\rho} \right)^2 + \dots \right]$$

Hence if $T/3\rho$ is small, $\sigma = T$ approximately. For most materials $T/3\rho$ is negligible, except when the material is in a very dry atmosphere.

The surface resistance of most materials is very much higher at low humidity than at high humidity. The exceptions are waxy materials such as paraffin and beeswax. For these any condensed moisture collects in drops

70 per cent humidity, however, the surface resistance decreases rapidly. New hard rubber maintains its high insulating properties only to 50 per cent humidity, while the resistance of glazed porcelain and old hard rubber decreases from the very lowest humidities. With the exception of paraffin the changes are very large. The resistance at high humidities of amber, glazed porcelain, and new hard rubber is about one-millionth of that at low humidities, while old hard rubber changes by a factor of 10^{11} , or 100 trillion.

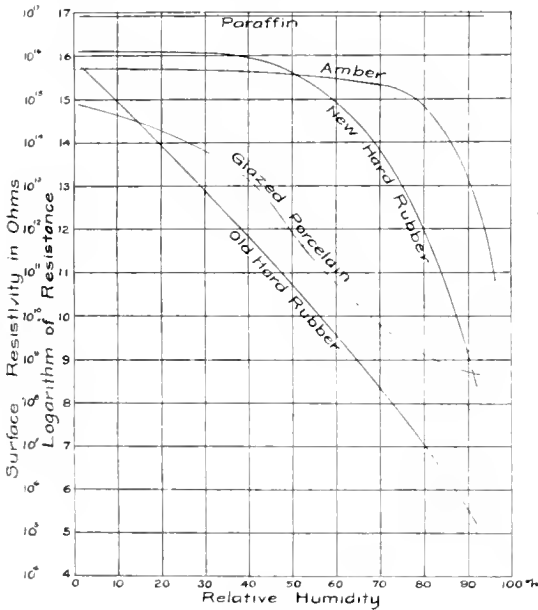


Fig. 1

Curves showing the relationship between surface resistance and relative humidity for some common insulators

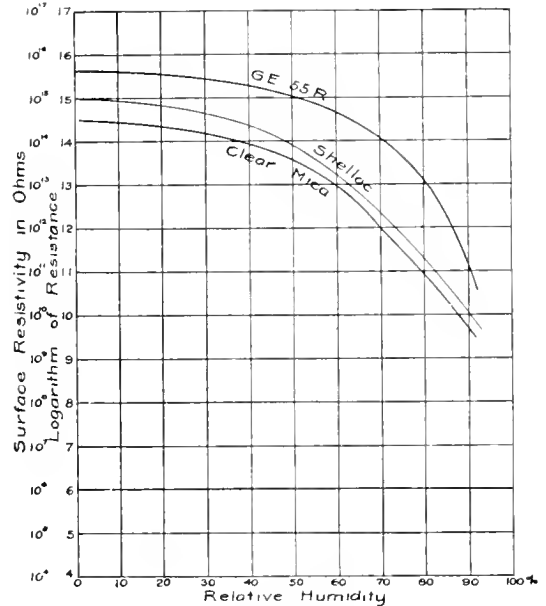


Fig. 2

and does not spread over the surface. With other materials the surface resistance is not infrequently a million times as great at low humidity as at high humidity. In one case the resistance changed by a factor of 10^{11} . To be able to show such enormous changes upon a curve it has been necessary to plot the logarithm of the resistance rather than the resistance. Three sets of curves are shown, covering materials of general interest. To facilitate comparison they are all plotted to the same scale.

The curves of Fig. 1 are grouped to show the very different behavior of some common insulators. They are all very good insulators at low humidity. Paraffin maintains its insulating properties at the highest humidities. Amber is an excellent insulator so long as the humidity is less than 70 per cent. Above

In Fig. 2 are grouped some materials which are good insulators. The G.E. 55R is one of several very similar moulding compounds which are being prepared by the General Electric Company. It compares very favorably with new hard rubber. Also it deteriorates very little, if at all, on exposure to light, which is in marked contrast to the behavior of hard rubber. Shellac was measured by coating a surface of glass. Also a number of compounds were measured in which shellac was used as a binder. In every case the curve was nearly identical with that shown. Evidently the shellac coated the other particles and the condensation was that caused by the shellac alone. The curve for mica is that for a very clear piece. A number of samples were examined and they showed great variability.

In Fig. 3 are given curves for some of the poorer insulators. The marble was a piece of clear Italian marble. The upper curve shows the effect of impregnating with paraffin. A piece was boiled in paraffin until bubbles ceased to come off. It was then sandpapered

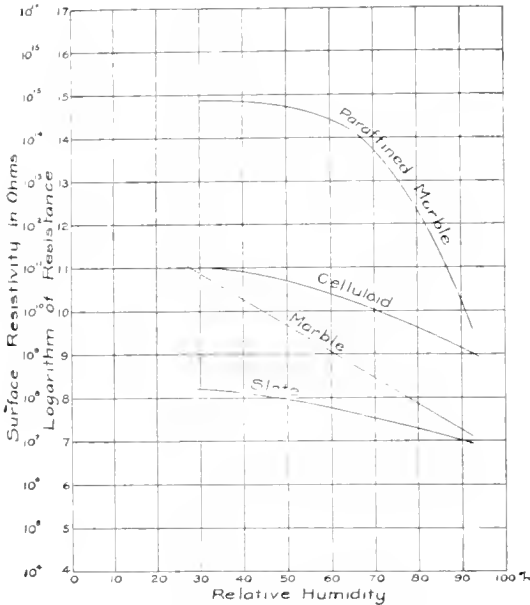


Fig. 3. Curves showing the relationship between surface resistance and relative humidity for some of the poorer insulators

to remove any paraffin which did not penetrate the marble. Experiments show that coloring materials do not materially affect the surface leakage of celluloid. Slate is very variable, and it would require many tests to fix an average value. It is one of the few insulators in common use where the current flowing through the volume of the material is usually greater than that flowing through the surface film.

Besides humidity there are other conditions which may affect surface leakage. Temperature produces an effect which is insignificant compared to the effect of humidity. However, exposure to light, either sunlight or ultra-violet light, may produce chemical changes at the surface which will greatly affect the surface resistance. Changes which may take place in hard rubber are indicated in Fig. 1. At 90 per cent humidity the new hard rubber had a resistance nearly 10,000 times as great as the old hard rubber which had deteriorated by exposure to sunlight. Other materials showed a slight deterioration, while some showed none at all.

Materials which are used in such places that they are either in constant service or must be available for service under all conditions must be judged by their poorest performance. Therefore in considering the surface leakage it is necessary to take the highest humidity to which the material is likely to be subjected. Within buildings the humidity occasionally is as high as 90 per cent. Hence insulators which are subjected to the normal fluctuations of humidity and which must be available for service at all times can best be judged by the value of the surface resistivity at 90 per cent humidity. For this reason the values of the surface resistivity at 90 per cent humidity are given in Table 2.

It should be noted that the surface resistance may be affected by very minute traces of foreign matter upon the surface. In the case of carefully cleaned quartz, the surface resistance corresponds very closely to that which is computed from the thickness of the water film* and the resistance of distilled water. But it requires only one one-hundredth of a milligram of common salt per square meter to lower the resistance by a factor of a thousand. With well cleaned glass, however, the resistance of the water of the film is much less than distilled water, corresponding quite closely to the resistance of water which has been thoroughly digested with pulverized glass. This shows that the water of the film dissolves material from the glass, so that a small amount of impurity on the surface will

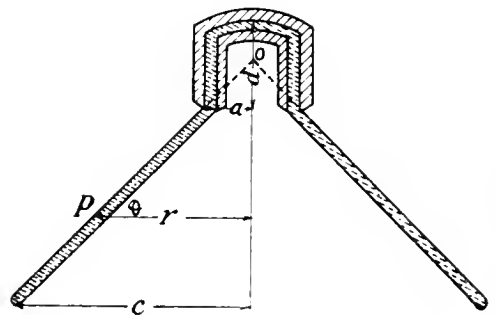


Fig. 4. Section of Porcelain Insulator between the electrodes, as assumed in example

not materially affect the surface resistance. In this same way the surface resistance of insoluble materials like rosin and amber will

*This was determined by Ihmori by weighing thin plates of quartz first in dry air and then in humid air. Wied. Ann. 31 p. 1006; 1887.

be greatly decreased by small amounts of soluble salts on the surface, while the surface resistance of soluble materials like mica and marble will be but slightly affected by their presence.

The above facts show that very slight differences between two samples will make marked differences in the surface resistance. A factor of 10 has often been observed between two samples which were supposed to be identical. The results which are given must,

therefore, be considered as giving the order of magnitude rather than exact values.

In order to facilitate the use of the results given in Tables I and II, Table III has been compiled. In it the materials are arranged in alphabetical order, and the volume resistivity and surface resistivity at 90 per cent humidity are given.

TABLE I

VOLUME RESISTIVITY OF MATERIALS

Material	Volume Resistivity
	Megamegohms*
Ceresin.....	Over 5,000,000
Paraffin, special.....	Over 5,000,000
Quartz, fused.....	Over 5,000,000
Hard rubber, new.....	1,000,000
Mica, clear.....	200,000
Sulphur.....	100,000
Amberite.....	50,000
Rosin.....	50,000
G.E. No. 55 R.....	40,000
Bakelite No. L 558.....	20,000
Electrose No. 8.....	20,000
Halowax No. 5055 B.....	20,000
Glyptol.....	10,000
Paraffin (Parowax).....	10,000
Shellac.....	10,000
Glass, Kavalier.....	8,000
Insulate No. 2.....	8,000
Sealing wax.....	8,000
Duranoid.....	3,000
Murdock No. 100.....	3,000
Beeswax, yellow.....	2,000
Khotinsky cement.....	2,000
G.E. No. 40.....	1,000
G.E. No. 55 A.....	1,000
Moulded mica.....	1,000
Porcelain, unglazed.....	300
Stabalite.....	30
Glass, plate.....	20
Halowax No. 1001.....	20
Dielectrite.....	5
Wood, paraffined mahogany.....	4
Gummon.....	3
Tegit.....	2
	Megohms
Bakelite No. 1.....	200,000
Wood, paraffined poplar.....	50,000
Condensite.....	40,000
Wood, paraffined maple.....	30,000
Celluloid.....	20,000
Lavite.....	20,000
Hemit.....	10,000
Marble, Italian.....	10,000
Fiber, red.....	5,000
Marble, pink Tennessee.....	5,000
Marble, blue Vermont.....	1,000
Ivory.....	200
Slate.....	100

TABLE II

SURFACE RESISTIVITY OF MATERIALS AT 90 PER CENT HUMIDITY

Material	Surface Resistivity at 90 per cent Humidity
	Megamegohms
Ceresin.....	Over 100,000
Paraffin, special.....	Over 100,000
Paraffin (Parowax).....	7,000
Bakelite No. L 558.....	900
Beeswax, yellow.....	500
Rosin.....	200
Sulphur.....	100
Sealing wax.....	80
Halowax No. 1001.....	70
Amberite.....	6
Electrose No. 8.....	2
Glyptol.....	2
	Megohms
Khotinsky cement.....	700,000
Halowax No. 5055 B.....	600,000
Insulate No. 2.....	400,000
G.E. No. 55 R.....	100,000
G.E. No. 40.....	10,000
G.E. No. 55 A.....	10,000
Shellac.....	10,000
Wood, paraffined mahogany.....	7,000
Mica, clear.....	5,000
Moulded mica.....	3,000
Murdock No. 100.....	2,000
Wood, paraffined maple.....	2,000
Wood, paraffined poplar.....	2,000
Celluloid.....	1,000
Condensite.....	1,000
Glass, Kavalier.....	1,000
Hard rubber, new.....	1,000
Porcelain, glazed.....	600
Gummon.....	400
Hemit.....	400
Duranoid.....	300
Bakelite No. 1.....	200
Fiber, red.....	200
Quartz, fused.....	200
Lavite.....	100
Porcelain, unglazed.....	60
Tegit.....	50
Dielectrite.....	40
Ivory.....	40
Stabalite.....	40
Marble, pink Tennessee.....	30
Glass, plate.....	20
Marble, Italian.....	20
Marble, blue Vermont.....	10
Slate.....	10

*A megamegohm is a million megohms.

As an example of the method of using the results for the estimation of resistance, the resistance between two electrodes insulated by a porcelain insulator of the form shown in cross-section in Fig. 4 will be computed. The resistance may be taken as that of two circuits in parallel; viz., that through the insulator and that over the surface. The

TABLE III
VOLUME AND SURFACE RESISTIVITY
OF MATERIALS

Material	Volume Resistivity Ohm-Cms.	Surface Resistivity at 90 Per Cent Humidity
Amberite	5×10^{17}	6×10^{12}
Bakelite No.1	2×10^{11}	2×10^9
Bakelite No. L 558	2×10^{16}	9×10^{13}
Beeswax, yellow	2×10^{13}	5×10^{14}
Celluloid	2×10^{10}	1×10^9
Ceresin	Over 5×10^{15}	Over 1×10^{17}
Condensite	4×10^{10}	1×10^{11}
Dielectrite	5×10^{12}	4×10^7
Duranoid	3×10^{17}	3×10^7
Electrose No. 8	2×10^{15}	2×10^{12}
Fiber, red	5×10^8	2×10^8
G.E. No. 40	1×10^{12}	1×10^{10}
G.E. No. 55 A	1×10^{15}	1×10^{15}
G.E. No. 55 R	4×10^{15}	1×10^{11}
Glass, Kavalier	8×10^{13}	1×10^7
Glass, plate	2×10^{13}	2×10^7
Glyptol	1×10^{15}	2×10^{12}
Gummon	3×10^{12}	4×10^8
Halowax No. 1001	2×10^{13}	7×10^{13}
Halowax No. 5055 B	2×10^{15}	6×10^{11}
Hard rubber, new	1×10^{15}	1×10^9
Hemit	1×10^{10}	4×10^8
Insulate No. 2	8×10^{15}	4×10^{11}
Ivory	2×10^8	4×10^7
Khotinsky cement	2×10^{13}	7×10^{11}
Lavite	2×10^{10}	1×10^8
Marble, Italian	1×10^{10}	2×10^7
Marble, pink Tennessee	5×10^7	3×10^7
Marble, blue Vermont	1×10^8	1×10^7
Mica, clear	2×10^{17}	5×10^9
Moulded mica	1×10^{13}	3×10^9
Murdock No. 100	3×10^{15}	2×10^9
Paraffin special	Over 5×10^{18}	Over 1×10^{17}
Paraffin (Parowax)	1×10^{16}	7×10^{15}
Porcelain, glazed		6×10^8
Porcelain, unglazed	3×10^{14}	6×10^7
Quartz, fused	Over 5×10^{15}	2×10^9
Rosin	5×10^{15}	2×10^{14}
Sealing wax	8×10^{15}	8×10^{13}
Shellac	1×10^{16}	1×10^{10}
Slate	1×10^8	1×10^7
Stabalite	3×10^{13}	4×10^7
Sulphur	1×10^{17}	1×10^{14}
Tegit	2×10^{12}	5×10^7
Wood, paraffined mahogany	4×10^{12}	7×10^9
Wood, paraffined maple	3×10^{11}	2×10^9
Wood, paraffined poplar	5×10^{11}	2×10^9

resistance R through the insulator will be

$$R = \frac{\rho l}{A} = \frac{\rho t}{2 \pi a d + \pi d^2} \text{ approximately, where}$$

t is the thickness of the porcelain, and a and d have the values indicated. The surface resistance between the outside electrode and the lower rim can be found by the following method. Let P be any point on the surface. The resistance of a circular element of the surface of width ds and circumference $2\pi r$ is

$\frac{\sigma ds}{2 \pi r}$: The total surface resistance R' is

$$R' = \int_a^c \frac{\sigma ds}{2 \pi r}$$

But $s = \frac{r}{\cos \delta}$ where $s = OP$

$$\therefore ds = dr \cos \delta$$

$$\text{Hence } R' = \frac{\sigma}{2 \pi \cos \delta} \int_a^c \frac{dr}{r} = \frac{\sigma}{2 \pi \cos \delta} \ln \frac{c}{a} = \frac{2.3 \sigma}{2 \pi \cos \delta} \log \frac{c}{a}$$

The resistance of the inside surface will be the same, so that the total surface resistance between electrodes is

$$\frac{2.3 \sigma}{\pi \cos \delta} \log \frac{c}{a}$$

To find a numerical value, assume

- $t = 1 \text{ cm}$
- $a = 5 \text{ cm}$
- $d = 5 \text{ cm}$
- $c = 20 \text{ cm}$
- $\delta = 45^\circ$
- $\sigma = 6 \times 10^8$ the value at 90 per cent humidity
- $\rho = 3 \times 10^{14}$

The value of ρ is taken as that of unglazed porcelain, since that under the electrodes is seldom glazed.

Then $R = 1 \times 10^{12}$ ohms, the resistance through the porcelain, and $R' = 4 \times 10^8$ ohms, the resistance over the surface. But the current through R is negligible in comparison with that through R' , so that the resistance between the electrodes is 4×10^8 ohms at 90 per cent humidity.

If the relative humidity is 40 per cent σ will be 2×10^{13} , and R' becomes 1×10^{13} .

The total resistance T is $\frac{R R'}{R + R'} = 9 \times 10^{11}$

which is only slightly less than R . At lower values of the humidity, the surface resistance becomes of less importance, so that for a

porcelain insulator of this form the leakage over the surface at humidities below 40 per cent is negligible.

These results show that the surface resistance must always be considered where the resistance of a solid insulator is being measured. The surface leakage may become

negligible at very low humidities. In other cases it becomes necessary to estimate its amount. For a considerable part of the cases which occur in practice the surface resistance is so much lower than the volume resistance that the latter does not need to be considered.

WATER RHEOSTATS

BY N. L. REA

CONSTRUCTION DEPARTMENT, GENERAL ELECTRIC COMPANY

A water rheostat is of great service in making heat runs and other tests on large generators. Below 2300 volts salting is necessary and a tank must therefore be used; although it is usually possible to step up the voltage and thus avoid this nuisance. With hydro-electric plants it is customary to suspend the rheostat electrodes in the forebay or tail race, preferably in running water to get rid of the gases. The results of some tests on rheostats of this kind are given. A number of wrong principles in design and construction of tank rheostats are mentioned, with recommendations for correcting the faults.—EDITOR.

It is often necessary to make heat-run tests on large generators after installation, which usually necessitates some form of artificial load. Many experiments have been made to devise a cheap, reliable, and satisfactory form of temporary water rheostat.

For voltages below 2300, salt must be used to lower the water resistance and therefore it is necessary to build a tank to hold the electrolyte. In the majority of cases, however, it is possible to step up the voltage and to connect the artificial load to the high-tension side of the transformers.

Water rheostats have been used satisfactorily for voltages as high as 45,000. Water rheostats for hydro-electric plants are usually installed either in the tail-race or in the forebay; and many experiments on spacing, type of electrodes, etc., have disclosed some surprising results. For use as electrodes, the following have been tried: spheres, copper bar or rods, carbon rods, iron plates, and iron pipes. The two latter give very good results and are usually available in a power-station. Rectangular plates are used which are hung from one corner by a rope to a strain insulator, or the rope may be tied to a standard line insulator installed horizontally. With this latter arrangement, it is, of course, necessary to disconnect the rheostat when making adjustments.

It has been found that the spacing of the plates (the distance between them) has very little, if any, influence on the load capacity. The surface contact resistance is the governing factor, for the same electrode surface passes practically the same current whether the plates are five or fifty feet apart. In a three-phase circuit, plates arranged in a straight

line with uneven spacing give apparently the same degree of balanced load as is furnished by a carefully arranged equilateral triangle.

When it is necessary to use more than one electrode per phase, more current will be transmitted if the connected plates are separated several feet than if they hang close together. If possible, the electrodes should be hung in running water to carry away the steam and gases which form on their surfaces; otherwise, arcing may be caused by this gas blowing the water away from the electrodes. In some cases the rheostat has been placed in the tail-race, and protected from waves by a hollow square of timbers. These timbers

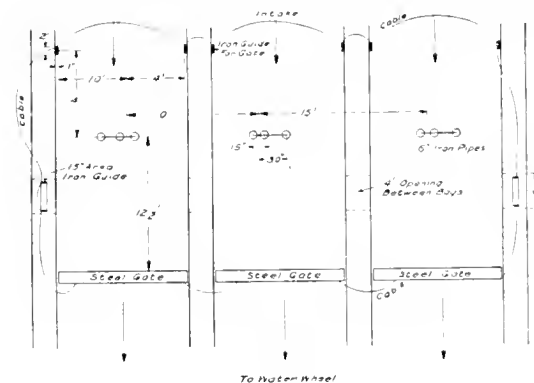


Fig. 1. Arrangement of Pipe Electrodes for Water Rheostat

must, however, be kept at some little distance from the electrodes or they will be carbonized by the current flowing over them and eventually take fire. It is rather astonishing to see a log apparently blazing under several inches of water. If the electrodes are installed inside

the building, care must be taken to eliminate the possibility of accidental shocks to operator.

It is advisable that all adjacent metal parts of the building be connected together with cables as a protection to persons and to

that considerable current was carried by these cables. The steel gates themselves are connected by shafting. No trouble, whatever, was found in keeping the load balanced with the same length of pipe electrode in each bay; there was no steaming at the pipes, and one could not tell by looking at them when the load was on or off the rheostat.

The curves were taken while experimenting on the number and length of electrodes necessary for this series of tests.

Under some conditions it is impossible to secure satisfactory results with a temporary arrangement such as just outlined; or again, it may be desirable to have a permanent rheostat as part of the power-station equipment.

The first cost and maintenance of a permanent rheostat is small and the expenditure is usually warranted by the advantages offered by the equipment. This is especially true for hydro-electric stations of any considerable size, or for those which contain several units. A good rheostat gives a ready and convenient means for testing machines or adjusting governors without interfering with the commercial operation of the power-station.

Much thought, time, and money have been expended in the past on various schemes of water rheostat design, and the same ground has been covered many times by different engineers. The natural way of approaching the problem is to construct some form of tank provided with an overflow and with a pipe for admitting fresh water at a point opposite the overflow. Then electrodes of pipe or iron plates are hung in the tank with ropes and strain insulators. This arrangement has the same capacity limitations as has the temporary rheostat, for satisfactory service is impossible when violent gassing (and consequent arcing at the electrodes) takes place. This arcing usually occurs at lower capacities in tank rheostats than in temporary outfits, due to the smaller amount and the poorer distribution of the fresh water.

Errors are frequently found in the design and construction of tanks, in the arrangement

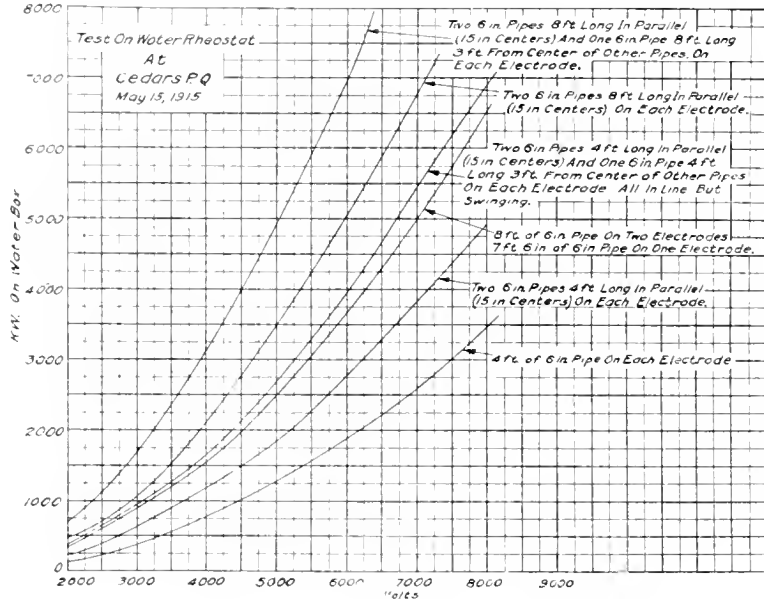


Fig. 2. Tests on Water Rheostat shown in Fig. 1

prevent burning between the iron and concrete. Any iron embedded in concrete seems to cause a concentration of current at that point.

Where rheostats are installed in running water a large number of fish are usually killed. When the plates are comparatively close together, a large fish lodged between them seems to offer less resistance than water and it carries enough current to burn it to a crisp.

A series of tests was recently made at the Cedars Rapids Manufacturing & Power Company. Fig. 1 is a sketch showing the arrangement of pipe electrodes used in this particular case, and Fig. 2 gives the curves resulting from the test. This water rheostat was located in the head-race and arranged as shown in Fig. 1. About 1000 cubic feet of water flowed through each bay per second while the rheostat was being tested. A large part of the surface of the steel headgates is always under water, so that these gates and all other iron in the water around the rheostat were connected together by cables as shown in the sketch. A loose connection showed

of electrodes, and in the manner of admitting cooling water. Some of the more common errors will be named, and the remedies developed by experience with various types will be described.

Wooden tanks have been constructed using the iron hoops common to stave construction, only to find that the current came through between the staves to the iron hoops and quickly burned many holes. This trouble can be overcome by several inside bands of flat bar iron against the inside surface of the tank. These bars must be firmly secured in place by bolts and vertical iron straps connecting the several bands together.

Many of these tanks have been carefully insulated from the ground which is unnecessary as the rheostat operates as well, and is much safer, with the tank grounded. Boiler plate or concrete construction is preferable to wood. It is advisable that metal reinforcing be omitted from concrete tanks, due to the lack of definite data on the effect of current on this reinforcement.

It has been found that a more intelligent use of cooling water will overcome arcing at

the electrodes and allow of a much higher load capacity. Two schemes have been used successfully. Both of them have, as a basis, a false bottom in a portion of the tank with some means for admitting the cooling water under pressure to this space.

The first rheostat constructed along these lines had three vertical wooden posts attached to the bottom of the tank and the pipe electrodes were slid over the posts. Several small holes were drilled in this false bottom around these posts. The pipes were kept from swinging and the jets of water played over the electrode surface, cooling and sweeping away any gas or steam.

In a later rheostat, the posts were made one-half inch smaller in diameter than the pipes and a large hole was drilled through them into the cold water space under the false bottom. The electrodes were capped to compel the cooling water to flow down between the outside of the post and the inside surface of the pipe.

With this arrangement the tank can be liberally salted, and loads up to 15,000 kw. at 13,000 volts have been carried without the least trouble from arcing.

PRACTICAL EXPERIENCE IN THE OPERATION OF ELECTRICAL MACHINERY

PART XII (Nos. 57 TO 59 INC.)

By E. C. PARHAM

CONSTRUCTION DEPARTMENT, GENERAL ELECTRIC COMPANY

(57) CRANE TROUBLES

Fig. 1 shows diagrammatically the connections of the limit-switch of a hoist induction motor and of that section of the controller which is connected to the motor stator. The object of the limit-switch is to open the motor circuit if the operator should forget and allow the motor to raise the hoist too far. Under this condition a ball carried by the hoist rope interferes with a lever, the consequent movement of which separates contacts *a* and *c* from contacts *b* and *d*, respectively. The opening of these contacts interrupts the L^1 and L^2 line wires that pass through the controller before going to the motor. On the down side of the controller a by-pass is provided to short-circuit the limit-switch contacts. This provision is made in order that, after the ball has opened the contacts of the limit switch, the controller may be used for lowering the hook but not

for raising it. Of course if the limit-switch contacts fail to touch for any local reason, the raising motion will become inoperative but the lowering motion will not.

An operator had run the hook too high and had tripped the limit-switch. Upon throwing the controller to the down side, the motor would hum and the electric brake would release but the hook would not lower. Ringing out with a magneto proved that all the wire parts of the lowering circuit were intact. Upon testing the controller cylinder, however, no ring could be obtained through strip *e* which was used to connect two cylinder segments together. An inspection disclosed the fact that a screw had worked loose in this strip so that finger *f* represented one side of a break in the circuit. This instance is cited because, out of a total of twenty or more controllers that had been subjected to unusually exacting service for over a year, this

simple defect was the only one that had given the local electrician trouble to locate. The same symptoms would have been caused by a loose finger *f*, also by excessive burning of that finger. A poor connection of tap *t* would have interrupted the stator circuit thereby

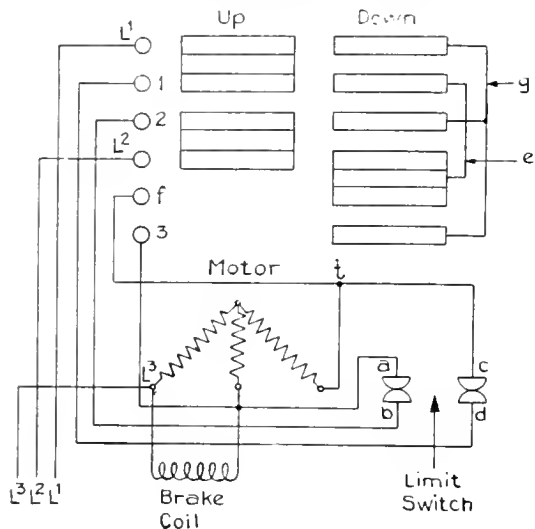


Fig. 1

rendering the crane inoperative in both directions.

It will be noticed that contacts *a* and *b* are connected to fingers 3 and 2, respectively, and that strip *g* short-circuits them on all down positions; also contacts *c* and *d* are connected to fingers *f* and 1 respectively, and that strip *e* short-circuits them on all down positions. Therefore, the hoist can be lowered whether the limit switch is closed or not, but it cannot be raised if either member of the switch is open because each member is in series with one of the raising circuits. In many cases where it is practicable to lower on all positions but impracticable to raise on any, inspection of the limit-switch will likely disclose a bad contact that may not be evident to the eye. Contact failure of fingers 1, 2, 3 or *f*, possibly on account of the cylinder having become eccentric, its shaft bent, or its bearings loose, will give the same symptoms for under any of these conditions the fingers may make contact only on certain positions of the cylinder.

On a similar crane that had just been installed, the line fuses would blow as soon as the controller handle was put on the first notch in either direction. This was found to be due to the connecting of limit switch wire

a to the L^3 stator wire instead of to the L^2 , as in the diagram. On another occasion the crane could be made to lower a load on all positions but could not be made to raise the load on any position. This was found to be due to a blown fuse; the open-circuit really disabled both the raising and the lowering circuits but the weight of the load was sufficient to lower it and there was too much noise to permit of noticing that the motor was not operating.

(58) MOTOR STOPPED AND REVERSED

When two alternators of the same voltage and frequency are driven by separate engines and are operated in parallel, the electrical interaction between them tends to keep them in step. This interaction consists of a local synchronizing cross current that always flows to the machine of lower frequency during the motor part of the cycle. The motor action of the lower frequency machine and the simultaneously increased generator duty of the higher frequency machine tend to equalize the frequencies.

Where the two alternators are not operated in parallel, however, this synchronizing action cannot exist; and in such a case a slight difference of speed will continuously and progressively change the phase relations of the two machines. This happens because the frequencies will be slightly different, and under this condition the higher frequency cycle will, at regular intervals, lead, coincide with, and fall behind (in regard to the relative speed of phase rotation) the cycle of the lower frequency.

A certain power-station equipment included two quarter-phase alternators; they were driven from different engines and were electrically isolated. A contractor installed a 10-horse power, three-phase motor at some distance from the station. The motor was

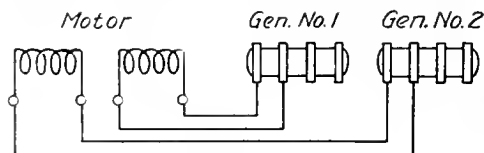


Fig. 2

connected to its compensator and trials proved the direction of rotation to be as desired.

A few days later the contractor was called in and was told that the motor was heating, although it had never been connected to the

load; and he was further informed that at that moment the motor was operating in the direction opposite to that in which it had run in its trial. He thought, of course, that some one had tampered with the wires; but this proved to be untrue. The key to the situation was suggested by the fact that, when the inspector got there, the motor was humming but not running. This action indicated single-phase operation and, as the operator could not recall having seen the motor stall before, an inspection was started in order to locate an open-circuit in one of the line wires. The humming of the motor was due to single-phase operation, but this was not caused by an open-circuit in the ordinary sense of that word. The action resulted from one of the quarter-phase generators having been shut down.

The wireman, who had tapped the motor line to the station service wires, had connected one phase of the motor to the conductors from one generator and the other phase to the conductors from the other generator as is indicated in Fig. 2, instead of connecting both phases of the motor to the same generator. The reversal of the motor's rotation had been due to phase rotation reversals incident to the frequency differences of the two alternators. The excessive heating had been caused by prolonged overloads that were incident to the motor being repeatedly retarded, stopped, reversed, and accelerated in the opposite direction.

Had the motor been loaded, it probably would have burned out for its circuit included no fuses or other automatic circuit breaking devices.

(59) UNSTABLE VOLTAGE

In Fig. 3 is illustrated the rise in the no-load voltage of an armature when the field current of the generator is gradually increased from zero to the value that corresponds to the practical saturation of the magnetic circuit. When the field current is small an increase a in its value produces an increase b in the value of the armature voltage. When the field current is large, however, an increase a in its value produces a much smaller increase b' or b'' in the voltage, because the field core is saturated, i.e., a given increase in the magnetizing current cannot add as much to the magnetism. Similarly, if the magnetizing current be gradually decreased from a high

value to zero, as soon as a value which corresponds to the steep part of the voltage curve is reached, a small decrease in the field current will produce a comparatively large decrease in the armature voltage. Practically, this means that when a generator is operated

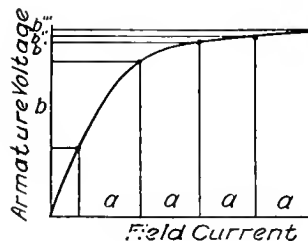


Fig. 3

with a weak field, the field will be unstable and so will be the dependent armature voltage. This takes place because a slight change in speed, in load, in brush contact, or in armature reaction will affect the voltage that is applied to the field circuit and there will result a disproportionate change in the armature voltage, thereby again affecting the value of the field current.

An operator complained that the voltage of his alternator varied so much that he could not operate the dependent motors satisfactorily. An inspector found that almost all of the voltage regulation was being effected by means of the exciter field rheostat, the alternator rheostat usually being entirely cut out. As a result of this procedure, the 125-volt exciter was being operated at voltages from 50 to 70 volts under the average conditions; and as there was no automatic voltage regulation, it was necessary to keep a man at the switchboard.

By gradually increasing the exciter voltage by means of the exciter rheostat and at the same time maintaining the alternator voltage by means of the alternator field rheostat, the exciter and the alternator were both adjusted to operate at their respective normal voltages; and the operation was greatly improved.

On the other hand, many instances of poor commutation of the exciter have been traced to the practice of operating with a considerable resistance in the alternator field rheostat, thereby necessitating an abnormal exciter voltage in order to obtain the required exciting current.

HISTORY OF THE SCHENECTADY SECTION OF THE

A. I. E. E.

(THE LARGEST SECTION OF THE INSTITUTE)

By S. M. CREGO

The Schenectady Section of the American Institute of Electrical Engineers grew from a small engineering club fostered by the General Electric Company and limited to its employees. Thus was the General Electric Engineering Society, organized in the summer of 1898 at a meeting of engineers at which Mr. W. J. Clark, now Manager of the Traction Department of the General Electric Company, presided.

Mr. W. H. Buck, now of the firm of Viele, Blackwell & Buck, was elected President of the new society and Mr. J. H. Jenkins, now Supply Manager of the Foreign Department of the General Electric Company, Secretary. Succeeding Mr. Buck two years later, Mr. Jenkins held the office of President for the next two years, and during his term of office the Society had grown to such size that it was necessary to secure new quarters for its monthly lectures.

A constitution and set of by-laws were adopted on June 1, 1898. A copy of these is still extant.

The Club's activities were not limited to the electrical field but embraced subjects of general engineering interest. Electrical subjects, however, were naturally given most attention, and the following list of speakers and subjects may be taken as representative:

Mr. E. W. Rice, Jr., Problems of Modern Central Station Design.

Prof. Elihu Thomson, Lightning and Lightning Arresters.

Dr. W. R. Whitney, Electric Chemistry.

Mr. W. J. Foster, Design of Alternators.

Mr. A. H. Armstrong, Current Railway Problems.

The General Electric Engineering Club soon recognized the advantages to be derived by merging with the American Institute of Electrical Engineers, and on January 26, 1903, it became known as the Schenectady Section of the A.I.E.E., Dr. C. P. Steinmetz being elected its first Chairman. Dr. Steinmetz officiated for three successive years and was followed by Mr. D. B. Rushmore, who held the office for two years. The following

members in the order named have held the Chairmanship for one year:

Mr. E. J. Berg,
Mr. M. O. Troy,
Mr. E. A. Baldwin,
Mr. E. B. Merriam,
Mr. J. B. Taylor,
Mr. G. H. Hill,
Mr. H. M. Hobart.

In the season of 1913-14 the Section was fortunate to be able to establish permanent and commodious headquarters in the building just then completed for the Edison Club. The auditorium of this building has a seating capacity of 500. The Edison Club has also placed at the disposal of the Section an office in the building for the purpose of committee meetings. This also serves as the Secretary's office.

The Schenectady Section was the ninth to be recognized by the Institute, and it is now the largest of the Institute's thirty-one Sections. Its activity and membership standing are indicated in the following table which shows statistics of the seven largest sections:

Rank	Name of Section	Number of Members	Number of Meetings Held During Past Season
1	Schenectady	791	18
2	Lynn	528	14
3	Chicago	450	7
4	Boston	392	10
5	Pittsburgh	378	9
6	Philadelphia	298	13
7	Pittsfield	275	11

The Schenectady Section has been exceptionally fortunate in being able to secure for its meetings speakers of authority in their respective spheres. That this has been the rule from the inception of the organization is in some measure an indication of the influential position which the Section occupies. The frequency of the meetings has varied somewhat in different years, but even during

the past season, when an unprecedentedly large number of meetings were held, no difficulty was experienced in securing the desired speaker for each of the eighteen meetings.

The Season's activities are varied by occasional meetings of a purely social nature, two of these, in the form of smokers, having been held last year. The season is usually ended by a dinner.

Fig. 1 shows the yearly increase in the membership of the American Institute of

foremen, and others of the General Electric Company's factory organization, with the hope that these men would be interested in securing the advantages of the Section by becoming active members.

The Apparatus Committee was assigned the duty of obtaining and installing apparatus needed by lecturers for experimental demonstrations.

The Classes Committee was formed to determine whether the Section members desired to organize classes and study subjects

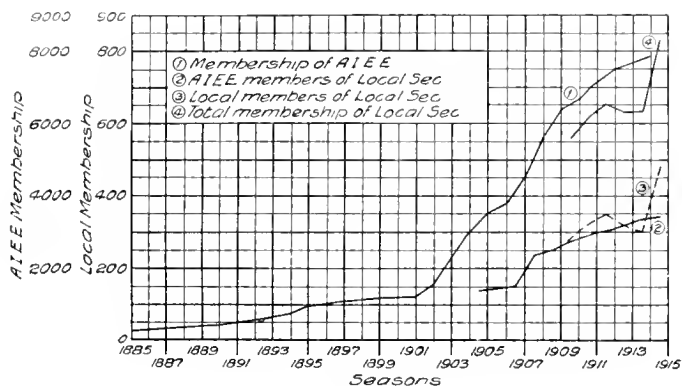


Fig. 1

Electrical Engineers and of the local organization. The Section now has 791 members. Of this number 336 are National members and 455 are Local members. It will be seen from the curves that during the present season the total number of members has increased by 156. The Treasurer reports the financial standing as excellent.

As an innovation, special committees on Factory Co-operation, Apparatus and Classes were appointed during the past season.

The Factory Co-operation Committee issued complimentary tickets for one or more meetings to the factory superintendents and

of general interest to members. Two classes, one in geology and one in photography, are now holding regular meetings.

For the coming season the Chairman is Mr. L. T. Robinson, the Secretary Mr. F. W. Peck, Jr., and the Treasurer Mr. W. S. Bralley. The Section is now in a very flourishing condition and has every promise for a future of continued usefulness and success.

The first meeting of the tenth season is scheduled for Oct. 12th (subject to change), at which Mr. J. J. Carty, Chairman of the A.I.E.E., expects to be present.

FROM THE CONSULTING ENGINEERING DEPARTMENT OF THE
GENERAL ELECTRIC COMPANY

INSULATION TESTING

The development of insulating materials has reached such a stage that radical changes in the standard materials are not to be expected. Improvement then lies in the treatment and application of these materials and a closer study of their electrical characteristics. At present little is known, for instance, of the relative importance of moisture, non-homogeneous, ionization, temperature changes, etc., insofar as they affect the electrical characteristics. A study along these lines is analogous to the study of magnetics and there is every reason to hope that the resulting improvement of insulating materials will be as pronounced as was the case with iron and steel.

It has often been asserted that dielectric strength measurements give sufficient information concerning the electrical behavior of insulating materials. Dielectric strength measurements simply show an ultimate effect and in this respect are a valuable help in the study of dielectrics. What takes place before breakdown occurs can only be determined by energy loss measurements. These measurements are, then, just as indispensable as dielectric strength measurements, for in the study of any subject the object aimed at is to discover both cause and effect.

There are a number of methods developed for measuring dielectric energy loss but most of these are limited to comparatively low voltages. The two high voltage methods that have proved the most practical make use of the cathode ray tube and the dynamometer wattmeter.

The cathode ray tube and its application are fully described in a paper read before the A.I.E.E., July, 1915, page 1115, by Mr. J. P. Minton of the Pittsfield Laboratory. This paper gives also a clear and concise summary of the progress made in the study of insulating materials.

A phase shifting method, making use of the dynamometer wattmeter, is being

developed in the Consulting Engineering Laboratory. It will greatly increase the accuracy of these readings, especially at very low power-factors.

The behavior of insulating materials under high frequency stress is now receiving the attention it deserves. When you consider that a large percentage of insulation failures are due to high frequency surges, it seems unusual that more attention has not been paid to this subject in the past. Materials that are superior to others under continued low frequency stress are not necessarily superior under transient high frequency stress. Comparative low and high frequency breakdown tests give very interesting results and are of considerable help to the designer of high voltage apparatus in selecting the most suitable insulating material.

The high frequency test is also a valuable aid in studying designs. As a rule, the weakest spots of a design under low frequency stress are the hot spots, where accumulative effects can cause final breakdown. Under high frequency stress the end turns of windings must bear the greater burden and it is here that trouble usually occurs. In studying high voltage designs, then, it is necessary to make tests at both low and high frequency.

There is one other development in insulation testing that is quite promising. Direct current voltages comparable in value with alternating current testing voltages can be obtained by the use of the new high voltage kenotron. This makes it possible to investigate the behavior of commercial insulations under equivalent values of direct current and alternating current stresses.

The kenotron has also proved of practical value in testing out long lengths of underground cable. The large capacity and consequent charging current often makes an alternating current test impractical.

G. B. SHANKLIN

GENERAL ELECTRIC REVIEW

A MONTHLY MAGAZINE FOR ENGINEERS

Manager, M. P. RICE

Editor, JOHN R. HEWETT

Associate Editor, B. M. EOFF
Assistant Editor, E. C. SANDERS

Subscription Rates: United States and Mexico, \$2.00 per year; Canada, \$2.25 per year; Foreign, \$2.50 per year; payable in advance. Remit by post-office or express money orders, bank checks or drafts, made payable to the *General Electric Review*, Schenectady, N. Y.

Entered as second-class matter, March 26, 1912, at the post-office at Schenectady, N. Y., under the Act of March, 1879.

VOL. XVIII., No. 11

Copyright, 1915
by General Electric Company

NOVEMBER, 1915

CONTENTS

	PAGE
Frontispiece, Dr. W. R. Whitney	1010
Editorial: The Paths of Progress	1011
Research	1012
BY DR. W. R. WHITNEY	
Electrical Equipment of the Vermont Marble Company	1015
BY JOHN LISTON	
The Thury System of Direct Current Transmission	1026
BY WILLIAM BAUM	
The Kinetic Theory of Gases	1042
BY DR. SAUL DUSHMAN	
Electrical Characteristics of Solid Insulations	1050
BY F. W. PEEK, JR.	
Isolated Power-House for Factories	1057
BY W. E. FRANCIS	
Mechanical Effects of Electrical Short-Circuits	1066
BY S. H. WEAVER	
The Theory of Lubrication, Part II	1074
BY L. UBBELOHDE	
Translated from <i>Petroleum</i> by HELEN R. HOSMER	
Practical Experience in the Operation of Electrical Machinery, Part XIII	1082
Armature Threw Solder; Load Was Unbalanced; Stator Coil Connections	
BY F. C. PARHAM	
From the Consulting Engineering Department of the General Electric Company	1084
Question and Answer Section	1085

GENERAL ELECTRIC

REVIEW

THE PATHS OF PROGRESS

The Panama-Pacific International Exposition has been the occasion for many gatherings of engineering and scientific societies at San Francisco during the summer and autumn of 1915, and a great amount of work has been accomplished. The subjects dealt with at these Conventions and Congresses are too many and too varied to permit of even a brief review. Most of these meetings were exceedingly well attended and were, beyond doubt, highly successful.

But, as is usual with such gatherings, the full benefit of the technical papers and discussions will only be felt by each individual after he has selected, read, and digested those papers in which he is particularly interested. The great mass of useful and interesting data presented precludes any one individual from attempting to even read one-half of the papers prepared.

The personal element always enters largely into the usefulness of such meetings, and we feel in this special instance that the personal element played an unusually important part.

The fact that so many notable meetings were held on the Pacific Coast this year will have a beneficial effect upon the engineering community throughout the country, as it has led to so many visiting the West that otherwise might never have taken the opportunity.

In the past the West has learned much from the East, and we feel that the East has still a great deal to learn from the West. This latter is especially true in those cases where the East is catering for Western business. A thorough understanding of each other's problems and requirements is essential to both parties for the best results, and this

year's meetings in the West should materially help in this direction.

The developments on the West Coast are something of which the whole nation may justly be proud, and the future of the Western states may be looked forward to with utmost confidence and satisfaction. The same spirit that has developed the natural resources of the West to their present stage can be depended upon to produce still more wonderful results in years to come.

The further development of the West is to be the work of the Engineer, in even a more marked degree than in any other section of the country. The greatest essential is a plentiful supply of energy. Much has already been developed; indeed we have noted some instances where more power has been developed than is at present used, and many cases where much more power can be obtained from sources already tapped. The problem will resolve itself largely into one of distribution; this is especially true for mining and agricultural work in districts that are not closely settled.

In a country where so much land must lie fallow until the Engineer brings water to the soil, distribution over large areas becomes the vital problem. The cost of such distribution is high; it is sometimes even prohibitive. Consequently, we sincerely trust that no unnecessary restrictions will be placed in the way of the Western Engineer in this great development work. In the construction of the necessary distribution systems it will be impossible to use the same class of work as is used in many more closely settled communities. Some cheaper form of construction is essential and any burdensome laws and regulations will only retard progress.

RESEARCH

BY DR. W. R. WHITNEY

DIRECTOR OF RESEARCH LABORATORY, GENERAL ELECTRIC COMPANY

It is pointed out in the beginning of this article that the processes of the world's work, or improvements in them, are made possible only by attaining an increased knowledge relative to them. Such knowledge can only be secured from research. It is also called to attention that while the result of a research may show that the desideratum is not to be attained along the line investigated, the resulting knowledge is almost certain to be of great value in some other direction. The present war has brought a number of nations to a startling realization of the need for extensive research to strengthen their national defence.—EDITOR.

The president of a manufacturing company who was hesitatingly considering the possible recovery of valuable waste solvents from a chemical process said: "You know we are making photographic paper and are not interested in the solvents. We buy them, use them and make a profit on the product." In other words, the existing condition was not unsatisfactory. It seemed, in fact, perfectly satisfactory. Nevertheless, he realized that this view was not foresighted and he corrected it to his advantage. A process or product susceptible of economical improvement, as are all of them, cannot be looked upon as an entity, enduring and unalterable. It changes like everything else. What this man wanted was that his process instead of continuing as it was, the best among its contemporaries, should become as it was not, the best among its future competitors. He really wanted continuing profit. Perhaps it is the impossibility of actually seeing what is not which accounts for our faith in what is: but who can name a product, a process, or even a faith which does not alter with time? One might almost say that the most typical impossibilities of one decade often become the liveliest realities of the next. Darius Green and Captain Nemo certainly taught us something. Rather than suppose that we will ever reach a stationary state of perfection in anything, it is more interesting and probable to assume that for some reason, either highly complex like the union of heredity and environment, or simply mechanical like the grain size in our gray matter, we cannot really conceive a physical impossibility. A good working hypothesis is: If it can really be conceived, then it may be made. If one deliberately analyzes the history of any manufactured article he is struck with its active mutation. This ought to jar one's feeling of complacency, but usually it does not. The things laboriously made in units by hand today will be made in dozens by machines or assembled on endless conveyors tomorrow.

Even in the oldest business of the world the continuous order of change is evident. The wooden plow was displaced by one forged

from the battle ax. Someone invented the coulter, and then came the moldboards of all shapes and sizes, and the wheel. Some Americans produced the light chilled plow, and others discovered that a man could ride and still plow. Then, before the plow business stopped growing, the double Michigan plows came along (a little one in front of a larger one), and then two large ones in echelon (for making a double furrow), next, multiple plows drawn by rope or windlass with steam power, then steam tractors and then gasoline tractors with twenty or thirty units, and perhaps then just dynamite,—who knows? How simple and familiar they all look up to the last one, and how difficult to see just beyond that point.

Confine yourself to your own day. Do you remember the big one-cylinder gasoline engine you put into that boat? It was easier and safer to row the boat than to start the engine. It was largely the love of the risk involved that made you use the engine. It weighed one or two hundred pounds per horse power. The ignition system was an engine by itself, and when it was operating it made you feel like a locomotive engineer, it had so much useless motion. Recall how perfect some of those little improved yacht engines looked and how natural it seemed to go to a two-cylinder engine? The next gas engine you saw was a four-cylinder, costing about the same as your first single cylinder, but quite a different animal. Of course the improvements need not consist of merely added cylinders and you laughed when someone suggested more, but sixes, eights, and even twelves are making the fours look a little old already. You guess now that from twelve the advance will be to twenty or more, or to a turbine type with many blades to take the thrust, or even infinite blades which means the plain rotating disks already described in the newspapers. No matter what you guess, the changes will come and always in one direction: "More for the money." Paradoxical as it may look, when we stand still we are going backward. If we want to stay we have to go forward.

That Allegheny Indian who first rubbed the rock oil on his aching bones started the line of research which now lets us run about so easily in automobiles. The petroleum industry has always been and ever will be a living, moving, growing thing. If we want to, we shall probably eat modified vaseline and wear clothes colored with modified paraffin, but it will not be done by being satisfied with what is, afraid to try what is to come.

Nature does not supply us with baskets and a sunny spot to place them so that we can catch the falling futures, but she shows us that swimming may be learned almost entirely by getting into the water, or at least by adding some push and a little kicking.

It was not my intention to discuss preparation for national defence, which is only a single one of those fields in which, when we want to advance beyond others, we shall probably have to excel in our efforts. Nor do I care to devote too much of this note on research to a comparison of the industrial situations in such leading countries as England and Germany. But, a few words chosen from modern English literature seem very pertinent. More on this point may be found in an editorial in the *Journal of Industrial and Engineering Chemistry* for October, 1915, from which I quote:

"The attitude of the government toward science was well illustrated during the debate of British Dyes, Ltd., when the Parliamentary Secretary of the Board of Trade stated that:

'A man conversant with the science and practice of dye manufacture was unfit to go on the directorate because, as he would know something of the business, the whole of the other directors, being but business men, would be in his hands.'

As Prof. Meldola points out:

'One feature of the new scheme which the chemical profession can view with favor is the distinct recognition of research as a necessity for the development of the industry. The Government will, for ten years, grant not more than 100,000 pounds for experimental and laboratory work. That is certainly a concession which marks an advance in official opinion. It will be for the satirist of the future to point out that it required a European war of unparalleled magnitude to bring about this official recognition of the bearing of science upon industry.'

According to Sir Ronald Ross:

'The war now raging will at least demonstrate one thing to humanity—that in wars at least, the scientific attitude, the careful investigation of details, the preliminary preparation, and the well thought out procedure bring success, where the absence of these leads only to disaster. So also in everything. After all, the necessity for research is the most evident of all propositions.'

As S. Roy Illingworth puts it:

'The inexorable law of the survival of the fittest is as true of nations as of animals and only those nations that are the most efficient in industry can have any chance of maintaining their entity.'

Dr. J. A. Fleming writes:

'A few days ago an eminent electrical engineer was sitting in my room here, and said to me,—I am too old to enlist or even do manual work in the manufacture of shells, but I have a considerable scientific knowledge which I am just yearning to employ in the service of the country, yet I cannot find any person in authority who will tell me how to do it.

'This sentence expressed concisely not only my friend's feelings, but my own, and I am confident that of hundreds of other scientific men as well. At the present moment, after 10 months of scientific warfare, I myself have not received one word of request to serve on any committee, co-operate in any experimental work, or place expert knowledge, which it has been the work of a lifetime to obtain, at the disposal of the forces of the crown.'

Sir William Ramsay says:

'It is bad policy to regret what might have been; it is much better to try to devise plans to make up for lost time; and the first essential is organization. It is notorious that there is little intercommunication between the various Government Departments: many of them are confronted by the same difficulties; many of these difficulties would be overcome if scientific advice were asked for; and the prime necessity at the present moment is a central body of scientific men to whom the various Governmental Departments should be compelled to apply for advice and assistance.'

In July Mr. Henderson, successor to Mr. Pease as President of the Board of Education, issued a White Paper outlining a 'Scheme Designed to Establish a Permanent Organization for the Promotion of Industrial and Scientific Research by the establishment of a single responsible body entrusted with the disbursement of a considerable fund. This consists of a Committee of the Privy Council with

'..... a small Advisory Council composed mainly of eminent scientific men and men actually engaged in industries dependent upon scientific research, which shall be responsible to the Committee.'

The first members of the Council will be Lord Rayleigh, Messrs. Beilby, Duddell, McCormick, and Threlfall, Profs. Hopkinson, McClelland, and Meldola, and the Committee of the Privy Council consists of Lord Haldane and Messrs. Ockland and Pease.

In this way does the English Government announce at last a change of policy and propose to retrieve its past inaction. Of this scheme *Nature* remarks:

'By its inception and publication the Government acknowledges and proclaims its appreciation of the work of science and by this acknowledgment alone gives scientific workers that encouragement and prestige in the eyes of the country which has too long been withheld.'

'Thus England has awakened after the most costly delay to a situation which she must probably work for years, at the best, to remedy, a situation which threatens not only her future supremacy but even her present existence.'

Research is not a word to conjure with. As a magic it is exactly like a grindstone. You can tie it around your neck or you can work it. The dictionary says that "*Research* is diligent protracted investigation especially for the purpose of adding to human knowledge." The dictionary is right. The man who investigated boron was diligent; he observed all its peculiar qualities and measured its quantities. When it failed to make a suitable incandescent filament as had been hoped and the "addition to human knowledge" of its low melting-point was made, his protracted diligence had already taught him that it was a great oxygen-eater. It would take oxygen even from aluminum oxide. So it happened that it was investigated in connection with copper castings. It took oxygen from copper. It made a perfect electrical and physical product of what had before been a failure. At that time magnesium was used in the manufacture of boron. The war came on and the price of magnesium rose. It was made only in Germany. Another research, or "diligent investigation" was started and for 5 or 6 months the "protraction" continued until a manufacturing method using American raw materials was devised. There is now little probability that this metal will ever cease to

be made in America. This illustration is given because it is fairly typical of research. The point attained is not always that particular spot aimed at, so far as knowledge is concerned. A yield is obtained, nevertheless, and the knowledge acquired is a perpetually enlarging accretion, so long as the diligent investigation is under way.

The impossibility of foreseeing the applications of a research and the certainty that all knowledge is of use might be illustrated by a thousand cases. No one fact, well known, can exist without reacting on the remainder of knowledge. In 1895 and 1898 the first discoveries of X-rays and radium rays were made. The facts as they were disclosed fed every science. Chemistry was given a jolt it had thought could never occur. Physics went back to the consideration of dimensions thousands of times smaller than before. Electricity's views of conduction were enlightened and the phenomena of electrical insulation of gases and oils were clarified. Medical diagnosis and surgery were given additional eyes and therapeutics a new reagent. From the man who today sees the gas holes in iron castings to the one who studies heredity by exposing eggs and sperms separately to the rays, all have to thank those who carried out the necessary researches on these rays. Few or none of these applications could have been predicted prior to 1895. What could have been predicted, however, with certainty was that some uses could be made of such disclosed facts.

ELECTRICAL EQUIPMENT OF THE VERMONT MARBLE COMPANY

By JOHN LISTON

PUBLICATION BUREAU, GENERAL ELECTRIC COMPANY

The quarrying and finishing of marble by modern methods involves the use of an extensive mechanical equipment, the essential elements of which are clearly indicated in this article. The writer has outlined the operating conditions in quarries, mills and shops and their relation to electric drive, and by specific reference has analyzed the factors which have influenced the selection of the electrical equipment.—EDITOR.

While the discovery of marble deposits in the State of Vermont occurred more than a century ago, only sporadic efforts were made to develop the industry along commercial lines prior to 1870.

The succeeding years, however, witnessed a marked expansion; new quarries were opened, mill and shop buildings erected, and the equipment of the various plants added to and improved to meet a constantly increasing demand, until the Vermont Marble Company, with about 4000 employees, attained an annual output in excess of a million cubic feet and became the largest producer of marble in the world. The timber, farm and quarry lands acquired, cover more than 25,000 acres and include about 75 quarries.

In the early days the quarrying operations were carried on very largely with manual and animal labor, while the mills and shops were operated at first by directly applied water power, which was later, in some cases, supplemented by steam drive.

Subsequent to 1870 there ensued a comprehensive and consistent improvement in the methods of power application, paralleling the commercial development of the company, and today practically all of the various properties are interconnected by an efficient modern electric distribution system, the energy for which is derived from four hydro-electric power stations, supplemented by two steam-driven generating stations, normally held in reserve. Electric motors are utilized for the operation of all forms of machinery in quarries, mills and shops.

The plants referred to in this article are all located in the State of Vermont, and in order adequately to indicate the character and extent of the electrical equipment provided, the following analysis will be divided roughly into three sections, viz.:

Various motor applications in the quarry, where individual drive is the rule.

Methods utilized in operating mill and shop machinery, with typical examples of both individual and group drive.

A general survey of the generator, transmission line and substation arrangement, and

the operating conditions imposed by the linking together of widely separated plants, with fluctuating energy demands, into a homogeneous system having a high power-factor with ample safeguards to insure an uninterrupted current supply.

There are at present in service a total of about 570 motors, ranging in capacity from 2 h.p. to 250 h.p., with an aggregate rating of approximately 14,000 h.p. Direct current units are in many cases applied to hoists, cranes and locomotives, and constitute about 25 per cent of the total motor equipment; the remainder being polyphase induction motors operating at 220, 440 or 2300 volts on three-phase 60-cycle circuits.

An interesting example of the reliability of electric motor drive is found in the group of double lever channelers, some of which are shown in Fig. 1. These machines are provided with a gang of long chisels set on either side of a strong framework and actuated through gearing by a 12-h.p. railway type direct current motor. The vertical reciprocating motion of the chisel gangs, combined with the slow forward movement of the machines, forms narrow channels or slots of the desired length and depth, usually at right angles to the "rift" or natural cleavage line of the marble strata, and cross channels are then cut or holes drilled at right angles to the main channels in order to secure blocks of the desired size.

It is obvious that the motors, which are mounted directly on the channelers, must be unavoidably and continuously subjected to a considerable amount of vibration when the channelers are in action; but in spite of these severe conditions the original outfits, which were installed in 1896, are today regularly applied on flat cutting and are operating with unimpaired efficiency after an active service of nearly two decades.

Owing to the diverse arrangement encountered in marble strata, it is frequently necessary to operate channelers at various angles to the horizontal, and, as the mechanical design of those shown in Fig. 1 limits their effective use to surfaces which are practically level,



General View of Vermont Marble Company's Principal Plant, located at Proctor, Vt.

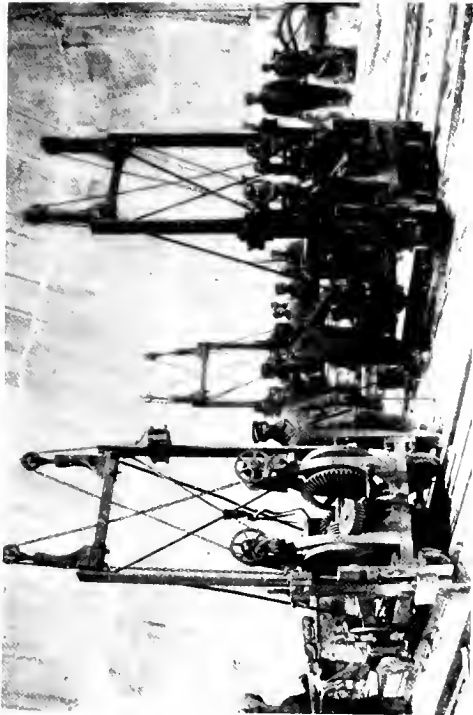


Fig. 1. Double Lever Channels, each driven by a 220-volt series direct current railway type motor

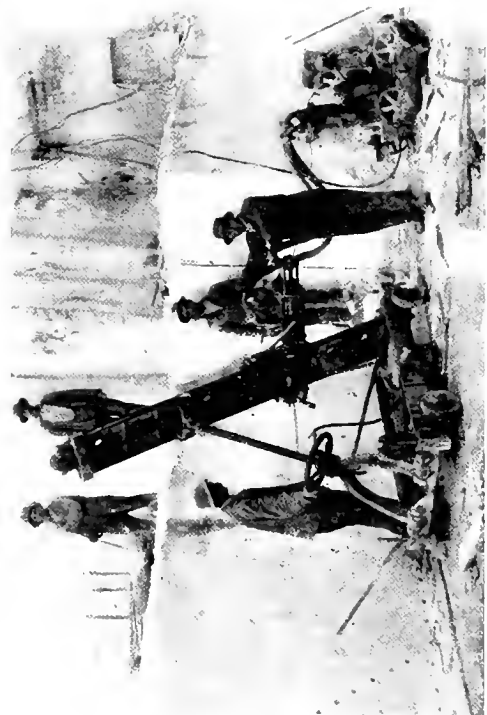


Fig. 3. Electric-Air Drill driven by a 5 1/2-h.p., 1800 900-r.p.m., 220-volt Form KT induction motor

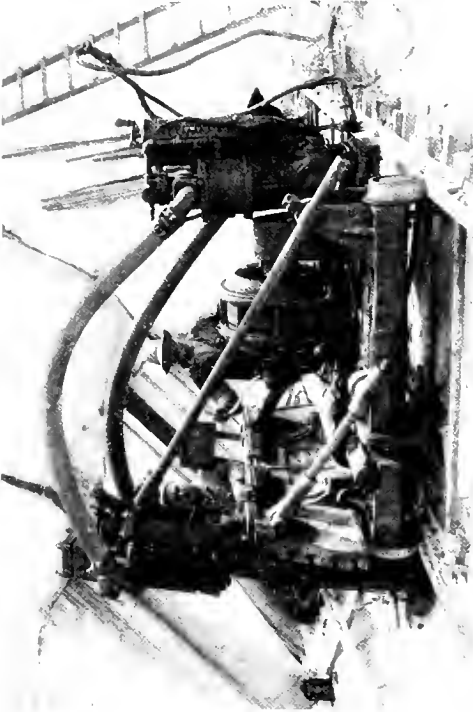


Fig. 2. Electric-Air Channeler driven by a 12-h.p., 720-r.p.m., 220-volt Form M induction motor



Fig. 4. Electric Locomotive for Underground Haulage at West Rutland Quarry

another type (see Fig. 2) has been developed which can accomplish both flat and slope channeling as required.

This machine is equipped with only one chisel gang, which is given a positive reciprocating motion by means of compressed air. This is in turn supplied in a closed circuit by a motor-driven compressor; the entire outfit comprising a self-contained and adaptable unit. The operator can secure all necessary speed adjustments through the motor controller.

There are in all about 100 electric channelers used in the Vermont quarries, including about two dozen of the old double lever type, which are driven by direct current motors, whereas the electric-air machines are uniformly equipped with 12-h.p. Form M induction motors. These motors have phase wound rotors and external resistance connected through slip rings, and are specially adapted for conditions requiring frequent starting under load with a relatively low current demand.

Supplementing the channeling process, the bottom of the block of marble is perforated by means of drills; the holes being usually driven either along, or parallel to, the "rift" or natural cleavage line, thereby rendering it possible to loosen the block by means of levers or wedges. No blasting is required as the actual work of quarrying marble is performed entirely by machinery.

About 70 electric-air drills are available for this work and operate on the same principle as the electric-air channelers, but the drill proper, and the motor-driven air compressor, are separate portable units connected only by flexible air tubing, as shown in Fig. 3. The load conditions are not severe and the compressor is direct geared to a two-speed $5\frac{1}{2}$ -h.p. induction motor.

While most of the quarries are open workings from which the detached blocks of marble can be removed with the aid of derrick hoists, some of them extend for a considerable distance underground, have heavy pillar supports for the roof or hanging walls, and in some respects entail work similar to that encountered in mining.

An example of this is the West Rutland quarry in which the workings have been carried to a depth of about 300 ft.; the opening at that level exceeding 2000 ft. in length. In this quarry electric lighting is required, and an electric haulage locomotive (Fig. 4) is used to haul the blocks of marble from the working face to the base of a slope hoist, which in turn elevates them to the surface.

The locomotive is operated on direct current, 230 volts, supplied through a motor-generator set to a guarded feeder wire running along one side of the track about 18 inches from the ground. In spite of the limited radius of action of this small tractor, it has proved to be a valuable addition to the quarry equipment.

As a rule, the natural ventilation and lighting of the quarries produces favorable working conditions, but at West Rutland the underground galleries extend a considerable distance from the open shaft, and an artificial circulation of air is therefore necessary. This is amply provided for by a 6-ft. upcast fan located on the surface and belt-driven by a 40-h.p. induction motor, and 250-watt Mazda lamps are used at all points where the daylight is inadequate.

From the nature of the work it is evident that underground water in varying volumes may frequently be encountered in quarrying, and as the quarry shafts are practically unprotected, a certain amount of surface drainage and seepage must also be provided for. The pumping sets used for unwatering the quarries include both reciprocating and centrifugal types, driven by induction motors. Small portable pumps driven by 2-h.p. motors are available for temporary use, and stationary units do not in any case require more than 35 h.p., as the operating head in no instance exceeds 350 ft. and the load demand is not heavy.

The flexibility of motor drive is well illustrated by the quarry installations already referred to, for while it would be possible to operate the isolated machines by means of air or steam, fed from a centrally located compressor or boiler at each quarry, the difficulty of installing air or steam pipe lines in the quarry, maintaining them in good condition to avoid pressure losses, and extending or relaying them to take care of the shifting of channelers and drills involved in progressive work, would entail installation and maintenance costs greatly in excess of those of the electric system. The efficiency of the latter is unaffected by temperature changes, which must always be considered with steam or air lines, and the laying of additional wire or cable to supply current to new machinery or to meet changes of location of any existing machine can be safely, easily and rapidly accomplished without interfering in any way with the operation of the remainder of the quarry equipment.

With individual motor drive the energy consumption of each machine is limited to its period of actual operation and the generating equipment need only be designed for the average maximum demand of the entire system. With steam or air, however, the compressors or boilers at each quarry would have to maintain full pressure throughout the working day, with a consequent low load factor during the time required for relocating machinery or for changing or adjusting tools on individual machines.

The conditions in a quarry are not by any means ideal for the operation of motors, due to the difficulty of completely protecting them from moisture, mechanical injury, or vibration strains; but many years' experience in the numerous quarries of the Vermont Marble Company shows that enforced stoppage of work, even of individual units, is exceedingly rare, and that the repair expense for well designed open type modern motors, in constant use over long periods, is confined largely to the rewinding of the smaller pump and drill motors. For the larger units it is practically negligible.

While a few slope hoists are used in handling the quarried marble, a large percentage of

Steel derrick masts with steel girder booms are largely used, and more than 20,000 blocks averaging about 20 tons in weight are handled annually, the largest blocks weighing about 55 tons. The maximum derrick lift at present does not exceed 325 feet.

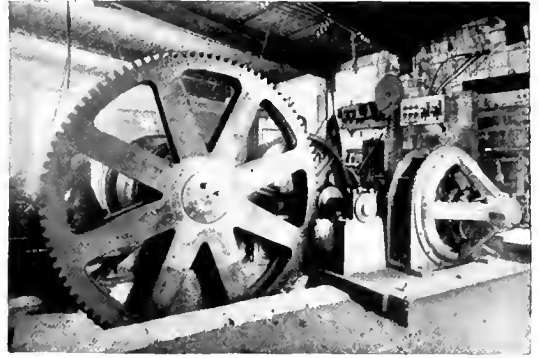


Fig. 6. Hoisting Equipment for Derricks—shown in Fig. 5—main hoist motor, 165-h.p., derrick swinging motor, 6-h.p.

The detail arrangement of the hoisting machinery for these derricks varies somewhat at different quarries, but in Fig. 6 a typical outfit is shown. At the right is a Form M slip ring induction motor direct geared to the main hoist, while on the wall at the rear is a panel board supporting a switch, circuit breakers and the contactors through which the motor resistance is controlled. The resistance units and the motor controller are located on the floor near the panel board and the small derrick swinging motor may be seen at the left.

It is evident from the nature of the work at the quarries that the derrick operation must ordinarily be intermittent, as the average service for the entire battery of derricks is less than one 20-ton block hoisted per day. Many of the derricks are of course utilized with greater frequency, while in other cases they are idle for considerable periods; but with electric drive they are at all times available for instant use and consume power only while in operation and in direct proportion to the amount of work performed.



Fig. 5. Hollister Quarry—showing two typical quarry shafts and two motor-operated derricks

the blocks are brought to the surface by means of simple derrick hoists similar to those shown in Fig. 5. There are in all about 80 of these derricks and the hoisting motors are rated at from 25 h.p. to 165 h.p. with smaller motors, usually about 6 h.p., for swinging the derrick.

When the blocks have been hoisted to the surface they are deposited on flat cars and hauled either directly to the mills or to storage yards where they are piled for future use: In the latter case the blocks are removed from the flat cars by means of electrically

the blocks are run off onto the sawing beds. The crane is equipped with travel, hoist and turning motors and has also a motor-operated winch for pulling the block-carrying cars onto the transfer car after the sawing operation is completed.



Fig. 7. Electrically-operated Gantry Crane serving block pile at West Rutland, Vt.

operated cranes in the manner shown in Fig. 7, and are later transferred to the mills as required. The amount of marble thus held in reserve is usually sufficient for about one year's output of the mills and shops.

Direct current motors are utilized for storage yard cranes, the one in Fig. 7 being equipped with five motors, viz., one bridge motor of 35 h.p., two hoist motors each 30 h.p., and two trolley motors each 7½ h.p. The crane has a bridge span of 160 ft. and a capacity of 50 tons. Its load conditions are not exceptional and it does not differ materially from the cranes used for the other block piles, or in other industries; it is referred to merely as a connecting link between the quarry and the mill.

When the blocks of marble are transferred to the mill for sawing they are delivered to the gang saws or "gangs" by a specially designed trolley type locomotive crane (see Fig. 8) which travels on tracks running lengthwise through the mill building between two rows of gangs.

The process of delivery is as follows: The overhead yard crane removes the blocks from flat cars in the yard and deposits them on a short heavy car, which is in turn placed on the tracks of the small transfer car, shown in Fig. 8 immediately in front of the crane. The transfer car is then moved into the mill by the crane and the car carrying

The sawing process and the method of adjusting the saws can be readily understood by referring to Figs. 9 and 10, which show two typical "gangs" at work. The saws are toothless and are made of soft iron ¼ in.



Fig. 8. Electric Locomotive Crane especially designed for delivering blocks to sawing beds at mills

thick and 4 in. wide when new. Small pumps deliver a mixture of sand and water to the saw cuts and the rigid framework containing the saws is given a horizontal reciprocating motion, the sand doing the cutting. There are more than 300 of these electrically

operated "gangs," and they are in every case driven in groups which comprise from 12 to as high as 43 gangs; the driving motors ranging from 75 h.p. to 250 h.p. Average conditions require about 100 h.p. for every 14 gangs, including the necessary sand pumps.

As the "gang" saw drive requires approximately 2500 h.p. in motors, it constitutes a large percentage of the total load. Constant speed squirrel cage motors have been adopted for this service, although a few wound rotor motors have also been utilized in some cases for starting duty.

The motors drive through overhead countershafts and, while in some cases they are direct connected in the line shaft, as shown in Fig. 11, as a rule they are belt connected. Extreme fluctuations may occur both in the starting and operating loads on individual "gangs," varying with the number of saws in each "gang" and the dimensions of the blocks of marble, and it might appear from this that "gang" saw drive would cause a very irregular demand on the power supply, but, the equalizing effect of the group arrangement of the "gangs" is such that a very steady load is imposed on the motors, and they do not adversely affect the power-factor of the system, which is normally maintained at from 80 to 85 per cent.

From the mills the marble passes to the finishing shops where all remaining operations are performed. The rough surfaces, left after the sawing process, are smoothed on rubbing beds, which consist of large steel disks rotating in a horizontal plane, on which a flow of water and sand is maintained.

There are about 65 electrically operated rubbing beds in the different shops and the older installations consist of groups of five or six machines driven through counter-shafting by 50-h.p. motors. Later, there developed marked tendency toward an individual drive system, with its inherent economy

in current consumption, and the more recent additions to the shop machinery provide a 25-h.p. motor, belt-connected to each pair of rubbing beds (see Fig. 12). The squirrel cage induction type of motor was adopted as a standard for this

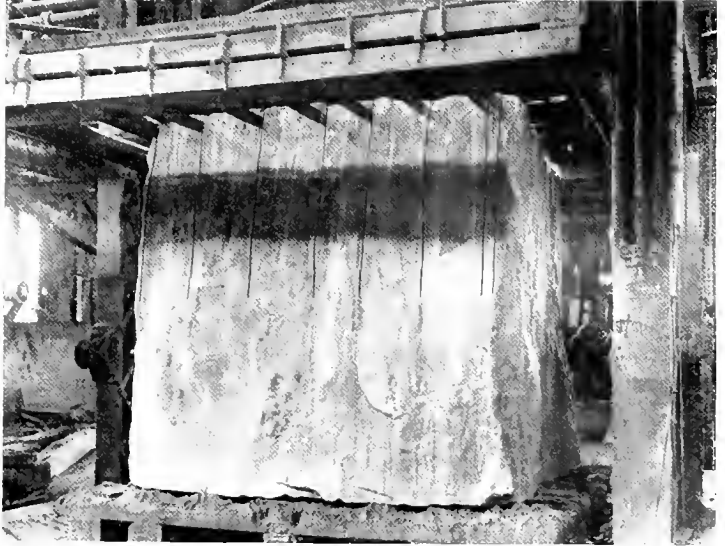


Fig. 9. Block of Marble being cut into slabs of varying thickness by gang saws

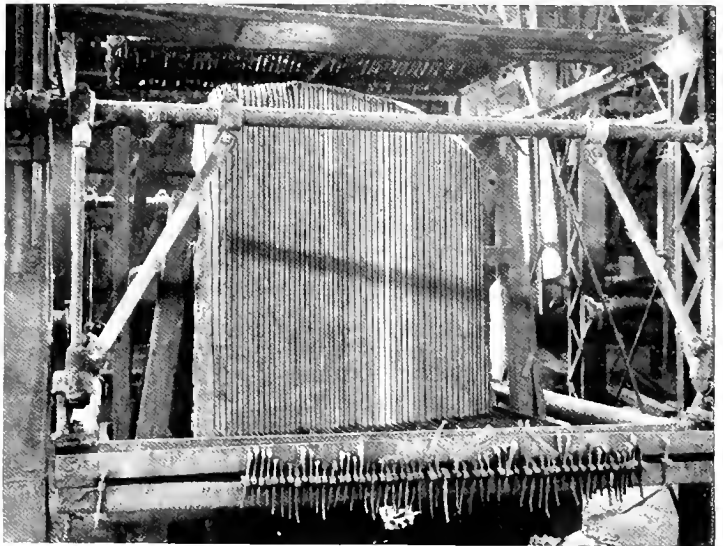


Fig. 10. Block of marble after sawing has been completed

work and for practically all finishing shop drives.

Some hand work is necessary in finishing marble products of intricate shapes, but most

of the polishing on flat surfaces is performed with the type of machine shown in Fig. 13. It consists of a heavy two-part hinged bracket, linked together by two driving belts, at the end of which is a vertical shaft with a polishing disk at the lower end. The workman, by



Fig. 11. 250-h.p., 240-r.p.m., Form M Induction Motor direct connected in line shaft—driving gang saws at Proctor Mill

grasping a large iron loop, controls the movement of the machine and guides the revolving polishing disk over the surface of the marble; the hinged bracket construction permitting the movement of the disk in any direction in a horizontal plane. The polishing disks or plates, like the saws and rubbing beds, utilize a copious supply of water, but do not require sand as they constitute in themselves the necessary abrasive. In the order in which they are utilized, they employ the following materials: carborundum, brown emery, fine hone; while the last operation utilizes a plate covered with felt in connection with a polishing putty. There are about 100 of these machines in use, but, as they individually constitute a light and variable load, they are always driven in groups.

A number of turning lathes of considerable capacity are employed in producing marble columns, and blocks more than 30 feet long can be handled by the largest lathe. In spite of their impressive size, these lathes do not at any time impose a heavy demand on the power system as they rotate very slowly when cutting, and large columns are usually turned at less than 5 r.p.m. For individual drive or for running two lathes with a single motor, not more than 10 h.p. is ordinarily required.

Two unique auxiliaries to the standard shop equipment are shown in Figs. 14 and 15.

The first is a 6-ft. circular saw employed in cutting and trimming marble slabs. It is provided with two motors, one rated at 25 h.p. for rotating the saw, and a 3-h.p. unit driving the feeding mechanism. The periphery of the saw has inset diamond cutting tools and very rapid sawing is possible, but it is not intended to perform the work ordinarily done by the gang saws or rubbing beds.

The second is known as a carborundum machine, and in Fig. 15 it is shown cutting grooves in two pieces of marble. The bed plate has a slow reciprocating travel similar to that of a planer, and the adjustable grinding elements are carborundum wheels of various sizes and shapes. Like the saw, it is independently driven, a 20-h.p. induction motor driving both tools and bed plate.

In the foregoing the references have been confined largely to those features of the equipment peculiar to the marble industry, but in general it may be stated that motor drive is utilized throughout all departments of the Vermont Marble Company, including the various machine shops, repair shop, carpenter shop and to some extent in saw mills. More than 6,000,000 sq. ft. of lumber is required annually for boxing and shipping marble but a large part of this is the product of steam-driven saw mills.

Several hundred pneumatic hand tools are used in the shops, and air is supplied to them at from 50- to 60-lb. pressure, by motor-driven compressors. Overhead electric traveling cranes of the usual types are found in both shops and yards, while those yards where the finished marble is stored or shipped are served by cranes constructed as shown in Fig. 16.

As previously mentioned, current is supplied to the various plants from four hydro-electric stations having a total capacity of 5525 kw., and two steam stations having an output of 1250 kw. Distribution is made through eleven substations, over transmission lines aggregating more than seventy miles in length.

The hydro-electric stations are all located on Otter Creek, a small stream which rises in Bennington County, Vermont, flows through Rutland and Addison Counties, and enters Lake Champlain near Vergennes. For many years prior to the adoption of electric drive it supplied the power requirements of some of the mills by means of simple waterwheel drives. Its total drainage area is less than 1000 sq. miles and above Proctor, where the first and largest generating station

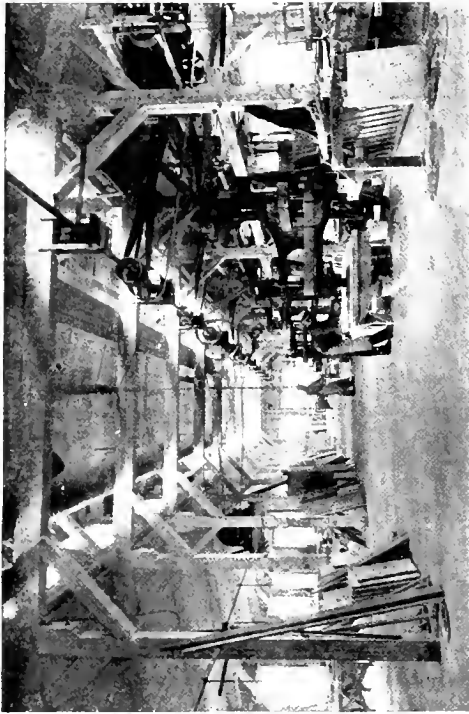


Fig. 13. Polishing Machines in Finishing Shop, group driven by 50-h.p. motor



Fig. 15. Carborundum Machine in Operation driven by a 20-h.p. motor



Fig. 12. Rubbing Beds in Finishing Shop, belt-driven in pairs by 25-h.p. motors

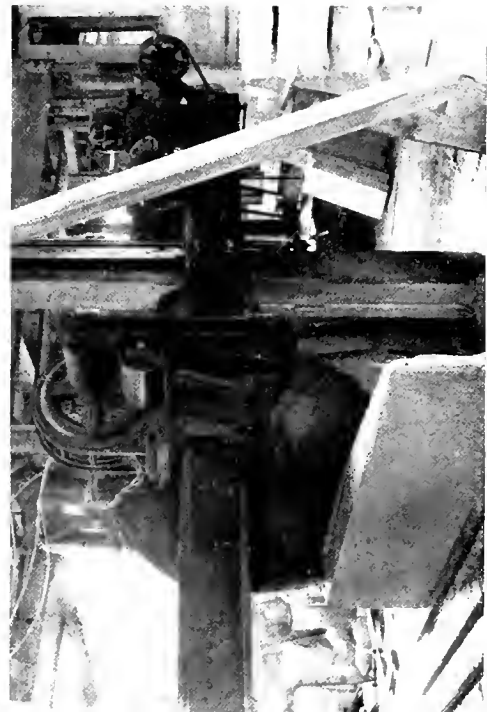


Fig. 14. Diamond Saw driven by a 25-h.p. motor with 3-h.p. motor on feed

was installed in 1906, the drainage area is only about 150 sq. miles, but a dependable water supply is insured by storage reservoirs of the Rutland Railway, Light & Power Company which are back of the falls at Proctor and an operating head of 120 ft. is available.

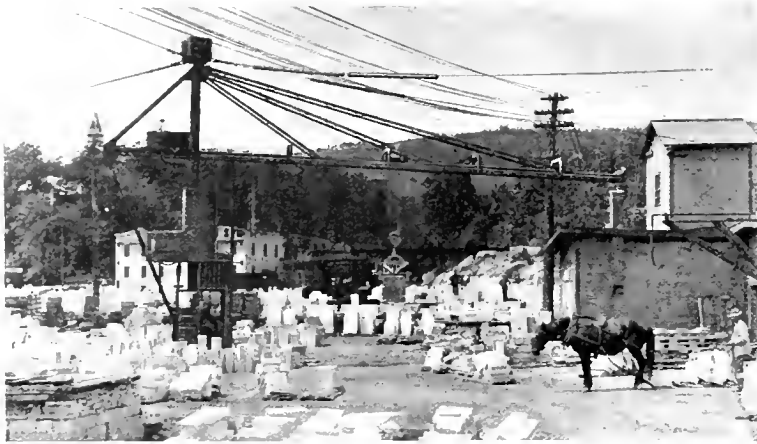


Fig. 16. A Typical Three-Motor Swinging Crane used in handling finished marble for storage or shipment

The station contains three 750-kw. 480-volt 514-r.p.m. three-phase 60-cycle alternators, each direct connected to a waterwheel. About 30 miles down stream the second

station was located in 1911, at Huntington Falls (see Fig. 17), with an operating head of 40 ft. The generators here consist of two 750-kw. 2300-volt 300-r.p.m. units with belt-driven exciters, as shown in Fig. 18. About two miles above this station is a third power plant, at Beldens, which was completed in 1914 and is practically a duplicate of the Huntington Falls station, having the same generating capacity and operating under the same hydraulic head. The drainage area above this point is approximately 615 sq. miles.

Four miles up stream from the Proctor is the fourth generating plant at Center Rutland, where, in 1915, a 275-kw. 460-volt 300-r.p.m. generator replaced an old direct waterwheel drive; the operating head here being 30 ft.

In addition to these four hydraulic plants are the two steam generating stations already referred to, which are normally held in reserve, but are placed in service during low water periods. An ample emergency supply is also available through the inter-connection of the transmission sys-

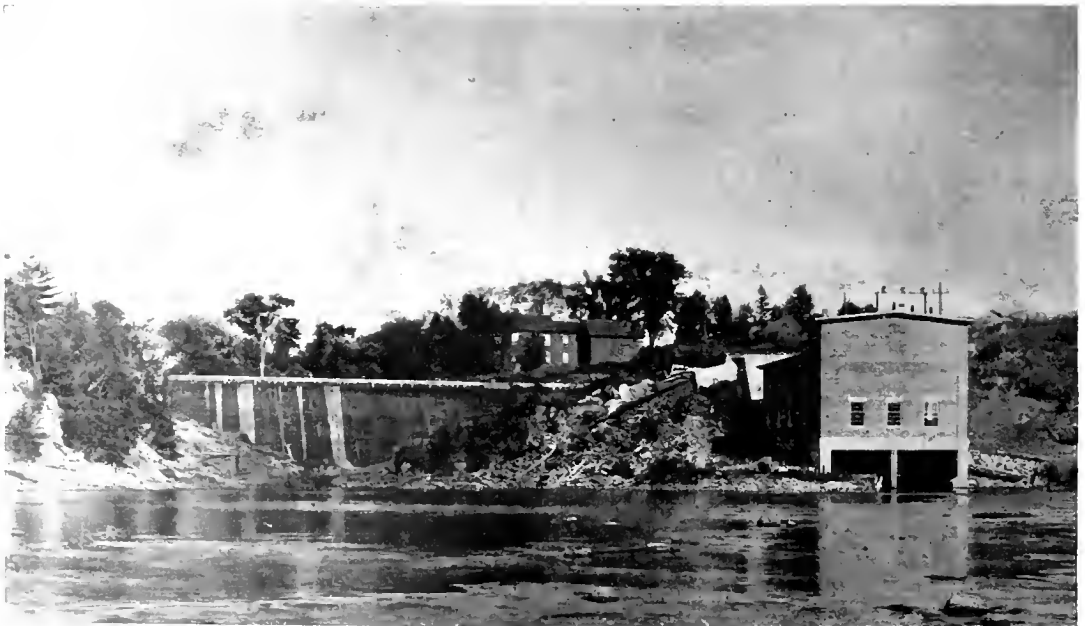


Fig. 17. Huntington Falls Power Station with concrete dam giving operating head of 40 ft.

tem of the Vermont Marble Company with that of the Rutland Railway, Light & Power Company.

Three transmission potentials are used on the different sections of the system, which includes 56 miles of 44,000-volt conductors, and 10 miles at 11,000 volts, all single circuit, while the connection with the railroad system referred to above is obtained by a $4\frac{1}{2}$ -mile 13,200-volt line. Wooden poles are used on all lines, with spans varying from 150 to 300 ft., excepting at railway crossings, where they are replaced by steel towers. The pole lines are not equipped with a guard wire, but protection is afforded by ten sets of aluminum cell lightning arresters.

When we consider that the present distribution system with its eleven substations has been a gradual growth during the past nine years, to meet increasing demands for power in widely separated plants which were successively electrified, the necessity for the various transformer ratings and voltages used can be readily understood.

Both single-phase and three-phase oil-cooled and water-cooled transformers, aggregating over 5000 kv-a., are installed in the substations; the largest unit being rated at

1250 kv-a. three-phase, and the smallest at 33 kv-a. single-phase. The potentials also range from 44,000 to 2300 for high voltage windings, and from 11,000 to 230 for low voltage windings. By means of this diversity in substation voltages there is secured a uniform operating voltage for each class of motor drive throughout the entire system.

Where the motor loads are of such a character that the voltage and capacity of the system is adversely affected, partially loaded synchronous motors are used to supply a compensating leading current, and the power-factor is thereby normally maintained at from 80 to 85 per cent—a very satisfactory result in view of the exceptional operating conditions existing for a large percentage of the motors.

The water supply can be relied on during a large part of the year and the hydro-electric stations ordinarily carry the entire load. The records for 1914 show that 16,600,600 kw-hr. was supplied by water power stations, while somewhat less than 1,000,000 kw-hr. was required of the steam plants.

The generators and motors supplied by the General Electric Company constitute about 65 per cent of the total electrical equipment.

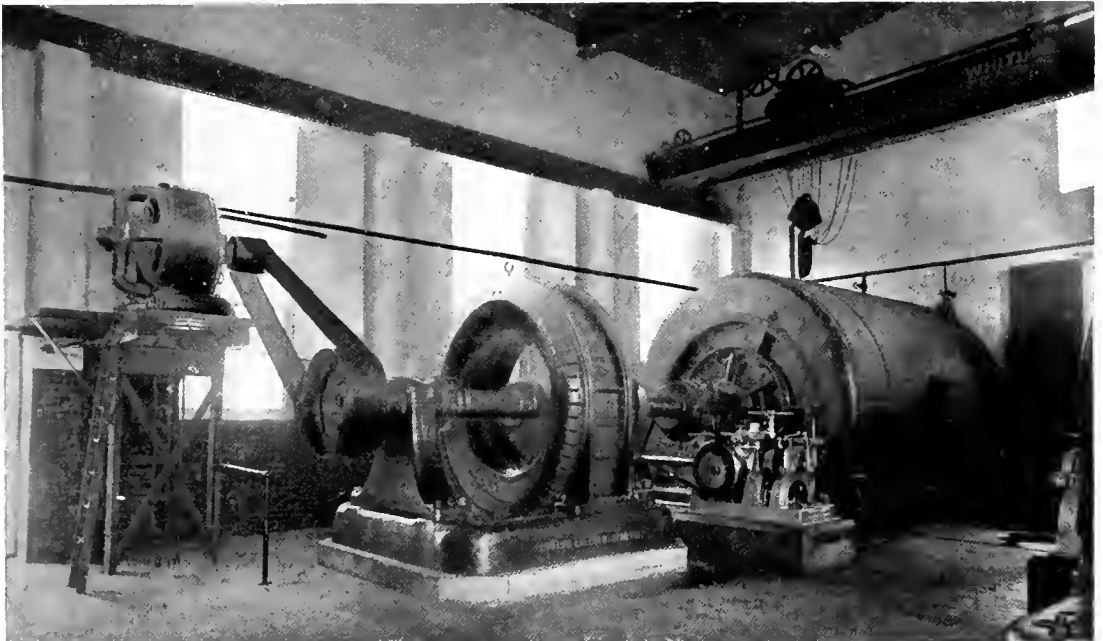


Fig. 18. 750-kw., 2300-volt, 300-r.p.m. Waterwheel-driven Generator in Huntington Falls Power Station

THE THURY SYSTEM OF DIRECT CURRENT TRANSMISSION

BY WILLIAM BAUM

This article forms a valuable work of reference. The author gives a very complete description of the Thury system of direct-current transmission and deals at considerable length with the advantages and disadvantages of its applications in numerous fields of work. It should be remembered that these advantages are features of the line construction and, as such, become only of great importance in connection with long-distance high-power developments of, say, 50,000 to 100,000 kw. capacity. The installations of the Thury system now in operation do not come in this class; consequently, experience with it is lacking in this field. Moreover, estimates made from the best available data covering long-distance high-power transmissions, using duplicate circuits and steel supporting structures, show that the first cost of the complete installation, including hydro-electric station, transmission line, and substation, is considerably greater for the Thury system than for the present type of three-phase alternating-current system as used in this country. Furthermore, when transmission voltages of the order of 150,000 are considered, one can be sure that difficulties in connection with the insulation of generators and motors to ground and between coupled machines will be greatly increased, and although the arrangement may be simpler there will be introduced construction complications involving considerable life hazard to the operating force. Consequently, from available data, there seems to be no reason for considering direct-current transmission for propositions where the present type of alternating-current transmission can be successfully and economically used.—EDITOR.

I. INTRODUCTION

The problem of transmitting direct currents in series is not a new one, the well known Brush and Wood series arc lamp systems being the forerunners of what is today called the "Thury system." This constant current scheme has found but a limited application in Europe, having replaced the well established polyphase constant potential systems in exceptional cases only. The reason for this is to be found in the fact that the direct current system is not a distribution system, but essentially a transmitting scheme possessing, for this particular application, a number of advantages of considerable interest to transmission engineers.

II. THE PRINCIPLE

In the usual transmission system one or several generators in parallel feed the line at a potential which is kept constant as far as possible, and the current varies with the load. The Thury system of direct current transmission is a series system in which the generators supplying the power and the motors absorbing the power are all connected in series in a single closed circuit. In this system the voltage varies with the load and it is the current which is kept constant.

Fig. 1 shows the closed ring and the connections of the generators and motors. This diagram is a simple representative of the Thury system. Fig. 2 shows the short circuiting switch by means of which the generators and motors can be switched in or out of circuit and disconnected from the line.

In the Thury system the current is constant and exactly the same in the whole of the circuit. The loss due to ohmic resistance in the line and in the machines is, therefore, constant and independent of the load.

The maximum power obtainable in this system is determined on one hand by the strength of the constant current, circuits are in operation with currents from 50 to 450 amperes; on the other hand, for a given current the power is limited by the maximum voltage which is permissible with regard to the insulation from earth. Plants of 100,000 volts and higher have been installed.

The Thury system permits the transmission of power from the generators directly to the motors without the help of any intermediary such as transformers, and at the same time leaves the generators and motors as independent units. Fig. 3 gives examples of a Thury series system showing the closed ring principle without any switch, apparatus or machine capable of breaking the circuit.

In 1888 when the transmission of power by direct current in series was first employed (Genoa, distance 27 kilometers [16.8 miles] 12,000 volts, constant current 45 amperes) polyphase current was still unknown from an industrial point of view and the series system appeared at the time to be the solution of the problem of long distance transmission. During the following years, however, three-phase transmission developed and its rapid and successful progress limited the further application of the direct current series system to a few exceptional cases. In these years interest was detracted from the Thury system, due to the fact that engineers were then almost entirely occupied with distribution for combined power and lighting purposes for which constant voltage was necessary.

In later years when it became necessary to arrange for transmission of power over great distances for which high voltage was required, certain disadvantages arose in adhering to transmission at high alternating voltage. Due

to these difficulties, interest was again awakened in the direct current series system because it avoids all effects due to induction, phase displacement, capacity and leakage to a certain extent.

Table I, page 1028, represents a list of the more important installations carried on upon the Thury principle and under the leadership of its inventor, Mr. R. Thury. The list is taken from Mr. Highfield's paper in the *Journal of the Institution of Electrical Engineers* (1913, part 222, vol. 51, page 640).

III. ADVANTAGES

(a) General

One of the chief practical advantages of the direct current series system is the fact that high tension underground cables can be used in which losses in the dielectrics are practically eliminated. Experience shows

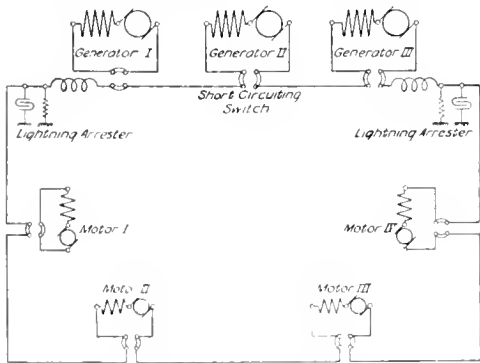


Fig. 1. Diagram of a Series Circuit for the Generation, Transmission and Utilization of High-Tension Direct Current

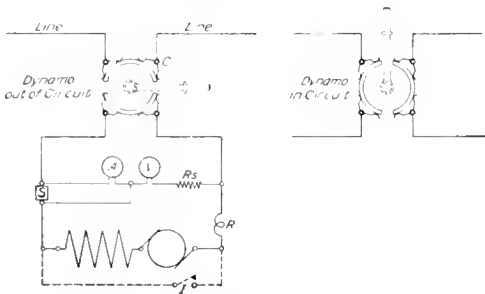


Fig. 2. Diagram of the Short Circuiting Switch employed in the Series Circuit shown in Fig. 1

that it is possible to employ cables of one conductor at high voltages in densely populated centers, across rivers, estuaries, etc.

In papers presented by Highfield before the Institution of Electrical Engineers (England) in 1907, 1912, and 1913, the series system,

with special reference to the plant of the London Metropolitan Electrical Supply Company, is described. Highfield discusses in detail the cable system which is for operation at 100,000 volts and a load of 12,000 kw., and these papers are valuable and interesting contributions to the subject.

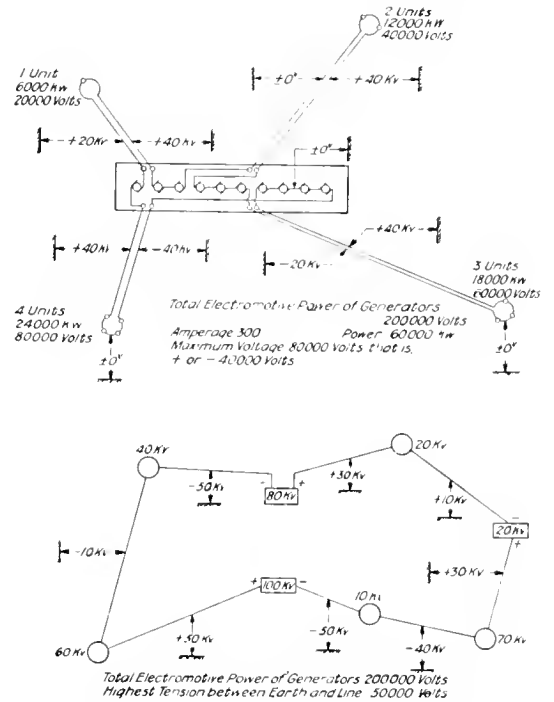


Fig. 3. Typical Examples of Series Circuits with Kilowatt and Kilovolt Data

Another point of interest is the use of the earth as a return circuit. In the above mentioned papers Highfield refers to experiments which Thury made on the Lausanne-St. Maurice line and reports in detail upon his work on the London line to prove the feasibility of using the earth as a return or as a reserve in case one cable breaks down. These experiments have proven that, owing to its constancy, direct current can be transmitted through the earth with only a small loss. The current density being relatively small (50 to 500 amperes) electrolytic effects upon pipes, etc., are localized to the proximity of the earth terminals.

The Thury system offers several further advantages of which the following should be mentioned. A higher voltage can be used than for alternating current with the same insulation, the great simplicity of the central stations on account of the absence of step up

and step down transformers, the absence of complicated switch gear such as circuit breakers and the usual breaking switches, and the impossibility of a great excess of current in case of damage to machines. Where desired, advantage can be taken of the fact that the motors on the Thury system have the property that the torque is independent of the speed.

This system of transmission allows the use of any natural source of power, great or small, which happens to exist in the regions through which the lines run. Individual central stations connected in series are entirely independent of local overloads or lack of demand, whatever the relative importance of these stations may be or whether the distance is great or small from the points of consumption. Their simultaneous running

is absolutely independent of the distances covered by the primary circuit, that is, independent of the resistance of the lines.

When the series system is combined with alternating current distributing plants there is no difficulty in linking together several lines fed by alternating stations of different frequency. Series motor-generators thus acting as a link form a valuable, elastic coupling for correcting both the variations of load and the differences of voltage caused by the load on the lines.

Highfield studied this question thoroughly with the object of connecting the twenty-four principal London stations. There exists no unity of system in London and lines are found one beside the other of 42, 50, 60, 80 and 100 cycles per second, or three- and single-phase, besides other sections fed by

TABLE 1

Description of Undertaking	Year of Start-up	Line Current Amp.	Total Length of Circuit Miles	PART. MACHINE UNITS						
				No.	Volts	Kw.	R.P.M.	Total Output	Total Line Pressure	
Soc. Acquedotto de Ferrari-Galliers (Italy), Genes, 1889	1889	45	74.6	18					630	14,000
Wasserwerke Zug (Switzerland)	1891	50	14.9	5	1,600	89	320		400	8,000
Papetries de Biberist (Switzerland)	1893	40	23.0	2	3,400				272	6,800
Communes du Val de Travers (Switzerland)	1895	65	21.7	3	2,600	186	260		590	9,100
				1	1,300	93	450			
				3	1,500			525	10,500	
Soc. d'Eclairage Electrique (Brescia, Italy)	1895	50	32.3	2	3,000				525	10,500
Soc. Romande de Electricite (Switzerland)	1895	50	22.4	4	3,500				700	14,000
Commune de la Chaux de Fonds et du Locle (Switzerland)	1896	150	32.3	7	1,800	288	300	1,890		12,600
Usines Electriques d'Eisenbourg (Hungary) Ikervare Steinamanger	1896	65	40.4	6	1,500	112	260		585	9,000
La Papelera Espanola Renteria (Spain)	1896	65	17.4	3	2,600	186			865	13,280
				2	2,740	194		865	13,280	
Soc. Industrielle d'Electricite (Italy)	1896	30	37.3	4	3,000				360	12,000
M. V. J. Dunand a Batoum (Russia)	1899	50	12.4	2	1,300				130	2,600
Usines Electriques d'Eisenbourg (Hungary) Ikervar Sopron	1899	40	74.6	4	2,500	112			400	10,000
Mines de Plomb Linares (Spain)	1900	60	37.3	3	3,500	238	320		630	10,500
*St. Maurice-Lausanne	1902	150	69.6	6	4,500	675	300	4,000		27,000
† Moutiers-Lyons First Stage:										
Station at Moutiers	1906	75	223.7	§ 5	14,400	1,080	300	4,300		57,600
‡ Second Stage:										
Station at LaBridoire	1911	150		4	9,125	1,368	428	3,600		24,000
‡ Third Stage:										
Stations at Moutiers and LaBridoire coupled in series	1911	150						8,400		56,000
‡ Fourth Stage:										
Station at Bozel	1912	150		§ 3	18,250	2,737	428			

* Straight transmission of 34.8 miles.

† Straight transmission of 112 miles, consisting of 106 miles of overhead wire and 6 miles of underground cable, the latter being at the extremity of the line and working at the full pressure.

‡ So far the total line pressure has not exceeded 75,000 volts, but it will subsequently be raised to 100,000 volts with a line current of 150 amperes.

§ Each unit consists of two double generators coupled to one water turbine.

§ Each unit consists of one double generator coupled to one water turbine.

direct current, and the harmonizing of these various systems is only possible with the aid of the series system.

The five different three-phase stations of the line belonging to the "Société Générale de Force et Lumière" (Grenoble-Lyon) are coupled and sustained by the Moutiers-Lyon series transmission, of which 28,000 h.p. is used for the general control of the three-phase line (46,000 h.p.) and for feeding the principal center of consumption in the town of Lyon. In this case the advantages gained by this combination of the two systems are important and interesting. It happens daily that two of the principal generating stations of this Company's distribution system are unequally loaded with reference to the capacity of the respective three-phase stations which feed them. The Bellegarde station generally has spare power, but that of Grenoble is not able to satisfy the consumers and at times of overload the speed of the turbines decreases slightly. Running in parallel with Bellegarde then becomes practically impossible, but at Lyon, the point of contact of the two lines, at least 100 km. (62 miles) from Bellegarde and about the same distance from Grenoble, the series system intervenes and reduces the load of Grenoble, thereby raising the frequency to that of Bellegarde. The latter can then be directly coupled in parallel with Grenoble. Each of the three big stations can thus be proportionately loaded in spite of the disproportion of available power and consumption.

This multi-circuit feature, which makes the constant direct current system especially efficient for inter-connecting a number of stations, systems or networks, can be applied to long distance railroading, as trans-continental lines where the stations feeding the railroad and all available sources of power near the railroad would be inter-connected by a series direct current system, resulting in economy of installation and operation together with a very high degree of reliability.

(b) Absence of Induction Effects

The absence of phase displacement and effects due to the capacity in the lines is advantageous to the transmission and to the central stations which are no longer exposed to the effects of resonance. At the same time running under small loads is facilitated by the absence of charging current due to the electrostatic capacity of the line at very high tension.

The reduction of corona effect as against alternating current, and the possibility of greatly reducing this effect by using equipotential lines either in case of return by earth or in case of the closed circuit, constitutes still greater advantage over alternating cur-

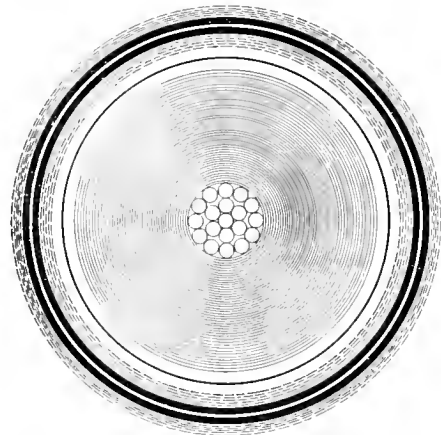


Fig. 4. Conductor Cable used in the Lyon High-Tension D-C. Transmission System. Its cross-section is 75 sq. m.m. (148,500 cir. mils). Full size

rent. The suppression of all induction effects permits the use of underground cables.

(c) Absence of Transformers

To obtain very high tension alternating current with constant voltage, step up transformers are necessary. Each of these transformers, if it is to be capable of producing a tension of, say about 100,000 volts, represents a considerable expense. The same high tension can be obtained with the direct current by connecting in series several units at reduced voltage without any machine having to stand more than 5000 volts between the frame and the winding. This subdivision of the tension has not only the advantage that intermediate transformers are unnecessary, but greater safety in working is effected and also simplicity of the installation.

(d) Transmission by Cable

The difficulties resulting from an overhead arrangement due to storms, etc., are eliminated in an underground transmission when such is possible; at the same time the cost of supervision and upkeep is reduced. The value of underground transmission for high tension is recognized especially in crowded centers so that expensive intermediate transformation is avoided.

A high tension alternating current rapidly fatigues the dielectric of the cable, heats it up and ultimately renders it unserviceable. The result is that one can only use underground cables for alternating current when the tension is relatively low and the distance not very great.

Cables with one conductor have been manufactured for tensions of 100,000 to 150,000 volts direct current between the conductor and the earth.

For nearly ten years a single conductor underground cable 9 km. (5.6 miles) in length has connected the central station of Vaulx en Vélín with the station of the Cie. des Omnibus et Tramways de Lyon in the Moutiers circuit, and has formed the line to the interior of the town of Lyon. This cable was designed to work normally at 100,000 volts direct current, 150 amperes, but actually works at a tension of 70,000 volts and although it is connected with an overhead line of 200 km. (124 miles) often exposed to atmospheric disturbances, it has not suffered from any accident since it has been in use. Fig. 4 shows a section of this cable full size which has been in service since 1906.

In England the Thury system has been adopted by the Metropolitan Company for general distribution in the West of London (297 sq. mi.). As the transmission had to be underground, the adoption of alternating current suitable for underground cables led to an estimate out of proportion to the economy of the project and it was that which led to the direct current being adopted. The first section of this distribution has been in service since 1911 and the scheme has fulfilled in every way what was expected of it.

The transmission over great distances by means of underground or submarine cables is an economic proposition with high tension direct current at 100,000 to 150,000 volts between the core and the earth, that is, 200,000 to 300,000 between the extreme conductors.

The losses, except those due to ohmic resistance, are negligible.

(e) Earth Return

The Thury direct current system permits the practical use of the earth as an active conductor. The use of the earth as a conductor presents considerable industrial advantages as it permits a reduction of 75 per cent in the necessary weight of copper for the same tension.

The Federal Government of Switzerland has made tests on the transmission scheme installed between St. Maurice and Lausanne (5000 h.p., 2200 volts, 150 amperes, 56 km. or 34.7 miles). One of the two overhead lines was replaced by the earth and the whole town service, traction and light was served during a period of 450 days by a single conductor. No accident caused by lightning or troubles on the earth connections and the numerous telegraph and telephone lines have become known.

The resistance of the two earth terminals, if they are well established, ought not to exceed one ohm. This resistance is only local, the distance separating the two earth terminals being of no influence. The earth can be used in two ways, as a neutral or as an active conductor. As a neutral the earth transmits no current, but only limits the difference of tension between the extreme conductors and the earth to half the total tension. In case of an accident on one of the lines, it permits the other to transmit at least half the energy.

IV. DISADVANTAGES

(a) Transformation

Whereas alternating current can be transformed by static transformers, the transformation of direct current requires rotative machines which are more expensive, require greater up-keep and are less efficient. This and the impossibility of subdividing the constant current are the two principal reasons which limit the use of direct current series transmission.

However, with alternating current the transformer must take the full voltage and, therefore, requires elaborate protecting apparatus whereas the machines of the direct current series system only take a part of the total tension. For instance, a motor of 1000 h.p. in series on a circuit of 300 amperes and 100,000 volts is calculated and insulated only for 3000 volts which is the maximum it can absorb, including 15 per cent overload. A motor for an output of 100 h.p. and fed by the same circuit would be calculated for 300 volts.

(b) Insulation from Earth

All machines on the Thury direct current system forming part of the high tension transmission circuit must be specially insulated from the earth and in such a way that the insulation can withstand the full line voltage without excessive strain. This special insulation is necessary for tensions over 10,000

volts or plus or minus 5000 volts between the extreme poles of the station and the earth. This insulation considerably increases the cost of the installation of the machines. It is necessary to insulate the bed plates of the machines, and as a precaution for the safety of the men, to insulate the ground around the machines and to avoid having any un-insulated objects around for some distance.

Originally the bed plates were mounted on a number of porcelain insulators. To prevent any accident, due to the splitting of an insulator, the concrete block underneath the insulators is insulated by arranging a number of insulating blocks underneath it. These insulating blocks are set in a pit which is afterwards filled up with an asphalt compound. With alternating current, insulation between the machine frames and the ground is not necessary, but on the other hand, a partition work is indispensable for all sections of the switch gear.

Where the Thury system is used, no general switchboards are required which may be said to reduce the danger to the operators. The necessary instruments are fitted on the machines and are, therefore, insulated by the machine insulation. Only a panel with the controlling instruments is installed at some distance from the machines and if an earth return is not used the panel must be insulated from the ground. This panel may carry a wattmeter, a voltmeter, a standard ammeter, and, if required, a registering voltmeter; these instruments being at the same voltage, can be manipulated when working without any danger. Their winding insulation must be the normal insulation of the corresponding machine.

When the machine has two armatures mounted on the same shaft there must be a specially strong insulation between the shaft and the punchings. This arrangement has been adopted for the Moutiers-Lyon line. The machines are calculated to give a normal tension of 9130 volts, but are frequently working at 10,000 volts.

(c) Commutation

In the Thury series system the commutators are a weak point as they must be very carefully made and generously proportioned, and this considerably augments the cost of the machines. Great attention must also be paid to the commutators during running, in which respect alternating current machines with slip rings have an advantage. This is undoubtedly the most serious difficulty

encountered in the production of satisfactory powerful units at high voltage with low amperage.

The first series machine made in 1890 was designed for a voltage of 1200 volts per commutator. In 1893 machines were made for a voltage of 3500 volts per commutator, and later 5000 volts per commutator. A higher voltage than 5000 volts has, up to the present time, not been exceeded in practice and this sets a limit to the size of the unit. With 5000 volts per commutator, twenty commutators are necessary to produce 100,000 volts. With four commutators per unit, which is the case in the La Rosière station of the Moutiers-Lyon line, five generator units are necessary for the tension of 100,000 volts at a constant current intensity of 150 amperes. The power thus available in this circuit is 15,000 kw., each unit of four commutators giving 3000 kw. With 300 amperes the power of each unit would be 6000 kw. and with 600 amperes 12,000 kw., this latter giving a total power of 60,000 kw.

It is evident from the above that the present day limit of 5000 volts per commutator means that the number of units to give a total high voltage is relatively great. This disadvantage, however, has one good point. In case of break down at any part of the plant it will only be necessary to shut down a small section. In a Thury installation erected in Zory in 1891 the generators in this station have been working for eight years at a rate of 18 hours per day at full load without having to change the carbon brushes, and during the 24 years of service not a single commutator has had to be removed. The voltage of these units, however, was not as high as 5000 volts, but something like 1600 volts per commutator.

(d) Constant Loss in the Mains

In the Thury series system the line is fed by a current of constant intensity and the loss in the line is, therefore, independent of the load. The efficiency of such a line is consequently low for small loads and then rises proportionately with the load. With relatively constant load this is not disadvantageous, but with a varying load the average efficiency of the transmission is considerably lowered.

When the prime movers used are heat engines or hydraulic machines using large reservoirs, the voltage and copper section of the line is important in order to obtain a suitable daily efficiency. On the other hand,

when water power is used without reservoirs the quantity of waste water during hours of small load is of little or no importance. Again, when the transmission line has several central stations in series as is the case in the Moutiers-Lyon line, and one of the stations makes use of the river without any reservoir, the constant loss is then of no importance. If any of the other stations wish to profit by economizing their water or their fuel, they can do so by allowing the station which makes use of the river without any reservoir to work under full flood. Each kilowatt added to the loss in the line is thus completely utilized at the other end without additional loss.

Thus in the series circuit, power can be added to the circuit at any point and this

power can be utilized at any point of the circuit whatever the distance or the resistance between the two points may be.

(c) Excessive Voltage Due to Open Circuits

As it is dangerous to interrupt a constant direct current, it is necessary to use all means in order to prevent the circuit from being entirely broken thereby eliminating a dangerous rise of pressure.

V. GENERATORS AND MOTORS

A description of the Thury generators and motors has frequently been given in technical literature. According to the *Elektrotechnische Zeitschrift*, 1906, page 1091, the generators of the Moutiers-Lyon plant have cast

TABLE II
SPECIFICATIONS OF THURY GENERATORS

Output.....	270 kw.
Speed.....	300 r.p.m.
Tension.....	3600 volts
Current.....	75 amperes
Number of poles.....	6
Bore.....	1250 mm. (49.21 in.)
Diameter of armature.....	1232 mm. (48.50 in.)
Axial pole length.....	300 mm. (11.81 in.)
Ventilating ducts.....	4 ea. 10 mm. wide (0.4 in.)
Number of armature slots.....	111
Number of coils.....	332
Number of turns per coil.....	3
Number of commutator bars.....	996
Diameter of commutator.....	1100 mm. (43.30 in.)
Width of commutator.....	75 mm. (2.95 in.)
Number of brush spindles.....	6
Number of brushes per spindle.....	2
Cross section of brushes.....	8×30 mm. (0.31×1.18 in.)

From this data the following characteristics would result:

Induced voltage at full load.....	3,736 volts
Air density at full load.....	59,000 lines
Maximum tooth density at full load.....	172,000 lines
Armature density at full load.....	73,000 lines
Magnet core density at full load.....	97,000 lines
Yoke density at full load.....	93,000 lines
Peripheral velocity of armature.....	3,820 feet per minute
Peripheral velocity of commutator.....	3,410 feet per minute
Maximum tension between two adjacent commutator bars.....	34 volts

TABLE III
SPECIFICATIONS OF THURY MOTORS

Output.....	360 h.p.
Voltage.....	3820 volts
Current.....	75 amperes
Number of poles.....	4
Bore.....	1262 mm. (49.68 in.)
Diameter of armature.....	1232 mm. (48.50 in.)
Axial pole length.....	300 mm. (11.81 in.)
Ventilating ducts.....	4 ea. 10 mm. wide (0.4 in.)
Number of slots.....	111
Number of armature coils.....	333
Number of turns per coil.....	3
Number of commutator bars.....	666
Diameter of commutator.....	750 mm. (29.52 in.)
Width of commutator.....	110 mm. (0.43 in.)
Number of brush spindles.....	4
Number of brushes per spindle.....	3
Cross section of brushes.....	8×30 mm. (0.31×1.18 in.)

steel frames with six cast-on poles. The armatures and commutators are fitted on the shaft with bosses. The drum windings consist of form-wound coils laid in slots. The main particulars of the individual machines are given in Table II.

Fig. 5 illustrates a typical Thury generator with an automatic regulator built by the Compagnie de l'Industrie Électrique et Mécanique, Genève, Switzerland. This machine is designed for 170 kw., 375 r.p.m., 3400 volts, 50 amperes.

Thury motors are practically of the same design as the generators. The station at Rue d'Alace of the Moutiers-Lyon plant has five series motors each of 720 h.p., coupled to 500-kw. direct current machines giving 600 volts and supplying the tramway circuit in Lyon. These motors are arranged as double machines, each bed plate carrying three bearings and two four-pole frames of cast steel. The poles are screwed on to the frame, and according to the *Elektrotechnische Zeitschrift*, 1906, the specifications are as given in Table III.

Fig. 6 is an illustration of a series motor for 220 h.p., 320 r.p.m., 3400 volts, 50 amperes, with an automatic regulator, built by the Compagnie de l'Industrie.

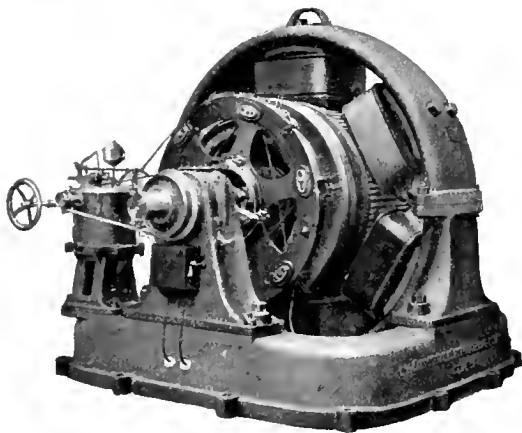


Fig. 5. A D-C. Series System Generator of 170 kw., 375 r.p.m., 3400 volts, 50 amperes capacity with Automatic Regulator

VI. REGULATION

(a) Generators

In the Thury series system each generator and each motor must have its governor; the generators to maintain the amperage constant on the line and the motors to maintain the speed constant, except in special cases. Two methods of governing the generators are

employed, (a) by varying the speed of the generator groups or (b) by varying the position of the brushes should the speed be constant. In the first method one governor alone automatically adjusts the speed of the generator groups according to the tension of

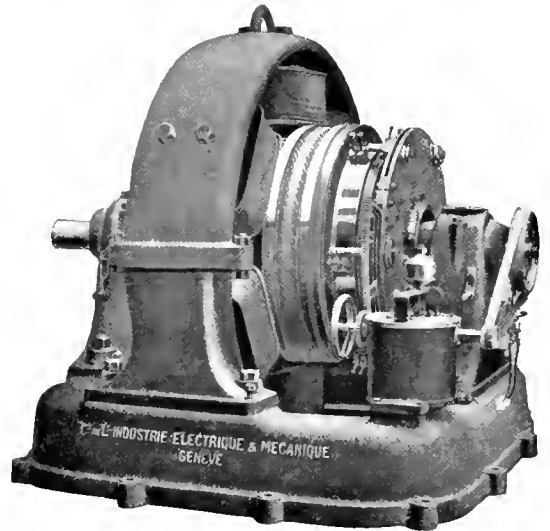


Fig. 6. A D.C. Series System Motor of 220 h.p., 320 r.p.m., 3400 volts, 50 amperes capacity with Automatic Regulator

the circuit. It works on the turbine nozzles by means of a ratchet and pawl device or is actuated by oil under pressure. The generators are then series wound with fixed brushes and without any regulating device. This method of governing is chosen when hydraulic turbines capable of running at low speeds with half the available flow of water produce the necessary power. To avoid the speed being reduced too far for small loads when the output varies greatly, it suffices to keep only the number of units running which the service actually demands.

Governing by moving the brushes is used when the construction of the turbine requires a constant speed or when the efficiency of the turbines at small load is of importance. In such cases a double control is necessary, one for the speed and one for the current intensity.

Speed governors are those generally used, but they are not required to fulfill the conditions which are demanded of governors controlling alternators; thus in the series system the control of the speed can be approximative, the division of the load between several units being independent of the speed.

The groups of the central stations can run at speeds varying 10 per cent one from another without any inconvenience and the division of the load suffers in no way. These conditions permit the best use of the inertia of flywheels.

This is very important when the inertia of the water in the pressure pipes plays an important part and could produce dangerous hydraulic recoil or surges. The fact that synchronizing is not required renders the governing of turbines or other prime movers with the series system much easier.

The equal distribution of the load between several groups might seem difficult to realize, but the use of powerful governors with a sensibility of 0.2 per cent has made the satisfactory distribution of the load possible. The chief point in the question of regulation, which is in favor of the Thury system, is that all synchronizing troubles are avoided.

b) Motors

To prevent the speed of the motor varying with the load, a special speed governor is employed. As each motor on the Thury system requires a governor, this is a serious drawback in comparison with the usual alternating synchronous and asynchronous motors. This constitutes a great objection to using the Thury system as a means of distribution.

VII. APPARATUS AND ACCESSORIES

In the series system the amperage being the same in all parts of the circuit, the necessary apparatus is the same for all the machines whatever their individual power may be. The windings of the different machines bear a great similarity and a uniform section of conductor can be employed. This is also an advantage from a manufacturing point of view.

For each unit the apparatus consists chiefly of a general control switch and an auxiliary switch. The former is mounted on arms fitted to the bed plate of the machine and provided with an ammeter and voltmeter. The object of the latter switch is to isolate any particular unit when cleaning or dismantling is necessary in which case the unit is properly connected to earth. When the rotation of the generators is reversed, they are automatically short circuited through a relay which acts upon the switch. The motors are similarly fitted with safety contrivances. General switchboards are not necessary.

The generators can be started up in a few seconds. In the case of a generator controlled by varying the speed, the attendant opens the turbine valve, the generator being short circuited. Owing to the poles being connected in series their effect is felt after the first two or three revolutions and the amperage rises according to the rate of starting until the normal intensity is reached. By opening the switch, the machine is brought in circuit and this occurs without any sparking.

In the case of a constant speed generator, the machine is brought up to its normal speed, the brushes are moved until the normal current intensity is reached and then the switch is opened. In order to shut down a variable speed generator, the turbine valve is closed and the generator is short circuited as soon as the voltage becomes zero. If the speed is constant, the governor is cut off, the brushes brought to the zero position, and the switch is then closed. The turbine can also be cut off and the switch closed as soon as the turbine stops. Starting-up and shutting-down generators is, therefore, a simple process and no breaking switch is required. There is no trouble as regards synchronizing or adjusting and this is particularly important in case of overload or accidents as synchronizing is in such cases often difficult and the cause of delay just when this delay is very undesirable. One feature of great importance in connection with generators on the Thury system is that automatic circuit breakers become unnecessary. Circuit breakers are not required owing to the fact that a damaged generator does not cause an increase of current but on the contrary the total current is decreased. The precaution taken consists in providing a relay for each governor which automatically shifts the brushes to the zero position in case of accident. The attendants have then only to short circuit and stop the machine. This same relay brings the generator brushes back to zero when the transmission line is accidentally cut or short circuited and prevents any subsequent re-excitation without the intervention of an attendant. A broken line is thus immediately rendered harmless unless doubled by any other line in parallel. In this case the broken line can be automatically cut off without interrupting the general circuit.

VIII. COST COMPARISONS

The cost of a d-c. transmission line is less than that of a line of similar capacity for alternating current, more particularly where underground cables are employed, and

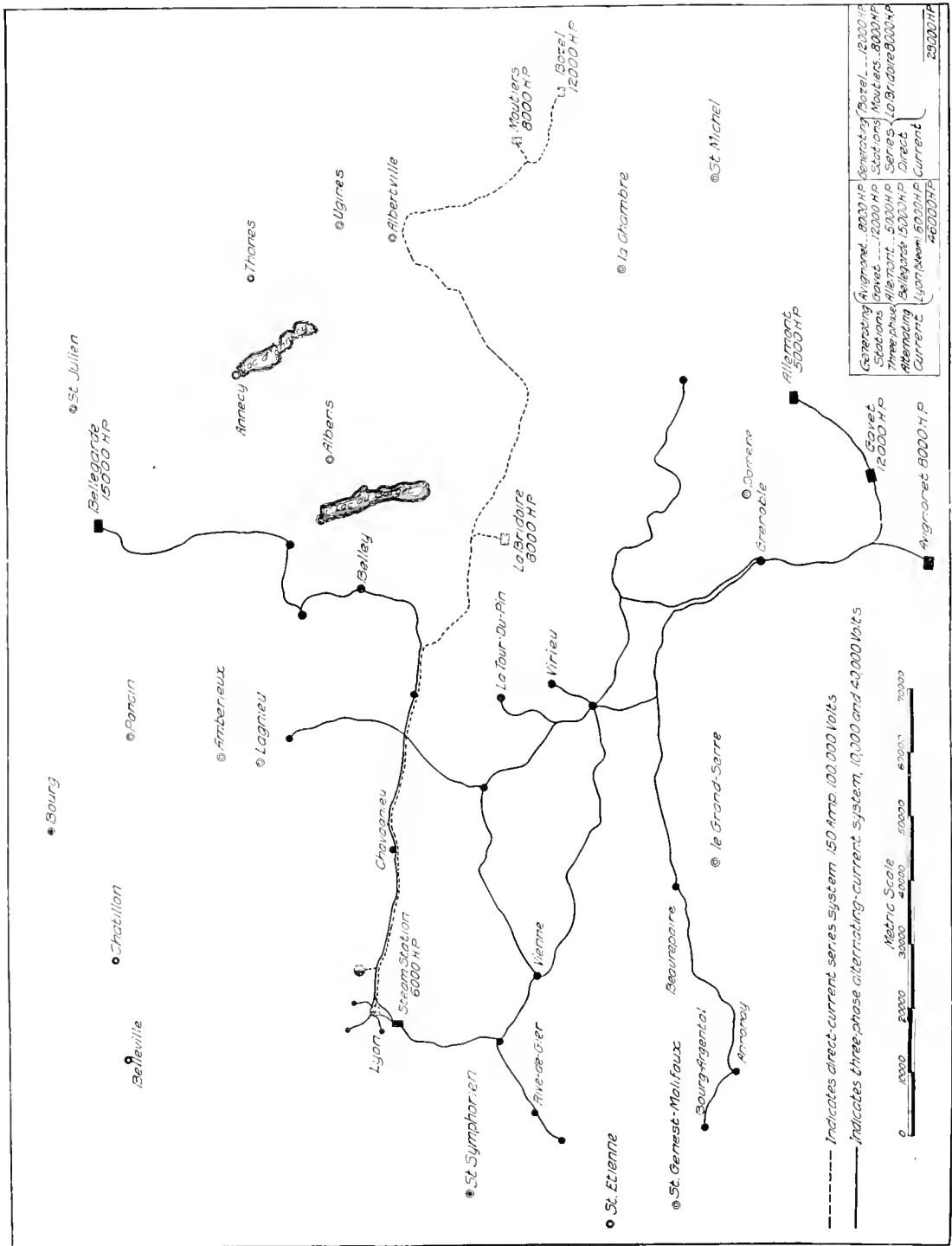


Fig. 7. A Map showing the Lyon Transmission Lines

further, the use of the earth as one of the conductors results in a very large saving. In addition to this the switch gear is simpler and cheaper. Against this, however, the cost of the necessary governors must be set, the commutator construction of the machine, the special insulation to earth, in short, the costly d-c. generating station.

The Swedish and Danish governments carried out investigations in regard to a transmission line between Trollhalten, Sweden, across the strait to Copenhagen, Denmark, and comparative costs were made up of a generating equipment and a 200 mile line for 90,000 volts. In this particular case the existing generating station is 25 cycles, and 50 cycles is required at Copenhagen, thus necessitating frequency changer sets.

The investigations resulted in favor of the Thury system, the d-c. generation and transmission using wooden pole line construction, a submarine cable across the strait and ground return being considered the most economical one and possessing favorable operating features. So far as known, this installation has not been made.

IX. MOUTIERS-LYON TRANSMISSION SCHEME

(a) General

The "Société de Force et Lumière" owns a three-phase distribution network covering an area of about 9000 to 10,000 sq. km. (3474-3860 sq. mi.) in the French districts of the Rhone, Isère, Savoie and the Loire. This network was originally fed by four hydro-electric stations distributing three-phase current at 40,000 volts, 50 cycles per second and was completed by three stations on the Thury series system. A steam plant also producing three-phase current formed the reserve at Lyon. The total power of the three-phase stations is 46,000 h.p. and at the present time the Thury stations generate 28,000 h.p. but they are capable of producing twice this power. The three-phase network was installed some years before the Thury section, the latter dating from 1906.

It is interesting to note the reasons which led the Société Générale to install the Thury system when it would have appeared at first sight to be more logical for the sake of uniformity to equip the three stations at Moutiers, Luzerne and LaBridoire with three-phase current. The choice of direct current made it necessary to build a sub-station at Lyon containing rotary converters for transforming direct to three-phase

current. This meant not only greater cost, but a lower efficiency than that obtainable by alternating current.

The direct current series line from both Bozel and Lyon is 200 km. (124 miles) in length. For a great part of its course it runs through mountainous country where storms and hurricanes frequently occur. Fig. 7 shows the complete transmissions, the dotted line represents the Thury transmission and the full line the three-phase transmission. A three-phase line would have been much more costly and more difficult to construct than a direct current line consisting of two conductors. Further, the company had to penetrate into the heart of the town of Lyon in order to furnish the tramway station with the necessary power. It was only possible to enter the town in this way by using underground cables and to do this with alternating current, the transmission tension would have had to be lowered. The application of the direct current series system made it possible to enter the town by means of a cable with full line voltage, thus making any transformers on the outskirts unnecessary.

A further consideration which led to the adoption of the Thury system was that it



Fig. 8. A Column carrying a Switch, Voltmeter, and Ammeter as employed in the d-c. series system

dispensed at once with all the inherent difficulties of running the different three-phase lines in parallel and its adoption meant the perfect control of the voltage and frequency in the heart of the most important center of consumption.

The first section of the Thury installation, erected in 1906, consisted of a single generating station situated on the Isère (Savoie) at a distance of 180 km. (112 miles) from Lyon. This station had four units, each of 1600 h.p. at 57,000 volts, 75 amperes; a fifth unit was added later. The current was transmitted to Lyon by an ordinary transmission line erected chiefly on wooden poles and fed the tramway station (an average of 2500 to 3000 kw.) and also the three-phase network of Grenoble and Bellegarde.

Later the three-phase network of Lyon rapidly developed and it became necessary

for 150 amperes as a test and raised in power to 900 kw. instead of 500 kw., the total generating power being thus increased to 18,000 kw. including reserve. The Moutiers station and also that at Bozel has a period of low water in winter. The LaBridoire station was installed with the object of maintaining a total production of 15,000 kw. (100,000 volts, 150 amperes) all the year round. The power is obtained from a natural reservoir formed by the lake of Aiguebilette working under a double head of water of 120 meters (394 feet). The stations at Moutier and Bozel usually work under the fullest load

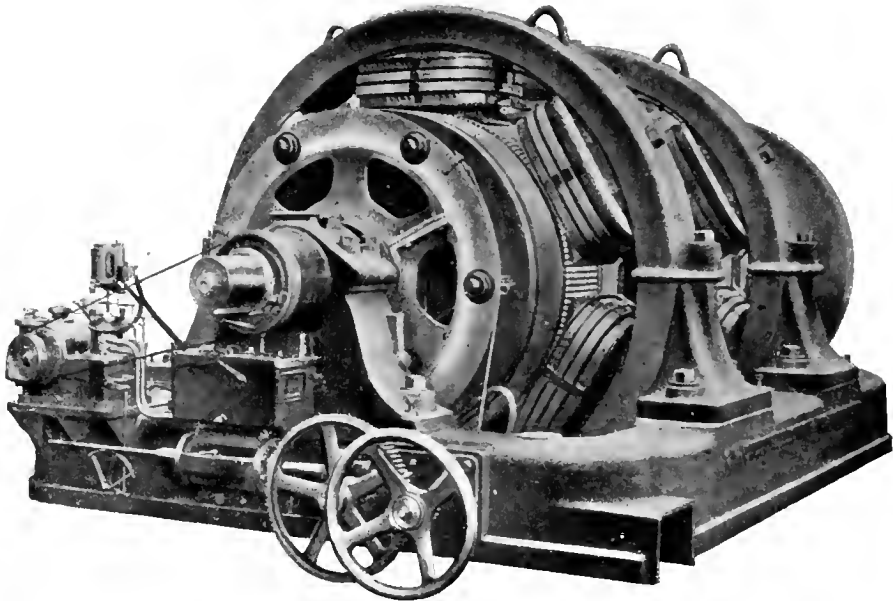


Fig. 9. A Double, Series, D.C. Generator of 2000 h.p., 428 r.p.m., 150 amp., 2×4565 volts with Regulator for the Moutiers-Lyon Transmission located in the Bridoire and Rosiere station

to considerably increase the help given by the Thury system and two new stations were established in 1909, one at Bozel (12,000 h.p., 150 amperes, 57,000 volts) at a distance of 200 km. (124 miles) from Lyon, the second at LaBridoire (8000 h.p., 150 amperes, 36,000 volts).

These new stations were connected in series with the Moutiers station; the armatures of the Moutiers generators (75 amperes) being coupled in parallel to obtain the 150 amperes of the new circuit. At Lyon the first motors were also supplied for 150 amperes and seven new converter groups of 200 h.p. were put into service on the Grenoble, Bellegarde and Lyon three-phase network. The two first converter groups were rewound

that the available water can produce. The LaBridoire station bears all the fluctuations and either maintains the control alone or jointly with the Bozel station. The station rarely works at night time, the water being economized as much as possible for the period of low water.

(b) Moutiers Plant

There are five units each of 3600 h.p. running at 300 r.p.m. The turbines have neither flywheels nor individual governors. A general governor regulates all the units in use simultaneously by means of a contrivance which acts upon the nozzles of the turbines. This governor is less sensitive than those of the Bozel and LaBridoire stations; it is only

brought into play when these two stations reach the limit of their control. In practice the governor is rarely in use, the load always being greater than the capacity of the station. The dynamos have no governors and, being excited in series, their brushes are stationary.

Each unit is fitted with a column carrying a switch, a voltmeter and an ammeter, shown in Fig. 8. A small switch attached to one of the bearings is used for short circuiting the dynamo. The machine is shut down by simply closing the turbine. This having been

Pelton wheels develop a maximum power of 4400 h.p. with a head of 720 meters (2362 feet). Each group forms a complete unit having its own control by means of an electric oil pressure regulator. This device shifts the brushes, thus obtaining a variable voltage from 0 to 4500 volts for each commutator. The current is 150 amperes and there are no signs of sparking under any conditions of load. The regulators, unlike those at Moutiers, are very sensitive and show variations of 0.2 per cent. The load is auto-

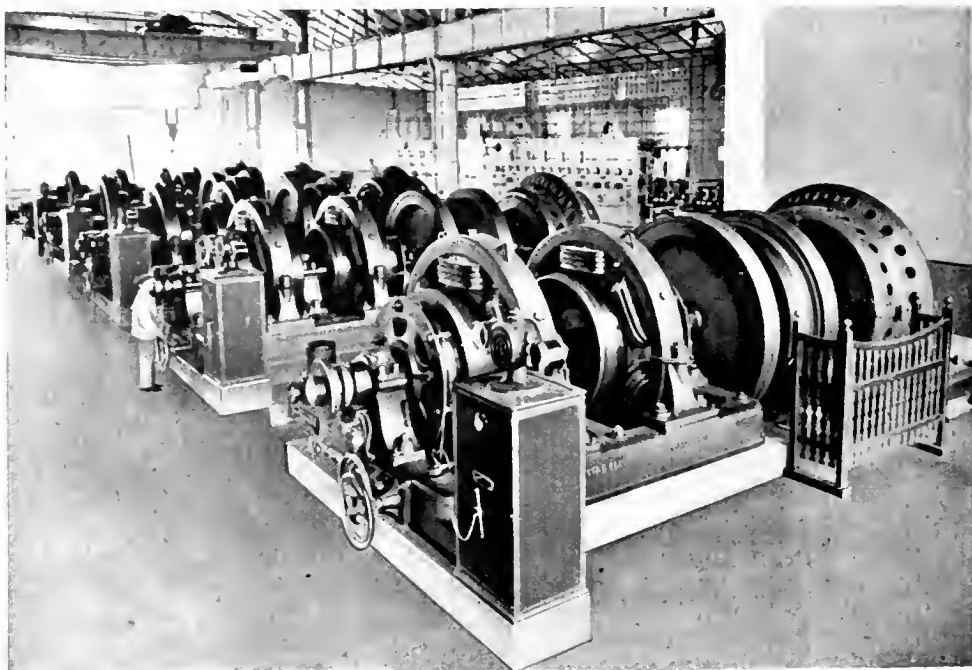


Fig. 10. D-C. Three-phase Converters, each group including 2000-h.p. series motors 2×4565 volts, 140 amp., 428 r.p.m., Vaulx en Vélín

done, the column is short circuited, thus disconnecting the dynamo from the circuit. There is no general switchboard but a small panel is used on which a meter, a general voltmeter and a standard ammeter are fixed. A recording device plots the daily fluctuations of voltage. No rheostats are necessary and the station is in charge of a superintendent and mechanics.

(c) Bozel Plant

This station contains three groups each of 1000 h.p. at 18,000 volts under normal conditions with a margin of 10 per cent. The speed of 428 r.p.m. is maintained by Piccard governors with the help of flywheels. The

machines are automatically distributed between the groups within a margin of 10 per cent. The apparatus is the same as in the Moutiers plant. The dynamos are connected in series by means of a single cable with single core which passes directly from one machine to another.

(d) LaBridoire Plant

This station contains four groups each of 2000 h.p. at a normal voltage of 9000 volts, 428 r.p.m. The station is equipped in exactly the same way as that at Bozel. The generators are shown in Fig. 9.

(e) Insulation

Each pair of dynamos is mounted on a carefully insulated bed of cement. The

insulators which support this bed are packed in a thick composition of asphalt and bitumen tested up to 100,000 volts alternating current. The control panel is mounted in the same way.

(f) Couplings

The couplings are of the Raffard type modified on account of the large power which they have to transmit and the insulation which they have to provide between the turbines and the dynamos. The coupling

are isolated by a series of circuit breakers and the connection of one section with the earth can thus be effected should any accident happen or any particular combination be necessary.

For a distance of 40 km. (25 miles) the line is carried on the same poles which carry the three-phase current at 40,000 volts. The rest of the line is supported on wooden poles, or uprights made of reinforced concrete. The length of the overload section is about 196 km. (120 miles).

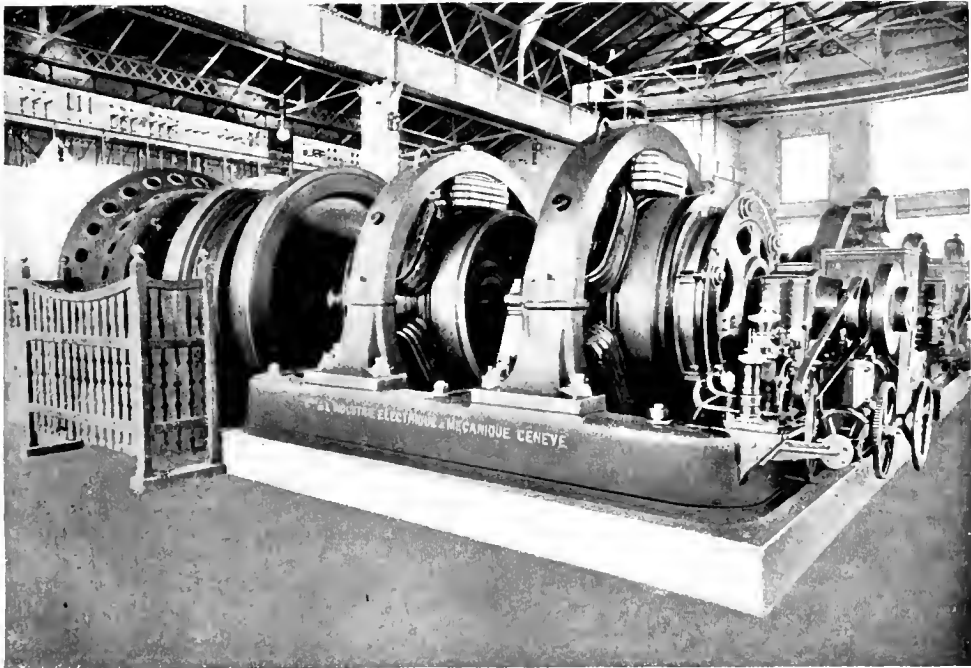


Fig. 11. D.C. Three-phase Converters including double, series, motors 2000-h p., 2×4565 volts, 428 r.p.m. with Oil-pressure Regulator, Vaulx en Vélín

is connected up by means of a belt, the two halves being at a distance of about 0.40 meters (1.3 feet) apart.

(g) Transmission Line

The constant current is 150 amperes at 100,000 volts. The line is 200 km. (124 miles) in length and consists of four conductors 9 mm. (124,740 circ. mils) in diameter. The total resistance is 5.3 ohms, including the underground cable which enters the town of Lyon. The loss under full load is 8 per cent and the weight of copper for the 800 km. (497 miles) is 456 tons. This works out at 30 kg. (66 lb.) per kilowatt. The two wires of each line form a mutual reserve. These

The overhead line runs into the transmission station of Vaulx en Vélín which is about $4\frac{1}{2}$ km. (2.8 miles) from the town center. From this point the power is carried into Lyon by the underground cable in order to feed the tramway station which latter has its converters giving 3000 kw. at 600 volts.

(h) Vaulx en Vélín Plant

This station takes two three-phase lines at 40,000 volts and distributes the current to Lyon at 10,000 volts. It also takes the current from the steam plant at Lyon. In this station the greater part of the series current power is converted into three-phase current at 10,000 volts by means of seven converters.

each giving 1400 to 1500 kw., and two converters of 500 to 700 kw. These converters are shown in Figs. 10 and 11. There is thus about 11,000 kw. available for increasing the general three-phase distribution, maintaining the voltage and frequency of the three-phase current. From this distributing station the secondary network which is entirely underground, feeds the chief industries of Lyon, which it is expected will absorb later a further 50,000 h.p. The extension of the Thury system is being studied and it is probable that a new line for 15,000 kw. entirely underground will be laid.

The converters in the Vaulx en Vélin plant consist of series motors 2000 h.p. driving the above mentioned generators of 1400/1500 kw. three-phase, 10,000 volts, 50 cycles per second at 428 r.p.m. The motors are identical with the Bozel and LaBridoire generators. They are also fitted with an oil pressure regulator which shifts the brushes. These regulators, in order to maintain a constant speed, are fitted with extremely sensitive tachometers and the speed can be adjusted at will. Thus a converter can be coupled to one or other of the three-phase networks (Lyon, Bellegarde or Grenoble) in spite of a slight difference of frequency which occurs daily when one or other of the lines is overloaded. In this way it is possible to couple an overloaded line having a low frequency to another having a frequency slightly too high. Once the lines are coupled in this way, the frequency of the overloaded line is raised by the energy from the line which happens to be under low load. In this way the Thury system divides the available energy proportionately amongst the five three-phase stations.

The steam reserve only comes into play in case of accident or when the hydraulic power fails. This power can, however, be used to the last drop of water and each line can work even when its own station becomes insufficient to supply the demand.

(i) Lightning Protection

The three generating stations at Bozel, Moutiers and LaBridoire and the converter station at Vaulx en Vélin are all equipped with protective apparatus against lightning. This consists of a condenser connected to the terminals of each station, an inductive resistance of iron and a metallic resistance linked to the earth for electrostatic discharges and to choke oscillations caused by lightning.

Conductors insulated with paper on the Berthoud Borel principle have given entire

satisfaction and so far no accidents have happened. Storms have only been indirectly the cause of disturbances, due to lines broken by falling trees, broken insulators or short circuit, probably caused by branches of trees blown on the wires by the wind. These troubles are partly due to the fact that a considerable portion of the line is only about 5 to 7 meters (16.4-23 feet) above the level of the ground. The security of the line would be considerably greater if underground transmission were used and it is more than probable that the next extension will be carried out underground.

X. CONCLUSIONS

The Thury direct current system is a transmission, and not a distribution scheme. The possible applications are much more limited than those of the polyphase system. The two systems are mutually complementary instead of competitive, each having its own sphere of application and both are suitable to work side by side. The Thury system possesses certain important advantages, particularly where power in bulk is to be transmitted from one point to another over a long distance, and for interconnecting a number of stations for the transfer of power and for power systems of networks covered by means of a single wire closed-ring circuit.

With the usual overhead construction the Thury system can claim the advantage inasmuch as only two wires are required and a given insulator will withstand a much higher direct current tension than alternating current tension. One of the prominent advantages of the Thury system is that underground and submarine cables can be, and have been successfully employed with very high tension. There are no inductive losses, phase displacements and capacity troubles; corona losses are reduced and losses in the dielectrics are practically eliminated.

A further important feature is the employment of the earth as an active return conductor which has been found practical with only small losses.

Owing to the saving which can thus be effected in the line, the fact that transformers are not necessary, and the absence of all elaborate switchboards, the cost of a transmission scheme on the Thury system may be lower in certain cases than the cost of an alternating current system. As several power stations on the Thury system can be put in series with the utmost simplicity, the system can be used for transmitting and trans-

forming into any desired frequency and voltage, thus enabling one alternating current station to assist another which may be unable to cope with its load, even though the two stations may not have the same frequency or voltages.

Although the Thury system plants are simple in construction and operation, there are several disadvantageous features; namely the large number of comparatively small machines necessary, the presence of high tension commutators as against slip-rings for alternating current, the difficult and expensive insulation necessary to insulate the machines from earth, and the rather complicated regulating apparatus.

It is usual for distribution purposes to transform the high tension direct current into alternating current and to do this rotary converters are necessary, as against static transformers in alternating current transmission schemes. Another point in the consideration of the Thury system is that the losses in the line are constant whatever the load may be.

In conclusion, the author desires to express his appreciation to Mr. R. Thury for the valuable assistance rendered to him in the study of this interesting transmission scheme.

XII. REFERENCE LIST

- Journal of the Institution of Electrical Engineers*
1907, vol. 38, page 407
1912, vol. 39, page 848
1913, vol. 51, pages 443, 640
- Electrical World*
1912, vol. 60, pages 1093, 1144
1913, vol. 61, pages 294, 759
- National Electric Light Association, 36th Convention, Chicago 1913, Hydro-electric and Transmission, page 96
- Elektrotechnische Zeitschrift*
1902, Heft 46, pages 1001-1005
Heft 47, pages 1016-1021
Heft 48, pages 1038-1042
1905, Heft 24, page 571
1906, Heft 47, page 1091
1908, Heft 28, page 679
1913, Heft 39, page 1115
- Zeitschrift des Vereins Deutscher Ingenieure*
1913, page 118
- Bulletin et Comptes Rendus Mensuels de la Societe de l'Industrie Minerale*
March, 1910, page 233
- Distribution de la Force A Grande Distance par l'Electricite par H. Cuenod, Paris, Cauthiers-Villats, 1900*
- Die Gleichstrommaschine von E. Arnold, Zweiter Band, 1907.

THE KINETIC THEORY OF GASES

PART II

BY DR. SAUL DUSHMAN

RESEARCH LABORATORY, GENERAL ELECTRIC COMPANY

In the present installment of this series of articles on "The Kinetic Theory of Gases" the author discusses the deductions from the theory of molecular collisions. It is shown that, according to the kinetic theory, the coefficients of heating conductivity, viscosity, and diffusivity are quantitatively connected with the length of the free path and molecular diameter. Tables of values are given of the average free path and molecular diameter for some of the more common gases.—EDITOR.

Free Path

In Part I we showed that gas molecules possess very high velocities, ranging as high as 18,000 meters per second in the case of hydrogen gas at room temperature. This is apparently in contradiction with the common observation that gases actually diffuse very slowly. Hydrogen sulphide gas generated in one corner of a large room will not be detected at the other end for quite a long time. Under normal conditions heat is conducted by gases at an extremely slow rate, yet if the gas molecules traveling from the hotter region possess high velocities, they should reach the colder region in an inappreciable small interval of time.

It is evident that if the molecules were mere point centers with no forces acting between them, there would be no chance of collision among them; on the other hand, if the molecules have definite dimensions, or exert attractive forces on each other, it is possible for such collisions to occur, and the molecules will therefore not be able to travel very far in a direct line. Thus we obtain an explanation of the fact that, while individual molecules travel with extremely great velocities, molecules of one kind actually diffuse into molecules of another kind at a very slow rate.

The use of the term "collision" naturally leads to another concept—that of *free path*. Ordinarily this is defined as the distance traversed by a molecule between successive collisions. Since, manifestly, the magnitude of this distance must be a function of the velocities of the molecules, we are further led to the use of the expression "average free path" (denoted by L), which is defined as the average distance traversed by all the molecules between two successive collisions. Mathematically, it is the sum of the free paths of all the molecules at any instant divided by the total number of paths.

However, this definition assumes that the molecules actually collide like billiard balls; that is, the molecules are assumed to be rigid elastic spheres possessing definite dimensions and exerting no attractive or repulsive forces on each other. This, however, can certainly not be in accord with the facts. We have every reason to believe that the structure of atoms and molecules is exceedingly complex. It is probably impossible to state definitely what is the diameter of a hydrogen atom or molecule. Also there is no doubt that the molecules exert attractive forces on each other for certain distances and repulsive forces when they approach exceptionally close. Otherwise how could we explain surface-tension, discrepancies from Boyle's law, and a host of related phenomena? To speak of collisions among molecules such as these is impossible. What meaning, therefore, shall we assign to the free path under these conditions?

It is readily seen that the most essential idea at the back of the term "free path" is this: We imagine it possible to take a cinematograph picture of the molecules in a given portion of space; we then consider their velocity components in a given direction and find that at the end of a certain distance L the average value of the velocity components of all these molecules taken in the same direction has decreased by a certain amount; in other words, the average number of molecules traveling in the given direction is less after they have traversed the distance L . On this basis, the term free path has a physical meaning which is independent of all ideas that we may form of the actual structure of the molecules or of the nature of the intermolecular forces.

Another method of overcoming the same difficulty is to investigate the relations between the free path and the other properties of a gas, assuming rigid spherical molecules with or without attractive forces

and then considering the case of any actual gas in terms of this hypothetical gas.

Methods of Calculating Mean Free Path

Evidently the mean free path must depend upon the molecular diameter, and simple considerations indicate that the length of the mean free path must vary inversely as the total cross-sectional area of the molecules per unit volume. Again, the magnitude of the coefficients of viscosity, heat conductivity and diffusivity of gases are intimately bound up with the length of the free path; whether it be transference of momentum from one layer to another as in viscosity, or transference of increased kinetic energy of the molecules as in heat conductivity, the rate of this transference must depend upon the number of collisions which each molecule experiences as it passes from point to point. We thus obtain relations between the mean free path, the coefficients of viscosity and heat conductivity on the one hand, and on the other hand, equations that connect the mean free path with the molecular diameter.

In the following sections we shall discuss these relations under the following headings:

- (1) Relations between mean free path and coefficients of viscosity and heat conductivity.
- (2) Relations between mean free paths; molecular diameter and coefficients of viscosity and heat conductivity.

Relation Between Coefficient of Viscosity and Mean Free Path

A gas streaming through a narrow bore tube experiences a resistance to flow, so that the velocity of this flow decreases uniformly from the center outwards until it reaches zero at the walls. Each layer of gas parallel to the direction of flow exerts a tangential force on the adjacent layer tending to decrease the velocity of the faster-moving and to increase that of the slower-moving layers. The property of a gas (or liquid), in virtue of which it exhibits this phenomenon, is known as *internal viscosity*.

As a simple working hypothesis we may assume, as Newton did, that the internal viscosity is directly proportional to the rate of decrease of velocity in the different gas layers. Furthermore, the viscosity must depend upon the nature of the fluid, so that in a more viscous fluid the tangential force between adjacent layers, for constant rate of decrease of velocity, will be greater than in the case of a less viscous fluid. We thus

arrive at the following definition of the *coefficient of viscosity*:

The coefficient of viscosity is defined as the tangential force per unit area for unit rate of decrease of velocity.

With this definition we are in a position to deduce the approximate form of the relation between the coefficient of viscosity and the free path.

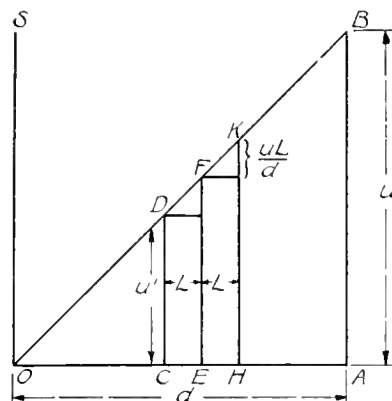


Fig. 2

Let u denote the velocity of flow of the gas at a distance d from a stationary surface. In the case of uniform flow along a surface, the velocity will decrease uniformly to zero as the surface is approached. We can therefore represent, as in Fig. 2, the velocity at distance $OA = d$ by the ordinate $AB = u$ and velocities at intermediate distances by the corresponding ordinates below the line OB .

We shall imagine the gas divided into layers parallel to the surface, each having a depth equal to the free path, L .

Let us denote the tangential force per unit area between adjacent layers by B . By definition:

$$B = \eta \times \text{velocity-gradient} \\ = \eta \times \frac{u}{d} \tag{11}$$

where η denotes the coefficient of internal viscosity.

But according to the kinetic theory, the tangential force per unit area is measured by the rate at which momentum is transferred per unit area between adjacent layers.

Owing to the relative motion of the layers, the molecules moving from a faster into a slower moving layer possess more momentum in the direction of flow than those moving in the opposite direction.

Let us consider any layer, CE or EH of thickness equal to L . We have chosen this particular value of the thickness so that we may be justified as a first approximation in assuming that the molecules starting at either of the planes CD or EF reach the opposite plane without suffering collision, that is, without change of momentum.

The momentum, parallel to the surface, of any molecule reaching the plane EF from the plane CD is $m(u' + G)$, where u' denotes the velocity of flow at the plane CD and G is the mean velocity of the molecules.

The momentum, parallel to the surface, of a molecule reaching the plane EF from the plane HK is $m\left(u' + G + 2\frac{uL}{d}\right)$.

The number of molecules that cross unit area per unit time in any direction in a gas at rest is equal to $\frac{1}{6} n G$, and this must be the same for the molecules traveling in a direction perpendicular to the plane EF , for the velocity of flow is assumed to be so small that the density remains constant throughout the different layers.

Hence the net rate of transference of momentum across unit area of the plane EF is equal to

$$B = \frac{1}{3} m n G \frac{uL}{d} \quad (12)$$

From equations (11) and (12) it follows that

$$\eta = \frac{1}{3} m n G L = \frac{1}{3} \rho G L \quad (13)$$

where $\rho = \frac{MP}{RT}$ = density

$$G = 15,800 \sqrt{T} M \text{ cm. sec.}^{-1}$$

In deducing this equation it has been assumed that the molecules all possess the same velocity G and the same free path L . It is evident therefore that the equation thus derived cannot be accurate. Introducing Maxwell's law of distribution of velocities, Boltzmann deduced the equation

$$\eta = 0.3502 \rho \Omega L \quad (14)$$

where Ω = average velocity

$$= 14551 \sqrt{T} M \text{ cm. sec.}^{-1}$$

and L is defined as the *average free path*.

Meyer in his "Kinetic Theory of Gases" used a different method of calculation and derived a relation of the form,

$$\eta = 0.3097 \rho \Omega L' \quad (15)$$

This is the relation usually adopted in text books on physics. On the other hand, the more recent publications, such as those of Jaeger¹, Millikan and Fletcher², prefer Boltzmann's formula. Following the latter authorities we have made use in the following calculations of equation (14) to determine the so-called mean or average free path.*

From equation (13), (14) or (15) an interesting conclusion may be deduced regarding the dependence of viscosity on pressure. As has been mentioned above, it is evident from very simple considerations that L varies inversely as the number of molecules present per unit volume. Consequently the product ρL is constant and independent of the pressure. The velocity, Ω , depends only upon the temperature and molecular weight. It therefore follows that, for any gas at constant temperature, the *viscosity is independent of the pressure, and must increase with the temperature*. The confirmation of these two deductions has been justly regarded as one of the most signal triumphs of the kinetic theory of gases. As is well known, the viscosity of all ordinary liquids *decreases* with increase in temperature. That the viscosity of gases must increase with temperature was therefore regarded as a remarkable conclusion.

At both extremely low pressures and very high pressures, the conclusion is not in accord with the observations, but this is due to the fact that the same derivation as has been used above is not valid under those conditions where either attractive forces between the molecules come into play or the pressure is so low that a molecule can travel over the whole distance between the walls of the enclosure without suffering collision.

According to the above equations, it is therefore possible to calculate L for a gas under given conditions from data on the viscosity. In Table IV are given the values of $L = \eta / (0.3502 \rho \Omega)$ calculated for different gases at 0 deg. C. and 20 deg. C. and 10^6 bars. The values of ρ have been calculated from the molecular weights, while the values of Ω have been taken from Table III.

(1) Fort. der Kinet. Gastheorie.

(2) Phys. Rev., 4, 440 (1914).

* In German text-books, L is referred to as "mittlere freie Weglänge." The term "mean free path" is used by English writers, most of whom adopt Meyer's formula. In view of the fact that we may have several different "means," we prefer the unambiguous designation "average free path."

$$L' \text{ (Meyer)} = \frac{0.3502}{0.3097} L \text{ (Boltzmann)} \\ = 1.131 L \text{ (B)}$$

In choosing values of η_0 (the viscosity at 0 deg. C.) from the large amount of data available in the literature, an attempt has been made to choose the most recent and most accurate values in each case. The authorities for the different data are given in footnotes. For η_{20} (the viscosity at 20 deg. C.) the experimentally observed value has been used in the case of air, while in all other cases use has been made of Sutherland's equation.*

$$\eta_{20} = \eta_0 \left(\frac{273.1+C}{293.1+C} \right) \left(\frac{293.1}{273.1} \right)^{\frac{3}{2}} \quad (16)$$

where C is a constant for each gas.

* The derivation of this equation is discussed on page 1048.

TABLE IV

COEFFICIENT OF VISCOSITY AND AVERAGE FREE PATH AT NORMAL PRESSURE

$$L_t = \frac{\eta}{0.3502\rho_t\Omega_t} \quad (\text{Boltzmann's equation})$$

$$L' \text{ (according to Meyer's equation)} = 1.131 L \text{ (according to Boltzmann's equation)}$$

Gas	$\eta_0 \times 10^7$	C	$\eta_{20} \times 10^7$	$\rho_0 \times 10^6$	$L \times 10^6$ (0°C.)	$L \times 10^6$ (20° C.)	$\Omega/L10 \times 10^{-6}$ (20°C.)
Air	1711 (1)		1809	1277	8.560	9.376	4940
H ₂	843 (2)	76.5 (3)	886	88.72	16.00	17.44	10060
He	1870 (4)	75.8 (5)	1964	175.7	25.25	27.45	4545
NH ₃	919 (6)	352 (7)	999	760.8	5.916	6.600	9152
H ₂ O	904 (8)	548 (9)	[1320 (10)]	[606.0]		[9.40]	
CO	1660 (11)	102 (12)	1752	1234	8.459	9.232	5101
N ₂	1670 (13)	111 (14)	1764	1234	8.500	9.287	5072
O ₂	1905 (15)	130.3 (16)	2018	1414	9.046	9.931	4432
A	2107 (17)	162 (18)	2239	1758	8.982	9.879	3998
CO ₂	1375 (19)	249 (20)	1472	1951	5.560	6.148	6115
Hg	1620 (21)		[5320 (22)]	[4200]		[14.67]	

References to Literature on Determination of η

The literature on this subject is very extensive. Fortunately most of the data have been summarized by Fisher, [Phys. Rev. 24, 385 (1904); Chapman, Phil. Trans. A. 211, 433 (1911), and Gilchrist, Phys. Rev. 1, 124 (1913)]. The latter's determination of the coefficient of viscosity for air is probably the most accurate value available of this constant, and has been used by Millikan in his precision measurement of the charge on an ion. According to Millikan [Ann. Phys. 41, 759, 1913], the most accurate value for the coefficient of viscosity of air is

$$\eta_t = 0.00018240 - 0.000000493 (23 - t) \quad (23 > t > 12)$$

According to this relation,

$$\eta_{20} = 0.0001809$$

For η_0 , Prof. Millikan quotes three values, see (1), whose average 0.0001711 we have used as probably the most accurate value.

Vogel [Ann. 43, 1235, 1914] has carried out similar measurements in the case of other gases. As he referred his results to η_0 for air = 1724×10^7 , we have re-calculated them to correspond with the above value. These are referred to as Vogel's corrected values.

Collision-Frequency

From the values of L and Ω we obtain the collision-frequency, Ω/L , that is, the average number of collisions per second. These are given in the last column of Table IV for room temperature. Thus, a molecule of nitrogen under ordinary conditions suffers over 5000 million collisions per second. It is not surprising, therefore, that gases diffuse relatively slowly.

Direct Determination of Average Free Path

The magnitude of the average free path under normal conditions is extremely small. As seen from Table IV it is about 10^{-5} cm, or $\frac{1}{250}$ mil. But as the pressure decreases the

The other authorities to whom reference has been made are:

- Kaye and Laby's Tables of Constants (K & L).
- Jellinek's Physikal. Chem. I, 1, p. 305-7.
- Markowski, Ann. Phys. 14, 742.
- In the following references, C , F and V denote Chapman, Fisher and Vogel respectively.
 - (1) Breitenbach, 1708.7; Fisher, 1709.2; Holman, 1715.7.
 - (2) V, 844; C, 854; Markowski, 841.
 - (3) F. (4) V, 1862; C, 1885. (5) F, 76.2; C, 75.3.
 - (6) V. (7) V. (8) Jellinek. (9) V. (10) K. & L. The values in square brackets are for 100 deg. C. (11) V.
 - (12) F. (13) V, 1666; C, 1672; Markowski, 1674.
 - (14) F, 110.4; C, 111.7; V, 110.6.
 - (15) V, 1905; C, 1900.
 - (16) C, 1303; F, 131.1; V, 133.
 - (17) C, 2107; V, 2100. (18) C. (19) V, 1370; F, 1387.
 - (20) C, 249; V, 277; K. & L. 240. (21) K. & L.
 - (22) K. & L. The values in square brackets are for 300 deg. C.

free path increases. At 1 bar which is about the degree of vacuum attained in exhausting ordinary incandescent lamps, the average free path for most gases is between 5 and 10 cms. A molecule of tungsten evaporated from the filament suffers very few collisions, if any, in traveling to the walls of the bulb, as is evident from the sharp boundaries of the blackened portions.

So far as the writer is aware the only investigators who have made any direct determination of the free path are Lenard¹, Robinson², and Franck and Hertz³.

The method used by all of these was the same—that of determining the average distance traversed by a gaseous ion between collisions. A charged molecule (ion) if endowed with a sufficiently high velocity, is capable of producing other ions by collision. It is therefore possible to measure the minimum distance at which two plates must be placed in a gas in order that it may be possible for the ions passing from one plate to the other to produce fresh ions by collision. Franck and Hertz obtained the following results:

Gas	Pressure	L	L (CALC.) = 20 DEG. C.	
			Meyer	Boltzmann
H ₂	45 bars	0.498 cm.	0.488 cm.	0.388
H ₂	81 bars	0.256 cm.	0.243 cm.	0.215
H ₂	152 bars	0.149 cm.	0.130 cm.	0.115
H ₂	167 bars	0.014 cm.	0.012 cm.	0.011
He	124 bars	0.256 cm.	0.250 cm.	0.221

The observed values of L appear to agree better with the values calculated according to Meyer's equation (15). The experimental evidence is, however, insufficient to be able to form from it a definite conclusion as to which equation is really more satisfactory.

Relation Between Coefficient of Viscosity, Heat Conductivity and Diffusivity

The kinetic theory of gases achieved a great triumph when it led to the conclusion that the viscosity is independent of the pressure. It led to still further important results when it prophesied the existence of simple relations between the properties of viscosity, heat conductivity and diffusivity.

From the kinetic point of view it is the same whether the molecules transfer

momentum from one layer to another or translational energy. The equations are quite analogous.

As in the case of viscosity, we consider any two layers CE , EH (Fig. 2), each of thickness L , between two plates whose temperatures are T_1 and T_2 and distance apart d . Let c_v denote the heat capacity per unit mass. The relative temperature drop between the planes CD and HK is equal to

$$2 (T_1 - T_2) \frac{L}{d}$$

Hence the heat transferred per unit area is

$$\begin{aligned} Q &= \frac{1}{6} n G \cdot 2 m c_v \frac{(T_1 - T_2) L}{d} \\ &= \frac{1}{3} \rho G c_v \cdot L \frac{(T_1 - T_2)}{d} \end{aligned}$$

Therefore the coefficient of heat conductivity,

$$k = \frac{1}{3} \rho G c_v L. \quad (17)$$

From equations (13) and (17) it follows that

$$\eta = k c_v \quad (18a)$$

A more accurate calculation of the heat conductivity shows that this equation is not quite correct, and should be written

$$\eta = B k c_v \quad (18b)$$

where B is a constant (greater than unity), whose value depends upon the nature of the forces that are assumed to exist between the molecules and the structure of the molecules themselves.

Similarly it can be shown that the diffusion constant of a one gas into any other is proportional to the coefficient of viscosity. The relations are, however, quite complicated.

According to Jeans, the value of the constant B in equation (18b) is 1.6207. This is, however, not in accord with the facts. Chapman⁴ has shown that for monatomic gases the value of the constant must be very closely equal to 2.5, while for polyatomic gases the value must be lower but not as low as 1.62*. These conclusions have been confirmed experimentally by Eucken⁵.

Table V taken from Eucken's paper gives the values of k (experimentally determined by

* S. Chapman, the Kinetic Theory of a Gas Constituted of Spherically Symmetrical Molecules. Phil. Trans. A, 211, 433 (1911).

* This value has been so generally accepted that even Kaye and Laby have used it in their tables, p. 33.

• Eucken Phys. Zeit. 14, 324, 1914.

¹ Lenard, Ann. Phys. 12, 714, 1903.

² Robinson, Phys. Zeit. 11, 11, 1910.

³ Franck and Hertz, Deutsch. Phys. Ges. 19, 1912, 19, 375.

Eucken), η (Vogel's data*) and c_v together with the observed values of B at $T=273$.

TABLE V

Gas	$k \times 10^7$	$\eta \times 10^7$	c_v	B Obs.	B Calc.
He	3360	1876	0.746	2.40	2.50
A	390	2102	0.0745	2.49	
H ₂	3970	850	2.38	1.965	1.90
N ₂	566	1676	0.177	1.905	
O ₂	570	1922	0.155	1.913	
CO	542.5	1672	0.177	1.835	
NO	555	1794	0.1655	1.870	
CO ₂	337	1380	0.1500	1.628	
H ₂ O	(429)	1006	0.342	1.25	
NH ₃	513.5	926	0.388	1.43	

According to Chapman, if it is assumed that the molecules are absolutely spherical and possess rotational as well as translational energy (see Part I), $B=1.90$ for diatomic gases, and 1.75 for triatomic gases. The results tabulated above would indicate that in at least the case of monatomic and diatomic gases this assumption must be in very good accord with the facts.

Relation Between Molecular Diameter and Mean Free Path

As mentioned previously, recent speculations on the structure of the atom lead to the conclusion that atoms and molecules are far from being the rigid elastic spheres postulated by the founders of the kinetic theory. If Rutherford's views are correct, and all the evidence points in that direction, we must conceive of the atom as consisting of a positively charged nucleus surrounded by one or more rings of electrons. The diameter of the nucleus is extremely small (less than 1/100,000) compared to the diameters of the electronic orbits, so that it is possible for the alpha particles, which have the same dimensions as helium atoms, to pass *right through* an atom of a heavy metal like gold. It is therefore certain that in the case of chemical combinations the atoms have inter-penetrated to form the molecule. The evidence deduced by Richards on the compressibility of atoms is also in accord with these views. On the other hand, it may be reasonable to speak of the diameter of a molecule if we think of it as the smallest distance apart to which the centers of two molecules can approach. Even

this definition may not be accurate, but we can make use of it as a physical basis for mathematical relationships.

Denoting the number of molecules per unit volume by n and the molecular diameter by d_m , it was shown by Clausius† that in the case of spherical molecules all possessing the same velocity, G , the length of the *free path* is

$$L = \frac{3}{4\pi n d_m^2} \quad (19)$$

If we take into account the fact that the molecular velocities vary according to Maxwell's distribution law, it can be shown that the *average free path*

$$L = \frac{1}{\sqrt{2}\pi n d_m^2} \quad (20)$$

Jeans has, however, pointed out that this equation cannot be accurate, since it takes no account of the persistence of velocities after collision¹. "On the average, a collision does not reverse the velocity in the original direction of motion, or even reduce it to rest, but there is a tendency for the original velocity to persist after collision." Jeans shows that in the case of two similar molecules colliding with relative velocities that may vary all the way from 0 to ∞ , the average value of the persistence is very nearly equal to $\frac{2}{3}$ of the value when the molecules collide with equal velocities. That is, on the average, the molecules traveling in a given direction will after collision have lost sixty per cent $\left(\frac{3}{5}\right)$ of their velocity component in that direction.

Hence, according to Jeans, the equation should be written

$$L = \frac{1.319 \frac{1}{2}}{\sqrt{2}\pi n d_m^2} \quad (21)$$

† See Jellinek, pp. 287-292.

Meyer's Kinetic Theory, pp. 161-3.

¹ Jeans, *Dynamical Theory of Gases*, p. 236, etc.

‡ This manner of defining the free path could obviously be extended to the case of molecules obeying any other law of force, where no collisions (according to the literal meaning of the word) occur. It has already been observed in a previous paragraph (p. 1042) that we might define L in terms of the ratio of the molecules traveling in a given direction at one point to the number traveling in the same direction at a point further along in the same direction. Jean's concept of persistence of velocities leads us therefore to the following definition of average free path which would hold in all cases except that of unlike molecules. We can define the average free path as being *twice the distance* which the molecules traveling at any instant in a given direction will pass over before losing sixty per cent of their velocity component in that direction. The factor 2 is required because, at any instant the molecules have, on the average, covered one-half the distance between collisions.

This definition has been suggested to the writer by Dr. I. Langmuir and although it may not be the usual definition, the latter is so vague that a scientifically correct definition would certainly help to clear the prevailing misunderstanding about the whole subject of *free paths*.

* No correction has been applied to any of the data given in Table V, as the intention was merely to illustrate the variations in the value of B .

According to Chapman, Jeans' formula is not quite correct. He has shown that for the case of rigid elastic spheres with no attractive forces,

$$\eta = \frac{0.4909}{\sqrt{2} \pi n d_m^2} \quad (22)$$

It will be observed that this equation differs quite radically from Meyer's or Boltzmann's equations for η . Comparing equation (22) with equation (14) it is seen that, according to Chapman,

$$\begin{aligned} L &= \frac{0.4909}{0.3502 \sqrt{2} \pi n d_m^2} \\ &= \frac{1.402}{\sqrt{2} \pi n d_m^2} \end{aligned} \quad (23)$$

This formula is true only for rigid elastic spheres with no attractive forces. Assuming the existence of such forces, the effect obviously must be to shorten the free path, and Sutherland* has shown that in this case,

$$L = \frac{1.402}{\sqrt{2} \pi n d_m^2 \left(1 + \frac{C}{T}\right)} \quad (24)$$

where C is a constant for each gas whose value may be determined from the temperature coefficient of the viscosity.

This equation, combined with equation (14) leads to the following expression for the variation with temperature of the coefficient of viscosity:

$$\eta_T = \eta_{273} \left(\frac{273+C}{T+C} \right) \left(\frac{T}{273} \right)^{\frac{2}{3}} \quad (16)$$

Sutherland's equation has been found to be in excellent agreement with the experimental data. The assumption therefore appears to be justified that the molecules approximate fairly closely to rigid elastic spheres surrounded by attractive fields of force.

Equation (24) combined with equation (14) and a knowledge of n enables us to calculate the *molecular diameter from the coefficient of viscosity*.

Relation Between Molecular Diameter and Van der Waal's Constant, b

At very high pressures or temperatures so low that the gases can condense, it is observed that Boyle-Gay-Lussac's equation

$$PV = RT$$

is no longer applicable.

Van der Waals found that the behavior of gases near their critical temperature and pressure** could be expressed quantitatively by a modified form of the above equation as follows:

$$\left(P + \frac{a}{V^2}\right) (V - b) = RT \quad (25)$$

In this equation, a/V^2 is a correction term added to P , which takes into account the attractive forces exerted by the molecules upon each other. The constant b denotes a small volume whose magnitude compared to V becomes of importance when we are dealing with gases near their critical state. According to Van der Waals, $\frac{b}{4}$ is equal to the total volume of the molecules.

That is,

$$\frac{b}{4} = n V \cdot \frac{\pi}{6} d_m^3$$

or

$$d_m^3 = \frac{3 \cdot b}{2 n V \pi} \quad (26)$$

The value of the constant b may be determined for each gas from the critical temperature (T_c) and pressure (P_c) by means of the relation:

$$b = R T_c S P_c \quad (27)$$

There is still a third method by which the molecular diameter may be calculated. According to Clausius and Mossotti, the volume actually occupied by the molecules may be calculated from either the dielectric constant D or the refractive index i by means of the equations:

$$n \frac{\pi}{6} d_m^3 = \left(\frac{D-1}{D+2} \right) \quad (28)$$

$$= \left(\frac{i^2-1}{i^2+2} \right) \quad (29)$$

Table VI gives the values of the molecular diameter calculated for different gases by each of these methods. The first column gives the values of d_m calculated from the average free path, L , according to the equation

$$L = \frac{1.402}{\sqrt{2} \pi n d_m^2 \left(1 + \frac{C}{T}\right)} \quad (24)$$

The values of C and L have been taken from Table IV.

The second column gives the experimentally observed values of T_c and P_c , and the values

* P. M. G. 507, 1893.

** "The Absolute Zero," GENERAL ELECTRIC REVIEW, February and April, 1915.

of b and d_m , calculated from these by means of equations (26) and (27).

The last column gives the values of d_m calculated by Sackur¹ from the refractive index for the D line. These data have been corrected for the difference between the values of n used by Sackur and by the writer. For

¹ Ann. Phys., 40, 97 (1913). The values for argon and helium are given by Eucken, Phys. Zeit., 14, 324 (1913).

n , the number of molecules per unit volume, at 0 deg. C. and 10^6 bars, we have adopted Prof. Millikan's value,

$$N = nV = 6.062 \times 10^{23}$$

that is, $n = 2.6696 \times 10^{19}$

A discussion of the different methods by which n has been determined is reserved for the next issue.

(To be Concluded)

TABLE VI
MOLECULAR DIAMETERS*

From Coeff. of Viscosity; Van der Waal's Constant, b , and Refractive Index

Gas	$10^8 \times d_m$ from Equation (24)	Critical Temp. in Deg. Absolute	Critical Pressure in Megabars	b Equation (27)	$10^8 \times d_m$ from Equation (26)	$10^8 \times d_m$ from Refractive Index
H_2	2.403	22.2	14.15	16.28	2.341	1.914
He	1.905	5.25	2.29	23.53	2.646	1.177
NH_3	2.967	405.9	113.8	37.10	3.080	
H_2O		647.0	220.4	30.52	2.887	2.276
CO	3.190	133.5	35.97	33.79	3.121	2.52
N_2	3.146	127.0	33.4	39.50	3.146	2.414
O_2	2.975	155.0	51.1	31.56	2.919	2.316
A	2.876	150.7	48.63	32.22	2.939	2.358
CO_2	3.335	304.0	73.80	42.83	3.231	2.782
Hg		1543.0	462.0	35.67	3.013	

* The critical data have been taken from Landolt and Bornstein's Tabellen and Jellinek, loc. cit., p. 444-5. The value of b is in cm^3 per molecular weight.

ELECTRICAL CHARACTERISTICS OF SOLID INSULATIONS

By F. W. PEEK, JR.

CONSULTING ENGINEER, GENERAL ELECTRIC COMPANY

Three types of insulation are in general use in practice, gaseous, liquid and solid. The author has shown in previous articles in the *GENERAL ELECTRIC REVIEW* that the mechanism of breakdown in gaseous and liquid insulation is very similar; the general laws which he has developed for air also apply for oil.* These laws are used in practice in calculating the breakdown voltages of air and oil.

The present paper treats of solid insulation, the electrical characteristics of which are quite different from those of the other two types. The laws of breakdown, etc., developed from experimental data, as well as suggestions for their practical application, are given.—EDITOR.

Gaseous and liquid insulations may be electrically stressed very close to the rupturing point without appreciable loss or heating. Considerable loss occurs only in corona or local brushes when some part is stressed above the breakdown point. Great loss in air and, to a less extent, in oil is thus a phenomenon which follows local breakdown after some critical voltage has been reached. Loss occurs in solid insulation as soon as the voltage is applied and increases rapidly with increasing voltage. Due to this loss the temperature of solid insulation increases after the application of voltage. The properties of the insulation, such as resistance, dielectric strength, etc., change with this change in temperature. The rupturing voltage of solid insulation will thus vary with the rate of application of voltage. For instance, a given piece of insulation may withstand a very high voltage for one minute, but break down at a low voltage applied for one hour.

Insulation Resistance

Among the solid insulations used in practice are varnished cambric, oiled and varnished pressboard, treated paper, treated wood, mica, micanite, soft and hard rubber, synthetic resins, glass and porcelain. The actual resistance of the insulating material is very high. Practically all solid insulating material, however, absorbs moisture to a greater or less extent. The capillary tubes and microscopic interstices, etc., in the structure become filled with moisture and gases. These afford conducting paths through the insulation, or part way through the insulation. The result is, in effect, a complicated arrangement of resistances and capacities in series and

multiple. This may be illustrated in Fig. 1. (a) and (b), where (a) represents a very much enlarged section of insulation, and (b) is a diagrammatic arrangement of connections. Thus, r_4 may represent the resistance of the insulation itself and r_1 , r_2 and r_3 the moisture or air paths. It can be seen by reference to (b) that direct current will pass through, and therefore measure, r_2 , r_1 and r_4 . Alternating current will, in addition, pass through r_3 to a greater or less extent depending upon the frequency. The effective resistance must, thus, vary with the frequency. It must also vary with the applied voltage if the insulation contains considerable occluded moisture or air. The d-c. resistance is very high in good insulation. For instance, for varnished cambric it is 20,000 to 50,000 megohms per cm. cube.

Insulation Loss

In oil, and particularly in air, there is very little loss until local brush or corona breakdown gradient is reached. The loss then increases directly as the square of the excess voltage above the critical voltage. With

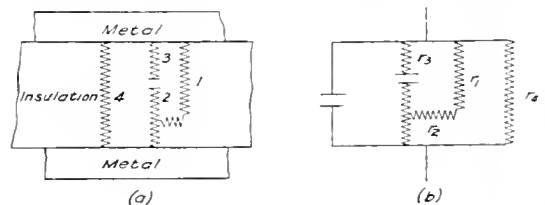


Fig. 1

solid insulations loss appears as soon as the voltage is applied. The loss may be due to:

(1) The so-called dielectric "hysteresis" or lag of the flux behind the electromotive force due to some molecular action.

(2) Conduction. Practically all solid insulations absorb moisture to a greater or less extent. The capillary tubes and microscopic interstices, etc., in the structure become filled

* F. W. Peek, Jr., "The Limiting Effect of Corona on the Electrical Transmission of Energy at High Voltages," October, 1911.

F. W. Peek, Jr., "Further Investigations into the Nature of Corona and Dielectric Strength of Air," December, 1912.

F. W. Peek, Jr., "The Sphere Gap as a Means of Measuring High Voltages," May, 1913.

F. W. Peek, Jr., "The Electric Field," December, 1914.

F. W. Peek, Jr., "The Law of Corona and Spark-over in Air," August, 1915.

with moisture and gases. In the non-homogeneous structure this makes a complicated arrangement of capacities and resistances in series and in multiple as shown diagrammatically in Fig. 1, and already discussed.

The losses due to (1) should vary as the square of the voltage and approximately as the frequency

$$p_1 \approx k_1 f e^2 \quad (1)$$

The loss due to r_3 must vary as the square of the voltage if the resistance is constant. The variation with the frequency will depend upon the relative values of the resistance and capacity reactance; the range will be all the way from

$$p_2 \approx k_2 f^2 e^2 \quad (2)$$

to

$$p_2 \approx k_2 e^2$$

The loss due to r_1, r_2 and r_4 , Fig. 1 (b), must vary as the square of the voltage, if the resistance remains constant, but is independent of the frequency

$$p_3 \approx k_3 e^2 \quad (3)$$

The total loss may thus contain the terms

$$p = p_1 + p_2 + p_3 = a_1 e^2 f + a_2 e^2 f^2 + a_3 e^2 \quad (4)$$

In poor insulation, or in insulation containing moisture, the loss may increase at a greater rate than the square of the voltage as the resistance will decrease with increasing voltage.

In homogeneous insulations in good condition the last two terms are small and the expression for loss becomes*

$$p = a e^2 f \quad (5)$$

and for certain insulations

$$p = a e^2 (f + c) \quad (6)$$

Deviations from the square law are generally due to the conditions of the insulation. From examination of a considerable amount of experimental data it is found that

$$p = a e^2 f \quad (5)$$

is generally followed, or, putting in this the gradient, g , in kv./min, in place of e .

$$p = b g^2 f 10^{-6} \text{ watts per cu./cm.} \quad (7)$$

At 25 deg. C. b is

2 to 15 for *Oiled Pressboard*—depending upon the quality or kind.

5 for *Glass*

7 to 10 for *Varnished Cambric*.

The values for *varnished cambric* were

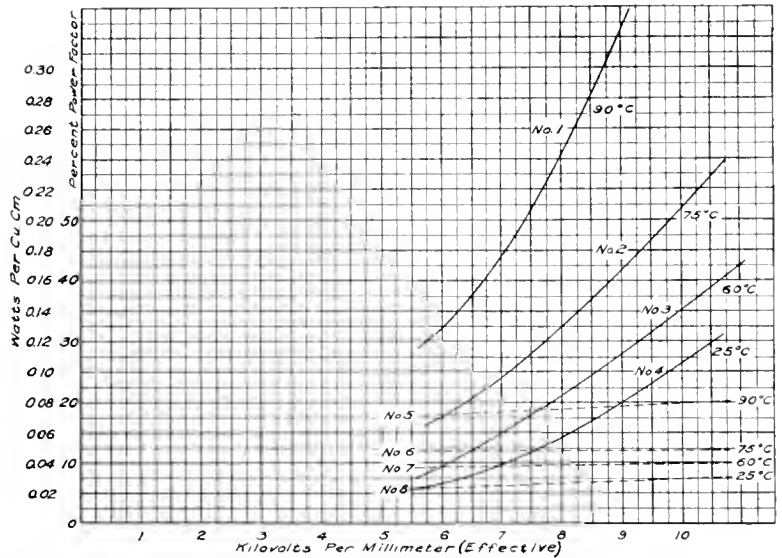


Fig. 2. Curves of Insulation Loss and Power-factor vs. Kilovolts (Oiled pressboard 5 mm. between parallel planes with rounded edges in oil)

Curves Nos. 1, 2, 3 and 4—watts per cu. cm.
Curves Nos. 5, 6, 7 and 8—power-factor

obtained for 60 cycles and 40,000 to 100,000 cycles.†

The loss, and therefore b , increases with increasing temperature in the form

$$b = k t^u \quad (8)$$

Where

t is the absolute temperature in degrees centigrade.

$$b \approx 1.2 t^{10} 10^{-26} \text{ for Varnished Cambric.}$$

or,

$$p = 1.2 g^2 t^{10} 10^{-32} \text{ watts cu. cm.}$$

This relation, however, is only approximate.

In some cases for insulations like varnished cambric the equation takes the form

$$p = b g^2 (f + c) \quad (9)$$

Where the insulation contains occluded moisture the losses become very great and

* F. W. Peek, Jr., "Dielectric Phenomena in High Voltage Engineering," page 185.

† The author analyzed considerable data taken at high frequency by Mr. Alexanderson published in the Proceedings of the Radio Engineers, June, 1914. It was found that this data followed equations (5) and (6) very closely. The constant b checked with the 60 ~ curves. See—F. W. Peek, Jr., "Dielectric Phenomena in High Voltage Engineering," pages 186-187.

the square law is not followed. It is of the utmost importance to keep insulation dry.*

Fig. 2 gives 60 ~ loss and power-factor characteristics of solid insulation at various temperatures. Fig. 3 gives a 60 ~ loss curve

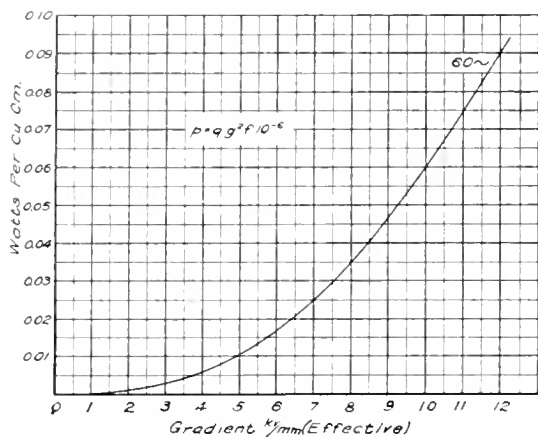


Fig. 3. Curves showing Loss in Varnished Cambric 4 mm. thick between parallel planes at 25 deg. C. Data from "Dielectric Phenomena in High-Voltage Engineering" p. 186

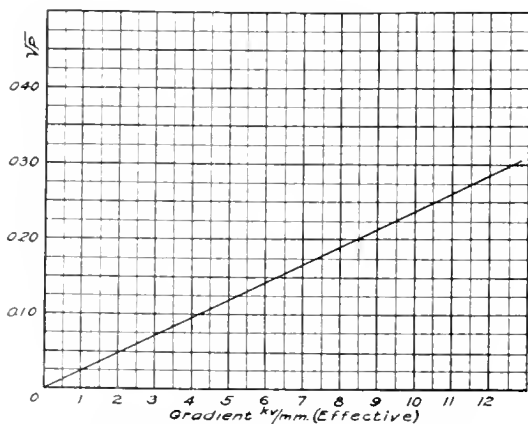


Fig. 4. Curve showing Loss in Varnished Cambric. Data from Fig. 3, plotted with \sqrt{p} . Straight line shows that loss varies as square of voltage gradient

This variation would be expected in different samples.

Dielectric Strength vs. Time of Application

The mechanism of breakdown is quite different for oil or air, and solid insulation. In oil or air a local breakdown may take place as corona or brush discharge; when voltage is removed the broken down dielectric is replaced. In solid insulation a local breakdown means charring or cracking and generally develops progressively into complete rupture.

The puncture voltage of solid insulations varies greatly with the time of application. This variation is due principally to heating where the time of application is comparatively long. The effect of loss is cumulative; the insulation becomes warm and while the loss

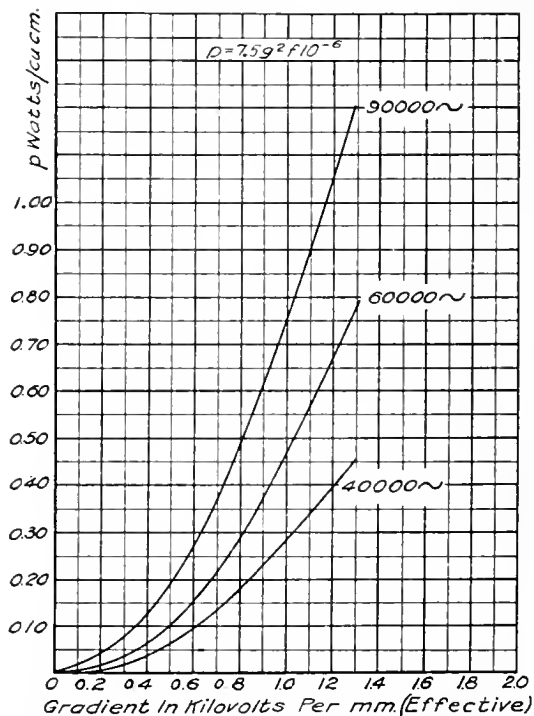


Fig. 5. Curves showing High Frequency Loss in Varnished Cambric at 25 deg. C. (Tests by Alexanderson.) Tests made between parallel planes, 21 sheets of insulation, thickness 5.9 mm.

for varnished cambric. This data is plotted between \sqrt{p} and g in Fig. 4. The fact that the points are on a straight line shows that the square law is followed. Figs. 5 and 6 show that the same characteristics obtain at very high frequency as at 60 ~. For these different samples the constant b is 7.5 for the high frequency tests and 9 for the 60 ~ tests.

increases with the temperature, the dielectric strength generally decreases with increasing temperature. The ultimate strength then depends upon the rate at which heat is conducted away.

The strength of insulation vs. time of application in a uniform field is best illustrated by the curve for varnished cambric in

* J. P. Minton—Measurement of Dielectric Losses with the Cathode Ray Tube, A.I.E.E., June, 1915. This interesting paper contains considerable data on dielectric losses for various insulations under various conditions.

Fig. 7. Where the time is not over a few seconds heat is not a factor. The strength of insulation, however, still rapidly increases with decreasing time of application. The reason for this, in the case of impulse voltages, will be discussed later. In practice certain arbitrary comparative tests, to include the effect of time, are made on insulations; the "Rapidly Applied Test," the "One Minute Test," and the "Endurance Test."

The *Rapidly Applied* breakdown voltage is found by applying a fairly low voltage and rapidly increasing until breakdown occurs. The voltage is increased at about 5 kv. per second.

The *Minute Test* is made by applying 40 per cent of the *Rapidly Applied* voltage, and increasing this voltage by 10 per cent steps at one minute intervals. The total time is usually 3 to 5 minutes.

The *Endurance Test* is made by applying 40 per cent of the *Minute Test* voltage and

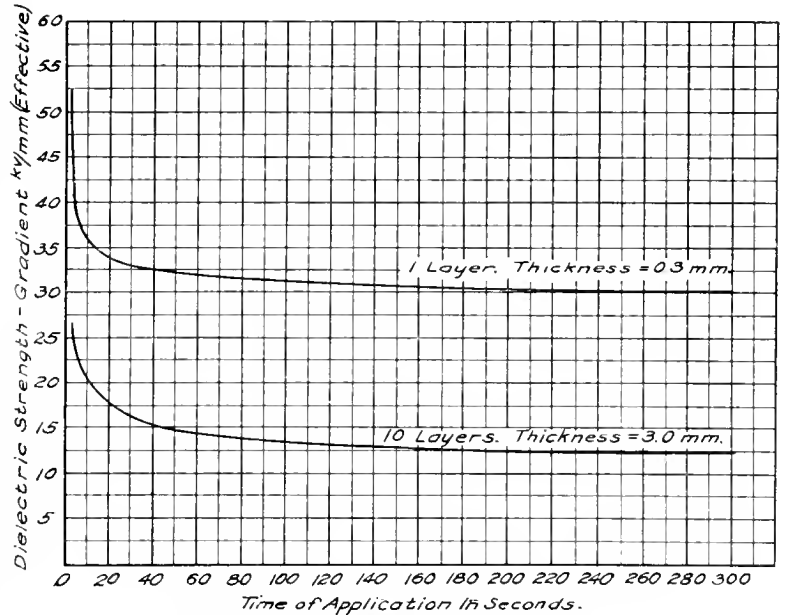


Fig. 7. Curves of Dielectric Strength vs. Time of Application. Varnished cloth between 10 cm. disks with rounded edges; 60 cycle; 25 deg. C.

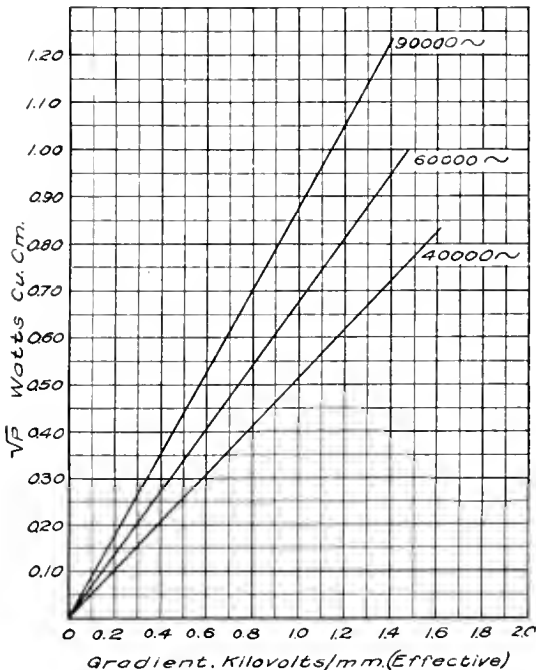


Fig. 6. Curves showing High Frequency Losses in Varnished Cambric at 25 deg. C. Tests made between parallel planes, 21 sheets of insulation, thickness 5.9 mm. plotted with \sqrt{p} from data in Fig. 5. Straight line shows that "square law" holds

increasing 10 per cent every hour or half hour until puncture occurs. These tests may be made at any given temperature. The tests are made in oil between 10 cm. diameter electrodes slightly rounded at the edges.

The one minute dielectric strength for the 3.0 mm. insulation, Fig. 7, is 12.5 kv/mm., the rapidly applied 26. kv/mm.

The strength-time curve follows the law*

$$g = g_s \left(1 + \frac{a}{\sqrt{T}} \right)$$

Where

a = constant for a given insulation.

g_s = constant for a given insulation of given thickness, temperature and frequency.

T = time of application in seconds.

g = strength in kv/mm.

Strength vs. Thickness

The apparent strength of insulation varies greatly with thickness. One minute strength-thickness curves for varnished cambric at 25 deg. C. and 100 deg. are given in Fig. 8. The author has found that strength-thickness curves follow the general law

$$g = g_t \left(1 + \frac{\alpha}{\sqrt{t}} \right) \tag{11}$$

* F. W. Peek, Jr., "Dielectric Phenomena in High Voltage Engineering," Chapter VII.

Where

- g = unit strength in kv. mm.
- g_0 = constant = unit strength at infinite thickness.
- α = constant depending upon the insulation.
- t = thickness in mm.

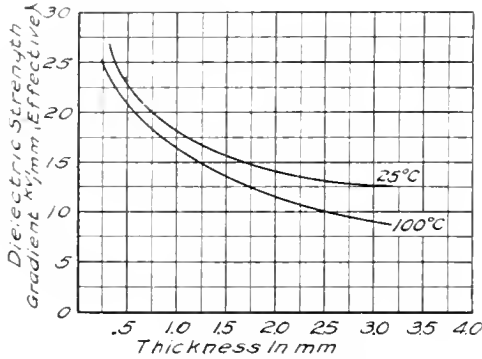


Fig. 8. Curves of Dielectric Strength vs. Thickness of Varnished Cambric. One minute; 60 cycles; between 10 cm. disks in oil

The constants g_0 and α will vary with the material.

Examples

For Porcelain, 60 ~ 25 deg. C. one minute test

$$g = 7.5 \left(1 + \frac{0.94}{\sqrt{t}} \right) \text{ kv. mm. effective.}$$

The puncture voltage is,

$$e = gt$$

For Varnished Cambric, 60 ~ 25 deg. C. one minute test.

$$g = 7.5 \left(1 + \frac{1.20}{\sqrt{t}} \right) \text{ kv. mm. effective.}$$

For irregular fields, as those around wires or cables, the apparent breakdown gradient of solid insulation is higher around small conductors than large ones.

Reliability of Solid and Laminated Insulation

The structure of most insulations is not homogeneous. If a given insulation is tested with terminals of varying area it is found that the average puncture voltage becomes lower as the area is increased, and thus the chance of it covering a weak spot is increased. As would be

expected the strength-area curve approximately follows the probability law.

An insulation built up of laminations is much better than a solid insulation as the weak spots in the laminations are not likely to line up. It is also much easier to make better and more uniform insulation in thin sheets.

Tests are useless for comparing insulation strengths unless made upon some standard basis.

Transient Voltages and High Frequency

The term "high frequency" is generally used in such a way that no distinction is made between sinusoidal high frequency from an alternator, undamped oscillations, damped oscillations, impulses of steep wave front, etc. Naturally the effect of continuously applied undamped oscillations is quite different from a single high-voltage impulse of extremely short duration. As the effects are attributed to the same cause—"high frequency"—apparent discrepancies must result. (See comparative tests, Table I.)

High Frequency

It takes energy and therefore time to rupture insulation. For a given potential a given number of cycles of very high frequency voltages, where heating does not result, are

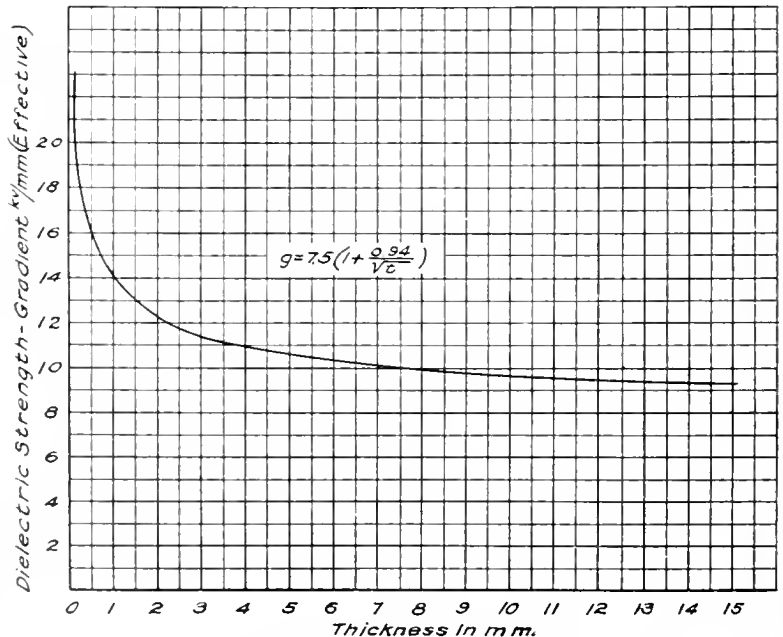


Fig. 9. Curves of Dielectric Strength vs. Thickness of Porcelain. One minute; 60 cycles; between disks at 25 deg. C.

therefore much less injurious than the same number of cycles at low frequency. This also applies to impulse voltages of steep wave front. Continuously applied high frequency is, however, generally very injurious for two distinct reasons:

(1) On account of the very great loss at high frequency from an alternator or undamped oscillations the insulation may be literally burned up in a very short time even at low voltages. This condition does not result in practice from surges, etc., on low frequency lines, but in high frequency generators, and transformers, etc. In such apparatus it is important to use very smooth electrodes to prevent local concentration of stress and charring of insulation. This is especially so

to produce the same results in the limited time. Impulse voltages of steep wave front many times in excess of the rupturing voltage may be applied to insulation without rupture if the application is very short—measured in microseconds. They may be caused in practice by lightning, switching, etc. If such voltages are sufficiently high, complete rupture may result at once. In any case if these voltages are much in excess of the 60 cycle puncture voltages the insulation will be damaged. As an example, an impulse voltage equal to three times the 60-cycle puncture voltage may be applied to a line insulator. During the very small time between the application of the voltage and the arc-over through the air, the insulator is under great

TABLE I
COMPARATIVE STRENGTHS OF INSULATION AT 60 CYCLES, HIGH FREQUENCY,
AND TRANSIENT VOLTAGES
Varnished Cambric

60 CYCLES BREAKDOWN GRADIENT KV/MM. MAX.		HIGH FREQUENCY (ALTERNATOR) 90,000 CYCLES KV/MM. MAX.		DAMPED OSCILLATIONS 200,000 CYCLES (TRAIN FREQUENCY 120 PER SEC.) KV/MM. MAX.		SINGLE IMPULSE CORRESPOND- ING TO SINGLE HALF CYCLE OF 200,000 CYCLE SINE WAVE. KV/MM. MAX.	THICKNESS
Time of Application		Time of Application		Time of Application		Time of App.	cm.
Rpdly. App.	One Min.	Rpdly. App.	One Min.	Rpdly. App.	One Min.	Single Imp.	
53	46.5	19.5	17.6			108	.06
42	31	13.5	10	55	56	78	.15
37	28	10	7.3	49	41	70	.25
33	27.5			41	30.5	60	.36

where contact is made with the air. If a local brush starts, on account of the great loss, it becomes very hot and extends out a considerable distance.

(2) In certain apparatus containing inductance and capacity very high local potential differences may be produced by very low applied voltage, by resonance and thus cause rupture by overpotential. The high frequency thus does not cause the rupture directly but makes it possible by causing overpotential. Local concentration of stress may also result in non-homogeneous insulation, as across the condenser and resistance combinations in Fig. 1.

* Impulse Voltages

If the time of application is limited below a definite value, higher voltages are necessary

* F. W. Peek, The Effect of Transient Voltages on Dielectrics, A.I.E.E. Aug., 1915.

F. W. Peek, Jr., "Dielectric Phenomena in High Voltage Engineering," Chapter VII.

stress. It may be that up to the ninth application of such a voltage there is no evidence of any injury while on the tenth application failure results. Each stroke has contributed toward puncture. It is probable that each application adds to or extends local cracks.

Cumulative Effect of Overvoltages of Steep Wave Front

Voltages greatly in excess of the "rapidly applied" 60-cycle puncture voltage may be applied to insulation without rupture if the time of application is sufficiently short. All such overvoltages injure the insulation, probably by mechanical tearing, and the effect is cumulative. A sufficient number will cause breakdown. Incomplete breakdown or local "cracking" can often be observed in glass. For example: A piece of oiled pressboard 3.2 mm. thick has a rapidly applied breakdown at 60 cycles of 100 kv. maximum. If sinusoidal impulses reaching their maximum in 2.5 micro-

seconds are applied, the number of impulses to cause breakdown is as follows:

KV. MAXIMUM OF APPLIED IMPULSES	NUMBER TO CAUSE BREAKDOWN
100	∞
140	100
150	16
155	2
165	1

If the impulses are of still shorter duration, a greater number are required to cause breakdown at a given voltage. Insulations, and line insulators, are often injured and gradually destroyed in this way by lightning.

When *very high* impulse voltages are applied to insulation explosive effects result; porcelain may be shattered, or cambric torn apart.

Damped Oscillations

By comparing columns 1 and 3, in Table I, it will be noted that the breakdown strengths of insulation for 60 cycles and for the damped oscillation used in this test do not greatly differ. The oscillation was sufficiently damped so that dielectric heating was not the main factor. This insulation was in good condition. If the insulation were allowed to absorb moisture to some extent, however, the 60-cycle strength would be greatly decreased; the strength for this particular damped oscillation would, however, not be greatly changed—the moisture would not be readily detected. The reason is a conduction or thermal one. A knowledge of many such factors is necessary when insulations are compared by "High Frequency Tests."

Operating Gradients and Temperatures of Insulations

Great caution is necessary in the use of tabulated values of insulation strength in design. On account of the variable quality of solid insulations, tests must be continually made to see that the product does not change. Vacuum treatment is necessary before use to remove moisture. Even when all of the test conditions are known, experience is necessary to judge the proper factor of safety. Aside from this, stress concentrations due to the shapes and spacings of the conductors must always be considered and allowed for. It is generally not possible to do this with mathematical exactness, but approximation must be made with all factors in mind. Care must be taken that the solid

insulation is below the rupturing gradient at any local point. If such a point is broken down locally the flux becomes still further concentrated. The puncture voltage will also decrease with frequency, etc.

It must be remembered that in design only a fraction of the gradient corresponding to the "one minute" breakdown voltage is permissible for continuous operation, the particular per cent depending upon the design, the rapidity at which heat may be radiated, or conducted away, etc. It is generally not more than 10 per cent; it is often as low as 5 per cent, sometimes as high as 30 per cent.

The maximum operating temperature of insulation is not definite. For low voltage apparatus, temperatures not high enough to cause electrical failure may cause mechanical failure, etc. With fibrous materials, as cloth and paper, the life of insulation will generally be greatly shortened if the operating temperature is above 100 deg.; for asbestos and mica in binders this limit is about 150 deg. Often the electrical properties will limit the temperature much below these values.

Mechanical Consideration in Design

It is of great importance to arrange designs in such a way that local cracking, or tearing is not caused by high localized mechanical stresses. This is especially so with porcelain, as in the line insulators. Expansion of a metal pin, localized mechanical stress due to sharp corners, expansion of improper cement, etc., will cause gradual cracking of the porcelain. The so-called deterioration of line insulators is often caused in this way. It is also often due to moisture absorption.

Permittivity

A knowledge of the permittivity of insulating materials is of as great importance as a knowledge of the dielectric strength.* If insulations are combined in design without this knowledge, concentration of stress and breakdown may result.

Insulations, such as dry paper, with low dielectric strength and low permittivity, are impregnated with oils or compounds of high strength and permittivity. The result is a dielectric of greater strength and permittivity. If the impregnating is improperly done, for instance so as to leave oiled spots and unoled spots, the dielectric strength may be less than the dry paper alone. This is due to the difference in permittivities of the dry

* For data on dielectric strength, permittivity, etc., see "Dielectric Phenomena in High Voltage Engineering," Chapter VII.

and oiled spots, which cause a concentration of stress on the electrically weak dry spots.

When a given number of sheets of several insulations of different permittivities are combined to form a plate, the dielectric strength of the resulting plate will vary with the method of combining. It will make considerable difference whether the different kinds of sheets are piled alternately, or otherwise.

Dielectric Field

Undoubtedly insulation is sometimes placed in apparatus in such a way that the stresses at local point are many times greater than necessary. To prevent such conditions the dielectric field must be considered. It is more satisfactory, for instance, to reduce stresses to one tenth by proper design than to seek an insulation of ten times the strength for improper designs.

ISOLATED POWER-HOUSE FOR FACTORIES

By W. E. FRANCIS

GENERAL ELECTRIC COMPANY

This article is a compilation of thoroughly practical and useful information to apply in the design, construction and operation of an isolated power-house. All sections of the power plant are treated under their respective side-headings. The information presented has been gathered from actual practice, and therefore it should prove to be well worthy of favorable consideration by the designers and operators of this type of power-house.—EDITOR.

In designing a plant for the supply of power, light, and heat it is first essential to obtain an intelligent survey of the field to be supplied, so that no mistake will be made when later selecting the apparatus that is to be the most suitable for the plant. It will be necessary not only to secure an accurate knowledge of the total energy required for present consumption but also to estimate, as closely as possible, the probable requirements of the future. Due regard also must be given to securing a spare outside source of power supply and adequate spare apparatus to use in case of breakdowns. The amount of steam that will be required for heating and other manufacturing purposes must also be considered.

Many firms have spent unnecessarily large sums of money on a power-house building but have failed to provide space in the building to properly install the machinery which, in reality, is the most essential part. A building for a power-house need not be ugly because it is built of iron girders and concrete instead of fancy brick with elaborate facings; and the machinery will operate just as well if the floors are of nicely laid concrete and cement as though they were of mosaic blocks.

The location of the power-house should be a central one; also it ought to be near a railway siding so that a cheap method of conveying the coal from the cars can be employed. One example of locating a power-house at a short distance from a railway siding is that of a certain station which pays \$1.00 a ton for coal

and \$1.85 per ton freight charge, but which has to spend 25 cents additional a ton for handling the coal after it has arrived. This high additional expense is due simply to the fact that the power-house was built across the street from the railroad. It might just as well have been placed with its boiler room next to the siding, which arrangement would have facilitated handling the incoming coal. It can easily be seen that if 6000 tons of coal were used per annum the extra charge for handling it on arrival would amount to \$1500.

In laying out a proposed new plant it is best to consider each item separately; therefore the following discussion will be treated in sections.

Boiler Room

A well equipped boiler room should contain the following apparatus: boilers, solidly constructed boiler mountings, forced or induced draught equipment, damper regulator, economizer, automatic stokers, ash exhauster, filters, feed-water heaters, feed pumps, feed-pump regulators, and boiler flow meters.

Type of Boilers

If the power-house is to be subjected to heavy overloads periodically, water-tube boilers offer a great advantage because of the rapidity with which steam can be generated to meet the peak loads; but, if it is ascertained that the load will be constant, boilers which hold a larger volume of water and steam would be very suitable since these can be worked uniformly day and night.

It is recommended that all the boilers be of the same manufacture and rating. The practice of purchasing cheap or second-hand boilers is to be condemned on the ground that it is false economy.

lives. It certainly will necessitate shut-downs and expensive repairs, to say nothing of the fact that even a scale $\frac{1}{16}$ in. thick on the heating surfaces demands an excessive coal consumption.

Boiler Arrangement and Mounting

A straight line arrangement of the boilers should be adhered to if possible. There should be an adequate drain to a river, or to a sewer that is beneath the boilers; and plenty of head-room should be allowed for taking off manhole doors and for inspection. On no account ought any part of a boiler to be buried in brickwork, otherwise corrosion may start and continue without being noticed. A double set of blow-offs should be installed, consisting of an approved cock placed in such a position that it can be easily turned with a key without having to get beneath the boiler; and beyond this cock there should be a screw-down valve having a soft metal seat which can be renewed from time to time; and the ends of the blow-off pipe ought to be led to some position where any leak can be immediately detected. The blow-off pipe should not be rigidly fixed, i.e., allowance should be made for vertical and horizontal expansion and contraction.

Safety Valve, Gauge Glass, and Whistle Alarm

The main safety valves should be fitted with rods connected to a screw and wheel which occupy an accessible position, so that the fireman can ease the valves occasionally and thus prevent the possibility of their sticking. There should always be two safety valves fitted to each boiler, and they ought to be of ample capacity to allow the excess steam to escape so fast that the boiler pressure will not increase more than 10 per cent when the furnace contains a bright fire.

The gauge-glass mountings should be fitted to a column from which one pipe leads to the steam drum or steam space, and another to a point near the bottom of the boiler. This method of piping results in a more accurate indication of the water level (because allowance is automatically made for difference in temperatures) than when both the steam and water are taken from points just above and below the gauge glass.

Approved whistle alarms are satisfactory, if kept in order, but visual observation is best since accidents have happened because the

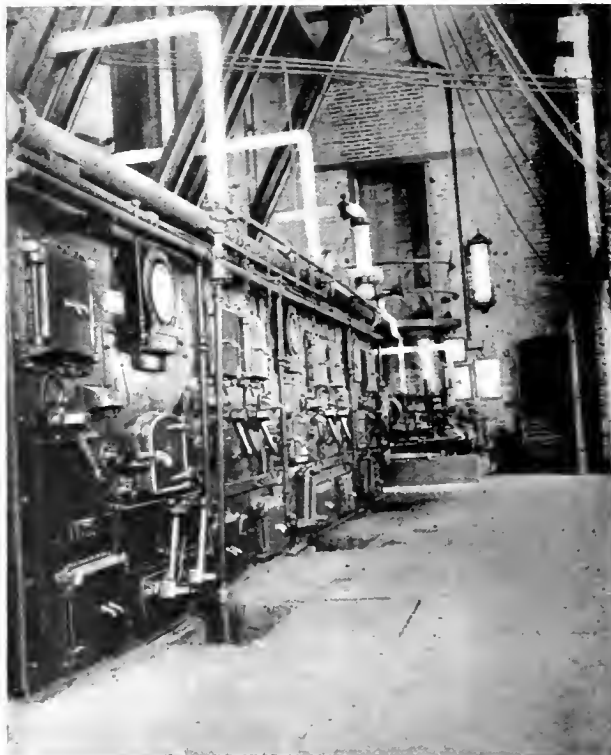


Fig. 1. An Installation of Flow Meters Measuring the Steam Output of the Individual Boilers of a Battery

Number of Boilers and Cleaning

An important point, which is often overlooked, is that in addition to ample boiler capacity to carry the heaviest load there should be one or two additional boilers, so that this number can always be laid off for cleaning. Many firms have learned to their cost that the hasty cleaning of a boiler at the week-end does not pay. As a matter of fact the boiler usually receives only a "lick and a promise." Frequently, it is blown down in a hurry and then cooled by pumping in cold water to permit the fireman to enter after it has been drained. The scale is then removed in the most get-at-able places, while in those other parts where perhaps its removal is more necessary it is allowed to accumulate until a cracked tube-plate or a leaky tube develops. This lack of thoroughness may endanger

fireman relied on such an automatic contrivance.

Feed-water Regulator

If the water level in the respective boilers is to be kept at the proper height, otherwise than by hand, it will be necessary to select and install the most efficient and reliable feed-water regulators on the market. These should never be bought under any other condition than those of the "kill or cure system," under which they are installed by the makers and paid for after they have "made good." Furthermore, only those devices which have been approved by the leading boiler insurance companies should be selected. One has only to look around or to inquire to find how many useless or practically useless articles for this purpose there are on the market. A good feed-water regulator is both essential and economical, and a regularity of boiler feed is one of the principal requisites for boiler economy.

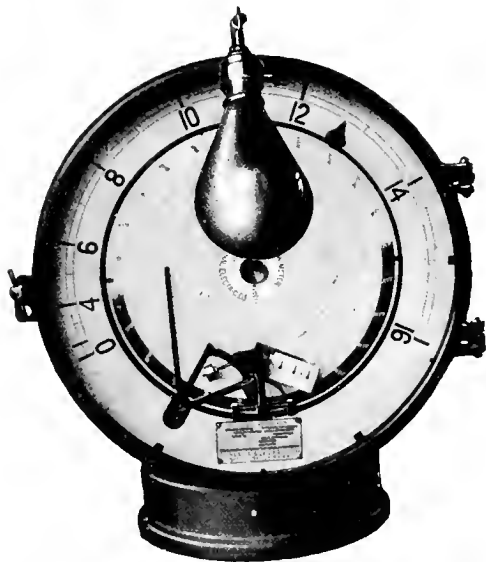


Fig. 2. An Indicating, Recording, Integrating Flow Meter

Automatic Stokers

Mechanical stokers when supplied with uniform size coal, that has been especially prepared for them by a crusher, and when operated by an intelligent and capable person will produce excellent results. Unless this type of stoker is given constant attention, however, the neglect allows of a big loophole for carelessness which results in waste. Any automatic device for firing coal is liable to make and leave holes in the fire bed unless

checked by careful observation. More money will be wasted by an inefficient mixture of gases in the combustion chamber than can be saved by decreasing the manual labor.

Unfortunately, it is not always realized that a cheap man in a boiler room is expensive.

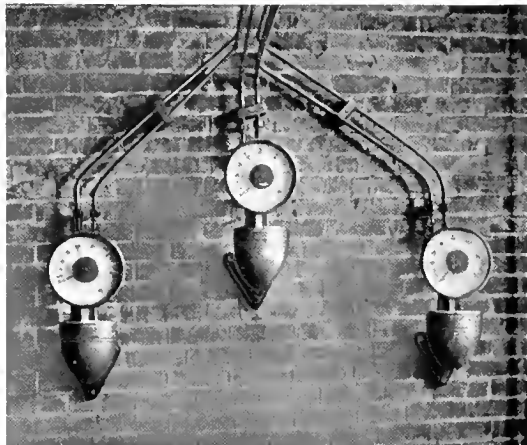


Fig. 3. A Typical Boiler Room with Steam Flow Meters Mounted on the Fronts

Actually, the brains of the operators should be centered in this part of the plant for it is here that the economy of the whole plant is determined.

The principal benefits to be derived from a mechanical stoker are:

- (1) Regularity of firing, i.e., the maintenance of a regular supply of coal moving across the bars at an even and desired thickness.
- (2) Reduction in cost of labor.
- (3) Reduction in the amount of clinkers formed, thereby causing better and steadier combustion of the coal.

These economies soon disappear with carelessness on the part of the engineers or firemen. For this reason a steam flow meter and a CO_2 recorder should be installed, the first to immediately show the fireman that his fires are not in proper condition and the second to give the engineer an absolute record of the percentage of carbon dioxide in the chimney gases.

Assume a battery of boilers in which each boiler is fitted with a steam flow meter. Should holes occur in the fire of any particular unit, the index finger on the flow meter will at once begin to travel toward zero which shows that an excess of cold air is rushing through the fire grate and is cooling the tubes or other heating surfaces. Again, should all the boilers

be apparently working to the same degree and should there be a leakage of air through the boiler setting, the CO_2 recorder will indicate this condition by the percentage of carbon dioxide in the chimney gases.

The composition of the chimney gases also shows the working of the furnaces under the boilers. When the fuel is properly consumed, the furnace gases should contain only nitrogen, oxygen, steam, and carbon dioxide. To secure this result an excess of air is required, but this excess must not be greater than a certain amount, otherwise there will be too great a volume of air heated and this heat wasted.

The percentage of CO_2 in the chimney gases indicates the amount of excess air entering the furnace. The relationship between the percentage of CO_2 and the amount of air is given in Table I.

TABLE I

Per cent of Carbon Dioxide Found in the Chimney Gases	Number of Times the Theoretical Amount of Air which Should be Admitted to the Furnace as Indicated by the Per Cent of Carbon Dioxide
4.0	4.9
5.0	3.5
6.0	3.0
7.0	2.5
8.0	2.3
9.0	2.0
10.0	1.7
12.0	1.5
17.0	1.0

Experiments tend to show that per cents of carbon dioxide from 10 to 14 give the most profitable combustion in the furnace as a general rule.

An inspection visit to a boiler room that is not equipped with these indicating devices and where the fireman is "taking it easy" will almost always disclose large holes in the furnace fire or leaky flues or settings. The elimination of these faults has oftentimes permitted a reduction in the number of boilers required to be in service.

Boiler Feed Pumps

The boiler feed pumps should be of an approved type, and each ought to be capable of supplying the battery of boilers for which it is intended without having to run at undue speed. In addition to these, there should always be a spare pump in readiness to continue the work should one on the line fail. These feed pumps are to be fitted with pump regulators and also with by-passes for hand control. Care must be taken, when the pumps are working in conjunction with a feed-water heater, that the water is able to

flow from the heater through the suction pipe to the pump below. Feed-water pumps should be situated in such a location that the fireman can observe their operation, for many unattended pumps have been wrecked by running away.

Economizer

By using an economizer a saving in coal of about 10 to 15 per cent can be made. Kent states that for a given quantity of chimney gases passed through it, its economy will be greater:

- (1) The higher the temperature of the gases.
- (2) The lower the temperature of the water fed into it.
- (3) The greater the amount of its heating surface.

From (1) it is evident that an economizer will save more fuel when added to an overloaded boiler than to a boiler working at its normal rate.

From (2) it appears that a smaller saving can be expected from an economizer in a power-plant in which the feed-water is heated by the exhaust steam from auxiliary engines than can be looked for when the feed-water entering it is taken directly from the condenser hot-well.

For the efficient working of an economizer, it is very essential that the outside of the tubes be kept thoroughly clean by means of mechanical scrapers; and it is especially necessary that the tubes should be periodically inspected, all scale removed, and any pitting or corrosion stopped. If this practice is not followed the economizer will become useless and will be an impediment to the chimney draught. Economizers must be fitted with ample cleaning doors underneath and large doors at each end for inspection and cleaning. All baffle doors and dampers should be made with ample clearance to allow for warping and expansion when hot. It has often happened that an economizer has been started before the brickwork has had time to dry, which has caused distortion due to rapid expansion and resulted in consequent trouble with dampers.

The use of an economizer introduces an additional element of danger. The apparatus can be and often has been as dangerous as a boiler; therefore during its manufacture it should be inspected and thoroughly tested, and its safety valves tried out before placing it in service. Also, it should be fitted with easily get-at-able blow-off cocks. Another

fact to be remembered, and a very important one, is that the designer of the chimney must be informed as to whether an economizer is to be included in the plant or if the use of one is contemplated. It has often happened that an economizer has been purchased as an afterthought, or has been added to an already existing plant, consequently an additional fifty feet or so has to be added to the stack or an induced or a forced draught system installed. This it is almost needless to say creates much annoyance for the owners.

Feed-water Heaters

There are various feed-water heaters on the market probably the best of which for most purposes is the open heater. This type uses the exhaust steam from auxiliaries in the power-house and in some cases steam from a steam-extraction device on a turbine. Most of these heaters are supplied with an internal float arrangement; but it is a good plan to also add an external float chamber on a separate water supply, that this may be used should anything go wrong with the former. The heater should be located above the feed pump; and the water-gauge, thermometer and pressure gauge must be placed so that the operator can easily see them, for an increase in temperature above normal or a decrease in water level below normal will cause the pumps to "kick," probably resulting in damage to them.

Main Stop Valves

The main stop valves should have outside threaded spindles and should be tested before leaving the factory. Where more than one boiler is installed approved non-return valves are to be fitted between the boiler and the main stop valves. Many accidents have occurred through this necessary precaution being disregarded. Not only is a non-return valve a safeguard against steam from other boilers entering a boiler in which a burst tube has developed or in which a manhole has blown out, but when raising the steam pressure in a boiler (which has been laid off for cleaning) with the other boilers in the battery working this non-return valve opens automatically when the pressure attains that of the others. Thus the fireman has no trouble in cutting in his boiler on the line. Feed check valves should be strong and well made, and the feed-water piping be made of brass, and approved for the purpose.

Check Valves

Check valves should be bolted to the boilers or to some short and rigid connection;

but on no account must the valves be fastened to long lengths of pipe that are merely screwed into the boiler and thus might easily become broken off. The internal extension of the feed pipe into the boiler is generally placed in a position where it will not retard circulation. This location varies according to the particular kind of boiler. It has been found in practice that the jet of feed water should not be directed so as to impinge on any plate that is in contact with the fire, nor should the pipe discharge its contents (which often contain sand and mud) toward one place only; the flow should be as distributed as possible.

Meters

A well equipped power-house should be furnished with the latest steam flow meters and water flow meters. These instruments have long passed through the experimental stage, and can no more be dispensed with than can the pressure gauge or safety valve.

Power-house Operators

A power-house must be operated on a methodical and intelligent basis if it is to be run economically. At its head must be a man who not only knows his work, but who also has at heart the interest of the company. Too often the men in charge of power-houses are subject to the whims and caprices of superiors in rank who have not the slightest idea of the rudiments of engineering. Such a practice may produce so disastrous a result that, at the end of a working year, it will be found that the isolated plant is not a paying investment.

Power-house Book-keeping

The power-house should be isolated, it should always be ready to supply power, light, and heat, and be ready for overloads; but, it should sell these commodities to the factory. No man can run a power-house efficiently unless he either has control of the power, light, and heat when it leaves the power-station or can send a monthly bill of them to the factory. When the superintendent receives these bills—so much for "power," "heat," and "light,"—he will give them attention and will issue instructions for repairs or renewals which will effect a saving wherever possible in order to lower the expenses of his manufacture.

This satisfactory method of billing can be put into practice through the use of steam flow meters. The power-house staff can determine (by a series of readings from the power and the light steam flow meters, which should be separate) the price to charge per

kilowatt-hour for power and for light. The amount of steam that is used in the factory can be arrived at by placing a recording and integrating steam flow meter in the steam lines. The cost can be determined and a fair rate charged per thousand pounds of steam used, to insure that there will be no waste of steam through leaky steam traps, or by exhausting into rivers, creeks, or sewers. The amount of return condensate should be registered and if it is not up to normal the factory should be penalized by charging a small percentage more for power, light, or heat, or some immediate arrangement can be entered into with the superintendent or the master mechanic to have the matter remedied. Too often the loss is blamed on the generating apparatus and operating engineers instead of on the carelessness and waste of the factory.

Ash Chutes and Ejectors

There are several makes of ash chutes and ejectors on the market and very little trouble is experienced with them provided care is taken not to choke them by too hasty feeding of clinkers or ashes. On no account should the ash pipe or bin bottom outside the powerhouse be exposed to the weather more than is necessary. Such parts as are exposed should be thoroughly lagged with some heating insulating material. If this is not done the damp ashes may become frozen daily in winter and more time and money be spent to thaw them than would be required to wheel them out with a barrow. For cleanliness and dispatch, however, an ash ejector when carefully installed and given attention is highly recommended.

Coal Bunkers

Local conditions primarily determine the location of the coal bunkers. Frequently these are placed directly over the furnaces, so that the coal can regularly be fed through large sheet-iron feed pipes to the mechanical stokers. Wherever the coal bunkers are placed, however, there should be a means provided for weighing the coal to each boiler when desired. This system in a boiler room soon pays for itself by the increased economy it secures. Desirable results are not obtained from forced tests that are run over a period of only a few hours. These give information as to what the boiler *can do*, but not what it *does do* in daily service from which latter the proper prices to charge the consumer should be determined.

Water Supply

The water supply to a power-station should be the best and cleanest procurable (not necessarily from the city water supply, but preferably from a river or lake if unpolluted). There should be two distinct sources of supply to prevent a possible shut-down with the attendant danger of burning or exploding the boilers. Chemical compounds should be avoided if possible. However, if some chemical must be used, soda ash will probably be found to be the most effective and least injurious. In some cases a judicious amount of lime may be found useful. Graphite when applied in reasonable quantities is also highly recommended as a medium for scale prevention and elimination. A good mechanical means for cleaning and maintaining cleanliness is, however, conceded by many to be more effective than any chemical means.

Engine or Turbine Room

The power-generating room should be well lighted day and night, and also should be well ventilated. If the window space is large but the room is not properly ventilated, a sweat and mist will cause much trouble in winter due to the difference in the temperature within and without. In some cases where the ceiling is high and there is but a small amount of window space, it is necessary to install an exhaust fan in the roof to take out the hot air and vapor and at the same time draw in air from the basement wherein it has had an opportunity to warm up somewhat before entering the engine room. Proper ventilation is most important because, among other reasons, if it is ignored valuable recording instruments may be ruined.

The skylights of the boiler room should be solidly constructed and be composed of sections not exceeding three feet in width so that they can be lifted easily. The hinges should be at the upper edge, so that when a skylight is lifted on its hinges and brought into a horizontal position rain will be prevented from falling on the boilers and spoiling the asbestos lagging, etc. (This is the position of the hinges used on the skylights of a ship.) If, on the other hand, the hinges are placed at the lower edge of the skylights, the boilers will be exposed to the sky at times. Such skylights are also difficult to fasten closed and are in danger of being blown to pieces by the wind.

Switchboard

The switchboard should be placed in a dry and well-lighted location and plenty of room

should be allowed at the back for replacing fuses, etc. A door having a lock should be fitted to the back, so that no unauthorized person can enter. Simplicity is the keynote of a successful switchboard.

The switches should be of ample capacity and be well-constructed; small cheap switches should never be used. The switchboard should be equipped with recording wattmeters for power and light in addition to the customary indicating instruments; and when the generators may be required to run in parallel, even while only changing over,

not to unnecessarily cool the condensing water which can be used as warm water for factory purposes and, second, to extract steam from say between the first and second stages of the turbine for heating and other purposes. Table II shows the amount of steam which can be extracted with a steady extraction pressure of 5 lb. or 10 lb. as required from a 750-kw. machine carrying 400 kw. The operation of the device is entirely automatic and it will maintain constant extraction pressure regardless of the mechanical load on the turbine. A device

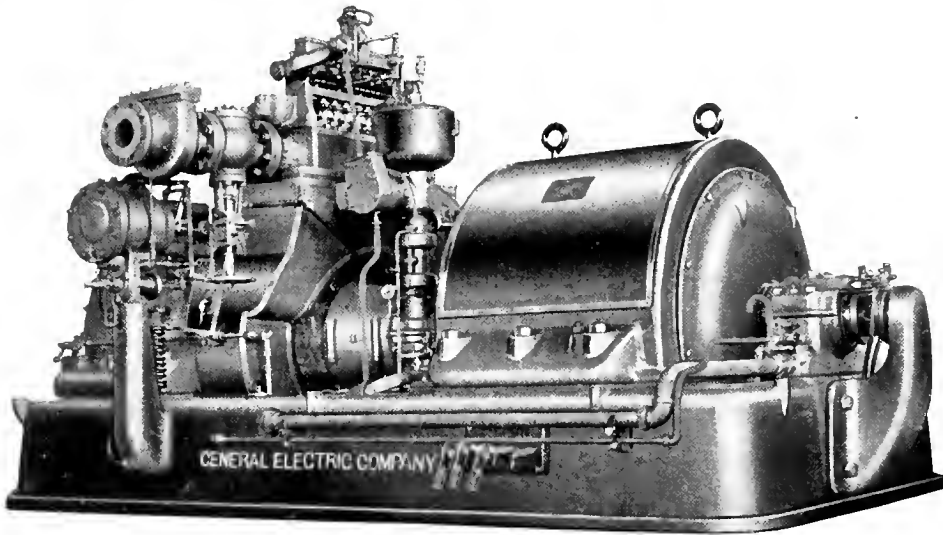


Fig. 4. A 750-kw. Curtis Steam Turbine equipped with an Automatic Steam Extraction Device

synchronizing gear and indicators should be installed. A good rubber mat should be placed in front of the switchboard for the safety of the operators.

Turbine

Turbines are rapidly coming into favor, especially in those cases where they can be coupled direct to high-speed generators. Turbines in which the number of wearing parts is reduced to a minimum, such as the Curtis, are recommended. Machines of this type are now available in sizes ranging from 100 watts to 35,000 kw. The best compromise in the economy of steam consumption and relative cost of upkeep and repairs determines the most suitable machine.

In equipments calling for a daily running load of 500 kw., two machines should be installed and run alternately. It has been found economical, first, to use a condensing turbine with a vacuum of say 26 inches so as

TABLE II

Load Kw.	Extraction in lb. per hour	Flow to Condenser	Flow at Throttle for 160 lb.-26 in.-100
5-lb. Gauge Extraction Pressure			
400	2,000	7,650	9,650
400	4,000	6,500	10,500
400	6,000	5,400	11,400
400	8,000	4,200	12,200
400	110,000	3,100	13,100
400	12,000	1,900	13,900
400	14,000	800	14,800
10-lb. Gauge Extraction Pressure			
400	2,000	8,250	10,250
400	4,000	7,250	11,250
400	6,000	6,100	12,100
400	8,000	5,100	13,100
400	10,000	3,950	13,950
400	12,000	2,950	14,950
400	14,000	1,950	15,950

which has proved to be successful in commercial operation for the extraction of steam from a turbine is shown in Fig. 4. It works automatically by means of a steam cylinder operated by a piston-type pilot valve, which has an adjustable setting for maintaining constant pressure. In conjunction with this steam extracting device a multiport back-pressure valve should be fitted because, being spring loaded, it opens and closes more gently than any valve operated by weights and levers. This insures a greater regularity in the operation of the extractor. It has been found that the extractor and relief valve system is more economical than that which uses exhaust steam direct from the turbines.

Exciters

In a power-house having two 500-kw. turbines there should be two motor-generator exciter sets and one turbine-driven exciter set; also an exciter can be coupled directly to the shaft of one of the turbine-generators. This last is a great advantage as it obviates the necessity of starting up the small set except at week-ends, and the big machines and exciters can be synchronized when changing over at night or morning. The small direct-current exciter set (turbine-driven) can be arranged for lighting the offices, power-house, and one or two rooms or warehouses when necessary; or there can be a turbine-driven alternating-current generator with an extension direct-current exciter. In the latter case it is a good plan to install a turbine of say 50 or 100 horse power that is to operate non-condensing (non-condensing, because when the large machines are not running the exhaust steam, boosted with some live steam to say 5 or 10 lb. pressure, can be used for heating the building and also for heating the feed water).

Condenser

The condenser room should be well lighted and the condenser pumps, traps, etc., easily accessible for attention and repairs.

In choosing a condenser the machine that is to be purchased is one that is well designed, and will stand up to the work. There are condensers which give daily trouble through inherent weakness of design, and others which give no trouble at all. A condenser should not be purchased simply on its merits to produce a high vacuum, but because of its simplicity and freedom from requiring continual repairs.

Miscellaneous

Great uncertainties attend the selection of steam traps as there are so many types on the market. Perhaps the simplest and best are those which for their operation depend on the displacement of a copper-sheathed float containing water-logged wood, and not those which use hollow floats that are liable to become punctured. Every well-equipped power-house should have racks for wrenches which ought always to be in their places ready for emergencies. The wrenches should be of standard sizes to suit the apparatus to which they are to be applied, i.e., not shifting wrenches. There should also be convenient vises and hand tools for making the small repairs that are so often neglected. All back pressure and reducing valves should be by-passed and isolated by means of stop valves so that they can be repaired readily, and these should be placed in an accessible position. The piping arrangement should be a simple one, and the most careful attention should be given to prevent a tangle of steam and exhaust pipes. Plenty of room for tightening up joints should be allowed around the pipes that are run in trenches. This is most essential if the maintenance expenses in the power plant are to be kept at a minimum.

Keeping of Records

There are various methods of keeping power-house data and the one that is to be used depends largely upon the size of the station. Generally speaking, simplicity should be the guiding factor for a complicated system that involves too much time on the part of the operating engineers is apt to defeat its own end. Weekly records of coal consumption and evaporation (when the power-station is equipped with scales over each boiler and water flow meters for measuring the water or steam flow meters for measuring the steam) are really necessary for efficient working. Records of carbon dioxide should be kept to safeguard the proper consumption of the fuel, flow meter readings should be made of the steam supplied to the factory, and light and power readings ought to be taken twice in 24 hours. A simple loose-leaf log-book can be procured for filing this data, and a copy of each page sent to the President of the company and to the Superintendent. This systematic recording of data will be of great assistance in securing economy in the power-house, with the result of a low charge for power, light, and heat for the factory.

Purchase of Coal

There are various kinds of coal—anthracite, bituminous, semi-bituminous, run of mine, and slack. To believe each salesman, one would conclude that the particular company he represents furnishes a better grade of any one of these coals than can his competitors. The heat-unit system, however, is the best salesman. Prompt coal analyses are now made at a reasonable price by reliable firms; and the coal should be bought on the system of so many heat units at one cent, not so many tons at a fixed price. Samples are to be taken from each car, as it is being unloaded. These are then carefully mixed,

quartered, and ground until reduced to a quantity sufficient to fill an air-tight can which is say four inches in diameter and seven inches high. This can is then dispatched to a reputable fuel engineering company, and the price fixed according to the number of heat units found per pound of coal. This system of purchase automatically causes coal dealers to refrain from supplying poor coal, but regardless of the quality which is supplied the purchaser receives full value for his money.

A rough and ready means of determining the number of B.t.u. in a pound of coal is given in Table III.

TABLE III

To Calculate the number of British Thermal Units in Coal from an Analysis of its Percentages of Moisture, Volatile Matter, Fixed Carbon, and Ash.
(Accurate within 100 B.t.u.)

Rules

- (1) Deduct sum of the per cent Moisture and Ash from 100.
- (2) Divide the result into the percentage of Fixed Carbon.
- (3) Multiply this result by 100.
- (4) Consult table below and find B.t.u. opposite this number.
- (5) Multiply this "B.t.u. figure" by the figure found by Rule 1.
- (6) Divide by 100, and the result is the number of B.t.u. sought.

Per Cent	B.t.u.	Per Cent	B.t.u.	Per Cent	B.t.u.	Per Cent	B.t.u.	Per Cent	B.t.u.
50	12240	60	14580	70	15590	80	15840	90	15480
51	12600	61	14760	71	15630	81	15840	91	15390
52	12840	62	14940	72	15660	82	15830	92	15300
53	13100	63	15120	73	15690	83	15810	93	15210
54	13320	64	15210	74	15720	84	15780	94	15120
55	13560	65	15290	75	15750	85	15750	95	15000
56	13800	66	15360	76	15780	86	15710	96	14880
57	14040	67	15420	77	15800	87	15660	97	14760
58	14220	68	15480	78	15820	88	15600	98	14670
59	14400	69	15540	79	15830	89	15540	99	14580

MECHANICAL EFFECTS OF ELECTRICAL SHORT-CIRCUITS

BY S. H. WEAVER

DRAFTING DEPARTMENT, GENERAL ELECTRIC COMPANY

There has been but little data available for satisfactorily determining the stress that will be set up in the mechanical parts of a generator when it is suddenly short circuited. The following article admirably supplies this lack for it contains the desired information and presents it in such a simple and practical form as to be readily applicable to design problems.—EDITOR.

Torque on the Shaft Between Two Units

In sets composed of two or more units, an electrical short-circuit on one unit will place a strain on the shaft connecting the units. The short-circuit dissipates electrical energy and this energy can only be obtained from the mechanical store in the rotating parts and is given out by the deceleration of the machines. The unit that is not short-circuited can give out its energy only through the shaft. The unit that is short-circuited has to absorb the electrical torque by deceleration and it receives torque sent through the shaft by the other unit.

Consider the connecting shaft of elastic material. The shaft to transmit torque must then be twisted through a torsional angle and the torque is proportional to that angle.

The mechanical action in the simplest form at the instant of short circuit is as follows: Unit No. 1 (the short-circuited machine) only gives out torque, for the shaft has not been twisted by the new load. As unit No. 1 is retarded, unit No. 2 begins to take load proportional to the shaft twist. When both units are giving up their proportional share of the energy the shaft twisting *does not stop* (because of the different angular velocities of the units) *but continues until unit No. 2 may take all the load*. When the large twist has equalized the angular velocities (zero relative to each other) the torsional forces in the shaft tend to bring the units back to the position where each gives up its proportion of energy, but the new angular velocities attained carry them beyond this point and a cycle of operations is completed. Thus the inertias of the units, connected by an elastic shaft, cause a mechanical torsional vibration between the machines and produce shaft strains higher than the proportional share of the load. This is called the "free torsional oscillation."

Alternating current gives an oscillating power or torque whose instantaneous values must be considered. Even with a low power-factor and small effective power, the pul-

sations of the torque are very great. The vibrating electrical torque is the "forced or impressed torsional oscillation."

The forced electrical oscillation causes a disturbance when impressed on a mechanical structure that has free oscillating properties. The mechanical frequency of oscillation depends upon the shaft dimensions and upon the inertias of the units. The amplitude of the mechanical vibration depends upon the amplitude of the forced electrical oscillation and upon both frequencies. It is possible to have a condition which the electrical engineer calls "resonance"; but the larger the ratio of mechanical to electrical frequencies the smaller will be the forces on the shaft.

The mathematical work detailing these general statements and simple formulæ reduced to predetermine the maximum torque on the shaft are given in Figs. 1 to 3. The considering of the current transient as being constant for the first cycle makes the formulæ average 10 per cent high for commercial machines. The single-phase electrical power at short-circuit for a power-factor of 0.2 is shown in Fig. 4. Figs. 5 to 7 show the instantaneous value of the shaft torque for different ratios of mechanical to electrical frequency, and show that the maximum stress occurs in the first cycle except in the case of resonance. As the power does not divide between the two machines in proportion to the inertias, the ratio must be multiplied by the value C , given in Fig. 8. These data show that the double frequency of power in a single-phase machine causes two points of resonance, and that while a three-phase machine has only one point of resonance it can be short circuited single-phase with about the same destructive effect. Fig. 9 shows that at resonance the torque increases with the time for a number of cycles until the power dies away.

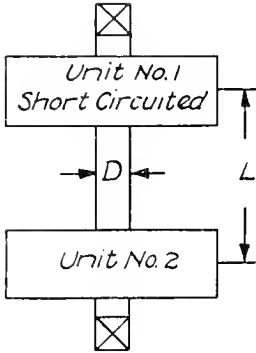
The practical importance of this article is in the formulæ that enable the mechanical designer to proportion the shaft so that the high stress and resonance points can be avoided.

Description of Mathematics

Equation (1), Fig. 1, is the mathematical statement that the torque on the shaft equals the decelerating torque of unit No. 2 which, in turn, is equal to the torque of the angular twist in the shaft. Equation (2)

states that the mechanical decelerating torque of unit No. 1 plus that of unit No. 2 must always equal the electrical torque. All the equations are written with the assumption that the short-circuit occurs at zero time so that the integration constant can be

Short Circuit Torque on Shaft.



$F(t) =$ Short circuit Torque on Unit No.1
 $F(0) = F(t)$ When $t = 0$ $t =$ Time
 α_1 and $\alpha_2 =$ angular distance
 I_1 and $I_2 =$ inertias
 $K_1 =$ Maximum Instantaneous Torque (Electrical)
 $K = 1,300,000 \frac{D^4}{L}$ For Steel Shaft.
 $T =$ Torque on Shaft
 $b = \sqrt{\frac{I_1 + I_2}{I_1 I_2}} K$

The Two Torque Equations are

$$T = I_2 \frac{d^2 \alpha_2}{dt^2} = K(\alpha_1 - \alpha_2) \quad (1)$$

$$I_1 \frac{d^2 \alpha_1}{dt^2} + I_2 \frac{d^2 \alpha_1}{dt^2} = F(t) \quad (2)$$

Both Distance (α) and Velocity ($\frac{d\alpha}{dt}$) are Zero at $t = 0$ Integrating (2) twice and combining with (1) gives

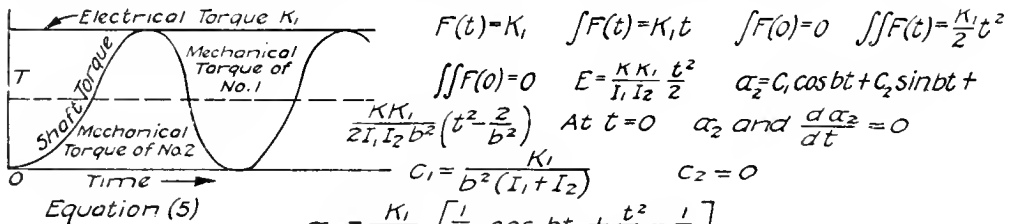
$$\frac{d^2 \alpha_2}{dt^2} + b^2 \alpha_2 = E \text{ where } E = \frac{K}{I_1 I_2} [\iint F(t) - t \int F(0) - \iint F(0)] \quad (3)$$

The General Solution of (3) is

$$\alpha_2 = C_1 \cos bt + C_2 \sin bt + \frac{E}{b^2} - \frac{1}{b^2} \frac{d^2 E}{dt^2} + \frac{1}{b^6} \frac{d^4 E}{dt^4} - \frac{1}{b^8} \frac{d^6 E}{dt^6} + \quad (4)$$

Determine value of C_1 and C_2 and substitute in (1) for T

Example :- Let $F(t) = K_1$, a Constant as in ideal continuous current.



$$F(t) = K_1 \quad \int F(t) = K_1 t \quad \int F(0) = 0 \quad \iint F(t) = \frac{K_1}{2} t^2$$

$$\iint F(0) = 0 \quad E = \frac{K K_1}{I_1 I_2} \frac{t^2}{2} \quad \alpha_2 = C_1 \cos bt + C_2 \sin bt + \frac{K K_1}{2 I_1 I_2 b^2} (t^2 - \frac{2}{b^2})$$

At $t = 0$ α_2 and $\frac{d\alpha_2}{dt} = 0$

$$C_1 = \frac{K_1}{b^2 (I_1 + I_2)} \quad C_2 = 0$$

$$\alpha_2 = \frac{K_1}{I_1 + I_2} \left[\frac{1}{b^2} \cos bt + \frac{t^2}{2} - \frac{1}{b^2} \right]$$

$$T = I_2 \frac{d^2 \alpha_2}{dt^2} = \frac{I_2}{I_1 + I_2} K_1 [1 - \cos bt]$$

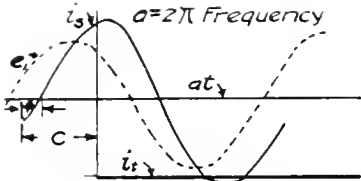
$$T_{MAX} = 2 \frac{I_2}{I_1 + I_2} K_1 \text{ If } I_1 = I_2 \quad T_{MAX} = K_1$$

Fig 1

determined by making both distance and velocity zero, thus measuring only the effect of the disturbance. Equations (1) and (2) can be reduced to (3) which is the elemental form of an equation for a forced vibration, the left-hand side representing a free system

while E gives rise to the forced system. The solution of equation (3) is equation (4), wherein the trigometric functions represent the complementary solution or free oscillation, b equals 2π times the mechanical frequency, and the remaining series part of the right-hand

Electrical Equations.



For single-phase $e_1 = \sqrt{2} E \sin(\omega t + c)$
 $i_s = \sqrt{2} I \sin(\omega t + c - \phi)$ Symmetrical
 $i_t = -\sqrt{2} I \sin(c - \phi)$ Transient
 $i_1 = i_s + i_t = \sqrt{2} I [\sin(\omega t + c - \phi) - \sin(c - \phi)]$
 $p_1 = e_1 i_1 = 2EI [\sin(\omega t + c - \phi) - \sin(c - \phi)] \sin(\omega t + c)$
 $p_1 = EI [\cos \phi - \cos(2\omega t + 2c - \phi) + \cos(\omega t + 2c - \phi) - \cos(\omega t + \phi)]$ Max. at $C = \frac{\pi}{2} + \phi$
 $p = EI [\cos \phi + \cos(2\omega t + \phi) - 2\cos(\omega t + \phi)]^*$

Let % = Percent Reactance per Phase
 KVA = Kilovolt-ampere rating of Machine
 N = Revolutions per Minute

$$F(t) = \frac{7040}{N} p = \frac{7040}{N} \frac{KVA}{\%} [\cos \phi + \cos(2\omega t + \phi) - 2\cos(\omega t + \phi)]^*$$

Polyphase Power :- $m = \text{No. of phases} > 1$ $x = \text{any given phase}$

$$e_x = \sqrt{2} E \sin(\omega t + c - \frac{2\pi}{m} x) \quad i_x = \sqrt{2} I [\sin(\omega t + c - \phi - \frac{2\pi}{m} x) - \sin(c - \phi - \frac{2\pi}{m} x)]$$

$$p = \sum e_x i_x = EI \left[\sum \cos \phi - \sum \cos(2\omega t + 2c - \phi - \frac{4\pi}{m} x) - \sum \cos(\omega t + \phi) + \sum \cos(\omega t + 2c - \phi - \frac{4\pi}{m} x) \right]$$

$$= m EI [\cos \phi - \cos(\omega t + \phi)] = \frac{KVA}{\%} [\cos \phi - \cos(\omega t + \phi)] \quad (7)$$

$$F(t) = \frac{7040}{N} \frac{KVA}{\%} [\cos \phi - \cos(\omega t + \phi)]$$

Torque for Single-phase short circuit :-

Inserting (6) in (4) finding C_1 and C_2 and substituting (1) gives

$$T = \frac{I_2}{I_1 + I_2} \frac{7040}{N} \frac{KVA}{\%} \left[\frac{-2a^2(b^2 + 2a^2)\cos \phi \cos bt + 6a^3b \sin \phi \sin bt}{(b^2 - 4a^2)(b^2 - a^2)} + \cos \phi + \frac{b^2 \cos(2\omega t + \phi)}{b^2 - 4a^2} - \frac{2b^2 \cos(\omega t + \phi)}{b^2 - a^2} \right] \quad (8)$$

If $n = \frac{b}{a}$ and $\tan \epsilon = \frac{3n}{n^2 + 2} \tan \phi$

$$T = \frac{I_2}{I_1 + I_2} \frac{7040}{N} \frac{KVA}{\%} \left[\frac{2\sqrt{0}n^2 + (n^2 - 4)(n^2 - 1)\cos^2 \phi}{(n^2 - 4)(n^2 - 1)} \cos(n\omega t + \epsilon) + \cos \phi + \frac{n^2 \cos(2\omega t + \phi)}{n^2 - 4} - \frac{2n^2 \cos(\omega t + \phi)}{n^2 - 1} \right] \quad (9)$$

For the greatest possible Maximum, add the Amplitudes ($\cos^2 \phi = 0$)

$$T_{\text{Max}} = \frac{I_2}{I_1 + I_2} \frac{7040}{N} \frac{KVA}{\%} \left[\cos \phi + \frac{6n + 3n^2(n^2 - 3)}{(n^2 - 4)(n^2 - 1)} \right] \quad (10)$$

Bracket value decreases for the large n toward the limit $[3 + \cos \phi]$

* $[\cos \phi + \cos(2\omega t + \phi) - 2\cos(\omega t + \phi)]$ is Maximum at $\omega t = \pi - \frac{2}{3}\phi$ and equals $4 \cos^3 \frac{\phi}{3}$

side is the portion which provides for the function E . The values C_1 and C_2 must be determined under the condition of angular distance and velocity equaling zero at zero time and substituting in equation (1) for the torque.

A simple example is worked out for $F(t)$ equal to a constant, which is the ideal case resulting from equation (5) and plotted in the curve adjacent.

The section headed "Electrical Equations," Fig. 2, shows the structure of the instantaneous torque equations for electrical short-

circuits. A constant c is used because the short-circuit occurs at zero time. This is a mathematical expression for the ideas on short-circuit given in Steinmetz's "Electric Discharges, Waves, and Impulses," except that the transient value of the current is taken as constant instead of logarithmic for the sake of simplicity and dealing only with the first cycle for maximum values.

The general expressions for polyphase circuits are not true for the so-called two-phase or 90 deg. displacement, but it can be shown by the same process that the equations

Torque for Polyphase Short Circuit :-

Placing (7) in (4) Finding C_1 and C_2 substituting in (1) gives

$$T = \frac{I_2}{I_1 + I_2} \cdot \frac{7040}{N} \cdot \frac{KVA.}{\%} \cdot \frac{b^2}{b^2 - a^2} \left[\frac{a^2}{b^2} \cos \phi \cos bt - \frac{a}{b} \sin \phi \sin bt + \frac{b^2 - a^2}{b^2} \cos \phi \cos(at + \phi) \right] \quad (11)$$

For $\frac{b}{a} = n$ and $\tan \epsilon = n \tan \phi$

$$T = \frac{I_2}{I_1 + I_2} \cdot \frac{7040}{N} \cdot \frac{KVA.}{\%} \left[\cos \phi + \frac{1}{n^2 - 1} \left\{ \sqrt{n^2 - (n^2 - 1) \cos^2 \phi} \cos(nat + \epsilon) - n^2 \cos(at + \phi) \right\} \right] \quad (12)$$

For the greatest possible Maximum add the Amplitudes

$$T_{MAX} = \frac{I_2}{I_1 + I_2} \cdot \frac{7040}{N} \cdot \frac{KVA.}{\%} \left[\cos \phi + \frac{\sqrt{n^2 - (n^2 - 1) \cos^2 \phi} + n^2}{n^2 - 1} \right] \quad (13)$$

Bracket value decreases for large n toward the limit $[1 + \cos \phi]$

Polyphase Generator :- Ratio of one phase short circuited to all

$$\text{phases short circuited} = \frac{(10)}{(13)} = \frac{1}{m} \frac{(3 + \cos \phi)}{1 + \cos \phi} \text{ for } m = 3 \text{ Ratio} = \frac{1 + \frac{\cos \phi}{3}}{1 + \cos \phi} \quad (14)$$

Resonance :- Special solution of (4) when $F(t) = (6)$ and $a = b$ or $n = 1$

$$\alpha_2 = \frac{K_1}{I_1 + I_2} \left[-\frac{8 \cos \phi}{3a^2} \cos at - \frac{7 \sin \phi}{3a^2} \sin at + \left(\frac{t^2}{2} - \frac{11}{4a^2} \right) \cos \phi + \frac{3t}{2a} \sin \phi + \frac{\cos(2at + \phi)}{12a^2} + \frac{t}{a} \sin(at + \phi) \right]$$

$$T = K_1 \frac{I_2}{I_1 + I_2} \left[\frac{\sin \phi \sin at}{3} - at \sin(at + \phi) + \cos \phi - \frac{\cos(2at + \phi)}{3} - \frac{2 \cos(at + \phi)}{3} \right] \quad (15)$$

t in the Amplitude of one term increases Torque with the time

Special solution of (4) when $F(t) = (6)$ and $b = 2a$ or $n = 2$

$$\alpha_2 = \frac{K_1}{I_1 + I_2} \left[-\frac{2 \cos \phi}{3a^2} \cos 2at + \frac{17 \sin \phi}{24a^2} \sin 2at + \left(\frac{t^2}{2} - \frac{2}{a^2} \right) \cos \phi + \frac{3t}{2a} \sin \phi - \frac{t}{4a} \sin(2at + \phi) + \frac{8 \cos(at + \phi)}{3a^2} \right]$$

$$T = K_1 \frac{I_2}{I_1 + I_2} \left[-\frac{1}{6} \sin \phi \sin 2at + \cos \phi + \frac{5}{3} \cos(2at + \phi) + at \sin(2at + \phi) - \frac{8}{3} \cos(at + \phi) \right] \quad (16)$$

Special solution of (4) when $F(t) = (7)$ and $a = b$ or $n = 1$ (Polyphase)

$$\alpha_2 = \frac{K_1}{I_1 + I_2} \left[\frac{2 \cos \phi}{a^2} \cos at - \frac{3}{2} \frac{\sin \phi}{a^2} \sin at + \left(\frac{t^2}{2} - \frac{2}{a^2} \right) \cos \phi + \frac{t}{a} \sin \phi + \frac{t}{2a} \sin(at + \phi) \right]$$

$$T = K_1 \frac{I_2}{I_1 + I_2} \left[-\frac{\sin \phi}{2} \sin at - \frac{at}{2} \sin(at + \phi) + \cos \phi - \cos(at + \phi) \right] \quad (17)$$

Fig. 3

satisfy this condition after the summations have been made.

Introducing the electrical torque equations (6) and (7) in general equation (4), then in (1) for the shaft torque T gives (8), (9) and (10) for the single-phase short-circuit, and (11), (12) and (13) for the polyphase short-circuit.

Maximum values for T are obtained by adding the amplitudes. This is the safest method as the maximum values plotted against n is a wave-like curve with high and low point in every variation of 2 in value of n .

Equation (14) shows the relative effect of short-circuiting one phase in a polyphase generator. It also demonstrates that if a short-circuit occurs between one leg and the neutral of a three-phase generator the effect is as destructive to the shaft as though all phases were short circuited.

At the points of resonance special solutions of equation (4) are required, these giving (15) and (16) for single-phase and (17) for polyphase short-circuits. In each solution one of the coefficients or amplitudes contains (t) thereby showing an increase of vibration

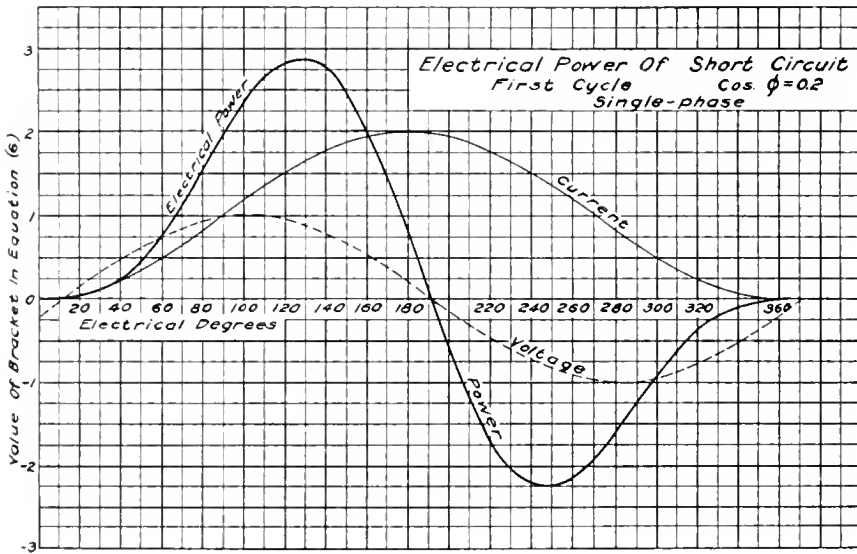


Fig. 4

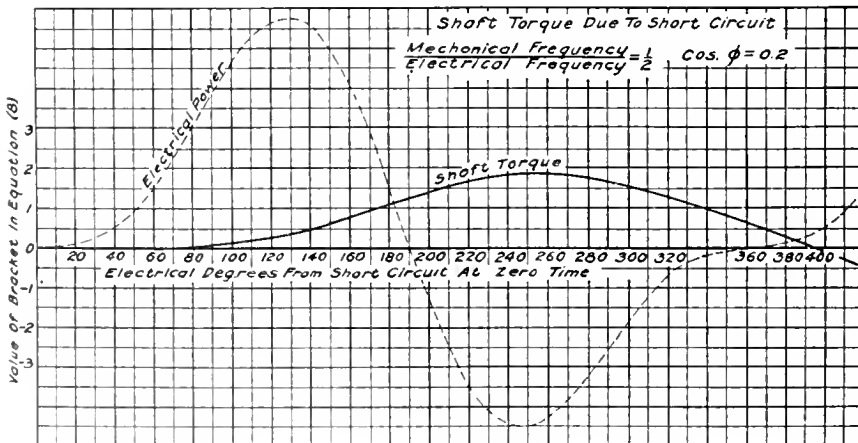


Fig. 5

with the time. Equation (15) is plotted in Fig. 9, wherein the radiating straight lines show the limit of the resonance factor of the equation. Actually, there would be an increase of vibration with the time for a number of cycles until the power died away.

Finally, curves for a short-circuit power-factor of 0.2 are shown in Fig. 8 plotted from

the formula combined with values of C and reduced to a practical form.

PART II. PULL ON STATOR FOOT-BOLTS

When a horizontal electrical unit is subjected to a short-circuit, the torque produced is usually so great that the resulting lever action would lift one side of the stator from

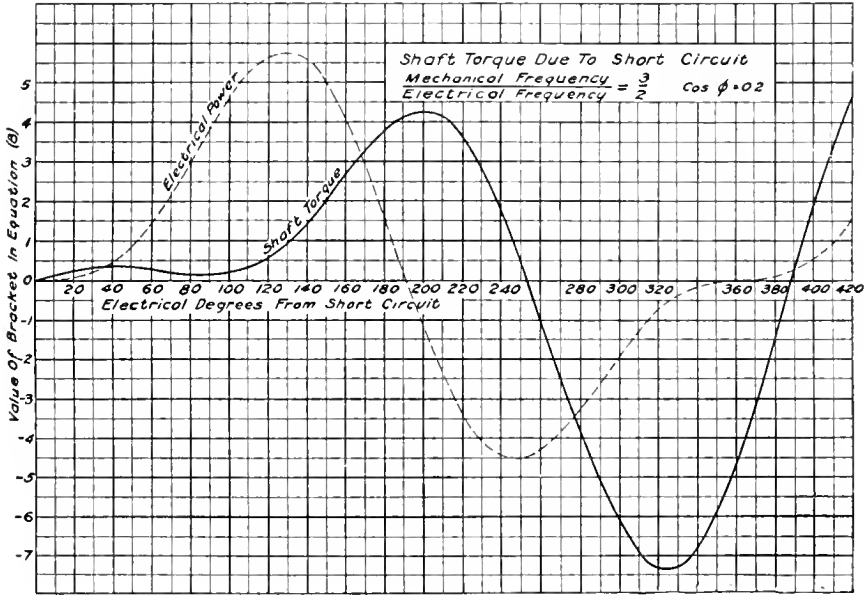


Fig. 6

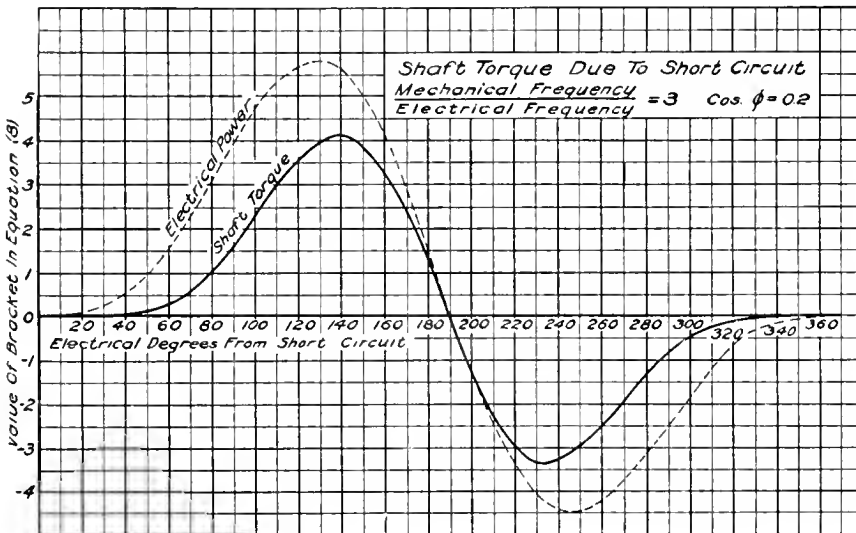


Fig. 7

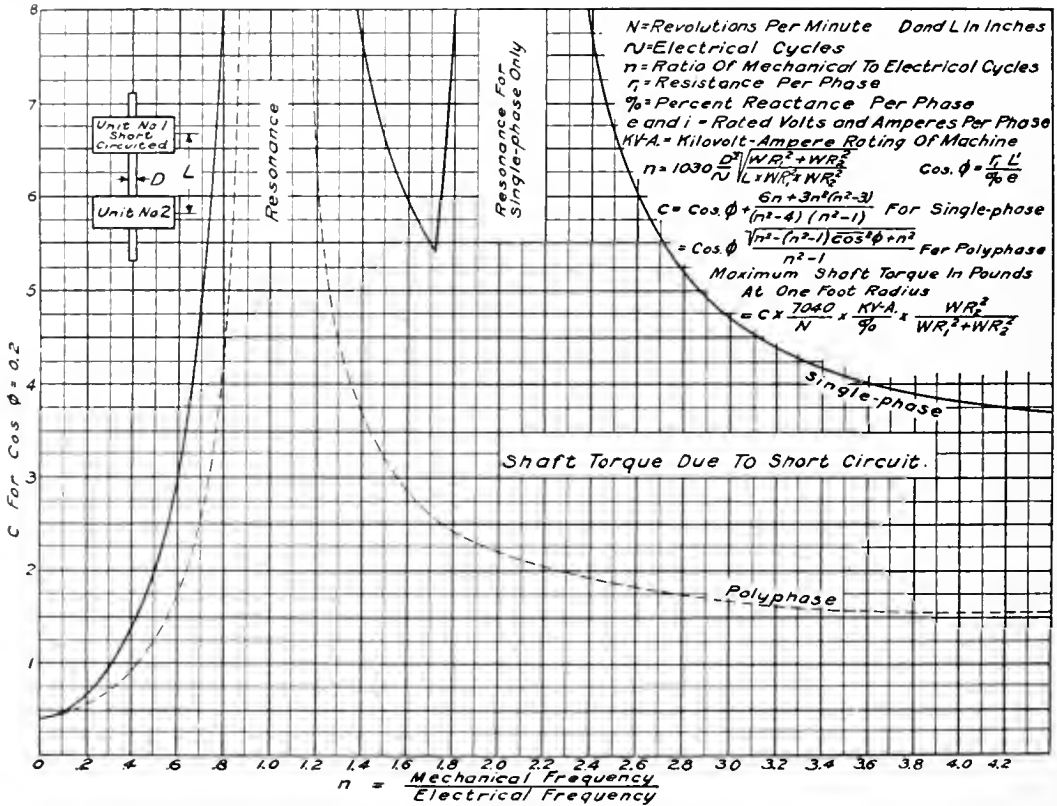


Fig. 8

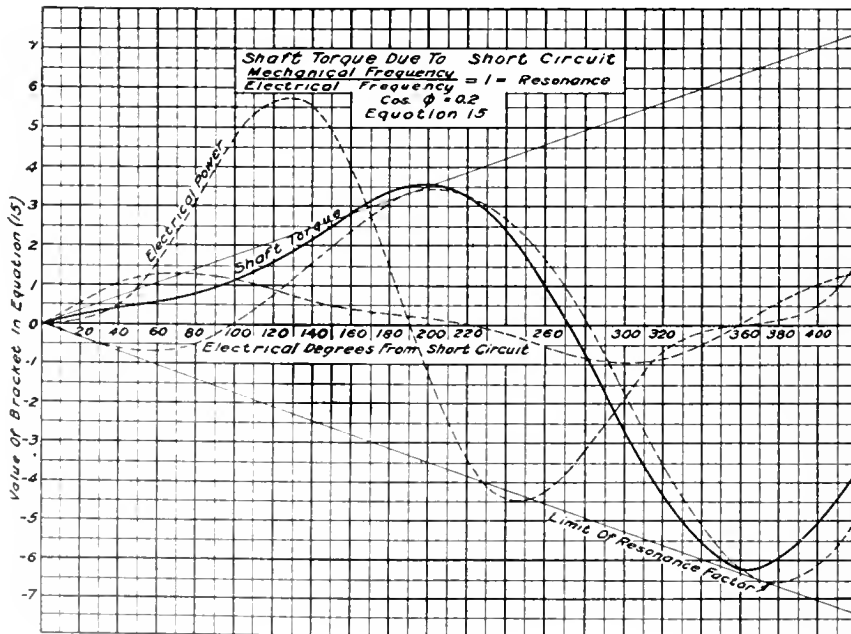


Fig. 9

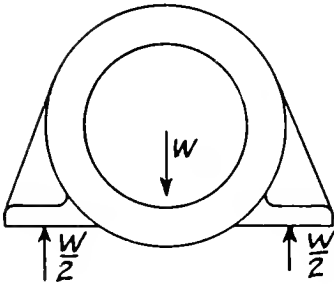
Stress On Stator Foot Bolts

Fig. 10a

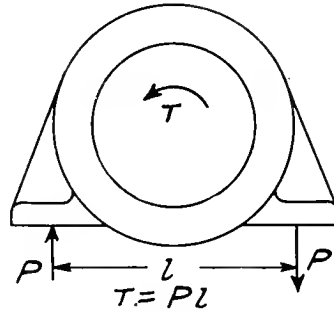


Fig. 10b

$$\text{Force on the left side} = \frac{W}{2} + P = \frac{W}{2} + \frac{T}{l} \quad (18)$$

$$\text{" " " right " " } = \frac{W}{2} - P = \frac{W}{2} - \frac{T}{l} \quad (19)$$

If $\frac{T}{l} > \frac{W}{2}$ the force is a pull on the bolts

$$T_{\max} \text{ for single-phase} = 12 \times \frac{7040}{N} \times \frac{\text{KV-A.}}{\sigma_0} \times 4 \overline{\cos^3 \frac{\phi}{3}}$$

$$\text{In inch pounds} = \frac{337970}{N} \times \frac{\text{KV-A.}}{\sigma_0} \times \overline{\cos^3 \frac{\phi}{3}} \quad (20)$$

$$T_{\max} \text{ for polyphase} = \frac{84480}{N} \times \frac{\text{KV-A.}}{\sigma_0} [1 + \cos \phi] \quad (21)$$

$$\text{Maximum pull on bolts on one side} = \frac{T_{\max}}{l} - \frac{W}{2}$$

*Stator Foot-Bolts**Horizontal Machines*

W = Weight of stator in pounds

l = Distance between bolt rows in inches

N = Revolutions per minute

KV-A. = Kilovolt - ampere rating of machine

σ_0 = Percent reactance per phase [percent voltage drop with rated current]

e and i = Rated volts and amperes per phase

γ = Resistance per phase

$$\cos \phi = \frac{\gamma l}{\sigma_0 e}$$

$$T_m = \frac{337970}{N} \frac{\text{KV-A.}}{\sigma_0} \overline{\cos^3 \frac{\phi}{3}} \text{ for single-phase}$$

$$= \frac{84480}{N} \frac{\text{KV-A.}}{\sigma_0} [1 + \cos \phi] \text{ for polyphase}$$

Maximum pull in pounds on all bolts on one side of stator = $\frac{T_{\max}}{l} - \frac{W}{2}$

Vertical Machines

Maximum shearing force in pounds on all bolts

equals T_m divided by radius of bolt circle in inches

the base if these were not bolted together. In many cases, as in large turbine-generators, etc., this pull on the bolts is excessive and determines the size of bolts required. The mechanical designer should know the maximum pull on the stator foot-bolts so that he can proportion the feet, their supports, the size of the foot-bolts, the foundation bolts, and the twist on the base itself.

The forces on the holding-down bolts can be easily determined by the simple principles of mechanics. Consider first the influence of the stator weight W shown in Fig. 10a. Assume the stator to be a "free" body held in equilibrium only by the forces acting upon it. It is evident that a symmetrical stator is held in equilibrium by the forces shown in Fig. 10a. Next consider the electrical torque T acting on the stator in Fig. 10b. T is a mechanical couple and must be opposed by introducing an opposite couple, or forces, whose moment equals T . Thus, placing the two forces P at the foot-bolts, T must equal Pl . Now, if both the weight W , Fig. 10a and torque T , Fig. 10b, act at the same time, there is on the one side the forces given by equation (18) and on the other side by

equation (19). The latter equation represents the pull on the foot-bolts.

All is known in equation (19) except the value of T which is obtained from equations (6) and (7) of Part I of this article, but changed to inch-pounds instead of foot-pounds and given as equations (20) and (21).

The remaining part of Fig. 10 gives the formulæ in a practical form.

The bolts connecting the stator to the base in a vertical machine are subjected to a shearing force instead of to a tensional force as in a horizontal machine. This shearing force on all the bolts combined can be calculated by dividing equations (20) or (21) by the radius of the bolt circle in inches.

Any movement of the stator has not been considered, for the smallest movement would carry the bolts beyond the elastic limit and also the inertia of the stator would enter and reduce the force. Furthermore, at a failure in a horizontal machine, the foot-bolts would be permanently elongated and loosen one side of the stator; and in a vertical machine the stator would move around so as to partially shear the bolts and they would have to be drilled out.

THE THEORY OF LUBRICATION

By L. UBBELOHDE

Translated for the GENERAL ELECTRIC REVIEW from *Petroleum*

By HELEN R. HOSMER

RESEARCH LABORATORY, GENERAL ELECTRIC COMPANY

PART II

II. LAWS OF FRICTION IN LUBRICATED MACHINE BEARINGS

The first installment of this article appeared in the October issue and dealt with the "Fundamental Physical Principles of Lubrication." The present installment covers the subjects of "The Laws of Friction in Lubricated Machine Bearings" and "The Failure of Oil Testing Machines." Later installments will treat of "Combined Oil and Graphite Lubrication" and "Investigations of the Future."—EDITOR.

a. General

The process of lubrication consists of the bringing between the moving surfaces, as for instance between the surface of the bushing and the journal, a fluid which prevents the surfaces from coming in contact, and whose internal friction is less than the dry friction when the surfaces are in direct contact.

Petroff¹¹, who first treated the problem of lubricated journal bearings from the theoretical point of view, has distinguished between internal friction and external friction of the lubricating material. This internal

friction (or viscosity) is that friction which acts between the particles of the fluid itself. See page 967. As external friction Petroff designates that which exists between the fluid on the one hand, and the two solid walls on the other. As a matter of fact Petroff pointed out that the external friction was really of very little significance (that it is, in fact, of no importance was shown on page 968). This limitation of Petroff's has, however, not been given sufficient weight by many of the later interpreters, so that the conception of external friction (see formulæ 12) is the real cause of the obscurity con-

¹¹ Petroff, *Neue Theorie der Reibung*, Hamburg, 1888.

cerning frictional phenomena, and has led especially to the testing of lubricating materials by entirely false methods, as is done in technical circles today.

It is not possible to take up these errors in detail, but they will be mentioned in general. In the course of time there has grown up the following point of view, from which indeed individual authors¹² differ more or less. The external friction is considered to be the property of the lubricant through which it is able to produce a stable and lasting layer of oil between the bearing and the journal. The external friction should, accordingly, prevent the oil from being squeezed out from between the journal and the bushing by pressure on the journal. It would seem important, therefore, that the oil should have as great an external friction as possible. On the other hand, the internal friction of the lubricant must be as small as possible, since the internal friction must be continually overcome during the turning of the journal. Therefore, those oils are considered the best which have the most favorable relation of external to internal friction, that is, in which the external friction is large in proportion to the internal. It is assumed that this relation is very different for different oils, and that they should be evaluated accordingly.

It will be demonstrated below, on the contrary, as it has been in an earlier section, that in reality it is the internal friction of the oil that is of importance, and all the effects in the bearing are to be traced back to it and to the property of capillarity, now appearing for the first time in connection with the problem.

For the purposes of this inquiry into the laws of friction in lubricated machine bearings, it is necessary to go back to the laws mentioned in section I-(b), page 967.

Coulomb's law for dry friction, (page 967) and Newton's law (page 967) for fluid friction are as different as possible. The dry friction is independent of the velocity and proportional to the total pressure P . The fluid friction, on the other hand, is independent of the pressure P and proportional to the velocity. It is especially to be noted that by constantly increasing the sliding velocity the fluid friction approaches zero; but the dry friction does not, but approaches a maximum μ_0 , where μ_0 is the coefficient of friction at rest.

Although in practice a lubricant is indispensable the technical man ordinarily uses

without hesitation Coulomb's law, and writes accordingly for the moment of friction

$$M = \mu \cdot r \cdot P \quad (9)$$

where P is the journal pressure, and r the radius of the journal. μ is here designated the coefficient of friction, but at the same time it is not identical with the coefficient of friction for the dry friction of the journal material against the material of the bushing, but must be especially determined by test for each case.

(b) Hydrodynamic Theory

On the other hand, Petroff has shown that the phenomena incident to bearing friction are governed by the laws of the internal friction of the lubricant. If it is assumed that the lubricant clings both to the revolving journal and to the stationary bushing (see page 970) and that the journal rests concentrically in the bearing, then the velocity in the lubricant

$$\frac{dv}{dn} = \frac{U}{\delta} \quad (10)$$

can be written, where U is the velocity of the journal surface and δ (presupposed to be small and uniform) the thickness of the lubricating layer. According to Newton's law, the moment of friction on the journal, if F represents the area of the inner wetted surface of the bearing, can be expressed by the following formula:

$$M = r \cdot \eta \cdot F \frac{U}{\delta} \quad (11)$$

For the case where the lubricant does not cling to the journal and bearing, but slides, the computation gives, if λ_1 and λ_2 are the coefficients of external friction on the journal and bearing:

$$M = r \eta F \frac{U}{\delta + \frac{\pi}{\lambda_1} + \frac{\eta}{\lambda_2}} \quad (12)$$

As a matter of fact this relation stated by Petroff does not come into consideration, since, as mentioned above (page 970), the lubricant does not slide. While, therefore, according to equation 9, the friction should be proportional to the journal pressure P and independent of the related specific pressure p in the lubricant, and while according to equation 11 it should be proportional to the velocity U , it should, according to equation 9, so far as the coefficient of friction can be regarded as a constant, be independent of U . Experience shows that neither formula 9 nor formula 11 holds for all cases.

¹² See, for instance, A. Martens, Mitteilungen aus den Kgl. techn. Versuchsanstalten Berlin 1888 Ergänzungsheft III, S. 7, 8 und 23; ferner ebenda 1900 S. 1 ff.—Post, Chem.—techn. Analyse, Braunschweig, 2. Aufl. 1881—Grossmann, Die Schmiermittel, Wiesbaden 1909, S. 75, 77, 78, 80, 108—110 und 250. Pierre Breuil, Bulletin du laboratoire d'essais du conservatoire nationale des arts et metiers, Paris 1906, No. 6, Tome 1 (1905-06). Rupprecht, Zeitschrift für Dampfessel und Maschinenbetrieb 1905, No. 4 u 5; 1907 No. 48 u. 49; 1908 No. 1 u. 47; 1909 No. 9.—Benedikt-Ulzer, Analyse der Fette und Wachsarten, 5. Aufl. 1908, S. 369 ff.—Rakusin, Die Untersuchung des Erdöls, Braunschweig 1906, S. 144.

The hydrodynamic theory of lubrication derived by Petroff provides, however, a general formula for the moment of friction, which, at sufficiently great velocities, becomes identical with equation 11, and at sufficiently small velocities with equation 9.

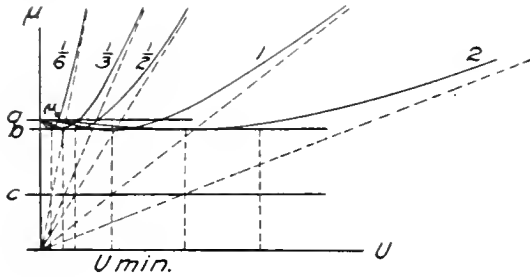


Fig. 4

The statement of the theory of lubrication of loaded bearings was not consummated at one stroke, but is the product of a number of students, who divided the work with the already mentioned Petroff somewhat as follows: In the years 1883-4, were published the investigations of Tower, from which it became apparent that the laws of fluid friction are involved in bearing friction. In the same year (1884) was put forth simultaneously by three different investigators, Lord Rayleigh, Stokes, and an unknown third (according to Reynolds, page 160), the fundamental differential equation for the theory of friction. Two years later appeared Reynold's article, "Concerning the Theory of Lubrication and Its Application to the Researches of Tower," in which he integrated the above mentioned equation, but by means of development of series, which are not at all easy to analyse. Under the inspiration of Striebeck's investigations (see below) appeared in 1904 the work of Sommerfeld¹³, who solved the integral in the finite form, and applied the results to enclosed and half enclosed bearings. Further, several general laws, as for instance the existence of a transition velocity, were first stated by him.

We must forego examining the derivation of these formulæ more closely, as this would lead us far beyond the limits of this article. The results of the theory in the form of several curves made by Sommerfeld will be discussed. But it must not be overlooked that the deviation of the exact theory from the formula of Petroff has its cause in the fact that the journal does not lie in the center of the bearing, as Petroff assumed, but deviates sideways according to the velocity, and this

displacement is greater the smaller the velocity and the higher the pressure. This idea of Reynold's has been further developed by Sommerfeld.

In the following figures and formulæ

- U = velocity
- M = moment of friction
- μ = coefficient of friction (coefficient of friction μ is defined by the equation $M = \mu r P$).
- P = pressure
- η = viscosity (or internal friction) of the lubricant.
- δ = difference of radii of journal and bushings
- r = radius of journal

In Fig. 6 are plotted as abscissæ the velocities U and as ordinates the coefficients of friction μ . For each curve the pressure P is constant.

The numbers on the curves are proportional to the pressures. The viscosity η is the same for all curves.

Now it is apparent that the coefficient of friction for the velocity zero has a certain constant value for all pressures, μ_0 (coefficient of friction at rest $\mu_0 = \frac{\delta}{r}$). With increasing velocities the coefficient of friction decreases for all pressures down to a small value, and then rises again. The minimum value for the coefficient of friction $\mu_{(min)}$ is the same for all the curves (line b) and amounts to about $\mu_{(min)} = 0.943 \mu_0$. It depends, therefore, just as does the coefficient of friction, at rest, only upon the dimensions of the bearing, is about 6 per cent smaller than the coefficient of friction at rest, and independent of journal

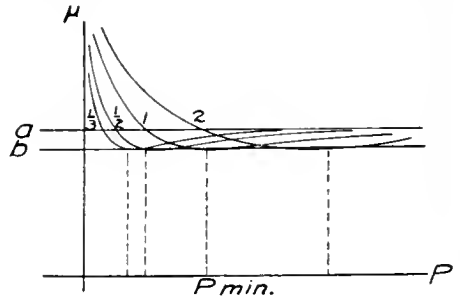


Fig. 5

pressure and velocity. In certain parts of the curve there is apparent, however, a marked effect of pressure and velocity. The higher the pressure, so much the greater is the velocity at which the minimum coefficient of friction is attained. The velocity at which

¹³ Sommerfeld, Ztschr. f. Mathematik u. Phys. 1904, S. 97.

this occurs is designated as $U_{(min)}$, and is called the "transition velocity." The pressure corresponding to the transition velocity, $P_{(min)}$ (see also Fig. 5) is called the "transition pressure." The value of the transition velocity is obtained from the following formulæ:

$$U_{(min)} = \frac{\delta^2 P}{15.1 \eta r^2}$$

$$P_{(min)} = 15.1 \frac{\eta r^2 U}{\delta^2} \quad (13)$$

The value of the transition velocity, according to this equation, increases with increasing journal pressure P , and with increasing fluidity of the lubricant, that is, with decreasing η . Since, as is well known, the value of η is markedly lowered by a rise in temperature, we can also say that the transition velocity increases with rising temperature. The converse holds for the transition pressure.

At high velocities the several curves approach asymptotically lines passing through the origin whose equation is:

$$\mu = \frac{2 \pi \eta r U}{\delta P} \quad (14)$$

For $U_{(min)}$ this straight line has the ordinate

$$\mu = \frac{2 \pi \delta}{15.1 r} = 0.416 \mu_0 \quad (15)$$

At $0.416 \mu_0$ is drawn a line c parallel to the axis of abscissæ. If the intersection of this line with the ordinate through $U_{(min)}$ be

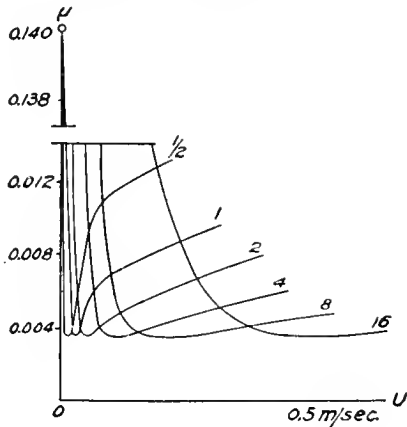


Fig. 6

connected with the origin of co-ordinates we will obtain the asymptote for our curves.

In Fig. 5, the pressures P are taken as abscissæ and the coefficients of friction μ as ordinates. The velocity U for each indi-

vidual curve is constant, the numbers on the curves being proportional to the velocities. The viscosity η is the same for all the curves. It should be noted that $P_{(min)}$ increases at the same rate as U , as was also indicated by Fig. 4.

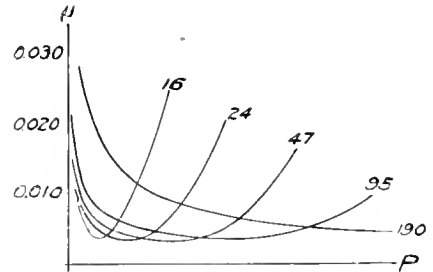


Fig. 7

(c) Comparison between the Hydrodynamic Theory and Practical Tests

Sommerfeld has, for purposes of comparison with the computed curves of Figs. 4 and 5, prepared two series of experimental curves from data in a very valuable article by R. Striebeck¹⁴. The first series of Striebeck's¹⁵ curves has as abscissæ the velocity U in meters per second, and as ordinates the coefficient of friction μ . The abscissæ of the second series of curves¹⁶ are quantities proportional to the journal pressures per unit length; to be exact, the journal pressure per unit of surface of the projection of the bearing upon a plane perpendicular to the journal pressure (in our symbols $\frac{P}{2r}$). The

ordinates again are the coefficients of friction μ . The numbers written upon the curves indicate in the first figure journal pressure per unit surface kg/cm^2 , in the second the number of revolutions per minute.

It cannot be overlooked that there is a general similarity in the forms of the theoretical and the observed curves. There is indicated, for instance, the existence of transition velocity or transition pressure, the increase of the transition velocity, in proportion to the journal pressure or the increase of the transition pressure in proportion to the journal velocity, and further, the fact that the value $\mu_{(min)}$ is independent of the pressure or of the velocity, as is shown by the fact that all the curves in Figs. 4 and 5, as well as in Figs. 6 and 7, rest upon the same straight line. The difference in scale, as well as the difference in journal pressures, and the velocities of revolution, are to be expected;

¹⁴ Striebeck, Die wesentlichsten Eigenschaften der Gleit und Rollenlager. Ztschr. des Vereins Deutscher Ingenieure 46, 341, 1902, abstracted in Mitteil. über Forschungsarbeiten, Heft 7, Berlin 1903.

¹⁵ Figure 7a by Striebeck.

¹⁶ Figure 6 by Striebeck.

but it follows from these that the curves in Figs. 6 and 7, and those in Figs. 4 and 5, indicated by the same numbers, are not directly comparable with each other. (Fig. 6.)

On the other hand, it must not be overlooked that there are important differences between the theoretical and the observed curves. Especially should it be noted, that of the curves in Fig. 6 none approach a straight line through the origin, but all bend back a little behind the minimum, as the velocities increase, and then rise much less steeply. Moreover, while the ordinate of the starting point μ_0 in Fig. 4 is only about 6 per cent larger than the smallest value of μ , in Fig. 6, the ordinate is twenty-five times larger than the last named value. (It should be noted that the ordinates in Fig. 6 have been very much shortened by omission of a strip between 0.012 and 0.138.)

According to the observations of Striebeck $\mu_0 = 0.14$. According to the Sommerfeld theory it should equal $\frac{\delta}{r}$, which in normal operation of the bearing may be less than 0.005. However, there exists a certain qualitative agreement even in regard to this value, for in both the theoretical and the observed curves all start from the same point in the axis of ordinates.

The cause of the higher range of the values determined by Striebeck may be traced, in the opinion of the author, in the left side of the curves, which indicate that in all, and especially at the lower velocities, no pure fluid friction existed, but that on account of faulty finish the surfaces of the journal and bearing were in direct contact throughout, so that dry friction also played a part, and raised the total frictional resistance very considerably. The theory provides for the appearance of negative pressures¹⁷ and also for a definite end point of the same, since at small velocities the layer of lubricant may become broken. The increase in this coefficient of friction after a period of rest of the journal is especially large. That direct contact of journal and bearing occurs can be shown by the fact that there is electrical connection between journal and bearing. The higher resistance caused by this dry friction may be diminished considerably by mixing graphite with the oil. This method will be considered below under the subject of "Oildag." At high velocities, on the other hand, disturbing resistances in the oil layer may arise from exceeding the critical velocity (see page 967) and this would have

an effect upon the form of the curve. Moreover the variation of temperature and the resulting alteration of viscosity must be taken into consideration. The difference between the theoretical and practical curves can not, however, be completely explained by these several causes.

EXPERIMENTAL PROOF

The advocates of the view that yet other properties of lubricants (lubricity, specific lubricating power, external friction, layer forming power, etc., see page 970) besides viscosity, exert a real influence upon the frictional resistance, can find good reason for their belief in the failure of agreement between the experimentally determined and the calculated curves.

It is therefore of interest to bring forward yet one more experimental proof. If the statement is correct, that the only property of the oil affecting the coefficient of friction is the viscosity, then all oils of the same viscosity should give the same coefficient of friction in a given bearing. The experimental proof of this fact may be taken from an investigation which was undertaken principally for other purposes.

The Marten oil testing machine for the testing of the frictional resistance of oils in journal bearings was used in the experiment. This machine, like all testing machines, is equipped for measuring the pressure, the velocity, and the temperature. The details of this equipment do not interest us at present¹⁸.

On this machine were tested 24 oils of entirely different viscosities, of different kinds and sources, at several pressures and velocities, and at entirely different temperatures.

Besides the coefficient of friction of the oils, there were also determined on this Marten machine, the viscosities, at the same temperatures which occur in bearings during friction tests. This is necessary, since the viscosity of oils is very markedly affected by the temperature. All the viscosity results are expressed as specific viscosities, not in Engler numbers, for as mentioned above on page 968 the Engler numbers are not proportional to the viscosities, and hence could not be used for our purposes.

The values are given in Table III, which will now be explained.

Columns 4 to 12 contain the coefficients of friction determined at various rotating velocities and bearing pressures on the Marten machine. All the tests from No. 1 to No. 15

¹⁷ Sommerfeld l. c. S. 137.

¹⁸ Marten's machine and tests therewith have been described in detail in the *Mitteilungen aus den Technischen Versuchsanstalten* (now the Königl. Material-prüfungsamt) Berlin 1888 and 1889, Ergänzungsheft 3 and 5, also same 1900, p. 1 ff.

(column 1) were carried out at the same temperature, that is, 75 deg C. (see column 3). The viscosity was therefore the same for every oil (column 3) in all the tests in the same horizontal line (that is, at all the different pressures and velocities).

The tests numbered 16 to 23 were made at different temperatures, which are given in the last horizontal line of the table. The viscosity of each oil consequently varies in the test recorded on the same line, and is written in parenthesis each time under the

corresponding coefficient of friction in the columns 4 to 12.

Several of these oils had equal viscosities: oils 3 and 4 at the temperature of 75 deg. for instance. In accordance with our statement the coefficients of friction of these oils, determined on the Marten machine, should be equal. Inspection shows that this is the case to a high degree of accuracy. We find the same for oils 7 and 8. Moreover, those oils whose viscosities are approximately the same also agree very closely in the coefficients of

TABLE III

1	2	3	4	5	6	7						11	12					
						COEFFICIENT OF FRICTION μ ON MARTEN MACHINE												
						Nature of Oil	Specific Viscosity, z , at 75°†	0.6			Initial velocity in m/sec. 1.2			2.3				
								Bearing pressure p in atm.										
7	18	33	7	18	33			7	18	33								
			0.0	0.0	0.0	0.0	0.0	0.0	0.0	0.0	0.0	0.0	0.0	0.0				
1.	Amer. refined.....	17.8	0656	0320	0231	0820	0410	0294	1050	0591	0387							
2.	Amer. unrefined....	19.9	0676	0348	0256	0849	0421	0299	1090	0570	0401							
3.	Gal. refined.....	26.6	079	0396	0276	0980	0510	0382	1440	0761	0526							
4.	Rum. distilled.....	26.6	080	0385	0264	0961	0510	0384	1575	0767	0561							
5.		27.3	0782	0390	0253	0991	0530	0382	1381	0781	0573							
6.		31.1	0798	0399	0271	1179	0560	0373	1451	0773	0526							
7.		32.7	0851	0470	0328	1183	0630	0441	1643	0863	0641							
8.		33.1	0799	042	0290	1137	0551	0440	1581	0840	0611							
9.	Amer. raw oil distilled to 180°.....	34.4	0853	0423	0296	1086	0598	0433	1590	0838	0637							
10.		37.2	0798	0429	0299	1120	0621	0436	1818	0935	0650							
11.	Rum. distilled.....	39.8	0817	0439	0319	1239	0651	0451	1778	0928	0663							
12.	Rum. distilled.....	41.1	0890	0430	0326	1231	0621	0490	1853	0961	0650							
13.	Rum. distilled.....	41.2	0910	0440	0337	1340	0602	0502	2061	1000	0653							
14.	Residue refined.....	49.6	0979	0499	0346	1450	0731	0559	2034	1070	0741							
15.	Residue refined.....	54.4	0890	0550	0387	1448	0790	0531	2151	1100	0823							
16.	Amer. refined.....		μ^*	0.0	0.0	0.0	0.0	0.0	0.0	0.0	0.0	0.0	0.0					
			z^{**}	0641	0331	0221	0760	0350	0240	0841	0410	0275	0275					
				(11.3)	(11.1)	(10.7)	(10.7)	(9.5)	(8.4)	(7.9)	(6.8)	(6.1)	(6.1)					
17.			μ	0699	0351	0245	0880	0426	0273	0956	0460	0313	0313					
			z	(18.5)	(18.0)	(17.3)	(17.3)	(14.9)	(12.9)	(12.4)	(10.5)	(9.3)	(9.3)					
18.			μ	0840	0426	0306	1139	0490	0326	1273	0598	0386	0386					
			z	(33.0)	(31.6)	(30.3)	(30.3)	(26.0)	(22.0)	(20.8)	(17.3)	(14.8)	(14.8)					
19.			μ	0876	0445	0316	1170	0550	0351	1357	0620	0393	0393					
			z	(37.6)	(36.0)	(35.3)	(35.3)	(29.4)	(25.0)	(23.7)	(19.7)	(17.0)	(17.0)					
20.			μ	0980	0483	0333	1191	0571	0371	1390	0710	0467	0467					
			z	(45.4)	(43.0)	(41.4)	(41.4)	(34.0)	(28.5)	(26.8)	(22.1)	(20.0)	(20.0)					
21.			μ	1230	0601	0441	1631	0763	0526	2016	0953	0608	0608					
			z	(91.4)	(86.6)	(82.7)	(82.7)	(66.5)	(54.0)	(51.1)	(40.9)	(33.8)	(33.8)					
22.			μ	1221	0603	0451	1716	0823	0517	1901	0864	0566	0566					
			z	(99.4)	(93.8)	(89.7)	(89.7)	(71.5)	(57.0)	(52.8)	(40.9)	(33.9)	(33.9)					
23.	Wagon oil, refined....		μ	1389	0785	0568	2128	1029	0698	2394	1140	0713	0713					
			z	(150)	(140)	(132)	(132)	(102)	(82.7)	(77.6)	(62.5)	(49.7)	(49.7)					
Temperatures at which tests No. 16-23 were made				22°	23°	24°	24°	27°	30°	31°	35°	38°						

* μ = coefficient of friction on the Marten machine.

** z = specific viscosity.

† Referred to water at 0° = 1.

friction. As a third example may be taken oils 12 and 13; here again the coefficients of friction agree very closely. The above mentioned oils were all tested upon the machine at the same temperature. This concordance of values is not found where oils have equal

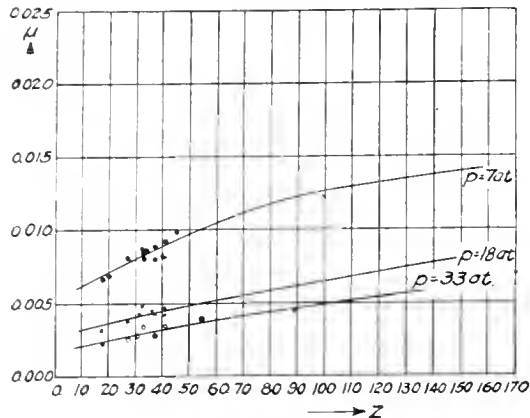


Fig. 8

viscosities at different temperatures. This is noticeable if we compare oil No. 1 with oil No. 17. The former has a viscosity of 17.8 at 75 deg. and a coefficient of friction of 0.00231 at a rotary velocity of 0.6 and a bear-

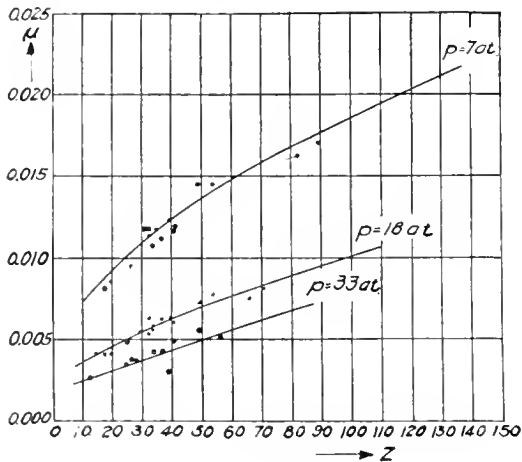


Fig. 9

ing pressure of 33 atmospheres. Oil 17 has at 24 deg. (see last line of table) almost the same viscosity, 17.3, and a coefficient of friction of 0.00245. A whole series of such examples can be taken from the table.

We may note from the table, moreover, that with increasing viscosity the coefficient of friction increases. If these results are plotted in the form of a curve with viscosities as

abscissæ and coefficients of friction as ordinates, the curve will rise continuously with increasing Z . This actually happens, as is shown in Figs. 8 to 10.

In one table are brought together the tests with the same rotary velocities. It is to be noted that the individual tests so group themselves that it is possible to draw connecting curves for all the tests which were made with the same bearing pressure or with the same velocity. The separate values lie very nearly upon this intersecting curve and the small deviations therefrom, generally not more than 5-10 per cent, can be accounted for by the error of the machine, which, however, is superior to most oil testing machines in regard to accuracy. Should any particular oil lubricate better or worse than another of the same viscosity, then the position of its coefficient of friction should fall quite outside the group, and so lie markedly higher or lower than the curve on our table. This, however, does not occur, and consequently the continuity of our curves proves that all oils of the same viscosity have the same coefficient of friction.

DEDUCTIONS CONCERNING THE EVALUATION OF LUBRICATING OILS

From these tests may then be drawn correct conclusions concerning the relative value of oils.

The oils investigated were of very different kinds. Among them were: American, refined and unrefined; Galician, refined and unrefined; Rumanian distillate; American crude oil, which had been distilled up to 180 deg. C. and was therefore a residue; also other residues, refined and unrefined. In other words, very expensive and very cheap oils were tested side by side. Nevertheless, there can be found in the table of curves no particular sort of oil which gave better results as to the coefficient of friction than another.

It is therefore erroneous to assign to an oil from any special region, or prepared or refined in any special manner, very much greater lubricating value than another, for it is only the viscosity of the oil in which one is interested from the purely mechanical point of view.

Of course this statement holds without restriction only for those cases where it is of no importance whether the oil contains asphalt or other material subject to decomposition under hard usage. But the restriction does not apply to by far the greatest

number of uses, where the oil is not raised to a higher temperature. It is quite otherwise for hot cylinder oils, compressors, etc. Then the oil must be as free as possible from decomposable substances and so should be carefully refined, but only because carelessly refined oils are subject to easy decomposition and formation of residues. Hence certain oils are, for secondary reasons, to be preferred.

III. THE FAILURE OF OIL TESTING MACHINES

The tests in Table III have yet another significance which leads us to a consideration of routine lubricant testing on the so-called oil testing machines.

The mechanical testing of lubricants is accomplished at present by determining on such a machine the coefficients of friction for any oil in question under the most diverse conditions of pressure and velocity according to a scheme similar to that indicated by the tests recorded in Table III. Now my investigations have shown that the coefficients of friction are dependent upon the viscosity of the oil alone. If, therefore, a number of oils of different viscosities be systematically tested, as I have done, and the coefficient of friction corresponding to each viscosity be determined once for all, for the particular oil testing machine in use, then these coefficients of friction will apply, without further experimentation, to all oils of the same viscosities. Hence all coefficients of friction on this machine could be predicted, and the continual testing of individual oils, which is nowadays the practice in various testing laboratories, would be unnecessary.

The reason that this relationship has not previously been recognized is to be found in the fact that the viscosity and hence the value upon which everything depends has not been expressed in a system of units that is proportional to the viscosity, i.e., not as specific viscosity, but as technical units which cannot be used in computations as proportional to viscosity (see page 968). Moreover, the relation of the viscosity to the temperature has not been sufficiently well determined.

It is safe to say that this simple relationship has not even yet become recognized, in spite of the thousands of tests of friction which have been made on oil testing machines, and although a few simple experiments would have demonstrated the close and reasonable connection, and in so doing proved the superfluity of the many routine tests.

Another thing should be noted. It can be seen from the explanation of the laws of friction in lubricated machine bearings (formulae 13 to 15) that not only the viscosity of the lubricant, the pressure, and the velocity affect the magnitude of the coefficient of friction, but also the form of the bearing. Especially important is the difference in diameter of bushing and journal. The oil testing machine does not take into considera-

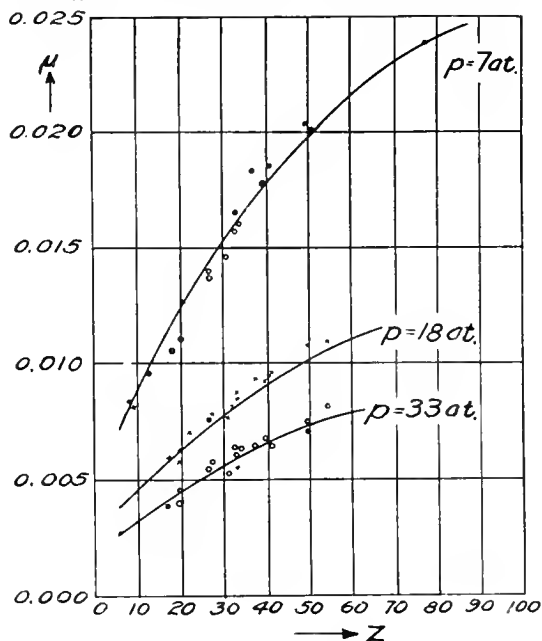


Fig. 10

tion the effect of the form of the bearing at all. The machines which are in most general use differ in the form of the surfaces of friction entirely from the bearings used in practice. Thus the Marten machine uses for ordinary tests only three narrow studs instead of a bushing. The hydrodynamic action in the bearing is very much affected by this, and the value of the coefficient of friction entirely changed. It is therefore quite incorrect to apply the coefficients of friction thus obtained to actual operating conditions. The machine is for this reason quite worthless for routine oil testing.

The usefulness of almost all the other oil testing machines should be regarded from a similar point of view. The machines of Fein-Kapf¹⁹ and of Kirsch have, for instance step bearings. Wilken's²⁰ machine has only a winged wheel which revolves in the oil container, and the resistance of which is measured. Dettmar's machine²¹ does not operate at a constant velocity.

(To be Concluded)

¹⁹ Dinglers Polyt. Journ. 1900, 608 und Ztschr. d. Vereins deutscher Ingenieure 1901, 343.

²⁰ Elektrotechn. Zeitschrift 1904, Heft 7.

²¹ Made by Lahmeyer & Co., Frankfurt a. M., s.a., H. Dettmar, Neue Versuche über Lagerreibung. Dingl. Polyt. Journ. 1900, S. 88.

PRACTICAL EXPERIENCE IN THE OPERATION OF ELECTRICAL MACHINERY

PART XIII (Nos. 60 TO 62 INC.)

By E. C. PARHAM

CONSTRUCTION DEPARTMENT, GENERAL ELECTRIC COMPANY

(60) ARMATURE THREW SOLDER

The most difficult troubles to diagnose are those that are due to two or more causes; especially is this likely to be true where an irregularity, which generally produces two or more symptoms, apparently produces only one of those symptoms. Any condition which will cause a continuous-current motor to spark will cause it also to heat, even if the heating is due directly to the sparking. Any irregularity that will cause a non-commutating pole motor to heat will generally cause it to spark; but that the sparking may be insufficient to suggest the cause of the heating is illustrated by the following instance:

A motor gave evidence of throwing solder; since the brushes sparked and since the armature heated excessively, overload was suspected and the suspicion was confirmed by applying an ammeter. The connected load was decreased; this relieved the heating and reduced the sparking, but the commutator was evidently too rough to permit of sparkless operation. Consequently, the commutator was then turned down and this resulted in sparkless commutation. The motor continued to operate with apparent satisfaction for several months. Then it was noticed that the commutator was gradually roughening and that the bars were becoming pink on those areas that the brushes did not wipe. It was then recalled that the same pinkish tint had characterized the bars before the commutator was turned down. As the motor seemed to be doing its work properly no further attention was paid to it until there was noticed a line of solder on the inner surfaces of the end-shield bracket arms just in line with the armature end connections. An inspection of the connections disclosed that they had been throwing solder. The armature was removed for resoldering. As the throwing of solder on the first occasion had been attributed entirely to overload and as the resoldering then had been done with very soft solder, it was decided to resolder the connections with tin solder for this would not melt at low temperature. The hard

solder idea was not carried out, however, because, when the armature was sent to the lathe to have its commutator turned, it developed that the man who did the turning had had considerable experience in such work and he noted at once that the mica was high. After undercutting the mica no further trouble was experienced.

The unusual part of the experience was that the mica, although raised enough to cause heating which was sufficient to melt the solder from the end connections, failed to produce the sparking that usually characterizes high mica.

(61) LOAD WAS UNBALANCED

One disadvantage of operating a polyphase motor from a service line, the phase voltages of which are unbalanced, is that the full load rating of the motor cannot safely be realized. Unbalanced impressed voltages cause unbalanced currents in the windings of the motor; and a condition can easily be obtained in which one winding of the motor is heavily overloaded while the other windings (or the other winding in the case of a quarter-phase motor) are correspondingly underloaded. This unbalancing effect can be better appreciated in connection with a quarter-phase motor since it has only two windings and those are parts of entirely independent circuits. Another, and perhaps more serious, effect of unbalanced line voltages (hence of unbalanced motor currents) is the liability of the motor to be subjected to single-phase operation as the result of a fuse blowing in the heavier loaded phase.

The operation of a certain quarter-phase motor was so much hampered by frequent blowing of its fuses that the owner reported the trouble and asked that a man be sent to examine it. It was stated that no particular pair of fuses gave all the trouble; sometimes one pair would blow, sometimes the other pair, and sometimes both pairs. When the inspector arrived the motor had been operating continuously for several hours and it seemed in no way distressed. The application

of a voltmeter and an ammeter, however, disclosed that both the voltages and the currents were unbalanced. The interchanging of the supply leads proved that the unbalancing was due to the supply circuit and not to the motor.

The cycle of conditions that was responsible for the fuses blowing apparently without selection was about as follows: With one phase carrying more current than the other, the motor would operate normally as long as the connected load demand did not exceed the capacity of the fuses of the overloaded phase. At times the load demand did exceed this capacity and then the two overloaded fuses would blow. This would throw all of the load onto the remaining phase, the fuses of which would then blow. This sequence is accountable for the apparently non-selective blowing of the fuses. Actually, all the fuses blew at so nearly the same time that no positive difference in sequence could be detected. That the motor occasionally would run continuously for hours without blowing a fuse was due to the fact that during such periods the load demand never became sufficient to heat the fuses to their melting point.

(62) STATOR COIL CONNECTIONS

The free speed of an induction motor depends on the number of poles of the stator and on the frequency of the supply circuit. One familiar with the windings of such motors can usually judge how many poles the stator has by observing the appearance of the end connections. If, however, inspection fails to give this information conclusively, it can be determined indirectly by measuring the free speed of the rotor and calculating the number of poles from this speed and the known frequency of the circuit by means of the formula: *The number of pairs of poles equal the frequency divided by the number of revolutions per second.* For example, if the speed were 1200 revolutions per minute, the revolutions per second would be 20 and, at a frequency of 40 cycles per second, the number of pairs of poles would be $\frac{40}{20}=2$; therefore the number of poles would be $2 \times 2 = 4$.

The number of coils per group, that is, the number of coils per phase per pole, can generally be determined by inspecting the stator winding. The insulation between groups is heavier and, therefore, is more prominent than the insulation between individual coils (as a matter of fact the armor

of the coils themselves is usually sufficient for the individual insulation). On all windings excepting those that have two coils per group, in which case the coils will be adjacent and their windings continuous so that their connecting jumper may be on the under side where it can not be seen, the number of coils per group can be ascertained by counting the number of short jumpers between coils: the number of coils per group will be one greater than the number of connecting jumpers.

If the number of slots in the stator is not exactly divisible by the product of the number of poles and the number of phases and the number of coils per group, it does not necessarily mean that the stator can not be connected both for three-phase or for quarter-phase operation; but if the number of stator slots is divisible by the product of the number of poles and the number of phases and the number of coils per group, it *does* mean that the stator can be connected both for three-phase or for quarter-phase operation.

A quarter-phase motor which had been heavily overloaded for a long time finally broke down and rewinding was necessary. Since the quarter-phase supply was eventually to be converted to three-phase it was decided to rewind the stator for three-phase service (the rotor was adaptable equally well for both services). Examination of the damaged winding showed that there were three coils in series for each group which gave the correct coil spread. The stator had 24 slots, therefore the number of poles was $\frac{24}{2 \times 3} = 4$.

As the speed of the motor was to be kept the same, it was necessary that the number of poles be unchanged. Therefore, for the three-phase winding, the number of coils per group had to be $\frac{24}{3 \times 4} = 2$. This grouping was observed in the rewinding. On the quarter-phase winding the reinforced insulations included three coils and two short jumpers; on the three-phase winding reinforced insulation was placed between alternate coils and included one jumper which could not be seen because it was underneath the coils.

In this particular combination of slots, poles, phases, and coils per group, the number of coils included between insulations might have been misleading to the novice, because the insulations of the three-phase motor included two coils while the insulations of the quarter-phase motor included three coils, such an appearance inviting a hasty conclusion.

FROM THE CONSULTING ENGINEERING DEPARTMENT OF THE
GENERAL ELECTRIC COMPANY

METHODS OF OBTAINING HIGH-POTENTIAL DIRECT CURRENT

Occasions often arise where it is desirable to obtain high-potential direct current, such as the precipitation of smoke, the testing of long high-voltage cables, corona investigations, etc. It is thought that a brief review and discussion of the various methods which are available for obtaining such a current will be of interest.

(1) The Static or Influence Machine

This is one of the oldest electrical devices and makes use of electrification by friction. The voltage which can be obtained is limited only by the insulation of the machine, or the leakage due to corona, and is probably in the neighborhood of 200,000 volts. The effective current is extremely small, not more than 0.005 amperes, even in a large machine. Owing to this limitation the machine is of use in making tests only where the loss is very small. The voltage wave-shape is, of course, perfectly flat.

(2) Storage or Primary Batteries in Series

A direct current of very high voltage can be obtained by connecting a great number of small battery cells in series. Assuming a voltage of 2 per cell, 50,000 cells would be required to give a potential of 100,000 volts. Even with small cells, it would be possible to obtain a current of as much as 5 amperes for a short time. Storage batteries would be connected in parallel groups for charging. The cost of the apparatus, however, is so high as to make it commercially impossible.

(3) Corona Rectifier

In this device a pulsating direct current is obtained by the rectifying effect of a gap, across which an alternating voltage high enough to produce corona, is applied. The voltage available is practically unlimited, but thus far 0.030 amperes is the greatest current which has been obtained. It has been found practically impossible to operate two or more of these gaps in parallel, owing to the difficulty of adjusting them so that the current divides uniformly, except by the use of high series impedance. This apparatus has never been carried further than the experimental stage, and is hardly worth considering for commercial use.

(4) Spark Rectifier

Rectification occurs when sparks are caused to pass across a gap consisting of a point and plane or point and sphere. A device of this kind has been built in France for testing cables with direct current.

(5) The Synchronous Switch or Mechanical Rectifier

In this device the voltage wave from a high-tension transformer is rectified by a mechanical device which makes contact at the maximum points of the positive and negative half cycles. Thus intermittent pulses of direct current are obtained once at every half cycle of the alternating current.

A current of 1 or 2 amperes can be obtained at 200,000 volts. It has been used to some extent in Germany for testing cables (E.T.Z., October 22, 1914). An improved device of this type has been used in which a polyphase current of a large number of phases is rectified by mechanical means. A moderately pulsating voltage wave can be obtained having an average variation of about 20 per cent from the mean.

(6) Dynamo-Static Machine

This device contains, in addition to a mechanical rectifier similar to the one described, a means for charging a number of condensers in parallel and then connecting in series for discharge. This scheme enables a moderate alternating-current voltage to be used on the mechanical rectifier and still offers a very high direct-current voltage. The current capacity of the apparatus depends upon the capacity of the condensers used, but it is necessarily much less than that of the simple mechanical rectifier.

(7) Mercury-Arc Rectifier

This apparatus gives a moderately pulsating voltage wave which can be smoothed out by a series reactance. The approximate limit of a single tube is 10 amperes at 10,000 volts. The operation of a number of tubes in series to give very high voltages has been suggested, but insulation difficulties have prevented the practical carrying out of this idea.

(8) Cathode Rectifier or Kenotron

This apparatus has been developed in the Research Laboratory of the General Electric Company, and is described in the GENERAL ELECTRIC REVIEW, March, 1915. It gives a pulsating direct-current wave which can be made practically smooth by the use of a series reactance and shunted capacity. Thus far the maximum output for a single tube is about 0.25 amperes at 100,000 volts. Any number of tubes can, however, be operated in parallel.

(9) Direct-Current Generator

A moderately high-voltage direct current can be obtained by connecting a large number of machines in series; but not more than 5000 volts can be obtained from a single commutator, and this only on machines of large kilowatt capacity. The insulation problems are difficult and the cost high when the total voltage is greater than 15,000 or 20,000. More than 100 amperes of current can be obtained with a wave-shape as flat as desired.

Summary

For direct-current voltages, not greater than 10,000, the mercury-arc rectifier, or the series connection of direct-current generators, is probably the most practical. For higher voltages the choice would be between the mechanical rectifier and the hot cathode rectifier.

STUART THOMSON

QUESTION AND ANSWER SECTION

The purpose of this department of the REVIEW is two-fold.

First, it enables all subscribers to avail themselves of the consulting service of a highly specialized corps of engineering experts, or of such other authority as the problem may require. This service provides for answers by mail with as little delay as possible of such questions as come within the scope of the REVIEW.

Second, it publishes for the benefit of all REVIEW readers questions and answers of general interest and of educational value. When the original question deals with only one phase of an interesting subject, the editor may feel warranted in discussing allied questions so as to provide a more complete treatment of the whole subject.

To avoid the possibility of an incorrect or incomplete answer, the querist should be particularly careful to include sufficient data to permit of an intelligent understanding of the situation. Address letters of inquiry to the Editor, Question and Answer Section, General Electric Review, Schenectady, N. Y.

TRANSFORMERS: NEUTRAL FROM DELTA CONNECTED SECONDARIES

(149) Is it possible to operate transformers in delta if they have center secondary taps connected to a common neutral? The object in making this connection is to obtain two voltages from the secondaries, i.e., 220 volts between secondary phase wires, and 110 volts between any secondary phase wire and the neutral.

Fig. 1 illustrates diagrammatically the scheme of transformer connections proposed in the question. Such a plan of connecting a neutral is impossible, for short-circuits in the windings would result when the middle points of the secondaries were tied together.

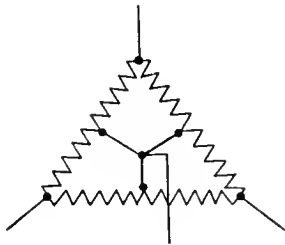


Fig. 1

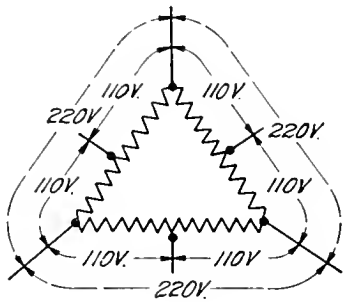


Fig. 2

There are, however, two other schemes which could be satisfactorily employed to obtain both normal voltage and half voltage from the secondaries of transformers connected in delta relationship.

The first is shown in Fig. 2, wherein three separate neutrals are used, one from the center of each secondary. This using of three separate neutrals will not cause short-circuits in the windings. It would not be possible to ground these neutrals, however,

for doing this would tie together the tap points of the secondary windings as effectively as in Fig. 1, and consequently the same short-circuits as described would take place in the windings.

The second feasible scheme for obtaining two voltages from delta-connected transformers is shown in Fig. 3; in this case the primaries must be delta connected. This method possesses an advantage over the one shown in Fig. 2 in that the neutrals may either be ungrounded, Fig. 3 (a), or grounded,

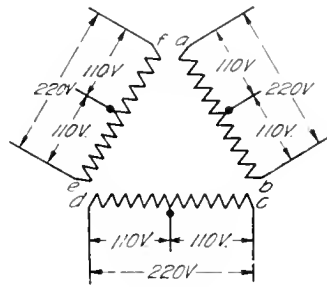


Fig. 3 (a)

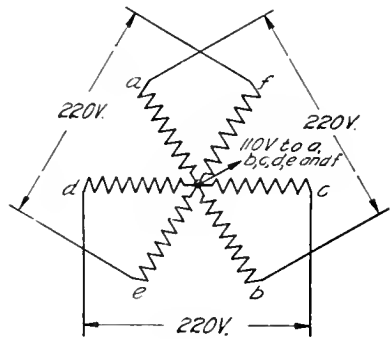


Fig. 3 (b)

Fig. 3 (b). In either the ungrounded or grounded scheme of connections, however, six phase wires are necessary while only three are required for the method shown in Fig. 2. Furthermore, the full secondary winding voltage cannot be obtained between all pairs of phase wires in the methods shown in Figs. 3 (a) and 3 (b); it can only be secured between those wires constituting three particular pairs, viz., a-b; c-d; and e-f. E.S.

RAILWAY MOTOR: SHORT-CIRCUITED FIELD COILS

(150) Can supposedly defective railway motor field coils be tested for short circuits without removing them from the pole pieces?

We know of no method which can be applied by a factory or repair shop to reliably determine whether a short circuit exists in a railway motor field coil while the coil is mounted on its pole core. Many schemes toward this end have been tried but they have afforded uncertain results. The principle employed in most of these trials has been that of measuring the resistance of the suspected coil and comparing this value with that of a normal coil. The information in regard to possible short circuits as gathered from the results of such tests can by no means be regarded as reliable, because greater differences in resistance than would be produced by a short-circuited turn, or few turns, can easily arise from other causes in perfectly good coils.

So far as we know the only commercially successful method of detecting short circuits in those field coils is one in which the coil is first removed from the motor and then placed around the core of a special transformer which passes such a heavy alternating flux through the coil that the heavy current generated in a short-circuited turn, if there is one, will cause the insulation to smoke.

The alternating current supplied to this testing transformer can be purchased at a suitable voltage from a lighting or power company (ordinarily railway companies have no alternating-current generating apparatus) or it can easily be secured by means of a home-made inverted rotary converter. For constructing such a converter an old railway motor is very adaptable. Two of the diametrically opposite field coils (series) should be removed and replaced with shunt coils; and two slip rings should be mounted on the end of the armature that is far from the commutator. These slip rings are to be connected to two diametrically opposite taps made to the end connections of the armature (similar to the connections employed in a single-phase rotary converter). Power for the converter can then be supplied from a trolley circuit, and the machine will be enabled to furnish alternating current to the transformer from the slip rings.

The transformer, though necessarily of special design, can easily be constructed in a repair shop. It merely consists of a primary exciting coil and a split core which can be opened up to pass through the railway motor field coil that is to be tested and then closed upon it. While the coil is being tested it should be under mechanical pressure, the same as when clamped in the motor.

The field coil will then act as the secondary of the transformer (the induced alternating voltage in the coil need not exceed three or four volts per turn); and if the insulation on the coil is in good condition no visual evidence of action within the coil will be observable, but if any turns are short-circuited the insulation will soon begin to smoke.

H.L.A.

KW., APPARENT KV-A., WATTLSS KV-A.,
P-F.: RELATIONSHIP

(151) It possible please show by a curve the relations between the equivalent values of apparent power, actual power, and wattless power at various power-factors.

It would be impractical, perhaps impossible, to represent the desired relationships by a single curve. However, by using one curve for each power-factor the very clear and useful curve sheet shown on page 1087 can be constructed.

The theoretical construction of the chart is based upon the fundamental and familiar vector right-triangle of which the hypotenuse represents the apparent power (apparent kv-a.), one leg the true power (kw.), the other leg the wattless "power" (wattless kv-a.), and the cosine of the angle between the true power leg and the apparent power hypotenuse the power-factor.

The reproduction of the chart on page 1087 is of a size that will prove to be directly useful. If it is desired, however, to construct the chart in a different size, the following geometric directions will be found to be simple and absolutely accurate.

(1) Lay off 10 equal divisions on the horizontal axis.

(2) Lay off 16 divisions on the vertical axis of the same length as those on the horizontal axis.

(3) With the origin as center describe an arc which will cut the horizontal and vertical axes at the tenth division.

(4) At the 9.5, 9, 8.5, and 5-point divisions on the horizontal axis erect perpendiculars to intercept the 10-unit radius arc named in (3).

(5) From the intersections of these perpendiculars with the arc draw straight lines to the origin and label these, which are per cent power-factor, 95, 90, 85, and 50.

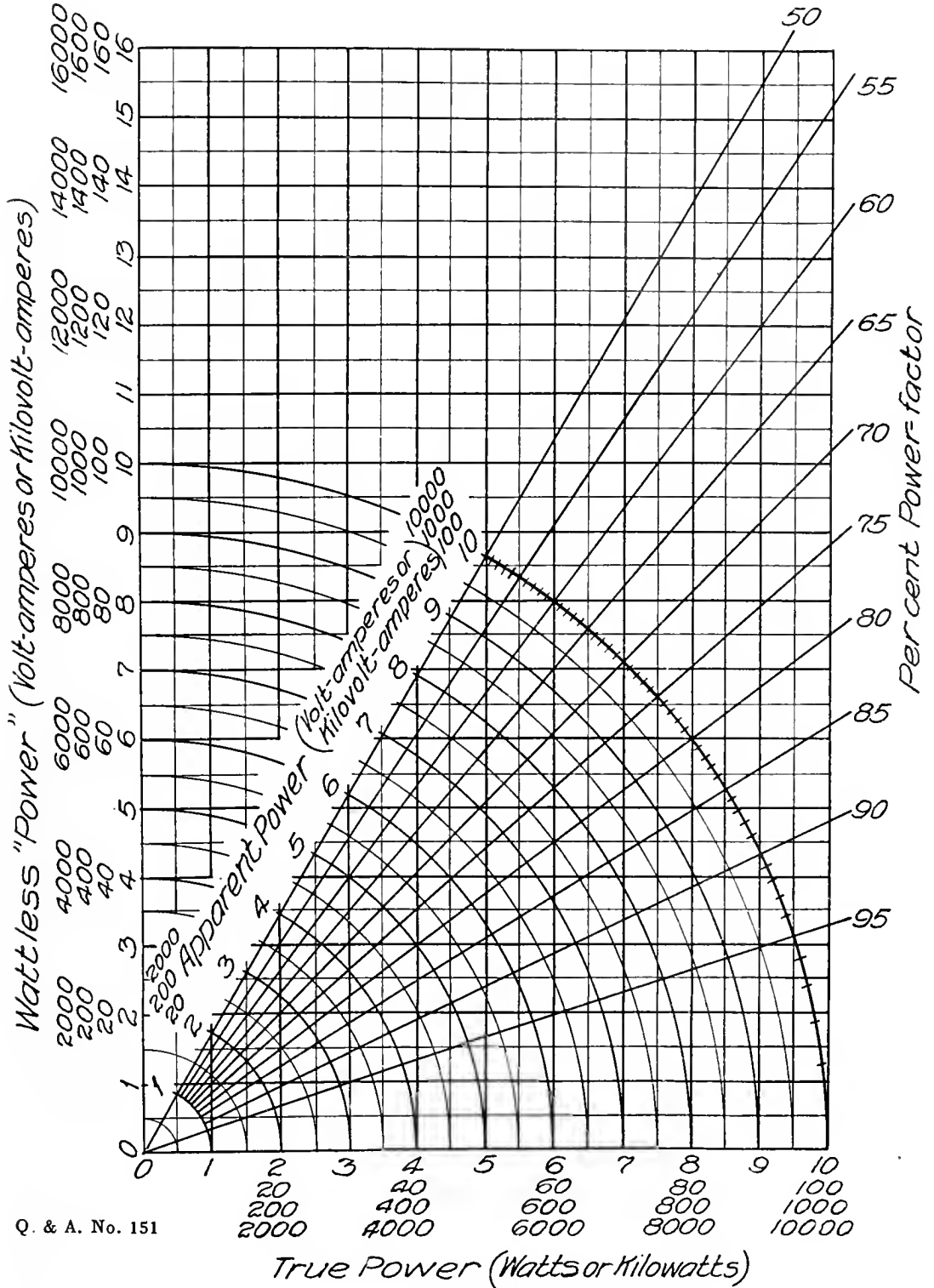
(6) Divide the distances 5 to 6, 6 to 7, and 9 to 10 on the horizontal axis into 10 equal divisions each. Without actually drawing in the perpendiculars erected on the horizontal axis at these points, mark the points on the 10-unit radius arc which would be the intersections of that circle and these perpendiculars if they were drawn.

(7) Describe the remaining arcs for apparent power using the distances from the origin to the divisions on the horizontal axis as radii.

It is particularly worthy of note that the chart when constructed as described is applicable over a limitless range of true power, apparent power, and wattless "power." This feature is secured by laying out all the scales (except that for power-factor which is a ratio) as multiples of 10. The scales that are given enable accurate readings to be taken from half a watt to 10,000 kilowatts. By shifting the decimal point uniformly on all the scales (except that for the power-factor which is to be held unchanged) readings may be taken on either side of the range just quoted if the necessity should arise.

The chart is so simple that a description of the method of applying it will be unnecessary.

E.C.S.



Q. & A. No. 151



The Trade Mark of the Largest Electrical Manufacturer in The World.

Sales Offices of the General Electric Company

This page is prepared for the ready reference of the readers of the General Electric Review. To insure correspondence against avoidable delay, all communications to the Company should be addressed to the sales office nearest the writer.

ATLANTA, GA., Third National Bank Building
BALTIMORE, Md., Munsey Building
BIRMINGHAM, ALA., Brown-Marx Building
BOSTON, MASS., 84 State Street
BUFFALO, N. Y., Electric Building
BUTTE, MONTANA, Electric Building
CHARLESTON, W. VA., Charleston National Bank Building
CHARLOTTE, N. C., Commercial National Bank Building
CHATTANOOGA, TENN., James Building
CHICAGO, ILL., Monadnock Building
CINCINNATI, OHIO, Provident Bank Building
CLEVELAND, OHIO, Illuminating Building
COLUMBUS, OHIO, Columbus Savings & Trust Building
DAYTON, Ohio, Schwind Building
DENVER, COLO., First National Bank Building
DES MOINES, Iowa, Hippey Building
DULUTH, MINN., Fidelity Building
ELMIRA, N. Y., Hulet Building
ERIE, PA., Marine National Bank Building
FORT WAYNE, IND., Fort Wayne Electric Works
HARTFORD, CONN., Hartford National Bank Building
INDIANAPOLIS, IND., Traction Terminal Building
JACKSONVILLE, FLA., Heard National Bank Building
JOPLIN, Mo., Miners' Bank Building
KANSAS CITY, Mo., Dwight Building
KNOXVILLE, TENN., Bank & Trust Building
LOS ANGELES, CAL., 124 West Fourth Street
LOUISVILLE, KY., Starks Building
MEMPHIS, TENN., Randolph Building
MILWAUKEE, WIS., Public Service Building
MINNEAPOLIS, MINN., 410 Third Ave., North
NASHVILLE, TENN., Stahlman Building
NEW HAVEN, CONN., Second National Bank Building
NEW ORLEANS, LA., Maison-Blanche Building
NEW YORK, N. Y., Hudson Terminal Building
NIAGARA FALLS, N. Y., Gluck Building

OMAHA, NEB., Union Pacific Building
PHILADELPHIA, PA., Witherspoon Building
PITTSBURG, PA., Oliver Building
PORTLAND, ORE., Electric Building
PROVIDENCE, R. I., 1012 Turks Head Building
RICHMOND, VA., Virginia Railway and Power Building
ROCHESTER, N. Y., Granite Building
SALT LAKE CITY, UTAH, Newhouse Building
SAN FRANCISCO, CAL., Rialto Building
SCHENECTADY, N. Y., G-E Works
SEATTLE, WASH., Colman Building
SPOKANE, WASH., Paulsen Building
SPRINGFIELD, MASS., Massachusetts Mutual Building
ST. LOUIS, Mo., Pierce Building
SYRACUSE, N. Y., Onondaga County Savings Bank Bldg.
TOLEDO, OHIO, Spitzer Building
WASHINGTON, D. C., Evans Building
YOUNGSTOWN, OHIO, Wick Building

For MICHIGAN business refer to General Electric Company of Michigan
DETROIT, MICH., Dime Savings Bank Bldg.
For TEXAS, OKLOHAMA and ARIZONA business refer to South-west General Electric Company (formerly Hohson Electric Co.)
DALLAS, TEXAS, 1701 No. Market Street
HOUSTON, TEXAS, Third and Washington Streets
EL PASO, TEXAS, 500 San Francisco Street
OKLAHOMA CITY, OKLA., Insurance Building
For HAWAIIAN business address
CATTON NEILL & COMPANY, LTD., Honolulu
For all CANADIAN business refer to
CANADIAN GENERAL ELECTRIC COMPANY, LTD., Toronto, Ont.
For business in GREAT BRITAIN refer to
BRITISH THOMSON-HOUSTON COMPANY, LTD., Rugby, Eng.

FOREIGN OFFICES OR REPRESENTATIVES:

Argentina: Cia. General Electric Sudamericana, Inc., Buenos Aires; Australia: Australian General Electric Co., Sydney and Melbourne; Brazil: Companhia General Electric do Brazil, Rio de Janeiro; Central America: G. Amsinck & Co., New York, U. S. A.; Chile: International Machinery Co., Santiago, and Nitrate Agencies, Ltd., Iquique; China: Andersen, Meyer & Co., Shanghai; Colombia: Wesselhoeft & Wisner, Barranquilla; Cuba: Zaldo & Martinez, Havana; England: General Electric Co. (of New York), London; India: General Electric Co. (of New York), Calcutta; Japan and Korea: General Electric Co., and Bagnall & Hilles, Yokohama; Mitsui Bussan Kaisha, Ltd., Tokyo and Seoul; Mexico: Mexican General Electric Co., Mexico City; New Zealand: The National Electrical & Engineering Co., Ltd., Wellington, Christchurch, Dunedin and Auckland; Peru: W. R. Grace & Co., Lima; Philippine Islands: Frank L. Strong Machinery Co., Manila; South Africa: South African General Electric Co., Johannesburg, Capetown and Durban.

General Electric Company

General Office: Schenectady, N. Y.

Member of the Society for Electrical Development, Inc.

"DO IT ELECTRICALLY"



The Trade Mark of the Largest Electrical Manufacturer in The World.

GENERAL ELECTRIC REVIEW

A MONTHLY MAGAZINE FOR ENGINEERS

Manager, M. P. RICE

Editor, JOHN R. HEWETT

Associate Editor, B. M. EOFF
Assistant Editor, E. C. SANDERS

Subscription Rates: United States and Mexico, \$2.00 per year; Canada, \$2.25 per year; Foreign, \$2.50 per year; payable in advance. Remit by post-office or express money orders, bank checks or drafts, made payable to the *General Electric Review*, Schenectady, N. Y.

Entered as second-class matter, March 26, 1912, at the post-office at Schenectady, N. Y., under the Act of March, 1879.

VOL. XVIII., No. 12

Copyright, 1915
by General Electric Company

DECEMBER, 1915

CONTENTS

	PAGE
Frontispiece, W. L. R. Emmet	1090
Editorial: The Paths of Progress	1091
Welfare Work	1092
BY JESSE W. LILIENTHAL	
Engineering in the Navy	1097
BY W. L. R. EMMET	
Depreciation of Property	1099
BY W. B. CURTISS	
A Model X-Ray Dark Room	1107
BY WHEELER P. DAVEY	
The Production of Damped Oscillations	1110
BY LESLIE O. HEATH	
The Theory of Lubrication, Part III	1118
BY L. UBBELOHDE	
Translated from <i>Petroleum</i> by HELEN R. HOSMER	
A Modern Acid-Dipping, Electroplating and Japanning Plant	1121
BY HORACE NILES TRUMBULL	
Protection of Railway Signal Circuits Against Lightning Disturbances	1127
BY E. K. SHELTON	
Growth of Current in Circuits of Negative Temperature Coefficient of Resistance	1129
BY F. W. LYLE	
Electrically Heated Enameling Ovens	1130
BY C. W. BARTLETT	
The Electric Motor in the Printing Industry	1136
BY W. C. YATES	
The Possibilities Open to the Central Station in Solving the Freight Terminal Problem	1142
BY JAS. A. JACKSON	
Portable Searchlights for Fire Departments	1144
BY L. C. PORTER AND P. S. BAILEY	
Practical Experience in the Operation of Electrical Machinery, Part XIV	1146
Crossed Resistance Wires; Motor Reversed; Elevator Trouble.	
BY E. C. PARHAM	
Theory of Electric Waves in Transmission Lines	1148
BY J. M. WEED	
The First 3000-Volt Locomotive for the Chicago, Milwaukee & St. Paul Railway Company	1154
BY E. S. JOHNSON	
The Kinetic Theory of Gases, Part III	1159
BY DR. SAUL DUSHMAN	
Question and Answer Section	1168
In Memoriam: George Crellin Cartwright	1170
From the Consulting Engineering Department of the General Electric Company	1171



W. L. R. EMMET

Recently Appointed a Member of the U. S. Naval Consulting Board
A short article by Mr. Emmet on Engineering in the Navy is published in this issue

GENERAL ELECTRIC REVIEW

THE PATHS OF PROGRESS

We publish in this issue a short article by Mr. W. L. R. Emmet, who has recently been appointed to serve on the U. S. Naval Consulting Board; in our last issue we published an article by Dr. W. R. Whitney, who has had the same honor conferred upon him.

The appointment of these and many other prominent men to a Board where their services and experiences will always be at the command of the government will, we hope, only be a first step in organizing the technical and scientific knowledge of the country for its permanent good. The method adopted for selecting the most suitable men to be the recipients of this signal honor is to be highly commended, as leaving their selection in the hands of the various responsible and representative scientific and technical bodies avoids the possibilities of political influences, which, if they entered into such selections, would defeat the object sought.

The existence of such a board will supply an imperative need if government work is at all times to be kept up to the usually high standard of commercial work, as by the very nature of things government employees cannot keep constantly informed on all phases of commercial developments and commercial developments are likely to always lead every other field of activities.

Any department of the government that can secure the best talent available in every branch of its work will be immeasurably stronger than when entirely dependent on its own resources.

With this good beginning in one department is it too much to hope that this same general idea will expand till the scientific and engineering talent of the whole country will be organized in such a manner that it will be available to every department of the Federal Government, and perhaps, in part, to the several State governments? Such a development might lead to the establishment of what would, in effect, become a National Privy Council of Scientists and Engineers.

The advice and experience of such a council would always be available to help in the framing of technical laws and regulations and would, we believe, largely reduce opposition, and, indeed, the cause of much opposition, to many phases of the government regulation of industries

It would surely have been of great service if some such properly constituted body of technically trained men had been available to co-operate in the preparation of the proposed Code of Safety Rules for Electrical Practice as is being prepared by the National Bureau of Standards.

We believe that if such a Council were established it would be a potent factor in raising the engineering profession to the plane where it properly belongs and in putting the status of the Engineer on an entirely different basis. In addition to other advantages it might well lead to establishing more harmonious relationships between industrial and commercial concerns and the governmental departments that are responsible for their regulation.

WELFARE WORK

BY JESSE W. LILIENTHAL

PRESIDENT OF THE UNITED RAILROADS, SAN FRANCISCO, CAL.

This quite remarkable address was read before the thirty-fourth annual convention of the American Electric Railway Association. It is based on actual experience and deals with "Welfare Work" in its very broadest phases; we feel that it will be read not only with interest, but with much profit by a large number of our readers. The author's "code of commandments" to govern the public utilities of which he is president is well worthy of a close study.—EDITOR.

The subject of this paper was not of my own selection, so that I am not certain to have understood it in the sense in which it was intended. It may have been meant to have reference to what an employer does for his employees or to what the utility does for the public at large, or both. I shall assume in its treatment that welfare work for any is for the welfare for all. I am not sure that you will all concede the point, but it represents my own profound conviction, not shaken by some conflicting experiences, that it will be the purpose of this address to narrate.

When at college I submitted to my professors for their approval as the title for a proposed Commencement Day oration the subject "Revealed, Abstract and Legislative Morality." I was assured that if I could do justice to the theme the oration would be a notable one. If I ever had any doubt as to the soundness of their comment, that doubt has been removed since I have assumed the presidency of a public utility. In other words, we have three possible standards of morality, namely, the one that is supposed to have been announced to us by an all-wise and all-knowing Supreme Being, the very conception of whom implies infallibility and beneficence. Then we have an abstract morality, that is to say, the one that, irrespective of any dictates on high, is prescribed to us by our own individual inner consciousness and by the stress of actual personal experience. And finally we have a legislative morality, that is to say, the one that our law-givers prescribe from year to year, with appropriate sanctions, in congress, state legislatures and city councils. That certainly makes morality an uncertain entity. The right and wrong of things, therefore, must as a practical question be a fluctuating quantity, depending upon the particular faith or standard of the one assuming to judge or the law which he deems controlling.

I have learned that in a similar way and very generally for similar reasons public welfare is a varying quantity and very often a elusive quantity. For one thing, public

welfare may mean what is actually for the public weal or it may mean what the public believes to be for its own welfare. And it may mean one thing at one time and another thing at another time, or one thing in one place and another thing at a different place. So it may be, as it has now become the fashion to proclaim, that what is best for the public is best for the utility. But even with this conceded, we shall still find ourselves always brought back to the question of what is really best for the public. It sounds Machiavellian to declare that for all practical purposes that should be assumed to be for the public's greatest good which for the moment it deems to be for its greatest good. It may be that something of this sort was in the mind of President Wilson when, during his campaign for the presidency, having been charged with inconsistency on the subject of the initiative and referendum, he is reported to have justified himself by saying, in substance: "I was able to demonstrate to my pupils at Princeton that the initiative and referendum would not work, and I can demonstrate to you now that the initiative and referendum will not work; but they do work." That is to say, it may be that there was nothing more in his mind in making that statement than that there was growing such an insistent demand on the part of the people for the right, without the interposition of any representative body, to themselves make and repeal laws that we should give them the chance to learn from actual experience that the thing would not work.

However, I do not wish to leave this incident without conceding that, our president being a man of conscience, it may very well be that he was finally persuaded that representative government has proven a failure.

At all events, to the man of conscience, with no ambition other than to do the best by his fellow men of which he is capable, there is something repugnant about a doctrine that requires the people to feel the rough places before they are permitted to reach the

stars; that the child must be allowed to burn its fingers so that it may understand the importance of shunning fire.

In this man of conscience the feeling is strong that he wishes to guide the people into the right path; that it is not necessary that they must first stumble and fall and bruise themselves before they can find the right path. I know from my own experience that we are not all agreed as to this and that in truth this is a very practical question that those of us charged with the duty of managing public utilities ought to endeavor to solve correctly, because I believe that on its correct solution depends the success of our management—depends the right standing before the bar of public opinion. We certainly cannot succeed with the public if there be any question in its mind of our absolute good faith, whatever the merit or lack of it, in the things that we offer to it.

One of the things making up the so-called public welfare program of the United Railroads was the establishment of a monthly magazine, distributed to each of its 3500 employees, as a means of communication between the men and the company. I contribute in each number a short talk to the men over my signature as president. A little while ago I received a very bright, well written letter from the wife of a motorman, in which, among other things, she said that she judged from my articles that I often felt "lonesome." I have been taking a long time to weigh that statement. I may not yet have caught her meaning. Was it that, notwithstanding the earnest effort made to propitiate the public, it had turned the cold shoulder? And yet we have been doing those things that were intrinsically right under every code of morals and that also appeared to be the things demanded by the existing state of public sentiment. It also happened that a very brilliant journalist, who had read one or more of these messages to the men which were intended to remind them of our duty to the public and of what we were doing in the performance of that duty, in one of which I asked why we had apparently not overcome the popular ill will towards us, said that I was striking a false note. I was told that I was furnishing excellent gun wadding for the fertile agitator; that I should not lose sight of the fact that the company, whether willingly or unwillingly, was a prize participant in a rising economic battle; that armed peace was the best we could hope for; that the only way to make popular what was

undoubtedly an unpopular corporation was to grant to employees all that they wanted and whenever they wanted it; to do the same thing for the city for the benefit of its competing municipal lines; to surrender to the jitney for love of the little fellow; to extend service whenever asked for; to equip and operate regardless of expense and to reduce fares to the Cleveland basis.

I am still smarting under that criticism. This doing your duty by the public costs money, and if it breed resentment rather than good will, or even if it only fail to eliminate existing ill will, had not the expense better be withheld? I am speaking from actual experience, and you are entitled to the benefit of whatever lesson it inculcates. I do not forget the exceptional circumstances under which our particular utility is operating. We have a successful and growing municipally owned and operated system, all of it competitive to our own, and consequently our company is constantly a thorn in the city's side. They pay wages and provide conditions that we cannot afford, and this makes it necessary for us to take the ordinarily indefensible position of preventing, while we can, the organization of our men. This in turn makes us anathema with organized labor and its sympathizers. Then the public accepts it as an undoubted fact that we have secured valuable franchises through the bribery of public officials, and the press does not allow it to forget that the so-called graft prosecution failed to secure more than one conviction. It is with this state of the public mind that our company has had to deal.

I accepted the presidency of the United Railroads only because I thought that I saw an opportunity to render public service. The years were advancing, so that it seemed my last opportunity, if any, to do so. I meant to start right with the public, and to that end began my administration with a formal statement—a sort of confession of faith—in which I made the acknowledgment that I conceived it to be the primary duty of a public utility to serve the public adequately and considerately. I pledged the company to scrupulously keep out of politics and promised that, if an attempt were ever made to influence public opinion, it would be done openly and in the name of the company. I declared it as my only motive for taking office that I was ambitious to improve the relations between the people and the company and invited the frankest criticism and the most cordial cooperation on the part of the public to that

end. Finally, in recognition of the strong sentiment in favor of municipal ownership that had been very markedly manifested in a recent election held to provide money for the extension of the city lines, I declared that I had no fault to find with the advocates of municipal ownership even of street car lines, but believed that if such ownership should obtain the properties themselves could be operated with the greatest good and with the largest profit to the public if entrusted to private management under public regulation.

Then, with the desire to treat the employees as generously as the revenues of the company would permit and at least as well as they would be treated by impartial arbitrators in case of an organization, demands made and refused and a strike threatened, we voluntarily granted a substantial increase of wages. Let it be remembered that the men were not organized and the increase was granted without any compulsion whatsoever. We devised a plan for insuring the lives of all employees in our service for a period of three years and upwards, without any physical examination on behalf of the insurance company and without any cost to the men for premium or otherwise; the families of the three-year men getting \$250 in case of death in the service, of the four-year men \$500, and of those having served five years or upwards \$1000. Each employee was allowed to select his own beneficiary arbitrarily. This insurance was giving to the men something that many of them, quite apart from the expense of insurance, could not give themselves. The men with tuberculosis, with cancer, with Bright's disease or with a weak heart was insured along with those who were organically sound. And this was better than an increase of wages, as to which there is no assurance that any of it would be husbanded.

Then, realizing as a paramount duty that as far as possible we must stop killing and maiming people and that to accomplish this we must depend on the vigilance, the loyalty and intelligence of the platform men, we said that, taking the sum paid in the previous year by way of damages for injury to persons or property as a basis, we proposed to give the entire amount that might be saved over this sum in succeeding years to these platform men in the exact proportion represented by the time contributed by them respectively to the service.

Finally it appeared upon investigation that many of our employees had gotten into the

hands of loan sharks and were paying as high as ten per cent a month for the loans which they had obtained. Many of these were men with the best of records, with excellent characters, but who through stress of circumstances, sickness in the family, financial distress of those having claims upon them, or otherwise, had found their wages inadequate for this abnormal condition and had nothing to take to the pawnbroker or remedial loan association as collateral. We say to these: "We will lend you the money that you need, without any security, taking from you simply your own promissory notes, payable in such installments as you may yourself determine to be practicable, considering other demands upon you, and bearing interest at the rate of five per cent per annum." Our files are full of grateful acknowledgment for what we have done in this direction, testifying eloquently to the good that has been accomplished.

When this program was announced we felt that the new management was keeping faith and looked for grateful response on the part of the public. There was a good deal of commendation, to be sure, but I am not certain that the true sentiment of the people at large was not voiced by a prominent and influential local newspaper, which said editorially in double-leaded type: "The Street Car Workers are Men; They are Not Children to be Coddled. President Lilienthal and his directorate should have heard what Lincoln Steffens and Austin Lewis told the New Era Club about welfare work the other day. Welfare work: The United Railroads might as well save its time and money. 'The only way to help labor,' said Lincoln Steffens, 'is to help labor to help itself.'" In other words, employees want nothing from employers that they do not demand and demand in a position where they can enforce their demands.

I have always believed in labor unions. Perhaps I do not believe in them as much as I used to. It is of course an indefensible position to maintain that employees shall not be permitted to organize. Even advocates of the open shop stop short of that. But sometimes, and, as already said, such is the situation in San Francisco, it is a condition and not a theory that confronts you. Organization of the men of the United Railroads would mean inevitably and logically a demand for the same wages, hours and other conditions that are conceded by the municipal lines, under the terms of the city charter, to men working on a track literally alongside

of our own. A demand would mean a refusal, because the company cannot concede the demand, and a refusal would mean a strike, which would be a calamity for the company, the public and the men. We have therefore been placed in the incongruous position of having to discharge men whose only fault may have consisted in joining the union, because the alternative was inevitable disaster.

I have of course had the experience that all of you have had and that may have hardened some of you—that it is not enough to be good 364 days in the year; you must be good the whole 365 and you must be good in the sense that the public chooses to use the term; that is to say, you must do the things that the public wants you to do and refrain from doing those things to which it objects. We have tried, in the interest of peace and good feeling, to meet that view too. I said at the outset of my administration that I would always grant to the city anything that it wished, but that I had no right to forget that, just as officials of the city were trustees of the people, I was a trustee for the creditors and stockholders of the company and therefore must exact a reasonable equivalent for any property rights surrendered. We discovered in a recent experience that we had been sowing the wind. Such an equivalent for a right proposed to be surrendered was recently asked by the company and promptly conceded by the Board of Supervisors. Their ordinance, however, carrying out the terms of the agreement was vetoed by the Mayor, a majority but not a sufficient number of the supervisors voting to override the veto, and the right in question was exercised without giving the equivalent. Upon an appeal to the courts the company's motion for an injunction to restrain the exercise of the right was granted. Unfortunately, however, this has proven to be a case of being good only 364 days in the year, and apparently in consequence of our legal victory the company is once more under the ban of excommunication, and the injunction, at this time of writing, is being violated, and boastfully violated, forcing the company to contempt proceedings.

What moral shall we deduce from all this? What is the public welfare? And what should be the course of conduct of a public utility? It is of course axiomatic that in things done or omitted the presumption is in favor of a popular public utility, assuming that any such exists, and against the unpopular public

utility. When the latter takes a step forward in a matter that should win popular approval it is apt to be charged with moving from fear and not from public spirit or the desire for public welfare. And the usual result or absence of result follows where an act, even though undoubtedly praiseworthy on its face and in itself and done from a proper motive, is said to have been done under compulsion, that is to say, from fear. Is that a reason for not making the effort to propitiate the public? Shall you refrain from taking this step forward because your motive in so doing may be impugned?

I realize that this paper is taking on a very personal aspect, but I apprehend that these conventions derive at least some of their value from the exchange of personal experiences. Nothing seems to drive home like actual occurrences. Should we not look upon these gatherings somewhat like revival meetings, where in response to the exhortations of the Billy Sundays we are impelled to take the platform and speak of the things of which we know, because they have happened to us? That, at all events, must be my excuse. And this is my story. When I was offered the presidency of the United Railroads, I had come to a time and condition of life where I had no financial, political or social ambitions. In dealing with the public, therefore, I at least as an individual have been in an exceptionally favorable position, because there have been no conflicting motives—none at least except possibly in having the one ambition to deserve and obtain the esteem of my fellow-men. And with this purpose and no other I have laid down for myself the following code of commandments to govern in the conduct of the public utility that has been entrusted to my management:

1. Accept loyally and without reservation the now universally proclaimed doctrine that a public utility is the servant of the people. Our courts of last resort have so declared, and the public utilities have bowed their heads in meek submission. Whatever the resources or lack of resources of the utility, we acknowledge that we must render adequate service. The requisite capital must somehow be provided, the matter of adequate return being irrelevant, except in the sense that the right exists to appeal to the rate-making bodies to provide for reasonable compensation for the service rendered. This requirement of adequate service existing, let us not wait until pressure is brought to compel this service. Anticipate the public demand.

Keep your door wide open to every complaint, so that you may not overlook the existence of such a demand. Forestall criticism by inviting recommendations, and in all close cases give the public the benefit of the doubt.

2. Give the affairs of the utility the widest publicity. The public is entitled to know what you are doing and how you are getting on. Conditions may be unfavorable, and you may fear that publicity might affect your credit, but you should not ask for credit that you do not deserve, and perhaps your misfortunes, when frankly told, may beget the public sympathy and good will which you so sorely need. I never knew anything so engaging as complete candor, and I shall not quarrel with the saying of the late Mr. Hawley that honesty is the best policy, even though he bade us accent on the word "policy." When I have been interviewed by the reporter of a newspaper however unfriendly I have answered every question directly and fully, and it has happened to me at least once that when such candor has not changed the tone of the unfriendly newspaper the reporter has insisted that this attitude be changed or that someone else be assigned to his task. I have gone to men who have assailed me and sought to explain to them my reasons for doing the things that they have criticized, and this has sometimes led to a change of front or, as in the case of at least one newspaper editor, to a statement that my position was justified, but that in order that his newspaper should hold its circulation it must continue to print the news in the form which his patrons expected. The abuse of the power of the press, however, involves a discussion that is foreign to my subject, and I shall keep away from it.

3. Treat your employees fairly and, as far as your resources will permit, generously. I believe that the man who is well fed and well clothed, who has a reasonable amount of time for play and recreation, who is in a position to save a little for a rainy day or towards the owning of his own home, who feels that the doors of his superiors are always open to receive suggestions or to redress real or imaginary grievances, who is not exposed to nagging and hectoring by officious subaltern officers, who is given the right of appeal, who is made to feel that all of the employees of the company, from the president down, are members of one family, each having the same paramount duty to serve the public and the employer, will give the best results, and therefore this is the ideal to be attained or at least

approximated as closely as conditions will permit.

It might be well, in furtherance of this idea, to have a council, composed of representatives of the men and the chief executive officers of the company, meet, say, once a month to consider measures for the improvement of the service and in the interest of efficiency. The representatives of the men should, I think, be selected by secret ballot—one, say, from each barn, where the utility is a street railroad company—the man receiving the largest number of votes to be the representative of that barn for the time being. In that way the most popular man would be chosen and through him all the employees of that barn would feel that they had a mouthpiece. A new election should perhaps be held every six months or year. This will at least furnish a sort of safety valve without providing much, if any, of a nucleus for agitation or organization.

4. Keep out of politics. I realize how great the temptation is to do just the contrary. The public utility is the target for the politician. That one of them who is not venally dishonest has, at least in recent years, found that attacks made upon it is the short cut to popularity. That one who is venal has found the strike bill the most lucrative source of revenue. It has seemed necessary to go into politics to keep such men out of office, and where the only purpose of the utility in so doing has been to eliminate such as these the motive is of course ethically justifiable. But we all know to what abuses this has led. The utility, to effectually accomplish practical results, has had to build up a political machine, and then having through this machine acquired the power not only to defeat injustice, to stifle bad bills and prevent biased judgments, the temptation to use that power for affirmative selfish ends generally proves irresistible. Then the people feel themselves throttled, and they are driven to rebel and are themselves then led into excesses by the desire for revenge, and it is from these excesses that we are now suffering.

5. The alternative remedy involves the next commandment—the appeal to the public for fairness and justice. Deem it your right and duty to influence public opinion. Complain of the wrongs that are done to you. Expose the methods of corrupt or unfair politicians. Combat the arguments of muck-rakers and pseudo-reformers. Never allow an untrue charge to remain unchallenged. Circularize the public. Buy space in the

newspapers. Participate in public discussions. But above all remember that whenever you do anything along these lines you must do it openly and in the name of the company. Do not hide behind reading notices. Do not have paid agents masquerading as independent gladiators. Let it be your fight, conducted in your name, as an appeal to the justice and reason of the people and based upon the trustworthy assumption that, approached in the right way, with patient and constant endeavor that appeal will ultimately not prove in vain.

I realize that I am proposing to you nothing that has not been suggested before in a form much more attractive and convincing than I have been able to give. But at least you have the picture of an actual personal experience acquired under circumstances of special interest, the recital of which may

teach something and inspire some course of action that I trust may prove of some practical value. I do not mean to be sacrilegious or visionary when I quote from the Scriptures in saying that "I do set my bow in the clouds." I place my confidence in the ultimate good sense and fairness of the people. Our salvation must be worked out through them, because after all, under our system of government, the power to deal with us in the last analysis rests in them, and we shall not have won our battle until we make the people feel that we are doing our duty by them. We must be politic enough to recognize our masters and public-spirited enough to be willing to make every effort to deserve the good will of the people.

The task will not be so difficult, if, as we should, we cultivate a frame of mind that makes this a labor of love.

ENGINEERING IN THE NAVY

By W. L. R. EMMET

CONSULTING ENGINEER, GENERAL ELECTRIC COMPANY

This article is of special interest as coming from the pen of one who has just been appointed to the U. S. Naval Consulting Board at a time when so much attention is being focused on "preparedness." The author shows some of the difficulties that those responsible for government work have to put up with; the sum total of these difficulties is usually labelled "red tape."—EDITOR.

While the navy has accomplished much in the direction of constructive engineering, most engineers and manufacturers who have been connected with naval work have felt that they labored under great difficulties and have desired some change of practice or organization which might render such efforts more effective and more expeditious.

New developments in engineering generally entail much labor and expense, even where the objects are very simple. There is scope for much thought in every construction if it is to be brought to a state of ideal fitness, and much experience has shown that new things do not pay unless they are done with great care and thoroughness.

The navy is in constant need of inventive development and much of its need relates to things which have no appropriate application outside of the navy itself. Improvements for the navy must come from within or from outside sources. If they are to come from within the navy itself, means must be provided for the necessary expenditure of time, study, experimentation, and construction, and if they are to come from outside, incen-

tives must be afforded to those who have the facilities for doing such work. It would seem that the present conditions do not fully meet either of these requirements. Some conditions may be suggested as possible reasons for these difficulties.

The first of these is the lack of authority and scope for continued effort afforded to engineers in the navy. Few officers other than the naval constructors are permanently engaged in engineering work and few are so detailed as to be able to devote themselves to one thing long enough to establish the influence and grasp of conditions necessary in the putting through of difficult undertakings. Executive and financial men in or out of the navy can seldom form sound judgment about engineering matters, particularly new ones, and engineers must be trusted and given ample authority in connection with such undertakings if the best progress is to be expected. In private industries, certain well tried men are so trusted after experience has shown that their judgment is dependable. The navy system does not tend to sufficiently establish the influence of such men. There

are many bright men, but it would seem that they lack scope for effective continuous effort.

Another difficulty is that the law and the yearly acts of Congress only allow certain specific expenditures, and it is hard to get money from Congress for activities which cannot be made to appear attractive to laymen in a paragraph of an appropriation bill. The navy should be organized to do research and development work as great corporations do it, funds should be provided for it, and at least a few men of the highest type should be kept on it without frequent and unnecessary changes of duty.

If the navy desires to render the study of its problems attractive to private manufacturers, it must modify the system of price competition upon which it now operates and must do as great private purchasers of machinery do, that is, it must have expert men in positions of influence and authority who can be trusted to purchase for reasons other than price, and whose positions are such that their good faith can be depended upon not only by the government but by those who do work for the navy. The great difference which generally distinguishes private business from public is that the former is largely governed and expedited by individual trust and judgment of character, while the latter is governed mainly by law and formula; but while this limitation of government business is common, it is not invariable and there seems to be no good reason why the navy should not be, to a great extent, relieved from a condition which interferes so seriously with constructive activities in engineering lines.

It would be interesting to know whether such men, for example, as Sir William White have not enjoyed in foreign navies a scope and permanence of engineering authority which is superior to that afforded to the many fine engineers who have served our navy.

It would seem that the accomplishment of such objects as are here suggested would necessitate some change in the organization of the personnel of the navy or in the customs governing its use. In the opinion of the writer, the present practice of using experienced

sea-going officers for much of the important engineering work of the navy is a very good one, which should be continued. It is believed that every department of technical work in the navy, including that of construction and repair, will be benefited by the services of such men. It is believed, however, that the activities of these men should be supplemented by a moderate number of first class experts, who, as a permanent engineering corps, can devote their lives to the practice of engineering. Such a corps should not be recruited from newly graduated cadets. It has been often proved that success as a student affords little indication of value as an engineer. Its numbers had better be taken from experienced officers and civilian employees of the navy who have reached the age of thirty and have shown the ability and character necessary to usefulness in such work. The members of this corps should hold positions of influence and importance in departments of the navy where engineering work is done. Their activities should generally be of a purely engineering rather than of an executive character, although they should not be entirely excluded from executive positions.

The possibility of making improvements in the equipment of existing vessels in the navy affords a very ready and practical means of making experimental development of new methods and devices, but such changes if they involve much expense can generally not be undertaken without authority from Congress. It may be quite as desirable to bring an old ship up to a higher standard of efficiency as it is to improve the design of a new ship, but under existing conditions it would seem that new methods must generally await their opportunity until new ships are authorized. In the opinion of the writer it would be desirable to provide an ample fund which could be used at the discretion of the Secretary of the Navy in developmental work, either through purchase of machinery or through manufacturing and experimenting in navy yards. Where these developments resulted in permanent improvements to vessels, the fund could be duly credited.

DEPRECIATION OF PROPERTY

By W. B. CURTISS

APPRAISAL DIVISION OF ACCOUNTING DEPARTMENT, GENERAL ELECTRIC COMPANY

This article on Depreciation is the first of a series on Accounting and Finance that is being written especially for the REVIEW. Depreciation is a very important factor to consider when dealing with property, yet its various phases are often but vaguely understood. The author has prepared a well arranged, intelligible article which will make interesting reading and serve the purpose of a work of reference. The principal subdivisions are: Explanation of depreciation, fluctuation, and amortization; Classes of depreciation; Methods of providing for depreciation; Methods of showing depreciation on the books; and the Necessity of proper provision for depreciation.—EDITOR.

The general subject of depreciation of property is quite complex and volumes have been written upon it by expert accountants, engineers, and others. While all authorities are in substantial agreement upon the fundamentals of the subject, their views differ on some of the questions related to it. The treatment of depreciation may, in a general way, be compared with the medical treatment of a sick person. In neither case can the treatment be described as coming within the domain of exact science. The physician diagnoses the case of the sick person and prescribes the treatment which his knowledge and experience lead him to believe will produce beneficial results; but if the patient does not respond to the treatment, the physician tries something else. So it is with the treatment of depreciation. It is known that several causes give rise to depreciation; and while no set rules can be laid down to determine exactly the total rate of depreciation or the rate due to any particular cause, these items can be determined within reasonable limits of accuracy by closely studying local conditions and applying the knowledge and experience gained along similar lines.

Definition of Depreciation

A dictionary definition of depreciation is—"the act of lessening or bringing down value." One authority defines it as "the loss, arising from years of service, in the value of the investment in perishable property." Various authorities have coined differently worded definitions, but in the sense here used the interpretation of them all is that depreciation is the deterioration of anything by use or time.

Depreciation vs. Fluctuation

The terms depreciation and fluctuation are sometimes confused, although they refer to conditions that are quite different in character. Depreciation is always a decline in value, due to the use of property or to its age regardless of whether it is in or out of actual service. If the property is in use it

wears, if it is not used it rots or disintegrates; in either case it tends to become obsolete in addition. Furthermore, a combination of all these factors may exist to a more or less extent. Fluctuation in value may be either up or down but unlike depreciation it is not due to the operation of the plant or the business. Fluctuation in the value of a plant and equipment is due to causes entirely apart from the operation of the plant, and among them may be mentioned the changes in the market price of labor and materials entering into the cost of buildings, machinery, etc. It is a well known fact that the cost of almost all classes of labor and material has advanced rapidly in recent years, and it requires but little thought to arrive at the conclusion that a building erected in the prosperous period of a couple of years ago, or a tool purchased in the same period, cost more than a building or tool of the same specifications erected or purchased ten or fifteen years ago. Changes in value due to fluctuation are not usually considered as affecting the operating profits, because they are influenced by considerations quite apart from the business and may be upward or downward. Generally they may be considered as temporary only, the increases of one period balancing the decreases of another period. On the other hand, when a plant is appraised the current costs of labor and materials (or the average costs over a term of years) must be taken into consideration, and thus the value of the property at the date of appraisal will be affected.

Depreciation vs. Amortization

Depreciation has been clearly defined. The term "amortization" has sometimes been used incorrectly when referring to depreciation; but it refers more properly to the accumulation of funds, by setting aside annually some stated amount at a fixed rate of interest, which are ultimately to be used in replacing capital investment in such items as franchises, mortgages, bonds, etc. It is important to make this distinction between the two terms.

Classes of Depreciation

Broadly speaking, depreciation may be divided into three general classes, as follows:

(1) Current repairs and renewals of a minor character to buildings, machinery, and equipment, including the replacement of small parts, all of which should be charged to the expenses of the year in which they occur.

(2) Repairs and renewals of larger and more costly parts or units, the cost of which may either be charged to the expenses of the year in which they occur, as in (1) or the cost may be distributed over a number of years.

(3) The gradual renewal of the plant part by part necessitated by the fact that, even after the repairs and renewals covered in (1) and (2) have been made, the plant will gradually age and tend to become obsolete.

Each of these general divisions is in reality the summary of a number of component parts which it will be necessary to consider, for although depreciation is usually expressed as some fixed per cent or rate for a given class of property, it actually represents the total depreciation from all causes, as determined by local conditions and experience.

Wear and tear is the most obvious type of depreciation, as its effects can be readily seen and it can be measured to some extent by the cost of repairs necessary to keep the machine or other property in good working or usable condition. This class of depreciation results from *use*. It is extremely doubtful, however, that the use of a piece of physical property ever wears it out completely, except in the case of very short-lived items, such as small tools and small shop fixtures. Certain parts of a machine will wear more rapidly than other parts and certain parts of a building, such as the floors, stair treads, roof, etc., will wear more rapidly than other parts; but, as time goes on, these parts will be wholly or partially renewed with the result that, from the viewpoint of wearing value, the property is maintained in a thoroughly good condition.

Age or physical decay goes on in spite of repairs and renewal of parts; and it may be said that practically all physical property, that has a normal life extending over a number of years, will eventually reach a stage where maintenance will be so extensive and costly as compared with the original cost that abandonment will be much more advantageous than repair. With some kinds of

property, the passage of time is directly responsible for depreciation, whether the property is in or out of use. A good example of this condition is the insulated wires and cables that transmit electricity. Such wires and cables are wrapped or covered with one or more layers of cotton, silk, rubber or other insulating material, and such materials will deteriorate with age or with exposure to the weather. The rubber will become dry and will crack and the fabric will rot if the wires are in use or not. The horse is frequently mentioned as an ideal illustration of depreciation caused by age. He has a certain number of years of useful life, just as machine tools, locomotives, or buildings have certain terms of useful life, such terms varying with the character of the property, the amount of repair work done upon it, the kind and amount of service exacted, etc. As applied to a horse, depreciation exists largely in the natural process of aging. Although his hoofs wear more or less, depending upon the character and location of his work, such wear can be minimized by shoeing at proper intervals; but the main cause of permanent depreciation in his case is age, and this condition cannot be offset by repairs. He must eventually be replaced because of physical decay. The conclusion to be drawn from these and other typical examples is that substantially all physical property, except land, begins to deteriorate from the moment it is put into use, and that, despite repairs made upon it, the time will surely come when it must be replaced.

Inadequacy is the term used to designate the depreciation that is specifically due to the growth of business. In the case of public utility corporations, such as street railways, electric light and power companies, gas companies, etc., inadequacy is frequently the result of public demands for better service. A review of the trolley system growth in almost any city offers a good example of inadequacy. Some twenty years ago a city's electric transportation service was usually furnished by small single-truck cars running over light weight tracks. The growth of the city and the consequent demand for better transportation facilities made it necessary for the railroad to add to its equipment from time to time. Naturally, the new equipment was of the type that was modern at the time of installation and gradually replaced the older equipment, not because the old was worn out but because it had become inadequate for the service demanded. If any of

the first cars be in existence at this date, they have outlived their usefulness as passenger cars and have become hopelessly inadequate to take any substantial part in the transportation problem as it exists today.

Obsolescence is the term used to designate the depreciation that is due to the development of newer and more economical machines or other property. It may also be designated as the depreciation due to changes or advances in the art or method of manufacture. It is similar to inadequacy in that it may result in the abandonment of property long before it is worn out and it may also, in some cases, result from public demands for better service. However, it is distinct from inadequacy and usually results from different causes. For example, when a progressive city legislates for the removal of all overhead telephone and electric light wires in the streets of the business district, the owners of the wires are compelled to place them in underground conduits. In those particular streets, the overhead construction has become obsolete and has to be completely replaced. In other sections of the city, however, the overhead construction is permitted and is the standard practice in those localities. It is probably true that obsolescence and wear and tear rank as the two chief causes for the enormous charges to depreciation in the past, although wear and tear can largely be made good by repairs. In some classes of property, such as electrical machinery, advances in the art of manufacture and design have been so rapid that machinery in great quantities has had to be replaced, long before it was worn out, by other machinery of newer and more economical types.

Deferred maintenance is the term used to designate the depreciation resulting from neglect in the way of repairs and general upkeep. In providing for depreciation, it is customarily assumed that the property will be maintained in an efficient operating condition and that the expense to be provided for is represented by the sum of the actual loss in value and the cost of repairs. Recognition is given to the fact that, in spite of adequate repairs, the property is constantly lessening in value. Deferred maintenance represents the expenditure that must be made upon any piece of property to put it into the best possible operating condition at any given time. It is not a class of depreciation that is taken care of in the depreciation account, as it represents expenditures for maintenance which are properly chargeable

to expense at the time the repairs are made. In any factory, for example, it will be readily understood that, at any given date, there would be many items of equipment needing repairs in order to bring them to their maximum efficiency. These repairs could not all be made at one time and it is, therefore, a fact that there is always more or less work to be done at all times. The condition, known as deferred maintenance, is only taken into account when property is appraised or sold. A purchaser naturally expects the owner to put the property in first class condition before the transaction is concluded, or insists upon an adjustment in price equivalent to the estimated cost of the necessary repairs.

Accidents sometimes result in very sudden depreciation. While accidental destruction of property should not perhaps be classed with the various classes of depreciation previously described, it is, nevertheless, a factor that cannot be entirely ignored. In a locality subject to earthquakes, a building or other structure may be badly damaged or even destroyed by a heavy shock. A bridge over a river may be carried away by flood. Such cases result in quick destruction of property values much in excess of the amount normally chargeable to maintenance. Probably no concern engaged in ordinary business makes provision for such accidental destruction of property by means of charges to the depreciation account, although there may be special hazards that are so handled. There are numerous kinds of insurance that can be purchased which will be applicable, such as those covering breakage of plate-glass windows, bursting of boilers, damage due to earthquakes, cyclones, floods, lightning, etc.; and insurance is probably the best medium through which to provide against such destruction of property.

The foregoing paragraphs explain the several classes of depreciation; and depreciation must be provided for out of income before any profits can properly be taken.

The annual charges to income for this purpose are to meet the eventual complete renewal of the plant (not all at once, but parts of it from time to time as become necessary). They are represented simply by the estimated yearly proportion of the loss in value that cannot be made good by current repairs and maintenance—a loss for which necessary provision must be made in advance against the time when the plant, or any portion of it, shall be entirely worn out.

inadequate, obsolete, or for any other reason will no longer be useful to serve the purpose for which it was provided. Before discussing the methods that may be used for providing funds to cover depreciation, consideration should be given to those kinds of depreciation that are of a current character and that are taken care of in the expenses of the month or the year in which the expenditures occur.

Maintenance, Repairs and Renewals

As here used, maintenance, repairs, and renewals are practically synonymous terms. The term "maintenance," as generally used, includes the cost of current repairs, replacement of small parts, and general upkeep, including the labor and material involved. Such expenditures form a part of the general operating expenses of a plant and should be charged to expense in the period in which they were made. As used in this article, the term "renewals" refers particularly to the replacement of small parts or of certain classes of small tools and devices which have but a short life, less than one year for example. Such renewals are quite properly chargeable to expense; but, in the case of a renewal of a large and expensive part that would last for several years, it would be proper to distribute the cost over a number of years or it might all be charged to maintenance in the year in which the expenditure was made. The complete renewal or replacement of property of importance, however, is not usually charged to maintenance, because it would result in abnormal drains upon the treasury and would destroy the comparisons that could otherwise be made of the cost of maintenance from year to year.

Useful Life of Plant

It is now clear that the depreciation of a plant must be provided for out of income each year during the life of the plant. It would not be possible to provide for the complete replacement of the plant out of the earnings of a single year, therefore, it must be provided for in annual installments. The next step of importance is to determine as accurately as possible the terms of useful life that may reasonably be expected of the several classes of property. This will require the exercise of skill and judgment, the knowledge of the local conditions, and a general familiarity with the art in which the property is employed. As an example, let us assume that the total wearing value (wearing value being the difference between the

cost and the scrap value) of a small plant is \$125,000, exclusive of land. The problem now is to determine the approximate useful life of each class of property comprising the plant, with the exception of land as the land cannot be worn out or destroyed for plant purposes. After a thorough investigation, let it be assumed that the value and life of the several classes of property are as follows:

\$10,000	useful for 5 years
\$30,000	useful for 10 years
\$45,000	useful for 15 years
\$40,000	useful for 20 years
<u>\$125,000</u>	

On considering these items, it will be seen that if annual provision is to be made for their replacement at the expiration of their useful life it will be necessary to set aside each year one-fifth or 20 per cent of \$10,000, one-tenth or 10 per cent of \$30,000, one-fifteenth or $6\frac{2}{3}$ per cent of \$45,000, and one-twentieth or 5 per cent of \$40,000. These can be tabulated as follows:

$\$10,000 \times 1/5$ (or 20%)	= \$2,000
$\$30,000 \times 1/10$ (or 10%)	= \$3,000
$\$45,000 \times 1/15$ (or $6\frac{2}{3}\%$)	= \$3,000
$\$40,000 \times 1/20$ (or 5%)	= \$2,000
<u>\$125 000</u>	<u>\$10,000</u>

This indicates that, if the estimated terms of useful life be conservative, the amount realized annually by the application of the rates of depreciation (20, 10, $6\frac{2}{3}$ and 5 per cent) against their respective property values will be sufficient at all times to provide funds for the complete replacement of worn out property with new property of equal cost.

The "mean life" of the plant may also be used to produce the same result. "Mean life" may be defined as the number of years that will be required to accumulate an amount equal to the wearing value of the plant as a whole, which in this case is $12\frac{1}{2}$ years. In the foregoing assumption certain predetermined portions of the plant will wear out in 5, 10, 15 and 20 years respectively, but it has been shown that the setting aside of an annual depreciation fund of \$10,000 will suffice to completely replace these portions as they wear out.

This can be shown in another way. It is obvious that certain portions of the plant will wear out before other portions do; e.g., that portion which has the relatively short life of 5 years will wear out four times while that

portion which has a 20-year life wears out once. Using the life (20 years) of the most permanent portion of the plant as the basis for calculation, the following figures are obtained:

Life in Years	Wearing Value	No. Times Installed in 20 Years	Total Investment in 20 Years	Years	Dollar Years
5	\$10,000	4	\$40,000	×5	= \$200,000
10	30,000	2	60,000	×10	= 600,000
15	45,000	1 $\frac{2}{3}$	60,000	×15	= 900,000
20	40,000	1	40,000	×20	= 800,000
	<hr/> \$125,000		<hr/> \$200,000		<hr/> \$2,500,000

The "mean life" is determined by dividing the dollar years by the total investment required during 20 years, which gives 12 $\frac{1}{2}$ years. The annual amount necessary to cover depreciation during the "mean life" is determined by dividing the total investment required by the number of years (20) during which the investment has been made, which gives \$10,000.

Methods of Providing for Depreciation

Authorities have written volumes on the subject of providing for depreciation and many individual viewpoints can be obtained by reference to published works on "Auditing," "Accounting" and "Appraisal of Property." It is also discussed in engineering publications. However, all authorities agree that the following three methods are in more general use; therefore only these will be considered.

- (1) Straight line method.
- (2) Diminishing value method.
- (3) Sinking fund or annuity method.

In all of these methods it is the usual practice not to include maintenance charges in the fund in addition to depreciation.

The *straight line method* provides for setting aside each year an equal proportionate part of the cost (less scrap value) based upon the life of the property. If a certain portion of the plant cost \$10,000 and its life be estimated as ten years with a scrap value of \$1000, the annual depreciation by the straight line method will be 10 per cent of \$9000 or \$900. This method is in most general use in manufacturing plants; but it is frequently argued that the combined charges to income for depreciation and maintenance increase as the years go by, for the reason

that while the fixed apportionment for depreciation is the same in the first year as in the last year of the life of the property, the repairs, etc., are relatively small in the first years and much more extensive in the

latter years. The effect of this would no doubt be noticed in the first fifteen or twenty years of the life of an entirely new plant, but after it had been in operation for a long period it would be comprised of units of all ages from new to worn out and consequently the criticism mentioned would be eliminated.

The *diminishing value method* provides for the setting aside each year of a fixed rate first applied to the cost and then to the diminishing value, such rate being based upon the life of the property. By this method the property is depreciated to scrap value at the end of its estimated life. If a certain portion of plant cost \$10,000 and its life be estimated as ten years with a scrap value of \$1000, the annual depreciation by the diminishing value method will be 20.57 per cent of \$10,000 or \$2057 for the first year and in decreasing amounts in the following years as will be illustrated later. It is claimed for this method that the combined charges to income for depreciation and maintenance are more uniform as under it the charges for depreciation are heaviest in the early years and constantly decrease as the years go by, whereas the maintenance charges are lightest in the early years and heaviest in the later years.

There is also another form of the diminishing value method that might be called the "false diminishing value method," which is a combination of the straight line and diminishing value methods. It is not to be recommended, however, unless in addition to the yearly charges for depreciation a further amount be set up out of the income to be carried as a special reserve for plant depreciation. The fallacy of this method is that while the rate of depreciation is based upon the life of the property, as in the

straight line method, it is applied, not to the cost (less scrap value), but to the diminishing value. The results will be illustrated later.

The *sinking fund or annuity method* provides for setting aside each year such a sum that, invested at a certain rate of interest compounded annually, it will equal the cost of the property (less scrap value) at the end of its life. If a certain portion of the plant costing \$10,000 has a life of ten years, with a scrap value of \$1000, and it is desired to set aside such a sum that, at 5 per cent interest compounded annually, will accumulate an amount equal to the cost (less scrap value) at the end of the life period, it will be found by referring to an annuity table that $\$9000 \times 0.0795$ will

of the ten years of life are identical in each case and that the capital investment has not been impaired. The fourth column, however, shows the operation of what has been termed the "false diminishing value method" and it is clear that, if the property is actually worn out in its assumed life of ten years, the capital investment in plant is impaired to the extent of \$2486.78, which is the difference between the total depreciation (plus scrap value) and the original cost.

Where the depreciation funds or reserves are invested in extensions to the plant, as is the usual practice in manufacturing enterprises, either the straight line or the diminishing value method is the proper one to use; for

TABLE I

Year	Straight Line Method 10 Per Cent on Cost, Less Scrap Value	Diminishing Value Method 20.57 Per Cent on Dimin. Value	Sinking Fund Method at 5 Per Cent Comp. Interest	False Dimin. Value Method 10 Per Cent. on Dimin. Value
1.	\$900.00	\$2,057.00	\$715.50	\$1,000.00
2.	900.00	1,633.87	715.50	900.00
3.	900.00	1,297.78	715.50	810.00
4.	900.00	1,030.83	715.50	729.00
5.	900.00	818.78	715.50	656.10
6.	900.00	650.36	715.50	590.49
7.	900.00	516.58	715.50	531.44
8.	900.00	410.32	715.50	478.30
9.	900.00	325.92	715.50	430.47
10.	900.00	258.88	715.50	387.42
5 per cent compound interest.			1,845.00	
Total depreciations.....	\$9,000.00	\$9,000.32	\$9,000.00	\$6,513.22
Scrap value.....	1,000.00	1,000.00	1,000.00	1,000.00
	\$10,000.00	\$10,000.32	\$10,000.00	\$7,513.22

produce the required amount, \$715.50. The sinking fund or annuity method is more applicable to public utility properties that have reached their full development than to manufacturing properties, as it usually provides for investing the accumulations in outside securities at from 3 to 5 per cent interest.

The results obtained by the use of the three methods of providing for depreciation are given in Table I. As a basis for the calculation, a \$10,000-portion of a plant has been assumed, its estimated life is to be ten years, and it will have a scrap value of \$1000. The few cents excess in the total depreciation obtained by the diminishing value method is of course due to not using the exact decimal in the rate of depreciation. This tabulation shows clearly the yearly amounts provided by the *three* recognized methods, and it will be seen that the net results at the expiration

on the assumption that a given enterprise is profitable, it can earn more money on its funds in its own business than it can by investing the same amount in outside securities.

Methods of Showing Depreciation on the Books

There are three methods in more or less general use:

(1) A general account for depreciation reserve is credited with the depreciation on all classes of property and an equal amount is charged to income

(2) Individual reserve accounts for each class of property are credited and an amount equal to the total of these credits is charged to income.

(3) The value of each class of property is written down and an amount equal to the total of these reductions in property values is charged to income.

A combination of (3) with either (1) or (2) may also be used where it is desired to set aside special reserves in addition to the regular scheduled depreciations for the purpose of providing against extraordinary contingencies. The method that shall be used in showing depreciation on the books must, of course, be governed by each enterprise. Of the three methods, the first is quite objectionable for the reason that, in crediting a general reserve account with the depreciation on all classes of property, it is impossible to determine the carrying value of any item or class of property without a detailed analysis of the general reserve account. Either (2) or (3) will be quite satisfactory if individual records are kept of the items comprising each class of property. The proper classification and recording of property is of great value. Unless individual records are maintained of the items comprising buildings, machinery, etc., there will be no closer reference to individual items than the total of the class of property in which such items are carried, and this will result in losing sight of the original cost and the carrying value. Thus the proper classification and recording of property will be found to be of great value.

Graphic Representation of Depreciation

Fig. 1 is a graphic representation of the trend of depreciation. Three of the series of seven curves are intended to illustrate the ways in which depreciation actually takes place, and the remaining four are intended to indicate the methods that have been explained for providing the necessary depreciation funds. These curves are similar to others that appear in Henry Floy's "Valuation of Public Utility Properties." In Fig. 1, however, one of Floy's curves has been omitted and one of the writer's has been added in order that the example of graphic representation of depreciation will be in agreement with the discussion herein. The explanation of the curves also closely follows Floy's text wherever the latter may be used to advantage.

Now assume that any piece of property cost an amount represented by the ordinate OC , and that it has an estimated useful life of a number of years represented by the abscissa OD , also that it has a scrap or junk value of an amount represented by the ordinate OA . As the scrap or junk value will be constant throughout the life of the property, except for the fluctuation in market value

of the materials which may be up or down, the horizontal line AB will represent the scrap value, below which there should be no depreciation. The ordinate OA will then represent the value at the beginning of the life period and the ordinate DB the value at the end of the life period.

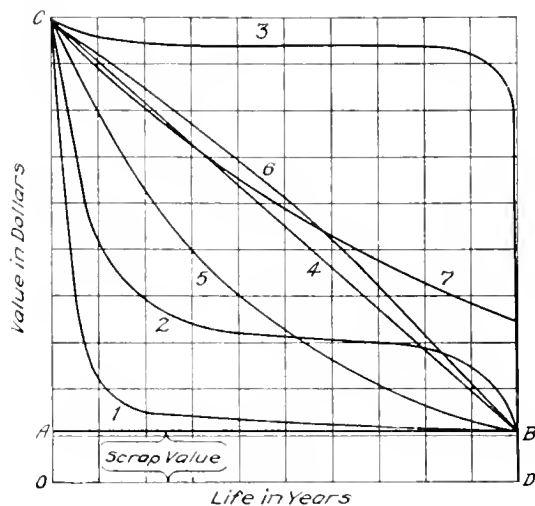


Fig. 1

In general there are two factors affecting values through depreciation, (a) the sale price that can be obtained if the property be sold before it is worn out, (b) its value as a working unit when used for its original purpose throughout its life.

Curves 1 and 2 may be used to represent the values of most pieces of property during any period of life as determined from the sale price for use elsewhere. As is well known, the depreciation of new apparatus or equipment, from the viewpoint of salable value, is very rapid from the time the apparatus is installed; but after depreciating rapidly in salable value in the early period of life, it only gradually depreciates to scrap value during the remainder of its life. The values thus illustrated are independent of the service for which the apparatus was purchased and installed.

Curve 1 represents the value of special machinery, tools, etc., which would be of very little value on any work other than that for which they were intended. It might also represent the value of any kind of property, the cost of removing which would be relatively high compared with its inherent value.

Curve 2 represents the sale value of readily movable property in general, i.e.,

property that can be moved and used to advantage in other locations and for other purposes than those for which it was originally provided.

Curve 3 represents depreciation due only to wear and tear until just before the end of the life at which time other classes, such as inadequacy and obsolescence, may have an important bearing upon the value. The assumption is made that the property in question will be kept in first-class repair and that if kept in that condition will be just as useful at all times throughout its life for its original purpose. Curve 3 therefore indicates a high continuous value, the loss representing a certain amount of depreciation through deferred maintenance and age.

These first three curves represent what may be termed "absolute" depreciation. They indicate very rapid rates of depreciation either in the earlier or in the later period of useful life, and it has been necessary for accounting purposes to fix upon some method of providing for this deterioration in some logical and uniform manner. The "straight line" method, the "diminishing value" method, the "sinking fund or annuity" method, and what may be termed the "false diminishing value" method will each provide a means for the accumulation of depreciation funds. The merits and demerits of each have been briefly mentioned. It is a fact that depreciation does not proceed at an even or uniform rate during the life of property, but for practical accounting purposes it is necessary to devise methods that will provide out of income, at a relatively uniform rate, the necessary funds to offset deterioration in value. The rates used in connection with these methods may therefore be termed the "theoretical" depreciation, and curves 4, 5, 6 and 7 come under this designation. The curves shown in Fig. 1 have been plotted from the values given in Table I.

Curve 4 represents "straight line" depreciation, in which a uniform rate of reduction in value goes on during life.

Curve 5 represents depreciation by the "diminishing value" method, in which more rapid reduction takes place in the earlier than in the later years of life.

Curve 6 represents depreciation by the "sinking fund or annuity" method; in drafting this curve, the compound interest values have been added to each year's

accumulation. Here the reduction in value is more rapid in the later years of life than in the earlier.

Curve 7 represents depreciation by the "false diminishing value" method; and, as was pointed out, there would be a loss to capital account of about \$2500 under this method, unless an adequate reserve in addition to the regular depreciation had been set up for such emergencies.

Necessity of Proper Provision for Depreciation

While this article relates to the depreciation of the permanent plant investment of manufacturing plants, it is equally applicable to physical property of all kinds, with the possible exception of land. It is a certainty that depreciation in one or more of its phases is an ever present factor in connection with all physical property, except land; and even in the case of land, farm land for example, depreciation exists if the land is not properly fertilized and cultivated after each crop. It is further evident that adequate provision must be made out of income against the time when the natural wearing or aging of the property will render it useless for the purpose for which it was obtained.

It is a self-evident truth that the capital account of any business must not suffer impairment for any reason, and as the permanent plant investment is usually an important part of the capital account, it is obvious that such safeguards must be established as will maintain this important asset at its proper value.

Generally speaking, capital is frequently impaired in manufacturing concerns by inadequate provision for depreciation and by charging to investment those expenditures which should be charged to maintenance. These errors in accounting methods result in the showing of false profits that are not earned; and if dividends be distributed to the stockholders, based on these false profits, the capital is impaired to the extent of such distribution.

In conclusion, it may be stated as an axiom that any business enterprise which has an investment in permanent plant and which does not make adequate provision for the depreciation of its plant, by setting aside from its earnings each year a sufficient amount to insure the replacement of the property at the end of its useful life, will sooner or later find itself in financial difficulties.

A MODEL X-RAY DARK-ROOM

BY WHEELER P. DAVEY

RESEARCH LABORATORY, GENERAL ELECTRIC COMPANY

The author describes and illustrates both a small and a large dark room specially suitable for X-ray work and as he has had much experience in this work the article should prove of considerable value to Roentgenologists.—EDITOR.

Anyone visiting the offices of a large number of X-ray practitioners is impressed by the small number of first-class dark-rooms. Men enjoying a large practice as X-ray specialists have had occasion to fit up rooms very well adapted to the purpose, but those with smaller practice, or those who use X-rays as an aid to diagnosis in their own general practice do not seem to have been so fortunate. It is with the hope of aiding such men in planning an efficient and convenient dark-room, that this article is written.

In planning a dark-room for X-ray work, space must be provided for the following:

(1) Stock solution of developer; (2) Developing shelf; (3) Sink; (4) Hypo bath; (5) Wash-tank; (6) Drying rack; (7) Racks for holding envelopes; (8) Interval timer; (9) Ventilating fan; and (10) Necessary lights and switches.

In addition to the above it is usually desirable to provide room for a moderate supply of plates and for a stock of chemicals. A small viewing screen in the dark-room is a great convenience but not a necessity. If frames are used for fixing, washing, and drying the plates (and the author believes that they should be), then space should be provided for them on the walls of the room.

The room should be planned so as to make everything as compact as possible, and so that it is never necessary to allow a plate, wet with hypo, to drip on the floor. The two dark-rooms described in this article have been found satisfactory enough to warrant them being called "Model" dark-rooms. One is in the Research Laboratory of the General Electric Company. Space was at a premium and the room was built out like a closet in one of the rooms. The other is in the office of a well-known surgeon whose X-ray practice is large enough to require the constant services of a trained Roentgenologist. In this case compactness was not as essential as the ability to handle a large number of plates quickly.

Both dark-rooms were planned with the idea of developing plates entirely by time. With the Coolidge tube the penetration and exposure can be made so definite that this method is by far to be preferred. Tank development was considered, but was thought

not to be economical enough of developer because of the large size of plates used in stomach and chest work. It is possible, however, to combine the convenience of the tank-method with the economy of the tray-method if the following technique is followed.

(1) Fill the tray quarter-full of *fresh* developer at some standard temperature (say 65 deg. F.).

(2) Insert plate.

(3) Shake tray vigorously from end to end and from side to side to remove air bubbles.

(4) Cover tray with a *light-tight* cover and leave undisturbed for ten minutes, as shown by the interval-timer. (Adjust the exposure so that this is the proper time of development.)

(5) After using, pour developer at once into an air-tight bottle just large enough to hold it, and put in water bath to keep cool. If care is taken not to use stale, discolored developer, this method has been found to be quite as satisfactory as tank development.

As soon as the plate comes from the developer it is put in a frame, washed in the sink and at once put in the hypo tank. After fixing it is washed in the wash-tank and hung on the rack to dry. The use of the frames will be found to keep the gelatin from being marred by finger prints.

A glance at the plan of either dark-room will show that (1) a plate is never brought near the developer after having once left it; (2) lights are turned on and off from the floor,—there are no switches covered with hypo to spread hypo-dust into the developer; (3) the sink is between the hypo and the developer so that in passing from one to the other the hands may be washed; (4) the running water of the wash-tank is in contact with the hypo tank, thus insuring cold hypo; (5) a plate can never drip hypo on the floor, even when being viewed on the viewing screen.

In planning the viewing screen, a great deal of experimental work was done to find the best possible source of illumination for negatives. Every style of incandescent lamp known has been tried and compared with north-sky and with the mercury arc.

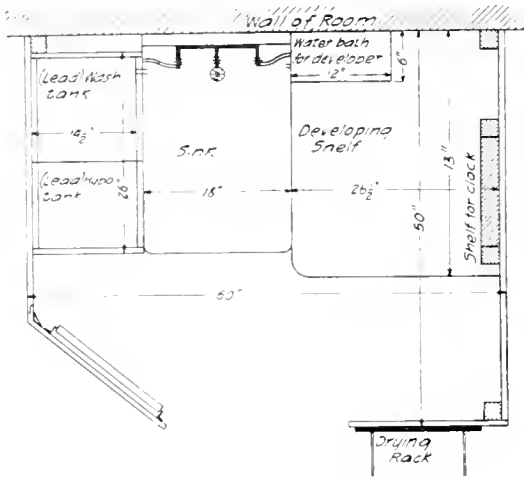


Fig. 1. Ground Plan, Dark Room No. 1

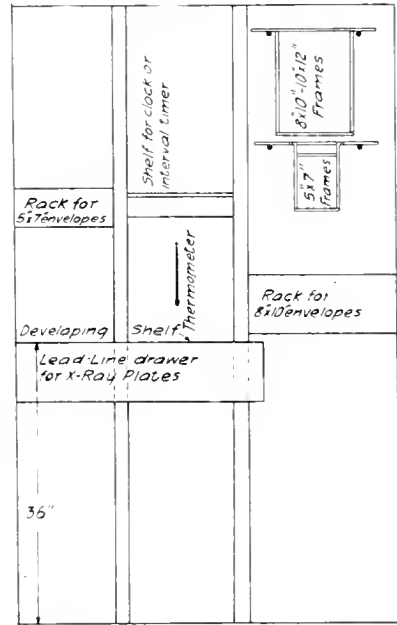


Fig. 3. Right Wall, Dark Room No. 1

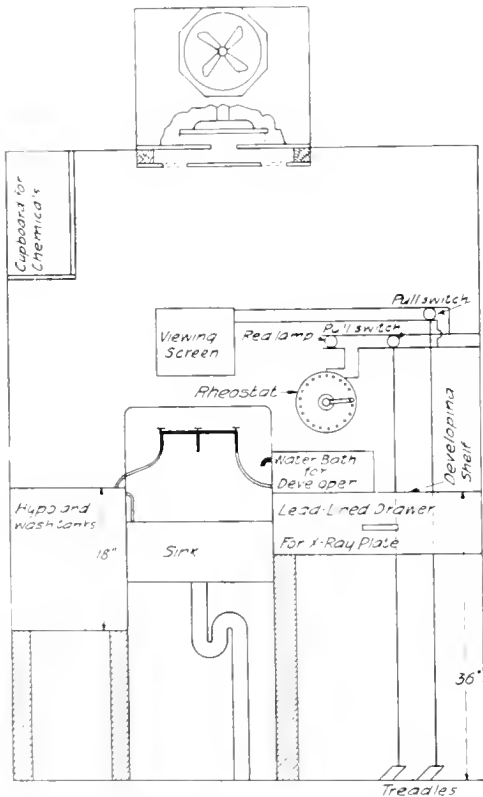


Fig. 2. Back Wall, Dark Room No. 1

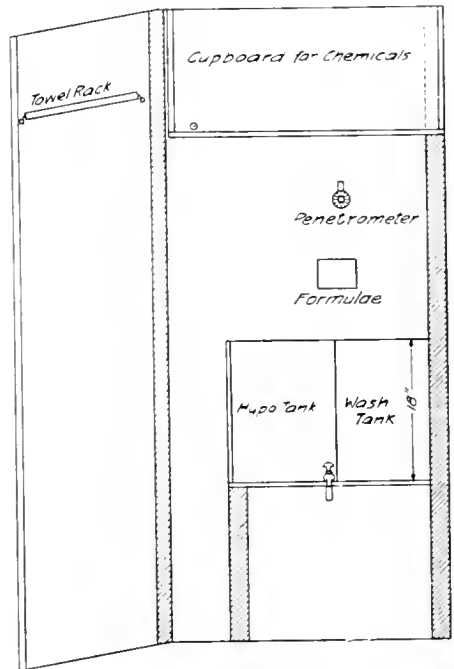


Fig. 4. Left Wall, Dark Room No. 1



Fig. 5

Method of Hanging Curtains in Doorway of Dark Room No. 1

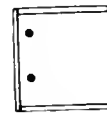


Fig. 5a

As a result, it was found that the "Blue Photographic Mazda" is by far the best source of illumination for viewing X-ray negatives. The viewing screens were therefore designed to be used with these lamps.

Plans of the smaller of the two dark-rooms are given in Figs. 1 to 6. This room was designed for use with plates not to exceed 10

by 12 inches in size. There is no reason why it could not have been designed for use with plates of any size. The walls were built of dry matched sheeting. The developing shelf was covered with lead partly to make it water-proof and partly to better protect the plates in the drawer from X-rays. Care must be taken to have plenty of overlapping of

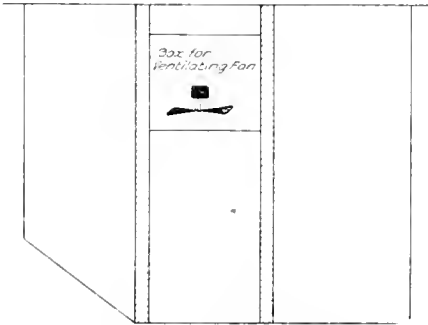


Fig. 6. Roof Plan, Dark Room No. 1

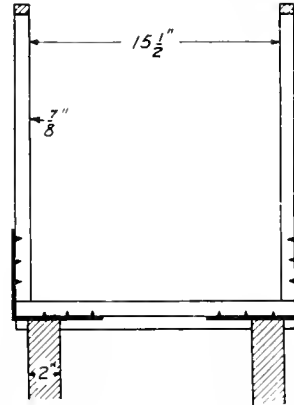


Fig. 9. End View of Drying Rack, Dark Room No. 2

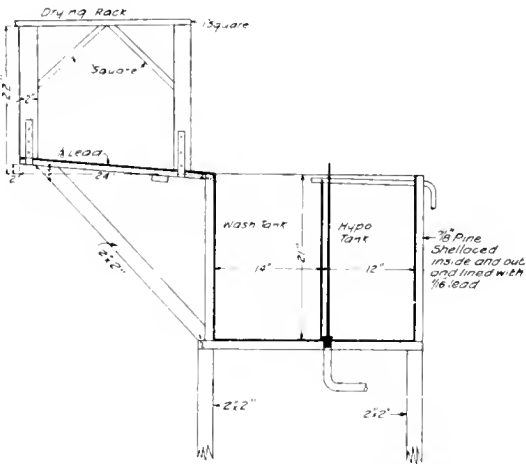


Fig. 7. Side View of Hypo and Wash Tanks and Drying Racks, Dark Room No. 2

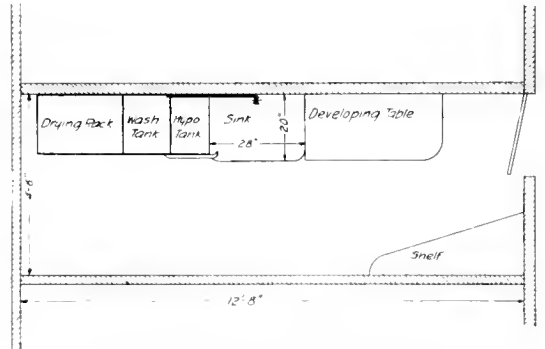


Fig. 10. Ground Plan, Dark Room No. 2

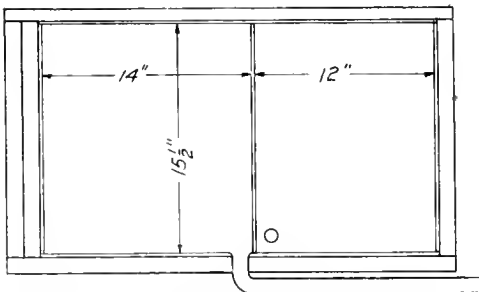


Fig. 8. Top View of Hypo and Wash Tanks, Dark Room No. 2

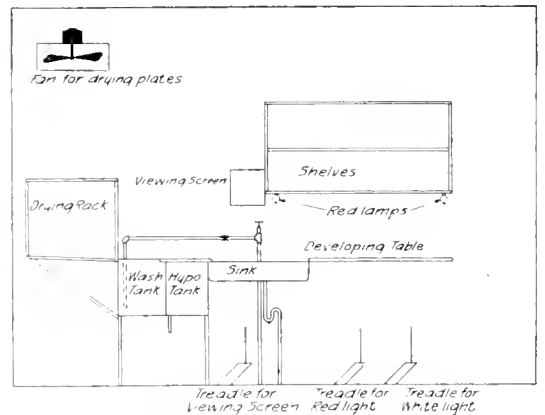


Fig. 11. Wall of Dark Room No. 2

lead so that the rays may find no open crack through which to enter. The rheostat, Fig. 2, is a 300-ohm rheostat, and has all the range needed for dimming a 50-watt red light. The use of light during development is, however, not as necessary with "time development" as with the ordinary method. It is the practice of the author to dim the lamp as much as possible, using it merely as a point of reference in locating things in the room.

Attention is called to the use of curtains in the doorway as a means of economizing space. Two curtains are hung on separate rods as shown in Fig. 5. The outside edges are fastened permanently to the door way. The inside edges are fastened to sticks about one inch square. These sticks act as weights and prevent the curtains from blowing in and causing light-leaks. Each curtain is wide enough to stretch completely across the doorway. A suitable housing, see Fig. 5a, painted black on the inside prevents light-leaking over the top of the curtains. The

curtains are made of double thicknesses of galatea.

Plans of the larger dark-room are shown in Figs. 7 to 11. Attention is called to the method of drying the plates with the fan. The arrangement of the red lights is also worthy of notice. Instead of using a rheostat, two 10-watt red lamps were connected in series. This made them both burn dimly. In accordance with the suggestion made above, they are used, not as a source of light for watching the development of the plates, but merely as marks to guide the operator in his movements about the room. One lamp is placed at the extreme end of the developing table, the other is placed over the sink. The dimensions of the hypo and wash tanks and of the drying rack are given in Figs. 7 to 9 in some detail as a guide to any who care to have similar work done. In Fig. 11 the switches governing the various lamps are not shown. The treadles will, however, indicate where these switches should be placed.

THE PRODUCTION OF DAMPED OSCILLATIONS

BY LESLIE O. HEATH

RESEARCH LABORATORY, PITTSFIELD WORKS, GENERAL ELECTRIC COMPANY

Damped high frequency oscillations are playing an increasingly important part in the testing of certain forms of electrical apparatus and of insulation. The author describes the three most important ways of producing such damped oscillations; viz. the "simple," the "coupled" and the "quenched-spark" methods. He treats the subject clearly and comprehensively and the value of his contribution is materially increased by the illustrations and diagrams.—EDITOR.

Within the past few years a certain amount of work has been done in testing protective apparatus, power transformers and various forms of insulation with damped high frequency oscillations. It is probable that in the future such work will be considerably extended and that some lines of investigation will require high frequency apparatus for producing oscillations of certain characteristics. In view of this situation a consideration of the various methods of producing damped oscillations and a comparison of the different types of oscillations produced by these methods may be of value in predetermining the effectiveness of any given type of high frequency system in any particular line of high frequency investigation.

A study of the various methods of producing damped waves points out certain advantages for each method; but in every method the oscillations are produced primarily by discharging a condenser through an inductance. There are in use three general systems

for producing damped waves, which may be termed the simple, the coupled, and the quenched-spark, which is a modification of the ordinary coupled system. It is well to consider these systems in the order given, as they were developed in this sequence.

Probably the most familiar example of the simple system is that shown in Fig. 1. The oscillating system itself is drawn in heavy lines. At each break of the interrupter in the primary circuit of the induction coil the condenser is charged to a high potential and is discharged across the gap through the inductance. The frequency of these oscillations when the resistance of the circuit is low, as it is in most practical cases, is given by the equation

$$f = \frac{1}{2\pi\sqrt{LC}}$$

where L = the inductance in henrys; and C the capacity in farads. In many cases it is more convenient to measure the frequency

by means of a wavemeter. These oscillations can be shown graphically by means of a Gehrcke tube¹ and rotating mirror, provided that the oscillations are sufficiently steady and the mirror is driven at the proper speed. The Gehrcke tube is a glass tube filled with a rarified gas having two polished aluminum electrodes in the form of round wires or flat strips which project inward from the ends of the tube and nearly touch at the middle. See Fig. 2. When a voltage is applied to the tube a glow starts at the middle and extends toward the ends along the electrodes a distance depending on the value of the voltage. If an oscillating voltage is applied across the terminals, at each oscillation the glow extends along the tube a distance roughly proportional to the voltage, so that if the tube is viewed in a rotating mirror, instead of a steady band of light, a series of bands of decreasing amplitude is seen, giving a fairly accurate representation of the wave train. A somewhat similar method of showing sustained oscillations by means of the cathode ray tube has been used by Ernst Ruhmer in experiments with the high frequency arc².

When such apparatus is not available it is usually practical for purposes of illustration to construct a low voltage oscillating circuit whose frequency comes within the range of

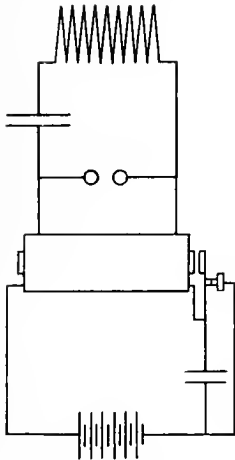


Fig. 1. Simple High-frequency Compound System

the ordinary oscillograph. Fig. 3 shows a damped wave train of 265 cycles as a theoretical example of a wave train produced at a very much higher frequency by the system shown in Fig. 1. The lower wave in Fig. 3 is a timing wave. The apparatus for produc-

ing the wave train shown in Fig. 3 consisted of some paraffine paper condensers and an air cored inductance. The condenser was charged on a 125 volt direct current circuit and discharged through the inductance, the oscillations being recorded by an oscillograph

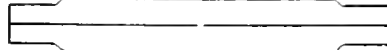


Fig. 2. A Gehrcke Tube

connected across a shunt which was inserted in the circuit.

The decrement of the oscillations is the difference of the natural logarithms of two successive oscillations in the same direction, and can be calculated from the equation

$$\delta = \frac{R}{2fL}$$

where R = the total resistance of the circuit; f = the frequency; and L the inductance in henrys.

The decrement of the oscillations shown in Fig. 3 as determined from wave micrometer measurements is 0.103 per complete period, a value which checks very well with the value calculated from the measured inductance and resistance of the circuit, taking into account the losses in the condensers.

In the case of the high frequency circuit, Fig. 1, the determination of the decrement

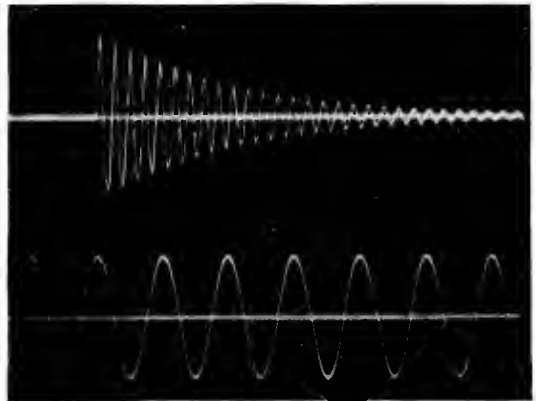


Fig. 3. Low-frequency Wave Train and Tuning Wave

from the constants of the circuit is not so easily accomplished on account of the resistance of the spark, which is usually a very considerable part of the total resistance. Furthermore the resistance of the spark varies throughout the wave train, being

relatively low at the start and increasing toward the end. As a result of this variation of spark resistance the oscillations decay more nearly according to a linear than a logarithmic function³. Dr. Chaffee of Harvard has experimentally shown by means of

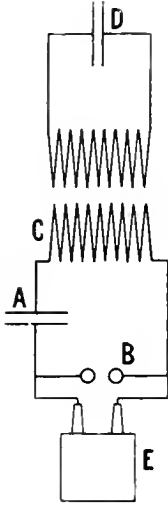


Fig. 4. Ordinary Coupled System

the cathode ray tube the linear damping characteristic of a high frequency spark⁴.

When oscillations of any very great amount of power are required the method of exciting the high frequency system, Fig. 1, by means of an induction coil is unsatisfactory, and a power transformer operating on a commercial supply system is substituted. With the high frequency system supplied by a power transformer special precautions are necessary to prevent the formation of a power arc at the gap, and to prevent the occurrence of a large number of discharges of varying initial voltages during one alternation of the low frequency supply voltage. To eliminate these troubles and to maintain a greater constancy of the oscillations various methods have been devised for rapidly extinguishing the spark, such as turning an air blast on the gap or placing the gap in the field of a powerful magnet; but probably one of the most effective methods is to replace the ordinary spark electrodes with a pair of heavy discs which are rotated by a suitable motor so that a spark occurs at a fresh place on the disk at every discharge.

Maintaining the regularity of the spark is greatly assisted by placing a suitable inductance in the low tension circuit of the trans-

former which charges the condenser; but this feature will be considered in more detail in connection with the quenched-spark system.

Fig. 4 shows the connections of an ordinary coupled oscillation system. The main condenser *A* is charged by the power transformer *E*, as in the simple system, and is discharged across the gap *B*, through the inductance *C*, which is the primary of an oscillation transformer, the secondary of which is in series with the condenser *D*. An equivalent auto-transformer can be substituted for the oscillation transformer without basically altering the operation of the system. The primary and secondary circuits must be in resonance or nearly so.

The practical advantage of the coupled system is that very high voltages can be produced in the secondary high frequency circuit without having a high resistance spark in the circuit. The spark, being in the primary, can be of a very moderate voltage. Thus where high voltages are required the coupled system is more efficient than the simple and oscillations of a lower decrement can be produced.

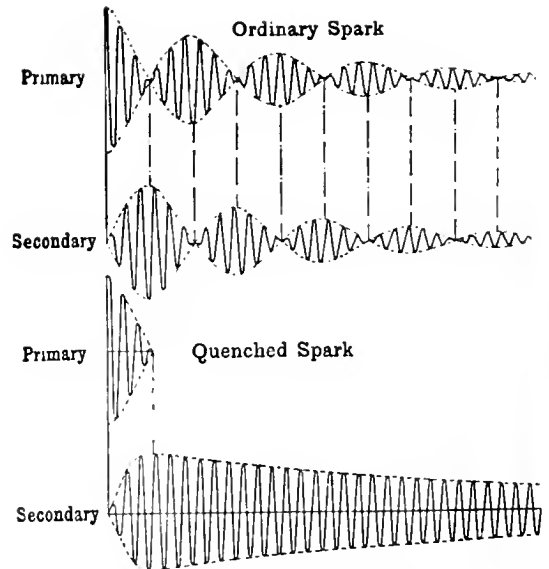


Fig. 5. Comparison of Ordinary and Quenched-spark Excitation of a Coupled System

The plain coupled system has one very serious defect. The oscillations produced by this method are split up into two frequencies, the wave trains being similar to those theoretically shown in Fig. 5. These oscillations of a coupled system can be shown by

means of the Gehrcke tube in the same manner as the oscillations of a simple system⁵. The two frequencies are theoretically given by the equation

$$f_1 = \frac{1-K}{2\pi\sqrt{LC}} \text{ and } f_2 = \frac{1+K}{2\pi\sqrt{LC}}$$

where K is the coefficient of coupling of the primary and secondary circuits.

$$K = \frac{M}{\sqrt{L_1 L_2}}$$

Where M is the mutual inductance of the circuits; L_1 , the primary inductance and L_2 the secondary inductance. In practice the foregoing equation for the two frequencies in a coupled system is only approximate since the damping characteristic of the spark in the primary circuit is not a negligible factor. The existence of these two frequencies in a coupled system is most easily shown by a resonance curve obtained by means of a wavemeter. Curve *B*, Fig. 6, shows a curve taken on an experimental coupled system at the Pittsfield laboratory. Oscillations of this type are hardly suitable for use in many high frequency investigations

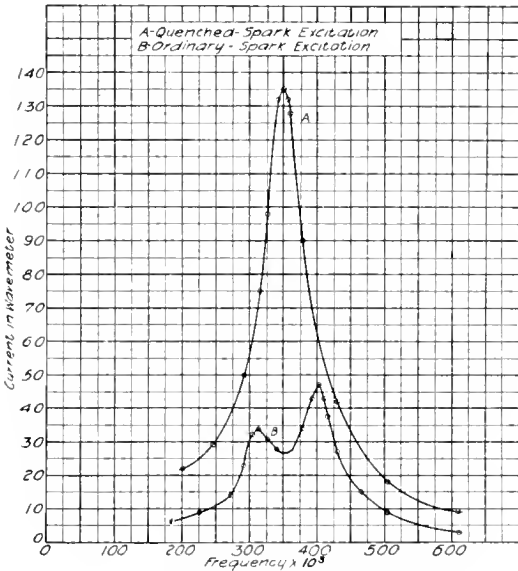


Fig. 6. Resonance Curves with Ordinary Spark and Quenched-spark Excitation

where any great accuracy is required, since wave trains of this complex nature would produce results of questionable value.

An interesting modification of the coupled system, producing single wave but operating on a different principle from the quenched-

spark system consists of the insertion of an atonic circuit between the ordinary primary and secondary circuits of a coupled system⁶. See Fig. 7. It is claimed that the use of this third circuit between the primary and secondary eliminates the coupling wave. This

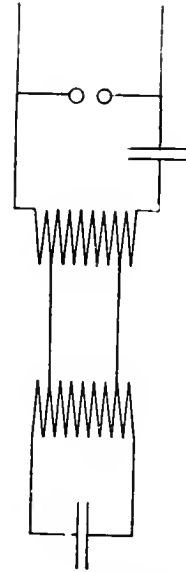


Fig. 7. Modified Coupled System for Producing Single Frequency

system is not so efficient as the quenched spark system but is claimed to be well suited for producing very powerful oscillations. Since it appears that the spark persists throughout the duration of the wave train in the secondary, it is probable that the oscillations have a linear damping characteristic similar to that of the oscillations produced by a simple system.

The oscillations produced by the quenched-spark system are of a single frequency and of characteristics which are determined almost entirely by the constants of the high tension high frequency circuits, which is circuit IV of the experimental quenched-spark system shown in Fig. 8. It will be noted that the only apparent difference between the connections of the ordinary coupled system and the quenched-spark system is the substitution of a special form of gap for the ordinary type of spark gap.

The type of oscillations produced by the quenched-spark method is shown theoretically in Fig. 5.

It was noted by Wien⁷ in 1906 that short spark gaps between metal surfaces very quickly recovered their resistance after the

passage of a spark. It has been found that a short gap, or series of short gaps, put in the place of the usual gap of the ordinary coupled system will extinguish the primary spark at the first node of the coupling wave (see Fig. 5) provided that the coupling between the two

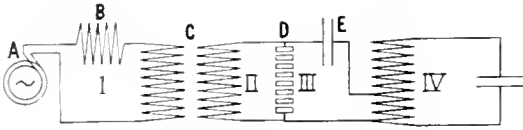


Fig. 8. Experimental Quenched-spark System

circuits is of a certain value, so that in effect the primary circuit III is open throughout the rest of the high tension wave train in circuit IV, Fig. 8. The purity of the wave produced in practice by the quenched-spark method is shown by the resonance curves secured by means of a wavemeter in the usual manner on an experimental system at the Pittsfield laboratory. See Curve A, Fig. 6 and Fig. 9. Each resonance curve in Fig. 9 was taken with a different value of resistance inserted in circuit IV, Fig. 8. The addition of resistance shows no change in frequency over the range covered, the only change being an increase in the decrement of the oscillations which is shown by the flattening of the resonance curves. All the curves in Figs. 6 and 9 would be much sharper had the damping factor of the wavemeter been lower.

An interesting point in connection with the quenched-spark system is that the power in the high tension high frequency circuit IV, Fig. 8, is constant over a considerable range of damping, the alternator voltage and frequency being held constant. This fact can be shown in two ways. If the resistance of the high tension high frequency circuit IV, Fig. 8, is increased the effective current decreases as would be expected from theory, and the primary current remains constant. See Fig. 10. If the power varied in circuit IV, the current would vary in circuit III. The gap therefore quenches uniformly over quite a range of damping in the high tension circuit IV. If the resistance inserted in circuit IV is varied in known amounts and the corresponding value of effective current noted, a curve can be drawn such as is shown in Fig. 11. The total resistance of the circuit is the sum of the resistance added plus the inherent resistance of the circuit, which includes copper losses, condenser losses and radiation.

The power at any point in the curve is given by the equation

$$P = I^2(R_H + R_L)$$

where I equals the effective current; R_H , the inherent resistance; and R_L , the added resistance. If the power is first assumed constant over the range explored,

$$P = I_1^2(R_H + R_{L1}) = I_2^2(R_H + R_{L2})$$

In this manner a series of simultaneous equations can be developed and the value of R_H determined. It is usually satisfactory to take the average value R_H as determined from a number of these equations since values derived from any given pair of equations may differ somewhat from the value determined from another pair, the difference being due to slight variations in the oscillations which affect the value of the effective current. The value of R_H determined by this method, and the added resistance multiplied by the square of the effective current gives the power at any point in the curve.

In this particular case the value of R_H was found to be 2.73 ohms and the power 476 watts. If a theoretical curve is plotted with a power of 476 watts with varying resistance,

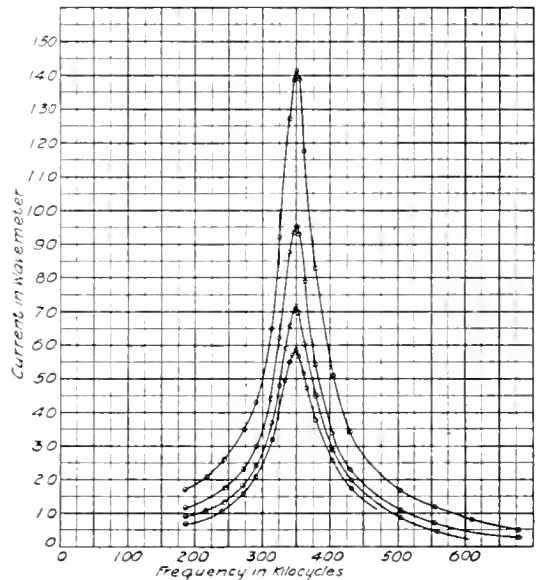


Fig. 9. Resonance Curves with Quenched-spark Excitation

the result is the curve shown in Fig. 12. The points observed in Fig. 11 plus the value of 2.73 ohms determined for the inherent resistance fall along the curve in Fig. 12 very well. A constant power of 476 watts is thus demonstrated with an inherent resistance of 2.73 ohms.

If the oscillations in circuit IV, Fig. 8, reached their maximum value during the first cycle of the wave train, which would be the case were the coupling between the high frequency circuits equal to unity, the maximum voltage in circuit IV would be given quite accurately by the equation, which applies directly to the simple system, Fig. 1.

$$E = \sqrt{\frac{2P}{NC}}$$

where P equals the power in watts; N the spark frequency; C the capacity of the condenser; and E the maximum voltage to which the condenser is charged.

Since in all practical cases the oscillations in circuit IV, Fig. 8, do not reach their maximum amplitude during the first cycle of the wave train (see Fig. 5) it follows that there is a loss in the resistance of circuit IV during the first few alternations while the oscillations are building up, so that the measured maximum voltage at high decrements is appreciably less than that given by the equation

$$E = \sqrt{\frac{2P}{NC}}$$

But at low decrements where the effective values of that portion of the wave train before the maximum are small as compared with the effective values succeeding the maximum, the calculated maximum voltage and the observed should check very closely. This is found to be the case in practice.

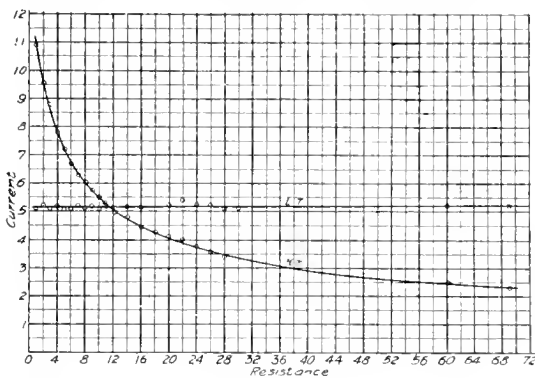


Fig. 10. Current in High and Low Tension Circuits of Quenched-spark System vs. Resistance

For satisfactory results and smooth operation of the quenched-spark system it is necessary that the coupling between primary and secondary high frequency circuits III and IV be of a certain value, and that the low frequency supply circuit be of a certain

critical reactance. The reactance of the low frequency system is adjusted by means of a variable inductance B in the low tension circuit of the power transformer C , Fig. 8. The required value of inductance in the low tension circuit of the power transformer is

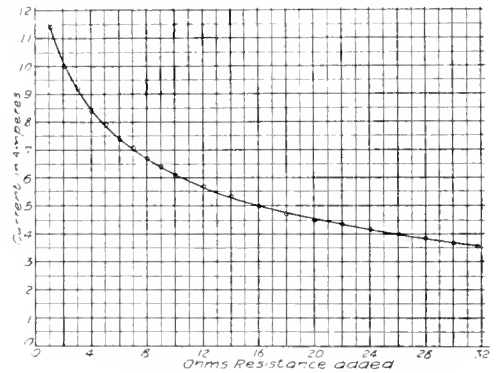


Fig. 11. Current-resistance Curve of Experimental Quenched-spark System

given approximately by the equation for resonance

$$L = \frac{1}{\omega^2 Cr^2}$$

where L is the inductance in henrys; measured in the low tension circuit I , Fig. 8; ω , 2π times the alternator frequency; C the capacity of the main condenser in farads; and r , the ratio of the power transformer. The value of L to produce resonance at any given frequency can be very readily determined

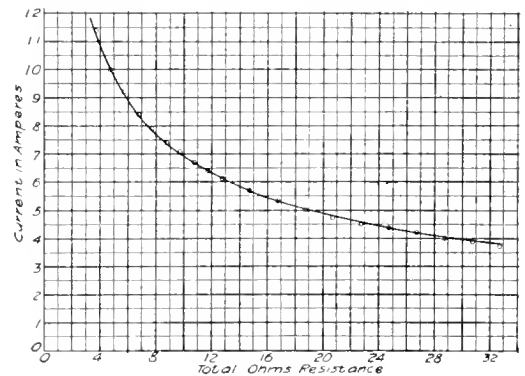


Fig. 12. Current vs. Total Resistance of Experimental Quenched-spark System

experimentally by measuring the current in the high tension circuit of the power transformer for different values of inductance with a given excitation of the alternator, care being taken that no discharges of the condenser occur during the measurements. Fig. 13

shows a resonance curve obtained in this manner with a quenched-spark system connected with a 420 cycle alternator. In the same manner it is possible to obtain similar curves for other frequencies. When the low frequency system is adjusted for resonance,

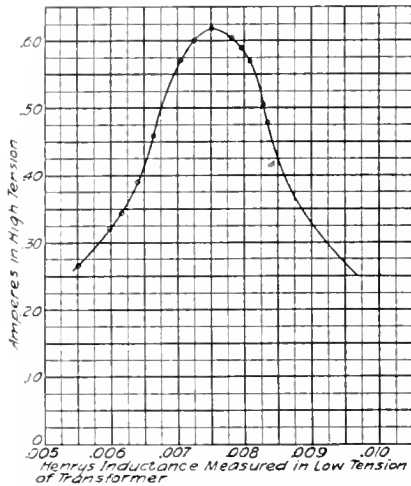


Fig. 13. Resonance Curve of Low-frequency System

with no discharges occurring, the voltage across the condenser *E*, Fig. 8, has a phase angle of 90 deg. in respect to the alternator voltage. Under these circumstances if a discharge occurred at the maximum voltage of the condenser it would bridge the gap *D* at zero voltage of the alternator and no power arc could occur, a condition which is necessary for satisfactory operation of the quenched gap. In practice it is found that a value of inductance somewhat in excess of the value required to produce resonance under steady conditions gives the best results. With proper adjustment of the system there is no difficulty in causing the discharges to occur with absolute regularity. Fig. 14, an oscillogram of voltage taken in the low tension circuit *I*, Fig. 8, shows one discharge per alternation occurring with a 420 cycle supply. The crest in the top of each voltage wave denotes the occurrence of a discharge. The same thing can be shown at other supply frequencies.

The same general rules govern the adjustment of the inductance in the low frequency circuits of the simple system, Fig. 1, and the coupled system, Fig. 4; but in these cases there are certain other factors to consider. With the quenched-spark system the primary spark may last only 11×10^{-6} seconds at an

oscillation frequency of 360,000 cycles and the power transformer is short-circuited through the gap only a very small fraction of time. With the simple, or plain coupled system, the spark for the same oscillation frequency persists for a very much longer time unless the damping is extremely high, so that the time during which the power transformer is short-circuited may not be a negligible factor. This point is particularly important in case high spark frequencies are desired.

In order to maintain a satisfactory constancy of the oscillations produced by the quenched spark method it is important that the surfaces of the discharge electrodes should be affected by continual use as little as possible. The previously described method of "resonance working" reduces the wear to a minimum with any given metal used as electrodes; but the metal itself is of the utmost importance. Experiments have shown zinc to be quite unsatisfactory. Aluminum probably gives somewhat better results⁹, copper gives good results with stationary electrodes, if frequently cleaned, but silver is very much more satisfactory and will last under much more severe conditions than copper. Platinum¹⁰ is probably superior to silver; but the writer has found tungsten electrodes to wear the least of any. Tungsten has also been used to some extent for this purpose in wireless telegraphy¹¹.

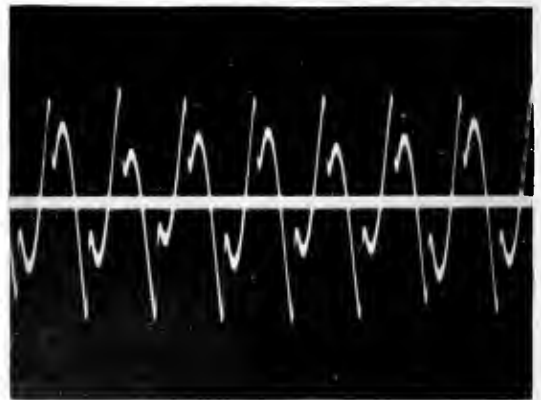


Fig. 14. Voltage Wave at 420 Cycles showing the Occurrence of One Discharge per Alternation

The high efficiency of the quenched-spark system is of considerable importance in some cases. The power in circuit IV, Fig. 8, may be 70 to 80 per cent of the power supplied by the alternator in circuit *I*.

In conclusion it can be said that the simple system, Fig. 1, is the most convenient to use in high frequency work where no great accuracy of measurements is required. On account of the resistance of the spark it is not suited for producing oscillations of low decrement, especially at high voltages. The frequency of the system can be readily varied by changing either or both the capacity and inductance of the circuit. If the system is supplied by a power transformer operated on the principle of the resonance transformer it is more satisfactory to change the value of the high frequency inductance than the capacity, since a change in the capacity would necessitate a corresponding change in the inductance of the low frequency system if the low frequency system is to be operated at resonance at the alternator frequency.

With the ordinary coupled system, where the high and low tension high frequency circuits, see Fig. 4, are tuned to the same, or about the same frequency, the oscillations are of such a complex nature as to be of questionable value in very extended high frequency investigations. As in the simple system, the frequency of the oscillations produced by the coupled system can be varied by changing the values of the constants of the high frequency circuits; but where such a change is made with the coupled system, it is usually necessary to also vary the coupling between the two high frequency circuits, so that, if changes in frequency are to be made very often it is usually best to provide an

oscillation transformer designed especially to meet these conditions.

The point of greatest importance in connection with the quenched-spark system is that very regular oscillations of a single frequency can be produced at decrements of the order of 0.03-0.04 per complete period with an efficiency of 70 to 80 per cent. In certain cases somewhat lower decrements can be maintained. The decrement can be varied by inserting a damping resistance in the high tension high frequency circuit IV, Fig. 8. The system is very well suited for operation at high spark frequencies, and can also be run at relatively low spark frequencies. More skill is required in operating an experimental quenched-spark system than the simple system, especially if changes in the oscillation frequency or spark frequency are to be made often, but with apparatus designed especially for such changes the system would require considerably less attention.

REFERENCES

- ¹ E. Gehrcke, *Verhandl. Physik Ges.* 6, 176, 1904. *Zeitscher. f. Instrumentenkunde* 15, 33, 278, 1905; also J. Zenneck—*Lehrbuch der Drahtlosen Telegraphie* p. 5.
- ² Ernst Ruhmer—"Wireless Telephony"—p. 168.
- ³ J. Zenneck, *Ann. der Physik*, March, 1904, Vol. 13, p. 822; or *Science Abstracts*, July, 1904, Vol. 7, A.
- ⁴ E. Leon Chaffee—*Journ. Franklin Institute*—Vol. 173, p. 466, May, 1912.
- ⁵ H. Diesselhorst, *Ber. Deutsch. Physik. Ges.* 5,320, 1907—6,306, 1908—*E.T.Z.* 1908, 703.
- ⁶ *Lumiere Electrique*, July 11 and July 18, 1914.
- ⁷ M. Wien, *Physikalische Zeitschrift*, No. 23, December, 1906, p. 872.
- ⁸ H. Rau, *Jahrb.* 4, 52, 1910.
- ⁹ M. Wien, *Jahrb.* 1, 469, 1908. 4, 135, 1911. *Ann. Phys.* 25, 625, 1908. *Phys. Zeitschr.* 11, 76, 311, 1910.
- ¹⁰ H. Boas—*Deutsch. Phys. Gesell., Vehr.* 13, 14 pp. 527-539—July 30, 1911.
- ¹¹ H. Boas—*Deutsch. Phys. Gesell., Vehr.* 15, 21, pp. 1130-1149, Nov. 15, 1913.

THE THEORY OF LUBRICATION

By L. UBBELOHDE

Translated for the GENERAL ELECTRIC REVIEW from *Petroleum*

By HELEN R. HOSMER

RESEARCH LABORATORY, GENERAL ELECTRIC COMPANY

PART III

IV. INVESTIGATIONS OF THE FUTURE

This installment concludes the series on "Lubrication." The former sections covered "Fundamental Physical Principles," "Laws of Friction in Lubricated Machine Bearings," and "Failure of Oil Testing Machines." The following section treats of the "Investigations of the Future" and describes very completely "Combined Oil and Graphite Lubrication."—EDITOR.

Although mechanical oil testing according to the present day usage will be done away with in the future, yet systematic investigations of friction can bring about an important advance in another direction. In illustration of this I will go back again to the curves of Fig. 6, and recall the fact that the frictional resistance in bearings depends upon the relative velocity of the rubbing surfaces, the pressure per unit area, the difference in diameter of bushing and journal, and the viscosity of the lubricant, as is shown also by equation (13). If it is a question, then, of choosing a lubricant for a certain bearing whose velocity, pressure, and difference of diameters are known, an oil should be taken of such a viscosity at the temperature of the bearing that it will stand at the lowest point of the curve (see Fig. 6), and in this way the optimum lubrication will be obtained. Under conditions otherwise similar, oils of increasing viscosity should be chosen as the pressure increases or the velocity diminishes, and oils of decreasing viscosity as the pressure diminishes and the velocity increases²².

Hence the lubricant *par excellence* in a mechanical sense does not exist. For each case there is a most suitable lubricant which can only be characterized in this regard by its viscosity. At present it is not known what viscosity will give the smallest coefficient of friction for each of the individual combinations of pressure and velocity. Hence systematic investigations of friction must be made for this purpose²³.

Types of bearings used in practice, with the most accurate definition possible of bearing and journal, as well as the determination of the difference of diameter, must be employed in these investigations, and not the oil testing machines, whose friction bearings differ entirely from the typical bearing. By such investigations would be rendered possible

a comprehensive orientation of conditions such as is now entirely lacking. They would constitute an effective advance and render a great service to technology. Similar systematic investigations could produce a like enlightenment as to conditions in other machine parts, such as the pistons of steam engines, valves, etc. The many difficulties of these investigations are yet to be overcome.

So much for simple oil lubrication. A wholly new and very important aspect of the matter is opened up by a method of oil and graphite lubrication recently made known. This will be considered in the following section.

V. COMBINED OIL AND GRAPHITE LUBRICATION

It has already been shown in Section II, (page 1078) that in the practical operation of machines one must take into consideration not only the fluid friction in the bearing but also the dry friction between the bushings and the journal, especially at low velocity, or at high pressure, or with both of these conditions existing simultaneously. The entire predominance of the dry friction over the fluid in this case can be seen by comparing the experimentally determined curves in Fig. 6 (page 1077) with the computed curves in Fig. 4 (page 1076). The fluid friction alone can produce only a slight increase of frictional resistance on the left ascending branch of the curves, in fact, only about 6 per cent in μ_{min} . (See page 1076.) The increase found in practice is, however, 500 times larger than this, and raises the coefficient of total friction at U_0 to nearly 25 times μ_{min} . Under the conditions this extraordinary

²² The author has previously pointed out this relation in "Post Chem.-techn. Analyse, Braunschweig 1906-7, Bd. 1, Heft 2, p. 327.

²³ This has already been begun at the Karlsruher Technischen Hochschule.

increase must be attributed to dry friction as well as fluid playing a part, and making up a greater or less fraction of the total frictional resistance according to circumstances.²¹

Now in order to obtain the optimum lubrication, the dry friction should be avoided as far as possible by using a lubricant of high viscosity. However, this presents very great difficulties in practice. The attainment of the optimum depends upon the following points:

1. Maintenance of a constant velocity.
2. Maintenance of a constant pressure.
3. Availability of a constant viscosity in the oil.
4. Dimensions and high polish of the bearings and journals.

But in practical machine operation it is not possible to fulfill all these conditions continuously, for the following reasons:

1. The velocity varies greatly; consider for instance, rolling stock on a railroad.
2. The load varies, as, for instance, in case of belt pressure, concussion, deflection of the shaft, etc.
3. The viscosity of the oil changes with the temperature.
4. The character and dimensions of the bearing alter, because of the temperature, wear, etc.

All of these causes work together in producing the result that dry friction enters into almost all cases, not only increasing the frictional resistance tremendously, but also at length altering the bearing by wearing and grinding, and thus constantly supplying further cause for dry friction.

The means must be sought, then, not to avoid dry friction, but to decrease it as much as possible.

We know that in Coulomb's law

$$R = \mu \cdot N,$$

which refers to dry friction, the constant is dependent upon the character of the surfaces, and is large when the surface exhibits large inequalities. The coefficient of friction for machine bearings is therefore noticeably higher when the journal and bearing have not been sufficiently well ground, and smallest when they have a high polish. Nevertheless, there are always some inequalities, and dirt in the bearing produces more as time goes on.

But there has been available for some time a means of reducing dry friction, viz., the so-called graphite lubrication. Finely

divided graphite has the property of levelling up the hollows in the surfaces, thereby diminishing the coefficient of friction.

Yet simple graphite lubrication cannot in most cases be substituted for oil lubrication, since the coefficient of dry friction even then would be many times greater than that for fluid lubrication; and moreover the application of the powdered lubricant to the sliding surfaces presents difficulties. A combination of graphite and oil lubrication is, however, of the greatest advantage, since the graphite reduces very considerably that part of the total friction due to direct contact of journal and bearing (dry friction), while the advantages of oil lubrication are all retained.

The use in practice of this combination has formerly been subject²⁵ to the difficulty that it was not possible to obtain a mixture of graphite and oil of sufficient uniformity.

An important advance came about through the discovery of Edward G. Acheson, described below:

An artificial graphite²⁶ made according to the well known Acheson process in the electric furnace and already used in large quantities for various purposes is employed, for the purpose under consideration two properties are of especial significance: first, Acheson graphite consists of almost pure carbon, while natural graphites contain varying amounts of other constituents which corrode the bearings and make their use for lubricating processes always uncertain; second, and specially important, is the fact that the Acheson graphite, because of the special method of preparation, is extremely finely divided, so much so that the particles exhibit Brownian movement. According to the measurements of M. Alexander²⁷ with the ultra microscope, the particles are of the order of magnitude of $100 \mu \mu$.

If this powdered graphite without further treatment be combined with water, it forms a temporary emulsion which settles out after a short time. Moreover, the graphite can be filtered off from this water emulsion without difficulty. Acheson produced, however, perfectly stable emulsions, which could not be separated by filtration, by treating²⁸ the

⁽²¹⁾ In general the part due to dry friction will be large, for it would appear that thin lubricants are used in most cases. The viscous oils are too expensive.

⁽²⁵⁾ See B.D.R., 140, 882, April 22, 1902. In this patent are proposed, besides graphite, mica and talcum.

⁽²⁶⁾ See M. F. Fitz-Gerald, *Kunstlicher Graphit, Monographien über angew. Elektrochemie* 15, (1904): see also P. Werner, *Ueber Acheson-Graphit als Schmiermittel*. *Ztschr. f. Chemie u. Industrie der Colloide* 7, 161 (1910).

⁽²⁷⁾ See Deflocculation. *Jour. Ind. Eng. Chem.* 4, No. 1 (1912).

⁽²⁸⁾ *Jour. Soc. Chem. Ind.* 29, 244 (1910), also *Jour. Ind. Eng. Chem.* 4, No. 1 (1912). The process has been patented in all countries since 1907. D.R.P. 191, 840, April 4, 1907.

specially prepared and powdered graphite with tannin.

For the details of the process, see the patent and publications of the inventor²⁹. It may be mentioned, however, that the effect of the tannin is to be accounted for by its well known and powerful effect upon the surface tension.

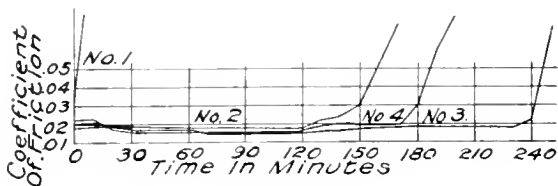


Fig. 11

This graphite is on the market as a paste in two forms, as "Aquadag" and as "Oildag"³⁰. The former contains, besides the graphite, water, and is for preparing water emulsions; the latter contains oil, and is suitable for making graphite-oil emulsions.

Mixtures of "Oildag" and any oil desired³¹ are used for lubricating. Only small quantities, about $\frac{1}{2}$ per cent of Oildag, are added, and mixed by stirring. The resulting emulsion may be used like the ordinary lubricants. According to the investigation of L. Archbutt³², it will pass through wick lubricators, etc., without any separation³³.

Several investigations concerning the reduction of friction by the Oildag-Oil mixture, have been published. Prof. C. H. Benjamin of Purdue University³⁴ has found that with a bearing pressure of 8.7 kg. per sq. cm. and 500 revolutions per minute, the frictional resistance of a bearing lubricated with a mixture containing $\frac{1}{2}$ per cent of graphite in the oil is only 60 per cent that with oil alone. After an hour the frictional resistance becomes 50 per cent.

Exhaustive researches by Prof. Charles F. Mabery³⁵ have shown that the coefficient of friction with the mixture of Oildag and oil is markedly lower than with simple oil lubrication. Especially interesting are these investigations of Mabery's which prove that even after an addition of only 0.35 per cent of graphite, the lasting qualities of the oil are significantly greater, and the amount of oil may be reduced one-half and still have the coefficient of friction smaller than before. This is illustrated by curves determined with a Carpenter Machine.

The tests shown in Fig. 11 were carried out with a pressure of 150 lb. per sq. in. and a velocity of 445 revolutions per minute.

As abscissæ is taken time in minutes, and as ordinates coefficients of friction. The oil used was spindle oil.

Curve 1 is oil alone, supplied at a rate of 6 drops per minute.

Curve 2 is oil alone, supplied at a rate of 8 drops per minute.

Curve 3 is oil with 0.35 per cent graphite, at a rate of 8 drops per minute.

Curve 4 is oil with 0.35 per cent graphite, at a rate of 4 drops per minute.

After 120 minutes the oil supply was shut off for all cases.

It should be noted on curve 1 that oil alone, supplied at a rate of 6 drops per minute, was quite inadequate.

Eight drops per minute (curve 2) was sufficient, but shortly after cutting off the supply the coefficient of friction increased very rapidly.

In curve 3 (with 0.35 per cent graphite) it is shown that not only with this last rate of supply is the coefficient of friction lower, but the oil lasts about four times as long after stopping the supply, as does oil without graphite. The graphite mixture at half this rate of supply (curve 4) produces a smaller coefficient of friction, and twice as long a retention of the lubricant after stopping the supply.

Fig. 12 shows very high pressure, 1200 lb. per sq. in., and a velocity of 444 revolutions per minute. As particularly suitable to the high pressure, a viscous American cylinder oil was used with bronze bushings. After 120 minutes the oil supply was shut off. It can be seen that the coefficient of friction with oil alone is considerably higher than that with oil to which 0.35 per cent of graphite has been added. The latter also lasted six times as long after the oil supply was cut off.

Oildag appears to have operated well in the cylinders of steam engines. The reports of comprehensive tests on the Government railways are favorable. Moreover, a considerable saving of oil in hot vapor cylinders is indicated.

(²⁹) See preceding footnote.

(³⁰) Furnished by Deutschen Acheson Oildag Company, Berlin, Friedrichstr. 61.

(³¹) The lubricating oil must contain no acid constituents, as otherwise the graphite will not stay completely emulsified.

(³²) Journ. of the Society of Chemical Industry. Dec. 30, 1911, No. 24, Vol. XXX.

(³³) There are also other trade products. These are, of course, made from natural, non-emulsified graphite, which, as mentioned above, does not exhibit the same lubricating properties.

(³⁴) According to Nach Ztschr. d. Bay. Revisions-Vereins 1908, S. 5-7.

(³⁵) Charles F. Mabery of the Case School of Applied Science of Cleveland, Ohio. Presented at the January, 1910, meeting of the American Society of Mechanical Engineers.

From all these investigations it appears that, in accordance with the theory, graphite properly prepared produces an extraordinary reduction of the coefficient of friction. Apart from this reduction in the coefficient of friction, which is extremely important from an economic point of view, the diminished wear of the bearing and cylinder materials, as well as the reduction in the amount of lubricant required, is very important in lowering the cost of operation. All of these factors increase considerably the coefficient of safety during operation, so that with oil

lubrication the machine parts can be much more safely overloaded than in other cases. This is of especial importance in light motors, aeroplanes, automobiles, etc.

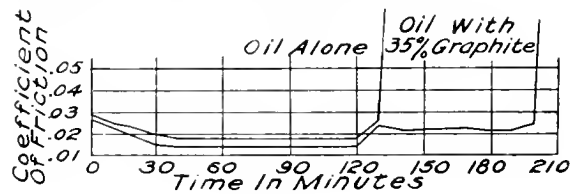


Fig. 12

A MODERN ACID-DIPPING, ELECTROPLATING AND JAPANING PLANT

By HORACE NILES TRUMBULL

SWITCHBOARD SALES DEPARTMENT, GENERAL ELECTRIC COMPANY

It has been so universally true that electroplating rooms are unhealthful that one has almost come to accept the belief that they must be so. Therefore it is of particular interest to read the following article which describes a recent establishment that offers its workers hygienic conditions equally as good as those existing in a well designed and operated factory. The article describes in detail the heating and ventilating of the building, and the mechanical and electrical equipment which is used to carry on the work of acid dipping, electroplating, and japaning.—EDITOR.

The various practical considerations involved in the production of manufactured articles require that the factory manager be ever on the alert to obtain whatever advantages may accrue from the use of the most efficient machinery and methods available. Under present day conditions, he must continually strive for both increased output and lower manufacturing cost. There is thus constantly before him the problem of determining whether to continue under existing conditions or to retire some or all of the present equipment in favor of other apparatus more recently developed.

The human factor must be considered also. There is a general agreement among thoughtful and experienced minds that, based on utilitarian principles alone, the environment of the workman is of great importance and worthy of careful attention.

In the case of perhaps the majority of electroplating establishments the general conditions in vogue certainly leave much to be desired from several standpoints. A description of a modern plant, which in completeness of working equipment and means of safeguarding the health of employees is unsurpassed, will be of interest.

This plant is a part of the Switchboard Department of the General Electric Company and is centrally located with regard to the various manufacturing sections of the

department from which it receives its work. The building is a one-story brick structure as shown in Fig. 1 and is divided into three rooms; one for acid dipping, one for electroplating, and one for japaning and enameling. It is lighted through a large amount of window space located both on the sides and top of the building. To aid the lighting system the interior of the building, with the exception of a five-foot border around the wall at the floor line which is treated with asphaltum, is finished with ecru paint.

The floors are of concrete and are kept dry by draining into sewer inlets. The floors of the dipping and plating rooms are, in addition, treated with asphalt and granite dust to make them acid proof.

The means of heating and ventilating these rooms is quite unique. For heating, what is known as the direct-indirect system is employed. Air enters the building through the several openings seen in Fig. 1 near the ground line and then passes up through steam radiators, which are of course heated in cold weather only. The radiators, one of which is shown in Fig. 2, are located in the interior of the building against the wall and above the air entrances.

The vitiated air is removed by a 35 h.p. motor-driven fan through a particularly effective system of hoods, flues, and ducts. Over the dipping tank (Fig. 3) and over the

cleaning tank (Fig. 4) a specially designed hood extends out from the wall at an angle of 60 degrees. Gases, fumes, and steam from the tanks, together with air from the room, are drawn up into the hoods through slots 12 inches long, ranging from $1\frac{1}{4}$ to $1\frac{3}{4}$



Fig. 1. Acid Dipping, Electroplating and Japanning Plant

inches wide. These hoods are divided into six sections, corresponding to the six sections of the tanks, and each section of hoods is provided with five slots or vents. From the vents the air is drawn through flues into the main duct which leads to the intake of the fan. Any section of the hoods may be shut off from the main duct by slides in the flues, to economize power when all sections of the tanks are not in use. The fan is located outside the building, rotates at a speed of 800 r.p.m., and develops a pressure of $3\frac{1}{4}$ oz per sq. in. It forces the exhaust of the building up a steel stack, which is higher than the surrounding buildings. This stack may be seen in Fig. 1. The fan, motor, and stack are treated with acid-proof paint.

The combined volume of the two rooms is 51,100 cu. ft.; and the ventilating system removes the steam and acid fumes above the dipping and cleaning tanks immediately and completely changes the total volume of air once every minute and a half. Thus the atmosphere in the room is kept fresh and pure, so that all danger to occupants from breathing impure air is avoided.

The painting and baking room is heated by radiation from steam pipes and is ventilated

by means of tilting-sash windows in the cupola.

The work of acid dipping is carried on in the usual manner, the dipping solutions being in removable earthen vats placed in reinforced concrete tanks along the wall (Fig. 3). Running water and steam is piped to these tanks which are connected to sewer drains.

Next to the dipping room is the plating room, a general view of which is shown in Fig. 5. On a balcony or platform overhead will be noticed three motor-generator sets. These furnish current at 5 or 10 volts for plating. Two of these sets are of 837 amperes capacity. They are supplied with double commutators which may be connected in parallel for 5 volts or in series for 10. The third set has a 600-ampere, 10-volt generator. The generators are separately excited

from the factory power system.

Below the balcony is the three-panel switchboard (Fig. 7) which controls the motor-generator sets and the three main

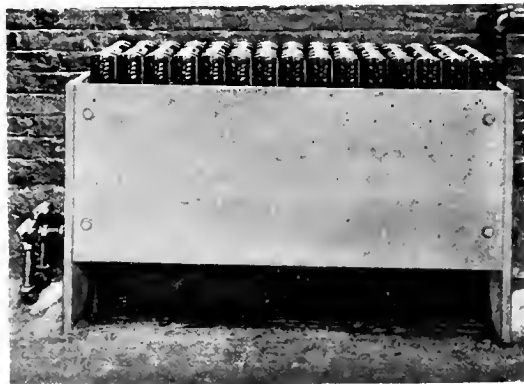


Fig. 2. Direct-indirect Steam Heating Unit

feeder lines. The feeders carry current at either 5 or 10 volts, depending upon the position of the three lower switches on the right-hand panel. On the lower section of each panel is a twin pull-button control switch which controls contactors for starting

or stopping the motor-generator sets. A circuit breaker is provided for each motor armature circuit and each generator field circuit. In case of overload, series overload relays in the generator circuit trip the generator field breakers. The switchboard is so arranged that all generators may be operated in multiple or any generator may supply any feeder.

Instead of obtaining the desired voltage by means of bulky rheostats mounted at each plating tank, sets of contactors are used, these being mounted on pipe framework suspended from the ceiling. One set is provided for each tank. At the tank is a pedestal (Figs. 8 and 9) on which are mounted a voltmeter, a clock dial, and a series of push-button switches. These push-button switches operate the contactors. For each tank there are six contactors, with resistances arranged in parallel, which give a control equal to a dial rheostat of thirty-six contact points.

In the plating room (Figs. 5 and 6) silver, nickel, copper, brass, and zinc plating and oxidizing are done. The equipment includes cleaning tanks, two spiral conveyer plating machines, four rotary-barrel plating machines and four still plating tanks. All plating machines are motor driven, the motor being run from the factory power system; all plating tanks are made of reinforced concrete.

The tanks for the two spiral conveyer plating machines are each three feet wide, three feet deep, and twenty-four feet long (inside dimensions). The walls are four inches thick and the top surface of the tank is thirty inches above the floor level. These two tanks are equipped with spiral conveyer plating machines. By referring to Figs. 6 and 8, an idea of the operation of this machine may be gained. A worm in the casing, extending along the end of the tank, is belted to a motor. This worm is geared to two long spiral conveyers which extend the length of the tank above the solution. These conveyers are connected at the farther end by a U-shaped rod over which rotates a disk with fingers that slide on the rod (Fig. 6). The work to be plated in this machine is hung on the lower end of S-shaped hooks. The upper end of each hook is hung on the continuous groove of the conveyer. As this conveyer revolves, the hooks advance along the groove or thread and draw the work through the plating solution. When the hooks reach the end of the first conveyer they are mechanically transferred to the beginning of the second conveyer, by being pushed along the U-shaped rod by

the fingers on the rotating disk. The work is thus moved through an arc of 180 degrees, then caught by the thread of the second conveyer, and in time is returned to the starting end of the tank. Work may be continually supplied to and removed from the machine by one man, and a large quantity completed in a short time. As this plating machine is run by a variable speed motor, the time of travel through the solution may be regulated to suit the conditions of various kinds of electroplating, the time to complete the travel varying from half an hour to an hour and a half.

There are two large and two small rotary plating barrels to accommodate work so shaped that it cannot easily be hung on conveyer hooks. The rotary plating barrel (Fig. 9) consists of an octagonal cage on a shaft and a concrete tank. In Fig. 5 the cage is shown raised and ready to be loaded. After loading, the cover is replaced and the cage lowered into the tank where its supporting shaft fits in bearings. The cage is then revolved in the plating solution by a motor located outside the tank. As the cage revolves, the work is tumbled which facilitates the plating. For assistance in loading and unloading the plating barrels, two air hoist equipments are provided. Very large or special work is plated in the still tanks.

No hot plating solutions are used, as baths have been developed which, when cold, plate as quickly as the old hot processes. All water used for plating solutions is distilled. All water used for cleaning is filtered. The still and filter are mounted on the wall above the cleaning tanks (Fig. 4).

The cleaning tanks are similar in construction to the acid dipping tanks. The cleaning compounds that are used hot are heated by steam coils. In place of the old method of stirring cleaning solutions by means of flappers run by rods from eccentrics on a line shaft, the solutions are agitated by admitting jets of compressed air into the bottom of the tanks from a pipe having a number of small holes. The air bubbles up through and thoroughly agitates the solution, giving excellent results. An air compressor furnishes air for the agitators and the air hoists.

The third section of this building is devoted to painting and baking. The sanding necessary on filled castings, and the painting are done on the bench along the wall shown in Fig. 11. Openings on this bench are connected by gooseneck pipes under the bench to exhaust



Fig. 4. Portion of Electroplating Room showing Cleaning Tanks, Ventilating Hood, Water Filter and Water Still

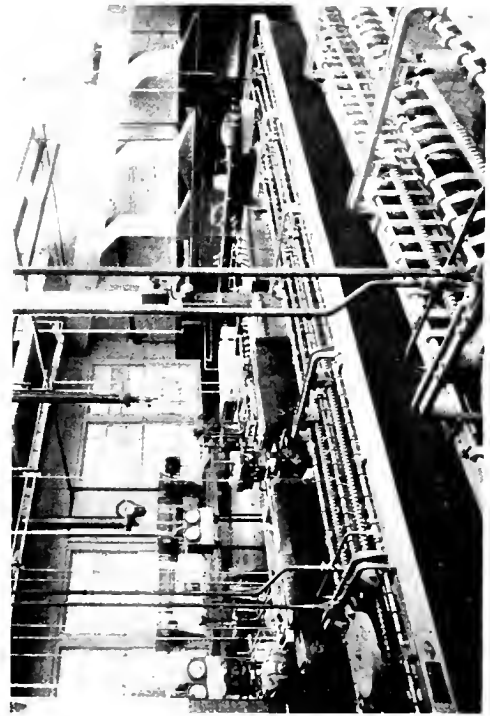


Fig. 6. Portion of Electroplating Room showing Spiral Conveyor Plating Machines



Fig. 3. Portion of Acid Dipping Room showing Dipping Tanks and Ventilating Hood



Fig. 5. Portion of Electroplating Room showing Power Plant on Balcony and Contactor System

fans which effectively remove all dust when sanding and paint motes when spraying.

Articles to be japanned are dipped in the tanks shown in the foreground in Fig. 11, and then placed on adjustable shelves or hung from racks in the electrically heated revolving bake oven.

This oven consists of a square brick room open on part of one end and lined with non-pareil insulating brick which is sprayed on the exposed surface with silicate of soda. In the oven is a motor driven turntable on which is built a steel cylinder ten feet in diameter and nine feet high, containing two opposite compartments with openings cor-

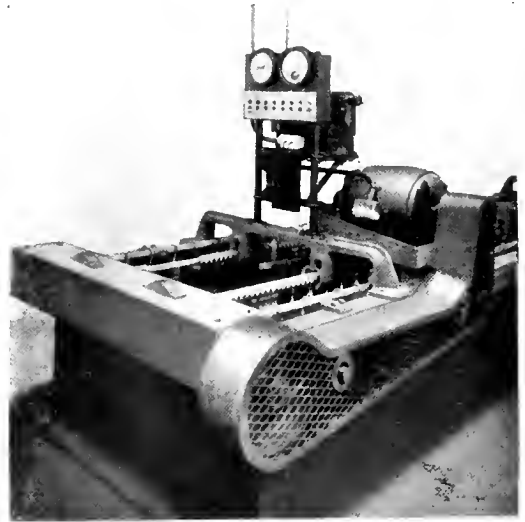


Fig. 8. End View of Spiral Conveyer Plating Machine showing Pedestal for Regulating Plating Voltage and Speed of Conveyer

where it may be unloaded and reloaded. If the turntable is turned 90 degrees instead of 180 degrees, both compartments will be in the baking zone.

The wire mesh gate shown raised in Fig. 11 is a safety device, and when in this position allows access for loading and unloading. It is necessary for the gate to be in the lowered

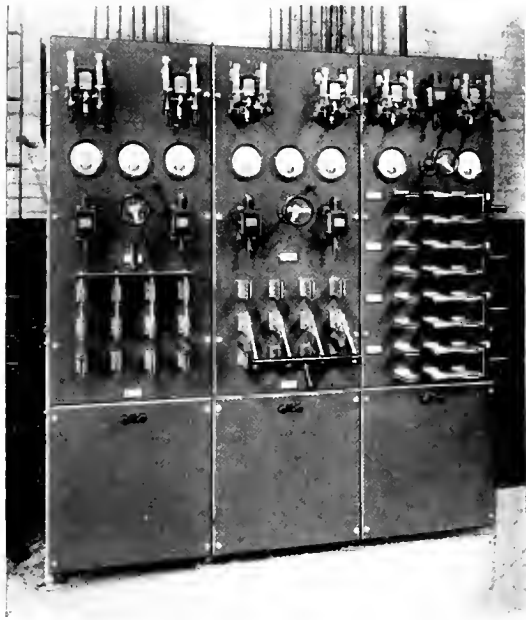


Fig. 7. Switchboard in Electroplating Room

responding to the opening in the brick wall. In the space between the brick wall and the steel cylinder there are placed a sufficient number of electric heaters, consisting of resistance grids, to bring the temperature of the oven to 500 degrees F. When the turntable is in such a position that one of the openings of the cylinder is in line with the opening of the brick wall, that compartment of the cylinder may be loaded with the material to be baked. After this is done, the turntable is revolved through 180 degrees. The loaded compartment is then in the baking position. The other compartment of the cylinder has now swung round to the position

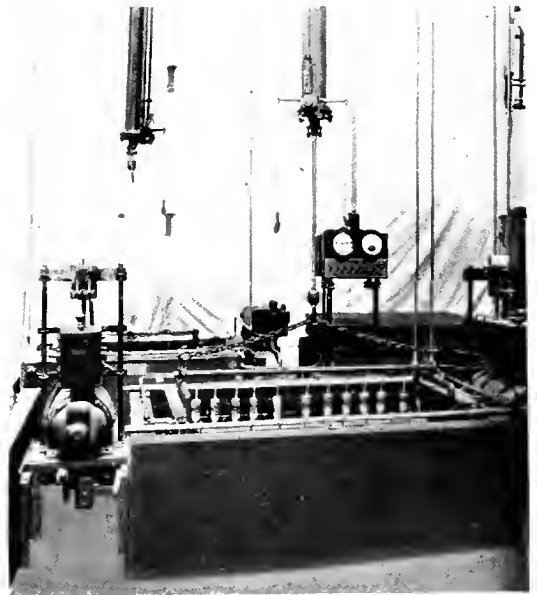


Fig. 9. Motor-operated Rotary Plating Barrel in Operating Position—Air Hoist Above



Fig. 10. Switchboard for Controlling the Heating of the Baking Oven

position before the driving motor circuit can be completed, thereby preventing movement of the turntable when the gate is up but allowing the table to be revolved at the proper time without danger of accident to the operator or others.

A means taken to conserve heat consists of two vertical doors or flaps along the edges of the oven opening, which press against the revolving cylinder and close to the outer air the zone between the oven and the cylinder. When the cylinder is revolving the flaps are drawn to one side automatically.

Clock dials, conveniently located, are used to show the time of placing a load in the oven. A dial thermostat located under the clock dials indicates the inside temperature of the oven. Behind the oven is located the switchboard (Fig. 10) which controls the heating of the oven. On the switchboard are mounted an ammeter, a circuit breaker, a relay, a lever switch for each bank of heating resistances and two single-pole contactors which are controlled either by a lever switch or an automatic time switch. By use of the automatic time switch, which has a resetting device, the current may be automatically shut off from the heating resistances at a predetermined time and turned on again when desired. Thus the work can be safely left baking when the attendant goes home at night, and when he arrives in the morning the oven will be at the required temperature and ready for the next load.

The oven and equipment are unique in design, and very efficient in operation. The objects accomplished by this revolving oven are; (a) continuous baking may be obtained without having to bring the temperature from that of the room to the baking temperature at each loading, (b) there is no fire risk as with gas-heated ovens, and (c) the turntable feature allows the work to be handled close to the oven so that floor space is economized and the distance necessary to carry the parts reduced to a minimum.

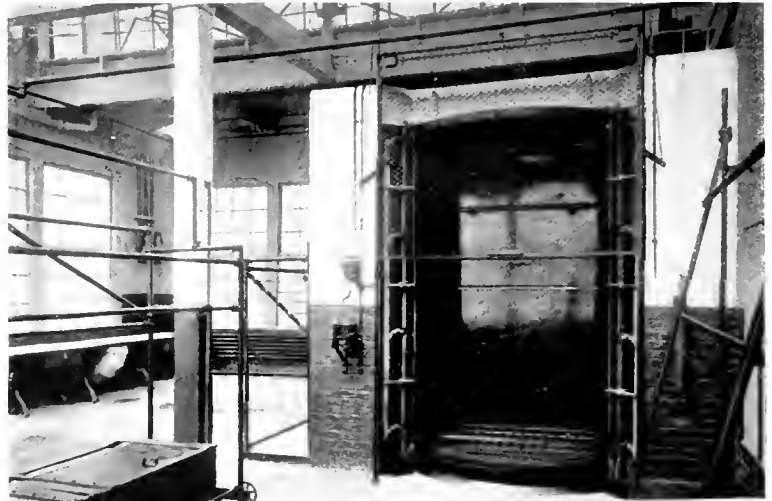


Fig. 11. Painting and Baking Room showing Paint Bench and Electrically Heated Revolving Oven—Oven in Loading Position

PROTECTION OF RAILWAY SIGNAL CIRCUITS AGAINST LIGHTNING DISTURBANCES

BY E. K. SHELTON

LIGHTNING ARRESTER ENGINEERING DEPARTMENT, GENERAL ELECTRIC COMPANY

The subject matter of the following article is well explained in its title. The author first classifies the various types of automatic block and interlocking signal systems and their circuits, and then classifies the apparatus that is to be protected on each circuit. Following these are statements of the locations where trouble is likely to occur due to disturbances, and descriptions of how the troubles can be eliminated by properly selecting and installing lightning arresters.—EDITOR.

The modern systems of railway signaling in this country all operate on the well-known automatic block and interlocking principle. They can be classified in three types or groups, viz., the mechanical, the electro-pneumatic, and the all-electric. The successful operation of the second and the third types is largely due to the effectiveness of the apparatus that protects their electrical elements against lightning disturbances. Consequently, a description of this protective apparatus and its operation should be of interest.

In studying the protection of these systems against lightning there are three main factors to be considered: first, the nature of the circuit and the importance of the service; second, the disturbances that are to be experienced; and, third, the nature and the type of the apparatus that is connected to the circuit.

The all-electric system of railway signaling can be divided into two general classes (dependent upon the method of operation) and these into further subdivisions in accordance with the detail circuits.

Automatic Block Signals and Interlocking Signals

I. D-C. Operated

- (1) Primary batteries
 - (a) Track circuits
 - (b) Signal mechanism circuits
- (2) Portable storage batteries
 - (a) Track circuits
 - (b) Signal mechanism
- (3) Stationary storage batteries
 - (a) Track circuits
 - (b) Signal mechanism circuits
 - (c) Battery charging circuits

II. A-C. Operated

- (1) Generating or power supply stations.
 - (a) Power supply line fed direct from generators used entirely for that service.
 - (b) Power supply line fed through step-up transformers or direct from another commercial system.
- (2) A-c. supply transmission circuits and line sectionalizing equipment—1100 to 11,000 volts.

(3) Step-down transformers at signal stations supplying 110 and 220-volt signal mechanism circuits.

- (a) Secondary transformers or low-voltage taps on main transformers supplying 6-volt track and 15-volt lighting circuits.

In these circuits are located the various pieces of electrical apparatus upon the reliable operation of which the success of the signal system depends. By an intelligent and proper application of lightning arresters to these circuits a high degree of reliability is secured. The classification of the signal apparatus connected in the circuits follows:

Apparatus to be Protected

I. D-C. Operated Systems

- (1&2) Track relays and signal control relays, contact points, signal motors, and lights.
- (3) Same as under (1) and (2) with the addition of the battery charging circuits, including the generator and rectifier.

II. A-C. Operated Systems

- (1) Generators and transformers with controlling switchboard.
- (2) Transmission lines, sectionalizing oil switches, and primaries of step-down signal transformers. (These in general are under 1.5 kv-a.)
- (3) Low-voltage secondary circuits: Track relays, signal relays, contact points, signal motors and lights.

These various circuits and the apparatus connected thereto are usually exposed, in a greater or lesser degree, to lightning disturbances. The amount of trouble that is experienced depends primarily of course upon whether the system is operating in a lightning zone, for the majority of disturbances are the result of lightning. Other types of trouble than those arising from direct lightning influences have occurred in some installations. For instance, there have been cases of static accumulations on the transmission circuits due to peculiar climatic conditions and, what

is more frequent, of surges on the main transmission circuits due to badly balanced loads. An example of this latter type of case is that in which a single-phase power supply for signal purposes is taken from a three-phase circuit that is carrying a badly regulated power load on the other phases.

As the signal control and operating apparatus is of the same general type for both direct-current and alternating-current circuits, and as the lightning arresters are the same for both services, consideration of the protection of both systems can be made under one common heading.

Generally speaking, it would seem that these low-voltage circuits ought to be quite well protected by the very nature of their installation but experience has shown that much damage can be done to their connected apparatus by lightning. Relay and instrument coils have been burned out, grounded or short-circuited between turns, and contact points have been arced over and fused together. For adequate protection against such troubles (which are severe because the insulations involved are rather delicate and therefore cannot withstand the strains to which general power apparatus may be subjected successfully) a discharge path having a low spark potential is necessary, and at the same time the path must be one which will not permanently ground or short-circuit. The vacuum-tube lightning arrester admirably fulfils both requirements. At all points on these low-voltage circuits where protection is desired this type of arrester should be employed, it being installed as near as possible to the terminals of the relays, coils, motors, lights, contact points, etc., that are to be protected. The single-pole vacuum-tube arresters designed for this service assure both satisfactory operation in themselves and the fulfilment of the signal circuit requirements.

The manner of grounding these arresters is of the same importance as that with other types of arresters, and perhaps more depends upon this feature than upon any other. At each signal station a good reliable earth ground of permanent value should be installed, to which must be connected the ground leads from the various arresters at the station.

The transformer secondary circuits of low-voltage alternating-current systems should be fused to their full capacity; this will prevent the fuses being blown when discharges occur over the arresters.

Aside from the actual signal circuits there are several auxiliary circuits involved where protection is of vital importance. Included in the third class of direct-current operated systems there is a charging circuit which is usually of from 350 to 600 volts and is supplied either from a motor-generator set or rectifier. Its lines are carried either overhead or underground along the track and tap into the signal stations for the purpose of charging the spare storage batteries. If this circuit is an overhead one and is subjected to only mild disturbances, a magnetic blowout arrester installed at the supply station will furnish sufficient protection, but additional arresters should be also applied at the signal stations if severe disturbances are experienced. Instead of the magnetic blowout arrester, the direct-current aluminum arrester could of course be applied but, since the circuit is non-grounded, the aluminum arrester would necessarily have to be a special one in that it must be made up of three units (two in series between lines and one from the middle connection of these two to ground) and, in addition, a special charging switch would be required so that the film could be formed on both plates of the ground cell.

In alternating-current operated systems the continuity of service depends almost entirely upon the reliability of the supply. The possibility of failure of the generating or transmitting apparatus, and the consequent endangering of life and property, demands that only the best equipment be employed. Considering the various parts of this supply system in order we have, first, the generating station feeding the supply line either directly or through step-up transformers. For an overhead distribution system the supply station should be protected by alternating-current electrolytic arresters and choke coils in the outgoing power lines. The step-down transformers which feed a signal station should be protected by graded-shunt resistance multigap arresters, or compression-chamber arresters, and it is also desirable to have choke coils in the taps to the transformers. If the signal stations are located at considerable distances apart and the overhead transmission line is exposed to frequent lightning disturbances, line arresters should be installed at frequent intervals between the stations to relieve the stresses on the line. These arresters should be of the same type as those at the transformers and should be connected directly to the line without choke coils.

GROWTH OF CURRENT IN CIRCUITS OF NEGATIVE TEMPERATURE COEFFICIENT OF RESISTANCE

By F. W. LYLE

RESEARCH LABORATORY, LYNN, GENERAL ELECTRIC COMPANY

This article was prompted by the contribution in our January issue on the Infinite Duration of Transients, which dealt with the growth of current in circuits of positive coefficient of resistance. The author takes the formula derived in the preceding article and shows how it may be applied to the consideration of the growth of current in circuits of negative coefficient of resistance; and for the critical and larger voltages, where this modified formula becomes inapplicable, a new formula is derived which will give the time required for the current to reach an indefinitely great value in circuits that are virtually non-inductive.—EDITOR.

In the January, 1915, number of the GENERAL ELECTRIC REVIEW, Mr. Chas. L. Clarke discusses, in a very interesting note, the effect which a positive temperature coefficient of resistance has on the time that is taken by an electric current in a conductor to rise to its full value.* As conductors, pure metals and most alloys show a positive temperature-resistance coefficient, but there are many conductors which display a negative coefficient. For instance, the negative characteristic is possessed by the pure metalloids—carbon, silicon, and boron—and by most chemical compounds.

Since such conductors do exist and have many rather unusual properties, a consideration of them and of their relationships may prove to be interesting when viewed in the light of Mr. Clark's equation.

In the circuit of constantly applied e.m.f. and simple non-inductive resistance, as treated in the article above mentioned, the relation between current and time is derived from an equation

$$\frac{E di}{[\lambda \delta \eta E - \lambda \delta \eta r_0(1 + \alpha h) - \alpha \lambda \delta r_0 E i^2] i} = dt = \frac{E di}{(a + bi + ci^2) i} \quad (1)$$

where α = temperature coefficient of resistance; E = applied e.m.f.; i = current; t = time; and the other quantities are physical constants which do not relate to the present question.

This equation is directly applicable to a circuit of negative temperature coefficient by simply changing the sign of α from plus to minus. By so doing, it is found that the sign of c changes, while those of a and b do not, and that the form of the solution depends upon whether the quantity $\sqrt{b^2 - 4ac}$ which is derived from the term in parenthesis in (1) has been made imaginary in the result. If $\sqrt{b^2 - 4ac}$ is still real, the solution remains as given by Mr. Clark's equation; if it has become imaginary, the solution takes on the entirely different form that will be given below.

Upon turning again to equation (1) it will be apparent that by simple transposition it can be written

$$\frac{di}{dt} = (a + bi + ci^2) i \quad (2)$$

The steady state representing the complete evanescence of transients is given by $\frac{di}{dt} = 0$ hence

$$a + bi + ci^2 = 0 \quad (3)$$

The limiting value of current i for the steady state is obtained by solving this for i and is

$$i = \frac{-b \pm \sqrt{b^2 - 4ac}}{2a} \quad (4)$$

It is at once noticeable that when α is negative $-4ac$ is negative and that under certain circumstances $4ac$ may be greater than b^2 under which conditions the equation will have imaginary roots and there will be no real value of i which gives a steady state of current.

The significance of the change of form in the solution of (1) when $\sqrt{b^2 - 4ac}$ is unreal is now apparent, for it represents an unstable circuit. As such, it should possess considerable interest and its general properties be worthy of investigation.

The solution here found represents the conditions frequently met in circuits of negative temperature-resistance coefficient. Boron and silicon conductors and many of their alloys with carbon produce these circuits, as do also many chemical compounds such as the oxides composing the Nernst glower.

The phenomena observed in such circuits may be illustrated as follows: On applying to the circuit a small constant voltage, a current flows starting at the value corresponding to the cold resistance of the circuit. By this flow the latter is heated slightly and the current increases. If the voltage is not too high, the current soon reaches a sensibly steady value and equilibrium is attained. As successively higher and higher voltages are applied, the current increases in a ratio somewhat greater than the first power of the voltage until a small further increase of voltage causes a very sudden current rise, and the rise will continue at an always accelerating rate until the circuit is ruptured by the overload. This unstable equilibrium exem-

* An errata note, applying to the article referred to, appeared in GENERAL ELECTRIC REVIEW, Feb. 1915, p. 152.

plifies the case where equation (4) has unreal roots.

The effect which the negative temperature coefficient of resistance has on the rate at which the current rises in value will now be explained.

As long as a voltage less than the critical is applied to the circuit, the value of $b^2 - 4ac$ is positive as in Mr. Clark's equation and the current will vary with time according to the statement of value given in his article, viz:

$$t = \frac{E}{2a} \log \frac{r}{a + bi - ci^2} - \frac{Eb}{2a} \left(\frac{1}{\sqrt{b^2 - 4ac}} \log \frac{2ci + b - \sqrt{b^2 - 4ac}}{2ci + b + \sqrt{b^2 - 4ac}} \right) + \text{const.} \tag{5}$$

and the current will be an exponential function of the time.

When the breakdown voltage is exceeded, this formula involves imaginary numbers and cannot be directly applied.

An integral in the form

$$t = \frac{E}{2a} \log \frac{r}{a - bi - ci^2} - \frac{Eb}{a} \left(\frac{1}{\sqrt{4ac - b^2}} \tan^{-1} \frac{2ci + b}{\sqrt{4ac - b^2}} \right) - \text{const.} \tag{6}$$

gives the relationship of current and time involving only real quantities.

For very great values of current i the first term of the right-hand member of (6) approaches the value $\frac{E}{2a} \log \frac{1}{c}$ and the second

term the value $\frac{Eb}{a \sqrt{4ac - b^2}} \left(\frac{\pi}{2} \right)$

The lapse of time t that is required for the current to reach an indefinitely great value is therefore finite and is equal to

$$\frac{E}{2a} \left[\log \frac{1}{c} - \frac{b\pi}{\sqrt{4ac - b^2}} \right]$$

for the ideal circuit of zero inductance treated herein. It is practically equal to this value for actual circuits which are virtually non-inductive. The necessarily increasing rapidity of the growth of current is sufficiently evident from the above consideration.

ELECTRICALLY HEATED ENAMELING OVENS

By C. W. BARTLETT

INDUSTRIAL CONTROL SUPPLY DEPARTMENT, GENERAL ELECTRIC COMPANY

While it is true that heat units in the form of electricity cost more than the same amount in the form of gas or oil, it does not always follow that heating by gas or oil is the cheaper or better method. Among the several fields of heating in which electricity has been proved superior to chemical fuel is that of enamel baking. A description of the types of electric baking ovens used and a contrasting of the advantages of electric heating against the disadvantages of fuel heating summarizes the contents of the following article.—EDITOR.

The recent action of a prominent automobile manufacturing concern in converting all its gas heated enameling ovens to electric service, together with the addition to its baking plant of a number of new ovens designed originally for electric heating, has served to concentrate on the electric type of oven the attention of others interested in the economical production of baked enamel parts.

The installation above referred to comprises twenty ovens, having a total content of more than 50,000 cu. ft., and the aggregate connected load will be approximately 6000 kw. This large installation was not determined upon until the superiority of the electrically heated oven over others heated by oil, gas, or steam had been thoroughly demonstrated by numerous and drastic tests; therefore, an analysis of the conditions developed and results obtained ought to be of interest.

Briefly stated, it was found that the electric type of oven insures a greater production,

with a lower unit cost, than do other types; it permits of utilizing a positive heat control, eliminates the danger of explosions, and in addition it produces a notable improvement in the quality of the finished enamel.

In regard to the first point, i.e., increased production, it was estimated that enamel could be baked from 30 to 40 per cent faster with electric heat than with either gas or oil heat, but actual tests made later in a number of ovens showed that the time required with the electrically heated ovens was in many cases 60 per cent less than that required by other types. These data were secured in tests of ovens that were formerly operated by gas or oil, as well as of those originally designed for electrical operation.

The remarkable production increases are due largely to the fact that practically all the available thermal energy of the electric current is directly applied in useful work, whereas with gas or oil-fired ovens the flame must be baffled or muffled in order to secure



Fig. 1. A View of an Electrically Heated Japan Baking Oven and its Controlling Equipment

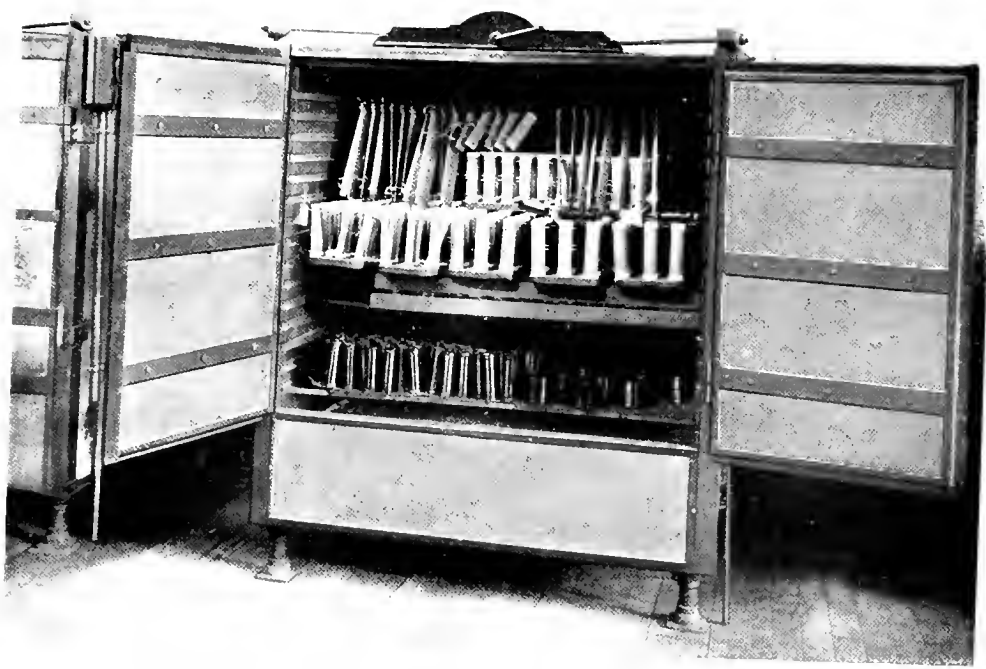


Fig. 2. A View showing a Loaded Electrically Heated Drying and Baking Oven

an approximation to uniform heating and for this reason the convection currents, which are the drying agents, are retarded. The electric heating elements give a uniform heat radiation and, therefore, muffling is unnecessary.



Fig. 3. A Set of Electrically Heated Drying and Baking Ovens

In addition to this factor of muffling, there is a very considerable loss of thermal efficiency in gas or oil-fired ovens due to the fact that considerable ventilation is required in order to take care of the combustion gases. As an instance of the improved oven efficiency rendered possible by electric heating, it was found that in a battery of gas ovens provided with eight 10-in. by 28-in. vents each, to carry off the gases, it required only one of these vents (and this one but partially opened) after the adoption of electric heating. Thus the thermal loss entailed through ventilation was reduced to practically nothing. With electric heat there are no combustion gases and ventilation is required only for the purpose of permitting the escape of the vapors produced during the baking process.

While in some cases the gross cost of heating ovens by means of electric current is greater than when using gas or oil, the improvement in production is such that a greatly increased output is insured for a given oven equipment. This feature may well be considered important, aside from the economy in time, in plants where floor space is limited or valuable. Where the enameling equipment is of considerable size, it will be found that the labor cost per unit is considerably reduced when electricity is employed for heating.

Furthermore, in comparing the costs of gas or oil-fired ovens with those of the electrically heated type, the latter must also be credited with a saving in the insurance rate, on account of the lessened fire risk.

In quality, the enamel baked by electric heat surpasses that by gas or oil. The work done by an electric oven is readily distinguishable from that of a gas oven by its finer finish and brighter gloss, which is accounted for by the fact that all combustion gases (which tend to dull the finish) are absent in the electric oven.

In lacquered work, especially, it has often been found that the products of combustion of the gas-heated furnace produce discolorations.

In the electric oven, with the correct arrangement of units, the heating is uniform and all parts of the work are baked to the same degree of hardness, whereas when done with gas it is often found that the work is baked much harder at the top of the oven than it is at the bottom.



Fig. 4. Combined Steam and Electric Oven for Baking Japan, one compartment being loaded and the other baking

In order to bake colored enamel properly, the temperature must be constant, for a variation of a few degrees may change the color of the enamel. For example, a white japan that bakes properly at 150 deg. may

turn to a cream at 165 deg. F. In the electric oven the temperature is more easily controlled than in the gas or oil oven; and the electric system adapts itself very readily to automatic control so that a uniform baking temperature can be maintained.

In all gas and oil installations there is always danger from fire and explosion. So long as these types are used, there is a constant and unnecessary risk which involves possible material damage, loss in production, and even loss of life. The use of electricity for heating eliminates this fire and explosion hazard.

Work is heated in an oil or gas furnace almost entirely from convection; the flame offering very little chance for radiation. With electric heaters the units are close to the work and heat is given off partly by convection currents but mainly by radiation. The radiating heat travels in straight lines, as do the rays of the sun, and is transmitted much more rapidly to the work and penetrates more completely and rapidly than does heat from convection currents.

The final operation in enameling is the oxidation of the surface of the enamel which gives finish and gloss to the work. In the gas or oil fired oven a large part of the oxygen is used in combustion, while in the electric oven, it remains in its free and uncontaminated state to do its work in oxidizing the enamel.

Electric heat is superior to steam heat as it is more easily controlled and as steam heat cannot be used except for low temperatures: For example, 400 deg. F. would require a steam pressure of 250 lb. per square inch, which is not to be desired.

Conversion of Gas or Oil Ovens to Electric Heat

Any oil or gas-fired oven can be adapted to electric heating with very little trouble. It is merely necessary to remove the oil or gas fixtures and to place the electrical units in the proper position in the oven. This position will depend upon the kind and shape of the work, and upon the size of the oven. If the old oven is effectively heat insulated and its interior walls are of low thermal capacity, this part of the oven may be left unchanged; but, if it is not so constructed, economy will demand that it be redesigned so as to obtain the greatest advantage of electric heat.

Arrangements should be made to cut off practically all ventilation when the work has reached a certain temperature as this will greatly increase the efficiency of the oven.

Ovens Especially Designed for Electric Heat

There are several different kinds of ovens especially designed for electric heat. These are thoroughly heat insulated and are most efficient for the class of work to which they are adapted.



Fig. 5. An Electrically Heated Drying Oven

Revolving Type

The revolving type of oven is so arranged that work can be put in or taken out half of the oven while the other half of the oven is baking. The oven is revolved by a motor and worm gear at the top. When the safety door in front of the oven is open, the motor is automatically disconnected from the line, which makes the outfit absolutely safe. This type of oven has several advantages.

(1) The space taken up is small compared with the output.

(2) The baking can go on while work is being put in and taken out.

(3) It is not necessary to cool down the oven every time a charge is put in, which makes the oven very efficient.

Drawer Type

In this type of oven the work is placed on a carriage and pushed into the oven. When one charge is baking a second carriage may be loaded and in this way the oven is never without a load. This type has an advantage over an oven where the work is hung on

internal supports in that it never has to be cooled down to take out and put in work, thereby giving a larger output from the same size of oven.

Enamel Characteristics

Different classes of work require different grades of enamel; and the enamels or japans

be dried and hardened in an oven at 160 deg. F. in three or four hours with much better results.

There are other enamel-japans that can be baked on at high temperatures. The advantage of these enamels is that at a high temperature the enamel can be baked on a great deal quicker than at a low temperature,

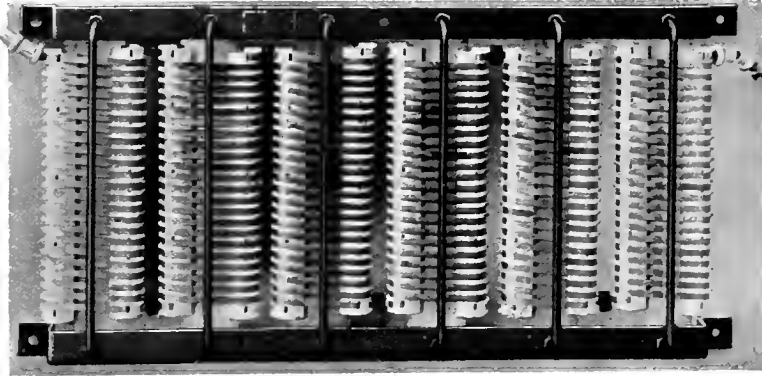


Fig. 6. An 11-Kw., 440-Volt Air Heating Unit

made by different manufacturers for the same kind of work may vary greatly in their constituents and in their baking treatment. It is imperative, therefore, in order to obtain the best results, to follow the instructions of the enamel manufacturer closely when using his particular product.

Some work, owing to its construction and material, will not stand a temperature of over 300 deg. F. for baking. For instance, any piece of work that is soldered will be

and a much larger production is therefore possible in the same amount of space. For example, an enamel that required four or five hours baking at 300 deg. F. can be baked on at 500 deg. F. in three-quarters of an hour.

The heater units are so designed that their resistor temperature will be considerably under the flash point of the enamels which are being baked, when the oven is running at its maximum baking temperature. In this way, absolute protection is afforded against

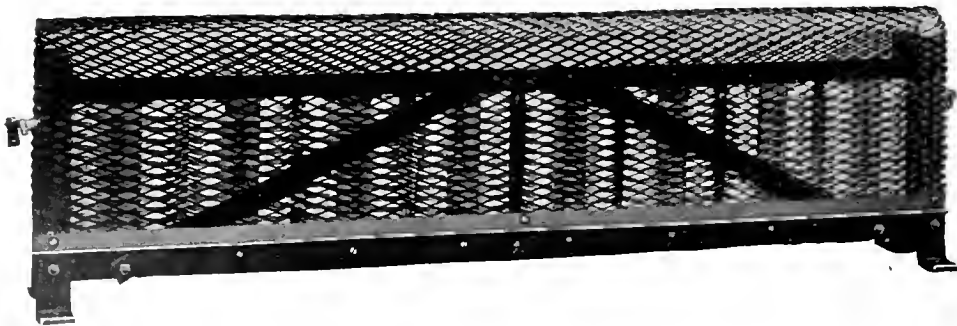


Fig. 7. A 5-Kw., Ribbon-Wound Air Heating Unit

injured at a temperature of 370 deg. F. On account of this fact, baking enamels have been manufactured which harden at a low temperature.

Some air drying japans which require twenty-four hours to harden in the air can

ignition of the oven vapors, whereas in the gas oven with an open flame there always exists a possibility of ignition from the gas flame which may result in a fire or explosion.

The advantages of baking electrically increase as the baking temperature is

increased; and the greatest economy, in general, is secured through the use of a high temperature baking enamel—for example, an enamel that bakes at 500 deg. F. Among the reasons for this fact are the following: The temperature of an oven may be raised to a high value in much less time through the application of electric heat than through the use of oil or gas, and at the same time electricity offers a greater safeguard against overheating of the oven contents. By bringing up the oven temperature rapidly the baking is done in much less time, and convection and radiation losses are reduced in proportion, thereby giving a greater

thermal efficiency than is possible with gas or oil-fired ovens. It is due to this lessening of time that from 40 to 50 per cent greater production can be secured from a given electrically heated oven than from an equal size gas or oil heated oven.

Location of Heating Units

The position of the units in the oven depends upon the size of the oven and the shape and quantity of the work. In some classes of work it may be desirable and even necessary to mount the units on the wall while in other cases the units will work to better advantage on the floor.

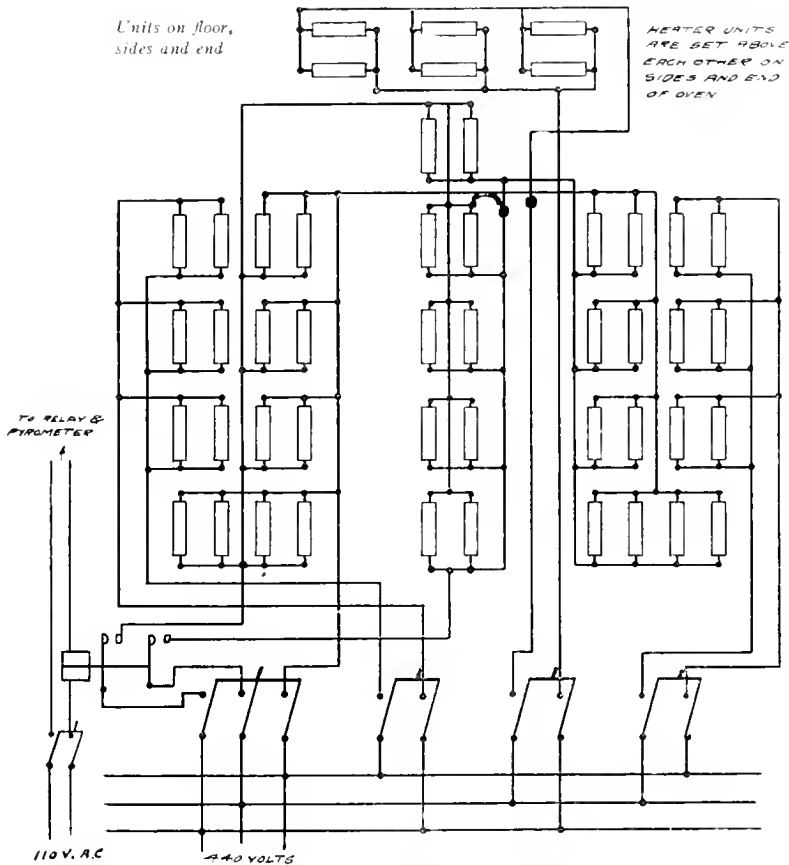


Fig. 8. Wiring Diagram for an Oven having Heating Units on the Floor, Sides and Ends

THE ELECTRIC MOTOR IN THE PRINTING INDUSTRY

By W. C. YATES

INDUSTRIAL CONTROL DEPARTMENT, GENERAL ELECTRIC COMPANY

The author makes an interesting review of the application of the electric motor to the printing industry. Statistics are cited to show the importance of the printing press and the general advantages of the electric drive are discussed. The motor and control requirements of job, flat bed, lithographing, rotary, magazine and newspaper presses are given. This article is an amplification of a written discussion given at the annual convention of the A.I.E.E. at Deer Park, Md.—EDITOR.

The claims of the electric motor found early recognition in the printing industry and, likewise, the requirements peculiar to that industry have long been given thorough consideration by the manufacturers of electric motors and controlling appliances. Some of the earliest specialized types of controllers used with industrial motors were those designed primarily to afford features of control essential to the proper operation of the printing press. As most noteworthy of such control equipments may be mentioned the full automatic type by means of which the operation of a large newspaper press can be completely controlled from a small group of push button switches. This full automatic remote control equipment for the printing press was in use in many newspaper plants at a time when practically all other electric motors applied to industrial service were equipped with manually operated controllers; the chief exceptions being self-starters installed with pumps and the control for electric elevators.

The importance, therefore, of the electric motor to the ideal drive of the machinery of a printing establishment, especially the presses, was determined years ago, and has been taken for granted ever since. It should not, however, be taken for granted that no new features have been introduced or that no improvements have been made. The amazing progress during the past several years in the art of electric motors, and especially their control, is naturally reflected in all motor installations including the printing plant.

The magnitude of a business is the largest factor in determining to what extent it may profitably be specialized upon. In this connection a few facts bearing on the size and rapid growth of the printing industry may be of interest.

The following statistics are extracted from the United States census reports of 1909 showing the condition of the printing industry at that time:

The foregoing figures indicate not only the rapid growth of the industry, but also the much more rapid increase of power used

which has come to be, for the most part, electric power.

The census reports show further that the printing and publishing industry stands sixth in the gross value of products among the manufacturing industries of the United States. It is interesting to note that the value added by manufacture to the raw material is over 72 per cent of the ultimate total value, which percentage is approached by few other industries.

It can be assumed that the census statistics cover the printing industry as represented by the establishments devoted entirely or primarily to that business. These are chiefly: Job printers, book and magazine publishers, newspapers, photo-engravers, electrotypers, stereotypers, lithographers, book binders.

Figures are not available covering the large number of printing plants which are adjuncts to other industries. Private plants are to be found in many large manufacturing establishments and their value is no doubt credited by the census takers to the industries represented by those establishments. As examples of such private printing plants are those which are a part of the equipment of manufacturers of food products and of proprietary articles.

The census report tells us further that the value of products of the printing, publishing and allied trades totalled for 1909 the sum of \$878,000,000. The manufacture of paper goods, including boxes, bags, and wall paper, may find credit in that total, but it can be taken for granted that the printing of silk, other cloth, and leather, although necessitating the use of machinery very similar to that employed in the printing of paper, is considered as belonging to those particular trades.

Newspapers, as can well be appreciated, comprise no small part of the printing industry. There are today published in over 10,000 towns in the United States and territories, approximately 2400 daily papers and 20,000 newspapers issued weekly or at other periods.

The greatest center of the printing industry in the United States is New York City where

that industry stands third in the list as regards the number of employees. The two industries which rank it are first the clothing industry followed by the aggregate of the various metal trades.

Enough has been said to indicate the magnitude and importance of the printing industry, in which industry the electric motor finds a most important field of application. In fact, the motor is indispensable as it furnishes the ideal drive for the various machines in a printing plant which in no modern establishment or one of any con-

all machines with the exception of the presses and folders the selection of a suitable motor is a relatively simple matter and no special features of control are involved. For the most part, constant speed motors are employed and the control may be an ordinary hand starter or in cases where remote control is desired, a self starter may be used which is operated from one or more push button stations. Where the work necessitates the use of an adjustable speed motor, a manually operated speed controller will usually answer the purpose.

PRINTING AND PUBLISHING ESTABLISHMENTS

	1899	1909	Per Cent Increase
Number of establishments.....	23,814	31,445	32
Total persons engaged.....		388,446	
Value of products.....	\$395,000,000	\$738,000,000	87
Capital.....	333,000,000	588,000,000	76
Total horse power.....	119,775	297,763	148
Electric horse power.....	41,413	229,312	450
Electric power purchased.....	33,582	197,692	490

sequence are operated by any other means. The chief factors favoring motor drive as compared to any other driving means are:

- No obstruction to light by overhead belting and shafting.
- Cleanliness.
- Quietness.
- Convenience of location.
- Saving of floor space and headroom.
- Economy of power.
- Wide range of speeds.
- Convenient control.
- Protection to the operator.
- Economy of time.
- Reliability.

These factors may be recognized as applying to almost any kind of machinery equipped with individual motor drive. There are no machines, however, to which the speed range, convenience of control, and reliability of the electric motor are of greater importance than to a printing press—especially one producing a daily newspaper.

In the general book, pamphlet and job printing industry motors are applied to composing machines, printing presses, folders, cutters, stitchers, and binding machinery. In newspaper printing plants, motors are used on composing machines, matrix and plate making machines, printing presses, paper hoists and conveyors and exhaust fans. For

The advantageous characteristics offered by the electric motor apply to all the power-driven machinery in the printing plant but especially to the presses, which require features of drive and control that nothing else can offer. In the following are taken up the several broad classes of printing presses, with a brief discussion of the types of motors applicable in general to each class and of the features entering into the proper control of the motors.

The various types of printing presses fall into three general classes:

- Small platen presses, ordinarily called job presses.
- Flatbed cylinder presses.
- Rotary presses.

Job Presses

These, used for printing cards, circulars, small jobbing and commercial work, have a type bed and impression platen which are both flat surfaces. The type form is held stationary, and approximately vertical, while the platen on which the paper is placed swings up to meet it. Hand sheet feed is the rule, though automatic feeds are sometimes used.

The general run of job presses requires motors ranging in capacity from 1/6 to 1 1/2 h.p. The motors are generally best mounted on the floor and arranged for belt drive to a fairly

large press pulley. Friction drive, using a friction pulley bearing against the flywheel, is also used.

The control requirements are simple. On direct current circuits a shunt motor is employed usually controlled by a no-voltage

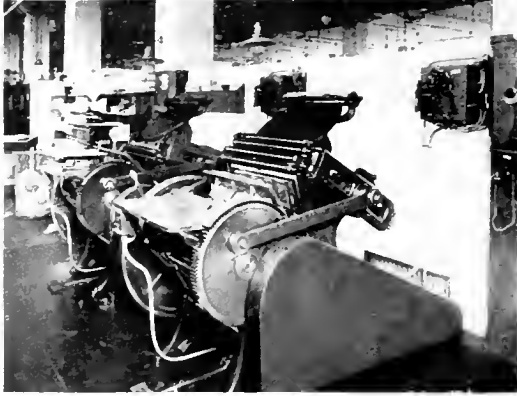


Fig. 1. Job Presses Equipped with Controllers and Push Button Stations

release speed regulating rheostat in the armature circuit. The small sizes of the motors used make permissible control of speed by armature resistance as the wastage of power is inconsiderable, especially as the motors are usually run at or near the normal speed.

There are applications, where the speed of production is of prime importance, where a push-button operated controller, providing predetermined speed setting, gives the best results. See Fig. 1.

On alternating current circuits the best results are obtained by the use of a commutator type single-phase motor. Such motors are available designed for speed control by brush shifting and with the shifting mechanism arranged for foot operation. See Fig. 2.

Flatbed Presses

These have the type forms carried by a heavy, rigid platen sliding back and forth in "ways," similar to the bed of a metal planing machine. At each pass the type passes under the impression roll at one end of its travel, and under the inking rolls at the other extreme. There are several classes of flatbed presses differing in the relative motions of the cylinder and platen, although in all types the impression cylinder always revolves in the same direction.

Flatbed presses are employed for sheet printing and are generally used for color work. The feed may be either hand or automatic.

The ideal location for motors is within the frame of the press, on brackets. Belt drive is preferable to gear or chain drive as the slipping of the belt serves as a protection against shocks to the motor and machinery. The motors required range in capacity, for different makes and sizes of presses, from $1\frac{1}{2}$ to 15 h.p., and must be capable of exerting a strong starting torque, for which reason the direct current motors are usually compound wound with about 20 per cent series field. The alternating current motors used are for two- or three-phase circuits and are of the slip ring type.

The ordinary requirements of speed variation are met by providing the d-c. motor with 50 per cent reduction by armature resistance, and with field control giving a 25 or 50 per cent speed increase above normal. In the case of the a-c. motor, a regulating resistance is furnished which permits of a speed range down to 50 per cent of normal. Ordinarily only the higher speeds are in requisition, the lower speeds being required for occasional jobs where an extra high grade of work is involved.

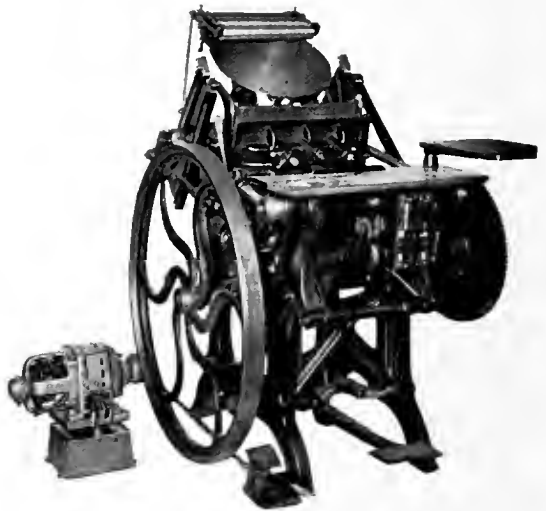


Fig. 2. A Job Press Driven by a Single-phase Motor, Foot Control and Friction Drive

The ideal control equipment provides for push-button starting and stopping and for predetermined speed control. The ability to start or stop the press from stations at both the feeding and delivery ends makes for greater convenience and safety to the operator

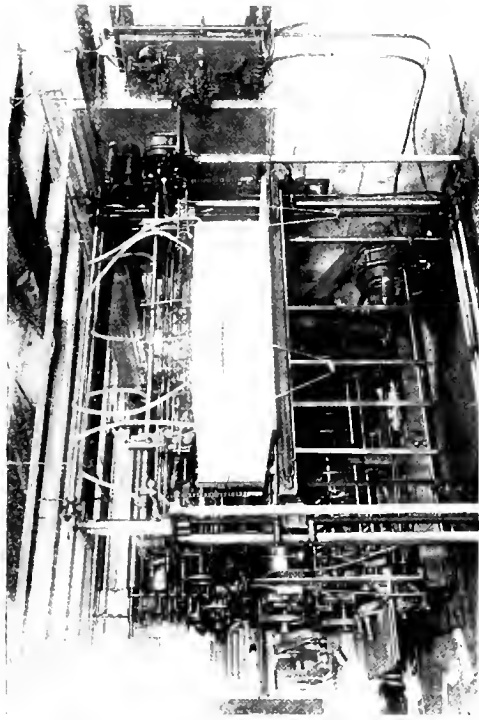


Fig. 4. A Predetermined Speed Push Button Operated, Three-phase Controller and a 7½ H.P. Motor Operating a Scott Offset Press for Lithographing

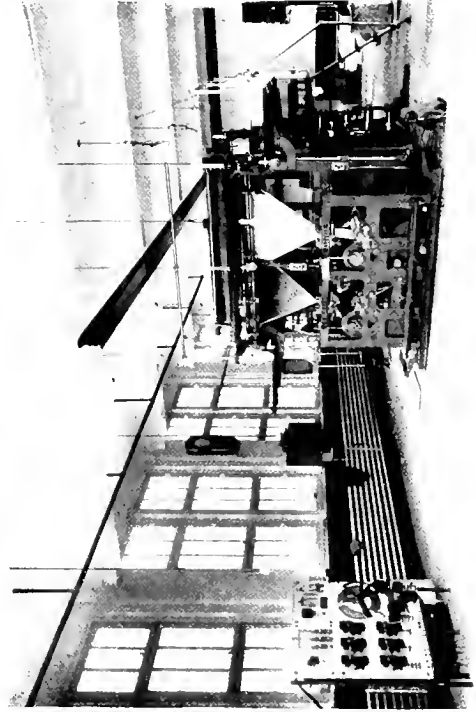


Fig. 7. An Electric Motor-driven Press and a Control Panel

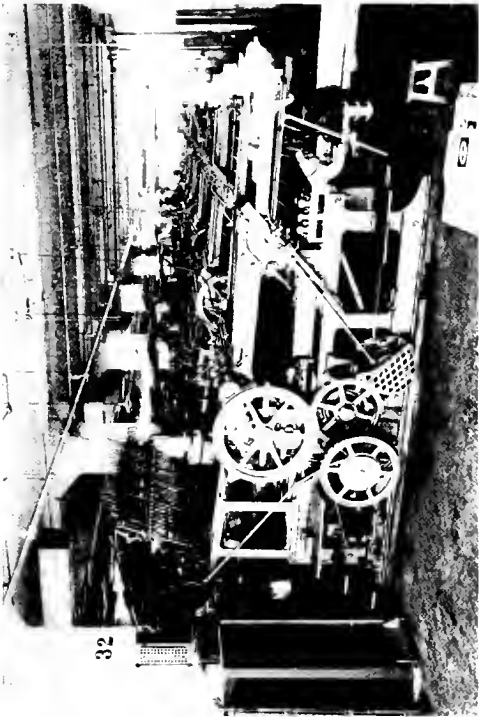


Fig. 3. A Row of Whitlock Presses Equipped with Electric Motors and Controllers

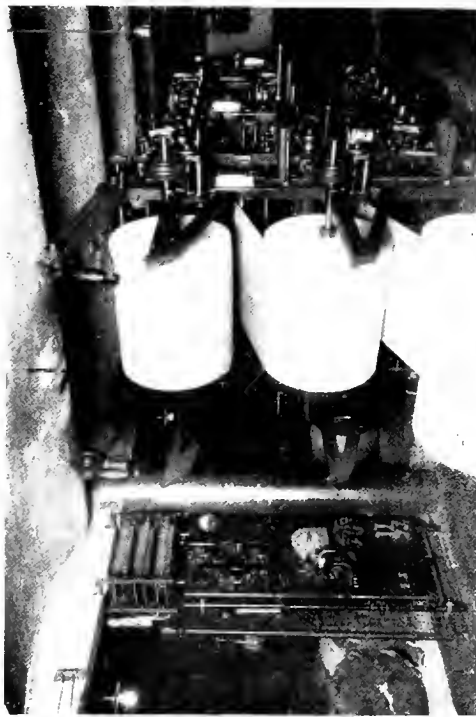


Fig. 5. A Basement Press Room showing a Control Panel at the Left

and is an important factor in the saving of time. The predetermined speed feature makes possible the proper setting of the ultimate speed for the work in hand so that when the press is producing it will run at that speed. Thus is avoided the wasting of time by reason of running too slow, as also the spoiling of work by reason of running too fast. Furthermore, it becomes possible to work to a definite schedule of production which is of great importance to the printer.

Other features of the control equipment are:

No-voltage protection to motor and to operator.

Overload protection to the motor.

Dynamic brake or solenoid brake for quick stopping.

"Jogging" or "inching."

Reverse for emergency conditions only.

In Fig. 3 is shown a modern installation of flatbed presses with direct current motors and with control equipments including all of the above mentioned features.

Recent developments in control equipments for use with alternating current motors incorporate all of these advantageous features. The essential difference is that dynamic braking is, in the nature of things, out of the question, and a solenoid brake is used. The results, however, are identical.

Lithographing Presses

The lithographing press differs from the ordinary flatbed press in that it prints from an engraved stone instead of from type. In its various makes and sizes it takes motors ranging in capacity from 2 to 10 h.p. The requirements as to the types of motors, speed range, and control features are the same as for the general run of flatbed presses.

Rotary Presses

Rotary web presses, used largely for magazine or newspaper work, employ curved stereotype, electrotype, or zinc printing plates, attached to the cylinders. They print a continuous roll or "web" of paper, which allows a much faster speed than even the automatic feed applied to flatbed presses. Due to this feature, and also to the elimination of heavy reciprocating parts, this type of press is superior in point of speed.

Small rotary presses, which may print either on a continuous roll or on automatically fed sheets, are used for work similar to that performed by job presses and flatbed presses. The motors required range in capacity from

2 to 15 h.p. and the types of motors and the control features are essentially the same as for the job and flatbed presses doing similar work. Fig. 4 illustrates a small rotary sheet-fed "offset" press driven by a $7\frac{1}{2}$ -h.p. induction motor and operated from push-button stations and a predetermined speed controller.

Rotary Magazine Presses

The sizes of rotary presses used for magazine printing require motors ranging in size from 5 to 35 h.p. The direct current motors employed are compound wound and of the adjustable speed type with a speed range by field control of 2:1, although occasionally a speed range as high as 3:1 is of advantage where the work which the press turns out is of widely varied quality. When alternating current motors are used they are of the slip ring type with speed control by resistance in the secondary circuit.

A suitable control equipment may be either "full automatic" or "semi-automatic," although the former is the more convenient to the press operators. By "full automatic" is meant entire control from push button stations. Each complete master station, of which there may be one or more, contains push buttons for "jog," "fast," "slow," "stop" and a two-button operated snap switch for "safe—run." Partial stations, of which there may be several, usually comprise "jog" and "safe—run."

The various contactors and other remotely controlled switching mechanisms actuated by the push buttons are mounted on a panel together with the knife-blade line switches, fuses and whatever instruments may be desired. The panel and resistances connected thereto may be placed in any available space as the complete control of the press is accomplished from the stations and the only devices on the panel ever manually operated are the line switches.

Pressing the "jog" button will cause the press to run at a very slow speed as long as the button is held closed. When the button is released the press instantly stops. Pressing the "fast" button will start the press off at the lowest speed and gradually accelerate it toward the highest running speed as long as the button is held down. When the "fast" button is released the press will run at whatever speed it has attained. Pressing the "slow" button causes the press to decrease in speed. The "stop" button is used to bring the press to a quick stop. The "safe—run"

buttons permit of opening the control circuits at any one station so as to prevent the starting of the press from any other station.

Whether the press be stopped by release of "jog" button or operation of "stop" or "safe" buttons, the brake comes instantly into effect and quickly brings the machinery to rest.

A "semi-automatic" control equipment differs from the "full automatic" in having a manually operated device for bringing the machinery up to running speeds. The "jog," "stop" and "safe—run" features are, however, controlled by push buttons exactly as in the "full automatic" equipment.

The equipments for induction motors accomplish much the same results as those for d-c. motors. The advantage in favor of the d-c. motor lies in economically producing speeds over a wide range. When the producing speed is to be at or near synchronous speed the induction motor offers no disadvantage whatever.

Rotary Newspaper Presses

The great advantages of motor drive as compared to any other drive in the case of rotary presses lie in:

Economy of space.—Crowded conditions usually prevail in a newspaper plant.

Convenience of control.—From several stations and by quickly operated devices.

Safety.—All is hurry and bustle and the press operators must be protected against carelessness.

Delicacy of control.—The web of paper must be slowly fed in while making ready and gradually accelerated to the full running speed.

Reliability.—The loss of an edition is a serious matter.

Some small newspapers are produced by single motor-driven rotary presses in which case the equipment is the same as described for the rotary magazine presses. See Fig. 5.

The larger newspapers, however, are run off from rotary presses which have a two-motor drive. A small motor is used, driving the press through gearing to obtain the make-ready slow speeds. A large motor is used to obtain the high producing speeds. Fig. 6 shows a combination of two induction motors. When the large motor takes up the work the small motor is electrically and mechanically automatically disconnected.

The motors required range in capacity from a 3 to 25-h.p. to a 10 to 100-h.p. combina-

tion. A speed range of 2:1 by field control and 50 per cent reduction by armature control is usually in the large motor of the d-c. combination. The running speed range of the induction motor combination is from normal down to about one-third normal. In either

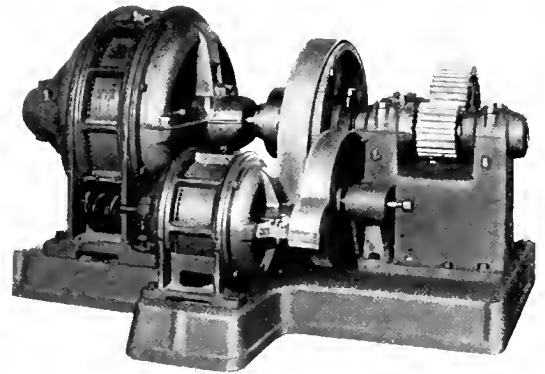


Fig. 6. A Two-Motor Alternating Current Driving Equipment

case the ordinary producing speed is usually figured at about 75 per cent of the ultimate possible speed in order to allow for contingencies of delay.

The control equipment for the two-motor drive is almost always of the "full automatic" type and the same features of control are incorporated as already described. The push button stations are the same as for single motor drive, but the control panel naturally contains a larger array of devices by reason of the fact that both the small and large motor must be controlled and in proper sequence.

Fig. 7 illustrates a modern newspaper press room. The equipment is a two-motor a-c. drive. The illustration shows a quadruple or double 16-page unit, capable of printing 30,000 16-page papers or 15,000 32-page papers per hour. Some large newspapers necessitate two, four, six, and even eight press units. Producing speeds vary from 20,000 to 36,000 papers per hour, of 12 pages per paper up 32 pages. Presses even larger and faster have been built.

The *Electrical World* of June 19, 1915, contained a very pertinent article describing the motor and control equipment of the *New York Times* as recently installed in the *Times* annex. From that article the following data have been taken:

The main presses are four double-sextuple, and one double-octuple. These will print 372,000 24-page papers in an hour under

ordinary operating conditions. When all are in operation, paper is used at the rate of a ton a minute. A ton of ink is consumed in the run of a single edition.

The main presses are operated by a total of ten 80-h.p. and ten 7 $\frac{1}{2}$ -h.p. d-c. motors, the drive being of the two-motor type and the control being full automatic.

There are three rotogravure presses, two of which are operated by a 14 and 2-h.p. two-motor drive, the other being driven by a single 10-h.p. motor. There are also 2 Cottrell presses, one driven by a 15-h.p. motor, the other by a 10-h.p. motor. These five presses print the pictorial supplement and the midweek picture number.

A certain New York publishing house which may be considered as typical of the largest up-to-date plants engaged in the production of magazines, color work, patterns, etc., utilizes a total of 310 motors of which 237 drive machines which are directly connected with the printing and allied work.

The plant includes 31 rotary presses driven by motors ranging from 5-h.p. to 25-h.p. and 45 flatbed presses driven by motors ranging from 2-h.p. to 10-h.p. in size. The total connected load is 440 h.p.

A summary of the entire motor equipment of the *Times* annex follows:

Machinery	No. of Motors	Total H.P. of Motors
Printing presses.....	31	946
Elevators.....	5	265
Conveyors and lifts.....	72	95
Fans, blowers, compressors....	37	86
Pumps.....	11	82
Autoplate machines.....	5	50
Linotype and monotype machines.....	61	20
Machine tools.....	14	19
Folders and cutters.....	8	17
Miscellaneous.....	48	38
Total	292	1618

THE POSSIBILITIES OPEN TO THE CENTRAL STATION IN SOLVING THE FREIGHT TERMINAL PROBLEM

By JAS. A. JACKSON

POWER AND MINING ENGINEERING DEPARTMENT, GENERAL ELECTRIC COMPANY

This article is specially opportune at this time, when we are daily reading of the congestion of freight at the large railroad terminals and of the resulting car shortage that is entailed by the delay in unloading. While the present conditions may be largely due to the fact that most of this freight is for shipment abroad, and to the difficulty of securing bottoms, the situation would be greatly relieved were the terminals equipped to expeditiously handle the freight from freight car to ship's hold. The electric motor as adapted to a number of conveyances now on the market would seem to afford the most satisfactory solution of the difficulty.—EDITOR.

In these days when the problem of how to reduce the high cost of living is uppermost in everyone's mind, many very satisfactory reductions could be made if business men and corporations would seek out methods for conducting their business in such a manner as would directly assist in lowering the cost of production without lessening the profits or, better yet, actually increasing them. Concerted action of this kind would undoubtedly produce good results and could not adversely affect the business of the country. Many situations present opportunities along this line wherein marked improvements can be brought about.

Among these it would seem as though the most fruitful field is in the reduction of transportation charges. Little remains to be done in reducing the cost of *hauling* freight for the rolling stock, roadbeds, vessels and harbors have been developed to such a high state of efficiency that any further

possible reduction in cost during the hauling period would be of but a fractional value. However, just the opposite condition prevails at the terminals and transfer stations. Here, the "gang" and the hand-truck still rule supreme, which means that the cost per ton for handling at these locations has actually increased due to the higher cost of labor and to the increase in overhead expense, including interest, depreciation, etc.

Here, then, is the opportunity for the central station to reduce transportation charges and at the same time to increase its profits by the sale of power. In order to induce terminal managers to make purchases of improved freight handling equipment, the central station power solicitor must make a thorough study of the freight handling business so that he may be in a position to recommend the particular type and size of machinery that will best fulfill the customer's requirements, and be able to tell him approxi-

mately how much will be saved by its use. The power salesman is in the ideal position to make such recommendations for, being interested only in the sale of power, he can give an unbiased opinion as to what machinery will be most successful.

To show what are the possibilities of this field a brief analysis of the present situation will be made, and to it will be added a short list of the types of machinery involved, together with a few facts that will show the benefits to be derived from the adoption of improved methods for handling freight.

While no figures are at hand, it is probably not far from true that at least one-third of the amount which the ultimate consumer pays for his goods is due to transportation charges in one form or another. An analysis of transportation charges, based on the average haul, shows that about 50 per cent of the freight charge is accountable to the high cost of handling in terminals. A few figures will suffice to prove this statement. The average length of freight haul on railroads is something less than 250 miles, and the average cost per ton-mile for hauling package freight (which this article particularly concerns) is about three miles. Thus, the hauling cost for one ton over the average distance is 75 cents.

Now, consider the cost of handling at the terminals. The average railroad shipment goes through at least two terminals and often one or more transfer terminals as well. However, to be conservative only two terminals will be considered, one at each end of the haul. Variable conditions and classes of freight make the cost per ton for handling difficult to determine accurately, but the available figures indicate that a safe average would be about 37 cents per ton per terminal. This figure does not include interest, depreciation, and fixed charges on the terminals. In the two terminals, then, the cost of handling will be 74 cents or approximately 50 per cent of the cost of moving the ton of freight from the time of its delivery at one freight house to its departure from the other. In the case of water-borne freight, the terminal percentage of the cost is still greater, for the cost per ton-mile in this case is from six to seven-tenths of a mill; and although the average haul is longer than on railroads, it is not sufficiently long to make the cost per ton per average haul equal to that on a railroad.

A saving of only one cent a ton per terminal on the miscellaneous freight handled in the

United States would result in a saving of approximately \$20,000,000 per annum, assuming that each ton goes through two terminals. A saving of 10 to 15 cents a ton is well within reason.

Now, turn attention to the machinery with which this saving can be accomplished. No one type of machinery will suit the requirements of all terminals because of the variety of freight to be handled and of the varying local conditions. In many places, a combination of two or more radically different types of machines working in conjunction with each other will be necessary to produce the best results. A partial list of apparatus that is adaptable to freight handling work will be educational:

- Storage battery operated trucks and truck cranes.
- Portable and stationary conveyors.
- Piling, tiering, and stacking machines.
- Winches and hoists.
- Locomotive, gantry, portal, and travelling cranes.
- Elevators, escalators, and ramps.
- Telphers and monorail systems.
- Industrial railways and cable-ways.

This list is of course incomplete, but it gives a general idea of the line of apparatus involved.

The installation and proper use of machinery will result, in part, in

- 1st: Decreased cost per ton for actual handling.
- 2nd: Increased terminal capacity.
- 3rd: Decreased cost per ton in interest, depreciation and overhead charges due to the larger tonnage handled for a small increase in investment.
- 4th: Increased storage capacity due to utilization of hitherto useless height.
- 5th: Increase in handling capacity with reduction of labor, due to greater unit loads and greater speeds.
- 6th: Decrease in length of time to unload and load, thereby increasing the earning power of vessels and cars due to the larger number of trips per year.
- 7th: Increased prestige of the port since freight will naturally follow the line of least resistance and lowest cost.

It would seem that the possibilities are so great in this field that power companies could afford to assign a wide-awake solicitor to study this problem in all large port cities and probably in large railroad centers as well. Electricity is undoubtedly the only form of

energy that is sufficiently flexible and safe to be applied to meet the conditions, and at the same time it is readily adaptable to all the machinery involved.

In conclusion, it might be well to mention that the efficient lighting of piers, freight houses, warehouses, etc., could also be considered a part of this work, and even

ornamental and decorative schemes could be taken up. There is one case where a large municipal wharf has illuminated its entire water side with large tungsten units installed primarily for decorative purposes, but which incidentally have practically put a stop to all thieving from the water side by harbor thieves.

PORTABLE SEARCHLIGHTS FOR FIRE DEPARTMENTS

BY L. C. PORTER AND P. S. BAILEY

HARRISON LAMP WORKS AND LYNN WORKS, GENERAL ELECTRIC COMPANY

This article gives a brief description of a portable searchlight set equipped with a gas-filled incandescent lamp and a storage battery. The beam of light can be concentrated or spread as occasion demands. Besides describing the apparatus the author recites its various uses.—EDITOR.

In many cases much valuable material has been lost by fires that occur at night through the lack of sufficient illumination to permit its removal from the buildings. It not infrequently happens that the electric light or other sources of illumination are put out of commission; or the supply may be shut off as a safety measure, and the work of fighting the fire is seriously handicapped thereby.

In several cities the fire departments are supplied with one or more searchlights. There are, however, thousands of places where such equipment is not available. To meet this condition there has been developed at the laboratory of Thomas A. Edison, in co-operation with the General Electric Company, a portable storage battery searchlight outfit. It consists of a waterproof 20-in. projector on a trunnion mounting. The projector



Fig. 1. Front and Rear Views of the Portable Searchlight Truck

contains a special 35-volt 750-watt, focus-type, Edison Mazda C lamp.

The searchlight is equipped with a hand-wheel focusing device, thus enabling the beam to be quickly and easily concentrated into a narrow shaft of light for long distance work and for smoke penetration, or spread out into a fan shape for close range operation. With the beam concentrated, its strength is a little over one million candle-power; sufficiently powerful, under ordinary conditions, to "pick up" a man half a mile distant.

The searchlight is mounted on two large wheels, from the axles of which is hung a 150-ampere-hour, 35-volt Edison storage battery. There is a switch with which to turn the light off and on. The projector, battery and carriage are completely self-contained and can be easily and quickly operated by one man. The beam may be thrown in any direction, spread out or concentrated at will.

It is claimed that the battery is particularly appropriate for this equipment, that

it may be left standing unused for long periods of time, be roughly handled, given a high rate of overcharge or otherwise abused, without serious harm. The battery will operate the lamp continuously for seven hours on one charge.

The complete outfit is approximately 5 feet high, 3 feet wide and 3 feet long; it weighs about 600 lb. It should find a wide application not only for municipal fire departments, but also for factory fire departments. It would be particularly valuable to factories, as it can be used for many purposes other than fighting fires. Night construction work can be carried on under its light. It can be effectively used on special occasions for advertising purposes to illuminate a sign, a flag, or in fact, flood-light the entire face of a building, in much the same manner as is being done by permanent installations of flood-lighting projectors.

The outfit should also be of service to military and naval organizations as well as for spectacular lighting at resorts, etc.



Fig. 2. Section of a Building Illuminated at a Distance of 210 Feet by a 750-watt Portable Searchlight

PRACTICAL EXPERIENCE IN THE OPERATION OF ELECTRICAL MACHINERY

PART XII (Nos. 63 TO 65 INC.)

By E. C. PARHAM

CONSTRUCTION DEPARTMENT, GENERAL ELECTRIC COMPANY

63 CROSSED RESISTANCE WIRES

The crossing of resistance wires is here meant to be the interchanging of two or more wires that are used for connecting a rheostat to a controller. When a controller has many notches, an interchange of wires of *adjacent* resistance sections may have no noticeable effect; unless, for example, an exact value of motor speed or an exact value of generator voltage is desired and the controller position that ought to give the result desired happens to involve the interchanged connections. In

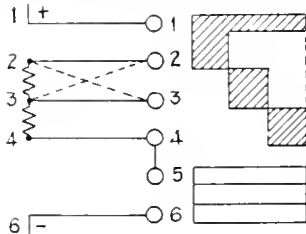


Fig. 1

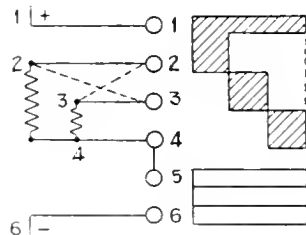


Fig. 2

the case of a motor it means, however, the loss of at least one speed adjustment.

The other extreme of crossed wires occurs through the interchange of the first and the last rheostat wires. In such a case, if the controller cylinder segments are just wide enough to maintain contact on one notch, the motor will start on short-circuit (if it does not blow a fuse or breaker) and on the last notch all of the rheostat resistance will be cut in. Between these extremes, various degrees of jerky acceleration will take place and the violence of the impulses will depend on the serial number of the displaced wires and on the degree to which they are displaced.

Fig. 1 indicates the connections of a two-section series resistance, and Fig. 2 those of the corresponding two-section multiple resistance which is not as generally used. In both cases, the full lines indicate the correct connections, and the dotted lines the interchange of two adjacent resistance wires. As the controller has only three steps, the crossing of even adjacent wires will have a marked effect. In Fig. 1, if the cylinder segments are narrow so that the first finger to engage breaks contact just after the next finger engages, the motor will start on only the 3-4 section and will jump violently; on the second notch the whole starting coil will be cut in and the motor speed will decrease; and on the third notch the whole coil will be cut out and the motor will again jump. Thus, in this case, not a single notch produces a normal result. If the cylinder is so constructed that any contact, when once made, is maintained throughout the sweep of the cylinder, the motor will jerk on the first notch, as before; on the second notch no change will take place because No. 2 finger is still active; and on the third notch normal acceleration will occur. In this case, the characteristics of only the first notch have been changed.

In Fig. 2, if the cylinder has narrow segments, the motor will jerk on the first notch because only section 3-4 will be in; on the second notch 3-4 will be open-circuited and the higher resistance section 2-4 cut in, causing the motor to slow; and on the third notch the cutting out of 2-4 will cause another jerk. The characteristic of every notch therefore has been changed. With wide segments, the motor will jerk on notch No. 1 as before; the second notch will introduce no change; and on the third notch normal acceleration will occur.

Ordinarily, the advancement of a controller changes the previously existing circuit to a circuit of lower resistance. This tends to prevent arcing of the fingers. The crossing of resistance wires, however, causes at some stage of the advancement a change to a circuit of higher resistance, thereby causing the fingers and segments (if of the narrow type) to burn and blister on their "off" sides.

In hundreds of cases of jerky acceleration, especially of car equipments, the trouble has been traced to an interchanging of resistance wires either at the rheostat, in which case operation will be affected on both controllers, or in one controller, in which case operation from only that controller will be affected.

(64) MOTOR REVERSED

Fig. 3 indicates the connections of the three-phase compensator that is used for starting a squirrel-cage induction motor. The particular motor dealt with in this section operated a stone crusher.

The quarry foreman complained that the fuses were being blown too frequently. Ordinarily, compensator fuses are installed on a small panel that is mounted above the compensator, and, as all leads are brought out of the compensator in a regular order that is maintained by the bushings through which they pass, the chances of confusing the leads are remote.

In this particular case, however, the installation was a temporary one and the compensator had been handled so roughly that there was but a little left of whatever order might have originally existed. Two of the fuse wires had become confused as indicated in Fig. 3, in which the full lines show the connections as they were and the dotted lines indicate the connections as they should have been. It is to be noted that with the dotted

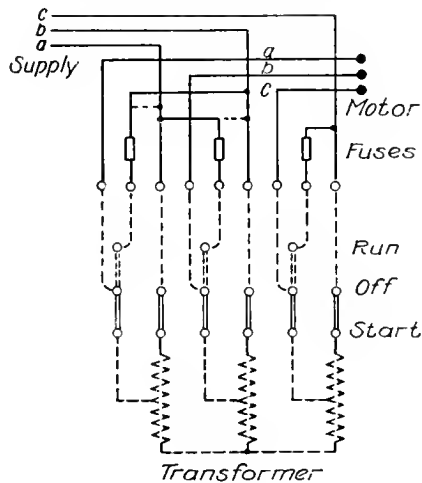


Fig. 3

connections the line wires *a*, *b* and *c* are applied respectively to the motor wires *a*, *b* and *c*; and this holds true irrespectively of the position in which the compensator switch may be. With the connections as

indicated by the full lines, however, the line wires *a*, *b* and *c* are connected to the motor wires *a*, *b* and *c*, respectively, only when the compensator is in its starting position. On throwing the switch to the running position, the line wire *c* is connected to motor wire *c* as in the first case, but line wire *a* is now connected to motor wire *b* and line wire *b* is connected to motor wire *a*, thereby reversing one phase of the motor. As the result of closing the compensator the motor would start in one direction, and on throwing the compensator to the running side the motor would stop and start in the opposite direction.

The fuses had blown each of the several times that an attempt had been made to start the motor; and, if the fuses had not blown, the probabilities are that the rotor would have developed a sprung shaft or some of the stator coils would have been pulled out of their slots. The attending help was not qualified to notice such a detail as the stone crusher turning in the wrong direction.

(65) ELEVATOR TROUBLE

In addition to the regular floor-limit stops, operation of which opens the motor circuit, motor-driven elevators have additional safety stops that open an auxiliary circuit-breaker should the car for any reason get past the top or the bottom floor stops. Fig. 4 shows one type of auxiliary circuit-breaker operating mechanism. Rope *R* passes round a grooved wheel *W*. The ends of the rope carry interferences that will be engaged by dogs on the car should it pass the top or the bottom limits. Wheel *W* turns with shaft *S*; arm *A* is free to turn on shaft *S* as a center and it

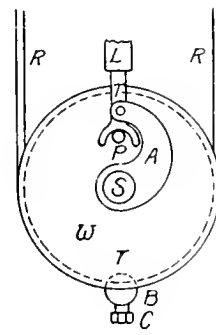


Fig. 4

carries at its upper end a trigger *T*, the forked end of which normally straddles pin *P* which turns with wheel *W*. Lug *L*, when up, holds the circuit-breaker closed. The ball *B*, which is fastened to the rope, rests in a

hemispherical depression in the groove of wheel *W*. It should be noted that in the positions indicated in the diagram all centers are vertically in line; pin *P* is in its highest position and lug *L* bears upward against the circuit-breaker mechanism. A pull on either end of the rope *R* will turn the wheel *W* and will thereby move the pin *P* to a lower point and break the toggle-joint setting of the parts. The breaking of the toggle-joint permits a heavy weight (not shown) to knock down the whole construction, thereby withdrawing lug *L* from under the circuit-breaker mechanism and causing the circuit-breaker to fly open.

An operator complained that the emergency trip had developed a tendency to operate at

any time, thereby stalling the loaded elevator between floors. An investigation disclosed that at some previous time an employee had operated the trip with a crowbar, to see how the mechanism would work. In resetting the mechanism, he had failed to restore the centers to a stable position. The jarring incident to the handling of heavy barrels on the same floor would shake the construction loose and release the circuit-breaker. The mechanism would then again be improperly set and again would be jarred down.

After properly resetting and aligning the parts as indicated in the diagram, there was no more trouble.

THEORY OF ELECTRIC WAVES IN TRANSMISSION LINES

By J. M. WEED

TRANSFORMER ENGINEERING DEPARTMENT, GENERAL ELECTRIC COMPANY

This article, the first of a series on the above subject, is devoted to a theoretical study of the behavior of transmission lines and connected apparatus with respect to the traveling waves which result from switching operations, arcing-grounds, short-circuits, etc. The present article presents a theoretical conception of the propagation of these waves and of their reflection from the open end of a line. The fundamental voltage, current, and energy equations are developed, and also those for the velocity of propagation and for the natural frequency of oscillation of the line.—EDITOR.

If we consider a generator of zero impedance and of voltage *E* connected instantaneously to a pure inductance by the switch of Fig. 1, the result is a gradual growth of current, such that

$$L \frac{di}{dt} = E \quad (1)$$

The current which enters the inductance at one end is leaving it at the other end at the same instant, since there is no capacity within the inductance for storing up current. The value of *L* involved in equation (1) is therefore the total inductance, and since there is no resistance the growth of current is uniform and continuous.

If the same generator is thrown suddenly onto the end of one wire of an indefinitely long transmission line of zero losses by closing the switch of Fig. 2, the capacity of the first element of the line is instantly charged, but current must flow through the inductance of this element to charge the second element. After the second element is charged there is no further growth of current in the first element, since there is no difference of potential applied to this element. The current set up at the first instant merely continues to flow, supplying the necessary charging current for successive elements of the line, and current

grows in but one element at a time, this growth being by an instantaneous change from $i=0$ to $i=I$. The current *I* and the electrostatic charging of the line to voltage *E* advance together with an abrupt or sheer wave front, so that the total voltage of the circuit appears at the front of the wave.

Equation (1) may be written in the form

$$d \frac{(Li)}{dt} = E \quad (2)$$

and for the transmission line; since we have an instantaneous growth of current from zero to a constant maximum value in successive elements of inductance, we may say that we have constant current with gradual increase of inductance, so that equation (2) becomes

$$I \frac{dL}{dt} = E \quad (3)$$

If *L* = the inductance per unit length of line this becomes

$$IL \frac{dx}{dt} = E \quad (4)$$

or

$$IL dx = E dt$$

where *dx* is an element of length.

If *X* = the total length of the line, and *T* = the time required for the charging wave to

traverse the line, the integration of equation (4) gives

$$IXL = ET \tag{5}$$

Considering now the relation between current, voltage, and the capacity of the line, we find the equation

$$EC \, dx = Idt \tag{6}$$

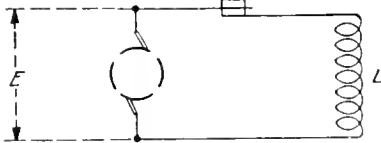


Fig. 1

where C is the capacity per unit length of the line. The integration of this equation gives

$$EXC = IT \tag{7}$$

From equations (5) and (7) we find the time required for the charging wave to traverse the line

$$T = X \sqrt{LC} \tag{8}$$

and since the velocity equals the length of the line divided by the time, we have,

$$V = \frac{1}{\sqrt{LC}} \tag{9}$$

Substituting (8) in (5) or (7) we obtain

$$\sqrt{L}I = \sqrt{C}E \tag{10}$$

whence

$$\frac{LI^2}{2} = \frac{CE^2}{2} \tag{11}$$

Equation (11) shows the equality between the electrostatic energy and the electromagnetic energy of the advancing wave,

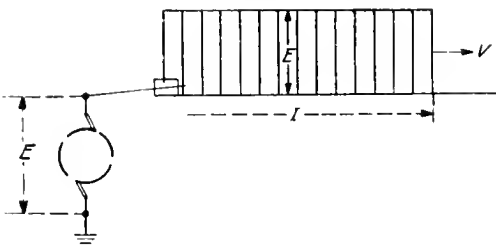


Fig. 2

since the first member represents the electromagnetic energy per unit length, and the second member the electrostatic energy. This condition of equality between electrostatic energy and electromagnetic energy is a characteristic of all pure traveling waves.

The total energy per unit length of the charging wave thus is

$$W = \frac{LI^2}{2} + \frac{CE^2}{2} = LI^2 = CE^2 \tag{12}$$

This energy per unit length multiplied by

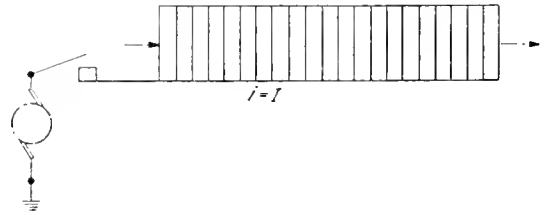


Fig. 3

the velocity of the wave gives the power absorbed from the generator. Thus

$$P = LI^2 \frac{1}{\sqrt{LC}} = I^2 \sqrt{\frac{L}{C}} \tag{13}$$

and

$$P = CE^2 \frac{1}{\sqrt{LC}} = \frac{E^2}{\sqrt{\frac{L}{C}}} \tag{14}$$

So far as the generator is concerned, with an indefinitely long transmission line this power is lost, just as much as though it had been consumed by a resistance of the value $\sqrt{\frac{L}{C}}$ ohms.

The quantity $\sqrt{\frac{L}{C}}$ has been called the "natural impedance" of the line. It has also been called the "wave resistance." "Wave impedance" seems a more suitable name than the latter since the energy absorbed by the line exists in it as electrical energy and is transmitted and may be returned to the source as such. For this wave impedance the symbol

$$Z = \sqrt{\frac{L}{C}} \tag{15}$$

is used.

From equation (12) we have also

$$I = \frac{E}{\sqrt{\frac{L}{C}}} = \frac{E}{Z} \tag{16}$$

Thus Ohm's law may be applied to a transmission line with respect to traveling waves, giving the amount of current which will flow into the line with a given voltage applied. This must be restricted, however, to the initial period of charging the line.

If we examine a point in the line after the wave front has passed, we find the constant current I flowing at the constant voltage E (which is the generator voltage) supplying the power

$$P = EI = I^2 Z = \frac{E^2}{Z} \tag{17}$$

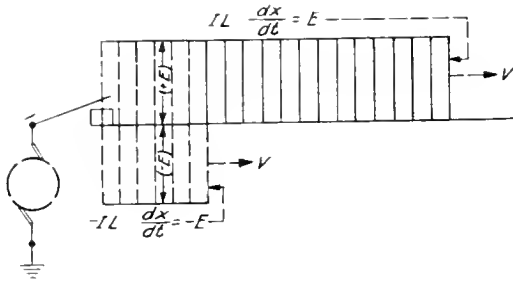


Fig. 4

Now, if the generator voltage be suddenly reduced to zero, current ceases to enter the line from the generator. One might, at first thought, expect the current to begin to flow back from the line into the generator. This, however, is not the case. The wave of current and voltage continues to progress in the line (see Fig. 3). The rear end of the wave is similar to the front end, except that the voltage E existing in the line here acts in a direction toward the generator, instead of away from the generator, and we have here a counter e.m.f. which is away from the generator, due to the cessation of current in that inductance from which the rear end of the wave is passing, whereas the counter e.m.f. at the front of the wave is toward the generator, occasioned by the current entering the inductance which is in advance of the wave. Kirchoff's law for voltage is satisfied at both ends of the wave, as expressed for the front end by equation (4). The same equa-

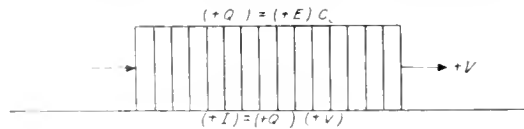


Fig. 5a

This equation for the rear end of the wave may be looked upon as belonging to a wave front of opposite polarity, the front of a wave of negative current and negative voltage, superposed upon the former wave of positive current and positive voltage, and thus reducing both current and voltage to zero (see Fig. 4).

That a wave with both current and voltage reversed, i.e., with negative current and negative voltage, always travels in the same direction along the line as one with positive current and positive voltage is seen by an inspection of Fig. 5.

Thus, in the wave of Fig. 5-a, with voltage E the charge per unit length of line is

$$Q = EC \tag{19}$$

Since the wave is traveling in the positive direction (toward the right) at velocity V , we have the positive current

$$I = QV \tag{20}$$

That is, with positive voltage and positive current the wave is moving in the positive direction.

Again, in the wave of Fig. 5-b, with voltage $(-E)$ the charge per unit length of line is

$$(-Q) = (-E)C \tag{21}$$

this being a negative charge.

Since this wave also is traveling in the positive direction, the current is negative, or

$$(-I) = (-Q)V \tag{22}$$

Thus, the wave with negative voltage and negative current is also traveling in the positive direction.

In other words, in Fig. 5-a, with positive voltage, the positive current, by transferring positive charge from the rear end of the wave to the front end, is seen to advance the wave in a positive direction, and in Fig. 5-b, with negative voltage, the negative current is seen to advance the wave in a positive direction, by transferring positive charge from the front

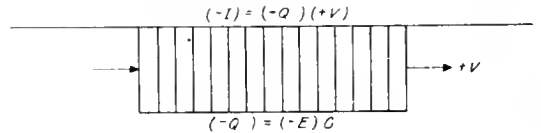


Fig. 5b

tion may be used for the rear end, but the opposing e.m.f.s are reversed with respect to the positive direction in the circuit. If we change signs on both sides of the equation to account for this, we have

$$-lL dx = -Edt \tag{18}$$

end of the wave to the rear end, i.e., by transferring negative charge from the rear end to the front end.

A similar inspection of Fig. 6 shows that a wave with positive voltage and negative current, or with negative voltage and positive

current, is advancing in the opposite or negative direction.

The wave of Fig. 6-a, with voltage E , is moving in the negative direction (toward the left). The velocity, therefore, is negative, or

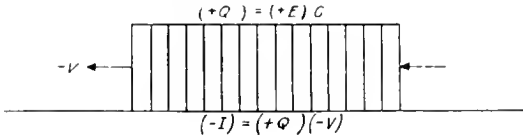


Fig. 6a

$-V$. Although the charge per unit length is positive, the current is negative, or

$$-I = Q(-V) \tag{23}$$

We thus see negative direction of travel with positive voltage and negative current.

The wave of Fig. 6-b, with negative voltage, is traveling in the negative direction. Both the charge and the velocity are therefore negative, so that the current is positive. Thus

$$I = (-Q)(-V) \tag{24}$$

That is, with negative voltage and positive current the direction of travel is also negative.

The diagram of Fig. 2 represents a single wire transmission line connected to one terminal of a single-phase generator, the other terminal being grounded. In an actual two-wire single-phase line, with grounded neutral or symmetrical potential with respect

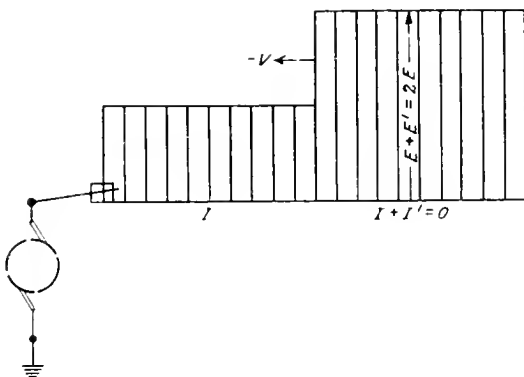


Fig. 7

to ground, the closing of the double-pole switch would at the same time send out a positive wave on one leg of the line, and a negative wave on the other leg. These may, in fact, be considered the positive and negative phases of one and the same wave.

In Fig. 2, if we assume that the earth is a perfect conductor, the distribution of the electrostatic flux lines at the surface of the earth will be similar to that at the neutral plane midway between the wires of a two-

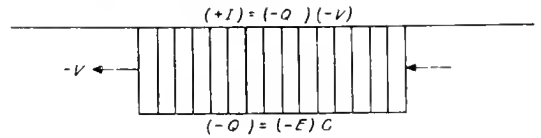


Fig. 6b

wire line, and the waves which we consider in connection with the single wire line are in every respect similar to that part of the wave of a two-wire line which exists between one wire and the neutral plane. The condition, so far as the single wire is concerned, is the same as with a two-wire line, of which the earth's surface represents the neutral plane. The discussion with respect to a single wire has been adopted because it is simpler, and the results can be applied directly to a two-wire line. It is only necessary to remember that with the two-wire line the signs of both voltage and current are in one wire the reverse of what they are in the other, the direction of travel being the same in both.

In a three-phase, three-wire line, due to various causes we may have waves between individual wires, waves between one wire and the other two, waves between one wire and the ground, or waves between all three wires and the ground. The principles involved, however, are the same as with the single wire, considered with respect to ground. The general problem will be simplified by continuing to consider various cases with respect to a single wire. It must be borne in mind, however, that where ground is spoken of, or shown in the figures, it may be taken as representing the neutral plane, or surface, and that where the wave phenomena exists between wires, only one-half of it is considered in this discussion, the other half being the image or counterpart of that considered. Also, where the line is shown as grounded, the counterpart line would also be grounded, so that the condition is similar to that of short circuit for a two-wire line. Where the line is grounded at the end farthest from the generator, therefore, it will be spoken of as a line with closed end, as distinguished from the line with open end.

If we consider the generator, of voltage E , connected to the transmission line of length

X. which is open at the end, the charging wave advances as in Fig. 2, until it reaches the farther end of the line. The line is then fully charged to the voltage E , with the current I flowing throughout its length. The voltage immediately builds up to a higher value in the last element of the line, on account of the current, I , which is still flowing into it after it has reached the voltage E . With the building up of this excess voltage, E' , in the last element, current must cease in next to the last element, otherwise the voltage E' would continue to build up indefinitely. Just how this occurs is seen when we consider that E' will act in the negative direction in the line, or toward the generator, while the cessation of current flowing in the positive direction produces an e.m.f. in the positive direction. Applying Kirchoff's law again, we have similar to equation (4)

$$IL(-dx) = -E'dt \quad (25)$$

This equation applies to a wave front of excess voltage and current cessation which now travels back toward the generator (see Fig. 7).

A comparison of equation (25) with equation (18) shows the difference that while in equation (18) both current and voltage are negative, in equation (25) the current is positive, the negative sign belonging to the differential of length of the line. This may be interpreted as signifying a wave of negative voltage and positive current which is traveling in a negative direction in the line, and superposed upon the static condition of voltage with zero current. We will obtain an equivalent interpretation, if we change signs on both sides of the equation, making voltage positive and current negative, thus referring the equation to the other side of the wave front. This gives

$$-IL(-dx) = E'dt \quad (26)$$

This equation represents a wave of positive voltage, E' , and negative current, $I' = -I$, which we may call the reflected wave, traveling toward the generator and superposed upon the advancing wave of voltage E and current I , which is still coming from the generator.

Deductions similar to those made with respect to the advancing wave, to determine the current which will flow into the line with a given voltage applied, will now show the excess voltage, E' , which will be built by the current I . Thus, similar to equation (6), we have,

$$E'C(-dx) = -Idt \quad (27)$$

Integrating (26) and (27), and solving for E' , we obtain

$$E' = I\sqrt{\frac{L}{C}} = IZ \quad (28)$$

whence, from equation (16)

$$E' = E \quad (29)$$

That is, the end of the line is at a voltage

$$E + E' = 2E \quad (30)$$

and the current is zero.

That the reflected current is equal and opposite to the advancing current may be more explicitly shown by applying Kirchoff's law for current to the end of the line. The current beyond the end of the line must be zero. Therefore, the sum of the currents in the line adjacent to the end must be zero. If I' be the reflected current, we have

$$I' + I = 0 \quad (31)$$

whence

$$I' = -I \quad (32)$$

It is instructive to note that the electrostatic energy of the superposed reflected and advancing waves is equal to the sum of the electrostatic and electromagnetic energies of both the advancing and reflected waves. Thus, for the advancing wave we have the total energy per unit length of

$$W = \frac{LI^2}{2} + \frac{CE^2}{2} = CE^2 \quad (12)$$

and for the reflected wave

$$W' = \frac{LI'^2}{2} + \frac{CE'^2}{2} = CE'^2 = CE^2 \quad (33)$$

whence

$$W = W' \quad (34)$$

Now, with the waves superposed, we have the voltage $2E$ and the current zero, so that the total energy per unit length is

$$W'' = \frac{C(2E)^2}{2} = 2CE^2 \quad (35)$$

whence

$$W'' = 2W = W + W' \quad (36)$$

This relation will always be found true, for the superposition of oppositely moving waves. In this case, the energy XW in the total length of the line was received from the generator during the time that the charging wave was traveling from the generator to the end of the line, and the equal amount XW' was also received from the generator during the equal time that the reflected wave was returning to the generator.

When the line has become completely charged to double voltage, there is no current flowing in any part of the line, and no longer any counter e.m.f. due to cessation of current, to neutralize the excess voltage E' . Since the voltage of the generator is only E , while that of the line is $2E (= E + E')$ the voltage E' will produce a current from the line into the generator, resulting in a wave of discharge traveling forward into the line (see Fig. 8). Negative current is produced which, as the wave advances, engages with more inductance at a rate sufficient to produce a counter e.m.f. equal to E' . Equation (18) applies here.

When, with advancing positive wave, the generator was shut down, resulting in the superposition of an advancing wave of negative current and negative voltage upon the former wave of positive current and positive voltage, the resultant current and voltage in the line were zero. The present case is the same, except that the wave of negative current and negative voltage are superposed upon a condition of double voltage and zero current, the resultant voltage being the generator voltage E , and the resultant current $-I$. This voltage and current exists in the entire

charged, leaving it in its initial condition, at the end of a period of time $4T$, four times as long as that required for the initial wave to traverse the length of the line. The cycle of operations thus traced would be repeated, ad infinitum, in an ideal transmission line,

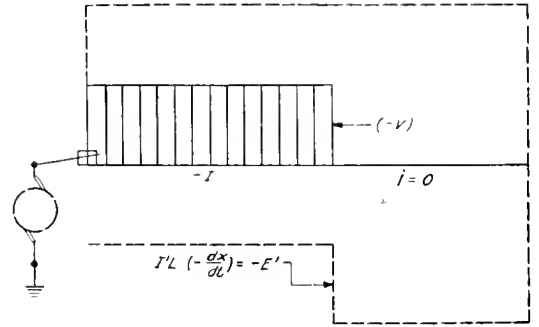


Fig. 9

with zero losses, and a generator with zero impedance.

The frequency of this oscillation, which is called the natural frequency of the line, is the reciprocal of the period, which is $4T$. Thus

$$n = \frac{1}{4T} \tag{37}$$

whence, from equation (8)

$$n = \frac{1}{4X \sqrt{LC}} \tag{38}$$

and from equation (9)

$$n = \frac{V}{4X} \tag{39}$$

Now, for an ordinary transmission line, V is approximately the same as the velocity of light, or about 186,000 miles per second. Hence, for a line open at one end, and with a generator of zero impedance at the other end, which is the same as though it were short circuited, or grounded, the natural frequency is

$$n = \frac{46500}{X} \text{ cycles per sec.} \tag{40}$$

The natural frequency of a line 100 miles long, for instance, is about 465 cycles per second.

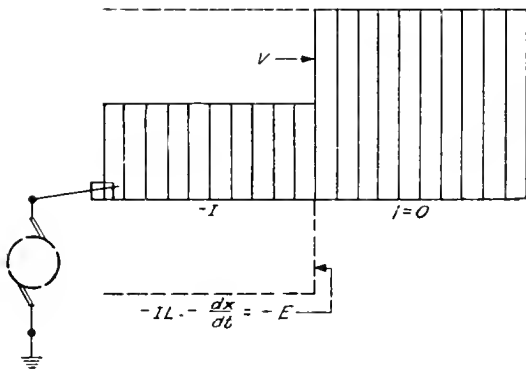


Fig. 8

line when the wave of negative current and negative voltage, or discharge wave, reaches the open end of the line. This discharge wave is then reflected in a manner similar to that of the charging wave (see Fig. 9) with the result that the line is entirely dis-

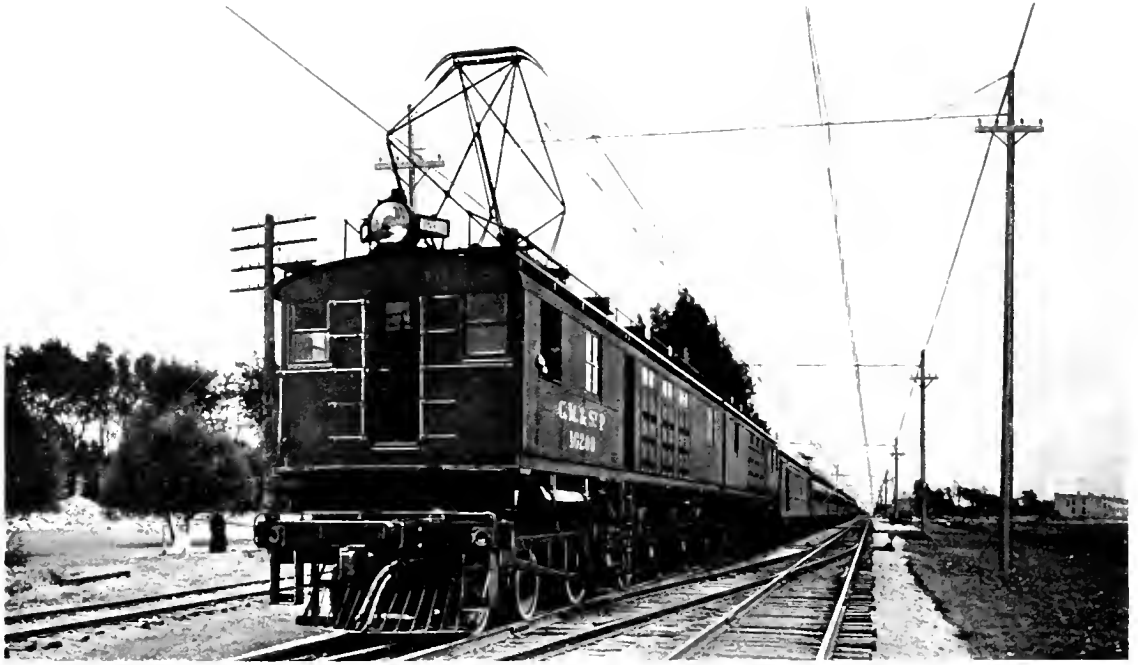


Fig. 1. The First 3000-volt, C., M. & St. P. Locomotive shown Coupled to the "Olympian," the famous transcontinental train between Chicago and Tacoma



Fig. 2. The First 3000-volt, 282-ton, C., M. & St. P. Locomotive on the Erie Test Tracks of the General Electric Company

THE FIRST 3000-VOLT LOCOMOTIVE FOR THE CHICAGO, MILWAUKEE & ST. PAUL RAILWAY COMPANY

By E. S. JOHNSON

RAILWAY AND TRACTION ENGINEERING DEPARTMENT, GENERAL ELECTRIC COMPANY

The trip of the first 3000-volt electric locomotive from Erie to the West attracted such wide attention that it is worthy of special note in the REVIEW. Beside recording the interest displayed en route the author cites interesting data concerning the locomotive. The regeneration of power is a feature that will attract world wide attention.—EDITOR.

Interest in the approaching electrical operation of the transcontinental lines of the Chicago, Milwaukee & St. Paul Railway has been greatly increased by the exhibition tour of the first locomotive over the railway company's lines. The "big motor" as it is called by the railway men was taken in charge by the railway company at Chicago and has been exhibited at all the principal cities on the system between Chicago and Tacoma. The great interest displayed indicates popular approval of the electrification project from every quarter. The contract made on November 25, 1914, called for the delivery of the first locomotive in ten months and it is worthy of record that this date was promptly met, shipment being made on September 25, 1915. That this quick delivery is remarkable can be appreciated when it is understood that the design is entirely new, that the capacity exceeds that of any electric locomotive ever built, that the voltage of the system is higher than any direct current system for commercial operation, and that the system of control is entirely new, being designed for regenerative braking. Since the first delivery several additional locomotives have been shipped so that electrical operation of the first division between Deer Lodge and Three Forks is expected to begin about December 1st.

These locomotives may be properly termed the first transcontinental type, since no electrification now in operation involves such continuous heavy service over long distances. The lines now being electrified include 440 miles of route, carrying both freight and passenger traffic over three mountain ranges all within the territory known as the Great Continental Divide. It is also intimated that electrification to the Pacific Coast is contemplated, which will give a continuous electrified stretch of 850 miles. Transcontinental electric train operation has never before been undertaken on so large a scale. Exhaustive tests were made by the manufacturing company's engineers before shipment and the locomotive performance easily

exceeded the expectations of the designers. Tests made on the regenerative braking equipment were especially gratifying to the engineers and the hauling capacity of the locomotives was demonstrated to the satisfaction of all concerned.



Fig. 3. The Locomotive on a Trip from Butte to Durant and Return on the B., A. & P. Rwy. with the C., M. & St. P. President's Special

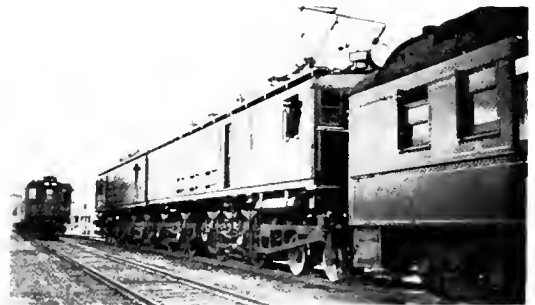


Fig. 4. The Locomotive and Train on the B., A. & P. Rwy. at Silver Bow

On account of the very general interest in the new locomotive the officials of the railway conceived the plan of making an exhibition tour in order to explain the various novel features to both the engineering fraternity and the general public. In all cities where an exhibit was planned a three column advertisement was inserted in the local papers for a week or ten days prior to the date of exhibi-

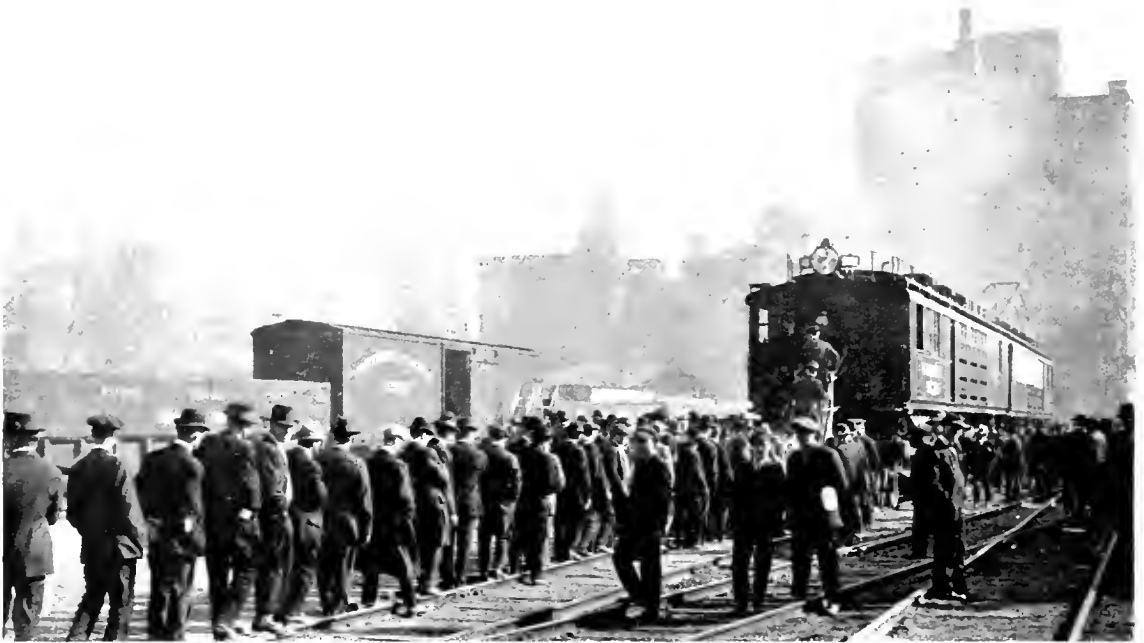


Fig. 5. The Locomotive on Exhibition near the Union Station, Chicago
Several thousand visitors inspected the locomotive

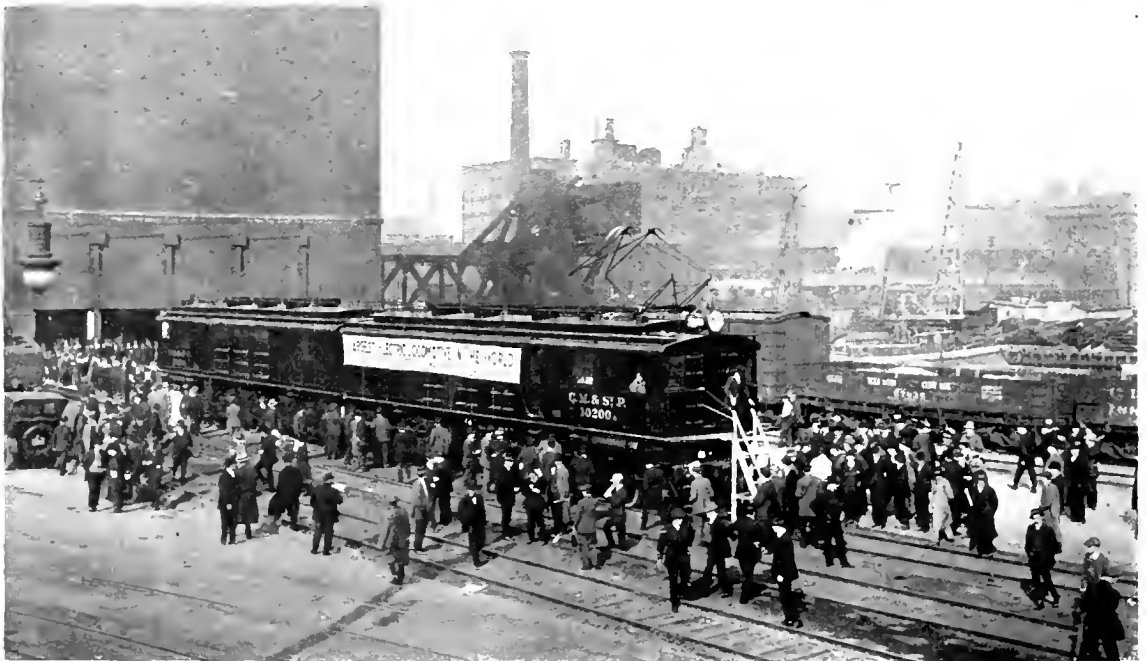


Fig. 6. Another View of the Locomotive while on Exhibition near the Union Station, Chicago

tion. The newspapers were also furnished with an abridged description of the locomotive for use in their news columns.

The famous transcontinental trains "Olympian" and "Columbia" will be hauled electrically through the Missoula and Rocky Mountain Divisions and the conditions of travel will be greatly improved by the elimination of smoke, gases and noise incident to steam operation, making a trip over this beautiful scenic route a very delightful experience.

The first public inspection was held in Chicago at Fulton Street near the Union Station on October 6th, from 12 noon to 4 p.m. It was estimated that 10,000 people gathered to see the great machine and 5000 visitors actually passed through the interior. So great was the popular interest that several "Movie" operators were on hand and made films at different points which are now being exhibited throughout the country. Several photographers secured pictures, one of which shows the electric locomotive coupled to the luxurious through train Olympian. See Fig. 1

Prominent among these visitors were many railroad officials located in Chicago and university professors; particularly those interested in engineering work at the University of Chicago and at Northwestern University. A number of students were dismissed from class work in order to give them an opportunity to examine the locomotive. Superintendents of motive power, street and steam railway officials, consulting engineers and city officials from Chicago and points within 200 miles took advantage of the opportunity to inspect the first transcontinental locomotive. Public men of every profession and city officials of Chicago were especially interested on account of the agitation in favor of electrification of the railway terminals of Chicago.

Visitors evinced great interest in the characteristics of the locomotive such as its capacity, speed, operation in cold weather, regenerating equipment, etc.

The equipment of the freight locomotive is sufficient to handle a 2500-ton trailing train on a 1 per cent grade at 16 m.p.h. and with passenger gearing an 800-ton train can be handled on the same grade at about 30 m.p.h. It weighs 282 tons and the length is 112 feet over all. Each of the eight motors has a one hour rating of 430 h.p. and a continuous rating of 375 h.p., thus providing a total of 3000 h.p. continuously. Each motor is geared to an axle by twin gears thus equalizing strains on the driving axles. The available

tractive effort at the one-hour rating is 85,000 lb., but for starting trains approximately 135,000 lb. is available at 30 per cent coefficient of adhesion.

The locomotive is equipped with two pantographs, one at each end, but one of these

**You Are Invited
To Inspect**

**THE WORLD'S
MIGHTIEST
LOCOMOTIVE
(ELECTRIC)**

On Public Exhibition

Union Passenger Station
ST PAUL

Tuesday, Oct. 12, 12 noon to 4 p. m.

***THE FIRST AND ONLY ONE OF ITS KIND—
more powerful than any steam locomotive—weight
260 tons—eight pairs of drive wheels—112 feet long
—every inch works—direct current 3000 volts—over-
head trolley—uses no coal, requires no water, carries
no tender, has no boiler—will handle uniform tonnage
irrespective of weather conditions. By regenerative
braking on down grades returns large part of power
used on climb up grade. Will be used to haul pas-
senger and freight trains over the Rocky Mountains.***

This is one of the most revolutionary sights in railroading—
the world's mightiest electric locomotive on its way to the
greatest project in railroad electrification, that of the main
line of the Chicago, Milwaukee & St. Paul Ry. for 440 miles
through the Rocky Mountains in connection with its trans-
continental service between Chicago, Milwaukee, St. Paul,
Minneapolis and the Pacific North Coast.

The public are cordially invited to enter and thoroughly inspect the
locomotive. Attendants will be on hand to explain details.

Chicago, Milwaukee & St. Paul
RAILWAY

Fig. 7. A Typical Newspaper Notice Inviting the Public to Inspect the New Locomotive

is sufficient to collect the necessary current should occasion demand.

The most novel feature of the locomotive is the regenerative braking which enables the locomotive to hold back the heaviest trains on the long descending grades—at the same time returning power to the line. The air

brakes are thus used only for emergency service or in making the final stop. Regeneration is controlled by the engineer through an auxiliary handle on the master controller which causes the motors to return power to the trolley in the proper amount to maintain

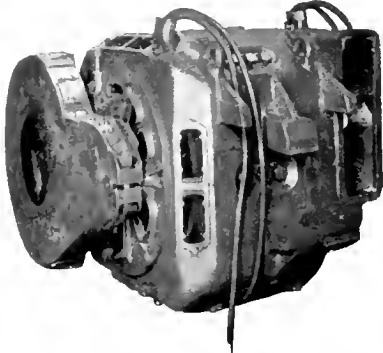


Fig. 8. One of the Eight, 430-h.p., 3000-volt Motors Used for Driving a C., M & St. P. Locomotive

any desired speed. This feature was very thoroughly tested on the General Electric Company's experimental track at the Erie Works.

The general public showed much interest in the fact that cold weather offers no obstacles to electric locomotive operation as is the case with steam engines. It was pointed out that steam locomotives are usually in difficulties in the winter time, necessitating extra leeway in the time table to take care of delays and that there will be no delays for fuel or water or cleaning fires and that the electric engine will always be ready at a moment's notice. With electric operation trains will move exactly as scheduled so the meeting and passing points may be figured to the minute. Fuel trains will be eliminated in the mountain districts thus giving room for additional trains handling revenue freight.

At Milwaukee an accurate count was kept and 5010 people went through the locomotive. As many more inspected the locomotive from the outside and either did not have the time or the opportunity to make an examination of the interior. Especial interest was displayed by the employes of the railway company, practically the entire office and shop force taking occasion to visit the machine.

In St. Paul 2550 visitors passed through the locomotive and in Minneapolis nearly 6000 people. Opportunity was also afforded the faculty and students of the Railway Engineering Course of the University of Minnesota to make a careful examination at a special hour.

On the trip west over the Chicago, Milwaukee & St. Paul lines stops were made at Aberdeen, Miles City, Butte and Missoula with 2000 to 3000 visitors at each stop.

At Butte, the President's special car was attached and a trip made over the lines of the Butte, Anaconda & Pacific Railway to Durant and return. It is noteworthy that the locomotive was operated under its own power as a demonstration to these officials the day it arrived at Butte after being hauled more than 2000 miles. Among the officials on the trip to Durant were President A. J. Earling; Vice President H. B. Earling; Assistant to the President, C. A. Goodnow in charge of electrification work, R. M. Calkins, Traffic Engineer at Seattle; A. M. Ingersoll, Assistant to the Vice President; R. Beeuwkes, Engineer in charge of electrification; Mr. H. A. Gallwey, General Manager of the Butte, Anaconda & Pacific Railway, and many others.

Final exhibitions were made at Ellensburg, Spokane (10,000 first day), Seattle and Tacoma. The number desiring to inspect the



Fig. 9. One of the Driving Trucks for a C., M. & St. P. Locomotive

locomotive at both Spokane and Seattle was so large that it was necessary to allow two days at each place for the exhibition. From Tacoma the locomotive was started on its way back to Butte where it will be placed in operation about December 1st.

THE KINETIC THEORY OF GASES

PART III

By DR. SAUL DUSHMAN

RESEARCH LABORATORY, GENERAL ELECTRIC COMPANY

In this concluding issue of the series, the author discusses the different methods which have been used for determining the number of molecules per unit volume of a gas under standard conditions. A table of atomic and electronic constants has been added at the end of the paper.—EDITOR.

In Parts I and II it has been shown that according to the kinetic theory of gases, the molecules possess velocities which range around 5.10^4 cms. per sec. at room temperature, that is, around 1600 feet per sec. From measurements of the coefficient of viscosity we were furthermore led to the conclusion that at ordinary pressures the molecules travel between successive collisions a distance which has about the same magnitude as the wave-length of red light. Finally we attempted to obtain some conception of the size of the molecules themselves. By assuming a definite value for n , the number of molecules per unit volume under standard conditions, we deduced the conclusion that the diameter of the molecules is about 2 to 3×10^{-8} cm. In the present issue, we shall discuss the different methods which have been used to determine the value of this constant, n , which is one of the most important fundamental constants in physical science. The product nV , the number of molecules per molecular weight is known as Avogadro's constant and will be denoted by N .

I. FROM THE FREE PATH AND VAN DER WAAL'S CONSTANT, b

It has been shown that the average free path L , and molecular diameter, d_m , are related by an equation of the form.

$$L = \frac{1.402}{\sqrt{2} \pi n d_m^2} \left(1 + \frac{C}{T} \right) \quad (24)$$

On the other hand, the molecular diameter may also be calculated from Van der Waal's constant b , by the equation

$$d_m^3 = \frac{3b}{2\pi n V} \quad (26)$$

By eliminating d_m from these two equations, it is possible to calculate n in terms of L and b .

It must be observed, however, that not only is there a certain amount of doubt regarding

the validity of the assumptions on which these equations are based, but even if these assumptions are granted, the conclusions derived from them are strictly true only for monatomic gases. The values of n obtained by this method, and given in Table VII, can therefore be regarded as only a first approximation to the correct value, even in the case of a monatomic gas like argon, while greater and greater deviations are to be expected as the structure of the molecules increases in complexity.

TABLE VII

Number of molecules per cm^3 at 0 deg. C. at 10^6 bars
Calculated from values of b (Table VI) and L
(Table IV)

Gas	$n \times 10^{-19}$
Argon	2.34
Nitrogen	2.67
Oxygen	2.99
Carbon monoxide	3.90

II. FROM INVESTIGATIONS ON BROWNIAN MOVEMENTS

A drop of water containing some fine particles in suspension when seen under a powerful microscope presents an intensely interesting phenomenon. Under the high magnification of an achromatic lens we see that the small particles are in constant motion hither and thither. Each little particle describes an extremely irregular path. (See Fig. 3.) The motion is the same no matter what the external conditions may be, the same, day after day; "eternal and self-maintained." This phenomenon is known as Brownian movement—after the name of the English botanist, who first observed it (1872).

The Brownian motion is exhibited by all kinds of suspensions and emulsions. An emulsion of gum arabic or mastix in water; a cloud of extremely fine dust particles in a gas; a suspension of clay in water; all these, when observed under the microscope, show the same irregular motions of the extremely small particles in suspension.

The similarity of this motion to that postulated by the kinetic theory for the invisible molecules led to the suggestion that the spontaneous motion of the Brownian particles is due to the continual collision with molecules of the medium in which the par-

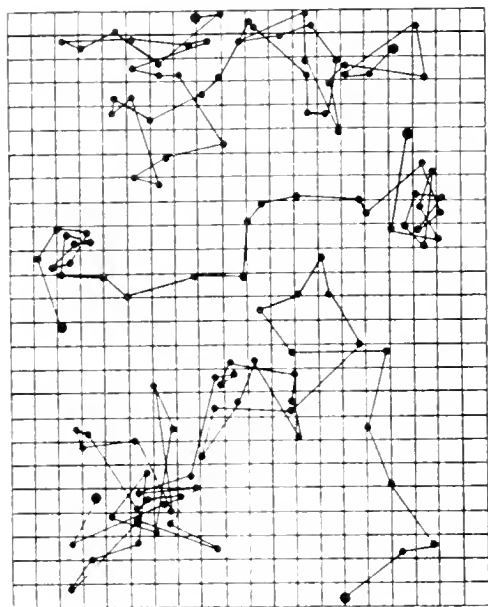


Fig. 3

ticles are suspended, that is, that the particles are really "large molecules," and therefore subject to the same laws as the much smaller molecules constituting gases. This theory was first formulated by Einstein (1905) and mathematically developed so that its conclusions could be tested out quantitatively by experiments. For our present purposes the great value of this theory consists in the fact that it has led to four different methods of determining the so-called Avogadro's constant, N , from which n may be calculated for any desired pressure and temperature.

For the mathematical derivation of the different relations, the reader may be referred to the literature mentioned in the footnotes. It has not been considered necessary to go into the methods more fully because most of this literature is readily accessible in English.

1. Equilibrium Distribution of Suspended Particles in a Vertical Cylinder

Assuming that the Brownian particles obey the same laws as gas molecules, it follows that

they must exert a pressure P , which is given by the relation

$$P = \frac{RT}{\Lambda} \cdot n$$

Now let h represent the mean height of any layer in a vertical cylinder containing an emulsion or suspension of fine particles in some liquid, and let n denote the concentration of particles at this height. Owing to the force of gravity, there will be a tendency for the particles to settle to the bottom, while owing to thermal agitation, that is, the Brownian motion itself, the particles will continually tend to move in other directions. The result of these two opposing forces is that in the equilibrium state, the distribution of the suspended particles decreases exponentially with the height. Einstein shows that under these conditions the following relation ought to hold true:

$$\ln \frac{n_0}{n} = \frac{N m' g h}{RT} \quad (31)$$

where

n_0 = number of particles per cm^3 at $h = 0$,

m' = "apparent mass" of the particle*

g = gravity constant.

\ln = natural logarithm

A similar relation is found to hold for the rate of decrease of density in our atmosphere with increase in height above the earth's surface. Owing, however, to the much greater mass of the particles in suspension as compared with the molecules of air, the actual rate of decrease of density is infinitely greater in the case of a suspension; Fig. 4 illustrates this very well. Each cylinder contains the same total number of molecules; the rate of decrease of density is, however, much greater in the case of oxygen than in that of hydrogen. Thus, in order that the pressure at 0 deg. C. may decrease to half value, we must rise to a height of 3.4 miles in air, whereas if our atmosphere were constituted of hydrogen (14.5 times lighter than air), we would have to rise to a distance of about 50 miles.

Equation (31) evidently furnishes a method of determining N with a high degree of accuracy. For this purpose it is necessary to count the number of particles present in different layers of the suspension and also to determine m' .

The most accurate method of determining the mass of a small particle in a suspension

* The term "apparent mass" is used to denote the difference between the actual mass and the buoyancy of the medium in which the particles are suspended.

involves an application of *Stokes' law*. According to this law, the velocity u of a particle under the influence of a force X is given by an equation of the form

$$X = 6\pi a \eta u \tag{32}$$

where

a = radius of particle

and

η = coefficient of viscosity of medium.

In the case of a particle falling freely under the action of gravity,

$$X = m'g$$

Consequently,

$$m'g = 6\pi a \eta u \tag{33}$$

If Δ denote the density of the particles and ρ that of medium,

$$\begin{aligned} m' &= \frac{4}{3} \pi a^3 (\Delta - \rho) \\ &= m \left(1 - \frac{\rho}{\Delta} \right) \end{aligned} \tag{34}$$

where m is the actual mass of each particle.

The coefficient $\left(1 - \frac{\rho}{\Delta} \right)$ allows for the

buoyancy of the particles in the medium.

By observing the rate of fall of the particles and determining both ρ and Δ , it is therefore possible to calculate $m'g$ in equation (31) and thus obtain a value for N .

Determinations of N by this method have been carried out in the laboratories of Perrin and T. Svedberg, both of whom have carried out a number of investigations on the laws of Brownian movements.*

The rate of decrease in n was found to obey an exponential law according to equation (31), and the values of $N \times 10^{-23}$ observed by Perrin in preliminary investigations varied from 6.5 to 7.2. A very careful investigation was carried out, using a fine suspension of a gum in water. The particles were centrifuged and a suspension obtained containing particles of as nearly the same size as possible, the average diameter being about $\frac{3}{4} \mu$ ($\mu = 10^{-4}$ cm). The value of m' was determined accurately by three different methods and n was counted in 70 cases. In this manner Perrin obtained the value $N = 6.8 \times 10^{23}$ which he considers to be accurate to within 3 per cent.

(2) Intensity of Brownian Motion

The irregular motion of the Brownian particles has this property, that for any given suspension the *mean square* d^2 of the

displacements during an interval of time t is a constant, that is,

$$\frac{d^2}{t} = \text{constant} \tag{35}$$

The value of this constant expresses, therefore, the intensity of motion of the particles

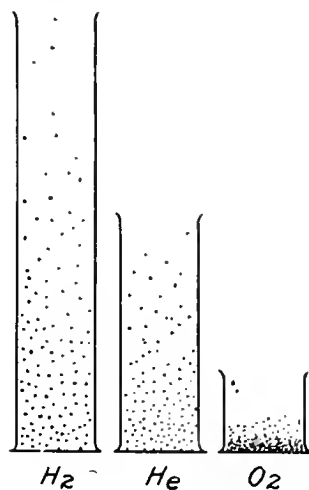


Fig. 4

in any suspension. The word *Lebhaftigkeit*, that is, "liveliness" may perhaps serve as a synonymous designation.

Fig. 3 represents the horizontal projections of the irregular path, described by three different particles of a mastix emulsion during a certain period of observation. Each space corresponds to 3.125μ , and the dots record the successive positions at 30 second intervals. The values of the distances travelled during these intervals are of course distributed according to Maxwell's distribution law; but from a large number of such observations, it is possible to calculate the value of the *mean of the squares* of the displacements.

Qualitatively it can be seen that the more "lively" the Brownian movements in any emulsion, the greater the rate at which this emulsion will diffuse into the pure medium. Einstein showed that the value of the diffusion coefficient D is given by the equation

$$D = \frac{1}{2} \frac{d^2}{t} \tag{36}$$

It can, however, also be shown that in accordance with Stokes's law,

$$D = \frac{RT}{N} \cdot \frac{1}{6\pi a \eta} \tag{37}$$

* Jean Perrin, Die Beweise für die wahre Existenz der Moleküle, Abhandlungen Bunsengesellschaft, Nr. 7, 124-207 (1913).
T. Svedberg, Untersuchungen über die Brownsche Bewegung, Jahrb. d. Radioakt. u. Elektronik, 10, 467-515 (1913).

It therefore follows that

$$\frac{d^2}{t} = \frac{RT}{N} \cdot 3 \pi a \eta \quad (38)$$

This equation gives us a method of determining N from the intensity of the Brownian movement.

Experimental observations have not only confirmed the validity of equation (35) but have also led to values of N of the same order of magnitude as those obtained by the first method.

Perrin using emulsions of rubber and mastix in water has obtained a value of 6.9×10^{23} , while Svedberg working with colloidal solutions of metals has obtained the lower value, 6.2×10^{23} .

Attempts have also been made to apply equation (37) directly to determine N from measurements of the diffusion constant. In this manner Brillouin, working under Perrin, has obtained a value 6.9×10^{23} , while Svedberg has obtained values ranging between 5.8 and 6.2×10^{23} .

So far we have spoken only of the translational motion of Brownian particles; but particles in suspension also suffer a rotational motion, and N may be determined by measuring the magnitude of the angular displacement of any particle at constant intervals of time. Denoting the mean value of the square of the average angular displacement in time t by A^2 , it has been deduced by Einstein that

$$\frac{A^2}{t} = \frac{RT}{N} \cdot \frac{3}{4 \pi a^3 \eta} \quad (39)$$

This method of determining N is not susceptible of great accuracy, although from observation on mastix emulsions Perrin has derived a value of 6.5×10^{23} .

Fletcher¹, working with Prof. Millikan, made a determination of N from measurements of the Brownian movement of small oil-drops suspended in air. In this case, however, he did not measure the mean square displacement, but the average arithmetical displacement d_a , which, as both he and Einstein have shown, is related to the mean square displacement (d^2) in the same time, by the relation²:

$$d_a = \sqrt{\frac{2}{\pi}} \sqrt{d^2} \quad (40)$$

By this method, Fletcher derived a value $N = 5.75 \times 10^{23}$.

More recently³ he has made more accurate determinations of N under similar conditions, from observations of the law of distribution of times of fall of oil-drops through a constant

distance. He thus obtains a value of $(6.03 \pm .12) \times 10^{23}$ which must be considered one of the most accurate determinations that has been made of Avogadro's constant.

III. From Spontaneous Variations in Density

At first sight there appears to be little in common between the Brownian movement, and the opalescence observed in gases at the critical point or the blue color of the sky, but it has been shown that each of these observations can be used to calculate at least an approximate value for Avogadro's constant.

The fact that all gases near the critical point exhibit opalescence indicates that under these conditions there are large variations in density, occurring throughout different parts of the substance. Smoluchowski has shown that this is to be expected as a result of molecular motions; for just as we have variations in molecular velocities from instant to instant, so we can expect spontaneous variations in density at any point. That is, there will be liable to occur at irregular intervals a congestion or rarefaction of molecules. The theory developed on this basis shows that it is possible to calculate N from observations of the degree of scattering of the light by a gas at the critical point, and the value obtained, about 7.5×10^{23} ⁽⁴⁾, is fairly close to those obtained by other methods.

In a similar manner it has been shown by Lord Rayleigh that the blue color of the sky is due to an actual scattering of the light by molecules of the atmosphere which are distributed irregularly in space. Observations of the relative intensities of the light coming directly from the sun and that coming from other parts of the sky lead here also to a determination of N . Lord Kelvin thus arrived at values for $N \times 10^{-23}$, ranging between 30 and 150, while more accurate determinations since then have led to values ranging between 45 and 75⁽⁵⁾.

IV. From Measurements of the Unit Electric Charge

According to Faraday's law, it requires the same number of coulombs to liberate or decompose by electrolysis amounts of different substances that are chemically equivalent. The Faraday constant, F , is defined as the number of coulombs required to decompose or deposit by electrolysis that weight in grams which is equivalent to 16 gms. of

(1) Phys. Rev. 33, 51 (1911).

(2) See also T. Svedberg, loc. cit., p. 496.

(3) Phys. Rev., 4, 440 (1914).

(4) Perrin, loc. cit., p. 182.

(5) Perrin, loc. cit. p. 185.

oxygen (or 1.008 gms. of hydrogen). Very accurate determinations of this constant have been carried out at the Bureau of Standards and the values obtained are (3):

$$F = 96,515 \text{ coulombs (Iodine} = 126.92), \\ = 96,494 \text{ coulombs (Silver} = 107.88).$$

The value 96,500 is therefore recommended by the Bureau.

Denoting the unit charge of an ion by ϵ , it follows that

$$N \epsilon = F \quad (41)$$

Thus the value of N may be determined from accurate measurements of the fundamental unit of electricity.

Instead of measuring the charge on an ion in solution, all the investigators in this field have worked with charged Brownian particles or ions in gases. That however the unit electric charge has the same value for all charged bodies, whether they be ions in solution or charged Brownian particles was first demonstrated by Townsend.

The method used consisted essentially in comparing the average velocity of ions in a gas under the influence of an electric field with their diffusion coefficient. From Stokes' law, equation (36), it follows that the velocity u of particles having a charge ϵ , in a field of strength H must be proportional to $H \epsilon$, so that

$$H \epsilon = 6 \pi a \eta u \quad (32)$$

Combining this with equation (37) for the diffusion constant, D , there results the relation

$$N \epsilon = \frac{RT}{D} \frac{1}{6 \pi a \eta} \quad (42)$$

Fletcher(4) and Eyring(5) have used a somewhat similar method to measure N for oil drops in ionized air and ionized hydrogen respectively.

Instead of determining D , they found it more convenient to observe d^2 , the mean square displacement, which is related to D according to equation (36). In both cases the values of $N \epsilon$ obtained were very nearly equal to 96,500 coulombs or 2.95×10^{14} electrostatic units (e.s.u.) thus showing that the value of $N \epsilon$ is the same for ions in gases as for ions in solution.

The two principal methods which have been used for the determination of the charge on an ion are those of H. A. Wilson and R. A. Millikan.

METHOD OF H. A. WILSON

A gas exposed to X-rays, or to the radiations from a radioactive substance undergoes ionization, that is, some of the molecules are made to give up one or more unit negative charges (electrons) and the residues thus become positively charged. The electrons themselves do not remain detached, but combine with neutral molecules to form negatively charged ions. The gas is said to be ionized. If the gas contains microscopic particles in suspension, such as exhibit the Brownian movements, the ions attach themselves to the particles which thus become charged in their turn, and by successive collisions with charged molecules the particles will receive or give up part of their charge until finally a stationary state is obtained.

It is a matter of common observation that a gas freed of dust particles can contain large concentrations of water vapor in a supersaturated state. C. T. R. Wilson observed that if a gas containing supersaturated water vapor is ionized, each ion acts as a nucleus for the condensation of a drop of water, so that from a determination of the number of water drops and their total charge, it is possible to calculate the charge on each drop. The results obtained by J. J. Thomson and Townsend were of the right order of magnitude but extremely inaccurate.

H. A. Wilson(4) also used charged water drops but measured their rate of fall under the influence of gravity alone and under the combined effect of gravitational and electric fields.

Let m' denote the apparent mass of a water drop (see page 1160); u and u' the rate of fall before and after applying the electric field of strength H . Assuming that the velocity of the drop is in each case proportional to the applied force, it follows that

$$\frac{H \epsilon - m' g}{m' g} = \frac{u'}{u}$$

or

$$\epsilon = \frac{m' g}{H} \left(\frac{u + u'}{u} \right) \quad (43)$$

The apparent mass m' was deduced by means of Stokes's law according to equations (33) and (34). The results obtained indicated the existence of ions with more than one unit charge, but the lowest value observed was about 3.1×10^{-10} e.s.u.

The experiments of H. A. Wilson were subsequently repeated by other investigators. Working under much more improved conditions their results have led to values ranging from 4.5 to 4.7×10^{-10} e.s.u.

(3) Bull. Bur. Stand. 10, 425 (1914).

(4) Phys. Rev. 33, 81 (1911).

(5) Phys. Rev. 5, 412 (1915).

(6) Phil. Mag. 5, 429 (1903).

METHOD OF R. A. MILLIKAN

Undoubtedly the most accurate results up to the present have been obtained by Prof. Millikan⁽¹⁾ at the University of Chicago. Whereas all the other workers in this field "had deduced the elementary charge from the average behavior in electrical and gravitational fields of *swarms* of charged particles" while the equations used by them hold true only for individual particles, Millikan avoided this source of error. A single oil drop suspended in air was isolated "and its speed measured first in a vertical electrical and gravitational field combined, then in a gravitational field alone." The equations used are therefore those given above. The result obtained in 1911 was $\epsilon = 4.891 \times 10^{-10}$ e.s.u. Subsequently more accurate data were obtained regarding the coefficient of viscosity of air, which led to the value $\epsilon = 4.774 \times 10^{-10}$ e.s.u. This is considered by Prof. Millikan as accurate to within 0.2 per cent.

In the course of these investigations, Prof. Millikan also arrived at the conclusion that "Stokes' law for the motion of a small sphere through a resisting medium breaks down as the diameter of the sphere becomes comparable with the mean free path of the molecules of the medium."

As pointed out by him, the simple form of this law involves the assumption that there is no slip at the bounding surface between the medium and the drop. The existence of such a phenomenon would tend to counteract the frictional force otherwise exerted on the suspended particle. These considerations therefore led Millikan to suggest the following modified form of Stokes' law, which was found to be in good accord with the experimental results.

$$N = \frac{6 \pi a \eta u}{1 + A L/a} \quad (44)$$

where

L = mean free path (see Part II).

A = constant.

The results obtained by Prof. Millikan form a direct demonstration of the view "that all electrical charges, however produced, are exact multiples of one definite elementary electrical charge; or, in other words, that an electrical charge, instead of being spread uniformly over the charged surface has a definite granular structure, consisting, in fact, of an exact number of specks or *atoms of electricity*, all precisely alike, peppered over the surface of the charged body."⁽²⁾

On a single oil drop it was possible to hold under observation for any desired length of time one ion or any definite number of such ions up to 150. In all cases, the charge was observed to be an exact multiple of the unit charge, $\epsilon = (4.774 \pm .009) \times 10^{-10}$ e.s.u.

Substituting this value in equation (41) it follows that according to Millikan

$$N = 6.062 \pm .012 \times 10^{23}$$

$$n = \frac{N}{V} = 2.6696 \times 10^{19} \text{ at } 10^6 \text{ bars and } 0 \text{ deg. C.}$$

$$= 2.7048 \times 10^{19} \text{ at } 1.01323 \times 10^6 \text{ bars and } 0 \text{ deg. C.}$$

V. From Radioactive Phenomena

As well known, a number of radio-active elements emit so-called alpha particles during the process of disintegration. It has also been shown that these particles possess the same mass as helium atoms and differ from these only in being positively charged. Upon these observations have been based four different methods for determining N , which are extremely interesting because they furnish an additional check, as it were, on the values obtained by the other methods described above.

1. Electric Charge on Alpha Particle

Rutherford and Geiger⁽³⁾ carefully measured the rate at which alpha particles are emitted by a given weight of radium, and also the charge due to a known number of the particles. Observations of a somewhat similar character were made by Regener⁽⁴⁾, but instead of using an ionization method of counting the alpha particles, he observed the scintillations produced by each particle on a diamond. It was found in this manner that the charge carried by one alpha particle was 9.3×10^{-10} e.s.u. according to Rutherford and Geiger, and 9.58×10^{-10} e.s.u. according to Regener. On the other hand, other lines of evidence have led to the conclusion that this is twice the unit charge. Thus, measurements of the charge on an alpha particle lead to a value of the unit charge, ranging from 4.65×10^{-10} to 4.79×10^{-10} e.s.u.

2. Number of Alpha Particles in a Given Volume of Helium

Since both the rate at which alpha particles are emitted and the rate at which helium is

⁽¹⁾ Phys. Rev. **32**, 1911.

Phys. Zeit. **14**, 796 (1913); Phys. Rev. **2**, 140 (1913).

⁽²⁾ Millikan, Phys. Rev. **32** (1911). The italics in all the quotations are the writer's.

⁽³⁾ Proc. Roy. Soc. **81**, 141, 162 (1908). Rutherford, Radioactivity, p. 135.

⁽⁴⁾ Rutherford, loc. cit. p. 52; 137.

formed by the same weight of radioactive element can be readily determined, we are obviously able to determine N directly.

Dewar observed that 1 gm. radium evolves 164 cubic millimeters helium in one year. Combining this with Rutherford's observation that 1 gm. radium emits 3.4×10^{10} helium atoms per second, it follows that $N = 6.0 \times 10^{23}$. Boltwood and Rutherford repeated these measurements and deduced the result $N \times 10^{-23} = 6.24$ to 6.4; while Mme. Curie, working with polonium obtained the value $N \times 10^{-23} = 6.5$ (1).

3. Period of Radium and Rate of Emission of Alpha Particles

The period of radium is about 2000 years, that is, at the end of this interval of time, half of the radium will have been transformed into helium and the other disintegration products. That is, each second there disappear $N \times 1.09 \times 10^{-11}$ atoms of radium. But this must be the same as the number of atoms of helium produced per second by one atom of radium. Since the atomic weight of radium is 226.5 and 1 gm. emits 3.4×10^{10} helium atoms per second, we obtain the relation

$$1.09 \times 10^{-11} \times N = 226.5 \times 3.4 \times 10^{10}$$

Hence

$$N = 7.1 \times 10^{23}$$

4. Kinetic Energy of an Alpha Particle

It has been shown in Part I that the average kinetic energy per gram molecular weight of any gas is equal to $\frac{3}{2} RT$. Denoting the kinetic energy of a molecule by K_T , it follows that

$$K_T = \frac{3R}{2N} T = \frac{1}{2} m G^2 \tag{45}$$

where m = mass of molecule, and G = square root of mean squares of velocities (Part I).

The constant R/N is usually denoted by k and is known as Boltzmann's constant.

This kinetic energy is converted into heat owing to bombardment of the radium by the helium atoms. Hence by measuring the rate at which heat is emitted by 1 gm. radium, it is possible to deduce still another value for N . Rutherford obtained in this manner the result $N = 6.2 \times 10^{23}$.

VI. From Radiation Laws for Black Body

From theoretical considerations of a rather complex nature, Planck arrived at the following equation expressing the relation

between intensity of unpolarized monochromatic radiation from a black body and the temperature of the latter.

$$I_\lambda = \frac{2 \pi c^2 h \lambda^{-5}}{e^{k\lambda T} - 1} \tag{46}$$

where

I_λ = intensity of monochromatic radiation of wave-length λ at temperature T .

c = velocity of light.

k = Boltzmann's constant (see above).

h = universal constant; so-called "Wirkungsquantum."

The coefficients $2 \pi c^2 h$ and $\frac{ch}{k}$ are usually denoted by c_1 and c_2 respectively.

From the form of this equation it can be shown that the intensity of the radiation at any temperature possesses a maximum value at a wave-length λ_m such that

$$\lambda_m T = \frac{ch}{4.9651 \times k} = \frac{c_2}{4.9651} \tag{48}$$

This is known as Wien's displacement law.

Again, it was shown by Stefan and Boltzmann that the total radiation varies with the temperature according to a relation of the following form:

$$I = \int_0^\infty I_\lambda d\lambda = \sigma (T^4 - T_o^4) \tag{47}$$

where

σ = Stefan constant.

T = temperature of radiating surface.

T_o = temperature of absorbing surface.

Integrating equation (46) from $\lambda = 0$ to $\lambda = \infty$, and comparing the result with the above equation, it can be shown that

$$\sigma = \frac{12 \pi \times 1.0823 k^4}{c^2 h^3} \tag{49}$$

From (48) and (49), h may be eliminated and $k = R/N$ calculated; that is, k can be calculated from accurate determination of σ and $\lambda_m T$.

According to the results obtained up to the present, the best values of the Stefan-Boltzmann constant and $\lambda_m T$ appear to be

$$\lambda_m T = 0.29 \text{ cm. deg.}$$

$$\sigma = 5.63 \times 10^{-5} \text{ erg. cm.}^{-2} \text{ sec.}^{-1} \text{ deg.}^{-4}$$

Substituting these values in (48) and (49) it follows that

$$N = 6.06 \times 10^{23}.$$

While this method has been discussed rather briefly, it is in reality one of the most important methods for obtaining an accurate value of N . Owing to the fact that the

(1) Perrin, loc. cit., p. 200.

development of all the above equations has been discussed very fully in another connection*, the writer has felt that a more lengthy discussion is unnecessary.

Summary

When we consider that by about a dozen totally independent methods, we obtain approximately the same value of N , the coincidence must appear more than accidental. Not only does this result represent the best deductive evidence for the belief in the existence of molecules and atoms, but the phenomena of Brownian movements may be considered as splendid visible evidence for believing that the kinetic theory is much more than a "theory"—that it represents a reality. There are indeed some doubts about certain phases of the theory, but the general point of view appears more justified today than it did twenty years ago.

In view of the results given above, it is evident that Prof. Millikan's statement is quite justifiable that "today we are counting the number of atoms in a given mass of matter with as much certainty and precision as we can attain in counting the inhabitants in a city. No census is correct to more than one or two parts in a thousand," and there is little probability that the number of molecules in a cubic centimeter of a gas under standard conditions (10^6 bars and 0 deg. C.) differs by more than that amount from 2.67×10^{19} .

Let us now see what this means. The highest vacua obtainable range from 10^{-3} to 10^{-4} bar. Even at this lowest pressure, the number of molecules per cubic centimeter is still 2.67×10^6 , or 2,670,000,000.

It has been shown in Part I that the number of molecules striking unit area of a surface is $\frac{1}{4} n \bar{c}$. For air at 20 deg. C. and 10^6 bars, this corresponds to 2.88×10^{23} . In other words, each square centimeter of a surface is being struck by this number of molecules per second. The pressure in an ordinary tungsten lamp is about 0.1 bar, the residual gas being probably all nitrogen. Under these conditions, each square centimeter of the bulb is being bombarded by about 3×10^{16} molecules per second.

APPENDIX

It has been felt that a paper on the Kinetic Theory of Gases would be incomplete without a table of the most accurately available values of a number of the constants to which reference has been made above. The table at the

end of the paper contains the values of a number of atomic and electronic constants, such as are being constantly used by physicists and chemists. References to literature and further explanations will be found in the main part of the paper.

A few remarks are, however, added in connection with some of the values given. The number in front of each of the following sections corresponds to a reference in the table.

(1) The values for V , F , e , ϵ/m_0 ; c ; and h are the fundamental experimental data from which all the other constants have been calculated, by means of the relations indicated in each case.

(2) Bull. Bur. Stand. 10, 425 (1914).

(3) R. A. Millikan, Phys. Rev. 2, 140 (1913).

(4) The values of ϵ/m_0 obtained in recent years are as follows:

Classen	(1908)	1.776×10^7 e.m.u.
Bucherer	(1908)	1.763
Wolz	(1909)	1.767
Malassez	(1911)	1.769
Bestelmeyer	(1911)	1.766
Alberti I	(1912)	1.756
Alberti II	(1912)	1.766
Neumann	(1913)	1.765
Schaefer	(1913)	1.767

The best average of these values is 1.766×10^7 e.m.u.

(5) Direct determinations of h have been carried out in Prof. Millikan's laboratory during the past two years. For this purpose the Einstein photo-electric equation (see GENERAL ELECTRIC REVIEW, October, 1914) was tested for the case of the alkali metals over a large range of frequencies. The values observed were $h = 6.561 \times 10^{-27}$ (K and Na)(¹) and 6.585×10^{-27} (Li)(²).

(6) The values of σ obtained by different observers(³) range all the way from 5.45×10^{-5} to 6.51×10^{-5} . Taking the weighted mean of all the observations to 1913, Coblentz arrived at the result $\sigma = 5.70 \times 10^{-5}$ erg. cm.⁻² deg.⁻⁴.

In a more recent paper he considers the value 5.61×10^{-5} as more accurate(⁴).

* See Recent Views on Matter and Energy, GENERAL ELECTRIC REVIEW, July, September, October, and December, 1914. Attention ought to be drawn in this connection to the fact that in the above paper, the distribution law was derived for the case of monochromatic polarized radiation, thus leading to the omission of the coefficient 2π in the expression for α . Thus I_λ in the equation given above is equal to $2\pi E_\lambda$, where E_λ = intensity of polarized monochromatic radiation. On the other hand, in the equation for the Stefan-Boltzmann law, $E = I$ according to the above notation.

(1) Phys. Rev. 4, 73 (1914).

(2) Phys. Rev. 6, 55 (1915).

(3) See the summary by Coblentz, Jahrb. d. Radioakt. 10, 340, (1913).

(4) Bull. Bur. Stand. 11, 97 (1914).

To c_2 and $\lambda_m T$, Coblenz assigned in his earlier paper, the values 1.4420 and 0.2905 respectively, while in a later paper he gave the values 1.4465 and 0.2911 respectively⁽¹⁾.

On the other hand, Warburg and his associates at the Reichsanstalt⁽²⁾ arrived at the results $c_2 = 1.4370 \pm 0.0004$ and $\lambda_m T = 0.2894 \pm 0.0008$.

Taking into consideration these data, it would seem that the values given in italics in the Table are in best accord with both the experimental observations and the deductions from the Planck equation. For those, how-

ever, who prefer to choose any other values of h , c_1 or c_2 , the table of corresponding values will be found useful. In each horizontal line are given the corresponding values of h , c_1 , c_2 , σ , $\lambda_m T$ and I_m . It is therefore very easy to perceive at a glance the effect of slight changes in the value of each constant on the values of all the other constants.

The last table summarizes molecular data which have been published in Parts I and II.

(1) Bull. Bur. Stand. 10, 1 (1914).

(2) Ann. Phys. 40, 608 (1913).

QUESTION AND ANSWER SECTION

The purpose of this department of the REVIEW is two-fold.

First, it enables all subscribers to avail themselves of the consulting service of a highly specialized corps of engineering experts, or of such other authority as the problem may require. This service provides for answers by mail with as little delay as possible of such questions as come within the scope of the REVIEW.

Second, it publishes for the benefit of all REVIEW readers questions and answers of general interest and of educational value. When the original question deals with only one phase of an interesting subject, the editor may feel warranted in discussing allied questions so as to provide a more complete treatment of the whole subject.

To avoid the possibility of an incorrect or incomplete answer, the querist should be particularly careful to include sufficient data to permit of an intelligent understanding of the situation. Address letters of inquiry to the Editor, Question and Answer Section, General Electric Company, Schenectady, New York.

CABLE, MULTIPLE-CONDUCTOR: AERIAL SUSPENSION

(152) Would it be inadvisable to use multiple-conductor cable hung from a messenger wire for light and power distribution at 2300 volts and 60 cycles?

The scheme outlined in the question can be successfully carried out provided properly constructed cable, hung in an approved manner, is employed.

Multiple-conductor cables suspended from messenger wires have been used to transmit power at voltages up to 13,000. Two types of cable are suitable for this purpose; one is of either varnished cambric or paper insulation and leaded (being suspended by hangers at least every 18 inches) and the other is of varnished cambric armored on the outside with band steel and made up without lead. Obviously, a voltage of only 2300 can be handled successfully by either type of cable. The varnished cambric cable with band steel armor and no lead possesses the advantage of being lighter in weight than the leaded cable, and therefore does not require such short spans, heavy messenger wire, or heavy pole construction. W.L.C.

INDUCTION MOTOR: QUARTER-PHASE TO THREE-PHASE

(153) Can standard quarter-phase motors be changed to three-phase by re-connecting the stator coils?

In a rather limited number of cases it is possible and practical to make this change in the manner described.

Concerning a particular motor it is first necessary to have data regarding the winding and magnetic densities, and also the condition of the insulation between phases. (It is obvious that the flux per pole after the regrouping of connections should be approximately equal to the original flux per pole,

and that the insulation between phases after the regrouping should be amply sufficient to withstand the voltage strain that will be present under the new conditions.)

It is usually practicable to reconnect a 220- or a 440-volt quarter-phase motor to 550 volts three-phase; but, outside of this combination, each individual case would have to be considered separately. A.E.A.

REACTANCE COILS: PROTECTION

(154) (a) Would it be practical to build a reactance coil for directly protecting a 110,000-volt transmission line?

(b) Could not a reactance coil be so arranged that during normal operating conditions it would not be in circuit but could immediately be placed in the circuit by automatic switches in time of trouble? Thus, under ordinary conditions its reactive voltage drop in the line would be eliminated.

(a) There are serious design and cost limitations that would apply in constructing a 110,000-volt current-limiting reactance coil. So far as we know there has none been built for as high a voltage. It has usually been found possible to secure an equal degree of protection for these high-voltage lines by inserting a reactance coil in the low-tension side, which practice permits of a more economical and substantial coil construction.

(b) The proposal to automatically insert a current-limiting reactance coil in a line has been considered on several occasions. It is the general consensus of opinion, however, that such a scheme would seriously lack the certainty of the coil accomplishing its purpose, viz., giving protection. In order that a reactance coil may be infallibly able to give instantaneous protection against short-

circuits or arcing-grounds, the device should remain permanently in circuit. The greatest damage (mechanically) occurs during the first two or three cycles. It is almost impossible to build a switch that can be relied upon to operate quick enough to cut reactance coils into a line before the system has been subjected to the heavy strains incident to the first two or three current peaks. It is entirely possible, however, that such an arrangement might be feasible for an installation wherein protection against arcing-grounds is more to be desired than protection against short-circuits.

C.M.D.

TRANSFORMER: BOOSTING

(155) Would it be feasible to use an ordinary single-phase transformer for boosting the voltage near the end of a line?

Theoretically, the scheme outlined in the question is thoroughly applicable, and it can be successfully used in practice provided the following conditions are fulfilled.

- (a) The frequency of the boosting transformer should be the same as that of the line.
- (b) The voltage of the high-tension winding should be nominally the same as that of the line.
- (c) The voltage of the low-tension winding should be approximately equal to the desired voltage boost of the line.
- (d) The current-carrying capacity of the transformer's low-tension winding should not be exceeded, in order that overheating will not result. The current-carrying capacity of the low-tension winding is equal to the volt-ampere capacity of the transformer divided by the low-tension voltage. This value should not be less than the amperes current that is furnished directly to the load.

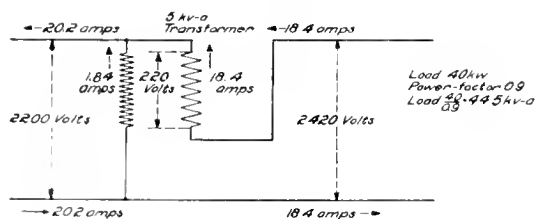


Fig. 1

Line load of 40 kw. at 90 per cent power-factor = $\frac{40}{0.9} = 44.5$ kv-a.

Load current = $\frac{44.5 \times 1000}{2420} = 18.4$ amps.

Booster transformer load = $\frac{18.4 \times 220}{1000} = 4.05$ kv-a., which it will be noted is less than the transformer capacity, 5 kv-a.

Booster transformer primary current = $\frac{4.05 \times 1000}{2200} = 1.84$ amps.

(e) The insulation between the transformer's low-tension winding and the ground should be strong enough to withstand (with a reasonable factor of safety) the boosted line voltage. This is a requisite because if the "through" line (the one in which the boosting winding is not inserted) should

become grounded the stress of the boosted voltage, instead of only half the boosted voltage, will be applied to the insulation named; the insulation of this winding will be subjected to the same stresses as the high-voltage winding, inasmuch as it is electrically connected to it. (Whether the transformer selected will be suitable in this regard can be determined from the following rule which is taken from the "1915 A.I.E.E. Standardization Rules," paragraph 500. "The secondary windings of distributing transformers shall be tested with twice their normal voltage plus 1000 volts.")

Fig. 1 is a diagram in which a 40 kw. load at 90 per cent power-factor has been assumed, the voltage for which is being boosted by a 5 kv-a. transformer. For the purpose of furnishing a guide in making calculations the instantaneous directions of the currents and values of the voltages and currents are indicated on the diagram.

E.C.S.

CABLES: POT-HEADS

(156) In running an underground 2200-volt, three-phase, 60-cycle, lead-covered cable with rubber insulation is it necessary or good practice to use pot-heads where connections are made to transformers in manholes or in transformer vaults in buildings?

Are pot-heads more necessary with varnished cambric insulation than with rubber?

It is not considered good practice to terminate either rubber insulated or varnished cambric 2200-volt cable in a manhole without the use of a pot-head which would properly seal the end of the cable. Pot-heads are also considered equally necessary for both rubber insulated and varnished cambric cables carrying higher voltages than 2200.

W.S.C.

GENERATORS, LOW-SPEED: FORCED VENTILATION

(157) Why is not forced-draft ventilation applied to cool low-speed (75 to 120 r.p.m.) electric generators?

A current of air at low pressure is produced most conveniently and efficiently by a fan which is inherently a high-speed device. It would be impracticable, however, to apply this practice to low-speed machines (such as are named in the question) because the fan, operating at low speed, would be inefficient and would have to be so large in order to pass the necessary volume of air that it would prohibit a compact mechanical and electrical generator design.

While the system of self-contained-fan ventilation is inapplicable to low-speed units for the reasons stated, the method of forced air cooling that is used with air-blast transformers could be successfully adopted. This plan, however, would entail the addition of a separate motor-driven fan set and air ducts to the generator. Although this system would be thoroughly practical and would present no engineering difficulties, it has seldom been used because of an aversion on the part of central-station men to adding auxiliary apparatus if it can reasonably well be avoided.

E.C.S.

IN MEMORIAM

CAPTAIN GEORGE CRELLIN CARTWRIGHT

Captain George Crellin Cartwright, Royal Warwickshire Regiment of England, who was killed while gallantly rallying a company which had suffered the loss of nearly all its officers in "the great advance" of September 26th, was born in London in March, 1882, and graduated from the Central Technical College of the City and Guilds of London Institute. He served in the 2nd Scottish Horse in the Boer War, receiving the Queen's Medal with four clasps.

Captain Cartwright came to New York after the Boer War and joined the student course at the Schenectady Works of the General Electric Company. After completing the course in the shops, he took a position in the Foreign Department of the Company. He was sent to Japan by the General Electric Company where he remained three years, returning to New York in 1910. He then went to Rio de Janeiro to represent the General Electric Company in Brazil for about a year. While in Rio he met the

late Dr. F. S. Pearson of the F. S. Pearson Engineering Co-operation and President of the Sao Paulo & Rio de Janeiro Electric Light and Tramway Company's. Dr. Pearson offered Captain Cartwright a position in the F. S. Pearson Engineering Co-operation London Office in charge of engineering and purchasing work, which was accepted.

He returned to London in 1911 and from that time until the outbreak of the war he was associated with the F. S. Pearson Engineering Co-operation—in particular in work in connection with the Barcelona (Spain) Power Transmission—the Ebro Irrigation & Power Company.

At the outbreak of the war, Captain Cartwright applied for a commission and was gazetted to a second lieutenantancy early in November, 1914. He was promoted to lieutenant in April, 1915, and to Captain in July last. Shortly before his death he was

attached to the staff of the 22nd Infantry Brigade as a machine-gun officer.

On the morning of the attack, on the 26th of September, Captain Cartwright, as Brigade Machine-Gun Officer, was in the front line trenches with his guns, observing the English advance.

A certain regiment in front had suffered the loss of nearly all its officers, and Captain Cartwright, seeing that the men needed assistance, immediately left the security of

his trenches and rallied the men and started to lead them forward again to the attack. He had hardly begun the advance when an unfortunate shot struck him about two inches below the right breast and came out at his back. He was carried to the rear and a doctor was brought and every possible aid given to him, but he lingered only two hours.

It will be seen therefore that he sacrificed himself by a voluntary act of bravery. As staff officer in charge of machine guns, his position was in the trenches observing the advance and directing his gun fire, and reporting the results to headquarters. As soon, however, as he perceived that the men in the advancing line in front had lost practically all their officers and needed a leader, he unhesitatingly and fearlessly rushed into the open and rallied the men and died leading them forward. He thus died the death of a true soldier, noble, brave and self-sacrificing.

Captain Cartwright's untimely death is a great loss to the service and to his country. He was an extraordinarily keen, able and efficient soldier, and most highly regarded by all his fellow staff officers. He was a capable and exceedingly well informed engineer—a man of brilliant mind, a student of art with a full appreciation and understanding of all that is best in life. He had many staunch friends who were endeared to him by the unusual personal qualities of his strong, high-minded character.



FROM THE CONSULTING ENGINEERING DEPARTMENT OF THE GENERAL ELECTRIC COMPANY

A STANDARD IN REFRIGERATION

The need of some method of producing artificial cold was felt centuries ago and various crude methods were used to obtain it. But it was only with the introduction of the shipment of large quantities of meat over long distances that it became imperative to develop some satisfactory method of cooling to prevent heavy loss from spoiling.

Apparatus making use of air as the cooling agent was first tried because the principle involved was best understood at the time and also because air was cheap.

A gradual evolution has taken place, during which different refrigerating agents have been brought into use, along with improvements in the apparatus employed.

From the first use as a means of preserving large cargoes of meat we have seen the number of applications for artificial refrigeration multiply until at the present time it has assumed a large commercial scale, and in the future will undoubtedly be considered as essential to comfort in large public buildings and homes as are our present heating systems.

The significance of refrigeration, then, as a branch of engineering must not be questioned.

Quite noticeable is the fact that there is at present no standard unit of refrigeration or standard cycle.

The determination of these is necessary from a scientific and practical standpoint, as considerable misunderstanding exists among engineers, manufacturers and users as to the rating and capacity of different refrigeration apparatus of different types, as well as difference in the same types among different manufacturers.

The settlement of this problem has been taken up in our country as well as abroad, and engineers and manufacturers are striving for a standard which will be universally adopted. A joint committee from the American Society of Refrigeration Engineers and the American Society of Mechanical Engineers have been working on the problem for several years. In their early consideration of the subject the committee found that the constants employed in the refrigerating industry varied as to value and it would be necessary to definitely determine their value before a refrigerating unit could be proposed.

A serious handicap, however, was the lack of suitable laboratory equipment and finally Congress was induced to make an appropria-

tion to permit the Bureau of Standards to take up these investigations. Their determination shows that the latent heat of liquefaction of ice is 143.4 B.t.u. per pound instead of the old determination of 142 B.t.u. This value is so near 144 that it is considered safe to use the latter.

From this determination, the joint Committee has proposed a value for the unit ton refrigeration equal to 144×2000 , or 288,000 B.t.u. per day of 24 hours, or 200 B.t.u. per minute. In England the ton refrigeration is considered equal to 322,600 B.t.u. per day based on the metric ton of 2240 lb. These values are also modified by a specified range of temperature on the machine, which is different in the two countries.

The British Institution of Mechanical Engineers also appointed a committee which recently reported on their work. In their opinion the most simple and unambiguous form of statement would be to express the cooling effect of a machine in calories per second, the calorie being the amount of heat necessary to change the temperature of 1 kilogram of water by 1 deg. C.

One calorie is $2.2046 \times 9/5$, or 3.968 B.t.u. One calorie per second is equivalent to $3.968 \times 60 \times 60 \times 24$ or approximately 342,860 B.t.u. per day. This value is little larger than the suggested standard unit of 288,000 B.t.u. per day in the United States and 322,000 B.t.u. in England.

The following recommendations have also been made by the British engineers:

1. Definite temperature range in condenser and brine end of machine.
2. That the refrigeration produced under standard condition be called the rated capacity of the machine; thus, a machine producing a refrigeration effect of 2 calories per second would have a rated capacity of two units.

It is the intention of the interested societies on both sides of the water to further consider the problem and come to an agreement as to the value of the standard unit under standard conditions and a standard theoretical cycle of operations for comparison.

The following recommendation for a standard unit of refrigeration has been made by Dr. C. P. Steinmetz and is very interesting:

"The calorie has been the standard energy unit in mechanics and in chemistry, until the

last decade, when the Joule was adopted in chemistry as the unit of energy. The Joule is the International Electrical Unit of Energy, and as such offers advantages over all other energy units in other fields of engineering. 1 cal = 4.186 kilojoule. It would, therefore, appear preferable to adopt the Joule also as the unit of refrigeration, just as it is the energy unit in chemistry, in electrical engineering, etc. One Joule per second then is one watt, and the adoption of the Joule as

refrigerating unit would permit to express the output of the refrigerating machine in watts or kilowatts. The only practical objection, which might be raised against this, is, that with electrically driven refrigerating machines, due to the extremely low efficiency of the cycle (less than 10 per cent), the use of the same energy unit for output as for input would show up the low efficiency, which is inherent in the process."

L. A. SIMMONS.



TK General Electric review
1
G5
v.18

~~Engineering~~
~~Series~~
~~18~~
~~18~~
~~18~~
~~18~~

Engineering

PLEASE DO NOT REMOVE
CARDS OR SLIPS FROM THIS POCKET

UNIVERSITY OF TORONTO LIBRARY

ENGINE STORAGE

