

**The** *Penkurt*<sup>®</sup> **1970**  
ISSUES  
**DEMODULATOR**

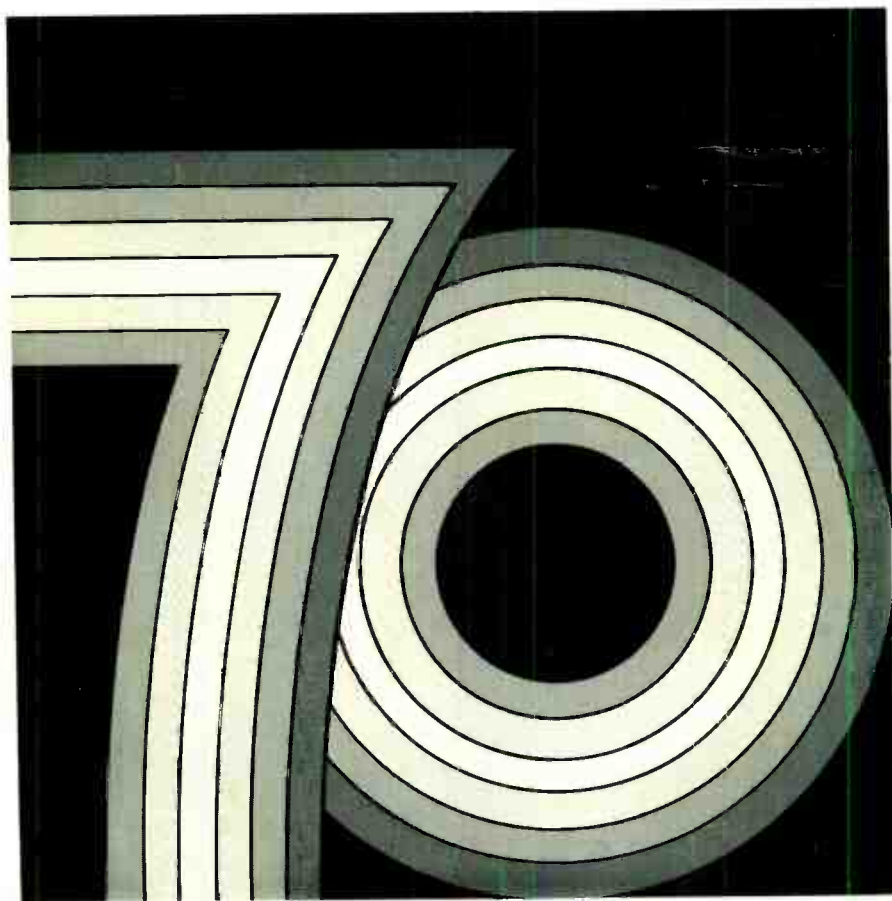



The *Lenkurt*®

**DEMODULATOR**

**1970  
ISSUES**

***LENKURT ELECTRIC***  
GENERAL TELEPHONE & ELECTRONICS



The LENKURT DEMODULATOR is a technical periodical published monthly and circulated without charge to those employed by companies or government agencies who use and operate communications systems, and to educational institutions.

This complimentary volume includes the twelve issues that appeared during 1970. If you wish to receive the LENKURT DEMODULATOR regularly, write Lenkurt, Dept. C134 for a qualification form.

Lenkurt, a subsidiary of General Telephone & Electronics Corporation, is a recognized leader in the development and manufacture of telecommunications systems and equipment to the railroads, power companies, petroleum and pipeline companies, broadcast and CATV firms, private data users, and military as well as other government agencies.

For more information about Lenkurt products and services, please contact one of our sales offices or Government engineering representatives, or write to our Main Office.

#### **District Sales Offices**

361 E. Paces Ferry Rd., N.E.  
Atlanta, Georgia 30305  
Phone 404 - 261-8282

130 North Franklin Street  
Chicago, Illinois 60606  
Phone 312 - 263-1321

340 Northcrest Building  
8609 Northwest Plaza Drive  
Dallas, Texas 75225  
Phone 214 - 363-0286

McIlvaine Building  
6201 Leesburg Pike  
Falls Church, Virginia 22044  
Phone 703 533-3344

#### **Government Engineering Representatives**

Tucson House, Suite 115  
1501 N. Miracle Mile  
Tucson, Arizona 85705  
Phone 602 - 624-3372

1027 Kikowaena Place  
Honolulu, Hawaii 96819  
Phone 808 - 895-288

6401 Tinker Diagonal, Rm. 213  
Oklahoma City, Oklahoma 73110  
Phone 405 - 737-4083

McIlvaine Building  
6201 Leesburg Pike  
Falls Church, Virginia 22044  
Phone 703 - 533-3344

#### **Main Office**

Engineering and  
Manufacturing Facilities  
1105 County Road  
San Carlos, California 94070  
Phone 415 - 591-8461

#### **GT&E International Sales Office**

1105 County Road  
San Carlos, California 94070  
Phone 415 - 591-8461  
Cable: GENTE LINT

# Contents

- JAN Lasers for Communication**
- FEB Holography**
- MAR Subscriber Carrier**
- APR Progress in Solid-State Radio**
- MAY Cables**
- JUN Cable Developments**
- JUL Domestic Satellites**
- AUG Some Aspects of Microwave System Reliability**
- SEP High-Speed Data Transmission**
- OCT Communications Yardsticks**
- NOV Crystal Filters – Part One**
- DEC Crystal Filters – Part Two**

Copyright © 1970

by

***LENKURT ELECTRIC CO., INC.***

Printed in the United States of America

**The**

*Leakert*

JANUARY 1970

# DEMODULATOR



**LASERS FOR COMMUNICATION**

Since the first Light Amplification by Stimulated Emission of Radiation (LASER) was demonstrated in 1960, this new kind of light has stirred the imaginations of almost everyone. The wide interest in lasers and their possible applications has produced devices that are used for everything from delicate eye surgery to taking "pot-shots" at the moon. There is an almost endless list of laser uses, but the one which has received major interest is the potential of the laser in the development of a high-density communications system. Engineering interest in this pursuit has been marked by almost a decade of growing optimism. Only in the last year or so has this enthusiasm begun to show signs of diminishing.

Scientists and engineers, in their pursuit of the laser as a practical communications system, have built an impressive technology and solved a number of problems. Workable methods of modulation and demodulation have been developed and are still being refined. Operating laser communications systems have been designed and demonstrated — in the laboratory. Many laser sources are now available, solid-state, gaseous and liquid, which are more compact and more efficient than the early solid ruby type. A complete system can be put together with equipment now stocked by several manufacturers. The problem which remains to be solved is the development of an efficient, inexpensive transmission technique which can compete with existing microwave and cable systems. This challenge is compounded by the fact that microwave and cable techniques are constantly being improved. Although the skeptics may not represent the majority, their attitude does explain the leveling-off of enthusiasm.

In spite of the obstacles, it seems certain that the search to find a workable, economically feasible method of harnessing the laser's tremendous message potential will continue until it is either accomplished or discarded as impossible. Prognostications of a system capable of transmission rates of  $2 \times 10^{14}$  bits per second are too tantalizing to put aside.

## The Basic Principle

The laser theory is based on atomic physics and dates back to 1917 when Albert Einstein pointed out that controlled radiation could be obtained from an atom (or molecule) under certain conditions.

Atoms in nature are usually in a relatively undisturbed or "ground" state. The energy of orbiting electrons is balanced with the energy in the atom's nucleus. These electrons occupy specific orbits determined by their own energy. As Einstein suggested, "pumping" energy into these electrons raises their orbits to the second, third or fourth level depending on the energy applied (see Figure 1).

Since the excited state is unnatural for an atom, it tends to return to its "ground" state, emitting a photon of radiation in the process. The energy of the photon is exactly proportional to its frequency — the higher the energy the higher the frequency. A system which produces more than one energy shift will produce an equal number of light frequencies.

## Coherent Light

When atoms return randomly to their ground state, they produce incoherent light. In the laser, however, the controlled bombardment of excited atoms, by photons of equal energy, regulates the return to the ground state, producing coherent light. This process of controlled stimulation



creates an internal amplifying effect. The moving photon wave front forces excited atoms to return to the ground state contributing their own photon of equal energy — exactly in phase with the moving wave. This process produces a coherent light wave whose amplitude continues to grow.

High energy photons produce X-rays or ultraviolet radiation, while low energy photons produce visible light of any color, radiant heat or radio waves. The precise amount of energy absorbed or emitted by an electron jumping from one energy level to another varies with each material and its atomic shell structure. The wavelength of an emitted photon depends on the magnitude and the specific location of the electron jump. Thus, an electron moving from the second to the first energy level will emit a photon with one wavelength, while an electron moving from the third to the second energy level will emit a photon of another wavelength, and an electron moving from the third to the first level



*Figure 1. Pumping energy into an atom stimulates its electrons into higher energy levels. As they return to their "normal" state, this energy is emitted in the form of photons. More electrons available at the second level improves laser action.*

will emit a photon of still another wavelength.

Many methods have been developed to improve laser efficiency. In the three-level method, atoms are pumped beyond the second level to the third where they are very unstable and quickly fall back to the second level. Here, the atoms tend to accumulate and are available in larger numbers for external stimulation. Four-level pumps offer even greater efficiency.

As the emitted photons travel along the laser tube stimulating the emission of other photons, the light wave continues to grow (see Figure 2). This wave is reflected back and forth between the ends of the tube by two mirrors, one of which is slightly transparent. A standing wave builds up within this resonant cavity increasing its amplitude with each successive pass. Any light moving at angles to the axis between the mirrors exits the system through the walls of the tube leaving only a parallel beam to pass through the partial mirror. This spatially coherent light beam can be focused, through properly constructed lenses, to a spot no wider than 0.0001 cm (approximately the wavelength of light). The intense heat produced by this kind of focusing explains the use of the laser as a precision cutting tool.

## Types of Lasers

Although there are several basic types of lasers (solid, gas, semiconductor, chemical, and liquid), gas lasers have more mode purity and higher stability and appear to be better suited for wideband communications.

The gas laser operates in a somewhat different manner than the early pink ruby laser. Instead of a solid crystal, a gas (such as neon) is used. Neon has several groups of energy levels, one of which is suitable for laser action. The problem presented by the use of neon was in finding a way to

*Figure 2. The growing photon stream bounces back and forth, emerging as brilliant, coherent light. Extraneous waves are lost through the wall of the laser tube, leaving only parallel light.*

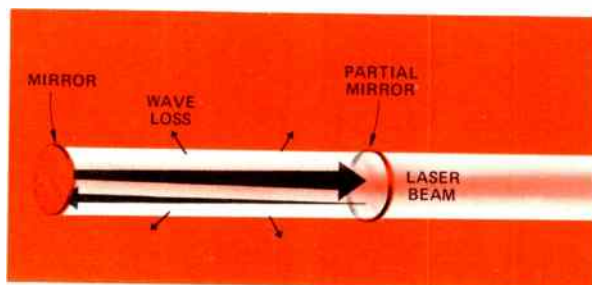

pump electrons to the upper level without also filling the lower levels, such as happens in the illumination of common neon light. One solution to this problem was achieved by mixing helium with the neon. The helium could be stimulated to a high energy state by radio frequency, having almost no effect on the neon. The excited helium atoms were then able to transfer their energy to the neon atoms at the desired level, forcing the neon's electron population into the most efficient configuration for laser action. Such juggling makes a wider range of laser materials available.

One of the newest and most powerful lasers presently available is the carbon dioxide laser. This gas laser, when properly cooled, has a typical efficiency between 5 and 10% (with some reports over 20%) and, as far as communications systems are concerned, has the lowest beam attenuation under light precipitation conditions. This is of particular interest because the earth's atmosphere is quite hostile to electromagnetic waves in the visible region. This problem can be demonstrated easily by shining a flashlight into a fogbank.

## Modulation

The most generally useful optical modulation techniques take advantage of the linear electro-optic effect of certain crystals. This effect refers to the alteration of refractive properties

of these crystals in the presence of an electrical field.

One of the first successful devices for amplitude modulating a laser beam makes use of the polarization properties of clear crystal potassium dihydrogen phosphate (KDP). As shown in Figure 3, KDP amplitude modulates the laser beam passing through it. The first polarizer blocks all light polarizations except, for example, the vertical. This divides the beam into parallel "ribbons". The KDP crystal has the unique property of effectively twisting the polarized "ribbons" in direct proportion to the voltage applied to it. The second polarizer, the analyzer, interprets the twist as a decrease in amplitude. If the voltage applied to the crystal is a modulated signal, the output from the second polarizer varies accordingly, producing an amplitude modulated light pattern. Commonly available optical modulators operate from DC to 100 MHz.

A laser beam in theory can be modulated in phase, frequency, amplitude and polarization. A great deal of comparative data is required, however, before the most efficient modulation technique is determined. The use of noncoherent detection methods, which lose the phase information of the carrier, makes phase and frequency modulation impractical. A method of PCM/PM (pulse-code modulation/polarization modulation) is presently receiving the most favorable attention.

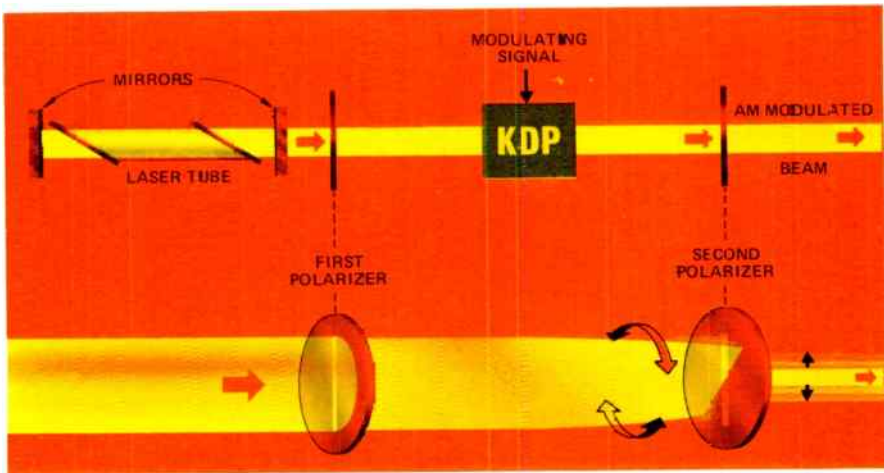

Figure 3. As the laser beam passes through a KDP modulator, it may be visualized as a “ribbon” of light twisting in proportion to a signal applied to the KDP crystal.

This technique is based on the representation of bits of either right or left circular polarization.

Gas and impurity-ion lasers require external optical modulators, based on electro-optic, magneto-optic and acousto-optic effects, in order to accept high frequency modulation. For semiconductor type lasers, it is possible to accomplish internal modulation by way of the current wave form. The Gallium arsenide laser, which has an efficiency rating of 5%, is a promising laser of the semiconductor, internally modulated type.

Most light modulators still require too much power or have inadequate bandwidth, and have been limited to visible and near infrared regions. On the brighter side, a lithium tantalate modulator has recently been developed which is capable of 80% modulation over a 220 MHz bandwidth with only 1/5 watt drive power. A Gallium-doped Yttrium-iodide garnet modulator has even achieved a 40% modulation over a 200 MHz bandwidth with 1/10 watt drive power.

A great deal of work is still to be done. The solution to the problem of efficiently modulating the laser's beam is closely related to new developments in the field of electro-optical crystals and this is a slow and expensive proposition.

## Demodulation

Laser demodulation can be accomplished with either a photomultiplier tube, a microwave phototube or high-speed solid-state detectors, each relying on the secondary emission of electrons from a cathode when struck by light photons. The photomultiplier technique redirects electrons onto other secondary emitting surfaces, causing amplification. This current is eventually collected on an output electrode. The photomultiplier tube has a range from DC to beyond 3 GHz, thereby detecting signals directly to baseband frequencies. The microwave phototube is designed with a traveling wave tube helix output, and is effective at the higher microwave frequencies. A modification of the microwave

*Figure 4. Cool gas forced through a heated pipe produces a lensing effect due to the refractive index of the gas at different temperatures. This type of lens has a soft surface and, therefore, less attenuation than a solid lens.*

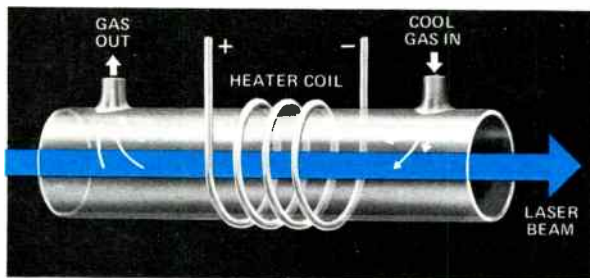

phototube, the cross-field electron multiplier, amplifies the signal before the electrons reach the helix. In both cases, since light frequencies are outside the bandwidth capabilities of the phototubes, the electron stream represents only the original modulation placed on the laser beam.

Optical heterodyning, using photomultiplier tubes, is also being explored. In this approach a laser local oscillator beam beats with the incoming laser signal in the phototube, producing an IF frequency equal to the difference between the two light frequencies. This IF signal is typically in the microwave region and may be amplified and demodulated by conventional methods. Frequency stability is maintained by a discriminator which supplies a control signal to the laser local oscillator.

## Laser Modes

The laser cavity is thousands of times longer than any wavelength at light frequencies, therefore a number of frequencies will resonate in the tube at the same time. This results in the output of a number of separate frequencies or modes. The separation of these modes is determined by the mirror placement in the laser. Since the transmission of only one frequency is desired, power distributed in modes other than the one to be transmitted is obviously wasted. Also, each mode acts as a carrier frequency

for any modulation. As sidebands are added to each mode, the bandwidth of modulation on any one mode is limited by the difference in frequency between the modes.

This problem can be solved by inserting a phase modulator inside the laser tube, driven at a frequency nearly equal to the difference frequency between modes, the output is converted to a typical FM configuration with sidebands occupying the positions formerly held by the various modes. This supermode approach eliminates the bandwidth limitation in the mode structure. Another phase modulator outside the tube will additionally compress all the modes together into a single frequency. The end result of this technique contains almost all the power of the various modes, plus a highly desirable single frequency. This super-mode beam is one approach which can be successfully modulated by any chosen method – with superior performance.

## Propagation

Although laboratory experiments have been very encouraging, the erratic attenuation of the earth's atmosphere appears to preclude any kind of reliable atmospheric transmission without having repeaters spaced so close together they become economically unrealistic. Electromagnetic waves begin to have some problems with the moisture content of the atmosphere just

beyond 8 GHz. In general, the higher the frequency, the greater the attenuation. There is, however, a band of frequencies in the infrared region which is much less susceptible than any in the visible or ultraviolet range. This "window" in the infrared portion of the spectrum is centered at about  $3 \times 10^{13}$  Hz and is 40 GHz wide. This happens to be the operating frequency of the powerful carbon dioxide laser.

Although atmospheric attenuation, along the earth's surface, is too severe for reliable transmission of a laser beam it may be possible to take advantage of the infrared window by using a carbon-dioxide laser as the up and down link of a satellite communications network. Serious proposals for a system of domestic satellite relays using lasers are presently under intensive study.

On the ground, it has been clear for some time that a closed pipe may be the only reliable way to transmit a message-bearing laser beam any significant distance. A number of approaches are being explored but all have serious cost disadvantages.

Optical waveguide can be devised which makes use of the latest developments in fiber optics, but resolution and signal attenuation are both unacceptable. Experiments with silvered pipes and solid lenses have not been much more encouraging.

While the parallel nature of the laser's beam is one of its most exciting characteristics, it creates inordinate demands for precise path alignment. The curvature of the earth, would still require several refocusing steps for the unbending laser beam. A waveguide pipe laid over a hilly terrain would require an unrealistic number of refocusing lenses. Even if quality lenses were inexpensively available, this technique will probably not be chosen

because of the cumulative attenuation of the solid lenses.

A unique approach has been the suggestion for a continuous gas-lens tube. Figure 4 shows a simplified arrangement of this concept. A steady stream of cool gas is pumped through a heated portion of the tube. The difference in the refractive index of the cool center of the gas stream and the warmer edges produces a "soft" lens for focusing the laser beam. This soft lens offers less attenuation than a solid lens, but if such lenses are spaced every 300 ft., the cost for a long-haul system becomes unrealistic.

It is safe to say that it would be possible to build a "workable" laser communication system across the country with the present level of technology. The problem is transmission cost. The rigid alignment requirements of laser beam transmission, plus the cost of closely spaced repeaters, do not give a very optimistic outlook for the laser's future in longhaul transmission — at least, not on the ground. However, it is conceivable that exceptionally dense population areas may, one day, be able to use the laser's extraordinary message potential for short hops where the cost of critical alignment and many repeaters can be acceptably maintained.

One thing is certain, the tremendous potential of the laser as a high-density communications system has not yet materialized. A great deal of work has been done and many obstacles have been overcome, but the basic problem of devising a suitable transmission technique is a dilemma awaiting a solution. The broad enthusiasm of the 1966 era could be reactivated by a major breakthrough, but for now it seems quite clear that, in the field of communications, microwave and cable are still the leading contenders.

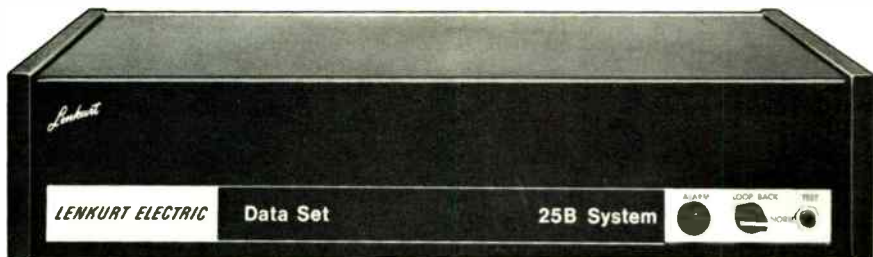

## Sending Data ?

Lenkurt's new 25B is one of the world's most versatile data, telegraph and telemetry transmission systems. The 25B's economical use of bandwidth offers reduced costs and greater profits than similar data sets. Adhering to the accepted communications standards of the CCITT, Bell System, and EIA, the 25B is designed to operate over all types of transmission facilities at speeds up to 75, 110, 150, 200 and 600 b/s. For additional information, write Lenkurt, Department C134.

**LENKURT ELECTRIC**

GENERAL TELEPHONE & ELECTRONICS

SAN CARLOS, CALIFORNIA, U.S.A.

**VIDEO, VOICE & DATA  
TRANSMISSION SYSTEMS**

### Lenkurt Offices

San Carlos	Chicago
Stamford, Conn.	Atlanta
Falls Church, Va.	Dallas

The Lenkurt Demodulator is circulated monthly to technicians, engineers and managers employed by companies or government agencies who use and operate communications systems, and to educational institutions. Permission to reprint granted on request.

The  
*Lenkurt.*

FEBRUARY 1970

# DEMODULATOR

# HOLOGRAPHY

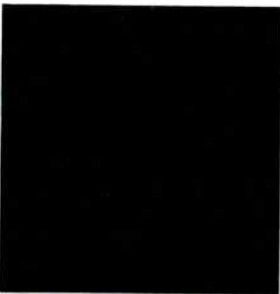

Holography, from the Greek root *holos* meaning whole, is a picture making process that captures the three-dimensional aspects of an object, rather than the flat, fixed-viewpoint of conventional photography.

In holography, three-dimensional images are formed from two-dimensional photographic negatives. In the recording process, a coherent wave source is split into two parts (Figure 1). Half the source (reference wave) strikes the holographic plate directly. The other half (object wave) illuminates the object to be recorded. Each point on the object reflects light onto the holographic plate. Having traveled different paths, the two waves are no longer in phase, and therefore reinforce or cancel each other as they converge on the holographic plate – producing an interference pattern (Figure 2). There is a unique interference pattern recorded over the entire holographic plate, for each point on the object.

Laser light is the most commonly used coherent source, but illumination may also be accomplished with electron waves, X-rays, microwaves, and acoustic waves.

Once the holographic plate has been exposed and processed, it is capable of reconstructing the original

three-dimensional object. Reconstruction is accomplished by illuminating the hologram with the same frequency reference wave used for recording. Since the hologram records all the information that the object wave contains, the reconstructed image will display this information – the size and shape of the object; the brightness of every point on the object; and the position of the object in space, from all angles that are intercepted by the holographic plate during the recording process.

Basically, a hologram is a recording of two coherent waves. When the hologram is illuminated with one wave, the other wave is simultaneously reconstructed.

There are two fundamental types of hologram – transmission and reflection. In a darkened room, transmission holograms are illuminated from behind with monochromatic light (one color). Reflection holograms, however, with their built-in filters are illuminated with white light (all colors) from the side where the viewer is standing, so



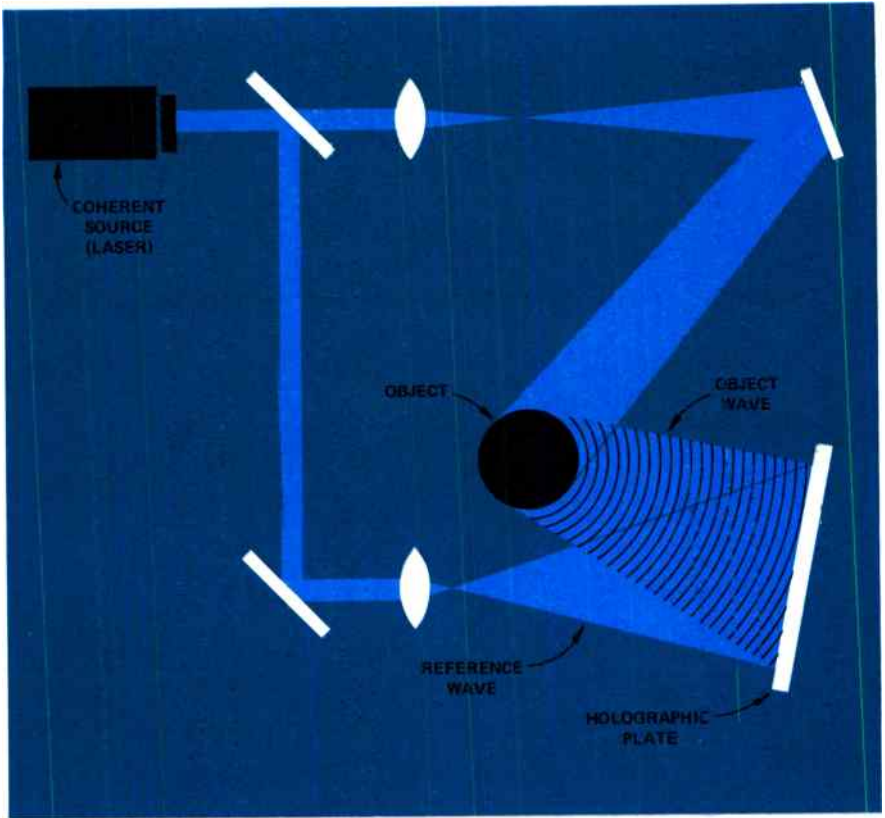

*Figure 1. Holographic recording process using laser illumination. The laser beam is split, with the object waves illuminating the object and the reference wave providing a coherent background. The two waves interfere at the holographic plate forming the hologram.*

the light is reflected from the hologram to the viewer. A reflection hologram is easier to handle because it may be illuminated in subdued lighting; although, it is not as dramatic as the transmission hologram.

### Background

Holography is not a new concept. Dennis Gabor, in 1948, introduced the

theory of holography. It was his hope that holography could be used to improve the resolution of electron microscopes. Unfortunately, limited by the intensity of the illumination, the photographic processing, and a disturbing background image, Gabor and the others experimenting with holography did not get the results they desired. The most important of these

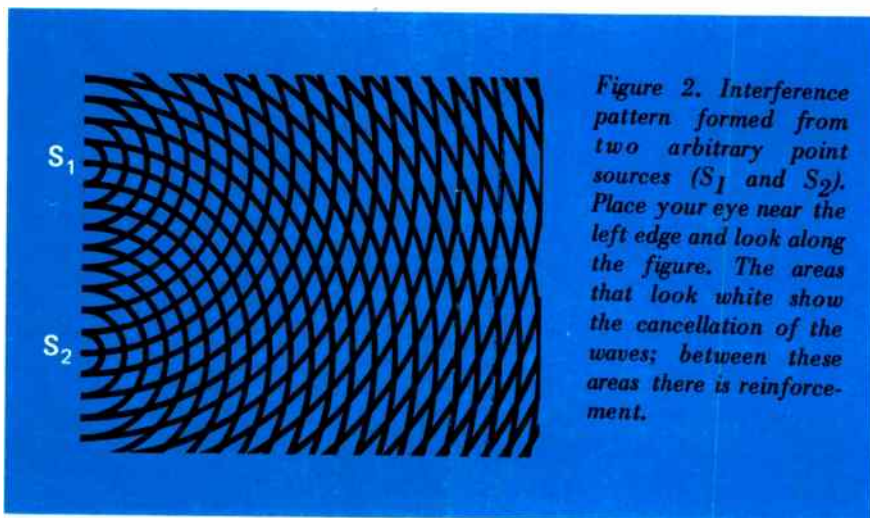

*Figure 2. Interference pattern formed from two arbitrary point sources ( $S_1$  and  $S_2$ ). Place your eye near the left edge and look along the figure. The areas that look white show the cancellation of the waves; between these areas there is reinforcement.*

limitations was the illumination intensity.

By 1962, with the development of the laser, intense coherent light became available – over-coming the illumination limitations and eliminating the background image. Laser light also made it possible to record objects which were not easily recorded in Gabor's original system. Objects with dark backgrounds and continuous tones could now be holographically recorded.

### Volume Holograms

Gabor's original hologram theory did not use coherent light; therefore, the thickness of the recording emulsion was considered inconsequential and the hologram was viewed as two-dimensional. With the use of coherent laser light, however, the emulsion thickness became an important factor. Specifically, if the emulsion is thicker

than the width of the interference fringes (see Figure 3), the object wave and the reference wave will interfere throughout the depth of the emulsion. This produces a volume hologram which is a stack of surface holograms, one atop the other.

If a reflection, volume hologram is made by using three colors of light (blue, green, and red), three holograms will be recorded within the same emulsion. When this hologram is illuminated by white light, each hologram will select the color from the white light to which it responds, and the result will be a three-dimensional color image.

### Whole from Part

The entire image from transmission holograms can be reconstructed from a fragment of the original hologram. This is not surprising, since each point on the object is recorded as an interference pattern, or diffraction grating,

over the entire hologram surface. This grating can be thought of as a Fresnel lens (see Figure 4). Such a lens focuses all the light falling on it at a particular point. A Fresnel lens also has the property that regardless of how many “rings” there are in the lens segment, or whether there is a complete ring, the light will still be focused at the same point. The resolution (clarity) of

the point is determined by the number of rings used. Therefore, as a smaller and smaller section of each Fresnel lens or diffraction grating is used, the clarity is diminished, but the point will still be imaged.

For the same reason that a part of the hologram will reconstruct the whole image, the hologram is relatively insensitive to blemishes and dust parti-

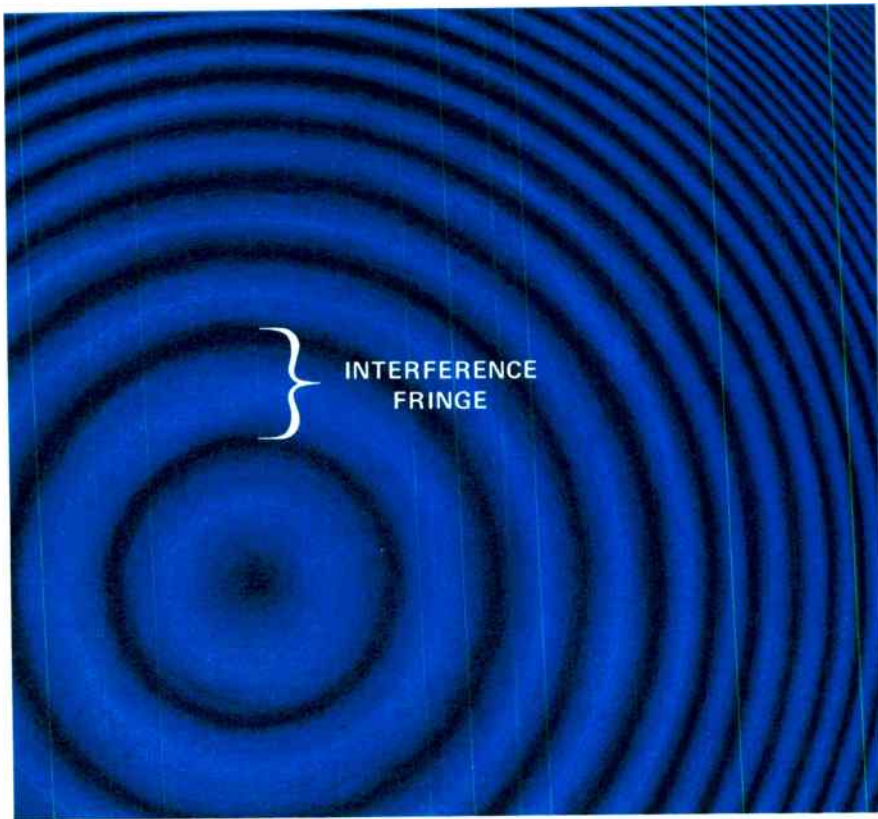

*Figure 3. A concentric ring, diffraction grating, for one point on the object, covers the entire holographic plate. The center of the grating need not be on the holographic plate. Such a grating, with variable spacing, focuses the light falling on it at a particular point.*

cles. If a blemish destroys part of a diffraction grating, but not all of it, the light will still be properly imaged. The image will not be destroyed unless the total surface of the hologram has been obliterated.

### **One Hologram Worth Many Words**

The large depth of field of holograms is a great advantage in microscopic investigations. It is particularly valuable for examining moving, microscopic objects in a thick sample. A pulsed laser is used to “freeze” the movement in a sample so it can be recorded on the hologram. When the object is reconstructed and viewed through a microscope, different layers of the sample can be brought into focus — something that cannot be done with a photograph where the movement has been stopped with a strobe light. This principle has been used to analyze the size and distribution of particles in aerosols, liquids, and smog. The old adage, “a picture is worth a thousand words,” can be extended — “one hologram is worth a great many pictures.”

It was Gabor’s hope that holography, being lensless photography, would improve the resolution of electron microscopes. Unfortunately, many of the problems that faced Gabor are still present today; since a magnification hologram has all the distortions observed with conventional lenses.

For holography at non-visible wavelengths, the situation is vastly different. For example, magnification is possible using X-rays for recording and

visible light for reconstruction — producing a sharply focused, magnified image. However, the technical problems of X-ray holography are severe, and have prevented its practical realization. Obtaining an X-ray source with sufficient intensity and coherence is a major obstacle.

### **3-D Imaging**

The three-dimensional aspect of holography has received widespread attention. Holography has several advantages related to 3-D imaging. Holographic reconstruction gives an image with high resolution and great depth of field. Parallax, as observed in reconstructed holographic images, allows the viewer to see around objects. Holograms also have some economic advantages such as full color images formed from less expensive black and white emulsions and no need for additional imaging optics.

Holographic three-dimensional imaging also has some disadvantages. The object must remain perfectly still for recording. The object motion can, however, be stopped by using a pulsed-laser for illumination. At the present, it is virtually impossible to take holographic pictures in daylight or under normal illumination because the object to be recorded must be illuminated with only one wavelength of light. Multi-color images are not promising, since these images require long exposures. The size of the object to be recorded is limited by the laser power. The largest hologram that has been made is 18 x 24 inches.

A 3-D holographic television system could be designed today, if available

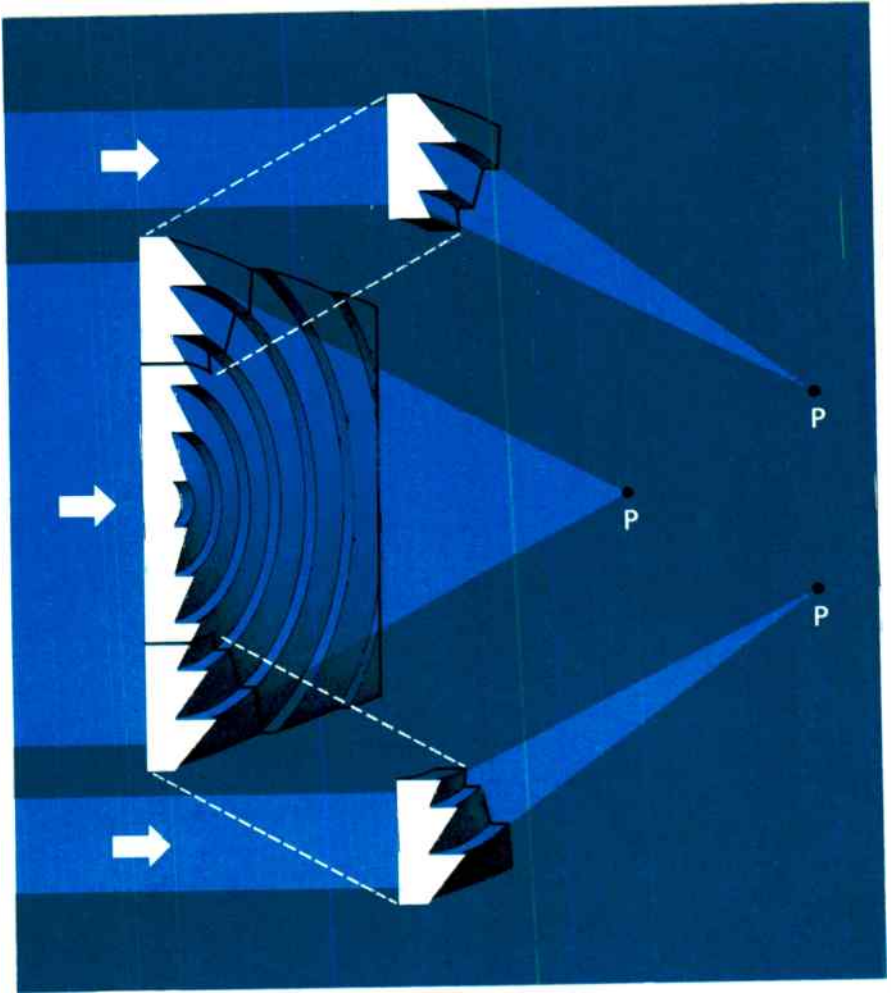

*Figure 4. The light falling on a Fresnel lens will focus at a particular point (P) regardless of how large a segment of the lens is used.*

components held tighter specifications. For example, a hologram 10 inches square and having 1,000 lines per millimeter has  $6 \times 10^{10}$  picture elements, compared with  $2.5 \times 10^5$  for a conventional television picture. If the scan rates of present TV systems

were maintained, a  $10^5$  increase in bandwidth would be necessary — a jump from 6 to 600,000 MHz. The entire radio-frequency spectrum, including the microwave region, would be inadequate to meet this requirement. If a suitable transmission

method can be found, it may one day be possible to watch holographic 3-D television in the middle of your own living room.

The first attempt at holographic movies involved taking a series of pictures of still objects and then viewing them in rapid succession producing a sensation of motion – the animated cartoon concept. The term “true” is used to describe the newest 3-D movie because it is a motion picture of a moving object. (Figure 5). This reconstructed image is truly three-dimensional and may be viewed without additional lenses or filters.

### Change Detection

Holography has many properties that make it natural for application to interferometry, a technique used to detect structural changes. For example, a hologram placed in its recording position will display the reconstructed image on top of the actual object. A subsequent slight movement of the object produces interference fringes between the object and image waves.

A hologram can be exposed more than once. The image waves, recorded at different times, can be simultaneously reconstructed and their interference pattern observed (Figure 2). Shock waves, for example, produced by projectiles passing through air or gas density changes can be easily recorded with pulsed-laser, double-exposure holograms.

A new method of holographic interferometry (III) has been introduced which uses a single-exposure, two-wavelength laser pulse in the recording

process; rather than the double-exposure, single-wavelength formerly used. This new technique can double sensitivity by proper choice of wavelengths and physical arrangement of components.

The field of nondestructive testing makes extensive use of HI. Holographic nondestructive testing (HNNDT) is a method of detecting or measuring the significant properties or performance capabilities of materials, parts, assemblies, equipment, or structures without impairing their serviceability. HNNDT is simply HI combined with suitable test-object stressing. Common types of stressing include temperature, pressure, sound, and vibration. HNNDT is now a practical design and quality control tool for analyzing sandwich structures, tires, rubber-to-metal bonds, and many other objects. Large areas may be inspected quickly, a variety of flaws can be detected simultaneously, and a choice of several low level stressing methods is available.

### Cryptography

A hologram is a coded message that can be decoded by using a coherent illumination source. If, however, the hologram were made with a diffuser such as ground glass placed between the object and the holographic plate, it could only be decoded using the same diffuser. If the same diffuser is placed so that it coincides with its own image, a sharp, clear picture of the original object is reconstructed – as if the diffuser were a clear glass.

The same diffuser must be used in both recording and reconstruction. A section of ground glass, 1 centimeter

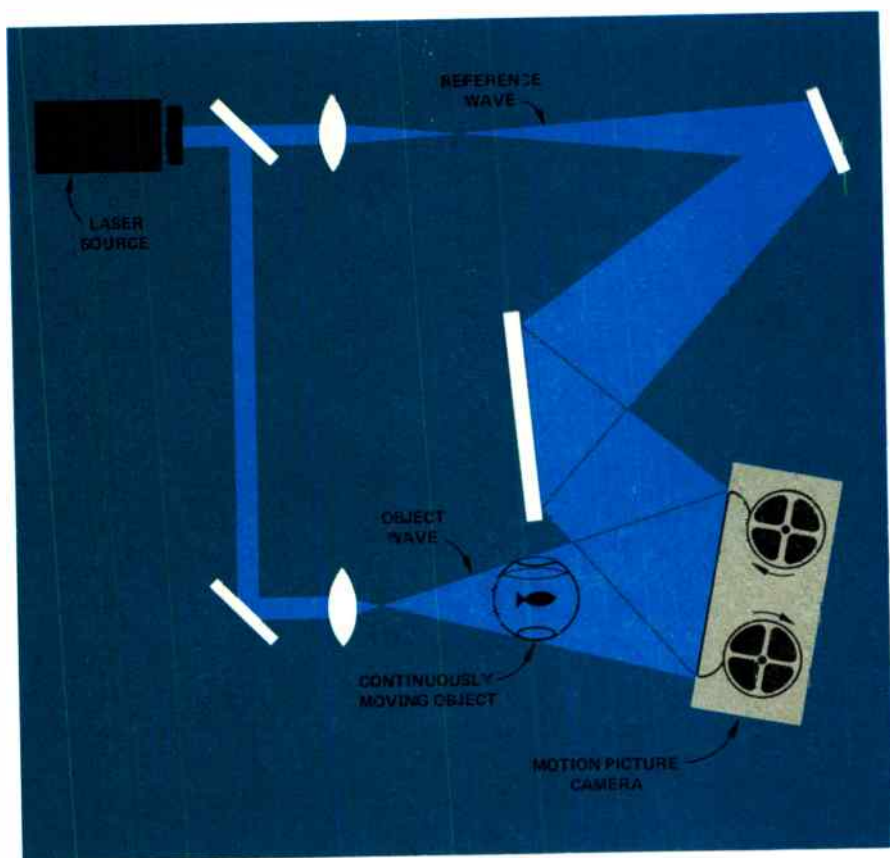

Figure 5. The basic system used to make the first “true” holographic movie.

square, can contain a billion distinct resolution elements, each of which retards the transmitted light. It is not probable that two ground glass samples would be similar enough to allow an image to form. With only one “key” to a cryptographic hologram, the message is considered secure.

### Memories Can Forget

Holograms are useful for data storage because many holograms can

be superimposed on the same photographic plate. Built-in redundancy is a must in today’s computer systems – transmission holograms, with their insensitivity to blemishes and ability to reproduce an entire image from a small fragment, provide the necessary redundancy. Optical memories capable of storing  $10^4$  bits of data on each page are stored in  $1 \text{ mm}^2$  on the hologram. A  $10 \text{ cm}^2$  hologram stores  $10^4$  pages – totaling  $10^8$  bits per hologram.

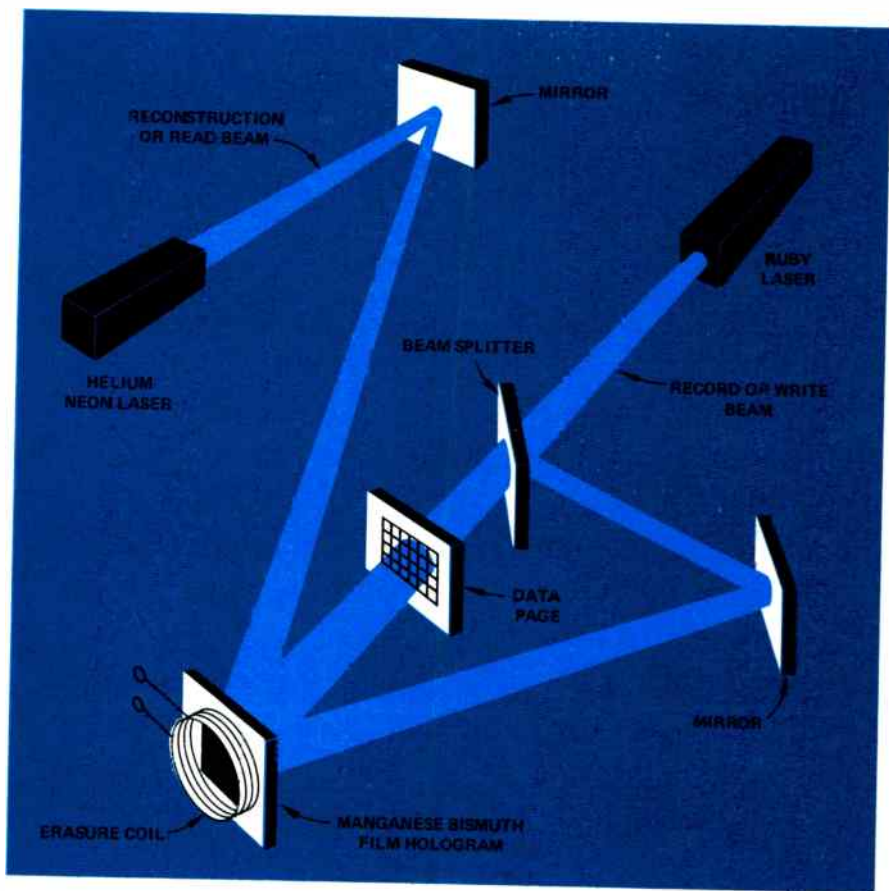

Figure 6. The simplified system for writing, reading, and erasing the magnetic hologram memory.

Until now, optical memories have been confined to the static, read-only type. This means, once made and inserted into the memory, the hologram can be read whenever necessary. This information cannot, however, be changed. Whenever a change is required, the old hologram has to be removed and a new hologram made and inserted into the memory.

A dynamic, read-write memory is now in the laboratory stage. These optical memories are capable of being written in the memory, stored, read at will, and then erased when new information must be entered. Ideally, these can be reused indefinitely.

These new holographic memories are made by depositing a single crystal layer of manganese bismuth (MnBi) on



a base of mica. A strong magnetic field, applied to this film, causes the magnetic moments of the atoms to line up making it ready for use as a hologram. During the hologram recording process, the magnetic moments of the atoms move out of alignment in accordance with the laser light interference pattern. The recording time for such a hologram is about 10 nanoseconds. The hologram is erased by simply applying a voltage to a nearby coil, creating a strong magnetic field perpendicular to the hologram surface. This magnetic field realigns the magnetic moments of the MnBi crystal (Figure 6). The hologram memory has now forgotten the old information and is ready to record the new data.

### Advertising

Reflection holograms have opened the door to hologram use in advertising. Not many people have lasers handy for reconstructing a transmission hologram image, but most people have a white light source, such as a flashlight or high intensity lamp, to illuminate a reflection hologram. Presently, the cost of producing hologram copies is rather high. Holograms,

nevertheless, are beginning to appear in the print media.

Advertising holograms seem best suited for inclusion in magazines, although books and newspapers can also carry them. As for direct mail — mailing a hologram is no more difficult than mailing a photograph.

Although many uses have already been made of holograms, there are probably others that have not been explored. Advertising with holograms will provide public exposure to holograms — the more exposure, the more possible applications.

### Commercial Applications

Holography is no longer just a laboratory curiosity, but now has applications in the fields of nondestructive testing, microscopic investigation, entertainment, information storage, and advertising. In fact, in the last two years, more than 500 companies in the United States alone, have made economic gains by taking advantage of this extraordinary form of photography, which permits the viewer to see around obstacles. Dr. Dennis Gabor, the inventor of holography, has forecast that by 1976 his brainchild will become a billion-dollar industry.



LENKURT ELECTRIC CO., INC.  
SAN CARLOS, CALIFORNIA 94070



STWP & ATA  
9th ANNUAL TECHNICAL  
ART SHOW & SEMINAR,  
HUNTSVILLE

# **CERTIFICATE OF MERIT**

AWARDED TO

**LENKURT DEMODULATOR**  
**Ernie King, Art Director**

"COMMUNICATION FOR THE 70's - - - THEME  
OF THE 1969 TECHNICAL ART SHOW, SPON-  
SORED BY THE HUNTSVILLE, ALABAMA  
CHAPTERS OF THE ASSOCIATION OF TECH-  
NICAL ARTISTS, INC., AND THE SOCIETY OF  
TECHNICAL WRITERS AND PUBLISHERS, INC."

*E. J. Barthoviak*  
CHAIRMAN STWP HUNTSVILLE

*Frank E. Johnson*  
CHAIRMAN ATA HUNTSVILLE

## **LENKURT ELECTRIC**

GENERAL TELEPHONE & ELECTRONICS

SAN CARLOS, CALIFORNIA, U.S.A.

**VIDEO, VOICE & DATA  
TRANSMISSION SYSTEMS**

### Lenkurt Offices

San Carlos  
Atlanta  
Falls Church, Va.

Chicago  
Dallas

The Lenkurt Demodulator is circulated monthly to technicians, engineers and managers employed by companies or government agencies who use and operate communications systems, and to educational institutions. Permission to reprint granted on request.

The *Lenkurt.*

MARCH 1970

# DEMODULATOR

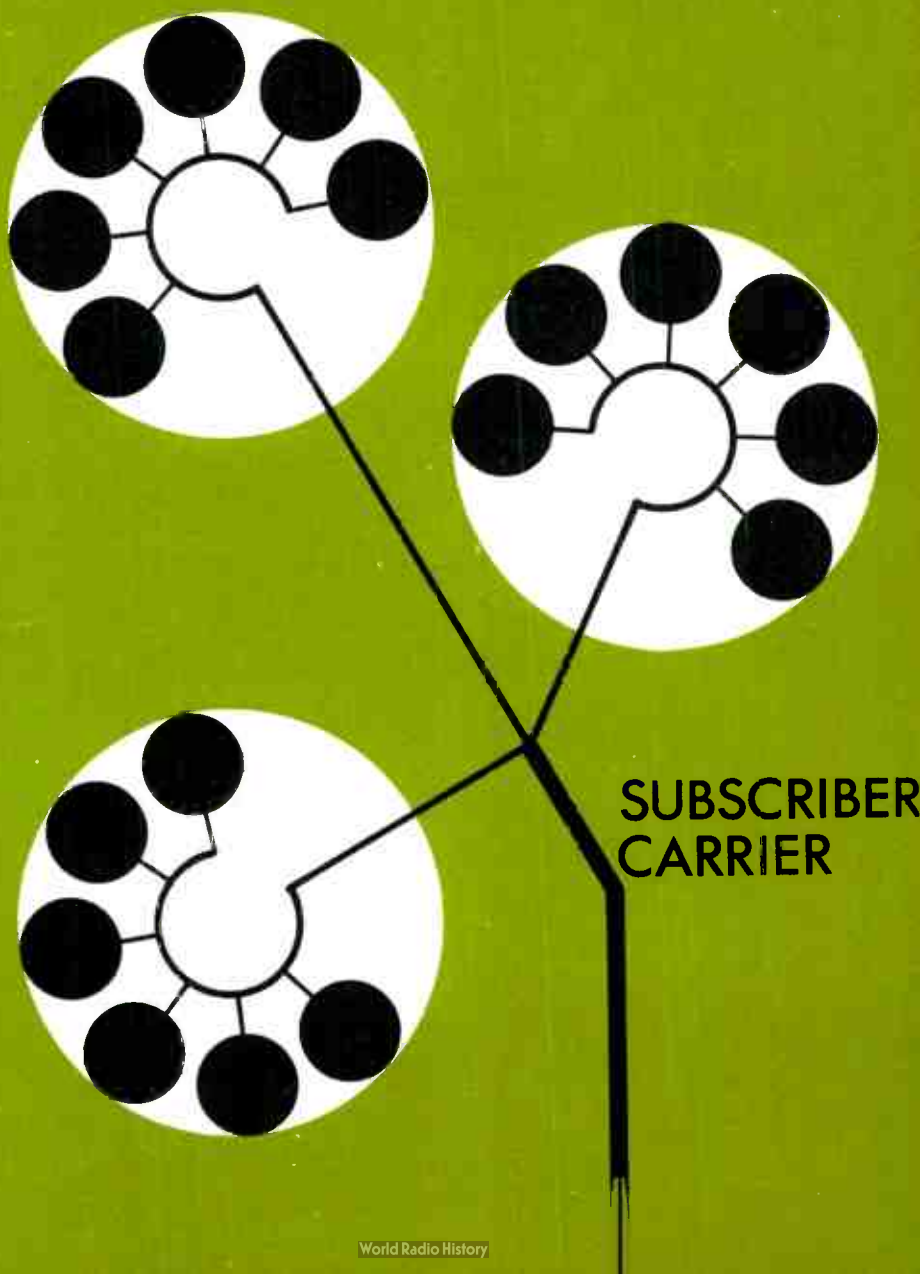

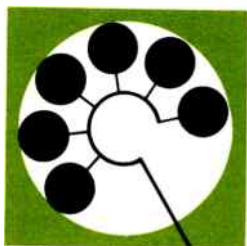

**Subscriber carrier transmission systems economically expand existing cable capacity to meet the demand for additional voice and data circuits.**

**M**an's unbounded desire to communicate has led to an ever increasing demand for new telephone circuits. A method of increasing telephone circuits without adding thousands of miles of wire is obviously desirable (Figure 1). While putting paired wires into cables serves to remove some of the wire from view, the problem of continually enlarging the number of physical circuits to satisfy the increasing demand remains.

Multiplexing permits simultaneous transmission of two or more signals over the same telephone circuit and has been one of the most valuable developments in the telephone industry since the early 1900's. Of course, the first multiplex carrier equipment was expensive and only practical for long distance circuits. As technology improved this condition changed.

The reduction in cost of multiplex equipment played an important role in the expansion of carrier for short haul transmission. One advance that made carrier practical for short haul transmission was in semiconductor technology, resulting in high performance, low cost transistors. The use of integrated circuits also improved performance and reliability, thereby decreasing cost still further.

Carrier transmission over open wire or cable between the central office and a subscriber is called subscriber carrier or station carrier. These systems provide less expensive transmission by using the medium more effectively. An ordinary cable pair carries one voice or data channel. The same cable pair,

using a station carrier system can carry six carrier frequency derived circuits which can be used for voice or data.

### **Three Types**

There are three basic types of subscriber carrier systems in use today. Each is designed to satisfy specific requirements, and each offers individual economic advantages. One class of subscriber carrier effectively extends the reach of the central office to outlying areas (as much as 30 miles away) and may carry 20 or more channels. A second type, providing six channels, serves to expand cable facilities closer to the central office. The third is a single-channel system specifically designed to add one additional subscriber to a cable pair easily and inexpensively at distances under 3.5 miles (5.4 kilometers).

Although the three types have different uses, they have some common advantages. All can be used with a combination of standard gauge cables. Minimum maintenance is possible because of the advantage of simply replacing defective equipment. Cable additions can, also, be deferred and planning flexibility provided using any of these carrier systems.

Multi-channel systems provide even greater service flexibility because each channel can be used for party-line service.

Multi-channel carrier equipment, for relief of existing facilities, is presently most practical at about 4 miles (6.4 kilometers) from the central office (Figure 2). Whereas presently, for

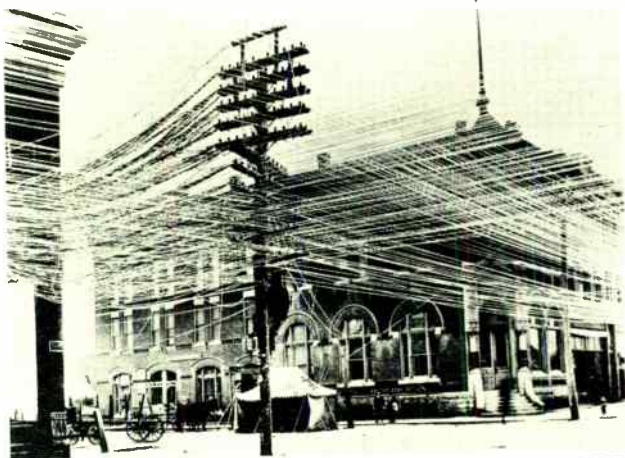

*Figure 1. Maze of wires in this 1909 photograph epitomized telephone circuits before multiplex techniques were developed.*

Bell Labs RECORD

initial installation, closer than 10 miles (16 kilometers) multi-channel equipment is not always practical. Cable must be installed initially, even when carrier is used; therefore, the economic trade-offs differ for initial and relief installations.

### **Upgrading and Expanding**

Subscriber carrier first proved suitable for expanding cable and wire to rural and sparsely populated areas. Customers in these locations were accustomed to multi-party service and shared a circuit with as many as nine neighbors. As the economy of the established rural population changed, demands for urban quality service increased. The migration of urban workers — accustomed to single or two-party service — to rural areas has also added pressure for improved telephone service.

One-party service is being established under ambitious upgrading programs. Improving service by adding new physical circuits to remote areas, however, is not always economically practical. Factors, such as the need for automatic toll ticketing and increased copper and labor costs, also influence the decisions of planning engineers

toward layout of new systems and planning the company's approach to growth areas.

The general need to upgrade service, relieve cable congestion, and provide growth margins in new developments has enhanced the addition of carrier equipment to exchange loop facilities. Carrier systems upgrade existing service and provide new service in areas without spare cable pairs. Additional benefits are realized in planning new cable installations around carrier systems.

Station carrier is also being used to provide temporary service for such functions as charitable and political campaigns, conventions, county fairs, home shows, sports events, etc. The largest application to date has been to provide immediate relief for a fraction of the cost of new cable installation. Carrier has gained recognition controlling new construction while meeting customer requests for additional and upgraded service in areas where facilities are already used to capacity.

### **Comparison**

Carrier systems used to supplement existing physical circuits must provide a high degree of reliability, transmis-

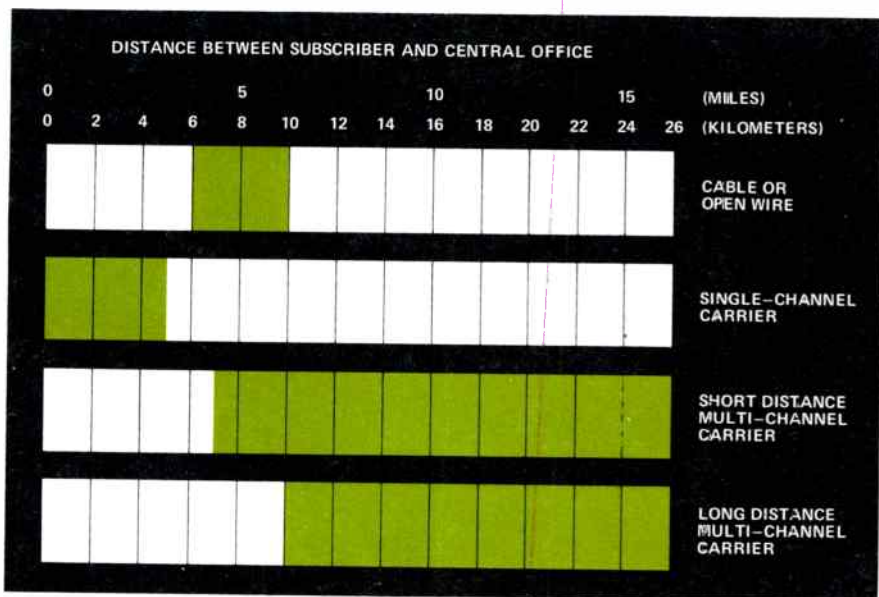

Figure 2. For relief of overloaded facilities, the green areas indicate, at the present level of technology, each system's recommended operating range.

sion performance, flexibility, and economy compared to the alternative use of cable.

Since carrier systems operate over physical circuits, total system reliability is the sum of the carrier reliability and the reliability of the physical circuit. Designing high reliability carrier equipment is thus a primary requirement. Although such tight quality control increases the product cost, frequent service complaints and high repair costs are not an acceptable compromise. Today's carrier systems have been able to maintain high reliability at reduced costs by using integrated circuits and semiconductor devices.

### Transmission Performance

Transmission advantages obtained from carrier derived circuits include signal consistency and stability. The quality of a carrier signal is almost identical at any cable length. In ad-

dition, net losses can be carefully controlled, and environmental conditions will have little effect on the stability of the circuits.

Long physical circuits (approximately 8 - 10 miles) contribute to increased noise, delay distortion, and degraded frequency response. These are major considerations especially when data is being transmitted. These parameters are degraded with increasing cable length. Using carrier, long loop transmission performance is significantly improved.

With station carrier systems such as Lenkurt's 82A, all carrier frequency signals leaving the central office are fixed at the same level. In the individual subscriber terminal, the received carrier level is regulated and the voice frequency is then detected. The carrier signal from the subscriber back to the central office is automatically pre-adjusted to compensate for cable loss. Channel signal levels within a carrier

system will be different because each channel is a different frequency and line loss varies with frequency. However, the level of a particular channel frequency in one system will be the same as the level of the same channel frequency in another system operating over cable pairs within a common cable sheath.

This automatic regulation reduces far-end crosstalk between systems by maintaining similar levels for all systems within the cable sheath, regardless of channel terminal location.

The automatic signal regulation eliminates the need for manual level adjustment and also makes it possible to install and maintain the equipment

by personnel not familiar with electronic circuits.

### Installation

Carrier systems can be added to almost any type physical circuit — open wire, cable (aerial and buried), or a combination of open wire and cable — to increase the number of circuits available for voice and data transmission, or to reach out distances where transmission limitations prevent the use of voice frequency circuits.

Once preliminary engineering is completed and a cable has been specified, carrier installation with systems such as Lenkurt's 82A and 83A is routine and much faster than installa-

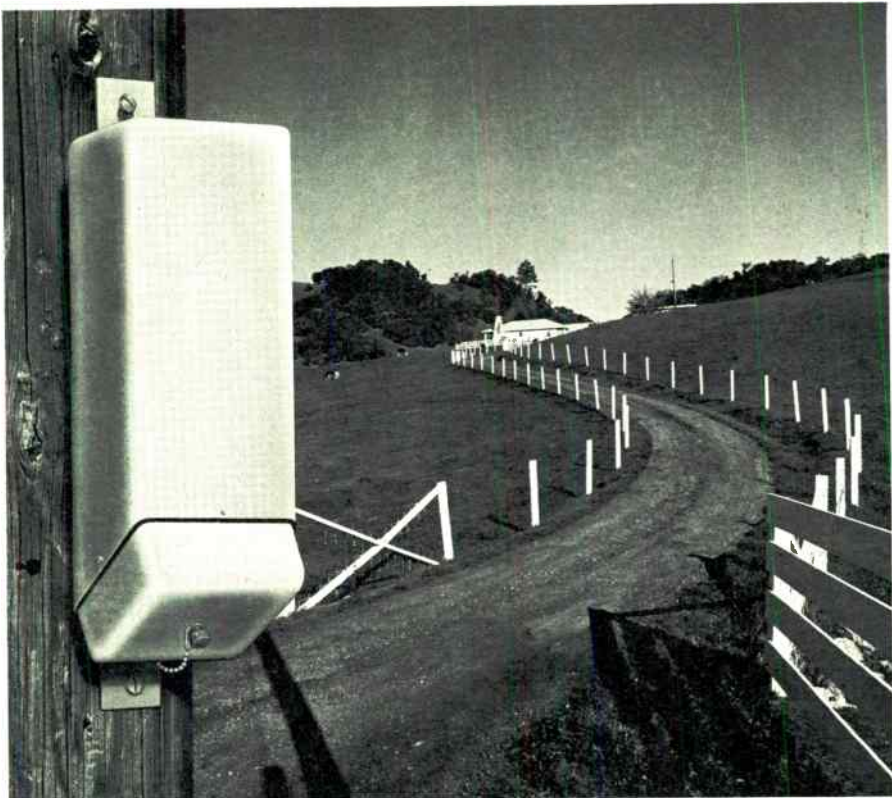

*Figure 3. The subscriber terminal, shown here pole mounted, may be placed at any point along the cable.*



*Figure 4. Operations at the Charlotte Speedway in North Carolina, were able to start on time, with the necessary additional telephone service provided by Lenkurt's 82 A Station Carrier system.*

tion of additional cable. Carrier equipment is installed at the same time as the home instrument, and can be placed at any point along the cable. No field adjustments are needed. The subscriber terminals and repeaters – identical in appearance – are designed for pole, crossarm, strand, or pedestal mounting (Figure 3).

### **Flexibility**

Carrier equipment is readily available making it practical to work existing cables to a 100 percent voice frequency fill, instead of the 80 to 90 percent usually specified. Carrier equipment can be drawn from stock, or inventory, and installed as quickly as any non-carrier circuit – even when cable pairs are available. This is an

important feature which is sometimes overlooked.

If carrier equipment is installed and the anticipated growth is not realized, the unnecessary carrier equipment can be removed and returned to stock with relative ease.

Short haul carrier equipment is practical for long term use in instances where the alternative is a long cable with a small circuit capacity.

If, however, carrier equipment is used as an interim measure to defer new cable provisions, carrier advantages are improved and shorter routes or larger growth rates are warranted. The degree of use which can be justified depends on the installed cost of a new cable in particular localities and on the expected return on investment.



After the addition of a new cable, station carrier systems used as a temporary means of providing additional circuits can be moved to a new location. There is a definite advantage in not having to rely on precise cable section forecasting. Instead, it is quite sufficient to use general circuit requirement forecasting for an area. Carrier equipment can be moved to meet changing demands; but, cable once laid, is fixed.

## Economy

In a typical exercise to determine cable size for a new facility, the area's expected five year circuit requirements are reviewed, and possibly revised to reflect the personal experience of local engineers. Based on the results, a cable size is selected. Since cable is supplied in standard numbers of pairs, the usual practice is to choose the next larger size cable to ensure adequate facilities. This method will sometimes result in specifying cable with as many as 50 percent more pairs than are actually necessary. This overspecification can be costly when great distances are involved.

Using carrier systems in planning for maximum future requirements, the plant engineer realistically sizes his new cable to the nearest number of pairs instead of the next larger size. Extra circuits can be added with carrier equipment as required — reducing both initial and annual costs.

## Practical Solution

When the Charlotte Motor Speedway in North Carolina, moved its administrative headquarters from downtown Charlotte to the race track near Harrisburg, N.C., it needed five additional circuits at the track immediately.

To install more cable facilities between the Speedway and the Concord Telephone's central office eight miles away would have been a time consuming project. Besides, a cable installation to provide five more circuits would be economically unsound.

In response to the problem, Concord Telephone turned to Lenkurt's 82A Station Carrier system. The 82A, designed to expand the capacity of a single subscriber cable pair to six private lines, proved to be an ideal solution.

The 82A, an extremely adaptable system, required no modification to the existing central office equipment or telephone subsets (Figure 4). All power for the repeaters and subscriber equipment was received from the central office supply, and no batteries were required for subscriber terminal or repeater operation.

A few days before the World 600 race, the Charlotte Motor Speedway officials requested an additional teletype circuit. Using 82A, another circuit was quickly and easily provided.

## Even Greater Capacity

Subscriber carrier transmission can be an economical alternative to cable when the annual circuit requirements are small or where the circuit length is quite long. If future requirements are uncertain, carrier provides interim relief, allowing time to gather reliable data before making a major cable addition. Carrier systems are also being used where new cable additions would provide a great many extra pairs that would lie idle for several years.

Until such time as an even greater density, lower cost transmission system becomes practical, carrier will continue to replace cable transmission on shorter and shorter loops.

LENKURT ELECTRIC CO., INC.  
SAN CARLOS, CALIFORNIA 94070

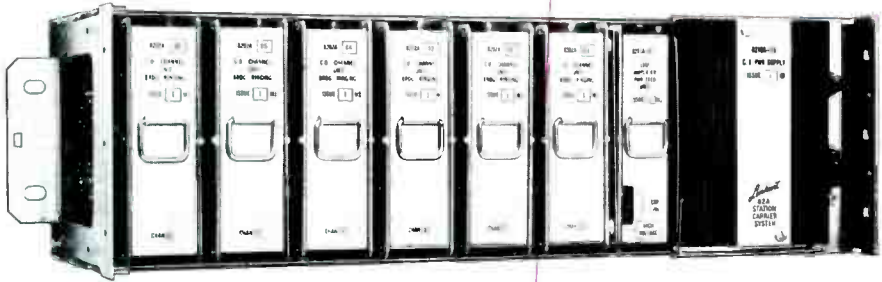

Lenkurt's 82A Station Carrier System expands the capacity of a single subscriber cable or open wire pair to 6 private-line circuits. The 82A is the perfect solution for service expansions where cable construction is being postponed, and where volatile growth of subscriber circuits and demand for service upgrading cannot be economically met by other means. For additional information, write Lenkurt, Department C134.

**LENKURT ELECTRIC**  
GENERAL TELEPHONE & ELECTRONICS

SAN CARLOS, CALIFORNIA, U.S.A.  
**VIDEO, VOICE & DATA  
TRANSMISSION SYSTEMS**

**Lenkurt Offices**

San Carlos  
Atlanta  
Falls Church, Va.      Chicago  
Dallas

The Lenkurt Demodulator is circulated monthly to technicians, engineers and managers employed by companies or government agencies who use and operate communications systems, and to educational institutions. Permission to reprint granted on request.

**The** *Penkurt.*

APRIL 1970

# DEMODULATOR



**progress in  
solid-state  
radio**

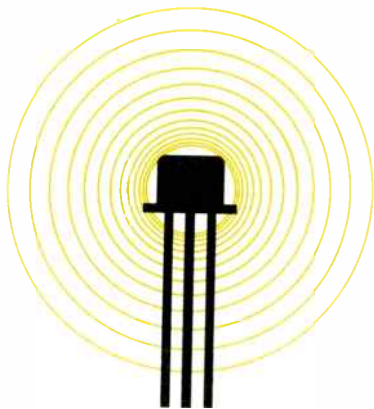

**“Progress begins by getting a clear view of the obstacles.”**

**W**henver there is a technological breakthrough, there is an automatic demand for “things” incorporating this new concept. Before design changes are made, however, it is mandatory to examine the present system closely to see what weaknesses exist and to determine what new problems might be created by incorporating this new development.

Unless careful thought and planning precede design changes, these changes can lead to a technological standstill—or even a regression—rather than a step forward.

More than a decade ago, semiconductors made their debut in the electronics world. Ever since that time, the demand for “solid-state everything” has become a way of life.

Microwave radio systems have not escaped the challenge to change to solid-state. Although, examining the obstacles involved, progress has not been as rapid as some expected.

Progress, as it concerns an all solid-state microwave radio system, must improve at least one of these areas—reliability, efficiency, noise performance, channel capacity, maintenance, or cost. If none of these areas are improved, the change is simply *that*—a change—and not progress.

To understand the progress of solid-state radio, it is necessary to get a clear view of the obstacles involved with microwave transmission—principally, generating a high power signal.

### **Microwave Repeaters**

The baseband or remodulating type repeater shown in Figure 1 illustrates how the modulated carrier is received and demodulated and then remodulated into a transmittable electromagnetic wave. For comparison, a heterodyne repeater is shown in Figure 2. The heterodyne repeater amplifies the signal, without demodulating.

The received modulated carrier must be amplified, because it has a low power level. It is easier, however, to amplify a low frequency signal. So before amplification, it is desirable to lower the frequency of the received signal. This is done by mixing the received modulated carrier with a signal from a local oscillator (L.O.). The L.O. produces a fixed frequency signal equal to the carrier frequency plus or minus an intermediate frequency (IF).

The mixer takes the sum or difference of the received modulated carrier and the L.O. signal. Since a lower frequency signal is desired, the mixer output is the difference of the

two signals —resulting in a modulated IF signal. A mixer used in this configuration is a down converter.

This IF signal is then amplified. At this point in the heterodyne repeater, the signal is converted back to a higher frequency, in an up converter. The signal is amplified once again and is ready for transmission.

Once amplified in the baseband repeater, the signal is fed to a discriminator which changes the frequency variations into a varying voltage. The discriminator is the demodulator; therefore, this varying voltage represents the baseband signal (the original signal before it modulated the carrier frequency to form the transmitted radio signal).

This baseband signal is used as the input to the transmitter where the

varying voltage is modulated again to form a frequency varying carrier. This modulated carrier has the proper frequency and power for subsequent radiation.

A desired output power of at least one watt has been established as a nominal level for baseband repeater systems. This output power has been a major obstacle in designing an all solid-state microwave radio system.

### First Attempts

Microwave radios began to change from vacuum tubes to solid-state designs, in the early 1960's. Total solid-state construction involves more than simply adapting semiconductor components and microwave design principles to meet existing industry standards for stability, noise performance,

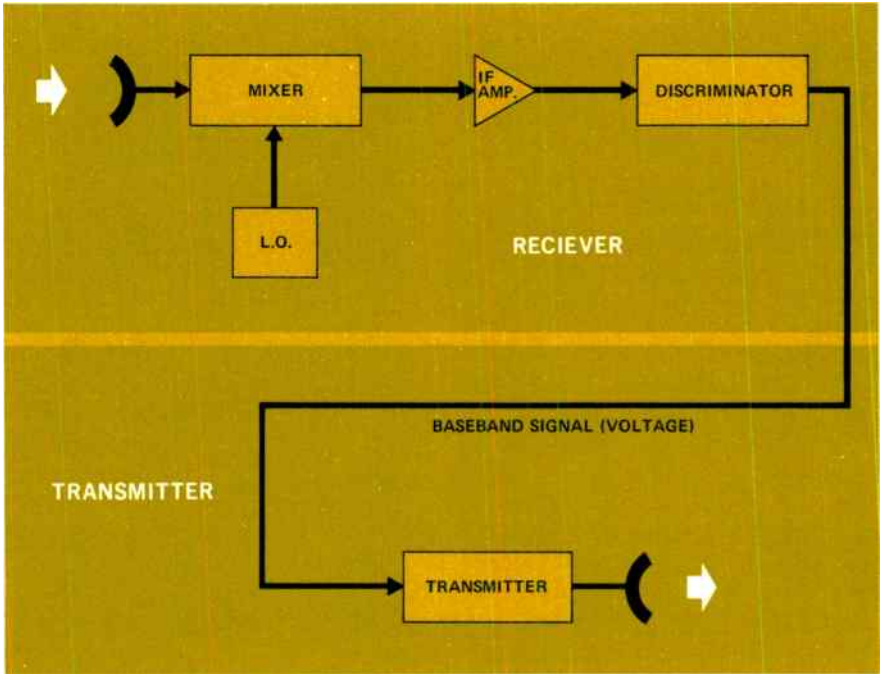

Figure 1. A microwave radio baseband or remodulating repeater is a receiver and transmitter in series.

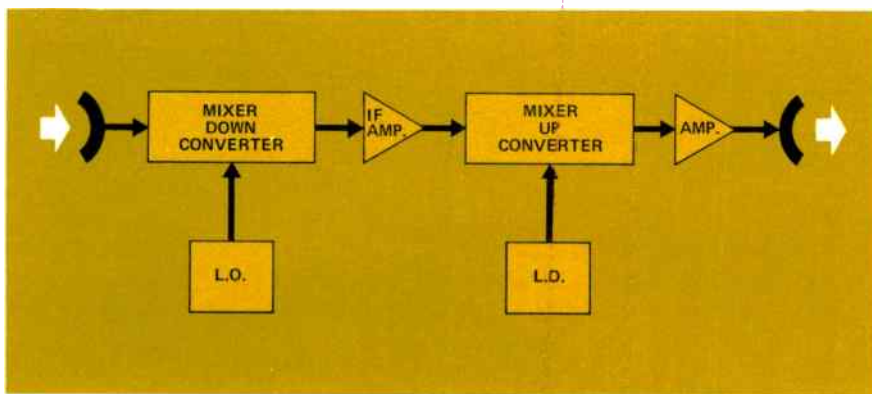

Figure 2. In a heterodyne repeater, the signal is amplified without being demodulated and remodulated.

bandwidth, and power. Cost, space, and reliability considerations are just as important.

The baseband receiver and transmitter both had a vacuum tube holdout—the klystron tube. In the receiver, the klystron tube was used as the local oscillator, and the transmitter was a klystron tube preceded by a modulation amplifier. A klystron tube simply takes a voltage input and produces a frequency output.

A solid-state replacement for the klystron would eliminate the need for a stable, high voltage power supply required for klystron operation. Solid-state devices do not need high voltages. It was expected that solid-state oscillators would also increase reliability making frequent field replacement of tubes unnecessary.

The local oscillator has one design requirement—low noise at low power. The transmitter design, on the other hand, has three such requirements—high power, low noise, and stable frequency output. The tighter specifications for the transmitter design makes it necessary to permit a higher noise level in the transmitter oscillator.

A solid-state oscillator was more readily designed to replace the L.O. klystron because of its lower power requirement. Consequently, a solid-state replacement for the transmitter klystron tube was an obstacle in the progress of all solid-state radio.

### All Solid-State

Since solid-state devices generate high power signals more readily at lower frequencies, an all solid-state microwave radio in the 2 GHz frequency band, rather than 6 GHz or even higher, was easier to achieve.

Lenkurt's 2 GHz all solid-state radio system, which provides up to 300 voice frequency channels, is shown in Figure 3. In this system a nominal power output of 2 watts is obtained by using high power varactor diodes in the multiplication stage.

As well as improved reliability with a 2 watt output, the all solid-state design offers many advantages. Replacing vacuum tubes with solid-state devices has the added benefits of longer life, reduced power consumption, and smaller systems in modular designs for simplified maintenance.

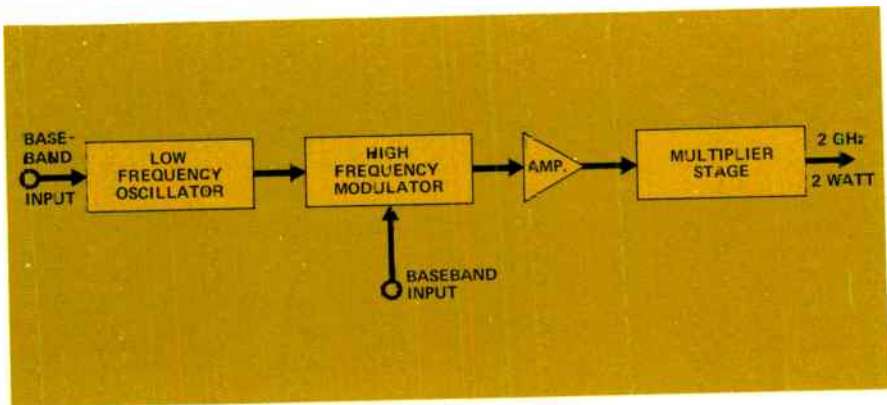

Figure 3. Lenkurt's 2 GHz radio transmitter was among the first on the market in that frequency band.

An operative all solid-state transmitter was a great challenge. Designers, working with state of the art components, persisted in their efforts to meet this challenge.

A marketable, all solid-state, 6 GHz microwave radio system was first produced, in 1962, by R.C.A. This system uses a crystal oscillator and has a capacity of 300 voice channels with an output power of about 1/2 watt.

The system shown in Figure 4 uses a crystal oscillator for generating a carrier frequency which is then amplified. Subsequent multiplication is accomplished by a varactor-diode multiplier chain, producing the desired carrier frequency at a reduced power level.

The transmission signal (the baseband signal) is used as the input to an FM oscillator (FMO). The FMO, in turn, converts the signal voltage to a varying frequency. The multiplied carrier frequency and the output of the FMO are up converted through a mixer, the output of which is the sum of the two frequencies. This output is also the desired modulated carrier frequency. One disadvantage of this

system is that power is lost in the up conversion.

The first obvious improvement desired in the crystal oscillator transmitter was an increase in the system's output power since it is directly related to the channel capacity. Another needed improvement was the lowering of the necessary multiplication factor, since noise is closely related to the frequency multiplication.

As transistors are improved for microwave application, it becomes possible to replace the crystal oscillators with transistor oscillators which could offer higher frequency outputs; therefore, a lower multiplication factor, to reach 6 GHz. It might also be possible to improve solid-state transmitters to provide a power output of one watt.

Transistors pose severe challenges to circuit designers; their problems are not worse than electron tubes but they are quite different. The problems associated with klystron circuits are all very familiar, and can be approached, therefore, with known alternatives. This is not the case when working with transistors in the microwave range.

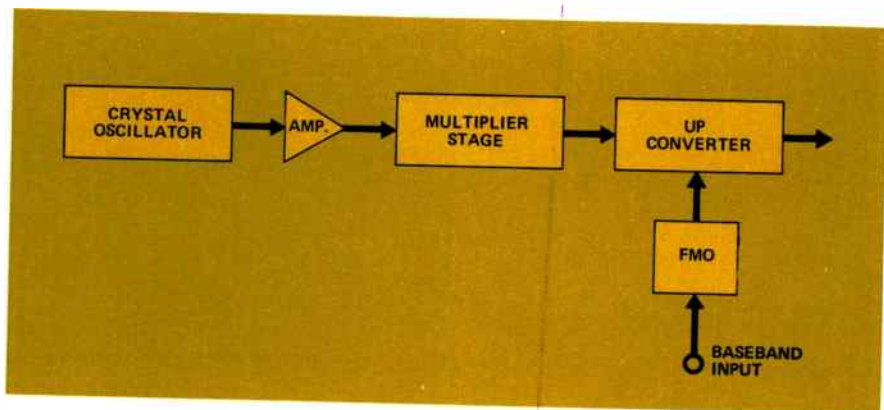

Figure 4. Crystal oscillators were the first solid-state replacements for the transmitter klystron.

These transistors are so new that the problems associated with them are not necessarily all understood. The preferred solutions to even the known problems have not yet all been found. Because of the newness of these transistors, it is necessary to follow design principles conservatively in order to guarantee a sufficient degree of system reliability. It is possible that present transistor designs will prove capable of meeting higher specifications than are now guaranteed.

### Transistor Oscillator

Transistor oscillators used in the present 6 GHz, all solid-state transmitters have a higher frequency output than the crystal oscillators first used. This higher frequency requires a lower multiplication factor to obtain the desired carrier frequency.

Transmitters using transistor oscillators have an automatic frequency control (AFC) device to insure that the output frequency is 6 GHz. In these solid-state transmitters, the baseband signal is used as the input to the transistor oscillator rather than being mixed with the carrier frequency

Lenkurt's new 6 GHz microwave radio offers improved, low noise performance. This all solid-state radio has a one watt output and a channel capacity of 1200 channels—large enough for transmission of two video signals, as well as voice and data. The low per channel deviation of this system makes it possible to provide 600 channels in the industrial band.

The "heart" of the transmitter is the FMO as shown in Figure 5. This unit provides a modulated microwave signal output at one-fourth the desired operating frequency. A crystal referenced AFC device provides precise frequency stability.

After modulation, the signal is fed through an amplifier. With a new power level of 6 to 8 watts, the modulated carrier goes through two frequency doublers. The output is a frequency modulated signal at one watt and a carrier frequency of 6 GHz—ready for transmission.

The one watt output insures a high enough signal-to-noise ratio for Lenkurt's large channel capacity. The thermal noise amplification introduced by the frequency multiplication is dir-



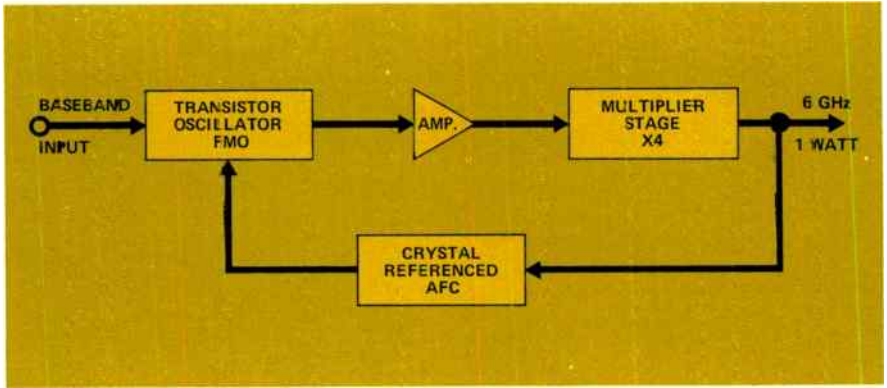

Figure 5. Lenkurt's 6 GHz solid-state microwave radio system uses two frequency doublers in the transmitter.

ectly related to the multiplication factor. Since the oscillator is by far the major source of transmitter thermal noise, this low multiplication factor minimizes output noise.

### Ideal Transmitter

The ideal solid-state transmitter would have a baseband input to a single "black box" whose output is a one watt, or greater, 6 GHz signal—without any need for power amplifiers or frequency multipliers.

At this point, high power output transistors have uncertain life expectancies. But, it is possible that such a transistor or even a new type semiconductor device may become available in the future. When these devices are developed, it could be several years before a new system could be in production.

There are two devices presently available that may, eventually contribute to the design of an ideal solid-state transmitter. The avalanche diode

might be used in place of the transistor oscillator to produce a 6 GHz signal at almost one watt.

The unsolved problems with the avalanche oscillator are that it is noisy and difficult to simultaneously stabilize and frequency modulate.

The Gunn diode has also been considered as an oscillator. It is much quieter than the avalanche diode at 6 GHz, but its present maximum power output at this frequency is only about 100 milliwatts. The same stabilization problems exist as for the avalanche diode.

Still another possibility is to use the Gunn diode as the oscillator, since it is quiet, and the avalanche diode in a power amplifier configuration. However, at present, neither the power nor frequency of the avalanche amplifier are sufficient for a solid-state transmitter. Despite these obstacles, the avalanche/Gunn combination appears to be the most promising next step in solid-state transmitter design.

# A short while back, there was a lot of noise about solid-state microwave systems. Now, there isn't.

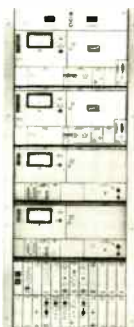

First came solid-state. Now comes Lenkurt solid-state. There's a big difference.

Now Lenkurt engineering offers 1200 channels in the common carrier band. And 600 channels in the industrial band. Both with superior performance at reduced deviations. And that means a quiet signal.

Lenkurt solid-state also modulates signals at higher basic frequencies. And offers less distortion and fewer multiplication steps by using doublers rather than triplers or

higher multipliers.

That means an even quieter signal. There are other features you'll appreciate, too. Like direct operation from battery voltage. Plug-in IF and baseband components that cut maintenance time.

All in all, the new Lenkurt microwave system will make you glad you didn't rush into solid-state.

And waited for Lenkurt to quiet things down.

**LENKURT ELECTRIC**  
GENERAL TELEPHONE & ELECTRONICS

Write Lenkurt Electric Co., Inc., Dept. C720, 1105 County Road, San Carlos, California 94070.

## Microwave Systems from Lenkurt

**LENKURT ELECTRIC**

GENERAL TELEPHONE & ELECTRONICS

SAN CARLOS, CALIFORNIA, U.S.A.

**VIDEO, VOICE & DATA**

**TRANSMISSION SYSTEMS**

### Lenkurt Offices

San Carlos

Atlanta

Falls Church, Va.

Chicago

Dallas

The Lenkurt Demodulator is circulated monthly to technicians, engineers and managers employed by companies or government agencies who use and operate communications systems, and to educational institutions. Permission to reprint granted on request.

The *Penkurt*®

MAY 1970

# DEMODULATOR

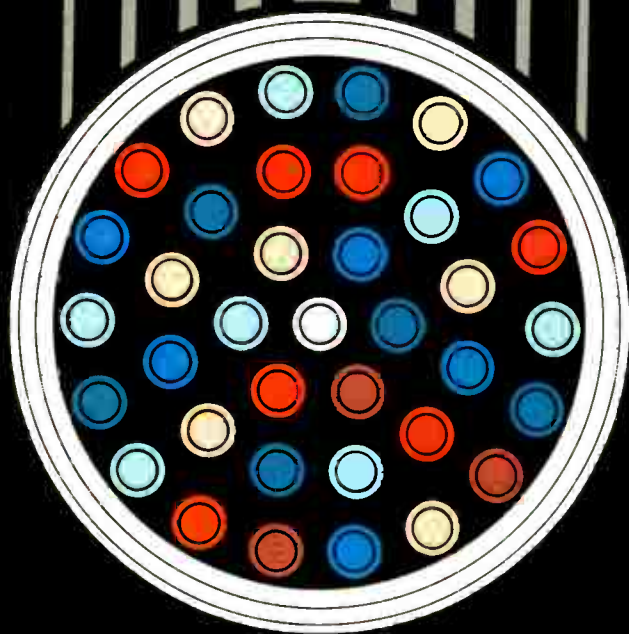

# CABLES

Telephone cable



... the changing constant

Cable has long been accepted as a fundamental element in a telephone plant. In recent years, however, cable's "public image" has been increasingly overshadowed by microwave radio, satellite relay, and even more exotic transmission methods.

While such transmission methods reduce the importance of cable in toll plant applications, it is still the mainstay of exchange distribution. The design and function of cable is not static. It comes in an increasingly wide variety of sizes and shapes, with a correspondingly wide variety of transmission characteristics for a multitude of uses.

Furthermore, the role of cable in telephone exchange circuits is changing. For instance, just a few years ago each pair of wires in an inter-exchange cable typically carried a two-way, voice-frequency conversation. A fifty-pair cable carried 50 conversations. Today, the same cable may handle 25 carrier systems, each of which handles 24 conversations—600 channels in all. Naturally, this places entirely different transmission demands on the cable.

### Cable Characteristics

The four fundamental electrical properties of the conductors in a cable are the same as those of any other transmission line:

1. *Series resistance* is the ohmic resistance of the conductors.

2. *Series inductance* is the self inductance of each conductor, plus the mutual inductance between the individual conductors.

3. *Shunt conductance* is the total resistance of the current leakage paths between the conductors.

4. *Shunt capacitance* is the electrical capacitance between conductors, including the capacitance effect of earth.

Since these electrical properties depend primarily on the physical configuration and the material used in the construction of any particular cable, they are sometimes considered to be constant—even though they change somewhat with temperature.

These are the four properties that define, for example, the attenuation characteristics of the cable. This produces the cable's "slope"—the characteristic attenuation-versus-frequency

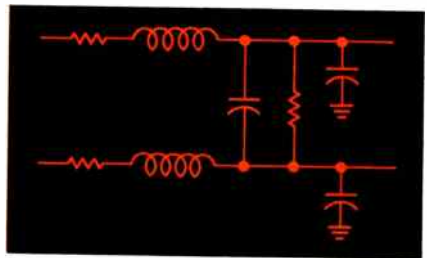

Figure 1. Line transmission characteristics are controlled by series resistance, series inductance, shunt capacitance, and shunt resistance.

curve shown in Figure 2. If the slope is not corrected, it distorts the level relationship of different frequencies within a signal.

The increasing attenuation with increasing frequency characteristic of cable is caused primarily by the small conductors used and by the short leakage paths between conductors. The small conductors have a fairly high series resistance, and conductor spacing is a major factor in determining shunt capacitance. Closely spaced conductors increase the shunt capacitance, making it easier for the high frequencies to follow the leakage paths between conductors.

Since economic considerations effectively rule out greater conductor spacing to reduce shunt capacitance, the traditional method of combating it

is to "load" the line with series inductance. The idea is to balance capacitive reactance with inductive reactance.

This works well for lower frequencies, effectively eliminating the slope over a limited frequency band. Unfortunately, however, a loaded line acts like a lowpass filter. While the low frequencies suffer comparatively little attenuation, the line has an effective cutoff frequency. At higher frequencies, attenuation increases very rapidly (see Figure 2). This cutoff frequency can be increased by using loading coils of smaller value and size and placing them closer together. But above about 35 kHz the coils become too small and the spacing too close to be economically feasible.

Since most modern carrier systems use a frequency band that extends far

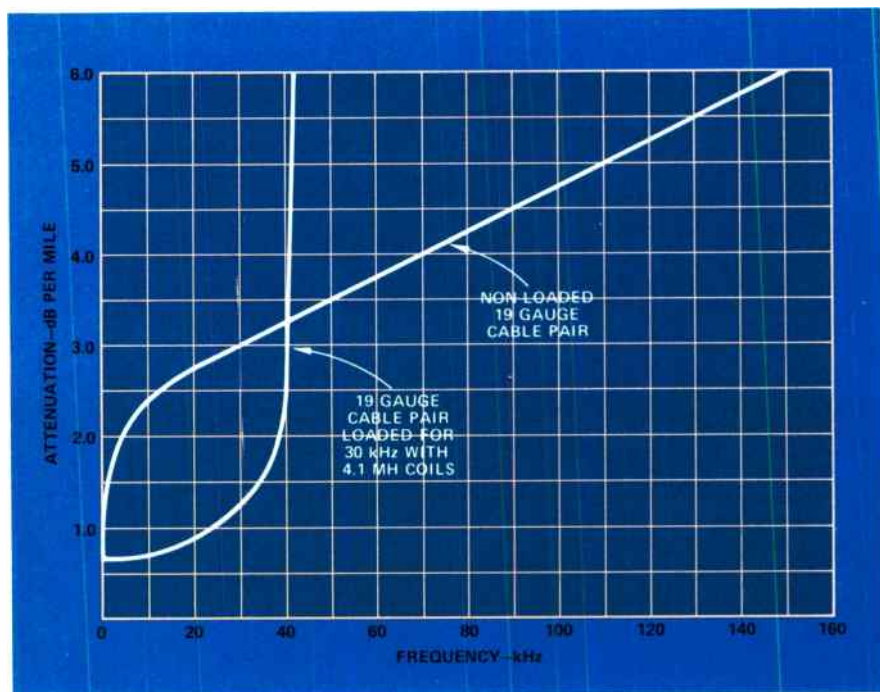

Figure 2. Non-loaded cable pair exhibits relatively constant slope, while loaded pair acts as a lowpass filter.

above 35 kHz, loading is not practical for cables used in carrier transmission (although loading is still used on long voice-frequency circuits). A common method used in carrier transmission to reduce distortion is the practice of frequency frogging, where the individual channels follow a "leap frog" pattern. The entire band of carrier frequencies is inverted at each repeater point (see Figure 3). Thus, the channel that occupies the lowest frequency slot (and hence suffers the least attenuation) in one section of the line occupies the highest slot in the next section.

Another way to compensate for slope is by using equalizing networks to introduce a slope opposite to that encountered in the line. An equalizer is much like a highpass filter with a slow and constant roll-off. When its characteristics are added to those of the line, the overall attenuation-versus-frequency curve is approximately flat. Some carrier systems have built-in slope equalizers, while others use external adjustable equalizers. Even with such corrective measures, cable is still a loss-prone transmission medium. Open wire, for example, introduces far less loss.

What makes cable attractive is economy. It is an inexpensive way to install

a great many circuits. The economy, of course, lies in the way cables are constructed.

## Cable Construction

A telephone cable consists basically of a number of insulated conductors inside an insulating sheath. Wire sizes run from 10 gauge to 26 gauge, depending on the application. Of course, large conductors (small gauge) introduce less loss, but they also raise the cost and make the cable more bulky.

And bulk should not be underestimated. In many metropolitan areas, cable ducts are already crowded nearly to capacity (see Figure 4), and additional space is costly. If ducts must be enlarged, or additional ones installed, the necessary construction work can be prohibitively expensive.

For these economic reasons, cables close to the central office most often use small conductors—typically 22 to 26 gauge. Farther out, larger cables are used.

Toll cables, on the other hand, may cover routes as long as 300 miles. Thus, there is a much greater opportunity for attenuation to build up. Therefore, toll cables are typically constructed of larger conductors. To give an example, 26-gauge, paper-insulated cable has a loss of about 26 dB

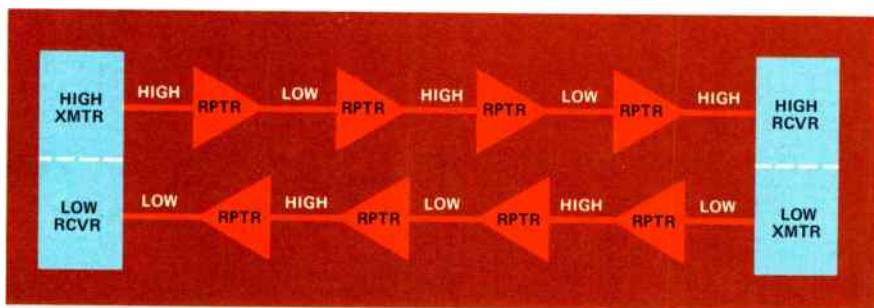

Figure 3. In frequency frogging, the entire frequency band is inverted at each repeater to equalize distortion.

per mile at 360 kHz, compared to only about 12 dB per mile for 19-gauge.

Another important factor in cable construction is the insulation, both on the individual conductors and in the outside sheath. Many cables use paper insulation around the conductors, primarily because it is inexpensive. The losses in paper-insulated cable are quite high because paper is not a particularly good barrier to the leakage



*Figure 4. Photo shows crowded cable ducts.*

paths. Furthermore, the varying insulation thickness causes conductance and capacitance to vary.

If moisture penetrates the sheath (even a pinhole can permit it), the paper gets wet reducing the insulation resistance and transmission characteristics of the cable. For these reasons, the trend is toward plastic insulation, which provides a better dielectric barrier to the leakage paths. However, moisture can still be a problem. In plastic-insulated cable, moisture can increase the mutual capacitance of the cable pairs, with a corresponding increase in attenuation.

The outer sheath has two functions—mechanical and electrical. Mechanically, it holds the conductors together and provides an environmental barrier. Electrically, it offers some protection from outside interference. Normal practice is to use two sheaths, one of metal and the other of plastic or rubber.

Another factor that must be considered in the construction of cable is pair balance. A magnetic field is associated with the current in a line; an electric field is associated with the voltage. It is desirable to have both the magnetic and electrical relationships between each conductor and the earth the same for both conductors—in other words, to have a balanced line. An unbalanced line can result in excess noise, crosstalk, and absorption peaks at certain frequencies. Fortunately, there is a simple solution to a major portion of the balance problem: simply twist the two wires around each other. Thus, the unbalancing condition is reversed at short intervals, and the inductive effects tend to balance.

### **Getting the Best Out of Cable**

Cable is not a perfect transmission medium. Properly used, however, it provides very satisfactory transmis-

sion. For many applications, it has no economic equal. It is not difficult to engineer a cable system if all new cable is to be installed. But often this is not the case. A typical cable carrier system, for instance, may use some new and some existing cable, often of different sizes —and almost certainly possessing different transmission characteristics.

The new cable should be chosen to provide the best transmission characteristics that are economically feasible, without regard to the characteristics of the existing cable. (If the existing cable has inferior transmission characteristics, there is no point in compounding them.)

Any pairs that are used for voice-frequency circuits are potential noise sources. They may pick up transients from switching equipment, for example. And if they happen to be connected to open-wire lines, these lines can act as radio antennas, introducing radio-frequency interference.

Noise is also picked up at carrier frequencies, but if it is introduced while the signal is at a high level, the noise will have minimal effect. Therefore, if possible, the entire existing

cable should be designated for carrier transmission. For this reason, also, it is often wise to use a short repeater run out of an office or in other high-noise areas. This keeps the signal level high in the areas where noise is most likely to be introduced.

If the new and existing cables are not the same, they will require a different repeater spacing and different equalization, depending on their individual characteristics.

Cable adequate for voice transmission is not necessarily satisfactory for carrier. For example, an imperfect splice that causes no trouble at voice frequencies can act as a diode rectifier at carrier frequencies, introducing substantial distortion.

Another consideration is the choice between aerial and buried cable. Often it is dictated by outside factors such as economics or aesthetics. For stable transmission, however, buried cable is more efficient. This is partly due to the fact that buried cable does not experience the temperature extremes of aerial cable. Since attenuation increases with temperature, as shown in Figure 5, high temperatures should be avoided when possible.

*Figure 5. Effect of temperature on attenuation is not a major factor, but it must be considered.*

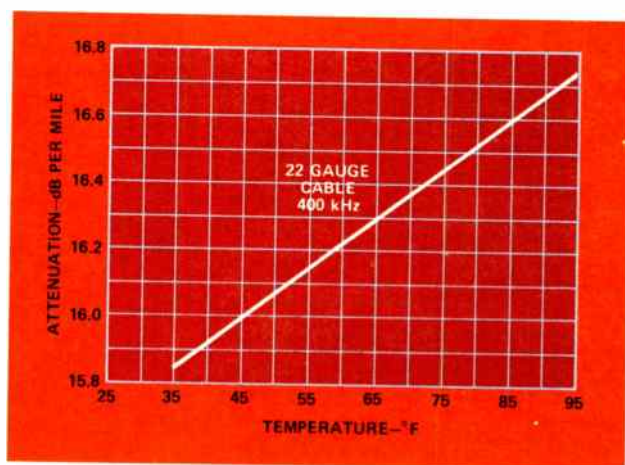



Buried cable is thermally insulated by the earth, and its year-round temperature variation in some areas will be no more than a few degrees. Aerial cable, with no such insulation, suffers from an "oven effect" that exaggerates the sun's heat. Tests have shown that the internal temperature of aerial cable on a hot day may be 18 degrees higher than the ambient air temperature.

On the other hand, both aerial and buried cable are subject to attack by pests such as insects and rodents. It is difficult to say which presents the greater hazard without specifically studying a particular locality.

### **Coaxial Cable**

Thus far, this discussion has concerned multipair cable. But coaxial cable has been receiving a great deal of favorable attention in recent years, after being overshadowed in the 1950's and early 1960's by microwave radio. A major reason for the renewed interest in coaxial cable is that radio frequency allocations are becoming increasingly congested in many areas. And for many uses coaxial cable can economically replace microwave transmission.

A coaxial cable consists of a solid inner conductor placed inside a hollow outer conductor. The two conductors are concentric and are separated by an insulator. This may be a solid such as plastic. But, in coaxial cables used for communications the insulator is usually air. The inner conductor is kept centered by support discs placed at intervals. This construction results in lower transmission losses than does solid insulation.

Regardless of the construction, however, a coaxial cable has much

lower losses than a twisted pair. Since it also has a lower attenuation-versus-frequency slope, the usable bandwidth is much greater. While ordinary cable carrier systems are usually limited to 24 voice channels, coaxial systems often carry 600 or more channels. For extremely heavy routes, the Bell System L4 carries 3600 channels. Channel capacity as great as 10,800 is being planned.

Coaxial cable also provides good protection from interference, since the electromagnetic energy propagation is confined within the tube. This is particularly important in some specialized areas such as video transmission.

A relatively new application for coaxial cable is the transmission of digital information. Multipair cables are adequate for bit rates suitable for 24 PCM voice channels, but the rates needed for high density systems demand the greater bandwidth available in coaxial cable.

### **Cable Development**

The basic factors in cable design are both well known and constant. But that does not mean improved cables are not being developed. On the contrary, the search is continuing for ways to improve the efficiency of both multipair and coaxial cables.

While the primary emphasis is on the development of new materials to reduce losses and distortion, other major objectives are to improve manufacturing methods while at the same time reducing costs.

Part of the development work is also aimed at new cables for specialized applications. These new cables will be the subject of the next Demodulator article.

# Reminder!



To continue receiving the  
Demodulator, you **MUST** return  
the questionnaire (attached  
to the March Demodulator)  
by **JUNE 1, 1970.**

***LENKURT ELECTRIC***

GENERAL TELEPHONE & ELECTRONICS

SAN CARLOS, CALIFORNIA, U.S.A.

**VIDEO, VOICE & DATA  
TRANSMISSION SYSTEMS**

**Lenkurt Offices**

San Carlos

Atlanta

Falls Church, Va.

Chicago

Dallas

The Lenkurt Demodulator is circulated monthly to technicians, engineers and managers employed by companies or government agencies who use and operate communications systems, and to educational institutions. Permission to reprint granted on request.

The *Lenkurt.*

JUNE 1970

# DEMODULATOR



Cable Developments

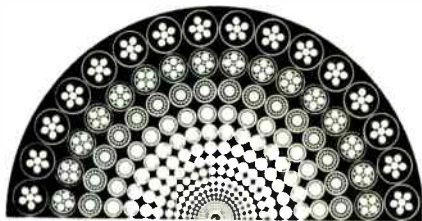

**Improvements in cable construction have eliminated some serious shortcomings and have increased overall performance.**

Telephone service was still in its infancy when the transition from open-wire transmission to cables began. The motivating factors were quite simple: aerial congestion quickly became intolerable in the urban areas where service was concentrated and open-wire lines were highly susceptible to storm damage.

This transition has essentially taken place, although open-wire continues to set longevity records in some rural areas. Not only do the same factors that sparked the trend toward cable still apply, but a new one has been added — increasing public concern with aesthetic values. As yet, no method has been found to make aerial transmission lines (open-wire or cable) an asset to the environment.

One solution has been to bury the cable. Despite the industry's many years of experience with cable, both electrical and physical problems remain. There is room for improvement in traditional applications, and newer developments, such as PCM transmission, make new and greater demands on the cable plant.

### **Cable Matures**

A multi-pair cable is far from an ideal transmission medium for either voice or carrier frequencies. Its shortcomings, such as the tendency to act as a lowpass filter, have been well documented (see the May 1970, Demodulator). Some of the solutions have also been presented: loading for voice frequencies, equalization and repeaters for carrier frequencies.

Equally important, however, is the physical construction of cable, because construction determines the electrical characteristics.

The basic characteristics of a transmission line largely depend on such factors as the size and material of the conductors, as well as their electrical proximity (physical spacing and the dielectric between them). Open-wire lines, of course, are insulated from each other by air space; so are most coaxial cables. However, multi-pair cables also must depend on other types of insulation.

The conductors in the first cables were wrapped with cotton string for insulation. Later, paper tape and pulp came into widespread use. These methods worked reasonably well as long as the insulation remained dry. Moisture can be kept out with a waterproof sheath. Lead has been widely used as a waterproof sheath, but it easily develops fatigue cracks which let in moisture. It is also heavy, difficult to handle, and expensive.

Another approach to keeping moisture out is to fill the cable sheath with dry air under pressure. Since this is quite expensive, it is often not economically justifiable, particularly for long cables that may contain only a few pairs.

A major advance was the development of Polyethylene Insulated Conductor (PIC) cables. This waterproof plastic insulation solved most of the problems caused by wet conductors, although PIC cables occasionally have defects allowing moisture to enter.

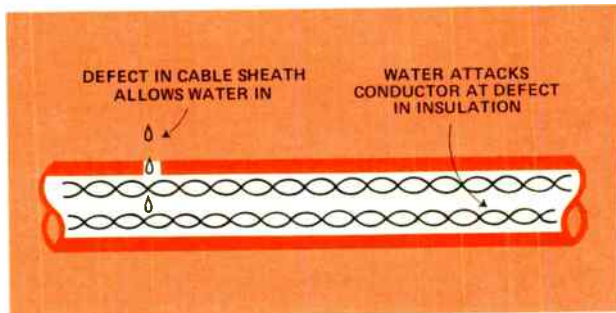

*Figure 1. Cable acts as a pipe permitting water to enter the sheath at one point, then travel hundreds of feet before attacking the conductors.*

Dry conductors alone are not enough for good transmission characteristics. Impure water has poor dielectric properties. And water inside a cable sheath, even though it does not reach the conductors, increases the capacitance between the conductors. In an extreme case where the cable is full of water, the transmission loss can increase about 55 percent at voice frequencies, and as much as 75 percent at carrier frequencies.

Polyethylene is also used to insulate and waterproof the sheathing. It usually forms an outer jacket over the metal sheathing, providing electrical shielding and mechanical support. This outer jacket is easily damaged while the cable is being buried. A lightning strike can also melt tiny holes in the jacket.

Another significant problem is the damage caused by gophers and other pests. In areas where such rodents are prevalent, cables are armored with a thick copper shield for protection.

Because about half the space inside a cable is filled with air, the sheath acts as a pipe. Thus any water that does penetrate can flow for hundreds of feet along the cable — even uphill where temperature variations create pressure differentials. This complicates repair, because some of the problems caused by moisture may not be close to the point where the water entered the cable (see Figure 1).

## Keeping the Water Out

Many different methods have been tried to keep moisture out of cables. One early method was to fill the cable with kerosene. However, kerosene is lighter than water, causing it to float away when water enters.

Petroleum jelly, which has good electrical properties, has long been attractive as a water repellent in cables. The main problem with petroleum jelly is its low melting point. It is likely to melt and flow out of cables stored in the sun. At the same time, a stiff filling compound is not satisfactory because it does not allow the cable to flex easily.

Recently, petroleum jelly has been mixed with pulverized polyethylene to form an excellent filling compound. The addition of an antioxidizing agent allows the compound to retain its putty-like consistency for years.

This filling compound has necessitated some changes in the insulation surrounding the conductors. Since the compound can cause polyethylene to deteriorate, conductors are usually insulated with polypropylene. Furthermore, filling the cable increases the capacitance between conductors. Since the new cable must be interchangeable with older PIC cable, it has to meet mutual capacitance standards of 0.083 microfarads per mile. This is accomplished through a 40 percent increase in the thickness of the polypropylene

*Figure 2. PCM systems use the same frequency band for both transmission directions; therefore, coupling from strong pulses leaving a repeater can seriously interfere with incoming pulses.*

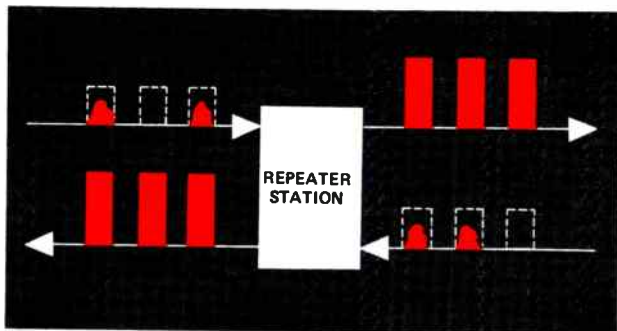

insulation on the conductors. The net result is a slightly larger cable.

While filled cable costs somewhat more than standard PIC cable, it offers a bonus in the form of reduced attenuation, particularly at carrier frequencies. Filling the cable permits the manufacturer to produce more uniform electrical characteristics. This can reduce attenuation as much as 15 percent compared with standard PIC cable (approximately 20 dB per mile at 772 kHz compared to about 23 dB per mile for 22-gauge PIC). This reduced attenuation is due to the filled cable's higher impedance and lower ac resistance caused by the thicker plastic insulation. This uncalculated bonus can result in fewer repeaters in a carrier system.

### PCM Transmission on Cable

With few exceptions, cable carrier systems use four-wire transmission arrangements — two wires for each direction of transmission. In addition, “traditional” carrier systems that use frequency-division multiplexing normally use different frequency bands for the two directions of transmission. Otherwise, the low-level signal coming into the repeater could suffer severely from coupling by the high-level signal coming out of the repeater on an adjacent pair, as shown in Figure 2. This condition is defined as near-end crosstalk.

PCM systems, on the other hand, use the entire available frequency band for each direction of transmission. A primary cause of errors in PCM transmission is impulse noise produced by near-end crosstalk between PCM systems in the same cable sheath.

For this reason, it has been recommended that PCM systems, such as Lenkurt's 91A, use two separate cables dedicated to PCM transmission. Since one cable carries one direction, both cables can be filled to capacity. Another way to decrease the near-end coupling is to limit the cable fill to about 70 percent of capacity, when only one cable is used. Still another is to decrease repeater spacing to maintain the level difference between the two transmission directions.

A new development, called T-Screen\* cable, shows substantial promise for PCM transmission. As shown in Figure 3, T-Screen cable incorporates a thin shield to divide the conductors into two separate compartments — effectively separating two cables in one sheath. The screen is made of polyester-insulated aluminum. The 4-mil screen is thick enough to provide the necessary electrical isolation, yet thin enough to flex with the cable without deforming.

The best results are obtained by combining the T-Screen with the

\*Registered Trademark, Superior Continental Corporation



*Figure 3. T-Screen cable uses an insulated shield to separate conductors effectively into two channels, thus reducing far-end crosstalk (FEXT), particularly for PCM transmission.*

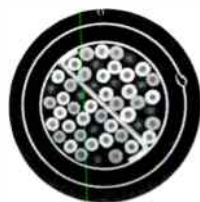

Courtesy of Superior Continental Corporation

filled-cable concept. The T-Screen decreases crosstalk (see Figure 4), and the cable filled with the petroleum jelly compound decreases attenuation and moisture problems. Reports from the field indicate that the use of this combination has permitted PCM repeater spacing to be "stretched" from 5,400 feet to 8,000 feet on 22-gauge cable. However, the savings obtained are partly offset by the increased cost of such cable (typically 5 to 20 percent, depending on the pair count).

Added economic advantages may be realized by using 24-gauge cable to produce 6,000-foot repeater spacing

for PCM. Such spacing eliminates separate locations for carrier repeaters and voice-frequency loading coils, since standard H-88 loading coils are placed every 6,000 feet.

### Coaxial Cable Developments

Like multi-pair cable, coaxial cable has been changing ever since its introduction to field use in the 1930's. Much of the change, however, has been in the application of coaxial cable, rather than in the basic design. The first commercial application in the United States carried 600 two-way voice channels on each pair of coax-

Courtesy of Superior Continental Corporation

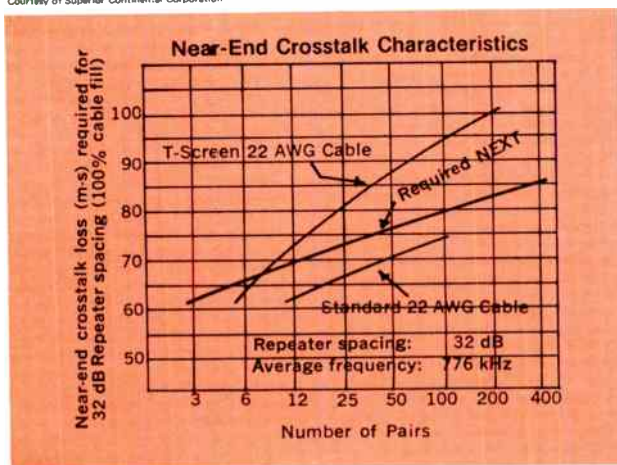

*Figure 4. T-Screen cable substantially improves PCM crosstalk performance with 100 percent cable fill.*

ials, using an L-1 carrier system. This version used a 0.27-inch cable and rubber discs to maintain separation between the conductors.

Soon, however, the standard size for high-density applications became 0.375 inches, as a compromise between cost and attenuation. Conductor separation was maintained with polyethylene discs to reduce the mutual capacitance. Increased circuit capacity was obtained by adding more coaxial "tubes" to a single cable, and by decreasing repeater spacing to permit more channels on each pair of coaxials.

Today, 20-tube cables are commonly used on heavy routes, and the L-4 carrier system transmits 3600 two-way voice channels on each pair of tubes.

While the electrical characteristics of an ideal coaxial cable are excellent, they are highly dependent on the physical relationship of the conductors. Since the outer conductor is hollow, and the inner conductor is normally held in place by thin discs about an inch apart, the tube is quite susceptible to crushing. Any such damage creates a discontinuity in the transmission path, resulting in deterioration of electrical characteristics.

Furthermore, the flexing involved in manufacturing, transporting, and laying the cable can cause fatigue in the outer conductor. For instance, flexing tests have shown that the

conventional serrated-seam outer conductor develops "dimples" under each serration, even with normal handling.

Partly because of a desire to improve the mechanical and electrical characteristics of coaxial cable, and partly because of the specter of a world-wide copper shortage, Bell Telephone Laboratories set out to develop an improved coaxial cable. The result is CLOAX (corrugated-laminated coaxial) cable.

CLOAX uses a thin copper skin laminated to a tinned-steel sheet with a copolymer adhesive, as shown in Figure 5. The entire laminate is laterally corrugated to permit flexing and to add crush resistance.

Because this design uses a soldered seam and does not deform easily, it has more uniform electrical characteristics; therefore, its transmission loss is said to be lower than conventional serrated-seam coaxial, and it provides better interference protection. CLOAX uses one-third as much copper as the previous design; it has twice the crush resistance, and four times the bending life (see Figure 6).

One seeming dark spot in the CLOAX picture is that continuous exposure to high humidities tends to destroy the copolymer-to-copper bond. However, initial tests at Bell Laboratories indicate that once the cable is fabricated and buried, this bond is no longer critical. As long as the cable is not disturbed, the inside

*Figure 5. The CLOAX cable outer conductor and shell are a laminate of copper and steel - resulting in less copper, greater strength and improved electrical characteristics.*

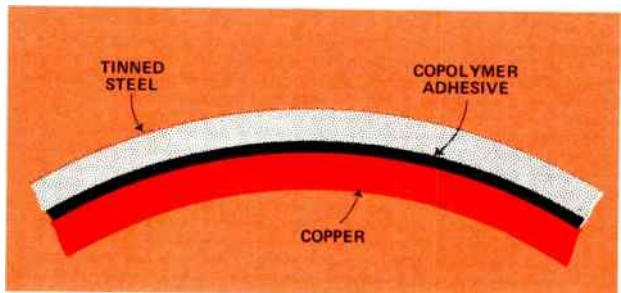



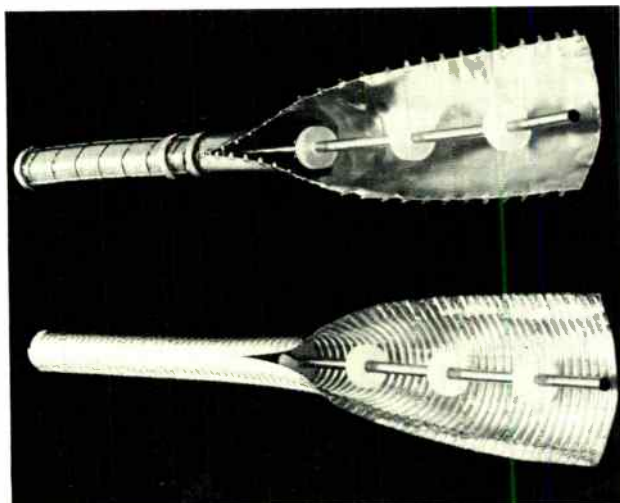

*Figure 6. The serrated-seam coaxial cable, on the top, uses a double wrapping of helically wound steel tape to give it strength. The corrugated-laminated coaxial (CLOAX), on the bottom, has greater strength, without such wrapping.*

Copyright 1969, Bell Telephone Laboratories, Inc.  
 Reprinted by permission of the Editor, Bell Laboratories RECORD

diameter of the conductor does not change. Therefore, the electrical characteristics remain constant.

### The Future of Cable

The more sophisticated forms of transmission – microwave radio, millimeter waveguides, lasers – tend to receive the publicity. They definitely occupy a position of importance in the communications industry, but they also have their shortcomings.

There is nothing particularly glamorous about cable, but it still has its

place. With the number of telephone circuits doubling about every seven years, cable's future seems assured.

Some of the recent developments in cable technology have been mentioned here. There undoubtedly will be others in the future – improved electrical materials, better protection from interference, better mechanical characteristics. Major efforts, in all areas, will be directed toward improved economy. For many applications, there is presently no technique in sight to compete economically with cable.

---

### Note from the Editor:

Book and Binder requests made on the Demodulator Survey Card could not be filled unless the proper money was enclosed. Please follow the instructions given on the last page of this issue and we will promptly fill your order.

We are making a concerted effort to fill all of your many requests – back issues, mailing list additions, etc. But, if by July 15 your requests have not been filled, *please* ask again. By that time we expect to be finished pulling staples and tallying the many thousands of survey cards we have received.

Thank you for your patience.

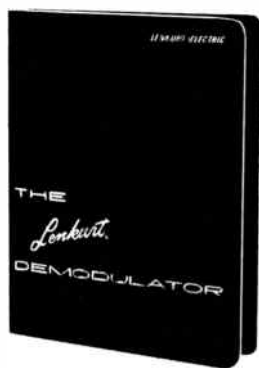
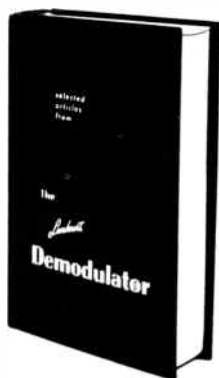

## Reprint Book

A valuable collection of Demodulator articles published through December 1965. Over 700 pages of information on multiplex technology, microwave radio, digital data transmission, semiconductor devices, and general communications. \$5.00 — postpaid; \$7.50, foreign addresses, first class mail.

## Binder

A special binder is available for storing issues of **The Lenkurt Demodulator**. These binders are covered in durable, embossed Lexide; each binder holds 24 issues. The cost is \$1.00 per binder, postpaid.

To receive the reprint book or binders, postpaid, send check or money order payable to Lenkurt Electric Co. For any other information about the "Demod", write Lenkurt, Dept. C134.

**LENKURT ELECTRIC**

GENERAL TELEPHONE & ELECTRONICS

SAN CARLOS, CALIFORNIA, U.S.A.

**VIDEO, VOICE & DATA  
TRANSMISSION SYSTEMS**

### Lenkurt Offices

San Carlos  
Atlanta  
Falls Church, Va.  
Chicago  
Dallas

The Lenkurt Demodulator is circulated monthly to technicians, engineers and managers employed by companies or government agencies who use and operate communications systems, and to educational institutions. Permission to reprint granted on request.

The *Lenkurt*  
**DEMODULATOR**

JULY 1970



Domestic  
Satellites

Vertical text on the left edge, likely a page number or reference code.



..... a versatile, reliable national communications network just over the horizon.

**S**ynchronous, geostationary satellites capable of directing signals to a network of earth stations scattered throughout the United States is the image portrayed by a domestic satellite system (see Figure 1). Such a system could serve populous areas where the demand is greatest, or provide communication links to areas which are not now easily accessible with terrestrial methods.

The proposed system would provide communications for all areas within the country, and could someday be interconnected with transoceanic cable and international satellites to overseas points, making it possible for today's telephone user, even in remote areas, to reach 188 million telephones — 96 percent of the world's total.

### Open Competition

The development of a domestic satellite system in the U. S. has been delayed pending the outcome of a government study. The results of this study have now been presented in the form of a Presidential memo suggesting the FCC give approval to any organization seeking to construct and operate a domestic satellite system, provided it meets certain guidelines.

The memo further suggests establishing a three- to five-year interim policy allowing competition to act within well defined limits to protect public interests.

Literally interpreted, the Presidential memo gives anyone with the funds and technology the opportunity to launch and operate a domestic satellite system, provided standards of com-

patibility are met and anti-trust laws are not violated. Specifically, the recommendations deal with financial ability, launching capability, room in space, and available frequencies.

When satellites are designed to fit a domestic network, they must compete, costwise, with existing service. Satellites can provide circuit performance and capacity equal to coaxial cable, digital systems and millimeter wave systems.

A satellite system able to compete economically with terrestrial facilities will have a limited number of drop-off points (earth stations). The earth stations should be limited for two reasons — cost and channel capacity. The channel capacity decreases with increasing station access; therefore, each earth station will have to gather traffic from a large area.

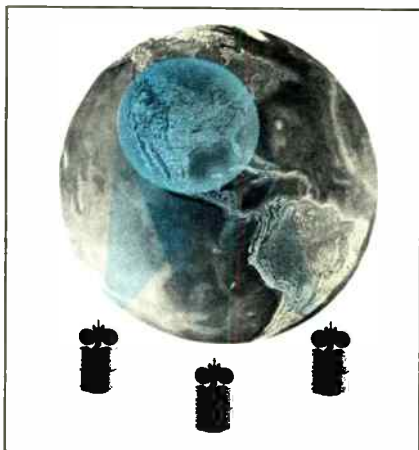

*Figure 1. A domestic satellite system would use a series of synchronous, geostationary satellites for communication with all parts of a country.*

The private enterprise approach to domestic satellite service may lead to a variety of special purpose systems. Three general plans are being considered, each in a different frequency range — 4 and 6 GHz, 10 to 40 GHz, and 30,000 GHz. The first system would operate in the 4- and 6-GHz range — presently used for most terrestrial radio transmission and for international satellite systems involving a few remotely located earth stations.

### Radio Interference

Radio interference can be a serious problem if there is an extensive microwave network near the earth satellite station. This condition is typically found in the proximity of urban centers. In the United States, the proliferation of 4- and 6-GHz terrestrial systems makes these undesirable for satellite use. However, there are not as many 4- and 6-GHz terrestrial links in Canada, and their proposed system, using these frequencies, expects to avoid radio interference by placing the earth stations outside the metropolitan areas. Even with the interference shielding offered by hills, it will probably be necessary to place earth satellite stations 50 to 100 miles (80 to 160 kilometers) from urban centers.

Radio interference affecting a U.S. domestic satellite system operating in the 4- and 6-GHz region is shown in Figure 2. The greatest interference is between the 4-GHz radio relay trans-

mitter and the highly sensitive earth station receiver, and between the high-gain earth station transmitter and the 6-GHz radio relay receiver.

International studies are in progress to find ways to avoid radio interference, with emphasis on the possible selection of preferred or segregated frequency assignments for satellite communication systems. The bands under study are above those generally used for terrestrial microwave systems. If exclusive assignments can be made for satellite service, earth stations can be placed near large centers where most circuits will be terminated.

Bell has studied a system that operates in the millimeter-wave frequency range between 10 and 40 GHz. Radio interference is no longer a hindrance with such a system. Atmospheric attenuation, however, is a much more serious problem, since electromagnetic waves in the frequency bands above 10 GHz are severely attenuated by rain and water vapor.

### Atmospheric Attenuation

A domestic satellite system operating above 10 GHz must be designed to withstand a few dB of attenuation due to atmospheric conditions — sometimes for long periods — and must have a diversity earth station for the rare occasions when excessive rainfall causes large attenuation (see Figure 3). According to studies, the most intense rain occurs in limited

Figure 2. Radio interference is a serious problem when the earth station for a 4- and 6-GHz satellite system is located near an area with 4- and 6-GHz radio relay systems.

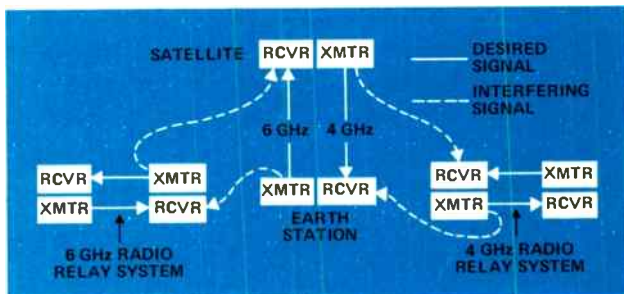

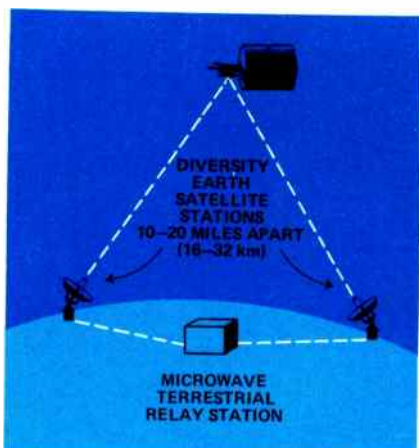

Figure 3. Diversity earth satellite stations avoid signal attenuation when heavy rainfall occurs.

cells, and rain covering large areas (several square miles) generally falls at the low rate of one inch per hour or less. Therefore, diversity earth stations separated by several miles have been proposed as a workable solution to atmospheric attenuation.

A third possible ground-to-satellite link would use a CO<sub>2</sub> laser. Such a system is not hampered by radio interference, and has a high tolerance against atmospheric attenuation. Although the frequency of a CO<sub>2</sub> laser (30,000 GHz) is higher than millimeter-waves, there is a transmission window, 40-GHz wide, centered at 30,000 GHz. This frequency, therefore, is less susceptible to attenuation than any in the visible or ultra-violet ranges. The CO<sub>2</sub> laser has also been suggested as a means of providing efficient inter-satellite communications — links between domestic and international systems

### Time Delay and Echo

Long time delay and the associated echo became apparent with international geostationary communica-

tions satellites. The minimum distance between any two points via a geostationary satellite is 44,600 statute miles (72,000 kilometers). Consequently, a U.S. circuit via satellite will have a round trip delay of more than one-half second compared with about one-tenth second delay for terrestrial cross-country transmission in the U.S. This delay is due to the distances involved and the resulting transmission times.

The speaker's echo tolerance depends on the delay time and the loudness of the echo. There are two ways to suppress the echo within tolerable limits. One form of suppression is to attenuate the echo — making it barely noticeable compared with the speaker's voice. As time delay increases, the echo attenuation must also be increased. A voice-activated switching device can also be used in the return circuit to keep the echo from reaching the speaker.

In the early 1960's, Lenkurt Electric, Bell Laboratories, and the Dollis Hill Laboratories of the British Post Office were studying the effects of delay, echo, and echo suppression. These studies resulted in specifications for new suppressors designed for long-delay circuits. Lenkurt's 931C echo suppressor was designed to meet these specifications and is capable of compensating for delays of the magnitude encountered with satellite links.

Artificial delays were used in a simulated telephone test circuit carrying regular telephone traffic. These experiments began to show slight adverse public reactions to calls with a round trip delay of about 300 milliseconds, and a significant increase in adverse reactions with a round trip delay of about 500 milliseconds.

Three different situations arise with long delays which may be disturbing, but are tolerable. The first of these is called "simultaneous talking." If both parties start talking within one-quarter

second of each other, both will continue talking until one party finally notices the other and ceases talking. When this happens, neither party will hear what the other has said.

“Hello calling” is the second condition encountered with long delays. When one party has been talking for some time, or has come to the end of what he wanted to say, he usually pauses and expects a response from the other party. This response may be delayed because the other party hesitates before answering. With the added satellite delay the talker may become impatient and start calling “Hello,” indicating he is wondering if the other party is still on the line, or if the connection has been broken.

“Break-in difficulties” characterize the third delay situation. One of the parties may wish to start talking by taking advantage of a short pause in the other’s speech. Therefore, he waits for a breathing pause by the other party. In a satellite call, it will take him about one-quarter second to note the pause. By the time his comments reach the original speaker, a minimum of another quarter second later, the latter may have resumed speaking. This condition is compounded if it leads to “simultaneous talking.”

Although the distance to the moon is greater than it would be to a geostationary domestic satellite, most people were made aware of these long delays with the telephone conversation to the moon during the Apollo XI moon landing. All of these delay-related conditions may become more pronounced and lead to verbal communication difficulties under the pressure of time and argument.

Since subscriber dissatisfaction increases in proportion to delay time, the CCITT (International Telegraph and Telephone Consultative Committee) recommended the following limitations on mean, one-way propaga-

tion time with appropriate echo suppressors: 0 to 150 milliseconds, acceptable; 150 to 400 milliseconds, acceptable, provided increasing care is exercised on connections as the mean, one-way propagation time exceeds about 300 milliseconds; and unacceptable above 400 milliseconds.

A follow-up analysis on the simulated delay circuits showed that only a small proportion of the people had difficulty talking and hearing, and an even smaller proportion rated the connection “fair” or “poor” (see Figure 4). Therefore, it would seem that the delay-related problems are not as serious as first thought to be.

One possible way to minimize delay is to use the satellite path for transmission in only one direction, and use the shorter delay, terrestrial system for the return connection. In this way, the maximum one-way delay would be acceptable and the total delay would be significantly reduced.

Once a domestic satellite system is operating, it will be necessary to have automatic switching which would limit each call to only one satellite hop,

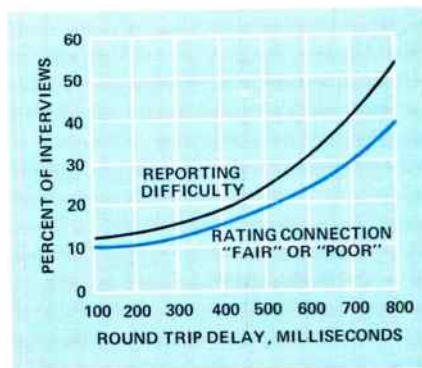

Figure 4. Only a small percentage reported having any difficulty hearing or talking during calls made on circuits with simulated delays. An even smaller portion rated the connection as “poor” or “fair”.

keeping the delay within the acceptable range. One way to accomplish this is to make the domestic system available only for calls within the country. An alternative plan would develop an inter-satellite communication system requiring only one up-and-down link. The situation to be avoided is multiple up-and-down links. For example, on a call from England to Hawaii there could be as many as three up-and-down links, with a U.S. domestic system in operation (See Figure 5).

Long delays cause difficulties only when there is two-way communication. Data, television, and facsimile transmission would be unaffected by these delays and ideally suited to satellite communication systems.

### Unique Outages

There are three types of outages affecting reliability on all satellite systems. The magnitude and exact occurrence of these outages depends upon the orbital placement of the satellite and the location of the earth station. The first is eclipse outage which occurs when the earth's shadow covers the satellite, causing the solar cells to become inoperative. These periods of eclipse last up to one hour, and occur each night for 43 consecutive nights in the spring and fall. However, the usual satellite design provides battery backup for most

channels to insure their continuous operation. To conserve satellite weight, it would be possible to keep a channel without battery backup for television transmission — a service normally “off the air” during the eclipse periods.

Sun transit outage is caused by radiation of electromagnetic energy from the sun when it crosses directly behind the satellite. This radiation is proportional to temperature; therefore, the sun is an extremely powerful noise source which, when in direct line with a satellite, overrides the satellite signal. This condition, occurring on about five days, two times each year, causes an outage lasting approximately 10 minutes. Terrestrial protection channels can be provided to avoid losses, since these short outages can be predicted with reasonable accuracy.

If a satellite should fail, there is a distinct likelihood that it will be impossible to restore it to service, and a replacement satellite would have to be launched. A temporary means of restoring satellite circuits will have to be developed, to avoid the serious effects of this outage on a sophisticated telephone switching network.

Aircraft do not cause interference with terrestrial communication links. This is not, however, the case with satellite communication where aircraft corridors pass through satellite beams.

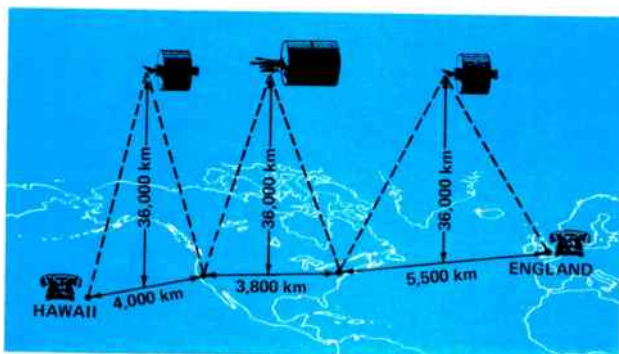

*Figure 5. Limiting intercontinental communications to one up-and-down link, there are several possible routes for a call from England to Hawaii.*





*Figure 6. Domestic satellite earth stations will look very similar to this international satellite earth station.*

This interference condition is still under investigation to determine its magnitude.

### **Weight vs Stabilization**

Narrow antenna beams used for satellite communication require precise spacecraft stabilization. Accurate sensing for final attitude adjustments can be achieved by measuring the satellite's electromagnetic radiation. Attitude control appears to be primarily a question of the reliability of components to be used in a system designed for at least 10 years of operation. A basic aspect of attitude control is the amount of fuel (weight) required to stabilize the spacecraft.

In comparison with the amount of fuel required to keep a satellite station operating, the weight for attitude control is small — a few pounds per year per ton of satellite weight. Therefore, the stabilization weight penalty imposed on a satellite having a 10 year operational lifetime, while significant, is not prohibitive.

### **How Soon?**

It is theorized that even if the FCC acts quickly, it would require about

two years of planning and construction before a U.S. domestic satellite system could become operational. Experts predict the initial volume will be only great enough to support one satellite system, unless there is a significant increase in traffic over the next two years.

The Canadian domestic satellite system is scheduled for launching in late 1972. The specific requirements of the Canadian system are not the same as for a U.S. system; however, a great deal can be gained from their experience.

Although the cost of domestic satellite links is not expected to provide immediate economic advantages over terrestrial links, it is anticipated that its versatility and reliability combined with the present varied modes of terrestrial transmission will ultimately provide a more efficient total communications system.

Someday in the near future the United States will be covered with a network of earth stations similar to the one shown in Figure 6, and all phases of communication — voice, data, facsimile — will experience the advantages a domestic satellite system.

**LENKURT ELECTRIC CO., INC.**  
SAN CARLOS, CALIFORNIA 94070



**Lenkurt's 931C Echo Suppressor eliminates the echo encountered in satellite, transoceanic, and transcontinental circuits. This compact unit features microelectronic design and reliable printed circuit construction. For additional information, write Lenkurt, Dept. C134.**

***LENKURT ELECTRIC***

GENERAL TELEPHONE & ELECTRONICS

SAN CARLOS, CALIFORNIA, U.S.A.

**VIDEO, VOICE & DATA  
TRANSMISSION SYSTEMS**

**Lenkurt Offices**

San Carlos  
Atlanta  
Falls Church, Va.  
Chicago  
Dallas

The Lenkurt Demodulator is circulated monthly to technicians, engineers and managers employed by companies or government agencies who use and operate communications systems, and to educational institutions. Permission to reprint granted on request.

The *Lenkurt.*

AUGUST 1970

# DEMODULATOR

MTBF  
MTTR

innage  
outage

reliability  
availability



99.9999%

some  
aspects  
of  
microwave  
system  
reliability

The following is the essential text of a talk given by Mr. R. F. White, a senior staff engineer at Lenkurt Electric Co., Inc., at the International Conference on Communications held in San Francisco in June, 1970. Because of the outstanding clarity of the discussion, and because the article is of general interest to communication systems users, it is being printed here for the benefit of all *Demodulator* readers.

In recent years the objectives for total reliability in microwave communications systems have become rather staggering. One example is the Bell System's stated objective of 99.98% overall reliability on a 4,000 mile system, which breaks down to an allowable *per hop outage* of about 25 seconds per year. Users of high reliability industrial systems are also talking about average per-hop reliabilities in the order of 99.9999%, or about 30 seconds per year, for their long-haul microwave systems.

This discussion is mainly concerned with the ways in which such microwave system reliabilities are being described, specified, and calculated, and with some apparent problems in some of the methods commonly used.

The microwave industry has long been accustomed to making estimates and calculations of outages due to propagation, using empirical or semi-empirical methods.

The results are usually stated either as a per hop annual outage, or as per hop reliability in percent. And it is interesting to note that calculations using these empirical methods indicate that by the use of suitable path engineering and diversity, it is possible to achieve propagation reliabilities in the above mentioned range.

Calculation methods for estimating the probable reliability of a microwave

hop with respect to *equipment* outages have also come into the picture in recent years, using the principles and practices developed by reliability engineering experts in other fields.

It has also become fairly common practice to express the calculated equipment reliability results for microwave systems in terms similar to those used to describe propagation reliability in percent as the term is commonly used by microwave engineers, or as a per hop "availability." (The latter term as used in reliability engineering is the ratio, over the period of interest, of the innage time to the total time.)

A natural extension of this practice is to add the per hop annual outages for equipment and for propagation together to get an overall outage to be used as a reliability "figure of merit" for the hop.

This discussion will attempt to show that *none* of these parameters—per hop annual outage, per hop reliability in percent, or per hop availability—provides an adequate description of the *equipment* reliability performance in the case of ultra-reliable systems. It follows, of course, that if this is so, the "overall total reliability" concept and figures of merit are equally unsatisfactory.

Microwave equipment availability or outage calculations always rest in the end on two basic concepts: the

“mean time between failures” (MTBF) and the “mean time to restore” (MTTR). The relationship between the two determines the outage ratio. (MTTR will be assumed to include notification time, travel time, diagnosis time, as well as the actual time to repair or replace the failed item. Thus, in this paper, it represents the actual average length of outage associated with a failure event.)

In high-reliability systems the relationships become quite simple, as shown in Figure 1.

The “innage ratio” is the term called “availability” by reliability engineers. Multiplied by 100 to convert it to percent, it is the “reliability” as used by microwave engineers.

Figure 2 shows how these parameters might look in a more or less typical *non-redundant* microwave hop.

The 5,000 hour figure in the denominator is an assumed value for the MTBF of all the equipment of a non-redundant microwave hop; it would correspond to an average of roughly two failures per year, and since the hop is non-redundant, each would be an actual outage.

A value of 5 hours is assumed for the MTTR, and as stated above, this is taken to mean all the time from the instant of failure until the equipment is restored and back in service.

These assumed values were chosen primarily for mathematical ease and are not intended to represent any actual system. This applies to any other values used.

What happens with a *fully redundant* configuration? Here, for simplicity, it is assumed that the non-redundant equipment is simply duplicated and that a perfect automatic sensing and switching system is provided. An MTBF of 5,000 hours for each side of the redundant configuration and an MTTR of five hours for

any equipment failure are also assumed. Note, however, that in the redundant system, a single or one-side equipment failure will not cause an actual system outage. Only two simultaneously existing failures, one on each side, can do this.

One further assumption is made in Figure 3, that failures on the two sides are totally random and independent.

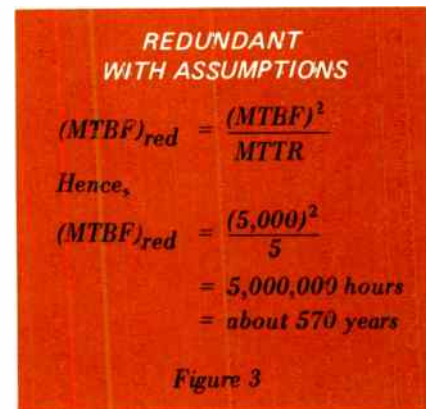
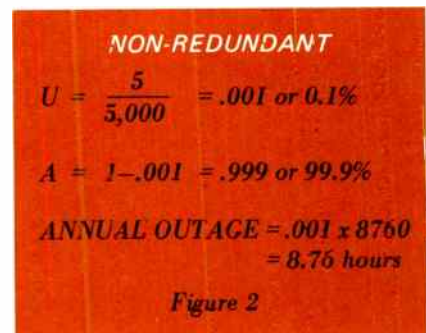
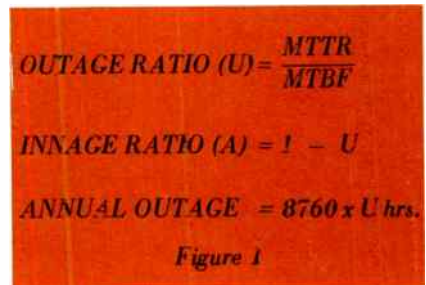

These mathematics illustrate that, given these assumptions, the average time between outages (actual system failures) on this hop would be 570 years.

Continuing with the same redundant example, Figure 4 gives the equation for calculating the outage ratio,  $U_{red}$ , for the redundant hop, and the actual calculation for this example.

This now represents a completed calculation which says, given all these assumptions, the equipment reliability characteristic for this hop can be described as 32 seconds of outage per year.

But, this figure of 32-seconds-per-year average outage is only a mathematical abstraction. Since an outage is by its very nature indivisible, there can only be, in any given year, either *no outage at all*, or an outage which, under the assumptions used, must be very much longer (5 hours per failure event in this model). Neither of these conditions —no outage or 5 hours outage— has any real relation to an annual outage of 32 seconds, and consequently the 32-second figure is a very inadequate way of describing this situation.

Figure 5 re-emphasizes the point that whenever the expected outage (MTTR) associated with a failure event is relatively large, the occurrence of such failure events must be extremely rare (MTBF very large)—if ultra-high reliability is to be achieved.

In real life microwave systems there are constraints imposed by the fact that the systems (at least the long-haul ones where ultra-reliability is most urgently needed) involve unattended repeater stations spread over rather considerable geographic areas, and often in relatively inaccessible locations. This makes it rather unrealistic to assume that the average restoration time, even under favorable conditions, will be less than 1 or 2 hours. Travel time alone will often be greater than this, particularly for failures at isolated points occurring at night or on weekends. In fact, the mathematically convenient assumption of 5 hours may be overly optimistic.

A restoration time measured in hours must be accompanied by equivalent MTBF's measured in millions of hours (hundreds of years) in order to show calculated reliability in this range of 99.9999% per hop.

#### REDUNDANT – WITH ASSUMPTIONS

$$U_{red} = \frac{MTTR}{(MTBF)_{red}} = \left( \frac{MTTR}{(MTBF)} \right)^2 = \left( \frac{5}{5,000} \right)^2 = .000001 \text{ or } .0001\%$$

$$A_{red} = 1 - .000001 = .999999 \text{ or } 99.9999\%$$

$$\begin{aligned} \text{ANNUAL OUTAGE} &= .000001 \times 8760 = .00876 \text{ hours} \\ &= \text{about 32 seconds} \end{aligned}$$

Figure 4

**FOR 99.9999% RELIABILITY**

**MTBF MUST BE ONE MILLION  
TIMES THE MTTR!**

*e.g., If repair time is five hours,  
MTBF must be 5,000,000  
hours (570 years).*

*If repair time is one hour,  
MTBF must be 1,000,000  
hours (114 years).*

*Figure 5*

This, coupled with the fact that it is impossible to have a fractional failure in a real system but only integral ones, is the real crux of the problem being discussed.

It has been shown how our example of a redundant hop could calculate out to an average per-hop annual outage of 32 seconds due to equipment. But it must be recognized that in a real system this is a meaningless value which cannot exist except by a wildly unlikely set of coincidences. Even if

the analysis and the assumed parameters and conditions were precisely correct, the hop would have to be operated for at least 570 years in order to get even a minimum test, and in that time we get 569 years with zero outage and one year—which could be anywhere along the line—with 5-hours outage. Thus, “annual outage” is quite meaningless, and even the availability or reliability parameters would be meaningful only for the average performance over something like 10,000 years, or 10,000 hops.

The situation is quite different with respect to propagation outages and the kind of difference is shown in Figure 6. Here, a simple propagation situation has been made up which also leads to the same annual outage.

The propagation outages shown are based on a simple assumption of a diversity path with a 40-dB fade margin, Rayleigh fading on each side, and a diversity improvement factor of about 100. Under these assumptions, each side of the diversity would have a reliability of about 99.99% or about 53 minutes of outage per year, consisting of perhaps 1,000 individual hits averaging on the order of 3 seconds

	<u>PROPAGATION</u>	<u>EQUIPMENT</u>
<b># ONE-SIDE FAILURES PER YEAR</b>	1,000	2
<b># OUTAGES PER YEAR</b>	20	1/570
<b>AVERAGE LENGTH OF EACH</b>	1.5 sec.	18,000 sec.
<b>TOTAL ANNUAL OUTAGE</b>	30 sec.	about 30 sec.
<b>RELIABILITY</b>	99.9999%	99.9999%

*Figure 6*

each. The diversity improvement factor of 100 to 1 would lead to about 20 simultaneous hits per year, that is, 20 actual outages, each averaging about 1.5 seconds in length.

The 20 or so simultaneous hits, giving a total annual outage of about 30 seconds, constitute enough events to provide a reasonably adequate statistical population over a year, so that results expressed in this way are quite meaningful and can be related to real-life systems.

But the situation is quite different in the equipment column, in which there are about 2 one-side failures per year, and about 1/570th of an actual outage per year, so that the annual outage is 1/570th of 18,000 seconds, or about 30 seconds.

The difference in scale and sample size between the two situations is about 10,000 to 1, and it is clear that, despite the fact that in both cases there is a calculated annual outage of 30 seconds, the two types of outage are in fact totally and radically different in nature and cannot be usefully combined or treated in a similar fashion.

Twenty outages per year, each averaging less than two seconds, and one outage of several hours occurring only once every five or six *centuries* simply have nothing in common with each other.

The point is that in such ultra-reliable cases, the propagation reliability and equipment reliability of microwave hops must be treated and described separately.

Annual outage remains a good way to describe the propagation reliability. Availability, or reliability in percent, is equally good. It would be useful, however, to include information about the number of events and their average duration, the annual outage being the product of the two.

For equipment reliability, two alternative methods seem to have some merit, though neither is entirely satisfactory.

One is simply to state the equivalent system MTBF as a parameter. In the case of ultra-reliable systems this is usually the redundant MTBF. Preferably the MTBF in hours should be divided by 8760 and the result stated in years, since it is easier to relate to the real world. A statement that the MTBF of a microwave hop is 570 years is likely to arouse some skepticism on the part of engineers familiar with electronic equipment; whereas, a statement that it is 5,000,000 hours might not have the same impact.

A second possibility would be to use this equivalent redundant MTBF to calculate the probability that the hop will operate without failure for a period of a year, using the standard reliability formula as given in Figure 7.

The expression  $R(t)$  gives the reliability function in the nomenclature used by reliability engineers; that is, the probability that the device under consideration will operate without failure for a time  $t$ .

Summing up, the equipment reliability calculations, in situations of this type, are really saying that there is a very high probability that the outage due to equipment in any year will be zero, but if such an outage does occur, it will be very long (comparatively) and will probably use up the allocated outage time for hundreds, perhaps thousands of years.

This poses the very serious problem that if—as is very likely to happen—equipment reliability prognostications, showing average per-hop outages of seconds, or even a few minutes, per year, somehow get turned into specification requirements (rather than just calculations or estimates), the supplier is faced with the awesome realization



$$R(t) = e^{-t/MTBF}$$

Which for a  $t$  of 8760 hours and MTBF of 5,000,000 hours comes to 99.825%.

For MTBF of 1,000,000 hours,  $R$  comes to 99.124%.

Figure 7

that the only way he can meet such a specification at all, over any time period of interest—even the entire life of the equipment in some cases—is to have zero outages due to equipment.

Another serious—though perhaps less apparent—problem is that there is no evident way to make any realistic evaluation of the relative worth of simply changing the odds that there will or will not be an outage. For example, suppose one has a hop with a predicted probability of one outage every 100 years. How much would it be worth to reduce the outage probability to one every 600 years? In either case any outage in a year, or even over the life of the equipment, is highly unlikely, and in either case, if an outage does occur, its length will be the same—the  $X$  hours it takes to repair and restore the equipment.

The limitation discussed here is a basic one which does not depend at all

on the validity of the assumptions or the calculations. It results simply from three things: microwave systems distributed over wide geographical areas; repeater stations (and often terminals as well) operated on an unattended basis; and outages due to equipment failure (unlike those due to propagation) requiring human intervention to restore and consequently, in general, requiring a rather large block of outage time associated with any outage event.

Regardless of the means used to describe it, there seems to be a parameter, with respect to equipment outages, which describes a situation that cannot exist in the real world, cannot be measured, and to which it is difficult to assign any economic or monetary value.

A further consideration is that the models customarily used in making equipment MTBF calculations consider only those outages or failures caused by chance, random failure of individual components for which no cause can be determined, and thus exclude most of the failures which occur in real systems—for example, failures due to human error in the design, the manufacture, the installation, the operation, and the maintenance areas; “early” or burn-in failures; wear-out failures; or unusual stress situations affecting both sides of a redundant system. Therefore, it is apparent that such *a priori* equipment reliability calculations should be treated with considerable caution.

**LENKURT ELECTRIC CO., INC.**  
SAN CARLOS, CALIFORNIA 94070

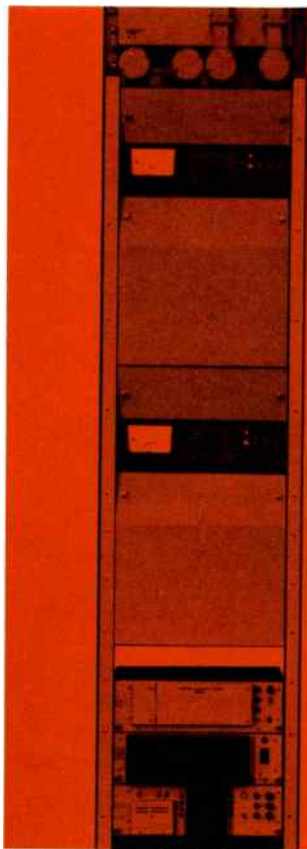

## Now 1800 Channels

Lenkurt's 75 Microwave Radio Systems are all members of a complete microwave radio family designed for point-to-point communication of message, data, and video. The 75 Systems are backbone systems designed expressly for high message capacity—up to 1800 channels or a video signal; and will operate efficiently on routes stretching 2,000 miles or more. For more information, write Lenkurt, Department C134.

***LENKURT ELECTRIC***

GENERAL TELEPHONE & ELECTRONICS

SAN CARLOS, CALIFORNIA, U.S.A.

**VIDEO, VOICE & DATA  
TRANSMISSION SYSTEMS**

**Lenkurt Offices**

San Carlos  
Atlanta  
Falls Church, Va.

Chicago  
Dallas

The Lenkurt Demodulator is circulated monthly to technicians, engineers and managers employed by companies or government agencies who use and operate communications systems, and to educational institutions. Permission to reprint granted on request.

World Radio History

**The**  
*Lenkurt.*

SEPTEMBER 1970

# DEMODULATOR

high speed  
data  
transmission

The large volume of data being transmitted today is relatively small compared to what is forecast for the future. Low-speed data is well understood and will undoubtedly handle a major portion of this future growth. However, the problems associated with high speed data transmission must be more fully understood before its potential can be achieved.

The use of higher data transmission speeds means a complete re-evaluation of transmission methods. But, just as computer technology has advanced from its first days of struggle, so too will the communications industry provide a wide range of reliable data transmission services and equipment. Since there are as many possible ways of transmitting data as there are types of communication channels, the challenge is to determine the best scheme for a particular application.

Using data transmission speeds of 2400 bits/second and higher, large volumes of data can be handled, but situations are also encountered which require thorough compensation techniques to reduce errors and provide high reliability. Ordinary circuit disturbances, normally disregarded by the human ear, must now be taken into account, because transmission impairments can seriously interfere with the discrete levels and frequencies associated with high-speed data transmission.

How are data signals affected by high-speed transmission?

### Effect on Data

When a tone or carrier is keyed rapidly by data pulses, sideband frequencies are created. These sidebands carry all the information conveyed by the pulse. Therefore, shifting these sidebands in relative amplitude (atten-

uation) or position (delay) causes errors in pulse reconstruction.

As data keying rates increase, the sidebands are more widely spread in frequency and the maximum pulse duration is reduced. The extra frequency range of the sidebands moves them to band-edge frequencies of increased delay and attenuation, thus reducing the chances of the pulse being reconstructed accurately at the receiver. With shorter pulse durations, slight shifts in time have a greater effect in degrading the pulse and increasing the possibility of losing it.

Both attenuation distortion and delay distortion have been recognized and successfully corrected for years through the use of equalizers. What, then, makes them so interesting now? The answer is that the old standards of equalization are not good enough for the current high data rates. These high rates demand greater usable band width. And further, they require equalization that is tailored to the particular circuit in use during any one random connection. This is beyond the capability of fixed equalizers.

Considerable research has resulted in the development of equalizers that change their characteristics automatically to fit those of the communications channel. Lenkurt, among others, has developed such an adaptive equalizer for digital signals. Lenkurt's equalizer contains a miniature special-

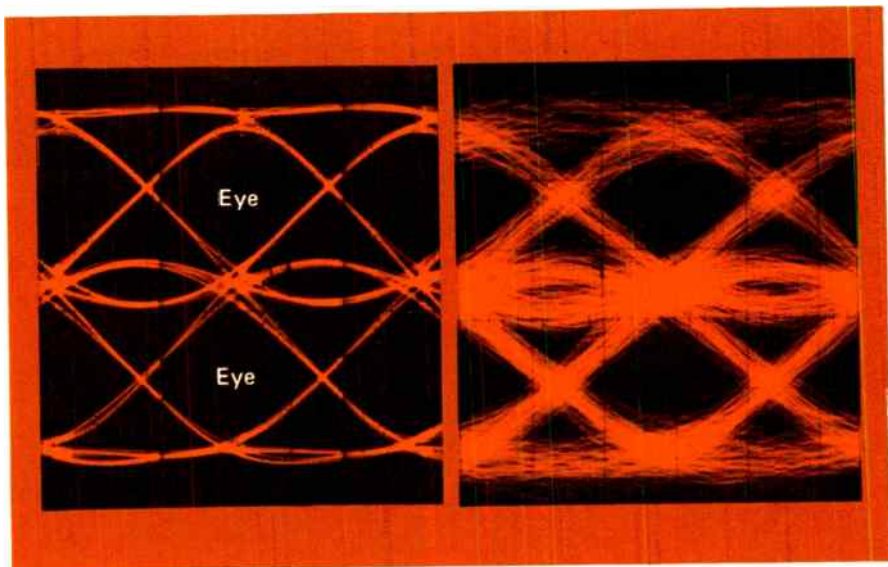

Figure 1. Eye patterns are used to measure the channel's overall performance. The pattern on the left represents a well-equalized duobinary signal, while the right pattern represents a slightly impaired duobinary signal.

purpose computer which adjusts signals to compensate for rapidly changing loss and delay characteristics. Such an equalizer is expected to permit previously unattainable reliability at data transmission rates as high as 9,600 bits/second.

When trying to determine the quality of a data channel, it is imperative to look at the total effect of all transmission impairments. For example, delay and attenuation distortion may be low, but if there are other distortions, the channel may not be satisfactory for data transmission. The eye pattern shown in Figure 1 is often used to determine overall channel quality, because any distortion will tend to close the eye – the larger the opening the better the channel.

Foremost on the list of transmission impairments is *attenuation distortion*, in which the fixed magnitude

relationships of the various frequency components of any information-carrying signal are disturbed.

### Attenuation Distortion

In an ideal communications channel, all frequency components of the signal experience the same attenuation. In other words, the channel has a flat, loss-frequency response from end to end. Such an ideal channel unfortunately does not exist; therefore, some frequencies are attenuated more than others – resulting in attenuation distortion (see Figure 2).

Attenuation distortion most commonly appears as band-edge roll-off. The causes of this distortion include capacitive and inductive reactances, filters in carrier systems, loaded cable that acts as a lowpass filter, and transformers and series capacitors that act as highpass filters.

Channel design can compensate for a reasonable amount of attenuation distortion. Additionally, linear compensating networks can be constructed to equalize attenuation to some degree. Such networks operate by introducing more loss into the low-loss portions of the band to smooth the channel's attenuation characteristic. However, if the loss variation is great, there may be difficulties in equalizing the high-loss part of the band. Consequently, a limitation on useful bandwidth and signal rates occurs.

Compromise equalization is quite effective against band-edge roll-off because all channels experience a somewhat similar roll-off, regardless of how a channel selection is made through a switched network. Thus, an equalizer can be adjusted to compensate for typical roll-off characteristics. The resulting equalized response will not, however, be exact for every circuit connection, but will generally extend throughout the usable bandwidth.

## Delay Distortion

While attenuation distortion disturbs the relative magnitude of the various frequency components in a transmitted signal, *delay distortion* upsets the time relationship between these components. This condition is manifested by some frequency components being delayed more than others during transmission.

A voice circuit acts like a bandpass filter. As the filter cutoff frequency is approached, delay distortion increases rapidly. This delay is produced by the inductive and capacitive reactances in the system; the various inductances and capacitances require a finite time to charge up and then discharge in response to a signal.

Such delay is not objectionable if it is constant for each signal frequency, in which case, all the components of

the signal are then delayed by similar amounts. However, if the delay varies with frequency, the components are delayed by unequal amounts and the data pulse shape becomes distorted. In a typical voice channel, the frequency of minimum delay is approximately 1700 Hz, with the relative delay symmetric about this frequency for carrier systems.

As in the case of attenuation distortion, delay distortion can be reduced by adding delay to selected portions of the transmission band. Ideally, delay equalizers should modify the delay characteristic without appreciably changing the loss. As shown in Figure 3, a properly selected equalizer can produce nearly uniform delay across a limited band without affecting the selectivity of the filters responsible for this type of delay distortion.

## Noise

Another detriment to error-free data transmission is noise. It is generally classified into two types. One type is often called simply *noise*, or sometimes *white noise* – implying that it is distributed uniformly throughout the frequency band of interest; the other type is *impulse noise*. White noise is the background “hiss,” composed largely of thermal noise occasionally noticeable on voice connections. This kind of noise interferes with speech much more than it does with data. The pulsed nature of digital data transmission makes it possible to avoid impairment by setting the amplitude above the background noise level.

It is primarily impulse noise that causes trouble in data transmission. Impulse noise takes the form of sharp clicks or bursts of energy arising from such sources as electrical storms or other electrical systems. Figure 4 illustrates the effect of impulse noise on data signals.

Figure 2. The attenuation characteristic of a telephone channel will assume this general form. The values of  $F_1$ ,  $F_2$ , and  $F_3$  are a function of the type channel used.

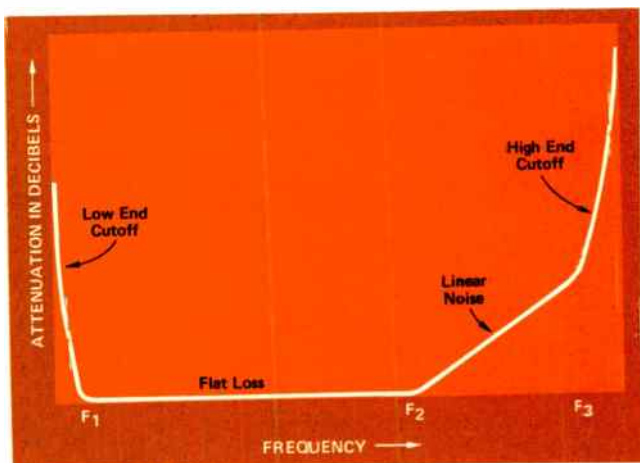
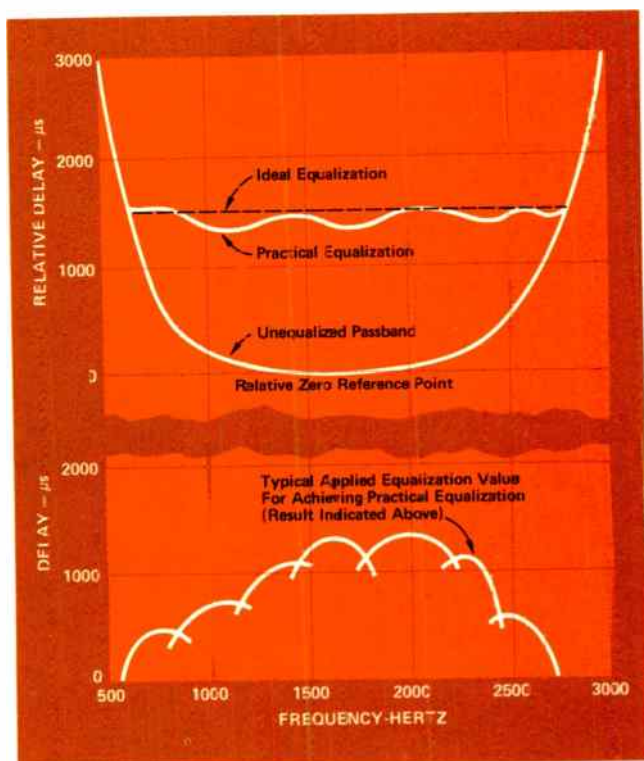

Figure 3. Equalization is provided by adding delay at specified points in the passband.



A large portion of impulse noise comes from switching and signaling equipment, power sources, and other electrical systems. Often these noise spikes have such a short duration that the human ear, with its slow response time, does not hear them. But, data transmission equipment can "hear" them. To a receiver, an impulse spike may "sound" like a data pulse, or cause severe distortion of an actual data pulse.

Here again, the effect is more pronounced in high-speed transmission, when data pulses are of shorter duration and more nearly approximate the duration of noise impulses. Furthermore, a prolonged burst of impulse noise can obliterate more pulses at high speed than at low speed.

Electronic switching systems presently being developed are expected to reduce one prevalent source of impulse noise.

Crosstalk caused by coupling between channels is another form of noise interference on data channels.

### Phase Jitter

With the coming of higher data transmission speeds, certain other types of transmission impairments have become more apparent. They are not really new, but have had little effect at low speeds.

For example, the term *phase jitter* was rarely heard in communication circles a few years ago. However, it is now a matter of concern to the industry because it is more critical at data speeds above 2400 bits/second.

Phase jitter causes a pure tone to have an associated FM spectrum at the output of a transmission system. In some cases this spectrum is random, similar to the noise associated with carrier generation. At other times, phase jitter takes the form of discrete spectral lines — often multiples and

submultiples of AC power frequencies — caused by coupling through power supplies or from power-line-associated equipment such as ringing generators. Industry guidelines for allowable phase jitter are in a transitional stage.

### Other Impairments

A great many minor problems can cause momentary disturbances, or *hits*, on data transmission channels. Individually, they may be only annoying. Collectively, they can seriously increase error rates.

Faulty amplifier components, switching of broadband facilities, and operation and maintenance errors on communication channels can cause sudden changes in signal amplitude. These changes are rarely more than 6 dB, but this is severe enough to disturb some AM data transmission.

Sudden phase changes cause amplitude transients when the signal returns to steady state. These phase changes can result from the switching of out-of-phase carrier supplies or the substitution of a broadband facility having a different propagation time.

Accidents, storms, construction work, or maintenance activity can cause a short-duration signal loss. Such a loss, when it occurs during data transmission is called a *dropout*.

### The Outlook

From the viewpoint of transmission quality, the demands for increased data speed and reliability could possibly be met best by building an entirely new world-wide network using special channels designed or conditioned specifically for data. This would mean working with costly, state-of-the-art equipment developed by the existing telecommunications industry. These special high-speed data transmission networks are already being planned. However, many of the



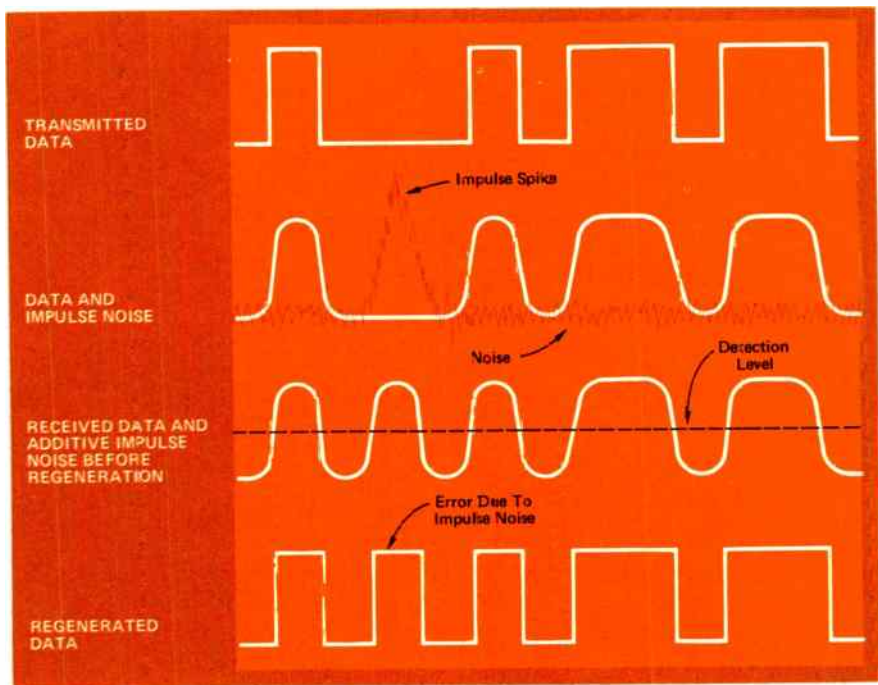

Figure 4. Data transmission is relatively unaffected by noise below the signal detection level; therefore, errors are quite likely to be caused by impulse noise, while white noise has little effect on the signal.

same transmission problems may be present in these new networks as well.

The switched telephone network has availability and flexibility in its favor. It can provide almost instant communication to any location that has a telephone. For some point-to-point data transmission applications, dedicated channels seem to offer the best solution. However, the inherent flexibility of switched networks means they will be called upon to carry more data in the future.

The result is increasing pressure for more stringent control of all the parameters that affect data transmission.

Rarely is one parameter a controlling factor, in data speed or reliability. Rather, it is a combination.

There is no shortcut to improving high-speed data transmission. The first step might be summed up as: more engineering attention to data when new facilities are being planned; the installation of equipment designed with data in mind; and more maintenance attention to data-transmission parameters. While these special high-speed systems are being improved, the existing low-speed systems will continue to handle the bulk of data transmission.

**LENKURT ELECTRIC CO., INC.**  
SAN CARLOS, CALIFORNIA 94070

This hardbound volume is an expanded, enlarged, and modernized version of an earlier Lenkurt publication, "Microwave Path Engineering Considerations 6000 - 8000 MC." This publication has assembled in a readily usable and practical form, the basic information, principles, techniques, and practices needed by an engineer in the planning and engineering of line-of-sight paths for microwave communications systems.

*Lenkurt*  
**ENGINEERING  
CONSIDERATIONS**  
for  
**MICROWAVE  
COMMUNICATIONS  
SYSTEMS**



Engineering Considerations For Microwave Communications Systems sells for \$10, postpaid, and \$15, postpaid for foreign addresses — write to Lenkurt, Dept. C134. (Make check or money order payable to Lenkurt Electric Co., Inc.)

***LENKURT ELECTRIC***

GENERAL TELEPHONE & ELECTRONICS

SAN CARLOS, CALIFORNIA, U.S.A.

**VIDEO, VOICE & DATA  
TRANSMISSION SYSTEMS**

**Lenkurt Offices**

San Carlos  
Atlanta  
Falls Church, Va.  
Chicago  
Dallas

The Lenkurt Demodulator is circulated monthly to technicians, engineers and managers employed by companies or government agencies who use and operate communications systems, and to educational institutions. Permission to reprint granted on request.

World Radio History

The  
*Leakert.*

OCTOBER 1999

# DEMODULATOR

**communications**

**yardsticks**

A yardstick is a measure of a system's quality, quantity, and performance. The often requested discussion of logarithmic units used to measure the quality of transmission systems is reprinted here with the addition of the metric units used internationally to measure absolute quantities. The results of the Demodulator survey are also being published at this time as a measure of performance.

**D**escriptive terms used in the telecommunications industry range from the infinitesimal –  $1/1,000,000,000,000$  watts/cm<sup>2</sup> the power rating for conversational speech – to the enormous – 6,000,000,000 hertz, the frequency of a typical microwave radio. Such a span would be unwieldy if simplifying expressions had not been established.

### Powers of Ten

The first step to simplicity is a shorthand notation which expresses numbers as powers of ten. We know that  $10 \times 10 = 100$  can be written  $10^2$ . Likewise,  $10 \times 10 \times 10 = 1000$ , or  $10^3$ . By definition, an exponent of three means the number 10 is used as a multiplier three times. A frequency of 6,000,000,000 hertz then becomes  $6 \times 10^9$  hertz (6 GHz).

Note that  $10^1 = 10$  and  $10^0 = 1$ . Numbers smaller than one can also be treated using powers of ten. By definition,  $10^{-1}$  is the same as  $1/10^1$ , or  $1/10$ . In this way, the power rating for typical conversational speech,  $1/1,000,000,000,000$  watts/cm<sup>2</sup>, can be written  $10^{-12}$  watts/cm<sup>2</sup>.

When discussing two relative values, it is sometimes convenient to use the term *orders of magnitude*. This is another way of expressing powers of ten. That is, one order of magnitude ( $10^1$ ) is 10 times as much, two orders of magnitude ( $10^2$ ) is 100 times as great, etc. Simple division indicates that a supersonic plane flying 1500 miles per hour (2500 km per hour) is 100 times faster than a man jogging at 15 miles per hour (25 km per hour). So, it can be said that the plane is two orders of magnitude faster than the man. Notice that orders of magnitude are really concerned with the exponent of the number.

### Logarithms

All the numbers in these examples use the same "base" number of ten. If we treat the exponent of the base number separately, another useful shorthand is achieved, called *logarithms*. In  $100 = 10^2$ , the logarithm of 100 is two. That is, the common logarithm (abbreviated  $\log_{10}$ , or just  $\log$ ) is the power to which the base ten must be raised to produce the number. The written form is  $\log 100 = 2$ .

The use of logarithms simplifies many forms of complicated calculations. Remember that to multiply like numbers (the number ten is used here to relate to common logs), it is only necessary to *add* their exponents ( $10^2 \times 10^3 = 10^5$ ); to divide, subtract exponents ( $10^5 \div 10^3 = 10^2$ ). Logarithms are used in the same way. Multiplications and divisions involving large numbers may be carried out by adding or subtracting the corresponding logs. In fact, any series of events involving multiplication or division, if expressed logarithmically may be handled by addition or subtraction. This is particularly valuable in the telecommunications industry, where a variety of measurements are necessary to describe the qualities of a signal as it passes through the system. Voltages, currents, and powers are measured; noise identified; and losses assessed. These are all made easier by the use of the logarithmic yardstick.

### Decibels

The basic logarithmic yardstick in communications is the decibel, derived from the less practical unit, the bel, named in honor of Alexander Graham Bell. A decibel is a tenth of a bel.

Early experimentation proved that a listener cannot give a reliable estimate of the absolute loudness of a sound. But, he can distinguish between the loudness of two different sounds. However, the ear's sensitivity to a change in sound power follows a logarithmic rather than a linear scale, and the decibel, dB, has become the unit of measure of this change. The relationship between any two power values can be calculated in decibels as:

$$dB = 10 \log \frac{P_1}{P_2}$$

If  $P_2$  is larger than  $P_1$ , the dB value will be negative; therefore, it is convenient to designate  $P_1$  as the larger power.

It should be emphasized that a given number of decibels is always the relationship between two powers, and not the absolute power value itself (Figure 1). For example, the gain in an amplifier, or the attenuation of a pad, can be expressed in decibels without knowledge of the input or output power of the device — just the change.

Decibels	Power Ratio
1	1.259
2	1.585
3	1.995
4	2.512
5	3.162
6	3.981
7	5.012
8	6.310
9	7.943
10	10.0
20	100.0
30	1000.0
40	10,000.0

Figure 1. Decibels and power ratios are related on a logarithmic basis.

### dBm

Frequently, however, it is convenient to represent *absolute* power with a logarithmic unit. One milliwatt is generally accepted as the standard reference for such purposes in the telephone industry, and signal powers can be written as being so many dB above or below this reference power. When this is done, the unit becomes dBm, in the expression:

$$dBm = 10 \log \frac{P_1}{P_2}$$

where  $P_2$  is one milliwatt ( $10^{-3}$  watts).

By adding a definite reference point, dBm becomes a measurement of absolute power, rather than just a ratio, and can readily be converted to watts. A measurement of 10 dBm indicates a signal ten times greater than 1 milliwatt, or 10 milliwatts; 20 dBm is 100 times greater than 1 milliwatt, or 100 milliwatts. A 15-dBm signal applied to an amplifier with a 10-dB gain will result in a 25-dBm output. Or, a standard test tone (0 dBm) will be measured as -15 dBm after passing through an attenuator of 15 dB.

It is important to note at this point that most meters used in the telephone industry are calibrated for measurements of voltage appearing across a 600-ohm termination (standard transmission line impedance). If the circuit to be measured is of a different impedance than that for which the meter was calibrated, the indicated power level will be wrong, and a correction factor must be taken into account. Using the relationship of  $P = E^2/R$ , the following correction factor is formulated:

$$dB = dB(\text{indicated}) + 10 \log \frac{600 \text{ ohms}}{\text{circuit impedance}}$$

For example, a +6-dB reading across a 500-ohm line is calculated:

$$\begin{aligned} dB &= 6 + 10 \log \frac{600}{500} \\ &= 6 + 10 \log 1.2 \\ &= 6 + 0.792 \\ &= 6.792 \text{ dB.} \end{aligned}$$

## Level Point

In most telephone systems, the toll switchboard is defined as the Zero Transmission Level Point (0 TLP), and the levels of both signal and noise at other parts of the system are usually referred to that point. A point in the transmission system where a signal has experienced a 16-dB attenuation relative to the toll switchboard is known as the -16-dB level point. Note that *level* used this way is purely relative and has nothing to do with actual power — a signal of any power will be down 16 dB at the -16-dB level point. When a standard test tone is transmitted over the circuit, its power in dBm at any point is numerically equal to the level in dB at that point.

## dBm0

Another term, dBm0, is used to refer measured power back to 0 TLP, and has useful significance in system planning. Measurements adjusted to dBm0 indicate what the power would have been, had it been measured at 0 TLP. For example, a tone measured at the -16-dB level point with a meter reading of +8 dBm, is equal to +24 dBm0.

In addition to dBm, there are a number of other logarithmic units used in the telephone industry which are expressed as dB above or below some reference power. One of the most common of these is dBnc, used in the measurement of noise.

## Noise Measurement

The Bell Telephone Laboratories and the Edison Electrical Institute did original research to determine the transmission impairment caused by noise interfering with speech. A large number of listening tests were made with different tones introduced as interference. The degree of interfer-

ence was determined by comparing the power of each interfering tone with the power of a 1-kHz tone that created the same degree of interference.

A power of  $10^{-12}$  watts, or -90 dBm, was selected as the reference power because it was found that a 1-kHz tone at this power has a negligible interfering effect. Any noise power encountered that was greater than this could be given a positive value in dB above reference noise, or dBrn.

These first measurements were made with the deskstand-type telephone offered in the 1920's, known as the Western Electric Type 144. From these measurements, curves were plotted - called weighting curves.

### **dBa**

Later, an improved handset, Western Electric type 300, (F1A weighting) came into general use, exhibiting a more uniform frequency response. Listener tests indicate that the new instrument gave approximately 5-dB improvement over the 144. Rather than change existing standards, a new reference noise power of -85 dBm ( $3.16 \times 10^{-12}$  watts) was introduced. This also necessitated a change in the units, resulting in the adoption of dBa - decibels adjusted.

### **dBrnc**

When the new 500 type handset was put into service in the 1950's, another line weighting was introduced, called C-message weighting. Since the new equipment was an improvement over the old, an even higher reference power would have been required to express equal interfering effects with equal numbers. But this might have resulted in some unrealistic "negative" values of noise interference. So the reference power was returned to -90

dBm, and the units dBrnc - decibels, reference noise C-message weighted.

Weighting curves (Figure 2) for each handset compare interfering effects for various frequencies and are referred to an interference of 1 kHz. Noise measuring sets are frequency weighted in the same way so that meter readings obtained are meaningful in terms of what the ear detects. That is, the instrument does not measure noise intensity alone, but takes into account the frequency of the noise and how the particular frequency affects the ear.

Since there is no weighting effect on a 1-kHz tone, straightforward conversion between dBa and dBrnc is possible by comparing reference power. A 1-kHz signal having a power of 0 dBm yields 90 dBrnc. But, because weighting networks attenuate other frequencies differently, a uniform 3-kHz band of noise (flat or white noise) will not be measured the same as a 1-kHz tone. White noise at 0 dBm will produce a noise reading of 82 dBa and 88 dBrnc. Approximate conversion is then accomplished by adding 6 dB to the dBa value:

$$dBrnc = dBa + 6.$$

For instance, using an instrument F1A weighted, a reading of 20 dBa would be equivalent to 26 dBrnc. The conversion factor is due to the 5-dB difference in noise reference power and an approximate 1-dB difference in weighting over the voice band.

At the present, dBrnc is more convenient to use than dBa.

### **Psophometric Weighting**

Circuit noise expressed in units established by the CCITT (International Telegraph and Telephone Consultative Committee) is gaining

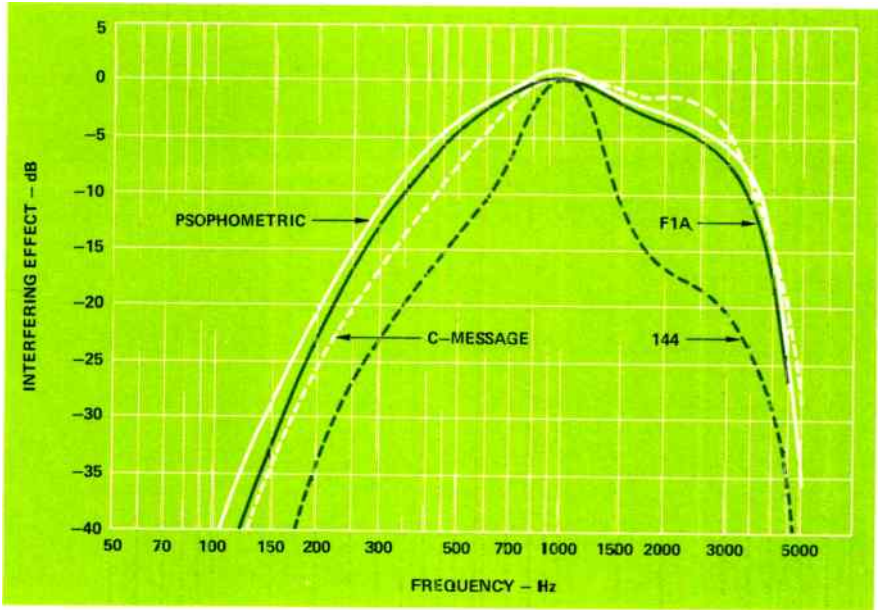

Figure 2. Weighting curves, based on listener response, show the relative interfering effect of noise on speech. All curves are referred to 1000 Hz except psophometric, which is based on measurements at 800 Hz.

recognition throughout the world. This international unit is linear rather than logarithmic and is in terms of picowatts ( $10^{-12}$  watts) of power, psophometrically weighted — pWp. (Psophometric is from the Greek word psophos, meaning noise.)

The reference level, 1 pWp, is the equivalent of an 800-Hz tone with a power of  $-90$  dBm, or a 3-kHz band of white noise with a power of approximately  $-88$  dBm. The shape of the psophometric curve is essentially identical to the F1A curve and similar to the C-message curve. Approximate conversion may be made as follows:

$$dBrc = 10 \log pWp.$$

Note that these terms all have absolute reference values of  $10^{-12}$  watts, and

are customarily written dBrc0 and pWp0 to relate the measurement to 0 TLP.

### Signal-to-Noise

Occasionally the term signal-to-noise ratio ( $S/N$ ) is encountered. The term, usually expressed in dB, indicates the number of dB the signal is above the noise. To obtain dBrc0 from  $S/N$ , it is only necessary to calculate how many dB the signal is above the reference noise power. The corrected reference (as mentioned previously for 3-kHz white noise) is  $-88$  dBm for flat noise channels. Conversions are therefore:

$$dBrc0 = 88 - S/N$$

$$S/N = 88 - dBrc0$$

$$S/N = 88 - 10 \log pWp0.$$



When it is necessary to measure speech or program volume in a transmission system, a dB meter or voltmeter is not adequate. The complexity of the program signal, as compared to pure sine waves, will cause the meter needle to move erratically, trying to follow every fluctuation in power. This would obviously be difficult to read, and has no worthwhile meaning.

## Volume Units

To provide a standardized system of indicating volume, a special instrument was created. Called a VU meter, it measures *volume units*, abbreviated VU. The VU meter is calibrated to read 0 VU across a 600-ohm line with a signal of 1 milliwatt (0 dB) at 1 kHz. The scale is logarithmic and reads VU above and below this zero reference. The instrument is not frequency weighted in any way, and while not designated for the purpose, it will read single frequencies directly in dBm. Its prime function, however, is to indicate the volume of complex signals in a way corresponding to the response of the ear. The reading is not instantaneous, but a value somewhere between the average and the peak value of the complex wave due to the meter's damping characteristic.

## Other Units

Various other logarithmic units are used in the telephone and communications industries to conveniently compare like values. Crosstalk coupling in telephone circuits is indicated in dBx, or dB above reference coupling, and may be measured with a noise measuring set such as used to obtain dBrc. Reference coupling is defined as the difference between 90 dB loss and the actual coupling. Two circuits having a coupling of -40 dB could be said to have a coupling of 50 dBx.

Decibels may take on many other absolute values depending on their reference. Whereas dBm is a unit of power referenced to 1 milliwatt, dBw (referenced to one watt) is equal to 30 dBm. Similarly, dBk are decibels referenced to 1 kilowatt.

Likewise, dBv for industrial use is defined referencing 1 volt. However, in writing the equation for such a measurement, it is necessary to observe the following relationship:

$$dBv = 20 \log \frac{E_1}{E_2}$$

where  $E_2$  equals one volt. The log of the voltage ratios is multiplied by 20, rather than 10 as in the power ratios, expressing the squared relationship of voltage and power ( $P = E^2/R$ ). It is assumed that all measurements are across the same impedance.

Another form of decibel unit related to voltage is referred to as dBv/600 and is read directly from a dBm-voltmeter calibrated at an impedance of 600 ohms.

Speech energy is commonly rated in terms of the intensity level of the speaker's voice measured 1 meter from his mouth. The standard Reference Acoustical Power, 0 dBrap, is defined as  $10^{-16}$  watts/cm<sup>2</sup>.

Other terms come into use in broadcasting: dBu, with 1 microvolt ( $10^{-6}$  volts) as the reference, and dBj, referred to 1000 microvolts ( $10^{-3}$  volts). Both are measurements of signal intensity or receiver sensitivity. Any number of logarithmic units could be devised to suit special purposes, using decibels referred to some standard unit of power - voltage or current.

As the need for different calibrations and reference points arise, new yardsticks will be defined for ease of calculation.

Measure	SI Unit	Derived Units
Length	meter (m)	area -- (m <sup>2</sup> ) volume -- (m <sup>3</sup> )
Time	second (s)	frequency -- hertz (H)
Mass	kilogram (kg)	
Temperature	kelvin (K)	
Electric Current	ampere (a)	

Figure 3.

Prefix	Symbol	Multiplier
tera	T	1,000,000,000,000 = 10 <sup>12</sup>
giga	G	1,000,000,000 = 10 <sup>9</sup>
mega	M	1,000,000 = 10 <sup>6</sup>
kilo	k	1,000 = 10 <sup>3</sup>
hecto	h	100 = 10 <sup>2</sup>
deka	da	10 = 10 <sup>1</sup>
deci	d	0.1 = 10 <sup>-1</sup>
centi	c	0.01 = 10 <sup>-2</sup>
milli	m	0.001 = 10 <sup>-3</sup>
micro	μ	0.000 001 = 10 <sup>-6</sup>
nano	n	0.000 000 001 = 10 <sup>-9</sup>
pico	p	0.000 000 000 001 = 10 <sup>-12</sup>
femto	f	0.000 000 000 000 001 = 10 <sup>-15</sup>
atto	a	0.000 000 000 000 000 001 = 10 <sup>-18</sup>

Figure 4.

### Conversion Factors

inches x 25.4	= millimeters
feet x 0.3048	= meters
miles x 1.61	= kilometers
pounds x 0.454	= kilograms
millimeters x .0394	= inches
meters x 3.28	= feet
kilometers x 0.621	= miles
kilograms x 2.21	= pounds

Figure 5.

### Absolute Quantity

The yardstick adopted by the communications industry to measure absolute quantities is really a meterstick divided into centimeters instead of inches. The metric scale is part of the SI (international standards) units used to simplify and clarify numerical communication between countries.

The basic SI units and their abbreviations are shown in Figure 3. The prefixes shown in Figure 4 are added

to these basic units to indicate the magnitude.

Since some English units are still prevalent and at times more familiar, conversion factors are offered to ease the transition to SI units. Figure 5 gives conversion factors for the two systems.

The equipment needed to provide world-wide communication is available and by adopting SI units the needed language is also provided.

# Demodulator Survey Results

The Demodulator's performance was measured by the survey sent out in March. Four different readership areas were studied – who, where, what, and how.

The “who” distribution (Figure 6) closely correlates with the 1960 readership, except for a slight increase of readers in the manager and technician categories.

Although the job classifications did not change drastically, there was a marked change in “where” the readers are employed. An increased percentage of the readership is employed in areas with peripheral concern in the telephone industry and a more direct involvement with the broader concept of communications. Figure 7 shows the change in job classification over the 1960 distribution.

While the readers' job classifications may be blurring, the readers are definitive about “what” they want to read. Specific information about the newest forms of communication described in applied rather than theoretical terms is in greater demand than broad and general discussions of communications and systems design. The most popular topic was satellites (not in the 1960 survey). Figure 8 shows the total distribution compared with the 1960 results.

The greatest measure of performance was gained from the “how” section of the survey, in which a clear majority indicated preference for style, page size, and subject treatment as they are presently being handled.

The *Demodulator* is flexible and will change to stay abreast of technology and readership interests.

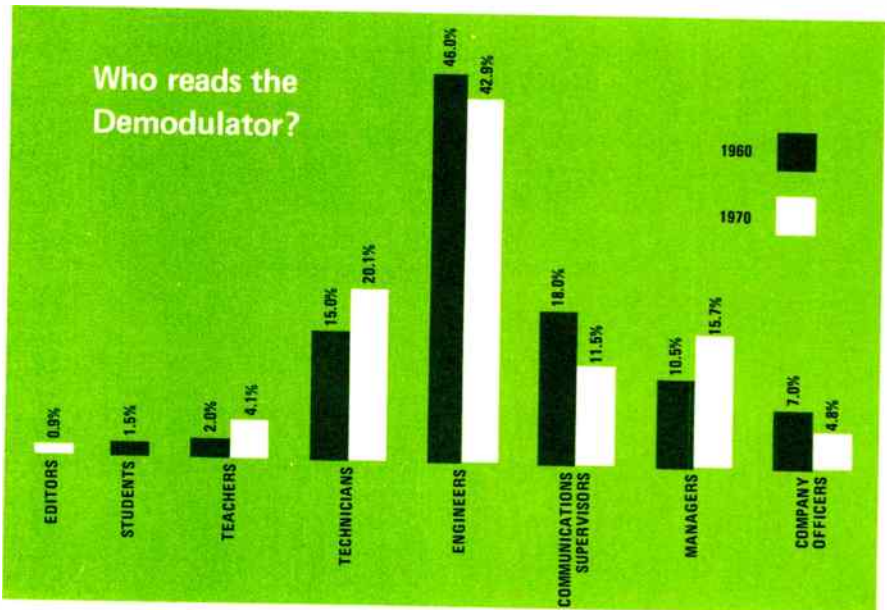

Figure 6.

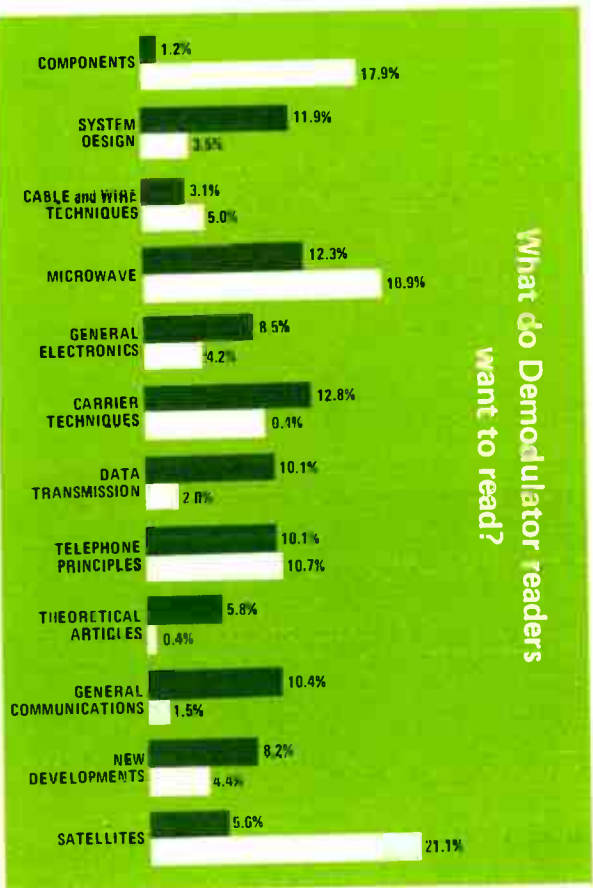

Figure 8.

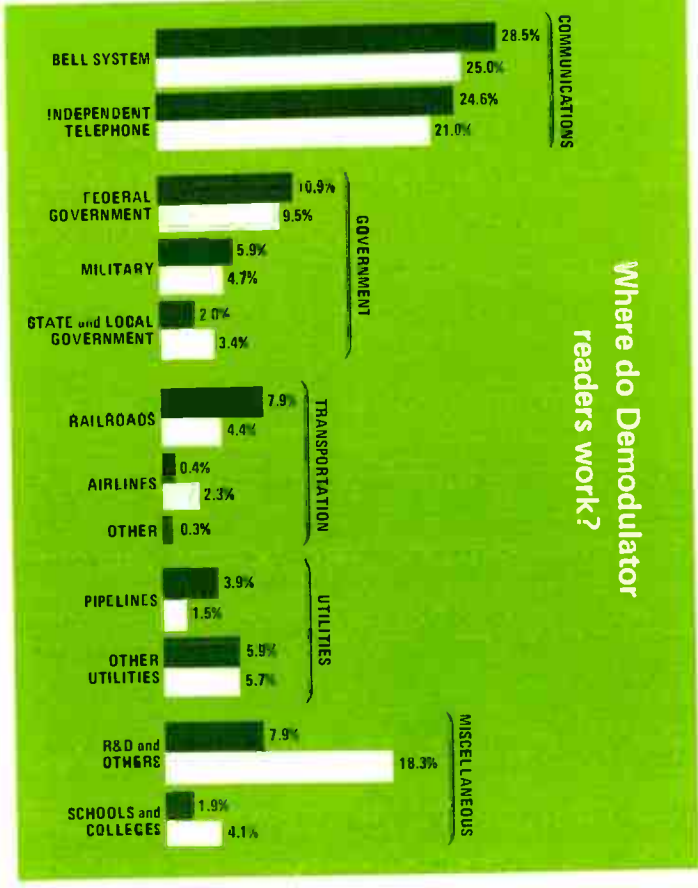
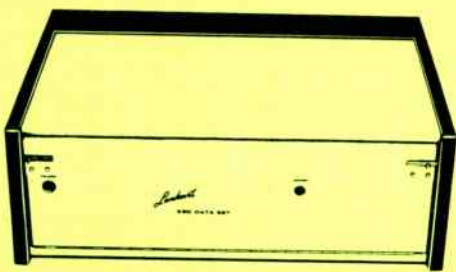

Figure 7.



## Our 4800 bit modem. The thing that makes it so cheap is the same thing that makes it so good.

### 4800 bits for \$3,325.

The secret is correlative coding (using our modified duobinary technique). It gives you an error rate of  $1 \times 10^{-6}$  at a signal-to-noise ratio of 20 dB. It gives you quick-polling (21.5 ms request-to-send / clear-to-send cycle). It gives you Automatic error detection (eliminating the need for redundant parity check bits). And it gives you a very low price tag, all at the same time.

Lenkurt invented correlative coding. That's why our 26D is the highest quality, most economical modem available for multipoint polled, CS line operation.

For \$3,325, the 26D offers: Simplex, duplex or half-duplex operation.

Transmit line equalizer.

Receive line equalizer.

Self-contained power supply.

Built-in test facilities.

Full compatibility with EIA, CCITT and MIL interface specs.

Optional equalization indicator (\$250 extra).

Or, for \$300 less, you can get the 26D without pre-equalization, for point-to-point applications.

And when one of our 25B modems is hooked up to the 26D you have a 150 bps secondary channel (for error control or low speed data) at no additional line cost.

Here's where you get them: Atlanta (404) 261-8282 /

Chicago (312) 263-1321 / Dallas (214) 363-0286 / Falls Church (703) 533-3344 / San Carlos (415) 591-8461.

Or write: Lenkurt Electric Co., Inc., Department C720, 1105 County Road, San Carlos, California 94070.

**LENKURT ELECTRIC**  
GENERAL TELEPHONE & ELECTRONICS

**Data Transmission Systems from Lenkurt**

# LENKURT ELECTRIC

GENERAL TELEPHONE & ELECTRONICS

SAN CARLOS, CALIFORNIA, U.S.A.

**VIDEO, VOICE & DATA  
TRANSMISSION SYSTEMS**

### Lenkurt Offices

San Carlos

Atlanta

Falls Church, Va.

Chicago

Dallas

The Lenkurt Demodulator is circulated monthly to technicians, engineers and managers employed by companies or government agencies who use and operate communications systems, and to educational institutions. Permission to reprint granted on request.

The *Lenkurt*

NOVEMBER 1970

# DEMODULATOR

crystal filters ◦ part one





**F**ilters have played such an important role in carrier communications that it is worth discussing their history and development, with an emphasis on crystal filters. The technique of carrier and multiplex system design points out the filter requirements and the need for certain types of filters.

Analogies are often used to describe filters, but comparing electronic filters to such things as a screen, a strainer, or a piece of paper used to separate solids and liquids may be misleading. A filter placed in an alternating current transmission path permits the free passage of certain frequencies and blocks others. The degree to which the filter blocks (attenuates) the signal is a function of the filter design and is measured in decibels.

## Resonance

The principle that allows a filter to discriminate between frequencies, passing some while rejecting others, is known as resonance. The reeds and strings of musical instruments exhibit this natural phenomenon of resonance — the desire to vibrate at a single frequency. Filter operation can be explained using the principle of resonance and the analogy of a child jumping rope. If the child is jumping at the same frequency that the rope is turning, the child can jump into, with, and out of the turning rope with little

Improved carrier design has followed closely on the heels of filter development. Crystal filter design has recently improved quality and reduced size of carrier and multiplex systems.

difficulty. If, on the other hand, the child is not jumping at the rope's frequency, there will be interference and the child will not be able to pass through the turning rope.

Perhaps this analogy belabors the point, but it is important to understand the relationship between resonance and filter operation. An ac signal at the resonant frequency of the filter will be passed through the filter and other frequencies will be attenuated. If this analogy were to hold exactly, the characteristic curve of such a filter would look like Figure 1.

Electronic filters, however, do not fit this single-frequency characteristic curve, but rather have varying degrees

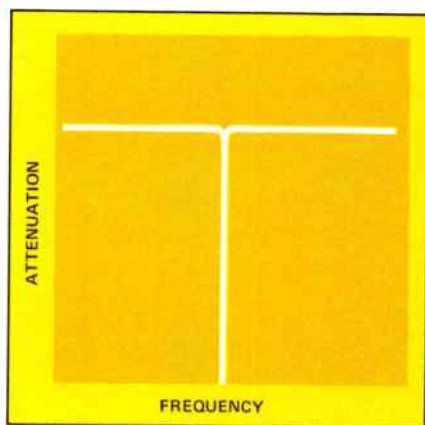

*Figure 1. A filter that blocks all except its resonant frequency would have a characteristic curve as shown.*



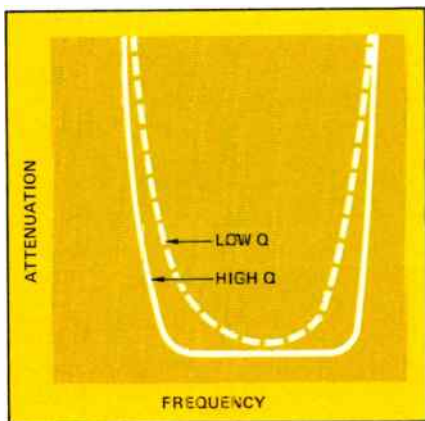

Figure 2. These curves show the passbands of the same filter made with resonators having different  $Q$  values. Note that high  $Q$  values must be used if the filter is to have a flat passband with sharp corners.

of sharpness, and actually pass a range of frequencies. This spreading of the pass region is a function of the filter resistance.

The term used in filter language to describe resonator sharpness is  $Q$ , which is inversely proportional to the resistance. High  $Q$ 's indicate low resistance, high efficiency, and the ability

of resonant circuits to obtain sharp, steep discrimination. Conversely, low  $Q$ 's indicate a lack of sharpness. Figure 2 shows what happens to the passband response of a filter built with either low  $Q$  or high  $Q$  resonators. The actual  $Q$  value required will be determined by the bandwidth of the filter and also by its approximate center frequency. For example a bandpass filter having a 4-kHz passband will require lower resonator  $Q$ 's to give the same flat passband if it is built at a center frequency of 10 kHz than if its center frequency is 10 MHz.

### Bandpass Filters

An interesting point worth remembering is that not all resonant circuits are considered to be filters; however, all filters are combinations of resonant circuits. The art of designing filters involves using a number of resonant elements properly coupled together so that zero attenuation is approximated at all frequencies in the desired passband and maximum attenuation is achieved at all other frequencies. Figure 3 shows a typical LC filter as a series of LC resonators.

The low  $Q$  of early LC filters motivated Lenkurt, and others, to devel-

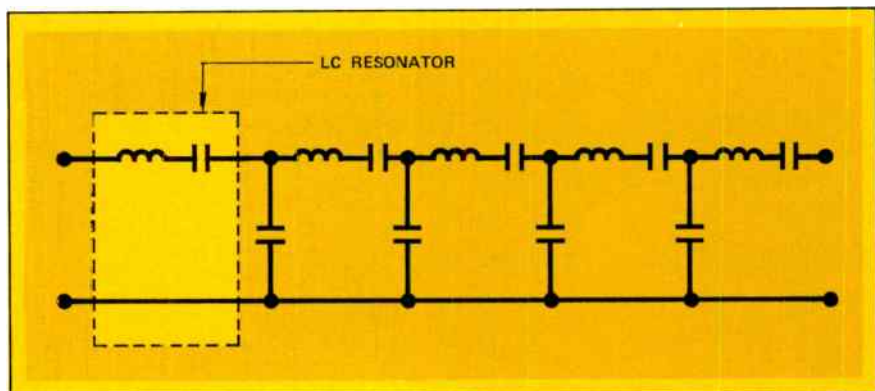

Figure 3. A typical LC filter is made up of a series of LC resonators.

op magnetic cores from powdered metals for low resistance inductors to improve LC filter sharpness. The rounded corners at the ends of the passband were eventually squared off by developing inductors with increasingly lower resistance ratings. It is still not possible to obtain stable inductors with  $Q$ 's much greater than 500. Therefore, the center frequency of an LC filter for a 4-kHz wide voice channel is confined to values less than 100 kHz.

### Early Crystal Filters

LC networks are not the only type filters capable of separating channels in carrier systems. Crystal filters are just as suitable and perform even better. Rather than using electrical components to form a resonant circuit, certain crystalline materials can be set in mechanical resonance by an electrical field. Such crystalline material is called piezoelectric and is such that mechanical vibrations can be excited in the crystal by ac signals.

A crystal resonator is simply a plate of piezoelectric material, usually quartz, with a metal electrode on each

side of the plate. If these two electrodes are connected to an alternating current, the crystal will try to vibrate at the signal's frequency. And, if the crystal has been cut to the proper dimensions, it will be set in resonance by the signal.

The passband for crystal filters has steep sides and square corners. This sharpness of a crystal filter is the result of the higher  $Q$ 's of the crystal resonators that comprise the filter.  $Q$ , the ratio of reactance to resistance, can be increased by lowering the resistance, as was done with early LC resonators, or by raising the effective reactance. A crystal resonator with the same resonant frequency as an LC resonator has essentially the same inherent resistance. But the effective inductance and capacitance of the crystal resonator differ in such a way that the reactance of the crystal resonator is much larger — resulting in a larger  $Q$ . Figure 4 shows typical values for an LC resonator and a crystal resonator designed for the same resonant frequency.

Crystal filters appear to be far superior to LC filters, yet crystal

	LC resonator	Crystal resonator
Frequency	10 MHz	10 MHz
Inductance	.01 mH	9.2 mH
Capacitance	25 pF	.028 pF
Resistance	4 ohms	3.8 ohms
$Q$	157	152,000

Figure 4. The table shows the equivalent values for an LC resonator and a crystal resonator operating in the same frequency range.

filters were not used in early carrier systems since performance is not the only criterion in filter selection. Since LC filters were improved to give satisfactory performance, the use of costly, bulky, high Q crystal filters could not be justified.

### Changing Requirements

Cost and size reduction are being stressed in this age of miniaturization. Therefore, the high cost and large size of low-frequency crystal filters make them even more unsuitable for miniaturized carrier equipment. But, for reasonable performance, at least at frequencies below several megahertz, inductors for LC filters also require a volume incompatible with present-day miniaturization.

The size of the quartz plates used in crystal resonators, and consequently, the filters themselves can be reduced by increasing the frequency at which the signal is filtered. The resonant frequency of a quartz plate is inversely proportional to the plate size; therefore, the smaller the plate, the higher the frequency. The upper limit on the resonant frequency of a crystal is determined by the smallest plate that can be easily handled and will not shatter at the resonant frequency.

From this it seemed logical that one way to reduce the size of crystal filters was to design a carrier system that filters higher frequencies — designing the carrier system around the filter. A small, inexpensive, high-frequency crystal filter had to be developed before the new carrier system could be designed.

Crystal size is the limiting factor in resonant frequencies but the mode of vibration is also a determining factor. The vibration mode — whether flexure, extensional, face shear, or thickness shear — is determined by the crystal cut.

### High-Frequency Filters

The cut considered for high-frequency crystal filters is the AT cut because it exhibits good frequency stability, as shown in Figure 5. The cut of the crystal determines the angle at which the plate (or wafer) is cut from the block of raw crystalline material and has nothing to do with the size of the crystal. Therefore, an AT cut crystal can come in a variety of sizes and consequently, a variety of resonant frequencies.

High-frequency AT cut crystals vibrate in a thickness shear mode. In this mode the surfaces under the electrodes move in opposite directions with both surfaces remaining parallel. Figure 6 illustrates the thickness shear mode of vibration.

In the thickness shear mode of vibration other modes and overtones of the fundamental resonant frequency can also be excited. In this case, experience has shown that rather than eliminating these unwanted modes and resonances, reduction of their intensity will accomplish the same results.

### Energy Trapping

As early as 1946, methods of eliminating unwanted modes of vibration were being studied. W. S. Mortley published an article in 1946 on his experimental observations of what has since become known as energy trapping. Mortley's theory was given little attention when it was first published. It was not until the early 1960's that his original work began to have relevance and was given the proper attention in crystal filter design.

Prior to Mortley's experimentation, unwanted modes of vibration were eliminated by thinning the crystal plate toward the edges. This had the effect of reducing the intensity of all modes except the desired thickness

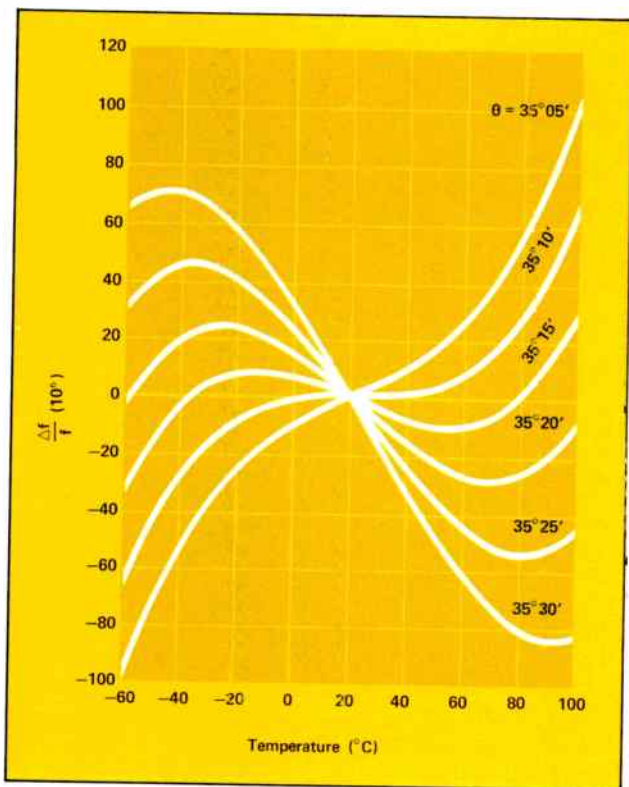

Figure 5. An AT cut crystal with an angle of  $35^{\circ} 10'$  has the best frequency stability.

shear mode. By reducing these unwanted modes, interference between them was avoided. This technique of thinning the crystal is known as shaping and works well in crystal resonators where there is an air-gap between the crystal plate and the electrodes. Mortley noticed, however, that shaping was not a successful technique for eliminating unwanted modes of vibration in crystals with deposited metal-film electrodes.

The reappearance of unwanted modes with deposited metal-film electrodes led Mortley to conduct some further experiments. From these he discovered that the intensity of some unwanted modes and also their frequency spacing with respect to the desired mode could be controlled by

the mass of metal in the film and the shape of the electrodes.

From these observations it was suggested that the same laws that apply to the propagation of electromagnetic waves apply equally well to the transmission of mechanical shear waves in quartz.

The comparison of mechanical shear waves in quartz to electromagnetic wave propagation was carried even further. The filter can be compared to a waveguide. Just as it is possible to have a high coefficient of reflection from the junction of waveguides differing slightly in dimensions, quartz crystal also reflects waves where the crystal changes shape. Therefore, by putting the proper step in the crystal in the direction of wave

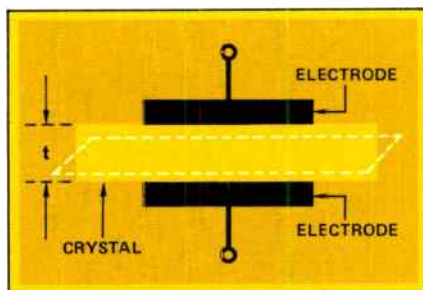

Figure 6. The dotted line shows the thickness shear mode of vibration in an AT cut crystal.

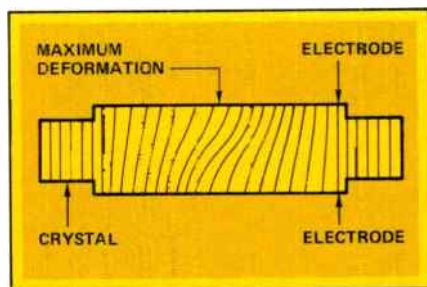

Figure 7. The shear waves are trapped in the thicker area under the electrodes.

propagation it is possible to trap the desired modes of vibration. Figure 7 shows the effect of dimensional changes on wave propagation.

For high-frequency filters, where the crystal is small and fragile, it is not practical to machine steps in the quartz. Crystal filters with metal-film electrodes deposited on a flat crystal plate have an inherent step. The metal-film on the outer surface of the crystal adds to the vibrating mass of the quartz plate, trapping the energy under the electrodes, because the boundary of the electrode acts like a dimensional step in the quartz plate. Those unwanted modes and resonances travel into the thinner unplated areas where they decay exponentially with distance.

Although Mortley had proposed this theory of energy trapping, the actual control of unwanted modes was more of an art than a science for many years after Mortley's paper. Bechmann in 1961 published a set of experimentally derived rules which give optimum

dimensional ratios for the crystal plate and the electrodes to suppress the unwanted modes. In 1963 Shockley, Curran, and Koneval formulated their theory of energy trapping which was essentially the same as Mortley's and which confirmed Bechmann's experimentally derived numbers.

### New Horizons

The theory of energy trapping has opened up a whole new area for high-frequency crystal filter design. This theory has led to the design of filters where multiple resonators are placed on a single quartz plate.

Crystal filter techniques have come a long way from the first high-cost, low-frequency, bulky designs rejected for carrier channel usage. Today multi-resonator crystal filters are responsible for reduced size and cost of improved carrier systems. These new multi-resonator crystal filters and their effect on carrier and multiplex system design will be the subject of the next DEMODULATOR.

LENKURT ELECTRIC CO., INC.  
SAN CARLOS, CALIFORNIA 94070

# Introducing Lenkurt's 2-GHz

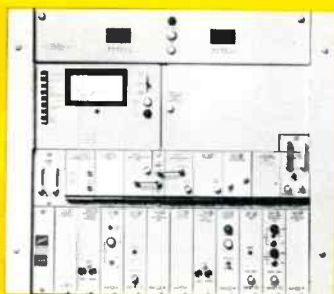
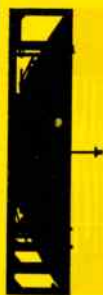

## Microwave Radio System

The 78F2 microwave radio, operating with up to 600 channels or a single video signal in the 1700 to 2300 MHz frequency band, is a 5-watt system providing space saving advantages and improved performance for common carrier, railroad, pipeline, electric utility, TV, and international applications. For additional information, write Lenkurt, Department C134.

***LENKURT ELECTRIC***

GENERAL TELEPHONE & ELECTRONICS

SAN CARLOS, CALIFORNIA, U.S.A.

**VIDEO, VOICE & DATA  
TRANSMISSION SYSTEMS**

**Lenkurt Offices**

San Carlos

Atlanta

Falls Church, Va.

Chicago

Dallas

The Lenkurt Demodulator is circulated monthly to technicians, engineers and managers employed by companies or government agencies who use and operate communications systems, and to educational institutions. Permission to reprint granted on request.

World Radio History

The *Penkurt*®

DECEMBER 1970

# DEMODULATOR

crystal filters ◦ part two



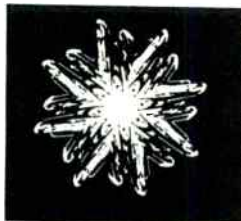

**Multi-electrode crystal resonators have substantially reduced the size and cost of crystal filters and offer improved design of multiplex systems.**

**I**n multiplex systems using LC channel filters, as much as 75 percent of the volume is taken up by the filters. Size reduction and improved performance are possible with the new technology of high-frequency crystal filters. The advent of filter size-reduction served as the impetus to further miniaturization such as the introduction of integrated circuits to produce an even smaller, more economical multiplex package.

Typical high-frequency crystal filters have as much as a 20:1 size reduction compared with LC filters for similar operations. In addition to the size reduction, crystal filters operate with greater stability over a wider range of temperatures than LC filters. Whereas LC channel filters were designed with a center frequency usually below 100 kHz, the optimum center frequency for low cost crystal filters is about 8 MHz. Multiplex systems can be designed to take advantage of the small size and high stability of these high-frequency crystal filters.

### **Coupled Crystal Resonators**

High-frequency crystal resonators use AT-cut quartz wafers that have metal-film electrodes plated on the surface of the wafer (see Figure 1). By applying the correct frequency signal to such a crystal resonator, the crystal will mechanically vibrate and electri-

cally behave like a resonant circuit. By coupling several such resonators together, it is possible to build a filter that has a suitable frequency response for operation as a bandpass filter. When each wafer contains a single electrode pair, the resonators are coupled electrically with shunt capacitors to form crystal filters.

Energy trapping is used to minimize the unwanted modes of vibration in high-frequency crystal resonators with plated metal-film electrodes. When the mass of the electrodes is large enough, the desired mechanical vibrations are

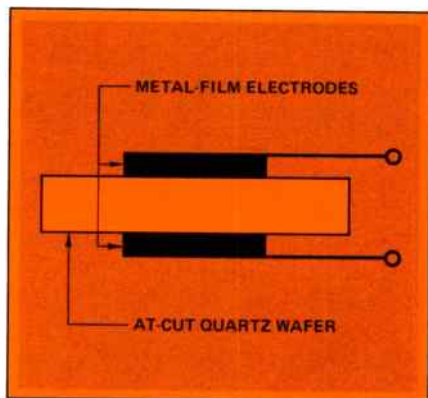

*Figure 1. High-frequency crystal resonators have metal-film electrodes plated on the surface of AT-cut quartz crystal wafers.*



confined primarily to the area under the resonator electrodes.

It is possible, however, to "let" the energy out into the unplated areas of the crystal wafer in a controlled manner by adjusting the amount of metal in the plated electrodes. The vibrations that do get into the unplated areas are vibrating at the resonant frequency of the crystal but the amplitude of the vibration decays exponentially with distance. It was discovered that these untrapped vibrations could be put to work rather than letting them decay. By placing another identical electrode pair close to the first one it is possible to set the second pair in resonance by these untrapped vibrations, since the resonant frequency of the second pair is the same as the first.

Electrode pairs are acoustically coupled when the resonant vibrations of one pair set another pair in resonance using the crystal as the only connection between them. Consequently, the crystal areas plated with metal-film electrodes form mechanically resonant systems, coupled by the transmission

of energy through the unplated quartz wafer.

The principle of acoustical or mechanical coupling can be illustrated by common materials such as a thick sheet of foam rubber and two identical metal blocks resting on top of the foam. Application of an alternating force to the top of one block will set it in vibration and if the other block is close enough, it too will vibrate because the foam rubber is capable of transmitting the vibrations. The blocks must be close together to be coupled because most of the energy is trapped under the vibrating block and the little that does escape is quickly attenuated by the foam rubber. Elaborating on the mechanical coupling, a mechanical model can be developed for acoustically coupled crystal resonators. Figure 2 shows such a mechanical model.

The amount of coupling between adjacent resonators depends upon the dimensions of the resonators, the thickness of the metal electrodes, and the spacing between resonators. Consequently, by changing these three vari-

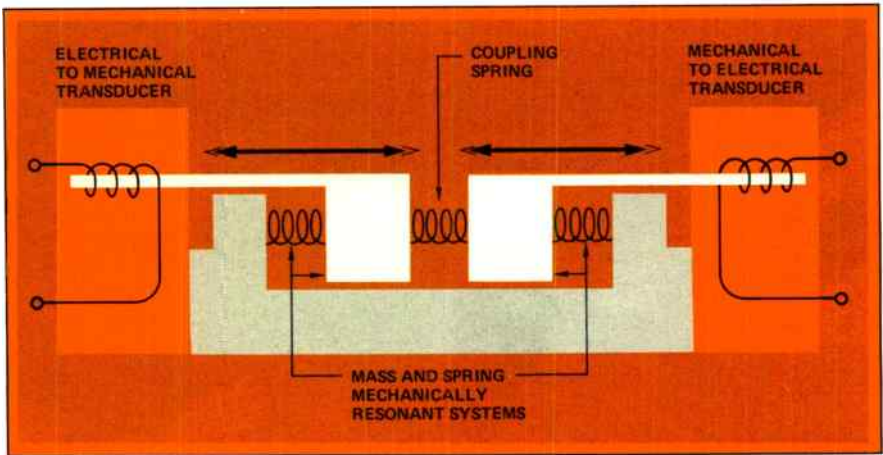

Figure 2. A mechanical model can be used to explain acoustically coupled crystal resonators.

ables it is possible to control the degree of acoustical coupling.

### Multi-Electrode Resonators

When all the resonators of a band-pass crystal filter are put on a single quartz wafer, the filter is referred to as monolithic. Figure 3 shows a monolithic crystal filter. It was the discovery that individual crystal resonators could be acoustically coupled rather than just electrically coupled that has led to the substantial reduction in both size and cost of crystal filters. As many as ten resonators have been placed on a single crystal wafer. With the proper arrangement of the electrode areas, it is possible to make relatively complex filters in a monolithic form. The center frequency of such monolithic crystal filters is in the range from 5 - 150 MHz with pass-bands ranging from 0.001 - 0.1 percent of the center frequency. Figure 4 shows the improved performance of each additional stage of a monolithic crystal filter.

Although it is possible to place as many as ten resonators on a single

crystal wafer, it is sometimes more reasonable to group several simpler multi-electrode resonators together. In this way the filter uses a combination of acoustical and electrical coupling between the individual resonators. Each of the simple monolithic structures are electrically coupled with a shunt capacitor. Such a filter, combining the advantages of both structures, is referred to as a polyolithic crystal filter.

Lenkurt uses polyolithic filters for its new 36A multiplex system. These filters have a center frequency above 8 MHz. Figure 5 compares the size of one of Lenkurt's polyolithic filters, which occupies only one cubic inch, with a conventional LC filter.

### Computer-Aided Design

Computers are often used in the design of LC bandpass filters. The same technique is being used in the design of crystal filters. With the proper computer program and the desired center frequency and bandwidth the necessary component values for an LC resonator can be calculated.

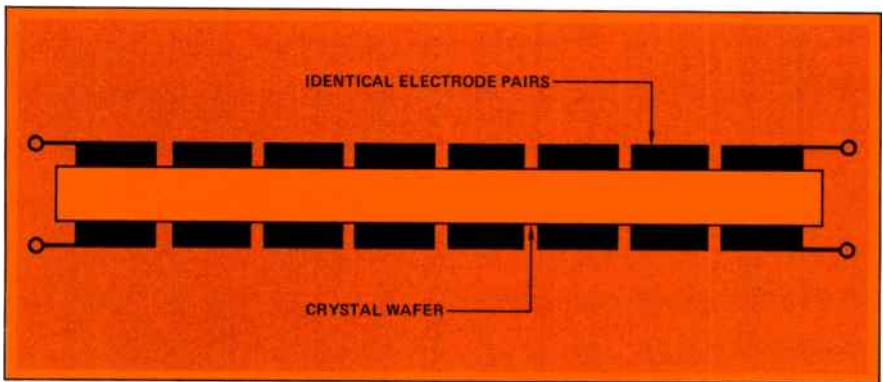

Figure 3. A monolithic crystal filter is a single crystal wafer with acoustically coupled resonators formed by plating identical electrode pairs on the crystal surface. Crystal filters are bi-directional; therefore, either end may be used as input or output.

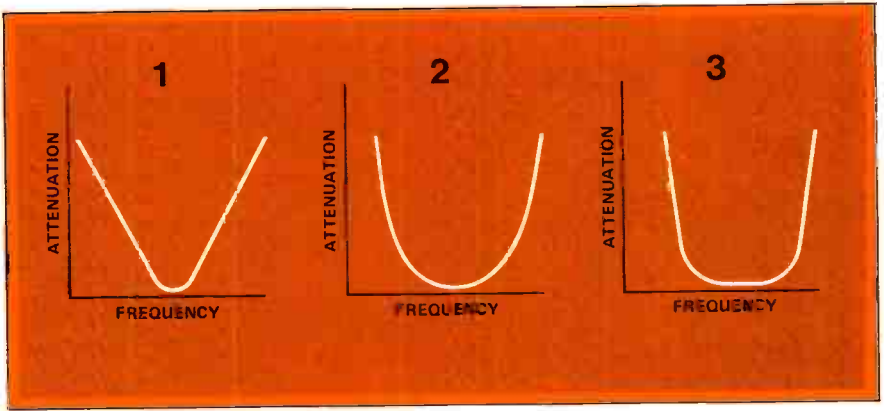
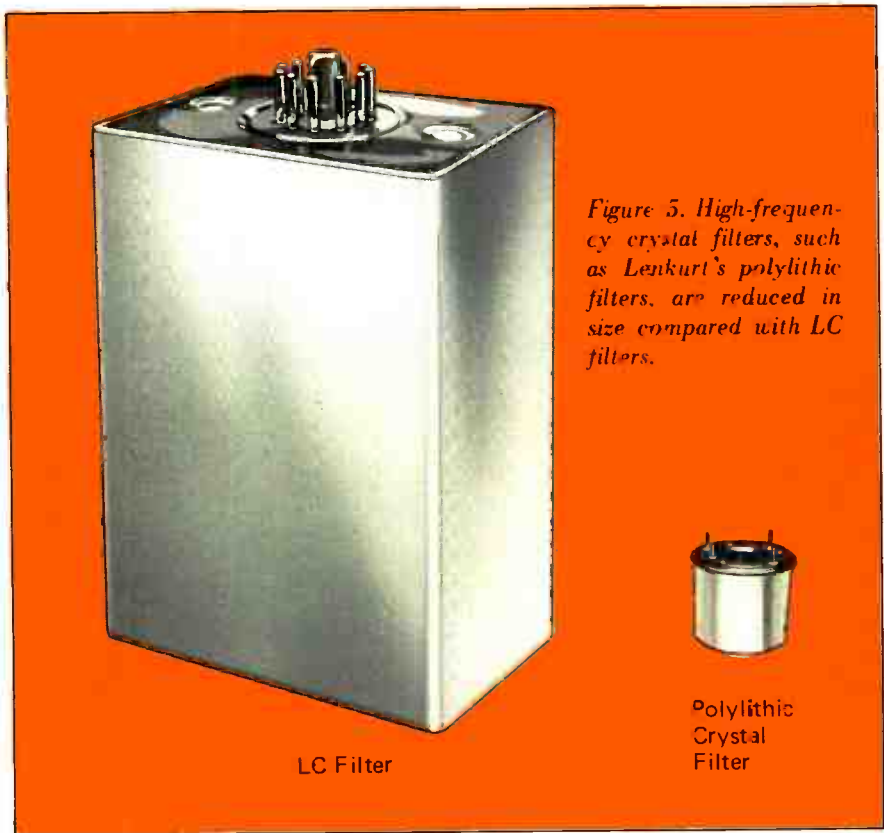

Figure 4. Each successive stage of a monolithic crystal filter improves the performance. The curves shown illustrate the successive improvement for three stages of a monolithic filter.



In designing a crystal filter for a particular resonant frequency, the desired information from the computer is the crystal size and shape and the dimensions of the electrodes. For multi-electrode crystal resonators, the spacing of the electrodes is also necessary. Using established computer programs, it is possible to calculate the component values for an equivalent LC resonator and from these values, the crystal filter requirements.

The circuit shown in Figure 6 illustrates the four electrical components needed to produce an electrical resonator equivalent to a two resonator crystal. Knowing these four component values, the dimensions of the electrodes and their spacing can be calculated. The optimum dimensions of an AT-cut crystal wafer are a function of the coefficients of elasticity of the crystal material used. The thickness of the crystal wafer is a function of the desired center frequency, since the resonant frequency depends solely on the wafer's thickness. The vibrations of the resonator never reach the edges of the plate because they are trapped under the electrodes; therefore, the lateral dimensions cannot affect the resonant frequency.

## Applications

The use of a two-step modulation scheme is one change in multiplex systems using high-frequency crystal filters. This new modulation technique translates the voice channel to an intermediate frequency (approximately 8 MHz) before filtering. In the second modulation step the filtered channel is translated to its appropriate frequency allocation for transmission.

Sophisticated mechanical design is also necessary when operating with radio frequencies. In the 8 MHz range, electromagnetic energy is being radiated by the wires and components used in the system. To minimize the possibility of electrical coupling between components due to radiated energy, sections of a high-frequency system are shielded from each other using metal plates and enclosures. Likewise the circuit path lengths used at this frequency are kept short to minimize the radiating and absorbing (transmitting and receiving) surfaces. Coaxial cable with its built-in shield, can be used where it is necessary to have long connecting wires and where external shielding is impractical. Figure 7 shows a multiplex channel unit from Lenkurt's 36A system which uses

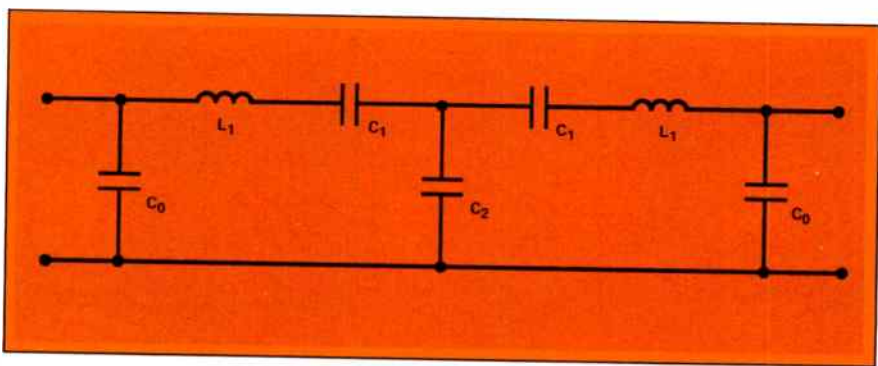

Figure 6. By knowing the values of the four electrical components illustrated, the equivalent two resonator crystal can be designed.

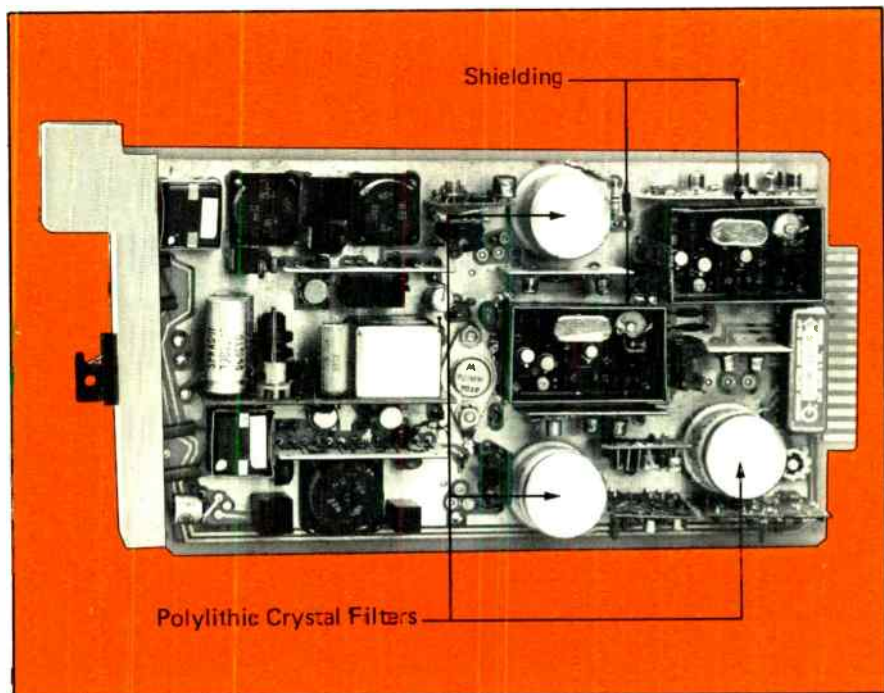

Figure 7. The channel unit for Lenkurt's 36A multiplex system illustrates the shielded, compact design used in high-frequency systems.

three polyolithic crystal filters operating in the 8 MHz range. Such a unit is compact and shields the high-frequency sections.

Two polyolithic crystal filters in Lenkurt's 36A system are used as channel bandpass filters – one for transmit and one for receive. The third is a narrowband carrier selection filter used to select the channel carrier from the multi-channel received signal. The recovered carrier is used at the receiver to demodulate the voice signal and to operate the signaling relay. The small

size of these filters has permitted the placing of a complete 36A channel unit on a single printed circuit card.

### What Next?

The development of monolithic and polyolithic crystal filters with their stable, narrowband, high-frequency operation and the added advantages of simplicity, small size, and economy, has done a lot to push crystal filters closer toward their introduction into broader fields than the field of highly complex technical instrumentation.

**LENKURT ELECTRIC CO., INC.**  
SAN CARLOS, CALIFORNIA 94070

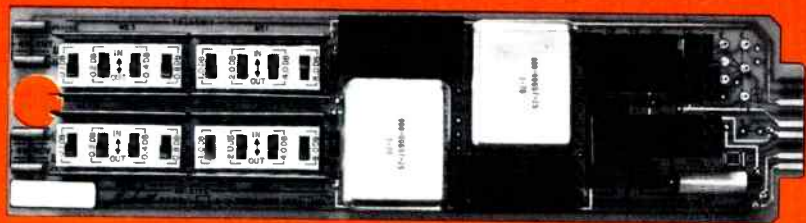

**LENKURT'S 5540A FOUR-WIRE TERMINATING UNIT** has eliminated the traditional use of separate pads or strappable terminals for attenuation adjustments between four-wire facilities and two-wire office equipment. Other advantages of the 5540A include improved performance, low cost, compact size, and front-access test points. For more information, write Lenkurt, Department C134.

***LENKURT ELECTRIC***  
GENERAL TELEPHONE & ELECTRONICS

SAN CARLOS, CALIFORNIA, U.S.A.  
**VIDEO, VOICE & DATA  
TRANSMISSION SYSTEMS**

**Lenkurt Offices**

San Carlos  
Atlanta  
Falls Church, Va.

Chicago  
Dallas

The Lenkurt Demodulator is circulated monthly to technicians, engineers and managers employed by companies or government agencies who use and operate communications systems, and to educational institutions. Permission to reprint granted on request.

World Radio History



