

WESTINGHOUSE

Engineer

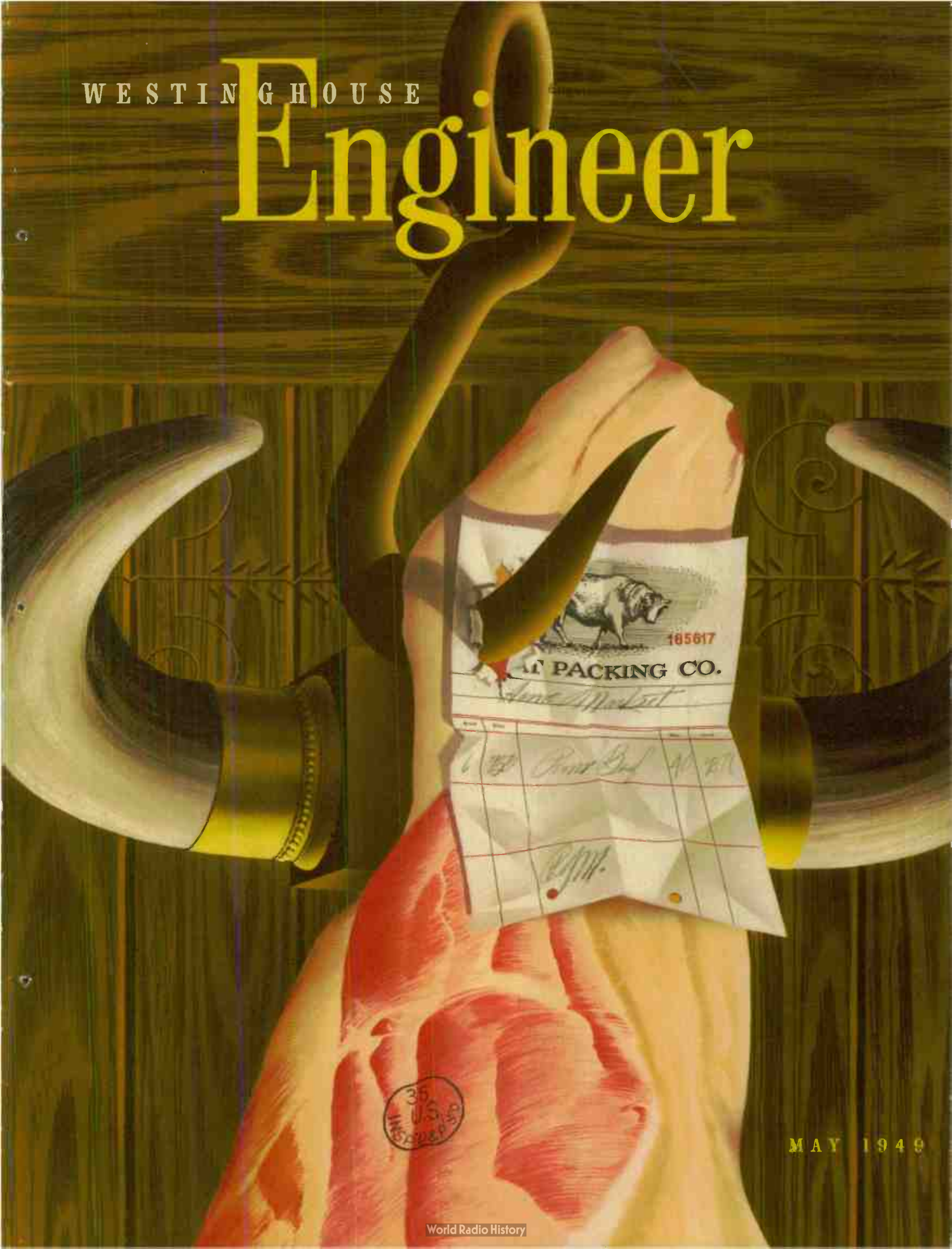

185617
AT PACKING CO.
James M. West

DATE	TIME	NO.	NO.
6/27	10:00	100	100

W. M.

35
U.S.
MAY 1949

MAY 1949

The *PASSING PARADE* of Problems

A technical problem is seldom, if ever, permanently solved. Its solution may be the best one at the time, but further developments may make possible a better answer. Or new developments, possibly in unrelated fields, may make the old scheme less desirable or even obsolete. For example, the sundial was at one time man's only means of measuring time. But as new techniques were developed, successively superior "clocks" have been contrived: the calibrated candle, the hour-glass, the spring-driven clock, the electric clock, the crystal oscillator, and just recently announced, the molecule itself. There is always a new crop of new answers to old problems, of which a few representative current ones follow.

• • •

One concerns underground secondary networks. This scheme, introduced in New York in 1922, has since become the standard method of power distribution in city areas of heavy load density. The system grew up using oil-filled network transformers. But, although fires have been extremely rare, the idea of oil below the streets in electrical equipment has never appealed to distribution engineers.

Ever since the industrial air-cooled transformer appeared about 13 years ago, engineers have been working to adapt it to manhole service. But they have been up against enormous difficulties in obtaining a transformer air cooled and hermetically sealed that is low enough in cost and small enough in size. Success appears to be at hand. After five years of successful operation with an experimental 500-kva unit, several are being constructed for underground service in Louisville. Also 23 Westinghouse sealed dry-type units, but of much larger rating—1250 kva—are to be placed in service in New York next year. While these particular units are not to be installed under the "sidewalks of New York," they are suitable for service underground or indoors where oil is objectionable.

• • •

A well-known solution to the problem of low power factor is the shunt capacitor. But shunt capacitors (along with most apparatus) have had a bad time in chemical plants, where the cases are quick to corrode. One large chemical company found the answer in capacitors having metallized surfaces sprayed with molten zinc, a finish developed originally to resist the elements encountered in outdoor distribution-line service. During a trial period, the results proved so satisfactory that the chemical company has gone all out for this type of unit. Several hundred kilovars of capacitors are being installed.

• • •

A chain reaction of problems, where the solution of one gives rise to another, is taking place in the saw mills of the Pacific Northwest. Spurred by research and product-development departments, lumber and paper mills are finding marketable uses for bark, sawdust, and other "waste" products that were formerly disposed of by burning in a boiler. The steam thus

produced was considered to cost little. Now, in many modern plants there is not enough "waste" to supply heat for the energy demands of the plants, resulting in actual fuel shortages that have to be made up with purchased fuels. Steam costs have thus increased to the point that prodigal uses of it are being viewed with critical eyes by accountants and engineers. One use of steam in these mills has been to drive the log carriages in which huge logs are swept at breathtaking speeds back and forth past vertical band saws.

In some cases the terrifically wasteful steam drives are being replaced with electric drives to reduce both fuel costs and maintenance charges. This has necessitated the adaption to log carriages of an adjustable-voltage electric drive similar to that used on electric elevators.

• • •

Increasing the weights and landing speeds of airplanes has given engineers many new puzzles to solve. One has been the development of better tires and tire materials to support the planes and to resist the landing shock. Also, progress in creating new synthetic rubbers, new cord materials, and new tire constructions has been so rapid that new, faster methods of testing them are essential. This has led to the increasing use of simulated service tests. One type of tire-test machine consists of a heavy flywheel brought up to speed over a period of many minutes, providing a known inertia against which the braking effect and resistance to shock of the tire can be tested.

• • •

In the race to keep abreast of rapidly mounting traffic congestion in cities, one of the best answers lies with vehicles that haul more people cheaper. One interesting new vehicle is a trolley coach that seats 58 passengers instead of the usual 44. It is a Twin Coach with three sets of wheels. One pair in the center is rigidly attached to the coach frame. The front and rear sets pivot and are interconnected so that as one pair turns in, the other out, enabling the long coach to round a corner with the same ease as the shorter lower capacity coach. The king-size trolley coach uses a single 140-hp, d-c motor mounted on the center pair of wheels. One large factor in keeping the cost per passenger low is the fact that the motor and control are essentially standard.

• • •

Larger flying freight cars mean greater electrical requirements. One new cargo plane under active consideration will have six or eight 300-ampere, d-c generators and two alternators of 8- or 11-kva rating each. That means an installed generator capacity of between 65 and 90 kw. Sizable for the air! Like vessels, this freight plane will have a cargo hoist.

• • •

No technical-problem famine is in prospect. Technical developments know no seasons, recognize no business cycles.

VOLUME NINE

MAY, 1949

NUMBER THREE

On the Side

The Cover—Dick Marsh, the artist, had never had the necessity nor the inclination to look closely at a side of meat. So when the problem of producing an authentic painting of one arose, he went from butcher shop to packing house, scrutinizing sides of beef, mutton, and pork for detail and eye appeal. Marsh finally found the side of beef portrayed on the cover, hanging picturesquely in the storage room of an old butcher shop.

• • •

Westinghouse has been awarded the contract to build the geared-turbine propulsion equipment for the U. S. S. United States, the Navy's super aircraft carrier. This vessel, which will handle heavy, multi-engine bombers, will have a greater displacement (65 000 tons) and a greater length at the water line (1030 feet) than any ship afloat. The drive will incorporate many of the lessons learned during wartime, when Westinghouse supplied most of the drives for big carriers.

• • •

Indicative of the ever-increasing demand for electric power is the growth in maximum ratings of turbine generators. The maximum rating of single-housing, 3600-rpm generators in service at present is 100 000 kw maximum, 80 000 kw nominal. Now being designed for Union Electric Power Company of St. Louis is a turbine generator rated 137 500 kw maximum output, 110 000 nominal. The generator will operate at hydrogen pressures of 30 pounds (for maximum rating) and 1/2 pound (for nominal rating). The turbine will operate at steam conditions of 1250 pounds gauge and 950 degrees F.

The contents of the *Westinghouse ENGINEER* are analyzed and indexed in the INDUSTRIAL ARTS INDEX.

Editor

CHARLES A. SCARLOTT

Editorial Advisers

R. C. BERGVALL
T. FORT

In This Issue

THIS MATTER OF MEAT 66

LIGHTNING ARRESTERS FOR ROTATING MACHINES 72
Edward Beck

THE PRINCIPLES AND PROSPECTS OF MICROWAVE COMMUNICATION 74
F. S. Mabry

WHAT'S NEW! 78
More push for earth moving—Dehumidifying unit—Battery charger—A-V drive—Giant valves—Ranger, Junior welder—Large and small Life-line motors—Grand Coulee generator—Racetrack lighting—Vacuum tank.

MODERN DISTRIBUTION SUBSTATIONS—A GROWING TREND 82
John S. Parsons

SWITCHGEAR FOR UNIT SUBSTATIONS 87
B. K. Smith and P. R. Pierson

STORIES OF RESEARCH 90
Cleaner than clean—Fretting corrosion tests—Scientists become lightning librarians—Arrest that surge.

AMPLIFICATION BY MAGNETIZATION 92
F. N. McClure

The *Westinghouse ENGINEER* is issued six times a year by the Westinghouse Electric Corporation. Dates of publication are January, March, May, July, September, and November. The annual subscription price in the United States and its possessions is \$2.00; in Canada, \$2.50, and in other countries, \$2.25. Price of a single copy is 35c. Address all communications to the *Westinghouse ENGINEER*, 306 Fourth Ave., P.O. Box 1017, Pittsburgh (30), Pennsylvania.

THE WESTINGHOUSE ENGINEER IS PRINTED IN THE UNITED STATES BY THE LAKESIDE PRESS, CHICAGO, ILLINOIS



Photo—U. S. Dept. of Agriculture

This Matter of *MEAT*

To most everyone a steak is but a juicy, tasty portion of a steer as manufactured by nature. To an engineer it is also compounded of the best in materials handling, a quantity of watt-hours, gallons of water, pounds of steam and refrigeration, miles of transportation, and a heap of organization, technical skill, and ingenuity.

EVEN a cursory inspection of the meat industry makes apparent several significant features. For one, its immensity. The annual retail value of meat products is now about 15 billion dollars, making it considerably larger than the automotive business. Also, the industry is of great diversity; livestock is produced by five million independent growers, is reduced to meat by 27 000 slaughterers, and the products are sold through many thousand retail outlets, so that no group is large enough to dominate or exercise control. Two problems characterize the industry to an uncommon degree: transportation and preservation. Among industries, meat packing is unique in one respect: primarily it is a disassembly—not an assembly—operation.

Meat, like the weather, is of intimate and constant interest to everyone. We like it and eat lots of it. This is fortunate, otherwise we would be a hungry people. Almost half of the land of the United States is suitable only for the growing of grass, which requires animals for conversion to human use. Also, nearly four fifths of all grain production becomes human food by courtesy of livestock.

The average American in 1948 consumed 145 pounds of meat divided thus: 63 pounds of beef, nearly 68 pounds of pork, with veal, lamb, and mutton accounting for the remaining 14 pounds. The total consumption in 1948 was about 21.3 billion pounds.

Meat consumption per person shows no definite long-term tendency to increase or decrease. In 1900, it was 151 pounds; in 1920, 135; and last year, 145. During the depression (1934) it dropped to 117, and in the high-income war year of 1944 it rose to 153. This suggests that consumption of meat is determined by the ability to buy it, which is the controlling factor

in the nation's meat supply and price too often overlooked.

The portion of the total family income spent for meat has not changed significantly (one's thoughts every shopping day to the contrary). The percentages of the family income spent for meat in 1929, 1939, and 1948 were 5.6, 5.3, and 6.6, respectively. The corresponding percentages of income spent in those years for all food were 23.9, 22.3, and 27.9.

Tastes—both as to kind and amount—throughout different regions of the United States are comparatively uniform, although some minor variations exist. In general more of the fatter cuts of pork have been consumed in the South, but this probably has an economic and not a taste-preference basis, and is disappearing. In general, people of the northeastern sections of the country prefer heavy, fat beef and lean pork. The reverse is true in the Southwest. A few local differences in demand are manifest, many being rooted in religious or early national backgrounds. The heavy skinned hams favored in certain sections of Pennsylvania are not generally demanded elsewhere. Some parts of the country and even sections of large cities require sausage to be seasoned differently. In Minneapolis, light, relatively fat beef sells better, while in its twin city of St. Paul the reverse is true. A few towns prefer beef from heifers or cows, while others, unaccountably, prefer that from steers.

The Conversion of Animals to Meat

Until about 1870 animals were shipped long distances from farms to slaughtering houses located not many miles from the retail stores. There was no other way to handle fresh meat. Fast, refrigerated transportation, now taken for granted, was unknown. Then in 1875 two men came to Chicago, one from New England—Gustavus F. Swift—and one indirectly from California—Philip D. Armour, founders of the present largest and second largest packing companies. Swift, in particular, who had come from Boston on a cattle-buying trip, was im-

This discussion of the meat industry was prepared by Charles A. Scarlott from information generously provided by Swift and Company, Armour and Company, Wilson and Company, the American Meat Institute, the National Livestock and Meat Board, the "National Provisioner," the National Independent Meat Packers Association, the U. S. Department of Agriculture, and the engineering and commercial staffs of Westinghouse.

pressed with the possible economies of not shipping a 1000-pound steer 1028 miles from Chicago to Boston when only about 570 pounds appear in the retail market. Less than three fourths of a hog and less than half of a lamb are converted to meat. But that is not the whole story. Animals shipped long distances by rail lose a significant amount of weight. Also, they must be fed and watered en route, which adds to the cost.

Hence were born the great packing houses in the populous animal country. The meat-packing industry is now centered in Iowa, Illinois, Minnesota, Kansas, Nebraska, Missouri, Ohio, and California. These eight states accounted for more than half of all meat produced commercially in 1947. Packing houses are usually close to growing or finish-feeding sites. On the other hand, livestock is grown in every state of the union, giving need for local packing establishments. In general, packers rely on animals grown or fed within a few hundred miles.

Setting up the meat-packing business in the Midwest three quarters of a century ago to provide fresh meat for the populous Eastern centers was not simply a matter of building packing houses and going to work. One indispensable link was missing—the refrigerator car. Development began in the early '70's. The first cars were chilled with ice before loading, and were re-iced several times en route with the only ice then available—natural ice cut from lakes in winter and stored in enormous ice houses for use throughout the summer. About 1877 a car using brine tanks filled with ice and salt was developed, which gave lower and longer-lasting temperatures. It was a vast improvement. The advent of artificial ice-producing machinery about 1880 initiated the decline in the use of natural ice.

The refrigerator car is now a familiar and indispensable cog in the giant, complex structure that provides any kind of fresh meat anywhere, winter and summer. The fleets of cars owned or leased by individual packers range from a few cars to about 5000.

"Meat packing" is a term carried over from the colonial days when the only way to preserve meat for more than a few days in warm weather was to "pack" it in salt or brine. Now all concerns that convert animals into food are called meat packers. The "big four" are Swift, Armour, Wilson, and Cudahy. The gross business of Swift reached the astonishing total of $2\frac{1}{3}$ billion dollars in 1948, while Wilson did a total of about 700 million dollars, suggesting in weighty figures the immensity of the meat industry. In 1947 the big four provided 58 percent of the nation's total meat supply. Although in the case of Swift, Armour, and Wilson, their main plants are in Chicago, and Cudahy at Omaha, each of these four meat packers has many other plants. Swift, for example, has about 50 packing houses, in addition to about 300 branch houses, 130 dairy and poultry plants, 7 separate refineries for meat fats and vegetable oils, 23 plant-food

factories, 31 oil mills, and 4 soap factories. Armour has 34 slaughtering plants; Cudahy, 13; and Wilson, 8.

But big as these four are they do not have the business to themselves. There are 5000 packers, each producing more than 300 000 pounds of meat annually, and 22 000 smaller packers. Of the total, 463 are under rigid federal inspection, which entitles them to do interstate business, export, and bid for government meat purchases. The remainder are subject to state or municipal regulations and restricted to business therein. Despite their small number, federally inspected packers do most of the business. They accounted in 1947 for 69 percent of the total cattle, 58 percent of the calves, 66 percent of the hogs, and 89 percent of the lambs. Federally inspected establishments are increasing in number. There were 298 in 1939. The subsequent addition of 165 suggests some decentralization.

From Range to Slaughter

A big factor in the meat business is geography, which engenders one of the industry's greatest problems—transportation. Most meat animals are raised in the plains and corn-belt states, whereas the center of meat consumption lies, naturally, near the populous areas, a thousand miles eastward. About 70 percent of all meat is consumed east of the Mississippi River, but only 37 percent of the meat animals are raised there. The major cattle-producing states, in order of importance, are: Texas, Iowa, Nebraska, Kansas, with 30 percent of the total, followed by Missouri, Illinois, Minnesota, California, Wisconsin, and Oklahoma, adding 25 percent more. Almost half of the sheep and lambs come from the rough grazing lands of Texas, California, Wyoming, Montana, Colorado, and Idaho. Iowa and Illinois account for one third of the hogs. Hog and corn production are inextricably linked. On the average 45 percent of the corn crop is fed to hogs. About 400 pounds of corn and 75 pounds of other feed are used to make 100 pounds of marketable pork.

Cattle, after being raised on the grasslands of the West and Southwest, sometimes are shipped to Kansas or Nebraska for an intermediate feeding on grass. Or they may go direct to feed lots for intensive or "finish" feeding, where they are confined in pens for several months as they fatten for market. These feed lots may be operated by the grower, if he has the grain or hay for them. Generally, however, animals are shipped to feed lots in corn-belt states where finish feed is more abundant. There is, on the other hand, a growing tendency to finish feed cattle in the area of their growth.

Throughout this period of growing and feeding, the animals are owned by either the original grower or by the feed-lot operator. The packer has no control over the supply of livestock that producers market. The owner decides when to market his steer, calf, hog, lamb, or sheep. That decision is compounded of many things: market

Photo—Wilson & Co. →



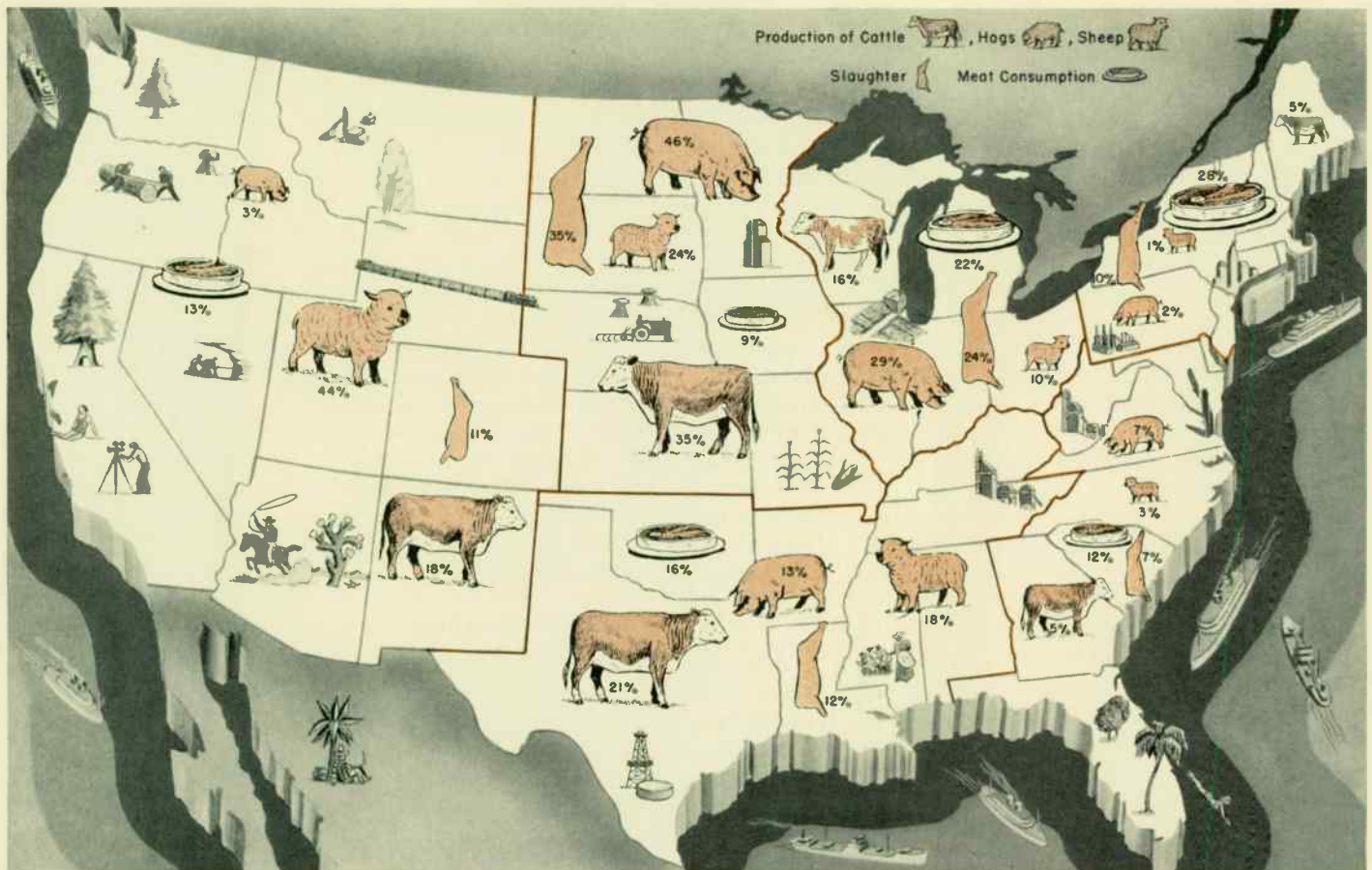

price, estimates of future livestock price changes, price and availability of feed, whether the animal is ready for market, the weather, need for cash, and so on. These factors add greatly to the complexities and competitiveness of the industry.

When the owner does decide to sell he has three principal courses open to him: (1) at local livestock markets including public auction, (2) direct to packers' agents, or (3) ship to one of the 68 public terminal markets, the one at Chicago being the largest and best known. Actually the number of animals arriving at the Chicago yards is only about twice that at St. Louis, St. Paul or Omaha. Chicago accounts for about ten percent of the total.

Public markets and stockyards are privately owned, with the largest packers excluded by law from participation. Anyone can bring stock to such a market for sale and anyone can go there to buy. The market simply provides stock pens and all necessary services, such as feed, water, handling, and certified scales. For this service the market company charges the seller a fee set by the government.

The owner wishing to sell on a distant public market consigns his stock to a commission firm, which acts as his agent to obtain the best possible price. The commission man deals directly with the buyers in a fashion historically picturesque and remarkably economical of conversation, albeit confusing to the stranger. A transaction at the Chicago yards, for example, may take place like this.

A buyer on horseback enters a pen containing steers and with practiced eye and hand judges the animals. His appraisal completed, the following conversation—if it can be called such—may ensue between agent and packer buyer:

Agent: "What are you saying?"

Buyer: "\$22.75."

Agent: "Over the hill."

Buyer: "Open the gate."

The agent had asked for a bid and the buyer offered \$22.75 per hundred pounds live weight. The agent told him he would have to go beyond the next dollar, i.e., above \$23. The buyer considered this too much and left.

Or perhaps the buyer may open the negotiation:

Buyer: "What do I hear?"

Agent: "\$22.75."

Buyer: "Weigh 'em."

Thereupon, with nothing committed to paper, the animals are driven to the scale. The weighman, an employee of the market, provides slips showing the weight and the selling price given him orally. This slip, which is the only written record of the transaction, is negotiable paper and (at Chicago) can be converted to cash by the grower or his agent, in the time required to go to the bank within the yards. Even the formality of check writing is, in this case, avoided. Selling practices differ somewhat from yard to yard, but in general animals are quickly converted to cash at public markets.

The animals, now belonging to the packer, begin their "last mile." They are driven to holding pens. Within a few minutes, or at most a few hours, the animal is killed ("dispatched" is the term now used) in the age-old manner. Cattle are stunned, hoisted by the hind legs to an overhead rail, and cut for most rapid bleeding. Hogs and sheep are killed in the same manner, but without stunning.

Immediately after being dispatched, cattle and sheep are skinned. Hog carcasses are passed through a vat of steaming water, are rolled in a dehairing machine, and singed free of small hairs, from which they emerge a beautiful white not commonly associated with hogs.

From this point on the animals do not leave the continuous conveyor line. As they proceed, the men skilled with knives begin their work, each deftly performing some small portion of the total disassembly operation. In federally inspected

plants the entire process is under the watchful eyes of Department of Agriculture inspectors. The conveyor system is such that all parts of a given animal are kept together until the inspectors have had opportunity for complete examination of the glands and organs for abnormalities, and, if necessary, diversion of part or the entire animal from the edible-products line. Federal inspection is exacting and rigid.

Within a few minutes and a few hundred yards of conveyor rail from the dispatching point the animal has been separated, under inspection, into many parts, and the components proceed their many ways—still on the conveyor—to refrigerator rooms for chilling. After chilling, large sections of fresh meat are slid along on their monorail conveyors directly into refrigerator cars that have been steam cleaned and chilled. Other kinds of meat, after chilling, are processed—as by curing, cooking, smoking, slicing, canning—packaged, and shipped, also in refrigerator cars or trucks.

The time between killing and counter is surprisingly short; usually about five days. Fresh meat can be and often is held under closely controlled refrigeration (below 45 degrees F) for longer periods—perhaps several weeks. Refrigerated storage spaces are expensive to build and to operate. As a result the total suitable storage capacity in the United States is about two weeks' meat supply. Thus the industry cannot indulge in hoarding as a price-manipulation device. The packer can store neither his raw materials nor his product. The time when animals arrive at the market is the choice of the grower. The problems (and cost) of storage and perishability likewise give small control over when he disposes of his product. The only substantial element of control is the price he bids on the day the animals arrive at market. Superimposed on the industry as a whole are other uncontrollable variables such as sudden heat waves, which affect markedly the amounts and kinds of meat consumed. Storms affect both the marketing of animals and the sale of meat. Also, the number of animals brought to market varies with the season.

Meat-Packing Mechanization

The meat-packing industry is surpassed by few in the degree of mechanization. It was the first major industry to de-

velop mechanical handling and continuous-line production. Henry Ford is reputed to have developed his idea for the automobile production line from a trip through a packing house. A visitor to a packing house is impressed not only with the actual processes of meat-carass disassembly but also by the adjunct mechanical devices. The intricate array of monorails, motorized belts, tools, and saws is a delight to a materials-handling engineer. Streams of water, both hot and cold, appear at many steps in the operations. Jets of steam are used profusely for sterilizing. Electric power has a prominent part in a packing plant not only to drive conveyors, pumps, and compressors, but also to provide the high levels of lighting required for precise cutting operations and for careful inspection. Also, germicidal lamps of the Sterilamp variety are used by many packers, their branch houses, and by many meat retailers, particularly where packaging is done. Chilling rooms are huge, requiring large amounts of refrigeration to remove animal heat and preserve the meat.

Some packers prefer to buy electrical energy from local utilities, others have sizable power plants—up to about 30 000 kw—wherein they generate their own electric power. Steam turbines drive electric generators and provide large volumes of low-pressure steam for plant use.

To give some concept of the electrical and refrigeration load, Swift's have made available these figures for their Chicago plant, which processes in an average year 900 million pounds of meat and by-products: 68 670 000 kwhrs per year; 3 433 000 pounds of steam per year; 1 000 000 tons of refrigeration per year. The connected horsepower is 28 500.

"All But the Squeal"

The meat-packing business is concerned with much more than the slaughter of animals and the preparation of meat for food. It has many other functions. Most of these stem from the by-product aspect of the business—which is so sizable that only the barest outline can be given here. To the meat-packing industry goes credit not only for making the first big-scale use of by-products but also for popularizing the idea. Witness that most famous of industrial phrases, anent utilization of all the hog but the squeal! Because of by-products the

Photos—U. S. Dept. of Agriculture



Photo—Wilson & Co



Meat processing is a multi-step procedure requiring frequent inspections and many highly skilled operations.

Photo—Swift & Co.

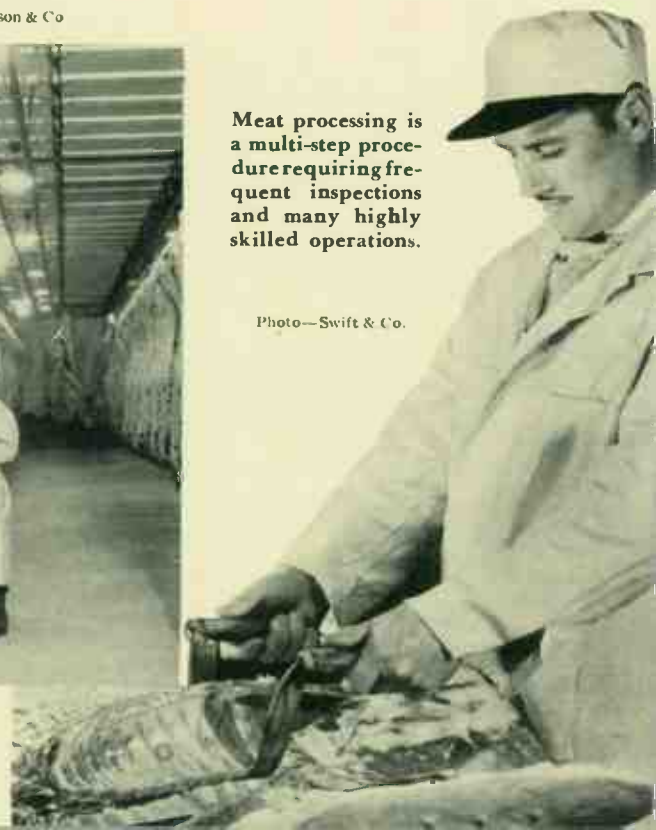

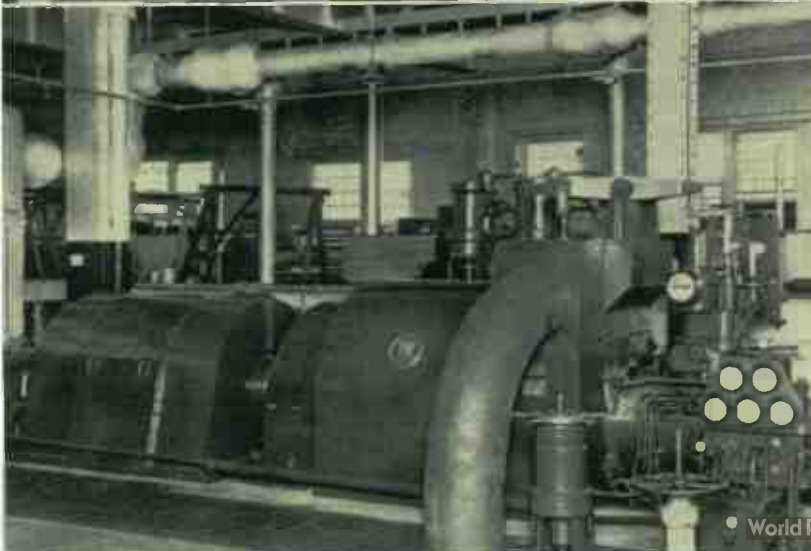

amount paid for cattle at times exceeds the amount received by the packer for the meat those animals provide. By-products often must cover all expense of packing, transportation, taxes, and operational expenses. Profits average less than one cent per dollar of sales.

By-products from beef begin with the hide, which is also the most valuable single by-product. Before the war, meat accounted for seven eighths of the total return from a steer and hides were responsible for two thirds of the remainder (i.e., 8.5 percent of the total).

Blood, another available animal product, has many uses. The outstanding one has been dried blood for animal feeds, but it has also been used in the production of waterproof glues and plastics. During the war, chemists took an increased interest in blood and its possibilities for clinical use. Sanitary techniques for collecting blood were developed, and the red blood corpuscles were separated from the plasma. Plasma has several constituents, two of which are prothrombin and fibrinogen, and are used experimentally in operations to stop hemorrhaging or excessive bleeding.

Bones are a source of numerous valuable products, both edible and inedible. Bone has long been processed into meal for soil fertilizer and for livestock and poultry feed, thus completing the nutrition cycle. Bones also provide chemicals, some used in water treatment and moulding operations. Glue, neat's-foot oil for leather dressing, some pharmaceuticals, and certain novelties, are of bone origin.

There are many other lesser known kinds of by-products. One is gelatin, made from the white structural tissue of the animal, and is obtained from bones and from the skins of hogs and calves. In addition to edible gelatin other kinds are used for pharmaceutical capsules, photographic film, and paper-making. Gelatin sponge is used in surgery.

More recently animal glands have found a score of health-giving functions. Insulin—the life-sustaining element for diabetics—comes from the pancreas of hogs, cattle, and calves. Incidentally, 20 000 head of cattle are required to produce one pound of crystalline insulin, hence economic insulin production necessitates large-scale operations. Animal thyroids provide an extract for treating goiter and cretinism. Scores of other invaluable pharmaceutical products are obtained from pineal, pituitary, thymus, parotid, and other glands.

Hair has many functions, such as in padding, air filters, and heat insulation. Selected hairs from the ears of cattle make "camel's hair" brushes. Eleven lambs are required to supply the "cat gut" for a single tennis racquet. Soaps, scores of oils and greases, glycerin, tallow, casings, and lard are other major packing-house products. Even the waste water and wash water of a packing plant are caught and treated to recover inedible oils and fats (desirable furthermore to minimize stream pollution).

Most curious of all by-products are gallstones, infrequently

The availability of fresh meat, while taken for granted, is a marvel of ingenuity, organization, and industry. One large factor is the ever-present willingness to adopt new ideas, new apparatus. The modern, help-yourself store at the top, with its gleaming refrigerated case loaded with prepackaged fresh meat, casts a shadow on the long familiar shop where meat is custom cut while you wait.* Not so evident to the public are the modern electrical and power devices, of which three representative Westinghouse equipments are shown: a Sterilamp installation in a Tenderay plant provides high-quality meats; a gleaming white, modern power center in a packing house; and a modern power unit providing electricity and low-pressure steam for the many functions in a meat plant.

←*Photo—"Supermarket Merchandising"

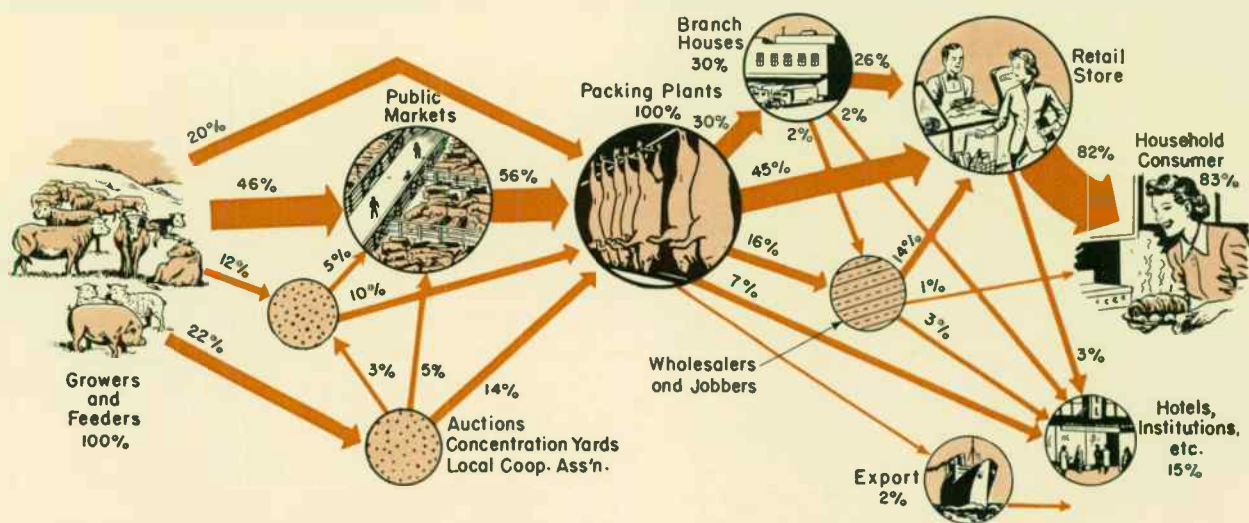

A simplified chart showing the flow of all meat from grower to table. The major flows from growers to slaughter follow four routes: (1) direct to packers through packers' agents, (2) public markets, (3) dealers, and (4) auctions, etc. Other channels between grower and consumer exist but are minor.

found in cattle. They are much prized by Orientals as good-luck and good-health charms. Silly? Perhaps, but at \$125 per pound, why not!

The adage about all but the squeal, while graphic, is an exaggeration. The best the research and operating departments of the packers can do is to use 78 percent of the live weight of a steer or lamb. About 22 percent is still shrinkage and waste, much of it being the water and feed given the animal just before the buyers appear. (This wasteful practice is called "fill" and fools no one, least of all the buyer.)

Several trends are noteworthy. The increasing number of canned, processed, and packaged-meat products is in evidence on every trip to the butcher shop. Canned-meat production has more than tripled in the ten years between 1937 and 1947 from 308 to 1099 million pounds, most being pork products. Beef accounted for 91 million pounds in 1937 and 136 in 1947.

Two newer trends daily becoming more conspicuous to the consumer are the growing availability of quick-frozen meat and prepackaged fresh meats. The frozen-food idea, delayed by the war, has since continued to grow steadily, but not at the rapid rate expected by its proponents. However, added to the packages of frozen vegetables and fruits in the self-service refrigerated cases are more and more frozen specialty meats. The increasing use of household refrigerators with sizable frozen-food compartments is aiding this trend.

But what about the old-fashioned butcher shop? That institution is one of the few remaining among retail establishments to offer resistance to packaged foods. The idea of packaged meats is not new. Witness the extensive and well-accepted packaging of frankfurters, luncheon meats, sausage, etc. But the purchase of a steak or chop still usually involves negotiation with the butcher as to what is wanted and how much, whereupon he must cut, weigh, and wrap it while the customer waits. This procedure seems to hold much that is wasteful. Meat cutting is a skilled operation requiring experience. To tie up expert cutters with many time-consuming aspects of making a sale seems foolish. Also, on busy shopping days it creates long lines that are wasteful of shoppers' time and nervous energy. Having fresh meat cut, transparently wrapped, and ready for examination and purchase, perhaps even on a self-service basis, appears to have merit. If the meat were cut and prepackaged at some point ahead of the retail counter—say in the store's back room—the time and skill of meat cutters could be used to better advantage, power tools could be employed, unsalable portions of the carcass could be put to better use than as dog meat or fat salvage. Much waste shopping time would be eliminated.

Why not, then, more prepackaged fresh red meats? Some problems must first be solved. Not the least is aggressive resistance from the strong butchers' union. Another is that buying habits of millions of housewives cannot be changed overnight. However, they can be changed; many can recall the resistance to sliced packaged bacon. One whopping big problem is the tendency for meat exposed to light to darken. Also, as meat becomes more finely divided, the preservation problem increases.

As matters stand now, however, prepackaging of fresh meat is on the increase. A survey in the fall of 1948 indicated that at least 178 stores with 100-percent prepackaged, self-service meat departments are in operation, the packages being displayed in open refrigerated cases. Several hundred more go part way with some kinds of prepackaged fresh meats. The prepackaged meat idea is most popular in California, with 40 stores, and Texas with 19. The trend is on the increase.

In the near future prepackaging will be done relatively close to the point of sale, if not in the same shop, at least not many miles away. But it is hard to believe that the problems of packing-house prepackaging—admittedly not easy—will permanently defy solution, because of the greater economies that prepackaging and by-product utilization at that point would permit. Also, prepackaging will permit establishment of national brand names, in which shoppers are placing increasing reliance. Already in a few instances packers have established delivery service of pre-cut packaged meats to homes. In any case, the trend may result in the eventual disappearance from view of the butcher's block and the sawdust-covered floor.

Accelerated aging of meat under conditions of high humidity and sterile atmosphere, such as by the Westinghouse Tenderay Process, is not new but is gaining in acceptance.

Various members of the meat industry are toying with other new ideas. Sterilization of fresh meat within sealed containers by high-energy nuclear particles from surge generators and Van de Graaff generators is being aggressively investigated. That such sterilization is possible has been clearly demonstrated. The problems have to do with taste and other chemical changes, mechanics of the process, and cost. Also, the use of radio frequencies to provide dielectric heat for meat processing or cooking is being explored.

Meat processing, most ancient of industries, is at the same time modern in its techniques. It has absorbed advances from almost every field of technology—knowledge of which will not make that next T-bone steak taste better, but may make it more fully appreciated.



Testing SV lightning arresters for rotating machines.

"Any ole" lightning arrester will not do for protection of rotating machines. Arresters for such purposes must be built with particular care and tested carefully before going into service. If the arrester does not operate when required, a large, expensive motor or generator may be damaged.

Lightning Arresters for Rotating Machines

EDWARD BECK, *Manager, Lightning Arrester Section, Westinghouse Electric Corp., East Pittsburgh, Pa.*

THE responsibility of protecting a rotating machine against lightning surges does not belong to the arresters at the machine terminals alone. Active cooperation is required between all components of the protective system (see "Lightning Protection by Inductance, Capacitance, and Arresters").

The complete equipment for adequate lightning protection of a rotating machine,* Fig. 1(a), consists of:

- 1—A set of lightning arresters on the overhead line, usually some distance ahead of the machine.
- 2—Inductance in the system between the arrester and the machine.
- 3—Capacitance from each phase to ground, at or near the machine, in series with the inductance.
- 4—Another set of lightning arresters, at or near the machine, in parallel with the capacitance.

During a lightning surge, the functions of these components are as follows:

The lightning arrester on the line limits the voltage applied to the rest of the system, as Fig. 1(b) demonstrates, and hence plays an important part in limiting the rate of rise of the voltage applied to the machine. Also, it takes the brunt of the surge, so that the machine arrester need not carry as high currents when it discharges. The line arrester is usually of the type commonly employed with transmission lines and static apparatus, such as oil-filled transformers and circuit breakers.

The inductance and capacitance in series control the time in which the surge voltage at the machine rises from zero to its maximum. This effect, combined with crest reduction by the line arrester, limits the rate of rise of voltage, thereby limiting the voltage between turns, as Fig. 2 indicates. The inductance may be lumped inductance, such as a choke coil or current-limiting reactor in the circuit, or it may be a transformer, or a length of the line itself may supply sufficient inductance. The capacitance is usually a capacitor, but if the circuit is in a cable, its normal capacitance may suffice.

The lightning arrester at the machine prevents the voltage at the capacitor, and, therefore, the voltage at the machine, from rising to a magnitude that endangers the insulation between windings and frame (ground). The conditions under which the machine arrester operates differ in several respects from those of arresters applied to static apparatus such as oil-insulated transformers. (The line arrester of Fig. 1 is of the

latter type.) First, because of the inductance and capacitance, the rate of rise of voltage applied to the machine arrester is relatively slow. The capacitance and inductance are selected so that the surge applied to the machine terminals requires at least ten microseconds to reach the crest of the machine test voltage. Tests and experience have established ten microseconds as corresponding to a conservative rate of rise that does not endanger sound turn-to-turn insulation. Arresters applied to static equipments directly connected to transmission lines generally do not have the benefit of wave-sloping capacitance and inductance and, therefore, frequently operate on much more rapidly rising voltages, which may reach a crest in less than one microsecond. The second difference is that line arresters take the brunt of the surge, which reduces the discharge currents and, possibly, the number of operations of machine arresters. However, the machine arrester must discharge much of the energy stored in the capacitor.

Because of these differences and because of the relatively low insulation levels of rotating machines (as compared to that of static apparatus such as oil-insulated transformers), machine arresters must have special characteristics. Arresters commonly used on transmission lines or static apparatus generally have higher impulse characteristics and hence should not be used to protect rotating machines. Likewise, machine arresters should not be used for the protection of lines or static apparatus (except dry-type, air-cooled transformers) because the margin in ability of these arresters to interrupt power-follow current (the arrester current due to system voltage after the surge has passed) is not as great.

Machine arresters are designed with an eye toward holding the impulse characteristics to the lowest practical value, thereby minimizing the surge crest voltage between windings and ground. Because of the lower impulse breakdown strength of machine insulation, this requirement must be more rigidly observed in arresters for rotating machines than in arresters for static apparatus. Hence, particular attention should be given to impulse characteristics of machine arresters to insure that they do not exceed certain values that depend on the voltage ratings of the arresters.

Westinghouse builds two families of lightning arresters tailored especially for use with rotating machines, a station-type (SV) and a smaller type (RM). The valve and series-gap elements of these arresters are especially selected and controlled

*"Lightning Protection for Rotating Machines," by G. D. McCann, Edward Beck, and L. A. Finzi. *Westinghouse ENGINEER*, March 1944, p. 60.

Figure 1

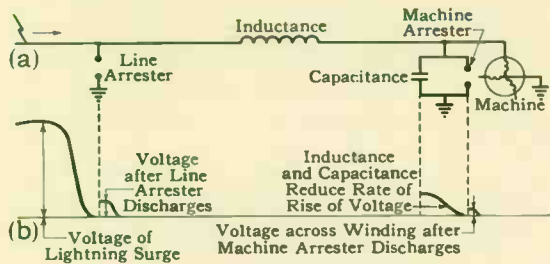

Fig. 1—The operation of all components of a complete protective system for machines.

Figure 2

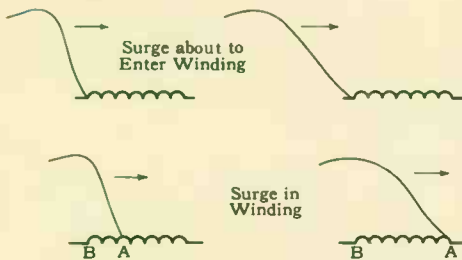

Fig. 2—Point A is at zero potential and point B at maximum surge potential. If the wave front is steep, as at left, maximum surge voltage is impressed across fewer turns, increasing the maximum voltage per turn.

during manufacture. Furthermore, all station-type (SV) arresters for rotating machines are tested when completely assembled to insure against excessive impulse characteristics.

The RM arresters are about the size of ordinary distribution arresters. They are used with smaller rotating machines. Their impulse characteristics and performance are similar to those of the SV. However, the lower cost of the RM does not justify impulse testing of each unit. These arresters are used without capacitors for protection of dry-type transformers.

Routine tests on SV arresters are made under conditions expected in normal field service. The impulse sparkover voltage is checked with a test wave that rises to sparkover in approximately ten microseconds. The discharge voltage is checked with a current of 1500 amperes crest and approximately 10×20 -microsecond wave shape. (The current rises to its crest in 10 microseconds and falls to half crest value in 20 microseconds.) The test values must not exceed the maximums listed in table I, otherwise the arrester is rejected. This procedure gives a high degree of assurance that these arresters will prevent dangerous high voltages to ground.

Arresters tested in this fashion have been in service for over 15 years. Operating experience has shown them to be an effective component for protection of rotating machines.

TABLE I—STATION-TYPE (SV) ARRESTERS FOR ROTATING MACHINES

Machine Voltage Class (Kv)	System not effectively grounded			System effectively grounded		
	¹ Arrester Voltage Rating (RMS Kv)	² Maximum Impulse Sparkover Voltage (Crest Kv)	³ Maximum Discharge Voltage at 1500 Amperes (Crest Kv)	¹ Arrester Voltage Rating (RMS Kv)	² Maximum Impulse Sparkover Voltage (Crest Kv)	³ Maximum Discharge Voltage at 1500 Amperes (Crest Kv)
2.4	3.0	9.5	9	3.0	9.5	9.0
4.16	4.5	14.5	13	3.0	9.5	9
4.8	6.0	19.0	18	4.5	14.5	13
6.9	7.5	24	21	6.0	19	18
11.5	12.0	37	36	9.0	28	27
13.8	15	46	45	12.0	37	36

1. The maximum 60-cycle voltage at which the arrester can interrupt the power-follow current after a surge discharge and restore itself to an insulator.
2. The maximum voltage at which the arrester begins to discharge on a test wave rising to sparkover voltage in about 10 microseconds. These values are, of course, higher than the average of the test results.
3. The maximum voltage across the arrester during the discharge of a 1500-ampere impulse current of 10×20 -microsecond wave shape. The impulse-current capacity of these arresters is much higher than 1500 amperes. But for an arrester operating under conditions recommended for protection of rotating machines, 1500 amperes is a good test value.

Figure 3

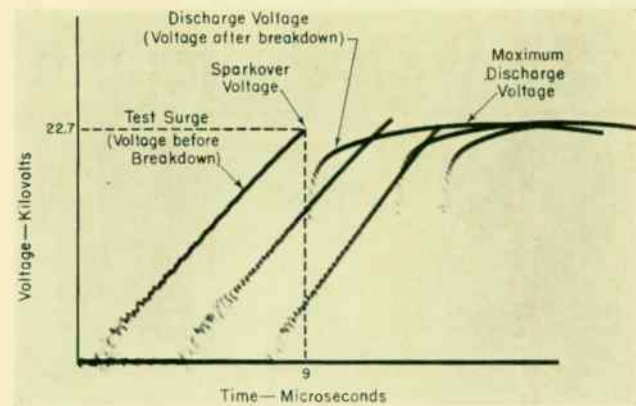
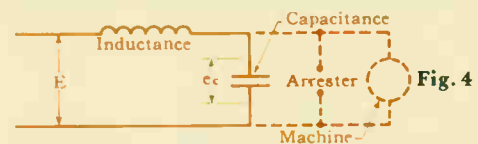

Fig. 3—This oscillogram records the application of three test surge voltages to an SV autovalve arrester. The rate of rise is such that the test voltage reaches sparkover value in 9 microseconds. In the three tests, sparkover occurred at 22.7, 24.0, and 23.2 kv, a variation of only plus or minus 3.0 percent from average. The maximum sparkover permitted in the production test on SV arresters of this type is 28 kv. The traces following sparkover represent the voltages across the arrester after discharge has occurred.

Lightning Protection

by Inductance, Capacitance, and Arresters

The fundamental circuit elements required to protect rotating machines against lightning by reducing the rate of rise of surge voltages consists of an inductance and capacitance in series (Fig. 4). If this circuit is



suddenly energized by a constant voltage E (analogous to a lightning surge) the transient voltage across the capacitor, e_c , rises from zero to a maximum and oscillates about E , as illustrated in Fig. 5(a). The period,

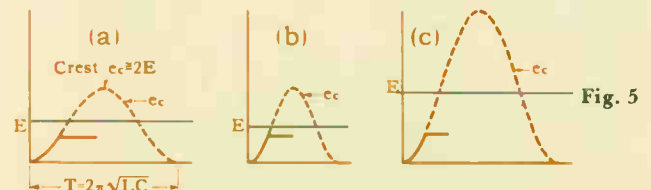

T , of the oscillation is determined entirely by the values of L and C , since $T = 2\pi\sqrt{LC}$. The rate of rise of e_c (and hence of the voltage across the arrester and the machine terminals), however, is dependent not only on T but also on the crest value of e_c . This crest value equals approximately $2E$, assuming no damping, and hence the rate of rise is dependent on the values of L and C and on the magnitude of E . If L or C is decreased and E kept constant, the crest e_c remains the same, but T is decreased, increasing the rate of rise of e_c , Fig. 5(b). If L and C are kept constant and E increased, T remains the same but the crest e_c is increased, again increasing the rate of rise of e_c , Fig. 5(c). Hence, to control the rate of rise of the voltage applied to the machine (through the condenser and arrester) L , C , and E all must be controlled. This controls the voltage between turns of the windings.

The crest voltage impressed on the machine insulation from line to ground could exceed the insulation strength of the machine. To prevent this, the voltage is limited by lightning arresters at the machine to a safe value as indicated by the solid lines of Fig. 5.

Thus, the line arresters, the inductance, and the capacitance limit the rate of rise of voltage and thereby the voltage between turns, and the machine arresters limit the peak voltage to ground. The two effects combine to give overall protection of the machine against lightning.

The Principles and Prospects of Microwave Communication

Traffic congestion is the order of the day, in communication channels as well as on city streets. The growing need of industry for avenues of communication has outrun the available frequencies for short-wave radio and power-line carrier. This has led to the opening of a vast new territory in the microwave region, using tools and know-how gathered in connection with wartime radar.

F. S. MABRY, *Manager of Engineering, Electronics and X-ray Div., Westinghouse Elec. Corp., Baltimore, Md.*

THE lives of people depend on the continuous functioning of public services—gas, oil, gasoline, water, electricity—and these, in turn, rely on continuity of communication. The demands for additional means of communication have become prodigious. In many cases it is impossible or uneconomical to expand further the present types of communication. Fortunately new systems of communication, utilizing microwaves, have been developed and can fill many of these needs.

The Growing Shortage of Channels

Present forms of communication cannot be expanded, or have room for only limited expansion. First, let's look at power-line carrier. Here is a highly reliable communication system. The power line is ruggedly constructed to withstand all kinds of weather and the conductors are almost ideally

Fig. 1—Microwave communication borrows heavily from apparatus developed for radar and kindred wartime electronic systems. At left is a klystron tube for generating small amounts of power at megacycle frequencies, center is a lighthouse tube used at somewhat lower frequencies, and, right, a modern, synthetic crystal.

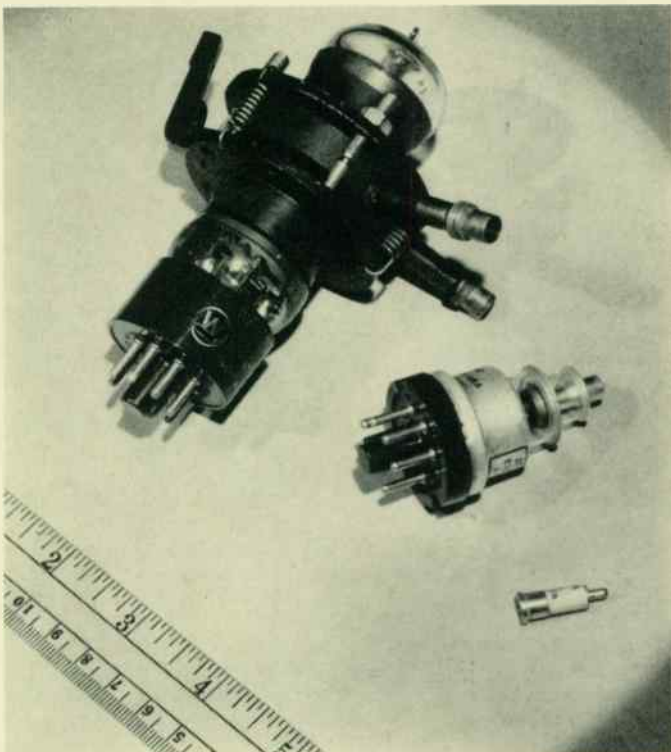

suitable to conduct the lower communication frequencies. The available frequency spectrum is the limitation. Standard power-line carrier apparatus operates in the frequency band of 50 to 150 kilocycles, which means 100 000 cycles of frequency spectrum or bandwidth. Using the most modern single-sideband voice communication carrier with terminals employing the same frequency, which span 4000 cycles of bandwidth for each channel, 25 channels would be the limit. Considering the functions of voice communication, telemetering, load control, supervisory control, and carrier relaying, the number of channels is often insufficient. Power systems are now so interconnected that these channels may have to be divided among several companies, because the interconnections may prevent use of the same frequencies in different parts of the composite system. Furthermore, many systems have grown up using older carrier equipment of the double-sideband, two-frequency type, which uses 15 or more kilocycles of bandwidth per two-way channel. These conditions can be alleviated by using microwaves wherever applicable, generally for shorter distances, and using the power-line carrier for only the longer circuits.

Privately owned telephone lines are limited in their capabilities for carrying additional channels. New lines are expensive not only in first cost but in maintenance. Also, because of the small conductor size and the closer spacing of the wires (as compared to power lines), they are more subject to disabling at the hands of the elements, and therefore are less reliable than the power conductors.

The Federal Communications Commission has recognized that microwaves offer a solution to many of these communication problems and has set aside a portion of the radio spectrum for this use. This section of the spectrum, which covers certain bands of wavelengths between 31 and 4 cm (frequencies between 950 and 6875 megacycles) opens the way to thousands of new channels.

Microwaves and Their Component Apparatus

Microwaves are simply radio waves having a higher frequency or shorter wavelength than most people are accustomed to, or know about. Prior to about 1935, tubes and circuit techniques for producing them were not available. The transmitting tubes, circuit components, and modern know-how techniques are by-products of wartime radar development. Lighthouse tubes, klystrons, crystal mixers, and cavity resonators were actually developed to a high state of perfection during the war. Some are shown in Fig. 1.

A lighthouse tube is a simple triode radio tube having a cathode, a grid, and an anode. It differs from a conventional



Fig. 4—A microwave antenna system for receiving and transmitting. The two 42-inch cones are identical.

permanent as soon as suitable equipment is generally available and commercial application has been made of it.

Characteristics of Microwaves

Microwaves are not reflected from the ionosphere like frequencies below about 50 megacycles. Neither do they follow the curvature of the earth like signals in the broadcast and low-frequency bands. They tend to travel in straight lines. For reliable communication with microwaves, large objects must not intervene between the transmitting and receiving antennas. Desirable antenna heights for different distances are shown in Fig. 5. The line-of-sight path between the two antennas preferably should not even graze the surface of the earth at intervening points. A clearance of 50 feet or more is desirable, and Fig. 5 includes this allowance. This clearance minimizes the amplitude of the variations in signal strength or fading due to storms or reflection from the earth.

In actual application, advantage should be taken of hills or high buildings to achieve the antenna heights required. The Bell Telephone Laboratories have conducted extensive tests on the reliability of microwave transmission and have concluded that "a high degree of reliability is practicable provided due allowance is made for the variations in the transmitting medium."³ These tests showed that the longer microwaves were most stable and somewhat less subject to

Fig. 5—Height required for antennas for line-of-sight operation over different distances. They allow 50 feet for ground clearance.

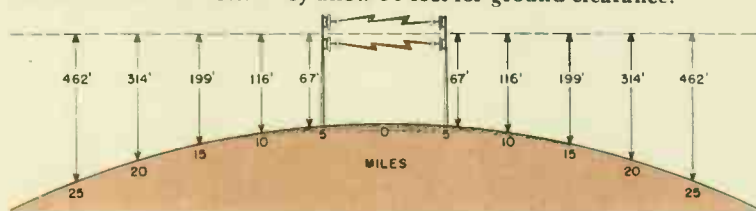

variations in the medium. By providing adequate transmitting power and using automatic gain controls in the receiving apparatus, strong and stable signals are received under all conditions.

Because of the short wavelength of microwaves, relatively simple antennas can be constructed that transmit them in a beam similar to the beam of a searchlight. The simplest method is to arrange the antenna at the focal point of a parabolic metal reflector. The diameter of the reflector mainly controls the size of the beam—the larger the reflector the narrower the beam. Other factors, such as evenness of "illumination," also have an effect. For example, Fig. 4 shows a typical parabola, 3.5 feet in diameter, that produces a beam only 20 degrees wide at 960 megacycles. To create a beam of this size in the broadcast band, say at one megacycle, would require a "dish" 2700 feet in diameter. Concentrating the energy into a beam is equivalent to increasing the power of the transmitter by a factor equal to the gain factor of the antenna and increasing the sensitivity of the receiver a like amount. Therefore, only a few watts of power are required for a communication circuit in the microwave bands. Many microwave channels in television relaying systems transmit powers of only a few milliwatts.

Both natural and man-made static is practically non-existent in the microwave bands. This is due partly to the use of small antennas, which are not readily influenced by electrostatic disturbances, and also to an absence of microwave frequency components in static discharges. The principal source of noise is in the receiving equipment itself, and is insufficient to concern the user. In any commercial equipment with suitable antenna and installation, the power output of the transmitter is sufficient to override receiver noise by a comfortably wide margin, even over the upper limit of distances indicated in Fig. 5.

The Mechanics of Microwaves

A typical microwave link serving four telephone lines at each terminal is depicted in Fig. 6. One cabinet houses the microwave transmitter, receiver, and power supply. Another cabinet houses the multiplexing or signal-combining equipment, and a third contains the telephone-line terminating apparatus. Separate antennas are used for transmitting and receiving. Where distances greater than line of sight are to be covered, the same kind of equipment can be used as a repeater.

When more than one conversation or other types of similar signals are trans-

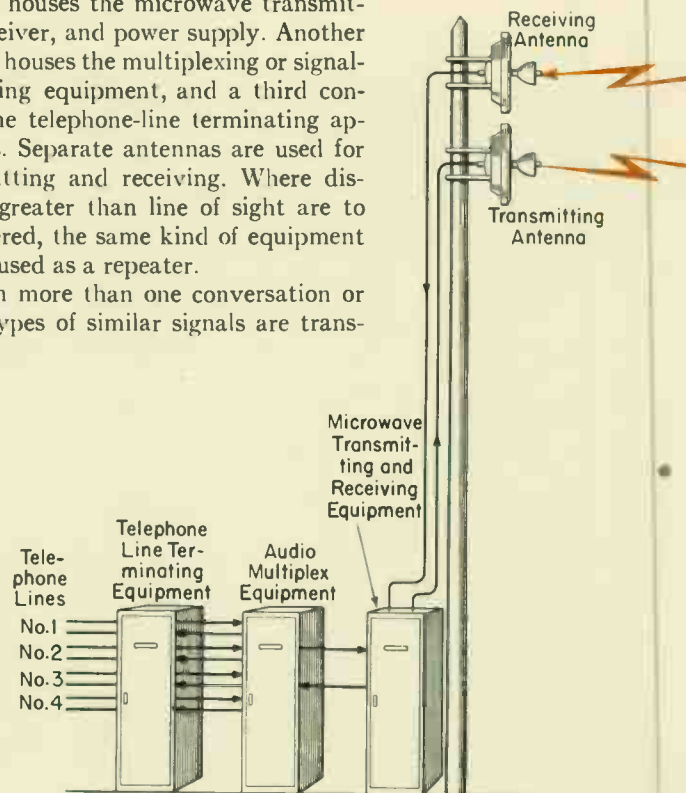

WESTINGHOUSE ENGINEER

mitted simultaneously over a single pair of wires or over a single radio-frequency carrier, the circuit is said to be "multiplexed." To prevent cross-talk, or interference between them, it is necessary either to (a) share time among them or (b) share frequencies, i.e., convert all but one of the various conversations to new frequencies separated in the frequency spectrum. The equipment that performs this function is called multiplexing equipment. Equipment employing scheme (a) is called time-sharing, time-division, pulse-time, or pulse-code multiplex. Equipment using scheme (b) is called frequency-division multiplex.

Where less than eight channels are required over a single microwave link, frequency-division multiplex appears to be more economical than time-sharing methods. It also spans less of the microwave spectrum. Where eight or more channels are required, one or more of the time-sharing methods appears to be more economical.

The multiplex scheme depicted in Fig. 6 is the frequency-division type. Equipment for four channels is shown although the capability of the system is seven. Just how this scheme works is shown in Fig. 7. Carrier frequencies of 8, 12, 16, 20, 24, and 28 kc are generated within the equipment. These are, in turn, modulated by the various signals to be transmitted, in a manner that eliminates the carrier and upper sideband from the output. The various outputs are then connected in parallel and the resulting complex wave is used for frequency modulation of the microwave carrier. At the receiving end the process is reversed and the signals are reconverted to their original form.

In time-sharing multiplex, the voice-frequency (or other) signals of the various channels are sampled or examined individually several thousand times a second. The amplitude of the signal at the time of sampling is used to control some characteristic of a pulse, such as position or amplitude, with respect to a reference value. With a pulse-repetition rate that permits each signal to be sampled at a frequency several times the highest frequency contained in that signal, the

original wave can be reconstructed from the received series of pulses with negligible loss of fidelity.

The telephone-line terminating apparatus shown in Fig. 6 consists of hybrid coils, line-balancing networks and ringing equipment, and line amplifiers when necessary. The hybrid coils, or transformers as they are called, provide the ratio arms of an impedance-bridge circuit used to separate the outgoing from the incoming signals. Line amplifiers merely raise the level of the signals to

suit the overall signal level requirements for the particular appreciation.

Microwave communication offers several distinct advantages over other forms. Paramount among these is channel reliability. It does not depend on continuity of power lines, pilot wires or telephone circuits between the two points. All of the elements involved can be located at the terminals, where routine inspection and maintenance can be performed readily. Due to the directivity of the antennas, the line-of-sight characteristic and the spectrum space available, they offer great freedom from interference. Where communication is needed in highly industrialized areas or cities, the cost of digging up streets or stringing lines required for other forms of communication can be avoided.

Large-scale application of microwaves will probably be made in the near future. Most of this will be in the 952 to 960 megacycle band, for two principal reasons. Frequencies in this band are more stable in their transmission characteristics, that is, they are least affected by fading, weather, etc. The equipment for this band is simpler and more closely related to techniques employed in equipment for lower frequencies.

Uses of Microwave Communication

Some of the contemplated uses of microwave point-to-point communication are as follows:

1—*Power radio service* includes those activities concerned with generating, transmitting, collecting, purifying, storing, or distributing by means of wire lines or pipelines, electrical energy, artificial and natural gas, water and steam for use by the public or by the members of a cooperative organization.

2—*Petroleum radio service*, having to do with prospecting for, producing, collecting, refining, or transporting by means of pipelines, petroleum or petroleum products.

3—*Forest-products radio service*, such as for lumbering, tree farming, and related woods activities for the purpose of forest protection, safety of life and property, and efficiency of operations in remote areas where other means of communication are not available.

4—*Special industrial radio service*, which applies to all commercial or industrial operations that are predominantly rural in nature; commercial and industrial operations in which an element of hazard to life and property can be mitigated by radio communication; industrial or commercial operations that react directly on the public welfare or safety; and those services bearing on public health or well-being.

5—*Land-transportation radio service*, such as intercity buses and trucks, railroads, cabs, and urban transit systems.

6—*Public-safety radio services* where spare radio communication is essential to either the discharge of governmental functions relating to the public safety or to the alleviation of an emergency endangering life or property. These include police service, except international; fire service; forestry service; highway-maintenance service; and special emergency service.

¹See "The Klystron—Radar-Receiver Oscillator," by Dr. Sidney Krasik, *Westinghouse ENGINEER*, November, 1946, p. 176.

²See "Radar Receivers and Crystal Rectifiers," by Dr. S. J. Angello, *Westinghouse ENGINEER*, March, 1947, p. 54.

³"Microwave Propagation Tests Over 40-Mile Overland Path," by A. L. Durkee, February, 1948, Proceedings of the I.R.E.

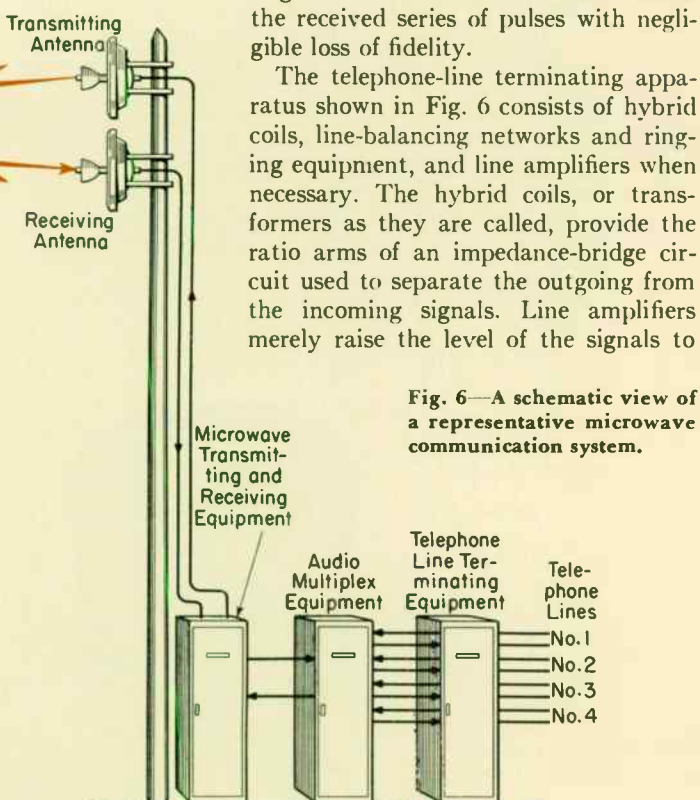
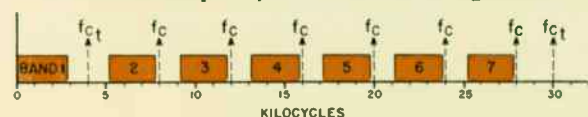

Fig. 6—A schematic view of a representative microwave communication system.

Fig. 7—Frequency spectrum of multiplex apparatus with carrier-frequency and bandwidth assignments.



What's NEW!

More Push for Earth Moving

THE record-size dipper on excavating shovels is rated 46 cubic yards, equivalent to about 60 tons of earth. This dipper is being used on a large Marion shovel, whose earth-moving ability was recently increased simply by making minor changes in the control equipments.

The shovel was placed in service five years ago by Hanna Coal Company for stripping the overburden from its surface mines. At that time its hoist operation was fast enough to meet production requirements. But as the demands increased and faster shovels were used, the need of speeding the hoist motion became apparent. The problem of how to do this without overloading the hoist motor, Rototrol, or other controls fell to Westinghouse Rototrol engineers, W. R. Harding and R. V. Lamb, who came up with a surprisingly simple solution. Essentially, it consists of adding another field (by changing two coils) to the Rototrol of the hoist generator and changing some control elements. This raises the level of hoist-generator voltage during hoisting and hence the speed of the motor. The resultant increase in the

The huge shovel (below) aided by the 46-yard dipper (left), new control elements, and new windings in the vertical-shaft Rototrol (right), is expected to move a million tons of earth per month.



quantity of earth moved per day is possible only because the generator and motor were not being worked to the limit of their thermal capacity. Furthermore the new field provides a wider range of voltage control at no load (from 100 to 600 volts instead of the previous 450 to 600 volts), which gives more precise control at light loads.

One of the tricks of the problem is to increase power in the hoisting direction but not in the lowering direction, to prevent the overhauling load from exceeding the capabilities of the rotating equipment. This is accomplished by utilizing the directive characteristics of a Rectox rectifier, connected across part of the hoist-generator field resistance. To change the direction of the hoist motion, the generator field current is reversed. During hoisting the rectifier acts as a short circuit, but during lowering it acts as an open circuit. Thus, in the hoisting direction, part of the field resistance is short circuited and consequently the generator delivers more power than in the lowering direction. A rectifier is better than a contactor for such operation, as it has no moving parts and requires no maintenance.

Tiny "Lungs" Help Ships Breathe

AT THE war's end the Navy decided to put many of its vessels in "cold storage," so that they could be reactivated quickly, but would not have to be kept active continuously. Compartments were completely sealed off, with the result that some means of "breathing" was necessary to prevent corrosion due to condensation of moisture in the air. The solution to this problem was found in tiny centrifugal fans that act as the lungs of the ship. The breathing is accomplished through a dehumidification material that reduces the humidity in the air to 30 percent or less, sufficient to prevent corrosion due to moisture. When the material has absorbed its maximum amount of moisture a timing mechanism operates a valve and an electric heating coil, and air is drawn by the tiny blower from outside the compartment. This air is passed through the heating coil and then through the absorbing material, thus effectively drying the material. Dehumidification then continues.

The fan unit consists of a 3-inch-diameter by 2-inch-wide centrifugal-type Multivane fan driven by a 1/100-hp, 3000-rpm motor. To date about 4000 of these units have been used by the Navy in their "lay-away" program.

These miniature blowers have found several other unique applications. One is in the manufacture of pretzels. After the dough has been formed into a pretzel shape, a small ventilation set directs a blast of air on it to "case-harden" it, allowing it to be handled more easily without distortion of shape. This blower is also used in many instances to cool radio transmitting tubes.

The complete dehumidifying unit used in removing moisture from ships in the Navy's "mothball fleet." The centrifugal fan at the top "breathes" through the moisture-absorbing material below. (Photo by courtesy of the Dryomatic Corporation of America).



WESTINGHOUSE ENGINEER



← THIS king-size needle valve (left) is being used to regulate the flow of water at the Bureau of Reclamation's Friant Dam near Fresno, California. In operation, the complete valve will be in the horizontal position and will pass almost a million gallons of water a minute. The assembled valve weighs 120 000 pounds and the needle alone, 20 000 pounds. The valve is rated 86 inches, the diameter of the penstock connection. In the photo, the nozzle, out of which the water is permitted to flow, is being lowered over the cone-shaped needle, onto the valve body. The gate valve (right) is larger still . . .

. . . It weighs 200 000 pounds and is over 47 feet high. The valve has two similar sliding gates, one for service and the other for emergencies. The vertical cylinders at the top house hydraulic pistons for raising the gates. The horizontal tank in front of the gate housing is a vent that prevents collapse of the structure by the vacuum that would otherwise form when water has drained from 4 by 12-foot conduit. Sixteen of these valves will be used at the Bull Shoals Dam in Arkansas. When installed, they will pass enough water yearly to cover 5½ million acres of land with one foot of water. →

What's NEW!

THE junior member of the motor-driven d-c welder family, appropriately christened the Ranger, Junior, is shown (right) with standard accessories. A light-duty, light-weight welder, it is rated 200 amperes at 50 load volts and a 50-percent duty cycle. Its welding current is quickly adjustable over the range from 30 to 260 amperes in four major steps, with intermediate values obtained by rheostat control of the generator field. The generator is wound with class-B insulation throughout and is connected in series with a reactor that insures complete arc stability. The Lifeline driving motor is built for either 220 or 440 volts, 3 phase, 60 cycles, and is controlled and protected by an integral, manually operated De-ion circuit breaker. The welder, which is of drip-proof construction and employs sealed-for-life ball bearings, is available in both portable and stationary models. The Ranger, Junior has an older engine-driven brother of the same rating and similar construction.

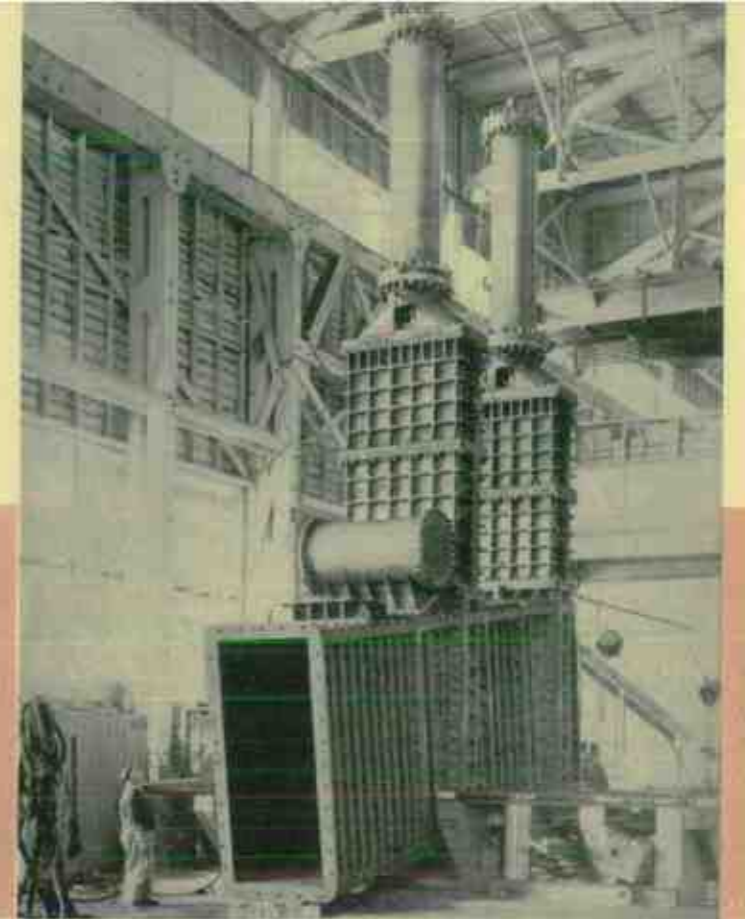

THE large and small of the poly-phase Lifeline motor family appear at right. At far right is the 203-frame motor, rated 1 hp at 1750 rpm. At left is a 682-frame motor, rated 350 hp at 1160 rpm. The largest contemplated at present is a 684H frame, rated up to 700 hp at 3600 rpm for continuous duty. One of the largest Lifeline motors in operation is the 600-hp, 3600-rpm motor (below) driving a boiler feed pump in a Southern utility. It is of drip-proof construction, rated at 40-degrees-C rise, and is assembled in a size-583H frame.



TWO cranes team up to lower this 587-ton rotor into the stator of a 108 000-kw waterwheel generator at Grand Coulee Dam, which is located on the Columbia River in Washington. This generator, one of ten similar machines, is now on the line. When all of the 18 machines intended for the project are in operation, their combined capacity will be approximately 2 000 000 kw, or over 3½ percent of the total in the U.S.

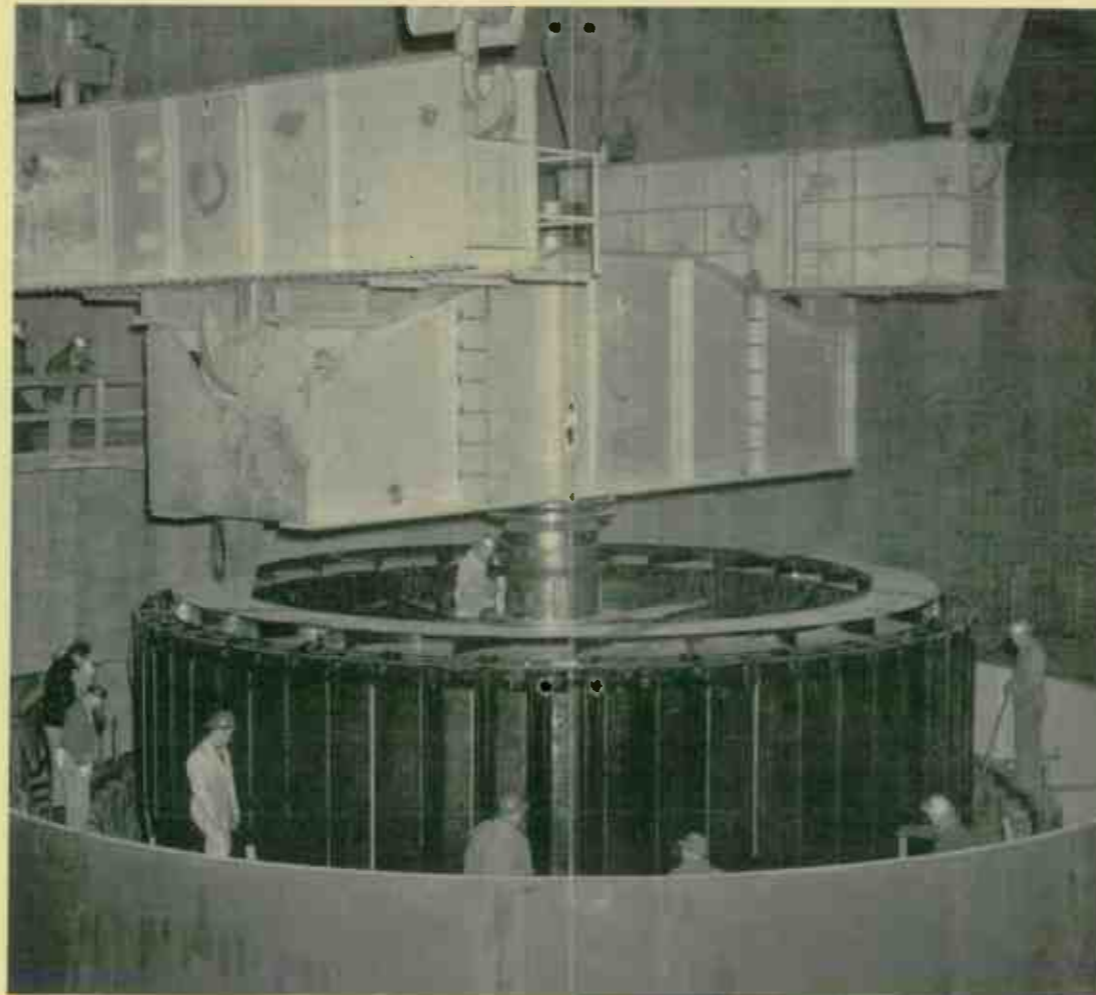

THIS well-lighted racetrack near St. Louis illustrates the trend to higher illumination of night events. Five hundred 1500-watt lamps, each in an 18-inch reflector, provide an average intensity of 25 foot-candles around the track and 30 foot-candles on the home stretch. . . . Indicative that heavy industry has come to the West Coast is this giant vacuum tank in the Westinghouse plant at Sunnyvale, Calif. Here the tank, which measures 15 by 10 by 16 feet deep, is being prepared to impregnate the core and coils of a 16 000-kva transformer.

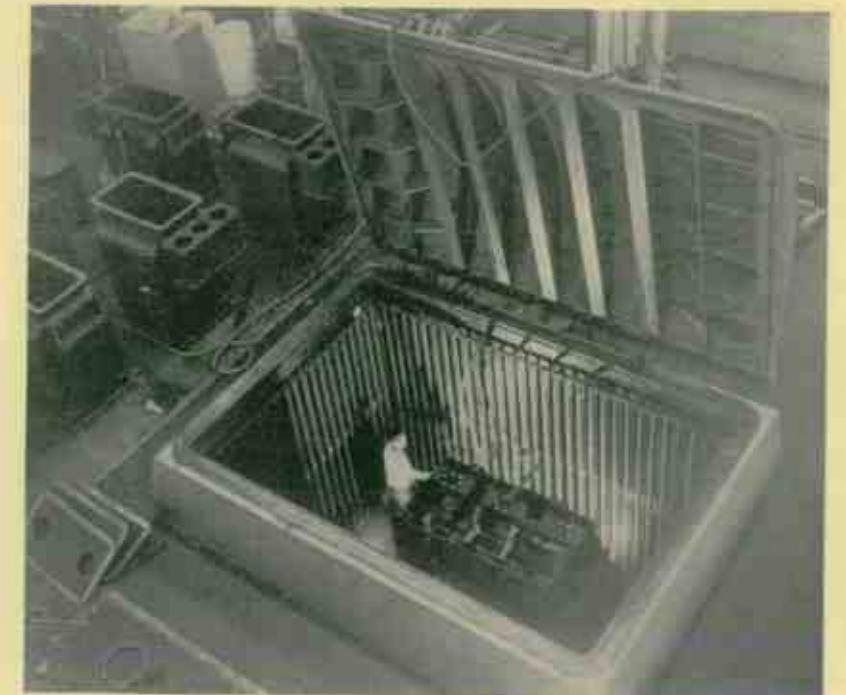
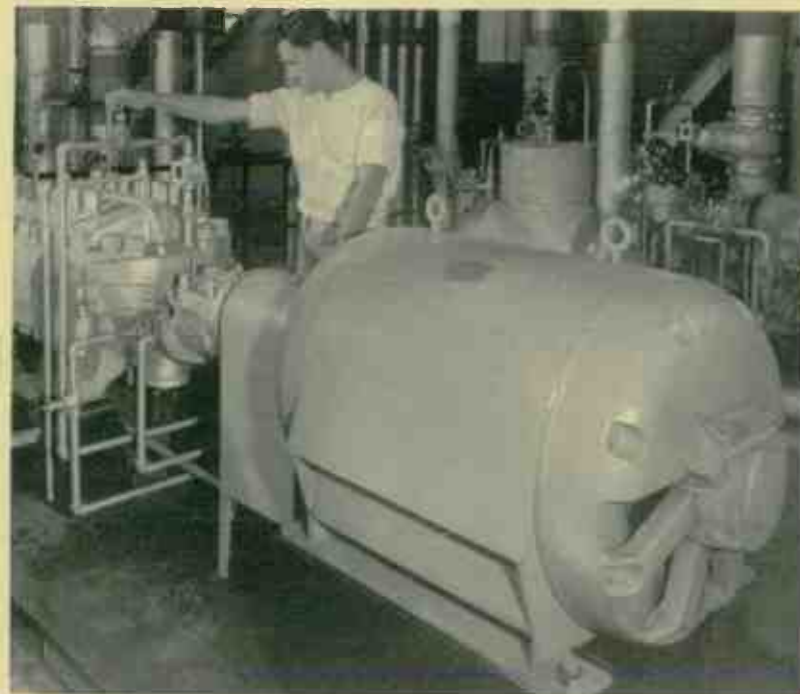

Modern Distribution Substations— A Growing Trend

Distribution-substation designs are as numerous as ants at a picnic. An analysis of distribution problems shows that in modern systems no more than a handful of simple, easy-to-maintain, factory-assembled designs would fulfill nearly all distribution needs.

JOHN S. PARSONS, *Distribution Engineer, Westinghouse Electric Corporation, East Pittsburgh, Pa.*

IF POWER distribution systems had continued their former trend of growing more and more complex the mechanics of the systems might some day have proved to be too much for the human mind to follow. Fortunately, for about the last twenty years the trend has been toward simplification and flexibility in these systems and associated equipment. Nowhere is this more evident than in the design of modern distribution substations.

The distribution substations of the 1920's were relatively large. Their firm capacity, which is the capacity of the station with one transformer or one subtransmission circuit out of service, was usually from 10 000 to 40 000 kva. These substations used both high-voltage and low-voltage buses, and often one or both of these employed transfer or double-bus construction. Distributing such a large amount of power from one location usually makes it necessary to use individual-feeder regulators in the substation on most, or all, of the primary feeders. Many of these large substations—most of which were designed over twenty years ago—are still in operation today.

Factory-Assembled Substation Idea Gains Acceptance

The first factory-assembled unit substations were developed

in the early 1930's in connection with the primary-network system. During the last fifteen years the gradual tendency has been toward smaller and simpler distribution substations in both network and radial systems. Recently many have been completely factory built, and the trend in this direction is gradually increasing.

The design of a distribution substation is affected by the type of subtransmission used to supply it. Grid, or network subtransmission, commonly used to supply the large distribution substations of the past, is slowly being supplanted by the simpler radial and loop types of subtransmission, which results in simpler distribution substations. This simplification is reflected in the absence of high-voltage buses and the decreased use of high-voltage circuit breakers in most modern designs. Three-phase transformers and bus regulation, rather than individual-feeder regulation, are becoming more common. Bus regulation is made practical by the relatively small firm capacity (usually less than 5000 kva) of the substations and by increasing density in load areas. Ordinarily bus regulation is provided by automatic tap-changing-under-load equipment on the three-phase transformers.

Wide acceptance of factory-assembled substations was slow, primarily because they offer the greatest advantage

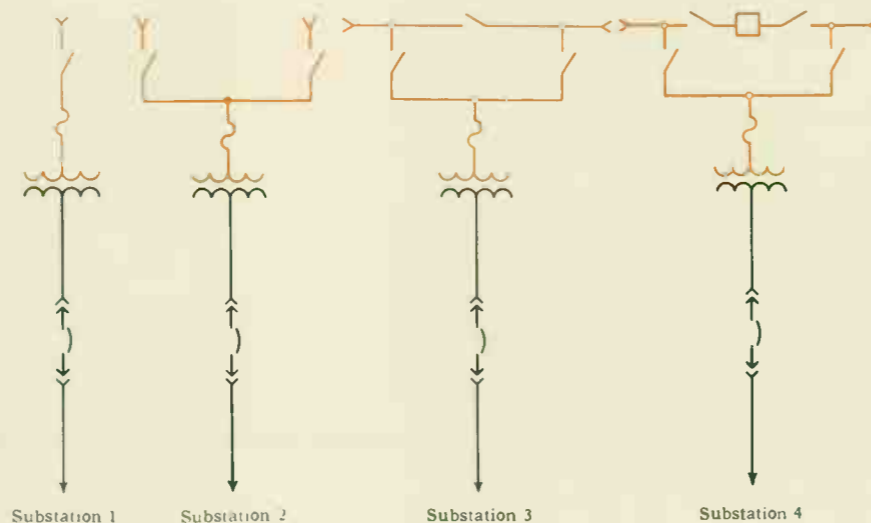
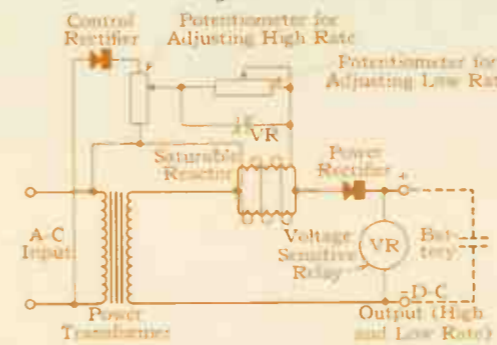

Fig. 1—Four variations of a single-feeder substation. Substation 1 is supplied by a single radial subtransmission circuit; Substation 2 is supplied by either of two radial subtransmission circuits; Substation 3 is supplied by a manually sectioned loop or tie circuit; Substation 4 contains a high-voltage circuit breaker to sectionalize automatically its subtransmission loop or tie circuit when necessary.

Easily Controlled Battery Charger



By incorporating a saturable-core reactor for control, this new battery charger provides stepless adjustment of both high and low charging rates and operates with a higher efficiency.

CONTROL with an ease comparable to that of tuning a radio is one of the features of a new family of chargers for industrial truck batteries. A new type of control eliminates previous schemes of adjustment by tap changing, and increases efficiency.

Chargers for truck batteries have long required a multiplicity of adjustments to enable the charger to handle the wide variety of cell combinations and capacities employed in industry. Lead-acid batteries require two charging rates, a high rate (at which charging is initiated) and a low rate (at which, to prevent gassing, charging is finished). Both must be controllable. In preceding units, rates were fixed by changing taps on a transformer, reactor, or resistor. In the new family of chargers, the entire high and low ranges are covered in infinitely small steps simply by twirling two small potentiometer knobs.

This flexibility is made possible by a saturable reactor, a variable inductance whose a-c impedance is controlled by a saturating coil energized by a small amount of direct current. This control current, which is supplied by a small rectifier, is adjusted by the potentiometer rheostats. At higher control currents, the reactor core is closer to saturation. The inductance and impedance of the a-c coils is therefore lower and the charging voltage higher. Hence, by means of the potentiometers, high and low rates are adjusted between the minimum and maximum. The charger is switched from high to low rate by a sensitive voltage relay that operates when the battery reaches the proper voltage. Along with ease of control, reactor adjustment is more efficient than resistor adjustment because of I^2R loss in the latter.

The new chargers are available for either lead-acid or nickel-iron-alkaline batteries, which are completely charged at a single high rate. Such chargers can be converted for lead-acid charging, however, simply by adding a plug-in relay unit.

The "A-V" Drive

THE granddaddy of all adjustable-voltage, adjustable-speed drives, is the combination of an a-c to d-c motor-generator

set and a shunt-wound d-c motor. Yet, because of the flexibility it offers in meeting the myriad requirements of modern high-speed industry, its use has steadily increased.

A modern version of this scheme, the A-V drive, adds to its flexibility. The new drive is built in ratings from 1 to 25 hp, all with standard motors of any enclosure, and in three standard speed ranges: 8 to 1 (by control of generator voltage alone) and 12 and 16 to 1 (by control of both generator voltage and motor field.) The potentiometers for voltage and field control are mechanically linked so that the motor armature voltage is raised to a maximum before the motor field is weakened. This sequence gives minimum heating, maximum efficiency, and maximum horsepower availability at all speeds.

A standard feature of the new drive is regenerative braking on speed changing and stopping; such control is very useful in many industrial applications. It is accomplished by using the motor-generator set as a braking load. The control equipment for the new drive is built in unit assemblies so that the additional features of reversing or jogging can easily be added. Jogging speed can be adjusted to any value between the minimum running speed and that corresponding to full generator voltage. This adjustment is accomplished by changing the setting on a potentiometer with a screwdriver.

Another unusual feature of the A-V drive is its electronic exciter, instead of the usual rotating type. Actually, two exciters in a single assembly are used, one each for generator and motor. Electronic excitation, supplied by thyratrons, is advantageous in that it is more compact and more flexible. It permits use of circuits that give closer regulation of speed or load.

The operator's control station houses the pushbuttons and speed-adjusting potentiometers required for manual control. The potentiometers are identical for all ratings.

The m-g set, the control equipment, and the exciters are housed in an attractive metal cabinet with hinged front doors and removable rear panels. The m-g set is of all-steel Lifeline construction with pre-lubricated, sealed-for-life ball bearings. All ventilating air to the m-g set is cleaned of dirt by replaceable Fiberglas filters. The base of the cabinet is the foundation of the m-g set. Rubber pads between the common feet of the motor generator and the base provide a resilient mounting that minimizes vibration.

This 10-hp A-V drive on a lathe consists of a control cabinet, a standard driving motor, and a pushbutton station. The cabinet is the smaller of the two sizes used for the range of ratings from 1 to 25 hp. The pushbutton station (right) contains the potentiometers for speed control.

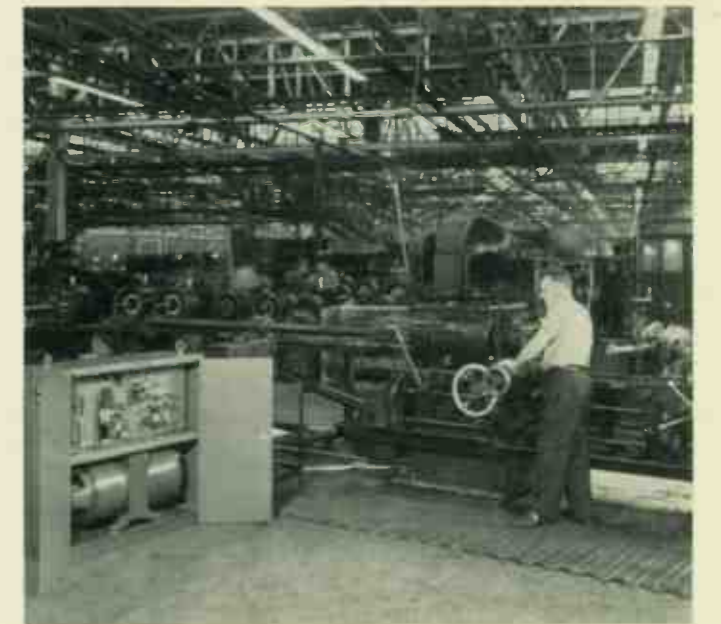

when employed in a modern, simplified distribution system. Modernizing most distribution systems is a long process, so only within the last few years have these simplified substations been applied generally.

Necessary Types of Substations

A great many factory-assembled substation designs are now available. These meet any distribution needs, either real or anticipated. Such a large number of designs, however, is not to the best interest of either the manufacturers or users of substations. A relatively small number of substation designs satisfactorily meets the present and future needs of modern distribution systems. Standardizing on these few designs would be an important step in lowering distribution costs. The following types of distribution substations meet practically all needs in providing adequate electric service at the lowest overall cost.

The *simple single-feeder substations* illustrated in Fig. 1 are ordinarily used to supply small towns, rural lines, and small or medium-size industrial plants. They are also frequently used on the edges of large substation load areas to relieve bad voltage conditions by taking over parts of long, heavily loaded feeders and their loads. The four are similar except for the high-voltage switching, which is influenced by the type of subtransmission supply. Each consists of a three-phase, tap-changing-under-load transformer, a disconnecting-type, metalclad air circuit breaker for the control of the primary feeder, a set of high-voltage fuses or protective links, and some form of high-voltage switching.

Substation 1 (Fig. 1) is supplied through a high-voltage switch by a single subtransmission circuit, either a radial circuit or a radial tap from a loop or tie circuit. This switch is of either the load-break or disconnecting type. When a disconnecting switch is used it must be capable of breaking the transformer magnetizing current, and should be interlocked with the primary-feeder breaker to prevent its being called on to interrupt load current. This substation is only as reliable as the single subtransmission circuit serving it. To improve reliability, a second subtransmission circuit is often

used. Both are connected to the transformer through a high-voltage selector switch or two disconnecting switches as shown in Substation 2. One circuit provides the normal supply; when it fails, the substation is manually connected to the other. When a selector switch is used it should be of the load-break type, or of the disconnecting type properly interlocked to prevent opening load current.

Two parallel circuits, as in Substation 2, provide satisfactory normal and emergency supply to a substation if they are in cable or on separate pole lines. Thus, when reliability greater than that of a single open-wire circuit is required, two parallel cable circuits are taken to the substation, usually over the same route, or two open-wire circuits are taken to the substation over separate routes.

Many distribution substations are supplied over two separate routes from open-wire subtransmission loops or tapped ties. A single-feeder substation thus supplied (Substation 3) is tapped to a single section of a loop or tie subtransmission circuit supplied from both directions. Manually operated, high-voltage air-break switches permit the circuit to be sectionalized and service restored over unfaulted portions. The subtransmission circuit can be sectionalized automatically at the substation by a high-voltage circuit breaker as shown in Substation 4. This permits the transformer to be connected to either of two sections of a loop or tie subtransmission circuit, and thus prevents a failure of the normal power supply from also interrupting the emergency supply. When the normal power supply fails, the substation transformer is manually connected to the emergency section of the subtransmission circuit on the other side of the high-voltage circuit breaker, by a high-voltage selector switch or the two disconnecting switches shown. When a selector switch is used, it is similar to that described in connection with Substation 2.

The *primary-network substation* (see Substation 5, Fig. 2) is a popular type used in both radial and primary-network systems. This bus-regulated substation utilizes a single three-phase transformer and is supplied from only one subtransmission circuit when used in a primary-network system. The transformer is connected to a single low-voltage bus, which

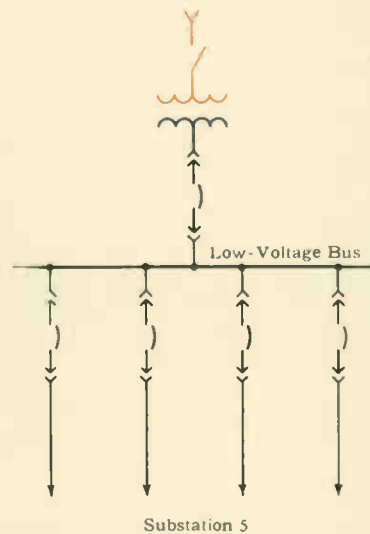
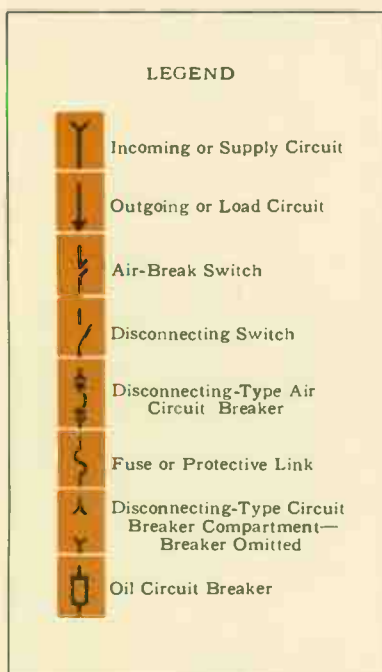
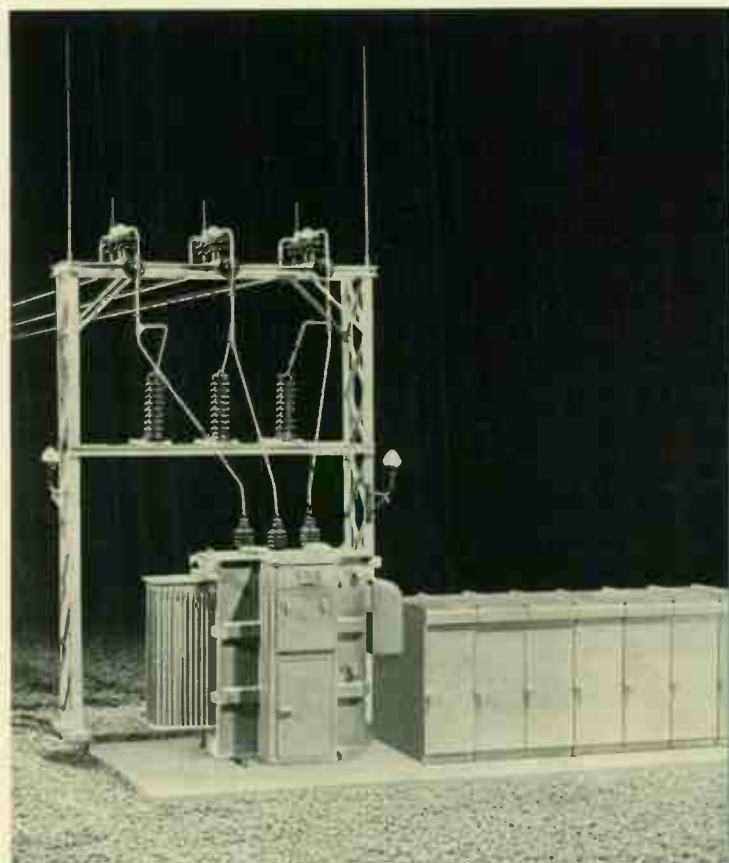

Fig. 2—The usual primary-network type of distribution substation; it can also be used in radial systems.



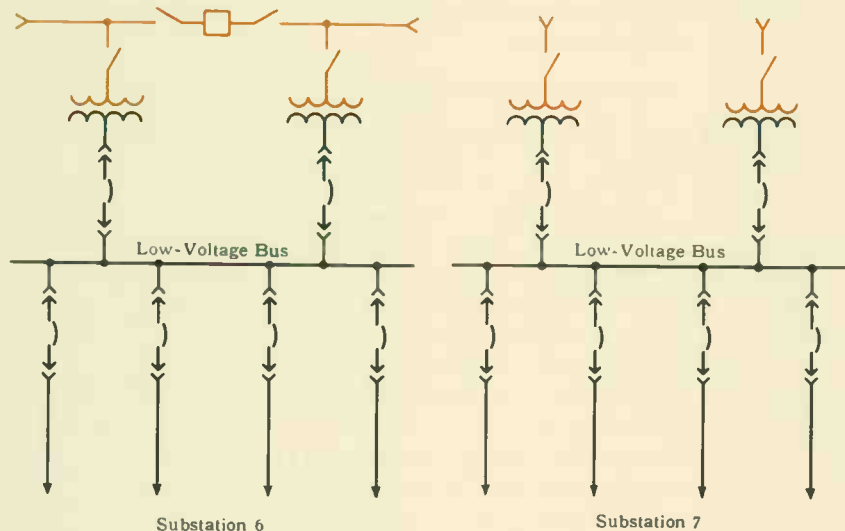
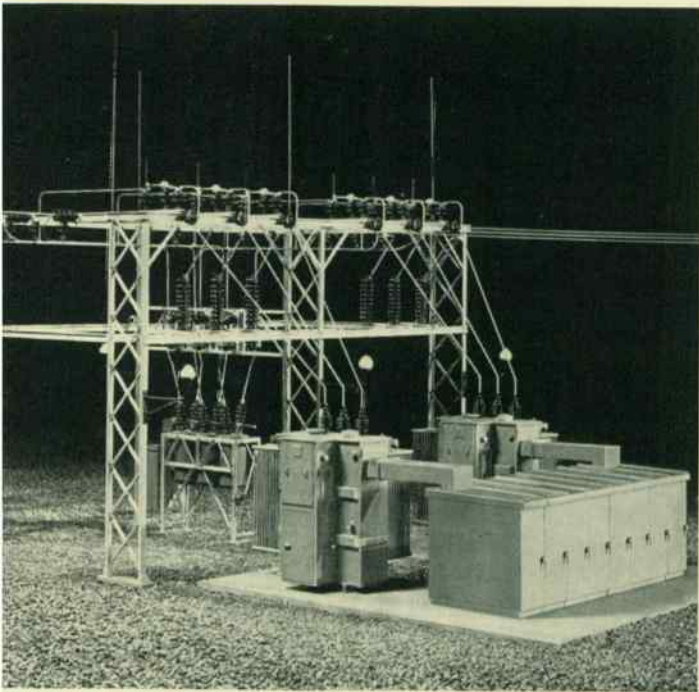

Fig. 3—The spot-network type of substation. Substation 6, used in radial systems, is supplied from an automatically sectionalized loop subtransmission circuit. Substation 7 is supplied over two radial subtransmission circuits.

is in turn connected to other low-voltage buses in similar primary-network substations by network tie feeders. The tie feeders are connected to the substation bus through primary-feeder breakers. These breakers and the transformer breaker are of the metal-clad disconnecting type, which permits quick removal from service for maintenance. A transformer breaker is always used in a primary-network substation to disconnect a faulty transformer or subtransmission circuit from the system without opening the primary grid.

Under normal conditions in a primary-network system any transformer or tie-feeder breaker can be removed for maintenance without interrupting load. Normally, current has two paths to all load taps, so the network tie feeders provide emergency supply to the substation's load when the normal supply is interrupted for maintenance or because of a fault in the substation transformer or its subtransmission circuit. Adjacent primary-network substations are fed from different subtransmission circuits so that network tie feeders function satisfactorily as the emergency supply when a subtransmis-

sion circuit is out of service.

Perhaps the best distribution substation for application in radial systems is the *two-transformer, bus-regulated substation* in Fig. 3. Except for the high-voltage switching, the two shown are the same. This spot-network substation, used in a radial system, renders practically the same quality of service as a primary-network system. This and the primary-network type best meet distribution needs in urban areas. The two tap-changing-under-load transformers in the spot-network substation normally operate in parallel to supply the radial primary feeders. Usually one transformer is supplied from one open-wire subtransmission-loop section, and the other from a different section using the high-voltage switching arrangement of Substation 6. If the subtransmission supply is from two radial cable circuits, the high-voltage circuit breaker is omitted as in Substation 7. When a transformer or subtransmission-circuit fault occurs, the proper high-voltage breaker, or breakers, and the associated transformer breaker disconnect the faulty portion of the system, includ-

Figure 5

Fig. 5—The double-bus spot-network type of substation. Substation 10 is supplied over two radial subtransmission cable circuits. Substation 11 has a high-voltage circuit breaker to automatically sectionalize its subtransmission loop or tie circuit.

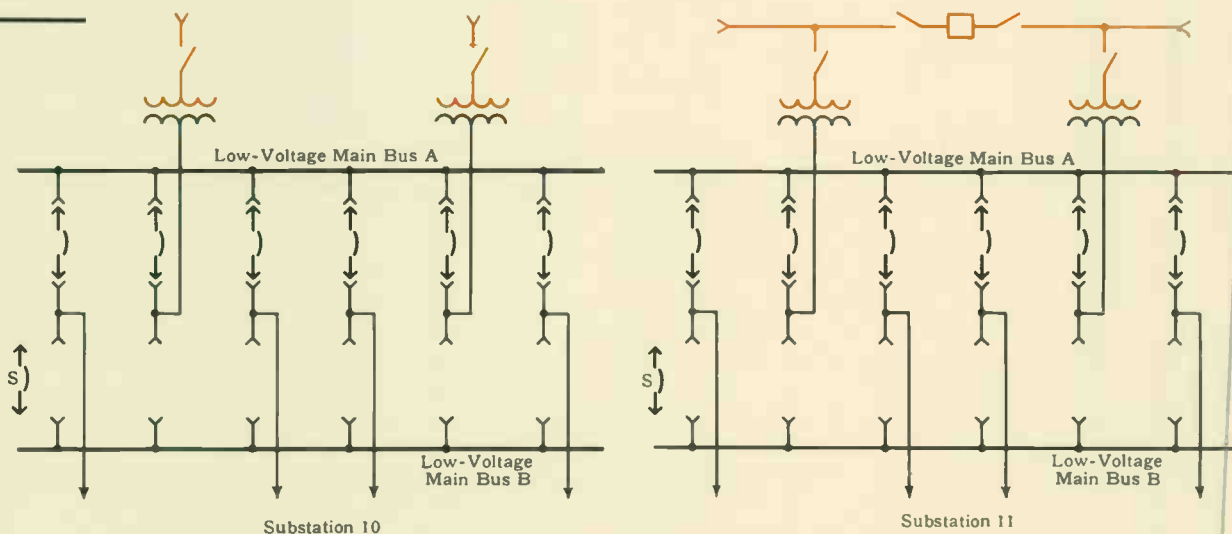

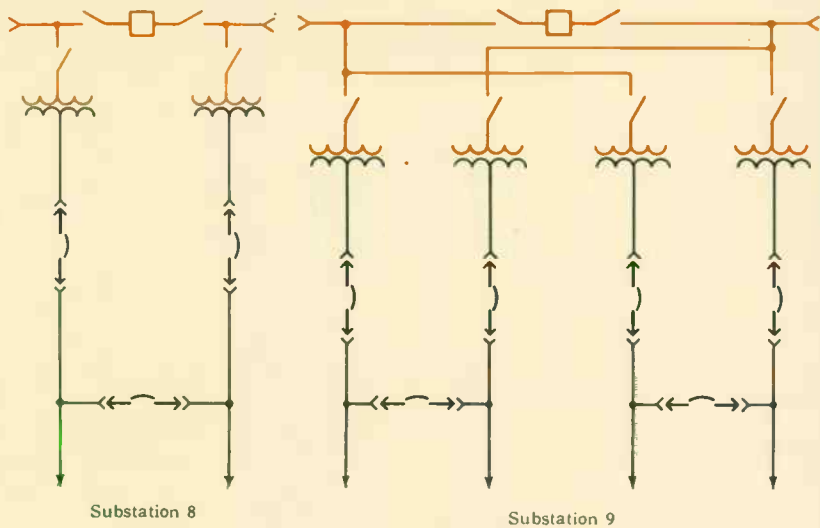
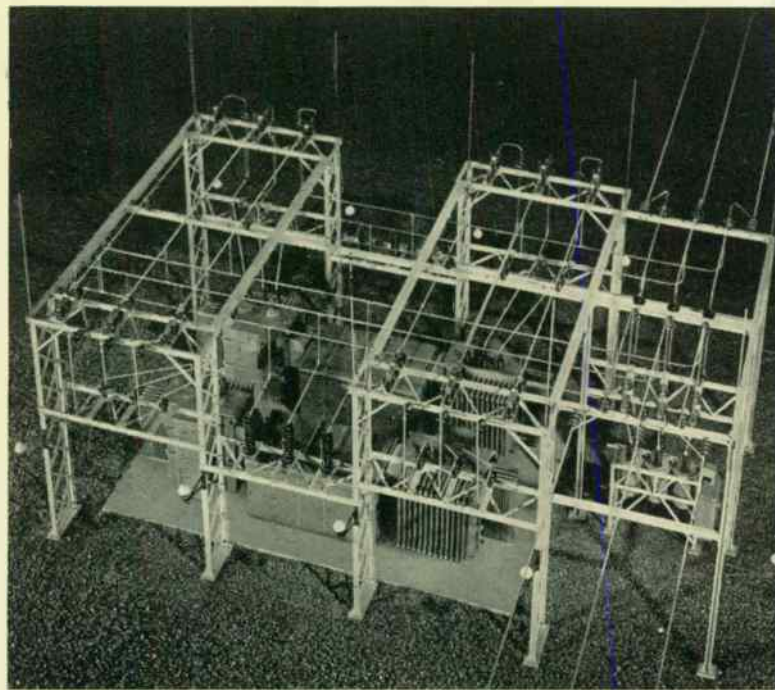

Fig. 4—Two types of substations with individual voltage regulation on each primary feeder. Substation 8 has individual regulation of each of its two primary feeders, Substation 9 on each of its four primary feeders.



ing one transformer from the substation. The remaining transformer carries the substation load without service interruption. Both transformers are equipped with automatic forced-air cooling, which operates only when one transformer is out of service. The firm rating of the substation is the load one transformer can safely carry over one or two peak-load periods with its fans in operation (about 1.65 times the self-cooled rating of one of the transformers).

Either transformer or transformer breaker can be maintained without service interruption. Disconnecting-type circuit breakers permit maintenance of any primary-feeder breaker with only a brief interruption of its load. The physical arrangement of these stations permits easy addition of primary-feeder breakers or replacement of the original transformers by larger ones. When the two transformers are located at the opposite ends of the row of metalclad switchgear, much of this flexibility is lost, since a transformer must be moved to make additions to the station.

Individual primary-feeder regulation is desirable, or es-

sential, in some distribution systems. Substations with such provision are in general considerably more expensive than bus-regulated substations. A desirable *feeder-regulated substation* for radial systems, Substation 8 (Fig. 4), has each transformer provided with tap-changing-under-load equipment. The low-voltage tie circuit breaker is normally open. When a transformer or subtransmission fault occurs, the subtransmission circuit and associated transformer are de-energized. This loss of voltage causes the associated primary-feeder breaker to open, and the tie circuit breaker to close a short time later. Thus a transformer or subtransmission fault causes only a very short service interruption to the associated primary feeder before this feeder is automatically connected to the other transformer in the substation. After repairs are completed and the transformer is re-energized, its primary feeder is automatically reconnected, with a momentary interruption of load. When a primary-feeder fault occurs, the feeder breaker is tripped due to overcurrent and the tie breaker is not closed. The application of this type of substation is somewhat limited. Because of the undervoltage relaying used, the primary feeders cannot be paralleled to supply a spot-network or an industrial-plant network system.

Where a substation with individual-feeder regulation and more than two primary feeders is required, it is formed of two or more of the two-feeder substations just described. Such a substation, Substation 9, is unique in that it has neither a high-voltage bus nor a low-voltage bus. It can grow to any desired size without increasing the interrupting duty on the primary-feeder breakers.

Wherever *maximum service continuity and flexibility* are required Substations 10 and 11 (Fig. 5) are used. In many cases service continuity is of great importance, such as the supply to a secondary network system in the commercial area of a city; similarly, flexibility is a great advantage where additional circuits or transformers are likely in the future. Except for the high-voltage switching the two substations are similar. The transformers, supplied from different subtransmission circuits, are paralleled on their low-voltage sides through the so-called "back-to-back" arrangement

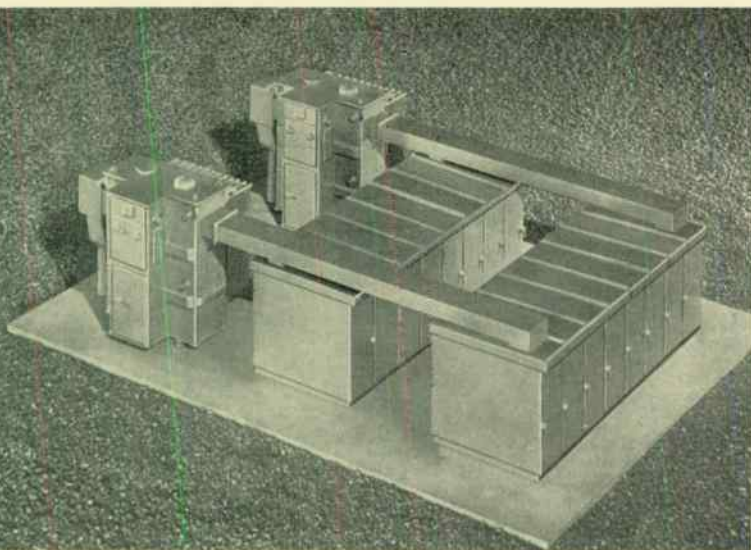

Figure 6

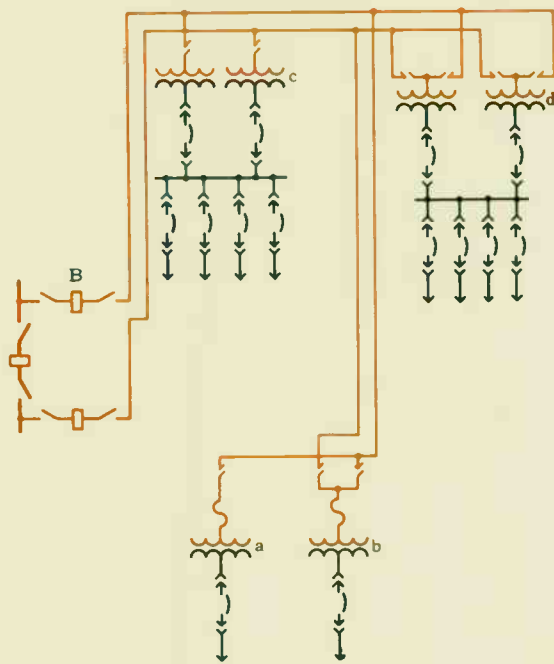

Fig. 6—Radial subtransmission circuits supplying modern distribution substations.

Figure 7

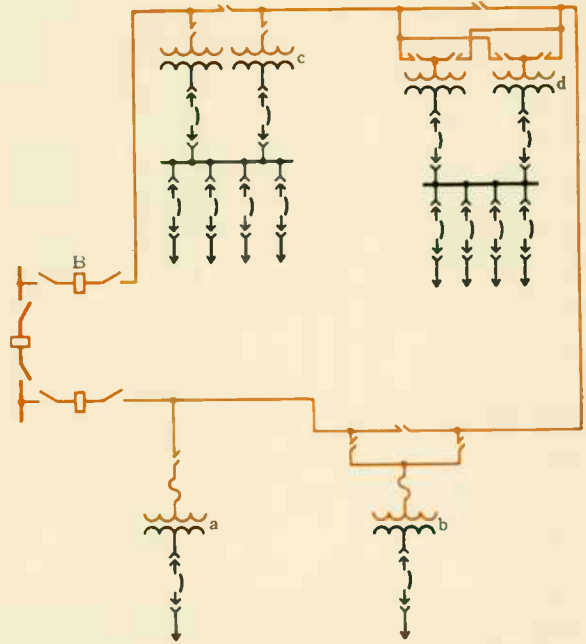

Fig. 7—Several methods of connecting substations to a manually sectionalized loop.

of switchgear. The switchgear consists of two rows of standard, single-bus, metalclad gear. Normally the two transformers and the primary feeders are connected to one bus through disconnecting-type circuit breakers.

The second row of switchgear consists of circuit-breaker compartments, minus the removable circuit breakers. The second bus, which is contained in this switchgear, serves both as a transfer bus, to permit maintenance of any circuit breaker without interruption of service, and as a spare bus to permit maintenance or extension work on either bus. It also allows prompt restoration of service to all loads if a bus fault occurs. With two spare removable breakers, any transformer or primary feeder can be transferred from one bus to the other without interruption of service. Except for the second row of switchgear compartments containing the spare bus, these substations are similar to the spot-network substations shown in Fig. 3.

Substations 10 and 11 are the only ones that use a double bus. Double and transfer buses are very common in substations built about 20 years ago. They are not considered as necessary in modern distribution substations for several reasons: the greater reliability of modern transformers, circuit breakers, and metalclad switchgear; the development of quickly removable, disconnecting-type circuit breakers and completely insulated, metal-enclosed bus; the introduction of the primary-network system; and the generally smaller capacity of distribution substations.

High-Voltage Switching Arrangements

The high-voltage switching arrangement used in any particular substation depends upon the number of transformers in the substation, the kind of subtransmission supply to the station, the quality of service required, and economics.

High-voltage switching arrangements applicable when the substation is supplied by *radial subtransmission* are illustrated in Fig. 6. Radial subtransmission is used when sub-

transmission circuits are cable. The transformer of substation *a* is connected to a single subtransmission cable through a high-voltage load-break or disconnecting switch. A fault on the subtransmission circuit interrupts the substation load until the trouble can be located and repairs made. The transformer of substation *b* is normally supplied from one of the two radial feeders. When a fault occurs on that feeder the substation is manually switched to the second, or emergency feeder by a high-voltage selector switch or the two horn-gap disconnecting switches shown. This high-voltage switching arrangement permits prompt restoration of service to the substation load after a fault on its subtransmission circuit. A transformer fault in substation *a* and *b* results in a service interruption until the defective transformer is repaired, or another one installed.

A subtransmission or transformer fault does not result in any service interruption at substations *c* and *d*. One of the transformers at substation *c* is automatically disconnected from the system and must remain out of service until the trouble is located and repairs are made. Both transformers are equipped with automatic forced-air cooling. The firm capacity of the station is the load that one transformer can safely carry over one or two peak-load periods with its cooling fan operating.

The primary-switching arrangement of substation *d* permits the transformer that is automatically disconnected from the system to be manually switched to the good feeder immediately. This switching arrangement is ordinarily used when a transformer fault is neglected in arriving at the firm capacity of the substation. Thus the firm capacity of this station is considered to be the rating of the two transformers. Forced-air cooling is not ordinarily used on the transformers. When using this method of high-voltage switching, the manual switching operation should be performed promptly to prevent transformer damage. Also, if a transformer failure does occur it is necessary to replace the faulty transformer

Figure 8

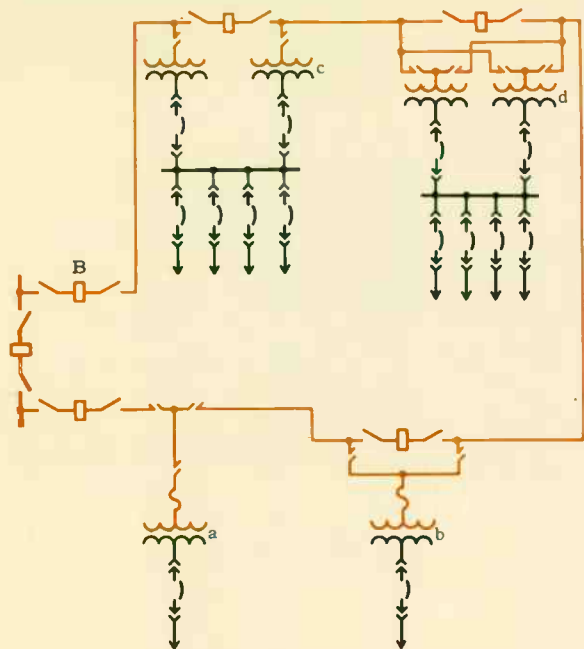

Fig. 8—Distribution substations supplied from an automatically sectionalized subtransmission loop.

promptly with a portable substation, or drop load at the peak-load periods.

Loop subtransmission is ordinarily used when the subtransmission circuits are overhead open-wire conductors. The four

primary-switching arrangements applicable to a *manually sectionalized loop* subtransmission circuit are illustrated in Fig. 7. This type of subtransmission does not provide as reliable service as the radial subtransmission of Fig. 6. A subtransmission fault causes both high-voltage breakers in the loop at bulk-power station *B* to open and interrupt service to all four substations fed from the loop. If the fault is in the portion from which substation *a* is fed over a radial tap, service cannot be restored to this station until repairs are made. Service can be restored to all of the other stations, however, without waiting, by manually operating the various horn-gap disconnecting switches. The primary switching arrangements shown with substations *c* and *d* are rarely used because the service continuity they provide is not in keeping with the reliability built in the other parts of these substations.

The most common form of loop subtransmission is the *automatically sectionalized loop* illustrated in Fig. 8. Faults in the loop sections with which substations *a* and *b* are associated interrupt service to these stations. Service can be restored—without correcting the fault—by manually operating the horn-gap disconnecting switches. If, instead of being on the loop the fault is on the radial tap from the loop to substation *a*, this station will be without service until repairs are made. Neither a subtransmission circuit fault nor a transformer fault causes any service interruption to substations *c* and *d*. The substations having the same letters in Figs. 6, 7, and 8 are similar except as mentioned.

The use of one or more of these substation designs, when supplied by simple radial or loop subtransmission, results in a simpler and more economical distribution system than most of those now in service. These basic designs are adaptable to most substation requirements and give reliable service and ease of operation.

...

Switchgear for Unit Substations

B. K. SMITH
Structural Consultant
Outdoor Substation Section

P. R. PIERSON, Manager
Station Cubicle Section

Westinghouse Electric Corporation
East Pittsburgh, Pennsylvania

Now that utilities are adding generating equipment to meet increasing demands for power, distribution substations, particularly those installed prior to 1937, are rapidly being outmoded. Modern substations are built with greater simplicity and flexibility, aided by standardization and coordination of both the equipment controlling the subtransmission supply, and the outdoor metalclad switchgear connected to the distribution circuits. The pace-setting progress in design of the necessary variations required to fulfill different needs has resulted in the general acceptance of substations for distribution service.

Subtransmission Switching Equipment

The subtransmission switching equipment is the connecting link between the incoming overhead line or underground cable and the power transformer. This equipment, which is

available for voltages between 15 and 69 kv, includes the steel structure, sectionalizing oil circuit breakers, instrument transformers, lightning arresters, disconnect switches, line terminations, insulators, high-voltage bus, lighting equipment, and grounding.

The steel structure is fabricated, galvanized and partially shop assembled in units as large as shipping and handling facilities permit. Two structure designs, for stations of 34.5-kv and 69-kv maximum rating, have been standardized, thus enabling quantity manufacture of identical components. Provisions are included to allow for load growth.

The switching equipment includes the oil breakers, switches, and lightning arresters. The breakers are frame mounted and are isolated from the incoming lines by hook-stick-operated disconnects. For isolating power transformers from the high-voltage bus, manually operated, gang-type air-break switches are provided to interrupt magnetizing currents. Lightning arresters are mounted on type-CSP (completely self-protected) transformers, or as close as possible to conventional transformers, when the latter are used.

The breakers are equipped with solenoid-type or pneumatic-type closing mechanisms controlled by panels (relays, switches, etc.) in the metalclad switchgear. The supply of power for operating the breakers is located in the switchgear



A unit-substation installation. Switchgear at the left controls breaker for four network feeders. The transformer at the right has tap-changing control to maintain voltage. The use of underground sub-transmission supply prevents exposure of live parts, thus safeguarding the residents of the neighborhood as well as the costly electrical apparatus.



← A completely factory-assembled switchgear installation ready for packing and shipment. At the left is the throat for connection to the transformer. The exposed panel at left is a standard network control panel for the transformer breaker. The exposed panel at right is equipped with standard feeder-reclosing equipment. The two sections at the right house the auxiliaries.



← A typical circuit-breaker section of unit construction from base to roof. The breaker withdraws from the right and the control equipment is housed in the left-hand compartment. Breaker arc chutes and insulating barriers are removed.



A typical five-kv, removable, magnetic air breaker. The right-hand face of the barrier assembly is steel for protection to operating personnel. When the breaker is in the disconnected position, removal of the barrier exposes the arc chutes and contacts for periodic inspection and maintenance.

whenever possible. This supply consists of a small auxiliary transformer energized from the low-voltage side of the power transformer. If the power supply must be located outside the switchgear, as is the case when a control storage battery is not used, the control transformer is connected on the incoming line ahead of the breakers.

For relaying and current indications, circuit-breaker bushings are equipped with current transformers of the multi-ratio type. For revenue metering, separate current and potential transformers are connected in the power-transformer taps and located in the switchgear, or connected in the main incoming circuits and mounted in the high-voltage structure. Meters can be built into the switchgear or mounted in weatherproof cabinets near the instrument transformers.

The buses and connections are generally of copper or aluminum tubing supported on outdoor insulators and interconnected by cast-bronze or cast-aluminum connectors. Flexible cable or expansion bends are provided for terminals of base-mounted equipment connected to structure-mounted equipment. These flexible connections prevent the damage caused by changes in temperature, wind, and other atmospheric conditions.

Each installation is provided with adequate general illumination by a system of structure-mounted luminaires complete with conduit and wire. A buried ground network provides for grounding the fence, all structure columns, lightning arresters, oil-circuit breakers, mechanisms of gang-operated switches, tanks of both instrument and power transformers, and the metalclad switchgear.

Distribution Switchgear

Outdoor metalclad switchgear is a variation of the indoor type commonly used in industrial plants and small utilities, and for auxiliary power in large generating stations. All features of indoor switchgear are retained in the outdoor type—compartmentation, insulation of high-voltage buses and connections, removable and interchangeable breakers—and other features—extra-heavy base construction, planned ventilation, heaters, illumination of compartment interiors, and a weatherproof enclosure with a weather-resisting outdoor finish—have been added.

Ratings of outdoor metalclad switchgear are the same as those of the indoor. Maximum insulation levels are 5 and 15 kv. Interrupting capacities of breakers are from 50 000 to 250 000 kva for circuits of 2300- to 4160-volt nominal rating and from 150 000 kva to 500 000 kva for circuits of 4800- to 13 800-volt nominal rating.

Trends in design are toward standard assemblies of standard circuit-breaker sections, which are the basic sections of metalclad switchgear, and auxiliary sections. Proper application of this apparatus insures a maximum of flexibility and often results in the use of but one rating of circuit breaker for several substations. Because all removable breakers of one rating are interchangeable, regardless of combination and whether indoors or outdoors, they can be reshuffled on a 100-percent salvage basis as load centers shift. Such flexibility and interchangeability insure maximum utilization of switchgear and minimize initial investment in operating equipment, spare breakers and parts, and maintenance accessories.

The basic circuit-breaker unit controls the secondary transformer circuits, feeder circuits, and tie or sectionalizing circuits. The base of this unit is of rugged construction adapted for attaching to the bases of adjacent units. These bases support the entire switchgear structure and also serve as skids. The stationary parts of the breaker housing are built

on the base, with compartments for the removable breaker, bus, line, and control panel. The side sheets, which project beyond the front and rear of the breaker, are formed with weatherproofing recesses to receive the preformed front and rear doors. These doors provide ready access to the interior and can be closed whether the breaker is in the connected or disconnected position. Weatherproofing is completed by a roof projecting over the front and rear doors to form an eave or peak for weather protection of the top door jamb, which is otherwise difficult to weatherproof. Ventilation is provided by openings at the bottom of the doors for incoming cool air and under the eave at the top for outgoing warm air. These openings are double screened to make them both weatherproof and insectproof.

Inside this weatherproof unit enclosure are the removable breaker and its auxiliaries. These devices consist of primary disconnects and their protective shutters, bus, line connections, current transformers, the control and instrument panel, and other accessories. This basic circuit-breaker assembly is a feeder unit when the line enters at the bottom by cable or at the top by roof bushings, and a transformer or tie unit when the bus enters the line compartment from an adjacent section. Thus, all switchgear sections are practically identical.

Circuit breakers are usually of the removable, magnetic, air-break type, closed by a solenoid operated from an auxiliary transformer and Rectox rectifier, and tripped from a tripping battery. Equipments are available for capacitor tripping or current-transformer tripping but these are substitutes recommended only where a battery is objectionable. Years of experience with tripping batteries have demonstrated their superiority for distribution duty.

The control panels of the circuit breakers are part of the stationary housing. They are available in numerous standard arrangements for control of the transformer-protecting breakers and for reclosing schemes for network or radial feeders. These standard panels provide adequate control at the lowest possible cost.

Auxiliary sections are associated with all substations except the single-feeder type, where the one feeder circuit breaker is part of the CSP transformer. These auxiliary sections match the associated circuit-breaker sections in appearance, size, and construction. They provide space for mounting instrument transformers, operating transformers and their fuses and secondary breakers, control panels, tripping batteries, and transition connections. Standard assemblies are available that fulfill the usual requirements of a set of disconnecting potential transformers, an operating transformer up to 15-kva capacity, three current transformers, a transition bus, a 24-volt tripping battery and charger, and a small panel. Obviously, 48-volt or power-type 24-volt batteries, special chargers, or 3-phase transformers for auxiliary power require additional auxiliary sections. These factors should be considered when estimating cost and allotting space for substations.

Practically all requirements of distribution substations can be met by standard circuit-breaker and auxiliary sections and standard variations. When planning a substation, the user should carefully consider his requirements as to maintenance, inspection, and testing. If these requirements are modernized as completely as is the switchgear being purchased, many special features affecting cost will be eliminated and standard sections will be used more extensively. A universal trend in this direction would be a contribution to the entire electrical industry, as standardization is the soundest method of insuring minimum prices.

Transformers for unit and coordinated substations will be discussed in a later issue of the *Westinghouse ENGINEER*.

Stories of RESEARCH

Arrest That Surge!

EVERYONE is familiar with the "shocking" sensation that often follows after one walks across a thick carpet and then touches a metal object. The friction of shoes on the carpet causes an electrostatic charge to be built up on the body, and it is discharged when metal is contacted.

Winds may do the same thing with telephone lines. Wind-driven sand, rain, or snow builds a charge on the wire as the particles whip past it at high speeds. Although seldom high enough to be dangerous, it may create an annoying static in telephone receiver sets.

In most commercial telephone systems these charges are eliminated from the circuit by small surge arresters that consist of two carbon blocks separated by a small air gap. One block is connected to one side of the line, the other to ground. The exact sparkover point is, of course, determined by the length of the gap. After a few surges have been handled by this type of arrester

Why Fret?

The control surfaces of large mating parts of heavy rotating machines often show unusual patterns of wear. The nature of this wear, known as "fretting corrosion," is not too well understood. To determine more accurately how fretting starts and the factors that affect it, this scale model of a large thrust bearing was set up in the Westinghouse Research Laboratories. The threaded "pipes" projecting from the top surface can be tightened or loosened, making it possible to subject the bearing to any type of loading desired. In this manner the motions between various surfaces, which are responsible for the fretting action, can be determined for any distribution of load. Relative motion between the two surfaces is picked up by small gauges and is recorded electrically.



the carbon itself begins to disintegrate and "pile up" at several points on the block face, eventually to such an extent that the gap is completely bridged.

This type of arrester is suitable for urban areas where replacement of worn arresters is economically feasible and easily accomplished. But in many types of service, such as in sparsely settled areas, or in the duty encountered by armed-forces equipment, they are not sufficiently reliable, nor do they have a long enough life. This fact led Dr. N. C. Beese of the Westinghouse Lamp Research Laboratories to attack the problem of creating a new method of arresting surges. The project was sponsored by the U. S. Army Signal Corps.

Dr. Beese had been working on cold-cathode, glow-discharge tubes so this suggested the idea of using a gas-discharge tube as an arrester. With a tube-like device, the arrester can be built sturdily and filled with an inert gas to give a more controlled breakdown point. The solution Dr. Beese found was to use two metal thimbles as electrodes with the open ends about $\frac{1}{16}$ of an inch apart, one connected to each side of the telephone line. A coaxial cylindrical sleeve surrounds these electrodes and is grounded. Narrow glass rings, sealed to each end of the outer cylinder, separate it from the inner thimbles and produce a gas-tight tube. Electrical discharges occur in the gaseous space between the inner and outer cylindrical surfaces. All exterior metal surfaces are nickel plated to give corrosion-free contact surfaces. Argon proved to be the most suitable atmosphere from the standpoint of reliability and availability.

The gaps in the tube must be such that the tube does not spark over at normal operating voltages. These include the d-c operating voltage of 60 volts and the a-c ringing voltage of 115 volts, or the sum of the two. Dr. Beese found the best gap length between the end caps and the grounded cylinder to be about $\frac{1}{16}$ of an inch. With this spacing the gas breaks down at 250 volts direct current, dissipating the charge to ground.

Sparkover voltage of such a device depends on the frequency of the applied voltage. A-c power lines require higher peak voltages than d-c lines to initiate a discharge. At 6000 cycles per second, the breakdown voltage is about ten percent greater than at 60 cycles. On steep wave surges, where the voltage rises at a rate of 10 000 volts per microsecond (comparable to the conditions encountered in a lightning flash) a voltage several times the d-c or low-frequency a-c voltage is required to produce a glow in the tube. Apparently a short but definite time interval is required to initiate a glow discharge, even with voltages much higher than that required for d-c voltages.

This telephone-line protective tube was designed to withstand the rugged use encountered in the armed forces and is therefore of extremely sturdy construction. Because of this strong construction—which adds to its cost—and the ability of the tube to withstand repeated high surges of voltage, any commercial version of this experimental tube would be best suited to rural service or other isolated areas where frequent replacement of arresters would be difficult or costly.

Scientists Become Lightning Librarians

LIGHTNING has long been a devastating and destructive force that men have both feared and yet found fascinating. But though it still has the same terrible tendencies, much of its effect on our lives has been minimized by making many of our devices and equipments "lightning proof." This type of protection has saved thousands, and possibly millions of dollars each year in property damage and has made it possible to maintain steadier electrical service. But merely because the problem has been

partially solved does not mean lightning research is ended. Lightning still wreaks havoc on occasion, and only through further investigation of its workings can better protection be built.

Because no two lightning bolts are identical, many individual surges must be "fingerprinted." Westinghouse scientists, who have been collecting lightning data since the 1920's, are building up a library by recording full information on each wave they are able to trap. In these experiments, equipment is set up on spots likely to be struck by lightning, such as the 535-foot Cathedral of Learning of the University of Pittsburgh.

One important piece of equipment is the fulchronograph. This device consists of a rotating wheel, the periphery of which is built up of laminations of permanent-magnet steel. As the wheel rotates, the laminations pass between narrow coils in which is the current to be measured. A graph of the current can be constructed by measuring the residual flux in the laminations. Two fulchronographs are used in these experiments, one of which is a high-speed device, recording durations up to 17 000 microseconds, and the other a slower speed device, recording durations up to one second. In addition, an automatic cathode-ray oscillograph records current magnitude, duration, and wave shape.

From the information thus recorded engineers can analyze the stroke in all its details. Thus "fingerprinted" it becomes a specimen in the lightning library. As an aid in the development of better protective devices some lightning surges, whose specifications have been stored away for reference in the library, are reproduced in the laboratory. The behavior of equipment when subjected to authentic lightning surges thus can be tested.

Cleaner Than Clean

THE days have long since passed when objects that look clean are accepted as being germfree. For disease-carrying bacteria can be present on even the most spotless-appearing surfaces and materials and yet not be detectable by the eye alone.

To prove beyond any question that Westinghouse Laundromats destroy bacteria as well as rendering clothes spotless, the Food Research Laboratories, Incorporated, an independent research organization, recently completed a year's exhaustive study of their effectiveness. The results were conclusive. Even without soap or detergents, in the normal cycle of the Laundromat bacteria were completely destroyed by the mechanical action of the washer and the 140-degree water.

A nine-pound load of shirts, towels, sheets, and pillowcases was deliberately infected with billions of the disease-carrying bacteria; this was accomplished by infecting each of twenty 2-inch square cloths with 150 to 200 million of representative types of heat-resistant pathogens and attaching them to the clothes. These bacteria included *Staphylococcus aureus*, which produces various types of infections; *Streptococcus pyogenes*, which may cause septic sore throat, scarlet fever, or other respiratory tract ailments; and *Escherichia coli*, which, although non-pathogenic, is an organism that serves as an index of contamination by the colon-typhoid-dysentery group of bacteria. Numerous tests were made, both with and without soap and detergents. At various time intervals samples of water and test clothes were removed and checked. In all cases 99 percent of the disease-carrying bacteria was destroyed after only three minutes (8%) of the Laundromat's normal cycle. After 20 minutes of the 36-minute cycle all of the pathogens were destroyed.

The complete destruction of all bacteria was further evidenced by the attempts made to encourage their growth by incubation. Failure to accomplish this showed that the bacteria were actually destroyed and not just inhibited or made dormant.

These tests confirmed previous research made by Westinghouse scientists before the first Laundromat was installed in a community laundry, which showed that the combination of the temperature of the water and the mechanical action of the washer effectively destroyed bacteria, either with or without soap or detergents. However, either soap or detergents materially increases the speed with which the bacteria are killed.

In the course of this research much interesting and valuable information has been recorded. For instance, lightning is of two varieties, "hot" and "cold." Hot lightning is a discharge of long duration. The current persists for a relatively long length of time (about 0.25 second), which can result in the starting of fires or melting of metal. Cold lightning, on the other hand, is a short-duration discharge of the shattering variety; maximum current is often reached in from one to three microseconds and the bolt is usually accompanied by loud thunder.

One of the outstanding events that occurred during the several years of intensive lightning research was the recording of a bolt estimated at 345 000 amperes atop the Cathedral of Learning in 1947. It consisted of five separate surges, which struck a mast atop the building and traveled simultaneously down the mast and at least two guy wires. The discharge completely shattered a four-foot wooden spar that insulated one of the guys from the building and traveled down through the steel frame to ground. The magnitude of the bolt was far beyond the capacity of all of the measuring instruments except a magnetic device and the photo-recorder. Through these measurements and some calculation the total current was estimated. The voltage may have been in the millions, since later experiments with the wooden spars indicated that over a million volts were required for flashover.

Results of these and other experiments with lightning have already appeared in the form of lightning-proof transmission lines, the completely self-protecting transformer, improved lightning arresters, and other developments. More can be expected.

The bacterial population of wash water before (at left) and after (at right) the Laundromat cycle. Below, a bacteriologist examines smears made from the wash water for any disease-carrying bacteria.

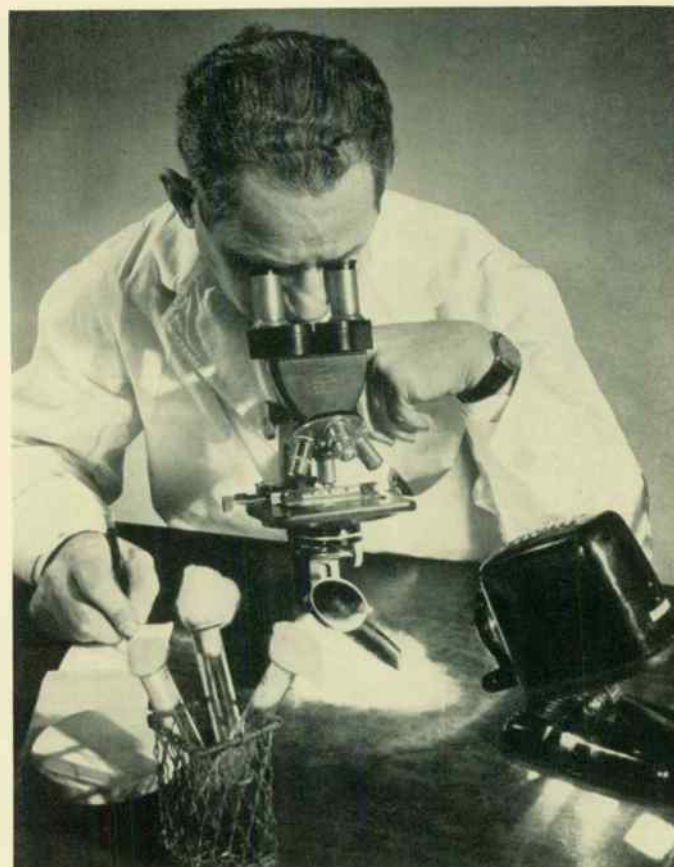
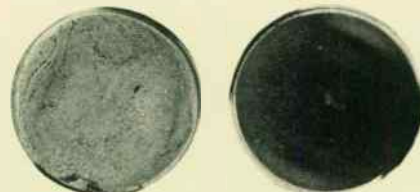

Amplification by Magnetization

In the rush to electronic devices, the magnetic amplifier was brushed aside. But now, revitalized by developments of the past decade, it is bidding high as an electrical tool for industry, offering new-found flexibility, dependable performance, increased efficiency, and higher amplification. It is useful in a variety of control equipments.

F. N. MCCLURE, *Industry Engineer, Westinghouse Electric Corporation, East Pittsburgh, Pa.*

THE word "amplifier" is generally associated with a circuit containing at least one electronic tube. But such is not always the case. Amplification of electric power can be accomplished also by the magnetic amplifier, which is being applied more and more frequently for control of industrial and commercial apparatus.

Principles of Operation

The magnetic amplifier, also known as a transductor or saturable-core reactor, is a device that employs a small direct current to control a large alternating current. One of the better-known saturable reactors is the three-legged type, Fig. 2. It consists of a magnetic core and two sets of coils, one for alternating current and one for direct current. The a-c coils,

placed on the outer legs, are connected either in series or parallel so that the a-c flux (ϕ_a) passes through the outside iron path, but not through the center leg, which carries the d-c coil. The d-c coil on the center leg sets up a saturating flux (ϕ_d) in the outside legs. Increasing the d-c ampere-turns on the center leg raises the degree of saturation and lowers the effective permeability of the outer legs. Consequently the reactance of the a-c coils is reduced, decreasing the total impedance in the a-c circuit and hence increasing the load current and voltage.*

The power dissipated in the load of a magnetic amplifier can be controlled by a comparatively small amount of d-c input power and therefore a large amplification can be obtained. For example, amplifiers with inputs of a few microwatts are

Fig. 1—A magnetic amplifier having uncut toroidal cores and distributed windings being tested in the laboratory. The amplifier at right employs the cut-core construction.

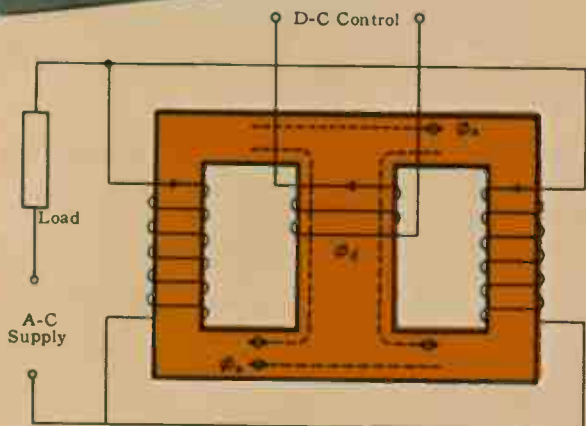

Fig. 2—The essential circuit of a saturable reactor.

*The theory of operation of saturable reactors is fully described in:
 1. "Direct-Current Controlled Reactors," E. C. Wentz, *THE ELECTRIC JOURNAL*, October, 1931, p. 561.
 2. "Direct-Current Controlled Reactors," C. V. Aggers and W. E. Pakala, *THE ELECTRIC JOURNAL*, February, 1937, p. 55.
 3. "Saturable-Core Reactor Now Smaller, More Capable," E. C. Wentz, *Westinghouse ENGINEER*, November, 1943, p. 115.

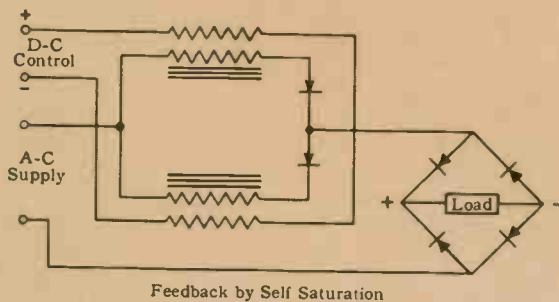
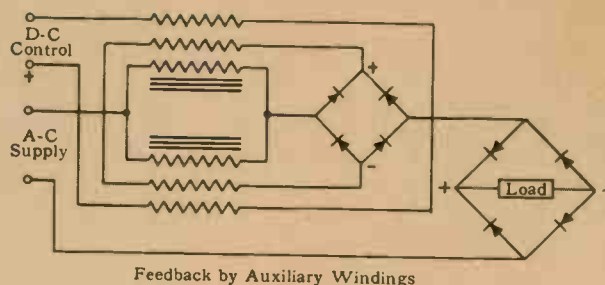

Fig. 3—Amplification of a magnetic amplifier can be increased by two schemes of feedback.

common and some with inputs of 100 micromicrowatts have been built. Power amplification can be as high as 100 million per stage. However, the time delay between a change in input and the corresponding change in output (inherent in this device because of its inductance) increases with amplification. Hence amplifiers having gains of this magnitude have time delays so long as to be impractical for most applications.

Small units can be built with time delays of only a few cycles and amplifications of 1000 to 10 000 per stage. Where longer time delays do not prevent successful operation, as is the case with equipments such as lighting controls, larger reactors can be built. Some with ratings of several hundred kva and time delays of several seconds are in service. Time delay can be reduced in various ways: by adding resistance in the input circuit (because the time constant of this circuit alone, which effects the total time delay, equals L/R); by changing circuit connections (for example, by connecting the a-c coils in series instead of parallel); and by using several stages, each of lower amplification, instead of a single stage.

Amplification can be increased by feedback, i.e., by feeding back part of the output through auxiliary windings or by self-saturation; these two methods are illustrated in Fig. 3. In such circuits, the a-c output is no longer a minimum with zero d-c input, as is the case in simple amplifiers. However, minimum output with zero input can be obtained by providing a fixed negative bias through a rectifier and an additional winding. This is illustrated in Fig. 4.

The magnetic amplifier inherently has a d-c input and an a-c output. However, if the load is connected through a rectifier, the output is direct current and the device becomes a d-c to d-c amplifier. (In such units, polarity of output is independent of polarity of input, and hence, a reversal of the input voltage does not effect a reversal of the output voltage.) Also, if the control power is alternating current, as is frequently the case, the input is connected through a pilot rectifier, creating an a-c to a-c amplifier. Rectifiers in both input and output

provide an a-c to d-c amplifier. Dry-type rectifiers are usually employed for such purposes.

Applications of Magnetic Amplifiers

Magnetic amplifiers are used in many seemingly unrelated fashions in units of all sizes. For example, some perform amplifying functions similar to those of electronic amplifiers, handling but small fractions of a watt in both input and output circuits. Others handle several kilowatts, for example, those used to supply adjustable voltage of either alternating or direct current for industrial equipments. But, in most applications their function is essentially that of an amplifier.

The *Rectomatic battery charger*, shown in Fig. 5, employs a self-regulating reactor, and a Rectox rectifier to convert the a-c output to direct current. The charger is used in floating service; that is, connected at all times to the battery, whose voltage must be maintained within close limits as the load varies. To maintain this voltage, the charger automatically adjusts the charging rate, proportionate to the varying demands of the battery.

The battery voltage (through the voltage control rheostat) is compared with the constant output from the voltage regulator and pilot rectifier. The difference between the two energizes the d-c control field of the saturable reactor. As the battery is charged, its terminal voltage rises, reducing the current in the control field. As a result, the voltage drop across the reactor coils increases, lowering the charging voltage.

The charger maintains the battery at its correct voltage within approximately plus or minus one percent at normal ambient temperature under any load within its rating. These limits are maintained even with a plus or minus five-percent variation in supply voltage.

The *current transductor*, Fig. 6, employed for measuring large direct currents, is a modification of the saturable reactor. But, unlike most saturable reactors, the transductor does not have d-c coils. Instead, the saturating flux is provided by the

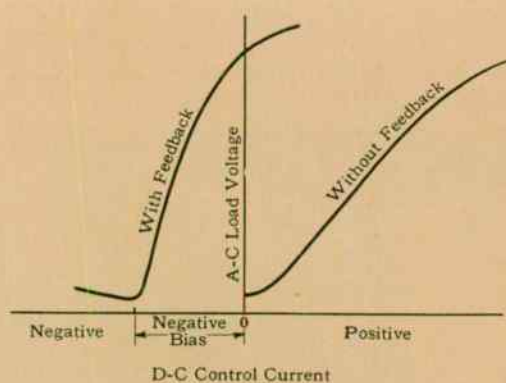

Fig. 4—Transfer curves for magnetic amplifiers with and without feedback. To obtain minimum output of a feedback amplifier with zero input, the load-voltage axis must be shifted to the left. This is accomplished by a bias through an auxiliary winding.

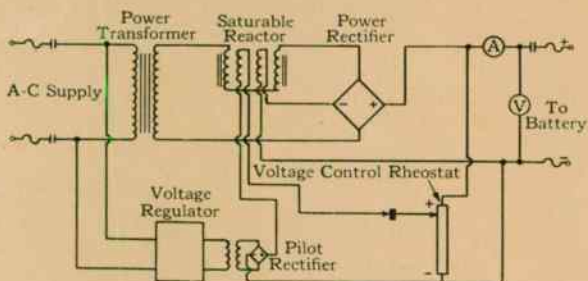

Fig. 5—The wiring diagram of the Rectomatic charger for floating service.

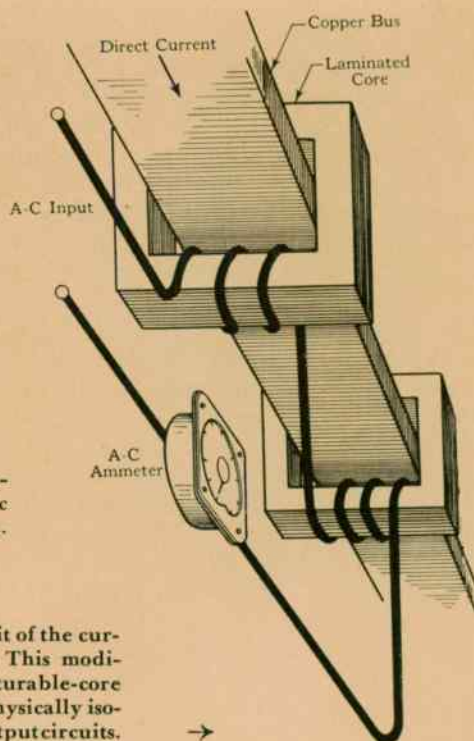

Fig. 6—The circuit of the current transductor. This modification of the saturable-core reactor features physically isolated input and output circuits.

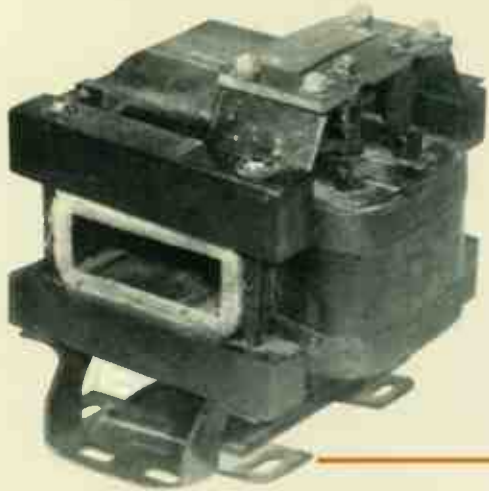

Fig. 7—The 2000-ampere current transductor (left) under test (above).

heavy-current bus, which passes through the two cores. The load is an a-c ammeter. Changes in bus current change the degree of saturation and hence the amount of alternating current. By proper design, the a-c ampere-turns are made nearly equal to the d-c ampere-turns. As a consequence, the ratio between the direct and alternating currents is nearly equal to the ratio between d-c and a-c turns, which facilitates calibration of the ammeter in direct current. A typical current transductor, rated 2000 d-c amperes, is shown in Fig. 7. Its accuracy is approximately plus or minus two percent at full load.

Thus, the transductor performs the same function as the conventional shunt. But the transductor does not have a physical connection between the d-c circuit and the metering circuit; such a connection is an intrinsic part of the shunt. Because of this conductive isolation, the leads between bus and instrument are no longer at bus potential. The lower lead-to-ground voltage reduces the personnel hazard and the amount of insulation required. Furthermore, calibration of each instrument with its leads is unnecessary because the amount of lead resistance in the metering circuit affects the instrument reading only slightly. The device is fairly insensitive to a-c voltage variations, making it possible to use any available source.

Light-intensity control has long been one of the better-known applications of magnetic amplifiers. The equipments

for a typical installation are shown in Figs. 8 and 9. By adjusting the voltage to the lamps, their intensity can be varied from blackout to full brilliancy, without using moving power contacts. Only a minute control signal from a small potentiometer is required to initiate the adjustment.

During World War II, military equipments made use of many magnetic amplifiers in servomechanisms and other control devices. A few of these were anti-aircraft detectors, controls for automatic pilots and V-2 rockets, and stabilizers for range-finder and gun mounts.

Because of the high ratio of maximum to minimum impedance, a high ratio of maximum to minimum output current can be provided. This characteristic makes it possible to use magnetic amplifiers as relays where zero current is not required for cutoff. Magnetic amplifiers can also be used to amplify the output of photocells and thermocouples in systems requiring automatic control.

The magnetic amplifier is used to regulate voltage, current, and frequency. One scheme for excitation control of generators employs a balanced-bridge-type amplifier. In such an amplifier, the output polarity reverses with a reversal of input polarity. Another scheme, Fig. 10, is used in control circuits of ignitron rectifiers.

Saturable reactors have been utilized to control the speed of induction motors, by reducing the primary voltage. When used with wound-rotor motors the reactors are connected in series with the stator and operate in conjunction with adjustable resistors in the rotor circuit; this reduces the number of contactor operations and attendant maintenance. Saturable reactors have also found application in starting synchronous machines where fine increments of starting current are required because of limitations of the power supply. The saturable reactor can be used as a supply of adjustable d-c voltage for machinery drives.

Advantages of Magnetic Amplifiers

The magnetic amplifier has advantages that make it particularly suitable for some applications, of which only a few are listed as follows:

Fig. 8—This panel is for lighting control of the Municipal Auditorium at Long Beach, California.

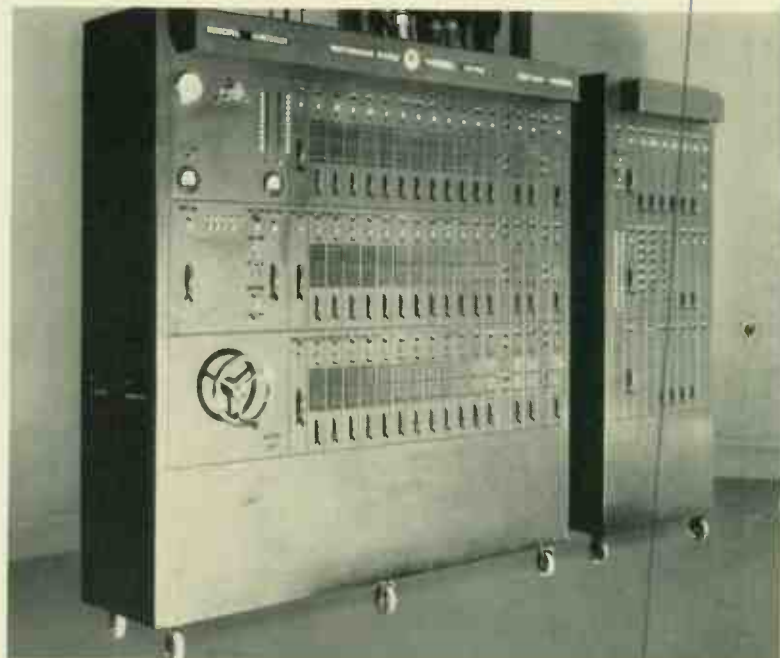

1—It is extremely rugged and maintenance free, being a static device without moving parts. Its life is usually determined by that of the dry-type rectifiers. If rectifiers are not used, the life approaches that of a transformer.

2—Usually it does not require a special power supply as it can operate from any source of alternating current. For most circuits it is fairly insensitive to variations in the a-c voltage.

3—Input and output circuits are physically isolated.

4—It can carry overloads for long periods of time without damage, much the same as a transformer.

5—It does not have the power limitations of tubes.

One limitation of the magnetic amplifier is, of course, its time delay. Another is core loss, which increases with frequency, limiting the maximum to about 50 kilocycles.

Materials and Construction

The materials employed in magnetic amplifiers are related to their history. The device dates back to about 1916, when C. F. W. Alexanderson developed a magnetic amplifier for radio telephony to modulate radio-frequency carrier by voice frequency. Although magnetic amplifiers have been used for many other purposes (mostly in control devices) since that time, their widespread application was prevented by the rapid development of vacuum tubes.

However, during World War II the Germans revitalized magnetic amplifiers with the purpose of replacing electronic units where shock and maintenance were a problem. The Swedes, also, have been developing these devices for the past ten or twelve years and have applied them to a large number of commercial equipments. In recent years, the flexibility and dependability of magnetic amplifiers have been improved by developments both in this continent and abroad. The most important of these are new materials, principally dry-type rectifiers and core alloys.

Rectifiers

During the past decade new dry-type rectifiers have been developed and the old ones improved. At present, the selenium, germanium, and copper-oxide types are most common.

Fig. 9—These banks of saturable reactors adjust the brilliance of lamps from maximum to blackout.

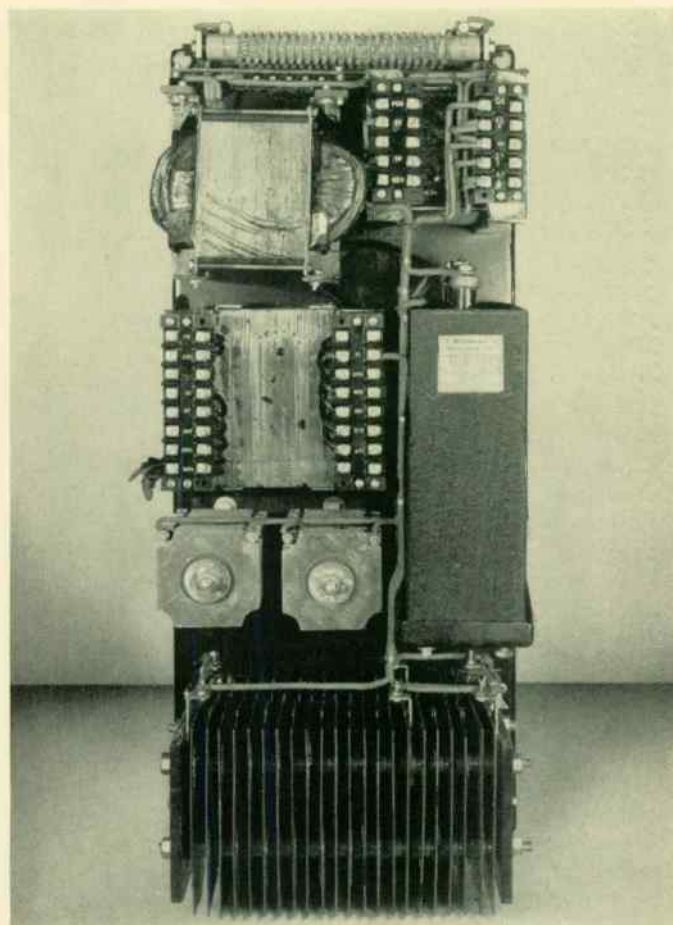
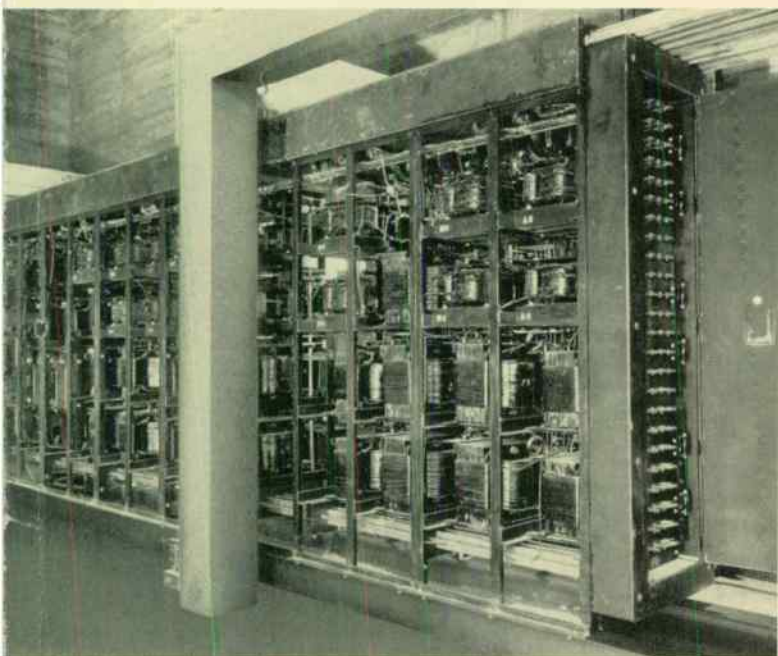

Fig. 10—The excitation panel of an ignitron rectifier uses a magnetic amplifier to control the ignition point by adjusting the bias voltage. The reactor is located above the capacitor at the right.

Modern rectifiers are manufactured more uniformly than was possible previously, which is important because differences in the rectifier characteristics affect amplifier operation. For the same reason, stability with aging and changing environmental conditions, such as moisture and temperature, is desirable. The rectifiers should have low forward resistance and high back resistance, since back leakage reduces power amplification. The inverse voltage rating should be as high as possible, consistent with other desired properties, to obtain light weight and sensitivity.

Core Materials

New core materials have made it possible to build smaller, more efficient amplifiers of higher amplification, which has increased the flexibility of the device. Each of these materials has some of the following characteristics:

1—Saturation at a very low magnetizing force, permitting operation with small input powers.

2—High flux density at saturation. The maximum flux density at which the amplifier can be operated determines the watts output per pound of core material.

3—A saturation curve with a very sharp knee close to maximum flux density, and nearly flat beyond the knee.

4—Low hysteresis and eddy-current losses.

Although these characteristics are very important, consistency of magnetic properties is even more important for

commercial purposes, as it determines the consistency of the production equipments.

Hipersil, the grain-oriented silicon steel widely used in power and distribution transformers, has a higher permeability, lower loss, and a saturation curve with a sharper knee than ordinary silicon steels. Hipersil is particularly useful where relatively large amounts of power are involved and low cost is important. Hipernik, a 50-percent nickel-iron alloy, has a higher maximum permeability than Hipersil, but it has a lower saturation flux density and is more expensive. The nickel-iron alloys containing 74 to 80 percent nickel have a still higher maximum permeability than Hipernik, but they have a lower saturation flux density and are more expensive. Nickel-iron alloys are useful for relatively low power applications involving small input signals and high gain.

Hipernik-V is a grain-oriented, 50-percent nickel-iron alloy with characteristics similar to the German material, Permenorm-5000Z. The composition is the same as Hipernik but the material differs in that it is drastically cold rolled and specially annealed. Its hysteresis loop, Fig. 11, for a toroidal core is substantially rectangular and nearly saturated at a very low magnetizing force. For comparison, B-H curves for standard Hipernik and silicon iron are shown. It is apparent that Hipernik-V has a sharper knee and reaches saturation at a much lower magnetizing force. Due to the cost of additional rolling, this material is more expensive than Hipernik. Although the more expensive materials have characteristics desirable for magnetic amplifiers, the less costly materials, such as Hipersil and other standard transformer steels, are adequate for many applications.

Many different types of windings and core construction, a few of which are illustrated in Fig. 12, are used in magnetic amplifiers. The a-c windings may be connected in either series or parallel. However, when using the reactors shown in Fig. 12

(c) and (d), the two d-c windings must be connected in series so that the a-c induced voltages cancel. Thus, a voltage of fundamental frequency does not appear across the terminals of the d-c circuit. This connection may introduce an insulation problem if the turns ratio between the a-c and d-c windings is too high. By transformer action, excessive a-c voltages may appear within the d-c windings.

Cores can be either wound from strip or built up with punchings. In the case of oriented materials, such as Hipersil and Hipernik-V, wound cores must, of course, be used, else the orientation is not utilized.

Wound cores can be either cut or uncut. Both types are illustrated in Fig. 1. Uncut toroids with distributed windings are used in high-gain applications to reduce leakage and to hold the effective air gap to a minimum. But since the coils must be wound around the completed cores, this construction is costly. To build the cut type, wound cores are cut in two, the coils placed over the laminations, and the halves butt-jointed. This construction is less expensive but the air gaps at the joints are undesirable, especially in small cut cores because more d-c control power is required. Split cores are entirely satisfactory in larger sizes for power applications where very high gains are not required.

The magnetic amplifier, an old and well-known device, today takes on an entirely new aspect because of recent radical developments in core materials, rectifiers, and circuit arrangements and analysis. The increasing complexity of modern control and automatization, greatly increasing the need for a permanent static amplifier, is no doubt also a factor in the enormous impetus given saturable reactors during the last few years. The rapid increase in the type and number of applications and the continued research and extensive development under way indicates that we have only begun to exploit their possibilities.

Figure 11

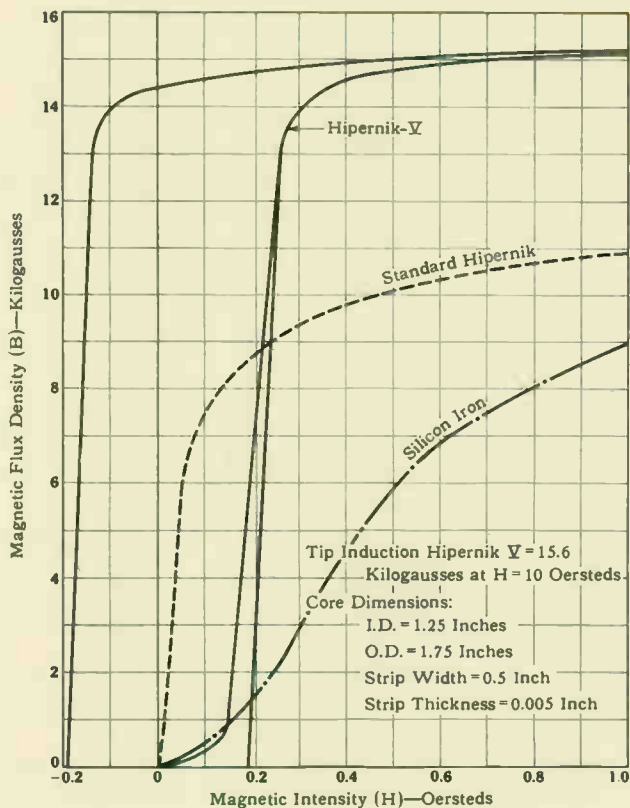
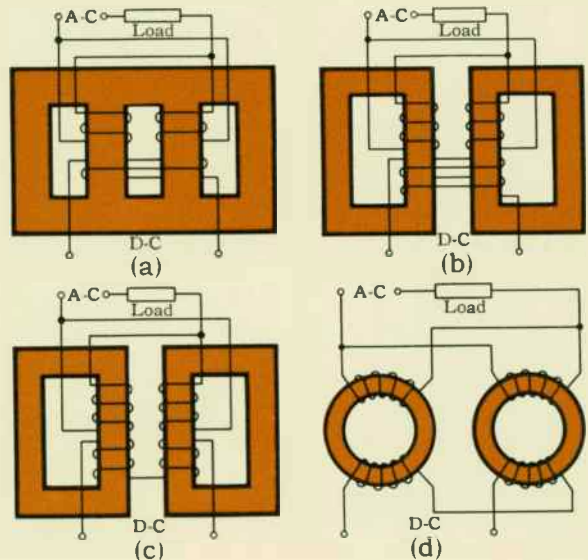

Figure 12

Fig. 11—The saturation curves of Hipernik-V, Hipernik, and silicon iron. Hipernik-V reaches saturation at a lower magnetizing force, which permits operation with smaller power input.

Fig. 12—Some of the many different types of core construction and circuits employed in magnetic amplifiers.



Personality Profiles

John S. Parsons was in on the ground floor in the development of network systems, and during his career has been granted over 40 patents on network distribution systems and equipment. His work with Westinghouse began in 1921, shortly after he finished his technical education at the U. S. Naval Academy and Georgia Tech. His first assignment was in relay engineering, where he designed the relaying for the first pump-proof network protector and also the first three-phase network relay. In 1930 he switched to the Central Station Division, where he serves as distribution expert.

P. R. Pierson's experience after graduating with a B.S. in E.E. from Clarkson College in 1916 has been repeated many times in the past decade. He was just getting started with Westinghouse when the first World War interrupted and called him into the Navy. When he returned to civilian life he rejoined Westinghouse in the Engineering and Service Department in Chicago. Here Pierson first learned about metalclad switchgear, at that time just in its infancy. In 1926, he came to East Pittsburgh to assist in its design. He is now manager of the section.

When *F. N. McClure* graduated from Carnegie Tech in 1942 with a B.S. in E.E., he had but one choice of vocation—the armed forces. So he joined the Army. When the war ended he was in Dutch Guiana, a Captain in the Signal Corps.

Upon separation, McClure joined Westinghouse and after completing the graduate-student course became an industry

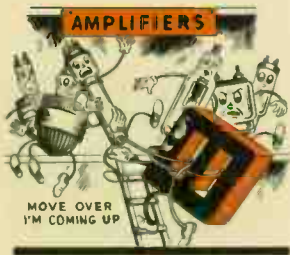

engineer of the Central Station Engineering Section. In 1948 he was selected to investigate and develop magnetic amplifiers for industrial, commercial, and military purposes, a task he has pursued ever since. Next month, he obtains a master's degree from the University of Pittsburgh.

McClure's fame among his colleagues stems from his activities as social chairman of the Central Station group. A re-

cent party he organized featured shmoo —shmoo on the cob, shmoo a la carte, distilled shmoo juice, etc.—all begging (and good enough) to be consumed.

Edward Beck, at one time leader in the Personality-Profile "derby" for the greatest number of appearances on these pages, returns again after four years' absence.



Beck's papers have all been on different phases of lightning protection, a subject he has pursued assiduously since graduating from Columbia in 1917 with a B.E.E. During this period of three-plus decades, he has assisted in the development of the lightning surge generator, the cathode-ray oscillograph, and many devices for lightning protection.

B. K. Smith has had an office in the East Pittsburgh Works for the past 20 years—but he is not and has never been an employee of Westinghouse. This peculiar arrangement began in 1929 when Smith was "lend-leased" to Westinghouse by International Derrick and Equipment Company of Columbus, Ohio, which makes the steel structure for Westinghouse unit substations. He serves as consultant and liaison man between the two companies.

Smith is particularly well fitted for this position, being a graduate electrical engineer (Ohio State, 1918) with vast experience in structural design. Besides, he is the big, friendly type, and a proficient diplomat. Before coming to East Pittsburgh, he was an electrical-trades instructor in Columbus and doing spare-time consulting for International Derrick. When Westinghouse asked for an electrical engineer with structural experience, Smith was the logical choice. Prior to teaching, Smith had been with the Bonney Floyd Company (a steel foundry) and Canadian Steel Foundries.

Many engineers can point to a record with Westinghouse that includes their entire working career. *F. S. Mabry* can do better than that. Even his technical training was obtained at Westinghouse, at Westinghouse Technical Night School. He graduated in 1925. Mabry originally came to Westinghouse in 1922 as a coil winder. In 1925 Mabry began a career in engineering that followed a definite and interesting pattern. He was associated with the development of the first power-line carrier communication and supervisory control equipment on the historic 220-kv power line in California. In October, 1930, that activity was moved to the Radio Division at Chicopee Falls, Massachusetts, and Mabry went with it as head man. By 1940 he had taken a leading part in the development of the U. S. Signal Corp's first high-power search-radar equipment—one of which was the famous unit that gave the disregarded warning of the attack on Pearl Harbor. Mabry was placed in charge of the Military Radio Engineering Section, and the men under his direction developed the Navy's first successful airborne search radar and followed that by developing the first Westinghouse shipborne long-range search radar with which a large part of the U. S. Navy was equipped during the latter years of the war. Mabry's ability to adapt himself to a wide range of engineering problems led to his selection as Manager of X-ray Engineering in 1945; then to the Industrial Electronics Division in May of 1948 as Manager of Manufacturing. Recently when the X-ray and Industrial Electronics Divisions were combined, who should be appointed Manager of Engineering? With his background, Mabry couldn't miss.



Mabry has always had many interests outside of engineering. He has long since given up basketball (he isn't called "Slim" without reason), in which he was proficient while a student. There yet remains billiards, home movies, and still photography. And when Mrs. Mabry decides she needs a new coffee table—Slim being a crackerjack cabinet maker, simply does the local furniture stores out of a sale.

Wind Mills

Man-made wind machines take many forms. The bottom picture shows the machining of a 123-ton rotor for one of the largest air compressors ever built. Teamed with two 25 000-hp electric motors, this compressor will whip up a 1500-mph gale in a new supersonic wind tunnel. The insert at left shows the impeller for a new forced-draft blower that will supply air for burning powdered coal. The rotor, about five feet in diameter, has specially shaped blades to cause air to enter the wheel with the least amount of turbulence.

