

Handbücherei

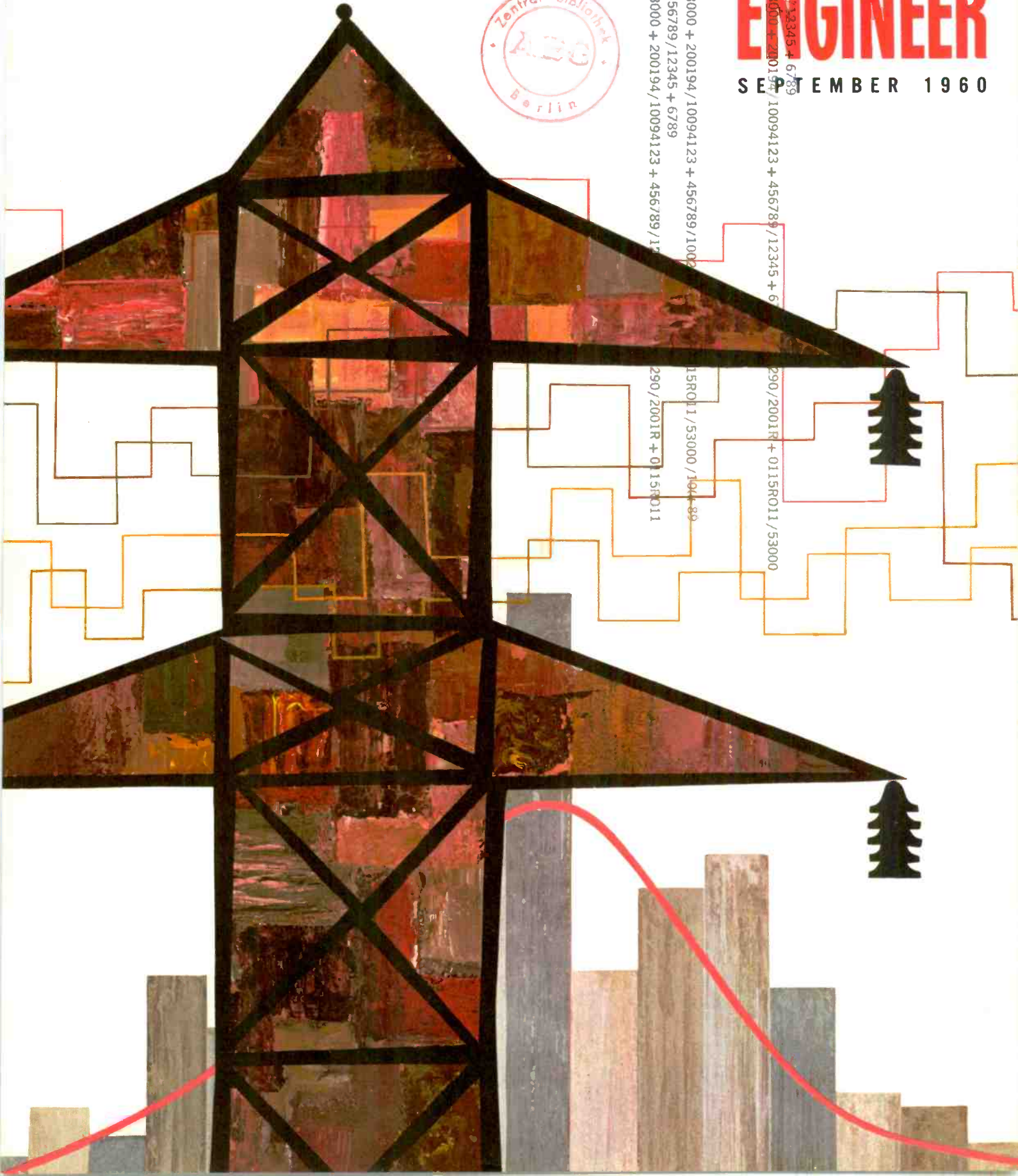

Westinghouse ENGINEER

SEPTEMBER 1960



345 + 6789
0194/10094123 + 456789/12345 + 6789
90/2001R + 0115R011/53000 + 200194/10094123 + 456789/12345 + 6789
194/10094123 + 456789
+ 6789 90/2001R + 0115R011/53000 + 200194/10094123 + 456789/12345 + 6789
5 + 6789 / 10
90/2001R + 0115R011/53000 + 200194/10094123 + 456789/12345 + 6789
00 + 200194/10094123 + 456789/12345 + 6789
90/2001R + 0115R011/53000 + 200194/10094123 + 456789/12345 + 6789

15R011/53000/104+89
90/2001R + 0115R011
90/2001R + 0115R011/53000
90/2001R + 0115R011/53000



This new switchgear plant is designed specifically for circuit breaker manufacture, permitting a changeover from job-shop techniques to in-line production and assembly. Circuit breakers and major components are progressively assembled on conveyORIZED multistation assembly lines. In-line testing (shown above) is carried on at the same rate as assembly, or in about half the time previously required for testing. Materials-handling techniques, similar to those used for assembly, move breakers from test station to test station; each station is designed as a self-contained unit, which need not compete for test facilities from other test stations. Extensive use is made of semiautomatic test equipment capable of giving visual and printed indication of test values.



Volume 20 · Number *5*

Cover Design: On this month's cover, artist Dick Marsh combines a portion of a transmission tower, a probability curve, and load charts to symbolize the technique of system simulation, described in this issue.

RICHARD W. DODGE, *editor*

MATT MATTHEWS, *managing editor*

EDWARD X. REDINGS, *design and production*

J. A. HUTCHESON, J. H. JEWELL,

DALE McFEATTERS, *editorial advisors*

Published bimonthly (January, March, May, July, September and November) by Westinghouse Electric Corporation, Pittsburgh, Pennsylvania.

Subscriptions:

United States and Possessions \$2.50 per year
All other countries \$3.00 per year
Single copies \$0.50 each

Mailing Address:

Westinghouse ENGINEER
P.O. Box 2278
3 Gateway Center
Pittsburgh 30, Pennsylvania

Microfilm:

Reproductions of the magazine by years are available on positive microfilm from University Microfilms, 313 N. First Street, Ann Arbor, Michigan.

The following terms, which appear in this issue, are trademarks of the Westinghouse Electric Corporation and its subsidiaries:

Selectomatic, Paraballoon, Magnestirrer, Rototrol, Refractoloy, Discaloy, Insuldur, Prodac, Rotrac, Trinisitor, Wemco.C

The Westinghouse ENGINEER is printed in the United States by The Lakeside Press, Chicago, Illinois.

Table of Contents

- 130 SYSTEM SIMULATION *J. K. Dillard and C. J. Baldwin*
A new tool for guiding electric utility expansion.
- 136 CREATIVE ENGINEERING *L. A. Kilgore*
Engineers with proven creative ability throw some light on the motivations and methods.
- 140 SERVO VALVES *W. B. Lloyd*
A key to hydraulic system performance is the servo valve.
- 145 ENGINEERING PERSONALITY—
DANILO SANTINI
- 146 GAS TURBINE FOR HELIUM-COOLED REACTOR
P. A. Berman
The industrial gas turbine has found a new running mate—the gas-cooled nuclear reactor.
- 150 REGULATION OF DISTRIBUTION VOLTAGE
D. N. Reys and J. Astleford
A new device and a new approach provide a flexible system of regulating distribution voltage.
- 155 DESIGN AND APPLICATION OF MAGNESTIRRERS
R. D. Thomas and D. M. Calabrese
Alloys can be more uniformly mixed with this method of stirring melts magnetically.
- 159 WHAT'S NEW
Ultrasonic Grain Refinement . . . Thermoelectric-Thermionic Generator . . . Thermally Stabilized Transformer Insulation . . . All-Static Numerical Control System . . . Prodac Control for Plate Mill.

SYSTEM SIMULATION . . . For Aiding Utility Planning and Operation. Piecemeal solution of the utility expansion problem is really no solution at all. This new statistical approach considers many variables simultaneously to help system planners obtain the optimum long-range expansion plan.

J. K. DILLARD, Manager C. J. BALDWIN, Project Engineer
 Electric Utility Engineering Department
 Westinghouse Electric Corporation
 East Pittsburgh, Pennsylvania

How can future events be predicted? This question has faced the utility system planner for years as he has tried to anticipate load growth, unit reliabilities, operating errors, and margin requirements. Expanding a power system economically depends in large part on utility management's ability to choose between alternate plans. To make economical choices, utility management needs to know what is likely to happen on the average and, also, what the odds are for unusual events. These unusual events also need a dollar evaluation.

Expansion planning has been difficult because of the many complex interrelated factors that must be considered before making each expansion decision. What will load growth be? What will operating expenses be? How much additional reserve will a larger unit require? What effect has inflation? Will an interconnection postpone a needed unit? How are future choices affected by present ones? Many more questions need answers.

A new technique, *system simulation*, has proved itself a useful tool in the solution of problems with so many variables that direct solution is impossible. Basically, a mathe-

matical model of the system is created. The model is a representation of the power system with equations and rules. The equations describe mathematically the reactions of the real power system to external stimuli, such as load growth. They also describe the interactions between characteristics of the power system, such as spinning reserve policy and maintenance programs. Human decisions that affect power system operation and development are included in the model as formalized rules.

With this model, daily operating experience of the power system can be simulated. When the model is formulated within the memory of a digital computer, real time is compressed. For example, twenty future years of daily experience can be simulated for one system in about six minutes.

The overall mathematical model of the power system is actually a combination of submodels (Fig. 1). One submodel generates the daily loads that confront the simulated system generating capacity. Another submodel describes that capacity as it is forced out, scheduled out, or operated to meet the load. Comparison of load and available capacity gives reserve margin, an indicator of the need for new generation or ties to a neighboring utility.

In addition to the load and capacity submodels, other programs plan transmission, calculate production costs, and determine the capital costs of plant additions. These submodels together produce the economic evaluation of

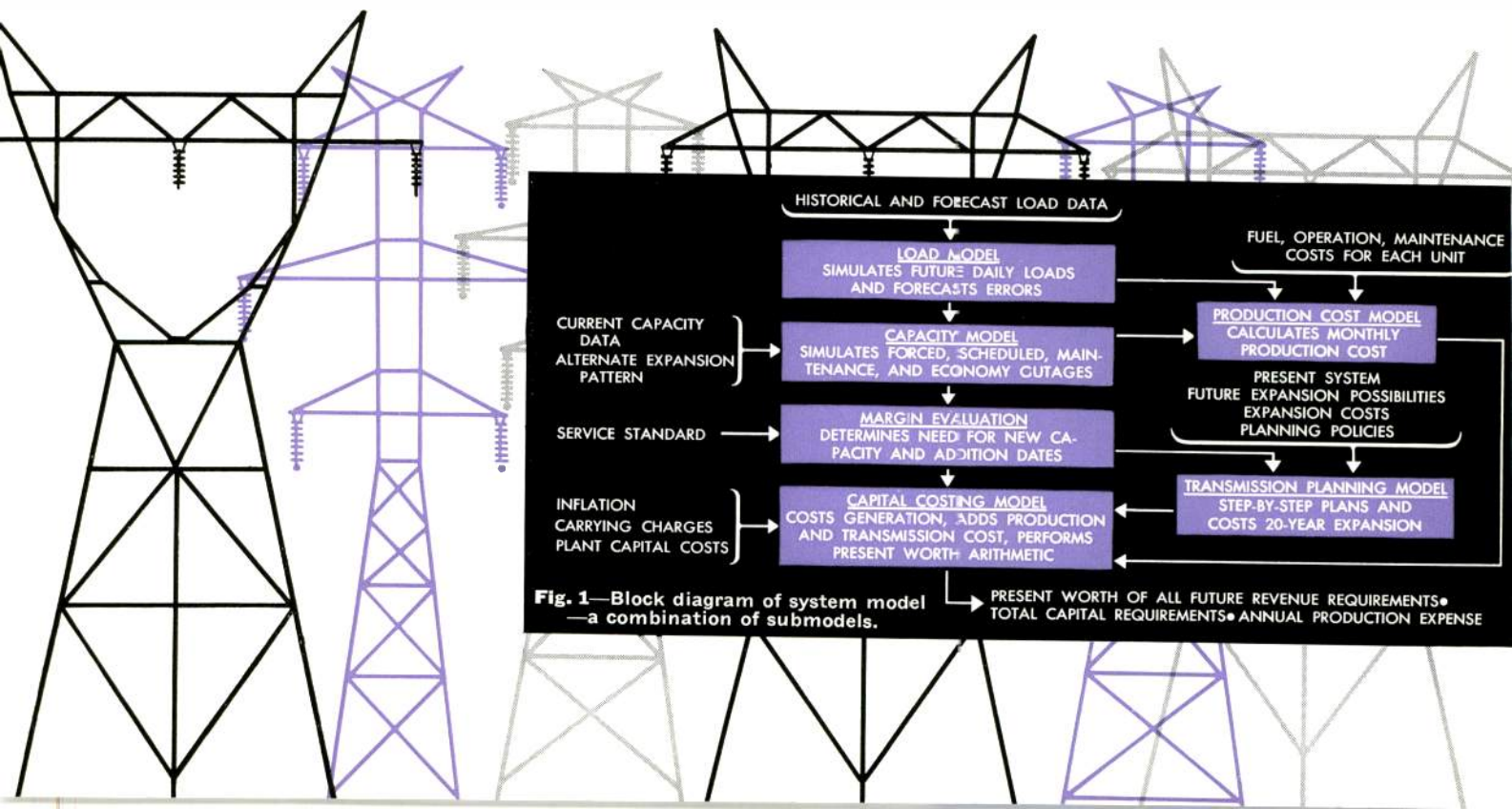

Fig. 1—Block diagram of system model—a combination of submodels.

alternate expansion patterns. Just how this is done is best described by considering each submodel in turn.

load simulation

Most utilities forecast annual kilowatt-hour sales, and from this forecast, estimate annual peak load. Actually, the peak that occurs is a highly variable quantity, dependent on business conditions and the weather on one particular day. When predictions are made far into the future, 10 to 20 years, the prediction is actually a trend line of annual peaks. The actual peaks that develop will be above and below the trend, as shown in Fig. 2.

The mathematical model for load starts with the forecast trend line of annual peaks and simulates annual peak deviations from the trend as they might occur. Deviations are generated using a "Markov chain" and a "Monte Carlo process." A study of historical deviations from trend provides the statistical basis for the process. Each year's deviation is composed of a part of the preceding year's (the chaining process) plus a random addition (the Monte Carlo process). This representation keeps annual peaks in successive years from making wild variations from trend.

Monthly peaks are next obtained by applying appropriate seasonal factors to the annual growth pattern. Here simulation is valuable because of its flexibility in accounting for changing seasonal factors as influenced by air-conditioning load, for example, or winter heating load. Different seasonal changes can be forecast, simulated, and evaluated as they influence expansion possibilities. A changing load factor or the geographical shift in load pattern can be studied.

The load model produces future annual peaks, monthly peaks, average weekday monthly peaks, and daily one-hour integrated peak demands. The daily peaks are secured from the monthly average by another Monte Carlo process. Studies of historical load data show that daily loads are

normally distributed, as in Fig. 3. On some systems different months show markedly different load statistics. The differences occur both in mean load and in load dispersion about the mean. Systems with a lot of summer temperature-sensitive load have summer load standard deviations several times those for winter loads or mild-weather loads. For example, June loads are shown to have high variability in Fig. 3. This variability is an important factor in determining required reserve margin.

Load models, like the other models, can be tailor-made to fit particular utility system conditions. For example, if the utility is a part of a power pool, load models may be required for both pool and member companies. These models will produce daily pool loads and daily member-company loads, which are correlated. Hot weather affecting one part of a pool will probably affect load in another part to some degree. The same applies to business conditions. These relationships can be faithfully simulated by correlating random numbers used in generating daily loads.

capacity simulation

The need for new generation and interconnection capacity in an expansion pattern is based on deterioration in reserve margin. Daily reserve margins can be simulated by comparing daily load and daily available generating capacity. A second submodel (Fig. 1) simulates this capacity.

Available generating capacity is made up of all units not on forced, scheduled, or maintenance outage. Some of the available capacity may not be run for economy reasons, but in times of peak load the capacity on economy outage can be used to meet the peak. If an optimum maintenance policy is followed, shortage in available capacity dictates the need for a new unit.

Whether or not an actual peak is carried depends on the spinning capacity. Failure to carry the peak may be caused by a shortage in available capacity (all available units

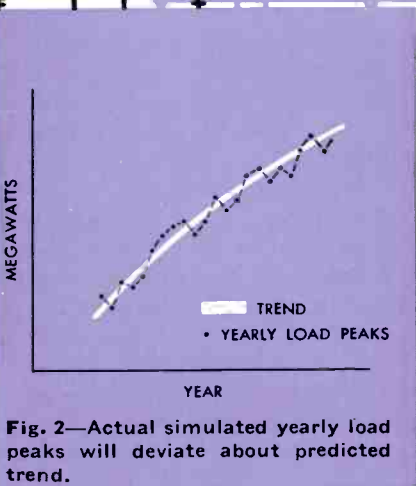
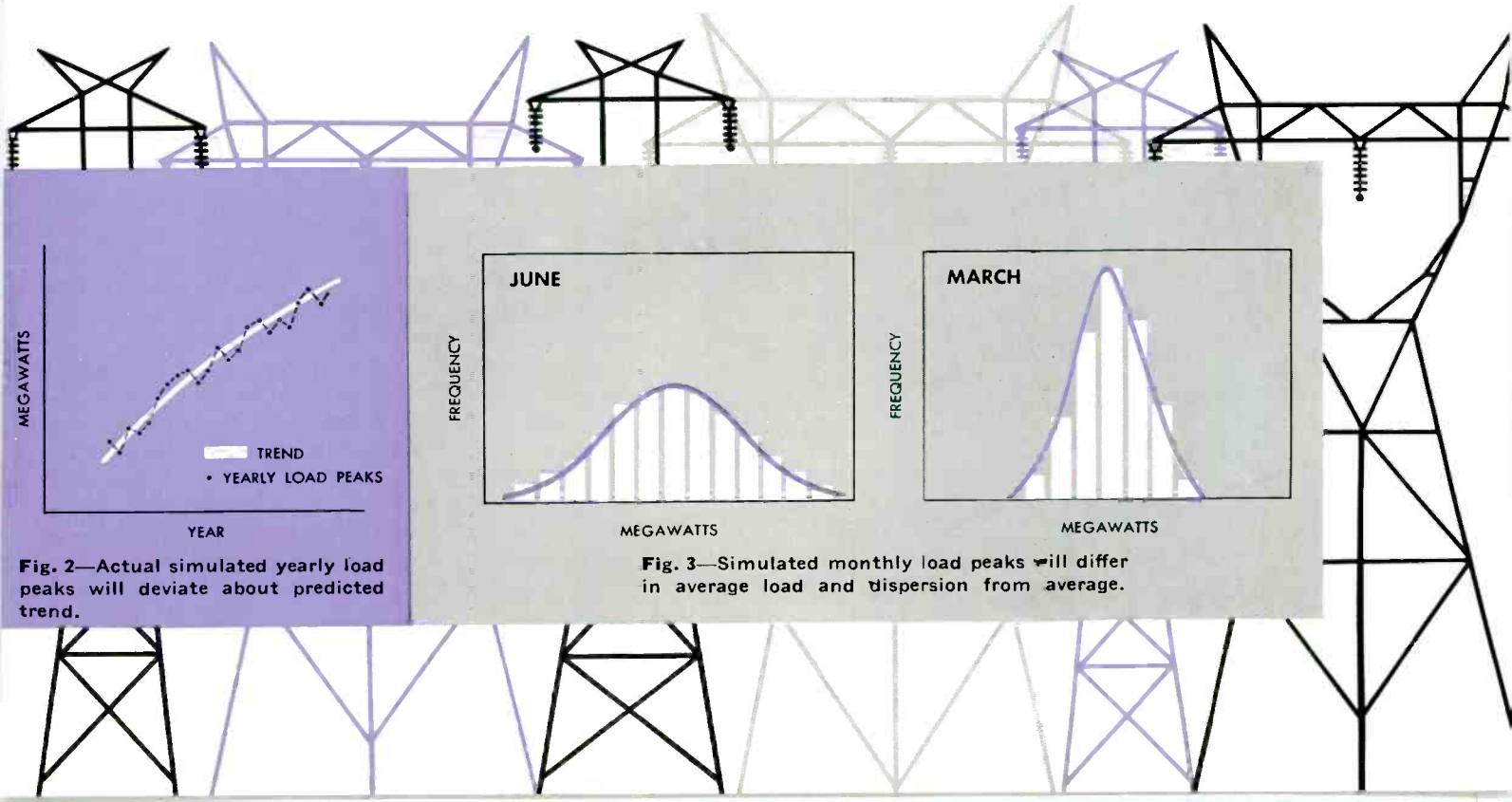

Fig. 2—Actual simulated yearly load peaks will deviate about predicted trend.

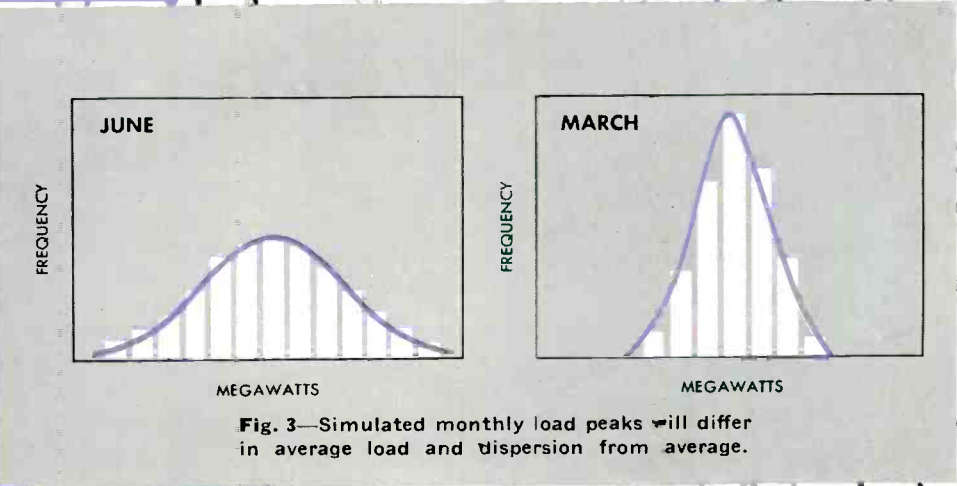

Fig. 3—Simulated monthly load peaks will differ in average load and dispersion from average.

running) or by inadequate spinning reserve. The generating capacity model is designed to detect both system conditions by simulating available capacity and spinning capacity during the peak period of each day.

Daily available capacity is determined by both chance (probabilistic) events and calculated human decisions (de-

terministic) events as shown in Fig. 4. For example, a forced outage is a probabilistic event, while the decision by system operators to shut down a unit for scheduled maintenance is a deterministic event. To produce daily available capacity, the model must simulate both events.

Forced outages are best simulated by a Monte Carlo process. Analysis of historical data, such as shown in Fig. 5a, provides the basis for drawing a probability curve of time between outages (Fig. 5b) and a second probability curve of outage duration (Fig. 5c). These curves are input data for the program. After each simulated forced outage, the model will produce the date of the next forced outage. First the model generates a random number, say between 0.00 and 0.99, and enters the curve of time between outages (Fig. 5b) with this probability number to determine the operating time to the next forced outage for that unit. A similar procedure, using another random number and the second curve (Fig. 5c), is used to find outage duration. Of course, this information is withheld from the human-decision part of the model.

A sequence of in-service and outage periods is generated (Fig. 5d). Partial outages can be included with appropriate probabilities. Additional random draws can be used to tell whether the outage affects spinning reserve in the critical peak period, whether it is postponable to the weekend, etc.

The important point is that each possible sequence generated by this process is a member of a statistical family of sequences. Thus, while the pattern is random, sequences 1, 2, and 3 (Fig. 5d) are all described by the same statistical parameters. These parameters may be based on each unit's history, or they may be engineering estimates of future performance of either existing or future units.

The capacity model generates characteristic forced outage histories for each unit on the power system. Total capacity not on forced outage each day is obtained by summing individual unit capacities.

Scheduled and maintenance outage patterns must be meshed with forced outages. Scheduled outage simulation requires simulation of both random events and human decisions. While chance events create the need for scheduled outage and determine the outage period, the actual date the work begins is widely postponable by human decisions.

The random need for scheduled maintenance and the random duration of the ensuing outage can be described using probability distributions based on forecast performance or on historical records of scheduled outages taken. Each unit may be represented by its own characteristic distribution, just as it is for forced outage simulation. Again, Monte Carlo random draws are used with these distributions to determine for each unit the days to next repair need and the scheduled outage duration.

Once the need for repair occurs on a unit, the unit may continue operating temporarily. A list is kept of units in this condition, and units scheduled out are taken from this list by decision rules, which simulate the decision rules used by system operators. Total installed capacity is divided between load, reserve, and maintenance functions. Enough capacity is allotted to load and reserve to carry the forecast peak load with the normal spinning reserve. Also a second contingency reserve can be provided. The remainder of the installed capacity is available for scheduled outage and periodic overhaul.

	RANDOM	HUMAN DECISION
Forced Outage Occurrence	X	
Duration	X	
Scheduled Outage Need	X	
Taking		X
Duration	X	
Maintenance Overhaul Taking		X
Duration		X

Fig. 4—Outages in capacity model are both random and deterministic.

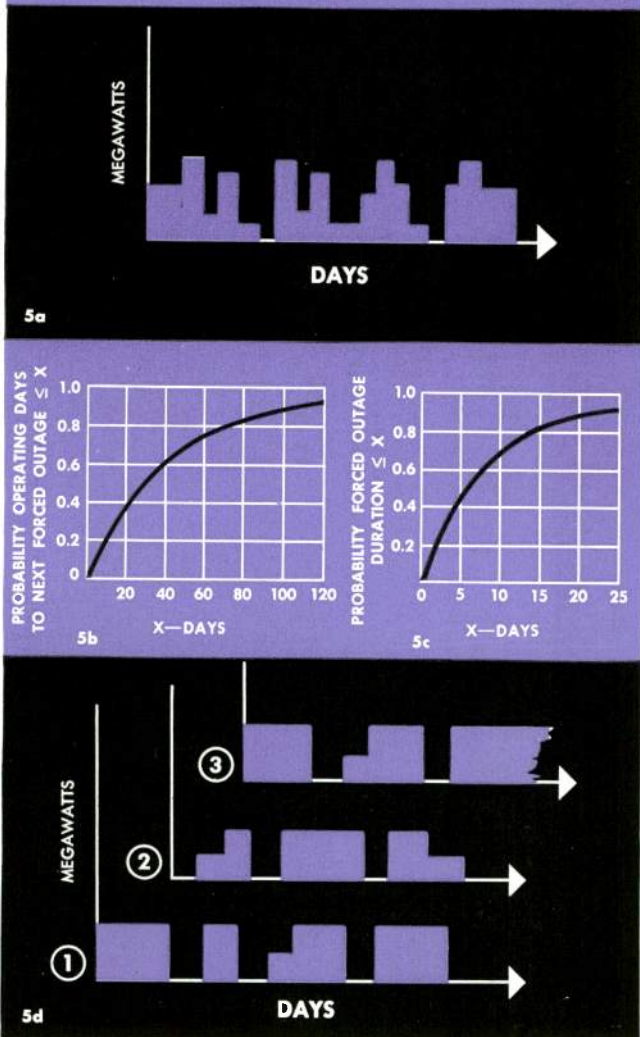

Fig. 5—(a) Historical performance data provides the basis for developing probability curves for determining time between outages (b) and outage duration (c). From this information, the capacity model can construct a sequence of in-service and outage periods (d).

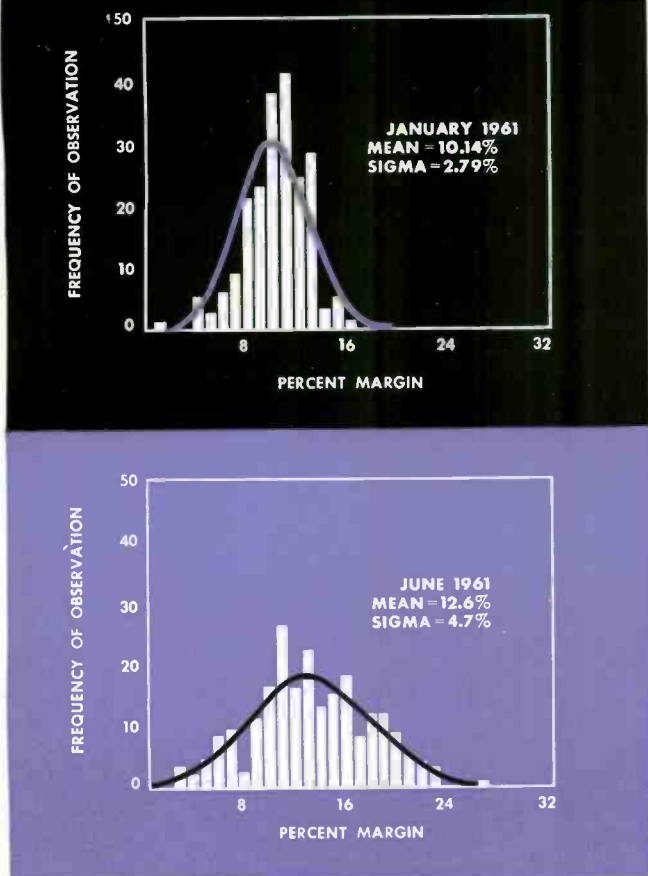

Fig. 6—Simulated monthly margin dispersions provide data for computing a mean and standard deviation, which are used to determine probability of load loss for any day of the month.

Maintenance outages are taken just like scheduled outages. The major difference is that their need is anticipated and planned, for example, once a calendar year or on some other basis. The particular maintenance planning rules of the system can be programmed into the model. When maintenance outages are meshed with forced and scheduled outage patterns, the daily simulation of available generating capacity is complete.

reserve margin evaluation

A simulated daily margin is obtained by comparing simulated daily load with simulated daily available capacity. The per unit available margin is expressed as

$$M = 1 - L / (C_i - C_o)$$

where M is the available margin in per unit, L the daily peak load in megawatts, C_i the installed capacity in mw, and C_o the capacity on outage in mw.

Histograms (frequency distributions) of available margins for two future months on a particular system studied are shown in Fig. 6: January is representative of the heating season, and June is representative of the cooling season. Each month for this particular year was simulated 10 times, with different possible combinations of capacities and loads as determined by intermingled probabilistic and deterministic events. About 210 different daily margins form the histogram for one month. As might be expected, the margin has a normal (or Gaussian) distribution. This is fortunate since such curves may be specified completely in terms of a mean \bar{x} and a standard deviation σ (See *Normal Distribution and Standard Deviation*, at right).

A negative margin means that load exceeds capacity, a situation that must result in loss of load. If the area of the normal curve in Fig. 6 is adjusted to be unity, the area to the left of zero margin corresponds to the probability of having a loss of load on any day during the month. The portion of the curve to the left of zero is an extension based on known properties of the normal distribution curve and the portion to the right.

The ratio \bar{x}/σ gives the distance from the mean to zero margin in terms of number of standard deviations. For January (Fig. 6), \bar{x} is 10.14 percent and σ is 2.79 percent. The ratio \bar{x}/σ is 3.63, meaning that the mean is 3.63 standard deviations from zero. The area under the curve to the left of zero can be calculated easily. Statistics references commonly contain tables giving area under a Gaussian curve between the mean and points separated from the mean by a distance t . Since t is equivalent to \bar{x}/σ , the area given in the tabulation is the area between zero and the mean. Since the total area under one-half of a Gaussian curve is 0.5, subtracting the tabulated value of area for a particular t from 0.5 gives the area to the left of zero. This

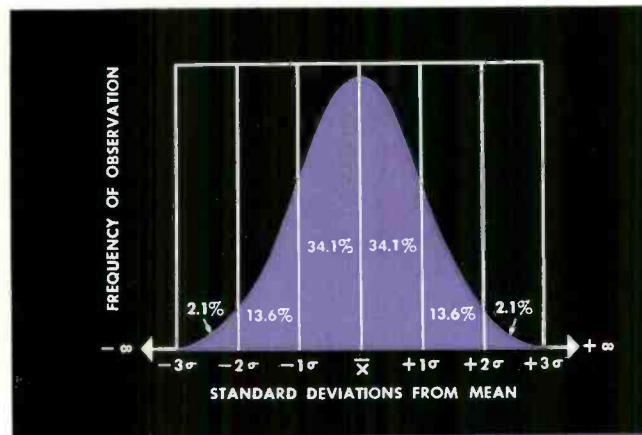

NORMAL DISTRIBUTION AND STANDARD DEVIATION

The normal distribution curve is based on one of the fundamental concepts of probability. This concept contains two principal postulates: (1) A variable (x) has a tendency to cluster about a center, or *mean* value (\bar{x}); and (2) individual readings will differ from the mean in a random but predictable pattern.

The amount by which the data differs from the mean value is expressed in terms of *standard deviation* (σ), which is the root mean square of the individual deviations from the mean, or:

$$\sigma = \sqrt{\frac{\sum (x_i - \bar{x})^2}{n}}$$

where x_i is each individual reading and n is the number of readings.

The standard deviation provides an indication of the dispersion (randomness) of data. If σ is large in proportion to the mean value, the data varies widely; if small, dispersion is small and a larger proportion of the data is near the mean value.

The standard deviation is an extremely useful means for analyzing data. For example, for a normal distribution, the probability of obtaining any particular range of deviations can readily be determined by expressing this range in terms of standard deviation units, and then comparing the area under the curve in this range to the total area under the curve (100 percent). For example, the probability of obtaining readings between plus two and plus three standard deviations is 2.1 percent.

area, 0.00014 for January, is the probability of shortage on a specific weekday in the month of January. If there are 21 week days in January, the probability of shortage some time during the month is approximately

$$1 - (1 - 0.00014)^{21} = 0.0029$$

or an equivalent risk of one day in

$$1 / (12 \times 0.0029) = 28.8 \text{ years}$$

A greater dispersion of margins is shown in June, as might be expected from the greater variability of load. The June curve also indicates that percent margin alone is not a reliable index of the adequacy of installed reserve. The fact that margin is higher in June than January is much more than offset by the higher standard deviation in June. In January, \bar{x}/σ is 3.63 and daily risk is 0.00014; in June, \bar{x}/σ is 2.66 and daily risk is 0.0039.

Note that monthly \bar{x}/σ is itself an excellent measure of risk. No further calculation need be made once familiarity with this concept is achieved. The changes in the ratio from month to month indicate the changing risk.

A single month's margin experience is enough to calculate an estimate of \bar{x} and σ , and hence t from which the probability of load loss may be obtained. This probability may be computed month after month as real time is simulated. If it is plotted for one simulation, as in Fig. 7, considerable seasonal variation is observed. Of course, some of this may be smoothed by better maintenance scheduling but usually not all of it. As load grows and no units are added, there will eventually be a breakthrough at some danger line. This line represents the upper limit permitted on load loss probability. When the curve crosses this line, another unit must be added.

Additions are made automatically in the model during the simulation, in sequence as selected from input data. The input data describes one particular alternate expansion pattern under study. The margin evaluation in the simulation assigns dates to each expansion step in the pattern. In this way, simulated expansion takes place with a consistent standard of service, which is expressed as the upper limit permitted on load loss probability.

A second simulation of a lengthy growth period, say 20 years, will show somewhat different dates for each step in an expansion plan. Random events and human decisions combine in different ways as the future system is simulated.

Since any simulation could be the *one* sequence that will actually happen, the expansion step dates cannot be fixed from one simulation with full assurance that they are right. Dates must be quoted with a probability interpretation.

models for economic evaluation

The economics of alternate long-range expansion patterns are determined by three cost components: generating plant capital costs, production expense, and transmission plant cost. These cost components can be computed separately for each proposed expansion pattern, referred to a common date with present-worth arithmetic, and compared to give the overall economic evaluation of the different patterns. The simulation technique is designed to provide costing information for this comparison.

An alternate expansion pattern specifies a number of new units in a reasonable sequence. Size, heat rate, location, type of fuel, and plant reliability may be specified. Included is an estimate of the first cost of each such new

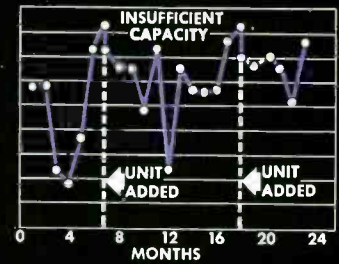

Fig. 7—When the probability of load loss reaches a certain value, new generating capacity must be added.

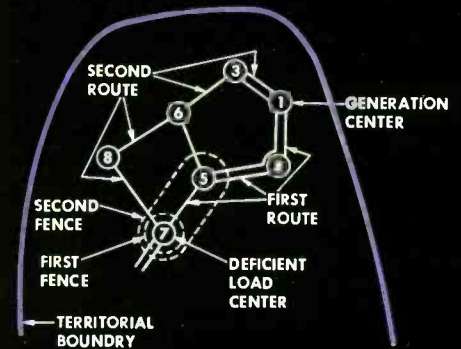

Fig. 8—This fencing method is used in the transmission planning model. Imaginary fences are drawn around each load or generation center. Any fenced area with an excess or deficiency of generation for its load must transmit or receive power across its fence. Successively larger areas are examined by fencing the original area and the next adjacent area along possible routes away from some area with deficiency or toward an excess of generation to satisfy need of original area. For example, assume that load center 7 has been found deficient in generation. Adequate transmission is found across a second fence drawn around centers 7 and 5 along the route to generation center 1. Hence, increase in transmission capacity is required only from center 7 to center 5.

PRESENT WORTH EVALUATION

Present worth is sometimes described as the "Just as soon as" . . . relationship. If an acceptable rate of return is 6 percent, you would "just as soon as" have \$1.00 today as 6¢ return plus your dollar back one year from now. The *present worth factor* in this example is $1/1.06 = 0.9434$.

Assume a \$3 000 000 turbine-generator unit is to be added in five years and a \$5 000 000 turbine-generator unit in seven years. Neglect the rest of the accounts (boiler, land, etc.) and succeeding units. Assume the carrying charge for the turbine-generator account is 10.6 percent (composed of 6 percent return, 0.8 percent depreciation, 3.3 percent taxes, and 0.5 percent miscellaneous). Further assume money is worth 5½ percent. The total present worth of all future revenue requirements for the two units as of 1960 is \$11 047 705, computed as follows:

	First Unit	Second Unit
(1) First cost	\$3 000 000	\$5 000 000
(2) Annual revenue requirements = (line 1) x 0.106	318 000	530 000
(3) Present worth as of installation date = $\frac{\text{(line 2)}}{0.055}$	5 781 818	9 636 363
(4) Present worth factor at 5½%	0.7651	0.6874
(5) Present worth in 1960 = (line 3) x (line 4)	4 423 669	6 624 036
Total present worth of all future revenue requirements for the two units	\$11 047 705	

The installation date may affect the estimated first cost and always affects the present worth factor.

unit. This cost estimate can be determined from generating station FPC accounts. If so, it is accompanied by an estimate of percent annual revenue requirements for each account. This percentage includes depreciation, taxes, and return. The product of first cost and revenue requirement percentage gives the annual revenue requirement in dollars, by accounts, to support the capital addition. These dollars are required each year after the plant is installed. They may be converted to a single sum, a present worth as of the installation date of the unit. Multiplication by another "present worth factor" will move the dollars back in time to the beginning of the study, say 1960. Then if the revenue requirements for each unit added in a 20-year period, for example, are summed as of 1960, a total present worth of revenue requirements is obtained for the generating plant capital cost component (See *Present Worth Evaluation*, page 134).

The second cost component needed is production expense. In comparing certain expansion patterns, this may be an important component. As an example, consider one pattern with all highly efficient, base-load steam units for future expansion. Production expense is minimized but some first cost premium may be paid to secure the best heat rates available. This plan may not have a lower present worth when compared to a plan with a few peaking gas turbines included. Peaking gas turbines have lower first cost and can delay installation of a larger, more expensive base load steam unit. While gas turbines are less efficient, and displace efficient steam capacity, capital savings may outweigh the production expense penalty. The problem is complicated, and the alternates must be evaluated as part of a long-range pattern.

The load and capacity models provide daily loads and available capacities as system operation is simulated. This information is used as input data to a production costing model. Because of the close tie between the two, production expenses can be computed accurately to reflect load changes, unit reliability differences (which affect availability), loading priority differences, and other details. This relationship between the submodels assures capital costs and production expenses that are computed consistently in any expansion pattern.

A number of techniques are available to compute production expense. The technique to use depends on the questions to be answered and the alternate patterns to be evaluated. The most accurate method uses hour-by-hour economic dispatch with consideration of unit shutdown. This is a lengthy computation and should be chosen only when accuracy demands it. It is better suited to short-range studies than to long-range forecasts.

An approximate method using load-duration curves has been developed and found to be sufficiently accurate for many studies. Separate load-duration curves are used for each month and for weekdays and weekends within each month. The curves are adjusted for spinning reserve, and units are costed running at minimum loads and at full load. Furthermore, unit availabilities are taken into account. A unit available one week out of four in a month figures into production costing for the month proportionally. These refinements result in an overall system production cost within about one percent of that computed with hour-by-hour economic dispatch. This accuracy is adequate for

many studies of future expansion patterns for utilities.

The final cost component needed for pattern evaluation is the transmission expansion cost. This component may be influenced substantially by changes in plant locations, by changes in unit sizes and installation dates, or by use of substation peaking units.

The approach used is called "fencing." Simply stated, the transmission adequacy at a generating plant, switching station, or substation is checked by placing an imaginary fence around the location (Fig. 8). Total transmission capacity is determined by counting the number of high-voltage lines crossing the fence and multiplying each by the historic maximum average loading of lines at that particular voltage. The transmission capacity so obtained is compared with net generation or load at the location to determine if additional transmission is needed.

Geographical areas containing two or more of these locations are also fenced. If insufficient transmission enters such an area, a new line is added.

Fencing and building of new lines in the transmission planning model continues month by month as loads grow and new units are added. Each time a line is added, a number of alternates are costed and the most economic expansion chosen. Express circuits are used and terminal costs minimized wherever possible.

For one system, approximately half an hour on an IBM 704 is required to produce a step-by-step transmission expansion pattern for 20 years. For each step in the plan, the program reports the terminals of all lines and their voltage, construction, and taps. The final output supplies for each substation location the number of breakers, the incoming lines of each voltage, the voltage and type of busses, number of transformers, the load, and generation installed. Finally, the capital expenditures of all construction and conversion are tabulated by years and accounts.

The annual cost of money, depreciation, taxes, insurance, operation, maintenance, and administration must be determined from past experience for the transmission accounts just as is done for the generating plant. The present worth of all future revenue requirements may be computed, using transmission system first costs, revenue requirements percentages, and dates of each expansion step. When transmission present worth figures are combined with those for generating station cost and production expense, the resulting figure is a total present worth of all future revenue requirements for the long-range pattern. When a number of patterns are so evaluated, the dollar effects of planning policies become evident.

conclusions

Many questions can be answered with this new planning tool. Are peaking units economical? When are retirements justified? How much can be spent to get a more accurate load forecast? What is reliability improvement worth? Do large-unit savings exceed extra reserve costs? When is the next unit needed? Can a nuclear plant be justified? How long should a long-range plan be? What effect has changing load factor? What is an optimum expansion pattern from an economic viewpoint? Answers to these questions and many more are made possible by the application of new mathematical planning techniques on modern, high-speed digital computers.



CREATIVE ENGINEERING . . . An Engineer's Viewpoint. How can engineering creativity be improved? The opinions of some outstanding engineers give some clues.

L. A. KILGORE, Director of Engineering
Westinghouse Electric Corporation
East Pittsburgh, Pennsylvania

Editor's Note: "Creativity" is a subject that has been bandied about considerably during the past few years, particularly with respect to science and engineering. There are many opinions about the mental processes involved in creative engineering, and about how to encourage creative effort.

This article is based on the opinions and ideas of a group of engineers who had already demonstrated strong creative ability. These ideas were expressed in a seminar held at the East Pittsburgh plant, to which a number of engineers who had made important technical contributions were invited. This article summarizes and analyzes the thoughts expressed at that seminar.

More than ever before, the growth of a company depends on new products and on major improvements in old lines. Hence, today management has a greater appreciation of the value of "creative engineering."

All engineering is creative to some degree. While product design is the most obvious example, similar creative effort must be applied by engineers in other specialized fields. The manufacturing engineer who designs a new production line, the systems engineer who analyzes and plans new systems, or the application engineer, who devises a satisfactory answer for specific requirements, can all make creative contributions.

Probably every engineer would like to be more creative. The question is: How? Just what is the nature of creative thought? Because of the widespread interest in this subject today, much has been said and written about

The best creative ideas sometimes are the result of a sequence of events: (1) concentrated effort; (2) mental relaxation, during which the idea occurs; and finally, (3) completion of idea.

it. However, some discussions emphasize one point, some another, and there are still conflicting opinions.

Some believe that creative ideas come with a flash of inspiration; others quote Thomas A. Edison as saying, "Invention is 99 percent perspiration and 1 percent inspiration." Some believe that the necessary requirements are a careful statement of the problem and then a logical problem-solving sequence; others contend that new ideas come more by chance association of concepts stored in the brain. Some people advocate a group attack on a problem, but others contend that an individual can do much better working alone; there are the "Brainstormers" and the "Anti-Brainstormers." And finally, still others contend that a person is born creative or not, that it can't be learned; others feel that creativity ability can definitely be improved. Each of these ideas probably is true to some extent, but further investigation is necessary to get a clear picture of some basic factors affecting engineering creativity.

Recently, the Westinghouse East Pittsburgh Division planned a series of classes for engineers on the subject of creativity. But before attempting to teach creativity, the first step was a seminar with a group of engineers who had made important contributions to new machines or new methods.

These engineers were first asked to think back to the time they got one of their best ideas. What were the conditions? How did they approach the problem? Just when did the idea come to them, and what was driving them? This group had a common desire to search for knowledge by comparing experiences so that the observations

were objective, and are worth repeating, since they disclose some of the fundamentals of creative engineering.

With one exception these men told of experiences where their best idea had come to them only after a great deal of hard conscious effort in reviewing past practice or theory and in analysis or experiment. However, the best idea did not come at the time of concentrated effort, *but almost invariably at a later time when the mind seemed idle*. For example, they mentioned such occasions as walking back from the laboratory, driving to work (by themselves), while shaving, and so on. The new ideas that occurred to them at these odd times were not always complete, but were a strong mental picture of something they felt would work.

This is not a new observation. Most people have experienced this situation, if not in connection with a technical problem, at least with some personal problem. This type of experience confirms the notion that the human mind does not move in a straight logical fashion to come up with really new combinations. It also supports the idea that our subconscious mind goes on working on our problems and can bring to our conscious mind ideas and suggestions if we are ready to listen.

These experiences emphasize one of the most important aspects of creativity—*strong motivation* is needed. Note that this group reported hard conscious effort in preparing their minds and trying for a solution; furthermore, the desire to find an answer must be very strong if the problem is to be retained in the engineer's subconscious mind and if he is to be sensitive to suggestions from this source. We cannot dictate to our subconscious mind, it only works on what truly concerns us.

The importance of motivation is not a new observation, but we were sufficiently impressed to go on and delve as deeply as we could into the motivation of the individual at the time of his best work. These men recognized that they were highly motivated at the time and mentioned in some cases a real feeling of urgency.

Somewhat surprising was the fact that almost universally these men reported that their chief drive at the time was to accomplish something *to gain recognition*. Some wanted the recognition of management, often from

someone higher than their immediate supervisor; others wanted this type of recognition from some respected technical leader. Two men were mentioned who inspired this type of reaction—Dr. J. Slepian of Westinghouse Research Laboratories and the late C. M. Laffoon, an expert in power generation. Each of these was a man of principle and a creative leader in his own field, and each showed an interest in creative, younger men.

Several of this group of creative engineers thought their drive came more from a desire to show their colleagues what they could do. Colleagues to some meant respected members of their department or project team. A few looked for recognition from highly respected engineers in their particular field throughout the world.

Some men said that they felt an inherent desire to solve any difficult problem that confronted them; and they felt a personal satisfaction in a good solution not necessarily associated with immediate recognition. In these cases, each individual was asked to think back in his experience to the earliest time that he recalled this strong self-satisfaction of solving problems or coming up with new ideas. In each case, the engineer could trace this feeling to an incident or incidents in his early experience, childhood or high school, where he had received some special recognition for solving difficult problems, or for a bright idea.

The late Benjamin P. Baker, who was the most inventive engineer at East Pittsburgh, volunteered the story of his first invention. When he was a small boy in the mountains of Virginia, he trapped rabbits and sold the skins to an old man who came around with a cart. The old man held up the skins and paid according to their length. An idea flashed into Ben's mind—his first invention—a rabbit stretcher. This was an ingenious device of strings and a rack for drying the skins under a steady tension. Ben recalled that while his drive at the moment was to earn more money, he did get a great deal of satisfaction from having his family and neighbors talk about "Benny's invention," and he resolved right there that he was going to be an inventor. Here was a man with a great deal of built-in motivation for creative effort, but he also recognized that he was stimulated by a

current desire for recognition of his accomplishments. Several other engineers cited similar cases, where a parent or teacher's special interest or recognition gave the individual a built-in desire to solve problems and come up with new ideas.

While people are not born with creative genius other than a sound mind, apparently some people develop this trait at an early age, based on experiences such as that described; these experiences sometimes furnish motivation throughout their career. However, the desire for current recognition can also be a powerful motivating force, and this is something that can be cultivated and developed.

As to special environment required for creative thinking, there was no agreement in this group except on one point—the need for at least brief periods during the waking hours when the mind could be free from concentrated efforts and thought-consuming details. This suggests the need for some simple physical chores, or leisure time, when the mind can be kept free.

Mention was made by some that the stimulus for the new thought that solved the problem was received through some chance observation that only vaguely resembled the ultimate new idea in shape or function. Most people can recall having memories or

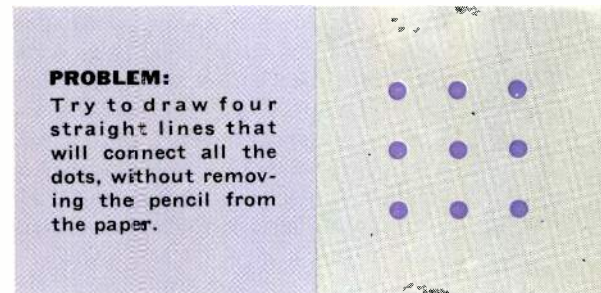

new ideas while looking at some vague shape such as a cloud bank or the glowing coals of a fireplace.

With regard to money incentives or privileges from management as motivation, the observation of most of these men was that these things were important when they reflected a true appreciation of the value of the man's work. Incidentally, awards and official recognition meant little unless accompanied by a genuine appreciation of the man and his work.

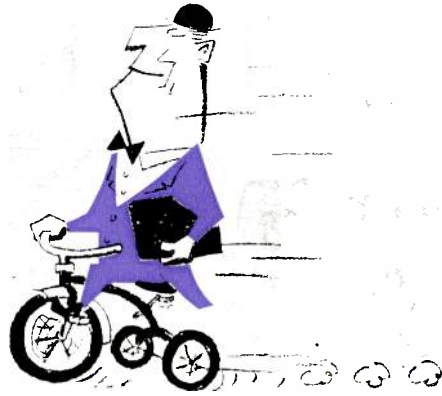

The creative person may be a nonconformist or eccentric in one respect, but quite conventional in all others.

The fundamentals of this whole problem lie in the physiology and the psychology of the human brain. The analogy between the human brain and the large digital computer is useful. The nerves send digital impulses to and from the brain; here the speed is measured in terms of tenths of second rather than microseconds. However, the human brain has a memory capacity of at least 10 billion bits of information compared with less than a million for present computers.

The brain apparently stores everything sensed or thought of in our lifetime. The problem, of course, is to recall the needed concept at the right time. Psychologists tell us that we recall things by association. Our associations are made at the time we first sense the object or the concept. This functions like a built-in computer program for cross-referencing information as it is stored. It is useful to note the common associations for recall. They are (1) by similarity of sensory response; this may be smell, taste, visual shape, etc.; (2) by correspondence in time or in sequence pattern; (3) by cause and effect; and (4) association by use or value.

Consider a simple picture of the mental process of creative thinking. It is apparently one of running back over our stored concepts and theories by a chain of associations until we find a concept that fits our needs; one that we feel is right. The chain of associations is not a random affair; however, there are many chance deviations. The path our chain of associations takes is strongly influenced by our desires of the moment. There are apparently multiple paths in our brain and while only the items of greatest momentary interest or urgency enter our conscious mind, still other action is going on at a

subconscious level. These theories explain the previous observation about the need for strong motivation and the apparent subconscious thought that occurs when we are strongly interested.

Since the mind associates concepts by cause and effect and by use or value, our original observations must be tied together with a satisfactory theory. A poor theory is better than none because it still serves as a link to tie together our observations. However, the more fundamental the theory the broader the range of experience it will tie together. The creative person is usually the type who tries to assign a cause for every observed fact. There is a direct benefit in the habit of digging into unexplained observations, because here we often turn up some fact that others have overlooked which may be the key to a new principle.

This desire to understand and explain things is a special form of curiosity. The fact that it is closely tied to creativity is attested to by the common belief that a natural curiosity is an essential part of creative ability. What is required is not just ordinary curiosity, but what might be called "scientific curiosity."

Association by use and value are obviously useful in everyday living, but too rigid a classification can be a block to creativity. Because the human mind tends to assign a single purpose to every object, we are unlikely to see how we can fit the object into a new use. New ideas in their original form are often crude, unfinished, even messy, and our training may have taught us to tolerate only

the accurate, complete, and neat solution. One reason junior experimenters who later study engineering often turn out to be creative may be that they learned quite early the habit of seeing new uses for discarded objects.

Another mental block occurs from too ready acceptance of unnecessary rules and limitations. This block can be illustrated by some of the trick problems such as the one shown here with nine dots. In this problem, almost invariably people accept the unspecified rule of going only from point to point and not going outside the square.

The creative person is by habit of mind freer from inhibitions and fixations than most; he is willing to question and to tear down old concepts to build up new ones. A person does not need to be eccentric or a nonconformist to be creative, but frequently creative people do show some of these tendencies and they should be understood. A man can be quite creative in one field and quite conventional in all other respects. Some can be creative and imaginative at one time and quite analytical and practical when the situation demands it.

The type of block that comes from assuming unnecessary limitations and rules can sometimes be overcome by a careful restatement of the basic problem to be solved, putting the problem first in the most general terms conceivable. Then as the objective is narrowed, unnecessary restrictions are avoided. Some people have found this so effective that they assume a careful definition is half the solution.

A few mechanical schemes can help force us to consider more combina-



Some people believe that creative ideas come with a flash of inspiration—others think that invention is 99 percent perspiration and one percent inspiration.

tions of ideas, such as charting all the functions associated with a problem and attempting to list all the methods of accomplishing each. However, even five functions and ten possibilities for each provides an unwieldy number of total combinations to evaluate and no assurance that a key element has not been overlooked. Some day electronic computers may help in this process.

One other technique to improve our opportunity for creative contributions is suggested by a statement once made by Dr. J. Slepian. He pointed out that there are two general ways to invent: (1) to have a strong need and apply all the facts and theory we can bring to bear on the one need; and (2) when we have either learned or developed a new theory or concept, to try the new principle on all problems we know to see if it offers any new solutions.

Psychologists have said that all human action and thought stems from a human need. But it has also been pointed out that our basic physical needs, once they are reasonably satisfied, cease to be strong motivating power. The needs that motivate the creative engineer are likely to be social—chiefly, the need to be recognized by a group or individual he respects.

In discussing this point with a group of engineering supervisors in an effort to help them motivate their people further for creative work, one young supervisor challenged the idea that physical needs were unimportant. So we asked him, "What physical needs are driving you to the extra effort and time you put into your job?" He thought awhile and then came back, "Well, maybe I don't have any—but my wife does." So we pressed the point further: "What were they?" "Well, new carpets, gadgets, and so forth." These, he finally agreed, were more a matter of prestige than real physical needs. But he had made a point, too—that whether they represent physical needs or social status, the ability to provide prestige items for the family can be important motivation.

A number of good ideas were developed with this same group of engineering supervisors about how to create an atmosphere for creative work. One was: It is important not to kill off some budding creative spirit by giving a new man's ideas the time saving treatment: "we tried it before," "it's impractical," etc. It pays to listen

open mindedly to those new ideas, if for no other reason than to keep from discouraging the habit and the motive. In fact, managers must go further, and show that new ideas are welcome even if they can't all be used. Often a manager can contribute greatly by arranging for a man with a new idea to tell his story to higher management, or to a group of his colleagues.

Does it help to discuss our problems with others? Certainly it helps us to get the problem better in mind if we describe it to someone. Also, another person brings a fresh point of view; he may not be inhibited by some unnecessary limitation that we have accepted because we are too close to the problem. The other man's ideas may not be good, but very often something he says may start you on a new line of thought. Someone has aptly said, "You don't invent in a vacuum."

Recently many have suggested the group approach to finding new ideas. It is generally agreed that it is desirable to have some in the group who are not too close to the problem. One form of this group approach, "brainstorming," sets up the rule that no critical comment is allowed, any ideas are acceptable (the more the better), and all ideas are to be recorded. The ideas must be evaluated later by one person. The group can easily get 30 ideas in 30 minutes, but only one or two are likely to be of any value. This may still be worthwhile, at least on simple problems where it is possible to get results without having to analyze or evaluate successive steps. It is also valuable to draw some of the group out of their too fixed values and concepts. For more involved problems the group approach can work if a small group have learned to accept each other's constructive criticism and analysis, and if they can develop sufficient team spirit to build on each other's ideas. A number of the creative engineers mentioned earlier spoke of getting real benefit from discussion with one or two others where they really allowed themselves to think about unconventional approaches to their problem.

How can an engineer improve his creativity? Obviously motivation is important. This is one thing that can be strengthened with a little time and effort. We can cultivate acquaintance and friendship with those who are

creative and with those who appreciate creativity. An understanding and a true respect for these people leads to a desire to gain their recognition. This is the key to this type of motivation. Reminding ourselves of the rewards of creativity is helpful, but even more important is the satisfaction of even a small success. The useful habits of the questioning mind and a scientific curiosity can also be developed. Improvements of this kind are slow, but worth the effort.

Some things can be done immediately. Creativity can be improved by carefully stating and restating the problem, being sure that unnecessary restrictions have not crept in. We can ask ourselves critical questions that force us to look at the problem from a new point of view. We can deliberately tear down old concepts to build up new ones. We can discuss our problems more with others who might have a fresh point of view. After our minds are charged with all the facts and theories, and having built up the desire for a solution, the next step is a period of incubation. Some time in our waking hours must be provided for the mind to be idle, to provide the opportunity for the subconscious mind to break through to the conscious. Confidence that we will ultimately find an answer is important. Some

SOLUTION:

This is one solution. Note that no restrictions were placed on lines crossing; nor was the problem restricted to the area bounded by the dots. Did you assume these restrictions?

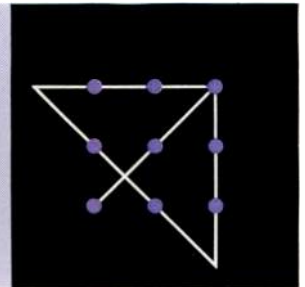

frustration is normal; the problem may even have to be put aside for considerable time. Persistence is an essential element in helping improve engineering creativeness.

In summary, there are a few immediate steps an individual can take to improve his creative ability, and there are still other far-reaching improvements in motivation and in personal habits that can be made by anyone willing to make the effort.

SERVO VALVES... The Link Between "Mind" and "Muscle" of a Control System.

WAYNE B. LLOYD
Air Arm Division
Westinghouse Electric Corporation
Baltimore, Maryland

Hydraulic actuating systems are becoming increasingly useful with high-performance servomechanisms, such as those employed in missiles, aircraft, and automated systems. The hydraulic actuator has high output force, fast response, and low weight.

The servo valve, which controls or meters fluid flow to the actuating device, determines hydraulic system performance. This valve transforms the electrical control signal to the work-producing hydraulic signal. Two of the most promising models developed in recent years are the *pressure-feedback* and *pressure-derivative feedback* valves.

basic elements of a hydraulic system

A typical hydraulic actuating system is shown in Fig. 1. The principal elements are the fluid power supply, the torque motor, servo valve, and actuator.

The pump delivers fluid power at pressures from 300 psi in some industrial systems to 4000 psi in some military systems. Peak flow delivered varies from one gallon per minute in small systems to over a hundred gallons per minute in larger systems. A reservoir is provided to allow for minor loss of fluid and for heat dissipation. Some systems also require a heat exchanger for additional heat dissipation. The accumulator supplies transient flows that exceed pump capacity.

The fluid used depends on the application. A variety of petroleum-based and fire-resistant fluids are employed in industrial applications; in military applications, petroleum-based fluids are used for medium temperatures and silicate ester-based fluids for high temperatures.

The servo valve, controlled by the torque motor, meters the flow of fluid from the hydraulic supply to the actuator. The actuator converts fluid pressure and flow to mechanical power to operate the load. Common forms of actuators are linear piston actuators, rotary vane actuators, continuously rotating piston motors, and continuously rotating vane motors.

valve elements

The servo valve is a combination of valving elements that control fluid flow. The most common elements are fixed orifices, flapper-nozzle valves, and spool valves. These elements are shown in Fig. 2.

Flow Control Valve—A basic form of servo valve, capable of moving an actuator in either direction at varying rates of speed, is shown in Fig. 3. This two-stage valve is made up of two fixed orifices, a double-acting flapper-nozzle valve, and a spool valve with four two-way porting stations. This servo valve is representative of a class of valves known as flow-control valves.

A spring-centered spool is used in the flow-control valve shown. Other flow-control valves may use mechanical

feedback from the spool to the flapper, but the end result is the same—a spool displacement from center proportional to input current. Since flow is proportional to spool displacement, which is in turn proportional to input current, output flow is proportional to input current.

A typical servo loop, using a synchrotie for position feedback and summation, is shown in Fig. 5a. The conventional flow-control valve is capable of satisfactory response in this servo loop when used with actuator loads of small mass. But when loads having large mass are driven, the flow-control valve can produce an unstable system, or require a low value of loop gain. Actually, high loop gains are desirable to obtain fast system response with minimum error.

loop instability

The need for more sophisticated valves can be illustrated with an examination of loop stability.

Instability arises when the action of the servo valve and load is resonant with respect to the input signal. Resonant response is caused by energy interchange between the compliant elements of the actuator and load mass. For example, a signal to the flow-control valve causes the spool valve to be displaced off center a discrete amount, which ports one side of the actuator to supply pressure through the small opening produced by spool displacement. The other side of the actuator is ported to system return through a similar small opening. With the flow-control valve, spool displacement is maintained by only the input signal, and is independent of flow and pressure to the load. Therefore, the high-pressure side of the actuator inflates to a pressure higher than the quiescent value, and the low side deflates to a pressure lower than quiescent, and the actuator shaft deflects torsionally as load torque increases. (Any structural compliance, either in the actuator mounting or between the actuator rotor and load, has an effect equivalent to shaft deflection.) Elastic energy is stored in the actuator oil and the actuator shaft, and is transmitted to the load mass as excess kinetic energy, resulting in transient overspeeding alternating with underspeeding until the energy is dissipated. The frequency response and time response of this system are shown in Fig. 4.

acceleration feedback

The problem of load resonance can be alleviated by negative acceleration feedback—a means for closing the spool valve opening as load acceleration increases, thus preventing excessive storage of compliant energy.

Although theoretically ideal, acceleration feedback is troublesome to mechanize. Direct implementation of acceleration feedback requires a precise acceleration transducer and considerable additional circuitry. Fortunately, the same result can be realized by another means—load differential pressure feedback to the spool valve. And this effect can be accomplished with a modification to the flow-control valve, which then becomes a *pressure-feedback valve*.

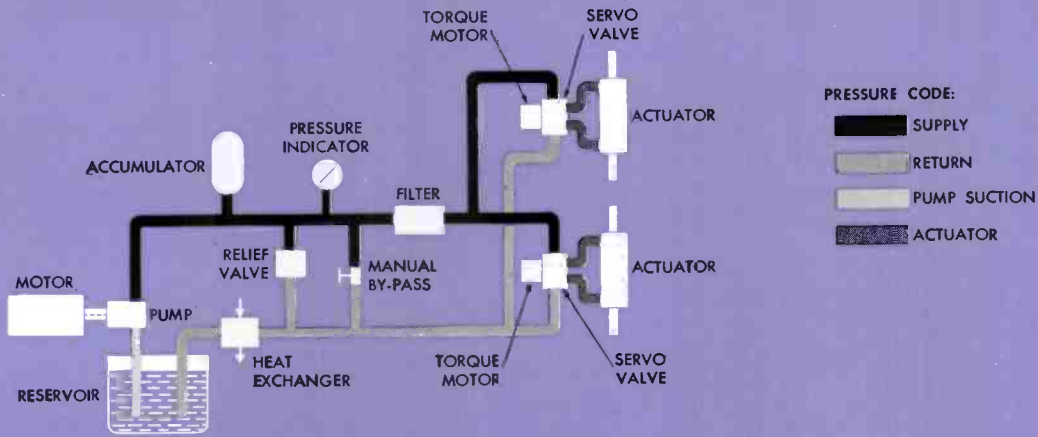
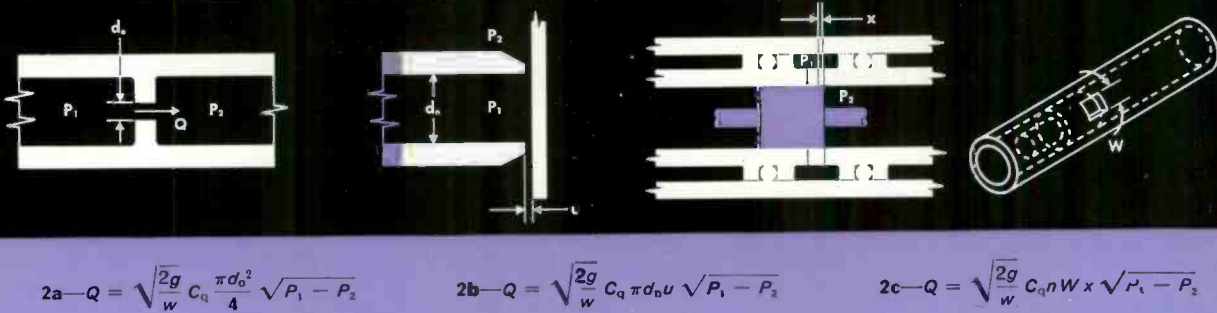

Fig. 1—Typical hydraulic system for a valve-controlled servo system.



SYMBOLS

Q=Flow, inch³/second
g=Acceleration of gravity, inch/second²
w=Fluid density, pound/inch³
C_q=Discharge coefficient, unitless
d_o=Hole diameter, inch
P₁=Upstream pressure, pound/inch²

P₂=Downstream pressure, pound/inch²
d_n=Nozzle bore diameter, inch
u=Distance between nozzle and flapper, inch
W=Peripheral width per porting slot, inch
x=Spool displacement from center, inch
n=Number of porting slots

Fig. 2a—The *fixed orifice* controls the rate of flow from high pressure P₁ to low pressure P₂, and is used in pilot stages and in resistance networks. Fig. 2b—The *seating valve* is a variable restriction that controls the rate of flow from high to low pressure. Variation in restriction is accomplished by varying the u dimension. Since the seating valve has zero friction, it is ideal for pilot stages. Fig. 2c—The *spool valve* element is used to control fluid power to the work actuator. It is a variable restriction device that controls the fluid flow rate from high pressure to low pressure. Restriction is varied by the axial position of the spool within the bore.

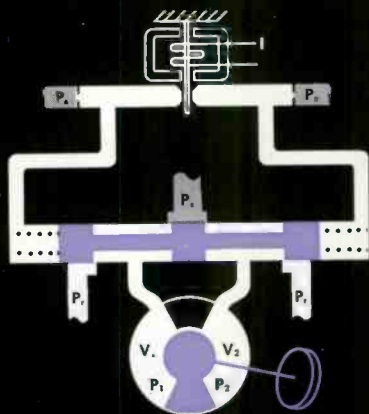

PRESSURE SYMBOLS:

P_s—Supply, P_r—Return, P₁, P₂—Actuator

Fig. 3—Flow-control valve used with rotary actuator.

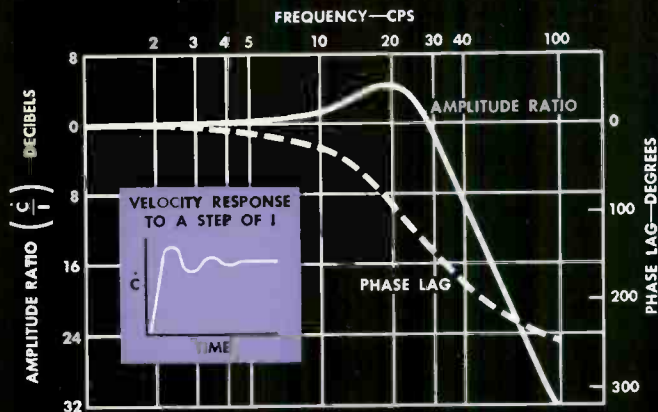
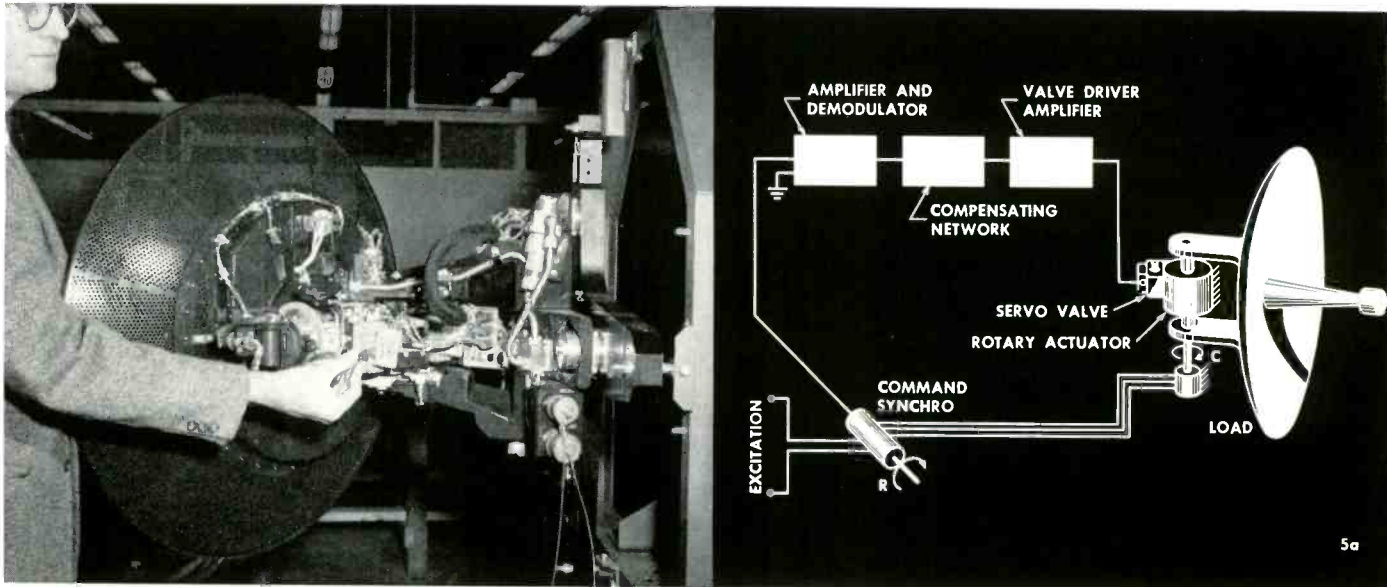

Fig. 4—Open loop frequency response and transient response of a flow-control system with mass load.



pressure-feedback valve

The pressure-feedback valve (Fig. 6) is constructed so that load differential pressure supplies an axial closing force on the spool valve. This is accomplished by making the cross-sectional area of the spool center land smaller than the cross-sectional area of the end lands. Hence, actuator pressure (P_{a1} in Fig. 6) causes a net force to the left on the spool assembly because of the greater area of the left-hand land; likewise, P_{a2} causes a force to the right. Therefore, when a difference between load pressures P_{a1}

and P_{a2} exists, a force proportional to this differential pressure acts on the spool. This force opposes the spool driving pressure ($P_1 - P_2$ in Fig. 6) so that the valve opening at any instant is proportional to the difference between driving pressure and load pressure.

Since load acceleration (a mass load assumed) is proportional to load torque, and load torque is proportional to load differential pressure, this pressure feedback arrangement is dynamically equivalent to acceleration feedback. The open-loop frequency response and transient

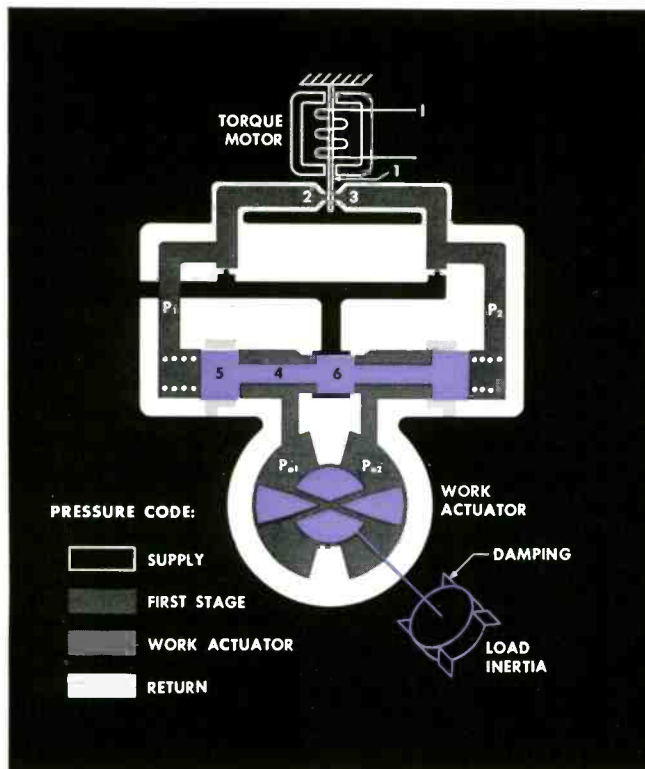

Fig. 6—Pressure Feedback Valve

Typical operation of the pressure feedback valve can be described as follows: Input current I to the torque motor coil causes the flapper (1) to move (in this example) to the left, which causes the left-hand nozzle (2) to become more restricted and the right-hand nozzle (3) to become less restricted. First-stage pressure, P_1 , becomes higher than its quiescent value while first-stage pressure P_2 becomes lower than its quiescent value.

The resulting first-stage differential pressure causes the spool assembly (4) to move to the right, which, in turn, causes work actuator pressure P_{a1} to increase; simultaneously, P_{a2} decreases. The resulting actuator differential pressure ($P_{a1} - P_{a2}$) produces torque that causes the load to accelerate.

While the load is accelerating, increasing actuator pressure, P_{a1} , causes a force to the left on the spool assembly because the end spool (5) has a larger diameter than the center spool (6). In like manner, the decreasing actuator pressure P_{a2} causes a force to the right on the spool assembly, but the net force on the spool is to the left, in opposition to the input force (P_1) from the first stage. This pressure feedback force serves to control the build-up of actuator differential pressure, thus preventing transient overspeed of the load as final velocity is approached.

Overall speed of response is rapid. For a step input of current, I , torque build-up occurs in 0.0025 second for a typical scanner drive.

Photo—The servo valve as positioned in an air-borne radar scanner drive.

Fig. 5a (left)—This schematic diagram of a feedback control loop illustrates the application of a servo valve to a scanner search loop.

Fig. 5b (right)—This machine tool table position servo uses a directly coupled linear actuator and a pressure feedback servo valve.

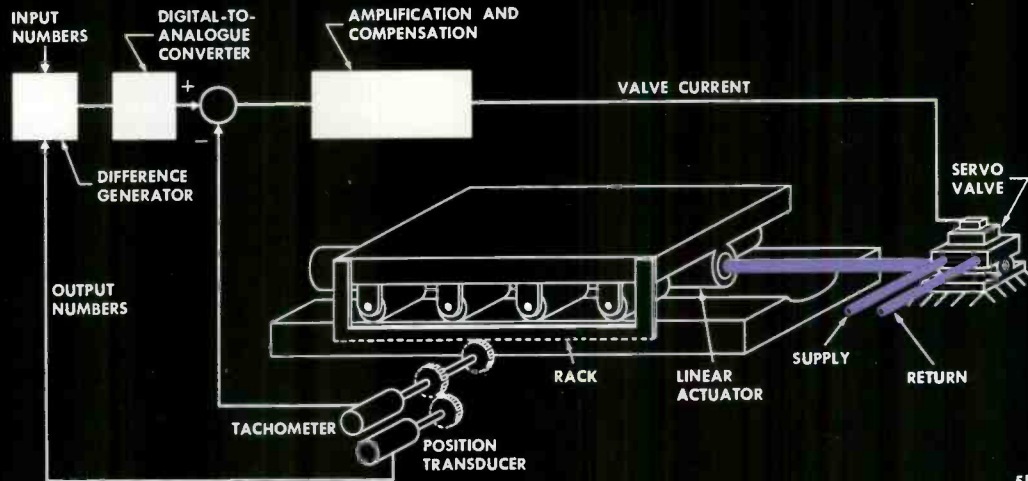

response of the pressure feedback valve is shown in Fig. 7. The pressure feedback arrangement makes possible a stable closed loop with higher closed-loop gain than can be obtained with a flow-control valve.

pressure gain

The pressure-feedback valve has been developed and is being built in production quantities for high-performance radar scanner drives. For systems where actuator and load friction can be kept low, the pressure-feedback

valve gives nearly ideal results with a mechanically simple unit. But for applications where load friction is high, direct pressure feedback is not as satisfactory (although results are better than with flow control). This is because direct pressure feedback lowers the *pressure gain* of the valve with respect to input current.

Pressure gain is defined as the amount of actuator differential pressure developed per unit of steady-state signal input current under stalled (locked rotor) conditions. The simple flow-control valve has a pressure gain that is infi-

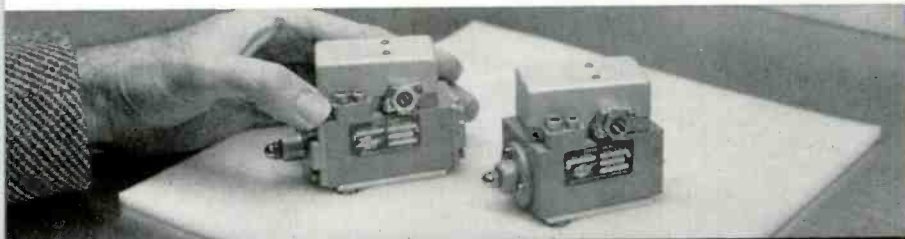

Photo—These pressure feedback (right) and pressure derivative feedback (left) valves are being used in air-borne radar scanner drives. These valves require a flow rate of up to 10 gallons per minute per valve at supply pressures up to 3000 psi. Fixed orifices with 0.006 holes are employed. Nozzle bores on the flapper-nozzle valves are 0.030 inch, and the quiescent gap between the flapper and nozzle is about 0.001 inch. Spools on the spool valve elements are about 0.25 inch in diameter, with a total peripheral width at each porting station of about 0.275 inch. Required input to operate the flapper valve is 5 milliamperes through a 2500-ohm coil.

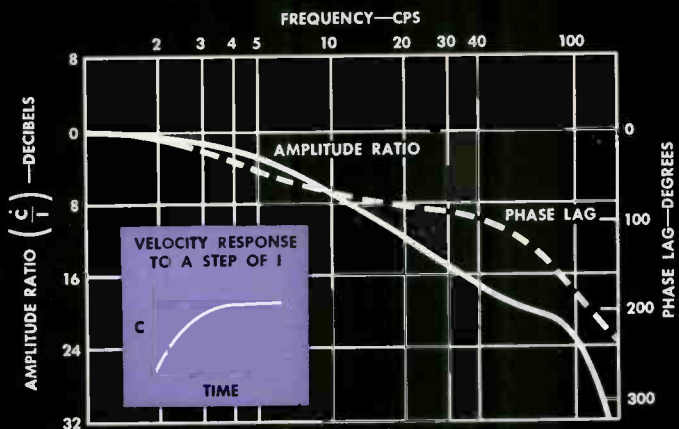

Fig. 7—Open loop frequency response and transient response of a pressure-feedback system with mass load.



ENGINEERING PERSONALITY *DANILO SANTINI*

Every morning hundreds of thousands of people step into elevators in office buildings all over the country, and are whisked silently and quickly to their floors. Very few realize the complexity of this efficient vertical transportation system. In all probability only a handful realize that an amazing array of electronic elements is responsible for their swift and smooth ride; or that the entire operation of the elevator system is carefully controlled by a computer control system that reacts to every change in traffic pattern.

Many of the developments that make this efficiency possible can be traced to the engineering skill of Danilo Santini. During his 37 years of association with elevators, Santini has contributed more than 45 patents with application to elevator systems and other fields. They range from speed-regulating devices to systems for controlling banks of elevators under changing traffic patterns.

Had he selected a career at an early age, Santini undoubtedly would not have thought of elevator engineering. Born in 1899 in Santa Fe, Argentina, Santini grew up in a large and closely knit family. He was tutored at home by an older brother for the equivalent of a grade-school education, and later attended a six-year technical high school. During the last two years of high school, Santini specialized in electrical subjects, and after graduation determined to pursue electrical engineering in a college in the United States.

At the age of 18, Santini came to this country to attend Ohio State University. Although he was qualified to enter the junior class, he chose to enter as a sophomore, because he had not yet mastered the English language.

As Santini now says, "A language barrier is a tremendous handicap when

you must learn technical terms as well as everyday conversation."

So Santini set about to master English. He studied the language 10 hours a day in Columbus, Ohio in preparation for entering Ohio State. But he soon discovered another handicap; the other Argentinians in his group continued to speak Spanish among themselves, and Santini felt this was a hindrance. So he left Columbus and moved to Salt Lake City, where he lived with an uncle who had been in the United States since childhood. Here he learned the customs and language of this country.

Once this task was out of the way, Santini returned to Columbus and entered Ohio State. To help finance his education he worked at a wide variety of jobs—a helper in an ice cream house, a draftsman, and for three years in a restaurant near the campus where he held, as he puts it, "every job from cook to cashier, dishwasher, and waiter."

In 1923, shortly after his graduation, Santini joined Westinghouse, and began his graduate student training. But even then he didn't stop his extracurricular work. He helped pile up large castings after office hours; he translated technical literature; he taught Spanish at the Westinghouse Club; and he was the first Spanish announcer at station KDKA in 1926. In fact, he announced the Firpo-Dempsey fight to South America.

When Santini completed the student course, he became an engineer in the control engineering department. In 1930 Westinghouse purchased the Kaestner and Hecht Elevator Company in Chicago, and Santini was sent there as a design engineer; the following year he was promoted to a section manager.

In 1937, the Westinghouse Electric Elevator Company (now the Westinghouse Elevator Division) was moved

from Chicago to Jersey City where the business and facilities of the ABC Company were acquired and integrated. Santini was among those who pioneered this enterprise. Starting as a section manager, he rose to section general engineer in 1942, subdivision engineer in 1944, manager of equipment engineering in 1945, manager of elevator engineering in 1958, and division manager of engineering in October 1959.

Santini's contributions to elevator design have been many. He holds patents, either singly or as a co-inventor, on a wide variety of developments. Among them are several on the Rototrol, a speed control and regulating device; Selectomatic Control, supervisory system in which the method of operation of a bank of elevators can be changed to suit different traffic conditions; and Automatic Selectomatic Control, in which a bank of elevators can be operated without attendants. He also played a major part in the development of Automatic Traffic Pattern, a control system that senses changes in passenger demand and automatically changes the pattern of operation; in 1958, Santini and three other engineers received a special patent award of \$3000 each for the development of this electronic system.

Evidences of Santini's work are everywhere, in office buildings all over the country. Notable among them are the elevators in New York's Rockefeller Center, the fastest in the world.

A part of every elevator engineer's job is to make his product efficient but "inconspicuous," in the sense that it performs reliably, safely, rapidly, and silently, with as little sensation of movement as possible. In this respect, too, Danilo Santini has done much to make the modern elevator system approach the ultimate in performance. ■ ■ ■

A GAS TURBINE FOR A HELIUM-COOLED REACTOR.

Gas turbine engineers were faced with some new design problems in this interesting and unusual gas-turbine application.

PAUL A. BERMAN
Industrial Gas Turbine Department
Westinghouse Electric Corporation
Philadelphia, Pennsylvania

In the Maritime Gas-Cooled Reactor Program, a high-temperature, gas-cooled nuclear reactor is being combined with long-life industrial gas turbines. The successful development of the high-temperature gas-cooled reactor will provide a heat source that can be used most efficiently with the gas turbine cycle.

The plant operates on a regenerative, intercooled cycle with helium passing directly through the reactor and rotating machinery without a secondary coolant loop. The turbines, which develop 22 600 hp, are designed for a maximum cycle temperature in the 1300 to 1500 degree F range, with normal continuous operation at 1300 degrees F. A maximum cycle pressure of 800 psi has been selected to provide an optimum size turbine for this power range. These pressure, temperature, and horsepower figures represent initial design point values; designers are confident

The gas turbine described in this article is being designed and built by Westinghouse for the Maritime Gas-Cooled Reactor (MGCR) Project under a contract with the General Dynamics Corporation. The project is being sponsored jointly by the Atomic Energy Commission and the Maritime Administration.

that machinery can be developed for higher ratings as higher reactor temperatures become available.

operating cycle

A cycle schematic diagram is shown in Fig. 1. Helium enters the low-pressure compressor from a precooler where its temperature has been cooled to about 85 degrees F. The gas is compressed from 310 to 520 psi, passed through an intercooler, and further compressed in the high-pressure compressor to the maximum cycle pressure of 800 psi. A regenerator then heats the gas to 740 degrees F before it enters the reactor. On leaving the reactor, the gas, heated to 1300 degrees F, enters the high-pressure turbine. The turbine expands the gas to 446 psi and 1025 degrees F, extracting sufficient energy to drive both compressor elements. The helium then passes through the low-pressure or power turbine, which develops the plant output power. Leaving the power turbine at 850 degrees F and 320 psi, the gas flows through the regenerator where heat is recovered to preheat the reactor inlet flow. Helium at 294 degrees F now re-enters the precooler to repeat the cycle. The plant will develop 22 600 horsepower at the coupling with an efficiency of 31 percent.

The efficiency of gas-turbine components are more dependent on volume flow than on mass flow. By variation of

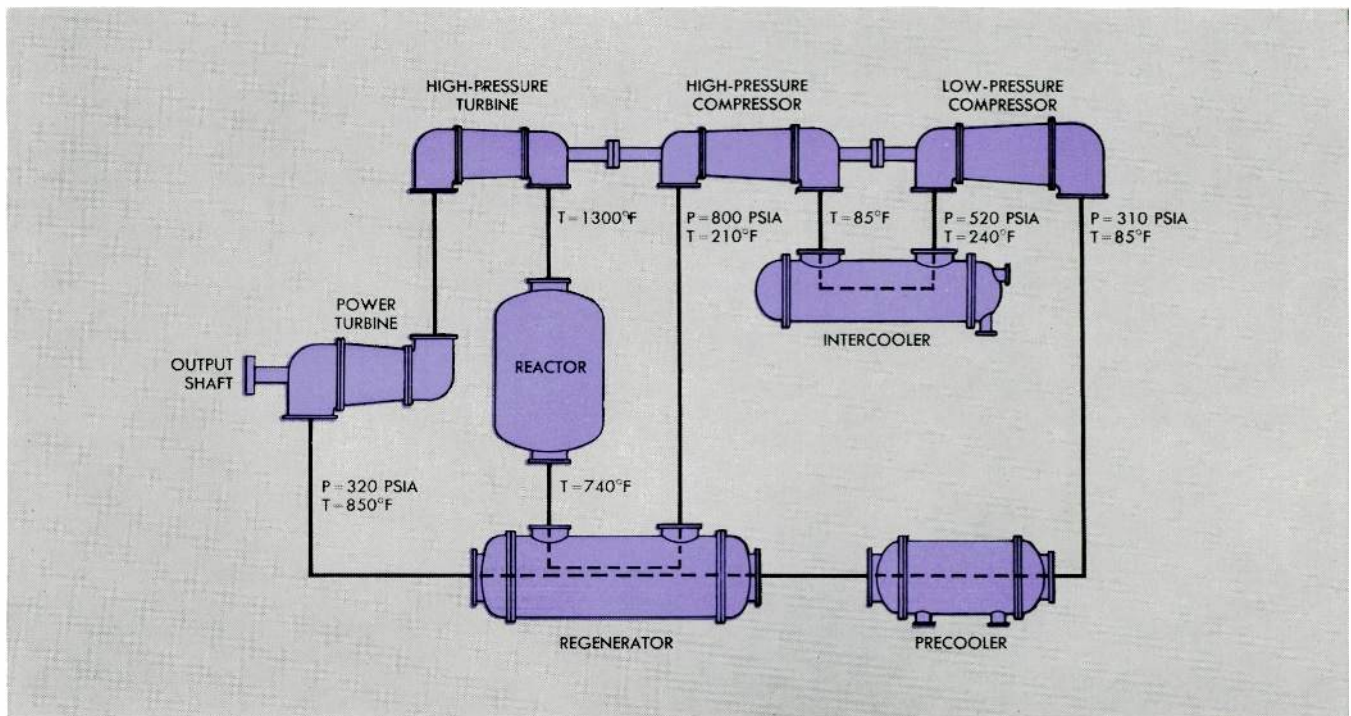
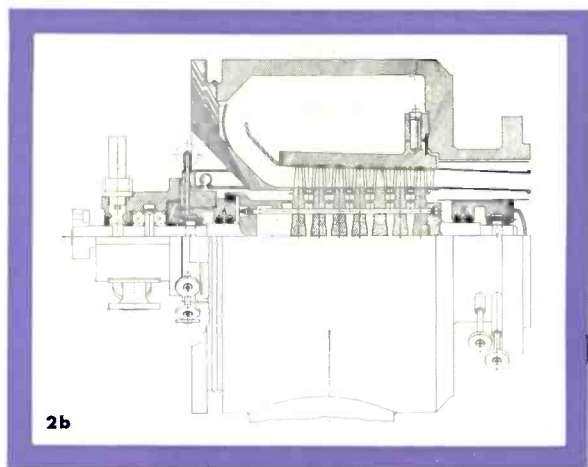
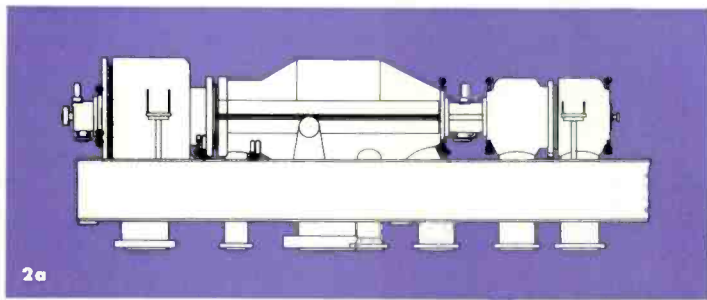

Fig. 1—Simplified diagram of the nuclear gas turbine cycle.



2b



2a

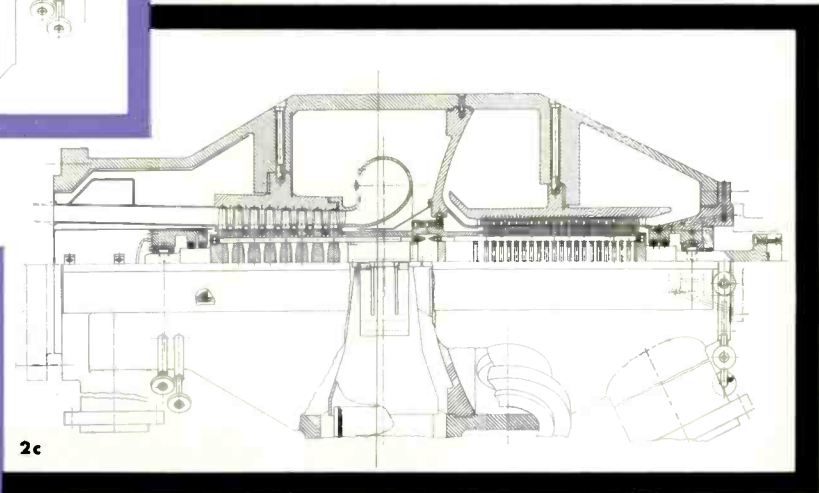

2c

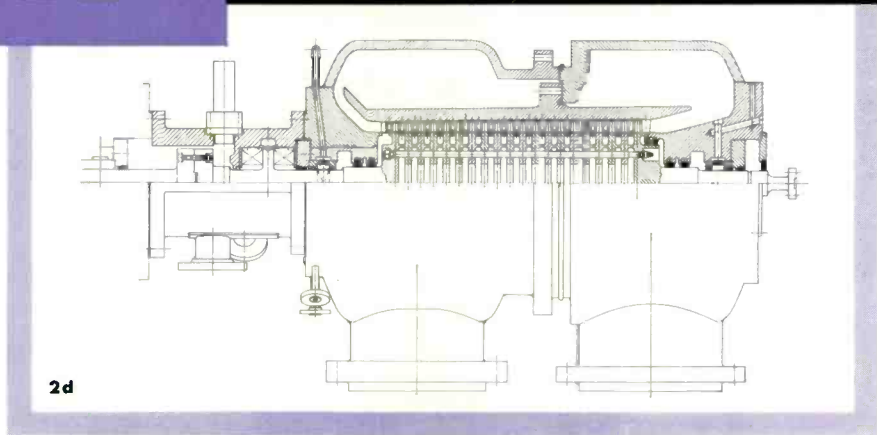

2d

Fig. 2a—Outline of turbomachinery on bedplate.

Fig. 2b—Longitudinal view of MGCR power turbine.

Fig. 2c—Longitudinal view of MGCR high-pressure element.

Fig. 2d—Longitudinal view of MGCR low-pressure compressor.

pressure level, as is possible in a closed cycle, operation at maximum efficiency is practical over a load range of 25 to 100 percent. As attainable reactor outlet temperatures increase, cycle efficiency will also rise. In a controlled atmosphere, gas turbine materials are available today that, with little development, will allow the gas turbine to be designed for 1700 degrees F and cycle efficiencies of 40 percent.

In the cycle shown, the power turbine can operate over its full speed range without affecting the high-pressure turbine and compressors, which provide reactor coolant circulation. The use of intercooling not only increases plant efficiency, but increases the power output per pound of fluid circulated, which leads to more compact components.

rotating machinery

All main rotating elements are of axial-flow design, with the high-pressure compressor having the smallest volume

flow, 13 500 cfm. Both compressors are designed with constant hub, or drum diameter and very nearly constant axial velocity throughout all stages. The low-pressure compressor has a 16-inch hub diameter while the high-pressure compressor has a 14-inch diameter.

The turbine staging is of the axial outflow type, which minimizes the exit swirl into the diffuser and allows all stages to use the same basic blade with increasing height through the turbine. The high-pressure turbine operates at higher temperatures and stress levels than any other component in the plant, and sets the compressor speed at 12 200 rpm. The power turbine shaft speed was set at 8500 rpm. This speed is based on economic considerations, in particular, to minimize turbine-gear combined costs.

The rotating machinery (Fig. 2) is composed of three basic units: the low-pressure compressor; the high-pressure unit, consisting of the compressor drive turbine and the

high-pressure compressor; and the power turbine. These three components will be mounted on a common bedplate, which will also contain much of the lubrication and seal piping to give a single compact assembly. Wherever possible, all main gas piping is connected in the bottom section of the casings, to simplify access to the components. The rotor of each of these units is mounted on two bearings, making a total of six bearing-and-seal assemblies for the entire plant. The combination of the high-pressure turbine and compressor into one rotating element eliminates the need for bearings and their associated seals in the high-pressure, high-temperature region.

high-pressure unit

The high-pressure unit consists of a single rotor with an eight-stage turbine and a twenty-one stage compressor mounted in one casing (Fig. 2c). Since this is the largest portion of the rotating machinery and contains the high-temperature and high-pressure piping, a horizontal casing joint is used to allow the top cover to be removed for inspection and service without disturbing the lower half.

The stationary turbine and compressor blading is made in half rings, or diaphragms, with an inner and outer shroud. These diaphragms are supported by an internal casing or blade ring. This type of construction simplifies sealing, handling, and inspection. The rotor is built up of a series of discs held together by "curvic couplings" and through bolts, which is typical of industrial practice (Fig. 3). This design results in a light, rigid assembly in which turbine rotor cooling is greatly simplified. Cooling is accomplished by allowing cool gas to enter the torque tube at the compressor discharge and be carried within the rotor itself to the various turbine stages. The gas passes through bolt holes in turbine discs and is metered at each stage.

The rotor is supported at each end by a pivoted pad bearing. This bearing allows high-speed operation of a light

rotor without the danger of oil film instability, which can occur in lightly loaded high-speed journal bearings.

For rapid power changes required during maneuvering, the power turbine is temporarily bypassed. A bleed or bypass manifold is incorporated into the discharge end of the high-pressure turbine casing. This manifold is integral with the high-temperature liners that guide the flow to the power turbine. A series of slots in the liners allows the gas stream to enter the manifold and the bypass line when an external valve is actuated.

low-pressure compressor

The twenty-stage low-pressure compressor is directly coupled to the high-pressure unit and rotates with it at 12 000 rpm, but is contained in a separate casing. Because of its relatively small size this casing is constructed with a single vertical joint. Since one rotating element is within the casing, assembly is less complicated by the use of a vertical joint and the sealing of the shaft ends is simplified.

As shown in Fig. 2d, one set of circular flanges makes up the only gas retaining joint for the entire casing, which as with all other helium-retaining parts, is fabricated from rolled and forged sections. This casing in particular is made up of cylinders, dished heads, and several forgings, two of which are the bearing and seal housings. Shaft sealing is provided by an oil barrier at either end of the casing.

The rotor is built up of discs, and uses the same curvic coupling and through bolts as the high-pressure elements.

power turbine

The power turbine operates with an inlet temperature of 1025 degrees F and an exhaust temperature of 850 degrees F. It has seven stages of blading similar in design to the high-pressure turbine blading. This casing also incorporates a vertical joint, which greatly simplifies the sealing required between the hot exhaust casing and the cool bearing and seal housing. A longitudinal section of the power turbine is shown in Fig. 2b. The construction of the rotor and stationary blade assembly is similar to that of the high-pressure unit. The turbine is equipped with a "dummy," or balance, piston to counteract the blade path thrust, thereby reducing the load that is imposed on the thrust bearing.

shaft sealing and lubrication

In a nuclear gas turbine, the seal and lubrication system must serve the following six basic functions: (1) Assure proper lubrication of all bearings under all possible operating conditions; (2) prevent lube oil from entering the main gas stream; (3) provide a barrier to prevent hot gas from entering the seal and lube cavities; (4) prevent radioactive material from entering the surrounding atmosphere or the lube oil; (5) allow recovery and reuse of any cycle gas that enters the seal system; (6) prevent air or other external contaminants from entering the main gas stream.

A relatively simple system has been developed to perform these functions (Fig. 4). A small amount of cycle gas is bled from the high-pressure compressor discharge and passed through a filter and cold-trap system to remove any radioactive material. This clean cool gas is then used as a barrier fluid to prevent radioactive contamination of the lube oil, and for protection against hot gas entering the

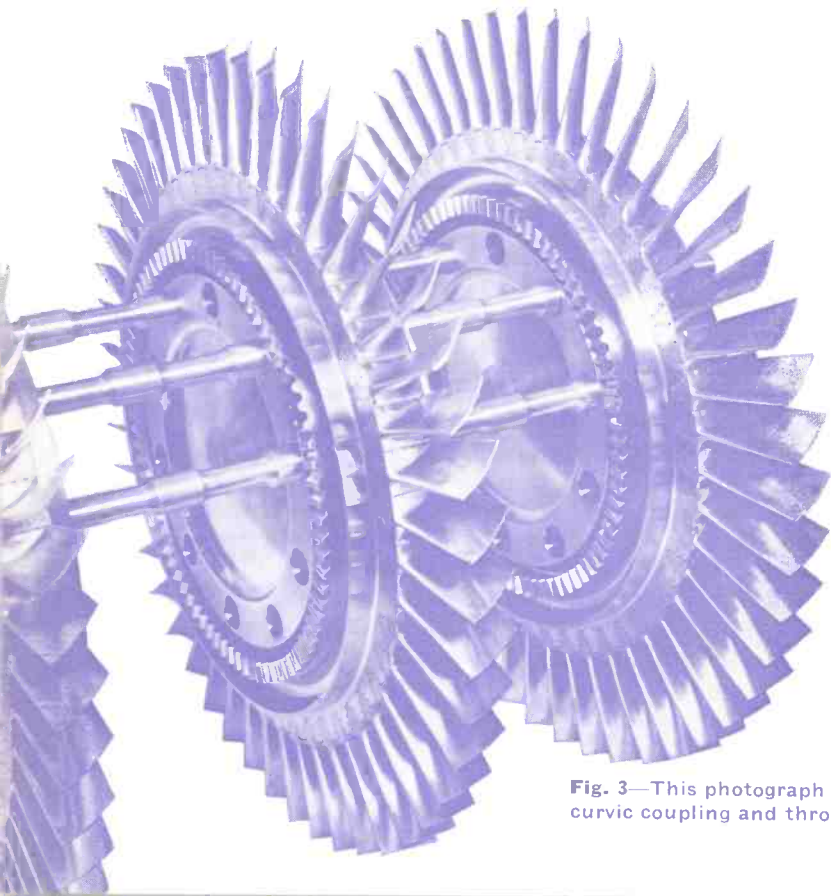

Fig. 3—This photograph shows industrial gas turbine curvic coupling and through-bolt assembly.

bearing housings. Spring-loaded labyrinth seals limit the barrier gas flow, both into the cycle and into the seal housing. The gas leakage into the seal cavity mixes with the lube oil and is scavenged. Seal flow toward the cycle cools the turbine discs near the two intermediate bearing housings, and helps to reduce the flow required by the dummy pistons.

Lube oil is contained in a closed system. Oil is pumped from a low-pressure reservoir through a cooler, filter, and regulators to the various bearings. The main gas pressure breakdown is taken across the bearings, which run flooded. After passing through the bearings, the lube oil pressure is then reduced through an orifice to the pressure level of the reservoir. Each bearing has a floating ring seal on either side of the pads to control the oil side flow. Inboard oil leakage passed this seal ring mixes with the clean barrier gas, the gas-oil mixture is scavenged from the housing and flows to a separation system where it enters a tank in which the solid oil settles out. A mixture of gas, oil vapor, and suspended oil droplets leaves the settling tank and enters a coalescing filter where the oil droplets are removed. Oil vapor is then removed in an adsorbent filter media and the clean gas is returned to the cycle. The outboard seal leakage flows to the low pressure reservoir which is maintained at 5 to 10 psi above atmospheric pressure.

An end-seal system is used to minimize external oil flow which would then require deaeration. The end seal is made up of two components: one element uses lube oil at 30 to 70 psi to form an oil barrier between two bushing type seals; the other element provides a seal when all oil pumps are shut down and the rotor has come to a halt. This static portion of the end seal may be either a mechanical, O-ring type seal, or a liquid seal fed from a periodically refilled standpipe. Leakage of oil to the atmosphere is vacuum treated before being returned to the internal system.

starting, cranking, and control

Gas turbine speed, and therefore gas flow, is controlled primarily by turbine inlet (or reactor outlet) temperature. A rise in reactor discharge temperature will increase turbine speed and coolant flow, tending to stabilize the reactor. The interdependence of the reactor and turbine on flow and temperature tends to provide a stable plant that is relatively easy to control.

Load variation can be achieved in any of three ways; changes in pressure level, changes in reactor discharge temperature, or bypassing of the power turbine. For rapid power changes, power-turbine bypass is used, while for long-time power modulation, pressure level changes are preferred. Reduction of the cycle maximum temperature to reduce load results in decreased cycle efficiency, and is not desirable.

A favorable characteristic of gas turbines is that turbomachinery efficiency is not affected by pressure level variation as long as shaft speed and volume flow are not changed. Load variation by pressure level changes results in a nearly flat part-load efficiency curve, down to 10 to 20 percent load; load will vary in almost direct proportion to system pressure level. As pressure level is decreased at constant-volume flow, the heat transfer surfaces increase slightly in effectiveness contributing toward a flat efficiency characteristic.

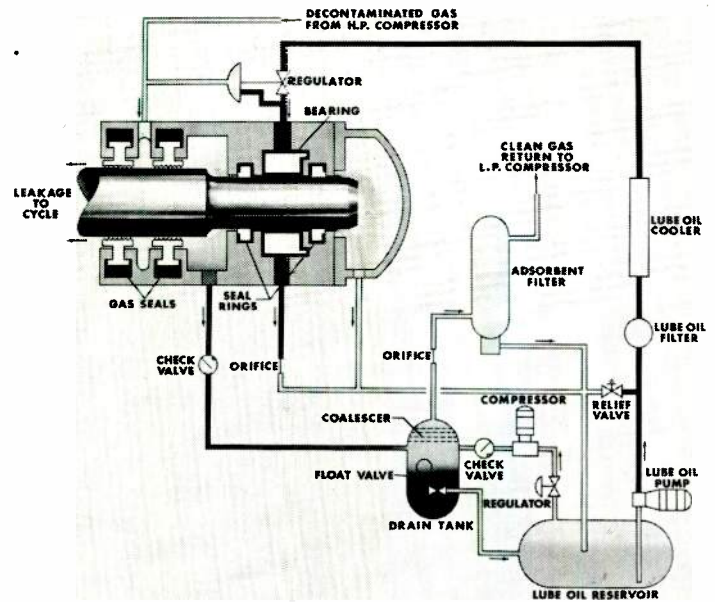

Fig. 4—Simplified bearing, seal, and lube schematic diagram.

The gas turbine can be started by an electric motor, steam turbine, or other small prime mover. The rotor is brought to a speed determined by reactor start-up cooling requirements. Reactor temperature is then increased and the gas turbine speed and flow will rise proportionately. Self-sustaining speed is reached at a reactor discharge temperature of approximately 900 degrees F. At this point the starting power is cut off and the gas turbine operates until reactor temperature goes below the self-sustaining level. The starting power can be applied at shutdown, driving the main compressors to provide coolant flow until the reactor and turbines have cooled.

Overspeed protection of the gas turbine is provided by the control system. However, the possibility of turbine overspeed is minimized by the self-regulating feature of the gas turbine reactor combination.

the plant of the future

As a prime mover, the industrial gas turbine has demonstrated a high state of reliability. Individual units have operated in excess of 60 000 hours. In a prototype installation, a unit recently operated for 15 months continuously at full load, and was finally shut down for scheduled refinery maintenance. The proven features of these industrial gas turbines are incorporated into the MGCR design.

Power levels of 150 to 200 000 kw can be reached with parts comparable in size to those now in use in open-cycle fossil fuel fired units. Temperature levels of 1300 to 1500 degrees F present no major turbomachinery problems; designers anticipate future operating temperature up to 1700 degrees F. At these temperatures, the nuclear gas turbine plant should offer an efficiency that is level at full and part load.

Westinghouse
ENGINEER
Sept. 1960

This article was abstracted from a paper presented at the Franklin Institute, Philadelphia, Pa. The original paper will be published in Monograph No. 7 of the Journal of the Franklin Institute.

REGULATION OF DISTRIBUTION VOLTAGE . . . A New Approach. Extensive studies of distribution systems have led to a new method as well as a new device for supplementary voltage regulation.

DAVID N. REPS
Electric Utility Engineering
Westinghouse Electric Corporation
East Pittsburgh, Pennsylvania

JOHN ASTLEFORD
Distribution Transformer Dept.
Westinghouse Electric Corporation
Sharon, Pennsylvania

A key problem in the expansion of electric utility distribution systems concerns the role that should be played by supplementary voltage regulation. As load grows in urban, suburban, and rural areas, economy of overall system design dictates the adoption of primary feeder circuit loadings and lengths that result in too low a voltage to outlying customers. This creates a need for regulation.

In 1959, a thorough study of voltage regulation problems throughout the distribution system was undertaken. Two results of this extensive evaluation are: a new method of regulation; and a new distribution voltage device called the Unereg regulator—that can be used with distribution transformers where regulation is required.

system study shows the way

Common practices of supplementary voltage regulation call for line voltage regulators, and fixed and switched shunt capacitors.^{1,2} Other well-recognized means of voltage improvement include line re-conductoring, or the splitting of circuits and the addition of new distribution substations.³

The most practicable and economic means of regulation has become increasingly difficult to identify. An undisputed place exists for both fixed and switched capacitors for correcting power factor, lowering system losses, and reducing capacity and investment. However, many sys-

tems and load conditions remain where, with capacitors applied to correct power factor to unity or even slightly leading, undervoltage remains prevalent in outlying areas. Apart from system redesign, the only apparatus for correcting voltage in such cases has been the line voltage regulator. Some time ago, speculation arose as to whether or not a more economical and versatile means of achieving supplementary voltage regulation could be found.

The possibilities of a device that could regulate voltage automatically on the load side of the distribution transformer appeared intriguing. Analysis of the feasibility and economy of such a device, however, required complete study of its effects on overall system design and cost.

In the initial search for an approach to the problem, an engineering development originally not intended for that specific purpose proved timely. That development was a new technique for finding the optimum distribution system, programmed for the IBM-704 digital computer.^{4,5} The method of comparing alternative designs of the total distribution system offered the means for studying alternatives of supplementary voltage regulation as well. The two alternatives compared were:

- (1) Application of line step-voltage regulators of the conventional type, located in the primary-feeder circuit.
- (2) Application of voltage regulation in association with individual distribution transformers.

Results of the comparison indicate that a voltage regulator used with the distribution transformer can offer a lower-cost means of supplementary regulation than conventional line voltage regulators.

Photo—The components of the new regulator.

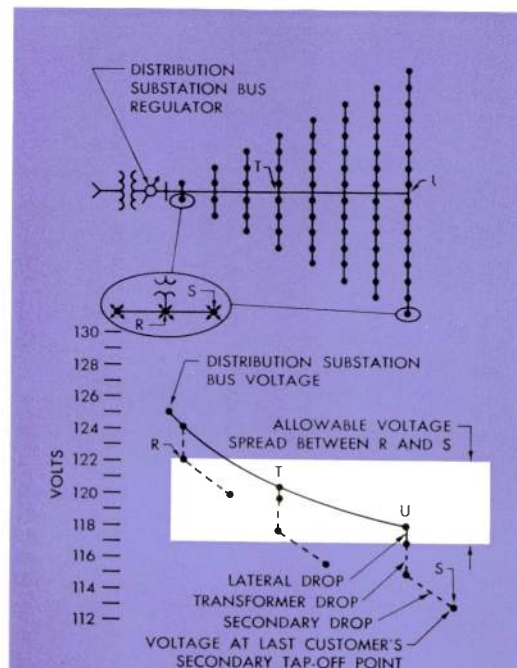

Fig. 1—Feeder load pattern and profile without supplementary regulation.

comparison of alternatives operating in system

To compare the two voltage re-regulation alternatives, consider first the one-line diagram of a primary-feeder circuit and system load pattern shown in Fig. 1. The primary-feeder circuit radiates from a distribution-substation bus that is regulated to maintain the substation bus voltage at 125 volts on a 120-volt base. The peak-load voltage profile of the feeder circuit is shown below the one-line diagram. The maximum-permissible voltage on any 120/240-volt secondary in the system is 122 volts (point R). At peak load, the secondary voltage at the most remote customer on the circuit is 113 volts (point S). However, the acceptable minimum voltage at this point is 117 volts. Hence the last customer on the circuit, and many others served between points T and U on the primary-feeder main, are subject to a peak-load voltage below the minimum-acceptable value of 117 volts on the secondary. Obviously, some means of supplementary voltage regulation must be applied to this primary-feeder circuit.

Application of Conventional Line Regulators—The application of a conventional feeder step-regulator is illustrated in Fig. 2(a). The function of the line voltage regulator applied to this feeder is to boost the peak-load voltage at its point of application. The regulator must be located such that the lowest voltage on any secondary ahead of the regulator is no lower than minimum acceptable. In the peak-load voltage profile shown, the voltage on the primary-feeder main just beyond the regulator is boosted to 125 volts. Voltage at the service tap-off point of the last customer on the circuit is 117 volts at peak load (point S).

The kva rating of the line-voltage regulator is governed by two factors: the load kva flowing through the regulator; and the required regulating range. The kva load flowing through the regulator is contained within the shaded area lying beyond the regulator. Of the 72 distribution transformers served by the primary feeder, 60 lie within the area requiring supplementary voltage regulation.

Boosting Voltage Regulation at the Distribution Trans-

former—One application of voltage regulation at the distribution transformer is illustrated in Fig. 2(b). Here a voltage boost is required at every distribution transformer serving a secondary on which voltage falls below 117 volts at peak load. The customers whose voltage would have to be re-regulated by distribution transformers with automatic voltage regulation are the same as those lying within the load area beyond the conventional line regulator applied to the same primary feeder. The distribution transformers requiring an associated means of automatic voltage regulation are contained within the shaded area. Voltage is boosted to 122 volts at the secondary of each voltage-regulating distribution transformer. Of the 72 distribution transformers served from the primary feeder, 60 are required to employ associated voltage regulation.

Bucking Voltage Regulation at the Distribution Transformer—Voltage-regulating distribution transformers can be applied in such a way that the relative number of transformers requiring this feature is reduced considerably below the number required to boost voltage. This application technique places the voltage-regulating distribution transformer at the "head end" of the feeder, in the vicinity of the distribution substation. In this application, the distribution-substation bus voltage is increased, as shown in Fig. 2(c), from 125 volts to 129 volts at peak load. With this increase in the voltage at the distribution-substation bus, voltage-regulating transformers need be applied only up to the point on the feeder where voltage drops to a value of 125 volts at peak load. At each voltage-regulating transformer, primary-feeder voltage is higher than 125 volts, but voltage is bucked-down to 122 volts, as shown. Line-drop compensation, used on the substation bus regulator and set to hold a primary-feeder voltage of 125 volts just beyond the last voltage-regulating transformer, assures that light-load primary voltage will not be excessive.

The distribution transformers that require bucking voltage regulation lie within the shaded area shown in Fig. 2(c). Twelve such transformers are required, as compared

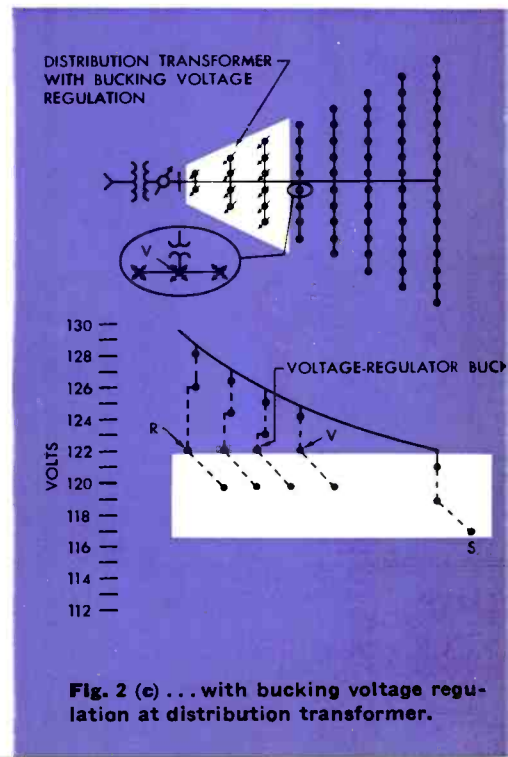
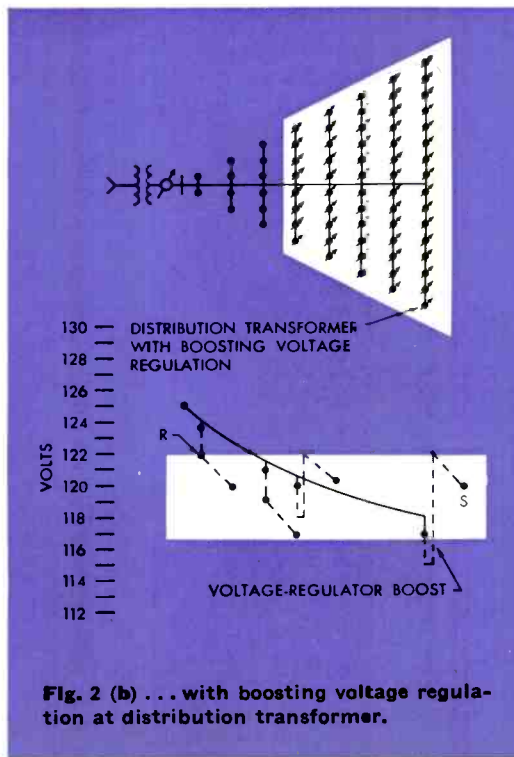
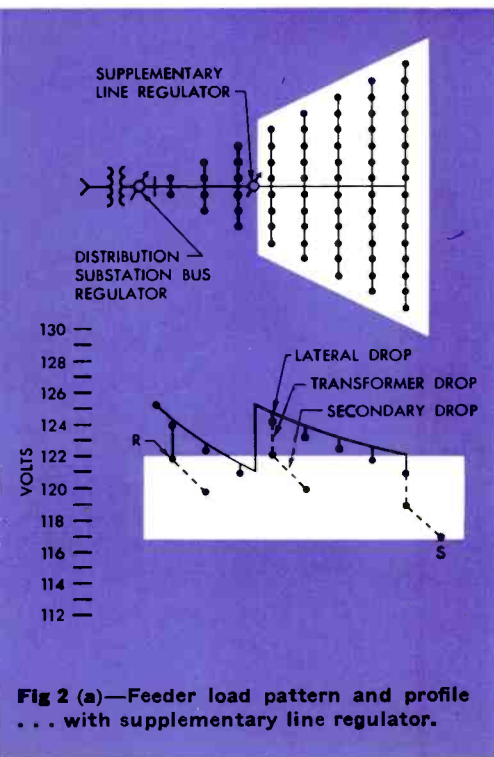

RESIDENTIAL LOADS WITH OPTIMUM NUMBER OF CUSTOMERS PER DISTRIBUTION TRANSFORMER

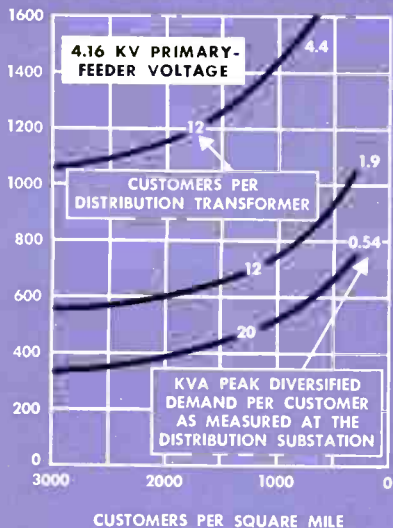

Fig. 3a

RESIDENTIAL LOADS WITH OPTIMUM NUMBER OF CUSTOMERS PER DISTRIBUTION TRANSFORMER

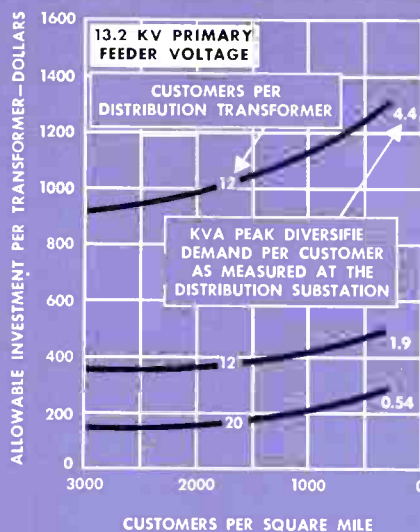

Fig. 3b

ONE CUSTOMER PER DISTRIBUTION TRANSFORMER

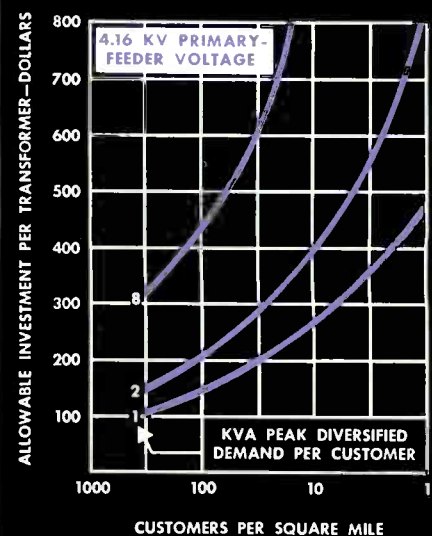

Fig. 4a

Figs. 3 & 4—Economic comparison of supplementary voltage regulation alternatives.

with the 60 needed to boost voltage as shown in the voltage-boosting application of such transformers depicted in Fig. 2(b). Thus this method offers considerable economy.

computer program analysis

The digital-computer developed for designing the complete distribution system was used to compare the economics of conventional line voltage regulators with "bucking" voltage regulation at "head-end" distribution transformers. The cumulative number of load patterns and system designs the program can consider is 2 488 320.

In the various systems studied, primary-feeder voltage drop, the key factor governing application of supplementary regulation, varies from values below that requiring re-regulation, to drops that result in extensive use of re-regulation. Program logic includes steps that locate, size, and cost the conventional line voltage regulators needed to confine voltage spread within specified limits. Then, the alternative of voltage regulation at distribution transformers is considered. The number of distribution transformers requiring "bucking" voltage regulation is determined, and finally, the cost of applying conventional line voltage regulators for the same system and load is divided among the transformers requiring bucking voltage regulation.

Results of the economic comparison between the supplementary voltage-regulation alternatives are shown in Figs. 3 and 4. These curves give the allowable investment in voltage regulation at each distribution transformer at which regulation is required, such that the cost of this method of supplementary voltage regulation becomes equal to the cost of conventional line regulators. Note that the allowable investment does not include the distribution transformer itself, but only the investment that can be made in a voltage-regulating device associated with each transformer at which re-regulation is required. As the curves show, the allowable investment in each device ranges from \$150 to over \$1600, indicating wide applicability for suitable apparatus selling for \$150 or thereabouts.

regulation at the distribution transformer

There are two basic methods of providing regulation at the distribution transformer: (1) The regulating mechanism may be a basic part of the transformer; or (2) the regulator may be a separate device, regulating the secondary voltage of the transformer.

The voltage-regulating transformer has a lower manufacturing cost, but has two drawbacks. First, addition of an automatic tap-changing mechanism to the transformer adds to the complexity of the design. And second, an integral design requires the stocking of two completely different types of distribution transformers in many kva ratings, each at different voltage classes.

The secondary-voltage-regulating device, as a separate attachment, can be universally applied to almost any distribution transformer, no matter what may be the primary feeder voltage, transformer, type or kva rating. *In fact, just two regulators, the 1½ and 2½ kva sizes, provide the full range of plus and minus five percent regulation for the 602 styles of transformers now built in eight kva and many different voltage ratings.* This approach was chosen.

A voltage-regulating device applied at the distribution transformer must meet stringent design requirements: (1) It must correct the voltage quickly and accurately and hold the secondary voltage within a narrow bandwidth; (2) it must have as much thermal overload capacity as the transformer itself; and (3) it must have an insulation level to match the basic insulation level requirements of the distribution transformer secondary winding; and most important, (4) the regulator must be reliable and maintenance free.

the new Unoreg regulator

The new regulator is self-contained, mounted in a small, oil-filled tank, and attachable at any convenient place on the low voltage side of the transformer. It has two basic parts: an induction regulator, and a voltage-sensing mechanism (see photo, p. 150).

ONE CUSTOMER PER DISTRIBUTION TRANSFORMER

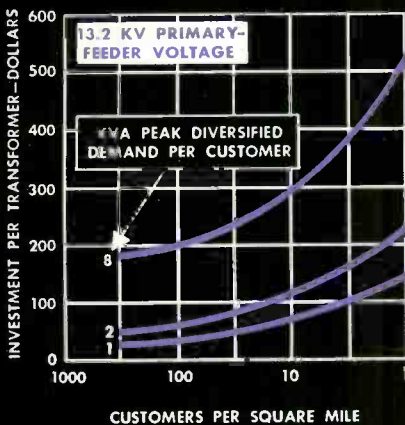

Fig. 4b

The Induction Regulator—The contactless induction regulator was selected for the correcting element in this device. The classical type of induction regulator was abandoned in favor of a new principle of operation, so that the usual tertiary or short-circuited winding was eliminated and the two series coils respaced on the stator. As a result, the size and weight of the induction regulator could be reduced.

The induction regulator corrects the input voltage by inducing a voltage in the series coils that either adds to or subtracts from the input voltage. The voltage induced in these coils is controlled by varying the angular position of the rotor on which the primary winding is wound. The primary and two secondary or series coils are connected to the distribution transformer secondary and the load as shown in Fig. 5. The use of two series coils in this arrangement provides balanced regulation of each 120-volt circuit in the 120/240 secondary.

In the “buck” and “boost” positions, which have a maximum angular displacement of 180 degrees, the new induction regulator acts as an autotransformer. But in the neutral position, the need for a tertiary winding is eliminated by repositioning the stator coil slots to 90 degrees spacing and increasing the size of the rotor slots, which has the added advantage of allowing more space to wind the primary coil. Throughout the voltage corrective range of the regulator, the voltage is corrected smoothly as evidenced by the graph of Fig. 6, which shows output voltage versus angular position of the rotor.

Drive Motor—The rotor of the induction regulator is positioned through a self-locking worm gear by a small gearmotor, which turns the rotor at 1/4 rpm; a voltage correction rate equivalent to 1 1/4 percent voltage change every fifteen seconds equivalent to conventional regulators.

Because of its conservative design, the induction regulator will boost the input voltage five percent even at 150 percent of the nameplate rating, and when loaded at the maximum continuous loading of modern CSP transform-

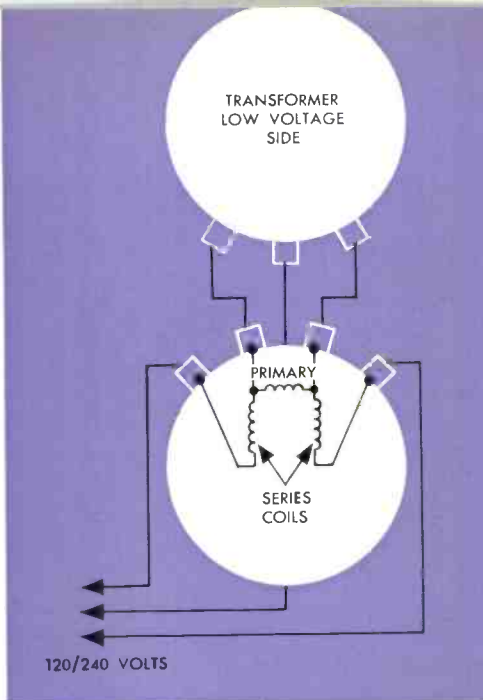

Fig. 5—Connection of regulator to distribution transformer and load.

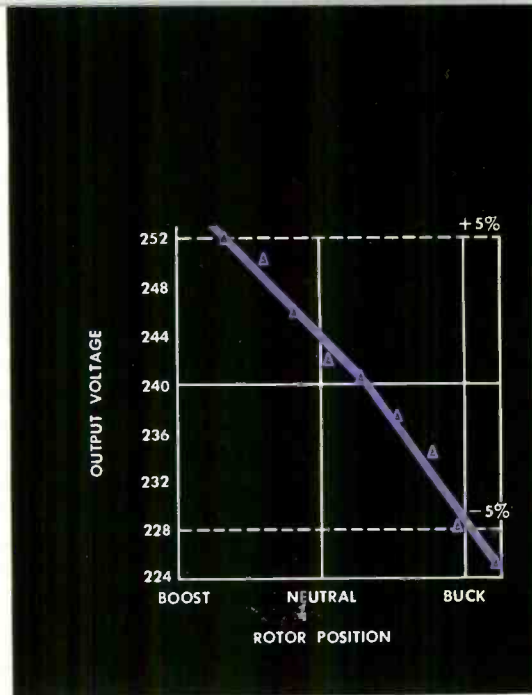

Fig. 6—Regulator output voltage versus rotor position—150 percent rated load.

ers, about 180 percent of nameplate rating, the Unoreg can still boost the input voltage about 4 1/2 percent.

Also, the waveform distortion of the output voltage of the newly designed regulator is negligible—the maximum measured rms distortion from a pure sine wave is less than one percent.

Static Voltage Control—In keeping with the reliability of the induction regulator, a static voltage control was developed specially to operate and control the Unoreg. The static control uses all solid-state components with no moving parts or contacts, and is encapsulated in an epoxy resin for maximum reliability. The control, gearmotor, and regulator are connected as shown by the schematic diagram of Fig. 8.

The output voltage of the regulator is measured by the control through the control transformer windings, and energizes the proper winding of the tandem shaded-pole gearmotor whenever the output deviates outside the preset bandwidth.

Using a Zener diode as a voltage reference, the control operates without any time delay to provide immediate voltage-corrective action. The midpoint voltage setting of the regulator control is 122 volts. The control is temperature compensated and meets the accuracy requirements of a Class II voltage regulating relay as defined by ASA standards.

The rotor is prevented from traveling beyond its 1/2 revolution regulation range by two snap-action limit switches. Although these switches will be operated very infrequently in most applications, special precaution was taken in the design to make them as reliable as the other components. They do not switch the motor current, but only a few milliamperes of current at about 25 volts to insure long life of the contacts.

The static control is protected from lightning or other transient voltage surges by the combination of the control or isolation transformer and nonlinear diodes, which limit all overvoltages in the control and control circuit.

mechanical design features

The mechanical design of the Unoreg was guided by two important considerations: First, the regulator must withstand the severe stresses imposed by high short-circuit currents without disturbing the alignment of the rotor within the stator bore; second, low sound levels must be achieved, which requires a very rigid assembly to prevent undue vibration of the mechanical parts.

The through-shaft, usually found in the center of the conventional induction regulator rotor, is omitted to allow complete filling of the slots with rectangular copper strap for highest space factor. In place of the shaft, the rotor is supported by end frames. The rotor turns on two spring-loaded and tapered nylon bearings which attenuate any radial rotor vibration by a factor of 10:1.

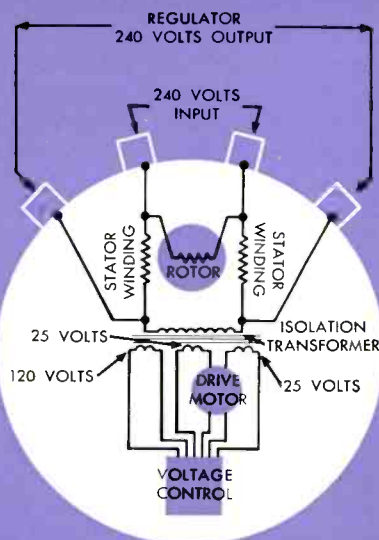
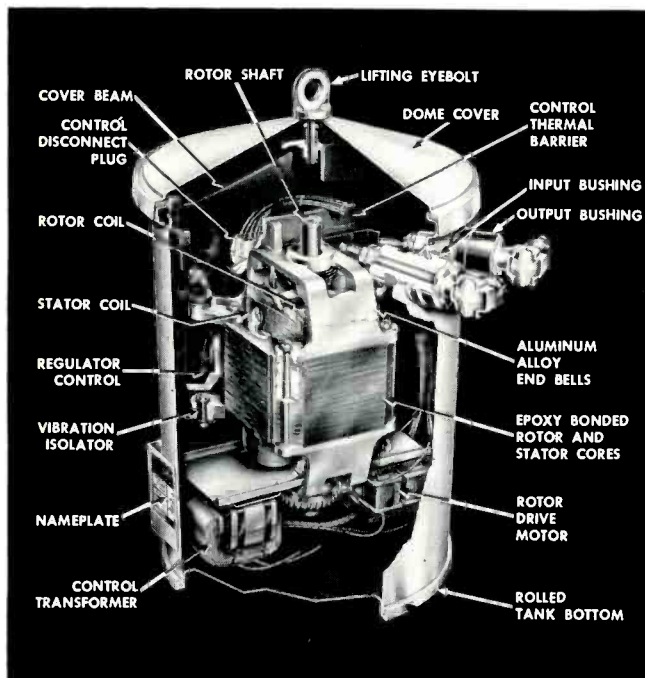

Fig. 7, Top—Cutaway drawing of new regulator.

Fig. 8, Bottom—Unoreg schematic diagram.

The entire induction regulator assembly is mounted on four vibration-absorbing isolators to reduce the sound level of the regulator to less than 45 db, even at 150 percent load.

The tank and cover are of standard Westinghouse construction for distribution transformers with lifting eyebolt and mounting bracket with standard 12 inch bolt spacing for ease of pole mounting.

Installation of the regulator is simplified by use of standard low voltage bushings, which are color-coded: brown for the input bushings, and green for the output bushings. In addition, the nameplate shows the proper connection of the Unoreg to the secondary line.

tests

As the Unoreg is a completely new product, with many new mechanical and electrical design features, an extensive testing program was conducted. The regulator was subjected to all commercial tests usually specified for this type of electrical apparatus. In addition, the regulator underwent thorough field tests.

The first field tests of the Unoreg regulator were made with dummy tanks to check the design of the mounting bracket, to determine what was the best location for the low voltage bushings.

As a result of these tests, the low-voltage bushings were moved to a single group on the tank wall opposite the tank bracket for the simplest and neatest connection to the distribution transformer and secondary line.

In addition, two 1¼ kva Unoreg regulators were installed on a utility's system. Both installations were provided with recording instruments to record input and output voltage, and secondary current. One installation was also provided with a rotor position indicator to indicate the number of operations of the regulator.

One unit installed on the low-voltage side of a 25-kva transformer at the end of a 4160-volt feeder made an average of 50 voltage corrections a day to hold the voltage within the 2.5-volt bandwidth. While tests will be continued for a long time, the results already obtained confirm the development tests and indicate that the regulator will give excellent performance in the field.

In summary, the Unoreg was specifically designed and developed for solving voltage regulation problems through a system approach and a new concept of regulation. However, many applications of Unoreg will be to boost low secondary voltages at the ends of long and heavily loaded feeders; and to improve service for those customers with erratic voltages because of widely fluctuating voltages. In short, the Unoreg will be an inexpensive answer to many voltage problems.

Westinghouse
ENGINEER
Sept. 1960

REFERENCES:

1. "Electric Utility Engineering Reference Book, Vol. III, Distribution Systems" Chapter 7, System Voltage Regulation, by H. E. Lokay; Westinghouse Electric Corporation, 1960.
2. Ibid, Chapter 8, Application of Capacitors, by Miles Maxwell.
3. Ibid, Chapter 3, Subtransmission and Distribution Substations, by D. N. Reps.
4. AIEE Transactions Paper 60-177. "Distribution System Planning Through Optimized Design." Part I—Distribution Transformers and Secondaries, by R. F. Lawrence, D. N. Reps, and A. D. Patton.
5. Ibid, Part II—Comparative Cost of System Voltages.



THE DESIGN AND APPLICATION OF A MAGNETIC STIRRING SYSTEM. Stirring the melt yields better alloys. This unique method uses a magnetic field for stirring.

R. D. THOMAS

Steel Mill Application Engineer
Industrial Engineering Dept.
Westinghouse Electric Corporation
East Pittsburgh, Pennsylvania

D. M. CALABRESE

D-C Machine Design Engineer
Large Rotating Apparatus Dept.

Westinghouse Electric Corporation
East Pittsburgh, Pennsylvania

Substantial improvement is made in high alloy and stainless steels by stirring the molten bath of steel in the arc furnace. Stirring allows faster melting and intermixing of alloy additions; it results in a more homogeneous mixture of constituents; and it provides a better balance of temperature between the top and bottom of the melt.

Various cumbersome and time-consuming methods have been used for stirring the molten steel. Two common methods are: hand rabbling, which is accomplished by manually pushing a paddle through the molten steel; and re-ladling, which consists of pouring the melt into a ladle and then back into the furnace. In each of these methods, the furnace must be shut down, with a resultant loss of time and heat.

About ten years ago, a different idea was conceived—stirring the molten steel by moving a magnetic field through it. This meant that all stirring could be done without manual labor, without tying up cranes, without shutting down the furnace, and with resultant savings of time. It has since been proven that inductive stirring produces better homogeneity, quicker melting and intermixing of alloy additions, and a more even temperature distribution in the melt than previous methods.

To keep the drive and control equipment of accepted standardized design, a rotating dc electromagnet was

chosen to produce the rotating magnetic flux. This design has since been named the Magne-stirrer. The first Magne-stirrer device was applied to a six-ton holding ladle to provide better homogeneity and to distribute more evenly the latent heat of the molten steel. Since then, this device has been applied to a 19 foot shell diameter arc furnace and to a 13½ foot shell diameter arc furnace.

theory of induction stirring

Induction stirring of molten steel is possible because steel is electrically conductive and essentially nonmagnetic in its molten state. The conductivity of molten steel allows the production of eddy currents, which necessarily accompany a changing magnetic field linking a conducting medium. Theoretically, the nonmagnetic property, which actually begins when the temperature of steel reaches the "Curie Point," is not a requirement. In practice, however, if the molten steel were magnetic, unbalanced magnetic forces would make it difficult to produce a moving field.

The eddy currents induced in the molten steel are electrical currents in a magnetic field. Thus a force is produced in the steel at right angles to both the electrical currents and the magnetic field (Fig. 1). This can be compared to a squirrel-cage induction motor in which the stator of the motor produces the moving magnetic field and the shorted conductors of the rotor contain the eddy currents.

The complexity of eddy currents can be simplified by assuming that the depth of penetration is large at very low frequencies and that the eddy currents themselves have negligible effect on the magnetic field that produces them.

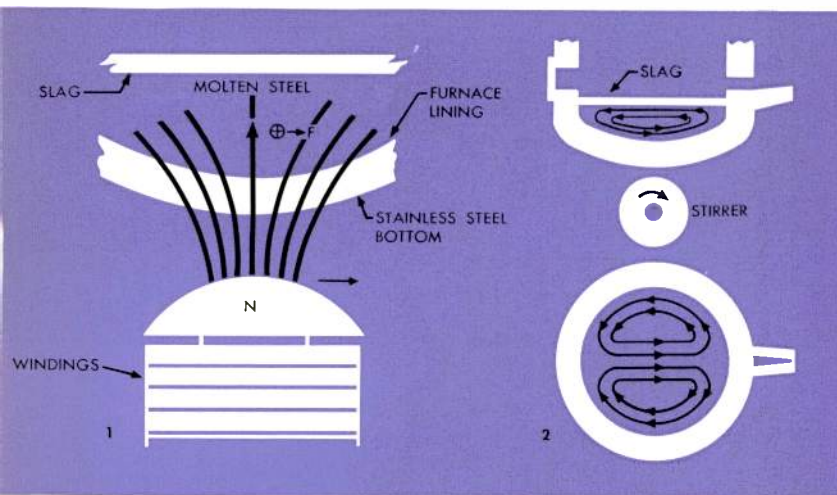

Fig. 1, Left—The effects of magnetic flux on the movement of the steel.
Fig. 2, Right—The stirring motion of the steel in the furnace.

For example, at any point in the molten steel mass the eddy currents will be proportional to the rate of change of magnetic flux density at that point. Thus,

$$i = K_1 \frac{dB}{dt}, \quad (1)$$

where i is the eddy current, K_1 is the constant of proportionality determined by the resistivity and the volume of the molten steel, and B is the magnetic flux density. The average effect can be approximated by assuming that the eddy currents are induced in a length of wire at the diameter of a circular mass of molten steel, and that the currents will flow in circular paths in the steel. If the variation in magnetic flux density is sinusoidal, then the maximum current in a stationary wire at the center will be:

$$I_{\max} = \frac{K_2 B_{\max} L f}{R} \quad (2)$$

Where K_2 is a constant of proportionality, B_{\max} is the maximum magnetic flux density linking the wire, L is the length of the wire in the magnetic field, f is the frequency of the sinusoidal variation of magnetic field and R is the average resistance of the paths of eddy currents.

The force, which is at right angles to the magnetic field and the eddy currents, will be:

$$F = K_3 B_{\max} I_{\max} L \quad (3)$$

where K_3 is a constant of proportionality. The time phase relationship between B_{\max} and I_{\max} results in a reduction of the force. When the motion of the molten steel is considered, the slip must be taken into account as it is in the induction motor.

The mere production of a changing or moving magnetic field in a volume of molten steel does not in itself make induction stirring practical. The fluid or hydraulic properties of the molten steel are a major factor in determining the efficiency of induction stirring. The most efficient stirring should occur in a molten steel mass with low viscosity. Not only is this determined by the temperature of the molten steel but also by the ingredients in the steel. If the viscosity is low, only a few horsepower in the melt itself produces vigorous stirring action.

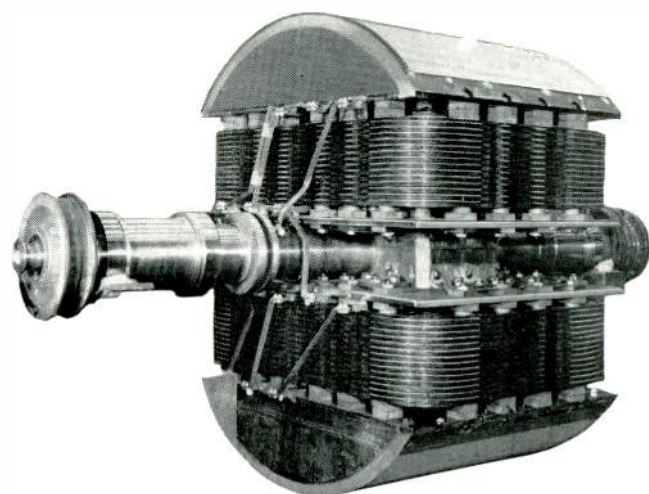

Fig. 3a—With the cover removed, the construction of the magnet coils and the pole heads of the stirrer is apparent.

From fluid mechanics, the force required to move a fluid is proportional to the square of the velocity of motion. Thus,

$$F = K_4 V^2, \quad (4)$$

where K_4 is a constant of proportionality determined by the viscosity and geometrical shape of the volume of molten steel and V is the velocity of the motion of the steel.

By equating (3) and (4), the magnetic flux density and the frequency of variation of the magnetic field required to produce induction stirring in the steel can be estimated.

design of the Magnestirrer

The Magnestirrer is a simple, rotating, two pole, dc electromagnet, which is driven at speeds between 25 and 60 rpm. The rotation of the electromagnet beneath a furnace produces a changing magnetic field in the molten steel; one main mode of motion in the steel is along the top of the furnace refractory (i.e., the bottom of the melt) in the same direction as the rotation of the Magnestirrer poles, then returning across the bottom of the slag, or top of the melt. This motion produces two kidney shaped paths, as shown in Fig. 2, with motion in one direction at the top of the melt and in the opposite direction at the bottom of the melt; this gives a stirring action that completely mixes all parts of the molten steel.

Because the size of the Magnestirrer is determined largely by the design of the furnace, each design must be considered individually. The depth of the refractory bottom must be given prime consideration, as the magnetic flux density in the melt decreases with an increase in the distance of the melt above the Magnestirrer. Thus the device should be as near to the melt as possible.

The location of supporting structures of the furnace is a determining factor in the efficiency of an induction stirring system. Efficiency can be affected by the losses induced in structural members with magnetic properties. Therefore, the furnace bottom, through which all of the magnetic field must pass, must be of nonmagnetic material.

Basically, the Magnestirrer is constructed of an iron core on a shaft, with magnet coils mounted on the core,

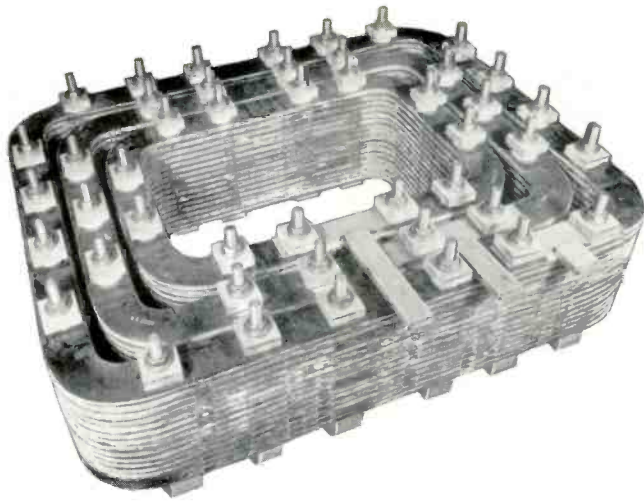

Fig. 3b—One of the three section coils, with its outer plates removed. This design provides rigidity.

and pole heads bolted to each end of the core. This is shown in Fig. 3a.

The latest magnet coil design is of the edge bent, copper strap type with three sections of coil weighing a total of $2\frac{1}{2}$ tons mounted on each pole. Edge bending the thin copper strap makes it possible to alternately space turns of the coil to provide a many surfaced flow path for the cooling air. The three sections of coil are supported by insulated through-bolts between two plates of steel to make a unit coil of sandwich construction. The unit coil is mounted and bolted on the core along with the pole head. One three-section coil with one of its outer plates removed is shown in Fig. 3b. This type of magnet coil design permits optimum cooling and provides rigidity that will withstand the stress of rotational forces.

Except for the pole heads, the Magnestirrer is completely enclosed in nonmagnetic steel covers designed so that cooling air can enter at one end and exhaust at the other end. The stationary air ducts are also made of nonmagnetic steel.

To allow easy removal of the Magnestirrer from beneath the furnace, flanged wheels are mounted on each end of the shaft. The entire unit can be wheeled out on rails for any required maintenance.

The shaft of the Magnestirrer is coupled to a jackshaft that extends either through or under the furnace lower rocker and is coupled to a gear reducer. The complete Magnestirrer and drive system is shown in Fig. 4a. A 6-foot Magnestirrer mounted beneath a $13\frac{1}{2}$ foot shell diameter furnace is shown in Fig. 4b.

the Magnestirrer drive and excitation system

The drive system consists of a mill type totally enclosed motor driving the Magnestirrer through a reduction gear. The control for this motor has been a reversing, dynamic braking, constant-potential steel mill control. The drive is started and automatically accelerated to base speed by armature resistance. By incorporating proper resistance and proper timing on timing relays, the torque developed by the motor can be limited to protect the gear reducer and shafts. In addition to this protection, a shear-pin coupling can be used between the motor and the gear reducer set to shear at approximately 200 percent of the maximum expected torque. A typical speed-torque curve for accelerating the Magnestirrer to base speed is shown in Fig. 5. The Magnestirrer speed can be adjusted to any value between base speed and weak field speed by field control with a motor-operated field rheostat. Experience indicates that optimum stirring effect for any given excitation occurs in a frequency range between one-half cycle per second and one cycle per second. For this reason the speed range of the motor and the size of the gear reducer are chosen to allow stirrer speeds between approximately 25 and 60 rpm for two-pole Magnestirrers.

The Magnestirrer is always started with no excitation on its windings. Therefore, only enough torque is required during starting to overcome inertia and losses in the drive. Once the unit has reached base speed, it is accelerated by using the motor-operated field rheostat, which inherently has some inertia compensation. If the Magnestirrer is to be stopped when it is rotating above its base speed, the

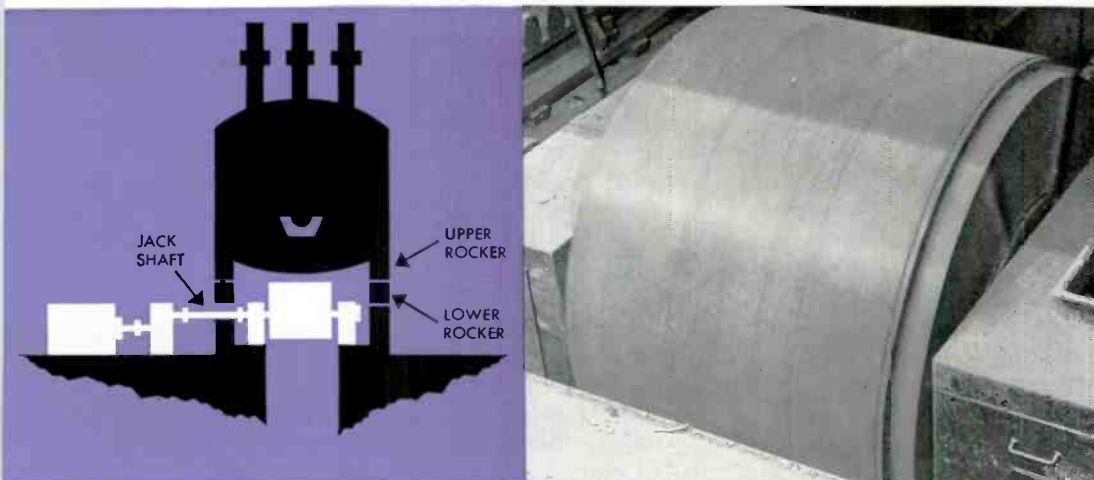

Fig. 4a, Left—The relative position of the drive equipment and stirrer under the furnace.
Fig. 4b, Right—An installed stirring device, mounted under a $13\frac{1}{2}$ -foot shell diameter furnace.

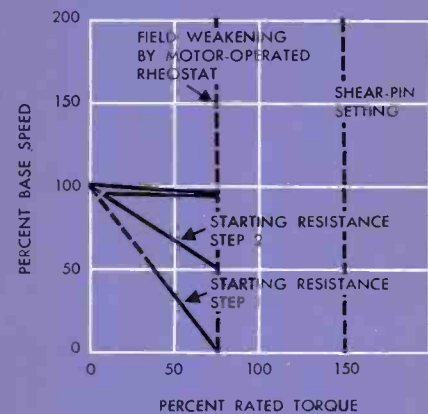

Fig. 5—Characteristics of the drive starting control.

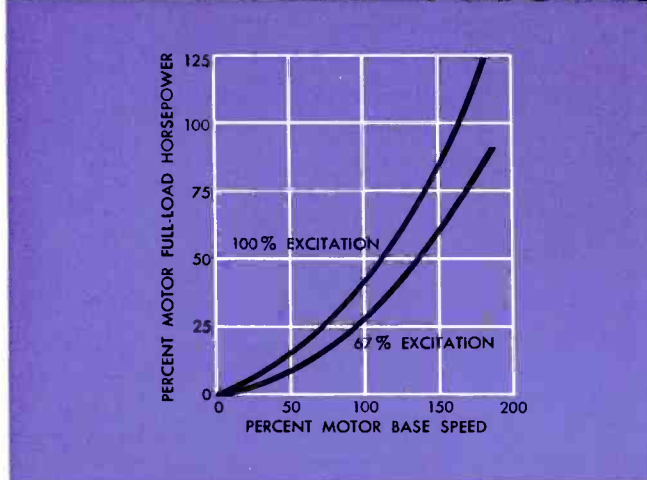
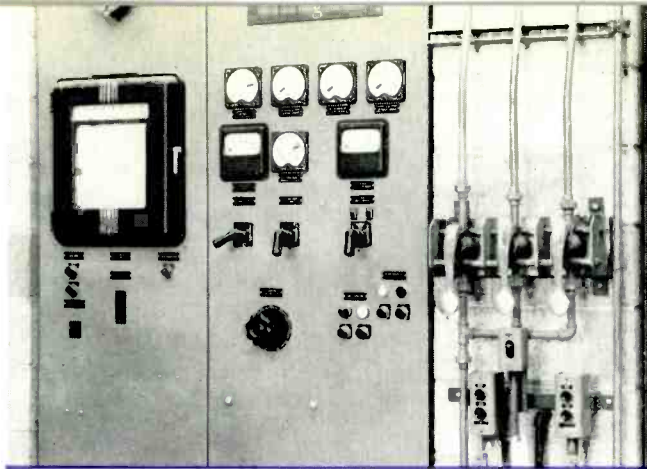

Fig. 6, Top—The control panel for the Magnestirrer device.
Fig. 7, Bottom—Stirrer drive performance characteristics.

motor-operated field rheostat automatically returns to its base-speed position, and dynamic braking brings the unit to standstill. Here again, the dynamic-braking resistors are chosen so that the torque developed is limited, to prevent any damage to the Magnestirrer or its drive system.

One excitation method that has been used is a constant-potential system that provides two values of excitation, by either inserting or shunting out a resistor in series with the Magnestirrer windings. An adjustable-voltage motor-generator set has also been used, which provides the operator with a choice of excitation current and speed so that an optimum stirring effect can be selected for each heat.

The current is fed to the Magnestirrer winding through brushes and slip rings on its shaft, in the same way that a salient-pole synchronous motor or synchronous generator is excited. The exciter can be either a 125-volt or 250-volt standard machine depending upon the design of the stirrer windings. Its output is adjusted from near zero excitation to full excitation by a hand-operated field rheostat mounted on the operator's control panel. When the excitation circuit breaker is opened, automatic field discharge is provided by a discharge resistor and blocking rectifier that are permanently connected across the windings.

The furnace bottom contains thermocouples connected to a multipoint temperature recorder with alarm contacts set at 600 degrees F. The alarm contacts are connected to a light and an alarm horn to give visible and audible alarm in case of a possible burn-through of the bottom. The alarm system is not interconnected with the drive or excitation control and allows the operator the decision to stop the heat, pour the heat, or continue the heat.

The control panel is located in the wall of the transformer vault adjacent to the furnace control panel. A picture of it is shown in Fig. 6. The indicating instruments and control devices are flush mounted on the front of the NEMA 1 enclosure. The excitation motor-generator set and the control cubicle containing the constant potential and adjustable-voltage control can be located remotely or in the transformer vault depending upon the available space. As with any steel mill auxiliary control, this equipment can be mounted in a NEMA 1 enclosure or on free-standing open panels. Drive and control components are standard, so are easily maintained or replaced.

Some thought has been given to the possibility of a reactor-controlled excitation system for the Magnestirrer field. This system would use ac power controlled by a saturable reactor and rectified to dc for energizing the Magnestirrer windings. It would have all of the versatility of the adjustable-voltage system previously described plus the advantage of complete static control components.

Magnestirrer performance

Actual Magnestirrer performance can be measured only by its ability to stir the molten steel. Since no means has been devised for measuring the velocity of the steel, other indications of stirring must be relied upon. Depending on slag conditions on top of the steel and the temperature of the steel, along with other variables, sometimes movement on top of the steel bath can be observed visually.

Another method of measuring performance is to observe the more even distribution of alloying additions and the faster recovery of alloys. This can be detected by wet chemistry analysis taken at close intervals after the alloys are added. Still another method of detecting stirring is by the temperature differential in the steel. During a refining period without the Magnestirrer, when the furnace operator is merely trying to hold the heat in the furnace, the temperature of the molten steel varies several degrees from the top to the bottom of the melt and has a tendency to stratify. If the Magnestirrer is used during this period, the temperature becomes more even throughout the melt.

The performance characteristics of the drive at two values of excitation are shown in Fig. 7. As expected, at the lower speeds the lines of flux do not move through the steel rapidly. Therefore, the drive is not required to supply much power. As the speed increases, required drive power also increases. These curves indicate that more drive power is required at higher excitation current. This, of course, can be predicted from the equations for force and horsepower to stir the melt. The force required is proportional to the square of the flux density, which is proportional to excitation current. The force required is also proportional to the square of the velocity at which the steel is moving.

As might be expected from the equations for stirring force, determination of the size and design of a Magnestirrer is an involved and time-consuming process because of the many variables and unknowns that must be considered. Therefore, computers are a valuable tool for analysis and calculation of these variables. They are useful in expediting the design, predicting the results, and extending the range of application of Magnestirrer systems.



ULTRASONIC GRAIN REFINEMENT IN INGOTS

A production line vacuum arc-melting furnace has been adapted with a transducer assembly for ultrasonic grain refinement in large ingots. The photo at left was taken before removal of the ultrasonic unit and withdrawal from the furnace of a 5-foot long, 12-inch diameter, 316 stainless-steel ingot. The ingot weighs about 2000 pounds and is removed from the bottom of the furnace, which is shown here. Previously, rotor steel ingots of this size and smaller heats of Refractoloy and Discaloy alloys and 316 stainless have been successfully refined using ultrasonics. The power input to the vacuum arc furnace is about six kilowatts and the furnace operates at pressures from 10 to 40 microns.

The combination of vacuum arc melting and ultrasonic grain refinement greatly improves the properties and yield of metals. Vacuum arc melting generally increases the yield from an arc-melting furnace; and the use of ultrasonic vibration causes a small "equiaxed" structure in the ingot. This structure is highly desirable since it ensures better mechanical properties in the material. ■ ■ ■

WHAT'S

IN THE NEWS

IN ENGINEERING

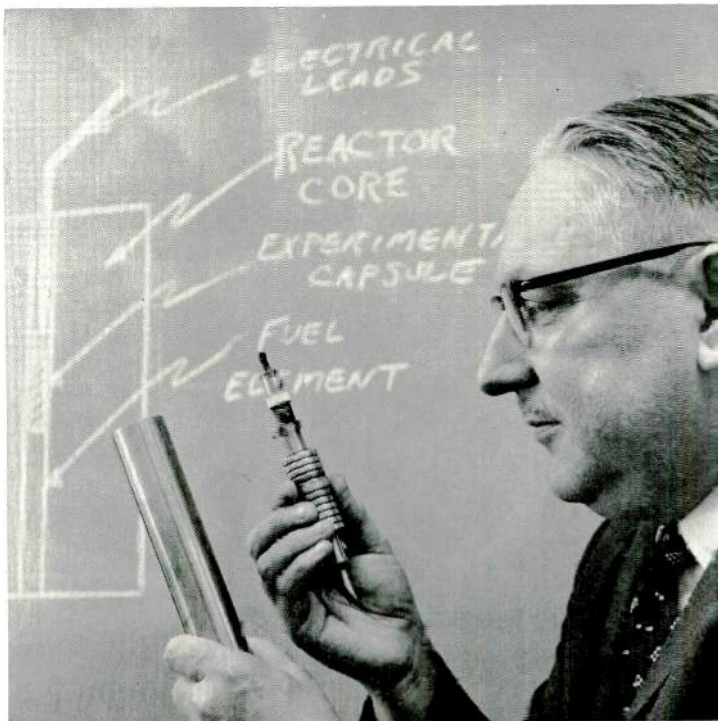

THERMOELECTRIC-THERMIONIC GENERATOR

Scientists have combined two advanced forms of power generation to convert the heat of fission inside a nuclear reactor directly into electricity. A thermionic and thermoelectric generator, shown at left, has been built into a nuclear fuel assembly and inserted into a nuclear reactor to produce electricity.

This experiment was operated at the Westinghouse Testing Reactor at Waltz Mill, Pa., and produced about one watt of power. It was designed to determine the feasibility of such a "dual" generator without consideration of optimum efficiency or high power output.

There are significant inherent power losses in today's nuclear powered generating stations, caused by the large temperature drop from the center of the fuel elements to the outside surfaces in contact with the cooling water. While some fuel elements themselves reach temperatures above 4000

degrees F in the fission process, nuclear scientists can get only about 600-degree temperatures out of the fuel elements and into the surrounding water. This limits the amount of heat that can be taken from the fuel.

To use the heat energy at the higher temperatures, scientists built a fuel element with the thermionic generator in its center and a thermoelectric generator surrounding it. Both methods of converting heat directly to electricity operate on similar principles, but operate most efficiently at widely divergent temperatures. A thermionic generator operates at about 3500 degrees F—but will not function efficiently at temperatures below 2700 degrees F. A thermoelectric unit, on the other hand, does not operate at such elevated temperatures, but works well in the temperature range of 600 to 1800 degrees F.

By putting the two types of generators in tandem, the heat passing through the thermionic generator flows through the thermoelectric unit. The elements are wired in series to give a combined electrical output over a very wide temperature range. ■ ■ ■

THEMALLY STABILIZED TRANSFORMER INSULATION

High permissible operating temperatures for transformers lead to increased load ability for the same life expectancy, or longer transformer life for the same load.

A new Insuldur insulation system, being used in all Westinghouse oil-immersed 55 degrees C distribution and power transformers, is twice as effective as the Insuldur system it replaces and will allow temperatures as much as 30 degrees C higher than untreated insulation and with the same life expectancy. The new insulation is completely compatible with standard WEMCO "C" oil, and no problem exists when oil from units with the improved insulation system is mixed with regular oil for re-use with other transformers.

The advantages of transformer overloading must be balanced against the cost of increased operating losses and voltage drop.

The bonus overload capacity of the 55 degrees C pole-type distribution transformers (180 percent of nameplate) remains the same, but these

transformers will have the additional safety factor of improved Insuldur insulation system.

The nameplates of all self-cooled oil-immersed power transformers will indicate a supplementary rating of 12 percent higher than the 55 degrees C rating.

Triple rated and forced oil cooled transformers will be rated 10 percent above the 55 degrees C rating.

Another feature of the new Insuldur system is its effect on the insulation structure as the transformer ages. Tests show that the shrinkage normally found with regular insulation can be reduced as much as 40 percent with the improved system under the same operating conditions. This alone means greater resistance to short circuit stresses throughout the life of the transformer. ■ ■ ■

ALL-STATIC NUMERICAL CONTROL SYSTEM

A new numerical control system for automatic machine tool control uses all-static, all-transistorized circuitry. The Prodac programmed digital automatic control consists of five basic units: the operator's control, tape reader, Prodac control unit, Rotrac pulse generator, and drive motors. The control unit contains a servomotor control and a series of transistorized modules—rack-mounted, plug-in control assemblies that are arranged for front removal.

Operating information is fed into the Prodac control unit by the tape reader, which accommodates a 1-inch wide, 8-channel punched tape. For semiautomatic operation, decade switches on the operator's console establish machine movement to any point up to 999.999 inches.

Position command information computed by the Prodac control is transmitted to the Trinistor servomotor control apparatus, energizing the servomotor and setting the machine tool in motion.

The Prodac control system controls one to five machine tool motions over the 999.999-inch span and handles all auxiliary machine tool functions. Control of the machine motion is on a point-to-point positioning basis—with a typical electrical accuracy of plus or minus 0.0005 inch, although higher accuracies can be made avail-

able for use in special applications.

Every machine motion is detected by the Rotrac pulse generator, which normally produces an electrical pulse for each 0.001 inch of machine movement. The pulse can be easily set for any increment of motion as required.

This position information is constantly fed back to the Prodac control unit where it is automatically compared to the programmed position. Any error energizes the Trinistor servo-drive control apparatus to correct machine position. Thus a constant, extremely accurate check on machine position is maintained. ■ ■ ■

PRODAC CONTROL FOR REVERSING PLATE MILL

Computer-programmed control will make the United States Steel Corporation's plate mill in Gary, Ind., one of the world's most fully automatic. Teamed with the control will be a 10 000-kw Ignitron converter-inverter power system, 400 cps Magamp regulators, and main drives and auxiliary equipment totaling about 36 000 horsepower.

The 160–210-inch reversing plate mill will handle slabs ranging from 3 to 24 inches thick, 48 to 75 inches wide, and 54 to 264 inches long. Mild low carbon, medium and high carbon, low and high alloy steels will be rolled in the mill. Finished plates will range upward from $\frac{3}{16}$ inch thick, 198 inches wide, and 45 to 125 feet long.

The Prodac control uses a combination of card programming, computing and correction monitoring by means of roll force and x-ray thickness measurements to produce plate within close tolerances of specified thickness, width, and length. The punched-card digital input to the computer-programming control will be minimal. The computer will determine the number and sequence of passes, settings of screwdowns, guides, etc., and will use control feedback information to correct for any product dimensional deviations.

Formerly, mills of this type were powered by flywheel or synchronous m-g sets. Now, the converter-inverter Ignitron arrangement will supply power to the mill drive motors with proper voltage polarities needed for reversing service and will permit regeneration of power. ■ ■ ■

J. K. DILLARD and **C. J. BALDWIN** are making their second appearance on these pages, and again as a team. And the subject they discuss in this issue, system models, is closely related to their previous article about choosing turbine generator sizes.

Dillard, manager of the Electric Utility Engineering Department, has recently returned from a European trip, during which he presented a paper containing much of the information discussed in this issue. As a matter of coincidence, he did the same in 1958 when he presented a paper discussing turbine-generator unit sizes at the Brussels World Fair. This time, he presented a paper at the CIGRE Convention in Paris, "New Horizons in System Planning," which he co-authored with H. K. Sels of Public Service Electric and Gas Company.

Since his last appearance, Baldwin has moved from the advanced development section to the projects section of the Electric Utility Engineering Department, but continues to work at finding new digital computer applications for power system problems. A major portion of his time since his last article has been spent heading up the operations research team formed jointly by the Public Service Electric and Gas Company of New Jersey and Westinghouse to develop the simulation techniques reported in this issue.

LEE A. KILGORE should be a familiar name to many of our readers. His name has appeared in the magazine at least six times as the author of articles on a wide variety of subjects, ranging from wind tunnel drives to human relations, and his current subject of creative engineering. During his career he has made many contributions both in the engineering and management fields. (Westinghouse ENGINEER, May 1958, p. 75)

The most recent recognition of his engineering contributions occurred on June 20, 1960, when Kilgore was awarded the Lamme Gold Medal by the American Institute of Electrical Engineers.

WAYNE B. LLOYD'S background in hydraulic control systems stems from a steady association with these devices since he joined the company in 1951. A graduate of the University of Florida in 1951 with a BME, Lloyd came with Westinghouse on the Graduate Student Course, and shortly thereafter, joined the Air Arm Division to work on such projects as the hydraulic power supply and servo loops for the Bomarc antenna.

In 1956, Lloyd was made Project Engineer in charge of the group working on hydraulic feedback control devices, such as the pressure feedback and pressure derivative feedback valves that he describes here. Lloyd was made a Fellow

Engineer, his present position, in 1959. Away from work Lloyd has done graduate work at Johns Hopkins and is active in the ASME.

PAUL A. BERMAN joined the Westinghouse Industrial Gas Turbine Department in 1953 to work on cycle analysis and thermodynamic design of commercial gas turbines. In 1954, he moved to the special projects section, where he worked on two new gas turbine concepts for the Navy.

When these developments were completed, Berman worked on closed-cycle nuclear gas turbine cycles for marine and commercial applications. He was instrumental in preparing the rotating machinery proposal submitted by Westinghouse for the Maritime Gas-Cooled Reactor Project, the subject discussed in this issue. Since August 1958, Berman has been MGR Project Engineer, coordinating the rotating machinery design.

Berman graduated from the University of Pennsylvania with a BSME in 1953, and obtained his MSME in 1956.

Astleford graduated from the University of Alabama in 1956 with a BSME, and shortly afterward joined Westinghouse on the Graduate Student Course. He was selected to attend the Advanced Design Course in early 1957, and upon its completion went to work in the Transformer Division. He is now a design engineer in the distribution transformer department, and in addition to the new regulator has worked on such projects as the ER breaker for large CSP distribution transformers.

A close parallel to the team of Reps and Astleford is that of **R. D. THOMAS** and **D. M. CALABRESE**. Thomas's job is helping to solve the problems of applying electrical equipment in the metal working industries, while Calabrese is concerned with the design of large dc motors and generators.

Thomas graduated from Rose Polytechnic Institute in 1952 with a BSEE, and immediately joined Westinghouse. He trained as a service engineer and

Personality Profiles



A distribution system engineer and a product design engineer worked together to produce this month's article on a new voltage regulator. This is appropriate, because **DAVID N. REPS**, the distribution engineer, originated some of the studies that pointed to the need for a new device, while **JOHN J. ASTLEFORD** worked on the design of the device that fills the need.

Reps is a native of New York City, and earned his BSEE from Columbia University in 1948. After two years with a consulting firm in New York, Reps joined Westinghouse in the Electric Utility Engineering Department; here his work has dealt primarily with analysis of the problems and needs of electric utility systems, and assistance in coordinating their solutions.

Reps earned his MSEE degree at the University of Pittsburgh in 1953, and is now pursuing a PhD in the School of Business Administration.

then performed that job in Cincinnati until he was called into the Army in 1954. When he returned from the service in 1956, Thomas joined the Industry Engineering Department, and a year later became a member of the metal working section. Here he has concentrated primarily on the application of electrical equipment to arc furnaces and processing lines.

Calabrese is a graduate of the University of Pittsburgh, where he obtained his BSEE in 1950, and his MSEE in 1959. He went into the Army shortly after graduation, where he served on Signal Corps teams that introduced new equipment to the field. After leaving the service in 1953, Calabrese joined Westinghouse on the Graduate Student Course, and then went to work in DC Motor and Generating Engineering. Among his design projects was that of the Magne-stirrer system, which he and Thomas describe in this issue.



Dwarfed by what appears to be a 30-foot beachball, an employe works from a bosun's chair while clamping seams of a radar Paraballoon—an inflatable antenna developed for the Air Force. Held up by low air pressure, the Paraballoon usually weighs about one fifth as much as rigid metal antennas. This allows the new type radar system to be helicopter-lifted into remote areas and set up within a matter of a few hours. After this clamping operation is completed and the desired contour is established, seams are permanently sealed from the inside.