

# At Gotham Audio, we have a lot to talk about.

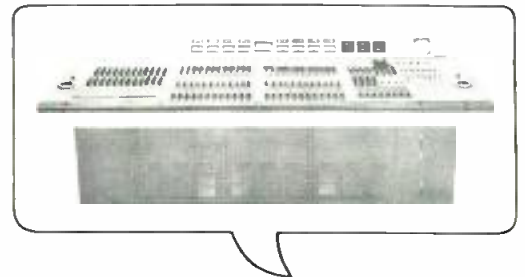
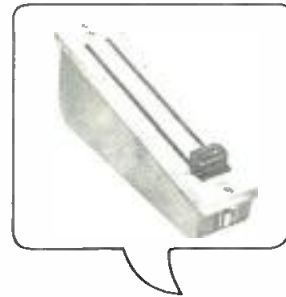
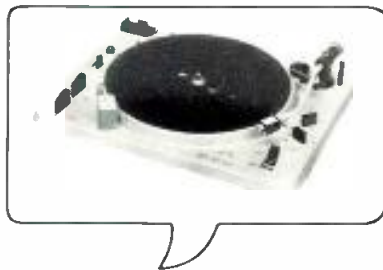
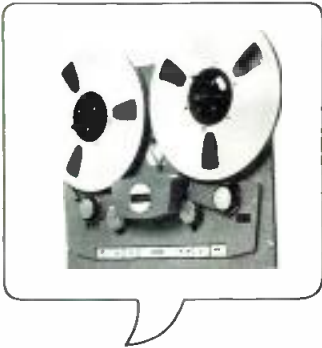
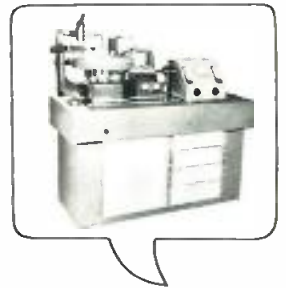

You're looking at only a few of our conversation pieces.

Altogether, we have about 300 different kinds of professional sound products. Ranging from microphones to tape timers. Reverberation units to tape recorders. Loudspeakers to flutter meters. And even \$70,000 studio consoles.

The names on all this equipment? They're worth *shouting* about. Because, they're without question the top manufacturers in their fields — companies that have consistently led the advancement of the state of the art.

We speak — with pride — of such companies as Beyer. EMT. Studer. And, of course, Neumann. (Gotham has been the sole U.S. distributor of Neumann microphones for more than a decade.)

If it's delivery and service you want to talk about, we have happy words for you there, too. Words like *quick. When promised. And — on time.*

Try us. You'll see. We're not talking through our hat.

**GOTHAM**  
AUDIO CORPORATION  
2 West 46th Street, New York, NY 10036 (212) CO 5-4111  
1710 N. LaBrea Avenue, Hollywood, CA 90046 (213) 874-4444  
In Canada: J-Mar Electronics Ltd

Circle 10 on Reader Service Card

www.americanradiohistory.com



THE SOUND ENGINEERING MAGAZINE

DECEMBER 1970 VOLUME 4, NUMBER 12

- 23 NEW CONCEPTS IN STUDIO EQUIPMENT DESIGN  
R. N. Andrews
- 26 CONSIDERATIONS IN ACOUSTA-VOICING STUDIO MONITORS  
Don Davis
- 28 UP GOES THE CONSOLE  
Jack Marrow
- 32 THREE VIEWS OF THE TELDEC DISC  
Martin Dickstein
- 32 Arnold Schwartz
- 36 Edward Tatnall Canby
- 2 LETTERS
- 6 THE AUDIO ENGINEER'S HANDBOOK  
George Alexandrovich
- 10 THEORY AND PRACTICE  
Norman H. Crowhurst
- 16 THE SYNC TRACK  
John Woram
- 19 NEW PRODUCTS AND SERVICES
- 38 BOOKCASE
- 39 CLASSIFIED
- 40 ANNUAL INDEX

db is listed in Current Contents: Engineering and Technology  
EDITORIAL BOARD OF REVIEW

George Alexandrovich

Sherman Fairchild

Norman Anderson

Prof. Latif Jiji

Daniel R. von Recklinghausen

William L. Robinson

Paul Weathers

John H. McConnell

## COMING NEXT MONTH

• A floating city's sound system is the topic of Richard Lerner's text and picture report on the involved and sophisticated paging, background music, theater, discotheque, and fog-blasting sounds made on the majestic Queen Elizabeth II, flagship of the Cunard Line.

David Klepper offers a description of the sound-reinforcement system that went into the National Presbyterian Church's new installation in Washington, D. C.

*Oh! Calcutta!* has been a long-running Broadway hit. In addition to its appealing nudes, the show has been praised for its sound system, rated as one of the best in modern theater. With fresh insights gained after its extended use, Robert Lipton, the system's designer, tells us about it. We might even have some pictures from the show.

And there will be our regular columnists. George Alexandrovich, Norman H. Crowhurst, Martin Dickstein, Arnold Schwartz, and John Woram. Coming in *db*, The Sound Engineering Magazine.

## ABOUT THE COVER

Refraction creates beautiful colors from the fine grooves of a Teldec Video Disc. Three editorial views of the impact of this product are to be found beginning on page 32.

db, the Sound Engineering Magazine is published monthly by Sagamore Publishing Company, Inc. Entire contents copyright © 1970 by Sagamore Publishing Co., Inc., 980 Old Country Road, Plainview, L.I., N.Y. 11803. Telephone (516) 433 6530. db is published for those individuals and firms in professional audio—recording, broadcast, audio-visual, sound reinforcement, consultants, video recording, film sound, etc. Application should be made on the subscription form in the rear of each issue. Subscriptions are \$6.00 per year (\$7.00 per year outside U. S. Possessions, Canada, and Mexico) in U. S. funds. Single copies are 75c each. Controlled Circulation postage paid at Easton, Pa. 18042. Editorial, Publishing, and Sales Offices: 980 Old Country Road, Plainview, New York 11803. Postmaster: Form 3579 should be sent to above address.

# letters

The Editor:

Our thanks to Rick Rogers of Ampex for his fine story on the recording of the *Celebration* show in quad.

We noted some details in the story that should be clarified and expanded. With your permission I'd like to provide that clarification.

To establish a definition of technique, we assumed the attitude that *quadrasonic* refers to the format of the listener in the audience and performers on the stage. We then assumed that *quadrasonic* refers to the format of the listener being on the stage, in amongst the performers. (This may or may not be the final definition we all agree upon, but it is a start.) Based on the above definitions, *Celebration* was recorded in quadrasonic sound with stereophonic enhancement. The basic recording was made in four track. The instrumentalists were recorded in four track using all four tracks.

Vocal and other down-stage performances were picked up on our "front line" of mics and unequally split (panned) between tracks 2 and 3. We had the option of panning the vocal content to the rear speakers (1 and 4). This was done on occasion for effect, but at no time could we put all vocal content on 1 and 2 or 3 and 4. To say it another way, each of the participating fm stereo stations had to receive vocal informa-

tion on at least one channel at all times.

In addition to the four-channel mix for quad, a mono mix had to be obtained for those who viewed the show without quad. The mono mix was done by combining the four-channel quad. Recording in simultaneous quad and mono made it necessary to give very careful handling to the amount of in-phase panned signal content. Failure to do this would have seriously affected the mono balance in a negative manner.

At no time did the in-phase panned signal appear on all 4 speakers *a la* "joy-stick" or otherwise. There may be some tempering factors here, but let's face it—no matter how you modulate the level on the tracks, a mono signal appearing on all four speakers is still going to be mono, not stereo. We used four non-directional mics at optimum points on the stage to enhance the quad effect. One of these four mics was used on each of the four quad tracks to give added support to the ambient room sound.

In closing I'd like to mention the strong support and backup we on the show received from our staff at Harry McCune Sound Service. The job could not have been done without them—plus a special word of thanks to Bill Duncan for his able assistance.

*Don Geis*  
Director of Recording  
McCune Studios  
San Francisco, Calif.

The Editor:

It is ironic that as the four-channel era comes upon us we are finally learning how to listen to two channels properly. Various matrix schemes have been proposed in the past couple of years which in general enhance two-channel listening by providing, in addition to normal left-right localization, a degree of fore-aft localization identified respectively with in-phase and out-of-phase signals in the two stereo channels. Many two-channel recordings, especially those with lots of reverberation, sound very good indeed over these matrix play-back setups since the reverberant information, by virtue of its random disposition between channels, excites

**Robert Bach**  
PUBLISHER

**Larry Zide**  
EDITOR

**Bob Laurie**  
ART DIRECTOR

**Marilyn Gold**  
COPY EDITOR

**Richard L. Lerner**  
ASSISTANT EDITOR

**A. F. Gordon**  
CIRCULATION MANAGER

**Eloise Beach**  
ASST. CIRCULATION MGR.

## SALES OFFICES

### New York

Specifax Media Sales, Inc.  
Manfred W. Meisels  
603 East 82nd Street  
New York, N. Y. 10028  
212-249-7768

### Boston

Specifax Media Sales, Inc.  
William H. Fields III  
49 Gray Street  
Boston, Mass. 02116  
617-426-5315

### Chicago

Jim Summers & Associates  
35 E. Wacker Drive  
Chicago, Ill. 60601  
312-263-1154

### Denver

Roy McDonald Associates, Inc.  
846 Lincoln Street  
Denver, Colorado 80203  
303-825-3325

### Houston

Roy McDonald Associates, Inc.  
3130 Southwest Freeway  
Houston, Texas 77006  
713-529-6711

### Dallas

Roy McDonald Associates, Inc.  
Semmons Tower West  
Suite 714  
Dallas, Texas 75207  
214-637-2444

### San Francisco

Roy McDonald Associates, Inc.  
625 Market Street  
San Francisco, California 94105  
415-397-5377

### Los Angeles

Roy McDonald Associates, Inc.  
1313 West 8th Street  
Los Angeles, California 90018  
213-483-1304

### Portland

Roy McDonald Associates, Inc.  
2305 S. W. 58th Avenue  
Portland, Oregon 97221  
503-292-8521

### Pennsylvania

Specifax Media Sales, Inc.  
Andrew N. McCreight  
Box 199  
Chester Springs, Pa. 19425  
215-363-7355

## advertisers index

Allison Research	17
Altec	11
CBS Labs	3, 5
Cadco	24
Dolby Labs	7
Fairchild Sound	4
Gotham Audio	Cov II
Koss	13
MCI	25
Maxell	15
Neve	4
Scully	20, 21
Sennheiser	6
Sony/Superscope	Cov IV
Teac	Cov III
Telex	9, 16
UREI	28
Visual Electronics	12

# Gainsmanship

... the art of broadcasting the maximum radiated signal without distortion, thumping, pumping or other undesirable effects. Automatic Level Controllers made gainsmanship possible. CBS Laboratories developed the original Audimax Automatic Level Controller more than 10 years ago and has been the leading supplier to the industry ever since.

Now, the new Audimax 4440—fourth generation Audimax—gives the industry new standards—adjustable recovery time, expanded return-to-zero function, long life Tantalum capacitors, space-saving slimline design and money saving add-on stereo capability.

You can set new standards of gainsmanship—  
increase your market coverage—improve quality.  
Write for full details or call to order (203) 327-2000.

Model 4440—Price \$725    Model 4450 (Stereo)—Price \$1,295



## CBS LABORATORIES

A Division of Columbia Broadcasting System, Inc. 227 High Ridge Road, Stamford, Connecticut 06905

now!  
**DOUBLE**  
 Audio-Actuated  
 Gate from Fairchild!

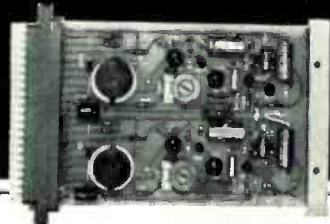

**MODEL 692 DAT**

With exclusive (Auto-Ten®) circuitry, the FAIRCHILD double automatic audio signal actuated gate performs various functions of changing gain of one or two circuits (per section). The 692 DAT can attenuate channel up to 80 db when not triggered. When "ON" series resistance is 30 ohms. Use it as a compressor expander or soft switch.

**SPECIFICATIONS:**

Adjustable trigger thresholds:  
 40 db and higher.  
 Turn on time: 3 Milliseconds.  
 Release time: 0.3 to 7 seconds.  
 Power required: 6.2, 18 or 24 V DC at 70 ma.

For complete details write today to:

**FAIRCHILD**

Sound Equipment Corporation  
 10-40 45th Ave., L.I.C., N.Y. 11101

Circle 16 on Reader Service Card

all four loudspeakers equally.

To a greater or lesser extent most stereo recordings benefit from such play-back; it is simply another way of listening to two-channels. But rarely has a record been made with primary information assigned to the left-right-sum-difference aspects of the two channels. Such a record came across my desk recently; it is DGG-138811, and I heartily recommend it to any one interested in matrix play-back techniques. The program is electronic music by Stockhausen, and one piece, *Contact*, is especially rich in its use of signal-processing techniques which most of us would like to think of as fairly recent developments. Surprisingly, the music dates from 1960, and this remarkable record has been out since May 1963. In addition to all that it has going for it in terms of content, the disk is one more example of DGG's flawless transfer and processing technology.

*John Eargle*  
 Chief Engineer  
 Mercury Record Productions, Inc.  
 New York, N. Y.

**db binders**

only \$4.95 postpaid

Heavy-weight binders are now available to hold the thirteen issues of Volumes 1 and 2. Rich brown leather-grained virgin vinyl, with our name printed in black on the spine and front cover, is electronically sealed over rigid board to give your volumes of **db** lasting protection. Keep your copies preserved in perfect condition, protected from dust and damage.

Please send me \_\_\_\_\_ copies of the **db** Magazine binder. My check for \$\_\_\_\_\_ is enclosed (sorry, no c.o.d.).

Name \_\_\_\_\_

Address \_\_\_\_\_

number and street

city state zip

(New York State residents please add 5% sales tax).

Mail to: **db** the Sound Engineering Magazine, 980 Old Country Road, Plainview, N.Y. 11803.

**Neve**

**B.C.M. 10**

**SOUND CONTROL EQUIPMENT**

styled to the needs of modern studios



**10 CHANNEL TRANSPORTABLE CONSOLE**

The Neve BCM 10/2 marks a new departure into the field of sophisticated audio control. It embodies ten full mixing input channels and two output groups and is conveniently transportable. Facilities are included for echo, studio foldback and talkback communication, stereo monitoring, cueing and D.J. "combo" working. All signal inputs and outputs are on LR connectors at the rear. Thus the BCM 10/2 provides for every possible requirements within its class. It is competitively priced and available for quick delivery. Full specifications will be sent gladly on request.

Telephone 076 386 776 (Ten lines) Telex 81381

**Rupert Neve & Co. Ltd. Cambridge House, Melbourn, Royston, Herts.**

Circle 27 on Reader Service Card

Circle 15 on Reader Service Card →

# Everything in Modulation



With the new CBS Laboratories Volumax 4000 automatic peak controller, the broadcaster, for the first time, has the ability to use all the modulation his transmitter can take while maintaining the highest signal quality ever attainable. The Volumax 4000 combines all the achievements of earlier Volumax models with new slimline design and silent automatic speech asymmetry control.

That's everything in modulation. . . .

Priced at \$725. That's everything in moderation.

Write or call to order (203) 327-2000.

## CBS LABORATORIES

A Division of Columbia Broadcasting System, Inc. 227 High Ridge Road, Stamford, Connecticut 06905

George Alexandrovich

# THE AUDIO ENGINEERS HANDBOOK

## How to Specify a Custom Audio Console

• This day and age it seems that every broadcasting station and recording studio has its own special requirements as far as sound processing is concerned. Highly competitive markets of sound recording

and broadcasting demand unique approaches to sound mixing and storage. In most instances custom designed equipment is the answer. It doesn't matter if the audio system is being built on premises or is

ordered from a manufacturer: it takes a certain amount of know-how to outline the basic system requirements. This set of requirements serves as a guide to the selection of appropriate components and circuits with over-all system performance spelled out precisely. These specifications can be used for pricing the system by manufacturing firms. The more exact the specifications, the more accurately price can be calculated. Also, if bid for quotation is sent to several firms (strongly recommended) there will be fewer chances of misunderstanding the basic needs of a customer. Just to illustrate how ridiculously inadequate requests for quoting may be try to imagine how you would price up a "custom audio console" specified as follows:

*FM stereo console.* The price for such a device answering to all the basic specs can range from a few hundred dollars to many thousands. Obviously whoever was buying was not aware of the fact that this type of spec is adequate only for certain type of stock console. It is equivalent to someone wanting to build a house and specifying it as a "two-story house."

There is also another extreme. There are engineers who think that by specifying a system and writing the specs around a certain brand of equipment they assure advertized performance at a known price. No substitutes are allowed in such instance. This type of specifying can often be found in government and educational fields. The trouble is that the fast pace of technological progress sometimes renders specified equipment obsolete before the appropriation for the system is approved. Many times a manufacturer is forced to supply a previous-generation product, quite often at higher cost with poorer performance.

The idea in writing specifications is that more choice should be given to the selection of systems components, while more emphasis should be made on over-all system performance. This spec should be realistic—there shouldn't be any noise measurements made with shorter inputs, the noise spec shouldn't exceed the theoretical maximum (don't think it doesn't happen), or any other spec which can't be met under any circumstances. Avoid over-specifying. An extra dB or two

# Beat the high cost of reverberation with the CV 571 only \$525

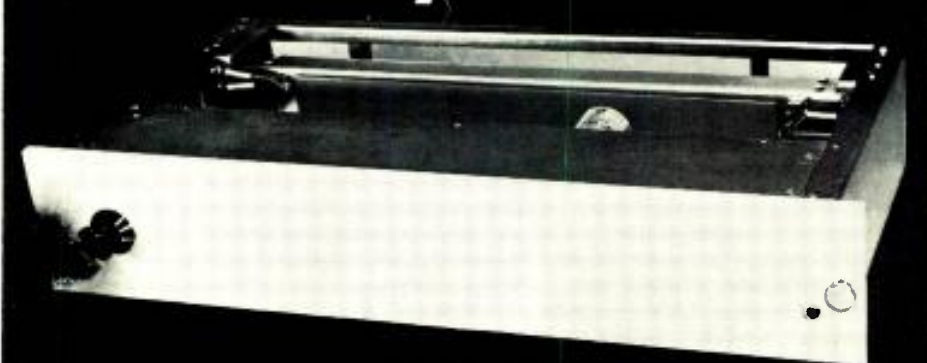

These days, a little reverberation can cost a lot of money. Because, with modern multi-track recording techniques, several individual channels must have reverberation added separately before final mixing. Requiring several dub-downs or elaborate patching before and during the final mix. And either way, you lose. Time. Money. Or both.

The CV 571 offers a practical alternative. Low in cost, this all-solid-state (silicon transistors and an IC) unit provides an adjustable 0-3 sec. reverberation, and works with input levels ranging from 0 to +6 dbm. Taking up a mere 3½" of vertical rack space, it can be readily "stacked"

to accommodate as many channels as necessary . . . for a good deal less than the cost of competitive units. Why not find out more about the CV 571? Mail the coupon to or call:

Yes! I'd like to know more about the CV 571 reverberation unit. Please send information to:  
NAME \_\_\_\_\_  
TITLE \_\_\_\_\_  
COMPANY \_\_\_\_\_  
ADDRESS \_\_\_\_\_  
(CITY) \_\_\_\_\_ (ZIP) \_\_\_\_\_



**Sennheiser Electronic Corporation**  
500 Fifth Avenue, New York, N.Y. 10036. Telephone 212-564-0433

Circle 18 on Reader Service Card

Circle 17 on Reader Service Card



# DOLBY AND MULTITRACK IN LONDON

With the increasing sophistication of pop and rock recording, quality conscious London studios are finding the DOLBY SYSTEM essential in preventing the noise problems which are otherwise inherent in multi track recording. In London's rapidly expanding network of 16-track studios, 19 of the 20 recorders currently in use are fully equipped with Dolby noise reduction units

Robin Cable at Trident Studios  
23 Dolby A301 units,  
including 16 on two 16-track recorders

Mike Claydon at I.B.C. Recording Studios  
fully Dolby equipped 16-track installation

Frank Owen at Island Studios  
30 Dolby A301 units,  
including 24 on three 16-track recorders

top right:  
One of the Dolby installations at Olympic Studios  
London's first multi-track studio to use  
noise reduction throughout

## DOLBY LABORATORIES INC

333 Avenue of the Americas New York NY 10014  
telephone (212) 243-2525 cables Dolylabs New York

UK and international:

346 Clapham Road London SW9 England  
telephone 01-720 1111 telex 919109 cables Dolbylabs London



**DOLBY SYSTEM**

may sometimes double the cost of a system or a device. If you decide to adjust your vu meters to 8 dBm for zero vu this may call for different line amplifiers in order to meet the 14 dB headroom requirement.

The following is the general breakdown of topics for writing a spec for a custom audio system or device.

1. *Purpose for which the equipment is being built.* Describe what the system is need for. Is it a broadcasting am or fm mixing console, or recording studio's control board or sound reinforcement system? Enumerate basic functions of the system (live broadcasts, news-room editing and mixing, sound recording, stage p.a. or any other function).
2. *Specific functions of the system or a device.* Describe all incoming and outgoing signal sources. Number of mics, lines, tape machines, and other sources. Output circuits and signal distribution. Number of channels and their designation.  
*Controls*—input faders (in-line or rotary) submasters, master fader.  
*Special effect devices*—equalizers, compressors, echo and reverb channels, noise reduction devices, limiters.  
*Switching*—input circuits, bus delegation, special circuits and monitoring channels (for instance monitoring of 8 track recorder in stereo and in mono—requirement for special switch).  
*Communications*—intercom and talkback circuits. Muting requirements of monitoring facility (describe equipment location for analysis of muting requirements).  
*Monitoring*—selection schedule, channel selection, foldback circuits, phones, solo buttons, cue circuits, phone lines.  
*Metering*—facilities. Phase detectors, peak indicators, agc meters.
3. *Construction* — Describe the of construction desired, include maximum allowable dimensions, shape, special surface finishes, styling. Weight limitations for portable equipment.
4. *Preferred panel layout and positioning* of critical components (include rough sketches). Leave

room for expansion or additions.

5. *Performance specifications*—
  - A. Range of input levels for each type of circuits. (mic levels, line levels, turntable levels, tape machine levels).
  - B. Required output levels. Give operating levels in dBm and vu and peak levels to be expected. (Mention equipment or circuits equipment has to work into).
  - C. Required frequency response, when roll-off is required specify frequencies and amount. (If operation requires response to 15 kHz don't demand response to 100 kHz—it will only make noise figures worse). Specify response for cue channels, monitoring, echo and reverb channels, phone lines, equalization spec.
  - D. Distortion. Give figures for maximum allowable distortion at operating level and at maximum level before clipping. Also set the limit on distortion at low frequencies and high end. Chances are that if no transformers are involved, distortion will be a small fraction of 1 per cent at all frequencies. Differentiate between main channels and circuits of secondary importance, (cue, talkback, slating, etc.)
  - E. Impedances. One of the most neglected areas in specifying audio systems. Compile data about recommended load impedances of each of the signal sources as well as input impedances of the equipment following the system or a device. Indicate where balanced circuits are

## back issues available

A limited number of back issues of db are available to interested readers who may have missed or misplaced earlier issues. When ordering please indicate date of issue desired and enclose 75c for each copy.

CIRCULATION DEPARTMENT  
db—The Sound Engineering Magazine  
980 Old Country Road  
Plainview, N.Y. 11803

preferred, mandatory or unnecessary.

- F. Noise. Specify required s/n of the entire system at operating levels (indicate exactly) at certain input levels. Remember that best practical average equivalent input noise figure is -127 dBm making best possible s/n of 67 dB when input level is -60 dBm. Expect this figure to be poorer in more complex systems and when measured using wide-band test techniques. Consider r.f. and a.c. interference. Use manufacturer's spec as a guide.
- G. Crosstalk. If all incoming signals end up as a mono mix, crosstalk is of no consequence. If adjacent channels are called to perform a separate and unrelated function, crosstalk should be specified to be better than 70 dB or whatever your requirement may be.
- H. Transients. In circuits where transients are to be avoided mention the highest allowable transient peak value. Specify what circuits are to be present and which are to be switched during the operation of the system.
- I. Monitor power requirements. Specify average and maximum power requirement for all speaker or phono circuits.

When writing the system specification, list the equipment preferred and mention all special features you'd like to see in the system. Small details sometimes make big differences in component cost. Take, for instance, illuminated *versus* non-illuminated switches. Prepare to pay almost double for lighting your push-buttons. Don't forget to ask for special features such as a standby power supply ready to take over in case of failure of the first one. Patching facilities, tone generators, connector types—all are details which make your system unique. *List them all.*

It is impossible to develop a universal set of rules for writing a meaningful spec, but it is hoped that the attempted summary will help the next time you write the spec not to forget some of the most critical requirements needed for system layout and accurate costing. By following these recommendations you will not only make the chore of the bidder easier but you will assure that you will get a better system.

TELEX MAKES  
CHOICE  
TAPE EQUIPMENT  
SO YOU CAN BE  
CHOOOSY.

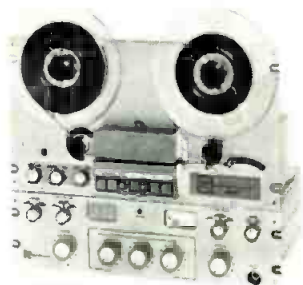

Magnecord 1021 —  
Single Channel Recorder

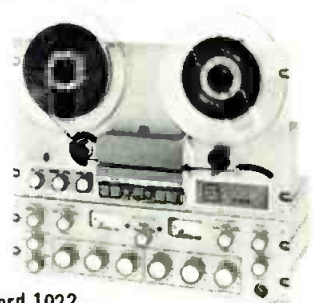

Magnecord 1022 —  
Two Channel Recorder

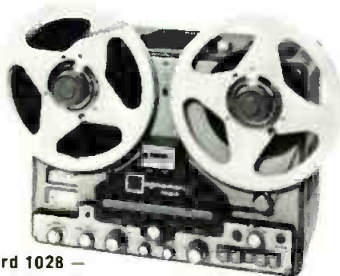

Magnecord 1028 —  
Two Channel Recorder



Viking Manual and  
Automatic Tape  
Cartridge Transports



Viking 87 —  
Tape Transport

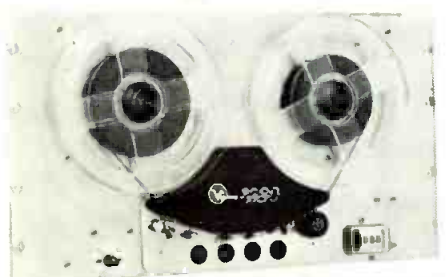

Viking 230 — Tape Transport

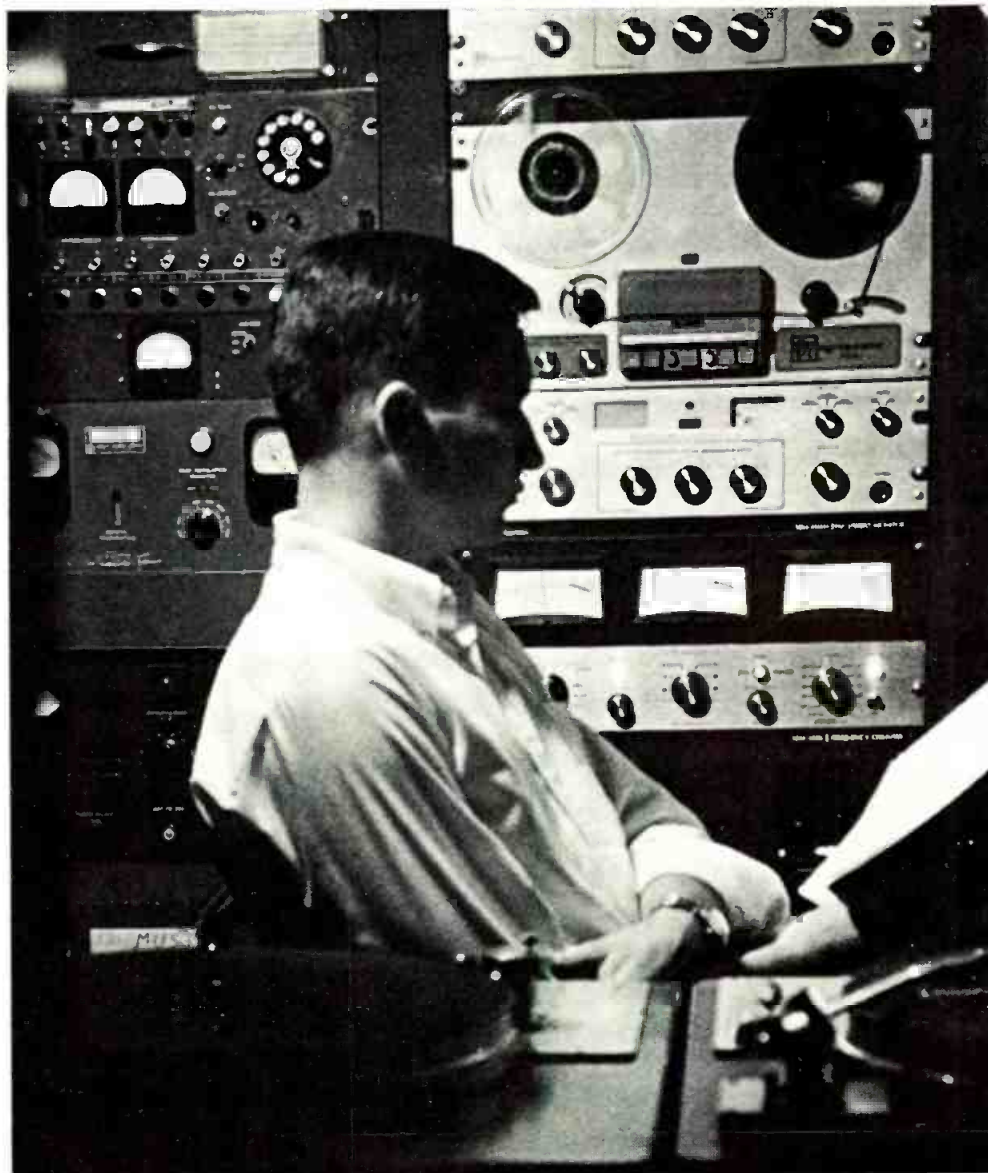

**KTIS AM/FM Stereo  
Had an opening in  
Their studio.  
They chose a  
Magnecord  
To fill it.**

PRODUCTS OF SOUND RESEARCH  
**TELEX**<sup>®</sup>  
COMMUNICATIONS DIVISION  
9600 Aldrich Avenue South  
Minneapolis, Minnesota 55420

Circle 19 on Reader Service Card

www.americanradiohistory.com

KTIS AM/FM STEREO, MINNEAPOLIS

# THEORY AND PRACTICE

• For some reason, twin-T networks possess a fascination for some people, including oscillator designers. And a twin-T network is one in which theory and practice are not too obviously connected, in most people's minds—including mine. But I did eventually come to grips with this relationship, so let's try here to show how.

The primary advantage of a twin-T circuit is that it behaves as a bridge, in which one terminal of input and output is common—a 3-terminal network. The conventional nulling bridge is a 4-terminal network, where the input and output terminals can have no common connection, and where any commonality (external impedance connecting between input and output terminals, or between both and some other common reference, such as ground) will invalidate the internal balance of the bridge. The twin-T overcomes this by allowing ground to be used as one terminal of both input and output (*Figure 1*).

Bridge theory is commonly explained with the aid of Thevenin's theorem concerning the super-posi-

**Figure 1. Comparison between the conventional bridge circuit and the twin-T configuration, (A) and (B) respectively.**

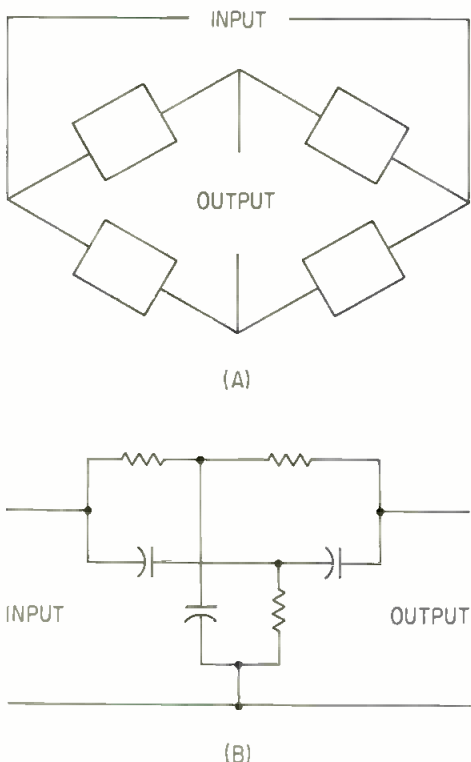

tion of networks (*Figure 2*). For the balance condition, it is sufficient to establish that there is zero voltage between the opposite points of the bridge to which the output is connected: zero voltage will also mean zero current.

But for an unbalanced condition, the open-circuit voltage difference is first derived, then Thevenin's theorem is applied to derive the source impedance at each junction point, along with the output impedance, and the imbalance output current and terminal voltage can be calculated.

The twin-T conditions are a little different. The input and shunt arms are somewhat like a conventional bridge, and then the output arms go across the junction points, like the output of a conventional bridge. But now a single output point, referenced to ground, is taken from a point at the junction of the output arms.

Unlike the conventional bridge, which has zero output current at balance, the twin-T does deliver current into this output arm at the null condition, but the voltage at the junction is zero—the same as ground.

The theory for this is not too difficult to treat in much the same way (*Figure 3*). It follows the method used for the unbalanced condition of the conventional bridge, then takes it one step further, to find the voltage at the output junction, which is equated to zero, using one input connection (ground) as reference.

To visualize this, we can use vector diagrams. In the classical twin-T, in which each series arm has twice the reactance or resistance (for balance or null condition) of the shunt arm, the vector diagram is shown at *Figure 4*.

With the output arms open-circuited (not connected together, or to any output impedance) the voltages at the T points,  $V_1$  and  $V_2$  lie on a circle through the input voltage and zero (ground) at points below the center line.

When the output arms are connected together (but no external

output impedance is applied) these voltages ( $V_1$  and  $V_2$ ) are loaded in, by the source impedance formed by the input and shunt arms, approximately toward the center of the circle, and the output arms then produce another quadrature component that brings output voltage precisely to the zero (ground) point.

With the conventional circuit, this balance happens at only one frequency. The vector diagram for other frequencies becomes much more complicated to draw. However, at balance or null frequency, the output load impedance is not important, because zero voltage will deliver zero current into it. But at other frequencies, the external load impedance can affect performance.

What happens away from null can be better visualized with a different combination of value that is purely theoretical in significance, but which does represent a limiting case for a whole range of practical values.

**Figure 2. How Thevenin's theorem is applied to an unbalanced bridge: at (A) the voltages available at the null points of the bridge are derived, in the absence of an output loading connection; at (B) the loading effect of the output load is considered.**

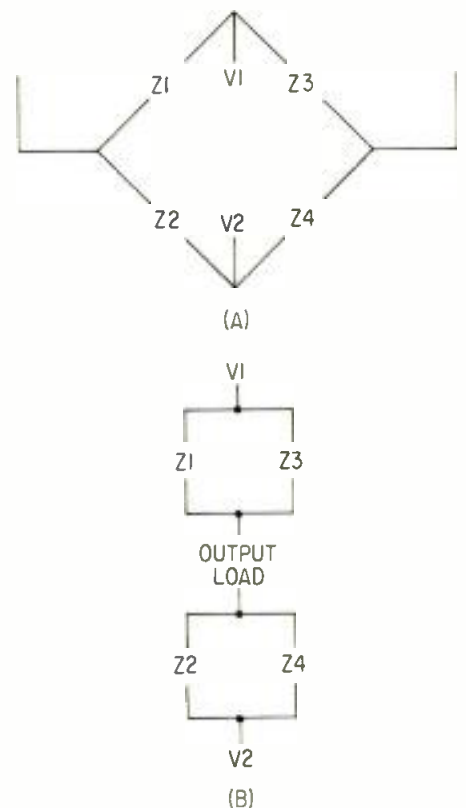

# Altec introduces a 4-foot control console with up to 28 inputs and 16 outputs.

It's built to your specs...delivered ready to use.

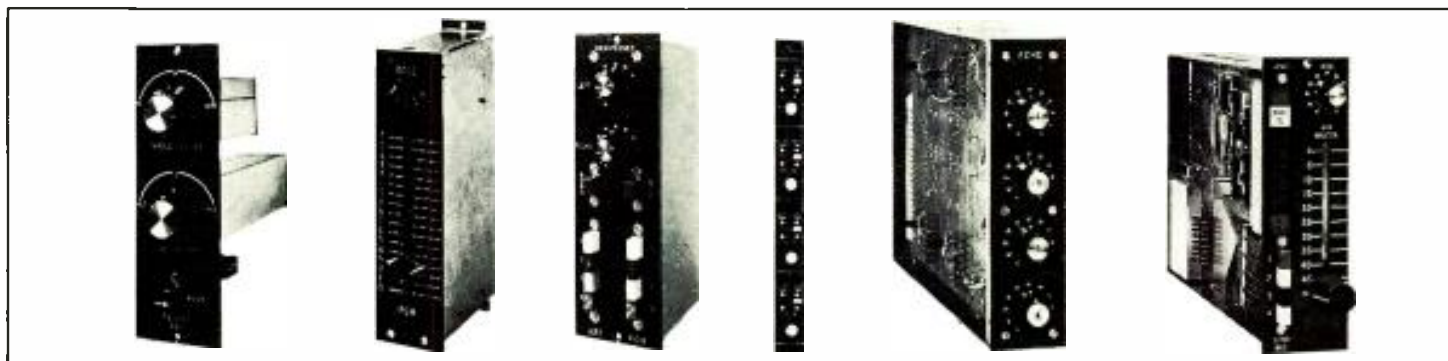

It's the all-new, all-solid-state Altec 9300A control console. Only 51½ inches long, it features direct-plug-in modular construction that lets you custom tailor your own board by simply selecting the specific modules you need.

The new Altec 9300A gives you up to 28 inputs and up to 16 outputs. And any input may be connected to any output by means of a switching matrix on each input channel.

Here are some exclusive features designed into the new Altec 9300A.

- Channel Check provides an individual Instant check of all input lines without interrupting the program.
- A Pre Cue pushbutton transfers signals from the output buss to the cue buss.
- A Modulite<sup>®</sup> Visual Volume Level Indicator on each module tells exactly how much level is being fed to tape machines.
- Echo Facilities permit selection of internal or external reverb devices and a bright or soft timbre.
- Color-coded knobs enable fast and easy matching of input channels with correct output selector modules.
- 22 dB of headroom.

Mail this coupon for all the details on the new Altec 9300A console.

To: Altec Lansing, 1515 South Manchester Ave.  
Anaheim, California 92803.

Please send me all the details on the all-new Altec 9300A control console – including information on how its unique modular design will let me simply plug in different modules as I need them.

I'd like to hear more. Please get in touch with me.

Name \_\_\_\_\_ Phone \_\_\_\_\_

Position \_\_\_\_\_ Studio \_\_\_\_\_

Address \_\_\_\_\_

City \_\_\_\_\_ State \_\_\_\_\_ Zip \_\_\_\_\_



A QUALITY COMPANY OF LTV LING ALTEC, INC.

Circle 23 on Reader Service Card

This is the case in which input and shunt arms have equal resistance and reactance, while the output arms are both infinite and equal to one another (two infinities are not necessarily equal, according to mathematicians). Now the voltages at the T point are at opposite points on the circle's circumference, and the output arms do not load the voltages away from these points (Figure 5). However the voltage at the output junction divides the bottom semicircle of the whole circle, thus producing zero output at the nulling frequency.

Now what happens when the bridge is out of balance (at other frequencies) is easier to see. The voltages at the T junctions move up

**Figure 3. Applying a similar method to understand the working of a twin-T network at its null frequency: (A), the input and shunt arms resemble the conventional bridge, enabling voltages at the T points to be calculated, in the absence of the output arms; (B), using these open-circuit T-point voltages, output current can be derived, and thus the voltage at the output junction point.**

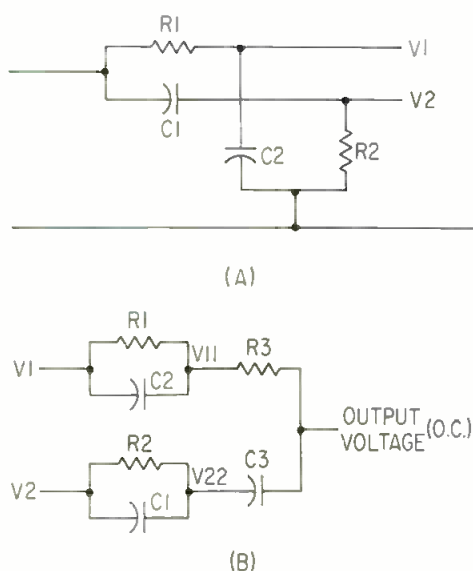

one side and down the other, remaining on opposite extremities of the circumference, while the voltage at the junction of the output arms moves also, around the circle's circumference.

Mathematical theory, too long to give in detail here, can derive the relationship between frequency and output voltage, along this vectoral circular path. And for the traditional, 2:1:2 network, the final output also moves along a circular path, but at a slightly different relationship to frequency.

As well as these two sets of nulling values, the latter of which is hypothetical, because infinite values are not practical, a whole range of realizable values can produce null conditions. The requirement is that each shunt element, at null frequency, shall have a value equal to the value (of reactance or resistance, both of which are the same at this frequency) of the two series arms considered as in parallel.

The hypothetical circuit just discussed gives the sharpest possible null (least attenuation at frequencies a given percentage away from the null frequency). The classic circuit gives an intermediate broadness, and taking a swing in the opposite direction, with the output arms smaller in value than the input arms, but maintaining the requirement described in the previous paragraph for producing a null, produces an even broader null. This can be appreciated as being due to an increased loading effect, of the output arm across the input section.

You may feel that there should be symmetry about this circuit, between the input and output series

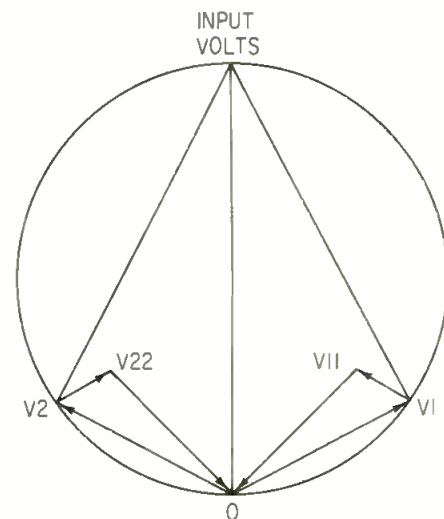

**Figure 4. The vector diagram derived at balance, for the conventional twin-T circuit, at null. The circumscribing circle is also the locus of output vectors away from null, but this is much more difficult to show.**

arms, that should result in symmetry of performance variation, contrary to the statement of the previous paragraph. Actually there is, because we omitted to state what was an implicit assumed condition, that invalidates symmetry of termination.

Without saying so, we assumed a voltage input and a voltage output. Applied to terminating impedances, this means we assumed zero source impedance input, and infinite load impedance output. If we reverse this assumed condition, which means the circuit will be current-derived rather than voltage derived, the exact reverse relationship holds about the sharpness of response as values of the arms are changed.

The fact that ideal terminating impedances (zero and infinity) are assumed means that all the sharpness responses thereby derives are theoretical, and will vary somewhat when finite impedances are used at the input and output.

But we have one more variation of twin-T configurations to throw into the picture, and this is one of its more interesting possibilities. So far we have discussed only circuits that actually provide a null, either in the classic 2:1:2 set of values, or in another combination that meets the requirement for producing a null.

What happens if values in similar relationships are used, but which do not meet the requirement for a null as spelled out earlier? Suppose, for example, the shunt arm is made equal to each series arm, for one

## Rapid-Q Tape Cartridge Equipment



- Automatic fast-forward rapid cue — minimizes wait between messages
- Exceeds all NAB standards
- Full logic switching — without relays
- Stereo or monaural

- Latest integrated circuitry — most compact recorder-reproducer available
- Proven servo-controlled drive
- Desk-top or rack-mount

**VISUAL ELECTRONICS CORPORATION**  
356 W. 40th St., New York, N. Y. 10018 ■ (212) 736-5840

# NEW PRO-4AA

The good sound you monitor is the Sound of KOSS

## Better than speakers

Here is a new, rugged, wide-range dynamic headset with good sensitivity that delivers precision monitoring far beyond that obtained by speakers. You exclude outside noise; you eliminate dis-

turbing room reflections. Freedom from distortion and flatness of response are exceeded only by the famous Koss electrostatic units. You'll find that the "Sound of Koss" is the *good* sound.

### TYPICAL RESPONSE CURVE OF PRO-4AA

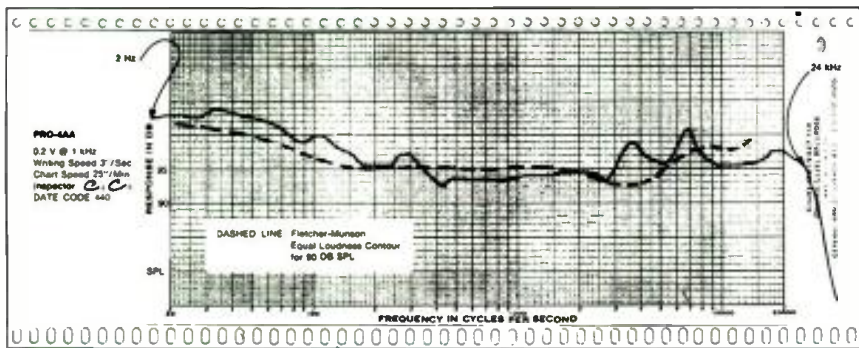

### WHAT THE SPECS DON'T TELL YOU—

**EXTENDED BASS RESPONSE TO 2 CYCLES/SECOND**—The compliance of the diaphragm is large, the seal is good against the ear and the physical design permits very long excursions to give you lo-lo bass at full level—and the PRO-4AA does it with liquid-filled cushions for perfect seal and superlative comfort, whether you wear glasses or not. This bass range response *exceeds* by 4 octaves that needed to insure good low-end monitoring.

**TAILORED CURVE SHAPE FOR FATIGUE-FREE LISTENING**—Characteristically the PRO-4AA runs  $\pm 3$  dB except below 150 Hz and for a rise at 6.5 kHz. As long as we must have *some* variation, we put the belly of the curve in the mid-frequencies to follow closely the Fletcher-Munson equal loudness contour for 90 db SPL at 1 kHz. This keeps fatigue low in long, intense sessions because you don't reach for the extremes of the range as you tire and your ears

become less sensitive. Last, but not least, the music sounds *good*.

**HIGHER HIGHS THAN YOU CAN USE**—The 24 kHz point on the chart is about where the "2" is in the figure 1521—the PRO-4AA needs longer chart paper than this standard charting equipment provides. Even though you can't hear these frequencies, the capability promotes good transient response in the range you do hear.

**WHY DOES KOSS RAISE THE BOTTOM?**—The wide-range coupler used for Koss measurements effects a perfect seal to promote high bass level almost to dc. An air leak to the sealed cavity lowers the bass response level. Koss feels that modern side-burns and luxuriant hair are good for a full 1-second leak or 4 dB less. This makes the PRO-4AA the flattest dynamic headset we know how to design at this time!

See and hear the PRO-4AA at your dealer today or write the factory for a 16-page catalog on "How to Choose Stereophones."



Price \$60.00

### ELECTRICAL SPECIFICATIONS

**Frequency Response Range, Typical:** 10-20,000 Hz ■ **Efficiency:** Medium ■ **Total Harmonic Distortion:** Negligible at 95 dB SPL. ■ **Source Impedance:** Designed to work direct from 4-16 ohm amplifier outputs. When used with headphone jacks where series resistors are employed, response should not be measurably affected, but slightly higher volume settings will be required. ■ **Power Handling Capability:** Maximum continuous program material should not exceed 5 volts as read by an ac VTVM (Ballantine meter 310B or equal) with average indicating circuitry and rms calibrated scale; provides for transient peaks 14 dB beyond the continuous level of 5 volts.

### PHYSICAL SPECIFICATIONS

**Cushions:** Fluid-filled for high ambient noise isolation averaging 40 dB throughout the audible range. ■ **Headband:** Extendable, stainless steel with self-adjusting, pivoting yokes; conforms to any head size. ■ **Boom Mount for Microphone:** Knurled, anodized, aluminum knob on left cup with threaded shaft and 2 compressible rubber washers; accepts all standard booms. ■ **Headset Cable:** Flexible, 4 conductor coiled cord, 3 feet coiled, 10 feet extended. ■ **Plug:** Standard tip, ring and sleeve phone plug. ■ **Element:** One inch voice coil virtually "blow-out proof"; takes surges up to 20 times rated maximum power levels. Has 4 square inches of radiating area from 2 mil thick mylar diaphragm. ■ **Weight of Headset Only:** 19 ounces.

 **KOSS** Stereophones

Koss Electronics, Inc., 4129 N. Port Washington Rd., Milwaukee, Wis. 53212 • Koss Electronics S.r.l., Via Valtorta, 21 20127 Milan Italy

Circle 20 on Reader Service Card

www.americanradiohistory.com

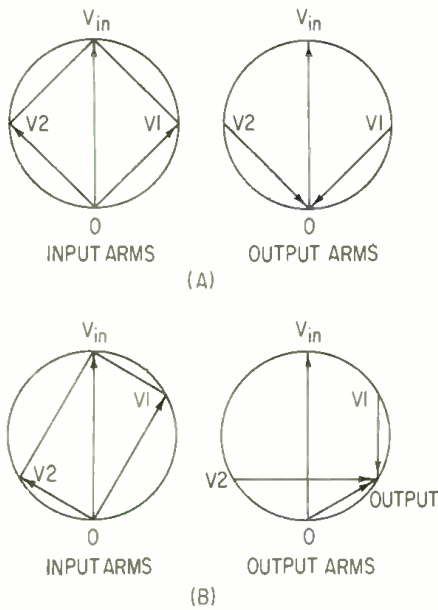

Figure 5. A hypothetical combination of values uses equal input and shunt arm values (at null) with infinite output arm values. (A) shows the vector diagrams for this at null. (B) shows the vector diagram for the same hypothetical network at twice null frequency.

variation, or one fourth of it for another, instead of the classic one-half, what happens then?

If the shunt arm is *greater* than the parallel combination of the series arms it shunts (as an equal value would be), the null does not occur, but a minimum in-phase signal is produced. The vector diagram of the response is now a circle, all of which is above the zero point (Figure 6).

If the shunt arm is *less* than the parallel combination of the series arms it shunts (as a one-fourth value would be), the critical frequency produces a reversed phase output rather than a null. This phase reversed output has minimum amplitude, but represents the maximum reversed-phase component (Figure 7). The vector diagram of the response is also a circle, this time enclosing the zero point.

Even the degree of variation we have now considered involves somewhat of an assumption, that was implied at the beginning, although we did not state it. The whole twin-T circuit possesses six elements, any of which may actually be varied in value independently. Three of these are reactances, which vary with frequency. So the number of possibilities for total variation is very high. A complete treatment of possible responses would become very complicated.

To simplify this, we assumed that at the critical or null frequency (whichever applies), the resistance values in one T are the same as the corresponding reactance values at that particular frequency in the other T. There is a little more to the complete treatment of this restricted group of possibilities, without getting into all the variations which make the consideration unmanageable, except perhaps to a computer. However, this extension does help a little.

It is achieved by considering the importance of tolerances on various components in the values to which we restricted ourselves. What if any individual component is a small percentage off its nominal, or calculated value? For small percentages of deviation, incremental math can help—wider variation becomes very involved. And for small percentages, the calculations show that certain values in the circuit are more critical to achieving desired performance than are others.

The calculations also reveal that other null possibilities can occur, beside those that make the assumption of precise symmetry between the two Ts. In fact any twin-T network, whatever its collection of values, will have either a null or a critical frequency: its output voltage will follow a circular vector locus of some sort.

Further, choice of certain value combinations enables particular values to be chosen to critical tolerances, while others are less critical, and also, for the phase-reversed output, choices of value sets are possible that control the output volt-

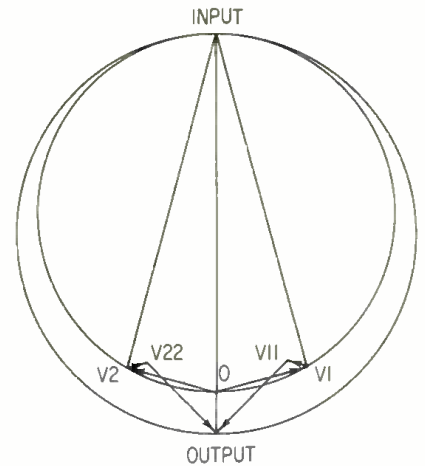

Figure 7. The vector diagram for a network in which the shunt values are one-fourth the value of each series element at critical frequency. The larger circle shows the locus of outputs at other frequencies.

age at critical frequency within close limits, which can prove useful.

An introduction to all the math needed for this is contained, for those who need it, in my book **Mathematics for Electronics Engineers and Technicians**. Before you rush out to buy it, I should warn you that it does not go much beyond the stage discussed right here, except in the math: if you want to go further than checking the math statements I have made, the book will leave you on your own.

However, the more complete math has been applied to a few charts that will make calculations for you, in my **Electronic Design Charts**, which puts the material in a form to enable it to be used in practical design. In the next issue, I will describe some circuits that apply this information to useful applications. ■

Figure 6. The vector diagram for a network in which all values are equal at critical frequency (which is not now a null). The smaller circle shows the locus of outputs at other frequencies.

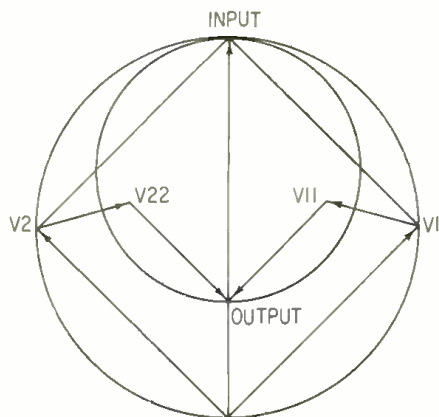

## you write it

Many readers do not realize that they can also be writers for *db*. We are always seeking good, meaningful articles of any length. The subject matter can cover almost anything of interest and value to audio professionals.

You don't have to be an experienced writer to be published. But it can be prestigious to be published and it can be profitable too. All articles accepted for publication are purchased. You won't retire on our scale, but it can make a nice extra sum for that special occasion.





## The only thing you'll ever get from a bent horn is a sour note.

Unless you're using the best in tape, you can expect a lot of sour notes among the sweet.

One way to tell which is best is to look at the guarantee. The best goes the limit. Ours is guaranteed, unconditionally. Maxell tapes must perform to your standards or we'll replace them, pronto, with no questions asked.

That's just one of the reasons more and more record and dupe makers specify the advanced Maxell F-20 magnetic tape. It's the one for high frequencies, capturing every note on the scale. 25 to 18,000 Hz. 10% greater tensile strength than conventional tapes. Plus an exclusive, our closely-guarded Hush-Hush process that practically wipes out hiss, permits fullest, truest fidelity for mono or stereo, recording and playback.

Maxell F-20. The bulk tape made specifically for duplicating and recording cassettes. For the sweetest sounds you ever heard.

- For general recording purposes, Maxell bulk tapes for C-60, C-90 and C-120 cassettes.

For details on all Maxell professional tapes, write

**maxell**® Maxell Corp. of America  
Dept. DB-1, 501 Fifth Avenue, New York, N. Y. 10017

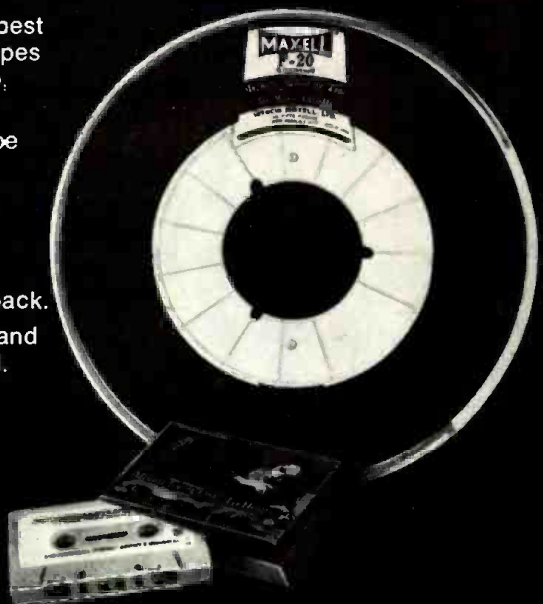

Circle 21 on Reader Service Card

[www.americanradiohistory.com](http://www.americanradiohistory.com)

# THE SYNC TRACK

## Music Theory for the Engineer

The following is somewhat of a trial balloon. If there is an indication of interest, the SYNC TRACK will feature a series of columns at irregular intervals on the subject of music theory. Although a recording engineer does not have to be an accomplished musician to perform his duties, a little knowledge of the language of music and musicians can be a great help.

• For a recording engineer, a workable definition of the term music might be: *Music* — a logical (more or less) sequence of varying frequencies, produced by an audio signal generator, and arranged in such manner as to produce a pleasant sensation at the ear of the listener.

For audio signal generator, we might substitute musical instrument, for any musical instrument is, in effect, merely a specialized form of signal generator, capable of reproducing some portion of the au-

dio spectrum. Of course, a clarinet sounds a lot different than the engineer's audio oscillator. Yet both are signal generators, capable of producing various frequencies, one at a time. The distinctive characteristics that enable us to differentiate one instrument from another will be discussed later.

Although the range of audible frequencies extends to about 20 kHz, the portion used for music generally uses only about the first 4 kHz. In fact, the lowest and highest keys on a piano, 27.5 Hz and 4186 Hz, may be considered as the practical limits of what we shall call the *music spectrum* of frequencies. Between these limits, there are more than four thousand different frequencies—if we consider whole numbers only. And, allowing for fractions, there are an infinite number of frequencies between our limits of 27.5 Hz and 4186 kHz. Obviously, not every possible frequency within these limits finds usage in music. In fact, the piano, which is capable of producing every music frequency, has only 88 keys. Therefore, we may correctly assume that only 88 separate frequencies are used in music.

Before specifically identifying the 88 frequencies and their musical names, we will divide the music frequency spectrum into smaller subdivisions of several notes each. There are several ways in which this may be done. The engineer might be inclined to seek some form of equal division for mathematical ease. For example, 10 divisions of 400 Hz each may seem logical. (0-400, 400-800, . . . 3600-4000 . . .) This might be a convenient arrangement, if the human ear was not a consideration. For the ear becomes far more sensitive to a given frequency difference ( $\Delta f$ ) as we approach the lower limits of the music spectrum. For example, although they are both 400 Hz apart, 400 Hz sounds much further removed from 800 Hz than does 3600 Hz from 4000 Hz. In fact, to the untrained ear, the difference between the latter two frequencies may be barely per-

ceptible. We would have to go from 3600 Hz to 7200 Hz to duplicate the same sensation of increased pitch that we hear between 400 Hz and 800 Hz. Now, since all our divisions should be readily distinguishable—one from the other—there would be no point in a system of sub-divisions that become less and less detectable with increasing pitch.

A more satisfactory system would be to divide the spectrum into units in such a way that the first note of any unit is equal to twice the frequency of the first note of the unit immediately below it. Thus, if the first note of unit 1 is  $f$ , the unit 2 first note will be  $2f$ . The first note of unit 3 will be twice  $2f$ , or  $4f$ . Unit 4 will begin with  $8f$ , and so on. We find that now, as frequencies increase, so does the physical size of the frequency interval between units, thus compensating for the ear's decreasing sensitivity to pitch changes at the higher frequencies. If we consider the lowest note of the piano (27.5 Hz) as the first note of unit 1, we will find that the highest note (4186 Hz) lies somewhere between the first notes of units 8 and 9. (3520 Hz and 7040 Hz). So, we may conclude that, for all practical purposes, music will encompass somewhat more than eight of our units.

In music, these units are referred to as octaves, since they are further divided into eight smaller divisions. Actually, the octave is divided into twelve equal intervals, but only eight of them are used to form what is referred to as a major scale.

We may now define the octave as:

*Octave* — the interval between any two frequencies,  $f_1$  and  $f_2$ , where  $f_2 = 2f_1$  (or for that matter,  $f_1 = 0.5f_2$ )

For the moment, let's refer to the eight divisions of a major scale by the numbers 1 through 8. If we sound a series of tones, making each one higher by a constant percentage than the preceding tone, the ear will attach no particular significance to the series. It will

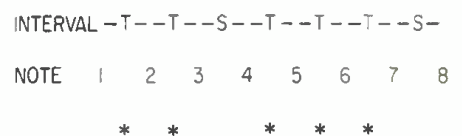

Figure 1. A tabulation of the eight notes of the octave, and the intervals between these notes.

### TAPE CARTRIDGE TRANSPORTS



Broadcast quality transports for all NAB type endless loop tape cartridges. Three models — manual, semi automatic or automatic for broadcast, industrial or commercial applications. Available in various monaural or stereo head configurations, single or dual speed. From \$86.00. Tape cartridges, associated record/playback electronics available. Made in U.S.

PRODUCTS OF SOUND RESEARCH  
**TELEX**  
 COMMUNICATIONS DIVISION  
 9600 Aldrich Avenue South  
 Minneapolis, Minnesota 55420

Circle 14 on Reader Service Card

Here once was a small company with weird ideas. Their namesake was their vice president, Allison Buff (a girl! Oh my, how unprofessional). If that wasn't bad enough they had the nerve to plaster her face all over their equipment. (Anybody knows that a girl's face doesn't belong on professional equipment.) They even took Allison to the big city and disgraced themselves even further by allowing her to serve KoolAid\* to their prospective clients.

Actually, the reason they did all these dumb things was that they wanted to keep their company small. They thought that these obviously inferior marketing approaches would deter people from buying their products and, hence, they would have no need for a large, complicated company. But, alack and alas, the tables have turned on Allison and her friends. They have failed in their efforts to deter sales. People all over the land, like RCA, Mercury and Columbia have gone ahead in spite of these obstacles and bought KEPEX anyhow.

Most likely, the cause of Allison's failure lies in the fact that KEPEX does what it was designed to do! Her once small company is now bustling and busy supplying KEYPIE to such users as A & M Records, Motown, Wally Heider, NBC, Walt Disney Productions, Glen Glenn, Sunset Sound and a whole big bunch of others.

Please help! Please don't buy KEPEX unless you feel it absolutely necessary to reduce the noise of your multitrack recording system, or to solve such problems as room leakage, guitar amp noise, air conditioner noise, excess breathiness on vocal tracks, or to remove or reduce "room sound" or excess over-ring on drum and other percussive tracks.

Please remember, should you buy KEPEX as a creative electronic music tool, or to increase presence on your tracks, or for whatever reason, that you shall have to look Allison in her plastic eye each time you use it.

Sob, sob . . .

Oh! If you're interested, Allison will send you her new free demo record, ho, hum . . .



**Here is your**  
**KEPEX**  
**equipment**

**From ALLISON RESEARCH, INC.**  
**7120 SUNSET BOULEVARD**  
**HOLLYWOOD, CALIF. 90046**

**To:**

---

---

---

---

\*Registered trademark, General Foods Corp.

Circle 25 on Reader Service Card

## Citizen Exchange Corps along with db Magazine and Billboard announce The Third Annual Audio Industry Exchange Visit to the USSR and Eastern Europe

A new exchange visit of professionals in the audio/music field is now being organized for a May 8th, 1971 trip to the Soviet Union and other Eastern countries. You will visit these countries and meet your work counterparts. You will see studios and broadcast facilities that do things differently from your way. The sponsors of the trip are the Citizens Exchange Corp. (a non-profit, non-political organization). Co-sponsors are db Magazine and Billboard. It is expected that the Editor of db Larry Zide, columnist John Woram, and Radcliff Joe of Billboard will be along.

What does it cost? How long will it be? Present cost is established at \$1068 which will be held until March 30th. This is an all-inclusive cost—air transport, hotels, meals, etc.—you will need very little pocket cash unless you are a souvenir grabber of large proportion. (It is anticipated that there will be a \$100 increase in cost after March 30th—so it pays to subscribe early.) The duration of the trip, starting from New York, will be three weeks, including return to New York.

I want you to know that I remain a strong supporter of "Bridge Building"—and in my definition this includes widespread exchanges of visitors from Eastern Europe and the Soviet Union.

Sincerely,  
Hubert H. Humphrey

Today, when strained relations between nations contribute to the world arms race, CEC is a small candle of hope among the lights that seek to ward off the darkness of destructiveness in the world. CEC in this way serves world brotherhood. The world deserves nothing less.

Senator Jacob K. Javits

The CEC is a private non-profit organization which conducts non-political exchange visits between citizens of the United States, the Soviet Union, and the countries of Eastern Europe.

The Editor:  
db Magazine  
980 Old Country Road  
Plainview, N. Y. 11803

Please send me a reservation form and more details.

Name \_\_\_\_\_

Address \_\_\_\_\_

\_\_\_\_\_ town state zip

sound like nothing more than what it is—a series of progressively higher frequencies. But, if the last tone in the series is only half as far removed from the preceding tone as the other intervals in the series, our attention will be drawn to this smaller interval. Upon hearing it, we will unconsciously sense that the series has reached a logical stopping point.

Consider a very rough mechanical analogy; a darkened flight of stairs. Ascending the stairs, we would have no advance way of knowing when the stairway would end. However, if the final step was only half the height of the preceding step, we would at once stop, in spite of ourselves, due to the sudden change of pace. So it is with the frequency series. A smaller interval draws attention to itself, and inclines us to rest upon it, rather than continuing further.

We find such a smaller interval between notes 3 and 4, and also between note 7 and 8 of the octave.

Now the other intervals within the octave are referred to simply as *tones*. These smaller intervals are called semi-tones. *Figure 1* is a tabulation of the eight notes of the octave, and shows the intervals between notes.

If we insert additional notes at the points marked by asterisks, we now have a series of twelve equally spaced intervals of a semitone each. These additional notes, although lying within our major scale, are not regularly considered as part of it.

Before continuing, we should begin referring to the notes by their musical names. In music, the frequencies of the major scale are named after the first 7 letters of the alphabet. At the octave, the letters are repeated again. Thus, notes 1 through 8 above will now be called c,d,e,f,g,a,b,c. The additional notes, marked by the asterisks, do not have letters assigned, but are named by referring them to the nearest letter note above or below, plus the addition of the word *sharp* or *flat*. The note between d and e may be called either d sharp (D<sup>♯</sup>) or e-flat (E<sup>♭</sup>). Note that there is no additional note between e and f. Because of this, e sharp = f, and f flat = e.

In the next column on music theory, we'll get into musical notation and time signatures.

# NEW PRODUCTS AND SERVICES

## TABLE-TOP DUPLICATORS



• A new line of tape duplicating equipment has recently been introduced. The illustrated unit is a model CS-4000 and typifies the product line. It is a table-top machine capable of making copies from either reel or cassette masters at eight times the original speed. It is available in full, two, and four (including quadrasonic) tracks, with

all tracks recorded simultaneously. Solid-state circuitry is used, and external bias adjustment and individual track recording capability exists. Other models in the line include different cassette slave configurations, 7-inch reel capability masters, and master/slave electronics systems. There is also a reel-to-reel (master) to reel or cartridge hub slave with 8:1 ratios. This is the model RR800.

*Mfr: Recordex Corp.*

*Prices: CS-4000 stereo cassette to cassette—\$3295.00*

*CS-4000 slave only, can be added to above—\$3070.00*

*RR-800 reel/cartridge hub four-slave system—*

*\$12,600.00*

*Circle 44 on Reader Service Card*

## ENVIRON MICROPHONE



• A pair of dynamic cartridges coupled through a novel distance discriminating network in the housing permit the user to select (with a switch) whether the microphone will accept or reject background sounds. In the super omni mode, both near and far sounds are picked up. When switched to the noise-cancelling position, sounds from sources more than three feet away are rejected while sounds originating a few inches from the mic are clearly picked up. Frequency response is 40 to 15,000 Hz and the three-wire termination offers the option of either 250 or 50 k ohms output termination.

*Mfr: Ingenuics, Inc.*

*Price: \$189.00.*

*Circle 33 on Reader Service Card*

## 8-CHANNEL DISTRIBUTION AMP



• Model DA415-8 is a compact distribution amplifier which provides a means of sending signals from one or more sources into eight separate lines with a minimum amount of interaction between channels. The unit consists of eight separate isolation amplifiers. Input and output is accessible individually through a 24-pin connector. There is a self-contained power supply. Voltage gain is unity. Specifications include: 1 dB response, 20-20 kHz; distortion, less than 0.3 per cent; noise 85 dB below a 4 dBm level; input impedance each amp, 100k; minimum input impedance (all amp inputs parallel), 12k ohms, output impedance, 10 ohms. Maximum output handling capability is +15 dBm.

*Mfr: Fairchild Sound Equipment Corp.*

*Price: \$245.00*

*Circle 43 on Reader Service Card*

## NEW GENERATION 16-TRACK RECORDER



• This new studio 16-track recorder has been designed to provide optimum performance yet sell at a price approximately half that of other 16-track present generation recorders. One of the principle features of the new series 100 is a new combination record/play head design which the company claims eliminates the need for a separate playback head and the complicated switching involved in overdubbing. The illustration is a closeup of the head configuration.

*Mfr: Scully (Dictaphone Corp.)*

*Price: basic 16-track recorder—\$13,750.00*

*basic 8-track recorder—\$11,250.00*

*Circle 42 on Reader Service Card*

## STOCK CONSOLE



• The RC168 is a total of eight channel stereo or mono outputs with up to 24 inputs, AUDEX bus selection and monitor mixing, 8 stereo pan pots, separate monitor mixing, individual control room and studio monitor level controls, 2 cue buses, and complete tip ring and sleeve patching. There's even a place for the producer to put his papers. Stock is 16 input, but options permit you to order 20 input or 24 input models. The console can be customized within limits to specified needs.

*Mfr: Audio Designs*

*Circle 41 on Reader Service Card*

*Circle 24 on Reader Service Card →*

**It was really  
the hit of the  
AES Show?**

**You'd better  
believe!**

**A new 16-track,  
2" pro recorder  
for \$13,750.  
You're putting  
me on,  
right?**

**Wrong.**

**The Scully  
Series 100 really  
out-performs  
recorders  
costing \$10,000  
more?  
They're truly  
innovative, not  
warmed-over  
something  
else?**



You heard  
it  
right.

I'm sold.  
When can  
I get a 100?  
How can  
I learn more  
about it?

Check.  
And, you can order  
from your favorite  
Scully distributor  
or directly  
from a Scully  
regional office.

Man, that 100  
will really swing  
with my console.  
I can buy only  
the basics I  
need. Add  
others later.

You can get  
the 100 next  
month.  
You can get  
all the facts  
by writing  
Ham Brosious  
at  
▶ **Scully**  
480 Bunnell Ave.  
Bridgeport,  
Conn. 06607  
or call him at  
203 335-5146



These product photos were taken at this past autumn's AES Convention. Space limitations prevented their appearing last month.



SSI is a new company that will manufacture an intriguing design on a new radial arm to be distributed by Elpa. *Circle 66 on Reader Service Card.*



URL's Autotec 16-track recorder was displayed before its delivery to Sound Ideas Studios. *Circle 60 on Reader Service Card.*



BASF has available a wide variety of black tape for duplicators. This is their C-90 for cassette use. *Circle 51 on Reader Service Card.*



Electro-Voice showed a consumer model of a four-channel stereo decoder system designed by Leonard Feldman. *Circle 82 on Reader Service Card.*



This 3M readout counter will tell you unerringly where you are on a tape. *Circle 54 on Reader Service Card.*



The Tandberg 6000X provides 1/4-track stereo, three-speed operation, cross-field heads, under \$500. *Circle 77 on Reader Service Card.*



The TEAC 313 with full remote control and 1/2—1/2—1/2—1/4 stereo heads. *Circle 72 on Reader Service Card.*



Mann is a company that makes cassettes and other formats in endless loop configurations. *Circle 83 on Reader Service Card.*



Electro Sound/Viewlex has a cassette duplicator system with facility for up to eight modules. *Circle 56 on Reader Service Card.*



Koss PRO 4AA earphones are dynamic units with extended frequency response and low distortion. *Circle 65 on Reader Service Card.*



The Tonus electronic music synthesizer. *Circle 69 on Reader Service Card.*



# New Concepts in Studio Equipment Design

*The application of op-amps to recording-studio console design is sweeping the industry. RCA Records has taken the operational amplifier one step further in the form of the uoab.*

THE concept of the universal operational amplifier board (*uoab*) was developed by Mr. Robert Breed of the RCA Record Engineering Labs at Indianapolis. The Recording Studios at New York were about to launch a large expansion program and needed several new consoles with the capability of handling 16-track recording.

It was felt that the *uoab* had such great potential that a break from more conventional design methods was indicated. Experience has shown this to be a very wise decision.

The *uoab* concept is simply this: one plug-in board capable of performing any function required in a studio with the exception of a power amplifier.

A universal board for all stages in a piece of equipment yields the following advantages: Duplicate design work is eliminated—all that is required for a particular application is the calculation of the feedback network for the desired gain and response. Maintenance is simplified—only one type of board need be kept on hand. Costs are lowered—It is cheaper to purchase one item in large quantities than to purchase several different items in small quantities.

A list of desired circuit properties along with typical *uoab* performance data is given in *Table 1*.

## CIRCUIT DESCRIPTION

The circuit of the *uoab* is given in *Figure 1*. Transistors Q1 and Q2 and associated components are emitter followers for power supply decoupling.

R7, R8 and C6 provide an offset voltage which can be used to polarize the output coupling capacitor, C1. The remainder of the components on the board allow connection of the *uoab* to perform three or four common functions without requiring any external components.

A large proportion of the development of the *uoab* was involved in the selection of the operational amplifier module to be used. All of the available operational amplifiers were screened for noise floor and output capability as well as the typical operational amplifier specifications of open-loop gain, bandwidth, frequency-response, and phase-shift characteristics. It

*At the time of the writing of this article, R.N. Andrews was manager of recording facilities engineering for RCA Records in New York City. He has since moved to other duties with that company based at their Indianapolis, Indiana facilities.*

**TABLE 1.**  
DESIRED QUALITY  
TYPICAL UOAB PERFORMANCE

Low equivalent noise input	- 129 dBm
Low distortion	Less than 0.03%
Selectable input impedance	From less than 0.1 ohm to greater than 10 Megohms
Low output impedance	Less than 5 ohms
High output capability	7 volts r.m.s. (load greater than or equal to 100 ohms.)
Low input power	1 watt
High isolation between inputs when used as an active combiner	Greater than 80 dB
Overload and short-circuit protected	Not damaged by indefinite overload or short-circuit.
Insensitive to noise on power supply.	Heavy power supply filtering and de-coupling is used.

**Figure 1. The circuit of the uoab described in the text.**

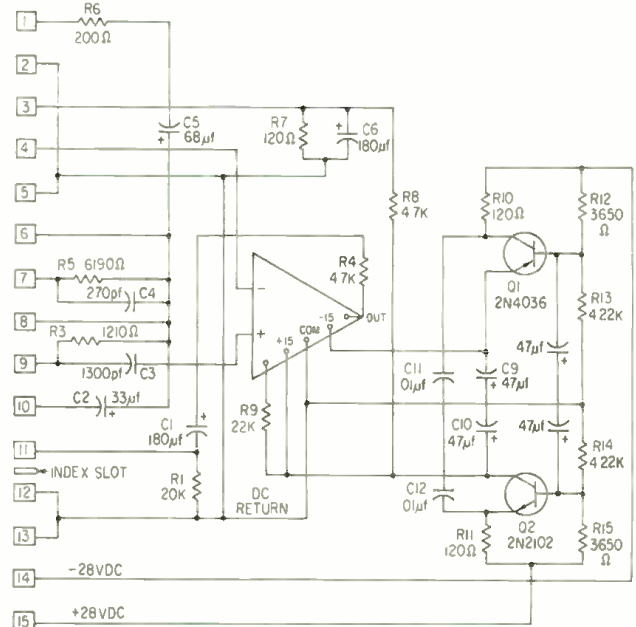

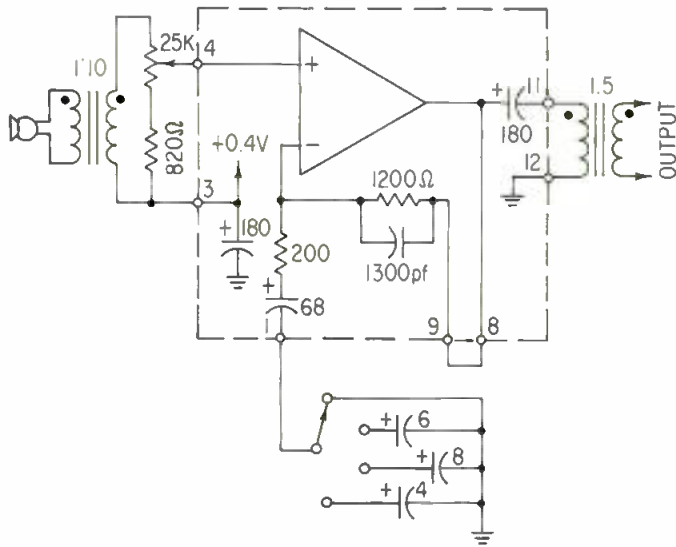

Figure 2. The microphone preamplifier circuit.

was found that with the current technology integrated-circuit operational amplifiers could not meet the noise and output capability requirements.

Therefore attention was directed to discrete component units. At the present time only two operational amplifiers have been found which meet all of the requirements. These are the *Melcor Model 1731* and the *Automated Processes Model 2520*. The Automated Processes unit has a two or three decibel lower noise floor, but both units give excellent performance.

potentiometer provides up to 30 dB of attenuation to allow adjustment for microphone sensitivity, and the switch provides a low-frequency roll-off which can be

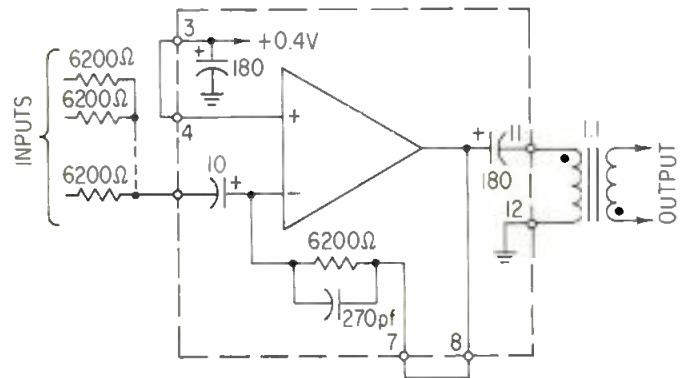

Figure 3. The active program combiner circuit.

used to minimize rumble and leakage from the rhythm section. The cutoff frequencies available are 15 Hz

### TYPICAL APPLICATIONS

Currently, the *uoab* is being used in several new 16-channel recording consoles and tape-mastering consoles in every stage except for the monitor power amplifiers. Also in use are a master tape duplicating rack and four eight-track tape playback machines using the *uoab*. It is worthwhile to take a closer look at exactly how the *uoab* is used in these devices.

The 16-channel studio consoles contain microphone pre-amplifiers, booster amplifiers, program combiners, and program amplifiers all using the *uoab*. Figure 2 shows the circuit of the microphone pre-amplifier. The (flat), 50 Hz, 100 Hz and 200 Hz. This stage provides about 50 dB of gain with a signal-to-noise ratio greater

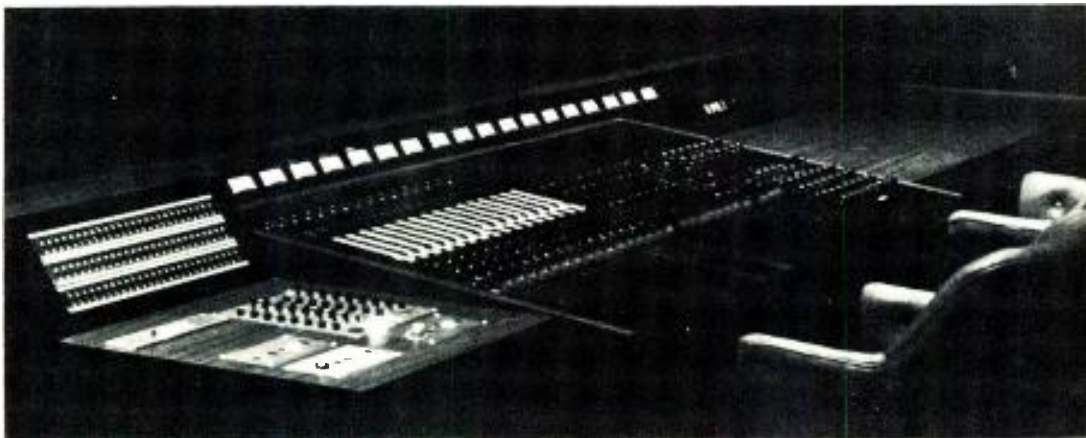

## Sounds Finest Quality .....

Show us the place and we will build you a studio  
 Any component or a complete facility ready for operation  
 Update your existing studio  
 From major equipment to accessories  
 Stock and/or custom items  
 Consultation

CADDCO Audio Industries Corporation  
 55 Oak St Norwood, N J  
 201-767-1787 914-359-4434

Circle 29 on Reader Service Card

# It's MCI's new total-logic JH10.

The logic is so total, not even a power failure (much less an engineer failure) can break or spill the tape.

"Sudden" is the most accurate word we can find for JH10's acceleration from "Stop" to any commanded tape function.

And for its conversion time from one- to two-inch, and vice versa.

Practically everything is plug-in for fantastically simplified maintenance and expansion from, say, 8 to 24 tracks.

Constant, electronic (not mechanical) tension control sensing reduces head wear, wow, flutter and speed variations.

Prices start at \$3,500.

Write: MCI, 1140 N. Flagler Dr., Ft. Lauderdale, Fla. 33304 • 305/524-3318. Distributed West of Rockies: Westlake Audio, 1047 Twinfoot Court, Westlake Village, California 91361 • 805/497-7924

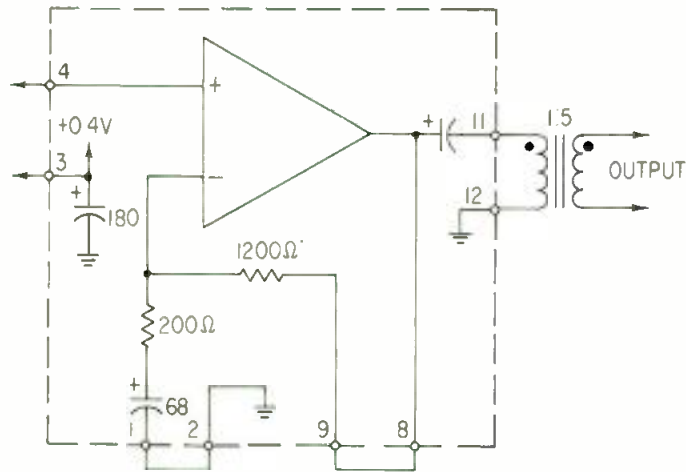

Figure 4. The circuit of a program amplifier.

than 70 dB.

An active program combiner is shown in Figure 3. The output transformer is used to cancel the phase inversion introduced by the combiner. As opposed to the classic passive combiner network, this circuit has no loss and yet has greater than 80 dB isolation between inputs.

The two examples discussed so far were both un-equalized stages. Figure 5 illustrates the use of the *uoab* as a tape playback amplifier, with NAB equalization. A signal-to-noise ratio of greater than 65 dB has been realized with the circuit.

The above examples point out the design advantages of the *uoab*. The only real difficulty with the *uoab* is characteristic of any high-gain, wide-band feedback amplifier, oscillation, care must be taken to insure the adequate grounds and other conditions necessary for good stability.

The maintenance record of the *uoab* has been excellent. Equipment utilizing nearly 850 boards has been in use for several months. So far, fewer than ten boards have failed, a rate of approximately one-tenth of one percent, and when a failure does occur, the down time involved is simply that required to isolate the faulty stage and plug in a replacement board.

The advantages offered by the *uoab* should lead to its being adapted to fields other than the recording studio where ease of design, high reliability, and simplified maintenance are desired.

The author wishes to thank H. Meurer, L. O'Hare, and J. Stupak for their invaluable assistance in preparing this paper. ■

Figure 5. This is a tape playback amplifier with NAB equalization.

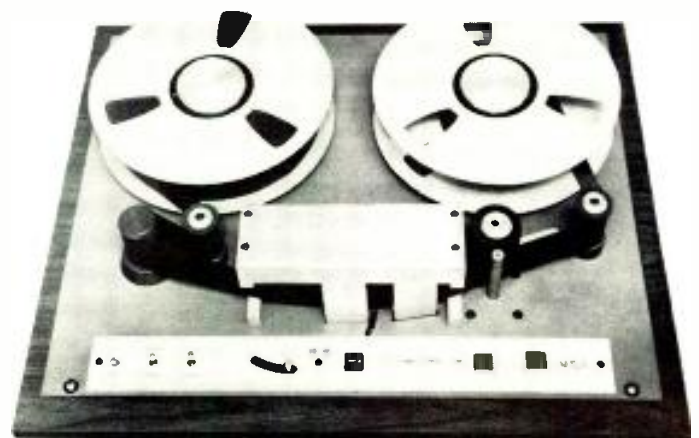
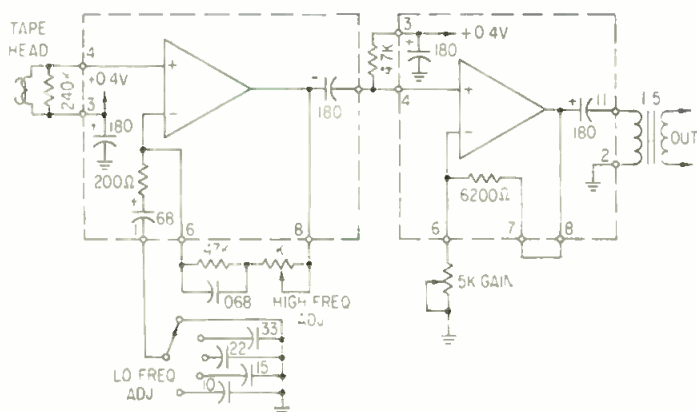

Circle 26 on Reader Service Card

# Considerations in Acousta-Voicing\* Studio Monitors

*Experience with a number of recording studio monitoring systems has brought to light basic acoustic considerations that can significantly influence the effectiveness of an Acousta-Voiced monitoring system.*

**I**F YOU TAKE two identical speakers in two different studios and Acousta-Voice\* each of them to the same amplitude response and sit exactly the same *physical* distance from them, there will still be subtle differences between them. Since the only difference in the two listening conditions is the studios themselves, we must examine the acoustic influence of each of the studios on the identical speakers.

## WHAT HAPPENS AT THE LISTENER'S EARS?

In a given enclosed space (Studio 1), if we assume a standard loudspeaker and a standard physical distance from that speaker for our listener's ears (mixer or producer), we can say that the complex waveform at the listener's ears represents a *standard* condition for the conditions we have specified.

If we now move that standard speaker into a second given enclosed space (Studio 2) of quite different size and shape as compared to Studio 1 and again sit at the standard *physical* distance from the standard speaker, what major parameter does Studio 2 change at the listener's ears? (We are assuming that in both cases the standard speaker has been Acousta-Voiced at the standard physical distance for uniform amplitude.)

Since we are using an Acousta-Voiced standard speaker we know that: 1. The amplitude at the listener's ears at both studios is the same. 2. The distortion, coloring, etc., at the listener's ears in both studios are the same.

What is not the same is the ratio of sound arriving directly from the speaker to the sound that has first been reflected from a room surface or surfaces before arriving at the listener's ears.

## SOUND FIELDS IN A STUDIO

Close to a speaker the direct sound predominates. As you move farther and farther away from the standard speaker the direct sound follows the inverse-square-law attenuation rate. After a certain distance has been reached, the sound has fallen to the same level as that

achieved by the complex multiple reflections going on in the room at the same time. This point in space can be calculated for any given speaker and room and is called critical distance ( $D_c$ ).

$$D_c = 0.14\sqrt{QS\bar{a}}$$

Where  $Q$  = the directivity factor of the speaker.  
 $Q = 5$  essentially says that the speaker's directivity is concentrated over 1/5 the surface that a perfect omnidirectional speaker would cover (total spherical coverage).

$S$  = the total *boundary* surfaces of the enclosed space.

$\bar{a}$  = the average absorption coefficient of the enclosed space.

Let's, for example, say that Studio 1 in our sample case has a total boundary surface area of  $S = 6850 \text{ ft}^2$  and an average absorption coefficient of  $\bar{a} = 0.456$  and that Studio 2 has an  $S = 3425 \text{ ft}^2$  with an  $\bar{a} = 0.172$ . Let's also assume that our standard speaker has a  $Q = 5$  over most of the range of interest.

STUDIO 1

STUDIO 2

$D_c = 17.5 \text{ ft.}$

$D_c = 7.6 \text{ ft.}$

This means that the ratio of *direct-to-reflected* (reverberant) sound is 1/1 for Studio 1 at 17.5 ft. and 1/1 in Studio 2 is 7.6 ft.

Typical ranges of directivity indexes ( $D_1$ ) and directivity factors ( $Q$ ) are shown in Table 1. The directivity index indicates the increase in on-axis spl that can be expected from a speaker with the indicated  $Q$  compared to a speaker with perfect omnidirectional radiation, if we assume equal power and equal efficiency for both speakers. In other words, making a spherical radiator into a hemispherical radiator allows us the use of twice the power into the reduced surface area.

*Don Davis is vice president—marketing, industrial products of Altec, a division of LTV Ling Altec.*

\*Acousta-Voice is a registered trademark of the author's company.

**What is not the same is the ratio of sound arriving directly from the speaker to the sound that first has been reflected from a room surface or surfaces before arriving at the listener's ears.**

Type of Sound Source	D <sub>1</sub>	Q
Person talking (no sound system)	3 dB	2
Coaxial loudspeaker in infinite baffle	7 dB	5
Cone woofers	7 dB	5
Multicellular horns	7-12 dB	5-15
Sectoral horns	7-9 dB	5-9.5

**Table 1. D<sub>1</sub> and Q rating for typical sound sources.**

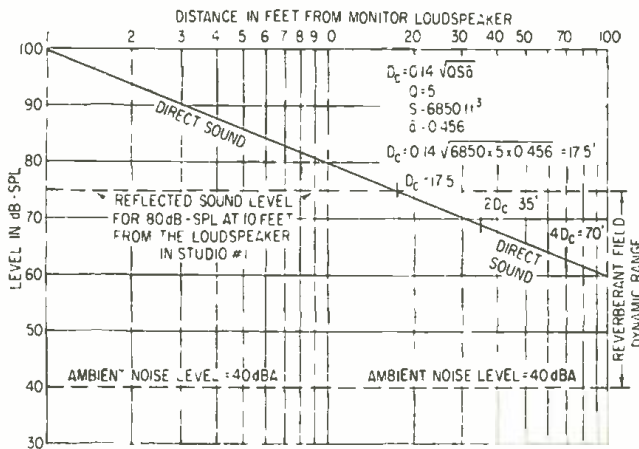

**Figure 1. The monitor speaker's output generates a reflected sound field that is relatively stable throughout the studio. This field will, of course, vary in level with the monitor's output. The ambient noise level is also present. The direct sound predominates until critical distance (D<sub>c</sub>) is reached. This diagram illustrates the changing relationships of these sound fields with distance in studio 1.**

**Figure 2. In the near field, predictions are difficult and measurements erratic. A coarse rule defining the near field would be not to get closer to the speaker than its largest dimension (typically four or five feet). The far field is that region where a doubling of a distance yields a -6 dB change. The reverberant field is that region where the sound level tends to remain constant with changing listener position. In recording studios the author feels that the mixer and producer should sit in the far, free field of the monitor speakers. In public auditoriums, the audience should sit in the far, reverberant field.**

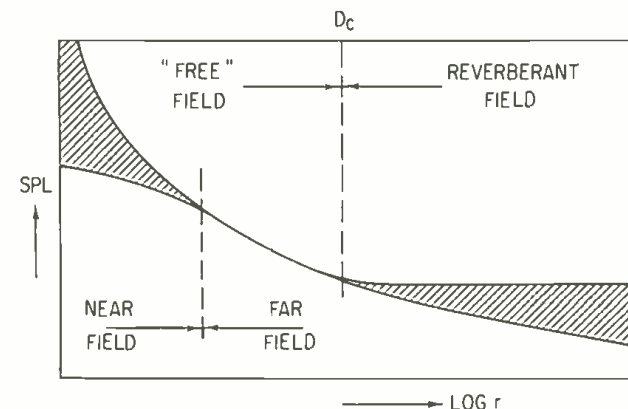

Q, as discussed earlier, is essentially the divisor of the spherical surface area covered by the speaker in question. For example, a Q of 2 (Q=2) means that the *total spherical surface* is divided by 2. Q=5 would be total spherical surface divided by 5. The exact definition of each in terms of the other is:

$$D_1 = 10 \log_{10} Q;$$

$$Q = \text{anti log}_{10} \frac{D_1}{10}$$

Unfortunately, few manufacturers specify the Q of their professional speakers.

### ACOUSTIC vs PHYSICAL DISTANCE

It can quickly be seen that sitting at the same *acoustic* distance from the standard speaker in each of these two studios requires a quite different *physical* distance. It is further evident that any effort at standardization would require a knowledge and specification of the desired *acoustic* listening distance.

### ADVANTAGES OF DIFFERENT LISTENING DISTANCES

If the listener is placed at D<sub>c</sub> or at acoustic distances less than D<sub>c</sub> it is possible for him to hear both the direct *and* reverberant sound of the original recording site's ratio of direct-to-reverberant sound that appeared at the recording microphone. Working in his own room's relatively stable reverberant field (beyond D<sub>c</sub>) does allow a wide area to be made amplitude stable but at the sacrifice of not hearing the reverberant field of the original recording site. Very accurate judgments can be made about microphone placement, for example, when the listening room's own reverberant field is not a dominating factor in what you hear. In sound reinforcement work the audience should always be beyond the D<sub>c</sub> for the auditorium.

It would seem that one of the major reasons it has been felt to be impossible to standardize monitor speaker systems in the past stems from the failure to include *all* the necessary controls: 1. Control the amplitude of the monitor speaker system. 2. Control the listener's *acoustic* distance from the monitor speaker system. 3. Control the directivity factor of the monitor speaker system with as high a Q value as possible.

If these three factors are standardized it is felt that repeatable monitoring conditions can be said to exist even in widely varying studio environmental conditions. ■

**Very accurate judgments can be made about microphone placement when the listening room's own reverberant field is not a dominating factor in what you hear.**

JACK MARROW

# Up Goes the Console

*Here are the adventures of placing a pre-built Audio Designs console six floors up in a New York skyscraper. It's told in an exclusive interview with John Eargle, chief engineer of Mercury Recording Productions*

**W**HEN constructing a new studio facility, or rebuilding an old one, a lot of thought must go into providing for a console that meets all the requirements of the studio. Since the modern multi-track console is hardly an inexpensive, easily replaceable device, some care must be devoted to specifying — and then realizing — the console that fits the particular needs of your studio. A brief look at the ads will show a variety of manufacturers ready to supply the modern studio with the console best suited for its purpose. Or, the studio may decide to go the route of a custom-designed and studio-assembled console.

Mercury Recording Productions' New York City facility has recently completed the installation of a new Audio Designs twenty-four-input — sixteen-output console. The photographs show what was involved in raising this factory-finished console from its delivery in the lobby of the building containing Mercury, to their studio six floors up.

We met with John Eargle, chief engineer of Mercury and discussed with him the reasons that led to the purchase of this particular console. Our first question was directed to find out just what had made him choose a modular console rather than a home-made one.

"Well, there were really two reasons. First: although the home-made console is certainly attractive in theory, it can be prohibitively expensive. Second: after

analyzing our needs, and comparing them with the stock equipment available, there didn't seem to be much point in going into a custom installation.

"Of course, referring to this console as a stock item is really stretching the ready-made concept a bit much. The only thing off-the-shelf about it is the fact that each of the modules is a catalog item. Beyond that, the layout, the number and type of modules used, does not necessarily conform to any other Audio Designs board. The console we ended up with is a collection of Audio Designs hardware assembled according to our particular needs."

*It would seem that you have managed to combine the advantages of both approaches to console design.*

"I think so, you know, once the minimum technical requirements have been met, the ideal console is really quite a subjective thing. Each studio has its own personality, and the engineers their own distinctive style. Console manufacturers seem to appreciate this, and so we have available a variety of modular designs which can be combined for the users' convenience."

The console was designed with a full sixteen-track output. We asked, *Do you think there is any technical point to recording on sixteen tracks at the same time?*

"Usually no. The sixteen-track concept is, of course, a valuable tool. But the flexibility it permits presupposes that the recording will be done in layers.

***The Audio Designs console delivered into the lobby by the movers that brought it as is from the factory in Detroit. Mercury chief engineer John Eargle inspects the console to check its survival from the long trip.***





*With blankets added the console is upended and brought to the elevator shaft where it is again placed horizontally.*



*Cables and other rigging are attached from the bottom of the elevator to the console. Slowly the elevator starts to rise, pulling almost nine feet and one ton of electronic gear slowly into the elevator shaft.*

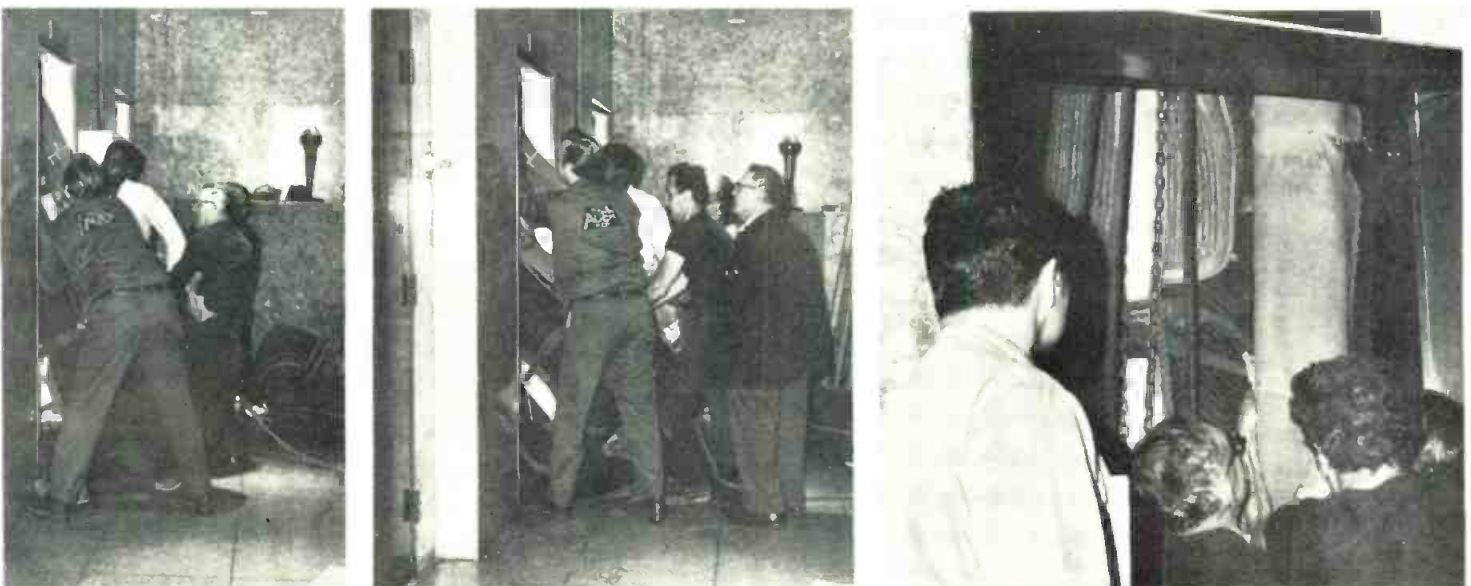



**Arrival on the sixth floor (the elevator holding the console is actually higher) and out it gently comes.**

For example, the typical contemporary rock group will consist of three to six players. Basic tracks will be recorded on the first four to six tracks, leaving the rest for additional sel-sync work. On the other hand, a large studio orchestra or big band is probably best served by a typical two-track stereo pickup. To record all sixteen tracks at once usually indicates that the equipment is running the engineer, rather than the other way around."

*But this console was designed for full sixteen-track output capability.*

"That's correct. We considered an eight-track output console, but didn't feel that there would be a significant saving. Remember, that the console must be able to monitor and remix a sixteen-track tape, regardless of how few tracks may be recorded at one time. And one must be able to record on any track or tracks of a sixteen-track tape. If you only have eight outputs you need additional switching so that these outputs may be routed to any tape input. We felt it was well worth the slight additional cost to have the instant record capability the full sixteen-track console offers."

The console is equipped with sixteen slide faders so that the producer may monitor-mix the program during the recording session. We therefore asked, *Does this present any problems?*

"It can indeed be confusing if the producer continually makes monitor changes that affect the engineer's evaluation of what is being recorded at the moment. However, it is also a valuable tool since it permits an instant mix-down during the session. And this mix-down may be recorded on an auxiliary machine so that a finished two-track tape is immediately available after the session."

**The control room door was much too small, so out came a double window into which the console just fit. Pushing and heaving gets it through and into position in the room.**

*In practice, do you use the console for tape mastering?*

"Yes, we do. Many of its features make it particularly attractive for mix-down work. For example, the rhythm tracks may be balanced on the recording side of the console, and then assigned to two of the monitor faders. Likewise the sweetening. Then, once internal balances are established, the mixer need only concern himself with a few sub-master faders on the monitor section, rather than trying to manipulate all sixteen tracks individually.

Audio Designs offers a unique push-button switching system known as Audex. Our last question concerned the echo facilities of the new Mercury console.

"The Audex switching system provides four echo-send lines. In addition we have master echo send level controls plus the individual send pots associated with each fader. That's a convenience that some other consoles seem to omit. And for even greater flexibility, we can bring the echo returns up on unused mixers, which may allow increased control both during recording, and later on in tape mastering."

In summing up, John told us that this method of buying a console permitted an active studio to lose only four working days before being returned to operation with the new equipment. This was accomplished even though the console was hard wired into place. But the wires were already waiting, the monitor speakers and rest of the control room were in, and only needed connection and could be immediately performance checked. It is impressive to contemplate the coordination of effort by both Mercury and Audio Designs that brought this all about.







*Now happily installed and busy, the Audio Designs console dominates the control room of Mercury's Studio A.*

# NOW! A NEW SOLID STATE LA-2A (THE LA-3A)



**new half-rack size (3½" high) \* lower noise \* new low price (under \$400.00)**

## THE NEW TELETRONIX LA-3A LEVELING AMPLIFIER

The LA-3A is all new! The only thing left untouched was the exceptional performance characteristics of the LA-2A. The electro-optical attenuator, that made the LA-2A so popular, remains the same, but that is where it ends. Improvements in overload characteristics, and signal-to-noise ratio add to its performance. We've squeezed its size. Two LA-3A's can now be mounted side by side in only 3½" of rack space. The all solid state LA-3A has more output power (+25dBm, vs. +18dBm in the LA-2A). The new contemporary styling will look great with your existing equipment. Send for complete technical details today!

# Urei

11922 Valerio Street, No. Hollywood,  
California 91605 (213) 764-1500

Exclusive export agent:  
GOTHAM AUDIO DEVELOPMENT  
CORP., NEW YORK, N.Y.

Circle 28 on Reader Service Card

www.americanradiohistory.com

# Three Views of the Teldec Disc

The Video Disc/MARTIN DICKSTEIN

## The Audio/Visual Impact of Teldec

THE time is rapidly approaching when it will be possible for someone to buy the morning paper, read about yesterday's football or baseball game, and then tear out a small flexible disc and replay some of the most vital plays of the game through the old tv set.

The latest entrant to the home-tv-player field is Telefunken/British Decca with their video disc. It was presented first in Germany in June of this year, and then for the first time in this country in October, in a demonstration sponsored by London Records. Teldec, the company whose name comes from its joint owners, is the organization which developed the theory and engineered the disc and playback unit (as well as the recording technique and equipment, of course) involved in the reproduction of video and audio signals from a rotating disc. The first attempt to produce pictures from a spinning record was made back in 1927 when the British inventor Baird recorded a 30-line transmission by the BBC on a 78-rpm record. With a bandwidth of 5 kHz, he satisfactorily reproduced 30-frames per second, but this is short of the resolution required for today's tv images. The disc method, therefore, was soon discarded, and it was not until about 5 years ago that the system was again picked up for further development. The result was the production of the *dense storage disc*, the system with the highest storage density ever attained.

Just as it was necessary with tape to develop a much greater relative speed of traverse between the medium and the recording or playback head (note the speed of the rapidly rotating head in video tape machines), so it is also required of the record that the speed of travel be higher than for audio to reproduce video information. The speed of rotation of the video disc is 1,500 rpm at 50 Hz (in Europe) and 1,800 rpm at the normal 60 Hz

in this country. To accomplish this, it is not possible to use a turntable of the standard record player. The method devised consists of having three holes around the center of the disc into which three pins fit when the record is placed on the player unit. The three pins, driven by a small synchronous motor, rotate the disc at the required speed. The rotation of the disc creates a thin layer of air under it which keeps the underside of the record from touching the player unit during operation, keeps the vertical flutter of the disc below 0.05mm, and provides a small upward pressure on the record which permits the pickup system to operate as it does.

Contrary to the pickup method used in audio where the cartridge actually rides in the grooves of the record, the pickup unit in this system rides freely on an arm (of 2 parallel bars) which is suspended out over the disc toward the center. The reproducer is driven toward the center of the record by a reduction gearbox which is itself connected to the disc-driving motor. The stylus is thus moved a distance of 0.008 mm (the width of each groove) during one revolution of the record. The record, suspended on the thin layer of air below it, is actually raised toward the stylus which picks up the pressure variations of the hill-and-dale impressions recorded at the bottom of the disc groove and translates this information to electrical signals in accordance with the video images to be reproduced. As the system is presently assembled, the transducer is returned to its starting position at the end of the playback by a string (or thin wire). This is to be improved, according to the engineers, in the models which will be ready for the market in 1972, the year in which it is presently anticipated the unit will be available to the public. The disc, as a means of reproducing video information, has several advantages over the other methods. It provides the quickest way of recuing in order to replay any previous

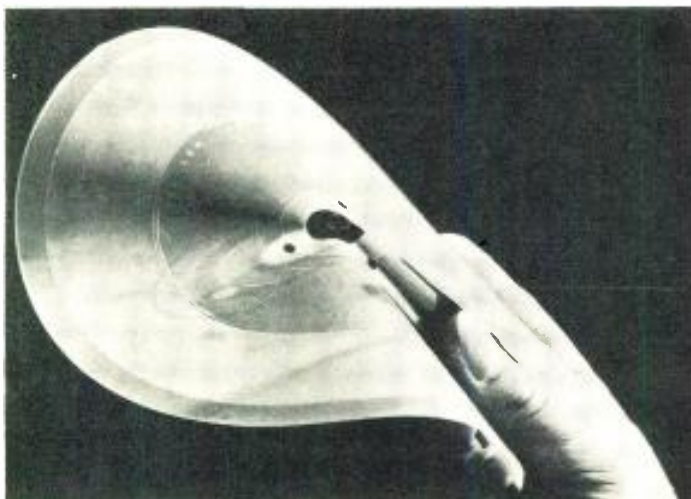

Figure 1. The virtually indestructible p.v.c. foil disc used in the video disc process invented by Teldec.

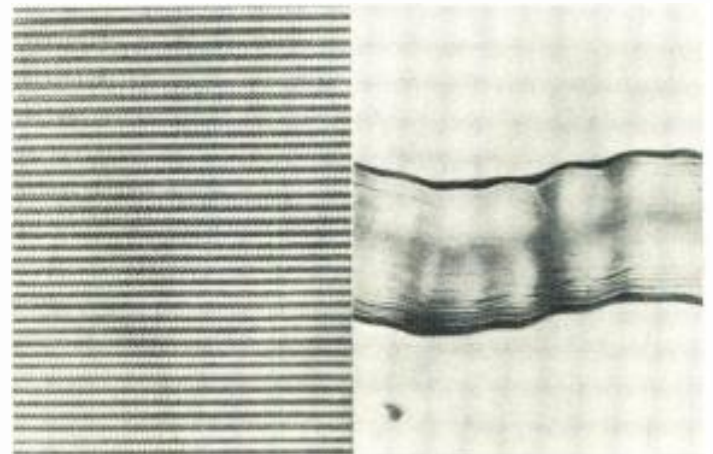

Figure 2. This microphotograph compares the relative densities of the video grooves (on the left) with those on a standard lateral audio lp. The video disc is vertically modulated and contains both video and audio information.

## Recording the Teldec Disc

THOSE of us at the Disc Recording session at this past October's AES convention saw an amazing demonstration of a high-quality television image which was mechanically cut and played back by a mechanical transducer. The first technical exposition and demonstration in the U.S.A. of the Teldec Video Disc was the highlight of the convention. It is a resounding affirmation to those who see a bright future for the disc recording art.

Currently there are four major systems, in addition to the video disc, competing for the home, advertising, and educational video market. Columbia Broadcasting System has developed its EVR system, RCA has Selectavision, there is 8-mm film, and video tape. The outstanding advantages of the video disc over these systems are its low cost, ease of mass production, ease of handling and storage, random access, short sequence repeat facilities, and simple reliable playback mechanism. The advantages of the disc in the video playback field are analogous to its advantages in the audio playback field. The implications of this revolutionary device to those in the disc recording and disc manufacturing fields are enormous.

How does the system work? Video information is mechanically stored on a disc. On playback the video signal is fed to the terminals of a standard home television receiver; the sound and image then appear in the usual way. The amazing part of this system is the storage of video information on a disc in mechanical form, and its subsequent playback from the disc. Extrapolating from present disc recording/playback technology, it seems impossible to extend the bandwidth from the present 0.015 MHz (15,000 Hz) required for audio to the 3.0 MHz (3,000,000 Hz) required for video.

Disc recording technology in use today is based on the inventions of Edison and Berliner of almost 90 years ago. There have been enormous improvements and advances, but the basic method of recording and playback has not changed. The inventors of the video disc have succeeded in developing an entirely new concept which more fully utilizes the information storage capacity of the disc. This brilliant engineering effort at Teldec was headed by Horst Redlich, Hans-Joachim Klemp, Gehard Dickopp, and Eduard Schüller.

Viewing the disc as an information storage device, just what were the problems confronting the Teldec engineers in developing the video disc? The bandwidth must be extended to 3.0 MHz while maintaining a reasonably long playing time. If we started out by using the current audio disc as a basis we would have to extend the bandwidth by a factor of 200:1. Since bandwidth is proportional to the linear groove velocity, an increase in disc rotation by a factor of 200 would get us the required bandwidth. This means recording at 6,600 rpm, and, all other things being equal, the playing time

would be reduced by a factor of 200:1 to an unacceptable 6 seconds. Noise also becomes a serious problem when using this brute-force solution. The noise in any system is proportional to the bandwidth, so that each time we increase the upper frequency limit by 0.02 MHz we can expect a decrease in signal-to-noise ratio of 3 dB. There is no doubt that if the classical method of audio disc recording were used, a practical video disc would be all but impossible.

Teldec engineers solved the bandwidth problem by increasing the rotational speed and decreasing the minimum wavelength. Rotational speed was increased to 1,500 rpm, increasing bandwidth by a factor of 45:1. Minimum wavelength was decreased from  $0.6 \times 10^{-3}$  inch (audio disc) to  $0.08 \times 10^{-3}$  inch. Playback of these extremely short wavelengths is one of the really basic problems of the video disc, and involves one of the most ingenious inventions of this new system. This aspect of the video disc will be discussed in next month's Feedback Loop. The upper frequency limit of the video system can be extrapolated from present audio disc by this simple formula.

$$\text{Video disc upper frequency} = \frac{N_{VD}}{N_{AD}} \times \frac{\lambda_{AD}}{\lambda_{VD}} \times .015 \text{ MHz}$$
$$\left( \frac{1500}{33.3} \right) \left( \frac{.6 \times 10^{-3}}{.08 \times 10^{-3}} \right) (.015) > 3.0 \text{ MHz}$$

N = Rotational speed

$\lambda$  = Wavelength

VD = Video disc

AD = Audio disc

With the bandwidth increased to 3.0 MHz, how can the playing time be maintained at a reasonable length with a rotational speed of 1,500 rpm? The pitch, spacing between adjacent grooves, was reduced from the present 0.004 inch to a very fine 0.000275 inch. To accommodate the fine pitch the maximum amplitude was reduced from the present audio disc standard recording level of  $0.31 \times 10^{-3}$  inch (this corresponds to a velocity of 5.0 cm/sec. at 1,000 Hz) to  $0.04 \times 10^{-3}$  inch, a decrease of 18 dB. The normal signal-to-noise ratio of a vinyl audio disc is approximately 60 dB, so that groove irregularities are of the order of  $0.31 \times 10^{-6}$  inch.

Teldec studies conducted with an electronic raster microscope found the surface roughness of the groove to be of the order of 100 Angstrom units or  $0.4 \times 10^{-6}$  inch, and is in close agreement with the 60 dB signal-to-noise ratio assumed above. Video disc modulation amplitude is therefore about 100 times greater than groove noise. It should be noted that vertical modulation is used in this system.

We had previously remarked that the signal-to-noise ratio decreases as the bandwidth increases, and with a bandwidth of 3.0 MHz the problem looms large. One of the most significant innovations of the video disc is the

**DICKSTEIN, continued**

material on the disc. This permits any portion of the program to be repeated at will. (This feature is similar to the instant replay used in sports events on tv.)

The video disc also has stop-frame action. Each groove carries two frames in the one revolution. Thus, by stopping the movement of the reproducer, the same groove is repeated as long as desired. This does not damage the disc as the stylus rides back over the ridge between two grooves because the stylus is not actually pressing on the record. (The disc can be played over 1,000 times without signal deterioration.)

The disc, because of the material from which it is made, is relatively indestructible and can be stamped (not pressed) out at a rate equal to 1,000 times the playing time. The video disc, which is only 1 mm thick, has grooves only on one side and is not cut all the way

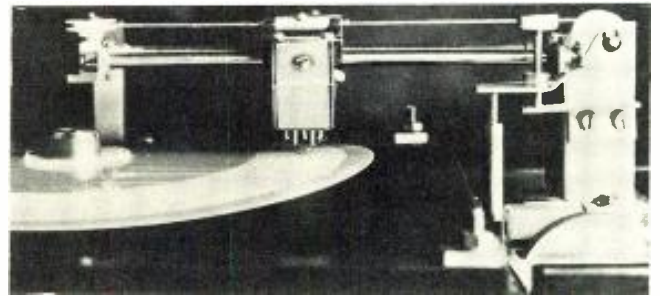

**Figure 3. The pickup arm and stylus of the video disc playback unit. Note the slight curvature of the disc as it rides on its cushion of air.**

in toward the center as are audio records. A 7-inch disc will contain about 5 minutes of program material while a 12-inch disc will hold up to about 15 minutes. (It is

**Table 1. Comparison Charts for Video Player Equipment**

MEDIUM MANUFACTURER CHARACTERISTIC	Video Tape (Ampex, Sony, Avco, Panasonic)	EVR (CBS)	Selectavision (RCA)	8mm Film (ABC, Sylvania)	Video Disc (Teldec)
Resolution & Bandwidth	Approx. 300 lines b & w Approx. 250 lines color (3.0 mHz.—4.5 mHz.)	500 b&w 300+ color 4mHz	250-300 Lines 3mHz	Approx. 250 lines 3 mHz	250 lines 3 mHz
Signal/Noise Ratio	40+ dB	40+ dB	40+ dB	40+ dB	40+ dB
Type of Sound	Magnetic heads separate from video	Sep. Mag. C.-1 Tr. b&w-2 Tr.	Separate head prob. embossed	Separate head prob. magnetic	Combined in same groove with video
Video Transducer	2 (or 3) mag. heads	Flying Spot Scanner	Laser and vidicon	Flying spot scanner (opt. col. dec.)	Ceramic pressure pickup
Speed of Medium	3.15 to 7.5 in./sec.	6 in./sec. (60 frames/sec.	7.5 in./sec. (?)	3 in./sec.	1800 rpm
Max. Play Time of cartridge (Disc)	30, 60, 90 min.	Color- 25 min. b&w-50 min.	30+ min.	Approx. 30 min.	7"—5 Min. 12"—15 Min.
Est. Cost/Hour of Material	\$12.50—\$26.00	C.-\$37.50 b&w- \$25.00	Color—\$5.00	ABC—\$12.00 Sylvania—\$60.00	App. \$5.95 for 15 min. (norm. lp cost)
Play Time vs. Copying Time	less than 50 times	less than 50 times	less than 50 times	less than 50 times	more than 1000 times
Est. Reproducer Cost	Ranges \$400-\$1000. (Up to \$1500 incl. TV recr.)	Indust. \$795 Cons. \$300	\$400	\$500+	\$150-\$350
First Market	Education, industry, and/or consumer	Education, Industry.	Consumer	ABC—Bdcast. Sylvania—(?)	Consumer
Planned Intro. Date	Most in 1971	1970-71	1971-72	ABC bdcst. now on market. consumer—(?)	1972
Special Comments	Some systems provide record facilities. Slow & stop action avail.	Playback Only	Holographic images. playback only	ABC & Syl. have different syst. ABC uses optic. encoding & de- coding. Syl. building unit into TV. Syl. marketing date not avail.	Uses disc playback only. Stop-action and quick replay. Cost to be \$2.75 in lots of 1,000

expected that by the time the units are available for sale, a changer will also be marketed and a 2-hour program will go on a stack of discs about 0.25-inches thick.)

The p.v.c. foil disc will be relatively inexpensive. With the record player unit estimated to be between \$150.00 and \$350.00 when mass produced, depending on whether the unit will be color (which will also be available in 1972) or black and white, this method of video reproduction is actually expected to outsell other devices in the field. At least it should hold its own as well as is the case with present audio records in relation to tape recorders.

In other methods of video reproduction, the audio signal has to be put on the medium and recovered from it by a completely separate audio system. In the magnetic tape system it takes a separate head. In the film systems, there is a separate reading unit. However, in the disc method, the audio is recorded by "pulse-position modulation" during the blanking interval between frames. This allows the audio to be recorded and retrieved by the same stylus as is used for video. (It might be interesting to note that in the first video disc, in 1927, the audio had to be recorded on a completely separate record from the video one.)

In comparison with present audio records, this video disc method of recording and reproducing information, if used *only* for audio, would be capable of reproducing up to about 70,000 or 80,000 Hz. Its possibilities also lie in the application of multi-channel audio use for the home.



Figure 4. The four Berlin engineers who developed the video system. They are: (left to right) Dr. Gerhard Dickopp (AEG-Telefunken), Hans-Joachim Klomp and Horst Redlich (both Teldec), and Eduard Schüller (AEG-Telefunken).

One area in which the new disc lags behind other methods of video reproduction for the consumer is in the *recording* of home-made program material. This is comparable, however, to the audio record field where the consumer buys only previously prepared sound information. It is expected, however, that at about the time the video disc is out on the market, there will also be available, for organizational use, a disc recorder unit for making multiple copies of original material.

A comparison of the home video systems presently in the works appears in *Table 1*. While some methods may have greater application at present in industry or education, they will all eventually be available for home use. It will be a simple matter of paying your money and taking your choice, making two connections to the antenna terminals, and sitting back in front of the old boob-toob with a choice of off-the-air or home-playback program material. Maybe not this holiday season, but for sure by the next year or so. In the meantime, have a Happy New Audio-Visual Year. ■

## SCHWARTZ, *continued*

use of *frequency modulation*. By maintaining a constant signal amplitude and encoding the information as a frequency variation full utilization of the 100:1 ratio of signal amplitude to noise is realized. A corollary of constant signal amplitude is that minimum pitch can be used so that maximum utilization of the record surface achieved. Redlich stated, "This [frequency modulation] enabled us to cut all frequencies at the same amplitude, and thus pack the grooves so closely together that it is virtually possible to dispense with an area between them."

Not much information was disclosed about recording techniques. Redlich stated, "It is obvious that special techniques had to be developed in order to make recordings of such fineness possible. Thus it was only by means of an intensive study of the cutting process that we were able to develop suitable recording equipment."

Some general observations can be made about the recording equipment. The video disc amplitude is 18-dB down from the audio disc standard recording level, while the audio cutter must have a capability of the order of +30 dB. Therefore, at any given frequency the power handling requirements of the video cutter will be of the order of 48 dB less than that of the audio cutter. Because of the use of frequency modulation, the video cutter percentage bandwidth will not be as great as the

audio cutter: the latter must now cover a range of frequencies of 500:1. It is extremely difficult to have a mechanical device vibrate in the megacycle region at any appreciable amplitude. At the given amplitude of  $0.04 \times 10^{-3}$  inch, the cutter velocity at 3.0 mHz would be 1900cm./sec.—and the acceleration would be  $36 \times 10^{-6}$  g. To avoid these difficulties, recording is done at a fraction of the real speed. Thus the cutter upper frequency limit is reduced, maximum velocities and accelerations are reduced, but recording time is increased proportionally. (*continued next month*) ■

Figure 5. One of the prototype players is shown with the ease at which it is put in operation.



# The Short-Short tv Disc

*The video disc and other audio/visual media have vast implications for the audio professional. Here is one astute observer's view of the Teldec disc and its place in the future.*

FORTUNATELY, what I have to say about the Teldec tv disc is supplemented in this issue by adequate technical exposition of the system, so I do not have to stick my neck out. My function, once again, is to evaluate an unusual breakthrough at the crucial interface between hardware and software, technology and distribution, engineering and sales. Where will *this* one fit in? Perhaps it is madness, at this early stage. But I will take the risk and hope to be cut down gently if I am wrong.

I have now seen with my own eyes two of the three major video recording systems that will challenge the familiar magnetic concept in the coming changeover to packaged recorded tv, I found each of these experiences exciting, even moving. Not only because these systems *work*, via principles entirely new in the tv area in a practical sense. But because both offer an overwhelming wealth of creative accomplishment and, even more, because in these early embodiments I was obviously viewing a large slice of our future right in front of me. I think back to 1927 when as a child I saw the first *Vitaphone* talking picture—a brief glimpse of Fritz Kreisler playing Dvorak's *Humoresque*. (It was the first in our town, in any case, not in a theatre but at an industrial exposition.) Columbia's EVR and Teldec's video disc, plus RCA's SelectaVision and others to come, should between them have an equivalent impact on life, education, and the pursuit of happiness.

Few of us realize as yet how immense is the present challenge to existing forms of television. There are those who think that tv *broadcasting* will soon vanish from the scene, swallowed up by the twin forces of cable tv and packaged video. Indeed, there is already a certain sense of panic in the television industry. It extends into every area—for the progress of these new giants of electronic communication will move them from one field to the next, from tv training in industry, in the services, in the vast field of public education (now much involved in magnetic tape video), onwards into the still youthful educational tv broadcasting or public tv. And so, inevitably, into the larger field of commercial and/or entertainment television. One after another, they will fall, or they will change their stripes to line up with the new powers. It is an exciting, also a frightening prospect, especially for those who are directly involved.

Against that background, we must look at the rival new systems with more than technical interest. There isn't the slightest doubt that there will be a new battle

of battles between them, to outmatch the well-remembered Battle of the Speeds of the early 1950s. There isn't too much doubt, I'd suggest that the outcome will also be similar. That is, no one system will win hands down, assigning the others to corporate and technical oblivion. Instead, there will be a drastic shifting about, each system claiming all (as usual), each system, moreover, *trying for* everything in concrete terms; yet in the end, each of the rivals will find its special place, according to its individual merits and weaknesses.

One never knows, even afterwards, whether that place was actually foreseen ahead of time by the promoters, behind the smokescreens of all-out propaganda! It all depends. Did RCA *really* think the 45-rpm disc would take over the classical field from the LP, already launched by CBS? Or was that canny corporate eye already fastened on pop and the juke box? No matter. What matters is what happened. (Even the original RCA tape cartridge, 'way back, found a small place—it is still used in educational work. And its four-track principle became universal in home stereo tape.)

So it will be in the future. The precise features of each of the new video systems are those which already fit it for its future place *viz a viz* the others. And so, given the ineffable gift of putting 2 plus 2 together, we have the future in our hands, don't we?

To begin with, the Teldec disc is much more than a tv disc. That is merely its first and present embodiment. Teldec or some other disc, a first cousin, will surely be the successor to our present audio product, offering wide solutions to most of the problems that now have the lp/45 combination boxed in for what must surely be a last stand. The audio field is shaken, too, by the Teldec disc. It can do just about everything, as far as we can see now. Let me sum it up, for emphasis, in my own words. Not so much as tv but simply as a disc storage-playback system.

To what extent will such a disc bridge the two recording fields: audio and video? Or the opposite, will we see a clean break between audio-only discs and those which include picture material? Ah—who knows! My feeling is that there could very well be one species, with variants (and perhaps a standard groove-speed parameter) to cover strictly audio uses and another, based on the present disc, to cover the audio-video combination in all its forms, since video information requires so much larger a bandwidth than audio. But a general principle must be kept in mind: in the coming years, recording of audio and video information together will be increasingly the norm. New technology, like Teldec, like SelectaVision, like EVR, like Sony, like Cartrac, will make it ever more practical, until people begin to take the combination for granted as the norm. The au-

**To begin with, the Teldec disc is much more than a tv disc.**

---

dio disc will *not* disappear since it still has much usefulness, notably in music. It will find a new place, hopefully at an economically viable price. Could be. Should be.

Look, then, at the video discs in their present configuration—putting aside other arrangements that are merely probable at this point. Where will the Teldec tv disc fit in? And where does EVR go? How about Sony, Ampex, and other magnetic systems (hopefully to be mutually compatible—they'd better be). What of RCA's more distant SelectaVision, the most revolutionary of all? (That's the one based on hologram imagery and laser techniques.)

First, the Teldec disc abounds in the traditional disc attributes of simplicity, convenience, ease of operation and—most of all—low cost. Teldec has released figures—you can take them or leave them. The argument is believable. Low production costs for the disc, particularly in the pressing. *High production speed*, which amounts to the same thing. That 1000 to 1 quoted elsewhere in this issue figure is impressive. Almost like a newspaper. It was cheapness and speed of duplication that ushered in the age of print many hundreds of years ago, and the same for the disc record in all its forms in recent years. In our day, complexity and slowness of duplication has held back magnetic tape video in crucial respects as a mass medium.

The Teldec players are, relatively speaking, of extreme simplicity. Forget about actual costs, though Teldec projects a price somewhere between a sixth and a third the price of EVR's player. That could become an even larger disparity in view of the simple Teldec configuration—no flying spots, no scanning, no vidicon and laser, no separate sound recording. Circuitry aside, the Teldec reproducer is, as I see it, less complicated than an ordinary microgroove disc changer and only slightly more involved than the simplest manual player, decoding circuitry aside.

With duplication speed roughly twenty times as fast as the other competing systems—give or take quite a bit in the long run—and *material* costs of information storage from one tenth to a twentieth that of all but RCA's laser system (Teldec says one half of *that* system) the set-up begins to take shape. This is obviously a mass-production formula, more so than any other system so far devised and by a very long shot. Juggle the parameters as you wish, it comes out that way.

Next—*quality*. Considering the above, we must note that the Teldec tv disc is 100-percent o.k.—by which I mean that it easily matches anything we can produce on present tv as far as the public viewer is concerned—sharp, clear, no ghosts, no distortion, no snow, etc. Specifically, this disc offers about the same parameters of quality as to the other major systems. 250 horizontal lines, a bandwidth of 3 MHz. Narrow (super-8) film,

magnetic video tape in the "home" configuration, SelectaVision, all will offer comparable specs. EVR is better. It offers more than we need at present—300 lines, 4 MHz. I have seen both, and EVR in color (from black and white coding). EVR is astonishingly good as a picture. The newer Teldec, black and white only at the moment (color is definitely promised for production units), is also excellent, entirely adequate for any public comparison with tv on the present home screen. No compromise will be apparent to the individual viewer. So this is not "cheap" television. It is, we may say, up to standard.

And that in spite of what might seem the shaky basis of a tiny disc groove, high-speed micro-tracked. The first U.S. demonstration at the AES convention occasioned some laughs—the picture skipped and jumped, the sound went *bzzzzz*. It wasn't the groove, I found out later. It was the problem of 50-Hz equipment in a 60-Hz area. The second and major demonstration a week later was vastly better. Not a trace of skip, good sound, bright, steady pictures. A *stable* system, disc or no disc. (They got hold of a huge 50-cycle generator, I was told.)

So far so good. Cheap, mass-producible. A good picture, no quality compromise of importance. Easy to use, to buy, to play, to store. Which brings us back to the most important over-all quality of Teldec disc, storage capacity. Note this from a Teldec chart: Information density on an audio disc: 5000 bits per square millimeter. That's quite a lot. Audio tape: only 1000 bits per mm (Teldec's figure). Videotape has done a lot better through ingenious recording: 10,000 per mm<sup>2</sup>. But photographic film (EVR uses it) goes 'way beyond tape at 50,000 bits per mm<sup>2</sup>. Via fine-grain photographic emulsion plus comparably fine electron-beam recording, we cram ten times as much information into a square millimeter of EVR recording space as is currently possible on audio disc. And fifty times as much as on audio tape. Variable figures, I am sure, but the idea is right.

Teldec video disc? No less than *500,000 bits per mm<sup>2</sup>*. One hundred times the lp figure, as already quoted.

No doubt there will be many qualifications and corrects and emendations to these figures, and plenty of impinging circumstances. The basic picture must nevertheless be taken seriously. This is an *economical* disc in every possible sense, and yet it is not a compromise: it can compete in quality.

Two major factors are left, which, after all of this, will determine the Teldec place in tv. They may seem superficial. I do not think so. (1) Still-frame ability. Pause, hold, freeze. (2) Playing time.

Teldec makes much fuss over the fact that one can hold back the carrier cartridge with a simple button, forcing the stylus to skip grooves, though without harm. The picture repeats. They demonstrated. I was not impressed.

The freeze action and its variants make a vital part of coming tv usefulness in the play-it-yourself area. EVR has made it central to its whole concept. Via EVR, still pictures and movies are equally possible, without compromise. You can remain on one frame indefinitely; you may move slowly from frame to frame by hand, in actual motion. (continued next month.)

---

**That 1000: 1 figure is impressive. Almost like a newspaper.**

# BOOK CASE

As a service to our readers we are pleased to offer these books from prominent technical publishers. All prices listed are the publishers' net. Shipping charges are included.

Use the coupon at the bottom of the page or give the complete title, author and coupon number. Be sure to indicate quantity on the special instructions line if more than one copy of a title is wanted. Full payment must accompany your order. We cannot ship c.o.d. Checks or money orders should be made payable to Sagamore Publishing Company, Inc. Because of the time required to process orders, allow several weeks for the receipt of books.

## Radio Broadcasting

*edited by Robert L. Hilliard.* Each of the five chapters has been written by a prominent educator with an extensive background of practical experience in commercial and educational broadcasting. 190 pages; 6 1/4 x 9 1/2; indexed; clothbound. **\$6.95**

**Circle 2 on Coupon Below**

## Radio Transmitters

*Gray and Graham.* Provides, in a logical, easy-to-understand manner, a working knowledge of radio transmitters for quick solution of problems in operation and maintenance.

1961. 462 pp. **\$16.00**

**Circle 40 on Coupon Below**

## Electronic and Radio Engineering, 4th Ed.

*Terman.* A thorough coverage, in easy-to-understand terms, of those principles and techniques which are the basic tools of the electronic and radio engineer. 1955. 1,078 pp.

**\$19.50**

**Circle 39 on Coupon Below**

## Radio Engineering Handbook, 5th Ed.

*Henney.* Prepared by a staff of specialists, this working manual of radio science provides information on each of the branches of radio engineering, with emphasis on working practice, final working formulas, dimensions, and actual useable circuits.

1959. 1,800 pp. **\$31.50**

**Circle 36 on Coupon Below**

## The Technique of the Sound Studio

*by Alec Nisbett.* This, is a handbook on radio and recording techniques, but the principles described are equally applicable to film and television sound. 264 pages; 60 diagrams; glossary; indexed; 5 1/2 x 8 1/2; clothbound. **\$13.50**

**Circle 1 on Coupon Below**

## Passive Audio Network Design

*by Howard M. Tremaine.* A complete and comprehensive guide to the design, construction, and testing of all types of attenuators, equalizers, and wave filters for the practicing audio technician or engineer. 288 pages; 5 1/2 x 8 1/2; softbound. **\$5.50**

**Circle 5 on Coupon Below**

## Transistors for Audio Frequency (Audio-Frequency Amplification)

*by Guy Fontaine.* 1967. This systematic and detailed treatment of the application of transistors in audio-frequency amplifiers shows how the published transistor characteristics are related to the principles of design. An ideal textbook or reference on the subject for engineers and advanced technicians. 384 pages; 5 1/2 x 8; illus.; clothbound. **\$7.95**

**Circle 12 on Coupon Below**

## Closed-Circuit Television Handbook

*by Leon Wortman.* Gives comprehensive detailed information about the field in an easy-to-understand presentation, suited to those who plan to use, install, and service cctv. 288 pages; 5 1/2 x 8 1/2; clothbound. **\$5.95**

**Circle 18 on Coupon Below**

## An Alphabetical Guide to Motion Picture, Television, and Videotape Production

*Levitan.* This all-inclusive, authoritative, and profusely illustrated encyclopedia is a practical source of information about techniques of all kinds used for making and processing film and TV presentations. Gives full technical information on materials and equipment, processes and techniques, lighting, color balance, special effects, animation procedures, lenses and filters, high-speed photography, and much more. 1970. 480 pp. **\$24.50**

**Circle 35 on Coupon Below**

## NEW EDITION

## Integrated Circuits

*Motorola.* This complete, authoritative volume of design and construction techniques for modern integrated circuits covers theory, thin-film techniques, diodes, transistors, thermal design, and other vital aspects.

1965. 373 pp. **\$13.75**

**Circle 30 on Coupon Below**

## Basic Bibliography of Science and Technology

*McGraw-Hill.* Important to the researcher, librarian, or student, this reference book lists and describes over 8,000 outstanding books in every scientific and technical field. A topical index organizes all subject headings into about 100 general categories enabling the reader to locate quickly the listings which pertain to his field of interest.

1966. 738 pp. **\$19.50**

**Circle 34 on Coupon Below**

## Noise Reduction

*Beranek.* Designed for the engineer with no special training in acoustics, this practical text on noise control treats the nature of sound and its measurement, fundamentals of noise control, criteria, and case histories. Covers advanced topics in the field.

1960. 752 pp. **\$19.50**

**Circle 33 on Coupon Below**

## The Audio Cyclopeda (2nd ed.)

*by Dr. Howard M. Tremaine.* New and updated, here is the complete audio reference library in a single volume. It provides the most comprehensive information on every aspect of the audio art. This new edition includes the latest audio developments including the most recent solid-state systems and integrated circuits. It covers all subjects in the fields of acoustics, recording, and reproduction with more than 3400 related topics. Each topic can be instantly located by a unique index and reference system. More than 1600 illustrations and schematics help make complicated topics masterpieces of clarity. 1760 pages; 6 1/2 x 9-3/8; hardbound. **\$29.95**

**Circle 20 on Coupon Below**

## Circuit Design for Audio, AM/FM, and TV

*Texas Instruments.* Texas Instruments Electronics Series. Discusses the latest advances in electronic design and application which represent the results of several years research and development by TI communications applications engineers. Emphasizes time- and cost-saving procedures throughout. 1967. 352 pp. **\$14.50**

**Circle 32 on Coupon Below**

## Acoustics—Room Design and Noise Control

*by Michael Rettinger.* 1968. The enormous problems and hazards presented by noise are dealt within an orderly and practical manner. With many charts, graphs, and practical examples, the text covers the physics of sound, room acoustics, and design, noise and noise reduction. 392 pages; hardbound. **\$17.50**

**Circle 21 on Coupon Below**

### Sagamore Publishing Company, Inc.

980 Old Country Road, Plainview, N. Y. 11803

Please send me the books I have circled below. My full remittance in the amount of \$..... is enclosed. N.Y. State residents add 5% sales tax.

1 2 3 4 5 6 7 8 9 10 11 12 13 14 15 16 17  
18 19 20 21 22 23 24 25 26 27 28 29 30 31 32  
33 34 35 36 37 38 39 40

Name .....

Street Address .....

City ..... State ..... Zip .....

Special Instructions .....

Canada and foreign: Add \$1.00 per book



**Acoustical Tests and Measurements**  
by *Don Davis*. Provide; a solid understanding of the entire subject of acoustical measurements; based on actual field test work, using commercial equipment. 192 pages; 5 1/2 x 8 1/2; hardbound.

Circle 7 on Coupon Below

#### Television Broadcasting

*Chinn*. A practical, compact technical guide to the equipment, systems, facilities, good engineering practices, and operating techniques of television broadcasting. 1953. 695 pp. \$17.00

Circle 37 on Coupon Below

#### Handbook of Electronic Tables & Formulas, (3rd edition)

A one-stop source for all charts, tables, formulas, laws, symbols, and standards used in electronics. Includes an 8-page, full-color fold-out chart showing latest FCC allocations for the entire frequency spectrum. 232 pages; 5 1/2 x 8 1/2; hardbound.

\$5.50

Circle 8 on Coupon Below

#### Handbook of Broadcasting, 4th Ed.

*Abbott and Rider*. This non-technical handbook sets forth clearly and thoroughly the fundamentals of radio and television broadcasting. Over 100 illustrations amplify the text.

1957. 531 pp. \$9.50

Circle 38 on Coupon Below

#### Electronic Musical Instruments

by *Richard H. Dorf*. Now in its third edition and sixth printing since its first appearance in 1954, this is considered the authority on electronic organs. 393 pages; 239 diagrams and photographs.

\$10.00

Circle 19 on Coupon Below

#### Intermodulation and Harmonic Distortion Handbook

by *Howard M. Tremaine*. A complete reference guidebook on audio signal intermodulation and harmonic distortion. 172 pages; 5 1/2 x 8 1/2; softbound.

\$4.25

Circle 9 on Coupon Below

#### Solid-State Electronics

*Hibberd*. A Basic Course for Engineers and Technicians. An extremely practical reference book for anyone who wants to acquire a good but general understanding of semi-conductor principles. Features questions to answer, problems to solve. 1968. 169 pp.

\$9.95

Circle 31 on Coupon Below

#### Practical PA Guidebook: How to Install, Operate and Service Public Address Systems

by *Norman H. Crowhurst*. 1967. This book gives all the basics needed to become a successful PA operator, in any situation where the reinforcement, relay, or distribution of sound can provide a service. 136 pages; 6 x 9; illus.; softbound.

\$4.50

Circle 15 on Coupon Below

## CLASSIFIED

Closing date is the fifteenth of the second month preceding the date of issue.

Send copy to: Classified Ad Dept.

db THE SOUND ENGINEERING MAGAZINE

980 Old Country Road, Plainview, New York 11803

Rates are 50c a word for commercial advertisements. Non-commercial and employment offered or wanted placements are accepted at 25c per word.

### FOR SALE

**STUDIO CLEARANCE SALE:** Crown 714C-L.P./Z Quarter track stereo recorder with adjustable heads for half track stereo playback, 2 V.U. meters, 4 mixed microphone or line inputs, 3 3/4, 7 1/2, incl. 15 ips speeds, 14 inch reel capacity, portable carrying case. Excellent condition \$455.00. Line output transformers available at \$25.00/pair. Ampex MX-10 four input mic./line stereo mixers. Three at \$250.00 each. Fisher KX-10 reverbs at \$30.00 ea. Pultec model EQP-1 Program equalizers. Two for \$550.00, 285.00 ea. Altec 1566A line amplifier/preamp. \$40.00. Presto 92-B recording amplifier with 4 1/2 inch illuminated V.U. meter and Presto 1-D cutterhead \$210.00. Presto 6-N lathe, 45/33 speed, suction tube, lamp, floor cabinet, and two leadscrews \$270.00. Extra leadscrews, hot stylus, and microscope available. Pickering model 410 mono. preamp. on rack panel \$18.00. 5 1/4 inch rack panel with three Simpson 4 1/2 inch rectangular V.U. meters and three controls \$53.00 E.V. 666 dynamic microphone and cable \$89.00. A.K.G.-Norelco D-200 E twoway dynamic with new cable \$44.00. Wiegand Audio Labs. 3402 Windsor Rd., Wall, N.J. 07719 Phone 201-681-6443.

AMPEX 351-8 w S.S. and 300 deck in black and walnut Formica cabinet. Two years old and in mint condition. Available in 90 days for \$7500. Picture on request. Two sets of Switchcraft 3800 series bus selector switches (new) with 1-12 interlocking and 1-4 interlocking for echo send arranged on single chassis two abreast and eight deep. Original cost \$71.40—\$45.00 each. Gotham Grampian 1D feedback cutter head, amp and power supply—\$625.00. McIntosh 5100 preamp/power amp combination. 40W/channel. Cost \$466.96—\$350.00. Fairchild Conax—\$395.00. AKG C-12 microphone. Cost \$453.96—\$275.00. Altec 8806 straight line pan pots. Cost \$130.00 each—three available for \$65.00 each. *Midwestern Sound Studios, 444 W. Leonard St., Grand Rapids, Mich 49504.*

**SOLID-STATE AUDIO PLUG-IN OCTAL (1" Dia x 2" H) modules.** Mic preamps, disc & tape preamp-equalizers, tape bias osc. & record ampl., power amps & power supplies. Send for free catalog and audio applications. *Opamp Labs., 172 So. Alta Vista Blvd., Los Angeles, California 90036.*

### FOR SALE

**WORLD FAMOUS DOLBY SYSTEM**, used by virtually every major record company now available for home use. ADVENT Model 100 (\$250) and ADVOCATE Model 101 (\$125). Connect one of these devices to a good tape recorder and the recordings you make will have 90% (10dB) less noise than before. NOW you can make perfect copies at 3 3/4 ips. You cut tape costs in half, double uninterrupted recording time, increase dynamic range, reduce distortion, tape saturation and head wear—in short you will make recordings better and cheaper than you could at 7 1/2 ips.

Please write us. We will send information on these products and where to buy them. *Advent Corp. Department AA, 377 Putnam Ave. Cambridge, Mass. 02139*

**MODULES FOR ALL TYPES** of applications. Discrete to thick film IC devices, Preamplifiers to power amplifiers. New Catalog with schematics. \$1.00. *PM Electronics, Inc., Box 46204, Seattle, Washington 98146.*

### WANTED

**16-INCH DISCS WANTED** containing old radio programs, comedy, drama, childrens shows, news, mystery, etc., or taped copies of the discs. *Don Maris, 1926 Cherokee Lane, Norman, Oklahoma 73069.*

### EMPLOYMENT

**PROFESSIONAL RECORDING PERSONNEL SPECIALISTS.** A service for employers and job seekers. Call today! *Smith's Personnel Service, 1457 Broadway, N.Y.C. 10036. Alayne Spertell 212 WI 7-3806.*

**SOUND RECORDING ENGINEER**—with at least four (4) years experience in 16 and 8 track recording and mix-down techniques. Must be competent in recording session procedure, to work independently at any time. The latest and most sophisticated recording equipment and studio facilities have been installed and are in production. For immediate attention and interview, write or call: *Mr. Donald Redinger, WRS Recording Studios, 210 Semple Street, Pittsburgh, Pennsylvania 15213. Phone (412) 683-6300.*

**SALESMAN & CO-PRODUCER** for very unusual Sound Production house. Call on ad agencies and educational packagers. Creativity and ability to develop projects essential. Some familiarity with sound recording. Call 212-799-4800.

# INDEX FOR 1970

## Index by Subject

### THE STUDIO

Considerations in Acousta-Voicing Studio Monitors, Don Davis. *December, page 26.*

Four Channel Stereo, John Eargle. *August, page 23.*

Hearing Loss and the Audio Engineer, W. Dixon Ward. *May, page 20; June, page 28.*

Low Frequency Sound Absorbers, Michael Rettinger. *April, page 44.*

A Modular Console Design, Edward J. Gately, Jr. *April, page 38.*

New Studios for Armed Forces Radio, Zachery H. Jaquett. *August, page 28.*

Powering Condenser Microphones, Gerhard Boré. *June, page 22.*

Up Goes the Console, Jack Marrow. *December, page 28.*

Decca's Vienna Venue, John Borwick. *January, page 26.*

Stereo Synthesis Systems, Robert Orban. *February, page 21.*

Studio Construction Techniques, William R. Graham. *April, page 34.*

### ACOUSTICS

Low Frequency Sound Absorbers, Michael Rettinger. *April, page 44.*

A Primer on Methods and Scales of Noise Measurements, Wayne Rudmose. *January, page 22; February, page 24; March, page 27; April, page 54.*

### BROADCASTING

Automated Radio Broadcasting, Gene Hostetter. *September, page 18.*

Four Channel Stereo, John Eargle. *August, page 23.*

A Four-Channel Stereo Broadcast, Richard Alan Rogers. *October, page 36.*

Hearing Loss and the Audio Engineer, W. Dixon Ward. *May, page 20; June, page 28.*

How to Mic a Sports Broadcast, Elliot Full. *March, page 30.*

Low Frequency Sound Absorbers, Michael Rettinger. *April, page 44.*

New Studios for Armed Forces Radio, Zachery H. Jaquett. *August, page 28.*

Phono Disc Compatibility, Sidney Feldman. *May, page 24.*

Powering Condenser Microphones, Gerhard Boré. *June, page 22.*

Studio Construction Techniques, William R. Graham. *April, page 34.*

### DISC

A Disc Recording Seminar, Larry Zide. *May, page 28.*

Four Channel Stereo, John Eargle. *August, page 23.*

Phono Disc Compatibility, Sidney Feldman. *May, page 24.*

The Teldec Video Disc—Three Views. *December, Martin Dickstein (page 32), Arnold Schwartz (page 33), Edward Tatnall Canby (page 36).*

### EQUIPMENT

Console Transformer Elimination, Allen P. Smith. *March, page 18.*

EVR at Takeoff, Edward Tatnall Canby. *July, page 30.*

An IC Line Amplifier, Walter Jung. *September, page 30.*

IC's—The Coming Revolution, Edward J. Gately, Jr. *September, page 36.*

Let There Be Quiet! Walter H. Nelson. *September, page 40.*

A Modular Console Design, Edward J. Gately, Jr. *April, page 38.*

A Multi-Speed Capstan Drive System, H. van der Wal. *June, page 22.*

New Concepts in Studio Equipment Design, R.N. Andrews. *December, page 23.*

Optical Sound-Track Processing, J.W. Dorner. *August, page 30.*

A Preamp/Balanced Modulator for Audio Experimentation, Robert C. Ehle. *January, page 28.*

A Primer on Methods and Scales of Noise Measurement, Wayne Rudmose. *January, page 22; February, page 24; March, page 27; April, page 54.*

Stereo Synthesis Systems, Robert Orban. *February, page 21.*

### EXHIBITIONS

#### AND PICTURE GALLERIES

38th AES Convention and Exhibition—Map and List of Papers, *April, page 48.*

NAB Picture Gallery, *June, page 30.*

L.A. AES Picture Gallery, *July, page 34.*

39th AES Convention and Exhibition—Map and List of Papers, *September, page 44.*

London Professional Audio Exhibition, John Borwick. *October, page 40.*

N.Y. AES Picture Gallery, *November, page 39; December, page 22.*

### SOUND REINFORCEMENT AUDIO-VISUAL

A Different View of Speaker Coverage, Elliot Full. *January, page 25.*

EVR at Takeoff, Edward Tatnall Canby. *July, page 30.*

Hearing Loss and the Audio Engineer, W. Dixon Ward. *May, page 20; June, page 28.*

A Mini Fair Comes to New York, Martin Dickstein. *November, page 32.*

Optical Sound-Track Processing, J.W. Dorner. *August, page 30.*

Powering Condenser Microphones, Gerhard Boré. *June, page 22.*

Synchronous Recording Technique, Sidney L. Silver. *July, page 25.*

The Teldec Video Disc—Three Views, *December, Martin Dickstein (page 32), Arnold Schwartz (page 33), Edward Tatnall Canby (page 36).*

### TAPE

Four Channel Stereo, John Eargle. *August, page 23.*

A Multi-Speed Capstan Drive System, H. van der Wal. *June, page 25.*

Synchronous Recording Technique, Sidney L. Silver. *July, page 25.*

Tape Duplicating—Status Report and Guide to Equipment, Norman H. Crowhurst. *November, page 26.*

## Index by Author

Andrews, R.N.: New Concepts in Studio Equipment Design. *December, page 23.*

Boré, Gerhard: Powering Condenser Microphones. *June, page 22.*

Borwick, John: Decca's Vienna Venue. *January, page 26—London Professional Audio Exhibition, October, page 40.*

Canby, Edward Tatnall: EVR at Takeoff. *July, page 30—The Teldec Video Disc, December, page 36.*

Crowhurst, Norman H.: Tape Duplicating Status Report and Guide to Equipment. *November, page 26.*

Davis, Don: Considerations in Acousta-Voicing Studio Monitors. *December, page 26.*

Dickstein, Martin: A Mini Fair Comes to New York. *November, page 32—The Teldec Video Disc, December, page 32.*

Dorner, J.W.: Optical Sound Track Processing. *August, page 30.*

Eargle, John: Four Channel Stereo. *August, page 23.*

Ehle, Robert C.: A Preamp/Balanced Modulator For Audio Experimentation. *January, page 28.*

Feldman, Sidney: Phono Disc Compatibility. *May, page 24.*

Full, Elliot: A Different View of Speaker Coverage. *January, page 25—How to Mic a Sports Broadcast, March, page 30.*

Gately, Edward J. (Jr.): IC's—The Coming Revolution. *September, page 36—A Modular Console Design, April, page 38.*

Graham, William R.: Studio Construction Techniques. *April, page 34.*

Hostetter, Gene: Automated Radio Broadcasting. *February, page 18.*

Jaquett, Zachery H.: New Studios for Armed Forces Radio. *August, page 28.*

Jung, Walter: An IC Line Amplifier. *September, page 30—A Switching Summing Amplifier, March, page 22.*

Marrow, Jack: Up Goes the Console. *December, page 28.*

Nelson, Walter H.: Let There Be Quiet! *September, page 40.*

Orban, Robert: Stereo Synthesis Systems. *February, page 21.*

Rettinger, Michael: Low-Frequency Sound Absorbers. *April, page 44.*

Rogers, Richard Alan: A Four-Channel Stereo Broadcast. *October, page 36.*

Rudmose, Wayne: A Primer on Methods and Scales of Noise Measurement. *January, page 22; February, page 24; March, page 27; April, page 54.*

Schwartz, Arnold: The Teldec Video Disc. *December, page 33.*

Silver, Sidney, L.: Synchronous Recording Technique. *July, page 25.*

Smith, Allen, P.: Console Transformer Elimination. *March, page 18.*

Wal, H. van der: A Multi-Speed Capstan Drive System. *June, page 25.*

Ward, W. Dixon: Hearing Loss and the Audio Engineer. *May, page 20; June, page 28.*

Zide, Larry: A Disc Recording Seminar. *May, page 28.*

TCA-40



TCA-40

**= TCA-40**

4-track, 4- and 2-channel playback

RA-41



(record amplifier)

**= TCA-41**

4-track, 4- and 2-channel playback  
2-channel record

2 RA-41's

**= TCA-42**

4-track, 4- and 2-channel playback  
4- and 2-channel record

(Mounting cradle and dust cover optional)

# HIGHER MATH

Three decks, three capabilities: the Simul-trak® TCA Series from TEAC.

Buy one, add onto it, and you're up to the next model. Keep going till you reach the top. Or start at the top, and get everything going for you at once.

All three units feature 4- and 2-channel playback – the only brand with auto reverse. And Models 40 and 41 can be modified to the full 4-channel capability of Model 42 as shown. Meanwhile, any one of these decks is compatible with your present 2-channel equipment without modification.

Other 4-channel tape decks may look like ours. But they either have only one motor – or they cost a king's ransom. (They don't sound as good, either.)

And any way you add them up, the TCA Series can never be obsolete. You don't even need a slide rule to show you why. Just a good pair of ears.



**TEAC**

TEAC Corporation of America  
1000 Colorado Avenue  
Santa Monica, California 90404

Circle 11 on Reader Service Card



## Sony portable studio \$995.00 (VW optional).

What happens when the talent can't come to the recording studio?

The recording studio goes to the talent. Simple move.

If you own the new Sony Model 772.

It's the only truly professional AC/DC portable stereo recorder on the market.

It's so compact that it enables you to assemble a top quality recording studio right in the trunk of a VW.

The Sony 772 with its 7½ and 15 ips

makes it uniquely suitable for master recordings—in the field.

It also has 7-inch reel capacity, built-in limiter, tape select switch for standard or low noise type, a fourth head for quarter track playback, and built-in nickel cadmium battery pack which automatically switches in if the AC fails, with absolutely no interruption.

The Sony 772 performance is fully comparable to studio recorders costing three

times as much.

The Sony 772 is available at select Superscope Special Application Products dealers.

For their names, as well as complete details and specifications, please write Special Application Products Division, Sony/Superscope, 8150 Vineland Avenue, Sun Valley, California 91352.

**SONY** SUPERSCOPE

© Superscope, Inc.

Circle 12 on Reader Service Card

[www.americanradiohistory.com](http://www.americanradiohistory.com)