

# db

THE SOUND ENGINEERING MAGAZINE

MAY 1973 \$1.00



DAVID R BLOCK  
 ART 303  
 499 S SNEILING  
 ST PAUL, MN 55116  
 M3

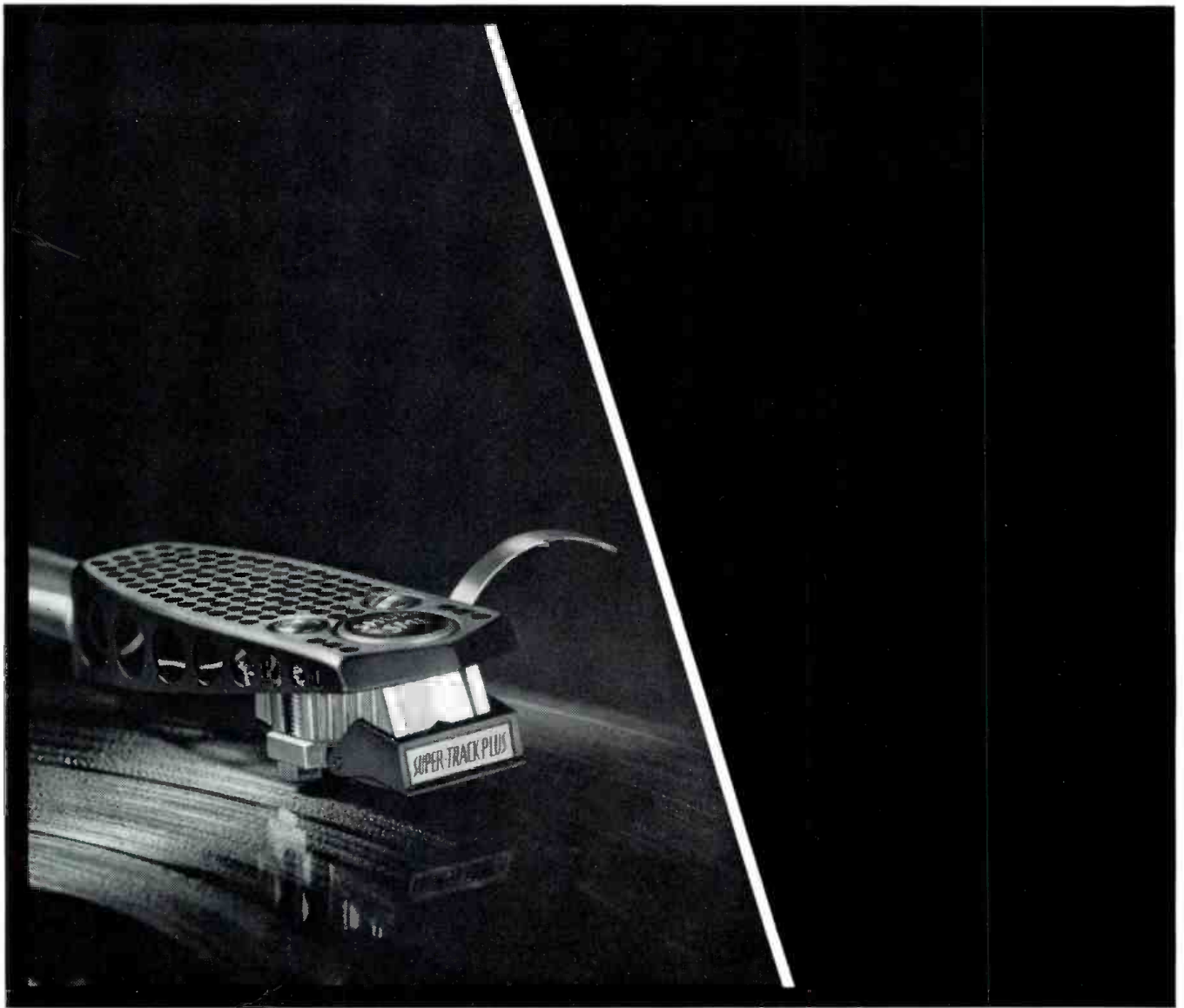

## anything II could do III can do better!

Several years ago, we decided that our next challenge would be to go beyond the best there was. Our computers told us we had taken the existing cartridge structure and stylus assembly of the V-15 Type II Improved as far as we could, and that hereafter, any improvement in one performance parameter would be at the expense of performance in some other parameter.

Therefore, over the past several years, a wholly new *laminated cartridge* structure has been developed, as was an entirely new stylus assembly with a 25% reduction in effec-

tive stylus mass! These developments have resulted in optimum trackability at light tracking forces ( $\frac{3}{4}$ - $1\frac{1}{4}$  grams), a truly flat, unaccented frequency response, and more extended dynamic range than was possible even with the Type II Improved, without sacrificing output level!

If you like its sound today, you will like it even more as time goes on. In fact, to go back to any other cartridge after living with the Type III for a short while is simply unthinkable, so notable is its neutral, uncolored sound. You must hear it. \$72.50.

INTRODUCING THE NEW

# SHURE V-15 TYPE III Super-Track "Plus" Phono Cartridge

Shure Brothers Inc. • 222 Hartrey Ave. • Evanston, Ill. 60204

In Canada: A. C. Simmonds & Sons Ltd.,

Circle 10 on Reader Service Card

# COMING NEXT MONTH

• Floyd E. Toole's absorbing two-partner on loudness begun in this issue will be concluded next month. Start it this month, and we are sure you will want to see the next issue.

Gerhard Nieckau is a free-lance audio consultant that details his adventures in attempting to modernize a studio in ancient Lima, Peru. Not all the world is ready for multi-channel recording!

In the April issue, we mentioned the bumping of a **db** Visits Neve (in England). John Borwick made the visit for us, and his article will appear in this next issue. Neve is an impressive factory.

And there will be our regular columnists: George Alexandrovich (on leave of absence), Norman H. Crowhurst, Martin Dickstein, and John Woram. Coming in **db**, The Sound Engineering Magazine.

# ABOUT THE COVER

• This Telex open reel duplicating system is used by Recording for the Blind, Inc. to copy spoken books. On page 31, read how these recordings are made.



THE SOUND ENGINEERING MAGAZINE

MAY 1973 VOLUME 7, NUMBER 5

- 24 MONITORING—ROOM ACOUSTICS  
Daniel Queen
- 27 LOUDNESS—APPLICATIONS AND  
IMPLICATIONS TO AUDIO, PART 1  
Floyd E. Toole
- 31 A VOICE FOR THE SIGHTLESS  
Zachary H. Jaquett
- 2 LETTERS
- 6 THE SYNC TRACK  
John Woram
- 12 THEORY AND PRACTICE  
Norman H. Crowhurst
- 17 NEW PRODUCTS AND SERVICES
- 21 SOUND WITH IMAGES  
Martin Dickstein
- 33 BOOKCASE
- 34 CLASSIFIED
- 36 PEOPLE, PLACES, HAPPENINGS

**db** is listed in **Current Contents: Engineering and Technology**,

<b>Robert Bach</b> PUBLISHER	<b>Larry Zide</b> EDITOR
<b>Bob Laurie</b> ART DIRECTOR	<b>John Woram</b> ASSOCIATE EDITOR
<b>A. F. Gordon</b> CIRCULATION MANAGER	<b>Hazel Krantz</b> COPY EDITOR
<b>Eloise Beach</b> ASST. CIRCULATION MGR.	<b>Richard L. Lerner</b> ASSISTANT EDITOR
<b>GRAPHICS Crescent Art Service</b>	

db, the Sound Engineering Magazine is published monthly by Sagamore Publishing Company, Inc. Entire contents copyright © 1973 by Sagamore Publishing Co., Inc., 980 Old Country Road, Plainview, L.I., N.Y. 11803. Telephone (516) 433 6530. db is published for those individuals and firms in professional audio-recording, broadcast, audio-visual, sound reinforcement, consultants, video recording, film sound, etc. Application should be made on the subscription form in the rear of each issue. Subscriptions are \$6.00 per Year (\$7.00 per year outside U. S. Possessions, Canada, and Mexico) in U. S. funds. Single copies are \$1.00 each. Controlled Circulation postage paid at Harrisburg, Pa. 17105. Editorial, Publishing, and Sales Offices: 980 Old Country Road, Plainview, New York 11803. Postmaster: Form 3579 should be sent to above address.

# DELTA-T 101

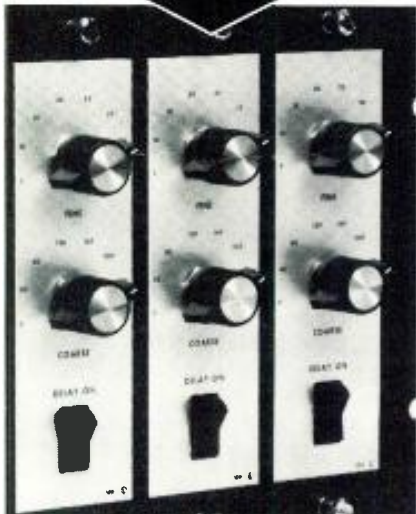

## ALL ELECTRONIC DIGITAL AUDIO DELAY SYSTEM

Five Independent Outputs  
Each Output Separately Adjustable  
in 5 ms Steps From 5-320 ms

The Delta-T 101 is an audio recorder and play-back unit which uses neither tape nor moving parts. It converts audio into a digital code and stores it in its computer solid-state memory. It can therefore offer you the following specifications:

- zero wow and flutter
- +22 dBm output with less than 1% distortion
- 60 dB dynamic range
- frequency response 20 -12kHz  $\pm$  2 dB
- standard 19" rack panel, 7" high and 18" behind the panel

In one stroke, the Delta-T 101 eliminates all the problems of tape delay: no mechanical failure, no wow and flutter, no drop-outs or broken loops, no tape hiss or distortion. You can plug it into your rack, set it, and forget it.

When the Delta-T 101 was being designed, we had two options:

- 1) Make a unit with all the flexibility demanded by the job;
- 2) Cut costs to the bone and let the "concept" sell the unit.

We took the first course. Sure, fixed delays would have been cheaper, but we know from experience that you never know exactly how much delay you will need until you make the installation. And even in fixed installations it becomes necessary to change delays to suit the speaker set-up required by a particular program. We made the steps 5 ms, because this is the smallest increment ever needed.

For additional information, call or write:

**GOTHAM**  
AUDIO CORPORATION  
741 Washington Street, New York, NY 10014  
(Tel: 212-741-7411)  
1710 N. La Brea Ave., Hollywood, CA 90046  
(Tel: 213-874-4444)

## letters

The Editor:

Mr. David Robinson's article in *db Magazine* (December, 1972) prompted me to share my idea of a stereo phase checker that I use consistently here at WMRI. I do not claim originality to the checker but possibly would to the use of the device.

The device simply consists of a stereo/mono splitter pad or possibly dual secondaries transformers could also be used.

The pad or transformer is used in reverse of its original intended purpose for checking out of phase conditions on stereo audio lines.

# db

THE SOUND ENGINEERING MAGAZINE

## SALES OFFICES

**New York**  
980 Old Country Road  
Plainview, N.Y. 11803  
516-433-6530

**Dallas**  
Roy McDonald Associates, Inc.  
Stemmons Tower West  
Suite 714  
Dallas, Texas 75207  
214-637-2444

**Denver**  
Roy McDonald Associates, Inc.  
3540 South Poplar Street  
Denver, Colorado 80237  
303-758-3325

**Houston**  
Roy McDonald Associates, Inc.  
3130 Southwest Freeway  
Houston, Texas 77006  
713-529-6711

**Los Angeles**  
Roy McDonald Associates, Inc.  
500 S. Virgil  
Suite 360  
Los Angeles, California 90020  
213-483-1304

**Portland**  
Roy McDonald Associates, Inc.  
2035 S. W. 58th Avenue  
Portland, Oregon 97221  
503-292-8521

**San Francisco**  
Roy McDonald Associates, Inc.  
Baybridge Office Plaza, Suite 265  
5801 Christie Avenue  
Emeryville, California 94608  
415-653-2122

## advertisers index

Ampex . . . . .	15	
Auditronics . . . . .	9	
Automated Processes . . . . .	3	
Beyer . . . . . facing Cover	2	
Bose . . . . .	4	
CBS Labs . . . . .	4	
Comm. Light and Sound . . . . .	20	
Delta-T . . . . .	2	
Electro-Voice . . . . . Cover	4	
Gately . . . . .	18, 29	
Gotham Audio . . . . .	2, 14	
ITI . . . . .	16	
Keypor-Century . . . . .	22	
Maxell . . . . .	11	
Neumann . . . . .	14	
Pacific Recorders . . . . .	16	
Ramko Research . . . . .	6	
Shure . . . . . Cover	2	
Sparta . . . . .	13	
Spectra-Sonics . . . . .	23	
Stanton . . . . .	8	
Tascam . . . . .	5	
Telex . . . . .	10	
Timekeeper . . . . .	12, Cover	3
Waters . . . . .	7	

# MagLink<sup>®</sup>

## SYNCHRONIZER

An indispensable tool in multi-track audio production, video mixing, editing and "sweetening," film sound track production, and foreign language overdubbing.



MagLink is a completely new approach to fast, efficient tape synchronizing, position logging and editing.

Videotape, multi-track audio, and magnetic film machines may now be locked in synchronism, offset, or stopped and started at preset positions with an

accuracy not formerly attainable. A master and any number and any type of slave machines may be controlled by MagLink and will remain synchronized even in REWIND and FAST FORWARD modes.

*Please send for further information.*

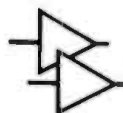

**AUTOMATED PROCESSES, INC.**  
**80 MARCUS DRIVE, MELVILLE, NEW YORK 11746 · 516-694-9212**

West of Rockies: WESTLAKE AUDIO  
 Los Angeles, Calif.

Europe: 3M FRANCE  
 Paris, France

Japan: NISSHO IWAI  
 Tokyo, Japan

Circle 12 on Reader Service Card

[www.americanradiohistory.com](http://www.americanradiohistory.com)

HOW GOOD SHOULD A REINFORCEMENT SYSTEM SOUND? SO GOOD YOU DON'T HEAR IT!



Listen to the remarkable **BOSE 800™**

Portable Loudspeaker System and all you'll hear is the performance, without artificial coloration. After all, isn't the performance really what the audience comes to hear?

**Bose 800, The Unobtrusive One**

Please send complete information to:

Name \_\_\_\_\_  
 Address \_\_\_\_\_  
 City \_\_\_\_\_ State \_\_\_\_\_ Zip \_\_\_\_\_  
 Return to Bose Corp.  
 The Mountain  
 Framingham, Mass. 01701  
 Dept. BD

Circle 21 on Reader Service Card

A simple stereo phase checker. Each pad is approximately a 60 dB loss.

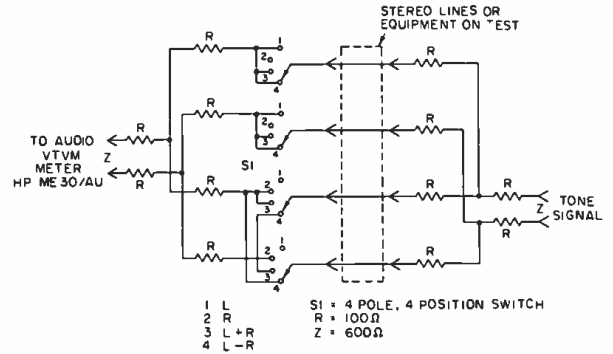

In the left plus right mode, and feeding a single tone into the circuit, and using either a vu or audio meter (vtvm) with amplification, a reference value can be arrived at by noting the value of the audio signal.

If the stereo channels are wired correctly and no phase problems are present, by feeding a left minus right signal into the circuit, a considerable drop in level will be noted, the value of which is the difference in dB less pad or transformer loss representing your amount of separation.

Impedance cone matching should be observed and the initial left plus

right reference signal should be known to actually be a left plus right signal.

I do not actually use the circuit to measure actual separation, but only as an indicating device to show maximum left minus right values I can possibly realize in phase alignment problems.

Actual separation is checked on the air by means of the stereo monitor, if actual amount of separation is desired, or by conventional other methods.

*William E. Loucks*  
 WMRI  
 Post Office Box 538  
 Marion, Indiana 46952

**Send only the best.**

Only the best is good enough. And that's exactly what you get with CBS Laboratories power twins, Audimax and Volumax. Audimax delivers a distortion free signal by eliminating thumping, background "swish-up" and audio "holes." And Volumax prevents overmodulation and permits maximum per-watt coverage power. The power twins! From CBS Laboratories, of course.

**CBS LABORATORIES**  
 A Division of Columbia Broadcasting System, Inc.  
 227 High Ridge Road, Stamford, Connecticut 06905

Circle 24 on Reader Service Card

www.americanradiohistory.com

## you write it

Many readers do not realize that they can also be writers for *db*. We are always seeking good, meaningful articles of any length. The subject matter can cover almost anything of interest and value to audio professionals.

Are you doing something original or unusual in your work? Your fellow audio pros might want to know about it.

You don't have to be an experienced writer to be published. But you do need the ability to express your idea fully, with adequate detail and information. Our editors will polish the story for you. We suggest you first submit an outline so that we can work with you in the development of the article.

You also don't have to be an artist, we'll re-do all drawings. This means we do need sufficient detail in your rough drawing or schematic so that our artists will understand what you want.

It can be prestigious to be published and it can be profitable too. All articles accepted for publication are purchased. You won't retire on our scale, but it can make a nice extra sum for that special occasion.



If you're seriously into music or sound reinforcement you want more than hi-fi products can give you. But full professional studio gear costs an arm and a leg, and you pay for a lot of things you may not really need.

## You pay for what you need

up to four additional input modules and other optional accessories including talkback, remote transport control, quad panner, and headphone monitor.

That's what you need and that's what you pay for.

That's why there's a TASCAM Model 10. It's an 8-in, 4-out mixing console, and it's just \$1890.

With the Model 10 you get what you have to have. Without sacrificing a single necessary function.

Each input module gives you mic and line attenuation, three bands of peak and dip equalization (two with frequency selection), pre- and post-echo send and receive circuitry, pan function, and a unique straight-line fader.

Each of the four submasters has a meter control switch (line/echo), independent monitor level control, echo receive level control, and a straight-line fader. You also get a master gain module and 4" VU meters with LED peak indicators. Plus pre-wired facilities for

Some things, however, you may or may not need, and we leave that choice up to you. For instance, the basic Model 10 is high impedance in and out, but studio line impedances are available optionally. You'll probably want low impedance mic inputs, but you may not need all low impedance line inputs. So we don't make you pay for them. You can order any combination of high and low input/output impedances according to your application.

Details and specs on the Model 10 are available for the asking. At the same time we'll tell you about our new Series 70 Recorder/reproducers.

We've got what you need.

**TASCAM CORPORATION**  
 5440 McConnell Avenue  
 Los Angeles, California 90066

Circle 26 on Reader Service Card

[www.americanradiohistory.com](http://www.americanradiohistory.com)

UP TO

# 65% SAVINGS

Plus performance that is creating excitement in Engineers around the country! "Fantastic sound" ... "Very Clean" ... "Superb! ... Send two more ..."

Proof? Our standard 10 day evaluation period lets you see and hear the performance and the full service. 2 year warranty demonstrates the reliability.

Place your order today. Then prepare yourself for a very satisfying experience!



TURNTABLE PREAMPLIFIERS

MP-8 (Mono) \$60  
SP-8 (Stereo) \$90

Outstanding sensitivity and near perfect reproduction. RIAA/NAB equalized — 0.5 mv sensitivity @ 1 KHz for +4 dbm out — Balanced 600 ohm out — minus 65 db S/N ratio — +20 dbm out max — ±1 db freq. response — Internal power supply — Table top/bracket mount. Shipping weight, 3½ lbs.



MIC/LINE AMPS

MLA-1 (Mono) \$68  
MLA-2 (Dual) \$96

Dual function utility amp. Inputs for mic and/or line — 600 ohm balanced outputs — mic input, —65 db for +4 dbm out — +20 dbm out max. — ±0.5 db response, 10 Hz-20 KHz — 0.1% or less dist. — Internal power supply — Tabletop/bracket mount. MLA-2, Stereo/Dual Mono. MLA-1, Mono. Shipping weight, 4 lbs.



DISTRIBUTION AMP  
6 BALANCED OUT

DA-6 \$95

One third the cost of comparable units. Six 600 ohm balanced outputs — Balanced bridging input — 26 db gain — +20 dbm out max. — Input level control — 0.1% or less dist. — ±0.5 db response, 10 Hz-20 KHz — Internal power supply — Tabletop/bracket mount — Shipping weight, 4 lbs.



TAPE CARTRIDGE  
LOADER (AUTOMATIC)

ACL-25 \$159

Precision winding without guesswork. Dial in the minute and/or seconds desired, throw switch to run. That's it! The exact amount of tape is fed onto the cartridge hub to the second, and shuts off automatically. No waiting around, no guesswork and 1 sec. accuracy. Also has exclusive torsion control for proper tape pack and winding of various cart hub sizes. TTL digital control circuitry. Shipping weight, 30 lbs.



RAMKO RESEARCH

2552 "E" Albatross P.O. Box 6031  
Sacramento, Calif. 95860 (916) 489-6695

John M. Woram

## THE SYNC TRACK

**"All the great machines in the world can't make music."**

Dear Mr. Woram:

I have been reading *db Magazine* for quite a while now and I generally look forward to each and every copy I receive. However, for the second time, your column on "Getting Back to Basics" has really burned me up.

I have done enough recording and have been in enough studios to finally realize that a lot of recording engineers are like kids with a new erector set. All the shiny knobs, switches, and dials, all the expensive and very sophisticated professional audio gear, are like toys for technicians to play with.

How can an engineer tell which microphone to use for recording a specific instrument if he has no idea of what that instrument is supposed to sound like? How many recording engineers have ever listened to the music that was happening on the other side of their glass-enclosed cubicle?

And therefore, Mr. Woram, we come to the crux of the issue. All these bright and interested kids that write to you, asking how to get into recording, should be told to study music!

There are too many rotten records produced today that sound like nothing any musician has ever produced. We have come to believe that high-fidelity sound should attempt to recreate a live performance. Supposedly, the goal of our entire history of recording has been to reproduce sound with

total and complete accuracy. If this is indeed our goal, then it is the responsibility of the recording engineer to have a first-hand knowledge of music; what's involved in performing it and what it is supposed to sound like when it is performed well.

If I owned a recording studio, the first question I'd ask a job applicant is what instrument (or instruments) he plays and what writing or arranging experience he has. Any competent person can be taught to run machines; the person who knows what his product is supposed to sound like will get the most out of those machines.

Enough of my raving. Please don't take this as a put-down of the entire industry. There are some really incredible people in the studios today. However, I hate to see our emphasis change from music to technology. All the great machines in the world can't make music.

Sincerely,  
Lee Harris  
Orange, N. J.

Now that is a letter! Mr. Harris says a lot that needs to be said. For whatever it's worth, I completely agree with the spirit of his letter, although I feel there is another side to this point of view that should be explored.

Those shiny knobs can indeed be-



# Waters Attenuator

key to trouble-free mixing



With a complete line of professional audio attenuators, Waters Manufacturing has solved the noise problems usually encountered in conventional fader controls.

The answer is MystR®—Waters' proprietary conductive plastic resistance element. MystR's glass-hard, smooth wiping surface achieves noise levels below 20  $\mu$ V (at least 100 db down) over a trouble-free life of at least ten million operations. Precision engineered to provide professional "feel," Waters' attenuators also feature adjustable damping. Zero to 90 db of truly "stepless"

attenuation is achieved with Waters' computer-controlled curve-shaping technique which actually tailors the attenuator resistance element assuring superior tracking accuracy. For your key to trouble-free mixing send for Waters' Audio Attenuator brochure which describes their complete line of linear and rotary attenuators and pan pots. Use the coupon provided, or better yet, phone 617-358-2777 for immediate service.



**WATERS  
MANUFACTURING,  
INC.**

Boston Post Road  
Wayland, Ma 01778

I'd like further information on Waters attenuators and MystR® conductive plastic elements.

Send me your attenuator brochure and "The MystR Story"

I need additional information:

\_\_\_\_\_

\_\_\_\_\_

Name \_\_\_\_\_

Position \_\_\_\_\_

Company \_\_\_\_\_ Phone \_\_\_\_\_

Street \_\_\_\_\_ City \_\_\_\_\_

State \_\_\_\_\_ Zip \_\_\_\_\_

Circle 29 on Reader Service Card

www.americanradiohistory.com

# Stanton. Brings on the new.



Bill Wertz, VP of WQLR, checks the chronometer, as Dennis Weidler is poised to put the station on the air. Pat Dyszkiewicz and Eric Toll watch.

A new Station, and a new sound hits the air in Kalamazoo, Michigan. WQLR STEREO starts serving the market in June, 1972 with all new equipment and new programming.

Every cartridge on every tonearm at WQLR is a Stanton. Vice President, Bill Wertz states, "We chose Stanton because we were starting fresh and we needed to impress the community with the quality of our sound from the very first on-the-air minute. Naturally, the well-documented reliability of Stanton's 500 series cartridges helped influence our choice."

## Radio stations all over the nation specify Stanton.

For on-the-air use, Stanton 500 series cartridges have the ability to withstand rugged handling without any lessening of audio quality. They meet all standards for reliability and sound quality. Stanton's Model 681EE cartridge is the choice of many stations for auditioning original recordings and making transfers. Its incredible low mass moving magnetic system (1/5 to 1/10 that of ordinary pickups) and its 10 Hz to 20,000 Hz response, contribute to its exceptional audio quality.

You can enjoy the professional audio quality of Stanton Products whether your purpose involves broadcasting or home entertainment.

Write today for further information to Stanton Magnetics Inc., Terminal Drive, Plainview, New York 11803.



**STANTON**

All Stanton cartridges are designed for use with all two and four-channel matrix derived compatible systems.

Circle 16 on Reader Service Card

come toys for technicians. However, this assumes that the technician has not yet grown up, and really doesn't understand his equipment. My son used to have a grand time when he'd visit the studio after a session. He would sit for hours playing with all those marvelous gadgets. He had no idea what he was doing, but he had a lot of fun doing it. Now that he's a little older (twelve years) he wants to know what all the knobs are really for. He's growing up. By the time he's old enough to be a recording engineer (next year, maybe), the console will be a tool—not a toy.

And that's the way it must be. All those controls can certainly be abused in the hands of a child. But if the technician regards the control room as a giant toy box, he should be sent home. If he is allowed to abuse the equipment, it's really not technology's fault.

No doubt there are some incompetent people in the studio today. However, I suspect there are just as many in front of the microphone as behind the console. This doesn't justify the incompetence, but it does point out that the recording technician does not have a monopoly on it.

Last month's "April fool" column took a facetious look at the Long Island Railroad. On a more serious note, it staggers the imagination to realize that people who make their living designing railroad cars could devise such an atrocity—and get paid for it yet! Or, read Norman Crowhurst's column in the December, 1972 issue. He describes his adventures with the Office of Education of the United States Government. You've got to hand it to those folks—they've developed incompetence into a fine art.

Incompetence is all around us. It would be nice to think that the recording studio was the exception, but unfortunately . . .

As to the recording engineer's conception of what a musical instrument is supposed to sound like—right on! But while we're on the subject, how many musicians know what their instruments are supposed to sound like—or, are capable of producing a musical sound from their instrument? It's handy to point a finger at the engineer when the group doesn't sound right, and no doubt some engineers have never heard a note that wasn't three pieces of glass away. But there are a lot of performers around today who just don't deserve to be heard any closer.

At times, the engineer must take over some of the responsibilities that the performer is either unwilling or unable to assume. But here it should be pointed out that the engineer is generally retained by—and therefore

responsible to—the producer. If the producer doesn't like what the engineer is doing, he must inform the engineer of his wishes. *But*, if the producer doesn't like what the performers are doing, he may be glad to have a technically knowledgeable engineer in the control room.

Should the engineer attempt to recreate a live performance with total and complete accuracy? I don't think so. A recording is *not* a concert; it is an art form all its own. Occasionally, a recording may be made at a live concert, but however valuable these sessions are as historical documents, it is usually the studio session that offers the best in recorded sound.

Magnetic tape is a marvelous tool for constructing the perfect performance. We all know of the editing jobs that have been done; there's the famous anecdote about the concert pianist who, on hearing a playback of his edited master tape, quipped, "I wish I could play like that."

Here, reality was sacrificed for the best of reasons. Small errors that might have passed unnoticed in the concert hall become all too obvious with repeated hearings. Technology allows us to hear the best of the performer, and this is no bad thing providing the editor does not display more musician-ship than the musician

At a rock session, real-time reality may exist nowhere but on the master tape. The complete recording may bear little resemblance to anything that happened in the studio. Without the technology, the recording would not exist at all.

The point of all this rambling is that technology is the engineer's "musical instrument." He must bring to the console as much artistry as the musician applies to his instrument. The engineer with musical training and no particular skill in the science of recording is of no value to anyone, and his sessions will reflect his shortcomings.

Every engineer already has a valuable musical instrument; it's called an ear. He *must* learn how to use it. A regular seat at a concert hall may do him more good than learning how to play the piano.

Some skill on a musical instrument, or in writing or arranging may be of value. But, too much skill may get in the way of good engineering. The engineer must attempt to remain detached (I didn't say disinterested) from the music. He is not a performing artist—he is a translator.

Hey, that's not a bad analogy. I remember some rather lengthy bi-lingual discussions I had in Moscow some time ago. The conversation went smoothly back and forth through our

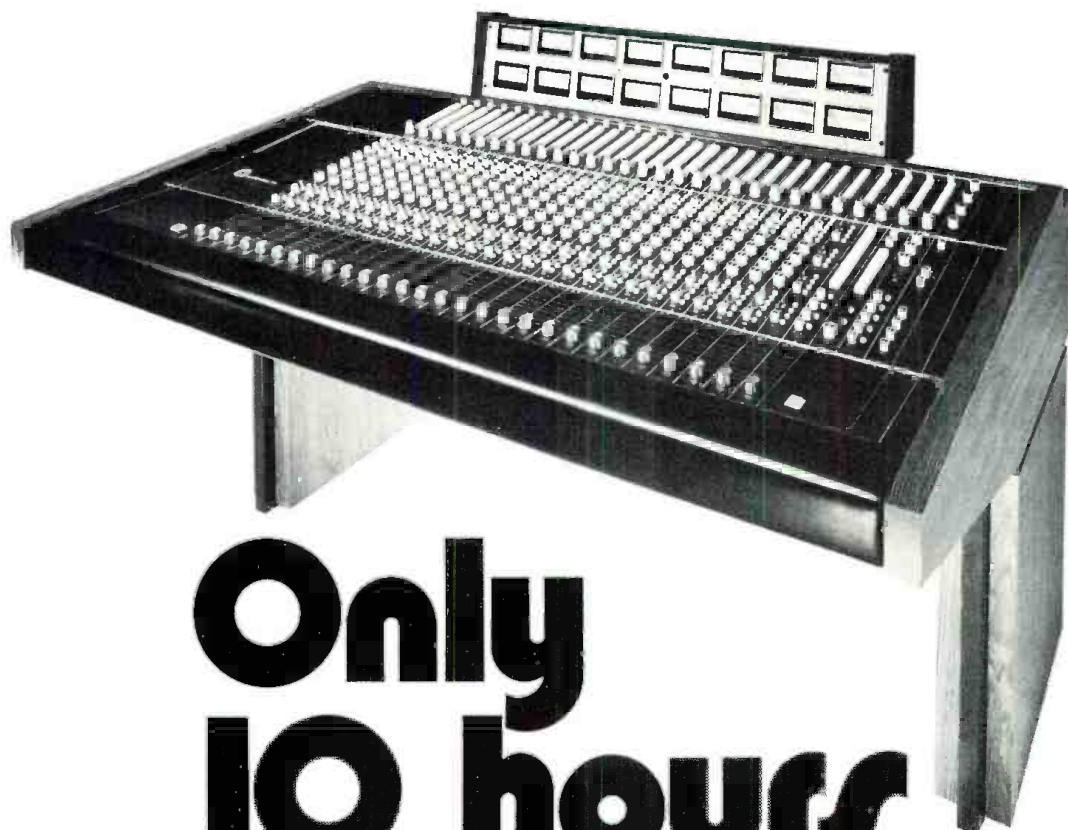

# Only 10 hours from opening crate to opening date

SON OF 36 GRAND is swift, because we spend 50 or more hours in factory checkout and proving performance.

Your SON OF 36 GRAND starts work as soon as it's installed. And the SON's track record for reliability, flexibility, and performance are your assurance that it will keep on working, keep on paying the rent.

But if problems arise, servicing is simply a matter of substituting modules. And that, too, is swift.



**auditronics. inc.**

P. O. Box 12637  
Memphis, Tenn. 38112  
(901) 276-6338

Distributed by:

Auditronics Systems Division, Memphis (901) 272-9641  
Milam Audio, South Pekin, Ill. (309) 348-3112  
Westlake Audio, Inc., Los Angeles (213) 655-0303

Circle 19 on Reader Service Card

[www.americanradiohistory.com](http://www.americanradiohistory.com)



Audiometric-type transducers make our headphones better. Better than any headphone you've ever tried. You can hear the difference; clear, live, distortion-free sound. But even more important, performance and sound are the *same*, all day, every day. Because our audiometric-type elements are absolutely stable to give you consistent performance at all times.

Originally, we developed audiometric elements for clinical hearing tests and measurements. This required elements that remain totally stable even with changes in temperature or humidity. Sensitive elements that respond efficiently to variances in frequencies and power input. Elements capable of sound reproduction at over 130 dB sound pressure level with very low distortion and without burning up.

Now we've modified and adapted this audiometric transducer element to give you a series of thoroughly professional headphones. Headphones you can rely on for stable performance — day in, day out. Clear and undistorted so you can truly monitor sound quality and balance and not just signal presence.

We make two series of professional models to meet your needs Series 1325 for stereo monitoring and series 1320 for communications, with optional noise cancelling boom microphone. Try our better hear muffs at better dealers — or write for free information. You'll hear more from Telex. ©

PRODUCTS OF SOUND RESEARCH  
**TELEX**®  
 COMMUNICATIONS DIVISION

9600 ALDRICH AVENUE SOUTH • MINNEAPOLIS, MINNESOTA 55420

CANADA: DOUBLE DIAMOND ELECTRONICS, LTD., Ontario  
 EUROPE: ROYAL SOUND COMPANY, INC.,  
 409 North Main Street, Freeport, N.Y. 11520 U.S.A.

Circle 13 on Reader Service Card

translator. The translator never intruded on the conversation, and we were scarcely aware of his presence, although the chat would have been impossible without him. He was a brilliant "engineer."

The recording engineer must do the same calibre job. He must not "interpret" the artist's work; he must simply translate it—in this case, into a storage medium for later replay. Anyway, once the engineer becomes an accomplished performing musician or writer/arranger, it would take a supreme act of will power to keep this skill from intruding upon the primary task of objectively recording the session.

When the engineer is called upon to create new sounds, he then becomes one of the performing artists. His instrument is the console, and he must know how to control it if he is to be creative. Any competent person can be taught to run machines—or to play *Jingle Bells* on the piano. But both accomplishments are a long way from what is needed in the studio. And all the musicianship in the world isn't going to be of much help when you have some thirty tracks of information spread over two or more tape machines, a vtr in the corner, a projector in the next room, and a producer on your back.

Trust me; this is *not* the time to ask if anyone wants to hear you play the guitar. You'd better have your technology mastered first.

I suppose Mr. Harris and I have said about the same thing; technology is supposed to be the servant of the recording industry, and not its master. The creative engineer may use the available technology as a tool—however, he must understand his tools if he is to get the most out of them.

The emphasis must not change from music to technology. The engineer must remain in control of his equipment, and this comes only with a complete understanding of technology.

If this understanding can be supplemented by an understanding of music theory, performance skills, writing and arranging ability, so much the better.

Some time ago, this column began a series of articles on music theory for the engineer. The series never got beyond Chapter I, since there was a total lack of response from the readers. I don't know whether this indicates a lack of interest, or, that the reader is already proficient in music theory. Whatever the answer, for those that don't have any understanding of music theory, it's never too late to begin learning, and the knowledge you gain will do you no harm at all. ■

# We offer you better quality masters, but you'll have to work for them.

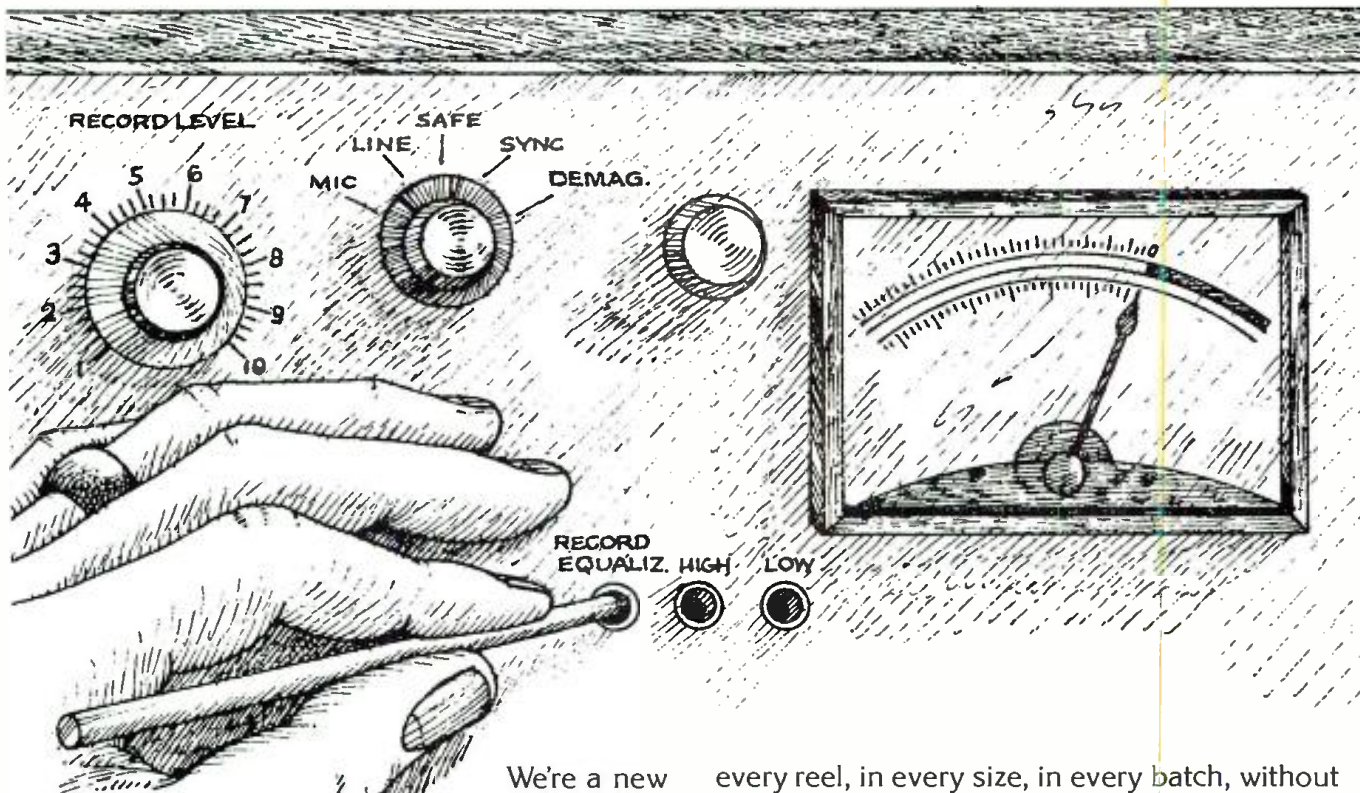

We're a new mastering tape formulation, so the limits of older tapes don't apply to us. Initially, our extra quality needs some getting used to. To upgrade your original recordings, you'll have to adjust your equalization and bias controls to our specifications. That's not much work, but it's necessary. And it's worth it.

When you play back your first reel of Maxell mastering tape you'll notice how clean it works. Our tape doesn't use a carbon backing so there's no messy carbon shedding. Sheddings cause noise, thumping and interference. On the reel, carbon can also transfer to the recording surface and cause dropouts.

Because of the care we take in the manufacturing process, you won't find any pinholes in our oxide coating. No pinholes and no shedding mean Maxell mastering tape is virtually 100% free from dropouts.

And you get Maxell's low noise level, wide range and freedom from distortion with

every reel, in every size, in every batch, without fail. That's a statement about quality performance you won't find other manufacturers making anymore. We're eager to draw your attention to the edge-to-edge, end-to-end quality you'll find in Maxell mastering tape.

Send in the coupon for documented evidence about Maxell tape performance. Then think about the repeat sessions Maxell quality will eliminate. That's a lot of work you won't have to do.

Send to: Maxell Corporation of America  
130 W. Commercial Avenue Dept. 5DM  
Moonachie, N.J. 07074

Gentlemen:  
Send me technical information and tell me how I can get Maxell mastering tape.

name/title \_\_\_\_\_

company \_\_\_\_\_

address \_\_\_\_\_

city \_\_\_\_\_ state \_\_\_\_\_ zip \_\_\_\_\_

**maxell**

The answer to all your tape needs.

Circle 30 on Reader Service Card

www.americanradiohistory.com

# Best-selling accessories for recording studios and broadcasting stations

Model T-1  
Electronic



## STOP CLOCK

A digital instrument that is the modern version of the traditional stop watch. It does everything a stop watch does except that the results appear on an easily read visual display.

### Features:

- Remote operation if desired
  - 120 volt 50 or 60 Hz.
  - Panel mounting possible
  - Provisions for slave units
  - High degree of accuracy
  - Highest quality design and construction
  - One year guarantee
  - A "delight" to use
- Only \$185.00

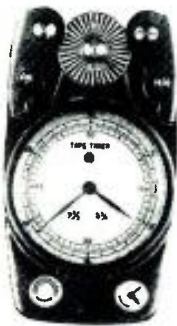

Standard Model

## TAPE TIMER

The most popular Tape Timer in the field.

### Features:

- Calibrated for 7.5 and 3.75 ips but can also be used at 15 ips
  - Easily mounted on any 1/4 inch recorder
  - Moves in unison with tape so that fast forward or reverse moves the pointer correspondingly
  - You can stop, rewind, fast forward or play tape continuously and repeatedly without deranging the timing
  - A "must" for editing
- Only \$59.95

New York State residents add 7% sales tax.

Send check to

# TIMEKEEPER

P.O. Box 835 Great Neck, N.Y. 11021

Norman H. Crowhurst

## THEORY AND PRACTICE

• Usually this column addresses itself to answer questions that involve an apparent conflict, or difference, between theory and practice. In this way, we may be apt to overlook direct *statements* with similar implications. If we know the statements are inaccurate, we mentally reject them and pass them by, forgetting that many less knowledgeable readers may accept the same statements as "gospel."

One recurrent example of this, in different contexts, involves the impedance of windings that occupy specified dimensions. The device could be a recording or playback head, a pick-up cartridge, a loudspeaker voice coil, or whatever. These devices have in common that the coil has fixed dimensions that it must occupy, but it can be wound of varying numbers of turns, of suitable wire gauge to be accommodated in the available space.

The kind of statement to which we refer is one that implies that a different number of turns, representing some specific value of impedance, is *inherently* better than some other choice. Of course, the best choice will be one that yields an impedance to match the electrical or electronic circuit with which it operates, or *vice versa*. We do not refer to that aspect of the question.

In the days of tube circuits, the only natural impedance of the circuit was high, and any other impedance must be accommodated with a matching transformer. Since the advent of solid state devices, circuits can be

designed to match virtually any impedance device that comes along. So the kind of statement to which we refer implies that there is something *inherently* better about using a low number of turns, or a high number of turns, or some specific number.

In some instances there may be specific sets of numbers that suit better than others, but broadly speaking, there are no numbers of turns or corresponding impedances that are *inherently* (that is, in theory) better than others. Let us look at a few examples to see what this means.

Take the voice coil for a specific sized loudspeaker. This will have specific dimensions (FIGURE 1) within which the coil must be wound. For maximum efficiency, it should fill these dimensions. If round wire is used to wind the coil, there will be some waste space between turns because they only touch at one point on the round. The best winding factor cannot be better than  $\pi/4$ , or 78.5 per cent, not allowing for the space occupied by wire insulation.

Assuming such round wire is used, there are quite distinct practical limitations to the numbers of turns that can be used. Suppose the gap width that can be occupied by coil, without rubbing, is 0.05 inch and the length of coil is 0.35 inch. This could be occupied by a single-layer coil of seven turns, wire diameter 0.05 inch. If the turn length (unwound) is 5 inches, this would be three feet of wire, with a resistance of about 0.013 ohms.

The impedance of such a coil, de-

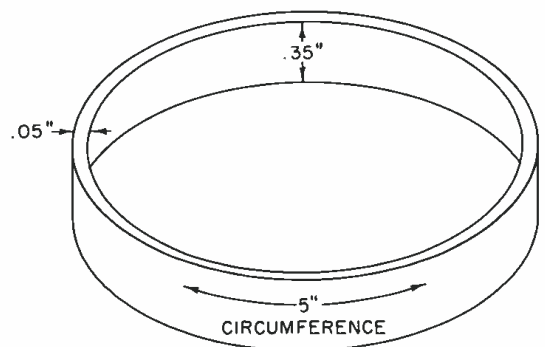

Figure 1. Dimensions of the loudspeaker voice coil discussed in the text.

# SPARTA PRODUCTS 'JUST RIGHT'

- selection
- quality
- price

CENTURY SERIES modular tape  
cartridge machines. Quad cabinet,  
all playbacks.

CENTURY SERIES triple rackmount  
Record/Playback.

AC155B REMOTE/STUDIO CONTROL  
unit. Stereo also available.

AS40B 8 CHANNEL stereo console.  
A20B 8 CHANNEL monoural also

GT12 CUSTOM TURNTABLE. Choose  
4-pole or synchronous versions.

**SPARTA, the just right company; small  
enough to be first name friends . . . big  
enough to supply EVERYTHING.  
Call us. Collect.**



## SPARTA

**ELECTRONIC CORPORATION**

5851 Florin-Perkins Road, Sacramento, Ca. 95828  
916 383-5353 TELEX 377-488 CABLE SPARTA  
A DIVISION OF COMPUTER EQUIPMENT CORPORATION

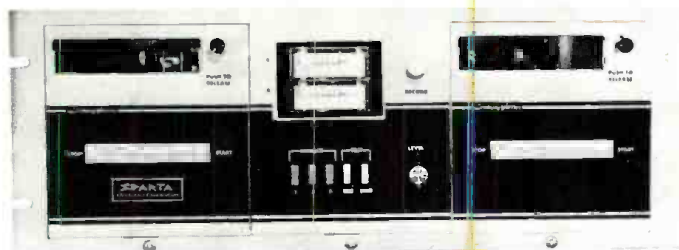

Circle 22 on Reader Service Card

www.americanradiohistory.com

pending on the acoustic efficiency of the design, would not be more than 0.1 ohms—probably less, so this is not a practical coil. But the same space could be fully occupied with 28 turns of wire diameter 0.025 inch, in a two-layer coil. This would take twelve feet of wire with  $\frac{1}{4}$  the individual turn cross-section, giving the coil 16 times the resistance, about 0.21 ohms.

This would bring the impedance up in the same ratio, to approaching 1.6 ohms, which is usable for many purposes. A three-layer coil would have 63 turns and a resistance 81 times the original single layer, or about 1.05 ohms, with an impedance approaching 8 ohms. A four-layer coil would have 112 turns and a resistance of 256 times the original single layer, or about 3.3 ohms, with an impedance of about 25 ohms.

From a practical viewpoint, odd numbers of layers create the difficulty of bringing the leadout from opposite ends of the coil. Most voice coils that use round wire have an even number of layers. So there are practical limitations to the impedance values that can be wound to fit a specified space.

A more efficient voice coil can be wound with rectangular wire—thin and flat, and put on edgewise (FIGURE 2). This avoids the loss due to the

*Figure 2. Method of winding loud-speaker voice coil with flat, rectangular wire, achieves better space utilization, and provides greater variety of impedance choice.*

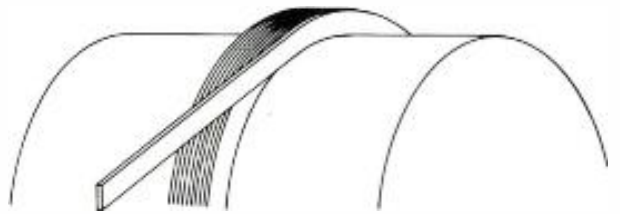

roundness of the wire and can result in a more efficient loudspeaker. With such a coil, the "far end" leadout can be brought back to the same end by twisting it so it can lie flat in the gap on the inside of the voice coil former. This removes the discrete choice limitation on impedances because a rectangular shape can be chosen of any proportions, so that any desired number of turns can be fitted in.

In this instance, there are obvious problems to winding coils with very many turns, that would represent high impedance.

In virtually every coil used in a transducer, space is limited by other constraints in the design. In the loudspeaker, the gap must be kept small to achieve a high magnetic field. In pickups and recording or playback heads, the limitation is set by the mechanical design of the system: the number of tracks on a given width of

tape, or the construction of the pickup needed to respond at the high frequency end, which must be small.

But within the design space allowed, wire gauge can be varied and number of turns adjusted to fill the space without affecting the efficiency of the device. Change of impedance may affect such things as crosstalk problems in the electrical circuit, but it will make no difference to such problems in the magnetic circuit. Magnetic densities are independent of the impedance of the electrical coils that produce them. The same electrical energy will be associated with the same magnetic density if both coils are equally efficient, which means if they equally utilize the available space.

Suppose, for example, the impedance is 500 ohms, of which 75 ohms is winding resistance, made up of 400 turns of a wire gauge that just fills the available space. Suppose that one volt across the 500-ohm impedance corresponds with a specified signal level. Because it is 500 ohms, this will correspond with 2 milliamps, which through 400 turns produces 0.8 ampere-turn of magnetizing force.

Now, for simplicity, suppose a wire gauge of exactly half the diameter is used (whatever that is). This will enable the same space to accommodate twice the width and twice the depth of turns, four times as many, or 1600. This means the wire will be four times as long, and of  $\frac{1}{4}$  the cross section. So its resistance will be  $4 \times 4 = 16$  times the original 75 ohms, or 1200 ohms. The impedance will also be 16 times the value, or 8000 ohms.

The one volt, two milliamp combination represented a power of two milliwatts. The same power, two milliwatts, in 8000 ohms, is represented by four volts with 0.5 milliamps. And 0.5 milliamps in 1600 turns is 0.8 ampere-turns, the same as before. Thus, making this change, providing the new winding occupies the same space (all of it) as the old one, does not change the efficiency at all.

The kind of statement to which I referred at the beginning runs something like this. There are all kinds of variation, but this one will show the idea: Half the turns will halve the resistance, and thus the impedance too. From here, different conclusions may be offered. One is that the same volt-

**Ask anyone.**



**DON'T THINK OF US AS A CHARITY.**

**THINK OF US AS AN INVESTMENT.**

And a good one. Because we can guarantee a substantial return for your money. It pays off in more black college graduates, with more training in more areas.

What we need is operating capital. Money we can put to work supporting forty private, four-year colleges.

These schools educate a lot of promising young kids who'd never get to college on their own. Almost three-quarters need some kind of aid. Over half come from families earning less than \$5,000 a year.

With your help, we can help more.

A \$5,000 donation will give four students one year at an average UNCF college. With \$20,000 we can equip a business education course. \$100,000 will support an entire economics department.

Send a check to 55 East 52nd Street, New York, N.Y. 10022. We think it's one of the best investments you'll make all year. A deal?



**A MIND IS A TERRIBLE THING TO WASTE.**

**GIVE TO THE UNITED NEGRO COLLEGE FUND.**

advertising contributed for the public good



age will produce twice the current, so this arrangement is better

Without pursuing all the possible erroneous conclusions that this false assumption could lead to, let us lay to rest the false assumption. Halving the number of turns, *without changing the wire gauge* (that was the false but unstated assumption) does halve the resistance (approximately, at least). But the impedance is reduced to *one fourth*.

To get the same ampere turns will require *twice* the current in half the turns. But that will result in only half

the signal voltage, inductively. So the impedance will drop from 500 to 125 ohms, while the resistance drops from 75 to 37.5 ohms. If you took 1/5th the turns, impedance drops by the square of 1/5th, or 1/25th, to 20 ohms, while resistance drops to 1/5th, or 15 ohms. The efficiency is rapidly disappearing.

If the number of turns were halved and the wire gauge changed so the winding still filled the same space, the diameter would be increased by about 41 per cent. This would cause the same length of wire to have half the

## At Ampex the same care goes into One Duplicate of One Recording that goes into 10,000 Duplicates of 10,000 Recordings

The same people do it and welcome it.

We hope no one feels that their duplicating job is too small or too large for us—we assure you it isn't. We also assure you that our size makes our duplicating prices more than competitive, our fidelity unsurpassed and our services almost endless.

If you want something recorded—anything—or a recording of any kind duplicated,

all you have to know is "Ampex." That's it, just "Ampex." We do the rest—recording, mastering, mixing, duplicating, mailing—or whatever part of these services you need.

For more information telling how easily and economically you can use Ampex's custom duplicating service, write: Ampex Stereo Tapes Division, Dept. D6, Ampex Corporation, 2201 Lunt Avenue, Elk Grove Village, Ill. 60007.

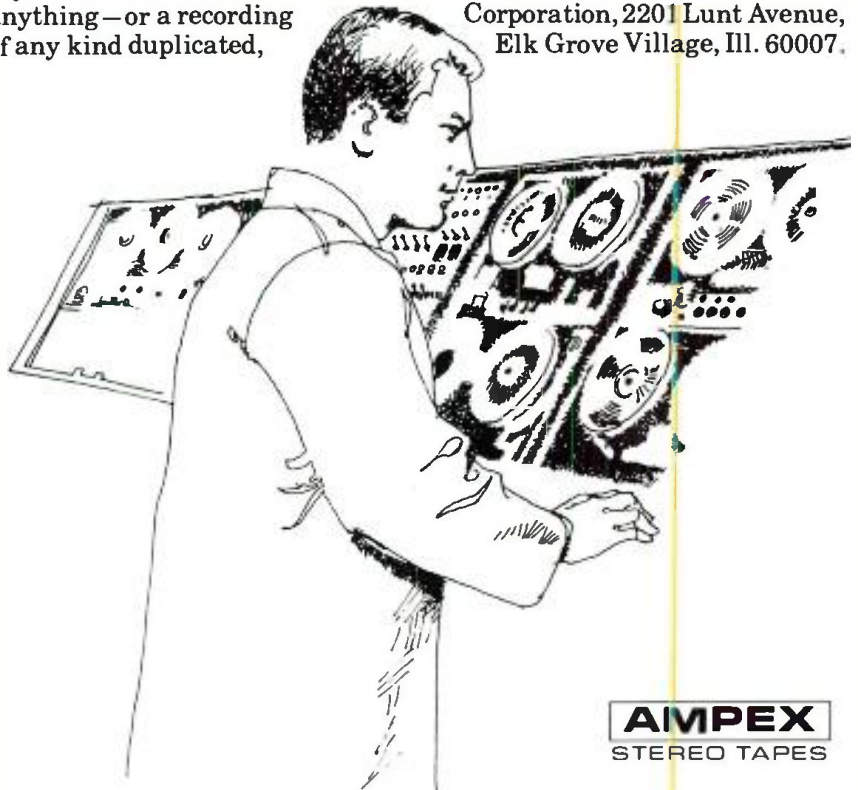

**AMPEX**  
STEREO TAPES

Circle 25 on Reader Service Card

## the new MEP-130 PARAMETRIC EQUALIZER CHANNEL MODULE

"Three Equalizers in one Module!"

ITI's new MEP-130 Parametric Equalizer Channel Module combines the best features of: 1) a 3-knob switched frequency equalizer, 2) a graphic equalizer and 3) an active program equalizer. With no stops, detents or arbitrary positions, the MEP-130's variable shape, variable shelving and infinitely variable frequency controls let it come closer to an average correction than any other equalizer.

The MEP-130 can produce a very sharp notch and hold that shape over various depths. In its broadest position, it is broader than most broad peaks in peaking equalizers. And, it can produce a peak or notch at any frequency and at any shape — contouring its characteristics to match any anomaly to be removed. In operation, one can accurately and quickly determine the frequency and amount of correction required since the peak can be heard as it sweeps through the point of correction. Also, the MEP-130 can simulate perspective effects, and provide several special effects since its frequencies can be swept during use.

Three overlapping frequency ranges (10-800 Hz), (100-8,000 Hz) and (400-25,600 Hz), boost or cut up to 12 dB. Selectivity or "Q" is continuously variable from 4 to 14 dB per octave with infinitely variable shelving curves for the high and low frequency ranges. Panel size is 1½" x 8", and depth is 6¾".

For complete information,  
please write or call:



International Telecomm, Inc.  
McCormick Road & Schilling Circle  
Hunt Valley, Maryland 21031  
(301) 666-7770

Export Agent: Gotham Export Corporation, New York, New York 10014



Circle 17 on Reader Service Card

resistance. So half the length of wire (needed for half the turns) would have ¼ the resistance. Now, as well as the impedance falling from 500 to 125 ohms, the resistance would fall from 75 to 18.375 ohms (or thereabouts).

When one has designed a few windings to fit in specified spaces (as we have) that kind of thing seems almost obvious. But it cannot really be obvious, judging by the number of letters from readers that we get, making incorrect deductions about how windings and their associated performance could be changed.

When we were in school, which is more years ago than we care to think about, there was a science class where the teacher encouraged us to think up ideas for "perpetual motion," or some equivalent device. There was the one about the motor that drove a generator, whose output was fed through a transformer to step up the power, so it could drive itself and have power left over for other uses.

We kind of got through our foolish noggins the notion that nothing can be more than 100 per cent efficient, after a few such wild goose chases. It seems that some never did get that quite straight, by the number of times I have to cope with one or other variant of it. ■

6 to 36 **IPS**



THE MDA-1B IS A SELF-CONTAINED RACK MOUNT, OR TABLE TOP UNIT, INTENDED TO SUPPLY DRIVE MOTOR

POWER TO PROFESSIONAL TAPE DECKS FOR THE PURPOSE OF VARYING TAPE SPEED UNDER PRECISE CONTROL.

\$625

## MULTISYNC MDA-1B

### FEATURES

- \* WIDE FREQUENCY RANGE 48 - 144 Hz
- \* VERNIER CONTROL FOR FINE PITCH ADJUSTMENT
- \* NO MODIFICATIONS OF RECORDER REQUIRED
- \* FIXED 120 Hz. FOR 30 IPS OPERATION
- \* FAIL-SAFE AMPLIFIER PROTECTION CIRCUITRY
- \* EASILY PATCHED FROM RECORDER TO RECORDER
- \* QUADRATURE DRIVE FROM DUAL AMPLIFIERS AND 90 DEGREE OSCILLATORS

### APPLICATIONS

- \* "PHASING-DELAY" EFFECTS
- \* TUNE TRACKS FOR RECORDING NON-TUNEABLE INSTRUMENTS
- \* 30 IPS DRIVE FOR 7.5/15 IPS RECORDERS
- \* COMPENSATE FOR OFF-SPEED TAPES
- \* VARIABLE-DELAY FOR DOUBLE-TRACKING
- \* LENGTHEN/SHORTEN RUNNING TIME OF BROADCAST TAPES

THE MDA-1B CONTAINS ITS OWN POWER SUPPLIES, OSCILLATORS, AND POWER AMPLIFIERS. THE CONNECTIONS TO AND FROM A DECK ARE MADE BY TWO CONTROL CABLES. THESE CAN BE INSERTED INTO EXISTING CONNECTORS WITHOUT ANY MODIFICATION TO THE TAPE DECK.

PACIFIC RECORDERS AND ENGINEERING CORPORATION  
11760 SORRENTO VALLEY RD., SAN DIEGO, CALIFORNIA 92121  
TELEPHONE (714) 453-3255



Circle 20 on Reader Service Card

## Copies of db on Microfilm

Copies of all issues of db—The Sound Engineering Magazine starting with the November 1967 issue are now available on 35 mm. microfilm. For further information or to place your order please write directly to:

University Microfilm, Inc.  
300 North Zeeb Road  
Ann Arbor, Michigan 48106  
A subsidiary of Xerox Corporation

In addition to Microfilm Copies available through University Microfilm, we have a limited number of regular back issues available. You may order these copies at \$1.00 each from:

Circulation Department  
db—The Sound Engineering Magazine  
980 Old Country Road  
Plainview, New York 11803

# NEW PRODUCTS AND SERVICES

## BI-POLAR POWER SUPPLIES

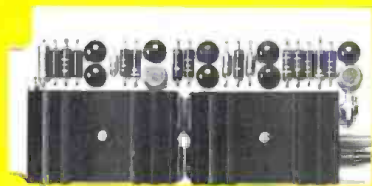

● Short circuit protection designed into the circuitry as an integral function is a feature of two new power supplies, model 411AC for unregulated, filtered d.c. and model 411 for selectable, regulated d.c. Model 411AC provides unregulated d.c. from 27 to 40 volts d.c. (plus and minus) with less than 0.25 volt ripple at one ampere and is designed to provide filtered d.c. for model 411. It may also be used as a source for any circuit using unregulated d.c. It is enclosed in a compact metal container (3½ inches high by 6½ inches wide by 8 inches deep) and may be conveniently located since heat dissipation is not a consideration. Model 411 provides selectable, regulated d.c. from 20 to 28 volts (plus and minus). Output is regulated within 0.3 volt and from no load to full load. The printed circuit is on standard card size, which may be inserted in a card holder or used with ten terminal bifurcated connector. Noise volume, both models, 100 µV positive and 300 µV negative, 20 Hz to 20 kHz.

*Mfr: Spectra Sonics*  
*Price: 411AC; \$84.00—411; \$66.00*  
*Circle 82 on Reader Service Card.*

## SPLICING BLOCKS



● Precision machined of non-magnetic, gold anodized duraluminum, these splicing blocks are specifically grooved to hold tape firmly during the splicing operation. A single edge stainless steel cutting blade and ten splicing tabs are included with each block. Three models are available: model QM-311 for ¼ inch tape; model QM-312 for 0.150 inch cassette tape, and model QM-313 for ½ inch video and audio tape.

*Mfr: Nortronics*  
*Circle 76 on Reader Service Card.*

## PARAMETRIC EQUALIZER CHANNEL MODULE



● The best features of a three-knob switched frequency equalizer, a graphic equalizer and an active program equalizer are contained in new compact Model MEP-130 module. All controls are continuously variable, with no stops, detents or arbitrary positions. The module has three overlapping frequency ranges; (10-800 Hz), (100-8,000 Hz), and (400-25,600 Hz), boost or cut up to 12 dB. The low and high frequency band "Q" controls vary the frequency band's skirt characteristics from 4 to 14 dB per octave. The low and high frequency band "Q" controls, when turned to the full ccw position, change their respective bands into continuously variable frequency shelving curves. The noise level is less than -84 dBm and the distortion less than 0.03 per cent thd, at any level from 0 dBm to +24 dBm (10-40,000 Hz). The module may be inserted in any line without program quality degradation.

*Mfr: International Telecom Inc.*  
*Price: \$670.00*  
*Circle 50 on Reader Service Card.*

## EXPANDABLE MODULAR RECORDING/REMIXING CONSOLE

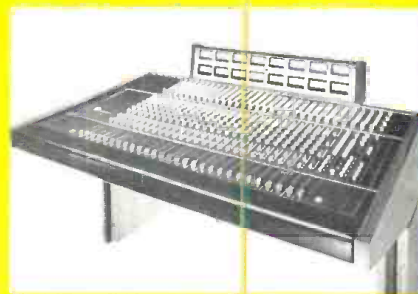

● Model 501 console is designed to accommodate 24 track recording and quad mixdown and is expandable to 26 inputs with complete metering, expandable patching and a full line of matching accessories. It has up to 26 input channels, each for mic and line with the following: Linear motion fader; microphone gain trim; input on/off switch; solo tape track or input fader; two independent studio cue mixes; echo selectable from monitor channel or input position; echo level control; echo send to four echo chambers in any combination; four knob equalizer; low and high cut filter; equalizer in-out switch; monitor level control; monitor channel assignment L-C-R; monitor sync overdub switch; quad pan pot; quad source selector from monitor matrix or program; independent selection to main 16 output channels. It has twenty-three program output channels, all console outputs at +24 dBm capability, balanced, transformer isolated. Sixteen vu meters are switched to indicate level conditions of all channels, including 16 main, 4 quad, stereo and mono, as well as cueing and monitoring controls. Master input muting kills all inputs simultaneously.

*Mfr: Auditronics, Inc.*  
*Circle 75 on Reader Service Card.*

## BATTERY OPERATED REWINDER

● This self-contained battery re-winder, model R36005, evenly spins a C-60 cassette back to its beginning in only twenty-two seconds. Measuring 4 inches by 2¾ inches by 2 inches, this compact automatic unit can be operated with one hand.

*Mfr: Robins Industries Corp.*  
*Price: \$15.00*  
*Circle 60 on Reader Service Card.*



## RECORDER/REPRODUCER

● Completely redesigned electronics and a new tape motion sensing system are featured in the new Scully 280B recorder/reproducer. S/N ratios top 72 dB at mastering speeds; bandwidth is essentially flat, displaying  $\pm 2$  dB 30 Hz to 18 kHz. All test and adjustment points are readily accessible on a mother-daughter board; all electronics slide out on roller arms; individual channel modules are easily removed. A new motion sensing system, called OPTAC, and internal logic enable the engineer to select a new mode and activate it without touching the *stop* button first. It also allows the engineer to enter and leave the record mode while the transport is in play. Selective synchronization is standard on all multi-channel machines, making it possible to record programming material synchronous with previously recorded tracks. Available in rack or console; one, two, and four channel models available with most of the popular head configurations.

Mfr: Dictaphone Corp.

Price: Starts at \$2,395.

Circle 87 on Reader Service Card.



## COMPUTERIZED AUDIO CONTROL SYSTEMS

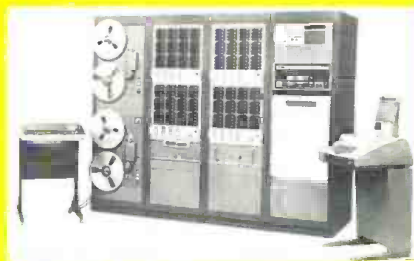

● Several new computerized audio control systems have been introduced by this manufacturer. Model 740 features an integral mini-computer plus two IGM 48-unit "Instacarts," two stereo reel-to-reel transports, automatic time-and-temperature announcer and complete high speed English log printout. Model 760 has a control unit equipped with dual magnetic tape memory and twin CRTs with keyboards which can store, change, schedule, and call up programs at will. Bat 1000 is a computerized system to provide broadcast management with integrated control of traffic, billing, payroll, and accounting work. They are also offering a simplified two-track control system, model 400; and model 502-4, with Instacart and direct access MOS memory.

Mfr: International Good Music, Inc.  
Circle 65 on Reader Service Card.

## DO YOU NEED A MIXING SYSTEM

BETWEEN THIS



AND THIS?

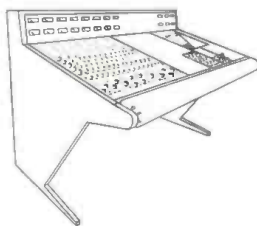

WHY NOT LOOK INTO GATELY SERIES 7 AND SERIES 8 CONSOLE BUILDING BLOCKS . . . THE MEDIUM PRICE CONSOLE MIXING SYSTEMS WITH EXPANDABILITY.



**GATELY ELECTRONICS, Inc.**

IMPORTERS AND MANUFACTURERS: Ortofon Disc Cutting Equipment, Schoeps Microphones, Jorgen Schou Transformers, C1616/C2424 Mixing Consoles, PROKIT, Series 7 and 8 Mixing Systems.

57 WEST HILLCREST AVE. • HAVERTOWN, PA. 19083 • 215-446-1415

Circle 14 on Reader Service Card

## SOUND LEVEL METER



● A ceramic microphone which gives flat response to 10 kHz and will operate in ambient temperatures as high as 125 degrees Fahrenheit is featured on model 452 type two sound level meter. The microphone is detachable and can be placed up to 500 feet away from the instrument. The meter circuitry is of the quasi-rms type which reads the true rms value of pure tones, white noise, and other complex waveforms, and is compensated to eliminate temperature dependent scale error of conventional meter/rectifier circuits.

Mfr: H. H. Scott

Price: \$298.00 (Accessory calibrator, \$115.00)

Circle 71 on Reader Service Card.

## MAGNETIC PHONOGRAPH CARTRIDGES

● These new units use a patented magnetic circuit, the variable magnetic shunt, which provides both extra linearity and lower mass than conventional arrangements. These cartridges feature high compliance, extended frequency response, and wide spectrum tracking ability at low tracking forces. Include user-replaceable styli and have output to match all conventional magnetic phono inputs. SL-15, moving coil cartridges, are also again available through authorized dealers.

*Mfr: Ortofon*

*Price: \$25 — \$80*

*Circle 55 on Reader Service Card.*



## VANDAL-PROOF SPEAKER BAFFLES

● A special screw which cannot be turned without its own wrench insures the safety of this speaker baffle. The baffle, made of solid cast aluminum, comes in surface mount, bi-directional, and recessed styles. The speaker grille consists of impervious stainless steel wire woven into a tight mesh and backed with a sheet of perforated metal. Adaptor rings available.

*Mfr: Soundolier, Inc.*

*Circle 88 on Reader Service Card.*



## 8-DIGIT CALCULATOR KIT

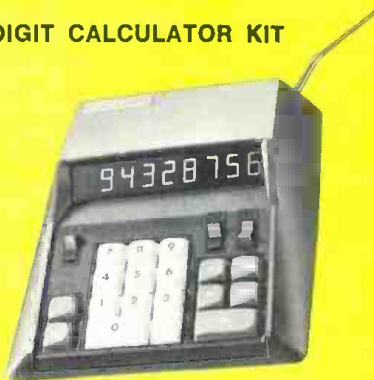

● This desk-top calculator, IC-2108 is a complete four-function unit with both floating and fixed decimal. A constant key permits chain calculations and a clear entry key allows removal of an entry from the display window without disturbing prior calculations. Negative answer, entry and result overflow indicators are automatically displayed and the color-coded keyboard is helpful when making lengthy arithmetical calculations. Complete instructions for building the calculator are provided with the kit; no extensive knowledge of electronics is required.

*Mfr: Heath Company*

*Price: \$79.95*

*Circle 70 on Reader Service Card.*

## T.V. PRODUCTION AUDIO CONSOLE

● The flexible model 210 microphone input panels may be used to fabricate a variety of portable consoles. Console includes a test oscillator, slate microphone, and boom—p.a.—auxiliary feeds. Push buttons and meter are lighted. Model 1604 TVK kit includes cabinet meters, power supplies, etc. Model 1604 TVW kit is wired.

*Mfr: Opamp Labs, Inc.*

*Price: #1604 TVK \$4,200*

*#1604 TVW \$6,500*

*Circle 56 on Reader Service Card.*

## QUADRIPHONIC DEMONSTRATOR



● Designed primarily for four-channel demonstrations, the Quadraswitcher provides for both two-channel and four-channel control. It has three modular components, a program selector, amplifier/receiver selector and speaker selector, designated by easy-to-distinguish "glo-buttons." The demonstrator can choose any of twenty-four different source components—any of twenty-four cassette tape decks, 8-track decks, open reel decks, tuners and/or preamps, or phones fed through outboard pre-amps. Each source plugs into the program selector module with a patch cord assembly. Line or auxiliary inputs and speaker outputs of twenty-four different four-channel and stereo amplifiers and/or receivers are connected to the module with patch cords and have switch button selection. Speaker outputs are fed into the input of the speaker system selector module. Up to twenty-four different pairs of speakers may be connected to the module with patch cords. Either front or rear signals can be fed to any pair of speakers. A helpful designation strip increases the quick-change capability of the translucent pushbuttons. Quadraswitcher mounts in standard 19-inch racks; it can be custom-mounted in walls and consoles.

*Mfr: Switchcraft*

*Circle 86 on Reader Service Card.*

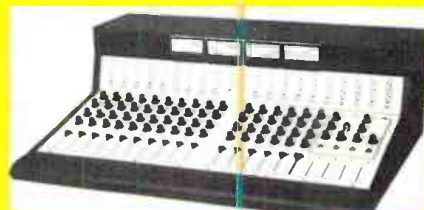

## QUARTER-INCH CONSOLE RECORDERS

● These professional audio recorders come in one- and two-track quarter-inch and four-track half-inch configurations, including the features of this manufacturer's M-79 multi-track series. Designed for broadcast, educational and recording studio use, the recorders operate at three speeds (7½, 15 and 30 in./sec.), but are capable of variable speeds from 5 to 45 in./sec. by virtue of a new d.c. servo capstan assembly. They embody the "isoloop" drive and single card electronics and are convertible to any of the one-, two- or four-track configurations. Rack-mounted configurations will be available later.

Mfr: 3M Company

Price: \$5,725 for four-track; \$3,725, two-track; \$3,325, one track  
Circle 53 on Reader Service Card.



## "BUILDING BLOCK" BROADCAST AUTOMATION

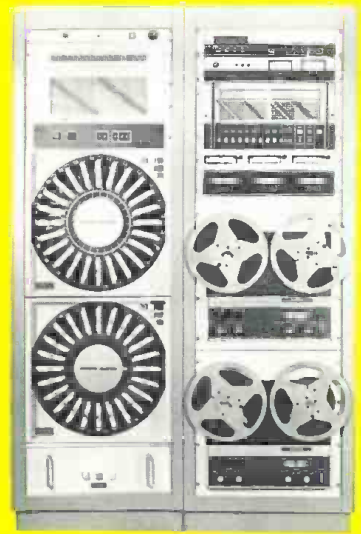

● This equipment, available in two stages, provides for lighter or heavier commercial needs. Spartamate I is a single rack filled with digital clock, program controller, line and monitor amplifiers, three Century Series tape cartridge playbacks and twin reel/reel transports; it offers part-time automation with limited commercial content. Spartamate II handles heavier commercial loads via a pair of 24-cartridge carousels and RS250 random access. (RS250 is a "search ahead" device with skip feature, enabling the user to program uneven spot loads.) Options include the AP2 alarm panel which gives both audible and visual signals, and the TA581 time announcer. Automatic logging is also available.

Mfr: Sparta Electronic Corp.

Price: Spartamate I: \$6,495

Spartamate II: \$12,500

Circle 67 on Reader Service Card.

## IT REALLY WORKS! (ask Joshua!)

That venerable old sound man of Scripture specified horns for a tricky outdoor job at Jericho. What was true in those days, holds true today. Nothing can match the efficiency and projection qualities of horns. Today, Community Light & Sound offers solid bass transients, excellent vocal projection and crisp highs — all in one compact package: the FRC — a full range co-axial horn that will accept at 15" LF driver and a 1-3/8" x 18 threaded HF driver. With proper drivers, the FRC handles 200W RMS and covers the PA audio spectrum with efficiency and projection that is available only from straight horns. Fiberglass construction makes the FRC virtually indestructible in portable service and 65 pounds light (less drivers).

The FRC is probably the most efficient full range speaker system available today. In applications requiring compact, lightweight, high output equipment for PA or instrument amplification, spec the FRC and "bring the house down!"



## Community Light & Sound

P.O. Box 21759, Philadelphia, PA 19146

FRC, \$265.00 List, less drivers also available as FRC/B (without HF horn) \$235.00 List, less drivers

Legs shown are optional

DEALER INQUIRIES INVITED

## BROADCAST CARTRIDGES



● Reduced tip mass, according to this manufacturer, produces outstanding frequency response for both on-the-air and critical listening. The three new cartridges in the series, built to withstand rugged handling, are: 600A, spherical stylus tip—tracks at 2 to 4 grams; 600E, elliptical tip—tracking of 1½ to 3 grams; 600EE, elliptical tip—1 to 2 grams tracking force.

Mfr: Stanton Magnetics

Circle 80 on Reader Service Card.

Circle 23 on Reader Service Card

www.americanradiohistory.com

# SOUND WITH IMAGES

## Inventions & Innovations

● During the last week in March, a convention and exhibit took place to which all sorts of people went, including members of many industries, organizations, hobby and avocation clubs and groups, general and varied enthusiasts, the curious, and of course, interested business men. Sometimes, this get-together can prove interesting to specialists in various fields, even hi-fi and audio/visual experts. At this latest one, there were a few things of varying interest, so there might be something for you, too.

PatExpo '73 took place at the New York Hilton Hotel and covered one large floor area. For four days, the International Patent and Licensing Exposition showed the latest in new products, unexploited inventions, and some revolutionary technology from all over the world. Over 600 exhibitors showed many more than 1,000 different items looking for licensees, manufacturers and buyers. The entire proceedings were sponsored by Patents International Affiliates, Ltd., New York and New Product Development Services, Inc., Kansas City, Missouri. Since 1965, similar exhibits took place in Chicago, Los Angeles, London, Geneva, and plans are presently in the works for another showing in Tokyo next year. But, back to this year.

Exhibits ranged from small items such as an automatic potato-peeler to a 50 pound portable kinetic punch, able to drive 1/8-inch holes in cold rolled steel at the speed of a punch a second. A great many of the items shown were for the household, many for gardening and hobby or spare-time activity, some for safety in industry or the home, many for general industrial application, and some for the general "good of man and world peace."

Setting the tone for the exhibit, a paper entitled "Transfer of Technology," by Mr. Hilton E. Patterson, Executive Vice President of New Product Development Services, ran down a brief list of inventions and discoveries from the beginning of iron metallurgy in Europe in 1000 B.C. to the first successful nuclear chain reaction in 1942, including such notable giant-

steps as the invention of movable type in 1456, the first U.S. patent (signed by George Washington, incidentally, in 1790) for an improved method of making potash, the cotton gin in 1794, the grain reaper in 1834, the telegraph in 1840, the typewriter in 1868, and the telephone in 1876. Further among the notable markers in the advancement of mankind's knowledge of science and technology, there were Edison's phonograph in 1878 (one of over a thousand for which Edison received patents), the "flying machine" in 1906, the first plastic material in 1909, and the first a.c. radio set in 1922.

Mr. Patterson then continued with some thoughts on scientific and technological advancements.

"Since 1942, technological advances have greatly increased man's productive abilities and raised his standard of living through increased income. The variety of conveniences at a person's disposal is staggering. Three technological developments which contributed nothing to our gross national product in 1942, today contribute several billion dollars and possibly up to one million jobs in the United States alone. These are television, jet airplanes in passenger use, and digital computers. In a very real way, each of these affect the quality of our lives.

"New technology and new uses for existing technology constitute the foundations on which major new industries and businesses will be built in the future.

". . . We have mentioned the terms of science and technology as aids to successful manufacturing. Let's distinguish between the two: Science is the body of knowledge, or as it is more commonly used, the knowledge of a specific field, say physics or chemistry. Technology is industrial science, or, as the dictionary puts it, 'a systematic knowledge of the industrial area.'

". . . The National Science Foundation estimates that industrial spending on research and development, excluding funds supplied by the Federal Government, totaled nearly sixty-six billion dollars during the 1960s.

"Over twenty five per cent of approximately 70,000 patents granted annually by the Patent Office are issued to the so-called independent inventor. Seventy per cent are claimed by corporations, and the remaining five per cent of the patents are products of inventors under contract to government agencies or universities.

Because of the great number of inventions and the need for a way to present them to industry where they can be put to use and because there is need for a different type of personality to promote the idea than it took to develop it, Mr. Patterson stated that "a new industry, involved in the transfer of ideas to actual use by the consumer, has been evolving to help bridge the gap between the individual inventor and industry, or between industries and within industries. This can serve the interest of both the inventor and the manufacturer who is seeking new products and processes to exploit by bringing the two together. The technology transfer industry is always looking for new ideas, new products, new processes from any source."

With these thoughts in mind, a very small sample of the items on display will indicate what the present is showing for the future.

In the field of safety, a Japanese manufacturer of electrostatic industrial smoke scrubbers and dust collectors presently in use in iron and steel, as well as mining and chemical plants in Japan, has come up with an electrostatic fog dispersion device for use at airports and on highways. The device, which can also possibly be used for smog dispersion, was demonstrated on a scale model of San Francisco over which artificial fog was generated for the test. The fog was gone in seconds. Electro-static paint sprayers made by the Nippon Kogei Kogyo Co., Ltd. of Japan are presently used throughout the world.

For safety around the home, a simple push on a button puts a scaffold up two stories or down to 3 feet. Helps one man put up his, or anyone else's, t.v. antenna.

From Korea, several items which can be a boon to a camper out in the field or a homeowner in an emergency were shown. Hanju Enterprise Co., Ltd., displayed a novel safety match which incorporated in its composition the solution to three common problems inherent in the ones in present use. The composition of the safety matches now in use produces strong fumes during use and sometimes can leave an ember in the wood stem when the head is burned out. The match also cannot be used when the head has been wet. The new match

works when wet, does not produce obnoxious smoke and odor and is out all the way when put out. The trick is in the chemical makeup of the head and stem. For those who still smoke, this same company has produced a cigarette which needs no match. Here's another boon for the outdoor man who either forgot his matches or to refuel his lighter. "Insta-Lite" ignites the cigarette by rubbing it against a striker surface, similar to that on a book or box of matches, which is on the side of the pack. When you consider that more than 562 billion cigarettes went

up in smoke in 1970, there's quite a potential market out there. One more invention by the same company is waterproof ignition charcoal. This comes in charcoal briquettes made of a special composition which will allow them to be ignited by a match, without the use of any inflammable liquid at all. High temperature is created all around, which ignites the adjacent briquettes without a trace of a single obnoxious fume. For outdoor cooking at home or at camp, this, too, seems to have potential.

For international application, the In-

terlingual Cultural Machinery, Inc. of New York City, announces an interlingual typewriter capable of typing any modern language. A complex keyboard with 180 keys and an electronic control system makes this possible. Languages such as English, Hebrew, Arabic, Slavic, German, Hindi, Pakistani, Latin, Korean, Japanese and Chinese are all possible. Anyone with a basic knowledge of languages such as Chinese or Hebrew, which use a different alphabet from ours, can learn to operate the machine. The cylindrical rotating drum in the typewriter can reproduce 5,520 characters of the Chinese language, sufficient for newspapers and most publications.

In the music field, XES-Series, Inc., N.Y., showed a prototype model of their new electronic guitar. This instrument is quadriphonic (four channel output) with a unique selection of output signals. Six transducers, of which two are in the neck of the guitar under the fingerboard, provide 35 different combinations of tone control. Fifty transistors and 100 other circuit components in the body, all powered by five standard 9-volt batteries, permit different sound effect combinations by flipping channel switches. Provision has also been incorporated for two other inputs such as microphone or guitar, to feed through this instrument. The outputs of the instrument can either be plugged directly into four amplifiers (or any number up to four) or fed by two internal f.m. transmitters to two individual receivers, or any combination of these output possibilities. It is even possible to disconnect the neck from the body very simply for complete portability or for attaching other necks for different sounds. All circuitry is on easily replaceable boards.

Among the myriad of other devices and gadgets described, presented or demonstrated at the PatExpo, there was a Vector-Trig calculator with circular slide rule; a computer-oriented slide rule; a "Trol-light" which permits a light to track its way around the room; extended board and multi-sided chess for four players or partners; a spherical chess game; and from the United Kingdom, a colorama system which can be used for advertising or home novelty or decorating or illuminated signs or . . .

The gamut was run from A to Z at this exhibit, and if you should like to see a similar exposition before PatExpo of 1974, there will be a Techno '73 in Tokyo beginning in November, 1973. This will be the first International Licensing Expo in Asia. It will take place at the Tokyo Science Museum. ■

## HOW TO MAKE ANY RECORD BETTER: PRESS IT ON Q-540.

Q-540 is the most significant advance in record compounds in years. Developed for CD-4 (quadraphonic) recording, it has the unique capability to absorb 4 blended discrete channels of sound and reproduce them with greater clarity and brilliance than has ever before been possible.

Q-540 is also far superior to ordinary compounds for pressing monaural, stereo, and matrix quad recordings.

Here's how Q-540 makes any record better:

- **GREATER BRILLIANCE** — To really appreciate the brilliance and clarity of Q-540 you should compare it to ordinary compounds. Hearing is believing.
- **LONGER WEARING** — A record pressed on Q-540 will play with perfect fidelity up to 3 times longer than one pressed on anything else. And the 30,000 cycle carrier channel necessary for CD-4 doesn't wear off Q-540 the way it does on other compounds.
- **ANTI-STATIC** — Because of Q-540's exceptional anti-static characteristics, there is far less surface noise, less dust attraction, and much greater ease in keeping grooves clean and lint-free.
- **FAST-FLOWING** — Increases production rate by shortening the pressing cycle. Fills better than ordinary compounds. Less susceptible to warping at faster cycle rate.
- **GOVERNMENT-APPROVED** — Easily surpasses all FDA and Public Health Service requirements through 1974.

**Q-540**  
Makes the best sounds better.



(213) 365-3991 • (805) 259-2360  
**KEY-SOR-CENTURY CORPORATION**  
26000 Springbrook Road • Saugus, CA. 91350

Pioneering in record compound production since 1948.

Circle 28 on Reader Service Card



# ULTIMATE

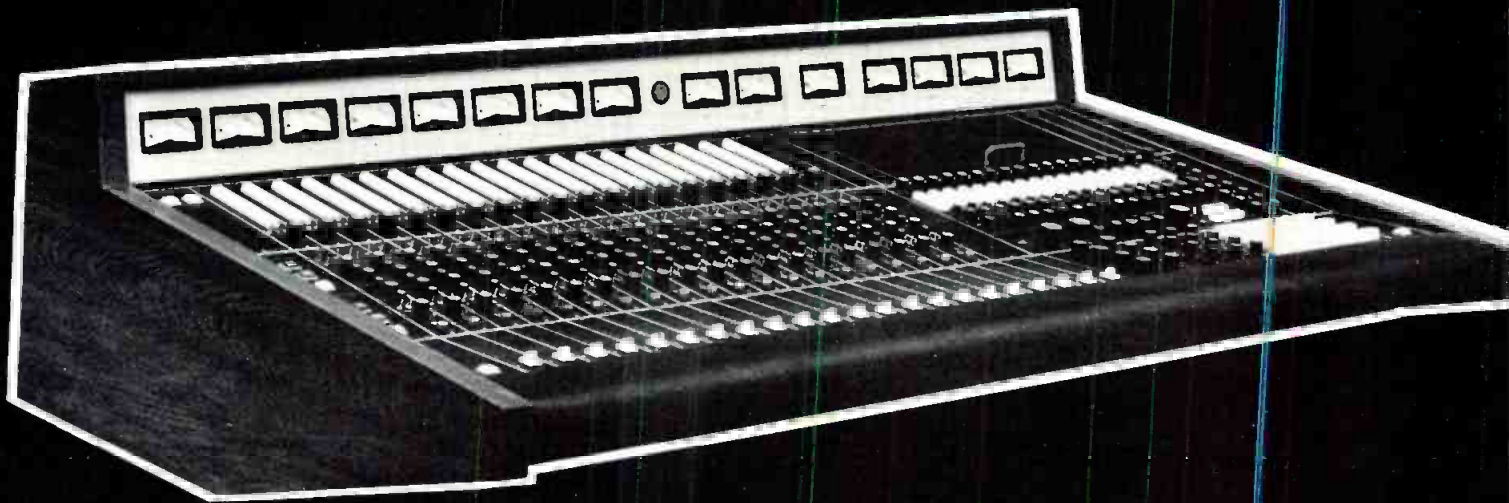

**PERFORMANCE:** SPECTRA SONICS design and quality control assures undistorted reproduction. Empirical data conclusively confirms that noise, frequency response, distortion, square wave response, peak overload and phase distortion specifications for SPECTRA SONICS control consoles are goals as yet unattained by other manufacturers of audio products.

**DEPENDABILITY:** SPECTRA SONICS consoles operate reliably, consistently and assure the maximum production time for the highest investment return.

A SPECTRA SONICS audio control console can be built to your special requirements, at competitive production prices.

Measure the performance of your console, compare it with SPECTRA SONICS specifications. For data on SPECTRA SONICS consoles or other quality audio products, write or call:

770 Wall Avenue  
Ogden, Utah 84404  
(801) 392-7531

6430 Sunset Blvd., Suite 1117  
Hollywood, Calif. 90028  
(213) 461-4321

## SPECTRA SONICS

LEADER IN ADVANCED TECHNOLOGY

Circle 31 on Reader Service Card



# Monitoring— Room Acoustics

*Reverberation occurs as late sound in a large room such as an auditorium and early sound in a small room. The author leads you to a full control of acoustics in the control room.*

**T**HE DREAM of the record or film producer is the interchangeable sound studio. A production staged at several different locations and yet capable of being intercut, without the individual sound of each location making the cutting obvious, would greatly enhance the versatility and economics of production. However, this has been an elusive goal to reach. The reasons lie in the difference in the acoustics of the various rooms. Approaches to solving the problem have included attempts to develop a monitor loudspeaker which would sound the same in any room and attempts to equalize the frequency response of the monitor speaker drive electronics to compensate for the effects of the loudspeaker and the monitor room.

The problem lies not so much in different sounding studios as in the monitoring. Studios can be made as dead as possible or miking be done as close as possible, using directional microphones recorded on separate tracks. The sound in the final recording can be controlled in the mix-down, utilizing artificial reverberation, equalizers, etc. However, the sound in this final recording will be the sound that the mix-down engineer hears in his monitor room.

Moving the same engineer into a different monitor room invariably results in a different sound, even when identical monitor speakers are used in each room. It would appear, therefore, that equalization of the electronics for the room is the answer. However, attempts to do this have met with limited success.

The technique of room equalization was developed to improve the naturalness and gain before howlback of sound-reinforcement systems in large rooms and auditoria. Before applying it to the monitor room, it is necessary to see the differences between these rooms and auditoria.

## PSYCHOACOUSTICAL FACTORS

The transmission path to the listener's brain for an impulse emitted from a source is affected by both physical and psychological factors. The first sound that reaches the ear is the impulse traveling directly from the source to the ear. Following this come reflections off close surfaces. After this come a nearly infinite number of reflections randomly mixed together as reverberation.

All human senses have a characteristic "fusion" period, during which all stimuli received seem to fuse into a single stimulus. Thus, for a motion picture to appear continuous,

even though it consists of individual frames, the frames must be flashed at a rate no less than sixteen frames per second or about 65 milliseconds between frames. Similarly, all the reflections of a sound impulse heard during those first 65 milliseconds are fused into a single stimulus. The sound heard after those 65 milliseconds is heard as a discrete stimulus. If that sound is a single reflection, it is heard as an echo. If it is an infinitude of reflections, it is heard as reverberation.

The exact fusion period varies from individual to individual and is greatly affected by fatigue, physical condition, and drugs. Many persons have experienced the flickering of a motion picture after having a few drinks. The fusion period can vary anywhere from 30 to 90 milliseconds although it usually varies only 50 to 80 milliseconds.

It is also generally accepted that the spectral characteristic of a sound is determined by the sound received during those first 65 milliseconds.

## ROOM MODES

The key, then, is in how these sounds combine in the different types of rooms. The characteristics of rooms that most affect acoustical performance (assuming the rooms have no concave surfaces that can focus echoes, etc.) are their major dimensions, their volume, surface area, and the nature of the surface. Associated with each major dimension are frequencies at which the dimension is a half wave length or a multiple thereof. If the room dimensions, that is, the length, width, and height, are nearly the same, then one single frequency will dominate. If one is much greater than the others, then the frequencies associated with that dimension will dominate. The best rooms are such that no dimension is more than three times any other and all are different.

Assuming that the room dimensions are reasonably unlike each other, they will cause fundamental modes at three frequencies, usually within an octave of one another, plus modes at multiples of these frequencies. About three octaves above the fundamental mode, the number of frequencies becomes so great that they no longer look like separate modes and the response of the room begins to look flat. In an auditorium in which the shortest dimension is twenty feet, the modes would become dense at less than two hundred hertz. However, in a monitor room where the shortest dimension may be seven feet, troublesome modes can exist up to 600 Hz.

Room modes occur because the sound wave is reflected back and forth between opposite walls. When the distance between the walls is a half-wave, the reflections appear to stand still, being at zero amplitude at each end. Thus they

Figure 1. At (A) we find a listener in a control monitor room, while at (B) he is in an auditorium, or the studio. In the monitoring room, the paths of the direct sound and the reflection differ by a few feet so they arrive only a few milliseconds apart. In the auditorium/studio they are separated by more than ten times that period. From this fundamental difference grow the many distinctions between the sound in the two types of rooms.

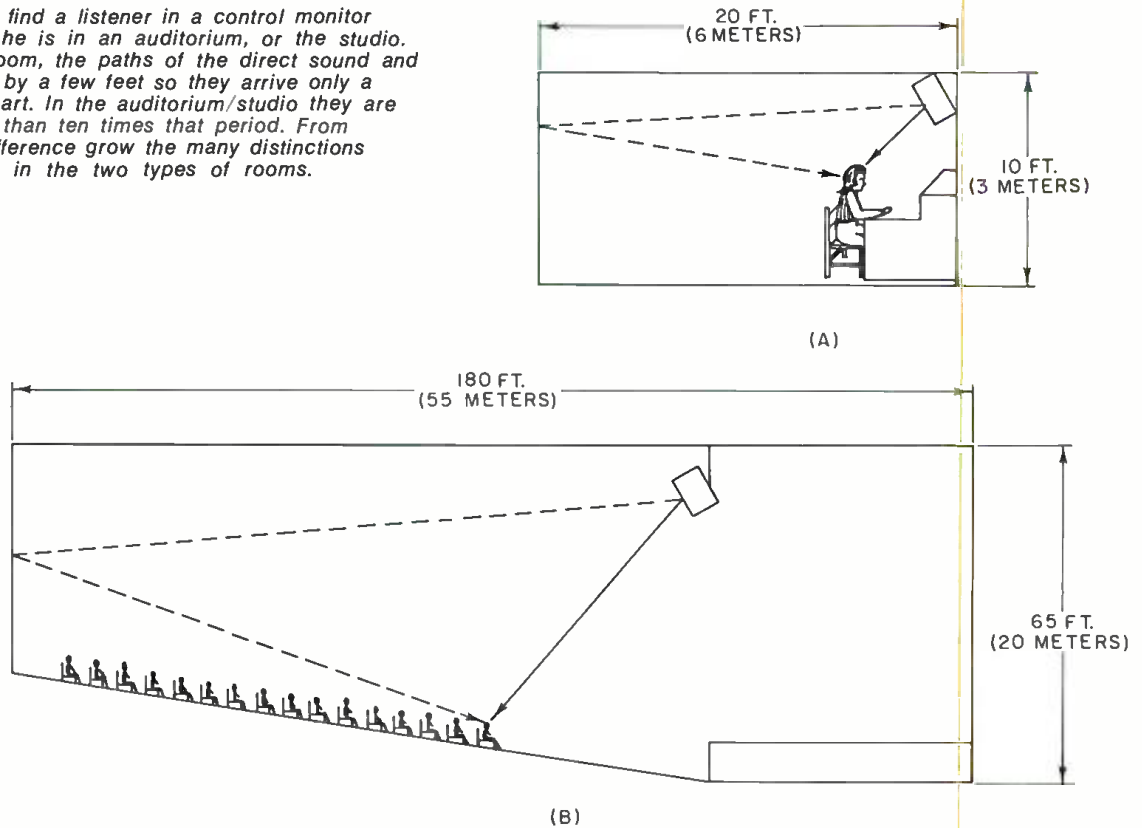

are referred to as standing or stationary waves. However, reflections need not go directly between walls. They can also bounce off walls obliquely in the manner of a billiard ball. It is easy to see that there could be many distances these reflections will travel, particularly at wave lengths which are short compared to the major dimensions of the room. The average length of all these paths is important in describing the acoustical characteristics of a room. The average length is referred to as the *mean free path* ( $d$ ) and it is determined by the volume ( $V$ ) and the surface ( $S$ ) approximately by the expression:  $d = 4 V/S$ . The greater the volume with respect to the surface area, the longer is the mean free path. The number of reflections which will occur in a given period of time ( $T$ ) is a function of the mean free path and the velocity of sound ( $c$ ):  $n = cT/d = cT/4V = cT/d$ .

As the mean free path increases, the number of possible reflections in a given time decreases since the sound must travel further before it is reflected. During the first 65 milliseconds after the generation of a sound, the small room with a short mean-free-path may have ten reflections while a very large auditorium may actually have no reflections reaching the listener during those first milliseconds (except for reflections from a stage enclosure, if used). Obviously the random reflections necessary to build a reverberant field cannot occur before even the first reflection is received.

From this, the walls and volume of the room can be seen to be analogous to the plates of a capacitor. As these plates become larger, it takes a longer time to charge the capacitor. Similarly, a very large room requires a long time to build up the reverberant field, whereas in a small room—the size of a monitoring room—the reverberant field will build up quickly, making the reverberant field a component of the early sound fused with the original impulse.

### SOUND ABSORPTION

Once charged, the reverberant field assumes a uniform level throughout the room, provided the input signal is

maintained. The level of this signal compared to the power level of the source is a function of the amount of absorption in the room. Thus, a room with an absorbent drop-ceiling and heavy drapes spaced away from walls or windows, or other absorbing measures will have less energy in the reverberant field, since more of the energy will be absorbed each time the sound impinges on the absorbent surface. However, the amount of absorption is not constant with frequency. Materials which do a good job of absorbing high frequencies frequently do a poor job of absorbing low frequencies. Low frequencies are frequently absorbed by vibrating panels or Helmholtz cavity absorbers which have very little effect on high frequencies. Unless extreme care is taken in the design of the boundary surfaces, it is unlikely that the absorption will be constant with frequency.

The effect of these differences in absorption with respect to frequency depends on the number of reflections during the early sound period. On each reflection, the energy density ( $D$ ) of the sound is reduced according to the absorption ( $\alpha$ ) of the surface. Assuming uniform walls, after  $n$  reflections the energy density is  $D(1-\alpha)^n$ . Absorption could change, for example, from .05 to .75 between 250 Hz and 1000 Hz so that the energy density, and consequently, the sound pressure level, in our monitor room with ten reflections averaged for the early sound would be down 7.7 dB at 1000 Hz compared to 250 Hz.

However, in our auditorium with one or less early reflections, the difference will be less than 2 dB.

Therefore, the distortion of the frequency spectrum by the room depends both on the absorption versus frequency of the room and on the discrete modes at wave lengths comparable to the dimensions of the room. The degree of effect of these on the sound will depend on the mean free path, a function of room size. The problem of equalizing an auditorium, therefore, becomes one of controlling the nature of the original sound primarily and then compensating for low frequency room modes which may create howlback below about 200 Hz.

## MONITOR ROOM EQUALIZATION

Yet, in the small room, both the room modes and the reverberant field will fuse with the sound in the first 65 milliseconds. It will appear, therefore, necessary to equalize the sound source for the room characteristic in order that spectral distortion be eliminated. However, two problems occur. One has to do with the transient nature of the sound and the second has to do with location in the monitoring room.

The room volume, surface, and absorption affect the rise and decay time of the reverberation. In the large auditorium or studio this rise and decay occurs during the late sound, leaving the early sound crisp. However, in the monitoring room, the reverberant field charges fast, blending the reverberation with the early sound. Equalization will not eliminate this muddy characteristic and could aggravate it, causing the recording engineer to attempt to correct for it in the mix-down.

The problem of room location becomes important because the room modes, which we have said may occur in the small monitoring room up to 600 Hz, are standing waves. They have peaks and nodes along the dimension with which they are associated.

Thus, as one moves from one end of the room to the other, one goes from a low amplitude to a high amplitude and then back to a low amplitude for as many times as there are multiples of a half wave length in the room dimension. The problem of equalization then becomes—what listening position in the room does one equalize? Considering that the half wave length of 600 Hz is only twelve inches, the listener needs to move his head only a few inches to give him a considerable change in spectral composition.

Furthermore, since there are several such room modes, the relative amplitudes of these will change substantially as one moves through the room. If many of them are grouped in an octave around a particular frequency, small movements can make large broad dips in the response—not to the point that the spectral distortion will be objectionable, but definitely to the point where spectral balance will change.

Therefore, room equalization can be effective at higher frequencies where the effect of absorption on the reverberant field is the main source of spectral distortion while keeping in mind that some distortion of the transient quality of the sound will take place.

Yet even at higher frequencies, problems can occur. Often a room has a hardwood floor, plasterboard walls, metal racks, and an acoustically treated ceiling. Such large differences in the absorption of different surfaces will cause a non-uniform or non-diffuse sound field. The spectral character will change as the head is turned. In such a room, one would have to decide which position of the head to equalize for!

## MONITOR SPEAKERS

Can the design of the monitor correct the problem? The monitor speaker has a characteristic response. If the response of another speaker is not the same, it can be equalized in the electronics. However, if the loudspeakers have differences in response from different angles, such equalization may not be useful, particularly if the equalization is done with respect to the on-axis response only. If one equalizes the power response, that is, the total response from all directions, this problem is less severe.

Nevertheless, a speaker that sharply beams higher frequencies so they do not excite the reverberant field will be difficult to equalize unless, as in the case of the room modes, the listener will be in only one position while listening.

Thus, the criteria for an interchangeable monitoring speaker is not so much that it have a uniform response, but that it have a uniform directivity *versus* frequency—since the response can be equalized if the directivity is constant. Nor should the exact directional characteristic be important (except for stereo cues) since in the small room the reverberant field will be part of the fused early sound and the directivity of the loudspeaker will be averaged out.

## MODE TREATMENT

The problem, then, is the treatment of the monitoring room modes. Were the walls completely absorptive, as in an anechoic chamber, the mode problem would be eliminated. But then, to be listened to from more than one position, the output of the loudspeaker would have to be identical in every direction, since the addition of so much absorption would have also eliminated the early reflections. Even if such loudspeakers could be obtained, there would be many other physical problems in monitoring in an anechoic chamber, not the least of which would be that the electrical equipment would have to be outside the room. An approach, not too practical in most cases, is to monitor in a very large room so that only the direct sound of the monitor loudspeaker appears in the early sound.

Some improvement is obtained by using a non-rectangular room; however this shifts the highest mode frequency down about twenty per cent.

Helmholtz cavity resonant absorbers may be used to reduce the worst of the modes. Then the monitoring positions within which all listening must be done may be designated. A rectangular room will have eight similar listening positions unless the center of the room is used as the equalizing point. Four of these will be near the floor.

Thus, procedure for designing a monitor room would be as follows: Select a loudspeaker with amplitude-frequency response curves (though not necessarily, reference levels) the same on axis, 45 degrees off-axis, and in the reverberant field.

Select a monitor room as large as possible and with dimensions as close to the ratios 1:1.7:1.47 or 1:1.45:2.1 as possible (ASHRAE Standard 36-62).

Place the loudspeakers in positions most favorable to provide directional cues needed for multi-channel monitoring if desired.

Provide as much absorption as practical, but apply it uniformly on all surfaces. An indoor-outdoor carpet on an open-cell foam pad can duplicate treatment on the walls and ceiling. Manufacturers' acoustical data can help in selection of carpets and absorption materials, but be sure you match the characteristics in all octave bands.

Calculate the major room modes based on the major dimensions according to the formula: frequency = 165/L, where L is the dimension in meters.

Insert a reference signal of noise in a third octave band above the mode diffusion frequency defined by the formula: frequency = 600/L<sub>s</sub>, where L<sub>s</sub> is the shortest major dimension in meters. Select the monitoring positions in the room. Using an omni-directional microphone, measure the response at each of these positions. Then drive the speaker with tones at the same voltage as the noise, and at the frequencies of each of the low-frequency room modes. At each frequency where the amplitude of a mode differs from the reference noise by more than 10 dB, construct a resonant absorber (e.g.: a concrete block absorber) on the wall associated with the mode.

Finally, use a third octave filter set to equalize the system for flat response at the monitoring point. Then—re-evaluate your favorite tapes. ■

# Loudness – Applications and Implications to Audio, part 1

*This article describes loudness as it applies to hearing. It tells how loudness affects the sound of the monitors, how it can be used to advantage, and what cannot be done to our independence of its effects.*

**L** OUDNESS IS A TERM used to describe the magnitude of an auditory sensation; it is primarily dependent upon the intensity of the sound. If loudness depended *only* upon the intensity of the sound producing the loudness, then the physical intensity as measured using a simple sound level meter would be an unambiguous measure of the loudness perceived by a typical listener. However, no such simple relationship exists.

The sounds we listen to come in an infinite variety of frequencies, timbres, intensities, and durations. Since each of these factors, and others, have a bearing on loudness and since the composition of sound is everchanging, it clearly is impossible to expect a single graph or equation to define completely the relationship between what one measures and what one hears. At present our knowledge of this complex relationship is imperfect but, such as it is, consists of experimentally-determined relationships between loudness and certain measurable qualities of sound.

In the following review of these relationships, attention will be drawn to instances where there is a link with one's normal listening experience and to other features which bring into focus matters related to high-fidelity sound reproduction.

## **LOUDNESS AS A FUNCTION OF FREQUENCY. PART 1: PURE TONES**

The names Fletcher and Munson are well known in the fields of audio and acoustics as being the authors of the

---

*Floyd Toole has impressive academic credentials. In addition he is a regular contributing editor to Canada's *Electron Magazine*.*

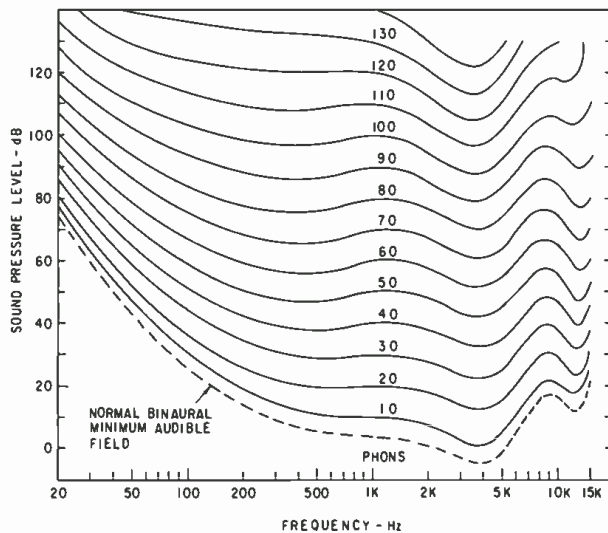

Figure 1. The Robinson-Dadson equal-loudness contours for pure tones. (after 150 Recommendation R226)

so-called “Fletcher-Munson curves.” These men, while working at the Bell Telephone Laboratories in 1933, determined in a reasonably comprehensive manner the relationship between the frequency of a sound (pure tones), its sound pressure level and its loudness.<sup>1</sup> The resulting equal-loudness contours have been reproduced and referred to in countless writings. In discussions of human response to sound in almost any context, these curves are used to close the credibility gap between the realms of objectivity and subjectivity. However, all too often in these discussions the meaning and value of the curves are misconstrued.

Although Fletcher and Munson were the first to produce a set of equal-loudness contours, they were not the last. The most recent redetermination of the loudness relationship for pure tones was by Robinson and Dadson at the National Physical Laboratory in England.<sup>2</sup> These contours, shown in FIGURE 1, have been adopted by the International Standard Organization (ISO Recommendation R226).

Insight on the real meaning of these contours might best be conveyed by a description of the procedure by which they were obtained. Listeners were seated, individually, in an anechoic chamber, facing a loudspeaker. In the course of the experiment, listeners were required to compare the loudness of a test tone with the loudness of a reference tone. The reference signal was always a pure tone of 1000 Hz. By many such comparisons using test tones of different levels and frequencies, a contour was derived which showed the sound pressure level of pure tones of different frequencies which were judged to have the same loudness as a reference tone of 1000 Hz. By repeating the procedure using different sound pressure levels for the reference tone, a family of equal loudness contours was generated. Naturally, the lowest contour is the hearing threshold, the level at which the sound is just audible.

Since the experiments involved humans, the results were subject to the numerous physiological and psychological variables that make us individuals. It was necessary, therefore, for the experimenters to take precautions which would avoid contamination of the results by these extraneous factors. Furthermore, in order to obtain results characteristic of a “typical” listener, the experiment was repeated using several subjects and the results were averaged.

Fletcher and Munson, in their earlier work, had originated a scale of loudness level or equivalent loudness using the unit *phon*. According to this method, the loudness level, in phons, of a sound is the sound pressure level of a 1000 Hz pure tone which is judged to be equally loud. The contours of FIGURE 1 are therefore identified in phons.

Probably the most obvious fact to be extracted from the curves of FIGURE 1 is that at the lower sound levels, both low- and high-frequency tones must be boosted in order to sound as loud as middle-frequency tones. Although the basic shape of the contours remains similar throughout, one can see a slight flattening of the contours at high sound levels, particularly at low frequencies.

At this point, some readers may have recognized the commonly-used justification for loudness compensators in high-fidelity amplifiers.

An alternative form of expression for this observation is to say that the ear is most sensitive to middle- and high-frequency sounds. It probably is no coincidence that the contours are lowest over the frequency band which includes the major speech frequencies (about 300 to 5000 Hz), signals of great importance to a human.

The crowding together of the contours at low frequencies reflects a more rapid “growth” of loudness there than at higher frequencies. By definition, loudness level in phons and sound-pressure level in decibels are in a one-to-one relationship at 1000 Hz. Moving down in frequency, however, one sees that a fixed change in sound level produces an ever increasing change in loudness level. At 20 Hz at low levels, a 10 dB change in sound pressure level brings about a 20 phon change in loudness level. At high frequencies this effect is relatively small.

An example of this, which can be drawn from one’s common experience, is the turning down of the volume control of a sound system. Since the volume reduction acts equally on all frequencies, the effect will be to reduce the loudness of the low frequencies more than that of the middle and higher frequencies. Consequently, the overall spectral balance of the reproduced sound will be altered; the dominant impression being one of diminished bass. A glance at the contours will reveal also that at sound-pressure levels below about 70 dB, we will completely lose some low frequencies. *i.e.*, they will be below hearing threshold. This is particularly interesting since, in contrast, 70 dB through the middle frequency range is a comfortably moderate listening level. Normal conversation is conducted at speech levels of 60-70 dB.

Let us shelve, temporarily, further ramifications of this discussion and move on to consider some other properties of loudness.

### THE EFFECT OF AGE

The equal-loudness contours of FIGURE 1 were obtained with subjects in the age range 18-25 years. In FIGURE 2 three of these contours have been reproduced but with supplementary dashed curves at the high-frequency end describing results with listeners aged 60 years.

It is common knowledge that with age there is a deterioration of one’s ability to hear high frequencies. In these curves, this fact is reflected in the elevated contours; a higher sound level is required to produce the same loudness.

Less obvious and rather interesting is the fact that the effect of age on loudness level is less at high sound levels than at low levels; note that the solid and dashed curves are closer together at 40 phons than at 80 phons. This phenomenon is known as *recruitment* and means, in common terms, that although a person may have difficulty hearing low-level sounds, his hearing may be closer to

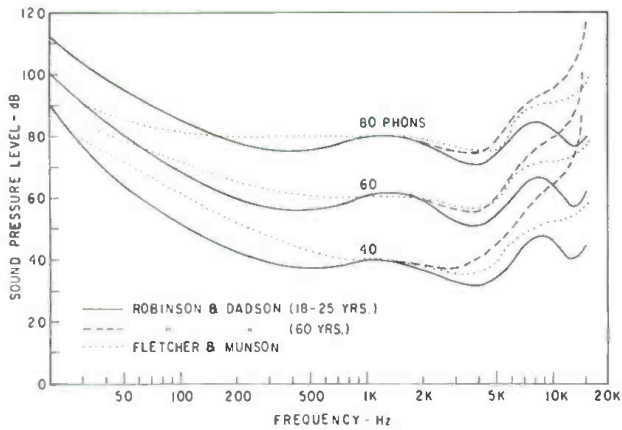

Figure 2. Equal-loudness contours showing the effects of age.

normal at higher sound levels. In current audio jargon, this characteristic could facetiously be described as a built-in noise-reduction system.

It should also be noted that many of the characteristics of "old" ears may apply to younger people whose ears have been repeatedly exposed to very loud sounds. The loss of high-frequency audition is one of the earliest and most obvious indicators of noise-induced hearing loss.

For general interest, the comparable Fletcher-Munson contours have been included in FIGURE 2 (dotted curves). At high frequencies the Fletcher-Munson contours fall generally within the range of age dependency. Below 1000 Hz the differences are large and inconsistent.

It may be appropriate to think on these variations in connection with any applications one might have in mind for these contours. However neat and regimented the families of contours look, they are by no means precise in an engineering sense.

#### LOUDNESS AS A FUNCTION OF FREQUENCY. PART 2: BANDS OF NOISE

The usefulness of the contours discussed so far is limited by the fact that they were obtained using pure tones which were listened to either in an anechoic room or through earphones. In attempts to have both the sound and the listening environment more closely represent normal circumstances, other equal-loudness contours have been determined using banks of noise presented to listeners by means of loudspeakers in normally reverberant rooms.

In 1956, S. S. Stevens of Harvard University published loudness data obtained in this manner. The equal-loudness contours shown in FIGURE 3 were adapted from a 1957 paper.<sup>3</sup> In spite of a general resemblance to the pure-tone contours there are large differences in detail.

More recently, (1966) Bauer and Torick<sup>4</sup> of CBS Laboratories published a partial set of equal-loudness contours obtained using octave-bands of pink noise in a simulated living-room environment. Again, there is little agreement in detail between these new contours and any of those discussed earlier. It seems as though each change in signal, listening environment or, perhaps, experimental procedure, leads to a modification of the measured loudness contours.

#### THE DANGERS OF OVERSIMPLIFICATION

To technical people, a graph has come to have a certain meaning: it can quickly convey an idea and yet, with closer scrutiny, it can yield accurate quantitative data. In the field of psychoacoustics, one frequently finds data presented in graphical form, but often it is inappropriate

# PROKIT

## THE FLEXIBLE MIXER SYSTEM with RAVE REVIEWS!

LARRY ZIDE in

"No kit I have ever built has had the quality of componentry that exists in this unit . . . This unit is fully professional in every way — nothing about it is consumer . . . Well worth the asking price of \$299.00 kit."

**db**  
THE SOUND ENGINEERING MAGAZINE

ED DELL in

" . . . one of the finest pieces of audio equipment available to the home user . . . In use, the SM-6A is the equal of any piece of audio equipment it has ever been our pleasure to use. Intermodulation distortion (60 & 6,000 Hz, 4:1) on the microphone inputs was 0.008% @ 0.6V out. In use the SM-6A is a solid, smooth, well built unit."

**the Audio  
Amateur**



SM-6A  
MIXER

\$299<sup>KIT</sup> \$499<sup>WIRED</sup>

- 6 mic, 6 line, and 2 mag. phono inputs
- low noise IC circuitry
- VU meters

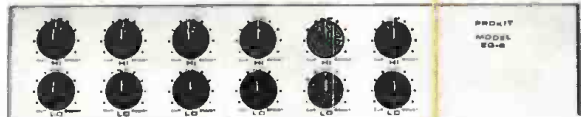

EQ-6  
EQUALIZER

\$149<sup>KIT</sup> \$299<sup>WIRED</sup>

- individual high and low frequency equalization for each SM-6 input



EK-6  
REVERB UNIT

\$179<sup>KIT</sup> \$325<sup>WIRED</sup>

- 6 individual send controls
- 2 quality reverb springs
- each input assignable to either or both outputs

**P  
K**

PROKIT DIVISION  
GATELY ELECTRONICS  
57 WEST HILLCREST AVE.  
HAVERTOWN, PA. 19083  
215-446-1415

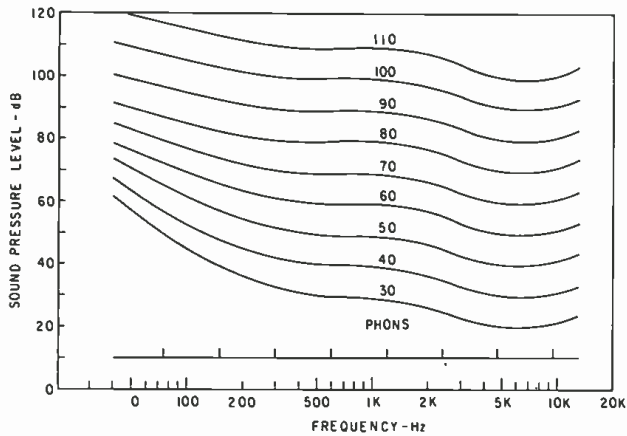

Figure 3. The Stevens equal-loudness contours for octave-bands of noise. (after Stevens, 1957)

to place much stock in the absolute precision or meaning of the data. Such is the case with equal-loudness contours. It is not that the individual results are wrong; on the contrary, they almost certainly reflect the true performance of the listeners in the context of those experiments. However, it is a dramatic and dangerous leap to the situation of a man listening to Beethoven in his living room. The sounds are vastly different, as are the acoustical environments and background noises. It may be possible even for the listener's mood and expectancies to override certain predictions based on "sterile" scientific data. Yet some audio engineers have mistakenly used these data as a basis for schemes which were intended to yield accurate results.

### LOUDNESS AS A FUNCTION OF INTENSITY

The phon is the unit of loudness level and as such is merely a measure of the sound pressure level of a standard 1000 Hz pure tone which is judged to have loudness equal to that of a given sound. Although it is useful in many respects it still tells us little about a listener's auditory impression of the strength of a sound. We need to know the relationship between sound pressure level and subjective units of loudness.

Based on experiments using several sounds and numerous listeners, a scale of loudness was developed which resulted in the rule-of-thumb that a 10 decibel increase or decrease in sound level respectively doubles or halves the loudness.<sup>5</sup> Strictly speaking, the conversion must be made in terms of phons rather than decibels since, as we have already seen, the equal-loudness contours are not equally spaced at all frequencies.

The unit of loudness is the *son*. One sone is defined as the loudness experienced by a person when listening to a tone of 40 phon loudness level. A sound of loudness two sones would be twice as loud, and 0.5 sones half as loud, as one sone.

Although the relationship has been widely accepted and used, it is not undisputed. A recent study<sup>6</sup> has resulted in six decibels as the sound level difference corresponding to a factor of two in loudness. This value has the logical advantage that half loudness corresponds to a decrease of energy to one-quarter (-6 dB) which, in simple theory, is produced by doubling the distance from a single sound source in non-reverberant space, e.g., outdoors. Judgments of loudness, according to this view, could be related directly to judgments of relative distance from a sound source.

More recently,<sup>7</sup> Stevens has modified the 10 dB conversion factor to 9 dB. It would appear that we have not reached the end of this discussion.

### LOUDNESS AS A FUNCTION OF DURATION

Discussions of loudness so far have assumed sustained and more or less uniform sounds. In reality, however, one also encounters many varieties of short-duration or transient sounds.

In the case of very brief sounds, the loudness appears to be somewhat dependent upon the duration of the sound. For a single transient event there is an apparent growth of loudness as duration is increased up to about 200 milliseconds. Beyond that, the auditory system arrives at a steady level of response. Consequently, 200 milliseconds may be considered to be a loudness time-constant or integrating time of the ear.

Repeated short-duration sounds and interrupted long-duration sounds present much more complicated problems to which there are few answers.

### MEASURING THE LOUDNESS OF COMPLEX SOUNDS

If uncertainty exists in evaluating the loudness of simple sounds under laboratory conditions, even greater are the problems of evaluating the loudness of the wideband, complex and ever-changing sounds of real life. Motivated in part by the need to evaluate the "noisiness" of annoying sounds as well as the more general quality of loudness, various methods have been developed for arriving at single-number ratings of complex sounds.

Some schemes make use of octave- or 1/3-octave-band spectral analysis of the sound, used in conjunction with equal-loudness contours and correction factors, to compute a single-number loudness rating. Of these methods, those of Stevens<sup>7</sup> and Zwicker<sup>8</sup> have been widely recognized. Both require expensive and complicated apparatus, and are, at best, cumbersome to use.

By taking some shortcuts in the loudness calculation, the process can be simplified to the point where it can be accomplished with relatively straightforward electronic circuitry. Recognizing this, Bauer and Torick<sup>4</sup> and Olson<sup>9</sup> have devised instruments to measure the loudness level of sounds.

Making even greater concessions in the interest of simplicity, one can use a conventional sound level meter employing an A-weighting network. The weighting network discriminates against low-frequency sounds so as to accommodate, approximately, the upward slope of the loudness contours at these frequencies. The A-weighted sound level is widely used in the measurement of noise where it has been found to correlate reasonably well with subjective impressions of annoyance as well as loudness. ■

### REFERENCES

1. H. Fletcher and W. A. Munson, "Loudness, Its Definition, Measurement and Calculation," *Jour. of Acoust. Soc. of Amer.*, Vol. 5, pp. 82-108, 1933.
2. D. W. Robinson and R. S. Dadson, "A Re-determination of the Equal-loudness Relations for Pure Tones," *British Jour. of App. Phys.*, Vol. 7, pp. 166-181, 1956.
3. S. S. Stevens, "Calculating Loudness," *Noise Control*, Sept. 1957, pp. 11-22.
4. B. B. Bauer and E. L. Torick, "Researches in Loudness Measurement," *IEEE Trans. on Audio and Electroacoustics*, Vol. AU-14, No. 3, pp. 141-151, 1966.
5. S. S. Stevens, "The Measurement of Loudness," *Jour. of Acoust. Soc. of Amer.* Vol. 27, pp. 815-829, 1955.
6. R. M. Warren, "Elimination of Biases in Loudness Judgments for Tones," *Jour. of the Acoust. Soc. of Amer.* Vol. 48, pp. 1397-1403, 1970.
7. S. S. Stevens, "Perceived Level of Noise by Mark VII and Decibels (E)," *Jour. of Acoust. Soc. of Amer.* Vol. 51, pp. 575-593, 1972.
8. Zwicker, E., "A Means for Calculating Loudness," *Acoustica*, Vol. 10, p. 304, 1960.
9. H. F. Olson, "The Measurement of Loudness," *Audio*, Vol. 56, pp. 18-22, Feb. 1972.



ZACHARY H. JAQUETT

# A Voice for the Sightless

*Thousands of books are annually put on tape by Recording for the Blind Inc. This article describes some of the acoustical rooms devised and used for this specialized requirement.*

THE COLLEGE STUDENT slipped his newest cassette into his tape recorder and settled back to listen. "Paren a plus b close paren" came over the tape in a clear, careful voice. No, these weren't the words to a new hard rock song, perhaps directed against the authority figures, Mom and Pop. The student was one of the 10,000 blind high school students and 3,000 college students who must depend upon tape recordings to "read" their textbooks. The subject was mathematics. With the aid of his tape recorder and his knowledge of braille, the student was able to keep up with his class. More important, he was able to participate fully in an education that would enable him to use his talents as a self-sustaining and contributing member of society.

A large number of the talking books used by the blind are produced by Recording for the Blind, Inc. which coordinates the services of 4,000 trained volunteers who work at twenty-five professionally-equipped taping centers in fifteen states. Recording is always an exacting and frequently an extremely challenging mental task. Foreign languages and classical subjects have to be read authoritatively, and scientific and mathematical books must be articulated so that the complex meaning of their phraseology imprints itself comprehensively upon the blind listener's memory. Taping is a team effort. The reader works in concert with a monitor who, using a second copy of the book being recorded, simultaneously proofreads the transcription. The monitor also operates the recorder, taping on a seven-inch two-track reel at  $3\frac{3}{4}$  in./sec. correcting mispronunciations and errors in phrasing and maintaining good sound quality.

In order to produce the enormous quantity of literature needed by the blind with consistent high quality, a good deal of attention has been paid to the design of the sound cubicles in which the recordings are made, produced by Industrial Acoustics Co. with exacting specifications aimed at maintaining a finely controlled acoustical environment

as well as an atmosphere devised to produce maximum comfort, alertness, and efficiency for the recorders.

In the New York studio, eleven IAC rooms are situated back-to-back or set up individually as dictated by arrangement of the studio. They are of different sizes, constructed with roof and wall panels whose interior side is a sheet of 22-gauge cold-rolled perforated steel and

*Figure 1. A person acting as a monitor operates the recorder, adjusting sound quality and doing proof reading at the same time.*



*Zachary H. Jaquett is associated with the Industrial Acoustics Company, Inc., manufacturers of the acoustic enclosures mentioned in this article.*

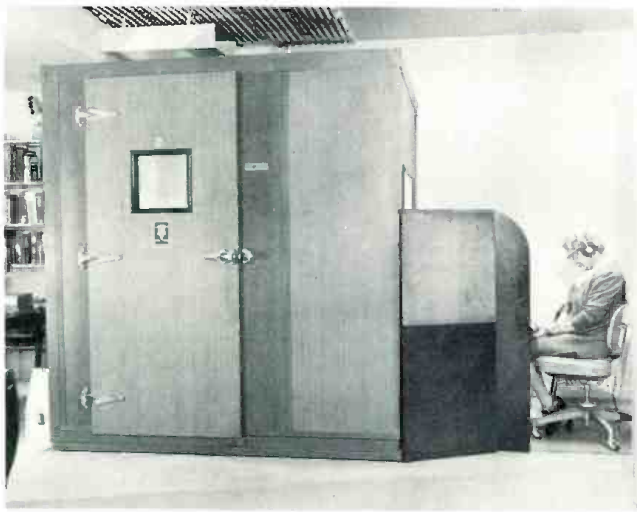

Figure 2. A typical sound-proof chamber.

Figure 3. Another view of the chamber, showing the clear communication between the reader and the monitor.



Figure 5. Tape books are kept in this library for speedy delivery as needed.

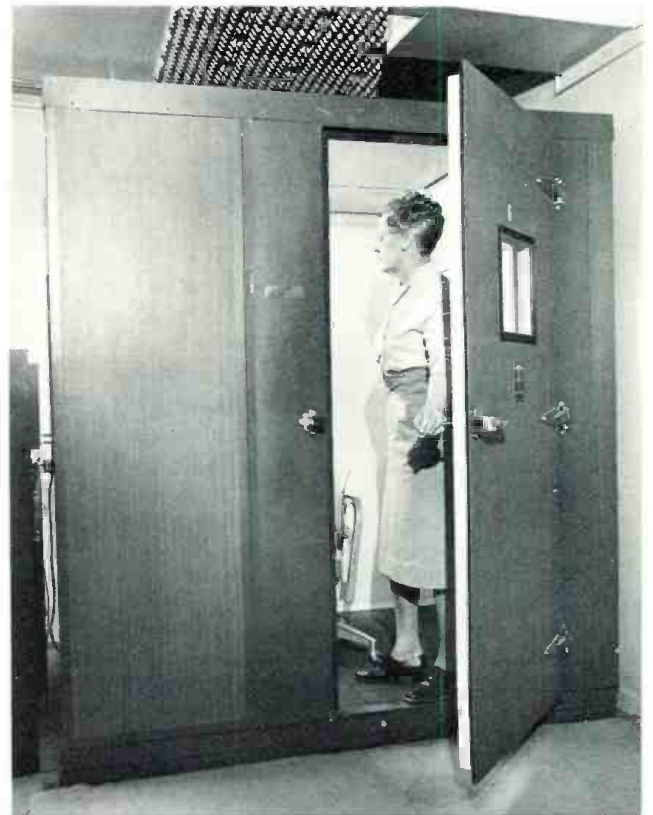

Figure 4. The chamber's doors have double acoustical seals.

whose outside face is a solid sheet of 16-gauge cold-rolled steel. In the middle of this metallic sandwich is an acoustical, sound-absorbing and sound-retarding fill which is mildew-resistant, incombustible, inert, and verminproof. Welding and riveting the face sheet to the panel assembly holds this filler in place. All panels are four inches thick and are joined acoustically and structurally with one-piece "H" members constructed so that there is no noise through panel seams. Panels making up the floors rest on properly loaded vibration-isolator rails providing a natural frequency of less than 7 Hz.

The well-lighted rooms are outfitted with a silenced ventilation system, either a discharge silencer in a roof panel acting as an intake and exhaust silencer, or a forced-ventilation system guaranteed to be below the binaural M.A.F. zero degree azimuth threshold of hearing.

For visual communication between reader and monitor during tapings, each room has a window, 24 x 30 inches or larger, made of two layers of quarter-inch safety glass separated by an air space and sealed in acoustically tight rubber seals. The air space contains a desiccant material to prevent misting.

The three and a half inch thick, clear-opening, sound-proof door is thirty inches wide and 74½ inches high, with double acoustic seals. Each door has a foot-square window and is equipped with architecturally heavy-duty butt hinges and an integrally mounted latch mechanism. Testing has indicated that these chambers have a certified rating of forty-two decibels in the speech-interference range.

As many as four thousand books a year are put on tape in these chambers, offering a valuable service in improving the quality of life for the blind. Incidentally, the painstaking attention to excellence which the engineering of the sound chambers provides has devised a set-up which can be useful in any situation where exact recording conditions are a must. ■



As a service to our readers we are pleased to offer books from prominent technical publishers. All prices listed are the publishers' net. Shipping charges are included.

To order use the coupon at the bottom of the page. Indicate quantity on the special instructions line

If more than one copy of a title is wanted. Full payment must accompany your order. We cannot ship c.o.d. Checks or money orders should be made payable to Sagamore Publishing Company, Inc. Because of the time required to process orders, allow several weeks for the receipt of books.

# BOOKCASE

**20. The Audio Cyclopedia (2nd ed.).** *Dr. Howard M. Tremaine.* New and updated, here is the complete audio reference library in a single volume. It provides the most comprehensive information on every aspect of the audio art. This new edition includes the latest audio developments including the most recent solid-state systems and integrated circuits. It covers all subjects in the fields of acoustics, recording, and reproduction with more than 3400 related topics. Each topic can be instantly located by a unique index and reference system. More than 1600 illustrations and schematics help make complicated topics masterpieces of clarity. 1760 pages; 6½ x 9½ hardbound. **\$29.95**

**1. The Technique of the Sound Studio.** *Alec Nisbett.* This is a handbook on radio and recording techniques, but the principles described are equally applicable to film and television sound. 264 pages; 60 diagrams; glossary; indexed; 5½ x 8½; clothbound. **\$14.50**

**7. Acoustical Tests and Measurements.** *Don Davis.* Provides solid understanding of the entire subject of acoustical measurements; based on actual field test work, using commercial equipment. 192 pages; 5½ x 8½; hardbound. **\$6.95**

**8. Handbook of Electronic Tables & Formulas, (3rd edition).** A one-stop source for all charts, tables, formulas, laws, symbols, and standards used in electronics. Includes an 8-page, full-color fold-out chart showing latest FCC allocations for the entire frequency spectrum. 232 pages; 5½ x 8½; hardbound. **\$5.50**

**24. Basic Electronic Instrument Handbook.** *Edited by Clyde F. Coombs, Jr. Hewlett-Packard Co.* A basic reference background for all instruments. Offers saving in time and effort by having complete information in one volume on how to get the most benefit from available devices, how to buy the best instrument for specific needs. Reduces chances of costly errors. Ideal reference book, it is an excellent source for the beginner, technician, the non-electrical engineering man, or general non-engineering scientific and technical personnel. 800 pages. Hardbound. **\$28.50**

**25. Operational Amplifiers-Design and Applications.** *Burr-Brown Research Corp.* A comprehensive new work devoted entirely to every aspect of selection, use, and design of op amps—from basic theory to specific applications. Circuit design techniques including i.c. op amps. Applications cover linear and non-linear circuits, A/D conversion techniques, active filters, signal generation, modulation and demodulation. Complete test circuits and methods. 474 pages. **\$15.00**

**26. The Design of Digital Systems.** *John B. Peatman.* Textbook for students desiring to develop a creative approach design capability through digital systems approach. Answers these questions: Under what circumstances it is desirable to implement a system digitally? What are some of the components available for implementing the system? How do we go about designing it? 448 pages. **\$15.50**

**31. Solid-State Electronics.** *Hibberd.* A Basic Course for Engineers and Technicians. An extremely practical reference book for anyone who wants to acquire a good but general understanding of semiconductor principles. Features questions and answers, problems to solve. 1968. 169 pp. **\$9.95**

**32. Circuit Design for Audio, AM/FM, and TV.** *Texas Instruments.* Texas Instruments Electronics Series. Discusses the latest advances in design and application which represent the results of several years research and development by TI communications applications engineers. Emphasizes time- and cost-saving procedures. 1967. 352 pp. **\$14.50**

**35. An Alphabetical Guide to Motion Picture, Television, and Videotape Productions.** *Levitan.* This all-inclusive, authoritative, and profusely illustrated encyclopedia is a practical source of information about techniques of all kinds used for making and processing film and TV presentations. Gives full technical information on materials and equipment, processes and techniques, lighting, color balance, special effects, animation procedures, lenses and filters, high-speed photography, etc.: 1970. 480 pp. **\$24.50**

**40. Radio Transmitters.** *Gray and Graham.* Provides, in a logical, easy-to-understand manner, a working knowledge of radio transmitters for quick solution of problems in operation and maintenance. 1961. 462 pp. **\$16.00**

**23. Wide Screen Cinema & Stereophonic Sound.** *M.Z. Wystozky.* First published in USSR in 1965 this excellent English translation covers wide gauge films, panoramic films, circular panoramic cinematography; technical fundamentals of stereo sound recording for film, as well as details of the Soviet systems now in use. 284 pages. **\$15.00**

**33. Noise Reduction.** *Beranek.* Designed for the engineer with no special training in acoustics, this practical text on noise control treats the nature of sound and its measurement, fundamentals of noise control, criteria, and case histories. Covers advanced topics in the field. 1960. 752 pp. **\$19.50**

**16. Magnetic Recording.** *Charles E. Lowman.* Reference guide to the technology of magnetic recorders used in audio recording, broadcast and closed-circuit TV, instrument recording, and computer data systems. Includes latest information on cassette and cartridge recorders; TV recorders; direct and FM signal electronics from low to wideband; servo-control and signal record/playback circuitry; capstan, reel, and head-drum servos for longitudinal, rotary, helical-scan, and disc recorders. Glossary, index, bibliographical information. 274. pp. **\$14.50**

**28. Environmental Acoustics.** *Leslie L. Doelle.* Applied acoustics for those in environmental noise control who lack specialized acoustical training. Basic information in comprehensible and practical form for solving straightforward problems. Explains fundamental concepts; pure theory minimized. Practical applications stressed, acoustical properties of materials and construction listed, actual installations with photos and drawings. Appendixes illustrate details of 53 wall types and 32 floor plans and other useful data. 246 pgs. **\$18.50**

**21. Acoustics—Room Design and Noise Control.** *Michael Rettinger.* 1968. The enormous problems and hazards presented by noise are dealt within an orderly and practical manner. With many charts, graphs, and practical examples, the text covers the physics of sound, room acoustics, and design, noise and noise reduction. 392 pages. **\$17.50**

**22. Acoustics of Studios and Auditoria.** *V.S. Mankovsky.* Basic theory plus a mass of design data covers the field with special reference to studios and places of public performance. For acoustical designers and specialists in sound transmission in cinema and broadcasting. Features exhaustive treatment of studio acoustics by the statistical, geometric and wave methods in parallel. 416 pgs. **\$15.00**

Sagamore Publishing Company, Inc.  
980 Old Country Road,  
Plainview, N.Y. 11803

Please send me the books I have circled below. My full remittance in the amount of \$\_\_\_\_\_ is enclosed. N.Y. State residents add 7% sales tax.

1	2	3	4	5	6	7	8	9	10	11
12	13	14	15	16	17	18	19	20		
21	22	23	24	25	26	27	28	29		
30	31	32	33	34	35	36	37	38		
39	40									

Name \_\_\_\_\_  
Address \_\_\_\_\_  
City \_\_\_\_\_  
State \_\_\_\_\_ Zip \_\_\_\_\_  
Special Instructions \_\_\_\_\_

Canada and foreign: Add \$1.00 per book

# CLASSIFIED

Closing date is the fifteenth of the second month preceding the date of issue.  
Send copy to: Classified Ad Dept.  
db THE SOUND ENGINEERING MAGAZINE  
980 Old Country Road, Plainview, New York 11803

Rates are 50¢ a word for commercial advertisements. Non-commercial and employment offered or wanted placements are accepted at 25¢ per word.

---

## FOR SALE

---

---

ONE STOP FOR ALL your professional audio requirements. Bottom line oriented. **F.T.C. Brewer Company, P.O. Box 8057, Pensacola, Florida 32505.**

PRE-EQUALIZED J.B.L. MONITORS; Little Dipper hum/buzz notch filters; Cooper Time Cube echo delay; B.B.C. reference monitors; Lamb "B" Dolby processors; Ortofon ultra-track cartridges; Schöeps condensers; Beyer ribbons; U.R.E.I. comp/limiters; Gately pro-kits; Infinity electrostatics; Crown amplifiers/recorders; dozens more. Shipped prepaid/insured from **Music & Sound Ltd., 11½ Old York Rd., Willow Grove, Pa. 19090. (215) 659-9251.**

TASCAM MIXING CONSOLES—\$1,890. Tascam ½-inch recorders — \$1,770. Shipped prepaid/insured including free alignment and calibration. **Music & Sound, Ltd., 11½ Old York Rd., Willow Grove, Pa. 19090. (215) 659-9251.**

SOLID-STATE AUDIO MODULES. Console kits, power amplifier kits, power supplies. Octal plug-ins—mic, eq, line, disc, tape play, tape record, amplifiers. Audio and tape bias oscillators. Over 50 audio products, send for free catalog and applications. **Opamp Labs. Inc., 172 So. Alta Vista Blvd., Los Angeles, Ca. 90036. (213) 934-3566.**

---

AUDIOTECHNIQUES, INC. WANTS TO BUY your used Scully Model 280 series tape recorders, any width from quarter inch to two inch. Write or phone Bob Berliner or Ham Brosious giving condition, serial number and configuration. **Audiotechniques Inc., 142 Hamilton Avenue, Stamford, Conn. 06902. (203) 359-2312.**

---

SAVE ON YOUR STYLUS COSTS! World's finest recording styli for all Westrex 3D models and HAECO SC-2. \$13.80 unwired, \$14.80 wired. Quantity purchases at additional savings. Satisfaction guaranteed. Send check or money order with your order to **HAECO, 14100 Aetna St., Van Nuys, Ca. 91401.**

---

AMERICA'S LARGEST SELECTION of new and used broadcast and recording equipment! Latest bulletins available. **The Maze Corporation, P.O. Box 6636, Birmingham, Ala. 35210.**

---

WHATEVER YOUR EQUIPMENT NEEDS—new or used—check us first. Trade your used equipment for new. Write for our complete listings. **Broadcast Equipment & Supply Co., Box 3141, Bristol, Tenn. 37620.**

---

HAECO announces complete repair service and overhaul for all Westrex cutterheads. Conversions of 3D-II and older models to higher performance standards and reliability. Helium cooling systems and hi-temp coils can protect your investment. Repair insurance program available. Rapid service. Lower cost. **HAECO, 14110 Aetna, Van Nuys, California 91401.**

---

CROWN TAPE RECORDERS, amps; IMF monitor speakers; AKG professional microphones; UREI limiting, Little Dipper; Fairchild; Crown warranty service station, more. **Barclay, 503 Haverford Avenue, Narberth, Pa. 19072. (215) 667-3048. or 120 Villa Crest Dr., State College, Pa. 16801. (814) 238-1598.**

## MULTI-TRACK

8 and 16

TRACK RECORDING CONSOLES  
THE SOUNDEST DOLLAR SPENT  
IN PRO AUDIO TODAY

1965 CHEREMOYA AVE.,  
HOLLYWOOD, CALIF. 90028  
P.O. Box 3187, Hollywood, CA. 90028  
(213) 467-7890



**CATV—MATV PRODUCTS**

- CONNECTORS
- WALLPLATES
- SPLITTERS
- AMPLIFIERS

**AVA ELECTRONICS CORP.**  
416 LONG LANE, UPPER DARBY, PA. 19082  
215—MA 9 9100

**STUDIO TAPE ELECTRONICS.** Advanced design incorporates all the desired features for updating or expanding outdated recorders or building new systems. Prompt delivery. **Inovonics, Inc., 1630 Dell Avenue, Campbell, Ca. 95008.**

**ONE AMPEX AG440-8** eight track with servo; immediately available; "demonstrator." Call collect (305) 776-4762. **Broadcast Automation Associates, 5199 N.E. 12th Avenue, Oakland Park, Florida 33308.**

**LOWEST PRICES** for stereo masters expertly cut on a Scully lathe with the Westrex 3D stereo cutting system. Stereo: 12-inch—\$33 per side; 7-inch—\$14 per side. Mono: 12-inch—\$22 per side; 7-inch—\$9 per side. We also cut demos—prices even lower. **Trutone Records, 6411 Bergenwood Ave., North Bergen, N.J. (201) 868-9332.**

**SPLICE FASTER, BETTER BY SHEARING . . .** replaces razor; specify .250-inch or cassette; \$16.95. With attached splicing tape mechanism, \$24.95. Details—**NRP Box 289, McLean, Va. 22101.**

**ONE AMPEX 3200 DUPLICATOR SYSTEM;** one master, two slaves; mono; full track two-track stereo; stacked stereo heads; "demonstrator." \$7,000. Call collect (305) 776-4762. **Broadcast Automation Associates, 5199 N.E. 12th Avenue, Oakland Park, Florida 33308.**

**ONE AMPEX AG440-8, EIGHT TRACK** recording machine; used less than one year (studio going 16-track). \$7,500. Call collect (305) 776-4762. **Broadcast Automation Associates, 5199 N.E. 12th Avenue, Oakland Park, Florida 33308.**

**BROADCAST AND RECORDING EQUIPMENT:** Scully; Metrotech; Langevine; Electrodyne; Q.R.K.; Micro-Trak; M.R.L.; Nortronics; McMartin; U.R.E.I.; Neumann; E.V.; A.K.G.; Sennheiser; Tascam; Atlas; Ferrograph; HAECO; Stevenson; Gately; D.B.X.; Advent; Altec; Fairchild; Audio Designs; 3 M; Magnacord; Telex; Inovonics; disc recording systems; package deals; installations; service. **Wiegand Audio, Middleburg, Pennsylvania 17842. (717) 837-1444.**

**RECONDITIONED PRECISION TAPE REELS,** as new; 1 x 10½-inch—10/\$35.00. 2 x 10½-inch—10/\$70.00. Free list. **Wide Response, 2926 Bentley Ave., Los Angeles, Ca. 90064.**

**PROFESSIONAL AUDIO TAPE RECORDER;** 8-track one inch Stephens Electronics; 3M top plate; Stephens amplifiers and sync panel; excellent condition; mounted in a roll-around pedestal. **Irv. Joel, 322 W. 48th St., New York, N.Y. 10036, (212) 582-1070.**

**CROWN CX 822, used. Barclay (dealer) 503 Haverford Ave., Narberth, Pa. 19072. (215) 667-3048.**

**RECORDING CONSOLE, used.** Solid state, eight input, two output, with complete patching facilities; monitor system for four-channel recording; excellent remote board. \$2,350. **Amboy Audio Associates, 236 Walnut Street, South Amboy, New Jersey 08879. (201) 721-5121.**

**LOWEST PRICES, fastest delivery** on Scotch recording tapes, all widths. We will not be undersold. **Amboy Audio Associates, 236 Walnut Street, South Amboy, N.J. 08879. (201) 721-5121.**

**NEW YORK'S LEADING** supplier of professional audio/video equipment and hi-fi stereo components. All major brands in stock. Call for quote—sales—service—leasing—trade-ins. **Martin Audio, 320 West 36th Street, New York, N.Y. 10036. Telephone: (212) 265-6470.**

**TWO-CHANNEL MONITOR EQUALIZERS** for your Altec's and J.B.L.'s are a steal at \$150. **Music & Sound, Ltd., 11½ Old York Rd., Willow Grove, Pa. 19090. (215) 659-9251.**

**LOWEST PRICES** for stereo masters expertly cut on a Scully lathe with the Westrex 3D stereo cutting system. Stereo: 12-inch—\$33 per side; 7-inch—\$12 per side. Mono: 12-inch—\$22 per side; 7-inch—\$8 per side. We also cut demos—prices even lower. **Trutone Records, 6411 Bergenwood Ave., North Bergen, N.J. (201) 868-9332.**

**ALTEC 290 drivers; 1003, 203, 311-60 horns; J.B.L. D-20s.** Call (213) 661-3223 in Los Angeles for information. Equipment shipped F.O.B. New York.

**SAVE ON YOUR STYLUS COSTS!** World's finest recording styli for all Westrex 3D models and HAECO SC-2. \$13.80 unwired, \$14.80 wired. Quantity purchases at additional savings. Satisfaction guaranteed. Send check or money order with your order to **HAECO, 14110 Aetna St., Van Nuys, Ca. 91401.**

**DIRECT BOX, 50k; 150 ohm transformer; 20 kHz ± 1 dB; XLR phone type connectors; ground switch. \$30.00. Gately Electronics, 57 W. Hillcrest Avenue, Haverstown, Pa. 19083. (215) 466-1415.**

## WANTED

**AUDIO ENGINEER** seeks part time work, NYC area; maintenance, construction, consultation, special projects. \$15.00 per hour. **Box 52, db Magazine, 980 Old Country Road, Plainview, N.Y. 11803.**

**EMPLOYMENT WANTED: ENGINEER,** experienced in all phases of recording, mixing, maintenance, construction, and design as well as in music, seeking position with larger studio; interest and expertise in music recording as well as commercial. For resume and further information write **Box 51 db Magazine, 980 Old Country Road, Plainview, N.Y. 11803.**

## EMPLOYMENT

**PROFESSIONAL RECORDING PERSONNEL SPECIALISTS.** A service for employers and job seekers. Call today! **Smith's Personnel Service, 1457 Broadway, N.Y.C. 10036. Alayne Spertell 212 Wi 7-3806.**

**EXPERIENCED MAINTENANCE ENGINEER** with some electro-mechanical background; top salary and benefits. For interview, call **Irv. Joel, A & R Recording, (212) 582-1070.**

**ENGINEERING OPPORTUNITY.** One of the nation's leading public television and radio production centers offers a challenging audio-engineering career opening. Candidates must be technically qualified and fully capable of quality production and state-of-the-art techniques. Send resume to **Bonnie Wells, WGHB-TV, 125 Western Avenue, Boston, Mass. 02134.**

**ELECTRONIC TECHNICIAN,** experienced, to service and maintain audio equipment in recording studio located in eastern Pennsylvania. **Box 54, db Magazine, 980 Old Country Rd., Plainview, N.Y. 11803.**

# PEOPLE, PLACES, HAPPENINGS

● Claude J. Hill, Jr. has been named vice president of marketing for MCI Inc. of Fort Lauderdale, Florida. The announcement was made by G. C. (Jeep) Harned the company president.

Claude will supervise the company's sales, customer and dealer service, and new product development efforts. Claude studied electrical engineering at Florida Southern College and was a field service engineer and later central regional sales engineer for the 3M Company's Mincom Division working in audio, instrumentation, and video recording equipment. As chief engineer of Glaser Sound Studios in Nashville, Claude gained experience in studio practice and operations. Claude is a member of AES, NARAS, and the American Federation of Musicians.

● A new studio, **Sound Arts**, has recently opened on the New Jersey shore, at Oakhurst. It claims to be designed for everything from a big band to small groups. The main studio of thirty by forty feet is complete with Hammond organ, grand piano, and synthesizer. What makes this studio unusual is that it is part of a larger audio complex which includes a high fidelity showroom, an audio repair facility, high speed tape duplication services and speech time compression.

● Ed Lewin has been added to the corporate staff of **Bell Sound Studios**, parent company of **Electro Sound** and **A & B Duplicators**, as vice president. Mr. Lewin, who has been associated with the firm for four years, moves up from the position of vice president of marketing for Electro Sound.

● A merger has been announced between **Neve Electronic Holdings, Ltd.**, manufacturers of professional sound control consoles, and parent company of **Rupert Neve Inc.**, Bethel, Connecticut, with **Bonochord Ltd.**, a British company. The management of Neve will continue as present except for **Rupert Neve**, who becomes vice-chairman of the Neve Group. **Robin Rigby**, chairman of Bonochord, has taken over the position of Neve chairman.

● The National Hall at the Olympia exhibition complex, London, England will be the site of the **Fifth International Audio-Visual Aids Conference and Exhibition** during the period July 17-20. Equipment relating to television, radio, films, photography, public address systems, and wall charts and maps will be shown. Educationalists will discuss such subjects as school radio in the next ten years, new developments in educational technology, innovations in industrial training, self-instruction in a university, and teaching children with learning disabilities. There will also be a special trade session, primarily for buyers and sellers of equipment. This will be held at Empire Hall on July 16-17 and will cover stereoscopic color television, designing for a video display and electronic film editing. Each session will feature stereoscopic color television with stereophonic sound, stereoscopic color film, and slide multiscreen displays. Organizer of the exhibition and conference is the **National Committee for Audio-Visual Aids in Education**, 33 Queen Anne St., London W1M 0AL, England. Trade sessions are focalized by **The Audio-Visual Association**, at the same address.



● Peter Dyke has been appointed national sales manager of **Acoustic Research**, manufacturers of high fidelity speaker systems, turntables, and electronic components. Previously, Mr. Dyke served as advertising manager for Acoustic Research and, prior to that, had been international sales manager for **H. H. Scott**. Another item of news from Acoustic Research is the announcement by its president, **Victor Amador**, that the company will be moving early in the summer from its Cambridge, Massachusetts location to an enlarged facility at Norwood, Massachusetts.

● Complete mono and stereo facilities, as well as a music and sound effects library, are being offered to advertising agencies and industrial users in the downtown Minneapolis area by **Sound 80 Studio**. **Bob Schultz**, former president of **Micside, Inc.** and well-known recording engineer, specializing in electronic music techniques, is the key man in the new facility. Future plans call for the installation of an electronic music synthesizer for creating special music cues and effects.



● **Johan L. Ooms** (right) receives a model Viking ship, symbolic of a trip to Scandinavia for himself and his wife, from **Diederik van Amstel**, managing director of **Polygram**, part of the **Philips** organization, based in the Netherlands, during festivities marking Mr. Ooms' silver anniversary with the firm and his retirement. Mr. Ooms, who had been in charge of international recording activities and electro-acoustical development, will continue on a consultive basis to serve the company. Mr. Ooms' retirement recalls a distinguished career. He was involved in the technical development of the tape cassette system and is a Netherlands delegate to the **ISO** (International Organization for Standardization) and to the **IEC** (International Electrotechnical Commission). He has been active in the **Audio Engineering Society**, and in 1971 became the first non-American AES governor. He has long been instrumental in promoting a better exchange of knowledge between U. S. and European technical engineers.

# StopClock

**A New, Accurate, Digital Timing Instrument for Recording Studios, Broadcasters, and Other Demanding Applications**

Timekeeper is proud to introduce a new inexpensive *Electronic StopClock*—a compact instrument featuring an easily-read visual display.

Only 5½" wide x 3¼" high x 5½" deep, it uses modern digital circuitry to provide accuracy of a very high order with exceptional long term stability. The large ¾" high, seven-segment numerals can easily be read from a distance of more than 15 feet. Maximum count is one hour (59:59:9).

Three remote-mounted push buttons are used for manual control: START, STOP, and RESET. These buttons may be placed in a console, operating desk or any convenient location. The clock may be remotely located in the equipment, or on a desk or table. (A mounting flange is provided.)

Operation is similar to any conventional stopwatch. The green button starts the clock; the red button stops it. The black button resets it to zero. These may be depressed in any order, or all at once, without damage to the clock. If it is desired to start the clock by releasing a button rather than depressing one, the green and black button are pressed simultaneously. When the black button is released, the clock will start automatically.

The accessory plug on the rear panel may be used for all remote operations. All BCD information is available at this plug for accessory units such as digital printers, slave units, etc.

The Model T-1 is supplied for 120 volt 60 Hz operation, in an attractive simulated walnut grained enclosure with a red lucite face. However, 120-volt 50 Hz operation is available at no extra charge if so specified at the time you place your order.

The Model T-1 is priced at \$185.00. As with all Timekeeper products, it is fully guaranteed to meet with your complete satisfaction, or your money will be promptly refunded. It is guaranteed for one year against any defects in manufacturing.

The Timekeeper Electronic StopClock is a must. More than a high quality timer—it provides the added convenience of full visual display, high accuracy and stability plus operational flexibility. Order one soon. You will be delighted with it.

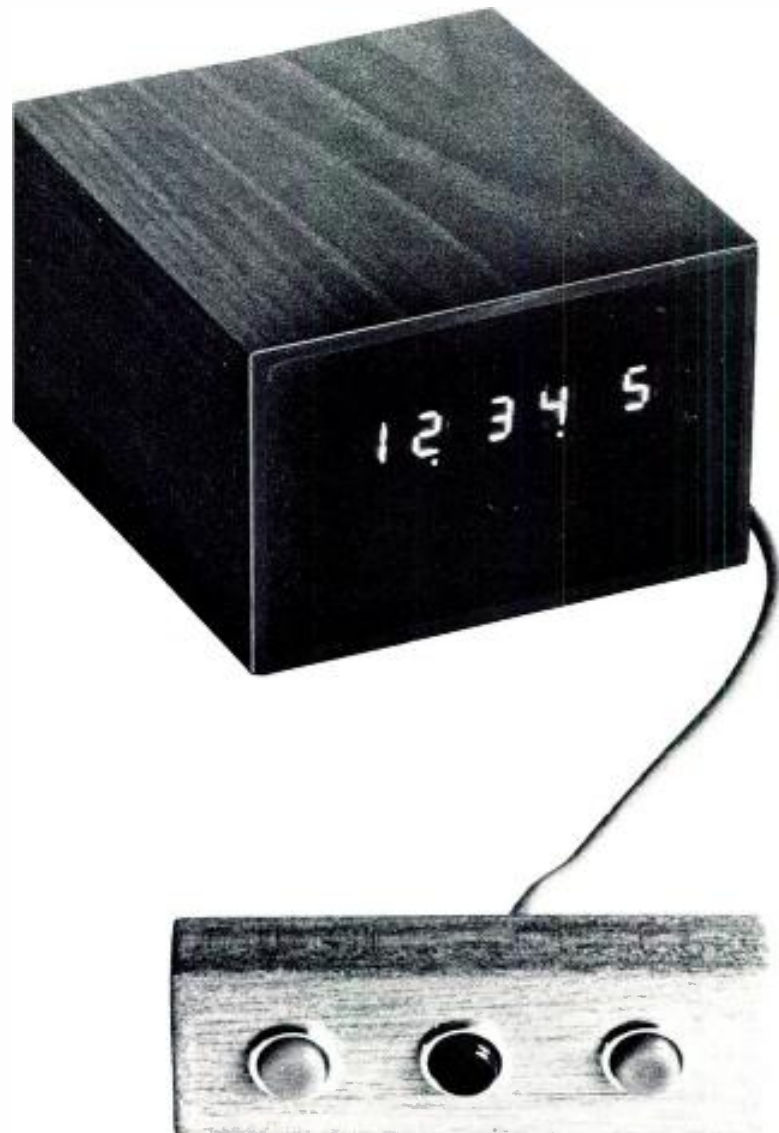

## TIMEKEEPER

P.O. Box 835, Great Neck, N.Y. 11021

Please send me \_\_\_\_\_ Model T-1 Timekeeper Electronic StopClock(s) at \$185.00. N.Y.S. residents add 7% sales tax. Add \$1.00 shipping per order. I enclose \$ \_\_\_\_\_

Name \_\_\_\_\_

Address \_\_\_\_\_

City \_\_\_\_\_

State \_\_\_\_\_ Zip \_\_\_\_\_

# Please don't dance on your tape recorder!

We've seriously gone about the business of designing the best possible loudspeaker for monitor use. With computers, and anechoic chambers, and all the rest. And, having gained a monster new insight into bass speaker performance, we've come up with what looks like a winner. The Sentry III.

We've run all the curves that prove, in a most scientific, sober fashion, that the system is really quite good. We've got polar graphs, and frequency response curves, distortion measurements, total power output curves, power handling\_test results, and SPL data galore.

But what happens when we demonstrate the Sentry III? Leading engineers (whose names we hesitate to divulge—but you know them) leap about in their control rooms DANCING for heaven's sake! Snapping their fingers and feeling the sound, and reveling in the sensory pleasure of a clean first octave. And last octave too, for that matter.

And they run from one side of the studio to the other trying to find holes in the distribution of the highs... and they can't... and they LAUGH! It's very unseemly (but secretly quite gratifying). So we try to thrust our good numbers and graphs at these

serious engineers, but they'd rather listen and compare and switch speakers. And make rude remarks about their old monitors.

Who will stand still long enough to heed our technical story? Perhaps you're the serious-minded, sober-sided engineer we're looking for. If so, by all means write us. We've got quite a stack of strait-laced, objective literature describing the new Sentry III monitor loudspeaker just waiting to be seen and appreciated.

And after you've read our story, perhaps we can arrange a demonstration of this new speaker for you. The Sentry III. Bring your tap shoes.



## New SENTRY™ III Monitor Loudspeaker

a **Gulton**  
COMPANY

*Electro-Voice®*

SENTRY III Frequency Response 40-18,000 Hz  $\pm$  3 dB; Sound Pressure on Axis at 4' with 50 watt input 113 dB; Dispersion 120° horizontal, 60° vertical; Size 28½" W x 20½" D x 34½" H; Weight 156 lbs. \$600.00 suggested professional net. SEQ active equalizer extends response to 28 Hz, \$60.00.

Circle 11 on Reader Service Card

ELECTRO-VOICE, INC., Dept. 531BD, 686 Cecil St., Buchanan, Michigan 49107