

HAM

NEW

RADIO

TODAY

SPECIAL FEATURE:
Working meteorscatter:
the definitive article

CONSTRUCTING:
an ATV pattern
generator

EXAMINING:
six metres with
Jack Hum G5UM

FEBRUARY '83
ONLY 75p

TESTING: the Yaesu FT102 HF all band
transceiver and FT790R

OPERATING: VHF propagation

PRACTICING: the RAE

PROCESSING: speech

LEARN MORSE WITH
THE HAM RADIO TODAY CASSETTE
MORSE COURSE RAPID RESULTS
SYSTEM BY G4HES

**COMPARISON
SALES AVAILABLE
ONCE AGAIN...
Call for details and have
a cup of Brenda's coffee
when you do the deal...**



AMATEUR RADIO EXCHANGE



There's a lot of talk among the radio fraternity about "grey imports," but what does this term really mean?

To the UK distributors of TRIO and ICOM it means enterprising retailers by-passing them and purchasing direct from overseas sources. (The YAESU situation is somewhat different as there are two importers in healthy competition.)

To you, the customer, cutting out the monopoly middle-man in this way means quite simply lower prices, of which more later. It also means choice—the ability to come to one showroom and try out all the rigs on the market side by side, and then select the one that's right for you, rather than having some salesman push a particular make because that's the one he's "authorised" to sell.

Sometimes you may hear doubts expressed about the suitability for UK use of "non-approved" imports, or about after-sales service on them. Well, if you're buying from us... relax. We haven't become London's leading Amateur Radio store by selling anything that's not serviceable, or by giving your repair to the first likely lad to walk in clutching a soldering iron!

We think that TRIO for example is great stuff. That's why we've always tried to have as much of it passing through our doors—back or front!—as possible, but at prices that are fair on the customer, like these...

TS-530S Good value at £537. Even better value at £489 here.
TS-830S Why pay £695 when you can buy it from us for just £649?

W • NEW • NE...

FT-980

Yaesu's latest HF transceiver, which fits neatly into their range between the FT-102 and the FT-ONE... and is an obvious competitor for the mythical (or merely elusive?) Trio TS-930.

Features like general coverage receive, notch filter, pass-band tuning and IF shift will make this rig a top-of-the-market bargain at a price yet to be announced, but which we anticipate will be not a million miles from **£925**.



IC-720A

Introduced a year ago, this superb HF rig from ICOM has become a firm favourite because of its remarkable general coverage

receive capability from 100kc to 30MHz, plus transmit facility across its entire range for commercial purposes.



OUR PRICE £795

IC-R70

Presenting the best in today's receiver technology from ICOM, featuring:

- Two VFOs • Frequency range 100kc - 30MHz
- Three IFs 70MHz/9MHz/455kHz • HF pre-amp
- Sensitivity 0.5 μ v AM - 0.32 μ v S/N 12dB

All this... and much more... for £469



IC-740

The latest addition to the ICOM transceiver range, this gives all mode coverage—AM/CW/SSB/FM—right across the amateur bands from 1.8 to 30MHz.

Incorporating such features as IF shift, pass-band tuning and notch-filter as standard, this is one rig that has to be seen and tried by anyone in the market for a really top-quality base station.



OUR PRICE £649



FRG-7

YAESU's evergreen communications receiver giving continuous coverage from 500kc to 30MHz on AM/SSB/CW. Still the best value for

money in the market... and even better value from us at

only £169 including FREE Heliscan aerial.

FT-102

A worthy successor in the Yaesu range to the evergreen FT-101 series, with so many extra features.

- Notch filter • Three 6146B final tubes • IF shift control • Band width control from 2.7kHz to 500Hz • APF control • RF processing
- Tunable audio network for speech tailoring • SSB/CW/AM/FM

OUR PRICE OF £725 INCLUDES AM/FM BOARD



373 UXBRIDGE ROAD, ACTON, LONDON W3 9RH

Tel: 01-992 5765/6/7 Just 500 yards east of Ealing Common station on the District and Piccadilly Lines, and 207 bus stops outside.

136 GLADSTONE STREET, ST HELENS, MERSEYSIDE
Tel: 0744 53157 Our North West branch run by Peter (G4 KKN), just around the corner from the Rugby Ground.

Closed Wednesday at Acton and Monday at St Helens, but use our 24-hour Ansafone service at either shop.

LICENSED CREDIT BROKERS * Ask for written quotation on HP terms. Also interest-free terms with 50% deposit.



CREDIT CARD SALES BY TELEPHONE.

All prices include VAT and are correct as we go to press. However, we reserve the right to vary them if forced to do so by the time this advertisement appears. Phone for up-to-date information, or send 50p for our full Stock List.

HAM RADIO TODAY

Editor
Frank Ogden G4JST
Advertisement Manager
Neil Terry
Managing Editor
Ron Harris
Sales Director
Ian Herbertson
Managing Director
T. J. Connell

Published by:
Argus Specialist Publications Ltd.,
145 Charing Cross Road,
London WC2H 0EE.
Telephone: 01-437 1002.

Distributed by:
SM Distribution Ltd.

Printed by:
Q. B. Ltd.

Subscription Rate:
UK £12.80
O/Seas Sur: £13.25
O/Seas Air £25.80
Ham Radio Today,
Sub Dept.,
513 London Road,
Thornton Heath,
Surrey,
CR4 6AR.

Ham Radio Today is normally published on the first Friday in the month preceding cover date. The contents of this publication including all articles, designs, plans, drawings and programs and all copyright and other intellectual property rights therein belong to Argus Specialist Publications Limited. All rights conferred by the Law of Copyright and other intellectual property rights and by virtue of international copyright conventions are specifically reserved to Argus Specialist Publications Limited and any reproduction requires the prior written consent of the Company. © 1982 Argus Specialist Publications Ltd. All reasonable care is taken in the preparation of the magazine contents, but the publishers cannot be held legally responsible for errors. Where mistakes do occur, a correction will normally be published as soon as possible afterwards. All prices and data contained in advertisements are accepted by us in good faith as correct at time of going to press. Neither the advertisers nor the publishers can be held responsible, however, for any variation affecting price or availability which may occur after the publication has closed for press.

CONTENTS VOLUME ONE NO.2 FEBRUARY 1983

REGULAR COLUMNS

LETTERS You write and we comment	4
MAGAZINE REVIEW What the other magazines are saying	5
NEWCOMERS' FORUM This month, Tony Bailey G3WPO looks at 10 metres and the mysteries of QSL cards	12
CLUB NET Around the clubs with Cyril Young G8KHH	30
TECHNICALITIES This month, the column is given over completely to speech processing. We include designs for both high performance baseband and RF speech processors	52

CONSTRUCTION

SIMPLE AMATEUR TELEVISION STATION Get into amateur television, home brew style. Pt 1 a pattern generator	16
SYNTHESISED HF TRANSCEIVER Pt 2 Pt 2, the receiver section including the preselector, RF preamp and IF board	36

FEATURES

WORKING METEORSCATTER This is the definitive guide to meteorscatter working	6
AMATEUR SATELLITES Amateur satellites and their operation are not always well understood	24
MECHANICS OF PROPAGATION Pt 2 Pt 2, VHF propagation	34
SIX METRES Jack Hum G5UM assesses the prospects for working in the six metre band	41
UPGRADING THE KW2000 SERIES Pt 2 Making good the wear and tear	47
RAPID RESULTS MORSE COURSE A new cassette based morse course designed to take the pain out of learning CW	56
PRACTICE RAE Practice the RAE with our very realistic mock paper	58
HF RIG GUIDE Our at-a-glance guide to HF transceivers. We also give an indication of secondhand equipment values	71

REVIEWS

DATONG FL3 REVIEW This box will enhance the best of transceivers and do wonders for the worst	20
YAESU FT-102 REVIEW A very good all round performer	60
YAESU FT-790R REVIEW A set which would make a good UHF prime mover	74

NEXT MONTH IN HAM RADIO TODAY **46**

LETTERS

CHANGING THE RULES

Sir, I have enjoyed electronics and radio on the constructional side for years and try to avoid the black box syndrome wherever possible. Your first issue is a good practical mag; I trust you'll keep it up and not cloud the issue with nebulous articles like some others I could mention.

I waited in eager anticipation for my licence having sent away my eight quid, pass certificate and evidence of nationality the next day. In October I chased a fellow at Waterloo whatsit about my licence and he sent me a form to fill in (don't they all?) I sent it back. Blow me if next week I didn't get a second. Still at least this time it showed my callsign, and they returned my pass certificate. To date no licence has appeared.

The point is that if I wanted a licence for my TV or Charlie Brown (sic) you can go to the Post Office and they give it to you straight away. It is high time the authorities had a re-think.

A statement such as 'we like to encourage the prospective radio amateur' is a joke. When you finally get your class B, you realise that you are a second class citizen with a third class allocation. Fine if you're into VHF and UHF but I don't have the room to put up a whopping 100ft tower. Devon is not particularly good for two metres. A bloke in our local radio club says that Plymouth to St Austel is DX. I can do better than that on 27MHz FM.

The answer is simple. Every radio ham should pass the RAE and an operators test to see if he can speak properly on the air and use the correct procedure. Class B should be allowed 28MHz and upwards; class A, the rest of the HF bands. The morse test should be for all frequencies below 28MHz.

Incidentally, I'd put CB licences up to £30 and give them 26 and 27MHz all-mode to FCC standards and no restriction on aerials except in respect of planning permission. Amateur radio standards would not deteriorate as long as there was a sensible practical exam plus the RAE of course. Unfortunately the bureaucrats, the RSGB and the 'Fine Business Old Man' set will ensure that things don't change.

As for me, I'll have to learn morse I suppose... I shan't play around with a handheld and rubber duck at radio rallies. I'm QRT and QSY.

PETER G6NSU

An interesting letter. Rather long and punctuated with rubbish, but interesting. The HO is a bureaucracy and the RSGB a gerontocracy. However the HO is seriously overstretched (it didn't anticipate the boom in amateur radio) and the RSGB should be changed from within rather than knocked from without. I believe that both organisations are out of touch with the movement they represent. Get to it and make them listen - Ed

PROFANITIES

Sir, I read the comments about self control on the letters page of the January issue with interest. I am a newly licenced amateur after passing the May 82 examination.

I transmit within the licencing regulations and consider myself to be in full control of what I say or do. Plenty of amateurs over the age of 18 do not transmit within the regulations and to quote 'belch profanities over the air'. When talking on the air it is difficult to tell the age of amateurs unless they offer the information. Several times I have made the mistake of reducing peoples' ages by two or three decades! I can't be blamed for everything. I am sure other young amateurs would agree with me. Perhaps some newly licenced amateurs are simply following the examples of people who have been licenced for 20 or 30 years.

I would like to point out that I am 15 years old, still at school and about to take my 'O' levels in the coming year so, if the suggestion to increase the licence age to 18 years was taken seriously, I would be prevented from enjoying this hobby for another 2½ years.

Kathryn Jackson G6LHY

PS After thoroughly reading my licence conditions I wonder if G3WPO knows his licence? Mine states that (section 9/2) 'The callsign shall be sent for identification purposes at the beginning and at the end of each period of sending, and whenever the frequency is changed. When the period of use exceeds 15 minutes, the callsign shall be repeated (in the same manner) at the commencement of each succeeding period of 15 minutes.'

Interesting. I'll tackle G3WPO about it - Ed

DEAD SQUARE

Frank, So you've decided to open a new ham radio magazine? Good, there's always room for a new'un. BUT, please, could I ask ever so gently: - not to attempt further assaults on the poor battered body of the English language.

One example, from the first issue: 'disinterested' is not the same as un-interested - see any dictionary. You wouldn't want your new mag to become the 'Grauniad' of ham radio, would you?

-don't try to boost circulation by knocking the RSGB. We all know it has its problems, as does any organisation, but the ham population in this country is not large enough to support two organisations, and anyway there are already enough scatterbrained ideas about to need a sobering influence. It's all happened before - remember Autin Forsyth's campaign in Short Wave Magazine in the Fifties? - and it didn't boost his circulation.

- and for Heavens' sake don't start putting nudes on the front cover. I know that it's all the rage, and the ex-CB'ers are used to it, but couldn't we have just one mag. that didn't have vast acres of T&B (sic)?

It would be nice to think that your mag. was so good it didn't need artificial circulation boosters.

Your first issue shows signs of a good spread of interest and I look forward to the next - and the next - and the next.

By the way, you are absolutely at liberty to label me dead square, or even dead, if you wish. My 19 year old son does, why not you?

WALLY BLANCHARD G3JKV

Like it, Wally. Actually I'm thinking of running a readers' wives column... Ed

NOVICE CW LICENCE

Sir, Thanks for a magazine with a new syle. I hope that it will continue.

A novice licence would be a good idea - say a test at seven words per minute. However it is hoped that the advocates for this do not see it as a shortcut to HF, allmodes. If such a licence is authorised then it should be for CW only until such time as the magic 12 words per minute is obtained and the PO test passed.

12 words per minute does not make anybody'superior' or a better operator. The pre and immediate post war system of CW only could be brought back with advantage.

I wonder - what the superior 'A' type operators (you hear a lot them on the bands with SSB) would say if it was required that they should be re-tested after, say, three years?

The remarks in various magazines and on the air regarding the 'simplicity' of the RAE and the corresponding numbers of new licences gains strength from month to month. It is because some people are upset that what was once a fairly exclusive club is now being enlarged. This surely cannot be a bad thing for amateur radio.

I sat the new style RAE and did find that it was easy but then I have, despite my young call, been associated with amateur radio for some 44 years. I do not presume that I am any better than anybody else but I have seen a lot of water and sour grapes flow under the bridge!

R DALY G8VYJ

There has to be some mechanism to limit the number of HF band users. The real question is about what form the limiting mechanism should take - Ed

BLACK BOX

Sir, I'm fed up with all the ballyhoo, flannel, bull, and price of the modern rig together with its decor sporting a vast array of knobs, switches pushbuttons, etc. On the very latest model, I tallied up 47!!

I still get by nicely thank you on HF with 50W of SSB/CW all around the world utilising only 12 knobs.

A PHELPS G4FLK

I couldn't agree more - Ed

MAGAZINE REVIEW

By Tony Bailey G3WPO

We start this month's magazine reviews with VHF Communications, a quarterly A5 format publication which has been on the market for some time (Subscriptions only) and originates from Germany. The English language version appears to have been the subject of some dispute with the UK agents this year, and the Spring issue has only just arrived. The magazine is aimed specifically at the VHF/UHF/SHF enthusiast, and is written in a precise to-the-point technical style, many of the articles having been translated from German (apparently not always by an Englishman).

For anyone engaged in constructional work at these frequencies, it is a must, with all back issues available if required. One sad change that has occurred over the years is the omission of pcb track masters, although the layouts are always given. The pcb's used to reproduced without fail at one time, but suddenly started being omitted. As the publishers also supply kits for the modules, one presumes this was an attempt to protect this part of the revenue — getting the pcb's from West Germany tends to be a bit expensive though.

The Spring edition has a couple of articles on Coherent Telegraphy methods, including part one of a practical article on suitable equipment. For those unfamiliar with this concept, it was covered some 5 years ago in QST, involving the use of very stable transmitters and receivers (within a few Hz), and receive bandwidths of the order of 10Hz (yes Hertz). Some complex control circuitry is used, a typical chain being mixer, integrator, sample-and-hold, mixer and timing and control. Two identical channels of the above are required, using phase mixing techniques to provide a constant recovered signal.

This may all sound complex, but when you consider that the benefit over a standard CW transmission received on a 500Hz filter is around a measured 24dB, which equates to the same received accuracy for a 25W normal CW signal, versus a 0.1W CCW (Coherent CW) signal, it looks worthwhile.

Other articles cover a wideband driver for shortwave bands (intended for driving a previously published transverter) and having a 3rd order intercept point of 48dBm, a computer derived 6 element Yagi (2M), Part 2 of a METEOSAT type receive converter, 24GHz Gunn Oscillator, VHF/UHF noise generator, a treatise on Pitfalls in Noise Figure Measurement, and some mods to improve the dynamic range of the TS700. As you can see, a varied coverage for the enthusiast.

The September and October issues of QST are to hand. The earlier issue covers a Step Attenuator, an unusual "Microprocessor Controlled LC Meter that sends Code", (the former looks interesting) and an analysis of the Half-Delta Loop antenna, amongst others. Going back to the CATV remarks made last month, a battle looks like developing between the FCC/ARRL/National Cable Television Association over the ARRL's petition to make CATV abandon Amateur Frequencies.

In the October issue we find the start of a solar array design for amateur use, a mobile automatic antenna tuner (roller coaster inductor required), details of how to Shunt-feed towers, and a cheap Iambic Keyer paddle (made from Perspex type material). Lurking in the Hints & Kinks section is a useful tip for HW-101 owners on how to improve the carrier suppression. Also noted is the fact that Al Slater, G3FXB, has once again gone away with the ARRL 1982 International DX contest trophy for Europe.

Practical Wireless offers some antenna hints for 2M DF'ing, more information on radio interference suppression, including practical details on an HF low-pass filter, and an add-on squelch unit for receivers lacking this facility.

Wireless World sometimes has something of interest to us — the November issue sees the start of a series on a 2 metre MPU transceiver. It offers SSB and FM (wot, no CW?) facilities, scanning and up to 9 memory channels. Details this month on the circuit only.

The main topic in the November

issue of Ham Radio is what is stated to be a major story — the first new rig from Heath for 8 years, in the shape of the SS-9000 transceiver. There nearly was an SS-8000 a few years ago but the WARC bands appeared on the scene just as it was completed so Heath had to re-design it!

And what a rig! Without going into details it is a 9 band transceiver, 2 digital displays, plus all the other goodies we have come to expect in rigs like the FT-ONE, PLUS a built in RS-232 interface, to which any computer, terminal, or modem can be connected. All of the transceivers facilities are controllable from the added keyboard (except on/off) AND the VDU will display the status of all functions, memories etc. With a bit of programming on the external computer it should even be possible to have the rig SEARCH for that DX-pedition and let you know when it finds it (and the band they are on!). And, of course, that pie-in-the-sky of the rig producing QSL cards, and the Log, is nearly here... Maybe it is all getting out of hand?

Slight snag, the price tag in the USA when the SS-9000's start appearing will be \$2495 — we will leave you to work out how near this figure in ££'s it will be. And in ready-built form only — they were very sensible in not letting this one loose as a kit!

Radio Communications' November issue offers RSGB members a directional loop receiving system, together with in-depth technical reviews of the Yaesu FT-480R and Icom IC290E 2M multimode transceivers. Also a "Triambic Keyer" — aimed at getting over the problem of terminating a string of dots accurately with the ordinary Iambic keyer. It uses 3 pushbuttons rather than a paddle, with two of them controlling the dots — certainly novel, although it may take some mastering to use properly.

December R&EW offers a 6 metre transverter — mainly the design of an experimental power amplifier, the remainder of the circuit coming from previously published modules in the magazine. ●

WORKING ME

We present a complete guide to one of the most demanding aspects of radio operation. The first part covers the basics of meteorscatter. The second part will describe operating procedure.

By John Matthews G3WZT

With increased activity on 144MHz, meteor scatter is being used by an increasing number of people to work long distances. For those that do not understand this means of propagation fully or would like to improve their chances of completing QSO's by this mode, the following article will put you on the path to success by removing the factor of chance.

WHAT ARE METEORS

Meteors are small particles of various compositions which are classified into 3 main types.

1. Stony meteorites, composed mainly of silica and magnesium oxides.
2. Siderites, which contain mainly iron with a small percentage of nickel.
3. Siderolites, containing mineral and metallic elements in varying proportions.

Gases mainly carbon monoxide, nitrogen and hydrogen are also abundant and are liberated when the meteor vaporises during its passage into earth's upper atmosphere.

The mass of these objects vary considerably and range between fractions of a milli-gramme up to 1 kilo-gramme.

The physical dimensions range from the size of a grain of sand to a tennis ball, but does not include the numerous micro-meteorites which have such small masses that they do not burn up but slowly settle down through the atmosphere as very fine dust like particles. It should be appreciated that this is a very generalised statement and objects outside these dimensions do exist, the point being made, is that in general, meteors are very small particles of material being attracted towards us by the earth's gravity.

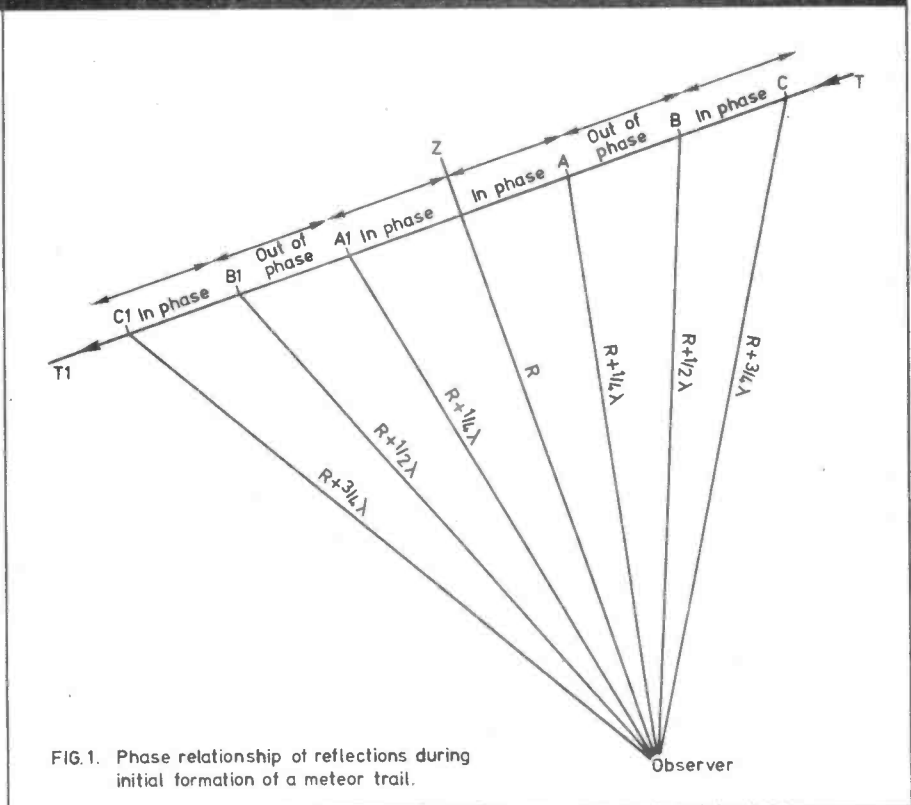

FIG. 1. Phase relationship of reflections during initial formation of a meteor trail.

Many of these particles are believed to be of cometary origin and this is almost certainly the case for major showers.

METEOR TRAILS

As the meteor is attracted by the earth's gravitational pull it begins to collide with molecules of air which become entrained in the surface. The heat produced evaporates atoms and it is the collision between the air molecules and the atoms moving off the meteorite which produce the familiar sight of a 'shooting star'.

This action produces heat, light and ionisation and in general takes place around the level of the E layer at a height of approximately 100km above the surface of the earth.

Meteor trails extend between 15 and 50km depending on the mass

and whether they arrive vertically or at some other angle to the earth's surface.

For the meteor scatter operator it is these 'tubes' of highly ionised particles that can be used to reflect radio signals very effectively at VHF frequencies, but only when an electrically conductive condition exists i.e. when free charge carriers (ions) exist.

By the time the meteor has reached an altitude of 70-80km the air density has increased sufficiently to completely vapourise the particle, unless it is very large and survives to be found on earth as a meteorite.

METEOR TRAIL REFLECTIONS

As stated earlier it is the ionised trails produced by meteor's which

METEOR SCATTER

are used to scatter and reflect radio signals, and the nature of their make up suggests that the condition for optimum reflection will not last for very long, this can be witnessed by the very rapid make up and disappearance of a 'shooting star' (meteor). In some the ionisation density is very low and scattering of the signal takes place rather than reflection. These are known as underdense trails and because of the low electron density signals pass through the trail and the total received energy is the sum of the individual reflections. However due to the rapid change in phase angles caused by multiple individual reflections bursts from underdense trails are very short. It is this condition which produces the familiar 'ping' with signals audible for only a fraction of a second. This of course serves no useful purpose other than to assure you that someone is transmitting on the specified frequency — hopefully your sked partner! Other trails produce high levels of ionisation and are known as overdense. With this type of meteor trail the high levels of ionisation cause total reflection of the wave giving much longer bursts of information which can sometimes last for 90s and on rare occasions 2-3 minutes. Strongest reflections will occur if the meteor trail electron density exceeds the value for total reflection from an ionised gas. This requires the trail to exceed 10^{14} electrons per metre of length.

SIGNAL LEVEL FLUCTUATIONS

Received signals reflected from meteor trails are often subject to considerable fluctuations in strength. There are two main reasons for this, both of which are due to more than one reflection being received at the antenna, sometimes in phase, and adding to the signal and at other times in anti-phase and cancelling.

The first are rapid fluctuations directly proportional to the frequency used. These have been measured by professional pulse methods and found to correspond to

a fluctuation of approximately 22ms at 144MHz. It is caused by a series of maximum and minimums which occur during the making up of the meteor trail, and is best explained with the aid of a simple diagram. (see Fig. 1).

As the meteor travels along the axis T.T1 insufficient scatter is produced before point AZ is reached. Reflections between ZA and ZA1 will travel the return distance from the observer between $2R$ and $2(R + \frac{1}{2})$ but waves scattered between AB and A1B1 will travel return distances between $2(R + \frac{1}{2})$ and $2(R + 1)$. Thus if the reflections from ZA ZA1 are positive in amplitude those in AB and A1B1 will be in anti-phase cancel. Those in BC and B1C1 are in phase with ZA and ZA1 and so add to the received signal strength. This rise and fall in signal strength is shown graphically in Fig. 2.

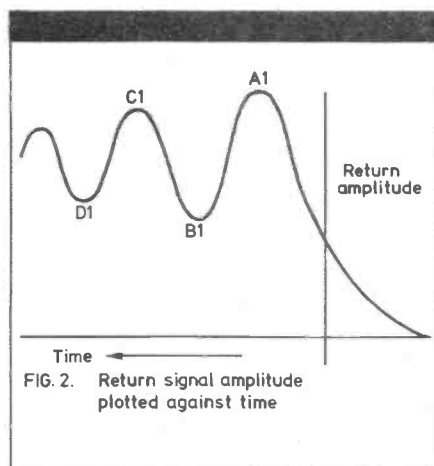

FIG. 2. Return signal amplitude plotted against time

When the trail is complete the signal will level off and then slowly decay as the ionisation is dispersed in the upper atmosphere by high altitude winds. The second reason in the simplest case, is believed to be caused by distortion of the ionised trail due to severe turbulence encountered in the upper atmosphere. It is quite common when receiving a long burst from distant m-s stations to find periods of several seconds when no signal is present, or at a very low level. Although this is not always the case it may be attributed to those reasons given above.

SIGNAL STRENGTH AND DURATION

When considering scattered signals from underdense meteor trails the duration is proportional to the square of the wavelength. In other words a 1s burst on 2m will only have a duration of 0.11s on 70cms.

The received energy is proportional to the third power of the wavelength which corresponds to a 27:1 reduction on 70cms compared with 2m. A signal 15dB above noise on 2m will only be 1dB on 70cms. (14dB reduction).

For overdense trails where most of the incident wave is reflected the duration is still proportional to the square of wavelength but the received energy is directly proportional to the wavelength. In real terms this means that a burst of 10s duration, 10dB above noise on 2m would be 1.1s long and 5.5dB over noise on 70cms.

On 4m the values would be increased to 42s duration and 16dB over noise compared with those on 2m.

These figures indicate why 70cms is a much more difficult band to work using this mode of propagation.

It must be said that some dedicated 70cms operators have had successful QSO's on this band but compared with 2m the combination of reduced received energy and signal duration make the completion of QSO's very difficult for all but the best equipped stations.

A certain amount of work is being done by some operators working cross band 4m/2m. In this situation the 4m listening station has the added advantage of the improvements offered by the lower frequency. 4m would most certainly be an excellent band for the meteor scatter enthusiast but unfortunately cannot be used to full advantage because it is denied to most operators in Europe.

EXPECTED RANGE

What distance can I expect to work using meteor scatter? This is a fre-

quent question and one which depends considerably on the conditions prevailing at the time. Generally it can be said the ranges expected are very similar to that obtained when working single hop sporadic E, normally between 600 and 2000km, although during levels of high meteor activity ranges of 3000km are possible.

Meteor scatter is normally a weak signal form of communication, particularly when stations are placed towards the limits of range. When attempting schedules with stations at ranges in excess of 1800km signal strengths can often be very low — only a few dB above the noise floor of the receiver with long periods of no signals at all. It is under these circumstances that the utmost patience is required as a burst of information may come along which is sufficient to complete a QSO when hope is running out. Shorter range stations between 1000-1500km can often provide regular, strong signals above S9 if using some of the major showers with correct timing. This is where most people start meteor scatter operating and develop an interest in this most fascinating form of VHF propagation.

DOPPLER FREQUENCY SHIFT

Any signal, audio or radio frequency which is radiated by, or reflected from a moving object will be subject to Doppler shift.

Reflections from meteor trails are no exception to this rule and are often affected to some extent by this phenomenon. The amount of frequency shift can be calculated if two factors are known.

1. The velocity of the meteor trail
2. The frequency of RF energy.

$$FD = V/C \times f$$

Where FD = unknown doppler shift in Hz

V = Velocity of meteor in earth's atmosphere m/sec

C = Velocity of propagation — 300×10^6 m/sec

f = Transmitted frequency in Hz.

Different meteor showers have a wide range of velocities when entering the earth's atmosphere.

For example, the April Lyrids

are 50km/second.

Therefore FD =

$$\frac{50 \times 10^3 \times 144 \times 10^6}{300 \times 10^6} = 24\text{kHz}$$

The maximum velocity of a meteor entering the atmosphere from within the solar system is 72km/sec. This limit is made up of two components and is the sum of the earth's velocity around the sun (30km/s) and the escape velocity from the solar system (42km/s). This value of 72km/s is attained by the November Leonids shower and gives a theoretical maximum Doppler shift of 34.5kHz. These figures are theoretical maxima and assume the reflecting medium to be moving at this speed.

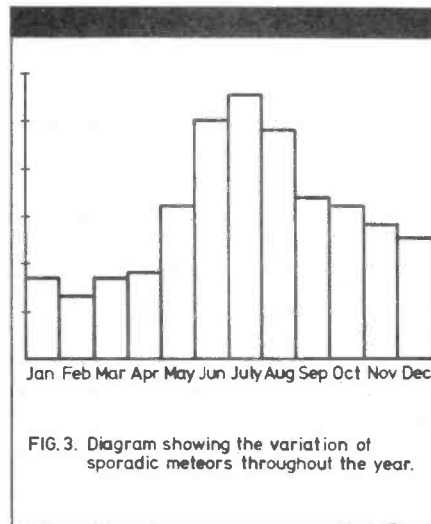

FIG. 3. Diagram showing the variation of sporadic meteors throughout the year.

This of course, is not the case in practice because it is only the meteor head which is moving at this velocity. The trail of ionisation produced by the meteor is stationary except for relatively small atmospheric disturbances, and as this is the reflecting medium Doppler shift should no be evident.

However in some instances Doppler shift can be heard and although personal observations seem to indicate that the bursts are all very short, this may not necessarily be the case, as often the Doppler shift moves the received signal completely across the pass-band of the receiver and the true duration and the amount of shift are never discovered. It is possible that this phenomenon is due to reflections taking place from the ionisation surrounding the meteor head which may also have a trajectory far from ideal for the path being worked.

SPORADIC METEORS

Sporadic meteors, as the name implies, have a random distribution over the sky with non-defined orbits. They account for the majority of particles that enter the earth's atmosphere although meteor showers with well defined orbits and high concentrations provide much improved propagation for short periods only.

Sporadic meteors can be used by the ms operator with considerable success throughout the year although certain times of the day, and months of the year give a definite improvement in communications efficiency.

ANNUAL VARIATIONS

There are certain months of the year which provide a much higher yield of sporadic meteors. A peak in activity occurs during June, July and August with minimum activity occurring in February and March. A diagram outlining these annual variations is shown in Fig. 3.

DIURNAL VARIATIONS

Owing to the earth's motion, certain parts of the day produce higher rates of sporadic meteors.

As the earth rotates on its axis, some parts are in sunlight and others in darkness. During the early morning around 06.00 the observer's part of the earth is forward on its journey around the sun and tends to sweep up the meteoric particles in its path whereas at sunset the opposite occurs as the earth is acting as a shield to incoming particles and only those with sufficient velocity to overcome that of the earth's motion will enter the atmosphere. Any meteors approaching the earth towards sunset will need to exceed the forward velocity of 30km/s whereas at 06.00 optimum conditions exist and the velocities are additive. Fig. 4 shows this in the form of a diagram which illustrates the relative motions and times.

Although sporadic meteor scatter can be used at any time of the day throughout the year best results should be obtained during the early mornings of the summer.

METEOR SHOWERS

At certain times every year, the earth, on its path around the sun,

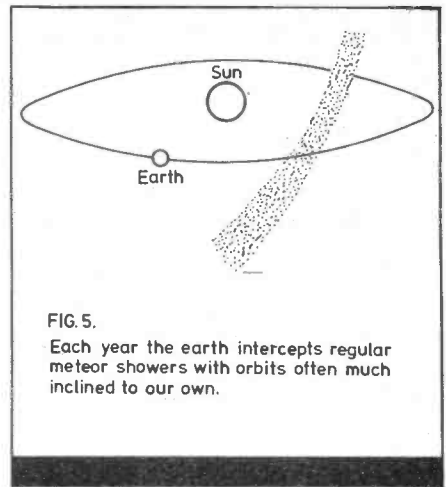
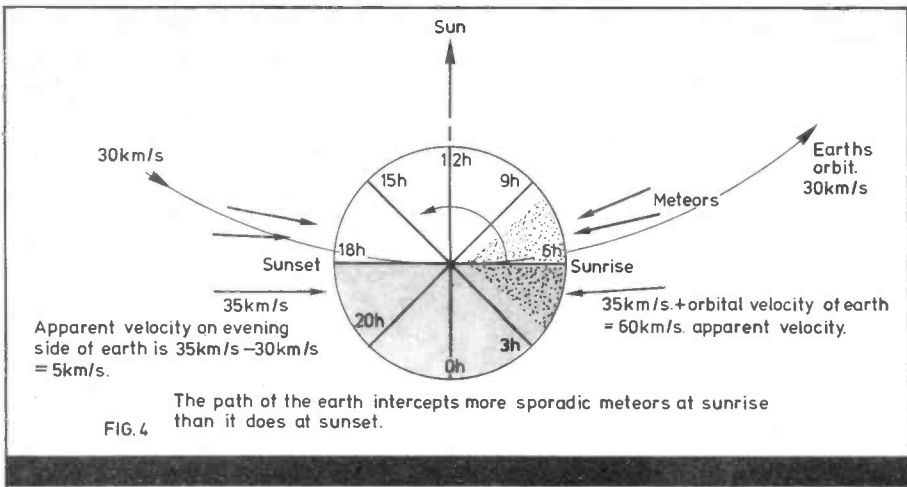

passes through large areas of concentrated particles resulting in a major meteor shower. (Fig. 5)

The distribution is uneven and contained in highly elliptical orbits around the sun which are inclined at varying angles compared to that of the earth. The origins are probably cometary and although the comets themselves are now extinct in most cases, the remains continue in predictable orbits and have celestial co-ordinates which allow accurate timing and positioning to be made.

THE RADIANT POINT

The radiant point is the position in the sky from which the meteors appear to originate and the shower name is taken from the constellation in that part of the sky which contains the radiant point. Hence the Geminids shower radiant appears in the constellation of Gemini and the Orionids in Orion. The only exception to this is the January Quadrantids. This particular constellation is

now obsolete and is incorporated into Boötes.

Although the meteors give the appearance of coming from a point source it is an effect of perspective and in fact they are moving in parallel paths towards us. This fact can be best understood by imagining two long straight roads running parallel to each other and stretching towards the horizon. In the far distance they seem to converge into a single point and this could effectively be looked upon as the radiant point (see Fig. 6 a, b, c).

The co-ordinates for establishing this point on the celestial sphere are known as Right Ascension (celestial longitude) and declination (celestial latitude) angles and are quoted in degrees or time. (Fig. 7). All meteor shower radiants have the same apparent motion as the stars, rising in the East and setting in the West due to rotation of the earth on its axis.

When the Right ascension and declination angles are known it is possible to plot the path of the ra-

diant point onto a plane surface and determine the best possible times and directions for meteor scatter communications in any given shower.

Plot of all major showers are shown in Figs. 8a-8k. The drawings and instructions on their use will be given next month.

It should be noted that the local times given for any shower and the optimum direction of propagation at a given time do not change from year to year although the peak of the shower is retarded by 6 hours each year over a 4 year cycle for a given location. This is accounted for by the fact that our year is $365\frac{1}{4}$ days long and the earth will have to complete 4 orbits of the sun (4 years) before it is in the same position at the same time again.

During this period the earth will have effectively completed one additional rotation on its own axis intercepting the same point in space again, at the same time of day. The date will also be the same due to the addition of an extra day (leap year).

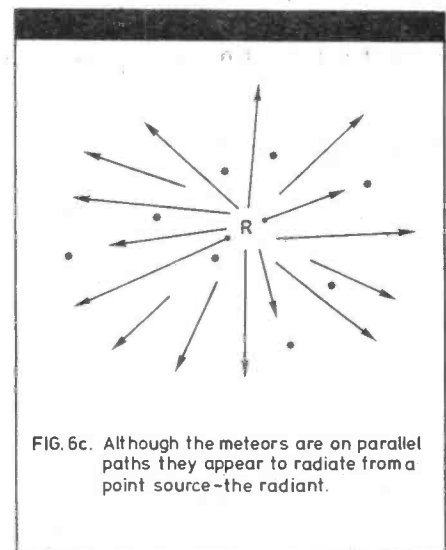
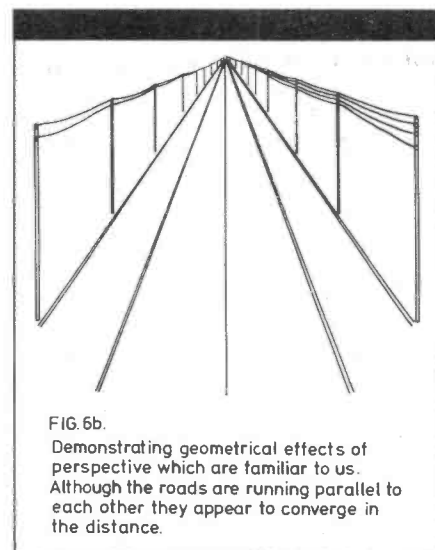
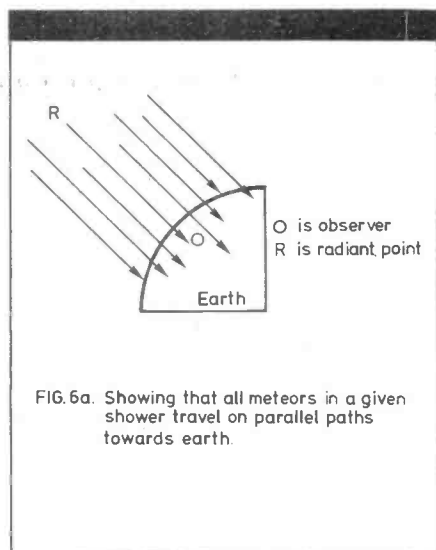

METEOR SHOWER ORIGINS

There are other occasional peaks caused by perturbations or by the period of the comet which originally formed the showers but they can be many years or even decades apart due to the very long orbital period.

Some of the showers and their associated comets with orbital periods are listed below.

ETA-AQUARIDS: May 6th.
Associated with Halley's Comet.
Period 76 years.
Next return 1986

PERSEIDS: August 12th.
Associated with Tuttle's Comet of 1862. Period 121 years.

GIACO-BINIDS: October 10th.
Associated with Giacobini's Comet. Discovered in 1926 with return of sub storm level in 1952.

LEONIDS: November 16th.
Associated with Tempel's Comet first noted in 1799 and has a period of 33 years.

URSIDS: December 22nd.
Most likely to be associated with the Comet Mechain-Tuttle. Discovered in 1945 and returns with useable rates of 10-20 per hour each year.

Fig. 9 shows the orbit of Halley's Comet which is believed to produce the Eta-Aquarids shower on May 6th. This gives an insight into the path of a meteor shower although the orbit is steeply inclined to that of the major planets.

If a particular meteor shower radiant goes below the horizon it is possible that the peak may occur at this time and deny meteor scatter operators at our latitude the advantage of maximum activity.

EQUIPMENT REQUIRED

ANTENNA: When attempting meteor scatter QSO's towards maximum theoretical distances it would be true to say that the bigger the antenna system the better the

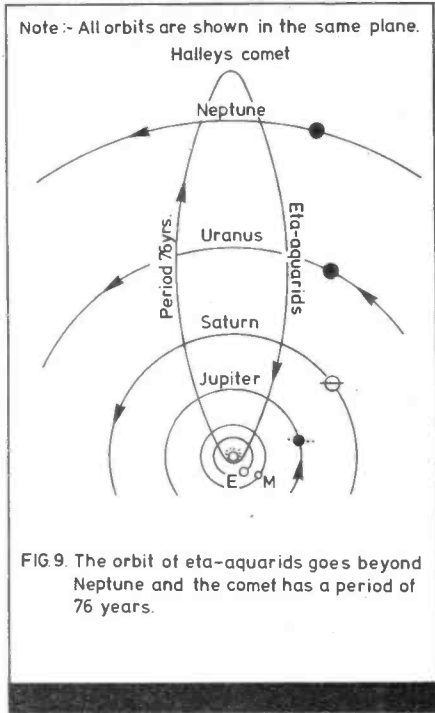
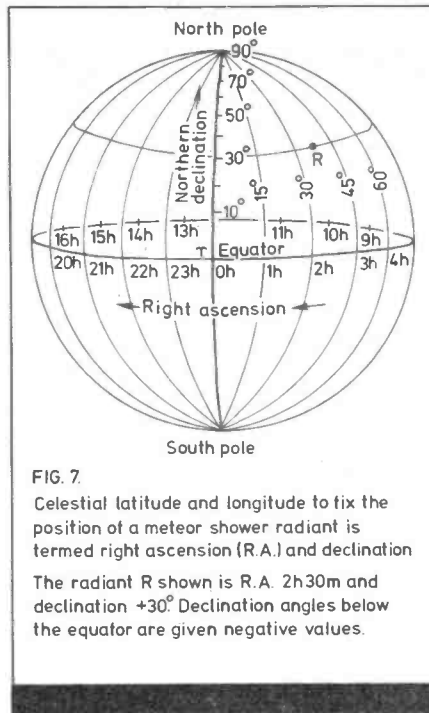

results. However big arrays do have certain shortcomings for the ms operator unless elevation is possible. This is due to the reduced vertical and horizontal beamwidths which will reduce signal levels at the lower and intermediate ranges as the height of the meteor radiant at the mid longitude point requires a certain degree of antenna elevation. The amount of elevation required for optimum performance at various distances is shown graphically in Fig. 10. A single yagi mounted as

high as possible above the ground will provide excellent results with distances in excess of 2000km and will also show a marked improvement over larger arrays at shorter distances due to the larger vertical beamwidth.

For longer distances the large array is without doubt superior but a long yagi with between 10 and 16 elements well above ground is quite adequate.

Continued next month

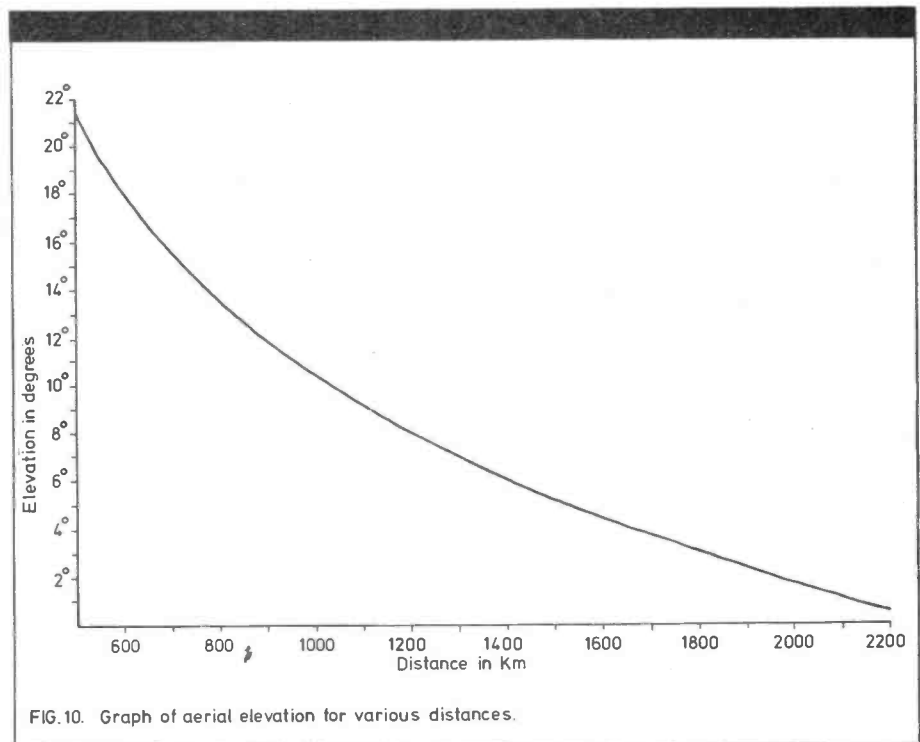

A new venture totally unconnected with any other amateur radio retailer

THE ENFIELD EMPORIUM

DAVE, G8SYG & MIKE, G6LHL

Would like to welcome you to their new emporium. It is just 1 mile from the North Circular Road in Enfield. There is plenty of room to park and cups of cocoa will be available to those in need of refreshment.

GOT AN IC 2E?

Why not let us MOD it? We can add an i.e.d. S-meter to your 2E (or 4E) while you wait!! We supply a completely new face-plate and the mod can either be carried out in our workshop (£20:25p) or we will supply a kit for you to fit yourself (£16).

LOAN SET

— We will have two licensed engineers in attendance to help you with any problems that you may have and they will be willing to repair rigs that were bought elsewhere! We will even offer you the use of a LOAN SET while yours is being repaired!!!

WE STOCK THE FULL RANGE OF



ICOM

EQUIPMENT AND ALL ACCESSORIES ARE AVAILABLE

WE CAN SUPPLY EQUIPMENT AND ACCESSORIES FOR

TRIO & YAESU

WE ARE ASP ANTENNA STOCKISTS

★★★★★★★★★★★★★★★★

TRIO — We are offering substantial reductions on TRIO prices to personal callers only. *(Trio 930S with built-in auto A.T.U. — now in stock)*

★★★★★★★★★★★★★★★★

STANDARD — We now have in stock the C58, the C78 and the brand new multi-mode — the superb C5800 (25 watts) only **£359.**

★★★★★★★★★★★★★★★★

ANTENNAS — We now have in stock the full range of TONNA and JAYBEAM antennas. We also have some very special bargains such as:—

2m Colinear (3dB)	£17.50 (Base station)
2m Colinear (6dB)	£33.00 (Base station)
10-15-20m Vert. trapped Dipole	£45.00
Halo (Sideband Mobile)	£5.75
Aerial Poles (1½" & 2") — Assorted lengths in stock.	Prices from £6.50
Chimney lashing kits (Heavy duty)	£15.00
Stand-off brackets — 12" £11 — 18" £12 — 24" £15.50.	

★★★★★★★★★★★★★★★★

ROTATORS — Kenpro KR 250 (Light Yagis) — KR 400 (Medium to Heavy) — KR 600 (Heavy) Daiwa DR 7600 (Heavy) — Hirschmann 250 (Heavy).

★★★★★★★★★★★★★★★★

BARGAINS — Sleaving **4 pence per m.**
 813 Valves (Normally £91.00 each) **£35 for TWO**
 807 Valves **£2.00 each**
 We cannot list all of the switches, coils, transformers and components that we have in stock so **COME IN AND RUMMAGE.**

★★★★★★★★★★★★★★★★

SWITCHES — Co-axial antenna switches from DAIWA — 4 Way **£36.99**; 2 Way **£10.50.**

★★★★★★★★★★★★★★★★

CRYSTALS — We have in stock a large selection of crystals, some very rare ... **£2.00 each**

★★★★★★★★★★★★★★★★

METERS — We stock the full range of DAIWA crossed needle SWR/Power meters.

CUE DEE

TONO
Linears

Specifications:

Antenna	4144A	10144A	15144A
No. Elements	4	10	15
Gain	8dBd	11.4dBd	14dBd
Front/Back	20dB	20dB	26dB
Front/Side	40dB	40dB	40dB
Boom Length	1.1m	4.5m	6.45m
Weight	1Kg	3Kg	5Kg
Boom		3 sections	4 sections

Independent Tests

Model	Boom	Gain	Length	Annaboda*)	Claimed
15144 (A)	3.1λ	13.0dBd			14.0dBd
C. C. Boomer	3.2λ	12.8dBd			16.2dBd
14 el Parab	2.9λ	12.7dBd			13.7dBd
Tonna	3.1λ	12.2dBd			15.7dBd

2M-50W	40 Watt Linear For 2 Metres	65.00
2M-100W	90 Watt Linear For 2 Metres + switchable pre-amp.	115.00
MR-150W	140 Watt Linear For 2 Metres + switchable pre-amp.	159.00
MR-250W	210 Watt Linear For 2 Metres + switchable pre-amp.	259.00
MR28	100 Watt Linear For 10 Metres + switchable pre-amp.	65.00
UC70	50 Watt Linear For 70cms+switchable pre-amp.	149.00

*) Gain over dipole under matched condition.

Full range of TONO products in stock.

Opening hours:
 Mon-Thur 9-6
 Fri 9-8
 Sat 9-6
AND NOW
SUN 9-1

★ **SPECIAL OFFER — Only £7.50 inc. p+p.** ★
 ★ **Slim Jim — Collapsible to 20 inches — can be mailed.** ★
PART EXCHANGES WELCOME

All prices include VAT. Goods normally despatched by return, but please allow up to 7 days.

281 HERTFORD ROAD, EDMONTON N9.

Telephone (01) 804 0128

Buses 249, 279 and 149 stop outside the door.



NEWCOMER'S

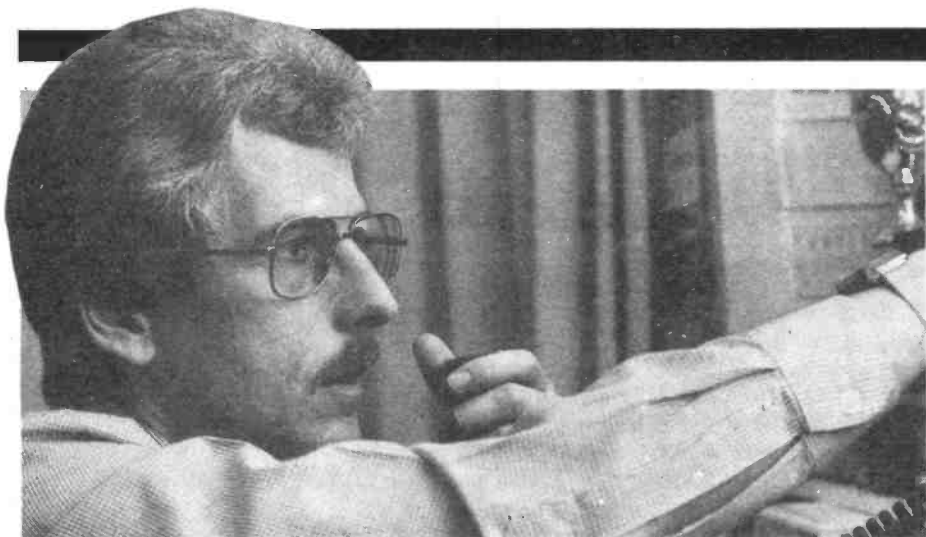

By Tony Bailey
G3WPO

Will QSL via the
bureau... or direct?

What that really
means. Also 10 meters
and a look at signal
reports

10 Meters

Back on the subject of HF operating, those of you with new shiny G4 tickets, ought to be thinking about getting some operation in on the higher frequency bands while there is still the chance. It is now generally accepted that the present sunspot maximum is on the decline, and especially in the case of 10 metres, the high traffic rates of the past few years, already declining this year, will soon be a thing of the past. With Winter here, conditions should be excellent for the next few months, before decline again to the Summer doldrums.

Anyone who has not heard 10 metres when it is really open has missed an experience. It is possible to work all Continents in a few hours, with only modest powers and aerials, with the band open in all directions at the same time. I will remember working all Continents many years ago with only 25W input of SSB and an inverted Vee dipole (a good aerial for those of you with limited space, with the apex mounted only 0.1875 wavelengths above ground) in under 2 hours. This contrasts with the state of the band during Sunspot minima, when you may be lucky to hear anything, other than Europeans, for days on end.

Most of the activity on SSB takes place between 28.5-28.6MHz, but under good conditions, and during contests, this will spread from below 28.4 up to 28.7MHz and above. Below 28.5MHz is quite a good hunting ground for DX, as many tend to pick a lower frequency when they want a chat, to avoid the QRM higher up. Many Australian (VK) stations tend to be looking for G QSO's around this area, so an early morning scan around this portion of the band could pay dividends.

If you want an idea of conditions on 10 metres, have a listen around 28.2MHz, which is the area reserved for Beacons. Although you may be hearing a particular beacon, you may not necessarily hear any stations from that area — people tend to forget that for part of the world, it will be time for sleep, so bear this in mind when you are looking for any particular callsign area. As for working the rare ones, we will cover this in a future column.

VP2LC/P		DX'PEDITION		QSL	
				G3WPO	
				JULY	
SWAN 350		14AVQ ANT		STAN VP2LC	
GARRY VP2LC-P		1748		21	
ST. LUCIA		RST 55		MODE 2XSSB ✓	
1970		QSL VIA		VE3GCO	

FORUM

TO RADIO: *G3 WPO/A*

OK 3 TOA

Jozef Izold
Rybník Nr. Levice

DATE	GMT	MHz	RST	MODE	TX	RX	ANT
2. XI. 1964	16.35	1.8	13/94	CW	10W	9TBS	Lc 41m

QRA JI 53

QSL VIA CRC PB 69 PRAHA 1

73 *JIZ*

Getting that QSL

Having got your contact, you will probably want to confirm the QSO in the form of a QSL card. The practice of QSL'ing has changed a lot in the past decade or so, and the days of automatic writing out of a card for every contact has probably gone for ever, although some Eastern Bloc countries still do so (judging by the number of European cards one gets). To get your QSL, you will normally need to send one, especially if the station is on the rare side, and there are basically two ways of doing this, with time and cost the main factors. These are either the use of a QSL Bureau, or by direct mail.

QSL Bureaux exist in many countries, usually as a service (sometimes free, or for a small fee) and run by National Societies, although there are many Independent ones. This is the slowest, but definitely the cheapest method, and at today's postage costs, probably the only way for routine cards. The RSGB have had a QSL Bureau for many years which is included in the Subscription as a service to members, and may be the only reason for joining the RSGB for some. Non-members may use the Bureau, but only to receive cards.

Every so often, depending on your card filling-in rate, you sort your cards into order, and send them off to the Bureau in bulk,

where they are broken down into their respective countries, and again sent in bulk to the Bureau in the destination country. Eventually they arrive with the individual stations, and the process can start in reverse. This may take anything from a month or so to several years, so you need patience as a virtue!

To receive cards, you will need, in the case of the RSGB, to send a supply of stamped self addressed envelopes to the appropriate QSL Bureau sub-Manager (who this is depends on your callsign), who then starts to fill up the first envelope until the postage weight limit is reached for the stamps, when it will be returned to you. Alternatively, you can specify that cards are to be returned every month or other period. At a guess, P.O. Box 88, Moscow, is probably the largest Bureau, handling all Russian cards.

The most expensive but quick(er) way is by direct mail, usually by Air. You will need the stations address, either obtained while working him, or via one of the International Call Books. The card is then sent, together with 2 or 3 International Reply Coupons (IRC's — obtainable from Post Offices) to pay for the return postage. Incidentally, buying IRC's can work out expensive — look for small ads offering them cheap in quantity as many stations receive more than they can use and sell the surplus.

My Manager is...

Many of the rarer stations ('rare' in Amateur radio terms means that little operation takes place from the location), especially those visiting the place specifically to dish out contacts — known as DXpeditions — use the service of a "QSL Manager" to relieve them of the burden of filling in what may amount to many tens of thousands of cards. Why any sane person would want to fill in such a quantity of cards on behalf of another person baffles me, but they do, and it is to him that you send the card, not to the original station. You will often get the Manager's callsign during the QSO, or find it published in a magazine.

If you intend collecting any Awards to adorn the shack wall, it is important that the right information appears on the cards you receive, and of course on those you send, (the other chap may be after an award and you may be the last one he needs). The most stringent requirements are those taken by ARRL for the coveted DXCC award (DX Century Club). Most HF operators aspire to this piece of paper, requiring a minimum of 100 valid QSL's from different countries. We will have a closer look at Awards next month, but the standard required by ARRL can usefully be extended to all cards. So when you frantically scribble out your details to that Easter Island Dxpediton, or the UA who wanted your card, remember the following:

- 1) The card must show clearly your callsign, date, time, frequency, signal report and mode.
- 2) The card must show no alterations or other evidence of tampering.
- 3) The country claimed must actually be on the official ARRL country list in force at the time of the claim (this list is obtainable from ARRL or the RSGB).

There are a number of other unspecified checks carried out, one will be checking some of the cards with the actual stations worked.

S-Meter reports

One of the items required is probably the most abused, yet essential part of a QSO exchange — the signal report. The existing RS (or RST for CW) code was evolved a long time ago, way before the advent of crowded bands, vastly in-

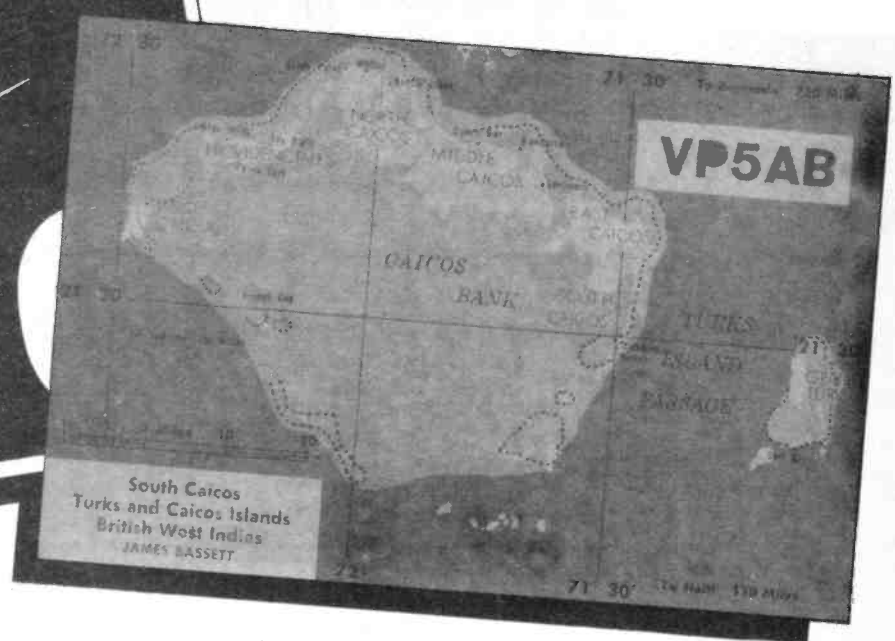
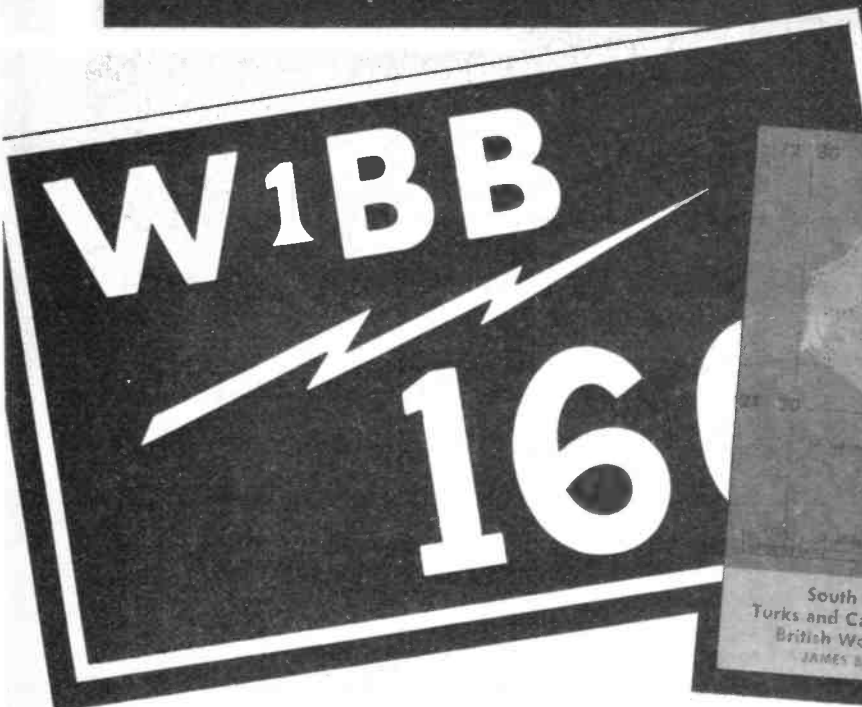

creased manmade interference, FM, extremely sensitive rigs etc., — and the 'S-Meter'. From the definitions of the RS code you will see that it is a purely subjective code, based on what your ears receive, and was never intended to be equated to an electrical equivalent. When someone gives you a report of 59 what does he mean?

If it is in a contest, then you are probably 32, not 59, but then everyone gives 59 during contests, so you would ignore this report anyway (it goes "you are 59 old man, please repeat my report and serial number, and I need your prefix...").

Is he using an S-Meter for your report? If so, then it still doesn't mean very much, even if he tells you that his rig is calibrated to the accepted standard (which one?). Varying receiver sensitivity makes a nonsense of such calibration. If you take two receivers of varying sensitivity but calibrated to the same standard for S9, then any given voltage signal will produce the same S-Meter reading on both. However, the less sensitive receiver will yield an inferior report if you use the RS system for an audible report. So using the S-Meter doesn't tell the transmitting station what the signal coming out of the speaker is like. At the extreme, if the receiver is very insensitive then you could be barely audible but S9!

An even better example is FM. The average modern transceiver

can provide a near fully quietened receiver for under 1uV of signal. On an audio report you would be S8 or 9 using the RS standards. You will be lucky if the S-Meter has even moved off the stop (or lit a cherry with the new rigs), so you would then be justified (but foolish) in giving a report from the meter of S0 or S1!

The S-Meter is useful for comparative reports i.e., "you are stronger or weaker", but be careful when saying that the signal has increased by 1 S-point unless you know what you mean. If the other station takes this at face value then he will assume that his signal has increased by 6dB (which is the accepted standard for an S-point), or equivalent to an increase in his transmitted power of 4 times (3dB for power doubling — 6dB for voltage doubling). Almost certainly, you will find that the steps between

the calibrated "S-divisions" on your meter are not 6dB, and may be anything from 3-20dB, and varying across the scale — some examples are given of S-Meter calibrations taken from reviews (the rigs remain anonymous). If you feel so inclined, spend some time actually checking your rig with a calibrated and correctly terminated signal generator.

Several solutions have been proposed, my own is to ignore S-Meters and go back to subjective reports using a simplified reporting system put forward some time ago by UA1IG which removes some of the intermediate steps in the existing 9-point scale. Any other suggestions?

Next month we will have a look at the subject of polarisation and VHF signals, and hopefully answer a few of your questions. ●

UA1IG S-Meter Scale

- S1. Very weak signal; impossible reception
- S2. Weak signal; reception with strained reception
- S3. Satisfactory signal; reception without particular strain
- S4. Good signal; reception without strain
- S5. Loud signal; loudspeaker reception

Signal Strength (as in standard RS code)

- 1. Faint signals, barely perceptible
- 2. Very weak signals
- 3. Weak signals
- 4. Fair signals
- 5. Fairly good signals
- 6. Good signals
- 7. Moderately strong signals
- 8. Strong signals
- 9. Extremely strong signals.

Go on a computer date

(and take along the wife and kids)

These are the dates of the London Home Computer Show. On display will be a complete cross section of the hard and software available to the home-user.

The emphasis is on the lower end of the price bracket, with computers from £50-£300.

You will be able to chat to the manufacturers and play with the computer before you buy.

So bring along the wife and kids (who'll probably be more of an expert on what you're buying than you)

Admission £1.50p (Children under 8 and O.A.P.s FREE)

*And if you're in a party of 20 or more, there's a 25% discount.

Friday 7th January '83

(10.00am-6.00pm)

Saturday 8th January '83

(10.00am-6.00pm)

Sunday 9th January '83

(10.00am-4.00pm)

**THE LONDON HOME
COMPUTER SHOW.**

Royal Horticultural Society's Old Hall, Vincent Street,
London SW1.

**For advanced bookings for parties of 20 or more, please send
cheques payable to Argus Specialist Publications Ltd. (Dept.
LHCS), 145 Charing Cross Road, London WC2H 0EE.
Telephone 01-437 1002.*

SAVE 50p

Present this token duly completed when buying your ticket for a
50p reduction. Only 1 token allowed per person.

Name Mr/Mrs/Miss

Address

Signature

HRT

A Simple Amateur Television Station

Build your own amateur television station in a series of easy stages. Although ready made equipment may be included, the accent will be on home construction. Pt 1: a pattern and synchronisation generator

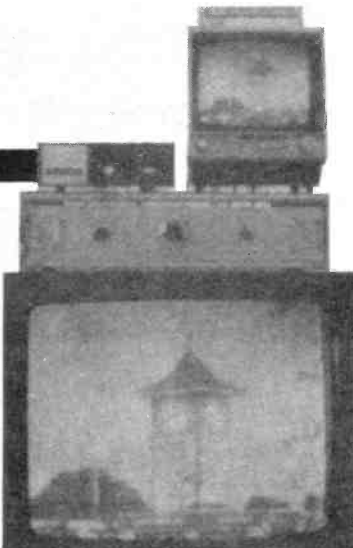

Amateur Television is a mode via which fast moving TV pictures can be exchanged. TV transmissions have taken place on the Amateur bands since the late 1940's early 1950's. Amateur TV should not be confused with SSTV where only still picture exchanges are possible.

The standard used in this country by Amateurs is 625 line negative modulation, that is to say the same standard as used by the ITV and BBC for their UHF service. The 70cms band is by far the most popular band for TV Amateurs but 24cms is now starting to show signs of activity. Receiving Amateur Television on the 70cms band has never been easier. The aerial can be any good 70cms aerial with the J Beam Multi Beam being the most popular. At UHF the down lead should be kept as short as possible and good quality coax is essential regardless of the mode, losses can be alarming.

The only problem comes in adapting your television set to the 70cms band, a part of the spectrum not normally tuned by the average domestic TV set. The way around this problem is to use an up converter, there are several on the market and all perform equally well. Microwave Modules, Wood & Douglas and Fortop all market these devices.



If you are not sure of the Amateur Television activity in your area then it is wisest to purchase a commercially built and tested converter rather than building your own.

The up converter plugs directly into your UHF TV aerial socket and usually converts the 70cms band to about Channel 34.

A good guide to activity is to listen on the two meter talk frequency of 144.750MHz for Amateur TV activity, when you are sure someone is transmitting, then tune your TV around Channel 34. There will usually be an increase in noise as you cross 70cms indicating the part of the band where the converter performance is optimum.

It goes without saying that getting the transmitting station to point his beam at you will give the best results. As a guide the station needs to be about S7 or stronger for a successful TV contact. TV pictures can often be exchanged between Amateurs in this country and France, Germany and Holland under lift conditions.

Once you have mastered the technique for receiving TV the next logical step must be transmitting your own TV pictures.

In the coming series of articles I will be putting together a simple low

power TV station that can be used for portable or fixed station working. The station will operate on 12v so a back pack walk around type of operation could easily be possible. By mixing home construction and interfacing some commercially built units, I hope to get the best out of both worlds. For example, the Test Waveform Generator will be constructional article number 1 along with a Character Generator for displaying your callsign electronically (article number 2). Video Switching, a way of making production changes between your available sources, will also be a constructional article (number 3).

TV cameras are best bought, as the home video market is now booming and difficult to compete with, particularly where cost and performance are considerations, lenses, tubes and scan coils being expensive items. A home constructed camera could not be as small and compact as a commercially available one. The view finder of a commercial camera would also be impossible to emulate using home construction, and is essential for portable working.

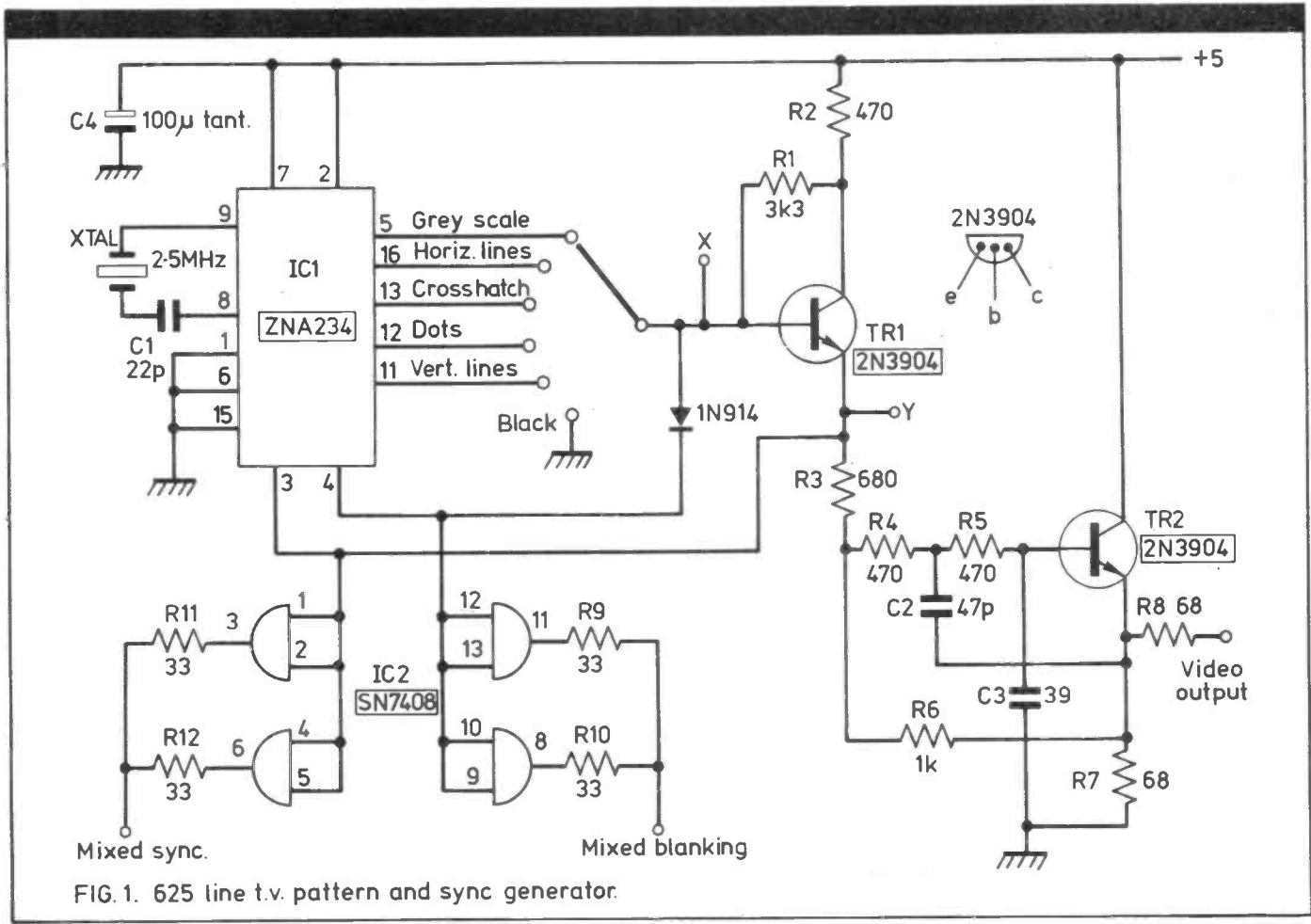
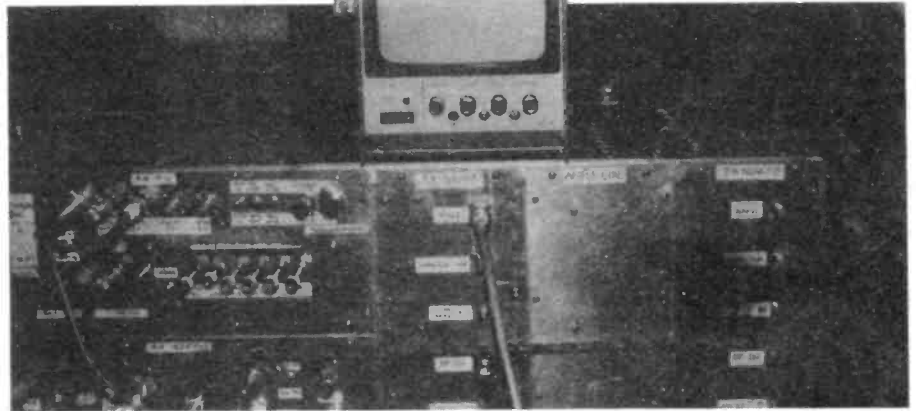
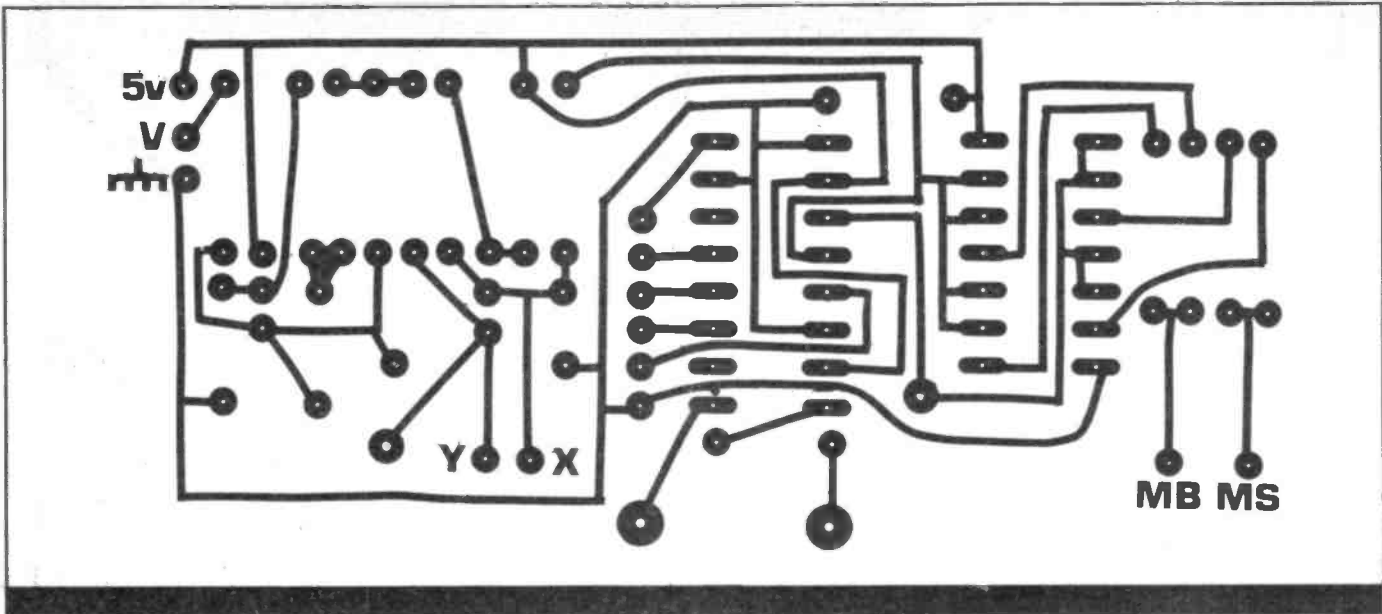

FIG. 1. 625 line t.v. pattern and sync generator.



Test Pattern and Sync Generator Module

This is the first module in our TV station. A good source of TV test waveforms is essential for setting up the rest of the station.

Grey scale being the most useful waveform for checking out our TV station, but crosshatch is very useful for setting up your TV set.

The circuit revolves around the Ferranti Pattern Generator ZNA 234. All the waveforms required are generated within the chip, but for some reason known only to Ferranti they are not processed with mixed blanking which is available from the chip. Ferranti also generate the grey scale waveform up side down, ie, it is a falling staircase not a rising

one as convention dictates. In order to keep the circuit as simple as possible I did not invert the staircase as its polarity is unimportant when adjusting your TV station. The ZNA 234 requires a 2.5MHz xtal oscillator. All the electronics are within the chip with the exception of the xtal which goes between pins 8 and 9 and requires a small 22pF capacitor in series with Pin 8 (C1). The value of this capacitor can be varied to adjust the line speed of the generator.

The TV waveform requires holes cutting in it so as to accommodate the pulse information which is essential to a TV transmission in order to start the line and field scan generators of the receiver at the correct time (sync pulses). These holes

are cut by a mixed blanking signal which turns on the 1N914 diode and turns off TR1, and thus suppresses the video signal.

It would seem to follow from the circuit diagram that by turning off TR1 we would also turn TR2 off, but things are not always what they seem, both Pin 3 and Pin 4 of the ZNA234 are returned to the +5 by 3K3 resistors within the chip.

The next stage is to add sync pulses to the waveform. This is done by using the mixed sync output to turn TR2 off. You can do this by reducing its base potential below the limit set by the internal pull up resistor on Pin 3 and R3 R6 R7.

The sync pulses are narrower than the blanking pulses and are offset slightly to cause two holes in the

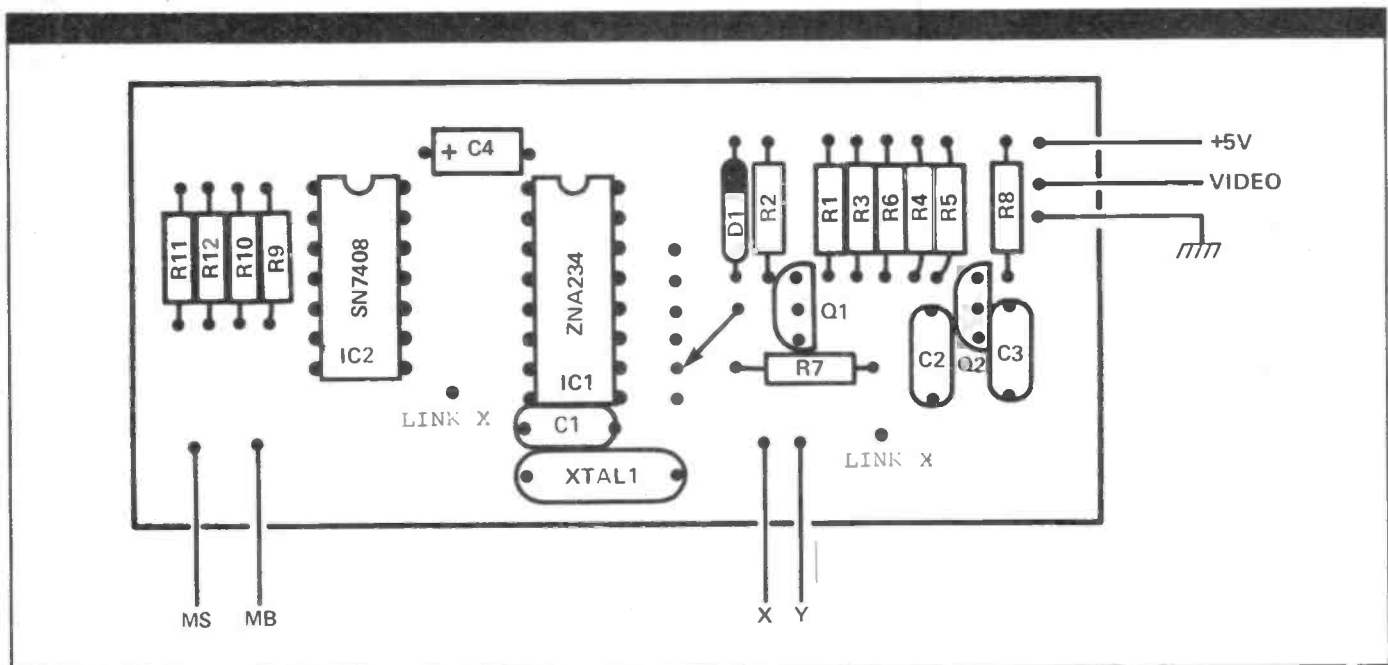

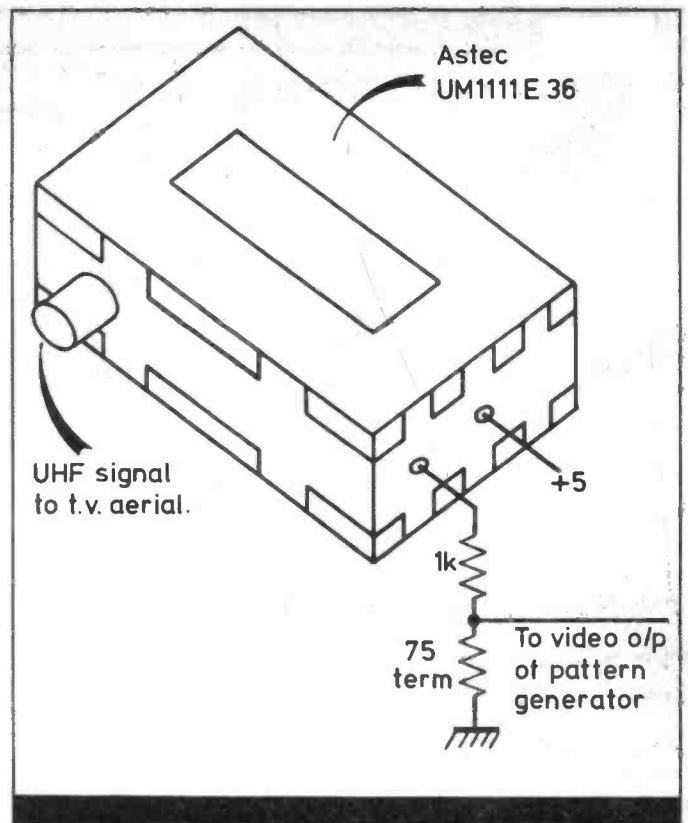
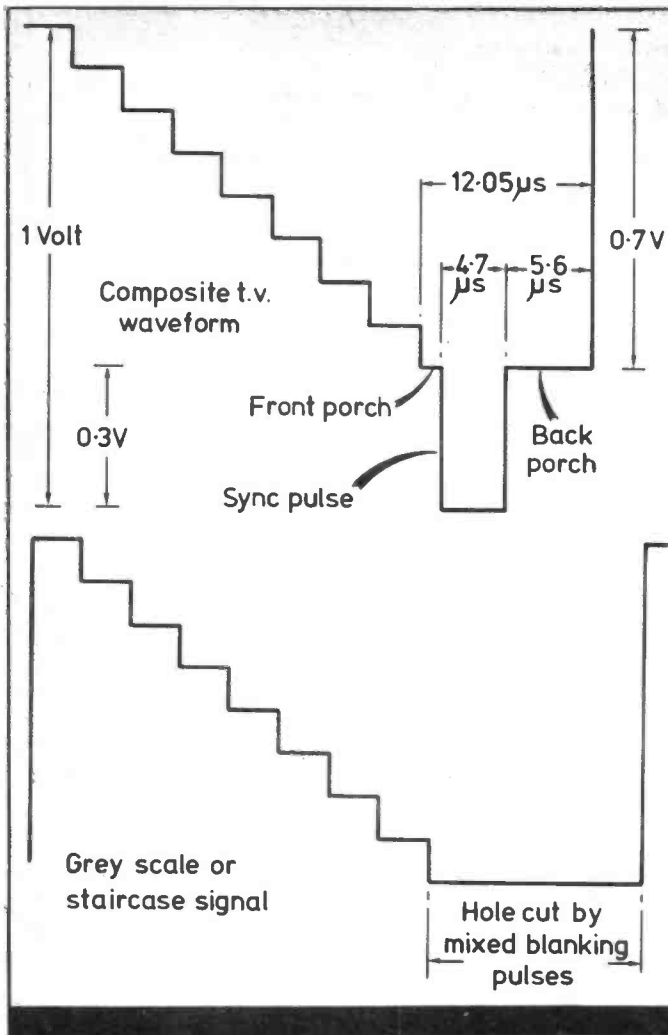

Although the module shown here in many ways forms the basis of an ATV station – the sync function is fundamental to operation – it can be used as an independent piece of test gear by hooking the video output into a UHF modulator of the home computer type. It also enables testing of the board with a domestic TV

picture, one before the sync pulse, called Front Porch and one after called Back Porch. I have included timings and levels for checking the video output should an oscilloscope be available for viewing the video signal. The output of TR2 is low impedance, and a series resistor is included to restore the output impedance to 75 ohm. The output must be terminated in a 75 ohm resistor before any measurements can be taken. C2 C3 R4 and R5 are part of a low pass filter to stop any out of band transients reaching the video output. If the generator is only required for TV service work and not to drive a transmitter then they can be omitted.

IC2 is not necessary to the working of the pattern generator, its only purpose is to provide blanking and sync pulses at a standard level of 2V P to P when terminated in 75 ohm. These pulses will be used by modules yet to be described. If the pattern generator is not to be part of a TV station then IC2 can be omitted.

The two inputs marked X and Y

are where next months electronic callsign generator connect to, for now just leave them floating.

One way to check your pattern generator is to couple it up to an ASTEC UHF modulator and view the result on your TV set. The UM 1111 E36 is the most commonly available of a whole range of modules supplied by ASTEC. These units are fairly inexpensive and seem to be quite widely used by the home computer manufacturers as a way of interfacing their machines to your TV set in order to display their little green men etc.

The UM 1111 E36 is a module about $1\frac{1}{2}'' \times 1'' \times \frac{3}{4}''$, the metal-can is connected to earth. The module has two other input Pins, the one in the centre connects to +5, the other being video input.

The level often needs adjusting to this and I have included a small resistor about 1K in series with the video input pin. If white crushing occurs when viewing grey scale then the 1K resistor needs its value increasing. If no white crushing is evident then you may be able to

reduce the resistor which may increase your contrast slightly.

I have deliberately not gone in to too much depth in my circuit description or explanation to Television in general. If you feel Television engineering appeals to you, in particular amateur television, the British Amateur Television Club produce an excellent quarterly magazine called CQ-TV which is sent to all members. The annual subscription is £4 per year and details can be obtained from Mr. B. Summers G8GQS, 13 Church Street, Gainsborough, Lincs. The British Amateur Television Club also have published two Handbooks called Amateur Television Volume 1 and Volume 2. Volume 1 has an excellent introductory chapter for the beginner. Please enclose S.A.E. to Mr. I. Pawson G8IQU for further details.

In next months issue I show the construction of an electronic callsign generator and will be showing you how to superimpose its output across the test pattern generator.

Datong FL3 Review

The subject of this review is the most recent of the Datong line of audio filters, which started with the Frequency Agile Filter, type FL1. This latter filter is unique as it possesses the ability to automatically lock onto an interfering heterodyne within the passband of the receiver, and will notch it out within 1 or 2 seconds. This is both claimed, and in practice is true, to be an advantage over the difficulty of manually tuning a very narrow notch filter onto a heterodyne whistle which may well move slightly after a short while.

The next model to be introduced was the FL2. This still features the notch filter, although not automatic in this model and with the addition of five pushbuttons and three potentiometers, the result is a very versatile multi-mode audio filter.

The FL3 is in fact identical to the FL2 except that it also contains an automatic notch filter, as in the FL1, thus enhancing its capabilities, whilst still providing a manually controlled notch. It isn't clear whether the automatic notch is the same circuit as for the FL1. For those already possessing the FL2, the notch filter pcb is available ready built (type FL2/A) to upgrade the FL2 to FL3. Another difference between the 2/3 is that the former allowed a DC supply of +8/20v (stated on the rear panel, or 10-20v in the instructions), the latter requiring 10-15v (reverse polarity protected).

The unit is packaged in a Vero G-Line metal case, with extensive screened legends on the front panel identifying the various controls, using both white and yellow to differentiate between the modes obtainable. External power is required of 400mA max at 10-15v DC negative earth. Phono connectors and leads are provided for the input/out-

By Tony Bailey G3WPO

**It offers a
receive signal
processing system
which can improve the
most expensive of
transceivers and
transform the
performance of older
models particularly on
CW**

put, and a 3.5mm jack for external power. Datong have taken the trouble to note that the DC jack plug will short the supply during insertion, and advise either switching off the supply or checking that it is short circuit proof.

The internal construction is on two pcb's, the main one carrying all the circuits except for the automatic notch filter which is on an additional pcb mounted upside down on pillars. The pcb's are of professional appearance and quality with few trailing wires. The review unit was supplied with instructions for the FL2 unit, plus an advertising flyer on the FL3, but no specific instructions on the FL3.

Can it work?

Before looking at the facilities offered by the unit, it is worth taking a look at the theory behind the FL3, as classic theory would lead you to believe that selectivity needs to be at an earlier stage in the receiver than the audio amplifier. The Datong philosophy is that with modern SSB receivers, the whole of the receiver amplification and mix-

ing chain is linear, including the detector (normally a product detector) with the main SSB filter selectivity guarding against blocking etc., placed early on in the chain. Together with an effective ABC system ahead of the main filter, the assumption is that extra selectivity can be placed at any point in the receiver system after this main filtering without resulting problems from overload effects.

Given this assumption, additional filtering at the AF end after a linear detector should have the same effect as if it was earlier on, and if the audio filter bandwidth is less than that of the SSB filter, then the former will control the overall passband. This argument does not hold for envelope detection as sum and difference products are present, although useful results are still claimed.

The only possible disadvantage is the appearance of an interfering signal stronger than the wanted signal within the main receiver passband, which will activate the AGC and cause a reduction in signal strength of the wanted signal. It is claimed that the effect of this when using the FL3 is similar to fading, and is not a disadvantage when compared with the benefits gained from the filtering.

The unit is not supplied with a circuit or block diagram, presumably in an attempt to guard the circuit design. A total of 12 poles of filtering are available, using tuneable state-variable active filters, involving some 22 op-amps. All 12 poles are used for CW, with the other modes using a combination of two 5-pole (one high-/one low-pass), and one 2 pole notch or peak filters. All three filters are tuneable from 200 to 3500Hz, using a linear control voltage for ease of tracking.

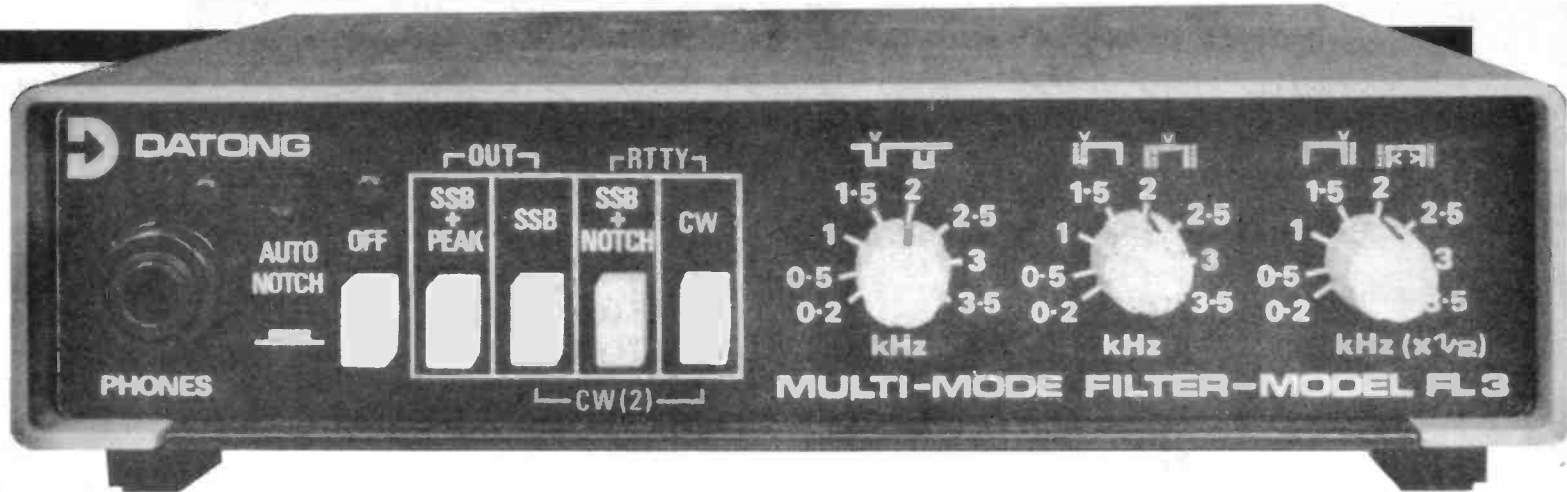

The filter skirts are claimed to be steeper than those of multipole crystal filters, and with the variable low and high-pass cut-offs, could be equated to the latest IF shift/width systems in terms of facilities. Computer generated response curves for the FL3 in various modes are given in the instruction leaflets, and reproduced here for comparison with the actual laboratory results on the review sample. A minimum stop band rejection of 40dB was aimed at.

Facilities

The filters' input is intended to be connected to the speaker or headphone socket of the receiver, with output either into an external speaker (1.5W into 4 ohms at 10v) or headphones with an overall gain of unity. The output (LM380N) is short circuit proof.

The FL2 has a number of selectable modes, suited for SSB, AM, CW, SSTV and RTTY, with the addition of one automatic, and one manual notch filter, the latter also

usable as a peak filter. The best way of explaining operation is to show how each mode operates individually.

SSB, AM & SSTV

For all of these modes, where a bandpass characteristic is required, the 'SSB' button is depressed, followed by adjustment of the two right hand controls. The first sets the lower cut-off frequency of the filter — normally this would be around 2.500Hz, as otherwise too much intelligibility is lost on a voice signal. The upper cut-off can then be adjusted to suit the interference conditions prevailing, down to a limit of around 1.5kHz for SSB, before quality suffers too much.

Heterodynes within the passband can be removed either by the automatic notch filter, or by manual filter (or two heterodynes removed using both!). As the notch is fairly narrow (200Hz claimed) it can be difficult to tune this accurately, so an additional mode — "SSB + PEAK" is provided where the in-

terference can be peaked first (using the left potentiometer), and the mode then changed to "SSB + NOTCH" to eliminate the whistle.

It is possible to switch the filter effectively out of circuit, whilst retaining the same audio output, by depressing the "SSB + PEAK" and "SSB" buttons together. This sets the filters to their extreme limits and disables control by the potentiometers, enabling comparison of the effect of the settings against the no-filter position. This feature was extensively used during evaluation.

CW

In CW mode, all filters are combined to provide 12 poles of filtering with good skirt selectivity, and a peaked response. In use, the functions of the potentiometers change, with the centre knob providing the peak frequency (calibrated), and the right-hand control the passband width (un-calibrated). A minimum bandwidth of 40Hz @ 3dB is claimed, with minimal ringing of the filter.

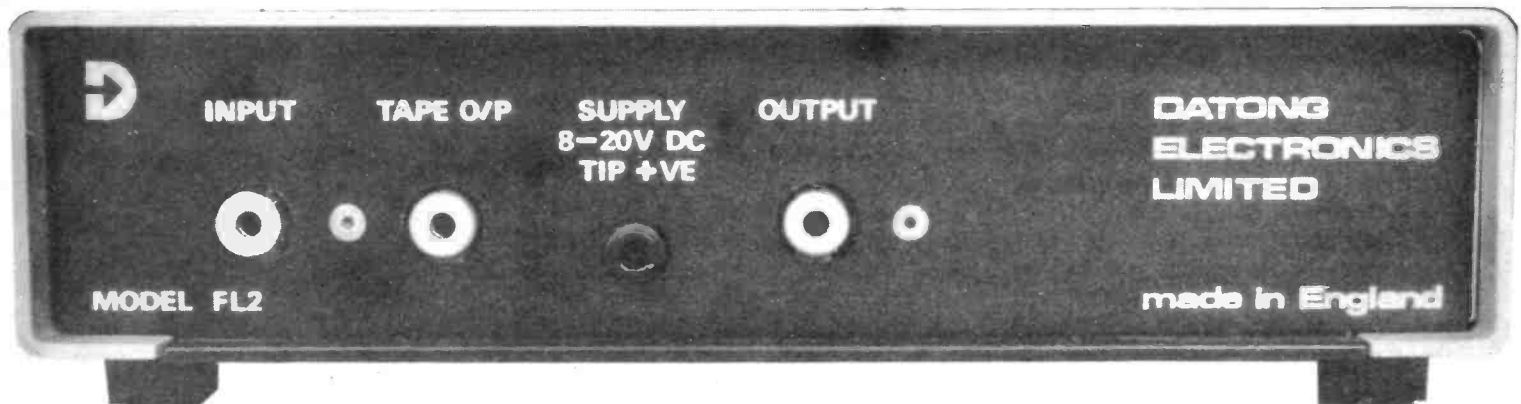

The unit plugs into the external speaker/ AF output socket of the receiver. After processing the signal, the unit will drive a loudspeaker directly

The FL3 in use

During the period of the review the FL3 was used with a Yaesu FT-102, equipped with both IF shift and passband width controls, together with a narrow SSB filter, and a vintage KW2000B, with none of these facilities was also used.

One of the most interesting results was that with the FT-102, the audio filter generally won compared to the shift and width facilities, and very infrequently was it incapable of at least matching the performance of the shift/width system. There was little doubt that the skirts of the FL3 filter were steeper than those of the FT-102, especially when the passband had been narrowed down on the 102. Evening conditions on 80 and 40 metres are a good proving ground for any filter system, and the ability to move either upper or lower cut-off frequencies proved a boon under difficult conditions, with the strength and frequency of the QRM varying from minute-to-minute.

The automatic notch filter is extremely effective on SSB, removing heterodynes within a second or so of their arrival, when many dB over S9. However, this part of the system did have one very annoying trait — the VCO appears to be locked to a multiple of the audio frequency actually being looked at, and was clearly audible at around 8kHz to the reviewer, and also to a shack visitor, as it hit the end of its range every second or so while scanning the audio spectrum. Hence it was only switched on when required and not left running continuously. Also, if the notch is locked to a heterodyne while receiving, then one transmits and returns to

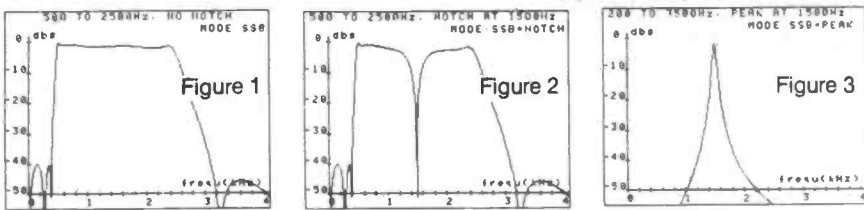

Figure 1 "SSB" — showing the steep skirts and the "flat-topped" response. Here only the low- and high-pass filters are in operation.

Figure 2 "SSB + NOTCH" — same conditions as figure 1 but the notch filter is also in circuit and set to 1500 Hz.

Figure 3 "SSB + PEAK" — conditions are identical to figure 2 but now the PEAK/NOTCH filter is set to PEAK instead of NOTCH. This mode is normally used simply as an aid in tuning the notch filter.

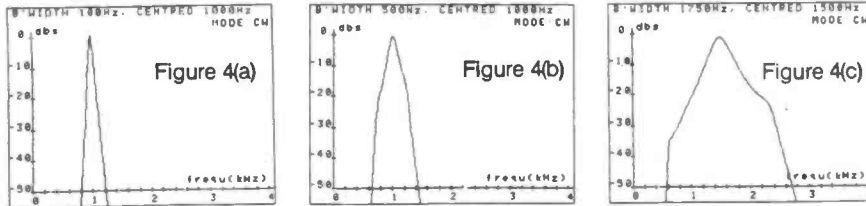

Figure 4(a), (b), (c) "CW" — showing the response in "CW" mode with a bandwidth setting of 100 Hz, 500 Hz and 1750 Hz. Note the "peaked" response and very steep skirts.

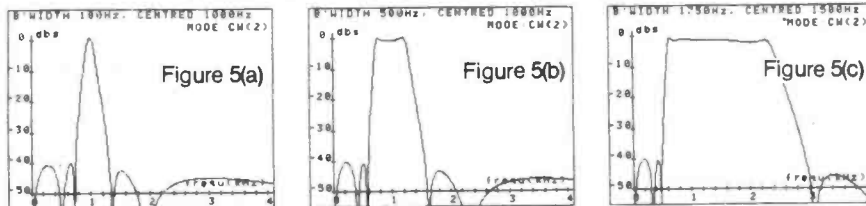

Figure 5(a), (b), (c) "CW(2)" — three graphs corresponding to those of figure 4 except that "CW(2)" mode was selected. Note the "flat" rather than "peaked" response.

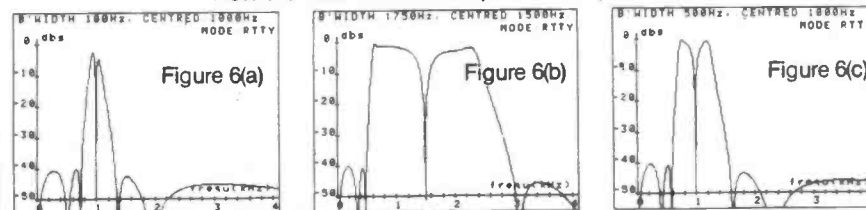

Figure 6(a), (b), (c) "RTTY" — three graphs using "RTTY" mode but otherwise with same bandwidth and centre frequency settings as figures 4 and 5.

An additional mode — "CW(2)" — is available for CW, requiring the depression of two push-buttons. This removes the peak filter from circuit, to leave only the high- and low-pass filters, giving a flatter response (the calibration then applies to both controls), useful for CW nets where stations may not be on exactly the same frequencies, or where you would like to know what is going on each side of the frequency.

RTTY

Depending on whether narrow or wide shift is received, there are two

options for filtering. In the case of narrow, the CW(2) mode is advised by Datong, initially tuning using the CW mode with the filter peaked midway between the two tones. The CW(2) mode is then selected and the bandwidth adjusted to suit. For wide shift, a special RTTY mode is used.

The notch filter removed in CW(2) mode is now used, and placed in the centre of the passband, with the notch position remaining central as the bandwidth is varied. This enables the mark and space frequencies to be peaked, with steep skirts both sides of each signal.



receive, the notch can lock to another heterodyne rather than the original.

An led indicator shows when the notch filter VCO is locked and the system effectively follows any frequency shift in the heterodyne. The real pleasure was the apparent absence of the 'tuner-uppers' during QSO's!

It was with the KW2000A that the real advantages of the filter became very apparent. This old trusty rig boasts one early design mechanical filter only, and while SSB is not too difficult to cope with, CW even under middling conditions can be very trying — as for contests...

On SSB, with the Datong filter set to the same nominal bandwidth and cut-offs as the filter, immediate improvements became apparent with reduction in the high-frequency chatter from adjacent stations. Reducing the bandwidth under crowded conditions gave good copy when the normal bandwidth would have been impossible. The effects of strong signals actuating the AGC were not really a disadvantage, compared with the ability to copy the signal in the first place.

On CW the 2000A became a totally new rig with good single signal reception possible under very crowded conditions. At minimum bandwidth setting, which should be around 40Hz at 3dB, tuning of the received signal was quite critical, with little of the ringing normally obtained with this sort of bandwidth on an audio filter. Even fairly wide bandwidths were effective most of the time — the advantage of being able to vary the bandwidth to suit

Typical performance data

Auto notch filter

Filter type: 2-pole, constant Q, switched capacitor
 Tuning range: 200 - 4000 Hz
 Lock time: Depends on signal strength; typically less than one second
 Notch depth: 40 dbS
 Filter Q: 10

Low and high pass filters

Filter type: Both filters are five-pole elliptic function
 Frequency range: 200 to 3500 Hz, linear tuning
 Minimum stop band rejection: 40 dbS.
 Rate of cut-off: 40 dbS in 500 Hz at 2 kHz, 40 dbS in 120 Hz at 500 Hz

Manual notch/peak filter

Filter type: 2-pole state variable, constant bandwidth
 Frequency range: 200 to 3500 Hz, linear tuning
 Notch width in "SSB + NOTCH" mode: 200 Hz at -6 dbS
 Notch depth: 30 dbS

General

Bandwidth range
 "CW (2)" & "RTTY" modes: 100 to 1750 Hz at -6 dbS (10 poles total)
 "CW" mode: 70 to 700 Hz at -6 dbS (12 poles total)
 Input impedance: 5000 ohms
 Overall voltage gain: unity
 Power output: 2 watts into 8 ohms with 15 v supply
 1.5 watts into 4 ohms with 10 v supply
 Output protection: The output stage (LM380) is short-circuit proof and over-dissipation proof
 Supply current: 85 mA zero volume
 400 mA max. output
 Supply voltage: 10 to 15 volts DC. Protected against reverse polarity
 Size: 184mm wide x 153mm deep x 44mm high
 (7.2 x 6.0 x 1.7 inches)
 Feet add 10mm (0.4 inches) to height
 Weight: 860 gms (31 ounces)

Accessories supplied: Input and output leads (phono plug to bare end), jack for DC power supply.

Optional extra: Mains power unit, AC mains to nominal 12 volts DC. MPU or MPU/1 for 240V, MPU/1A for 220V.



the conditions is very useful and beats an array of varying width fixed filters hands down.

Summary

The Datong FL3 filter can be thoroughly recommended, especially for the CW operator with an indifferent existing receiver. Even with a modern receiver, it can help to eliminate much of the remaining QRM, and is always under the control of the operator who can set the modes and bandwidths to suit the

conditions. The only gripe is the audibility of the VCO noted earlier, but this may not worry a large percentage of users, and only occurs when the automatic filter is not locked.

At a selling price around £129, the unit is not cheap, and it might be possible to ungrade your existing rig for this money. However, from the results obtained, the advantages could well outweigh the price for many people and you have the advantage of having it for the next rig you obtain.

Amateur Satellites

AMSAT-UK and
Ham Radio Today
have co-operated to
produce this guide

Compiled by

Cyril Young G8KHH

Orbiting Satellite Carrying Amateur Radio "OSCAR" is possibly the only radio field in which Hams were not the pioneers, but they were certainly not far behind.

OSCAR 1 was launched on the 12th December 1961 and stayed in orbit for 20 days sending "Hi" in morse as it circled the earth from its 100 mW transmitter. June the following year (1962) saw the launch of OSCAR 2 another "Hi" beacon lasting for only 18 days, it was to be another 3 years hard work before OSCAR 3 went into space in March 1965, although was the first communication satellite receiving on 144.1 MHz and retransmitting on 145.9 MHz, unfortunately the flight was only partially successful.

In December 1965 OSCAR 4 was launched, receiving on 144.1 MHz and retransmitting on 431.9 MHz, maintaining orbit for three months then, due to rocket failure, went into a highly elliptical orbit.

The first ground controlled satellite was OSCAR 5 which went into orbit in January 1970, lasting only 2 months. OSCAR 5 carried beacon transmitters only; however a great deal of information on controlling satellites from the ground was gained from the flight.

Almost 2 years later OSCAR 6 carried a forward message relay system (cold store) a beacon and transponded 145.9 MHz to 29.45 MHz at a power of 2 watts PEP. OSCAR 6 circled the earth for 4½ years.

The OSCAR programmes have been developed over three phases. Phase 1 purely experimental, just to see what was possible. OSCAR's 1-5 covered this phase.

OSCAR's 6-9 and the Russian RS1-8 formed phase 2 as long life medium orbit satellites, with transponders and state of the art experimentation.

Phase 3 consists of high altitude (Dx) Orbits with sophisticated transponding and control systems.

WHAT YOU CAN HEAR NOW

The current operational satellite is OSCAR 8, orbiting the earth every 103 minutes at an altitude of 910 km. The on board equipment consists of transmitters, receivers and controlled system. The batteries are charged by the solar cells when the satellite is in the sunlight zone of its orbit.

OSCAR 8 receives on one amateur band and transmits in another (see table one). This satellite repeater system is known as a transponder, the modes of operation acceptable to the transponder are CW, SSB, RTTY, NBFM and AM, although only the first four are recommended, being power efficient and of low duty cycle. OSCAR 8 carries two transponders and is under the control of several ground stations around the world, including the UK (Guildford University).

The Soviet Union joined the Amateur Radio Satellite Race in October 1978, with two satellites RS1 and RS2 (RS is derived from the Radio Sports Federation, the controlling body of amateur radio in the U.S.S.R.) both these satellites only lasted a few months. However, at this time RS 5-6-7-8 are still in orbit.

AMSAT's first attempt for a high altitude (Dx) satellite known as phase 3A failed to go into orbit when the ARIANE launch vehicle plunged into the South Atlantic in May 1980. This exercise was repeated again earlier this year, it seems ARIANE rockets are prone to go down rather than up!

WHERE TO FIND THE SATELLITES

Satellite transponders are

specified by mode type:

Modes A, B, C, D, J and U are in current use, the following table shows how the modes differ:

Table 1.

Mode 'A': Uplink 145.8-146 MHz in the 2 metre band. Downlink 29.3-29.5 MHz in the 10 meter band.

Mode 'B': Uplink 435-438 MHz (70 cm band). Downlink 145.8-146 MHz (2m band).

Mode 'C': Frequencies as mode 'B' but lower power.

Mode 'D': Battery charge Mode, transponders off, beacons may be operational.

Mode 'J': (made by Jamsat) Uplink 2 meters. Downlink 70 cm. Frequencies as 'B' mode.

Mode 'L' Uplink approximately 1296 MHz (23 cm band). Downlink 435-438 MHz (70 cm band).

It will be observed from Table 1 OSCAR 8 signals may be heard from 29.4 to 29.5 MHz or on 435.1 to 435.2 subject to the mode of operation for the day, also providing the satellite is above the receiving station's horizon. Beacon transmissions on CW will be heard subject to the above conditions. The majority of signals heard will be CW or SSB, there is a little RTTY and SSTV activity; SSB signals on 10 meters will usually be USB, however, at higher frequencies (2 meter and 70 cm) 'phone signals may be LSB because of transponder characteristics.

ORBITAL INFORMATION

The simplest way to understand OSCAR orbits is to imagine you are out in space observing the earth, rotating on its axis from west to east with the north pole at the top. If you could detect the satellite orbiting

Table 2

Satellite Status and Operational Frequencies MHz

Satellite	Uplink	Downlink	Beacons	Notes
OSCAR 8 Mode A	145.85-145.95	29.4-29.5	29.402	
OSCAR 8 Mode J	145.9-146.00	435.1-435.2	435.095	Inverting transponder * Experimental beacons on 7.05-14.002-21.002-29.510 also 2.401-10.47 GHz
OSCAR 9 (UOSAT)			145.825	
			435.025	
RS-3			29.231/401	
RS-4			29.360/403	
RS-5	145.91-145.95	29.41-29.45	29.331/452	Robot Uplink 145.826
RS-6	145.91-145.95	29.41-29.45	29.411/453	(downlink 29.331)
RS-7	145.96-146.0	29.46-29.50	29.341/501	Robot Uplink 145.836
RS-8	145.96-146.0	29.46-29.50	29.461/502	(downlink 29.341)

* Inverting transponder where the pass band becomes inverted, HF becomes LF USB becomes LSB etc. This applies to all future amateur space craft.

the earth you would see it come from behind the earth over the Antarctic region procede northwards across the equator, then disappear over the north polar region. This part of the orbit is known as the 'ascending node'. The remaining half of the orbit, when the satellite travels from north to south, is called 'the descending node'.

An orbit commences when a satellite crosses the equator travelling north; and all current orbital predictions relate to this time in universal clock time (UCT) = (GMT) = (Z) and the degrees west of the Greenwich meridian where it occurs. It is possible that orbital predictions for the phase 3 (highly elliptic orbit) satellites will operate to a different theme; an orbit will commence when the satellite passes perigee (lowest altitude possible) and the predictions will be based upon that point in time and position.

The 'degrees west' method of stating longitude often confuses those who are more used to working in degrees east and west. To ex-

plain, up to 180° W the numbers are the same, after that another 10° in the same direction would bring the longitude to 170° East by normal standards, but to 190° W in the parlance of the amateur satellite world. 160° E equates to 200° W and so on round to the Greenwich meridian again, hence 5°E = 355°W...See fig. 3

ORBITAL DETAILS

The orbit of OSCAR 8 is fairly stable so it's possible to issue accurate predictions of the time of equatorial crossings and corresponding longitudes of every orbit for several months ahead.

Probably the best known of these predictions is the calendar which is available through AMSAT-UK (c/o G3AAJ) 94 Herongate Rd., Wanstead Park, London E12 5EQ. Alternatively predictions for the week ahead are available on telex or from the news bulletins over GB2 RS and all AMSAT and AMSAT-UK nets.

The first orbit of the day is called the 'reference' orbit and will obviously occur in the first period of the day, these are usually out of range from the UK. The data given in Table 3 will enable future orbits to be calculated with great accuracy, given any reference orbit information.

Having determined the basic data for an orbit, this has turned into beam headings, Acquisition (AOS) and Loss (LOS) of signal times for your particular location. These are calculated from computer programmes 'look-up' tables and tracking maps.

RECEIVING SATELLITE SIGNALS

Reception on the 10 meters from OSCAR-8 and RS satellites differs from normal reception in that it's basically line of sight and it is usually necessary to be able to receive the satellite's signals while your transmitter is actually 'on the air'. As the satellite's power is

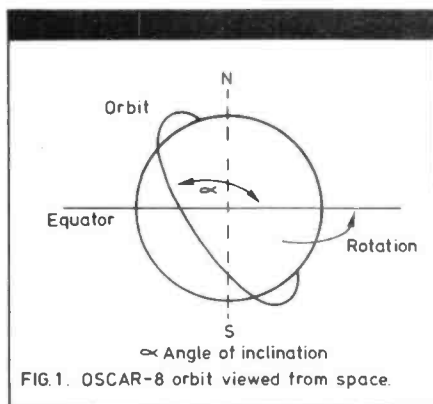

FIG.1. OSCAR-8 orbit viewed from space.

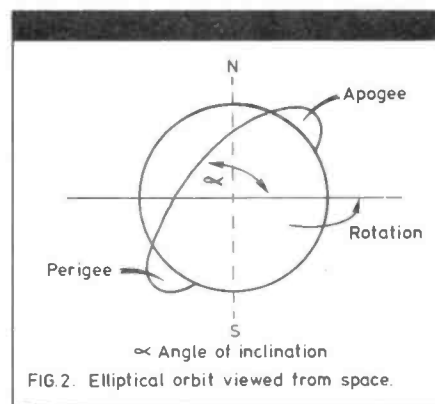

FIG.2. Elliptical orbit viewed from space.

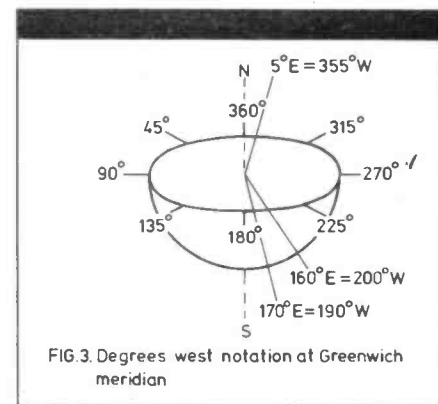

FIG.3. Degrees west notation at Greenwich meridian

TABLE 3

Orbital Parameters

	OSCAR-8	OSCAR-9	RS-3 to RS-8
Period (minutes)	103.223	95.3	118.519 to 119.765
Longitude increment (degrees)	25.807	23.86	29.7566 to 30.0683
Inclination (degrees)	98.898	97.46	82.9542 to 82.9629
Mean altitude (kilometres)	910	550	1633 to 1675

shared between all relayed signals, transmissions could be only a few milliwatts per signal. The performance of most amateur band HF receivers falls off in the 10 m band particularly at the high end. A simple low noise preamplifier to provide about 20 dB of gain will greatly improve reception.

ANTENNAS FOR SATELLITE COMMUNICATION

A simple dipole or ground plane aerial will enable good signals to be heard from the nearer passes but for serious DX work at horizon distances, a low angle beam of some kind should be considered. Simple and compact beams with good gain for their size are the HB9CV and ZL-special designs. A compressed version of the latter will be found in Short Wave Magazine, September 1972. For the near overhead passes, a fixed dipole running north-south, or crossed dipoles will be sufficient for 10 meter reception.

OSCAR-9 and transmissions on 2 meter uplinks can be expected to be adequate if the beam is correctly aimed. A small amount of elevation on a 2 m beam can be advantageous for terrestrial as well as satellite communications; typically an eleva-

tion of about 15° on a six element beam gives quite an improvement. For the very high angle passes there is frequently sufficient RF off the side of the beam, but a dipole, or crossed dipole mounted above a reflector gives better results.

POLARISATION

A satellite in orbit without a sophisticated stabilization system will roll and tumble due to external influences of solar and terrestrial origin. The orientation of the satellite's aeriels, as seen from the ground, change in direction. The polarization to cater for all orientations is circular. Good results can be obtained with horizontal or vertical polarization alone for most of the time but fading could be troublesome. Better reception can be obtained by having both horizontal and vertical polarization available and switching between them to select the strongest signal. Some satellite's aerial systems are circular polarized, ground stations using the same sense of circular polarization will show some signal advantage when the satellite aerial is pointing towards the observer.

Other times selected linear polarization will be better, the best

all-round results will be achieved by the station who can switch between horizontal, slant, vertical or left or right hand circular polarization; a means of obtaining these options from a crossed yagi array is detailed in the RSGB VHF/UHF Manual. Polarizations used in current orbital systems are shown below.

BAND PLANS

As with other amateur allocations, there are band plans for the orderly use of the space sections of the downlink bands. (See figure 4).

It is essential that terrestrial QSO's are not held on satellite channels, a large number of DX contacts have been ruined by ignorant operators holding local QSO's on satellite channels. They fondly believe that because they are not members of AMSAT or RSGB they do not have to comply with channelising or other protocols concerning Ham Radio.

RANGE OF COMMUNICATION

For a station at sea level in the British Isles, the horizon distance to OSCAR 8 is approximately 3740km, equivalent to a ground distance of

TABLE 4

Satellite Aerial Polarizations

System	Polarization
OSCAR 8: 2 m uplink, mode A	Left-hand
OSCAR 8: 2 m uplink, mode J	Right-hand
OSCAR 8: 10 m downlink	Linear
OSCAR 8: 70 cm downlink	Linear
OSCAR 9: 7/14/21/29 MHz	Linear
RS3-8: 2 m uplink	Linear
RS3-8: 10m downlink	Linear
OSCAR 9: 2m/ 70cm/2.4 GHz/10 GHz	Left-hand

Circular polarization for OSCAR 8 only is true for northern hemisphere and reverse for the southern hemisphere.

about 3250km, with a maximum ground range of twice the latter, the 2m range can be exceeded considerably under lift propagation conditions. For example E layer ionisation will enable VHF and UHF signals to be received by the satellites when they are below your horizon.

TELEMETRY

Now you know where to listen for the satellites you will be able to hear many countries and it is interesting to copy the telemetry sent down continuously on the beacon frequencies.

The morse code telemetry from OSCAR's 8 and 9 consist of three figure groups while RS3-8 telemetry is made up of letters and figures in a variable format; at speeds between 12 and 20 words per minute. The telemetry gives details of such parameters as battery voltage, current and temperature, power outputs etc.

RTTY and ASCII telemetry carry similar parameters to the CW telemetry but with 60 channels available, more information can be transmitted. The tone frequencies transmitted by frequency modulation from UOSAT conform to the Kansas City CUTS system and are ideal for reception on a home computer. UOSAT also contains a speech synthesizer which will be used to 'speak' telemetry and other announcements as required.

Special report forms for telemetry reception are available from AMSAT-UK.

SIMPLE SATELLITE OPERATING

Ten steps on how to communicate through amateur satellites. For example working OSCAR 8 in mode A.

1. From orbital data, check when a convenient orbit will occur and calculate AOS/LOS times and any beam heading information needed.
2. Tune your 2 m transmitter to the 145.85-145.95 MHz segment before the calculated AOS time, using a dummy load.
3. If your aerials are rotatable point them in the direction from where the satellite will come over the horizon. Keep the beam orientation information

where it can be seen at a glance.

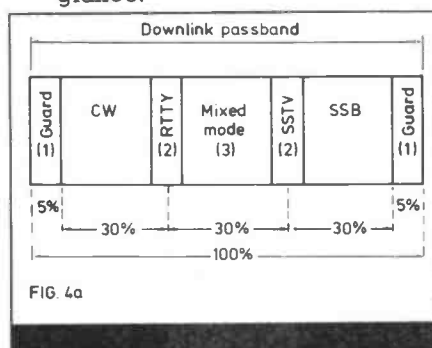

FIG. 4a

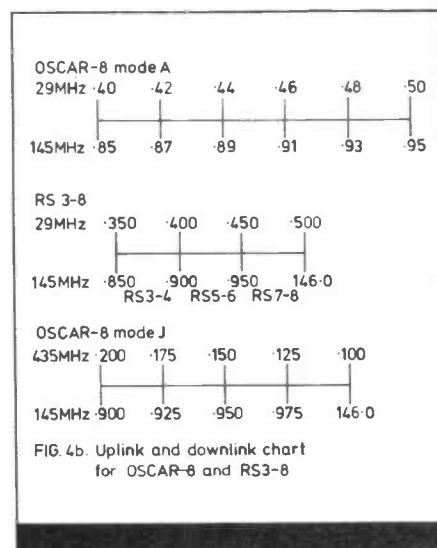

FIG. 4b. Uplink and downlink chart for OSCAR-8 and RS3-8

4. Set up your receiver to cover the 29.4-29.5 MHz part of the 10 m band and ensure the receiver is not muted or desensitised when the transmitter is used.
5. Listen for the telemetry on 29.402 MHz remembering the satellite is travelling towards you at about 4½ miles per second, causing a doppler shift upwards in frequency of about 700 Hz at the start of the orbit.
6. When the satellite is within range you should hear SSB and CW signals as you tune across the passband. Next find out if your signal is being relayed by the satellite. Do not transmit a powerful carrier or swish your BFO across the passband trying to hear yourself. This is very antisocial and unfortunately all too prevalent.

You can find your signal to within a few kilohertz on 10m. For example if you transmit on 145.900 MHz the middle of the uplink passband, your 10m signals will be in the middle of the downlink passband at 29.450 MHz. Due to the cumulative effects of doppler shift on both 2 m

and 10m you should tune 4-5 kHz away from the calculated frequency, higher if the satellite is approaching or lower if its receding from you. Fine adjustment of frequency can be obtained by swinging the receiver tuning in preference to swinging the transmitter.

7. Put out a 'CQ' call, monitoring your own signal on 10m, be prepared for someone breaking in; satellite working is the ultimate in break-in operation. Some CW stations are crystal controlled so tune around in case anyone is answering you on another frequency. Once contact is established a QSO should proceed in the usual way remembering the maximum 'visible' time of the satellite is between 15 and 25 minutes, most contacts are of 'contest style'.
8. If you generate the required ERP by a low power transmitter, feeding a high gain beam, don't forget to turn the aerial from time to time, Accurate time keeping is necessary to have the aerial pointing in the right direction at the right time. Turn the array in increments equal to the half-power beam width, for example, 45° for an 8 element yagi. In times of good propagation the 'true' path is not necessarily the best.
9. After you have made your contacts, and you wish to send a QSL card, mark the card with '145/29 MHz via OSCAR 8 orbit No...' in the frequency space on the card. Many operating awards and certificates for OSCAR operation cannot be claimed unless the QSL card specifies operation via satellite. A list of available OSCAR awards is available from AMSAT-UK.
10. The essence of successful satellite working is like any other Ham band operating, only more so, due to the short period you have to work in; listen first, most essential, don't hog the channel, use minimum power, having completed a QSO move off the channel, try to educate others in the correct methods of satellite operation.

UOSAT-OSCAR 9

Designed and constructed at the

University of Surrey (UoS) this is a research satellite and not a communication satellite, it does not carry a transponder. UOSAT is a research tool with a lot of interesting information available for the radio amateur. Full details of the satellite are available from AMSAT UK. A few details taken from their publication state that 2m addicts can tell by the interpretation of its radiation counter readings, if an aurora is likely; HF propagation can be determined by checking its 7/14/21/29 MHz beacons, pictures of the earth are available from the camera array on the satellite; UHF/microwave enthusiasts have the 2.4 and 10 GHz beacons to play with.

The telemetry transmitted in ASCII code can be fed straight into a computer.

During approximately the last six months UOSAT has not been under command by Surrey University and only the 145 and the 435 beacons have been active. After stupendous efforts by the team at Stamford University USA on September 20th 1982 they managed to bring UOSAT under control again when they shocked a command signal into the satellite using a high power UHF transmitter. It switched off the 2m telemetry beacon and enabled Surrey University to re-command the satellite. Extensive

tests during the night orbits of Tuesday 21st September showed all the space craft systems — bar a few exceptions — were working as expected after nearly six months non use. It is expected UOSAT will have all systems 'go' in the near future.

At the time of going to press UOSAT is under full control of Surrey University and is being switched off, except while over Surrey to conserve power. Telemetry is being transmitted at 300 bauds also at 45.5 bauds RTTY. Corrections are under way to attitude and spin in an attempt to reduce the Z axis spin to one revolution per minute. The radiation detector 20 keV counter is operational despite telemetry indications of low EHT voltage. This is thought to be a telemetry fault. All HF beacons will be restored soon...

It is expected that UOSAT-10 will be launched on an Ariane space vehicle sometime between the 17th and 21st April 1983. Further information available from AMSAT-UK.

AMSAT-UK

It's only right those who use amateur satellites should contribute towards the programmes. This is the only reason why AMSAT-UK was formed some 10 years ago. Membership is open to anyone. The minimum membership donation is £6.00 per

year, but extra donations are always welcome. OSCAR News is the publication which keeps members in touch with present and future activities.

NETS

AMSAT-UK run several nets where news is disseminated and questions can be asked. The most regular of these is on 3780 KHz every Sunday morning at 10.15 local time. There is also a half hour information net every weekday evening at 7.00 p.m. on the same frequency. Irregular nets take place on 144.28 MHz.

AMSAT-USA also run nets on Sunday evenings on 14.282 and 21.280 MHz usually at 18.00 and 19.00 GMT respectively. These USA nets are a world wide news service (net control W8GQW, WA2LQQ).

The author wishes to thank AMSAT-UK, AMSAT-USA, Ron Broadbent (G3AAJ) for their kind permission to publish extracts from their literature and OSCAR News.

Membership and all enquiries relating to satellite communications should be sent to Ron Broadbent (G3AAJ), Secretary, AMSAT-UK, 94 Herongate Rd., Wanstead Park, London E12 5EQ. All communications must be accompanied by an SAE to ensure a reply. ●

Don't call that rare DX station you have already worked if others are calling him, or you will be preventing them having a chance.

Don't call stations in your own area at horizon times, as they have but a few seconds daily in which to work at the distant ones, but most of one orbit to work you.

Don't call CQ incessantly. A short burst is quite enough, then listen, otherwise you are degrading AGC and using up battery power unnecessarily. Many of the rare ones are crystal controlled, and you will need to listen for them, and they won't get in anyway if everyone is transmitting.

Don't transmit off schedule, nor on any Wednesday unless you have specific permission to do so, otherwise you will be wrecking valuable experimental work.

Don't use the top 200kHz of 2 m for terrestrial contacts even when no satellite is 'up'.

Do discourage others from us-

ing the space band for local contacts, this is mostly due to ignorance of the complete band plan for 2 m. Ask them to move, politely.

Do pay maximum attention to your receiving system, as when it is good enough you will hear returns from even 100mW exp uplinks, and hence work a lot more dx, and run less power yourself. Attention to higher gain, narrower angle and less noise on your downlink is cheaper and far more productive than anything else you can do.

Do listen attentively on the frequency that you are considering using, until you are sure that another station is not already there.

Do use the outer limits of the passband, thus avoiding the already overcrowded centre, and encouraging others to spread out too to avoid unnecessary QRM.

Do listen to AMSAT bulletins, news items and the nets, and benefit by applying the updated operational information heard, and relay to others.

Do keep clear of specific frequencies where rare or weak stations are known to be and do not sit there and call CQ hopefully; listen instead.

Do move off frequency where you have answered a CQ or a call, as it is the original caller's frequency, and he may be crystal controlled.

Do let people know if you are crystal controlled, by adding 'cc' or 'xtal' with your call, so that they can comply with the above.

Do try to be patient enough to listen for and work the weak ones.

Finally do try to have meaningful QSO's via OSCAR, e.g. by spreading the word on new stations, schedule, and items of common interest, rather than merely exchanging a few numbers. Names and QTH's are a common courtesy on all amateur QSO's, so why not on OSCAR?

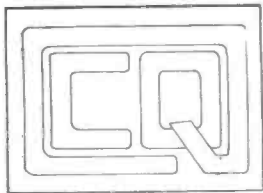

THE CQ CENTRE

10 MERTON PARK PARADE,
KINGSTON ROAD, LONDON SW19
(JUNCT. MERTON HALL RD)
TEL. 01-543 5150

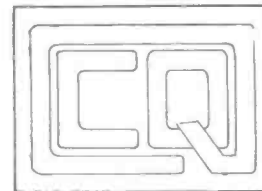

A MERRY XMAS TO ALL FRIENDS AND CUSTOMERS
LARGE STOCK OF NEW AND S/HAND EQUIPMENT
ICOM - YAESU - TRIO - STANDARD - FDK - AZDEN ETC.

FULL RANGE
LASHING KIT, POLES,
CABLE, ROTATORS
JAYBEAM -
SMC ANTENNAS
SWR POWER
METERS ETC.

HB9-CV
2 EL. BEAM
2 METRE + 70CMS
4.5 DB FORWARD GAIN
18DB FRONT TO BACK
£8.50 WITH CLAMP
WE CANNOT POST THE
2 METRE VERSION OF
THIS ANTENNA

SLIM JIM
FOR 2 METRES
AND 70CMS
COMPLETE WITH 4 METRES CO-AX
£7
OR £8.50 INC.
POST + PACKING

STOP PRESS: Now available - a brand new Morse Tuition Tape from G4HXZ. Based on tried and tested subliminal techniques. Includes:- Alphabet - Numerals - Punctuation - Plain Language-simulated Post Office Amateur Morse Test at 12 w.p.m. Full instructions and check sheet included. **£6.50 inc. p&p.**



INSTANT CREDIT NOW AVAILABLE THROUGH LOMBARD
TRICITY - PLEASE PHONE OR WRITE FOR QUOTATION



NORTHERN AMATEUR RADIO
SOCIETIES ASSOCIATION
are proud to announce their
AMATEUR RADIO
WEEKEND
(formerly Belle Vue Exhibition,
Manchester)
to be held at
PONTINS HOLIDAY
VILLAGE, SOUTHPORT
19th & 20th MARCH,
1983

New and used equipment, computers, software,
components, QSL cards, etc etc
Bring the FAMILY and have a great weekend. Free
parking.
Self catering chalets on site for all, at very reasonable
prices
Entertainment day and evening
First class catering, bar, etc
Chalet details - Pontins direct
Full Details re Weekend G4 GOM
SAE to 20 Guiseley Close, Bury BL9 5JR

PROP: A L BAILEY G3WPO

WPO COMMUNICATIONS

We have KITS AND MODULES for the discerning amateur with a special range for the visually handicapped amateur. All with G3WPO COMPREHENSIVE INSTRUCTIONS and SERVICE.

2 METRE MONITOR RECEIVER - An economical high sensitivity FM 6 channel crystal controlled receiver (Tx and PA to follow) in module form. RF Helical filter, Xtal 10.7 and multi pole ceramic 455kHz filters. All inductors prewound, + 12v DC supply required. COMPLETE KIT with FREE S20 crystal ONLY £29.95 with 40dB skirts ceramic filter or £34.95 with 70dB filter. Also £34.95/£44.95 built. 156MHz marine version also available (no crystals supplied) (0.70).

TWO-TONE OSCILLATOR - built and cased unit essential for checking your SSB rig linearity and PEP output (with a scope). Switched tones and balance/level controls. Internal or external power +9-14v DC. Low distortion design at £17.95 (0.70).

IAMBIC KEYS - A start-you-off ready-built and cased unit with dot/dash memories and automatic keying polarity selection to $\pm 250v$ at 50mA. Speed 8-50wpm + with tune up switch. Negligible standby consumption from PP3 or external 9-14v DC. Requires suitable paddle such as Bencher or MK704 (not supplied). Only £19.95 (0.70).

VHF PRESCALER - Upgrade your counter with our 150MHz + divide by 10 unit in a very small enclosure at very small price! Featured in July 1982 RadCom. Kit £5.09 or built £6.10 (0.40).

RX80 ATU - Featured in August 1982 RadCom. Complete kit for this antenna tuning unit for the RX80 or any other HF receiver - ideal for the SWL. £23.42 (1.50) including metal case and drilling instructions. Most parts available separately.

CAPACITY ADD ON UNIT - Another RadCom feature (September 1982) being a clever little unit which will enable most DFMs with an accessible gate pulse to measure capacitance from 1pF to 1000uF. CMOS. Kit with case/instructions £11.65 (0.70).

We also manufacture ready built equipment specifically designed for the VISUALLY HANDICAPPED AMATEUR, including a TALKING FREQUENCY COUNTER (HF/VHF), AUTOMATIC VSWR/POWER METER and BROMA - as published in September '79 RadCom (HM Government Approved unit). All at sensible prices - more details available on request.

All prices include VAT. Units ex-stock or we notify you by return of delivery date (except handicap aids which are normally to order 2-3 weeks). Postage given in brackets (max. any order £1.50). Further details available for 9 x 4 s.a.e. DISCOUNTS available to Clubs for 5 off any unit. We also can supply all RS COMPONENTS range - write for details. MAIL ORDER ONLY. Cash with order please.

20 FARNHAM AVENUE HASSOCKS WEST SUSSEX BN6 8NS

CLUB NET

Cyril Young G8KHH



The first club that we pay a visit to this month proves a point that I was trying to get over to a group of overseas students who were fascinated with their first contact with Ham radio and then preceded to complain that none of them worked in electronics and therefore did not have a hope of becoming a Ham.

Of course this is not true; Ham radio knows no boundaries political, religious or professional wise, Vicar, Tax man, Chef, Ham radio is an absorbing hobby that can be enjoyed by all and fosters friendship throughout the world.

Jumping off my 'orange box' I now turn to the club that brought these words to mind, the WORLD ASSOCIATION OF CHRISTIAN RADIO AMATEURS AND LISTENERS, founded in 1957 by the late Rev. Arthur W. Sheppard G3NGF; which only goes to prove my previous comment.

As the club's title suggests, WACRA is world wide with an excellent following in the UK and most English speaking countries. The Club now has members in Poland, Italy, Holland, Switzerland and is growing at quite a considerable rate. The only essential qualifications for membership are — to be interested in radio and a Christian of any denomination.

Of course, the club's aim is to encourage world radio fellowship leading to world wide Christian friendship. A great need in the world today! Weekly meetings of such a

club is not possible, but nets and scheds are organised on 80 meters for UK and 20 meters for World Wide.

Another interesting field the club fosters is tape sponding; far more personal than writing letters. The club issues a quarterly newsletter to which members can contribute to air their views. They also run their own award certificate plus their own QSL bureau. It is a non profit making organisation and the annual subscription is kept to an absolute minimum, standing at the moment at £2 per year and due on April 1st. For further information contact — Rev. Leonard D. Collie G3AGX, Micasa, 13 Ferry Road, Wawne, Nr. Hull HU7 5XU, England, enclosing an SAE, or telephone 0482 822276.

The magazine from our next club really made me cringe when I read it. I could not believe a magazine of such size could be published with so many errors and spelling mistakes, but a covering letter of explanation reassured me and provides an interesting approach.

The large number of errors — (and I do know the final figure but had better not give it away) — is part of a competition in which the errors are counted the winner, with the correct number winning a prize of an LED clock module! This is what I call being original, so the BOLSOVER AMATEUR RADIO CLUB get top marks for ingenuity!

This club, which covers the Mansfield, Chesterfield, Dronfield and Worksop area — when you have corrected the errors — what appears to be a very interesting magazine with something for everyone, even items not pertaining to Ham Radio but nevertheless very interesting and

amusing, like their 'Know your members' crossword, which took up a couple of pages. Well done Tony G8EGD!

Bolsover Club meet on Wednesday nights at 8pm at the Angel Hotel, Castle Street, Bolsover, Derbyshire, and on the 5th of January 1983 they are having a committee meeting; on the 12th, a talk by the Worksop Repeater Group, on 19th a Film Show and on 26th, a Compiler Meeting (Compiler of what, Computer language?, I wonder!).

While their club is not very large at the moment, they are certain there is a large number of people in the area that could become members. If you are in the district why not go along one club night and see if their activities interest you.

I have received a very interesting letter from Norman Jaques G8VQV, Secretary of the READING TELEPHONE AREA RADIO CLUB (that's a new one on me, I must admit). Norman doesn't say whether the club is purely for members of the 'Busby Organisation' (or has Busby been shot down when it became British Telecom). Anyway, they obviously had quite an event at the end of September/early October under a special call sign GB2BT to celebrate the first full year of British Telecom and of the Club. Congratulations all round to the club for its first full year of activity.

The event was started with a call to G8ASK at the Bournemouth Telephone Exchange and went on to make almost 260 calls on HF and VHF bands during the 24 hours of the contest. At midnight GMT the club took advantage of the new licencing arrangements, which enabled a short wave listener member

of the club to become what they expect to be the first non-licensed person to pass a message over the air under the new Home Office regulations; when shortwave listener Mike Gray spoke to Chris G6AHH. The event also included a mini exhibition set up to show the various facets of amateur radio to staff of the Reading Telephone area. Major interest was shown in fast and slow scan TV links and a demonstration of computerised RTTY set up by the club Chairman, Bob Wootten G8VMX; plus a display of D.I.Y. equipment and a demonstration of CW by Roger G3UAX.

For more information on this club and its activities contact — Norman Jaques G8VQV, 40 Broad Lane, Upper Bucklebury, Reading RG7 6QJ.

I haven't heard from Christopher Moore, Secretary of the PINFOLD RADIO CLUB, this month, but on re-reading his last letter there is one point I didn't have room for last time. The club, though small in numbers is not lacking in enthusiasm, being part of the Pinfold Social and Handicraft Centre for disabled and handicapped people is obviously short of cash. Funds will only permit the purchase of one radio magazine a month. I'm sure there must be some Hams in the vicinity who have no further use for their magazines, instead of throwing them in the dustbin, throw them in the general direction of THE PINFOLD RADIO CLUB, at 24 Sally Ward Drive, Walsall Wood, West Midlands, WS9 9JZ, where they will be much appreciated.

If flying rusty metal turns you on! OSCAR NEWS the official journal of AMSAT-UK is

just right for you, in fact it's intended for all users of OSCAR Satellites and is issued free to AMSAT-UK members.

Ron Broadbent G3AAJ the Editor, is to be congratulated on the production of an excellent publication. Each edition has that 'certain something for everyone' mixture. Even if you don't work the satellites there is a lot of interesting reading.

Of course there are no weekly meetings but there are regular nets held on Sundays, 3780kHz at 10.15 local time and on the same frequency every evening at 7pm there is a half hour information programme.

If satellites are your interest, membership of AMSAT-UK is a must. For further information on the satellites and of membership of AMSAT-UK contact Ron Broadbent, Secretary, AMSAT-UK, 94 Herongate Road, Wanstead Park, London E12 5EQ or on 01-989 6741. If you write, enclose an SAE or you won't get a reply says Ron!

GLENROTHES & DISTRICT AMATEUR RADIO CLUB GM4GRC have just elected a new committee at their October AGM, they are probably by now well under way with their new programme. Regrettably their newsletter omits to say where and when the club meets, but a line to Gavin Lucas GM4EJI Club Secretary, Provosts Lane, Leslie, Fife, Scotland, or a call on the air will bring you all the details.

Being the start of a new year, it seems most clubs are crying out for their subs to be paid. Among these is the **CHICHESTER & DISTRICT AMATEUR RADIO CLUB**, who meet at the Fernleigh Centre, 40 North Street, Chichester, on first Tuesday and third Thursday of each month at 7.30pm. Their next meetings on 4th January and 20th January appear to be quiet club meetings, just to get over Christmas!

Their Secretary tells me that the club's coffers have been raised by £400 as part of

the profit from this year's Brighton Rally.

An item from their Newsletter asks 'who are you?' — well, who are you? This is a very personal problem that most clubs must have sometime, with new members and visitors not recognising members they have possibly worked, ID badges should be worn as a matter of courtesy. If you don't possess a badge why not wear your QSL card? Or if you're good at graffiti put your name and number on your shirt.

Some members of the club are investigating the possibility of setting up a hospital ATV programme, on similar lines to hospital radios. If any other club has any experience along these lines perhaps they would like to talk to the Secretary, M. Allen G4ETU, 2 Hillside, West Stoke, Chichester, Sussex PO18 9BL, or by phone: West Ashling 463.

Members, don't forget your subs, or this will be your last Newsheet, says the Treasurer, J. Francis G8STD... (How about some christian names boys!).

Another new club's Newsletter to arrive this month is from **ECHELFORD RADIO SOCIETY**. Have you tried kite flying aerials? Tony Rush G3ABZ apparently filled to breach at a recent meeting with an entertaining evening on 'Kite Flying & Aerials'. From the information gleaned from an article on the subject in the club newsletter. I for one have discovered why my kites don't fly...the top of the hill is not the right place to be!!! More information and details of Tony's kite and aerials are given in their newsletter. I've no doubt that copies of the newsletter could be obtained from the club at a price.

There is also an excellent article about getting on the air cheaply — simplicity rules OK — QRP valve equipment by G3MCK.

I see the club meets every second Monday and last Thursday of the month at 7.30 in the Hall, St. Martin's Court, Kingston Crescent, Ashford, Middlesex. Club nets are held

at 10.00 local time on Sundays, frequency 1.93MHz + — QRM and 2 metre nets on Wednesday 20.00 local on 144.575MHz (FM).

For further information contact the Secretary, Anton Matthews G3VFB, 13a King Street, Twickenham, Middx., with an SAE or on 01-892 2229.

THE ROYAL NAVAL AMATEUR RADIO SOC-

YOUR LOCAL CLUB...

AMSAT-UK:- Secretary, Ron Broadbent G3AAJ, 94 Herongate Rd., Wanstead Park, London E12 5EQ. Telephone: 01-989 6741.

BOLSOVER AMATEUR RADIO CLUB:- Secretary, Dave G6KIF. Telephone: Chesterfield 811666. Club meets: at the Angel Hotel, Castle St., Bolsover, Derby. Wednesdays at 8pm.

CHICHESTER AND DISTRICT AMATEUR RADIO CLUB. Secretary, T.M. Allen G4ETU, 2 Hillside, West Stoke, Chichester, Sussex PO18 9BL. Phone: West Ashling 463. Club meets: at Fernleigh Centre, 40 North St., Chichester, on first Tuesday and third Thursday of the month at 7.30pm.

COVENTRY AMATEUR RADIO SOCIETY:- Secretary, D.R. Farn, 14 Corfe Close, Clifford Park, Coventry CB2 2JG. Club meets: Baden Powell Scout Headquarters, Radford, Coventry, at 8pm Friday nights.

CRYSTAL PALACE AND DISTRICT RADIO CLUB:- Secretary, Eric Yeomanson G3IIR, 32 Gaynsford Rd., Forest Hill, London SE23 2UQ. Club meets: third Saturday in each month at All Saints Church, Parish Rooms, Upper Norwood at 8pm.

SOUTH DORSET RADIO SOCIETY:- Secretary, A.

IETY. Ploughing through the club's newsletter — and I do mean 'ploughing', it's almost the size of Readers Digest — I came across some pages designed to update the RNARS callbook; against some of the names and callsigns the words, in typical naval disparagement 'delete, non payment'. I wonder how many are shocked into paying their subs?...a practice that could be usefully employed by other clubs!

Prior G6HEL, 3 Greenways, Dewlish, Nr. Dorchester. Club meets: first Tuesday of the month at the Wyke Regis Army Bridging Camp, Weymouth at 7.30pm.

EAST LANCASHIRE AMATEUR RADIO CLUB:- Secretary, Norman Jenkin G4CGT, 5 Minster Crescent, Darwen, Lancs. BB3 3PY. Telephone: (0254) 75037. Club meets — at the Shadworth Centre, on the first Tuesday of each month.

ECHELFORD AMATEUR RADIO SOCIETY:- Secretary, Anton Matthews G3VFB, 13a King St, Twickenham, Middx. Telephone: 01-892 2229. Club meets: every second Monday and last Thursday of the month at The Hall, St. Martin's Court, King's Crescent, Ashford, Middx., at 7.30pm.

FAREHAM RADIO CLUB:- Secretary, Brian Davey G4ITG, 31 Summer-ville Drive, Fareham, Hants PO16 7QL. Club meets: each Wednesday 7.30pm in room 12, Porchester Community Centre.

GILWELL SCOUT AMATEUR RADIO GROUP:- Secretary, Terry Lockyer, 18 Allison Close, Waltham Abbey, Essex EN9 3MY.

GOOLE RADIO & ELECTRONIC SOCIETY:- Secretary, Richard Sugden, 8 Kings Road, Swinefleet,

Goole, North Humberside DN14 8DJ. Telephone: (0405) 84462. Club meets: Tuesdays at 7.30pm at the Goole Junior Chamber, Paradise St. Club meets: Tuesdays at 7.30pm at the Goole Junior Chamber, Paradise St.

RADIO SOCIETY OF HARROW:- Secretary, Peter Marcham G3YXZ. Club meets: Fridays at 8pm at the Harrow Art Centre, High Rd., Harrow Weald, Middx.

HASTINGS ELECTRONIC AND RADIO CLUB:- Secretary, George North G2LL, 7 Fontwell Avenue, Little Common, Bexhill-on-Sea, Sussex. Telephone: Cooden 4645. Club meets: Wednesdays (contact Secretary for new venue).

IPSWICH RADIO CLUB:- Secretary, Jack Tootill G4IFF, 76 Firecroft Rd., Ipswich, Suffolk IP1 6PX. Telephone: (0473) 44047. Club meets: second and last Wednesday of each month 8pm in the Club Room, 'Rose & Crown', 77 Norwich Rd., Ipswich, Suffolk.

RADIO SOCIETY OF KENYA:- To The Secretary, C/o P.O. Box 45681, Nairobi, Kenya.

MALTBY & DISTRICT AMATEUR RADIO SOCIETY:- Secretary, Ian Abel G3ZHI, 52 Hollytree Ave., Maltby, Rotherham, Yorks. Phone: (0709) 814911. Club meets: Fridays 7pm Methodist Church Hall, Blythe Rd., Maltby.

MID WARWICKSHIRE AMATEUR RADIO SOCIETY:- Secretary, Mrs Mary Palmer G8RZR, 12 Edmons Close, Woodloes Park, Warwick CV34 5TX. Club meets: First and third Tuesdays in the month at 61 Emscote Rd., Warwick, at 8pm.

NEWQUAY & DISTRICT AMATEUR RADIO SOCIETY, Secretary, P.L. King G4GFY, 23 Trevella Veau, St. Erme, Truro, Cornwall. Telephone: Truro 71133. Club

meets: alternate Wednesdays at Treviglas School, Newquay.

NORFOLK AMATEUR RADIO CLUB:- Secretary, K.W. Belton G4NRL. Club meets: 7.45pm at the Crome Centre, Telegraph Lane East, Norwich, each Wednesday.

PINFOLD RADIO CLUB:- Secretary, Christopher Moore, 24 Sally Ward Drive, Walsall Wood, West Midlands SW9 9JZ.

POOLE RADIO AMATEURS SOCIETY:- Secretary, Tony Lacock G3XYD, 36 Bushell Rd., Poole BH15 3HE. Club meets: 7.30pm, Poole Technical College on the last Friday on each month.

THE G-QRP CLUB:- Secretary, Rev G.C. Dobbs G3RJV, 17 Aspen Drive, Chelmsley Wood, Birmingham B37 7QX. Telephone: (021 770) 5918.

READING TELEPHONE AREA RADIO CLUB:- Secretary, N.W. Jaques G8VQV, 40 Broad Lane, Upper Bucklebury, Reading RG7 6QJ.

R.A.F.A.R.S. Secretary, Flight Lieutenant D.H. Rycroft G4OKO, Royal Air Force, Locking, Weston-Super-Mare, Avon BS24 7AA. Telephone: Banwell 288131, Ext: 335/237.

ROLLS ROYCE AMATEUR RADIO CLUB:- Secretary, Les Logan G4ILG, 19 Fenton Ave., Barnoldswick, Colne, Lancs BB8 6HB. Telephone: (0282) 812288. Club meets: first Wednesday of each month at the Rolls Royce Sports & Social Club, Barnoldswick.

R.N.A.R.S. Secretary, CRS M. Puttick G3LIK, 21 Sandfield Crescent, Cowplain, Portsmouth, Hants. Telephone: Waterlooville 55880.

ST. DUNSTAN'S AMATEUR RADIO SOCIETY:- Ian Fraser House, Ovingdean, Brighton, East Sussex BN2 7BS.

Secretary, E.C. John, 52 Boradway Avenue, Wallasey, Merseyside L45 6TD. Telephone: (051 638) 5514.

ST. HELEN'S AND DISTRICT AMATEUR RADIO SOCIETY:- P.R.O. Alan Manchester G6FJU, 67 King Edward Rd., Dentons Green, St. Helen's, Merseyside. Club meets: Conservative Rooms, Boundary Rd., St. Helen's, at 7.45pm every Thursday.

SPALDING AND DISTRICT AMATEUR RADIO SOCIETY:- Secretary, Dennis Hoult G400, Chespool House, Gosberton, Risegate, Spalding, Lincs PE11 4EU. Telephone: (077 586) 382. Club meets: first Friday of each month at the Market Room, White Hart Hotel, Market Place, Spalding at 7.30pm.

THORNTON CLEVELEYS AMATEUR RADIO SOCIETY:- Secretary, Mrs. Jen Ward G8YOK, 143 Arundel Drive, Poulton-le-Fyld, Blackpool, Lancs FY6 7TZ. Club meets: every Friday evening at 8pm at the Sports Centre, Victoria Road East, Cleveleys, Nr. Blackpool.

WAKEFIELD & DISTRICT RADIO SOCIETY:- Secretary, Rick Sterry G4BLT, Telephone: Wakefield 255515. Club meets: alternate Tuesdays in room 2, Holmfield House, Denby Dale Road, Wakefield at 8pm.

WHARFEDALE REPEATER GROUP:- Secretary, Jack Burgess G3KKP, Moor End, Hawksworth, Guiseley, Leeds LS20 8NX. Telephone: Guiseley 72231.

WIRRAL & DISTRICT AMATEUR RADIO CLUB:- Secretary, Gerry Scott G8TRY. Telephone: (051 630) 1393. Club meets: 8pm on second and fourth Wednesday of each month at the Irby Cricket Club, Irby Mill Hill Road.

WORLD ASSOCIATION OF CHRISTIAN RADIO AMATEURS & LISTENERS:- Secre-

tary, Len Colley G3AGX, 'Micasa', 13 Ferry Rd., Wawne, Nr Hull HU7 5XU. Telephone: (0482) 822276.

YORK AMATEUR RADIO SOCIETY:- Secretary, K.R. Cass G3WVO, 4 Heworth Village, York. Club meets: each Friday at 7.30pm at the United Services Club, 61 Micklegate, Yorks.

LOTHIANS RADIO SOCIETY:- Secretary, E. Evans GM6JAG, 4 Burdiehouse St., Edinburgh EH17 8EY. Telephone: (031 664) 5403. Club meets: second and fourth Thursday of each month at the Drummond High School, Edinburgh.

CENTRAL SCOTLAND FM GROUP:- Secretary, Colin Dalziel BSc., GM8LBC, 12 Dunure Drive, Earnock, Hamilton ML3 9EY.

GLENROTHES & DISTRICT AMATEUR RADIO CLUB:- Secretary, Gavin Lucas GM4EJI, Provosts Lands, Leslie, Fife, Scotland.

CQ-CQ All Club Secretaries. Without contributions from you, your Club will not appear on these pages, so come on, let's be having some news! (and don't forget to give full details of where and when the club meets).

Between us we could make these pages quite attractive by adding a few pictures. Every Club has its keen amateur photographer. Providing the 'photo's are sharp we want to see them, in black and white or colour, whether they be of members, club rigs, field days, home brew etc. I throw down a challenge, which club will be the first to send us a picture of their 'fox' in hiding in a recent 'fox' hunt.

Thankyou to all the Secretaries who have sent me information, please keep it coming.

In the panic of getting our first issue underway I forgot to wish everyone a Happy New Year and good DX hunting in '83.

Until next month 73's.
Cyril G8KHH (Not QTHR).

TALK TO THE WHOLE WORLD



..... and discover a new one for yourself. If you're experienced or even a beginner our skilled preparation will enable you to obtain a G.P.O. Licence.

British National Radio & Electronics School, Reading, Berks. RG1 1BR
FREE brochure without obligation from:— HRT/12/816

British National Radio & Electronics School
READING, BERKS. RG1 1BR

Name

Address

BLOCK CAPS PLEASE

THE WAY AHEAD

SLIMLINE MASTS or LATTICE TOWERS
FIXED TOWERS or MOBILE TRAILERS
PORTABLE MASTS or WINDOW MOUNTING
YOU NAME IT! WE PROBABLY MAKE IT!

JUST SOME DESIGN FEATURES

- TELESCOPIC TILTOVER FOR EASY ACCESS.
- VERSATILE WALL OR POST MOUNTING.
- SAFETY LATCH TO RELIEVE CABLE.
- SIMPLE WINCH OPERATION (Single and Double).
- UNIQUE 15FT SECTIONS FOR EASY TRANSPORT.
- OPTIONAL HEAD UNITS (Extra).
- HOT DIP GALVANIZED FOR PROTECTION (BS 729).
- ENGINEERED TO B.S.I. STANDARDS.

WIND LOADING BASED ON CP3 CHAP V PT. 2.

AT MANUFACTURERS PRICES! NO MIDDLE MEN!

A FEW MODELS FROM OUR WIDE RANGE

THE VERY POPULAR SM30 SLIMLINE MAST, Unobtrusive, Telescopic, Tiltover, up to 31ft. SM30WM (Wall Mount) £230.00. SM30PM (Post Mounting) £241.00. Optional Reducer Tube RT1 £12.50. Rotor Head RH1 £30.50. Ground Socket GS1 £23.50.

LATTICE TOWERS - TELESCOPIC - TILTOVER

Post Mounted (PM) Wall Mounting (WM)

AT 32PM 'Mini Tower' up to 32ft	£360.00
AT 42PM Series 2 up to 44ft	£806.00
AT 52PM (Heavy Duty) Series 2 up to 56ft	£899.00

OVER 50 TYPES! WE JUST CAN'T GET THEM ALL IN!

Send SAE (9x6) for full details of these and many other Altron Products. - Callers welcome. Open Mon-Fri 9am-5pm, Sat 9am-12.45pm.

WE DESIGN - WE MAKE - WE SUPPLY. DIRECT. YOU GET BEST VALUE AND SERVICE - SAVE \$\$\$!

Prices include VAT & UK Carr. C.W.O.

THE ONLY MANUFACTURERS OF ALTRON PRODUCTS

ALLWELD ENGINEERING
UNIT 6, 232 SELSDON ROAD,
SOUTH CROYDON, SURREY CR2 6PL

Telephone: 01-680 2995 (24 hr)
01-651 6734

Get it right from the start.

A GOOD START is essential to short wave listening and expert advice is important in achieving this. Firstly, a receiver is only as good as the antenna it sees. The old adage regarding wire antennas "as long and as high as you can" is still good, but at best is only good for PEAK PERFORMANCE on one or two frequencies, or at worst none.

For PEAK PERFORMANCE on all frequencies you need good matching between your Receiver and Antenna. If you plan to listen on the high frequency bands up to 30MHz then you know you can't have an antenna for every frequency! BUT we can offer you MUCH IMPROVED PERFORMANCE from your receiver by using an antenna tuning unit that will electrically change the length of your antenna to match the frequency you select. In other words - A MATCH FOR ALL FREQUENCIES.

You'll see many antennas being advertised under gimmicky names, but when it comes down to it they're only random wires or odd configurations, but at the end of the day, if you're expecting the performance the manufacturers specified, then you'll have to buy an antenna tuning unit. DON'T! We'll give you one ABSOLUTELY FREE when you buy your receiver from Amcomm, as well as complete advice on an antenna to suit your available space.



1 YAESU FRG 7700 +	£329.00
FRT 7700	inc. VAT
1 YAESU FRG 7700M +	£409.00
FRT 7700	inc. VAT
1 ICOM ICR7 +	£469.00
FRT 7700	inc. VAT
1 TRIO R1000 +	£297.00
FRT 7700	inc. VAT
1 TRIO R600 +	£249.00
FRT 7700	inc. VAT



Get it right. HAVE PEAK PERFORMANCE FROM THE START. BUT DON'T FORGET, ADD £6.00 IF YOU REQUIRE NEXT DAY SECURICOR DELIVERY.

YAESU - JAYBEAM - HYGAIN - BANTEK - AMTECH - CUSHCRAFT - ICOM and 50 other major lines - all ex stock.

E&OE

OPPOSITE SOUTH HARROW TUBE STATION ON THE PICCADILLY LINE.

Amcomm Services,
194, Northolt Road, South Harrow,
Middlesex HA0 2EN.
Telephone: 01-864 1166 Telex: 24263.

SHOWROOM OPENING HOURS
TUES-FRI. 10.00am - 6.00pm continuous
SAT. 9.00am - 5.00pm continuous



The mechanics of propagation

Part 2

How it works

If the mechanics of radio propagation were the same regardless of the frequency being employed, life would be a bit dull on the amateur bands, whether one was using Top Band or 70 cm. As it is frequencies from about 30MHz upwards and into the UHF region are dependent almost entirely upon the six-mile thick shell of air that surrounds the earth for their occasional ability to travel hundreds and, indeed, thousands of miles, to the delight of our VHF and UHF enthusiasts.

The newcomer to the VHF bands, 144MHz in particular, can be a bit disappointed when he finds that he can only work a matter of a few miles over what is generally called 'quasi-optical' distances, that is, a bit further than the optical path between the two stations. Provided the two stations can 'see' each other they can communicate, and if one station is on the top of a mountain the range can be quite considerable.

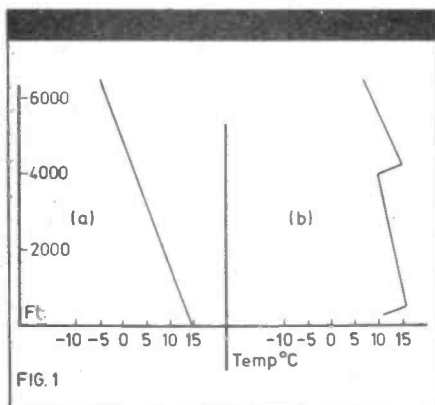

Fig. 1 (a) shows the relationship between height above sea level and the temperature of the atmosphere under standard conditions.

(b) The changes that occur when conditions are conducive to refraction at around 4000ft.

The basic facts of VHF propagation explained.

But the day, or night, comes when the band seems full of Continental stations and stations in the farthest parts of the UK, and all hell is let loose as everyone tries to QSO them before 'normal' conditions return. This may be an hour or so or very much longer. So what's it all about?

Back to the shell of air where it all happens. This atmosphere, or more scientifically the troposphere, is densest at sea level as one would expect, thinning out with height until a near-vacuum is reached. The whole atmosphere, and it weighs millions of tons, is clutched to the surface of the Earth by the force of gravity. Air pressure is measured in Bars, the practical unit being the millibar, mB, with the standard pressure at sea level being taken as 1013.2mb. The importance of this measurement will be seen later.

The weather charts of the UK and part of Europe shown on BBC TV are extremely useful to VHF operators and should be studied regularly if the forecasting of DX conditions on the VHF bands is to be undertaken. The maps in the daily press can be helpful but naturally cannot be as up to date as those on TV.

Tropospheric refraction

On the charts we see areas of high or low pressure which infer a varying density of air molecules. From our knowledge of the ionosphere we know that changes in the density in that region refract HF signals to the extent of returning them to earth many thousands of miles away. Much the same happens in the varying density of the troposphere. The degree of 'bending' is quantified by the 'refractive index'.

The effect of this refraction on VHF signals is to gradually bend them so that they tend to follow the curvature of the earth, following the boundary between two differing air masses, a warm air mass riding over a colder and denser air mass. This boundary occurs at heights of, very roughly, 5000ft or less. Suitable refractive effects hundreds of miles away will bring the signal back to earth again. This ducting may be a quite narrow path or it may spread over a wide area, depending entirely upon the nature and extend of the air masses boundary region.

In the summer time tropospheric bending will sometimes take place when the upper air remains warm after a hot day but the lower air is cooled off, frequently by the off-shore breezes along a coastline. The boundary between the warm

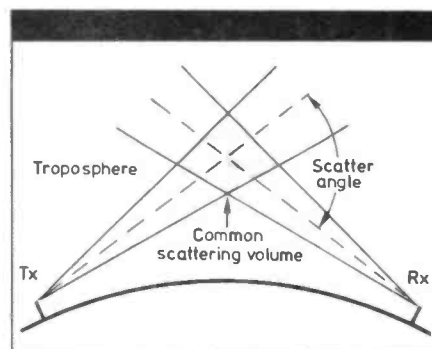

Tropospheric scatter.

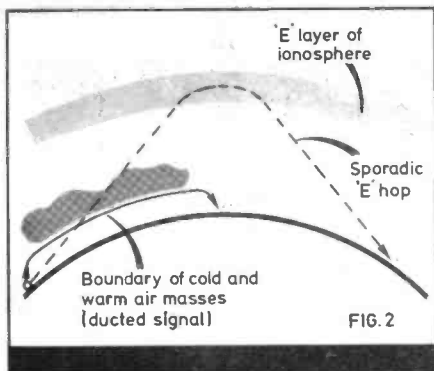

Ducting and sporadic E

and cooler air will extend normal VHF ranges.

Radio signals on the 70cm UHF band will sometimes exhibit more tropospheric bending than those on 144MHz and thus travel greater distances.

Propagation of 2m signals can also occur, albeit spasmodically, when there are suitable patches of ionisation in the lowest layer of the ionosphere, the E layer. Multiple hop propagation by this mode over many hundreds of miles has been recorded.

Weather fronts

The first sign of likely DX conditions on the 144MHz band can be detected by monitoring the VHF/FM broadcast band, 88 to 108MHz, when Continental stations start to appear among the normally heard local stations. It may extend to interference with VHF and UHF TV reception, from European TV stations, with a possible apology from the announcer for the herring bone-like patterning that appears under these conditions. If that doesn't get you rushing off to the shack to check the VHF and UHF bands then nothing will!

Back to the weather chart. We are looking for a stable, high pressure area moving, very generally, from west to east bringing settled conditions. The conditions we want for DX-ing come in the period when this area moves away and is replaced by colder, more unsettled conditions, from the west or north-west, with the cooler air undercutting the receding warm air and creating the boundary conditions in the troposphere. In due course the VHF DXer brings together all the information that is already available from weather charts, including changes in barometric pressure, and his immediate weather condi-

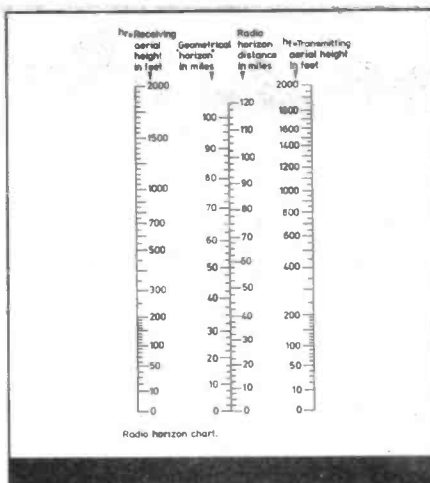

Place rule between outer columns to compute radio horizon.

tions such as wind direction, cloud formations etc sufficiently well to be able to predict VHF and UHF propagation conditions in the immediate future.

Troposcatter

One mode of communication using the troposphere is forward scatter whereby the signal, at high power levels, is beamed into the troposphere where it is scattered by normal atmospheric turbulence. The distant station, using very high gain antenna systems, can pick up signals of sufficient strength to permit commercial operation. Amateur applications of forward scatter are very limited because of the high power levels involved.

Yet another way of communicating on VHF involves using the stream of ionisation that is produced by a meteor when it enters our atmosphere, in effect a short-lived reflective layer. The transmitted information can be coded and sent at high speed to effect communication. Amateurs have done a lot of work in this area. For a full description see the article by John Matthews G3WZT in this month's issue of Ham Radio Today. It should be mentioned that scatter technique can also be employed using the ionosphere as well as the troposphere.

Auroral contacts

Storms in the ionosphere are well-known for the, sometimes, almost complete wipe-out of communications on the HF bands, and they may result in the appearance of an aurora, a curtain of flickering

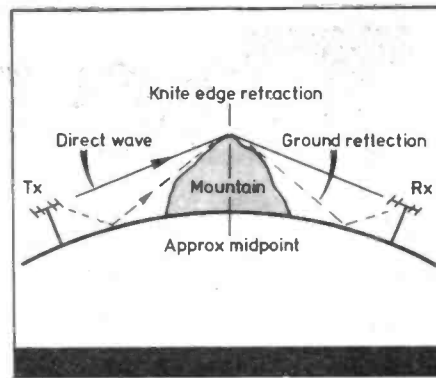

Knife edge refraction remove.

coloured lights in the northern sky. This curtain of intense ionisation acts as a very good reflector of VHF signals. Communicating via the aurora means turning the beam towards the curtain regardless of the direction of the other stations, which are doing the same. However signals via the curtain are invariably rough in character and speech is frequently rendered unreadable. Resort to CW is often the only answer.

Knife-edge diffraction

Under certain conditions, it is possible for a ridge of hills or mountains to exhibit noticeable diffraction of a VHF wave travelling over the crest. This phenomena of wave propagation is known as knife-edge bending, and has been demonstrated for years with light rays. The transmission over a practical knife-edge diffraction path depends on the shape of the ridge, the distance separating the stations and the angle from the stations to the obstacle.

Moonbounce

Radio amateurs have been experimenting with lunar communication since 1953, (*moonbounce*). Moonbounce allows communication on earth between any two points that can observe the moon at a common time and has attracted the attention of growing numbers of VHF amateurs.

The earth-moon-earth (EME) path varies from 442,000 miles to 504,000 miles for a round-trip signal, which takes approximately 2.5 seconds to make the journey. Only 7 percent for VHF energy that strikes its surface is returned. In spite of this EME contacts are almost daily on 144 and 432MHz. For 144MHz moonbounce the total path loss is about 225dB.

A general coverage synthesised HF transceiver Part 2

Perhaps it is a little ambiguous to refer to the 'receiver' because, in reality, there is much common circuitry between both transmit and receive modes. The IF board, block diagram Fig. 11 and schematic Fig. 13, acts as both an SSB generator and receiver at a spot frequency of 9MHz. It can be regarded therefore as a single channel crystal controlled SSB transceiver. The on-board Schottky ring mixer couples up to the synthesised local oscillator described last to transvert the signal onto the desired working frequency. But first, the preselector/preamplifier circuitry, the heart of any decent communications set.

Preselector

The incoming signal from the aerial changeover relay requires routing to the balanced mixer on the IF board via the preselector (Fig. 9) and possibly the pre-amplifier (Fig. 10) if it is too weak for satisfactory reception without the pre-amp. The function of the preselector is to remove unwanted signals which fall within the image response of the main mixer (the Schottky ring on the IF board). I suspect that most people who read this will understand the term 'image response' but let's take nothing for granted.

Supposing you wish to receive a signal on exactly 7MHz, then the LO (local oscillator) will have to provide a frequency of 16MHz to provide an IF signal of 9MHz, the one frequency which the main transceiver board (Fig. 11) can accept. Why 16MHz? The mixing is always subtractive in this design so that 16MHz (LO frequency) - 7MHz (signal frequency) = 9MHz (IF frequency).

Unfortunately, the on board mixer will produce a 9MHz output (and hence a response from the

By Frank Ogden G4JST
Editor Ham Radio Today

receiver) whenever the difference between the frequency of the LO and an input signal is 9MHz. This $16\text{MHz} - 9\text{MHz} = 7\text{MHz}$ (the wanted signal) but $16\text{MHz} + 9\text{MHz} = 25\text{MHz}$. Without the preselector, the receiver would be as sensitive at the image frequency as it is at the signal frequency. Thus the preselector filter allows through the wanted signal frequencies but blocks off image frequencies. As an aside, the ratio between receiver sensitivity at both signal and image frequencies is termed the image rejection ratio. If a set was quoted as having a rejection ratio of 80dB, then it would require an image signal of 10mV to produce the same output as a wanted signal of just 1uV. The design given here achieves at least this level of performance over the major proportion of its frequency coverage. When used in conjunction with a typical amateur aerial tuning unit (ATU) the rejection ratio approaches 100dB, a flawless performance.

Design

The design differs substantially from

accepted practice in that it is low-pass rather than bandpass. I have a particular hatred of banks of tuned circuits, each requiring tuning and tracking adjustments over the frequencies of interest. Furthermore, this synthesised transceiver is a general coverage design and the typical sort of preselector circuit which tends to get published in lesser magazines just wouldn't do for this project. Fig. 9 shows the circuit detail in all its elegant simplicity — three toroids and a twin gang tuning capacitor such as you will find in the junk box. L7 and C39, L8 and C40 are IF traps tuned to 9MHz series resonance. They are 10.7MHz IF transformers with the associated internal capacitors wired for series connection, together with a few extra turns added on the former to bring the resonant frequency down. RFC2 simply provides DC bypass to remove static voltages on the aerial system.

The operation of the preselector and the response for various settings of VC1 is best displayed graphically, Fig. 13. As the capacity reduces the preselector response transforms from lowpass with slight ripple, through an intermediate stage of wide bandpass to fairly narrow bandpass at minimum capacity.

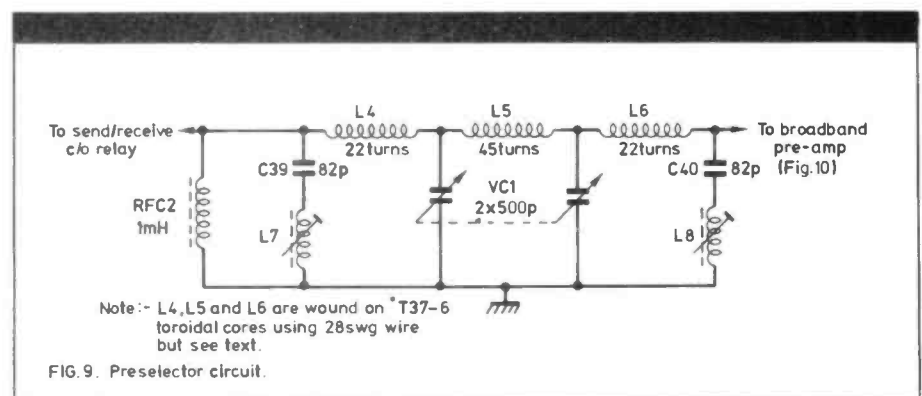

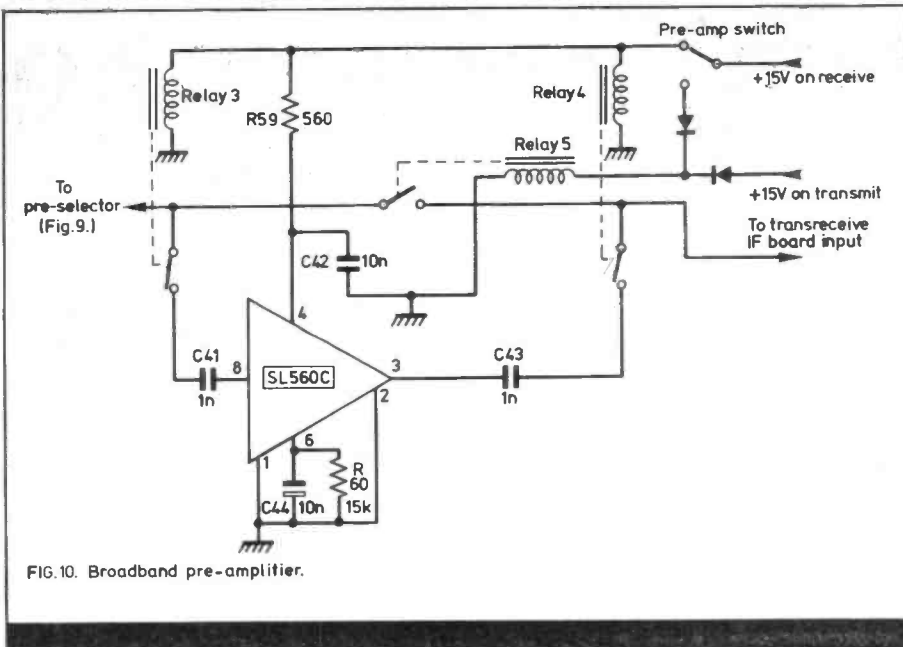

FIG. 10. Broadband pre-amplifier.

The maximum frequency tunable with the arrangement as shown is about 35MHz.

The number of turns on L5 is quite critical and individual circuits may require turns adjustment on this toroidal inductor. It controls band-pass ripple, particularly towards the HF end of the tuning range. If you add too many turns, the tuning response becomes very narrow and can lead to high transmission losses. Too few turns, creates the classic 'double hump' of over coupling which, while not serious, is annoy-

ing in an otherwise perfect circuit. The 9MHz traps are adjusted by feeding in a massive 9MHz signal and tuning the slugs for minimum response in the receiver. When everything is correctly adjusted the preselector allows coverage of every amateur band (including 10M) without-resetting.

Broadband pre-amplifier

The pre-amp design is fairly straightforward and uses a bipolar low noise, high level amplifier to

produce a gain in the order of 20dB ($\times 10$). Its use is only occasionally needed — mostly on 15 and 10M where signal levels tend to be rather lower than on the LF bands. However, the performance without the amp in circuit is nearly always adequate when used in conjunction with a half decent aerial system; the limiting factor tends to be QRN and solar noise rather than receiver sensitivity. Since it operates in the receive mode only, the entire circuitry of Fig. 10 can be left out if desired.

The IF board

This is, in essence, the design produced by James Bryant G4CLF as an applications exercise for the company he was then working for, Plessey. The complete IF board is available from a couple of suppliers including Ambit International. I understand though that Ambit supplies the board fitted with 10.7MHz SSB crystal filters. There should be no problem in departing from the 9MHz IF used in the prototype. However the 'B' input diode matrix will have to be rewired to programme 10.7MHz offset into the HEF4751 divider/synthesiser chip. Brief details of how to do this were included in last month's article.

Since the board is essentially a 'black box' type article, I don't propose to go into great lengths ex-

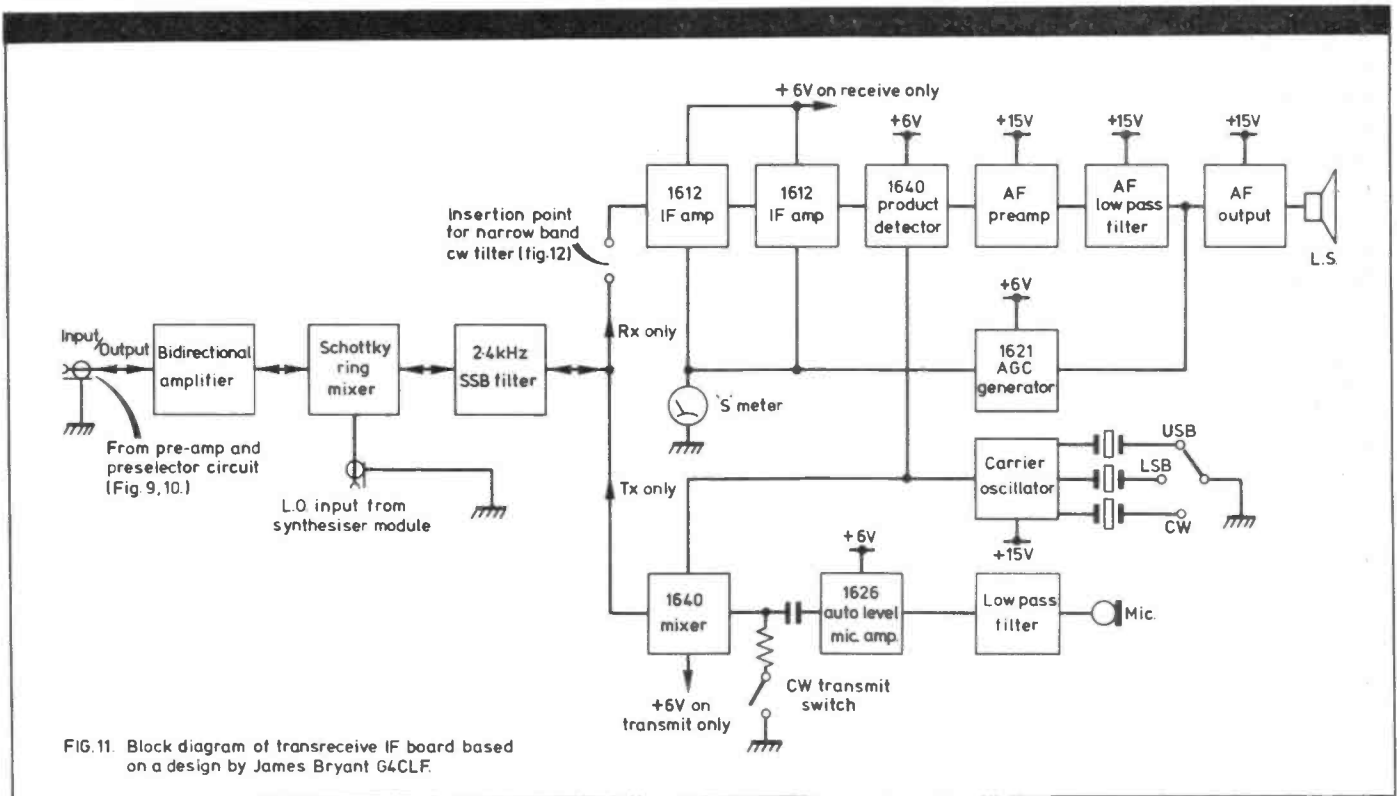
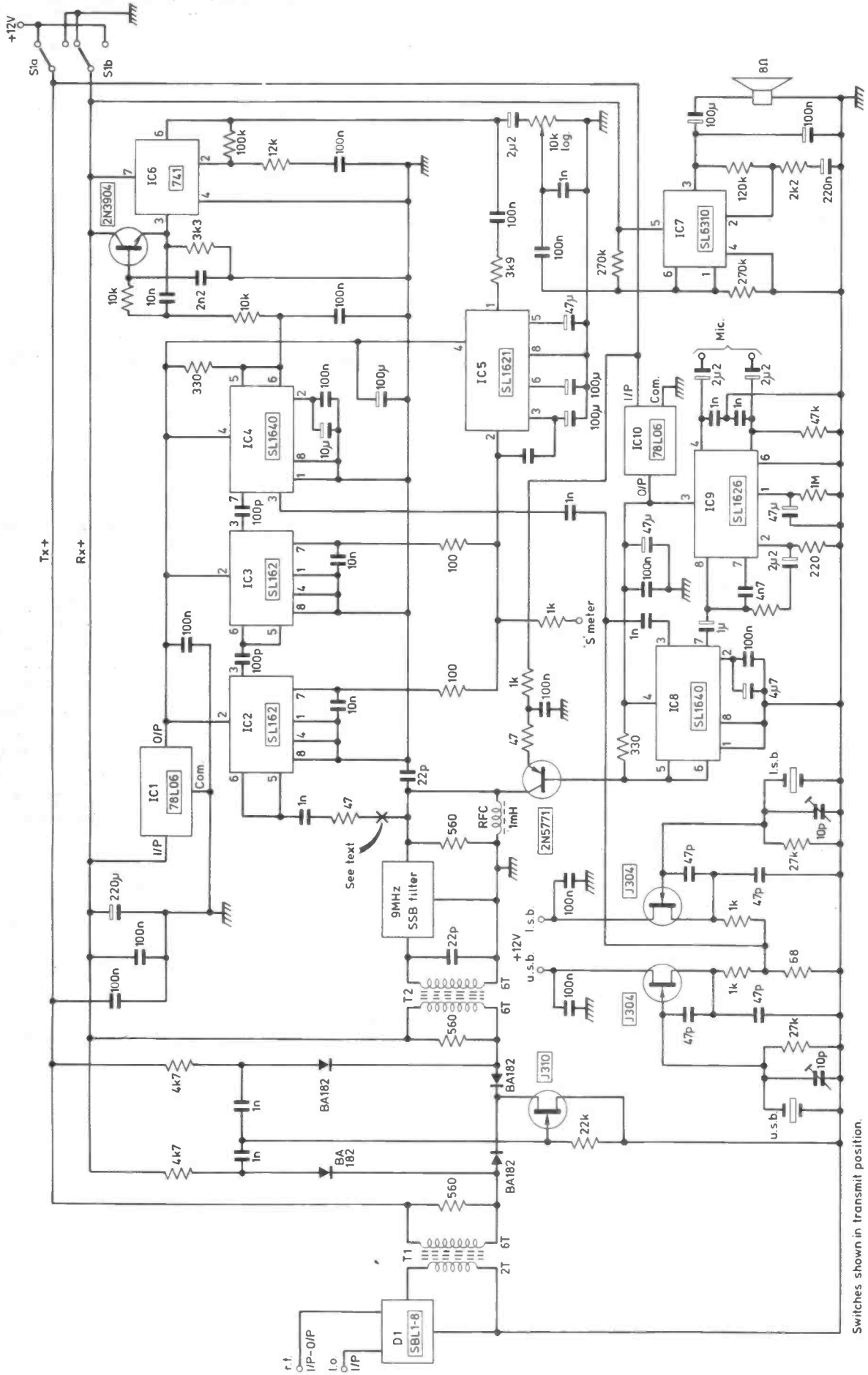

FIG. 11. Block diagram of transceive IF board based on a design by James Bryant G4CLF.



plaining how it works. I have, however, a couple of observations to make about using it. Make no mistake, it's a great circuit and the 600 and 1600 series of radio communications ICs produced by Plessey Semiconductors are without doubt the finest, most elegant parts available in the world. That is no bull, it's fact. They have lower power consumption, lower component count, more flexibility than anything which ever came out of Japan or the US. But they can be tricky to use if you don't know the rules.

AGC faults

For instance some users complain of first syllable distortion or transient LF oscillation connected with the 1621 AGC generator. They complain that the device tracks a rapidly rising signal in a series of little jumps rather than smoothly. This particular wrinkle is generally attributed to power supply decoupling (there are high charging currents involved) or an IC design fault. Neither is the case. This is how to cure the problem...

The problem such as it is originates from unwanted coupling of the carrier oscillator (the USB/LSB/CW generator of Fig. 11) into the input of the IF strip. The mechanism is this: In the presence of no signal the 1612 IF amplifiers revert to maximum gain, about 70dB. Any stray carrier oscillator coupling to the input of the strip is amplified by this amount and applied to the signal port of the product detector. The same signal supplied by the carrier oscillator is applied to the other port. There will almost certainly be a significant

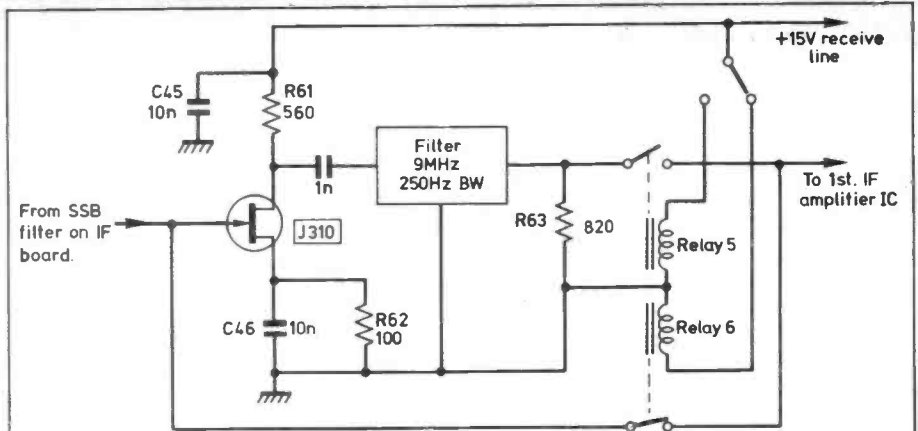

FIG.12. 250Hz cw filter circuit (optional).

phase difference between the two signals. If a low level signal is suddenly placed on the input to the strip — ie a wanted SSB signal — then the demodulated audio will cause the 1621 AGC generator to depress the gain of the 1612 based IF strip. The reduced gain will also reduce the level of the stray C/O signal applied to the signal port of the 1640 product detector. The resultant change in phase/amplitude vectors between the two CW signals causes a step DC change on the output pin of the 1640 product detector. It should be remembered that the 1640 is in essence a four quadrant multiplier which produces a DC difference voltage in response to two signals of the same frequency but differing phase. The 1621 AGC generator sees the step change in DC level in the same manner as recovered audio...it reduces the gain of the strip even further in response. The result is massive oscillatory overshoot in the AGC system.

The cure is straightforward:

remove all stray coupling of C/O to the input of the strip. This can be done with additional screening or, in severe circumstances, by a neutralising circuit.

Bidirectional amplifier

The J310 bidirectional amplifier, which switches automatically by PIN diodes, can overdissipate with certain samples of device in the G4CLF circuit. The result of this will be excessive device junction temperature and a very short life. The zero bias configuration of the original circuit produces standing currents in the range 20 to 60mA. It doesn't take much knowledge of Ohm's Law to appreciate that the 300mW limit will nearly always be exceeded. The answer is to include a 100 ohm resistor in parallel with a 10nF capacitor in the device's source connection. This provides enough back bias to reduce dissipation to a safe level without compromising strong signal performance.

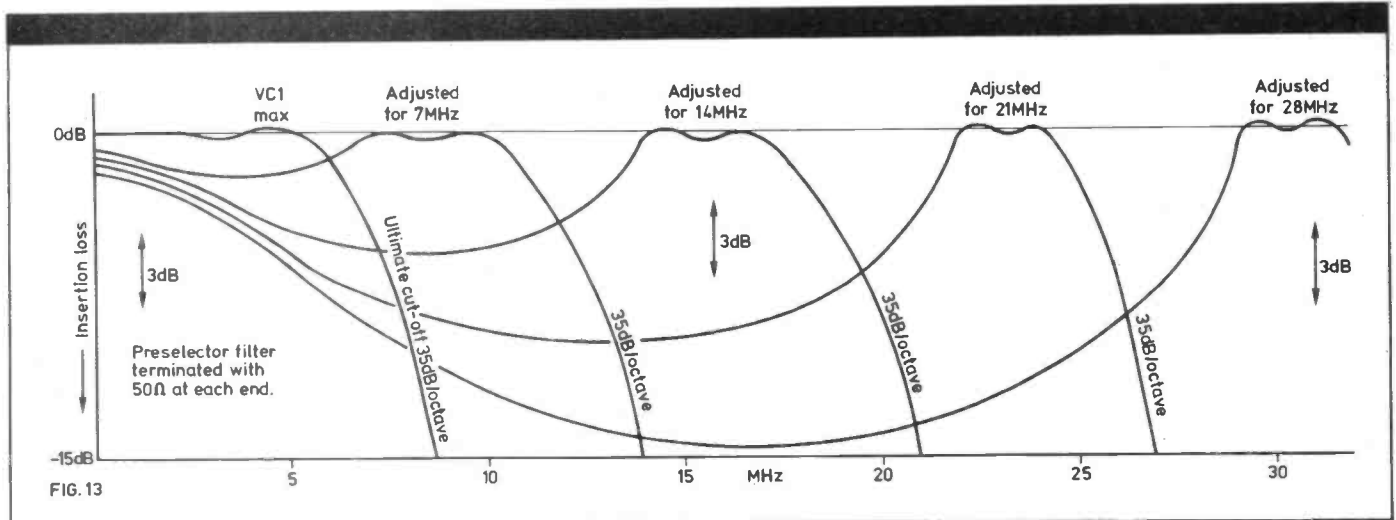
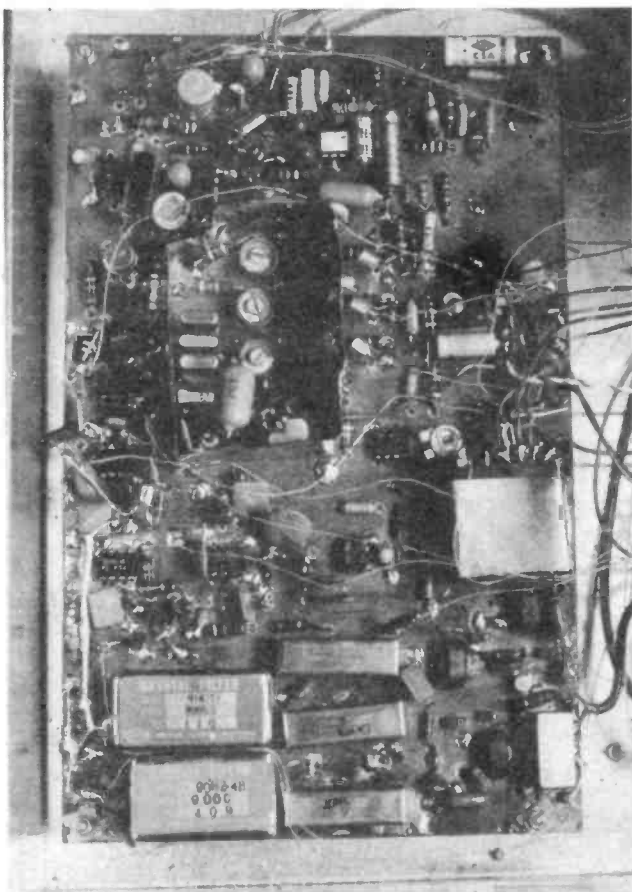

FIG.13

COMPONENTS LIST

Synthesiser Module

Q1 to Q3	BC108	R9	2.2K	Relay 1	12V miniature reed relay
Q4	2N3819	R10	22K	Relay 2	
Q5 to Q8	BC108	R11 to R14	22K	VR1	100K lin, high quality moulded track
Q9 to Q10	3SK51	R15	1K	C1 to C9	100nF
Q11 to Q15	BD530	R16	1.5K	C4	TCA see text
D1 to D26	IN914	R17	1.5K	C5	TCB see text
VC1	KV2115 (one section)	R18	390 (see text)	C6	TCC see text
VC2	KV2225 (two sections)	R19	22K	C7	470pF
IC1	HEF4750 Philips	R20	22K	C8	100pF
IC2	HEF4751	R21	22K	C9	56pF
IC3	SP8690 Plessey	R22	3.3M	C10	4.7uF 25V tantalum
IC4	4049	R23	100K	C11	10nF
IC5	741	R24	27K	C12	10nF
IC6	4049	R25	10K	C13	10nF
IC7	4011	R26	18K	C14	10nF
IC8 to IC12	4029	R27	470	C15	4.7uF
IC13 to IC17	4016	R28	22K	C16	330nF
IC18	4011	R29	1K	C17	10uF 16V tantalum
IC19	4040	R30	22K	C18	1000pF
IC20	SL560C Plessey	R31	1K	C19	100n
IC21	4511	R32	82K	C20	100n
LED 1	any	R33	82K	C21	47pF
ZD1	30V (27V + 3.3V)	R34	100K	C22	1000pF
	400mW miniature glass	R35	470K (preset)	C23	100n
ZD2	7.5V 400mV miniature glass	R36	2.2K	C24	10n
ZD3	4.7V 400mV miniature glass	R37	82K	C25	100n
R1	2.7K	R38	2.2K	C26	100n
R2	150	R39	22K	C27	10n
R3	TRA, 18K (see text)	R40	22K	C28	470n
R4	3.9K	R41	100K	C29	10n
R5	1M	R42	100K	C30	10n
R6	100K	R43	6.8K	C31	100n
R7	4.7K	R44	220	C32	100n
R8	2.2K	R45	10K	C33	100/16V
		R46	100K	C34 to C35	100n
		R47	82K	C36	10n
		R48	1K		
		R49	100		
		R50	220		
		R51 to R58	270		



The photograph (left) shows the IF transceiver board. The two crystal filters can be clearly seen.

The pre-selector unit is shown below. The extra capacitor sections were used to extend tuning range beyond 35MHz.

Next month:
the transmitter
section.

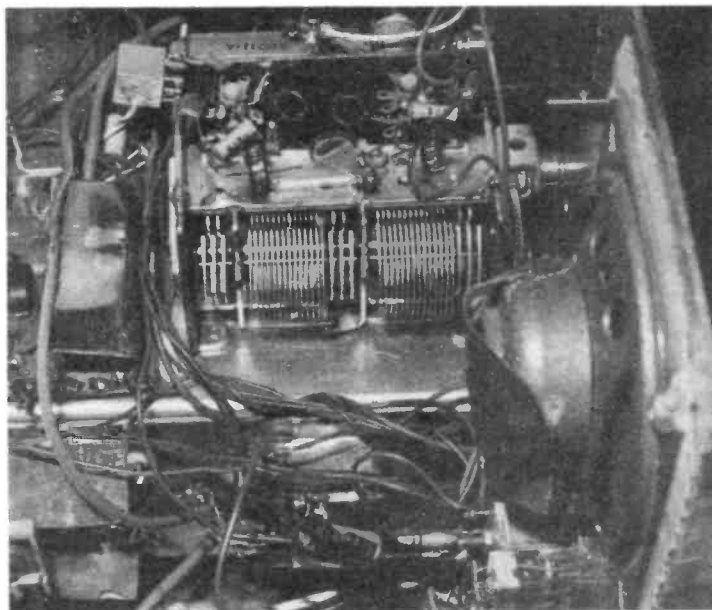

A look at SIX METRES

With an amateur frequency allocation at 50MHz likely, Jack Hum G5UM reviews the operating prospects.

The postcard said simply '6 metres. Go ahead. Licence to follow!' It was one of perhaps a couple of dozen such postcards received by a small number of British amateur radio licensees three and a half decades ago from the headquarters of their national organisation, the Radio Society of Great Britain, to tell them that a new VHF band was about to become available to them. (An indication of the age of this prized relic in the G5UM collection of electronic memorabilia is revealed by the worth of the stamp on its back — tuppence.)

Yet little time remained to explore the delights of this new found 6m band on the part of the few who were granted these special permits to do so back in the late Forties. Already the video writing was on the wall: the spread of television nationwide was promised in order to extend BBC coverage beyond the confines of the south-east of England. The single modest 405-line transmitter sitting on its hilltop at the Alexandra Palace in north London was the harbinger — though hardly the prototype at 17kW peak white —

of things to come. Its frequency of 45Mc/s (yes, 'Mc/s': the 'megahertz' did not come in until much later) was uncomfortably close to 50Mc/s.

There was little time; it was not wasted time. Already the potential of the 50MHz band had become evident to the handful of British radio amateurs who had taken the trouble to build receiving equipment for it. Their objective was to determine whether or not signals at 'six' could be received from across the Atlantic, for in the US just two years after the war the band was in active use by the amateur service.

British amateurs had good reason for their optimism. They had noted that at a time of exceptional sunspot activity the MUF (maximum usable frequency) was 'going very high' and might even reach 50MHz to produce Transatlantic communication by multi-path propagation. There did indeed seem to be a strong case to put to the Licensing Authority that 'Six' was a band capable of great development, and that it could be made available to the British radio amateur before time ran out and television arrived.

Intensive lobbying by the national society of the Licensing Authority bore fruit. The 'go ahead' postcard dropped through a couple of dozen VHF aficionados' letter-boxes in the weeks before Christmas of 1947, and the licences followed a few days afterwards.

History was made within a matter of days: G6DH, the station of Denis Heightman at Clacton, on England's east coast, succeeded in working W1HDQ, the station of the famed Ed Tilton in New England (he was the metre-wave columnist of the American amateurs' magazine *QST*). This success was quickly followed by several other transcontinental contacts on '50Mc/s' from the stations of the few UK transmitting enthusiasts who were allowed to use the band and had had time to build equipment for it (generally a telegraphy transmitter with facilities for emitting amplitude modulated telephony when circumstances were propitious).

If not 'Six' then 'Four'

But as has been said earlier, the electronic writing was on the wall. Within little more than a year after the epoch making events of November, 1947, both the newly acquired 6m band and its longer-established companion at 5m had been withdrawn as BBC television was poised to extend its coverage. Parenthetically, it is worth recalling that a 'Grand Goodnight' was organised for March 31, 1949, when nearly every one of the 5m users in the Greater London area — about seventeen of them! — met on the band for the last time before the clock came up to midnight to signal that 'Five' was no more.

Meanwhile, although 144Mc/s (as it was still known) began to attract adherents its shorter haul propensities by contrast with 5m and even more with 6m became very evident to those VHF workers who had enjoyed their operating on the two now withdrawn lower frequency bands. Would it not, they thought, be possible for Authority to find them an allocation somewhere in the lower reaches of the metre-waved spectrum? Where to find such an allocation with television dominating the lower part of that spectrum was not an easy question to answer.

The quest was not abortive: in

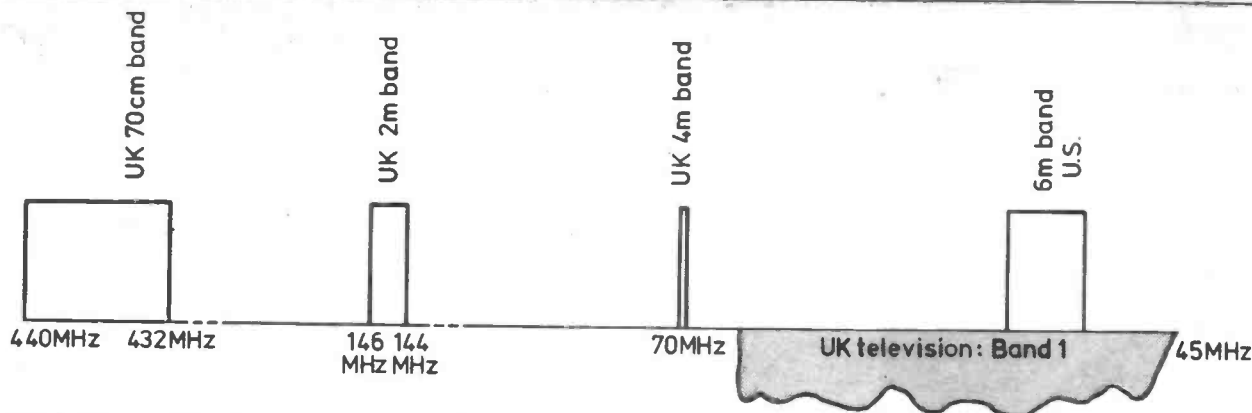

FIG. 1. The position in the spectrum of the three lower-frequency vhf amateur bands is shown in this diagram. A UK allocation at 50MHz would be within the 4MHz area enjoyed by North American amateurs but at present--in Europe--occupied by Band 1 television.

the middle Nineteen Fifties a special allocation — peculiar to the British because it was not internationally assigned to the Amateur Service — was granted at 70MHz. Here was 'electronic manna from heaven', a new band that promised to be better than 'Two' if not quite as good as 'dear old Five'. Subsequent experience proved that these guesses were substantially correct: 70MHz showed itself to be 'a bit too high' to catch the big openings remembered from the 6m days when the MUF extended itself into the metre-wave spectrum. And anyway even if 4m *did* produce extended propagation this was of little avail: there was nobody overseas you could talk to! As has been said, the band was peculiar to the British (apart from the few brave souls, themselves often British, whose jobs took them

to Gibraltar or Cyprus or other emigré outposts where 70MHz stations could be established, if only temporarily).

By contrast, the 50MHz band being widely allocated to the Amateur Service offered the prospect of inter-Continental long distance working at those periods of the sunspot cycle when the maximum usable frequency would embrace it. Operators on 'the next band down' at 28MHz found conditions there to be a guide to what might happen on 'Six': if 'Ten' opened up to long haul working there was a chance that 'Six' might do the same.

All of which was small consolation to amateurs in the countries of ITU Region 1 (Europe and Africa) where 50MHz was sparsely allocated, by contrast with Region 2 (the

Americas) and Region 3 (east Asia and Oceania) where it was in widespread use. Obliterated by video signals in much of Region 1 and in all of the United Kingdom, the 6m band looked rather like a write-off in amateur communication terms where the British radio man was concerned.

The phasing out of '405'

It was the advent of colour television which, strangely enough, offered hope in the mid-Sixties that 50MHz might after all have a future within these islands. Surely, it was argued at the time (and more insistently as the years passed) the continuation of 405-line television in Bands 1 and 3 is a profitless policy when the nation is changing over massively to 625-line colour TV in Bands 4 and 5? Profitless, perhaps: but while the last small pockets of black-and-white reception remained in existence it was policy that they should be given a 405-line service on VHF.

Britain's rooftops told their own story of Band 4/5 antennas burgeoning by the million in place of the old VHF ones. Where Band 1/3 antennas were still visible it was generally in a prone position on house roof-tiles.

So if there was a minimal logic of continuing a 405-line TV service there was a rather stronger logic that pointed to the wasteful consumption of megawatts of mains energy for the benefit of a miniscule and dwindling 405-line clientele. Inevitably there came the moment, long awaited by 6m-band enthusiasts, of the announcement that VHF television would be phased out by the mid-Eighties.

PANEL 1: A SELECTION OF 6M BEACONS AND THEIR FREQUENCIES

Europe

GB3SIX	50.02MHz	Anglesey
ZB2VHF	50.035MHz	Gibraltar

Africa

ZS5TR	50.05MHz	Durban
ZS6DN	50.0501MHz	Johannesburg

South America

FY7HF	50.039MHz	French Guiana
PY2AA	50.062MHz	Sao Paulo, Brazil

Asia

Japan	50.01MHz	Many locations centred on this frequency
-------	----------	--

Central America

6Y5RC	50.025MHz	Jamaica
-------	-----------	---------

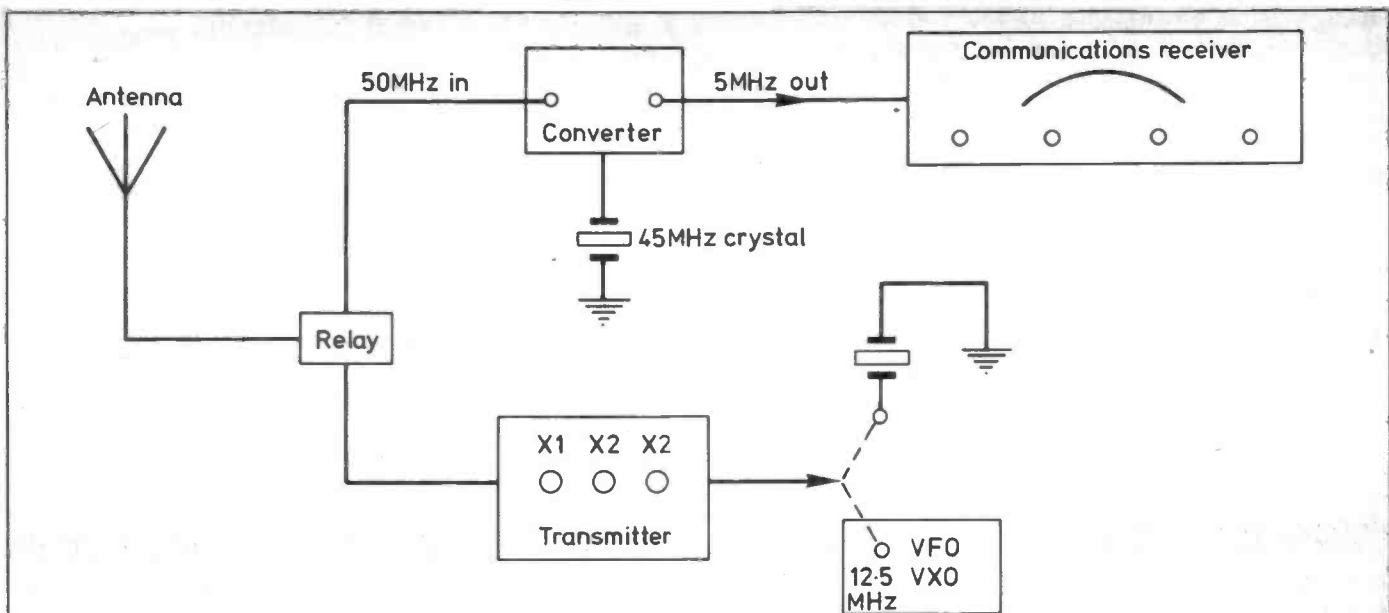

FIG 2: A block diagram to illustrate the ease with which a 50MHz station may be set up. The coaxial feed from the antenna is introduced to a coaxial relay to be switched as follows: to a three-transistor converter fitted with a 45MHz local oscillator crystal to develop an IF of 5MHz to be fed to the station communications receiver. For the British band of 50-52MHz the receiver tunes 5-7MHz. For the American band of

50-54MHz the receiver tunes 5-9MHz. If these tuning ranges are not convenient any other tuning span may be chosen by appropriate selection of the converter local oscillator crystal, e.g. a tuning coverage on the 'IF strip' of 26-30MHz (to represent 50-54MHz) would require a converter crystal at 24MHz, which when subtracted from 50MHz produces the desired IF in the converter.

On 'transmit' the antenna is

switched to a three-stage unit that accepts the outputs from a variable frequency oscillator at 12.525MHz which it multiplies twice, then twice again to produce the transmit frequency of 50.1MHz, the centre frequency of the British allocation. The three-stage unit may utilise any power transistors rated to operate above 50MHz or three valves such as two E180F multipliers and a QQVO3/10 power amplifier.

Long before this happened those same enthusiasts had not by any means been sitting idly by awaiting the passage of events. Recognising the future potential of 'Six' many of them had equipped their stations with 50MHz converters (home built at first: later commercial models appeared) to feed into main station receivers to monitor what the rest of the world, or at least those countries which had the band, were doing with it.

One lone but powerful voice from Europe was that of EI2W, the station of Harry Wilson near Dublin ('...the only licensed 50MHz station in Europe'), which during the Fifties demonstrated the band's capabilities by working literally hundreds of American stations on 'Six' in the sunspot maximum which came round in the customary eleven-year cycle right on cue after the great DX openings of the late Forties.

Cross-band working

With the passage of successive eleven-year cycles came the

thought that although British amateurs were not permitted to *transmit* on 50MHz there was no barrier against *receiving*. Why not, then, many of them asked, *send* on 28MHz and *receive* on 50MHz? None of them was fortunate enough to enjoy permission to send as well as to receive on 'Six', unlike the redoubtable EI2W, who by the end of 1979 had worked into 40 of the USA states by direct 50MHz exchange, using no more than 40W and a home-built 3-element beam antenna.

For the rest it would need to be cross-band or nothing. And cross-band it soon turned out to be, with remarkable success. Countries throughout the world where the 50MHz allocation existed were opened up for cross-band communication with the United Kingdom. These cross-band 50-to-28MHz exchanges began to become almost commonplace, if one may be permitted the use of an adjective that does less than justice to the foresight of the pioneers of 'Six' in this country. Their diligent monitoring of

28MHz, of significant signals at or near 50MHz (eg, Russian television), plus the selection of the crucial moment when 'Six' would promise to peak — notably at the equinoxes — brought them due reward.

An even greater reward was imminent and this was the possibility of engaging in transmission as well as reception on 'Six'. Towards the end of 1982 it was announced that '...for research purposes only, a very limited number of Class A licensees will be permitted to operate from 50 to 52MHz outside UK broadcasting hours on a non-interference basis'. This cheering news showed that the foot in the fifty meg door was prising it just that little bit more open — but not by much, for the concession which was granted allowed little more than a few hours of transmitting time generally at dead of night when all-pervasive television had at last closed down and before it was resumed at an all too early hour soon after.

And there the matter rests as these words go to press — but rests

hopefully in the belief that where 50MHz in Britain is concerned nothing can be the same again, only better. Now the construction (or purchase) of equipment for the newly acquired band may be considered. Now more time may be devoted to exploring it with profit. But what equipment?

What to use on 'Six'

To many operators the transverter principle will be the favoured one, with its capacity to give instant SSB or CW on 50MHz from an existing transmitter, either HF or VHF. To others the older style concept of a converter feeding a communications receiver will be preferred, used in conjunction with a separate transmitter. Both units can be of such simple design that an average home constructor could build one of each on a Saturday morning. The accompanying block diagrams show possible configurations.

Where a 6m converter is concerned the non-professional radio-man with no access to sophisticated test equipment may harbour misgivings about aligning the device. He need not worry: if he is unable to receive the Anglesey beacon GB3SIX on 50.02MHz he will almost certainly be within range of television transmissions that comprise an all too permanent signal source! Anyway, if he constructs the transmitter first he can use its output (fed into a dummy load) as the means for aligning the new-built converter.

What of a suitable antenna? It must be admitted that its size may be slightly intimidating, larger than an antenna for the 70MHz band (and that is 6ft across) but much smaller than the big HF beams to be seen in many urban localities.

While it is tempting to go for the most basic antenna of all — a half-wave dipole — it should be remembered that such a device provides no gain. Preferably, a beam should be built (or bought, when commercial designs appear).

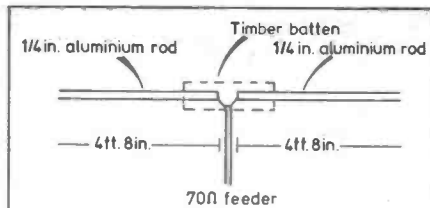

FIG. 3a. Half wave dipole for 50MHz

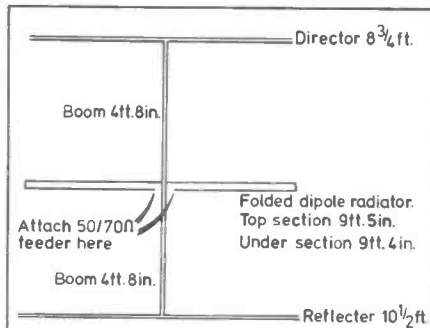

FIG. 3b. Yagi antenna for 50MHz

If a dipole it is to be, two rods each 4ft 8ins long are required, mounted on a batten to make a total length of 9ft 5in, after allowing an inch between the inner ends of the rods where the 70 ohm feeder is to be connected.

If a beam it is to be, then a reflector 5% longer than the radiating element and a director 5% shorter will be required, all three elements mounted along a boom and separated by a quarter-wavelength (4ft 8in) from each other. The radiating element will need to be constructed as a folded dipole to bring the impedance back up to a practical value. By compressing or stretching the folded dipole the experimenter can adjust its impedance to match that of the coaxial feeder.

It must be emphasised that this approach to antenna construction is the 'cheap and cheerful' one, and it gives encouraging results. The perfectionist, the ham with time to spare to extract the last ounce, will wish to devote the maximum effort towards getting his 50MHz antenna exactly right by using the information readily available from the standard textbooks.

What to hear on 'Six'

Outside of UK television hours the British listener on 'Six' will find the world to be his oyster. Even within television hours, if he abates video interference by nulling it out with a directional antenna he should hear some of the overseas beacons which are on continuously at the bottom end of the band (a selection of them is in the panel herewith) together with much overseas DX, if past experience over the last dozen years is any guide. Amateur DX will be found in random parts of the band simply because different countries allocate different areas of 50MHz to their nationals, eg, the Americans enjoy the full 50-54MHz, the Australians 52-54MHz and the British 50-52MHz.

In an attempt to solve this frequency-incompatibility problem the Americans have devised the 6m bandplan shown in Panel 2 herewith. Although neither mandatory nor capable of world wide implementation it is all the same a useful practical device for ordering things tidily on 'Six'.

Something else the newcomer to the 6m band will discover is the rather special camaraderie that infuses its occupants, rather akin to that evident in the microwave spectrum, where the feeling of being engaged upon pioneering work is strong.

This feeling of togetherness finds expression in The UK Six Metre Group which was formed in Britain early in 1982 and enjoys the support of many of the very earliest users of the band; one of them did sterling work on 'Six' back in the historical 1947 era, another has achieved the coveted WAC ('Worked All Continents') cross-band from 50MHz.

Across the Atlantic a Texan ham, K5ZMS, has been instrumental in setting up the Six Meter International Radio Klub (SMIRK) '...to promote international activity on the 50MHz band'. Its membership exceeds 3,000 transmitting amateurs in nearly 50 countries.

The true enthusiast for 'Six' will tell you that on this band may be detected a rekindling of the true ham spirit as once it was known. He may well be right. Readers of this piece can find out by trying it for themselves. ●

PANEL 2: USA 50MHz BANDPLAN

50 to 50.1MHz	telegraphy only
50 to 50.08MHz	beacons
50.1 to 50.5MHz	telegraphy and ssb
50.2MHz	national calling frequency
50.5 to 54MHz	repeaters and fm operation

HAM INITIATIVE TEST

The Question

What's better than a VP9 QSL card

The Answer

An annual subscription to

HAM RADIO TODAY

All you have to do is fill in the coupon below, send it with your remittance and we will be pleased to book your personal subscription to HAM RADIO TODAY for 15 issues although you will have only paid for 12!

— What are you waiting for?

(Please note that this special introductory offer is only valid if your subscription booking is postmarked on or before 18th March 1983)

SUBSCRIPTION ORDER FORM

Cut out and SEND TO:
 HAM RADIO TODAY
 513, LONDON ROAD
 THORNTON HEATH,
 SURREY,
 ENGLAND.

Please commence my personal subscription to HAM RADIO TODAY with the issue

SUBSCRIPTION RATES

(tick as appropriate)

- £12.00 for 12 issues UK
- £13.25 for 12 issues Overseas Surface
- £25.80 for 12 issues Overseas Air Mail

I am enclosing my (delete as necessary)
 Cheque/Postal Order International Money
 Order for £
 (made payable to ASP Ltd)
 OR
 Debit my Access/Barclaycard*
 (*delete as necessary)



--	--	--	--	--	--	--	--	--	--	--	--	--	--	--	--

Please use BLOCK CAPITALS and include post codes.

Name (Mr/Mrs/Miss)
 (delete accordingly)

Address

Signature

Date

HAM

RADIO

NEXT MONTH

TODAY

SPECIAL PROJECT: In next month's issue we will present a really excellent little 80m QRP transceiver which offers a perceived performance comparable with main station equipment.

Operating in both DSB and CW modes the set comprises a high performance direct conversion receiver, including features such as RIT and high level mixing together with a low distortion MOSFET output stage delivering about 4W PEP or CW.

We've produced a design of unbelievable simplicity without sacrificing performance. The March issue will offer full constructional details including PCB artwork. We are also arranging for a complete kit of parts to be made available because we think that there will be a big demand for this smashing little set.

WANTED URGENTLY

A RADIO AMATEUR WHO CAN WRITE, OR EVEN BETTER A LITERATE *AND* TECHNICALLY COMPETENT RADIO ENTHUSIAST WILLING TO ACT AS AN EDITOR'S ALTER EGO.

DUTIES TO INCLUDE ALL ASPECTS OF MAGAZINE PRODUCTION: SUBBING, WRITING, ORGANISATION, THE ARRANGEMENT OF EQUIPMENT REVIEWS AND A DOZEN OTHER THINGS CONCERNED WITH A BRIGHT, NEW AMATEUR RADIO MAGAZINE. IT WOULD HELP IF YOU HAVE HAD PREVIOUS EXPERIENCE ON A MAGAZINE, BUT DON'T LET IT STOP YOU APPLYING IF YOU HAVEN'T!

APPLICANTS SHOULD BE CHEERFUL IN

THE FACE OF ADVERSITY, ENJOY WRITING, AND ABLE TO GET ALONG WITH CREATIVE PEOPLE (INCLUDING AN ECCENTRIC EDITOR). A WILLINGNESS TO LEARN IS CONSIDERED ESSENTIAL AND IF YOU CAN DRIVE A CAR IN ADDITION TO AMATEUR RADIO GEAR, SO MUCH THE BETTER.

IF YOU'RE INTERESTED APPLY WITH FULL C.V. TO RON HARRIS, MANAGING EDITOR, ARGUS SPECIALIST PUBLICATIONS, 145, CHARING CROSS ROAD, LONDON, WC2 0EE. ALL APPLICATIONS WILL BE TREATED IN THE STRICTEST CONFIDENCE AND MUST NOT BE TYPEWRITTEN.

Upgrading the KW2000 series of HF transceivers

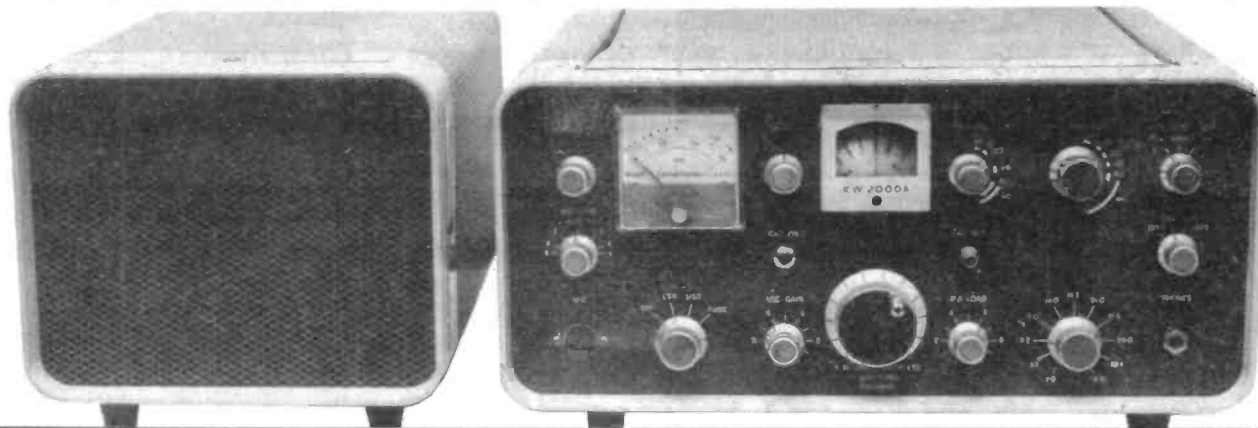

In Part 1 of this series a general description was given of the KW2000 series of HF transceivers, which represent particularly good value-for-money on the second-hand market at present. This second article gives guidance on the diagnosis of any faults which may be present, and the third article will cover the alignment procedure. Subsequent articles will give details of some of the many modifications which can be carried out to improve various aspects of the performance. Before any modifications are attempted it is strongly recommended that the test procedure to be given in this article is followed since any fault which may exist may well be more difficult to trace after modification, and it may well not be obvious whether a malfunction is due to an error in the modification or whether it already existed! It is assumed that the reader possesses a few hand tools including a decent soldering iron, a set of proper alignment tools, ie. hex nylon type (DO NOT USE A MATCHSTICK OR FILED-DOWN KNITTING NEEDLE AS THIS CAN BREAK THE HEXAGONAL CORES!) and a multi-range test meter (not DVM) of at least 20k ohm/volt which is able to measure up to 10M ohm resistance. A good quality signal generator is

Part 2

By M. T. Healey, G3TNO
and R. Charles

Making good the wear and tear

also useful although not essential unless the alignment has been severely tampered with. A dummy load and some means of measuring RF output power (eg. an SWR meter) are also required, and a general coverage receiver is useful if the 2000 has been badly misaligned.

Initial test procedure

In this section a complete test procedure is given which should be adopted with a newly acquired rig to verify that all sections are operating correctly before any modifications are attempted. If a fault is found at any stage during the testing it should be repaired before proceeding any further with the tests.

The causes and cures for various commonly encountered faults are given later in this article.

The transceiver should first be removed from its case by removing all four feet on the underside of the cabinet and then gently sliding the chassis forward to clear the case. At this stage it is as well to have a completely clear bench on which to work. Next the power supply and a suitable aerial system should be connected, and the transceiver switched on and allowed to warm up for 5-10 minutes. Following the list in **Table 1**, the various controls should be checked for smoothness of operation and absence of crackles or any intermittency of operation, checking through the bands on receive only from 28MHz to 1.8MHz, placing a tick in the right-hand box of **Table 1** if a control is considered to be working correctly, and noting any faults found in the centre column. There is no point in continuing until there is a complete set of ticks since the same ground may have to be covered twice if any problems are ignored at this stage. It is useful to keep the check list for future reference in case of the recurrence of a fault; this will save the repeated investigation of the same problem!

Next the transmitter's basic operation should be checked. The

aerial system should be removed and the rig connected to a good dummy load as shown in **Figure 2A**. Filament lamps should not be used as a load since their resistance changes with power level, they are inductive and they tend to radiate! The 3.7MHz should be selected and, with the MIC GAIN control at minimum, the rig is set to TUNE and tuned up as described in the handbook, that is by gradually increasing the mic gain and adjusting PRE-SELECT and PA TUNE and LOAD for maximum output. The function switch is then set to either USB or LSB, the MIC GAIN set to minimum and INT. MOX selected. This puts the rig into transmit but with no drive to the PA, so there should be no power indicated on the power output meter or SWR meter. Assuming this is so, the PA standing current can be checked, the correct value being 50mA on the KW2000A and B, and 25mA on the KW2000 which has only one PA valve. If the correct current is not observed the PA bias control, which is on the rear of the PSU chassis, should be adjusted to obtain the correct value. A useful check of the matching of the two PA valves in the KW2000A and B is to return the rig to receive by switching from INT. MOX to EXT. MOX, reset the bandswitch to 1.8MHz and tune up as before. Following the procedure given

above, the PA standing current should now be checked, the correct value in this case being 25mA (again, with no RF output). * If this condition is not met (ie. standing current 50mA on all bands except 1.8MHz where it should be 25mA), and two PA valves are not a matched pair. The best course of action in this case is to fit a new matched pair, but it may be possible to find a valve in the junk-box which will give a reasonable match with one of the pair already fitted. As before there is no point in proceeding further until these conditions can be achieved.

Assuming that the above conditions can be met a table similar to Table 1 should be drawn up listing the remaining controls, ie. MIC GAIN, PA TUNE and PA LOAD, and these should be checked for smoothness of operation. The PRE-SELECTOR should also be checked in the TUNE mode. Any jumpiness of PA current as the MIC GAIN is varied in the TUNE mode should be noted, since the current should rise smoothly from zero up to 125mA on the KW2000A and B (and approximately 70mA on the KW2000) on 3.5MHz. If any jumpiness exists it may indicate a faulty (or dirty) MIC GAIN control. The power output under key down conditions should be checked against the figures given in **Figure 2B**, the PA current being 200mA in the case of the

KW2000A and B or 100mA for the KW2000.

Curing problems with the controls

It is the firm opinion of the writers that any of the potentiometers which are in any way intermittent should be replaced by good quality new components rather than attempting to clean or repair them. Such a repair is unlikely to last very long, and it is worth avoiding later problems for the price of a new component.

Cleaning

VFO tuning control: if this feels notchy or lumpy as so often happens the only cure is to replace the ball bearing reduction drive with a new one. On the KW2000B the reduction drive is part of the VFO tuning capacitor so the capacitor will have to be replaced as well! If the tuning of the VFO is intermittent as the tuning control is rotated, and it is difficult to net, the most likely cause is a worn tuning capacitor and again a replacement is really the only cure.

Switches: if stiff or rough in operation the indexing mechanism at the front of the switch should be cleaned, after which a 'trace' of light grease should be applied to ball-bearings, not forgetting to oil the shaft lightly where it passes through the bush on the front panel.

Noisy switches can almost always be cured with a good quality switch cleaner (aerosol) with its own lubricant, for example RS components contact cleaner/lubricant cat. no. 554-175 or similar. Cleaners of the type containing carbon tetrachloride should not be used as these can damage the switches and also are considered to be hazardous to health.

When cleaning switches, a small amount of cleaner should be applied to each wafer in turn, at the same time operating the switch from position to position. This actually helps the cleaner to do its job. It should be ensured that the power is off!

After switch cleaning some time should be allowed to elapse before switching on, as the switch cleaner will cause drift of the RF circuits around the band-switch.

*The reason for the drop in standing current is that one PA valve is switched out of circuit on 1.8MHz to reduce the output power.

Table 1

CONTROL	FAULT IF ANY	TICK IF OK
On/Off Sideband Select and Tune		
AF Gain		
RF Gain		
VFO Tuning		
IRT Tuning		
IRT, ITT etc Switch		
Pre-Selector Tuning		
Band Select		
Cal. on Button		
Cal. Set		

Failure to receive or poor receive

If during the preceding checks the receiver is found to be poor or inoperative, checks will have to be made to determine if the fault is in

the AF, IF, mixer or RF stages, or, indeed, the power supply.

REMEMBER THAT THE VOLTAGES THAT EXIST IN THIS TRANSCEIVER CAN BE LETHAL, SO TAKE GREAT CARE, AND

REMOVE THE MAINS PLUG FROM ITS SOCKET IF YOU NEED TO SOLDER COMPONENTS, ETC. SWITCHING THE TRANSCEIVER OFF AT THE FRONT PANEL IS NOT ENOUGH AS MAINS VOLTAGE IS STILL PRESENT WITHIN THE TRANSCEIVER AND POWER-SUPPLY CABINETS UNDER SWITCH-OFF CONDITIONS.

Assuming, first of all, that the receiver is totally dead, the following procedure should be adopted:

1. Switch on and observe that all valve heaters are glowing.
2. If not, switch off and check the heater of the offending valve or valves for continuity on the ohm range of the multimeter. (There should be only a few ohms across the heater pins.) If just V11 (VFO) and V10 (HF oscillator) are not glowing it is as well to remember that these two valves have their heaters supplied separately from all the other valves, and a check should be made on the supply voltages at the valve pins of the HF oscillator V10. (It is impossible to measure the heater voltage actually at the pins of V11 VFO as these are in the VFO compartment.) Replace any valves with open circuit heaters with new replacement valve(s). (See VFO footnote Table 2).
3. If, however, only a few valve heaters are glowing, and possibly very brightly, switch off immediately! Remove mains plug from socket! Now check the wiring to the multiway plug/socket from the power supply as these are rather prone to breakage, especially in the plug.

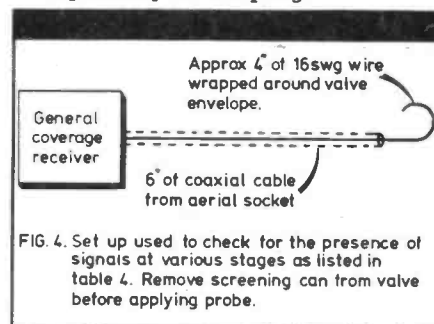

FIG. 4. Set up used to check for the presence of signals at various stages as listed in table 4. Remove screening can from valve before applying probe.

Assuming that all valve heaters are glowing and the receiver is still dead, look at the voltage stabiliser V20. This should be seen to glow a purple colour. If not, most probably either V20 is defective or no HT is being supplied from the PSU. Check leads/plugs/back to PSU and

Table 2

Voltage checks. Receive condition. Control settings. LSB, Bandswitch, 3.5MHz. AF Gain, Midway. RF Gain Minimum. EXT MOX.

VALVE	PIN NUMBERS									NOTES
	1	2	3	4	5	6	7	8	9	
V20	+	150			+	150	0	-	-	IF voltage low or high check V20, R96, R100
V17	0	20	0	50Hz 6.3	50Hz 12.6	225	240	1	70	IF voltage on Pin 2 low, check, V17, Ti T, Primary, R100, C151 IF voltage Pin 2 high check V17, R93, C125 IF voltage pin 9 low, check, V17, R92, C125 IF voltage pin 9 high, check, V17, R94, RV95 slider to chassis
V16	100	-5	0	0	0	100	0	3.5	50Hz 6.3	IF voltage pin 1 or 6 low check voltage at V20, RFC9, R13
V15	175	0	A/C 2.6	A/C 6.3	6.3	135	-1	.6	A/C 12.6	IF voltage pin 6 high/low check V15, R82, R81, C109, C127
V14	0	-.3	A/C 12.6	A/C 6.3	4	-	-.43	-	-	IF voltage pin 5 low, RX gain will be low, check V14, R68, R69
V13	0	-	A/C 6.3	A/C 12.6	200	135	3.5	-	-	IF voltages high/low check V13, R70, R72, R71, C105, C104, IFT4
V12	0	-	A/C 6.3	A/C 12.6	215	3.0	-	-	-	IF voltages high/low check V12, R22, C22, C97, C98, R66, IFT5
V11	115	0	7.8	A/C 6.3	A/C 12.6	72	1.2	4.5	4.2	VFO See note below. But check V11 and voltage from V20
V10	Approx -2.5	0	A/C 6.3	0	220	0	170	-	-	IF voltages high/low check V10, R51, RFC7, R49, C71, C75, C193
V9	-1	1.2	A/C 6.3	A/C 12.6	235	52	0	-	-	IF voltages high/low check V9, R46, R47, R48, IFT2, C27, R28. Also V4 if pin 5 V9 low
V19	0	1.2	A/C 6.3	A/C 12.6	240	52	0	-	-	IF voltages high/low check V19, R114, R115, R116, R117, R221, C22, C134, C135, C136, Mech. filter
V6	.35	-23	.35	A/C 6.3	0	0	235	35*	0	*Voltage pin 8 depends on band selected. IF voltages high/low check R39, R40, R123, R36, APC1, R35, V6, C37

Note: All voltages $\pm 10\%$

Note: All voltages within the VFO are difficult to measure and a 9 pin plug/valve holder with suitable test points on it and interposed between valve and VFO. If any resistors are found defective in the VFO it is best to replace them all.

fuses. Invert the transceiver chassis and measure from the low voltage HT rail to chassis (the HT rail is wired in red). A reading of 250V should be obtained. If no voltage is present check the fuses in the PSU. If the heaters are glowing and HT is present but the receiver is still dead check the voltages on the pins of the receiver valves against the values given in Table 2, working from the output stage back to the RF stage. A simple check on the output stage (V17) is to switch on and, with the multimeter set to ohms and one probe to chassis, connect the other probe to the G1 pin of the pentode section (pin 3). A loud pop should be heard as the probe is connected and disconnected from the grid. If not, and all voltages around V17 are correct, check the PHONES socket as this incorporates a switch which disconnects the loudspeaker when headphones are used, and this sometimes gives trouble through wear and tear. Another point to be borne in mind is that, due to a fault in the change-over circuits, the rig may be permanently in transmit. This can be checked by measuring the voltage on pin 6 of V21 (VOX amplifier), which should be approximately 240 volts if the rig is in the receive mode; if it is much lower the 2000 may well be stuck in transmit. Removing V21 from its socket briefly will prove the point, as the rig will then revert to receive. However, do not leave V21 out for more than a few seconds as this unbalances the heater voltages to the other valves. If removal of V21 does bring the receiver to life, and replacement by a new valve does not cure the fault, check all the resistors on pin 7. These resistors are of high value and have a nasty habit of going open circuit. Also check the capacitors in the circuit for leakage. If the receiver persists in remaining dead proceed through the voltage checks of Table 2. The correction of any problems found during the voltage checks will normally cure even the most stubbornly deaf 2000 unless, that is, someone has had a go at the alignment and left it miles out of adjustment! It is worth noting that the RF/IF alignment of an untouched KW2000 receiver will remain extremely stable over a period of many years. At worst a slight "tweak" may be required on the 10, 15 and 20 metre bands only, and then only if com-

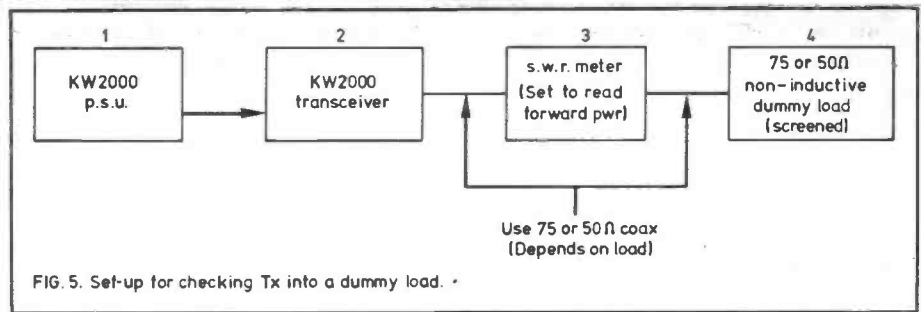

FIG. 5. Set-up for checking Tx into a dummy load.

Table 3

Voltage check. In TX condition. Control settings — Band 3.5MHz. Mic gain — Minimum, LSB, Int Mox, Mic connected.

VALVE	PIN NUMBERS								COMMENTS	
	1	2	3	4	5	6	7	8		
V1	70	0	0.4	0	0	90	0	0.8	A/C 6.3	If pins 1 or 6, low, V1, R3, R4, C2, C145, C3.
V2A	—	—	—	0	0	150	0	2.6	A/C 6.3	If pin 6 low check, V2, R12, R11, R10, C8.
V3	1.0	0	1.0	A/C 6.3	A/C 12.6	0	45	50	0	If pin 7 or 8 low, check R18, R19, R21, (+ +)
V4	170	0	1.5	A/C 6.3	A/C 6.3	170	0	1.45	A/C 12.6	If voltage pins 1+6 low check V4, R28, C23.
V5	210	0	1.7	A/C 12.6	A/C 12.6	210	0	1.7	A/C 6.3	If voltages pins 3+8 low check V5, R32, R26.
V8	0	A/C 6.3	225	0	-50	0	0	0	TopCap 750	If no volts on Top Cap check RFC4, HT fuses
V23	0	6.3	225	0	-50	0	0	0	TopCap 750	in P.S.U. wire broken in multi-way connector on back of KW2000

Note: Most of the faults found in KW2000 series on TX ie. low drive or intermittent drive were caused by R18, R19, R21, going very high in value due to ageing.

(+ +) = These resistors are often the cause of low/intermittent TX drive.

Table 4

STEP	Fit sniffer to:	External RX Frequency	Checking
1	V16	455KHz approx	Carrier OSC. See xtals in KW2000 for exact frequency
2	V11	Depends on VFO setting. 2.5MHz to 2.7MHz	Exact frequency depends on KW2000 VFO setting. Checks VFO
3	V4	2.995 to 3.155MHz Depends on VFO setting	Check 1st TX mixer to see if some output is present ON TX ONLY ie. 455KHz + VFO
4	V5	Depends on KW2000 VFO and band selected. But on frequencies dialled up on KW2000.	Checks 2nd TX mixer to see if some output is present ON TX only
5	V7	As above	Checks some output is present from driver stage
If signals are present in steps 1-5 there is no point in doing step 6.			
6	V10	Tune RX to LF edge of band selected on KW2000 + 3.155MHz eg. Band selected on KW2000 = 3.5MHz + 3.155MHz = 6.655MHz etc.	This checks V10. HF oscillator is working on all bands.

ponents such as capacitors or resistors have been changed in the RF stage or mixer. However, the complete alignment procedure will be given in the next article for anyone who wishes to carry it out.

If the receiver is working it is not normally very difficult to get the transmitter going, so if performance is poor on transmit it is worth checking the stages which are common to both receive and transmit paths, namely the VFO, HF oscillator and carrier oscillator. This is far easier to do on receive as you can hear what is happening.

Faults on transmitter

In the case of a transmitter fault the voltages in Table 2 should be checked as well as those in Table 3 since a fault in the receiver can reduce the transmitter drive, parts of the signal path being common to both modes. There are, however, a few conditions in which it is inadvisable to leave the rig while checking the receiver performance:

1. No control of PA bias, ie. PA hard on.
2. Blown HT fuse to PA anode circuits as this can damage the screen grids of the PA valves.

These dangerous conditions can be discovered rapidly in the following manner:-

1. No control of bias: set the rig to INT MOX and note the standing current on the front panel meter. if this is high, adjust the bias control on the PSU. If it is found that the bias control does not affect the current SWITCH OFF IMMEDIATELY and check the grid bias components for the PA including the valves and C48 which, if short circuit, puts HT onto the control grids. The wiring to the multi-way plug on the back of the KW 2000 should also be checked for broken wires under the clamp.

2. Blown HT fuse in anode circuit: this can be caused by faulty PA valves, no bias on control grids, incorrect tuning, or instability (incorrect neutralising can cause the PA to go unstable — see next article). If a fuse blows persistently the fault should be investigated at once. The fuse should NEVER simply be replaced by one of a higher value as this can cause expensive damage! A blown HT fuse is often indicated by a sudden drop in PA standing current to virtually zero (the meter reads PA cathode current so there

will still be a slight reading, caused by screen current, even with no anode volts present in transmit mode).

There is one fault on the transmitter which is obvious without too much trouble, namely absence of CW sidetone and output power, and VOX inoperative with key down. The rig will also produce no output in the TUNE mode. This is due to the tone oscillator V15 failing to oscillate. A check should be made either in TUNE or with the key down and with the receiver AF gain control at about one third, when the tone should be heard in the loudspeaker. If not check V15, R87, R88, R89, R90, R91, C4, C119, C120, and C121. The tone oscillator can be very 'touchy' if these components have aged.

Do not proceed to check the transmitter without the tone oscillator as it is used to provide drive during tune up and on CW. Without it, it is very difficult to tune up correctly!

Assuming that the proceeding tests have been carried out and any faults found have been repaired, the transceiver should now show signs of life on both transmit and receive unless, of course, the alignment has been tampered with. There are a few simple tests which can help if there is still a problem such as no transmit output or low receive sensitivity. A general coverage receiver can be used to listen for signals from the various parts of the circuit, lightly coupling the receiver to the KW 2000 as shown in Fig. 4. Table 4 gives details of what should be observed in each case. Note that in steps 3 to 5 the transceiver should be set to TUNE with the MIC GAIN

turned fully up. However, the PA current (if any) should be monitored and not allowed to rise above 100mA at any time. If the current is too high reduce the MIC GAIN. The information gained from Table 4 can be used to provide clues to the location of the fault. For example, if signal is present in steps 1 and 2 but not in step 3 it is possible that there is a fault in or around V3 (transmit IF amplifier). This means that no signal is arriving at the grid of the first transmit mixer V4, so there is no mixer output. Alternatively, V4 may not be mixing due to valve or component failure. If that is so, re-check those stages very carefully using the tests given in Tables 2 and 3. The tests of Table 4 will at least identify the area in which the fault is located.

Once all the tests in Tables 1 to 4 have been carried out the rig should be working well enough for the alignment to be checked. However, this will only be necessary if:-

1. The rig has been tampered with.
2. Max receive gain and max transmit drive do not coincide when adjusting the pre-selector tuning.
3. Components have been replaced in a particular stage, in which case it should only be necessary to re-align the stage concerned, or at worst the stages before and after.
4. If some of the modifications to be described later have been carried out.
5. It is desired to get the best results possible!

The complete alignment procedure will be given in the next article. ●

Table 5

Approximate power ± 10% output to be expected
Key down in LSB or USB

KW 2000 A/B	KW 2000	Measured output power (Yours)	Band
25 watts*	25 watts*		1.8MHz
100 watts	50 watts		3.5/3.7MHz
100 watts	50 watts		7.0MHz
100 watts	50 watts		14.0MHz
85 watts	46 watts		21.0MHz
80 watts	40 watts		28-28.6MHz

Measured on my KW 2000A on bird thro' line watt-meter into 50

Measured on friends KW 2000 on Bird thro' line watt meter into 50

Power output figures are included only to give a rough guide as to what to expect.

*Reduced HT to P/A by switch on P.S.U.

Technicalities

The topic for discussion this month is speech processing, the adding of 'punch' to transmitted audio.

Given the boring uniformity of modern commercial radio gear, the variation in 'received' quality of the audio constantly surprises me. Without doubt some people have a resonance of voice which accords well with the limited bandwidth transmissions used in amateur radio. Other individuals, perhaps using identical equipment, sound thin, watery and difficult to pick out of the noise or QRM.

What makes it even odder is the lack of correlation between a person's normal voice and how they sound over the air. There are operators who sound the same both on the air and face-to-face. There are others that you wouldn't even recognise when going from one medium to the other. I have rationalised the difference by assuming that the spectrum of the average person's speech is split up into discrete frequency bands with very little in between. For instance the major resonances of the vocal tract may occur in the range 200 to 300Hz, 700 to 900Hz, 1.5kHz to 1.9kHz, etc. The actual pattern will depend on the individual.

Radio equipment is designed to transmit only those frequencies which fall between 0.3 to 3kHz. I think that the reason for this will be obvious to everyone: the higher the modulation frequency, the larger are the bandwidth requirements of the radio spectrum of the transmitted signal. Furthermore it is generally held that speech frequencies outside these limits are of little value in conveying the sense of the communication. The consequence of this is that radio equipment only responds to a fairly slender speech band and if the voice pattern doesn't match with the equipment pattern, then 'thin audio' will be the perceived result.

Matching voice to equipment

What can be done about this? The short answer is that the equipment

SPEECH PROCESSING

By
Frank Ogden G4JST

must be tailored to suit the voice pattern of the individual within the constraints of the bands of frequencies between 0.3 to 3kHz. This tailoring requires that deficient areas of the individual's speech spectrum should be boosted. The way that most people do this is swapping microphones around until they find a combination which gives the most punch to their speech. This is not particularly scientific and can get a bit expensive. It is also possible to modify microphones. For instance I use a standard Yaesu desk mic. I can't remember the model

number off-hand but it is the one fitted with the goose neck. I found the mic hopelessly bassy when used with my homebrew transceiver. I effected a cure by taking out the mic capsule (the transducer element) and blocking off two of the three equaliser holes in the back of the capsule. While this action had no effect on the top end of the speech spectrum (this section was OK) it neatly tailored the bottom end to suit the characteristics of my voice and the equipment in use. Result — pretty good audio.

It illustrates a point that quite a lot can be done to improve the talk power of a signal with a fairly simple modification. I could possibly have tackled the problem by placing a relatively low value capacitor in series with the mic connection to produce the required bass rolloff.

Talk power

A much more elegant solution with wide applications would be to use a graphic equaliser. I have actually tried one of these devices in radio work and I can report that they do quite a lot for an otherwise poor signal. A graphic equaliser is a

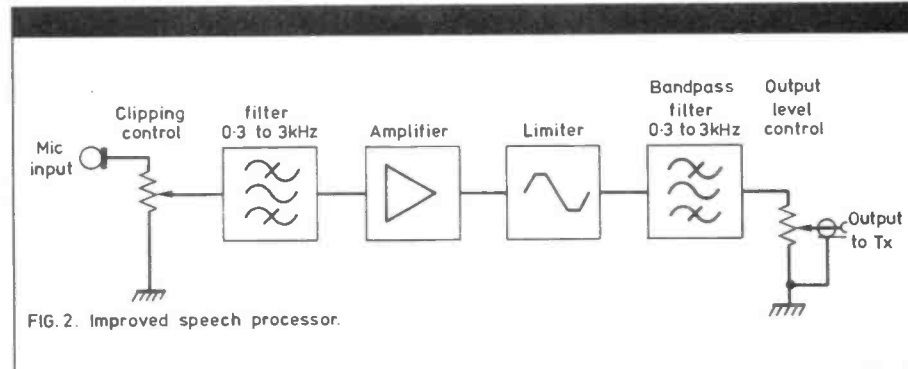
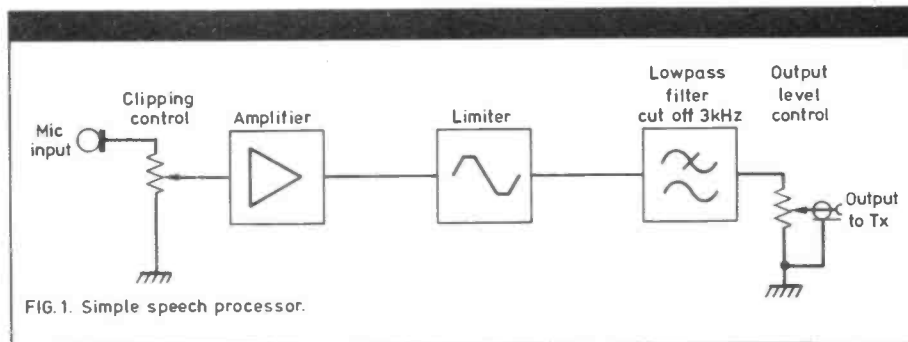

device which offers precise control of an audio frequency passing through it in the manner of a very comprehensive tone control network. I must add that the one I borrowed was intended for hi-fi applications and only had about four process bands in the frequency spectrum of interest. Even so, it produced very encouraging results and had at least as much good effect as a simple speech processor.

I am convinced enough of the value of graphic equalisers when used for radio transmission that I have commissioned a special *Ham Radio Today* design optimised for the purpose. We hope to bring you the project shortly. The biggest plus in favour of equaliser against the standard type of processor is that the equaliser beefs up the audio without introducing any distortion and therefore makes the resulting sound far more pleasant to listen to. Having said that the clipping type processor, power mic, call it what you will can make a valuable contribution to long distance audio when used correctly.

Clipping speech

Just about everyone will have looked at speech displayed on an oscilloscope at sometime or other. The thing that stands out about such a trace is the presence of high peaks of short duration — transients — set against low level signals which make up the majority of the trace. It

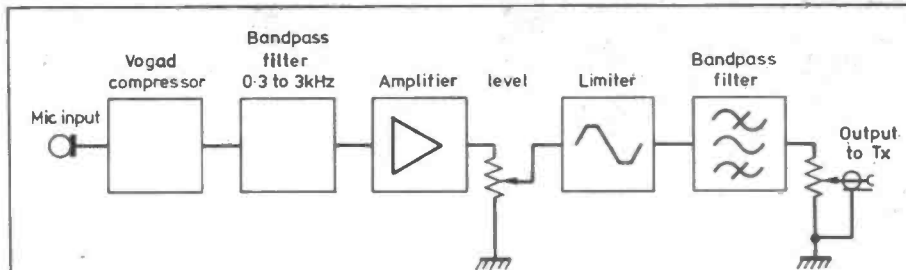

FIG. 3. Auto levelling baseband speech processor.

is the low level stuff in between the transients which carries most of the information in the sound. The peaks just get in the way. If the background is amplified more than the transients, the effective talk power will be lifted in proportion. This is exactly what the simple processor (block diagram Fig. 1) does. It amplifies the mic signal to a level far higher than the transmitter can possibly use and then clips the tops off the peaks reducing them to much the same level as the background. The process effectively boosts these all-important low level signals to an amplitude which will modulate the transmitter fully.

By definition, this process is non-linear which means that the processed wave now contains components which weren't present in the original. Generally speaking, these 'intermodulation' products have no value in the sense of conveying information and can swamp the wanted signal if present in large enough quantities. This is why all

clipping type processors use filters in the output.

Crucial filters

The conventional wisdom dictates the use of filters in the output of a processor to avoid the 'splatter' produced by high order harmonic products while leaving the frequencies of interest — 0.3kHz to 3kHz — a straightthrough path to the transmitter. This is the purpose of the block marked 'lowpass filter' in Fig. 1. Note though that the unwanted intermod products are produced by a mixing process. For instance, if there are separate high level speech components at 5kHz and 4kHz they mix together to produce unwanted outputs at 9kHz — outside the passband of the filter — and 1kHz, most definitely inside. In this case, the 1kHz intermod product was derived from speech components nominally outside the response characteristic of the filter. This is the reason that simple speech processors are not

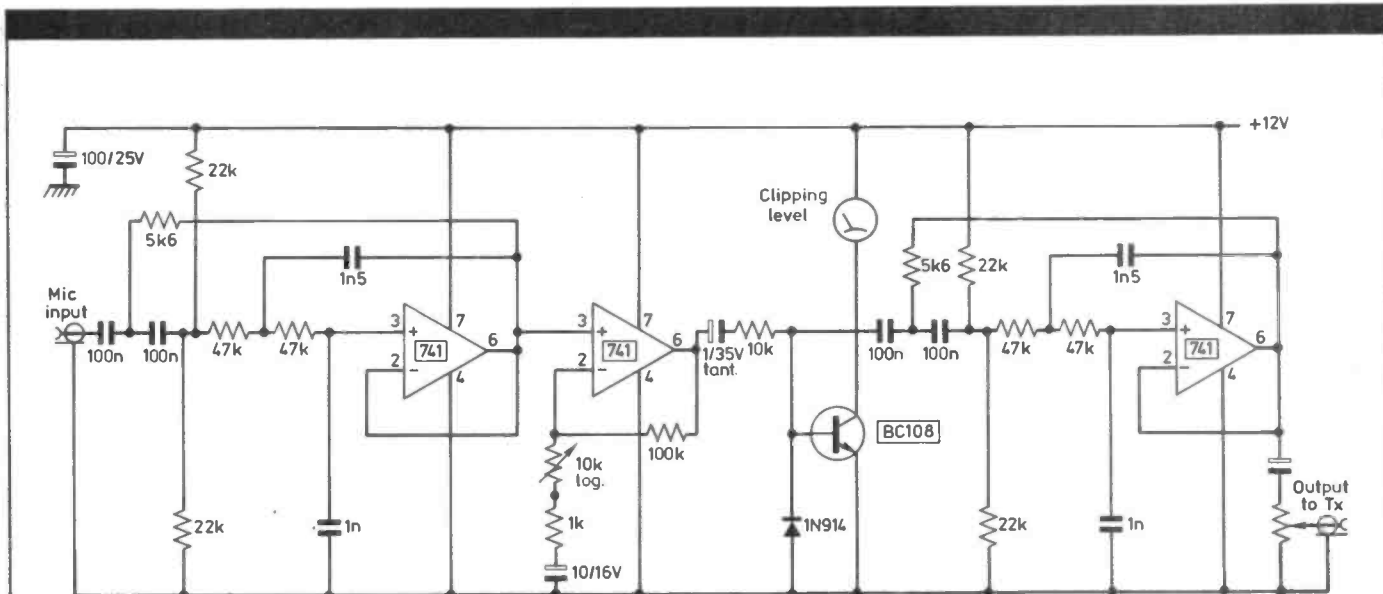

FIG. 4. Improved baseband AF processor.

very effective because, although the average power level may be improved by up to four times, the benefits are masked by a load of unwanted rubbish. When the SSB output level from the transmitter is viewed on the standard type of power meter there is great temptation to wind up the processor level to peak on the output meter. Don't do it. There is a critical point where distortion on the signal will undo the good work of a processor.

A great improvement can be made on the simple processor of Fig. 1 by adding another filter ahead of the limiter which performs the clipping function as shown in Fig. 2. It limits the frequencies which are presented for processing to those which have communications value. The effect of the extra filter is to reduce the possibility of frequencies outside the desired spectrum mixing down to produce in-band intermod products. Given that most transmitters and trans-receivers already have substantial amounts of AF filtering it could be argued that filters placed after the limiting element have little value. It is strange therefore that most published designs in other magazines hardly ever include filters in the right place!

Furthermore the pre-clipping filter should also possess an LF rolloff characteristic for a similar reason: high level, low frequencies can mix upwards to produce very

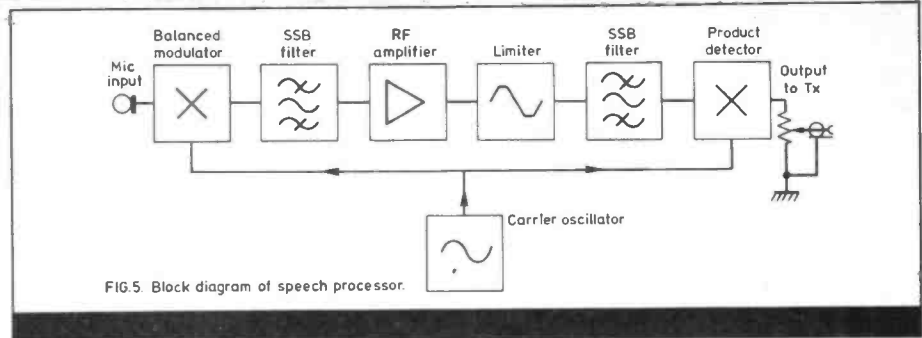

FIG. 5. Block diagram of speech processor.

unpleasant intermod products in the passband.

A further sophistication can be added to the processor of Fig. 2 in the shape of a VOGAD — Voice Operated Gain Adjustment Device. This type of circuit produces autolevelling of the audio presented to the clipper/limiter. It ensures that the optimum level of speech is always applied to the processor element. If the level of voice drops — for instance if you move further away from the mic — the VOGAD brings up the gain. Its position in circuit is shown in Fig. 3. For those that want to try their hand at building one, an IC based VOGAD circuit is shown in Fig. 7. This combination offers a worthwhile improvement on traditional processor designs.

RF Speech processor

There is quite a lot of talk on the airwaves about the magic of RF speech processing. Generally held opinion

considers that this method is very effective in increasing talk power. It is certainly far more effective in use than simple baseband processors of the type shown in Fig. 1. RF processors work by converting microphone audio into an SSB signal, amplifying the resulting RF envelope, clipping it and then passing it through a further SSB filter to remove the harmonic and intermod products.

There is no difference in operation, from the processing point of view, between baseband and RF units. The RF method is clearly and demonstrably superior because the resulting cutoff characteristics of the crystal filters usually employed are far steeper than anything which could be fabricated at audio frequencies. For instance, a good quality SSB filter may attenuate signals 2kHz beyond the edge of its passband by up to 60dB, a ratio of 1000:1. You would be lucky if the average audio filter attenuated by 12dB under similar conditions.

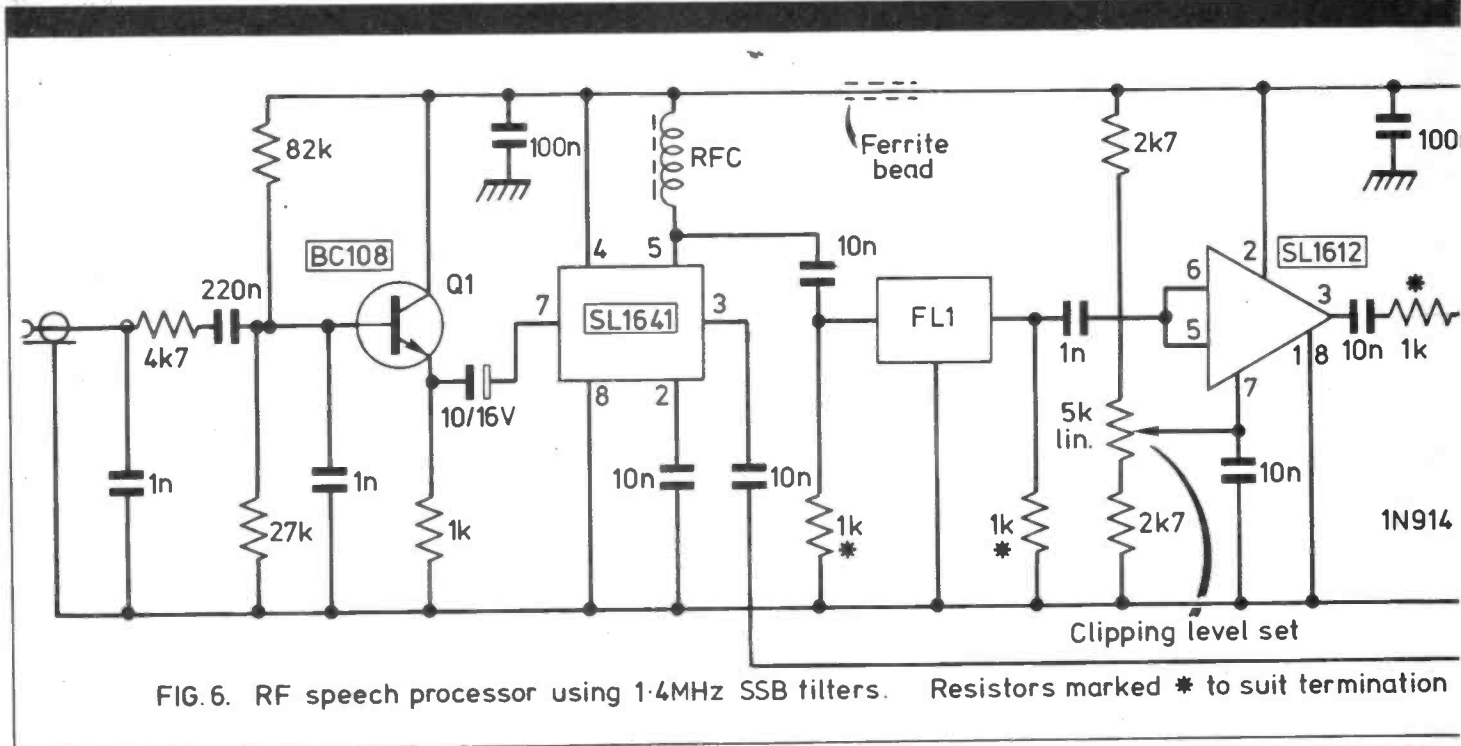

FIG. 6. RF speech processor using 1.4MHz SSB filters. Resistors marked * to suit termination

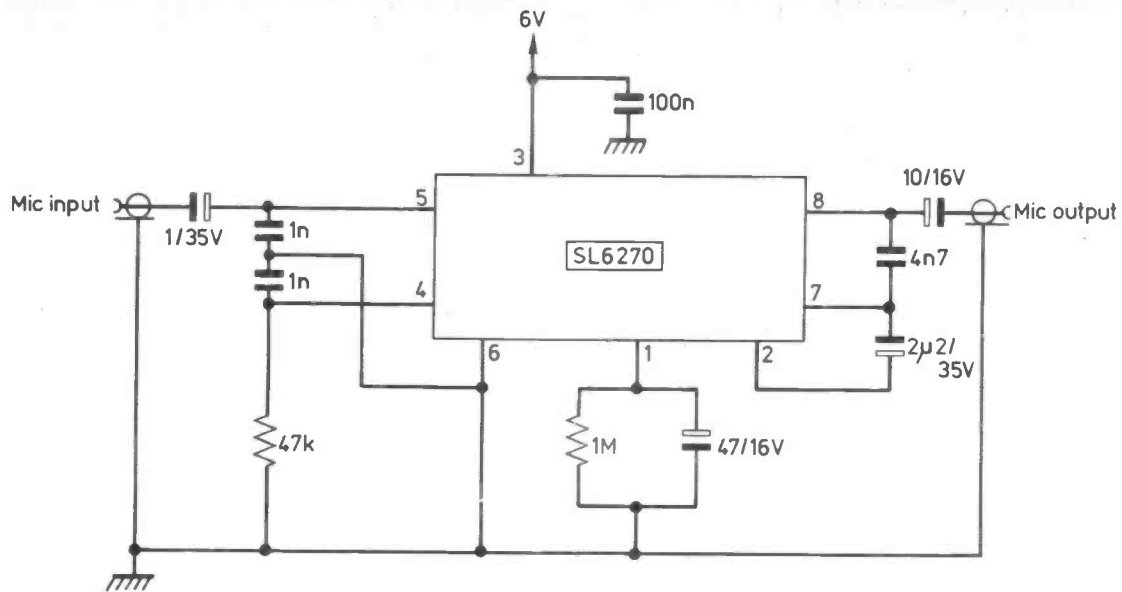

FIG. 7

12dB, incidentally, is a ratio of four.

My interest in RF speech processors arose with the purchase of a pair of 1.4MHz SSB units at Breadboard, the London electronics show. At £3 each they were a snip and could not be ignored. The resulting circuit of my experimental project is shown in Fig. C, block diagram is Fig. 5. I confirm that the circuit operates very well and is a substantial improvement on the improved baseband processor of Fig. 3. Although both circuits operate on the audio in the same way, the re-

ceived quality of processed audio from the RF design is noticeably better for identical levels of processing. The reason for this is simple. The only SSB modulation frequencies which get clipped are those which are within the passband of the crystal filters with the result that out-of-band derived intermod products are almost non-existent.

The carrier frequency of the filters is relatively un-important. The 34dB gain IC amplifier used in the prototype operates up to 15MHz. The only important criterion is that

the filters are of SSB type and that they are reasonably well matched in terms of centre frequency. I have shown an LC type carrier oscillator for use in conjunction with the 1.4MHz design. This is simply because I didn't have a suitable crystal to hand. A proper crystal controlled oscillator would be far better for stability reasons.

As with the baseband design, a VOGAD circuit ahead of the RF processor would offer some advantage but I haven't tried that yet.

G4JST

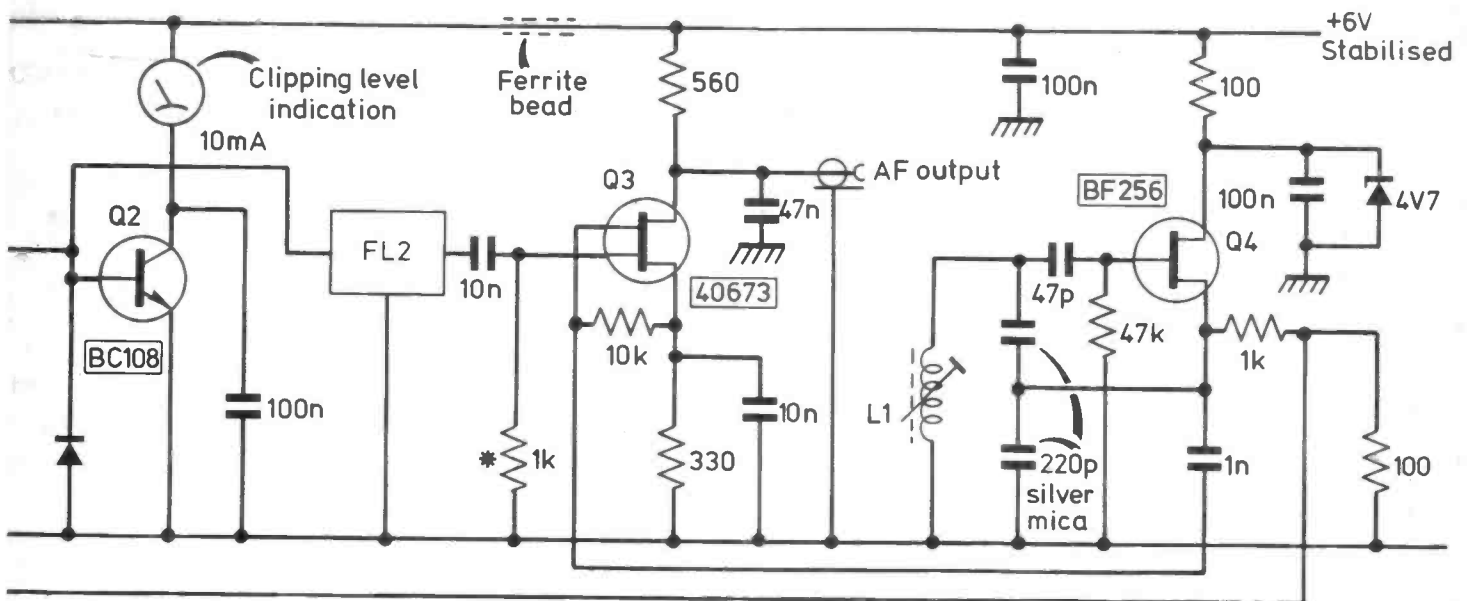

resistance of filters.

Rapid Results Morse Course

By Shirley Hesketh G4HES and Ron Ray G3NCL

a	. -
b	- ...
c	- . - .
d	- ..
e	. .
f	.. - .
g	- - .
h
i	..
j	. - - -
k	- . -
l	. - ..
m	- -
n	- .
o	- - -
p	. - - .
q	- - - . -
r	. - .
s	...
t	-
u	.. -
v	... -
w	. - -
x	- .. -
y	- . - -
z	- - ..
1	. - - - -
2	.. - - -
3	... - -
4 -
5
6	-
7	- - ...
8	- - - ..
9	- - - - .
0	- - - - -

Although it is impossible to take all the pain out of learning CW, you can go a long way to make it easier for yourself. Our morse course, used in conjunction with our new two cassette learning system, provides an excellent basis for tuition to the PO test standard.

Tuition cassettes can be obtained by sending a cheque/ PO for £11.45 payable to Argus Specialist Publications Ltd to the magazine address on page 3. Mark the envelope 'HAM RADIO TODAY morse course' and remember to include your name and address.

Sooner or later all radio enthusiasts will take a look at the Morse Code and make an effort to learn it...and let it be said at this early stage of the game, some will take to it like to the proverbial 'booze-up in a brewery' while others will make hard going of it all. This presentation of Morse Code tuition is designed to start you off on the correct footing, with the introduction of groups of code characters covering the whole of the alphabet A to Z in strict alphabetical order. The first group will consist of characters A B C D E and F; the second batch will have the seven characters G H I J K L and M; the third seven will comprise N O P Q R S and T; and the fourth and final letter cell will involve U V W X Y and Z. That's it! Four cells covering the whole 26 letters split down into easy learning collective units.

Before making a start, however, there are truths that beginners need to realise. The first is that the learning of Morse Code can be likened to the learning of any foreign language in that the brain needs to adapt to the *sound* of that language before it can begin to make any sense of it. The initial problem lies

in the difficulty of sorting out the sound of the short 'dots' (better said as 'dits') from the longer 'dashes' (better said as 'dahs'). Once this is overcome, and it takes less time than you might think, then we come to the second fact. That is that only with **REGULAR** exercise can the brain adapt to fast recognition of the sounds of the different characters. Once you start, regular and consistent practice is absolutely **ESSENTIAL**.

Making a Start

The Code will have to be memorised the hard way, but in the way of easing the load, this 4-Cell method learning system really does come into its own.

Start off with group one: A B C D E F. Pick out the magic 'A' and while looking at it, say to yourself 'dit-dah'; the 'dit' for the short dot symbol, and the 'dah' for the longer dash symbol. The essential facts to have in mind are as follows:

the 'dah' is three times the length of the 'dit';
the gap between them is equal in length to a 'dit';

the space separating two letters is equivalent to three 'dit's';

the separation between two words is understood to be about seven 'dit's'.

So now start going through the letters in group one, mentally adjusting to the sound and rhythm of each morse character, or, to put it another way, listening to the way each symbol flows into a pattern of movement. For instance a 'C' will sound as 'dah-dit-dah-dit', while the 'F' pattern comes over as 'dit-dit-dah-dit'. Notice how, even at this early stage of the listening game, these two letters click into a pattern .. The learning and memorising process must now continue — but with a difference. So pick up this magazine and, while reading through the words, every time you spot one of the letters in this first magic group, speak the morse equivalent aloud. Good fun if you are in a train/bus/car/shower or out shopping or wherever — the venue doesn't matter! and the thing always to remember is **KEEP IT UP!**

As soon as the morse characters for **A B C D E** and **E** are fully implanted in your memory cells, take the next step towards your class A licence by popping into your cassette player the *HRT Learning Cassette*. It's all there — examples of the group one characters arranged in well-proven practice sequences. Side A commences with a spoken introduction of the A-F group followed by several minutes of 'listen-and-learn' practice, with each character sent at a good speed which brings out the sound of each individual letter. If you have stereo equipment you can even turn off the voice track to check that you can really correctly recognise the sounds. **NEXT** pick up your ball-point pen and write down in groups of five in **SMALL LETTERS** not capitals, each letter as you hear it. If you miss a character then quickly pen in a stroke and wait for the next one. At the end of the group of five characters, go back to your starting point and down to the line below ready for the next five. You will have to go down a line sooner or later and if you work right across a page first you could miss several letters in the time it takes to get back to the start of the next line.

Second Stage

The next batch of seven Morse char-

acters **G H I J K L** and **M** will have to be memorised, firstly by letting your memory cells familiarise themselves with the individual feel to each character. As with the first group, keep the practice going as often as you can so that this second section of the alphabet becomes firmly implanted in your memory. Again pick out from the pages of this magazine all the letters to which you now know the Morse characters and speak them aloud as you do so. With practice you will soon find that you have mastered the first half of the alphabet. You can practice too with the second section of the *HRT Cassette!*

Third Stage

Now we have a group of the seven letters **N O P Q R S** and **T**, each with its own distinctive run of rhythm to be memorised. You may well find that this third group is one of the easiest to master, but never-the-less practice as before by spelling out the dit-dah sequences as each Morse character is recognised. Don't forget, too, that you can use the third section of your *HRT Cassette*.

Final Go

With the remaining six letters **U V W X Y** and **Z** we come to the group containing characters that receive little useage. Even so, work as before committing them to memory and 'speaking' them when you pick them out from printed matter. With the completion of the alphabet you can now enjoy a new pastime — reading out vehicle number plate letters in morse code. It is an occupation which will soon sharpen up your grasp of Morse! Now too you can sit down with your cassette machine, preferably using headphones, and start to really listen to the fifth section of the *HRT Cassette* which covers the whole alphabet from **A** to **Z**.

Useful Pointers

While learning it is best to practice taking down random Morse rather than straight text because this forces you to listen to each character, and the eventual aim is to react instinctively to a sound by writing down a letter. With the random Morse, always work in groups of five letters (entering a stroke if you do not instantly recognise the letter), and write subsequent groups below the

first in a column. This does save time and also, more importantly, saves you possibly missing out letters. You will note that we have the alphabet written out in strip form (in small letters to remind you not to use capitals) so that it can be cut out and carried around should you forget a letter.

When Should I Send?

Ah yes! The hardest of all questions with, may we add, a very wide range of answers. **HOWEVER**, as a guide only, if you possess a key and an oscillator (and even the Datong D70 can double up as a practice oscillator) then feel free to plug in the key and have a go when you want to. **BUT** if you are a little on the light side with the rhythmic feel to most of the Morse characters, then in all probability you will make a hash of it and feel rather disappointed. This is why nearly all other tutorial courses say something about waiting until you can copy morse at about 8-10 words per minute, assuming that, if you have reached such heights then you must have acquired some degree of feel for each character. Seriously, though, take to the key when you feel ready — and always carry it around with you!

The Assistance Department

There are several useful learning tools you could acquire. The aforementioned Datong D70 Morse Tutor; any one of the 'clip on your jeans' type cassette recorders cum radios complete with lightweight headphones; even one of the many versions of the micro-cassette recorder. Why the D70? Well, consider the advantages of a lightweight, physically small device capable of sending you random Morse Code. The unfavourable side of the D70 rests with the small internal battery. But ignoring this (?) and remembering that the more useful cassette/radio units use a 3.5mm jack socket, as does the D70, you have your answer!

In conclusion

You can expect to need at least a month of constant practice to master the basic alphabet — so go to it! **Next month** we will talk about the process of building up your speed to the required 12 words per minute — and about learning the numbers in Morse — which is a far easier proposition.

PRACTICE

PRACTICE

PRACTICE

Try your hand at the Ham Radio Today RAE practice papers. Using our special facilities, we have provided questions which very closely parallel those set by the City and Guilds Institute.

The full exam requires the candidate to answer 95 questions in three hours. The 25 questions given here should be completed in about 50 minutes

- 1) Having written to inform the necessary officials of your intention to set up a station at alternative premises, the minimum time which must elapse before the station may be operated at these premises is:
 - a) the same day
 - b) one week
 - c) ten days
 - d) one month
- 2) An amateur sending and receiving station for wireless telegraphy may be used by:
 - a) the licensee and family aged over 14 years
 - b) the licensee and husband/wife
 - c) the licensee only
 - d) the licensee and holders of Amateur Radio Certificates when under the supervision of the licensee.
- 3) The amateur's licence and log book is liable to inspection by:
 - a) a person acting under the authority of the Secretary of State at any reasonable time
 - b) a person acting under the authority of the Secretary of State at any time
 - c) officials of the Radio Society of Great Britain at any reasonable time
 - d) the local police, on receipt of complaints, at any time
- 4) The purposes for which an amateur wireless station may be used includes the use of the station for sending to other licensed amateur stations:
 - a) messages in plain language which are remarks of a business nature providing these are known to both the sending and receiving stations
 - b) any third party messages which may appear necessary in times of national disaster
 - c) messages to amateur wireless stations in general
 - d) details pertaining to the commercial equipment used by the operating station
- 5) In the terms of the Amateur Licences A and B, the term "UK" shall mean only:
 - a) England, Ireland, Scotland and Wales.
 - b) England, Northern Ireland, Scotland and Wales.
 - c) the United Kingdom of Great Britain, Northern Ireland, the Isle of Man and the Channel Islands
 - d) the United Kingdom of Great Britain and Northern Ireland

- 6) The maximum bandwidth for J3E transmissions is chosen so as to:
 - a) not exceed 25 kHz
 - b) not exceed 2.5 kHz
 - c) be within the narrowest possible frequency
 - d) not exceed 1/25 th of the frequency band being used
- 7) When constructing an aerial in the proximity of an overhead power cable, proper precautions must be taken to the satisfaction of:
 - a) the station owner
 - b) the local police
 - c) the Home Office
 - d) the owner of the power cable
- 8) Particular care will have to be taken to minimise the risk of interference to others when aerials are sited:
 - a) in a loft
 - b) close to overhead power lines
 - c) less than 20ft above the ground
 - d) within 50yds of an aerodrome boundary
- 9) To reduce mains-borne interference when using an end-fed antenna one must ensure that:
 - a) the mains earth is used
 - b) a good, short low-resistance connection to a cold water tap is used
 - c) no earth connection is used
 - d) a good, short low-resistance connection to an earth spike is used
- 10) To comply with the Licence regulations pertaining to non-interference, the Licensee shall conduct tests on his equipment:
 - a) weekly
 - b) from time to time
 - c) on the receipt of new equipment
 - d) on receiving complaints from any other user of wireless telegraphy

The Radio Amateurs' Exam is divided into two parts: the first assesses knowledge of the licencing conditions while the second assesses technical competence. Both sections require a pass or the exam will be failed as a whole.

The questions given here should be answered without any reference to textbooks or other teaching aids. Don't cheat as you won't be able to when you sit the real exam!

Simply ring or tick the correct answer options. Look in next month's issue of Ham Radio Today to see if you would have got your ticket.

- 1) Many VHF and UHF repeaters have a pause between the end of audio transmission and the generation of a tone, usually "K" or "T". The reason for this is:
- it takes time for the repeater to switch from transmit to receive mode
 - to give the opportunity for other stations to use the repeater
 - to identify the repeater
 - to give the operator time to switch from transmit to receive mode

- 2) Using the recommended radio-telephony phonetic alphabet G2MUR would be sent as:
- Golf 2 Mike Uniform Radio
 - Golf 2 Mexico Uniform Radio
 - Golf 2 Mike Uniform Romeo
 - Golf 2 Mexico Uniform Romeo

- 3) In a series tuned circuit with an inductance of 400 μ H and a capacitance 144pF, the resonant frequency will be:
- 66.3kHz
 - 663 kHz
 - 0.0663 MHz
 - 6.63 MHz

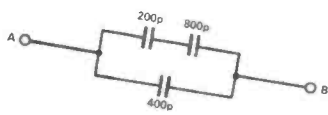

- The effective capacitance between terminals A and B is:
- 1400 pF
 - 600 pF
 - 285 pF
 - 560 pF

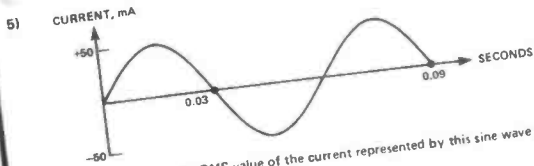

The frequency and RMS value of the current represented by this sine wave is:

- 16 Hz 70.7 mA
- 11 Hz 35.4 mA
- 16 Hz 35.4 mA
- 33 Hz 70.7 mA

- 6) The current gain of a transistor used in a common collector (emitter follower) connection is 50. The external emitter resistance to ground is 10K ohms. The device input resistance will be approximately:

- 500K ohms
- 200 ohms
- 5000 ohms
- 5M ohms

- 7) A transistor amplifying with an efficiency of 50% or less is likely to be operating in:

- class A
- class AB
- class B
- class C

- 8) If the input frequency to the mixer stage of a radio receiver is 1.8 MHz and the required intermediate frequency is 470 kHz, the local oscillator frequency should be tuned to:

- 470 kHz
- 1800 kHz
- 2270 kHz
- 2740 kHz

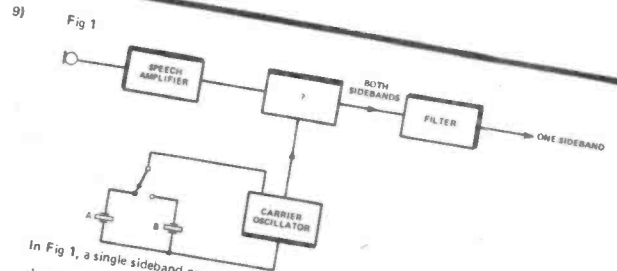

In Fig 1, a single sideband generator, what label should be given to the box marked:

- unbalanced modulator
 - balanced modulator
 - buffer amplifier
 - voltage controlled attenuator
- 10) In Fig 1, what is the purpose of the two components marked A and B:
- to switch frequency bands
 - to switch from transmit to receive
 - to provide upper and lower sidebands
 - to allow for repeater frequency shift

- 11) A 30 MHz half wave dipole has an input impedance of about 80R when the length L and height H are:

- L metres 5
- L metres 2.5
- H metres 2.5
- H metres 5

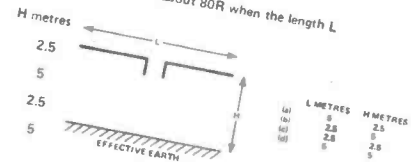

- 12) In the Yagi directional aerial arrangement shown below, the director is of length:

- A/2
- A
- more than A/2
- less than A/2

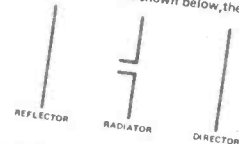

- 13) Tropospheric propagation is usually the major mode for:
- frequencies below 30 MHz for local communications
 - frequencies above 50 MHz for long-distance communications
 - frequencies above 1 GHz
 - frequencies above 50 MHz for line-of-sight communication

- 14) In order to measure the peak envelope power by the "two tone" test method, the following equipment is needed:

- an audio oscillator generating two tones, a dummy load and an oscilloscope
- a dummy load and an oscilloscope
- a dummy load and an audio oscillator generating two tones
- an audio oscillator operating at two known frequencies

- 15) A milliammeter M having a full scale deflection of 5 mA is to be used as a voltmeter measuring up to 200 V, the circuit needed will be:

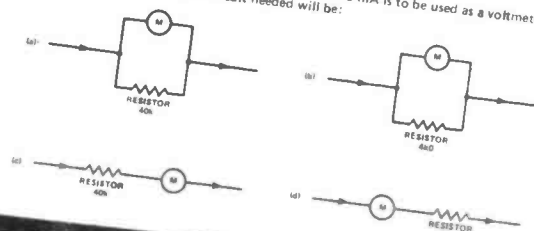

FT102 Review

Yaesu's successor to the FT-101 offers a high quality, versatile receiver together with a transmitter of professional performance standards.

By Tony Bailey G3WPO

The FT-102 transceiver is the latest addition to a long line of equipment from what we have come to expect as one of the leaders in commercial amateur radio rigs. The unit loaned for review was the basic transceiver, with a number of options fitted — the AM/FM facility, with 6kHz AM filter and 1.8kHz narrow SSB filter. A number of additional filters can be fitted for CW. Other outboard accessories are available — in the UK these would normally be the SP-102 External Speaker/Audio Filter (with adjustable AF response), the FV-102DM synthesised scanning external VFO, and the FV-102 1.2kW Antenna Coupler.

Two problems came to light on removing the transceiver from its more than adequate packaging. Firstly, the mains lead was a 3 wire type, but fitted with a 2 pin European moulded plug, so this had to succumb to a pair of wirecutters for fitting a 13 amp plug. Secondly, the unit does not come with a microphone.

This seems a strange omission when you are talking of £700+ of equipment — even the cheaper 2M mobile rigs seem to manage this useful little extra. The handbook details a number of suitable Yaesu mikes, but the only Yaesu one to hand was the wrong impedance.

Even if the correct impedance (low) had been available, it wouldn't have helped as the mike connector is an eight pin special, conspicuously not included in the accessory pack (although plugs for most other sockets are), so some time was lost in obtaining a suitable microphone — a point to bear in mind before you leave the shop. In the meantime, the rig was used on CW.

The overall appearance of the FT-102 is impressive, housed in a very durable enclosure, and following the traditions of modern transceivers, there are 38 controls to play with on the front panel. However, these are sensibly laid out and marked and it only takes a short while to familiarise oneself with those most frequently used. The rear panel possesses a number of sockets, some of which will probably never be used, but again these are all clearly indicated.

The handbook impresses on the reader that the operating voltage of the transceiver should be checked before connection, by reference to a label on the rear panel. Unfortunately, there was no information on this panel, or any shown in the manual photographs. The only place it does appear is on the packaging box that contains the mains lead.

The manual itself is in the usual comprehensive Yaesu style, with explicit operating instructions, backed up by photographs and drawings. Full circuit diagrams are given, the only comment being that Yaesu could take a leaf out of Icoms' book and add typical voltages throughout the circuits.

Facilities Available

The transceiver is fairly wide at 368mm, which may be a consideration on the bench, by 129 high and 309 deep. A nice touch is the provision of an extra pair of feet for the underside which enables the operating tilt to be changed. The tuning knob is positioned centrally, and is pleasant to use with a nice feel, although the reviewer would have preferred a dial capable of being spun, as it takes a while to get from one end of the band (in 500kHz segments) to the other. Tuning rate is 17kHz per turn, as with the 101 series, and the unit is provided with a backlit analogue dial, calibrated in kHz, as well as a bright green fluorescent display, reading to 100Hz.

An addition to the display panel is a set of annunciators showing the reception mode, including any wide or narrow filter options. Two meters



There are lots of knobs and switches on the FT102 although the front panel is relatively uncluttered by modern standards

are provided, one monitoring the signal strength, and doubling as the ALC level on transmit, the other switch selectable for PA current, compression level, plate voltage, and centre discriminator on FM receive. Having the ALC indication available separately as well as the other Tx levels is a useful feature. The internal speaker, which gave good quality with adequate output, is mounted underneath the top panel.

Inside the box

As would be expected, the internal construction is to a high standard, allowing for the fact that the modular construction generates a lot of interconnections. There was little evidence of interstage screening, except around the driver and PA area — The only real cause for criticism was a trailing wire running under the AM filter, above the pcb.

Bells and whistles

As previously mentioned, there are a large number of controls to master, most standard on a modern rig, but a few are unusual. All are mentioned in the following para-

graphs for completeness.

To the left, and immediately underneath the meters, are the AC power switch, and a Heater on/off switch for the valve PA, intended as a means of power conservation during long periods of reception. This control also brings the rear mounted fan into operation which runs whenever the PA heaters are on. It is quiet in operation, and not obtrusive. This is followed by a series of 6 presettable potentiometers, which can be depressed back into the panel when set, for Vox Gain, Vox Delay, Mic Gain, Compression Level, Noise Blanker Level and Squelch (when fitted with the FM unit).

Underneath these are 6 push-buttons for MOX (manual Tx/Rx switch), RF Amplifier, Narrow Filters (if fitted), Processor On, Noise blanker On, and Monitor. This last control allows the user to monitor his own transmitted signal via an extra product detector (useful when setting up the processor), as well as for sidetone.

The remaining items on the left are the mic socket, standard 0.25" jack socket for phones, the mode switch, and a concentric RF+AF gain control. It would be unlikely that any user would want to turn the AF gain up more than about half way, after this point both your ears

DYNAMIC RANGE AS CALCULATED FROM TEST 4	1.9MHz	90dB
DYNAMIC RANGE AS CALCULATED FROM TEST 4	3.7MHz	90dB
DYNAMIC RANGE AS CALCULATED FROM TEST 4	7.05MHz	90dB
DYNAMIC RANGE AS CALCULATED FROM TEST 4	10.1MHz	88dB
DYNAMIC RANGE AS CALCULATED FROM TEST 4	14.2MHz	92dB
DYNAMIC RANGE AS CALCULATED FROM TEST 4	18.1MHz	86dB
DYNAMIC RANGE AS CALCULATED FROM TEST 4	24.5MHz	92dB
DYNAMIC RANGE AS CALCULATED FROM TEST 4	28.5MHz	80dB

Conditions: RF amp off, ABC manual

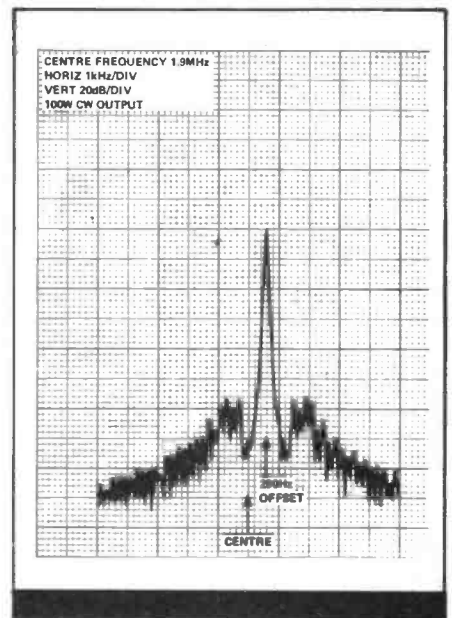
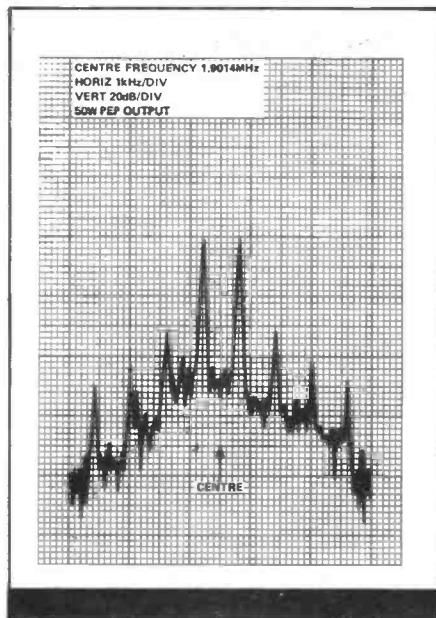
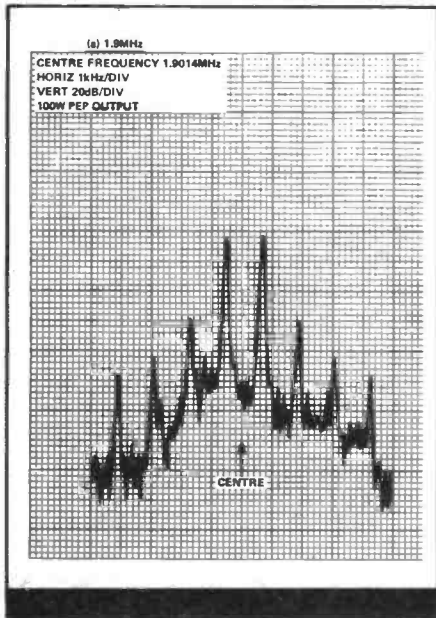

and the internal speaker will probably give up. All the rotary switches are positive in action, without needing a lot of force.

The other 20 controls...

On the upper level, to the right of the frequency meter, are the Loading, Plate, and Drive controls. The latter controls the carrier level on CW, AM & FM, and the drive to the processor on SSB effectively enabling control over the power output, down to well under 500mW.

To the right of the tuning knob, are six pushbuttons, two controlling the ABC for fast or slow, and on/off. The next looks after the ALC meter, toggling between normal and Peak Hold, another useful feature. The two remaining buttons are the Rx/Rx clarifier select, both complemented

by adjacent red LED's as reminders. It is here that a disadvantage of the rig shows up (although it is not alone in this respect), if you ever work any DX-peditions.

The Clarifier (or IRT/ITT) control only allows +3.6/-3.2kHz excursions from the nominal frequency (the handbook states +/-2.5kHz or more). As the FT-102 does not have any memory facility, or dual VFO's etc, it is not possible to work even the lowest split frequency encountered, which is normally "5-up or down". Looking at the circuit shows that this could be easily modified if you want 5kHz or more shift and aren't afraid to dive inside.

Moving to the remaining controls we find the meter select switch, followed by the band change,

covering all of the new WARC frequencies, with the additional 500kHz bands required for complete coverage of 10 metres obtained by an additional pushbutton. A Pre-select control is fitted with which the selectable RF amplifier is tuned to receive, and the transmitter driver stage. This has a fairly broad tuning response on receive, but is sharper on transmit.

3 dual concentric controls complete the facilities — the clarifier control is teamed with a Tone control, although the response of this seems to be mainly restricted to the first half of its travel. Two more of the filter facilities follow, the first a tuneable I.F. notch filter, selected by an additional pushbutton, the other a tuneable Audio Peak Filter, again pushbutton selectable. The

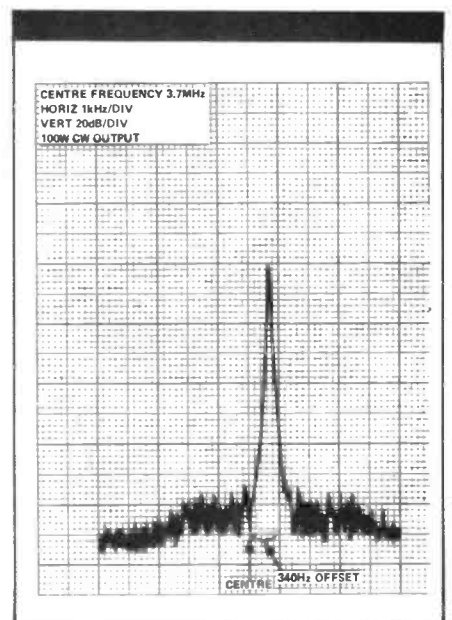
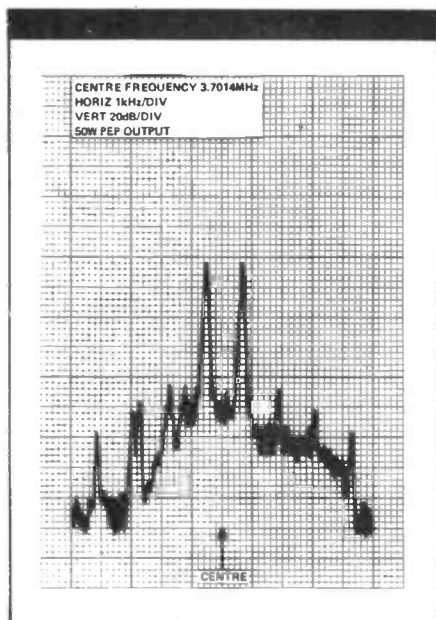
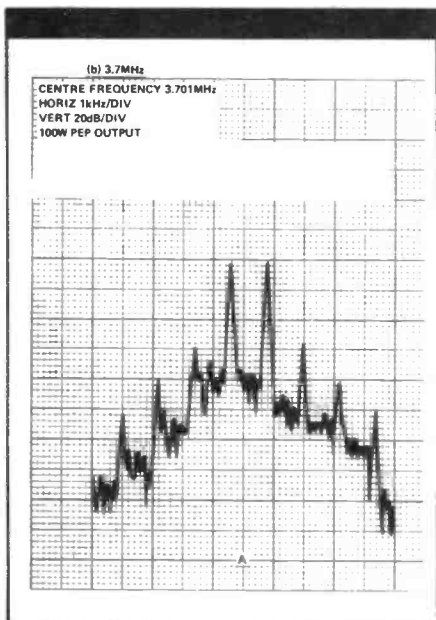

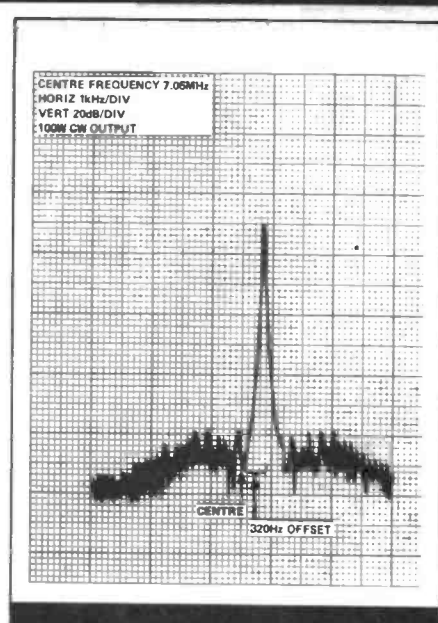
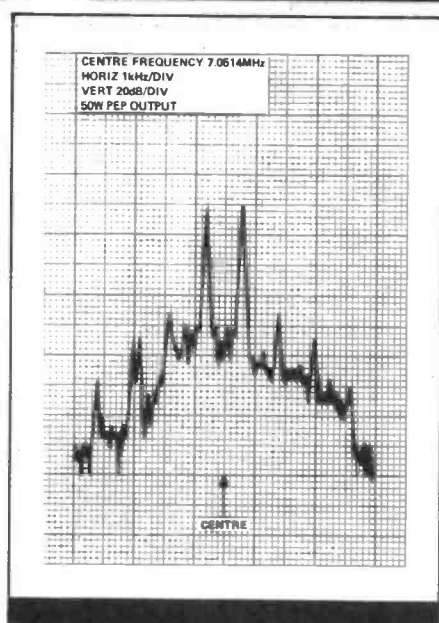
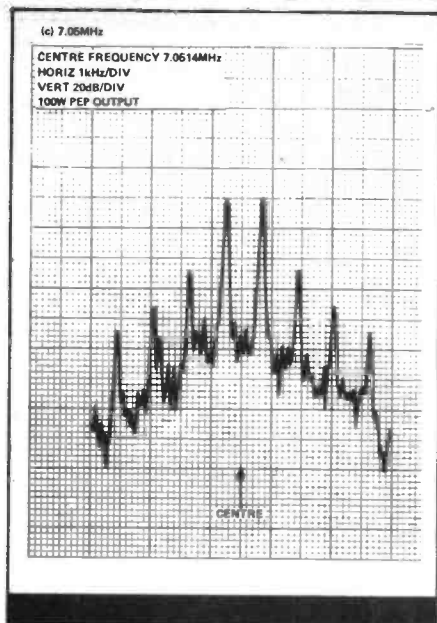

latter is intended for use in the CW mode, and only functions when CW is selected. Both work well, the notch filter being effective, useable within the passband of a speech signal without too much loss of intelligibility.

The last of the controls sets the width of the i.f. passband and enables the selected passband width to be moved across the received signal. These are arranged as a friction coupled concentric pair, so that once the width has been set to the optimum, allowing for QRM etc, the two controls can be rotated as one for setting the passband relative to the received signal. Some time was needed to get used to these, but the manual is very helpful with explicit instructions and diagrams on their use.

The rear panel

A brief tour of the rear panel shows the normal SO239 antenna socket. In addition an auxiliary antenna is allowed, as well as an external receiver, with options on how these combinations are used. Muting, sidetone and other controls are also available for the other receiver.

Low level Tx output for transverter use (0.1v rms into 50ohm), external VFO, AF out (for recording), IF out (for spectrum analyser), external PTT, and the key jack (why is this always relegated to the back?) are among the more notable connectors available, but there are a number of others including a 12v dc output for accessories.

Finally, lurking under the bot-

tom panel are a number of potentiometers, for the sidetone pitch and volume, and for setting up the Tx audio response. This latter feature could be useful, especially for the YL operator who suffers from most rigs being shaped for the male voice, with the result that most YL's sound alike. As satisfactory results were obtained on the air, these controls were not adjusted, but have obvious advantages for compensation if your voice characteristics tend to base or treble.

The Circuit

Unlike the 101 series, the FT-102 uses dual conversion (8.2MHz and 455MHz) on transmit and receive. Signals from the antenna can be routed through a tuneable high voltage (24v) RF dual JFET

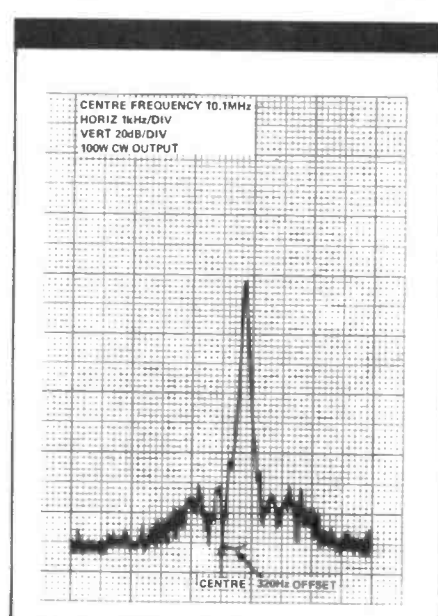
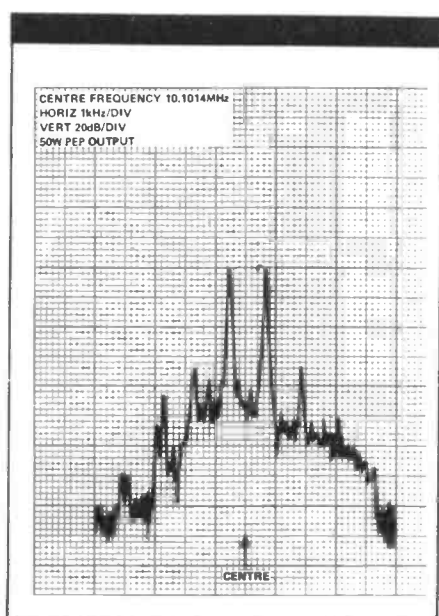
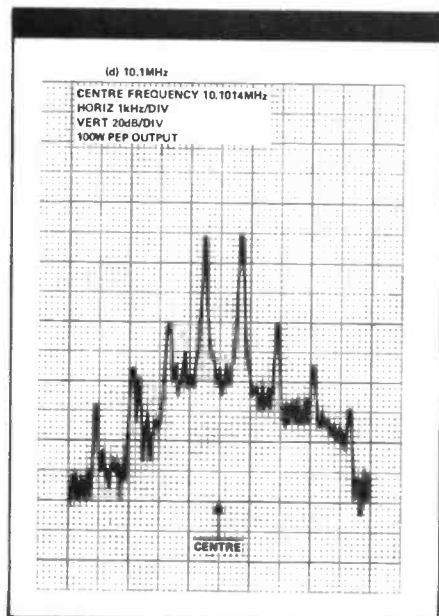

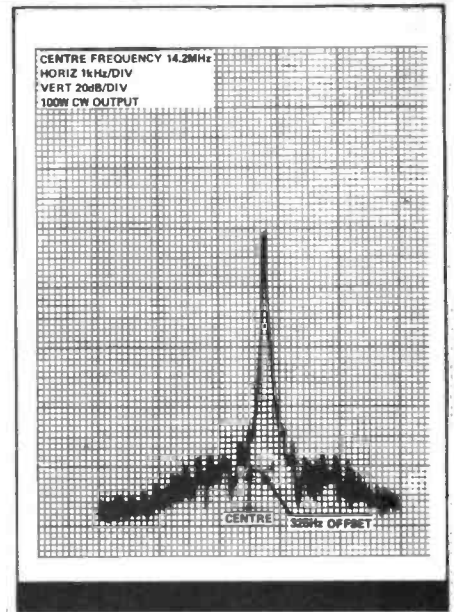
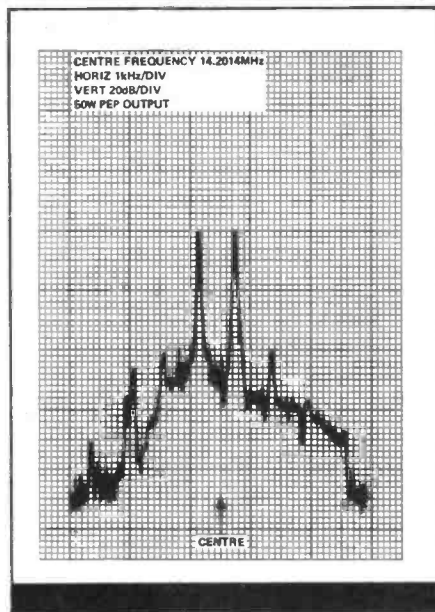
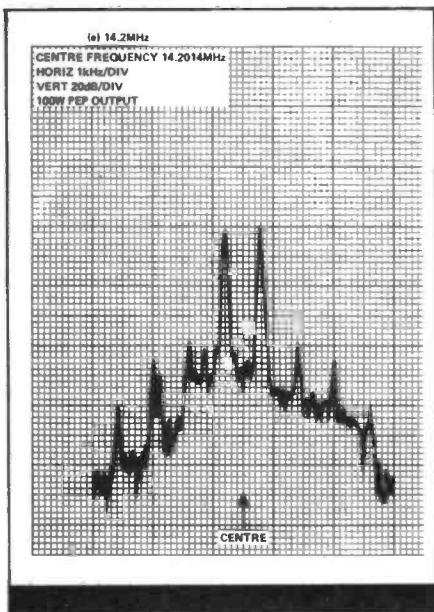

amplifier, or bypassed direct to the switched bandpass filters (Yaesu claim over 100dB dynamic range in the bypassed mode). The first active balanced mixer (again at 24v) converts signals to the first I.F. of 8.2MHz, and then via a monolithic crystal filter to the main I.F. unit. The wideband I.F. output is taken off immediately before the crystal filter, and can be used to drive a panoramic adaptor or spectrum analyser.

After I.F. amplification (again at 24v and using discrete devices rather than I.C.'s), the signal passes to the first of the crystal filters providing the main selectivity. Just prior to the filter, and positioned to avoid degradation of noise pulses is the noise blanker gate. The AGC circuit of the blanker has a front panel adjustable time constant to

cope with varying noise pulse widths, doing this with commendable efficiency on man-made sources, although it is unable to cope with interference such as static etc., as would be expected.

A large number of options are available with the filters — in addition to the fixed 2.9kHz 8 pole crystal filter through which both SSB and CW signals pass (except AM which has its own 6kHz option), if the narrow facility is fitted extra cascaded filters can be placed in the signal path to take benefit from the pre-filtering. A further dual gate mosfet provides additional I.F. amplification, then to the second mosfet mixer, producing the final I.F. of 455kHz.

More filtering is provided by a 2.9kHz 3 pole ceramic filter, again with options for additional CW nar-

row crystal filters at 500 or 270Hz bandwidths. If the AM option is fitted, then these last set of filters are bypassed. All signals are processed further by a bipolar Q-Multiplier, and the optional tuneable notch filter if required (40db notch claimed), followed by additional I.F. amplification, prior to product detecting for SSB and CW modes. Some of the amplified signal is fed to a narrow band I.F. monitor output, and to the AGC detectors (diode) and AM detector unit, if fitted. AGC is amplified and fed to the RF and first i.f. amplifiers for control, as well as the S-Meter circuit.

After diode product detecting, with injection from a 455kHz third local oscillator, both CW and SSB signals are routed through independent active filters, and the audio peak filter (CW only) prior to AF

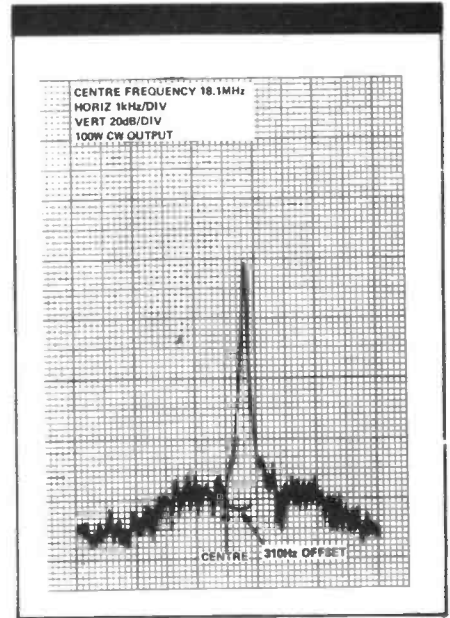
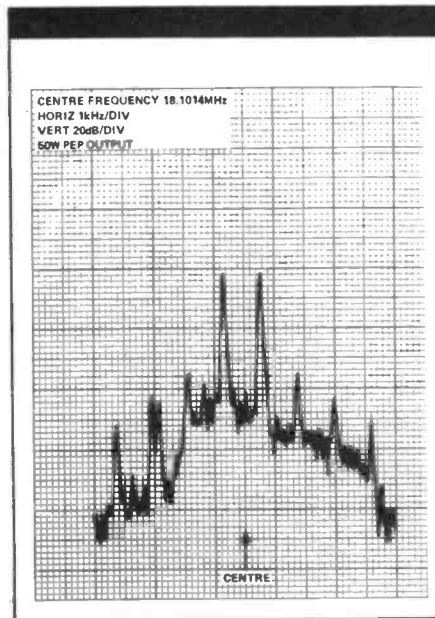
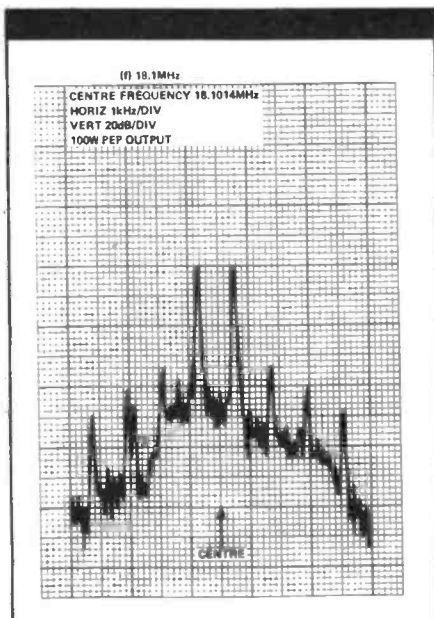

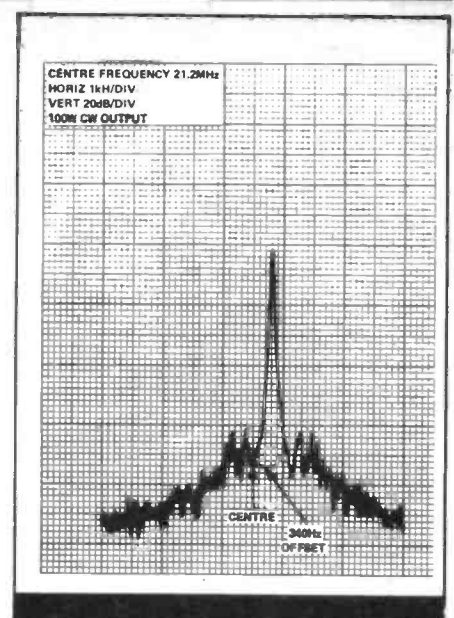
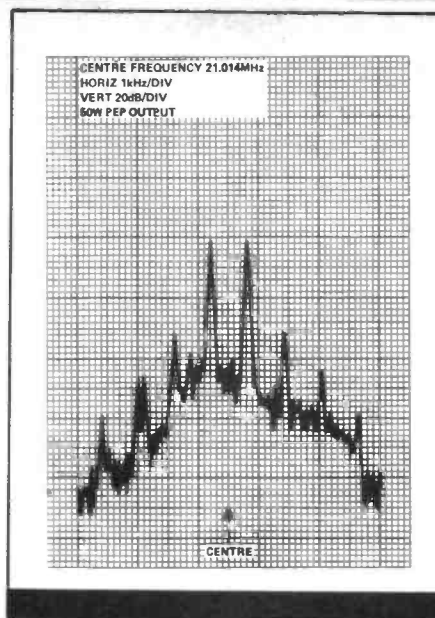
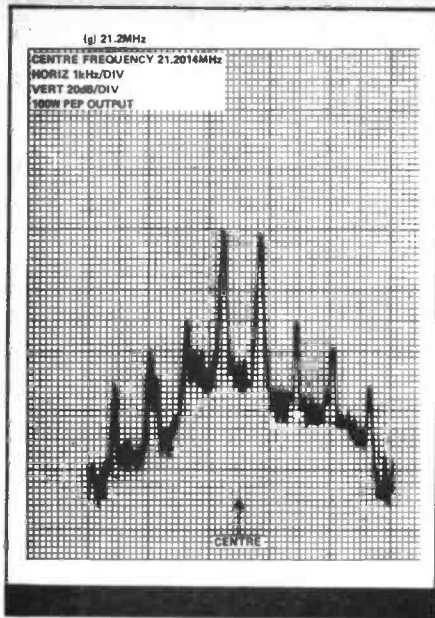

amplification and the speaker.

On the transmit side, the input from the low impedance microphone is amplified and applied to a balanced Schottky ring mixer, buffered, then via a ceramic SSB filter for conversion in the second mixer to 8.2MHz. If the speech processor is used, the filtering signal is amplified by the receive second I.F. amplifier, clipped and then applied to the mixer. Both processed and unprocessed signals are then filtered through the first bank of filters used for the receive section.

After conversion to signal frequency, further amplification is needed for the 12BY7A valve driver stage, at which some of the signal is available for transverter applications. Preselector tuning follows, driving the 3 × 6146B power amplifier stage, into the antenna via a

conventional pi-network coupler. The provision of 3 of this type of valve is unusual — Yaesu claim that third-order IMD products are reduced by a factor of 10 over 2 valve and solid state designs. Certainly, the on-the-air tests went a long way to back this, providing the power output was kept down to the recommended levels, and not pushed to the maximum.

The usual ALC is fitted, but unusual in that a peak hold circuit is fitted, allowing easier reading of the meter.

The Synthesis system

A new PLL synthesis system is used in the FT-102, primarily to allow the Passband Shift feature to work synchronously with the Width function. It is fairly complex to describe con-

cisely but the main features are as follows:

One of 6 narrow band switched VCO's, feeding the first mixer, is mixed with a 13.715 — 34.215MHz PLL signal, the latter frequency determined by the band, mode, I.F. shift and VFO setting. The 1-4MHz output from this mixer is divided to 500kHz, by a programmable divider, and this output phase detected against a 500kHz signal from a 10MHz reference oscillator. A DC output proportional to the phase difference between the two 500kHz oscillators then locks the selected VCO by means of a varicap diode.

The 13.715-34.215MHz signal is derived from the 10MHz reference and a 19.215MHz VXO, the latter controlled by the mode and IF shift settings, then applied to a pre-mixer which is also driven by the VFO

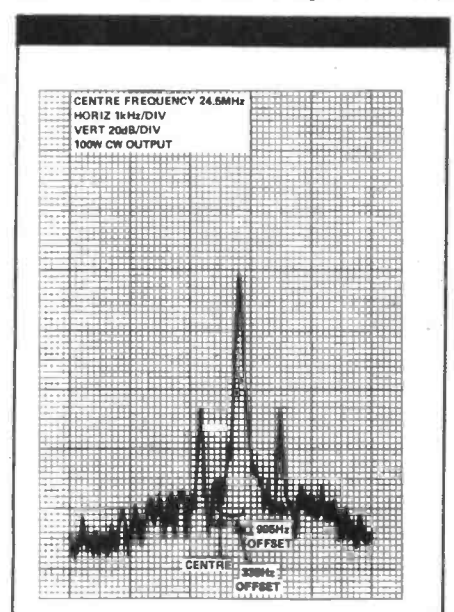
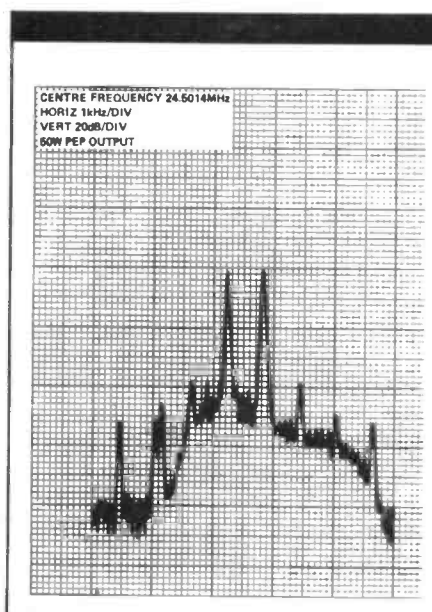
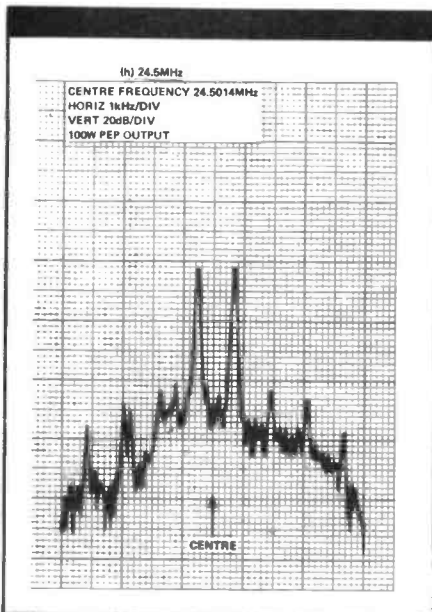

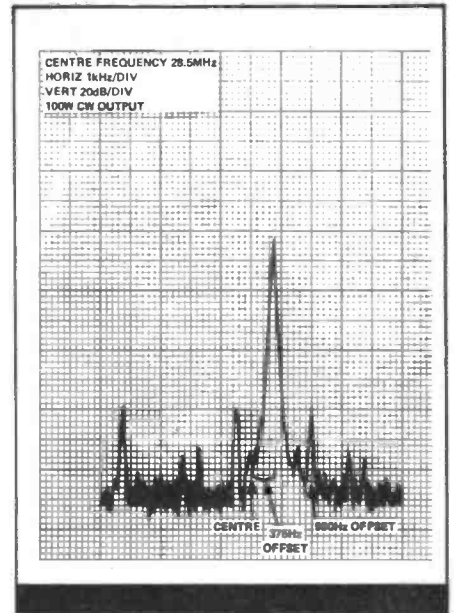
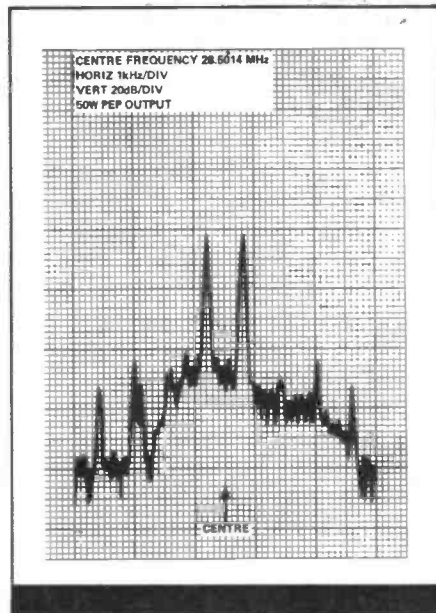
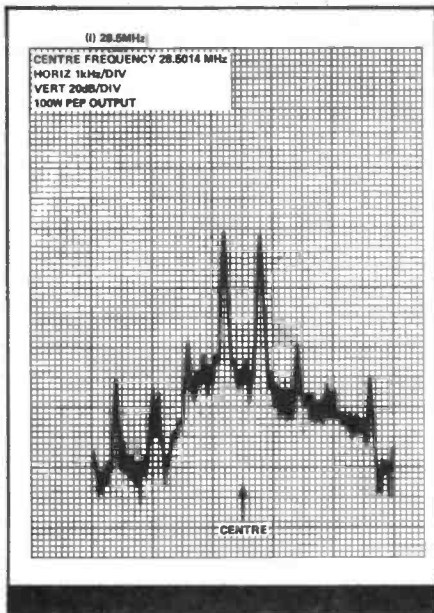

(5-5.5MHz). On bands below 14MHz the 13.715-14.25MHz output is applied straight to the PLL mixer, while above 14MHz a second pre-mixer takes this output together with a 10MHz (14-21MHz) or 20MHz (above 21MHz) signal, before delivery to the PLL mixer. It should be noted that considerable band-pass filtering takes place at all stages in this signal chain.

Moving on to the second I.F. injection, the 8.67MHz signal is produced by mixing the 19.215MHz vxo with another 10.54MHz vxo (frequency set by the width control). This latter signal is also mixed with an 11MHz signal in the third mixer to give the 455MHz I.F., allowing the Shift function to tune the second local oscillator, while the width function synchronously tunes both

the second and third local oscillators.

The VFO is a little unusual in that it uses a custom i.c. rather than discrete devices. Certainly the stability of the whole system is excellent, with only very slight warm-up drift apparent.

The FT102 on the air

During the period of review, the transceiver was used on all bands available, with the accent on the receive function, as this is basically the more important end as far as most people are concerned. The review sample had one strange fault on the 7MHz band — above 7.3MHz the PLL system unlocked with loss of tuning. This problem was not apparent on any of the other bands, or on two other 102's quickly checked.

With all the facilities available for rejection of interfering signals, there was little QRM which could not be disposed of or reduced considerably by a combination of the shift/width and audio notch functions, except for interfering signals very close to the wanted signal. A Datong FL3 Multimode Filter, which is supposed to perform as well as this type of shift/width system was also tried as a comparison.

There is no doubt that the Datong filter was more effective than the FT102 system, very noticeably so with very close QRM, indicating that the audio filter skirts were steeper than those of the shift/width system. The manual states that the two shift-width controls should normally be aligned upright, but this resulted in an obvious offset between USB and LSB — about 30 degrees offset towards the LSB side seemed about right. With the bandwidth narrowed to any great degree, the high frequency noise generated seemed in excess of what one would normally expect.

The noise blanker system did all that was claimed for pulse type interference, and the dreaded Woodpecker, mostly eliminating this completely when the correct pulse blanking width had been found. As might be expected, it had no effect on static type noise, and the addition of a straight limiting system or a threshold adjustment would have helped. Again, not unexpectedly, at higher signal strengths the blanker also chopped received signals, at times making them unreadable.

The antenna system used was a

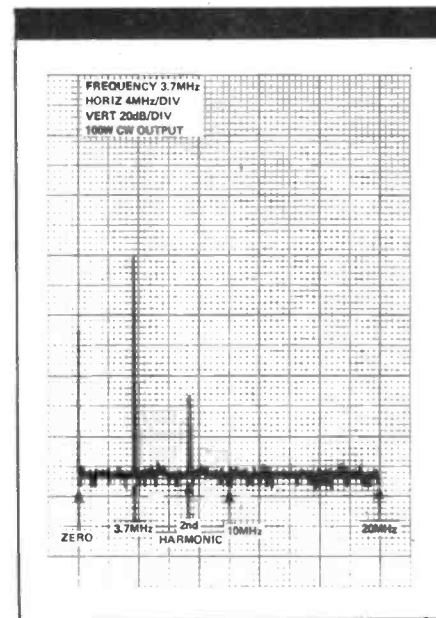
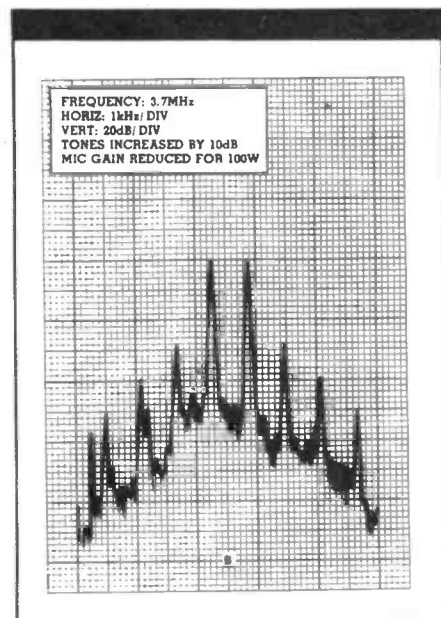

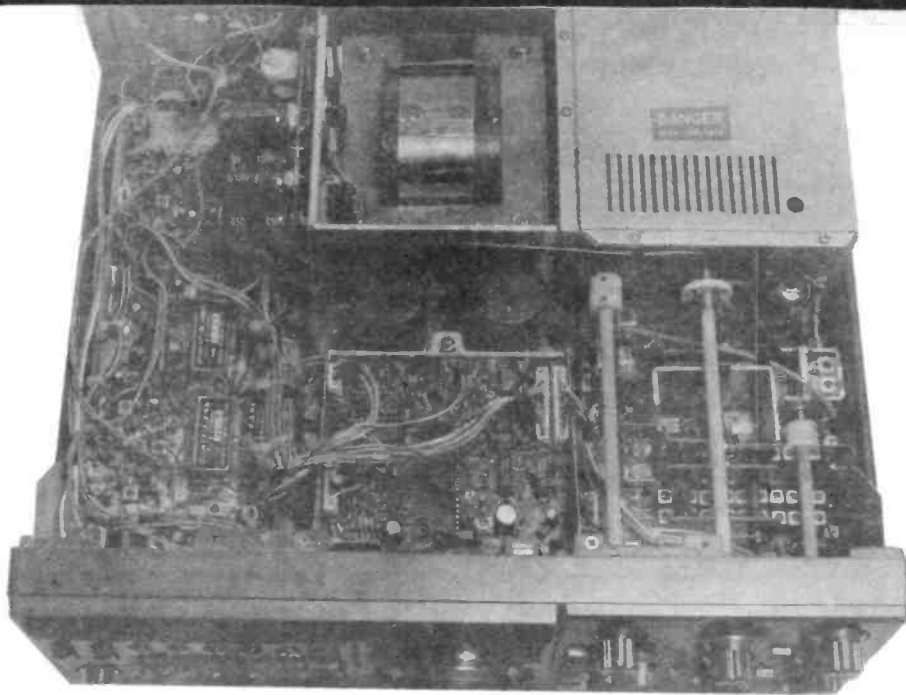

If it were not for the "DANGER" sign warning you to keep your fingers out of the valve PA compartment, you could be forgiven for thinking that the FT102 is all transistor. It is clear from our tests that the set outperforms nearly all competing solid state gear. Thermionic emission is far from dead

G5RV, together with an HQ-1, and a Transmatch type ATU. There was infrequent need for the RF amplifier to be in circuit, as adequate sensitivity was obtained at all times, on 28MHz, with little evidence of cross modulation or other nasties. There are a number of spuri — with a double conversion system and many oscillators this is not surprising. Ten were found across the tuning range, constant in frequency on each band, but varying in strength. None

were strong enough to move the S-Meter, or particularly troublesome, and generally only noticeable on 28MHz when the band was quite.

Audio output was more than adequate, with an effective AGC system, no 'pumping' observed, although very slight peak distortion was apparent at even moderate volume levels.

Both the AM and FM facilities were fitted, although the former was not used on transmit. AM receive on

DYNAMIC RANGE AS CALCULATED FROM TEST 7	1.9MHz	73dB
DYNAMIC RANGE AS CALCULATED FROM TEST 7	3.7MHz	71dB
DYNAMIC RANGE AS CALCULATED FROM TEST 7	7.05MHz	74dB
DYNAMIC RANGE AS CALCULATED FROM TEST 7	10.1MHz	76dB
DYNAMIC RANGE AS CALCULATED FROM TEST 7	14.2MHz	77dB
DYNAMIC RANGE AS CALCULATED FROM TEST 7	18.1MHz	75dB
DYNAMIC RANGE AS CALCULATED FROM TEST 7	21.2MHz	73dB
DYNAMIC RANGE AS CALCULATED FROM TEST 7	24.5MHz	56dB

Note: Test 7 at 28.5MHz not possible

broadcast stations gave perfectly acceptable quality, and although the width facility is disabled on AM, the shift can still be used to good effect. Likewise the FM Discriminator is efficient with an effective 'soft' squelch. Both the activities just below 28MHz, and those on 2M using a converter were monitored without any problem.

Turning to transmit, no problems were found in loading the rig into any of the antenna systems, although the SWR needed to be kept low for optimum results. A few people related stories of FT-102's being returned due to parasitics on some of the new bands, but no such problems were encountered. DC power output approaching 200W was possible, but generally around 100W p.e.p. output was used as recommended by the handbook. The microphone eventually supplied was a Yaesu MH-1B8.

Complimentary reports were received on SSB from many stations, with most activity directed at the States on 15 and 10 metres. The processor appeared optimum set at an indicated 10dB, with higher levels causing some degradation of quality. The reviewer is not a fan of VOX, but this appeared to work satisfactorily, with quiet operation of the change over relays. The anti-vox setting caused a few problems, as there did not seem, to be a point at which this could be set so that it functioned correctly, while allowing actuation again if a strong signal had appeared during the receive period.

The monitor facility was used but the reproduced audio was very poor, sounding as though the mixer had incorrect injection levels.

On cw, the lack of specific CW filters did not provide particularly startling results, but the selectivity is probably adequate for run-of-the-mill contacts, without too much competition around. The Audio Peak Filter helped a lot without too much ringing. Anyone contemplating serious SW work would need one of the optional filters which should have better selectivity characteristics than that perceived listening to the narrowed bandwidth of the SSB filter. On transmit, no adverse reports were received, the usual semi-break-in system via the VOX being provided, with sidetone via the monitor function.

As with nearly all transceivers

TEST RESULTS ON YAESU FT-102 HF TRANSCEIVER

RECEIVE MODE: all receive tests carried out at the following frequencies unless otherwise stated:-

a. 1.9MHz b. 3.7MHz c. 7.05MHz d. 10.1MHz e. 14.2MHz f. 18.1MHz g. 21.2MHz h. 24.5MHz i. 28.5MHz

1) Test dial calibration against CW tone

The test dial will only display to an accuracy of 100Hz and it is possible to change the audio note by up to 100Hz without any visible change on the front panel frequency indication.
All test frequencies were accurate within 100Hz of display.

2) Set generator level for 12dB s + n to n: record level of CW tone at each point with equipment set for USB reception

a. 2uV b. 2uV c. 2uV d. 2.5uV e. 2uV f. 2.8uV g. 3.2uV h. 2.5uV i. 2.3uV
FOR 12dB S+N:N RF AMP OFF VOLTAGES MEASURED AS EMF

3) With equipment set for CW reception (minimum bandwidth) repeat test 2 at 14.2MHz only

14.2MHz CW 1.3uV EMF

4) Couple two generators through a combiner: adjust one for 12dB s + n to n at each test point (equipment set for USB reception): tune second CW generator to f + 50kHz: increase level of this generator until SINAD is degraded by 1dB: record level of both generators

a. 2.35uV/80mV b. 2.5uV/80mV c. 2.5uV/80mV d. 3.2uV/90mV e. 2.5uV/110mV f. 3.2uV/70mV g. 3.2uV/100mV h. 2.5uV/25mV
RF AMP off AGC off Generator levels measured as EMF. See table for dB dynamic range conversion

5) Repeat test 4 at 14.2MHz with equipment set to receive CW at minimum bandwidth

14.2MHz CW 1.25uV EMF/90mV EMF at F+50kHz

6) Repeat test 4 (equipment set for USB reception) with the noise blanking system functional: record results at 14.2 and 21.2MHz only

14.2MHz dial indication: no blanking 2uV/100mV; 50% blanking 2uV/125mV; 100% blanking 2uV/80mV
21.2MHz dial indication: no blanking 3.2uV/100mV; 50% blanking 3.2uV/90mV; no blanking 3.2uV/80mV

7) Repeat test 4 with second generator set for f + 6kHz: record level of both generators

a. 2uV/9mV b. 2.2uV/8mV c. 2uV/11mV d. 2uV/14mV e. 1.4uV/10mV f. 1.4uV/8mV g. 2uV/10mV h. 1.6uV/1.1mV Generator levels measured as EMF. See table for dB conversion

8) Set equipment to 14.2MHz: slowly sweep a 50mV EMF signal from 450kHz to 30MHz: record any unscheduled responses

Receiver section tuned to 14.2MHz: unscheduled responses occurred at 18.1, 15.7, 15.3, 15.1, 14.7, 13.7, 12.7, 8.2, 7.2, 4.75, 4.1, 2.84, 2.37, 2.04, 1.58, 1.42, 1.29, 1.19, 1.09, 0.95, 0.83, 0.75, 0.675, 0.615 MHz. All generator harmonics discounted

TRANSMIT MODE: all tests to be carried out at the frequency points a to i unless otherwise stated, 50ohm dummy load.

9) Set equipment to transmit on SSB (USB): connect two-tone generator to microphone input and increase the level of both equal tones until the observed PEP output level reaches 100W. Record third and fifth order intermod products for each point

Tests 9, 10 and 11 see plots.

10) As for test 11 but back off the input level at each frequency point to produce half (-6dB power, -3dB voltage) the previous output power: record third and fifth order intermodulation products

11) As for test 9 but repeat with single tone (CW); record result

12) Set equipment to 3.7MHz: record level of 2nd, 3rd, 4th and 5th harmonic products at maximum single tone output

Test 12 plot (harmonic output spectrum at 3.7MHz) on previous page

13) Check for satisfactory operation into 3:1 VSWR at 28.5MHz, maximum single tone output level

Satisfactory

Our observations

- 1) This is the problem of using digital readout for what is basically an analogue function. It should prevent no problem in normal circumstances though.
 - 2) The sensitivity of the FT-102 receiver section is sufficient in that you would probably not need to use the RF pre-amp function available with this set.
 - 3) The receiver sensitivity in the CW mode was measured only at 14.2MHz. The result is satisfactory and in accordance with the reduced bandwidth required for CW.
 - 4) The figure shown here and in Table 1 indicated the strong signal performance of the FT-102. The test simulated with the ability to copy a weak SSB signal in the presence of strong signals on a nearby frequency. Although the results are satisfactory by the standards of most HF amateur radio gear, they fall short of the manufacturer's claim for more than 100dB dynamic range. The results we obtained were a little over 90dB at best. Furthermore, the strong signal performance appears to fall off on the two highest bands. It must be said that the precise measuring technique affects the results obtained, particularly the frequency difference separating the two signals. Our yardstick of 50kHz is perhaps more stringent than Yaesu's. However, we feel it reflects better the conditions likely to be encountered on, say, the 40m band at night.
 - 5) Strong signal performance on CW, 14.2MHz only. Very good, but still not the 100dB claimed by Yaesu.
 - 6) Given the effectiveness of the noise blanking system in practice, the lack of degradation in dynamic range is outstanding. Highest possible marks. Curious though as to why the 50% setting on 14.2MHz should actually improve the dynamic range of the receiver.
 - 7) This test simulates the adjacent channel performance: how much a strong neighbouring signal will interfere with the reception of a weak one. The results are satisfactory but not outstanding. However, the shift/width IF system would considerably enhance the performance in a real life situation.
 - 8) This test shows the receiver's sensitivity to transmissions which it isn't actually tuned to. As can be seen from the results the receiver would be liable to interference from a wide range of off-frequency signals. We suspect that these responses are a direct result of the large number of control loops in the digital VCO. However the typical ATU/aerial system would attenuate off-frequency signals well below the level simulated in this test. But even so . . .
- 9,10,11) Every aspect of transmitter operation was outstandingly good. The measured intermod levels (see graphs) had more in common with professional than amateur equipment standards. Excellent.

OUR CONCLUSIONS

While the FT102 in transmit mode is outstandingly good, the receiver section doesn't really match up. If it hadn't been for the publicity blurb with which Yaesu decided to launch the transceiver, then we probably would not have been so critical. However, we did find some rough edges in the receiver having gone out of our way to look. In fairness, Tony Bailey G3WPO, our practical reviewer, experienced no difficulties in practice save for a receive sprog in the 10m band. In all, I would be very happy if I owned one.

G4JST

designed primarily for SSB, the CW operator has to make do with the facilities provided, or build something specifically aimed at the mode. However, the FT-102 is no worse in this respect than any other transceiver of its type and will give perfectly satisfactory results in this mode.

Summary

Reviewing a rig is like reviewing a car — one reviewer will swear by it, another will swear at it, with personal preference showing through at times (you will have guessed that I like CW). What may be a bad or good point with one person could be totally irrelevant to another. Bear in mind that you can find something wrong with virtually anything, especially if you are looking for it, and such comments have to be taken in context. The fact that, for instance, a receiver has a horrible sproggle on 28.056MHz that bends the S-Meter against the end stop (not the FT-102 I hasten to add) may be indicative of bad design in various areas, but it becomes unimportant if you never use CW or 10 metres itself.

The major question to ask is "Does it provide what I want for the money?"

From an overall viewpoint, the FT-102 is a pleasant rig to use, and impressive to look at, with no major problems apparent and has the benefit of extensive signal processing available on receive. With options fitted, the transceiver should be very useful to the HF and transverting VHF operator, with sensible extra facilities taking the place of some of the more less-used and exotic features found in this price range. The completely controllable power output was liked, and essential with the varying licence restrictions for the new bands. If additional features are required, they can be obtained with the FV-102 remote VFO, which offers scanning and memory facilities, together with split frequency operation.

The valve PA should withstand abuse and will be an advantage for those wary of solid state equivalents — certainly it could not be faulted on quality of the transmitted signal. With some shopping around, it should be possible to obtain the FT-102 for around £700, at which it represents good value at its position in the market.

MICRO CHOICE

YOUR COMPUTER BUYER'S GUIDE

... should be the first choice of magazine for anyone contemplating the purchase of a microcomputer, whether as a first time user or as an existing owner wishing to upgrade.

In this special publication, we take a look at the art of choosing a micro or printer, as well as letting our reviewers loose on the top machines in the market. You'll find reviews of the latest microcomputer systems such as the ACT Sirius 1, Apple III, BBC Micro, Commodore 64 and ZX Spectrum, and we'll also be taking a look at some of the old favourites such as the Apple II,

On Sale At Your Local Newsagent
From December 3rd
Priced £1.75

VIC-20 and TI-99/4A, to see how they fare in the modern marketplace. In addition, you'll find up-to-the-minute reviews of various printers.

If you're at all confused by the wide range of microcomputer systems available, you'll need Micro Choice — the magazine that helps you make the right choice!

MICRO CHOICE ORDER FORM

Please send me copy(ies) of
Micro Choice.

Cut out and SEND TO:

513 LONDON ROAD,
THORNTON HEATH,
SURREY,
CR4 6AR.

*I am enclosing my (delete as necessary)
cheque/Postal Order/International Money
Order for £.....
(made payable to ASP Ltd)*

OR

*Debit my Access/Barclaycard *
(*delete as necessary)*



--	--	--	--	--	--	--	--	--	--	--	--	--	--	--

Please use BLOCK CAPITALS and include post codes.

NAME (Mr/Mrs/Miss)

ADDRESS

.....

..... POSTCODE

Signature

Date

HFRIG GUIDE

An at-a-glance guide to specifications and prices for as many HF sets as we could find. It also offers a yardstick for assessing the value of secondhand equipment. However, as with used cars, the correct valuation depends on the condition of the item. *Caveat emptor* — let the buyer beware!

We would be pleased to hear from anyone who could add to our pool of information a VHF/ UHF guide will follow shortly

The Key

The key is given in full here, up dates will carry a shortened version.

TYPE	TC = transceiver. M = Mobile. B = Base.	DYN	is the RX dynamic IMD range, where known (i.e. from reviews or manufacturers data).	VOX	may of course be added. Q = optional extra (to fit inside rig).	A DIAL	indicates Analogue Dial. Y = fitted. N = not available. O = optional extra.
AC	Y = runs off AC mains. N = will not run from AC mains.	IF's	are the number of i.f stages.	PA	Y = fitted. N = not available. O = option.	D DIAL	indicates Digital Frequency Readout (as analogue key).
DC	Y = runs from 12v direct. N = will not run from 12v. O = in both cases that an optional supply is needed.	NB	shows whether any noise blanker or limiter is fitted. N = Not available. NL = Noise limiter fitted. NB = Noise Blanker fitted. VW = Variable Width Noise blanker fitted (best for anti-Woodpecker). O = Optional extra only.	P INPUT	is the manufacturers rated PEP input on SSB.	MEM	Indicates memory facility, N = not available. O = Option. 6 = 6 memories.
BANDS	Figures represent metres X = No WARC bands covered. O = Some bands optional (usually 160M, or some of 10M). In the case of rigs marketed from 1979 on, early versions may not have had the WARC bands fitted, and this is also indicated by O. P = Only part of 10M covered.	IF SHIFT	Y = fitted. N = not available. O = option.	P OUTPUT	is the stated PEP output or measured (where known).	SPLIT	indicates whether split frequency operation is possible. Y = fitted. N = not possible. O = option (often optional via external VFO).
MODES	S = SSB. A = AM. C = CW. F = FM. K = FSK. Letter in lower case = option.	IF WIDTH	Y = fitted. N = not available. O = option.	CW	indicates the CW keying method. S = semi-break in via VOX system or manual switch. F = Full listen through facilities.	QRP	Y = low power output. N = not possible. V = continuously variable power output (other than by detuning!).
RF	TS = semiconductor. FE = FET. V = Valve. PW = Power semiconductor.	SCAN	Y = fitted. N = not available. O = option (often external). O = additional filters available as option. N = No extra filters possible.	VFO	indicates the VFO type. FRE = Free running VFO. PLL = Phase locked type but continuous tuning. SYN = Synthesised VFO with discrete steps. MPU = Microprocessor controlled with extra facilities. XTL = Crystal controlled.	YEAR	is the year of introduction.
		F OPTION	RF = RF processor fitted. AF = AF processor fitted. N = not available (except external one			£ NEW	is a lowish price for that year.
		PROCESSOR				£ S/HAND	is the current average secondhand price (private sale).
						COMMENTS	any other useful info available.

As another first for the magazine, we would like to introduce the first of our regular guides to the Commercial equipment market. You could equate it to Glass's Guide to cars, and it is intended to serve the same purpose.

Since the origins of the commercial transceiver around the late 60's, there have been a vast number of rigs brought to the market place, most of which you have probably

forgotten existed. Our guide is intended to cover as many rigs as can be found, from all the major manufacturers who have sold in the UK. The main facilities offered are covered, trying to select those of most importance to the average operator, together with their dates of introduction, price during the first year of sale, and the latest secondhand price that has been found, culled from the various For

Sale columns of the magazines.

As you may guess, it was a major task to set up this first review, and many hours going through magazines and literature were involved. Some of the facts and figures are difficult to come by 10 years or more after introduction, so there are bound to be a number of errors and omissions at present. Any readers spotting errors, or who are able to furnish further information, are in-

	TYPE	AC	DC	BANDS	MODES	RF	DYNAMIC RANGE	IF's	NB	IF SHIFT	VARIABLE IF	SCAN	F OPTON	PROCESSOR	VOX	PA	P INPUT	P OUTPUT	CW	VFO	A DIAL	D DIAL	ITEM	SPLIT	ORP	YEAR	£ NEW	£ SHAND	COMMENTS
HEATHKIT																													
HW7	BTC	O	Y	40-15 X	C	TS			N	N	N	N	N	N	N	TS		2	S	FRE	Y	N	N	N	Y	70	35		QRP KIT D/C RX
HW8	BTC	O	Y	80-15 X	C	FE			N	N	N	N	N	N	N	TS		2	S	FRE	Y	N	N	N	Y	75	95		QRP KIT D/C RX
HW12A	MTC	O	O	80	S	V			N	N	N	N	N	N	N	2V	200		N	FRE	Y	N	N	N	N	63	59	60	KIT
HW22A	MTC	O	O	40	S	V			N	N	N	N	N	N	N	2V	200		N	FRE	Y	N	N	N	N	63	62		KIT
HW32A	MTC	O	O	20	S	V			N	N	N	N	N	N	N	2V	200		N	FRE	Y	N	N	N	N	63	62		KIT
HW100	BTC	O	O	80-10 X	SC	V			N	N	N	N	N	N	N	? 2V	180	100	S	FRE	Y	N	N	N	N	68	125		KIT
HW101	BTC	O	O	80-10 X	SC	V			N	N	N	N	N	N	N	Y 2V	180	100	S	FRE	Y	N	N	N	N	72	148	150	KIT
HW104	BTC	O	Y	80-10 X	SC	V			NB	N	N	N	N	N	N	Y BB		100	S	FRE	Y	N	N	N	Y	76			KIT
SB101	BTC	O	O	80-10 X	SC	V			N	N	N	N	N	N	N	Y 2V	180	100	S	FRE	Y	N	N	N	N	67	165		KIT
SB102	BTC	O	O	80-10 X	SC	V			N	N	N	N	N	N	N	Y 2V	180	100	S	FRE	Y	N	N	N	N	70	185		KIT
SB104	BTC	O	Y	80-10 X	SC	TS			D	N	N	N	N	N	N	Y BB		100	S	FRE	Y	Y	N	O	Y	75			KIT
ICOM																													
IC701	BTC	Y	N	ALL X	SC	TS			NB	N	Y	O	N	RF	Y	BB	200	100	S	SYN	N	Y	O	Y	Y	78	899	520	2 VFO's
IC720A	BTC	O	Y	ALL 6R	SCAK	TS		2	NB	Y	N	N	O	RF	Y	BB		100	S	SYN	N	Y	1	Y	V	80	690	600	2 VFO's
IC730	MBTC	O	Y	80-10	SCA	TS	95	2	NB	Y	N	N	O	RF	Y	BB	200	100	S	PLL	N	Y	9	Y	Y	82	586	520	
IC740	BTC	O	Y	ALL	SCAF	TS		2	NB	Y	Y	O	O	RF	Y	BB			S	SYN	Y	Y	9	Y	Y	82	659		Built in keyer
KW																													
ATLANTA	BTC	Y	O	80-10 X	SC	V		2	NL	N	N	N	N	N	O	2V	500		S	FRE	Y	N	N	O	N	69	199		DRIFTS !
KW2000	BTC	Y	O	ALL XP	SC	V		2	N	N	N	N	N	N	Y	1V	90	50	S	FRE	Y	N	N	N	N	63	165	130	200kHz bands
KW2000A	BTC	Y	O	ALL XP	SC	V		2	N	N	N	N	N	N	Y	2V	180	100	S	FRE	Y	N	N	N	N	64	195	165	200kHz bands
KW2000B	BTC	Y	O	ALL XP	SC	V		2	N	N	N	N	N	N	Y	2V	180	100	S	FRE	Y	N	N	O	N	69	264	209	200kHz bands :
KW2000E	BTC	Y	O	ALL X	SC	V		2	N	N	N	N	N	N	Y	2V	180	100	S	FRE	Y	N	N	O	Y	72	265	250	500kHz bands
TRIO																													
TS120S	MBTC	O	Y	80-10 X	SC	TS		1	NB	Y	N	N	N	N	Y	BB	200		S	PLL	Y	Y	N	O	?	79	495	335	
TS120V	MBTC	O	Y	80-10 X	SC	TS		1	NB	Y	N	N	N	N	Y	BB	20		S	PLL	Y	Y	N	O	?	78	408	300	
TS130S	MBTC	O	Y	80-10	SC	TS		1	NB	Y	N	O	O	RF	Y	BB	200		S	PLL	Y	Y	O	O	N	81	491	400	DFC option for
TS130V	MBTC	O	Y	80-10	SC	TS		1	NB	Y	N	O	O	RF	Y	BB	20		S	PLL	Y	Y	O	O	N	81	404	400	130 S/V/ 830.
TS180S	BTC	O	Y	ALL O	SCK	TS		1	NB	Y	N	O	O	RF	Y	BB	200		S	PLL	Y	Y	O	O	N	79	700	520	With DFC £820
TS288A	BTC	Y	Y	80-10 X	SCA	TS			NB	N	N	N	N	Y	Y	2V	180		S	FRE	Y	N	N	O	N	74	310		also CB channels
TS500	BTC	O	O	80-10 X	SCA	V		2	N	N	N	N	N	Y	Y	2V	200		S	FRE	Y	N	N	O	N	68	203		
TS510	BTC	O	O	80-10 X	SC				N	N	N	N	N	Y	Y	2V	180		S	FRE	Y	N	N	O	N	69	180		
TS520	BTC	Y	O	80-10 X	SC				NB	N	N	N	O	RF	Y	2V	200		S	FRE	Y	N	N	O	Y	74	340	340	
TS520S	BTC	Y	O	ALL X	SC				NB	N	N	N	O	RF	Y	2V	200		S	FRE	Y	N	N	O	Y	77	437	340	
TS530S	BTC	Y	N	ALL O	SC			1	NB	Y	N	N	O	RF	Y	2V		100		PLL	Y	Y	O	O	V	80	535	475	Mod TX for WARC
TS820	BTC	Y	O	ALL X	SCK				NB	Y	N	N	O	RF	Y	2V	200	100	S	PLL	Y	N	O	O	V	76	710	425	
TS820S	BTC	Y	O	ALL X	SCK				NB	Y	?	M	O	RF	Y	2V	200	100	S	PLL	Y	Y	O	O	V	77	832	425	
TS830S	BTC	Y	O	ALL	SC	FE	90	2	NB	Y	Y	N	O	RF	Y	2V	220	100	S	PLL	Y	Y	O	O	V	80	640	580	
TS900	BTC	Y	O	80-10 X	SCAK	FE			NB	N	N	N	O	N	Y	2V	300		S	FRE	Y	N	N	O	N	73	530	250	
TS930S	BTC	Y	N	ALL 6CR	SCAK	FE		4	VW	Y	Y	N	N	RF	Y	BB	250		FS	PLL	Y	Y	8	Y	Y	82	1080	N/A	2 VFO'S

vited to write and let us know. A number of rigs are missing, purely due to lack of information, as are some of the manufacturers, such as Drake and Swan, but these will be added later. Experts on the FT101 series are especially asked to provide information that may be missing or incorrect.

Concerning prices, bear in mind that with the introduction of VAT, inflation during the transceivers

lifetime, and price cutting, a typical figure for any rig is often difficult to give. Hence the price shown is during the first year of life, and towards to lower end of the range found. This can result in the secondhand price being greater than the original, or a variation in a series being adrift on price. Also bear in mind that s/hand prices may include some options which will affect the price quoted.

There should be enough information to enable you to judge the facilities of a secondhand transceiver, or price the model you are wanting to sell.

The guide will be updated regularly, and others will follow, the next being 2M transceivers (excluding handhelds), using slightly different headings to take account of the operational differences between HF and VHF.

	TYPE	AC	DC	BANDS	MODES	RF	DYNAMIC RANGE	IFs	NB	IF SHIFT	VARIABLE IF	SCAN	F OPTION	PROCESSOR	VOX	PA	P INPUT	P OUTPUT	CW	VFO	A DIAL	D DIAL	ITEM	SPLIT	ORP	YEAR	£ NEW	£ SHAND	COMMENTS	
YAESU / SOMMERKAMP																														
FT7	MTC	O	Y	80-10 X	SC	FE		1	NB	N	N	N	N	N	N	N	BB	10		FRE	Y	N	N		N	78	335	250	Also xtals.	
FT7B	MTC	O	Y	80-10 X	SCA	FE		1	NB	N	N	N	N	N	N	N	BB	50		FRE	Y	O	N		N	79	400			
FT75	MTC	O	O	80-10 X	SC	TS			NB	N	N	N	O	O	1V		50	30		XTL	N	N	N	O	Y	72	150	125	VXD control	
FT75B	MTC	O	O	80-10 X	SC				NB	N	N	N	O	O	2V		120	60		XTL	N	N	N	O	Y	75	175		VXD control	
FT ONE	BTC	Y	Y	ALL	GCR	SCAFK	PW	>95	2	VW	Y	Y	O	RF	Y	BB	100	F	MPU	Y	Y	10	Y	Y	81	1295	N/A	Built in keyer		
FT100	MBTC	Y	Y	80-10XP	SC	TS		2	NL	N	N	N	N	N	N	N	2V	150	S	FRE	Y	N	N	O	N	66	200			
FT101	BTC	Y	Y	80-10 X	SCA	TS		1	NB	N	N	N	O	N	Y	2V	260	S	FRE	Y	N	N	O	Y	71	229	195	160M Option & MK2		
FT101B	BTC	Y	Y	ALL	X	SCA	TS	1	NB	N	N	N	O	N	Y	2V	260	S	FRE	Y	N	N	O	Y	73	360	325	Same as FT277B		
FT101E	BTC	Y	Y	ALL	X	SCA	TS	1	NB	N	N	N	O	RF	Y	2V	260	S	FRE	Y	N	N	O	Y	75	500	325			
FT101EE	BTC	Y	Y	ALL	X	SCA	TS	1	NB	N	N	N	O	O	Y	2V	260	S	FRE	Y	N	N	O	Y	75	470	340	No processor		
FT101EX	BTC	Y	O	80-10 X	SCA	TS		1	O	N	N	N	O	O	Y	2V	260	S	FRE	Y	N	N	O	Y	75	410		Bare bones only		
FT101Z	BTC	Y	O	ALL	O	SCA	FE	83	1	NB	N	Y	O	RF	Y	2V	180	S	PLL	Y	O	O		Y	79	488	425			
FT101ZD	BTC	Y	O	ALL	O	SCA	FE	83	1	NB	N	Y	O	RF	Y	2V	180	S	PLL	Y	Y	O		Y	79	569	465			
FT101ZFM	BTC	Y	O	ALL	O	SCAF	FE	83	1	NB	N	Y	O	RF	Y	2V	180	S	PLL	Y	O	O		Y	79					
FT101ZDFM	BTC	Y	O	ALL	O	SCAF	FE	83	1	NB	N	Y	O	RF	Y	2V	180	S	PLL	Y	Y	O		Y	79		590			
FT102	BTC	Y	N	ALL		SCAf	FE	>100	2	VW	Y	Y	O	RF	Y	3V	200	100	S	PLL	Y	Y	O	O	V	82	700	N/A		
FT107M	BTC	O	Y	ALL		SCAK	FE	90	1	VW	Y	Y	O	RF	Y	BB	240	125	S	PLL	Y	Y	O	Y	V	79	569			
FT150	MBTC	Y	Y	ALL	X	SCA	TS	1	N	N	N	N	O	N	Y	1V	120	S	FRE	Y	N	N	O	N	67	215				
FT200	BTC	O	O	80-10 X	SCA	TS		1	N	N	N	N	O	N	Y	2V	240	S	FRE	Y	N	N	O	N	71	132	200			
FT200B	BTC	Y	O	80-10 X	SCA	TS		1	N	N	N	N	O	N	Y	2V	260	S	FRE	Y	N	N	O	Y	72	236				
FT201	BTC	Y	Y	80-10 X	SCA	TS		1	NB	N	N	N	O	N	Y	2V	260	S	FRE	Y	N	N	O	Y	74	350	250			
FT250	BTC	O	O	80-10 X	SCA	TS		1	NL	N	N	N	O	N	Y	2V	240	S	FRE	Y	N	N	N	Y	68	160	200	4 x xtal also		
FT301	BTC	O	Y	ALL	X	SCAK	TS	75	NB	N	N	N	O	RF	Y	BB	200	100	S	FRE	Y	N	N	O	Y	76	500			
FT301D	BTC	O	Y	ALL	X	SCAK	TS	75	NB	N	N	N	O	RF	Y	BB	200	100	S	FRE	Y	N	N	O	Y	76	600			
FT301S	BTC	O	Y	ALL	X	SCAK	TS	75	NB	N	N	N	O	RF	Y	BB	20	10	S	FRE	Y	N	N	O	Y	76	410			
FT301SD	BTC	O	Y	ALL	X	SCAK	TS	75	NB	N	N	N	O	RF	Y	BB	20	10	S	FRE	Y	Y	N	O	Y	76	480			
FT401	BTC	Y	N	80-10 X	SCa				NB	N	N	N	N	N	Y	2V	560	S	FRE	Y	N	N	O	N	71	200	250			
FT401B	BTC	Y	N	80-10 X	SCA				NB	N	N	N	N	N	Y	2V	560	S	FRE	Y	N	N	O	N	74	307				
FT500	BTC	Y	O	ALL	X	SCA	V	1	N	N	N	N	O	N	Y	2V	500	S	FRE	Y	N	N	O	N	68	250				
FT501	BTC	O	O	80-10 X	SC	V		1	NB	N	N	N	O	N	Y	2V	560	S	FRE	Y	Y	N	O	Y	73	375				
FT560	BTC	Y	O	ALL	X	SCA	V	1	O	N	N	N	O	N	Y	2V	560	S	FRE	Y	N	N	O	N	72	180				
FT707	MBTC	O	Y	80-10	SCA	TS		80	1	NB	N	Y	N	Y	Y	BB	100	S	FRE	Y	Y	N	O	N	80	510				
FT901D	BTC	Y	O	ALL	X	SCAFK	TS	90	1	NB	N	Y	O	RF	Y	2V	180	100	S	PLL	Y	Y	N	O	Y	78	725	645		
FT901DE	BTC	Y	O	ALL	X	SCAK	TS	90	1	NB	N	Y	O	RF	Y	2V	180	100	S	PLL	Y	Y	O	O	Y	78	725			
FT901DM	BTC	Y	Y	ALL	X	SCAFK	TS	90	1	NB	N	Y	O	RF	Y	2V	180	100	S	PLL	Y	Y	1	Y	Y	78	905	550	Curtis keyer inc	
FT902D	BTC	Y	O	ALL	O	SCAFK		1	NB	Y	Y	O	RF	Y	2V	180	100	S	PLL	Y	Y	O	O	Y	80	724				
FT902DE	BTC	Y	O	ALL	O	SCAFK		1	NB	Y	Y	O	RF	Y	2V	180	100	S	PLL	Y	Y	O	O	Y	80	710			Curtis keyer inc	
FT902DM	BTC	Y	O	ALL	O	SCAFK		1	NB	Y	Y	O	RF	Y	2V	180	100	S	PLL	Y	Y	1	Y	Y	80	800	800	Curtis keyer inc		

FT7900

REVIEW

By Tony Bailey G3WPO

**A look at Yaesu's
magnificent UHF
all-rounder**



Actually, 'all-mode' is a slight misnomer — multimode would be more appropriate as the 790R does not provide AM (or FSK). What it does give you is SSB (upper and lower), CW and FM, together with a lot of facilities to help you find the activity on the wide open plains of 70cm.

There are a considerable number of multimode transceivers available for both 2M and 70cm, some portables, others base stations useable mobile, or vice versa. The FT-790R is a little difficult to categorise. It isn't really a true portable rig in the sense that a handheld is, (although it runs similar power to most handhelds) but it was probably designed, as is most likely to be used for this purpose. It isn't really a base station, due to the low power, and the fact that the BNC antenna socket is on the front (nothing on the back although there is a large hole which looks as though it might be intended for an antenna socket).

And it definitely isn't a mobile rig, at least not in the sense that it would be particularly safe to use on the move, unless you weren't going to change frequency. Ever tried reading a small LCD display at night (or in sunlight, despite Yaesu's remarks), or pressing very small keypad buttons on the move?

On the assumption that you can fit it to one of these purposes, most likely as an over the shoulder portable (it comes with suitable straps), then the 790R offers many facilities, especially if you like to keep an ear on the activity around the band.

Power for the rig is derived from 8 internally mounted C size ni-cads or alkaline batteries, or an external DC source, taking 100mA on receive and 750mA on transmit (FM/1W). One word of caution — there is no reverse polarity protection, so watch battery insertion and especially the DC power plug which is wired with the outer conductor as the positive connection. The manual warns that serious damage will result if incorrect polarity is used — there are means of protecting against this without any major voltage drop, and for the sake of a few extra components...

The usual comprehensive Yaesu manual is provided, with full user and alignment instructions, with all test points etc clearly marked on photographs of each of the boards.

Internal construction is typical of the Yaesu style for VHF/UHF rigs, very compact but well engineered. Most of the circuit is on one side of the case and behind the front panel, with the batteries occupying about 75% of the space under the lower cover. Anyone using the rig mainly for portable applications would be well advised to use the optional Ni-cads — dry cells work out very expensive even over a short period of time.

What it does

Control over the frequency and facilities is by the 4-bit microprocessor, with access to the external world via 8 small keypad type buttons, plus two on the microphone, allowing scanning in both directions, either of the main dial or the 10 memories. The only disadvantage of the main dial scan is that you have to scan the whole frequency coverage i.e. 430-440MHz, and it would have been nice to be able to select just a 1MHz scan window — there isn't usually much to be seen above 435MHz, and normal activity is centred around two specific areas. The step rate is governed by one of the selector keys, either 100Hz/1kHz or 25kHz/100kHz for SSB/CW and FM respectively. Frequency selection is by either the main photo-chopper dial, using either of 2 keypad selectable VFO's, or by scanning, using the up/down buttons on the microphone supplied.

While in the scan mode, you have the choice, by means of a slide switch inside the case (cover easily

removed), of stopping on busy or clear channels, or a manual stop. When scanning is halted by a signal, the channel will be monitored for 5 seconds, after which the scan is resumed until the next signal is found.

Priorities & memories

An alternative 'priority channel' scan is also allowed in which one of the memory channels is selected as a priority channel. Assuming the main dial is then selected, the memory channel will be checked every 5 seconds for activity — if a signal is found then the receiver stops on the memory channel.

The memories themselves are easily loaded with any frequencies within the tuning range — the dial is set to the required frequency and then programmed into one of the 10 channels by depression of a single button. This is a very useful facility on 70cm where you can spend most of the evening tuning around looking for stations. By memorising say, the local repeaters, calling frequencies (both FM & SSB) and some of the simplex channels most activity will be caught.

Also, a memory back-up is provided so none of the channels will be lost when the rig is switched off — this applies also to the 2 VFO's, both of which return to their last used frequencies when switched back on. The back-up lithium battery cell comes with the rig, but with

this facility de-selected on the internal switch.

Full repeater facilities are offered, with both + and 1.6MHz shifts (or other splits by use of the memories), together with a tone burst, controlled by one of the keypad buttons, OK for portable and fixed use, but not very sensible for mobile, although most 70cm repeaters whistle up easily enough.

One useful addition is a Clarifier control (or IRT if you like). Depression of a keypad button shows 'CLAR' on the display, and the receive frequency may be altered, to a maximum of 10kHz, in steps of 100Hz by the main tuning knob or the microphone buttons. This functions in all modes with the same step rate.

The rear apron of the rig has a few more switches. Battery check, lamp for S-Meter/backlit LCD display, and noise blanker options can be activated, together with low power (0.2W) output, if you really want to conserve the batteries. External power (3.5mm) and charge (2.5mm) jack sockets for the optional ni-cads, an external DC socket, and the case lock latch complete the line-up.

On the left side are two additional jacks (both 3.5mm), one for an external PTT (foot switch sug-

It's a bit large and heavy for a handtalkie, and a bit awkward to use as a mobile. However, it offers excellent performance and would make a sound basis for a 70cm station as the prime mover



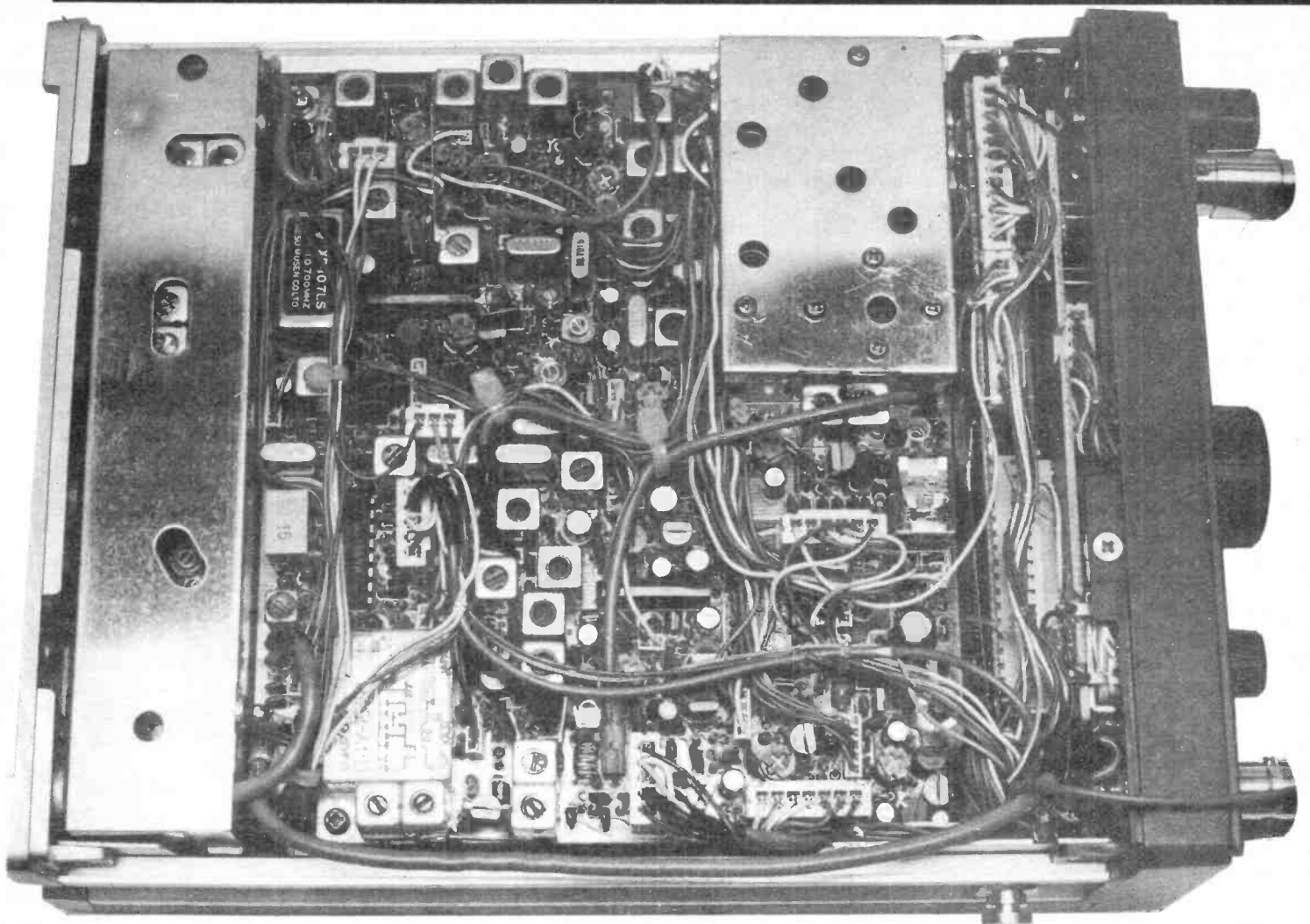

gested — ?) the other for external speaker (8 ohm).

Delving inside the case, in addition to the scan halt control switch, we find further switches for the tone squelch option, the memory backup, and an audio speech compressor for both SSB and FM. The manual states that when the latter is used the "average power in the SSB mode will be increased with some loss of fidelity" — a strange admission for a manual! It didn't in fact seem to make a great deal of difference so was left on during the review period.

A 1/2 wavelength (13" actual) rubber ducky came with the rig, and certainly put out a useful signal.

A small S-Meter cum Battery check/power output is provided on the front panel. The only point worth noting is that the S-Meter has an extremely long time constant compared with most.

The Circuit

The receiver circuit is fairly conventional, with double or triple con-

With so much crammed into a small space it has the appearance of a serviceman's nightmare.

version, depending on the mode. The input is well protected against out of band signals by a low-pass filter, and 2 helical resonators, one each side of the RF amplifier. After conversion to the first i.f. of 67.3MHz, bandpass filtering follows, then conversion to the 10.7MHz 2nd i.f. A matched pair of 30kHz bandwidth monolithic crystal roofing filters, between which a signal sample is taken for the noise blanker, follows, finally routing the signal to one of two i.f. amplifiers, dependant on the mode in use.

The noise blanker uses an amplified signal from between the two filters, which is rectified and used to switch off both the alternative i.f. amplifiers for the duration of the noise pulse. A portion of the amplified noise is also rectified and used as blanker agc.

The first local oscillator is derived from a VCO running at

approximately 120.9-124.2MHz, which is then tripled and filtered, prior to mixing with the incoming signal. The same VCO is used at its fundamental frequency in a PLL mixer, also fed with a 119.225MHz signal from a crystal oscillator. The output from this mixer at 1.666-4.997MHz is fed to a programmable divider, instructed by a 4-bit control unit, which looks after the various options discussed earlier, and the output compared with a 4.266MHz reference signal (this reference oscillator, the divider, latch and phase detector are all in one chip). Any phase difference is used to control a varactor diode which shifts the VCO to correct the phase difference. In case the phase difference exceeds the control range, an unlock signal is generated which biases off both the receive and transmit circuits.

FM signals undergo a third conversion to 455kHz in a ubiquitous MC3357 chip, then final selectivity via an LFH-15S ceramic filter (15kHz @ -6dB), before limiting amplification and detection via the

3357 again. The squelch facilities of the same chip are used, both for the audio squelch and also the scan interrupt function.

SSB and CW signals are processed at 10.7MHz by a crystal filter (2.4kHz @ -6dB), amplified and then demodulated via an i.c. product detector, before audio amplification and shaping. AGC is derived by diode detectors, and used to control gate 2 of the i.f. Mosfet amplifiers, as well as the S-Meter indication.

To transmit

On transmit, the input mic amplifier is also used as the speech compressor when required, the output filtered for AF shaping, before routing via bipolar switches to the FM or SSB generating circuits.

For SSB, the conventional balanced modulator/filter method is used, routing through the same filter as for SSB receive. An ALC controlled amplifier follows, then mixing using balanced FET's up to 67.3MHz. After bandpass filtering and buffering, conversion to final frequency follows, where a power output of 1 watt pep is obtainable from the driver/amplifier. Before reaching the antenna, two low-pass filters are used to aid harmonic suppression (quoted at better than -50dB).

FM is generated by means of a varactor diode modulating the same oscillator used for SSB conversion to 67.3MHz, otherwise the circuit is the same as for SSB. A toneburst is

available using a crystal controlled oscillator (7.168MHz divided by 4096).

CW mode utilises the PLL unlock signal as a keying control, with carrier injection from the 10.7MHz USB oscillator, with the audio circuits inhibited.

On the air

During the review period, the FT-790R was used mainly as a base station, with some portable and (warily) mobile operation. The supplied antenna was used for portable and also mobile, and a colinear and Multibeam for base operation.

As a portable rig, the unit performed admirably well, especially from the mountain tops known locally as the South Downs. Received reports were good, with little objection to the speech compressor when in use. Another 790R at the other end of a QSO used the compressor with little audible degradation at fairly good signal strengths.

One interesting phenomena was that received signals were apparently better, in both recovered audio and S-Meter reading, on FM than SSB, when the other station was using comparable power in both modes. The manual quotes similar sensitivities for both so it may be that the review sample had appreciably better FM sensitivity, otherwise all we have learnt about the advantages of SSB over other modes needs amending!

Mobile operation, bearing in

mind the difficulties mentioned earlier, was satisfactory with the low power output. Those who haven't used 70cm mobile may be pleasantly surprised at the results obtainable. One of the more noticeable effects is that generally, signals either tend to be there or not there with little in between. Most areas have effective 70cm repeaters available which extend the mobile coverage considerably. The noise blanker is reasonably efficient at removing much mobile interference, considering it is non-adjustable.

As a base station, there is little to comment on, other than the front mounted antenna socket! The scanning facility is more than useful when activity is low, as is the priority function if you are listening to a QSO but want to keep an ear on another channel. Nobody could be found to try out the CW function unfortunately, otherwise the rig performed satisfactorily.

One useful tip — if you use both SSB and FM, keep one of the VFO's around 433.5MHz, and the other at 432.3MHz. This saves a lot of time if you change modes, as to move down the band rapidly you need to either do a lot of knob turning, or wait while the scan gets there, or stay in FM mode to get to the SSB portion as otherwise moving 1MHz in 1kHz steps takes an eternity.

Summary

The FT-790R is a compact and useful transceiver, and could be used quite adequately for any of its intended roles. As a mobile rig, it is less than ideal due to the LCD display, and panel mount tone burst button. However, control over the frequency can be via the microphone controls, leaving one free to concentrate on the driving, providing the LCD display is easily visible — this may be difficult in a lot of vehicles. At a price of around £325, it is approximately £50 more expensive than its 2M counterpart.

The writer has been told that some of the models around have had the front ends modified by some suppliers and that the modification causes a number of problems both on transmit and receive. No further information is available but this may be worth checking on before purchasing.

The review sample was supplied by Amateur Radio Exchange of Ealing. Price £325.

YAESU FT-790R

MEASURED SENSITIVITY IN RECEIVE MODE

Generator level for 12dB SINAD
FM mode 430MHz: 0.1 microvolt

Generator level for 12dB SINAD
FM mode 434MHz: 0.1 microvolt

Generator level for 12dB SINAD
FM mode 439MHz: 0.12 microvolt

Generator level for 12dB SINAD
SSB mode (USB) 432MHz: 0.1 microvolt

Note: Voltage measured as EMF

NEXT MONTH

electronics today

INTERNATIONAL

THE ETI ORGAN

Here's a major project for all you budding musicians — a two-manual and bass pedals organ. This design has a single main board that does all the usual organ stuff and also includes a very realistic-sounding multi-voice rhythm module. Sounds expensive, doesn't it? Wrong. The start-up kit to build one keyboard will cost less than £100, while a full kit (excluding cabinet) will be available for under £300. A fully-built version will also be available, still at well under the price of organs with an equivalent performance.

ZX81 ENHANCEMENT

Here's a very cheap little project for anyone who owns a ZX81 and sometimes feels like breaking it by hitting it with the cassette recorder. Yes, we've got details on how you can solve all the legendary problems this computer has with SAVEing programs, and very cheap it is too!

LOGIC PROBE

Not another logic probe? Yes, here's one that's a little more complex than before, which will give you an indication of pulse presence and polarity besides the usual high and low indications.

CRYOGENIC COMPUTERS

Do you get cold feet when you think about electronics? IBM's design engineers took it a stage further, and next month we'll be telling you what they're up to.

DESIGN COMPETITION

There's one group of people who'll be camping outside the newsagents next month: the ones who entered our Design competition. The next issue will reveal the name of the person who won the £100 prize for the best design based on free PCB we gave away with the October issue. We've also decided to publish one or two runners-up.

**LOOK OUT FOR THE
FEBRUARY ISSUE ON
SALE 7th JANUARY**

Articles described here are in an advanced state of preparation. However, circumstances may dictate changes to the final contents.

SUBSCRIPTION ORDER FORM

Cut out and SEND TO :
Electronics Today International,
513, LONDON ROAD,
THORNTON HEATH,
SURREY,
ENGLAND.

Please commence my personal subscription to Electronics Today International with the issue.

SUBSCRIPTION RATES

(tick as appropriate)

- £13.15 for 12 issues
- UK
- £16.95 for 12 issues
- overseas surface
- £36.95 for 12 issues
- Air Mail

I am enclosing my (delete as necessary)
Cheque/Postal Order/International Money
Order for



£



(made payable to A.S.P. Ltd)
OR

Debit my Access/Barclaycard*
(*delete as necessary)

.....

Please use BLOCK CAPITALS and include post codes.

Name (Mr/Mrs/Miss)

Address

.....

.....

Signature

Date



SUBSCRIPTIONS

The magazine you hold in your hand is the biggest seller in the UK electronics field. Why risk your newsagent running out? Take out a subscription using the form provided, and make sure of getting the next 12 issues. Don't you deserve not to miss out on the best?

The Amcomm Hotline.

**Call 01-422 9585 3 Lines now
for fast delivery!**



ICOM 290E
2 mtr. all mode tcvr.
Phone for Price.



YAESU FT1 Gen. Cov.
Tcvr. Call now for ex stock
fast delivery.



YAESU FT102 9 Band
Tcvr. Call before 2pm for
price and you'll have it next
day.



**YAESU FT290R/
FT790R.** Waiting for you
with free Nicads and Charger



ICOM 720A Gen. Cov.
Tcvr. Call us and we'll
put a smile on your face.

THE NEW YAESU FT980 TRANSCEIVER



Can you afford to buy anything
else! Write or call 01-422 9585
(3 lines) for price, specification
and leaflet.

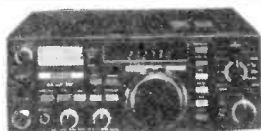

ICOM 730 8 Band Tcvr.
Leading H.F. Mobile. Call
01-422 9585 for quote

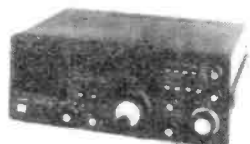

YAESU FRG7700.
Still with free antenna tuner -
call fast - we'll deliver fast.



ICOM IC-R70 Rcvr.
Call us and we'll
deliver free and include an
antenna coupler.



**YAESU FT480R All
mode 2m tcvr.** YAESU's
big success. Call us now
to make it yours.



**ICOM 251E 2 mtr all
mode base.** We can't get
enough - call now and try us
for price and delivery.

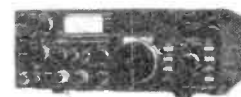

ICOM 740 WARC Tcvr.
A host of features at a real
competitive price - call now.



TONO 7000E/9000E.
We just need your call and
it's on the way.

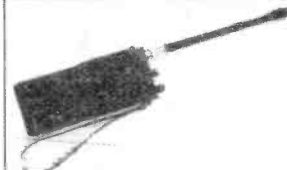

ICOM Twins IC4E/1C2E
Both ex stock. Call us now.



**YAESU's Handheld
Twin FT708 and FT208**

E&OE



Amcomm Services,
194, Northolt Road, South Harrow,
Middlesex HA0 2EN.
Telephone: 01-422 9585 (3 lines)
Telex: 24263

OPPOSITE SOUTH HARROW
TUBE STATION ON THE
PICCADILLY LINE

SHOWROOM OPENING HOURS
TUE-FRI 10.00am-6.00pm CONTINUOUS
SAT. 9.00am-5.00pm CONTINUOUS

ASK FOR DETAILS
OF OUR INTEREST FREE AND
LOW DEPOSIT H.P.

We also stock:
DATONG, JAYBEAM, HYGAIN,
MICROWAVE MODULES, TONO AMPS,
TELEREADER, RSGB Publications.
HOKUSHIN, G. WHIP,
TET, TOKYO H.P. LABS
and many more.
ROTORS: CDE, KENPRO, HIRSCHMANN
SKYKING ETC.

EMPORIUM GUIDE

MONTHLY IN HAM RADIO TODAY YOUR OWN 'WHERE TO BUY IT' GUIDE

AVON

Booth Holdings Bath

6 GOLF CLUB LANE, SALT FORD, BRISTOL
Tel: 02217 2402
Open: Tues-Sat 9am - 9pm
Close Mondays

Radio Communications
Amateur P.M.R. Marine
557732
UPINGTON
Tele. Radio & Lab
12-14 Pennywell Road, Bristol BS5 0TJ
YAESU

LANCASHIRE

AERIAL BOOSTERS

Trebles incoming weak signal
B11 - for VHF/FM radio; B45 - for UHF television
Next to the set fitting. SAE for leaflets. £7
Electronic Mail Order Ltd,
62 Bridge Street, Ramsbottom, Lancs BL0 9AGH

YOUR RIG IN OUR HANDS
Consult G3LLL, Yaesu experts, sales & service + FT101 mod kits.



39/41 Mincing Lane, BLACKBURN BB2 2AF
Tel: (0254) 59595 Closed Thursday

LOOKING FOR TRANSEIVERS! AERIALS! AMATEUR RADIO ACCESSORIES! TRY YOUR LOCAL LISTED STOCKIST

LEICESTERSHIRE

ELLIOTT ELECTRONICS THE 'HAM SHACK'
FOR THE RADIO ENTHUSIAST
26-28 BRAUNSTON GATE, LEICESTER. TEL: 553293
Open: Mon-Sat 9.00am to 5.30pm

LONDON

THE CQ CENTRE

10 MERTON PARK PARADE, KINGSTON ROAD, SW19
Tel: 01-543 5150
Open: 6 days 9am-6pm (late night Weds until 8pm)

DAVE MICK G8SYG G6LHL

The Enfield Emporium AMATEUR RADIO

Hours: Mon to Sat 9-6, Late Friday 9-8, Sun morn 10-1
281 Hertford Road, Edmonton N9
Tel: 01-804 0128

MIDDLESEX

14 COMMUNICATIONS

130 HIGH ST, EDGWARE
Tel 01-952 8185/7488/8860
Open Mon-Sat 9am-6.30pm. Sun 10am-1pm
Same day Mail Order/24 hr delivery via Securicor
Stockists of YAESU, etc

FOR YOUR BUSINESS TO BE INCLUDED, CALL SHEILA OR JAN ON 01-437 1002

W. MIDLANDS

DEWSBURY ELECTRONICS

176 Lower High St. STOURBRIDGE
Tel: (0384) 390063
Open: 9.30-5.15. Closed Thurs. & Sun.
ACCESS/BARCLAYCARD

SCOTLAND

JAYCEE ELECTRONICS JOHN GM30PW

20 Woodside Way, Glenrothes, Fife KY7 5DF
Tel: 0592 756962
Open: Tues-Sat 9-5.
Quality secondhand equipment in stock. Full range of TRIO goodies. Jaybeam - Microwave Nodules - LAR.

SUSSEX

SOUTHDOWN
RADIO
SUPPLIES

40 TERMINUS RD EASTBOURNE
Tel: (0323) 639351

pen: Mon-Sat 10-6 (Closed Thurs)
Stockists of: Yaesu, Trio, Tonna, FDK etc + secondhand and ex-Government equipment in stock

YORKSHIRE

4 Cross Church St, Huddersfield Tel: 0484 20774
Open: 6 days 9-5.30

Closed Weds. Thurs 9am-8pm
G4MH Mini Beam

'Always a good selection of new & 2nd hand equipment in stock'



Amateur Radio Shop

Please include my business details in the next available issue of HAM RADIO TODAY:

BUSINESS NAME:

ADDRESS:

TEL. NO.:

OPENING HOURS:

RETAIL WHOLESALE MAIL ORDER (Please tick)

CONTACT: (FOR OFFICE USE ONLY)



BARCLAYCARD
VISA

CLASSIFIED

THE PATH TO
SUCCESSFUL SALES!

01-437 1002

Extension 213

ADVERTISEMENT RATES

Semi-Display (min 2 cms)

1-3 insertions £5.50 per cm
4-11 insertions £5.00 per cm
12+ insertions £4.50 per cm
Lineage 30p per word (min 15 words)
Box Nos. £2.50

Closing date 1st Friday of the month preceding publication date.

All advertisements in this section must be prepaid. Advertisements are accepted subject to the terms and conditions printed on the advertisement rate card (available on request)

Send your requirements to: BRIDGETTE SHERLIKER.
HAM RADIO TODAY CLASSIFIED
ADVERTISING, 145, CHARING CROSS RD,
LONDON WC2H 0EE.

LOOK NEW COMPONENTS AT GREAT PRICES FROM LETCHWORTH ELECTRONIC COMPONENTS.

SPIRELLA BUILDING, BRIDGE ROAD, LETCHWORTH, HERTS. SG6 4ET. ENGLAND. (TRADE WELCOME, EXPORT INVITED). LISTS 65p. TEL (04626) 70354 & 79681.

VALVES! AL60/E5, DAF91/60p, DAF96/62p, DF91/52p, DF92/58p, DF96/63p, DK91/78p, DL96/95p, E92C/E2, EABC80/78p, EB91/65p, EBC81/85p, EBC90/80p, EBF80/72p, EBF89/90p, ECC81/90p, ECC82/75p, ECC83/88p, ECC84/60p, ECC85/70p, ECC88/E1, ECC189/92p, ECF80/70p, ECF82/70p, ECH35/E1.75, ECH42/E1.25, ECH81/60p, ECH83/90p, ECH84/70p, ECL80/58p, ECL82/78p, EF39/E1.35, EF80/50p, EF85/52p, EF86/72p, EF89/E1, EF91/E1.70, EF92/E2.45, EF183/67p, EL34/E1.65, EL36/E1.65, EL84/66p, EL91/E6.75, EM81/85p, EZ80/65p, EZ81/75p, GZ32/E1, GZ34/E2.50, IL4/58p, IR5/78p, IS4/52p, IS5/60p, IT4/54p, KT66(MOV)/E12.50, KT66(USA)/E8, KT77(GL)/E9.75, KT88(GL)/E12.50, OA2/80p, OB2/85p, OC3/E1.35, OC3/E1.60, PCC84/E1, PCC85/E1.04, PCL82/95p, PCL85/E1.20, PCL805/E1.20, PFL200/E1.55, PFL270p, PY500A/E1.65, PY800/92p, PY801/92p, QVQ03-10/E6, TT21/E28, TT22/E29, UV8C80/75p, UB81/98p, UB80/85p, UB89/85p, UCC85/65p, UCH42/E1.50, UCH81/85p, UCL82/90p, UL84/85p, 3S4/72p, 4-65A/E42, 5U4G/98p, 5Z4G/GT/98p, 5763/E6.25, 6AG7/E1.40, 6AK5/70p, 6AL5/65p, 6AM5/E6.75, 6AM6/E1.70, 6AQ5/E1.10, 6AS5/E2.25, 6AS7/E1.15, 6AT6/80p, 6AV6/65p, 6AV6/70p, 6B6/60p, 6BD6/E1.25, 6BE6/E1, 6B6/E1.30, 6B07A/E1.50, 6B80B/E1, 6B87/E1.15, 6BZ6/E1.75, 6C4/60p, 6CB6A/E1.45, 6F8GT/E1.75, 6F33/E22, 6J5GT/80p, 6J6/75p, 6K7/E1.25, 6L6GT/E1.25, 6O7/E1.10, 6SA7/E1.35, 6S67/E1.18, 6SL7GT/90p, 6SN7GT/89p, 6V6GT/95p, 6080/E11, 6146A/E8, 6146B/E11, 6550/E9.50, 807/E1.45, 811A/E22, 813/E32, 833A/E110.

SOCKETS B5/E1, B7/75p, B7G/20p, B7G SKIRT/35p, B7G CER PCB/25p, B9A/25p, B9A SKIRT/35p, B10B PCB/12p, INT OCTAL/55p, B7F&B8A CANS/35p, 8 pin DIL/9p, 10 WAY TAG 80ARDS/65p.

DIODES! OA91/9p, IN4002/5p, IN4005/6p, IN4007/6p, PP3 CLIPS/6p, 6.3V/2A MES BULBS/32p.

AUTO BULBS! 6V/21W sec/18p, 6V 18/3W sbc/25p, 6V/36W sec 38mm/45p, 12V 42/36W pre focus RHD head lamp bulb no. 354/75p.

BULK BARGAINS! EABC80 100/E75, ECC83 100/E65, EF85 100/E50, EZ80 100/E62, EL84 100/E62.

COILS IFT II, 465 KHz, 1.6 MHz, 10.7 MHz at £1.35 each.

ALSO TRANSFORMERS, RESISTORS, CAPACITORS, HARDWARE, ETC. POSTAGE 50p/E20 - max £3. INSURANCE £1/E100. PLEASE ADD 15% VAT.

LISTENER & QSL CARDS. Quality printing on Coloured and White Gloss Card at Competitive prices. SAE for samples. S.M. TATHAM "Woodside" Orchard Way, Fontwell, Arundel, W. Sussex.

051-228 3483

A1

INTRUDER ALARMS LTD
WHOLESALE SUPPLIES
MAIL ORDER DEPT

BELL BOXES.....	£8.00	CONTROL PANELS	
DUMMY BOXES.....	£4.50	BATTERY T/E/E.....	£20.00
BELL 6in.....	£7.50	F.S.N.....	£36.00
SIRENS.....	£4.50	CONTACTS	
MINIMITE.....	£2.50	ALUMINIUM.....	£1.85
ELECTRONIC.....	£7.00	SURFACE.....	£0.75
CALBE (4 core).....	£7.00	FLUSH.....	£0.65
PRESSURE MATS		QUICKFITS.....	£0.75
STAIR.....	£0.95	BEAMS	
STANDARD.....	£1.60	INFRA RED.....	£31.50
		ULTRASONIC comp.....	£38.00
		REC BATTERY.....	£8.95

DISCOUNT ON QUANTITY

Please add 15 per cent VAT for orders less than £30 - P&P £2. Over £30 P&P FREE

A1 ALARMS LTD
85 Derby Lane
Old Swan, Liverpool 13

AERIAL PARTS

14swg Hard Drawn Copper Aerial Wire 20p per m (post 2½p per m); Strong PVC covered stranded Aerial Wire 6p per m (post 2½p per m); 300 ohm Twin Ribbon Feeder 12p per m (post 2p per m); 75 ohm Twin Feeder 18p per m (post 2p per m); UR43 50 ohm COAX 20p per m (post 3p per m); UR70 50ohm COAX 20p per m (post 3p per m); UR67 50 ohm LOW LOSS COAX 50p per m (post 5p per m).

W. H. WESTLAKE, G8MWW
Clawton, Holsworthy, Devon

CALL SIGN LABEL BADGES professionally engraved, by return of post. £1.50 cash with order (state name & call sign) A-K SIGNS - H, 2 Pickwick Road, CORSHAM, Wilts., SN13 9BJ

MORSE CODE CASSETTES. Cassette A: 1-12 w.p.m. for amateur radio examination. Cassette B: 12-25 w.p.m. for professional examination preparation. Price of each C90 cassette (including booklets) £4.75. Price includes p&p etc. MH ELECTRONICS (Dept. H), 12, Longshore Way, Milton, Portsmouth PO4 8LS.

AVIATION FREQUENCIES

Throughout Europe
As used by BA and other major Airlines.
384 Pages. £5.75 inc p+p
Order by phone. Access and Visa welcome.
Other lists available.

AOS (HRT) West London Building,
White Waltham Aerodrome,
Maidenhead SL6 3NJ
Tel: (0628 82) 5362

COURSES - RADIO AMATEURS EXAMINATION. City & Guilds. Pass this important examination and obtain your licence, with any RRC Home Study Course. For details of this and other courses (GCE, professional examinations, etc.) write or phone - THE RAPID RESULTS COLLEGE, Dept JN1, Tuition House, London SW19 4DS. Tel: 01-947 7272 (9am-5pm) or use our 24 hr Recorded Service: 01-946-1102 quoting Dept. JN1

ANTENNES TONNA (F9FT)

YOUR NUMBER ONE CHOICE FOR 6m, 2m, 70, 24 & 23cm ANTENNAS

50MHz		1250MHz or 1296MHz	
5 element*	£31.74(a)	23 element*	£25.90(b)
144MHz		4 x 23 element antennas - power splitter - stacking frame	£140.00(a)
4 element	£13.01(a)	Telescopic Portable Masts	
9 element fixed	£15.44(a)	4 x 1m	£15.96(a)
9 element portable	£17.46(a)	4 x 2m	£19.15(a)
9 element crossed*	£28.52(a)	ANDREW HELIAX LDF4-50 COAXIAL CABLE	
13 element portable*	£27.21(a)	Attenuation per 100ft 144MHz - 0.8dB	
NEW 17 element fixed	£35.19(a)	435MHz - 1.6dB. 1296MHz - 2.9dB	
435MHz		£2.90 per metre(a) 'N' type connectors for LDF4-50 male or female	£10.35
19 element	£18.14(a)	MICROWAVE MODULES - ROTATORS - COAXIAL CABLES ETC.	
19 element crossed*	£30.05(a)	POWER SPLITTERS AVAILABLE FOR 2 OR 4 ANTENNAS	
21 element 432MHz	£26.00(a)		
21 element ATV	£26.00(a)		
144/435MHz			
Oscar Special			
9 & 19 element*	£30.05(a)		

*Denotes 50Ω ONLY - all others 50Ω OR 75Ω Ω μετάρως
PLEASE ADD CARRIAGE AS SHOWN (a) £4.00; (b) £1.80.
Terms: Cash with order, ACCESS-VISA - telephone your card number. ALL PRICES INCLUDE VAT AT 15%
For full specification of our range send 30p for Catalogue. Callers welcome, but by telephone appointment only please: 01-946-1102

RANDOM ELECTRONICS (H)
12 CONDUIT ROAD, ABINGDON, OXON OX14 1DB. Tel: (0235) 23080 (24 hours)



HAM RADIO TODAY

CLASSIFIED ADVERTISEMENT — ORDER FORM

Rates of charge: 30p per word per issue (minimum of 15 words). Box Nos. £2.50p per issue and post to **HAM RADIO TODAY, CLASSIFIED DEPT.,**

			£4.50
			£6.00
			£7.50
			£9.00
			£10.50
			£12.00
			£13.50
			£15.00

Please place my advert in **HAM RADIO TODAY** for issues commencing as soon as possible.

I am enclosing my Cheque/Postal Order/International Money Order for: (delete as necessary) £. (Made payable to A.S.P. Ltd)

Please use **BLOCK CAPITALS** and include post codes.



OR Debit my Access/Barclaycard
(Delete as necessary)



Name (Mr/Mrs/Miss/Ms)

Address
(delete accordingly)

--	--	--	--	--	--	--	--	--	--	--	--

Signature..... **Date**.....

All classified advertisements must be paid for in advance.

Daytime Tel. No.

THE **microdot**



£381.74
inc. carriage

(Standard unit cost — VAT not included)



CW/RTTY COMMUNICATIONS TERMINAL

STANDARD FEATURES INCLUDE

- Integral high resolution video monitor
- Professional keyboard with many special functions
- Real-time clock (constantly displayed)
- Transmit and receive both CW (morse) and RTTY (teleprinter)
- Users callsign programmed in
- Receive CW speed tracking and display
- Self checking facility
- Char. by char. or 'page' transmission modes
- Stylish two tone metal cabinet

OTHER OPTIONAL FEATURES

- Printer interface board (Centronics compatible)
- On-board 40 column printer (12v)
- External 80 column printer (SEIKOSHA GP100A)

Forget all those messy wires, the MICRODOT now offers a totally integrated communications system. Write for full details to:

POLEMARK LTD., Lower Gower Road, Royston, Herts. SG8 5EA. Tel. Royston (0763) 47874

ADVERTISERS INDEX

ALL WELD.....33	ENFIELD.....11
AMATEUR RADIO EXCHANGE.....2	H. LEXTON.....84
AMCOMM.....15, 33	NORTHERN AMATEUR RADIO.....29
BNRS.....33	SMC.....78, 79
CQ.....29	POLEMARK.....82
DATONG.....83	WPO.....29

DATONG NEW PRODUCT

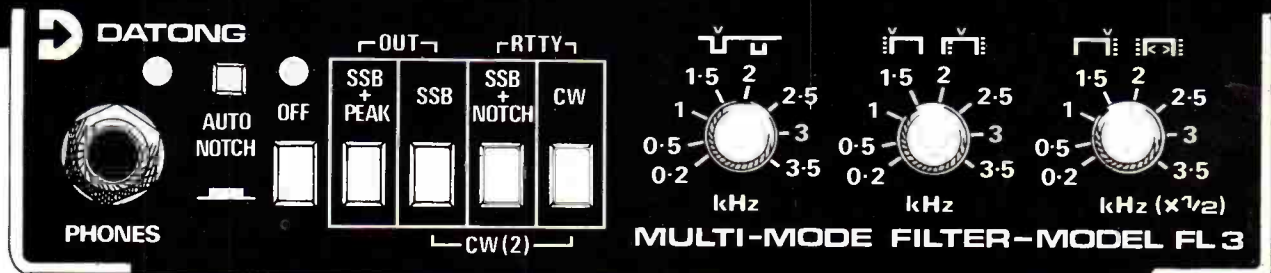

MODEL FL3-A NEW AUDIO FILTER WITH AUTO-NOTCH

A NEW AUDIO FILTER FROM DATONG MODEL FL3

Model FL3 gets it all together! It combines all the power of the FL2 which continues in production with a remarkable new automatic notch filter - a concept which we pioneered with our FL1. In one stylish case Model FL3 offers the complete solution to receiver audio processing. We believe that such a powerful combination of filtering capabilities has never been offered before in one package.

NOTCH FILTER SCANS CONTINUOUSLY

User of our FL1 will confirm the practical advantages of an automatic notch filter. With absolutely no help from you the operator the automatic notch tirelessly scans the receiver's audio output until a continuous audio tone is received. When it is the notch filter locks on and removes it. If the tone changes in frequency the auto-notch follows.

SHOOTS DOWN TUNE-UP WHISTLES AND HETERODYNES

Imagine the benefits. A tune-up whistle no longer causes any problem; after a second or two it simply drops out of ear shot. Those tiresome whistles that occasionally descend on a QSO become a thing of the past. Only the "LOCK" lamp on the FL3's panel reminds you of what you are thankfully missing.

PLUS LOW PASS, HIGH PASS AND MANUAL NOTCH

While all this is happening you still have three other independent filters at your disposal. Imagine, for example that another SSB station starts up 2 kHz

high. Instead of trying to copy through all that high-pitched monkey chatter simply wind down the low-pass filter (the right hand knob) and wipe it out. Then perhaps a teleprinter starts up 300 Hz above your carrier frequency; a touch on the high-pass filter knob (the middle one) cures that.

Finally maybe a second whistle appears. Since the auto-notch is busy, just bring in the manual notch as well and tune it out (left hand knob).

PHENOMENAL SKIRTS WINKLE OUT CW

For CW and RTTY the low-pass, high-pass and manual notch filters combine to give a 12 pole fully variable filter with remarkable skirt selectivity. Compared with lesser filters you can use a much wider bandwidth for a given interference suppression - this makes tuning easier and reduces ringing effects.

ATTENTION FL2 OWNERS!

At Datong we don't believe in "planned obsolescence". There's no need to throw away your FL2 to get an FL3. Instead you can convert it to an FL3 using our conversion unit, Model FL2/A.

This is a fully assembled PCB module with its own board-mounted "IN/OUT" switch and "LOCK" lamp. Installation involves four soldered connections to the existing FL2 PCB and one track cut.

Model FL2/A is also suitable for building into other equipment where an automatic notch function is required.

FREE HARDWARE KIT

As an introductory offer Model FL2/A will be supplied complete with a punched and printed FL3 front panel to replace the FL2 panel, plus PCB mounting hardware.

**TECHNICAL
REPRINT OFFER**

The filtering in Model FL2 and now in Model FL3 has been carefully conceived to give maximum possible benefit in real life reception conditions. The thinking behind the product design has been described in depth by the designer, Dr DA Tong in "Ham Radio", November 1981. A limited number of reprints of the article are available free on request.



ALL DATONG PRODUCTS ARE
DESIGNED AND BUILT IN THE U.K.

PRICES

All prices include delivery in U.K. basic prices in £ are shown with VAT inclusive prices in brackets.

FL3	112.50	(129.37)	AD370	56.00	(64.40)	RFA	20.50	(33.02)
FL2/A	34.50	(39.67)	AD270 + MPU	45.00	(51.75)	Codecall		
FL1	69.00	(79.35)	AD370 + MPU	60.00	(69.00)	(Linked)	28.00	(32.20)
FL2	78.00	(89.70)	MPU	6.00	(6.90)	Codecall		
PC1	119.50	(137.42)	DC144/28	34.50	(39.67)	(Switched)	20.50	(33.02)
ASP	72.00	(82.80)	DC144/28			Basic DF System	●149.00	(171.35)
VLF	26.00	(29.90)	Module	28.00	(32.20)	DF System	●159.00	(182.55)
D70	49.00	(56.35)	Keyboard Morse			Complete Mobile DF		
D75	49.00	(56.35)	Sender	119.50	(137.42)	System	●214.00	(246.10)
RFC/M	26.00	(29.90)						
AD270	41.00	(47.15)						

See previous advertisement or price list for further details.

Data sheets on any products available free on request - write to Dept HR
DATONG ELECTRONICS LIMITED
Spence Mills, Mill Lane, Bramley, Leeds LS13 3HE, England. Tel: (0532) 552461

**G4JDT
HARVEY**

EAST LONDON HAM STORE

H. LEXTON LIMITED

191 FRANCIS ROAD LEYTON E.10
TEL 01-558 0854 TELEX 8953609 LEXTON G

DRESSLER AMPLIFIERS

These are high power 240V linears using 4C x 150 or 4C x 350 Eimac Tubes NOT using the grounded Grid system. Fully protected, no thermal damage to PA finals possible.

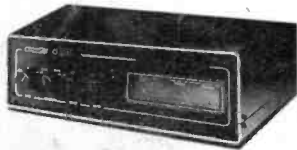

DRESSLER AMPLIFIERS NOW MORE POWER

D70 70cm 300wfm 600w PEP	£550.00
D200c 2mtr 125wfm 200w PEP	£285.00
D200 2mtr 300wfm 600w PEP	£500.00
D200S 2mtr 400wfm 1KW PEP	£600.00

GASFET DRESSLER PRE-AMPS

VW2GAAS 150w	£40.00
VW200GAAS 750w	£69.00
VW200GAAS 1kw	£79.00
VW2RPS 50259	£24.00
VW2RPS N Type	£22.00
VW7RPS 50259	£24.00
VW7RPS N Type	£18.00
VW Interface	£18.00

Powered by the linear or with separate interface.
0.7-0.9dB signal to noise
0.2dB insertion loss

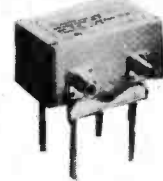

GASFET MASTHEAD PREAMPS

3SK97 GASFET Available separately £5.00

AVAILABLE SOON NEW MODELS
YAESU FT 726 6-2-70 TRANSCEIVER + BAND WORKING FACILITY PRICE T.B.A. + TRIO/KENWOOD.
TR7930/795025/50W FH MOBILES + TR3500 70VMS PORTABLE + R2000 RECEIVER. TS430 HF TX/RX GEN COVER.

ICOM	ICOM	ICOM	TRIO/KENWOOD
IC740 HF 100W £660.00 IC720 RHF 100W G/C £883.00 IC730 HF 100W £586.00 IC2K1 Linear £829.00 IC2K1 LPS P.S.U. £211.00 PS15 P.S.U. £99.00 PS20 P.S.U. £130.00 AT500 A.T.U. £299.00 RX70 Receiver £469.00 RS15 P.S.U. £99.00	IC2E 2mtr fm portable £159.00 IC4E 70cm fm portable £199.00 IC25G 2mtr 25w/fm £235.00 IC290 2mtr 10w fm/ssf £366.00 IC251 2mtr 10w fmkw/ssf/base £495.00 IC451 70cm 10w fmkw/ssf/base £630.00 IC490 70cm fm/ssf mobile £445.00 ICSP3 Speaker £29.00 ICSM5 Mic £29.00	Accessories £ 4.25 ICLC 1 2 3 case £ 12.00 ICWM9 SP Mic £ 29.50 ICBP2 6V pack £ 20.00 ICBP3 9V pack £ 6.95 ICBP4 empty pack £ 39.50 ICBP5 12V pack £ 3.75 ICCP1 charging lead £ 9.75 ICDC1 12V car park £ 18.98 LCB leather case £ 45.00 BC30 Base Charger £ 60.00	TS830 General Coverage RX TX £995.00 TS830 100W HF £650.00 TS530 100W HF £475.00 TS130 100W HF £495.00 TS130 25W 2mtr FM SSB £390.00 TS790 25W 2mtr FM P.O.A. £245.00 TS790 45W 2mtr FM P.O.A. £300.00 TR3500 2mtr Portable £200.00 TR3500 70cms £220.00 TR730 2mtr FM £245.00 AT230 £110.00 SP230 £34.00 DM801 GDO £60.00 R600 Receiver AM SSB £190.00 R2000 Receiver £360.00
YAESU FT one gen coverage TX/RX £1295.00 FT102 150W 10mtr-160mtr £690.00 FR707 100W 5-15mtr P.O.A. FR707 70A P.S.U. P.O.A. FC707 A.T.U. P.O.A. FT107M 9 band 100W P.O.A. FP107 P.S.U. P.O.A. FT107ZD 160-10mtr P.O.A. FR3020M 160-10mtr AM/FM £495.00 SP901 Speaker £30.00 FC902 A.T.U. £135.00 FL2100Z 1 2KW PEP linear £425.00 FC102 Speaker P.O.A. FC102 A.T.U. P.O.A. FR102 V.F.O. P.O.A.	YAESU FT290R with mods £245.00 FT480R 2mtr mobile FM/SSB £365.00 FT780R 70cm 7.6 switl Shift £400.00 FT780R 70cm 1.6 switl Shift £440.00 FT208 2mtr portable FM £195.00 FT208 70cm portable FM £205.00 FT230 2mtr FM mobile FM £220.00 FRG7700 receiver AM/FM/SSB £295.00 FRG7700 memory £80.00 FT790 VHF Multi £290.00	FRV7700A 118.150 £ 60.00 FRV7700B 50.60/118.150 £ 75.00 FRV7700C 140.170 £ 65.00 FRV7700D 70.80/118.150 £ 72.00 FR7700 Aerial Tuner £ 37.00 FRA7700 Active Antenna £ 36.00 FF5 Filter £ 9.95 MMB11 FT290 Car Mount £ 22.00 NC11C Charger £ 8.00 NCB Base Charger £ 44.00 FT208/208 108 £ 44.00	DIAWA CN520 1.8-60 MHz £ 32.00 CN540 50-150 MHz £ 34.00 CN620A 1.8-150 MHz £ 52.00 CN630 140-150 MHz £ 74.00 CNW518 3-30 MHz ATU £170.00 CNA1001A AUTO ATU £150 ROTATORS DR7500R 3 ELE BEAM MF £105.00 DR7500X 3 ELE BEAM MF £ 95.00 DR7600R HEAVY DUTY 2 ELE HOMTR BEAM £148.00 DR7600X HEAVY DUTY 2 ELE HOMTR BEAM £138.00
Morse Readers MBA electronic Morse RTTY reader £190.00 Microdot/Morse RTTY printer VDU/Key Board/all one piece £850.00 TASCO 610 Codemaster £189.00	DATONG D70 Morse Tutor £ 56.35 PC1 Gen. cov. converter £137.00 FL1 Agile filter £ 79.35 FL2 Active filter £ 89.70 FL3 Agile filter & notch £129.37	ASP Auto clipper £ 82.80 D75 Manual clipper £ 56.35 PFC Speech clipper £ 29.90 AD270 Indoor active ant £ 47.15 AD370 Outdoor active ant £ 64.40 RF A Wide band AMP £ 33.92	SONY ICF2001 receiver £140.00 Microwave modules MML 144 30 1 3w drive £ 9.95 MML 144 100 L S 1 3w drive £159.95 MML 144 100 S 10w drive £139.95 MMC 435 600 ATV converter £ 27.90 MM2001 RTTY receiver £189.00 MM4000 RTTY transceiver £269.00 MM1000 KB key board - transceiver £299.00 MM728 144 £109.95 MMD050 frequency counter £ 75.00 ALL MODELS STOCKED
WELTZ SP200 1.8 160MMZ 20 200 1KW £ 59.00 SP300 1.8 500MMZ 20 200 1KW £ 79.00 SP400 1.30 500MMZ 5 20 150 £ 59.00 SP250 1.6 600MMZ 20 200 2K £ 43.00 SP15 1.08 160MMZ 5 20 200 £ 29.95 CT150 150 400W Dummy Load £ 31.00 AC38 3.5 30MMZ A.T.U. £ 59.00 SP10X 108 150MMZ 20 20 £ 19.95 CT300 Dummy Load	MORSE KEYS Morse keys Swedish brass key £ 49.00 Himound HK706 £ 11.00 Himound HK708 £ 20.00 Himound HK7022 £ 22.50 Kenpro squeeze key 100 electronic key £ 57.00 Dawa DK210 Electronic keyer £ 41.00	POWER SUPPLIES The Lexton 7 amp Max 12 amp £ 49.95 20 amp Max 22 amp £ 79.95 Fully protected against overvolts, over current S/C protected & RF protected. Trade enquiries invited and own name can be provided.	

TONO	TONNA	TET	JAYBEAM
2M 50W Linear amp 1-3Win £ 62.00 2M 70W Linear amp 10Win £ 90.00 2M 100W Linear amp 10Win £115.00 8.500 CW RTTY Terminal £299.00	144 4ELE £12.00 432/440 21 ELE £19.00 144 9ELE 432/435 21 ELE ATV £27.00 144 9ELE crossed 30 0 144 435 9 19ELE £31.00 144 9ELE portable 30 0 144 19ELE £30.00 144 16ELE £33.00 1236 23ELE £27.00 144 13ELE portable £29.00 Phasing Harnes 430 440 19ELE crossed telescopic masts 435 19ELE £19.00	HB33T £189.00 HB34T £202.00 HB35T P.O.A. HB35C £280.00 SQ22144 £ 55.00 SQ220X144X4 £ 90.00 SQ007 70cm P.O.A.	TB3 HF 3 band £189.00 VR3 band verticle £ 46.00 C52M colinear £ 54.00 5Y2M 5ELE YAGI £ 14.00 8Y2M 8ELE YAGI £ 17.00 10Y2M 10ELE YAGI £ 24.00 PBM1010EPARABE AM £ 44.00 PBM1414EPARABE AM £ 55.00 5XY2M £ 28.17 8XY2M £35.00 10XY2M £46.00 Q4Y2M £29.00 Q6Y2M £39.00 Q8Y2M £44.00 MBM548/70cm £35.00 MBM88/70cm £48.00 8XY 70cm £42.00 12XY 70cm £52.00
SCANNING RECEIVER Scanning Receiver Sx200N £249.00 Drawa SR1000 £ 70.00	144MHZ 432MHZ 1250-1296 4ELE £12.00 19ELE £18.00 23ELE £25.00 9ELE Fox £15.00 19ELEX £26.00 9ELE Port £17.00 21ELE ATV £26.00 9ELE x £28.00 144/435 9+19ELE £30.00 13ELE Port £26.00 Power splitters etc. available	HOXIN GP5 2mtr colinear 6 4DB £33.00 DX1 discone TX TX £34.00 HF5DX 80 40 20 15 10 mtr Vertical £84.00	
ROTATORS Kenpro KR 250 £ 44.95 Hirshmann HR 250 £ 50.00 Kenpro KR400RC £100.00 Kenpro elevation rotator £ 85.00	See the new standard C5800 Multimode 25W SSB FM/CW 2mtr. £359.00		

ALL ACCESSORIES AVAILABLE - PLUGS SKTS CO-AX 2MTR COLINEAR £31.50. 70CM COLINEAR £31.50



PRICES INCLUDE VAT AT THE PRESENT RATE OF 15%
OPEN MON-FRIDAY 9:00-5:30. SATURDAY 10:00-3:00. INSTANT HP FACILITY AVAILABLE
EASY ACCESS M2-M11-M1 NORTH CIRCULAR ROAD-EASY PARKING

