



DX Monitor

Devoted Exclusively to
Broadcast Band DXing

December 20, 1980

Volume 18, Number 13

Issue Number 566

In This Issue

Eastern DX Roundup	2	Western DX Roundup	13
IRCA Swap and Shop	4	More Thoughts on Tape Recording	
Western DX Roundup	5	From the TRF & other Portables .	16
DX Worldwide - East	7	A DXers Guide to China: Comments	20
DX Worldwide - West	9	Unreported Stations Update	21
Eastern DX Forum	11	CDXR or Something Else?	??

DX Calendar

- Mon Dec 29 WIBA-1310, Madison, WI, will test from 0100-0400 EST w/5000 watts on directional pattern.
- Mon Dec 29 WHJJ-920, Providence, RI, 5000 w, will test 0400-0430 EST. Test will consist of five minute periods of 5 kHz TT with a single letter repeated over and over again in Morse code, with a different letter for each five minute period. Voice and morse code IDs (using 1000 Hz TT) will be given every five minutes. Verifications will be issued to anyone who can correctly identify any two of the six code letters used. Send reports to Craig Healy, Technical Dept., WHJJ, 115 Eastern Avenue, Providence, RI 02914. Arranged for IRCA/NRC by Craig Healy (Editor's Note: This test will, in effect, consist of tones on 915 and 925 kHz, for the most part. Most receivers are too selective to pick them up if you're tuned to 920; instead, tune your radio to 925 or 915, set your selectivity control for its narrowest position, and turn on your BFO. If you don't have variable selectivity or a BFO, well...good luck. I forgot to ask Craig which pattern they'd be using for the test, but I assume it will be non-directional. bp)
- Tue Jan 6 WLET-1420, Toccoa, GA, will test 0015-0045 EST w/Polka & march mx, voice and morse code IDs, and 50/600/1000 Hz tone bursts. Send your reports to Jan Bethke, WLET, 423 Prather Bridge Rd., Toccoa, GA 30557. Arranged by Karl Jeter.
- Mon Jan 12 WEYZ-1450, Erie PA, will test 0000-0030 EST w/big band mx and IDs every 10 minutes. Enclose an SASE with your report and send it to J.J. Sanford, PD, WEYZ, P.O. Box 1184, Erie, PA 16512. Arranged by Harley Steward, NRC.
- Mon Jan 12 WDMP-810, Dodgeville, WI, 250w, ND, will test 0100-0130 EST. Send rpts to Richard Carroll, WDMP, Box 116, Dodgeville 53533.

Odds & Ends

No sign of CDXR as of 5 p.m. Monday 12/15. Rumor has it that Robert Kramer forgot to show up at his own gettogether and suffered an unmentionable fate at the hands of Bobo, the CADX monster. On the other hand, the column may have just been delayed in the mail. If it shows up before I run this thing over to the printer, I'll put it at the end of the bulletin. Otherwise something else will appear in its place.

Flash Tips: KXNW-1510 will hit the air in mid-January and KSCR-1420 (Renton, WA) will come on sometime in early 1981, per Pete Nolan. KPAM-1410 in Portland, OR changed from rock to contemporary Christian programming on Dec 1, according to Bill Block. And Bill Hardy informs us that the Mutual Radio Theatre was cancelled as of December 19, 1980.

Have a Merry Christmas and a DX-filled 1981. 73, bp.

EASTERN DX ROUNDUP

Bob Lazar

3837 Milan Dr., Apt. 1

Alexandria, VA 22305

Deadlines: Tuesdays

- 540 WGTO FL Cypress Gardens, 11/24 0155-0157 xlnr on ET w/ OM w/ ID & anmt of test, jingle ID as "The best trucking station in the nation, WGTO, moving on", then C&W song. (BD-ON)
- 560 WQAM FL Miami, has been a regular occupant of this channel the last few weeks along w/ WIND/WFIL/Jamaica. (KAZ-NY)
- 580 CKAP ON Kapuskasing, very good @ 0104 s/off 11/10. (KAZ-NY)
- 610 WDAF MO Kansas City, fair-good w/ "61 Country" ID's & giving something away to the hundredth caller at 576-7000. 0256 11/17. (KAZ-NY)
11/24 0157-0159 poor-fair u/ unid OC w/ C&W song, OM w/ CST TC & two "61 Country" ID's, talk about a "Family trip to Disney World" contest, more C&W mx. (BD-ON)
- 620 WTMJ WI Milwaukee, very good w/ ID & ment of win \$1000 in the Big Money game. 0316 11/17. Often heard lately. (KAZ-NY)
unid??*noted u/ WTMJ w/ sweep tones 0225-0342 11/17. (KAZ-NY)
- 740 KRMG OK Tulsa, 11/29 0135-0150 fair w/ "Nightline" phone-in talk show. ID as "KRMG, The Voice of Tulsa" @ 0145. (BD-ON)
- 860 WHRT AL Hartselle, 12/1 1742 local nx, Texaco Haroline Supreme oil ad, s/off @ 1747:30, then SSB. Fair in CJBC null. Pleased with this one. (DHM-PA)
- WFMO NC Fairmount, 12/1 1714 s/off. (DHM-PA)
- WLBG SC Laurens, 12/1 1715 very clear s/off anmt. (DHM-PA)
- WUCR TN Sparta, 12/1 1728 shoe store ad, then s/off w/ SSB. (DHM-PA)
- WEVA VA Emporia, (tentative) in w/ religion way u/ CJBC. I think I caught WEVA ID. Are they REL now?? 1656 11/29. (KAZ-RI)
- 870 WFLO VA Farmville, fair at 1658 s/off 11/29. (KAZ-RI)
- 880 WRRZ NC Clinton, (tentative) suspected u/ WCBS during N.C. SSS opening at 1654 11/29. Gone at 1700. Heard & IDed once before. (KAZ-RI)
- 890 WHNC NC Henderson, good w/ nx about Warren County in WLS null. 1647 11/29. (KAZ-RI)
- 880 WRPD OH Worthington, in w/ ID & ment. of Solid Gold Weekend u/ WCBS 1710 11/29. (KAZ-RI)
- 900 WJWL DE Georgetown, 12/1 1644 picked out s/off w/out SSB in heavy local WCPA QRM. (DHM-PA)
- 920 WMEL FL Melbourne, (tentative) w/ temp of 73° o/ HJAE in AU ex 2119 11/12. (KAZ-NY)
- 930 CKNS ON Espanola, 12/1 0340-0356 real surprise, good w/ many ads mentioning places like Blind River & Elliot Lake; femme DJ w/ R&R. (KVJ-GA)
- 940 KIOA IA Des Moines, poor-fair on fade up w/ Reloj Cuba in null 0322 11/17 w/ ID & local wx, then T40 mx. (KAZ-NY)
11/30 0302-0315 poor w/ T40 mx such as Billy Joel, OM w/ CST TCs & other anmts between songs; "KIOA" ID's. (BD-ON)
- WCPC MS Houston, 11/10 1752-1755 poor u/ CBM w/ pop song, OM w/ ID & TC @ 1755. (BD-ON)
- WNRG VA Grundy, 12/1 1657 YL DJ w/ highway fatality rpt, Navy recruiter ad, local nx item, ID. UPI nx @ 1700. (DHM-PA)
- 960 WKZA PA Kane, 12/8 1645 s/off by OM w/ ment of 1 kw power. #14 on this channel. Fair. (WPT, DXing at work in Marlow Heights, MD)
- 970 CBZ NB Fredericton, in // CBH-860 w/ fair signal. 1725 11/26. (KAZ-RI)
- 980 CFPL ON London, 11/30 2325 strongest stn on channel w/ light pops, promos. (DHM-PA)
- 990 WVSC PA Somersset, 11/29 s/off 1700 mentioned a 7 a.m. s/on, FM ment. (KVJ-GA)
- 1010 KRLA AR Little Rock, (tentative) suspected w/ C&W mx u/ WHN/CFRB 0350 11/28. (KAZ-RI)
- 1060 WMGL IL McLeansboro, 12/6 1726 fair thru bad QRM w/ C&W, local ads, "1060 MGL" ID's. (RAL-VA)
- 1070 CBA NB Moncton, 11/15 1812-1814 xlnr w/ OM w/ wx including storm warnings for Cape Breton coast, CBC jingle, instrumental EZL mx. (BD-ON)
- 1090*unid*??*noted o/u CKKW w/ sweep tones 0225-0342 when I went to bed as TT's only ID when you're not on the channel. (KAZ-NY)

1130 WMGA GA Moultrie, 12/6 1700 poor thru WNEW w/ Ai nx, local ads, ABC World of Sports, ID. (RAL-VA)

1150 WIMA OH Lima, fair-good w/ ID & ment of coverage of O.S.U. Buckeyes FB 0403 11/22. (KAZ-NY)

1240 CJNH ON Bancroft, briefly in w/ loud unid FFC. ID as CJBQ Music Radio 800, phone #, Ont. ment & soon lost. CJNH is CJBQ's twin. (CJBQ not heard.) Time was 0225 11/26. (KAZ-RI)

1260 WNDE IN Indianapolis, good w/ ID, then nx 0300 12/1. (KAZ-RI)

1290 WCHK GA Canton, 12/3 1729 spot, Christmas song. Fair o/ CJBK, no sign of pest WFBG. (WPT-DC)

1300 WOOD MI Grand Rapids, 11/30 2343 very strong w/ instrumental mx, ID @ 2346. (DHM-PA)

1310 WEEL VA Fairfax, good w/ "Nobody covers Northern VA like N. VA's Radio 1310 WEEL" 0304 12/1. (KAZ-RI)

1340 CKDK ON Woodstock, 11/15 0442-0446 fair w/ pop song, jingle ID @ 0444, another pop song. (BD-ON)

1380 WBNX NY New York, 11/15 0316-0324 fair-good u/ CKLC w/ gospel mx by a choir, OM ID "This is WBNX, New York, 1380" @ 0324. (BD-ON)

1400 WNEX GA Macon, 12/8 0001 s/off by OM w/ no SSB. Call letters followed by location, then off. Fair atop GY pile. #10 on 1400. (WPT-DC)

1440 KITA AR Little Rock, 11/28 1800 s/off, ment. inspirational pgming & 6 a.m. s/on. Not hrd since was KOKY. (KVJ-GA)

*WAJL*FL* Winter Park, 12/8 0027 Eting w/ 250 hz TT & ID by male CE. Fair u/ WGIG. #13 on this channel. (WPT-DC)

*WGIG*GA* Brunswick, 12/8 0012 "WGIG on the air for technical adjustments, operating w/ 5000 watts", male CE. Fair to good. (WPT-DC)

WBGR KY Paris, 11/28 xlnt w/ ABC nx promo 1725, R&R & short s/off 1730.

KMLB LA Monroe, 11/28 1804 w/ promo "where AM means All Music". (KVJ-GA)

1460 WWWG NY Rochester, 11/17 1731-1738 good for a few minutes, then faded. OM w/ "WWWG Community Events", ID "3WG, the spirit of Rochester, keeping watch on the Christian community", into rel. mx. (BD-ON)

CKRB PQ St. Georges de Beauce, 11/17 1739-1741 very poor u/ WWWG/CJOY w/ OM w/ FF ad, anmts, EZL song. (BD-ON)

1470 WMBD IL Peoria, 11/27 2352 Coke ad, wx, ID, promo. (DHM-PA)

WBIG NC Greensboro, 11/17 1707-1711 poor-fair w/ CHOW. OM w/ local nx, ad for a bank in Greensboro, OM w/ Economics & Stock Market Report. (BD-ON)

1480 WJLE TN Smithville, 12/5 1729 s/off by YL. Missed city but L in calls & sunset charts led to claim. Fair. (WPT-DC)

1500 WLQV MI Detroit, 12/1 0230-0245 w/ religious mx, promos mentioned "AM-1500" & "Love", songs a lot like a BFL mx stn. (KVJ-GA)

1530 WDEY MI Lapeer, 11/17 1700-1703 fair w/ WCKY w/ ID, OM w/ local nx. (BD)

1550 WRHC FL Coral Gables, good at 1730 s/off w/ s/off anmt in SS, then EE. ID as WRHC-Coral Gables-Miami. (KAZ-RI)

KQWB ND West Fargo, 11/15 1750-1800 poor w/ pop songs, OM w/ ID's, CST TCs, contest info & other talk between songs; OM ID as "Total Radio is KQWB in West Fargo, ND, it's 5 o'clock". (BD-ON)

WKBA VA Vinton, 11/15 1705-1715 very good w/ OM w/ religious sermon, bit of religious mx. OM w/ ID & s/off anmts, off @ 1715. (BD-ON)

WMIR WI Lake Geneva, 11/15 1723-1728 poor-fair w/ QRM. OM w/ CST TC & college football scores, OM "Randy Michaels" w/ "Radio 15 WMIR" and other anmts ending pgm. (BD-ON)

1560 WPAD KY Paducah, 12/1 0158-0201 fair w/ C&W song, OM: "This is 1560, WPAD Paducah" into nx. (BD-ON)

KTUI MO Sullivan, 11/27 1759 s/off w/ SSB noted in WQXR null. My first daytimer from west of the Mississippi! (DHM-PA)

WBOL TN Bolivar, 12/3 1745 s/off by OM w/ ment of 250 w power. #15 on 1560. Fair signal. (WPT-DC)

1570 KVLG OK Frederick, 11/28 poor w/ s/off 1829, FM mention. (KVJ-GA)

KTER TX Terrell, 11/28 fair just before KVLG w/ 1827 s/off. (KVJ-GA)

1580 WEYY AL Talladega, 11/27 1735 strong sports pgm, interviewing football coach, several ads, fade out at 1743. (DHM-PA)

KNIX AZ Tempe, w/ C&W mx & ID at fair peak 0203 11/17. (KAZ-NY)

KDAY CA Santa Monica, poor-fair w/ REL pgm ending, then ID given as "KDAY Santa Monica", then address given. 0259 11/17. (KAZ-NY)

WAMY MS Amory, 11/27 1744 s/off noted u/ WLIJ. (DHM-PA)

WLIJ TN Shelbyville, 11/27 1743 suddenly on top w/ s/off anmts & SSB. (DHM-PA) 11/17 1744-1745 poor-fair w/ CBJ OM w/ CST TC & s/off anmts, off @ 1745 w/ no SSB heard. (BD-ON)

unid ?? s/off 1726-1729 11/29. S/off format featured God Bless America, then Lord's Prayer, then more God Bless America. Anyone down south know who this is? (KAZ-RI)

DX TESTS

1060 WHFB MI Benton Harbor, 12/8 0125 (tentative) 1000 hz TT, heavy KYW QRM prevented me from reading voice. Fair signal. (WPT-DC)
1420 WLET GA Toccoa, 12/2 test apparent no-show as of 0040. Rats!! (My first CPC-arranged test). (KVJ-GA)

THANKS THIS WEEK TO THESE REPORTERS

- BD - Bill Dulmage, Box 1221, Prescott, ON KOE 1TO
(RF-2200)
- KVJ - Karl V. Jeter, 3590-C Clubhouse Circle East, Decatur, GA 30032
(HQ-150, TRF, SM-2, 4 ft. NRC loop)
- KAZ - Neil Kazaross, 30 King Philip Rd., Pawtucket, RI 02861 and Union College, Box 1024, Schenectady, NY 12308
(Modified TRF, SM-2)
- RAL - Bob Lazar, 3837 Milan Dr., #1, Alexandria, VA 22305
(Yaesu FRG-7, SM-2)
- DHM - Don Moore, Box 157, RD #5, Bellefonte, PA 16823
(Yaesu FRG-7000, 15" Radio West ferrite loop)
- WPT - Bill Townshend, 4500 Connecticut Ave. NW, #901, Washington, DC 20008
(Realistic TRF)

Oh oh! Time for a few gentle comments on reporting from ye friendly editor. All reports should be sent in in the same format that they appear in the column. That means that each one should have the date and your initials on it. Also, don't forget to include city, state, calls, frequency, time, program details and reception quality. Please use only one side of a sheet of paper and please try to avoid sending in stuff that is over a month old. I've actually been doing a little DXing, not that much though. Please note that due to a two week vacation that I'm taking, the next EDXR deadline is January 6. There will not be an EDXR in the 1/10 DXM since that deadline falls while I'll be gone. Also, the 1/3 EDXR will likely be pretty skimpy since the deadline for that one was early, only two days after the previous one. Merry Christmas and the best of DX in the New Year! 73.

IRCA Swap & Shop

EDITOR : TIM O'HARE
20023 84th W.
EDMONDS, WASH. 98020

WANTED DIGITAL FREQUENCY COUNTER. PREPAID CALLS ONLY TO 408-265-5532 OR WRITE:
RANDY MILTIER - 1068 FAIRVIEW AVE. - SAN JOSE , CALIF . 95125

FOR SALE KENWOOD R-1000 RECEIVER EQUIPPED WITH A COLLINS 2.9Kc MECHANICAL FILTER INSTALLED IN AM NARROW POSITION. IT IS EIGHT MONTHS OLD AND HARDLY USED. HAS GREAT AUDIO, SENSITIVITY AND SELECTIVITY. INCLUDES MATCHING SPEAKER AND HEADPHONES. ALL FOR \$ 400.00.

FOR SALE AUTEK RESEARCH 1980 MODEL QF-1A AUDIO FILTER. AS NEW - \$ 45.00

FOR SALE 1975 ZENITH TRANS-OCEANIC PORTABLE RECEIVER. HAS ELEVEN BANDS, HARDLY USED & LIKE NEW. \$ 150.00

RAYMOND MARTINEZ - 8074 CANTERBURY WAY , BUENA PARK, CALIF. 90620
PHONE PRE-PAID TO 714-994-5837.

WANTED OLD "RADEX" AND OTHER SIMILAR RADIO MAGAZINES FROM THE BEGINNING OF RADIO UNTIL THE FIFTIES. BOUND OR SINGLE ISSUES OK.
WILHELM HERBST - CORNELIMUNSTERSTR. 2 - D 5000 - KOLN 41 , WEST GERMANY

FOR SALE HALLICRAFTERS SX-62A RECEIVER. IT HAS SIX BANDS WITH A FREQUENCY COVERAGE OF 540 Kc TO 108 Mc. IT CAN RECEIVE BOTH AM & FM AND INCLUDES A HALLICRAFTERS R-4A SPEAKER. ALL FOR \$100.00 OR MAKE OFFER.
JAMES E. CRITCHETT - 1635 WALBRIDGE ST. - RED BLUFF , CALIF - 96080

FOR SALE PANASONIC RF - 2800 PORTABLE RECEIVER. HAS DIGITAL READOUT ON SHORT - WAVE BANDS. AM & FM HAVE A REGULAR ANALOG DRUM TYPE DIAL. IT IS IN GOOD CONDITION AND MAKES A NICE BACKUP SET FOR CHECKING SHORTWAVE PARALELLS. I MUST SELL TO MEET FUTURE COLLEGE EXPENSES. \$ 145.00 INCLUDES UPS SHIPPING.
JACK LATTEMAN - 314 N.E. 56th St. - SEATTLE , WASH - 98105
PREPAID CALLS ACCEPTED AT: 206-522-1017

(Continued on Page 10)

Nancy Hardy
2301 Pacific Avenue
Aberdeen, WA 98520

WESTERN DX ROUNDUP

All times are
Eastern Local

Phone for hot WDX tips: (206)532-6827 till 10:30pm(PT) --no collect calls
DEADLINEs: Tues. 12/23, wed. 12/31, Thursdays 1/8, 1/15, 1/22 & 1/29

REPORTERS FOR THIS ISSUE:

- (JH) John Hart-P.O. Box 644-Carlin, NV 89822
Panasonic 594, Shotgun loop, 1800' Beverage
(JJ) Jef Jaisun-12860-136th NE-Kirkland, WA 98033
SP-600, 3' wedge, 2200' SSE Beverage
(NK) Naoki Kanaya-1017 Knickerbocker Dr.-Sunnyvale, CA 94087
GE Superadio, Sm-2
(SMM) Steve Wittman-2248-37th Street-San Pedro, CA 90732
realistic TRF, rKG-7, 3' wedge

OF SPECIAL INTEREST

- 850 KGOE CA, Thousand Oaks 12/1 0213 at long last this stn has finally gone fulltime! Hrd w/fair to good signal in KOA null w/WOR mx & "K-G-U-E, hadio 85" jingles. At 0220 gave temps for Athens, Paris, Moscow, London, Tokyo. ...and here at KGOE it's 30C. (SMM)

- 550 KOY AZ, Phoenix 12/1 1D at 0152 then spot for a Scottsdale restaurant and sports talk. (NK-CA)
- 560 KMON MI, Great Falls 12/1 1810 w/fair sig. o/KLLZ. 1D "K-M-O-N, the Country Giant." MT wx, C&W mx. New. (JH-NV)
- 590/ KRXM/ CA, San Bernardino/BCN, Tijuana noticed that these two stns. 690 XETRA are virtual carbon-copies of each other. Both continually use the slogan "clutter-free," both have "call girls" roaming SoCal giving away \$100 if you say "--plays better mx" & \$500 if it's written down & is being carried on you. Both are giving away "credit cards" to callers good for a current album or other prizes. Both stns. have similar jingles, & both have toll free numbers--(800) 442-5282 for KRXM/(800) 522-1069 for XETRA!!! Also, both have "90" in their frequency! (SMM-CA)
- 600 KUGU CA, San Diego 11/13 0014-0025 promo for "KUGU" sweepstakes, then C&W mx. Strong sig. w/"radio six" slogan at 0025. Splash from KRUC-610. (NK-CA)
- 620 KGW OR, Portland 11/13 weak sig., QRM from KRUC-610. Playing rr mx, then good 1D at 0034. (NK-CA)
- 690 KRUC OR, Prineville 12/1 on top at 1405, again 1615, 1621, 1627 w/ clear 1D. Good sig., spots for Prineville bank, Supermarket, radio Shack. QRM from KBLI, mighty 6-90 pests. New. (JH-NV)
- 700 WLW OH, Cincinnati 11/13 mx, weak 1D at 0059, then NBC nx. (NK-CA)
- 720 WGN IL, Chicago 12/2 0100 hrd w/good sig. in KJWW null w/"WGN nx," Chicago wx. First time able to get them thru KJWW pest. (JH-NV)
- 760 WJL MI, Detroit 11/21 good 1D at 0230 by Om. Played classical type mx. (NK-CA)
- 770 KXA WA, Seattle 11/21 weak 1D by male anncr. at 0217. QSB every 6 min. oldies mx. (NK-CA)
- 860 KLSU OR, Medford 11/30 2007 faded in loud & clear o/KOA/KTAC splatter out to KWHO s/off, in again 2018. YL DJ, rr/pop mx. ex-KSHA.(JH)
- 930 KEMW CA, Paradise 11/22 1504 ABC commentary. Excellent reception.(NK)
KSEL 1D, Pocatello 11/14 xlnt w/VW spot at 0119. (NK-CA)
KVGW WA, Yakima 11/30 1225 almost local strength w/ads for Yakima stuff. (JJ-WA)
- 940 KGLL OR, Bend 11/30 1135 spot for United Savings & anncr. Mike Newman. (JJ-WA)
- 950 KUK WA, Seattle 11/14 0127 weak 1D, rr mx. Too much QRM. (NK-CA)
(XEMW) BCN, Tijuana was totally off the air for 15 days--from Sat. 11/22 - Sun. 12/7 1315 (when noted back on again). Went off again Sun. night 12/7 at SS, but back on Mon. 12/8, so may be having trouble w/their nighttime facilities. (SMM-CA)
- 960 KDOT UT, Provo 11/29 2110 w/spot for tire dealer in Provo-Urem.(JJ)
- 970 KBBE CA, Modesto 11/29 1931 Modesto U.C. football game & live spot for Dodge. (JJ-WA)
- KNUU NV, Las Vegas 11/29 1929 YL doing s/off. (JJ-WA)
- 990 KHVH HI, Honolulu 12/1 0559 bombing in o/KKIS, CBW, XET, et al w/ YL ments. of HI, Newsradio 99, followed by NBC nx. (JJ-WA)
- 1050 KWSG CA, Wasco 11/29 1945 standard s/off w/OW. (JJ-WA)

- 1060 KKKQ AZ, Tempe 11/28 "Radio KQ" ID hrd at 0041, "KQ nx" at 0051. (NK)
+11/29 2240 "KKKQ" ment. live, some mx; muddy mixing w/CFGN & KPAY. (JJ-WA)
- 1090 KBOZ MT, Bozeman 11/24 LD 0512, back to mx quickly. mixed w/XEPNs / (NK-CA)
- 1110 KPIP CA, Roseville 11/28 1145 w/SS pgming, spots for Bicycle Barn (Sac'to), Roseville Square, LD as "radio Once Diez," also Ka-Pe-I-Pe. Enrique Rodriguez host, SS mx. first time hrd since call change. (JH-NV)
+11/30 1046 w/SS, ment. of Sacramento, stomping in! (JJ-WA)
- 1120 KMOX MO, St. Louis 11/28 0115 Pepsi ad hrd u/KPNW. (NK-CA)
- 1140 KMJJ NV, No. Las Vegas 11/29 1919 dominating the freq. w/MOH mx & spot for someplace in Las Vegas. (JJ-WA)
- 1190 KRZJ KS, Beloit 11/29 0838 SHS w/good sig. LD "11-90 KRZJ" w/ Lettermen, Olivia N-J mx, numerous local spots, PSA for Beloit, Tipton, KRZJ sports, wx. Out to KADZ 0850. New, tnx to FTS-IA, CDKX in 11/8/80 DXM for positive LD of WTH. (JH-NV)
- 1220 KIBE CA, Palo Alto 11/29 1953 classical mx, LD'ed "These are the Classic Stations, K---FM & KIBE, Palo Alto." (JJ-WA) (KDFC-102.1 San Francisco is the FM.--NH)
- 1230 KWG CA, Stockton 11/14 0127½ very clear LD, soft mx. (NK-CA)
- 1240 KJGU CO, Durango Su 11/30 0900 s/on followed by America the B.L. 10 sec. later KELK local pest s/on w/a blast! Great good luck, the timing on this catch! KJGU is not even an easy catch in its own area! (JH-NV)
- 1290 *KHSL* CA, Chico MM 12/1 0700 on the air "for engineering tests and adjustments." Only LD hrd w/good sig. (JH-NV)
KHEEN CA, San Bernardino 11/18 2246 clear LD as "K-men 129." playing oldies. (NK-CA)
- 1300 *KPMO* CA, Mendocino Su 11/23 0419:40 nice LD popped through, but nothing else. Per call to stn, AM is automated, calls were changed about a year ago. FM still KMRB. This one a nice surprise! (JJ-WA)
- *KMPS* WA, Seattle Su 11/23 0340-0600 noted off & on w/ET. SP is extremely rare! (JJ-WA)
- 1340 KATA CA, Arcata 11/30 1142½ "right here on KATA" blippo LD. (JJ-WA)
KDEN CO, Denver 11/30 0057 w/fair sig., lots of QNM/QSB. "K-D-E-N" radio nx, local wx. O/u KQL. New. (JH-NV)
- 1360 KHOK OH, Myrtle Creek 11/30 1122 positively taking KMO to the cleaners! Talk about late skip. This stn is new, running "wonderful K-roar" slogans, including one that went "K-K-O-A, K-roar, Radio Legend." bp & pb didn't believe me when I came running into the other room screaming about this one. Now they do, hi. This stn completely disappeared when I switched from Beverage to the wedge. (JJ-WA)
- 1430 KALI CA, San Gabriel 11/24 SS noted, LD at 0639. (NK-CA)
- 1460 KKNY NE, Kearney (Car-knee) 11/28 0700 in well, o/KDUN/KYSN w/LD, regional wx, spot for Air Nebraska. "radio one-46, K-K-N-Y." Out to KDHN. (JH-NV)
- 1470 KDHN TX, Dimmit 11/28 0717-0722 fair sig., faded in/out. LD as "KDHN Dimmit, Castro County," also "14-70 Cowboy Country" w/ various spots for cotton ginning, electric motor service, furniture in Hereford. New. (JH-NV)
- 1480 KWIZ CA, Santa Ana 11/24 LD at 0600, then EZL mx. KWIZ nx at 0601. (NK)
- 1520 KACY CA, Port Hueneme 11/24 0604 noted w/s/off. (NK-CA)
- 1590 KQMA OK, Oklahoma City 11/24 0602 wx & LD hrd. Clear LD at 0324. (NK)
KVBG KS, Great Bend 11/29 2132-2140 w/very good sig. "K-state Basketball Network," during KS State-N. Iowa bkb game. Out to KEND. Back in 2148-2200. New. (JH-NV)
- 1610 TIS WA, Ashford 11/30 0400 w/road info & ments. of Paradise on Mt. Rainier. Or was this K. Paradise, hi. (JJ-WA)

UNID's:

- 990 UNID o/u KKIS & XET MM 12/1: 1. 0413-0422 heavy soul/disco rock, chicken jock at 0420 w/chicken rap, followed by Kenny Loggins "This is It." 2. 0500 LD w/UM coming out of light piano mx sounded like "KNO, 15, --- 99." bp recalls hearing an LD, KNON or similar, on an ET several years ago. Anyone know who this is? Not WNOX, per call. 3. 0505 slow soul rap fading up as part of a tune, followed by very gosselly-sounding mx. Thick choral stuff at 0511, like relig. sounded black. Thought about KWAN, but isn't this too early for them? And, is this the same stn I hrd 11/9 (see 11/29 WDXA)? And/or the one NW reported in the 12/15/79 WDXA? (JJ-WA)
- Out of room. Will hold 4 more of JJ's UNID's till next week. ♡

DX**Worldwide**Neil Kazaross
Host Editor

All times UTC

Deadline Tuesdays

50 KING HILL RD. FAWCETT R.I. 02861 401-722-3652 1200- 2315 ELT

Could some artistically talented user please design their DXWW-a editor a column heading with his name and Schenectady NY address on it? Thank.

TA DX ROUNDUP (all from Mark Connelly unless noted)

- 747 t HOLLAND, avant-garde jazz briefly gd., eventually lost to slop 2244 Dec.8.
- 756 PORTUGAL Lisboa to good peaks w/slow religious- sounding choral mx. & funeral dirge, 2350 Dec.3 .
- 765 SENEGAL Dakar good w/FF talk 2223 Dec. 1. Fair thru WABC slop w/ excited talk in African lang. 0627 Dec.3. Blasting in w/man yelling (preaching?) in AA 2250-2300 Dec.5; Best TA tonite. (Connelly-MA)
- 891 ALGERIA Algiers v.gd. w/male AA vocal. 0126 Dec.4. Gd. w/chanting 2217 Dec.5.
- 1053 GREAT BRITAIN BBC fair w/man in EE thru WHN slop, 0617 Dec3.
- 1197a MOROCCO(Tentative) man & woman in FF 2222 Dec. 5.
- 1206 FRANCE Bordeaux fair w/man & woman in FF 0610 Dec.3. Fair w/FF talk in WCAU slop 2239 Dec.8.
- 1349 MAURITANIA Nouakchott noted w/bits of moaning/loud het 2230, Dec.1. (Connelly-MA) many times a loud het has made me moan!- ed.
- 1377 FRANCE Lille v.gd. w/man & woman .in FF 0610 Dec.3.
- 1403.6 GUINEA Conakry, here(400hz low): good w/a-cappella male & female chanting, the only really loud highband TA at the time 0520 Dec.6.
- 1422 W.GERMANY/ALGERIA(?) Saarbrucken w/GG talk o/u a station w/AA chanting, SAH about 3 Hz, 0602 Dec.3.
- 1566 UNID Carrier but no discernable audio 0440 Nov.25.(Stutterheim-NY) Welcometo DXWW-E! This is probably Tunisia which has a big signal but lousy audio. -ed.
- 1581 UNID Carrier but no audio readable 0445 Nov.25. (stutterheim-NY) I have no reports of any but on this channel. As this is not a ITU regular TA channel I must assume that somebody drifted.-ed.
- 1593 W.GERMANY Langenburg good w/piano mx 0618 Dec.3.

PAN AMERICAN DX ROUNDUP

- 535 UNID EE BBC mx then jazz at 0212. Rock mx to 0400. Apparent s/off 0402 w/ment of 19 meter SW band. Then lkhz TT, then carrier off at 0412. (Stutterheim-NY) This is R.Free Grenada //15045 SW - I believe -ed. Date Nov.25.
- 582.6 UNID A weak carrier has been noted here around 0200 recently. No Ideas. (Thomas-FL)
- 595 UNID noted 0150-0205 Nov. 25 Man & woman in DD. Looped south, but better on LW. (no question as to lang. because my parents are Dutch.) who? (Surinam-600?) Heard several times since.First appears around 0100,peaks about 0300,gone around 0400. I heard a met of 49 meter band. (Stutterheim-NY) Matt phoned in this last info. But today as I'm typing this I received a mail gram with the following info which further deepens the mystery. -ed. Now that's dedicated reporting!!!-ed.
- 595 DOMINICA Definately s/off at 0240 & gave phone number so I called. He said that they are running 10KW AM & 60 watts FM. When I asked about DD programming he said they did none themselves but that he, too, has heard DD on 595 after his station s/off!! Dec.11.was date. (Stutterheim-NY) As this ment SW it is not likely Surinam as R. Paramaribo has no SW listed. Perhaps it is coming from R.Netherlands relay in Bonaire, Neth. Antilles. Maybe a new ECB tx. or else a strange spur from SW to ECB-ed.
- 615 UNID v.poor & rare carrier here 0205 Dec.2. but soon faded. HCMJ1 reported occupies this channel but its listed 50kw must be pointed the other way. (Thomas-FL) I heard Em.Gran Columbia last Spring for the only time. Their 50 kw sounds more like about 3 kw.-ed.
- 640 GUATEMALA Guatemala. LV de Guatemala atop the channel w/fanfare & ID's & chimes 0600 Nov. 30. (Thomas-FL)
- 640 NICARAGUA Managua gd.w/ment of Sandanistas & either YNSDR or YNFDR calls. (Thomas-FL) 0605 Nov.30.
- 655 UNID CL piano mx here w/OM in sS 0452-0455 Nov.25.(Stutterheim-NY) YSS in El Salvador -ed.

- 655.7 UNID Weak carrier hetting YSS-655 at 0406 Dec.4. There's an HC listed on 656 which given tonight's xlnr S. Am.cx is a possibility.(Thomas)
I checked WRTH 79 & 80 but could find no HC listed here. Could you let me know which one is listed here & where it's listed-ed.
- 720 CUBA Colon CMGN Dec.5. 0502-0515. Battling it out w/WGN. ID as R. Habana Cuba into vocal SS mx. Much SS political talk.(Zavatsky) (CT) welcome to IRCA & DXNW-E!! -ed.
- 725 SURINAM Paramaribo SRS xlnr w/slow male vocal ballad 2225 Dec.5(Con)
- 725 COSTA RICA San Jose TILA Dec 5 0528-0545. Fair w/instrumental mx by YL ancr. at 0530 K.Columbia ID. (Zavatsky-CT)
- 743 UNID Fair carrier, no audio, hetting another UNID on 744.3 at 0410 Dec.4. (Thomas-FL)
- 744.3 UNID poor carrier here 0218 Dec.2.& most other nights w/ occ. bits of SS male vocals but no ID. (Thomas-FL)
- 779.8 UNID LA whipping a ferocious het on usual Cuba/wBBM-780. The low side LA had boisterous SS screaming & frequent use of reverberation. No definite ID was extracted- this heard at 0121 on Dec.4 & on some other nights as early as 2230 GMT. (Connely-MA)
- 814.1 UNID Weak carrier detectable after the HC-815 s/off 0503 Dgc.2.(Thom)
- 815 ECUADOR Finally can assign a country to this long standing UNID. Noted w/HC NA & R.??? (2-3 syllables) at 0503 Dec.2. S/off. Audio is very undermodulated so a complete ID is going to be Tough(Thomas)
- 825 ST. KITTS Basseterre makes it in well every night: heard at 2227 on Dec.1 w/a dramatic religious presentation. (Connely-MA)
R.Paradise noted 2324-2340 Dec.4. V.g.d.w/RIG pgm in EE. at 2330 ID by OM into more RIG pgm after ID.(Zavatsky-CT)
- 834 BELIZE Belize City R.Belize 0320-0335 Fair w/OM ancr. in EE talk on local events, ID's, TC's, also commercials. (Zavatsky-CT)
- 835.5 UNID Pretty good(in fact best ever) carrier here 0055 Dec.3 but audio covered by Belize. HC's good tonight so HCC-1 a maybe(Thomas)
- 960 COLOMBIA Magangué mixed w/WFGL : fast SS talk w/Sutatenza & Colombia ment's.0130 Dec.4.(Connely-MA)
- 1010 Regarding my tentative report of YVQE. what I ment to say was that it was so far u/WINS that I'm not 100 % sure.(Kaz-NY)
- 1070 VENEZUELA Maracaibo YVMA good w/Mundial Zulia ID o/WIBC w/ CB: nulled, 0147 Dec.4- hetted by HJAG about 100 Hz low. (Connely-MA)
- 1080 HAITI Port-au Prince 4VRW noted w/soft spoken man & woman in FF o/u SS LA w/WTIC nulled. 0152 Dec. 4. (Connely-MA)
- 1080.3 UNID SS talk fierce het on WTIC: audio of the LA (rxed in the 1Khz selectivity position was too mushy for a good ID 0224 Dec.4.(Con-MA)
- 1100 COLOMBIA Barranquilla HJAT loud w/SS ads, jingles, shouting way atop Second SS LA, 0142 Dec. 4. (Connely-MA)
- 1110 VENEZUELA Carupano YVQT dominate w/ Caracas phone numbers, Banco del Caribe ad, Carupano & Ven. Ment's, ad for "Zulia- La Cerveza" (I feel that Heinekin or Molson are much better-ed.) 0201 Dec.4(Con)
- 1365 HONDURAS Danli. I Haven't heard this station here in the past several weeks. Have they gone?. (Thomas-FL)
- 1475.6 UNID weak carrier/no audio here 0241 Dec.2. Not looped Haiti but rather N-3. HC? YN?. (Thomas-FL)
- 1555 CAYMAN ISLANDS Good w/ ad for"King Cola", then sports pgm. 0008 Dec.4. (Con) King Cola must be better than Zulia Beer-hi-ed.
- 1555 UNID Heard w/ GSTQ at 0433 then carrier off at 0435 Nov. 25. (Stutterheim-NY) R.Cayman is back on 1555 now -ed.
- 1578a CUBA Cadena Agramonte outlet noted v. weak w/ het, bits of SS talk 0007 Dec. 4. (Connely-MA)

CONTRIBUTORS:

Mark CONNELLY 30 William Rd. Billerica, MA 01821- HQ 180A, TrF, Car rx, W2.
Matt STUTTERHEIM Rd-1 Box 702, Glenford, NY 12433- Collins 51-J-3. 100'lw.
Sanserino loop w/blown FET amp.
Gerry THOMAS POB 2036 Pensacola, FL 32503- Mod-frog, Mod-SPR-4, loops & lw's.
Mark ZAVATSKY 196 Figlar Ave. Fairfield, CT 06430 DX-160, Box loop, lw.

It's good to welcome two new reporters this issue. 73's & have very Merry Xmas DX - KAZ

Besides double typing some letters, this typer now likes to double skip lines occasionally. Someday this column will look perfect. (Yeah, maybe after I retire!!)

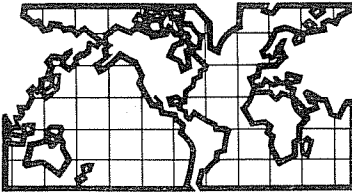

DX WORLDWIDE - WEST

Pat Martin - Editor

P.O. Box 843, Seaside, Oregon 97138

(503) 738-3198 - deadline Tuesday

The Latin conditions continue to be pretty good. Bruce Portzner even logged YNGR-620 over KGW-Portland. On with the reports:

PAN-AMERICAN DX ROUNDUP

- 620 NICARAGUA, Managua-YNGR battling KGW and generally winning w/Rockish vocals, ID's w/electronic noises and ments of Managua and Nicaragua from 0247 to 0302-11/30. (BP)
- 815 UNID, carrier w/bits of mx at 0732-11/30. (BP-Wa)
- 830 UNID, SS strong w/many R. Reparista or similar ID' , "...para 3 de la manana" TCS and S. American type mx-0710 to 0750-11/30. One ad mentioned Bogota and Guayaquil. Nothing close listed (naturally). Colombia w/new slogan??? (BP-Wa)
- 870 UNID, SS briefly o/WML w/Raygun noises in middle of song at 0440-11/30, then SS talk w/poss. R. (2 syllables) ID. (BP-Wa)
- 880 MEXICO, Los Mochis-XEPMK, good o/KRVN w/mx, ads, and canal 88 ID's from 1323-1343-11/30.
- 890 HONDURAS, local quality w/ R. Honduras ID, then play by play of some sport-0230 (BP-Wa) 11/30. (BP-Wa)
- 910 MEXICO, Mexicali-XEAO o/local KIXI w/R. Mexicana ID-0509-11/30 (BP-Wa)
- 975 UNID, bongo mx and SS talk 0752-0818-11/30. Fait to nil-likely Costa Rica. (BP-Wa)
- 1120 UNID, SS talk and slow romantic SS vocal song 0356-11/30, during KPNW fade. (BP-Wa)
- 1150 MEXICO, Mexicali-XERM-good w/ R. Sensacion ID at 1259-11/30. (BP-Wa)
- 1370 UNID, SS o/u KAST/KEEN at 0405-0459 11/30. Caught one R. Noventa or similar ID. (BP-Wa)

TRANS-PACIFIC DX ROUNDUP

- 155 USSR, Khabarovsk-0855-11/4-Fair with RR Mor mx, // to 191. (RET-Ca)
- 182 USSR, Petropavlovsk-0856-11/4-Fair sig. w/RR pgm, not // to 191. (RET-Ca)
- 191 USSR, Blagoveshchensk-0854-11/4-Loud sig. w/RR talk, Mor mx (RET-Ca)
- 200 t USSR, Yakutsk-vy weak RR talk noted here // to 182, 0853-11/4. Irkutsk w/250 KW is also probable here, although Yakutsk is alot closer. (RET-Ca)
- 236 USSR, Magadan-1050-11/4-Good sig. w/RR talk. (RET-Ca)
- 245 USSR, Vladivostok-1052-11/4-good signal w/RR talk. (RET-Ca)
- 550 ALASKA, Anchorage-KENI-hrd. again o/KMWI, but only w/loop, not LW. Noted w/rr mx and Radio 55 ID's. Anything besides KMVI or KOAC at night is rare on 550, hrd at 0928 on 12/3. (PM-Or)
- 567 NEW ZEALAND, Wellington-2YA hrd. w/National prog. at 0930-12/3. (PM-Or)
- 585 USSR, Svobodnyy-Moscow chimes IS poking through severe sloop at 0930-11/20. Nothing else noted. This IS really cuts through the crud. Are they thinking of DXers? (RET-Ca)
- 590 HAWAII, Honolulu-KGMB w/Sports talk show at 0830-12/3. Was looking for new call change but hrd. ancer say "KGMB-590", o/u KHQ/KUGN/etc. (PM-Or)
- 650 ALASKA, Anchorage-KYAK, hrd. good w/C&W mx, TC and temp. at 0911-12/3. (PM-Or)
- 657 NEW ZEALAND, Wellington-2YC hrd. w/cias. mx and low key ancr at 0945-12/3. (PM-Or)
- NORTH KOREA, Pyongyang-good w/KK talk at 1105-11/19. (RET-Ca)
- 660 ALASKA, Fairbanks-KFAR, poor w/TVI, noted w/rr and -10 degrees at 0921-12/7. (PM-Or)
- 666 NEW CALEDONIA, Noumea-hrd. fair w/OM in FF, modulation a little beeter than normal, at 0825 on 12/4. Maybe to word is getting around on their low mod. (PM-Or)
- 700 ALASKA, Anchorage-KBYR hrd weakly w/rr mx at 0918-12/3. (PM-Or)
- 750 ALASKA, Anchorage-KFQD hrd. well almost local quality at 0845 on 12/2. (PM-Or)
- 756 CHINA, CPBS good signal at 1050-11/19, CC talk. (RET-Ca)
- 780 ALASKA, Nome-KNOM hrd. fair o/WBEM at 0856 on 12/3, with C&W mx. (PM-Or)
- 783 NEW ZEALAND, Wellington-2YB hrd. w/EZL mx at 0955-12/5. (PM-Or)
- NORTH KOREA, Pyongyang-poor w/KK ranting at 1055-11/19. (RET-Ca)
- 864 JAPAN, UNID station w/OM and YL DJ's, Pop mx (Xanadu-aargh)-Fair at 1020-11/19. (RET-Ca) Sounds like one of the HBC stations, poss. JOQF at 3 KW)
- SOUTH KOREA, Gangneung-ILKR at 1025-11/19, weak KK talk, // to 3930 SW. (RET-Ca)
- 990 HAWAII, Honolulu-KHVV, good w/ABC nx at 0900-11/10. Hi. nx at 0905. (RET-Ca)
- 1008 AUSTRALIA, Brisbane-4IP, good o/NZ with hyped rr ancr. at 0814 on 12/7. (PM-Or)
- 1035 NEW ZEALAND, Wellington-2ZB hrd. w/Tonight Show at 1009 on 12/7. (PM-Or)
- 1044 NEW ZEALAND, Dunedin-4ZB hrd. // to 1035 w/Tonight Show at 1010-12/7. (PM-Or)
- 1107 AUSTRALIA, Sydney-2UW-fair w/ OM in mx at 1101, into Pop mx, after wx at 1106 on 12/7.
- 1116 AUSTRALIA, Brisbane-4BC, hrd. w/Jingle at 1117 on 12/7. (PM-Or) (PM-Or)
- 1287 JAPAN, Sapporo-JOHR weak at 0845-11/10 w/JJ talk and mx. (RET-Ca)
- 1467 JAPAN, NHK 2 synchros at 0840-11/10, w/ JJ talk, // to 747. Always nice to hear JJ w/ 1 KW of power! (RET-Ca)
- 1476 USSR, Vladivostok-weak w/Moscow Chimes at 0959-11/20, then faded under humming sound on freq. (RET-Ca)

1503 JAPAN, Akita-JOUK-w/JJ talk at 0820-11/10. (RET-Ca)
 1575 ?? USSR, 0243 to 0310, looping NW, fair sig. good to occ. fading, WW prog. talk on Moscow Arts, symphony pgm. w/EE comments. ID as Moscow radio at 0245. N. A. serv. of R. Moscow and NA chimes at 0300-YL talk til fade out at 0310, freq. given as SW and 500 M. MW. (JH-Nv) (J. Hart-Are these times right? at 0300 it would be about Noon in Eastern USSR. Never hrd. English Service on 1575 KHZ, but there is a RR service (low power). Sounds like it may be a SW image. FM)

VERIES

639 NEW ZEALAND, Alexandra-LYW, reg. R. NZ card in 3 weeks-2KW. (PM-Or)
 702 JAPAN, NHK sent routine vq and R. Japan stuff in one month. (BP-Wa)
 828 AUSTRALIA, Sale-3GI sent v/l in 2 weeks. vs Colin Barrett, Regional manager. Address is P.o. Box 330-Sale 3850. (BP-Wa)
 882 NEW ZEALAND, Auckland-LYC sent vq and friendly letter in 6 weeks, v/s Barry Hartley Senior technician-address: P.o. Box 2209-Auckland. (BP-Wa)
 1044 CHINA, my recent verie should have been for R. Peking JJ service, not Guizhou PBS. (BP)
 1062 CHINA, Guangdong PBS vq rec. in 4 weeks from Peking-veris ll from China. (PM-Or)
 1323 FIJI, Rakiraki-nice v/l and card in 6 weeks for taped report. Verie signer: S.B. Raniga-Advertising Manager. (PM-Or)
 1350 NEW ZEALAND, Rotorua-LZC-reg. vq w/friendly letter in 3 weeks-verie 60 from NZ. (PM)
 1575 CHINA, Wenzhou PBS card rec. in 3 weeks. (PM-Or)

THANKS TO THESE REPORTERS

J. HART - P.o. Box 644-Carlin, Nv 89822 -Receiver-Panasonic RF-594 AM/F, port.-SM-2,1600 * Bev.
 BRUCE PORTZER-6546 19 NE-Seattle, Wa. 98115-FRG-7,2300 ft. NW/SE Bev.
 RANDY TOMER-1969 27th St.-Arcata, Ca. 95521-HQ-180A-SPR-4, Barbed Wire Fence ant.-Ground syst.
 YER EDITOR- E.H. Scott rx-230 foot LM/Loop-Ground System.

(Swap and Shop...continued)

WANTED RECENT EDITION OF " BROADCASTING YEARBOOK " (NO MISSING PAGES) . WRITE STATING CONDITION AND PRICE (VIA UPS OR USPS)

WANTED ANY EDITION OF THE RADIO SPECTRUM HANDBOOK BY JAMES M. MOORE. WRITE STATING CONDITION AND PRICE (VIA UPS OR USPS)

MIKE HARDESTER - 574 DEER SPRINGS ROAD - SAN MARCOS , CALIF. 92069

FOR SALE TWO COLLINS R-392 RECEIVERS. FREQUENCY COVERAGE IS 500 Kc TO 32 Mc. SELECTABLE BANDWIDTHS OF 2,4, OR 8 Kc. WITH POWER SUPPLY - \$175.00. WILL DELIVER UP TO 300 MILES.

FOR SALE COLLINS R-390A RECEIVER. 500 Kc TO 32 Mc. EQUIPPED WITH MECHANICAL FILTERS. PRICE - \$ 350.00. WILL DELIVER TO 300 MILES.

FOR SALE PANASONIC RF 2200 PORTABLE AM, FM & SHORTWAVE. THIS UNIT HAS ONE OF MY DIGITAL READOUTS FOR AM. PRICE - \$ 180.00 & I WILL SHIP THIS ONE.
 RALPH SANSENER - 8422 CRANE CIRCLE - HUNTINGTON BEACH, CALIF. 92646
 PHONE: 714-536-3198 - NO COLLECT CALLS PLEASE!

WANTED DRAKE MS-4 SPEAKER AND AL-4 LOOP ANTENNA.
 TIM O'HARE - 20023 84th W. - EDMONDS WASH. 98020

WANTED. Diagram for ITT Mackay Marine 3010 Receiver.
 David J. Ronecker, 212 Yale Avenue, San Antonio, TX 78201

A Combination that Can't be Beaten

For Results...real long-distance signals on short wavelengths you can't beat the

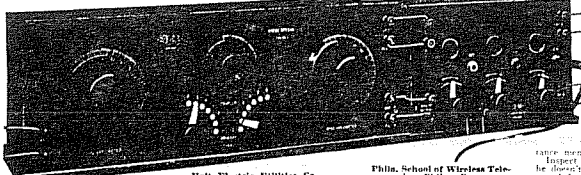

Grebe Receiver (Type CR-3) and Detector and 2-Stage Amplifier (Type RBH)

This is the outfit which made a reputation for itself in the recent QSO tests. You can get into the Big Boy game and become one of the dependable long-distance men with this outfit. Inspect this outfit at your Dealer's. If he doesn't carry our line at yet, drop us a post for catalogue, mentioning his name.

Darkey-Towler Electric Co., Lansing, Mich.
 Continental Radio and Electric Co., New York
 DuPont-Hill Electric Co., Pittsburgh, Pa.
 Heister-Hill Electric Co., Houston, Texas

Holt Electric Utilities Co., Jacksonville, Fla.
 E. S. Katzenbach, Trenton, N. J.
 Bell and Phillips, Brooklyn, N. Y.
 Manhattan Electrical Supply Co., New York
 Parent Electric Co., Inc., New York City
 Geo. W. Parry & Co., Washington, D. C.

Phila. School of Wireless Tele-graphy, Phila., Pa.
 J. H. Pitts, Inc., Boston, Mass.
 Western Radio Electric Co., Los Angeles, Cal.
 Leo J. Metzberg Co., San Francisco, Cal.
 Central Radio Institute, Independence, Mo.
 Klumbe Radio Company, Kankakee, Ill.

A. H. GREBE & CO., Inc.
 78 Van Wyck Blvd.,
 Richmond Hill, N. Y.

"I WISH YOU A MERRY CHRISTMAS..."

EASTERN (THE COLUMN OF THE 80's) DX FORUM

Paul Mount
471 Emerson Avenue
Teaneck, NJ 07666

KARL FORDE 2714 N. LeClaire Chicago IL 60639

Nov 30

Time for a DXF to bring you up to date on what's been happening around here. How long has it been, Paul? (Last one was Mar 29-p) WCFL made the big switch to music a few weeks ago, but the station seems uncommitted in seeking any particular audience. During the first week, the DJ seemed to be playing records at random. I actually heard "Won't you take me down to Funkytown" between a Barry Manilow song and a Niel Diamond tune! As far as the local band scene goes, the news continues to be bad. I've heard that WJJD-1160 will be on nights sometime in the future, and WONX-1590 should be on with their nighttime authorization soon. WJPC-950 and WRMM-1410 are already on nights, and WLTH-1370, WEEF-1430 have authorizations. If WAIT-820 and WBEL-1110 manage to get unlimited approval just about every station in this area will be AM, and probably MSP! DX has been alright during November, but not as good as last year. Due to my schedule most DX has been at sunrise, with WRUS-610, WMIL-1330 and WAIV-600 all logged within the past few weeks. Veries have been few, I'll list them next time. The Chicago Area DXers (CADX) are publishing a bulletin again for the first time since 1974, and I'm glad to be a part of it. Speaking of CADX, I'll see you at the Holiday Get-together, I'll be the one dressed as a lizard. 73

MICHAEL JEZICRSKI 3908 Circle Dr. Brookfield IL 60513 (312) 447 3164 11/28

Thanks to all of you for your DX Records reports. What? I didn't contribute, you say. Well, don't you realize that DX Records is not just another passing fad? No, sir or ma'am, DX Records is the column of the future! (Just so it isn't called the column of the 80's, hi-PR!) The President and boD of IRCA has already decided to make DX Records a daily column, due to the incredible support from the membership. If you'll believe the latter, you'll believe the former. Please folks, more contributions? I'd like to throw a little fuel on the fire of stn formats. I really can't condemn the WL format that's taken the BCE by storm, since I've never heard it. However, one thing I've noticed about music formats is that, with some exceptions such as classical, the idea of the format is far different than the actual format. For instance, "adult contemporary", another popular format, ideally would be light pop, modern country, and some oldies from Streisand, Bathis, etc all mixed together. In some cases, such as on WCLR-FM or WEQY-FM here in Chicago, they do follow that mix rather closely. However, WRCK-FM, a local station which recently dumped its laughable disco format for AC has never budged from the T40 chart, and now even rebroadcasts (simulcasts?-p) WLS eight hours a day. WCLR will certainly play light T40 stuff like Air Supply or Christopher Cross, but will skip over the heavier stuff. WRCK won't skip a thing. Now somebody tell me that AC/DC or Devo are adult contemporary. It seems to me that that term is now used simply as a euphemism for whatever is popular. "Top 40" has the automatic connotation of teenager music, so why not slip in the word "adult" and then play T40? Easy listening is another example. That term is a nice way of describing Muzak, elevator music, or audio-sedation, whichever you like. I strongly resent stations that slither phrases like "Beautiful music above the noise" soothingly past me and follow those phrases with pop music twisted into monotonous string renditions that are specifically designed to pacify and nearly hypnotize listeners. This garbage is not beautiful, but is an insult to its listeners. (Or non-listeners, as it goes-p). Music, whether it be classical, rock, jazz, country, or big band, should be designed to entertain, not to prevent ulcer. Excuse me, I just heard the Muzak version of "Peg" and I think I'm going to be sick. I hope that all of the members of IRCA have a happy holiday season. Joyeux Noel. 73's Mike.

RCB GERARDI 1418 N. Lincoln Apt. D Benton IL 62812

30 Nov

Since I've not sent in a Forum for three years (sri Paul), I guess I'd better start with a re-intro. I'm 27 years old, single, and work for my town's police dept (midnight to 8 AM CLT) on the complaint desk, and also manage the apt complex where I live. I've been DXing for 13 years, from various locations in the US and outside the US. Equipment here consists of; a TRF 12-655, DX-160, 1943 Motorola (KW-SW) and a KW-SW Magnavox portable. Antennae are: an IRCA loop, 528 foot mini-beverage (n-s) and dipoles for the 10-15-20 meter Ham bands. My other interests include: flying

(RG-IL continued) photography, backpacking, camping, space exploration, history, and reading science fiction. I'm just starting to collect airchecks again, so if anyone would like to trade their locals for some of mine (St. Louis area & S. IL AMs-FMs, write. (Okay gang, he asked for it! -FRM) Also, being a considerable portion of American Indian, I'd be interested in receiving some airchecks of any stations that have programs in any Indian language! On the local scene, we received the biggest snowfall (7 in) in anyone's memory for TGiving, but I wasn't able to check how it affected local cx though. WSON-860 changed from C&W 1 Nov to "Oldies", still has a C & W flavor though to its promos, community spots, and syndicated features (like "Redneck" report). WGGH-1150 is requesting listeners to write the FCC and "pray" for them to get permission "to provide the area with 24 hr relig. broadcasting". As they put spurs all over the band now, it would ruin DXing here. KROK-630 is really promoting their new NBC affiliation, with many promos by NBC personalities, to counteract the old KSD image. More later. Paul, I will report often from now on, as forums are good sources of info. (Thanks for your first time Forum to me RG, would be nice to have more. Tape coming-FRM)

NICE ILLINOIS TURNOUT THIS TIME. LET THE MEMBERS KNOW WHAT YOU'RE INTO, TOO!

HARRY HAYES 9 Henry St. Wilkes Barre PA 18702 EST

It seems that everywhere that I dial lately that I pick up "The Music of Your Life" Just like you said, Paul, WFEL is now programming this pre-packaged garb. I have nothing against the music, some of it is interesting, but it is packaged like typical syndicated fare garbage. You can tune to any one of these stations and hear the same songs. The format even invaded Wilkes-Barre on WKRZ-1340, ex WBER. I have a feeling the format isn't going to last long. One station with a good format now is WCFL Chicago with an oldies format that seems all pre-1974 and no current hits at all. It's a nice escape. I don't know how long this format will last, knowing WCFL's "hat switching" policy. My last report to Bob Lazar didn't seem to make it thus I will say that it's been a good season so far. Almost all DX here has been the sunset variety, too many ANers and this seems to be where it's at anyway. Some catches so far, all at sunset: 10/7 WFIG-1290 SC 10/23 KOSE-860 AR 1 kw. 10/25 WDDY-VA 1420, WOLD-1330 VA, WLAT-1330 SC, WDIC-1430 VA 10/28 WHIC-1520 KY 1 kw. WVOE-1590 NC. 11/4 WVCY-1270 MI. 11/5 WDLR-1550 OH WIXX-1590 WI. 11/6 WATC-1290 TN 11/16 WARU-1600 IN 1 kw, WAWA-1590 WI 1 kw and I consider my best catch this season so far. 11/27 WNOG-1260 TN now 5 kw WUNI-1410 and WLAQ-1410 1 kw. Yes, the DX is there at sunset, folks, catch up on your sleep and do it at SSS. 73 (Editor's note: Normally long lists of DX aren't allowed in DX Forum - they belong in DX Roundup - but in light of Harry's report not reaching Bob Lazar I allowed it here-FRM)

SAUL CHERNOS 70 Ridge Drive Toronto, ON Canada M4T 1E6

Hello... I got all 'your' letters to WMLB from the DX test last June. Some are incredibly detailed. Letters came from WI, IL, etc - good going all! 1560 WQXR all night now! My favorite frequency for mass logging rats! At least they have a FM SP! Anyone want to trade TV Guides? Send a card or guide, and state in order of preference what area of Canada (by province) you'd prefer, & I'll send 'em off. I was at the bank and see IRCA cashed my check for their almanac, super. I'm looking forward to it (hint, hi!) It might help solve a few UNIDs here. The 1979 QSL v/s of the year was WCCO's Barbara TB Chopyak. Who will it be this year. WZIR-FM (NY) Bill Nichols, WMLB(CT)'s John Ramsey, or others. Who? Robert Bove of WKVA (no longer there)..was runner up last year, as he sent me a photograph of owner w/boa constrictor around neck and a nice blonde (not also around his neck, hi!). Barbara Chopyak wrote the friendliest letter ever. I'll send it in, perhaps on. I suggest all DX clubs, together, hold a QSL v/s of the year, and award a prize to both v/s and recipient (a small prize) (like exemption from having to verify for a whole year Hi?-FRM) Better go... all the v/s'ers are going to send me nice QSLs and I gotta be ready for a mail deluge. 73's and maybe CUN 7- Saul.

FRM- 471 Emerson Avenue Teaneck NJ 07666

Take this space to wish you all well during the holiday season. 73



CJRW
Gulf Broadcasting Company Ltd.
SUMMERSIDE
PRINCE EDWARD ISLAND



Western DX Forum ★★☆☆

IRCA—Serving the Broadcast Band DX'er Since 1964

Editor: Ric Heald • 814B Ohio Street • Vallejo, California 94590 USA

1980/1 Deadlines—Every **Wednesday** 10 Days Prior to Publication Date through 18 March 1981

(Note: **Tuesday** Deadlines Prior to U.S. Holidays and 3-Day Weekends)

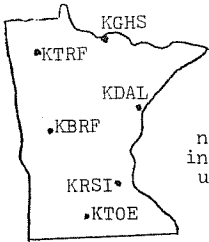

MARK LEWIS, 333 N. RENGSTORFF #11, MOUNTAIN VIEW,
CA 94043 - 01 December 1980

Got DXM #563 today and was surprised to learn that IRCA membership cards do exist. Don't leave home without one, hi. On a semi-related matter, I saw a copy of the "Complete Shortwave Listeners Guide" in a store and noted that it listed IRCA. However, it listed HQ as being in Riverside, California. Was this the old HQ or what? (Yes, unless DEE had a hand in that, hi. But it was HQ years ago-RtH.)

Belated congrats to you, RtH, on your KNBA job. How goes it on the broadcasting front? (It's modulating right along, hi-RtH.) I may break my normal rule of not logging California stations to log KNBA when you're on the air. At least it's a guaranteed QSL, hi. (Providing the report is IRCA/NRC standards and for a local report, deady accurate-RtH.) KNBA makes it here during the day with semi-local strength (average 38-42 on a scale of 60 on my homemade S-meter) but gets obliterated by KEX a short while before s/off.

My penguin pal list grows some more; add David Delatte of Jackson, Louisiana (near Baton Rouge), and a new IRCAnaut, Marc Crumpler of extremely local Sunnyvale. Marc is into both SW and MW and has persuaded me to try a little SW DX. Speaking of that; Santa, if you're reading this, I've been real good this year, and I'd like the DX-100 please, hi. Dave belongs to (get this) 17 other clubs, and is on the IRCA CPC. My connections throughout the country are growing. Next I'll conquer Canada.

As for DX; not too many catches lately, but here they are: KXEL, KXL, KLAD KYAK and a very tentative KUMU. RtH, do you have a list of stations that Alan Roycroft is the v/s for? (No-RtH.) QSLs in from WHB, KOA, WSB and CJOC.

I agree with RtH's forum concerning the hazards of DX'ing while still in school. I noticed myself slipping in studying time. One really must be careful when rationing their time. For that reason, I must end this forum, not to mention that I have nothing else to say. Till next time, 73 de ML.

JEF JAISUN, 12860 136th AVE. NE, KIRKLAND, WA 98033 - 02 December 1980

Ah, the joys of a Beverage antenna! Twenty-two-hundred feet of wire stretched over hill, dale, tree, neighbor's driveway, sticker bush and railroad track. The final 200 feet rested gently on the floor of Sammamish Valley, a healthy's stone's throw from the river. BP, PE and I braved the elements of Puget Sound's duck weather and aimed the beam rather SE, roughly 135°. From 4 PM PLT 29 November to 10 AM the next morning. DX rolled in like a total wave. Well, maybe like a rolling swell, hi. I counted 23 new stations officially, with a few others yet to be deciphered from tapes. Best catches include YNM, Managua 620 under KGW (1), KPIP 1110, KWSO 1050 and the new KROR 1360 Myrtle Creek, Oregon, o/u KMO at 8.22 AM PLF. A couple unIDs that aren't in my book include KNFO and KAQA, both 1340, heard around 8.45 AM, and a SS station that sounded like a K--- call, also 1340 at 0900. Anybody heard of these?

Seems we have a mystery on 990. The following MM, 01 December, I was hearing all kinds of things around Jazzbeaux on KKIS (now AN-7). At 0413 ELT to 0422, heard lots of heavy disco rock and soul stuff, including Kenny Loggins "This is It" at 0422. Not WNOX per call. At 0500 an ID surfaced out of some light piano music, sounded like "KNO-, 15, --- 99." By 0508 I had somebody doing a soul gospel-type rap, followed by very gospelly choir music. I thought KWAN, but isn't this too early for them? They didn't answer the phone. Does XET run EE religion MM? Thought I heard them still in SS. Well, in the 29 November WDXR I reported possible KKIS with soft pop and disco, only to be told by NH that KKIS is off at that hour (0410). (And KKIS is BFL/Mor-RtH.) This week they were definitely on, but with Al Collins. So who's running the soft stuff and the gospel and the disco? Looping ESE. Oh yes, in the disco segment at 0420 I heard a chicken rock announcer blurt something about "Monday morning... Christmas season...".

weather back to normal, rain (?)." Ach, you don't suppose a KJR spur?!?! (Merry Christmas, hi-RtH.) It all brings back RW's report of 15 December, when he also heard the choral music.

Hey, RW--did you ever find out who it was? As an addendum, bp recalls hearing an ET several years ago that sounded like KNON, and he never did manage to track 'em down.

On a different note (B^b), I see that KKNW 1510 expects to be on the air by Christmas. I just about croaked when I saw what the new owners paid for it; \$32,000!! This is the station I'd been trying to research through the FCC, who never responded to my letter. For that price, IRCA could have floated a loan and run the station for MW ET's, hi. And Tracy Mitchell, PD, says KJR will NOT go CW. Sorry Ric, just a rumor with no credence, clearwater. (I'll bet mountain daredevils there's no revival, hi-RtH.) 73 de JJ.

DAN BRINKMANN, 509 PARK DR., #10, SUNNYSIDE, WA 98944 - 03 December 1980

Hello. I'm a new member to IRCA as of October 1980. I finally decided to write after receiving 5 DXMs. I began DX'ing 10 years ago and didn't know that there was a club whose members did the same thing. My first receiver was a Standard Electric (about 100 years old). Doing a paper for class late one night, tuned in to a talk show which turned out to be the late Ira Blue on KGO. I was amazed as I lived in Tacoma at the time. I then discovered that there were hundreds of stations I could hear. I began keeping logs four months ago, then found out about verifications. Boy did I miss out.

Current receiver is a Realistic DX-200 with a longwire antenna (until I can afford a better receiver). Hoping to get an amateur license in the near future, but learning code is a hassle.

Since joining IRCA, I've heard 42 stations, 13 states, four provinces. Only WHAS is verified, unfortunately.

I would mention stations here, but this place is so small that if we had a station it could cover the entire area with less than a watt of power from a coat hanger -- wait, we do have one station, KREW 1230. Format is contemporary with news and some talk. It is hard to distinguish from reception levels of Tri-City and Yakima stations at night even though I have never caught them going to reduced power at night.

Inviting and BCB DXers in the area to drop a line or call me at (509) 837-7992, when nearby.

Just caught KOY 550 Phoenix, called, and got verbal confirmation. Good catch for me. DJ announced it on the air, then said is was 51 degrees and only 25 degrees here. 73. (Welcome to IRCA and WDXF, Dan. Many thanks for the phone call; enjoyed chatting with you. Please report as often as you can-RtH.)

BRIAN ALLEN, 1035 KERNER WAY, LA HABRA, CA 90631 - Rcvd. 04 December 1980

Greetings from the fine city of La Habra. I thought it was about time for an intro. I've been a member of IRCA for only three years, so I decided not to waste time writing my first forum.

I'm 20, single, and have been BCB DX'ing for seven years, on and off. I don't have any impressive totals to give you, but that's because I try to take my time and send out the best quality reports I can. I can't stand sending out reports and getting no reply; it's downright disgusting. Even though not all stations reply, I want to give it my best shot.

Receiver here is a National NC-200 with your basic two-foot spiral loop.

I am extremely pleased with my receiver, but a change must come with my antenna. The more I read about them, the less I understand. I may be forced to order some IRCA reprints.

Best catches include KWWT 540 Ft. Dodge, Iowa, a daytimer testing one night, and WHAM 1180 Rochester.

I'm not good at long letters, so 73 and good DX to all. (Welcome to the famous WDXF and IRCA, Brian. Please forum whenever you can-RtH.)

DENNIS VROOM, 1128 PORTLAND AVE., #6, ALBANY, CA 94706 (415) 526-8136
Rcvd. 04 December 1980

Hello. This is my first forum in about ten years. I dropped out of DX'ing about nine years ago and have renewed my interest in DX last September. I'm 30 and began DX'ing in 1966. I work for the Ford Motor Company in Richmond. My totals are 342/56, states 32/23, provinces 5/3, countries 24/10. Foreign totals are 68/10, including Alaska and Hawaii. My 24th country, Tonga 1017, was added to my totals on 23 November. I've been trying for this one since 1968. Was heard at 0049 PLT with talk and a weak

signal. KTNQ 1020 causes quite a bit of interference.

Kirbati 846 was also heard that morning with a fair signal and South Pacific music.

Seven reports sent out this season with five returns. HLAZ 1566 S. Korea, QSL, program schedule, FEBC information; JOBB 828 Japan, QSL and R. Japan newsletter; 2GF 1206 Grafton, NSW, Australia, QSL, letter, travel brochure and stickers; WSB 750 Atlanta, QSL; KRVN 880, two coverage maps for day and night. The two stations I have not heard from are KNIX 1580 and KKAA 1560. Do these two verify? (KKAA used to, and promptly-RtH.) Those two states are needed for veries here.

Receivers used here are a Hammarlund HQ-180C and a Panasonic RF-2800. The HQ-180C is the main receiver. Antennas are a four-foot altazimuth loop and an SM-1 loop. The four-foot loop is the main antenna.

Art Peterson, I have heard that echo-chamber-type signal here. The signal is always weak and the audio even weaker.

Brian Vernon (NRC) reports this station as being JOAR 1053 Japan. It has been heard at this location around 1000 GMT on various dates.

KORL 650 Honolulu was heard the evening of 28 November. K-65 news was heard at 2000 PLT. This is the earliest that I have heard any Hawaiian station.

The Japanese station on 702 that is being heard on the West Coast is probably JOKD Kitami. Two NHK stations are listed in WRHB: JOKD and JOFB Hiroshima. JOKD is located 900mi/1440km NE of Hiroshima, on Japan's northern island of Hokkaido. Both stations are listed for 10 kw. JOKD has been heard three times at this location. The next time JOKD is on, I will send them a report and will find out if my idea is correct. (Remember when JOKD was on 1370 and a regular pest?-RtH.) 73 and good DX. (Welcome back to WDXF, Dennis. Good to have another Bay Area DX'er.-RtH)

FATHER JACK PEJZA, 3433 SOMERSET AVE., CASTRO VALLEY, CA 94546 - Rcvd 06 Dec

Because of a lack of time over the past few years, my forums have been few and far between. For the next few months at least, I will have more time on my hands, so perhaps I'll contribute more than I have.

From September to the early part of December, I attended the Vatican II Institute for Clergy Renewal in Menlo Park, California. Beginning in February, I'll be finishing up on a M.S. in Private School Administration at the University of San Francisco.

I'll try to DX a little more than I have for the past few years.

I too was saddened to hear of Mort Meehan's death. I always enjoyed talking with him at conventions and get-togethers. His friendliness will be missed by all who knew him.

Because of limited finances, I can't send out Christmas cards to many, so I want to wish all of you a blessed Christmas and a Happy New Year.

RALPH FIDYK, GENERAL DELIVERY, BEATY, SK SØJ ØCØ - Rcvd 06 December 1980

Hello from Saskatchewan to everyone. Weather here is weird; it's normal, hi. There is three inches of snow here; no problem.

DX has been good since August, but spare time is limited until later this winter. DX stations here are coming in loud as early as 1900 ELT. Speaking of time, what is the difference between ELT, EST and EDT? These terms have been used in the DXM. (Eastern Standard, Eastern Daylight, and Eastern Local. The latter, sort of an "inclusive language" term, hi-RtH.)

Several AM stations are getting quite dull in my opinion. They play a lot of so-called Hit music, Top 40 or whatever. I keep turning the dial if I want to hear the latest hits. Usually I listen to a station for more than a few minutes when I hear something interesting (often a specially put together selection of old and new music) or if it has local information.

Oh well, this is good for local stations. 73. (Welcome to IRCA and the pages of WDXF, Ralph. Always good to hear from your neck of the woods-RtH.)

GARY LARSON, 2806 LINCOLN, BURBANK, CA 91504 - 02 December 1980

Just got the Vallejo area phone directory. In the portion for Dixon I see there's a listing for KYLO radio transmitter, Pedrick and Tremont Roads. Where is the city of license. (Repeating from a previous forum, it's Davis and FM-RtH.)

I see there's a request line for KNBA (642-6397). (As per DXM #562, my forum-RtH.) If you should hear RtH while he's on the air (Noon-s/off, hi-RtH) you might give him a jingle and request a record. (Oooops, that's Saturday only folks--daily in the not too distant future-RtH.)

Have been able to hear KGOE 850 here after sunset, but 250 watts doesn't go far with KOA on.

RtH, is the area out in the Dixon vicinity flat or what? (As a pancake-RtH.) Is the ground damp and good for DX or regional reception. (Very dry and excellent for AM, FM and TV DX-RtH.)

RtH, I'm sure the tape of KTHO I got was BfL. It was AM too. Could they simulcast the FM? (Not sure. They may at night when 590 is KUGN/KFXM and blocks KTHO. But definitely MRK daytime-RtH.) Sorry about asking regarding KOLI.

In the current Fresno phone book there is a listing for KOLI AM and TV. Haven't heard them here yet. What is their format? It used to be BFL/MOR, I thought.

KNCO sounds like a place to begin in radio, hi.

W. George Elliott, if you see any CKOV promo things hanging around, please send a few my way.

Does anyone know if KGUD 1490 is live or automated? Once heard what thought was them with KROQ nulled, but 1490 here is bad.

Also got the Santa Barbara phone book. They list a KAVL, 721 Cliff Dr. Can't be two stations because KAVL is 610 Lancaster. Anyone know about them?

KBIK 1410 Lompoc is listed with a Santa Barbara number. Thought KROQ was an unusual AM station with transmitter on a hill. KBLS is on a Mountain Rd (Gibralter) in Santa Barbara. 73.

RIC HEALD, 814B OHIO ST., VALLEJO, CA 94590 Tele-Forum: (707) 644-0700 to 2200 PLT and prepaid - 10 December 1980

Gary, many AM stations have their transmitters on hilltops. For starters, KYA 1260 San Francisco atop Candlestick Hill. KAJO 1150 Klamath Falls, KYTE 970 Portland.

Good to see so many new members reporting. If you are a new member, why not drop me a forum telling about yourself, how you began the hobby, equipment, etc?

DX here has been severely hampered by noise. Started in the day after our first winter-like storm one week ago. Just driving around town sounds like a million light dimmers. Hope this clears up soon. Seems like every power line and transformer around the city is emitting noise.

Had some strange happenings around WKRP-West last Saturday. For some unknown reason, we kept cutting off the air. The VU meter on the board was at less than 40 db but the modulation monitor kept running in the red. We finally cut back to 250 watts. Natural'y the CE couldn't be found, hi. But what's strange, next day everything was back to normal and has been since.

Good to see Father Jack back in WDXF, hope you have a chance to realize your goal of more DX time. Sort of strange typing up a Castro Valley address again. For the newer members, that's where I lived when I first took over this section several years ago. Good DX location.

That's it this time. Keep 'em coming gang. And I, like Father Jack, am limited in the finances department this year, so will take this opportunity to wish all of you and your family a most joyous and blessed Christmas and a prosperous New Year. Good DX to all and to all a good night. 73 de RtH..

MORE THOUGHTS ON TAPE RECORDING FROM THE TRF AND OTHER PORTABLE RADIOS

by Mark Connelly

The purpose of this article is to update portable radio-to-tape recorder interfacing techniques initially outlined in the "Travelling DXer" article.

Several considerations were addressed:

1. The earphone jack is best used as a tape-out jack; a separate jack for stereo headphones should be installed for private-listening purposes. Earphones made for portable radios have too poor audio quality to be suitable for extended periods of private listening. The small earphone jack is to be modified to provide audio out and still allow speaker listening. This former earphone jack is treated as a tape-output only.
2. A local speaker/headphone audio level pot should be used so that adequate levels for recording may be put on the audio line without being too loud for comfortable speaker or headphone listening. The speaker or headphone volume may thus be adjusted without effecting the tape-record level set by the main receiver pot.

3. Impedance "seen" by the audio output transistor(s) should be between $4\ \Omega$ and $40\ \Omega$ under all conditions.
4. The receiver/recorder interface should accommodate a variety of tape recorder input impedances and acceptable recorder-input levels. Some cheap cassette portables have microphone inputs, but no auxiliary/remote inputs. Mike inputs usually call for a low-impedance, low-level signal. Some, however, call for a low-impedance/high-level signal. Auxiliary/remote inputs on cassette portables and the normal phono-jack inputs of hi-fi cassette and open-reel home component decks require a high-impedance audio input, usually between $500\ \Omega$ and $50K$. $5K$ is a good high-impedance-condition compromise.
5. Level-varying and impedance-varying interface components should be located as close to the tape recorder input jack as possible; to prevent hum pick-up a low-impedance/high-level audio condition should exist along most of the line from radio to recorder. This requires that the components used to match the tape-input characteristics be installed outside the radio on a small "Vectorboard" (incorporated into the patch cord) near the recorder end of the patch cord.
6. We may occasionally want to use both the speaker and the headphones. Instead of disabling the speaker by plugging in the headphones, a separate switch is used to turn the speaker off or on.

The modifications to the radio and the construction of the necessary patch cord are detailed in drawings to follow.

After performing modifications: Put the receiver on a clear signal at normal listening level after setting the $250\ \Omega$ local-gain (added) pot at lowest resistance (highest volume). Plug patch cord into recorder and make test tapes at each of the 3 switch positions (on the patch cord switch). If the audio is too low on all switch positions, increase the receiver's main pot, then adjust the installed pot to make the listening level comfortable again. Satisfactory audio levels should then be attainable. If the recording sounds good level-wise, but there is distortion or "motor-boating" (audio oscillation), try a different impedance switch position & make any necessary audio-level readjustments.

Figure 1 - Stock portable radio/audio connections to earphone jack & speaker, before transmogrification.

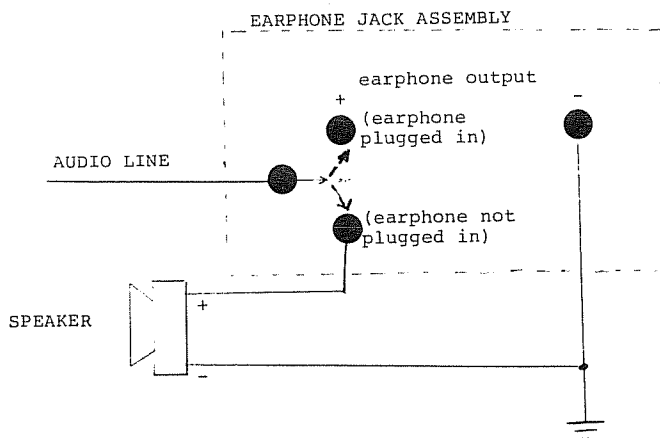

SUMMARY OF MODIFICATIONS

Figure 2 Drill chassis and mount a stereo headphone jack, a small 0 to 250Ω potentiometer, and a micro-miniature toggle switch at convenient locations on the radio. Wire these up, according to the drawing below:

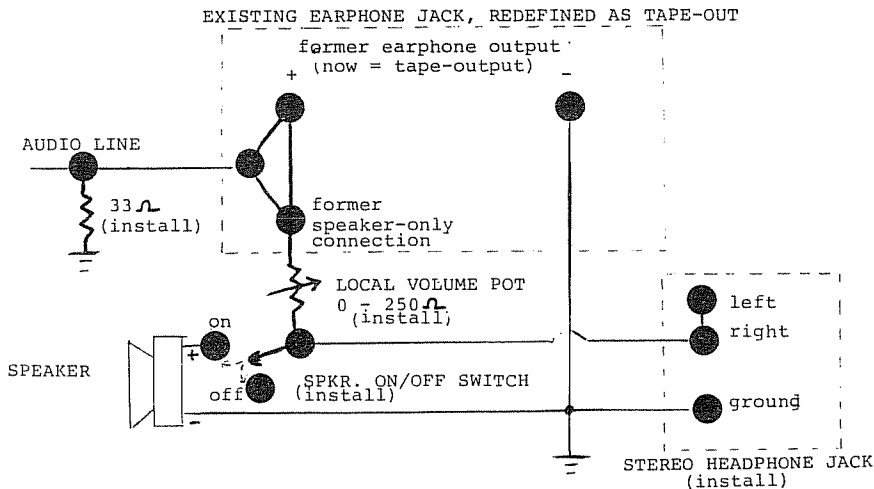
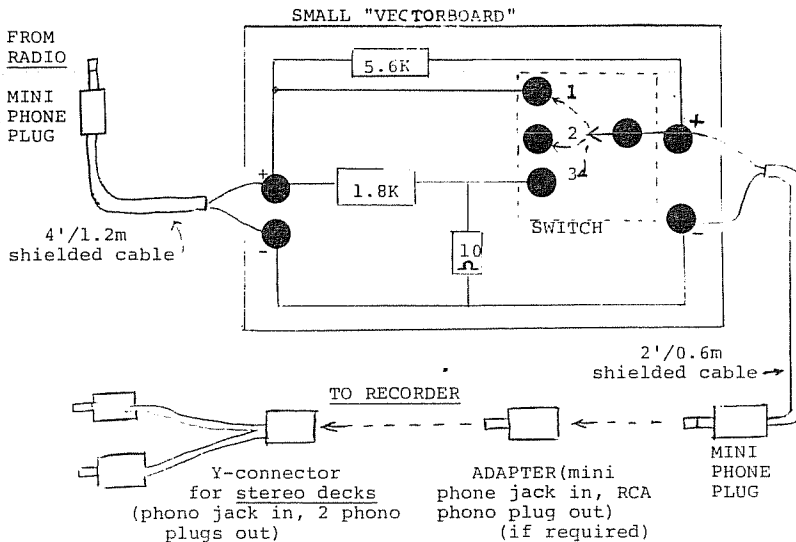
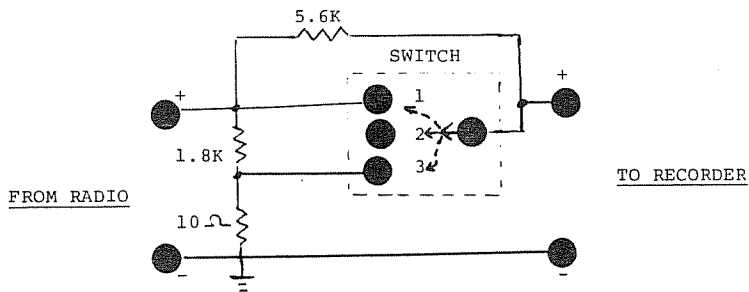

Figure 3 - Patch Cord Assembly (not drawn to scale) - outside radio.
Cut the patch cord 4'/1.2m from one end, 2'/0.6m from the other end.
Note: + = centre conductor of cord, - = shield (outer conductor).



NOTE: Switch used is an SPDT/ centre-open, 3-position type.
Switch positions in this application: 1 = Low impedance/high level out,
2 = High impedance out (centre position), 3 = Low impedance/low level out.

Figure 4: Schematic of vectorboard part of patch cord



APPENDIX

PARTS LIST

Inside radio (Figure 2)

- 33 Ω resistor Radio Shack # 271007 (pack of 2, only 1 used)
- 0-250 Ω pot { Cramer Electronics (Newton, MA.) 1979 catalogue, p. 179
- { Clarostat # 381L-250
- stereo headphone jack Radio Shack # 274312 (pack of 2, only 1 used)
- SPDT micro-miniature toggle switch Radio Shack # 275625

Outside radio (Figures 3 & 4)

Patch cord to tape recorder

- patch cord - 6'/1.8m Radio Shack # 42-2420
- mini-phone plug each end
- "vectorboard" " " # 276-1394 (only a piece of it is needed)
- SPDT centre-off toggle switch " " # 275325
- 1.8K resistor " " # 271-1324 (pk. of 5, only 1 used)
- 10 Ω resistor " " # 271-1301 (pk. of 5, only 1 used)
- 5.6K resistor " " # 271031 (pk. of 2, only 1 used)

Additional patch-cord accessories which may be necessary for some tape decks

- adapter: mini-phone jack to RCA phono plug Radio Shack # 274326
- stereo Y - adapter: phono jack to 2 phono plugs " " # 422435

TOOLS & MISCELLANEOUS ITEMS REQUIRED

Solder, soldering pencil, longnose pliers, wire cutters ("dikes"), wire stripper, X-Acto (or similar) knife, drill, drill bits of the proper diameter, solder wick or sucker, screwdriver.



A M
1450 KC.



F M STEREO
99.3 MC.

P. O. BOX 883
WILLIAMSPORT, PA. 17701



(Casey) Radio Center

P. O. BOX 870 / 3130 BLANCHETTE ST. / BEAUMONT, TEXAS



KOBQ / RADIO 145

P. O. Box 1056, Yuba City, California 75991

2614 Jackson Street
San Francisco, CA 94115
12-8-80

Dear Bruce,

I think your China list is certainly a major effort. However, its major fault is that it contains many of the geographic errors I made in my initial report of about a year ago, plus those carried on through the years by WRIVH, and even some which are in the FERC log. It looks to me like the FERC log loggings are correct, but they too, do not incorporate some boundary changes relating to Nei Monggol and Jilin. So using Monitor Vol. 18 #3, let's go through your report and do some updating.

- p.29 Under Fujian, the city s/b "Dehua"
Qinghai was "Tsinghai"; I have neverseen it as "Chinghai"
- p.30 The National program is broadcast 1200-1230 on C-1, C-2, and P-1 outlets (for the most part) but not on the C-2 schedules I have seen
- p.28 Xinjiang program schedules list Beijing time in them -- but the s/off and s/on times seem to be backed up two hours (s/off on most services is 1:30am Beijing time, and possibly 1:30 in Urunqi, but apparently they treat it like 11:30pm. Who knows?)
- p.31 The C-1 and C-2 stations do have the 5+1 time pips; most provincials have the same thing, but I did note one province which differed. Some of the locals have no time pips. "East is Red" was noted on the hour only, after the pips and an announcement pertaining to the time in Beijing; never on the half-hour. "Internationale" was heard only at s/on and s/off. (That's the 1st s/on and the last s/off.)
- p.32 About half of the provinces have verified for me.
- p.33 549 Zhangzhou is FJ, not JS
558 Jianyang is FJ, not JS
567 s/b "Hebei"
594 Wencheng is ZJ, not FJ
684 s/b Hebei. Tangshan listed
693 Jiangsu - delete. This was my error.
Sichuan - delete. My error. S/b Xian, Shaanxi.
702 TS - I believe this is JS with TS rather than FJ. Some of the old WRIVH's indicate this. The verie in EE simply said "the stations are in our area."
720v (varies 719-723) - JS with FS//1044
750 TS - pretty well confirmed as in FJ
792 TS - I believe this is Shanghai w/TS. Indicated in old WRIVHs.
837 FERC lists Wuhan local on 873. It is certainly not impossible to have both this purported 300kw C-1 outlet and L pging*. However, it was not listed in the SD newspaper programs as a C-1 freq., and 873, which certainly would not have 300kw with local programs, was/. *on 873
846 s/b Shanxi
909 Wencheng is ZJ
936 I think this is Hefei with TS, rather than FJ. Once again, old WRIVHs say so
1107 Hunjiang is JL, not IN
1224 Chengdu (not Chengdo) is in Sichuan (not QH)
1251 Xining QH is fulltime Mongolian
1314 s/b Kuzhou rather than Suzhou (both are cities in JS)
1440 s/b Liuzhou rather than Linzhou. This station carries some Mongolian programming for minorities in GX (so says the pgm. schedule)
1476 Wencheng is ZJ
Huangshi is in Hubei rather than Hebei
1503 The JL city is Liaoyuan, but this appears to be Liaoyang IN
1566 Ya Xian is in GD, not SD
1575 s/b Wenzhou
1593 Jingshan is in Hubei, not Hebei

In any case, I appreciate all the work you put in on this. WRIVH has always carried Wencheng in FJ, and who knows, perhaps a border shift did take EK place there, too. But it is definitely across the border in ZJ. I do have documentation on all the other stuff as well.

--- Pete Taylor

UNREPORTED STATIONS UPDATE

by Don Kaskey

The following charts list the total number of stations in the USA and Canada and the volume they were last reported as being heard.

IRCA--thru Volume 18 #9 (11/22/80)

	v18	v17	v16	v15	v14	v13	v12	Prior	Total
CANADA	159	134	28	14	8	1	2	53	399
USA	1208	1446	701	262	141	96	156	538	4548
TOTAL	1367	1580	729	276	149	97	158	591	4947

NRG---thru Volume 48 #6 (11/24/80)

	v48	v47	v46	v45	v44	v43	v42	Prior	Total
CANADA	183	120	18	18	6	8	2	44	399
USA	1210	1948	440	227	116	115	44	448	4548
TOTAL	1393	2068	458	245	122	123	46	492	4947

Additions to unreported lists: Brand new stations--LA-KNEK-1190, ~~OB~~-KLWJ-1090, AB-CKER-1480....

Deletions to unreported lists: The following stations have been reported as heard during Volume 18 (1 thru 9) by IRCA members;

Mark Connelly	(*N.S.)	VOCM-590-NF; NF-CFNW-790, NF-CFSX-910, NF-VOAR-1230, NF-CHYM-670,
F.Todd Skaine	(IA)	IA-KNIA-1320, WI-WISV-1360, MN-KWLM-1340, MN-WCMP-1350, IL-WJBM-1480,
Karl Forth	(IL)	AR-KURM-790, PA-WBUT-1050, ND-KXPO-1340, TN-WXQK-790, MO-KJCF-1400,
John Hart	(NV)	UT-KURA-1450, NM-KSVP-990, CO-KRLN-1400,
Mark Connelly	(*ME)	ME-WEME-1230, ME-WDME-1340,
W.P. Townsend	(DC)	VA-WKYY-1420, NC-WJIK-1580**, NY-WDOS-730,
Robert Kramer	(IL)	MI-WIKB-1230, WI-WXGO-1230, SC-WBZK-980,
Mike Jeziorski	(IL)	MI-WMIQ-1450, MJ-WSWG-1540,
Rich Toebe	(CA)	AK-KPRB-900, OR-KFLS-1450,
George Carter	(WY)	SD-KBFS-1450, ND-KHND-1540**
Neil Zank	(NE)	MN-KKOJ-1190**, AR-KTLO-1240,
John Sullivan	(NC)	FL-WSBB-1230,
David Wurl	(WI)	MB-CISV-1530**
Robert Wien	(CA)	AZ-KTBA-1050**
R.F. Kemper	(CO)	UT-KRPX-1080**
Bill Helms	(UT)	UT-KMTI-1590 (chg from 1340)
Karl Jeter	(GA)	LA-KJIN-1490,
Bruce Portzer	(WA)	AK-KBBI-1250,
Bruce Portzer	(*TX)	TX-KQIZ-1360,
Paul Mount	(OH)	OH-WYNO-1130**
Pat Martin	(OR)	AK-KCAM--790,
John Clemmer	(IL)	MS-WPRL-1190**
Rob Gerardi	(IL)	AR-KAPZ-710**
Bill Nittler	(CO)	NM-KNMX-540**

*=other than home location

**=new stations recently on the air...

KGOE Has 24 Hours in Every Day

By Ray Richmond

Valley News Staff Writer

Word finally came down late last week — after a long delay — that station KGOE-AM (850) has been granted permission by the Federal Communications Commission to expand its daily broadcasting hours to 24.

As was reported in the Valley News on Thanksgiving Day, the expanded schedule allows the 500-watt Westlake Village outlet to carry Los Angeles Kings hockey games and basketball from Cal Lutheran College, Pepperdine University, California State University, Northridge, and a variety of Valley high schools.

Along with the night sports coverage, KGOE continues to air Dallas Cowboys football, Notre Dame football and basketball, Saturday Sports Line with Los Angeles Lakers guard Brad Holland, and Dodger and Angel pre-game shows during baseball season.

That's it for sports. The rest of this story deals with KGOE's flip side — a side that often makes listeners forget they're tuned in to a station with less power than those serving most colleges.

Granted, KGOE is only a pint-sized closet community station serving an area blocked from most broadcast signals by mountains. It concentrates on the West San Fernando Valley, parts of Ventura County and the Conejo Valley.

This is also a station with a lot of chutzpah, however. It thinks it's big. How many 500-watt stations (and at night, only 250 watts) would:

- Send two reporters each to the Democratic and Republican national conventions?
- Follow Ronald Reagan up to his ranch near Santa Barbara for live interviews, alongside all the other boys on the bus?
- Dare to go out on a political limb by airing daily syndicated broadcasts, prior to this year's election, by Ronald Reagan, Max Rafferty and John Ehrlichman?

"We realize we're in an area populated by a mostly upper-middle-class, well-heeled crowd," says Jim Simon, the station's part-owner, general manager and part-time talk show host. "And the people are very, very conservative politically, so we gave them what they wanted."

It was only a bit more than two years ago that Simon, a former program and news director at KABC, bought the 9-year-old station. KGOE was playing bubble-gum rock 'n' roll and not much else back then.

Simon decided his best move would be to take his acquisition out of the gumball machine and into the community to drum up some interest.

The result has been an advertising tab up 45 percent over 1979.

By broadening its base, Simon emphasizes, KGOE has narrowed its emphasis so as not to compete with Los Angeles' bigger stations.

"We just stopped doing what everyone else is doing and started experimenting with what the big stations can't do," says Simon. "KNX, KPWB and

Valley News, 12-5-80, via Gary Larson

KMPK can cover the bases better, but they can't send a reporter to Thousand Oaks City Council meetings, or to a Pierce College event.

KGOE was, until last week, a dawn-to-dusk operation — on at 6 a.m., off when the sun went down. With the FCC red tape finally severed after a 10-year effort, the station now signs on at 5:30 a.m. and off at midnight.

The weekday schedule features adult, contemporary, album-oriented rock music from 5:30 to 6:30 a.m., followed by Newsblock (a news-commentary show a la KABC) with Simon and Ginny Pryor from 6:30 to 9:30 a.m. Then from 9:30 to 5 p.m. it's back to music with wild-and-crazy Scott Hayden (9:30 to 1 p.m.) and with mellow Randy Merritt (1 to 5 p.m.).

Another Newsblock is aired from 5 to 7 p.m., followed until midnight by sports. Simon says he has yet to fill the midnight to 5:30 a.m. block, although he's considering, among other things, "The Larry King Show" offered by the Mutual Broadcasting System, of which KGOE is a member station.

It's during the Newsblock shows that KGOE truly reaches out to its service area and makes everyone a part. The station employs local merchants and politicians to comment on everything from the price of poultry to the state of the stock market.

For example, a man who runs a precious-metals shop in Thousand Oaks, Martin Anderson, gives the "Gold and Silver Report" once weekly.

Brett Modesti, owner of the local Five-Star Meats, discusses the prices of meat and poultry in a weekly commentary. Tom LaPorte, a local stockbroker for Dean Witter, gives morning and afternoon stock-market reports daily.

Weekdays at 9 a.m., Ray Swierz, owner of Swierz Produce in Thousand Oaks, discusses produce, direct from his market. County Supervisor Ed Jones calls every Wednesday to give a five-minute update on the Board of Supervisors, and Congressman Barry Goldwater Jr. calls once a week from Washington.

KGOE even involves the mayors of Thousand Oaks, Madge Schaeffer, and Simi Valley, Elton Gallegly, who drop in to talk about what's going on in their communities. The whole area seems to be in on it.

Simon employs a full-time staff of 11, 7 part-timers and a host of stringers from local newspapers and schools.

"Just because we have a weak signal doesn't mean we can't do things big stations do. If our reporter has a microphone in his hand, someone will talk to him."

Its signal is weak, but Simon says his station still covers a broadcast area the size of the city of Seattle. It can be heard as far north as Santa Barbara, as far south as Universal City.

At night, power drops to 250 watts because Denver station KOA is protected on the same frequency by FCC sanction. Any more than 250 watts would interfere.

One other full-time radio station, KNJO-FM, and one public-service outlet, KCPB-FM, operate in an area with more than 100,000 residents combined in Thousand Oaks and Westlake.

"You can also hear us all through the San Fernando Valley, all through Ventura County," comments Simon. "There's a big community out there and not many of us covering it."

It Only Hurtes When Reading Today's News

Valley News 11-28-80 via Gary Larson

So you want to be in radio, huh? So you want to write news and read it on the air, garnering all the fame and prestige that accompany the job, do you?

What follows is a typical Monday morning in the life of KRTH-FM news director Hettie Lynne Hurtes — the station's one-person news staff.

4:30 a.m. — She steams in the door, scans the Los Angeles Times for the morning headlines, rips copy off the Associated Press, City News Service and RKO Radio Network news wires, writes the weather and calls the police and fire departments and the California Highway Patrol for traffic and other updates.

Most of the news concerns fires, being that this is the morning after Los Angeles' long Sunday of seven area blazes. So Ms. Hurtes busily throws together 10 to 12 minutes worth of copy for the first newscast at 6 a.m.

"From 4:30 to 5:30 is the toughest part of the day," she says. "I'm just running everywhere to pull it all together. It's insanity.

"I'm expected to do all of my own engineering, operate my own board, do all the tape cutting, decide which sound bites I want to use, write the news and manage to grab a cup of coffee in between it all."

5:34 a.m. — She grabs a cup of coffee, accidentally kicks it and spills part of it on her dress while taking a bite of a bagel. "Oooh! I'm trying to walk and talk at the same time, and it's just not working."

6:12 a.m. — She finishes reading her first of three long news segments of the morning (6, 7 and 8 a.m.) and welcomes funnyman London & Engleman into the studio for their 6 to 10 a.m. show.

"One thing I love about the job is how time passes so fast," says the blond-haired, hazel-eyed Ms. Hurtes from her office. She then turns her attention back to some wire copy and mutters to herself while crossing out lines here and there, adding here and there, cutting out certain paragraphs and taping others in place.

6:30 a.m. — "I'm on next," she shouts while running from room to room. It is to be the first of her shorter three- to five-minute headline-reading newscasts that she presents on the half-hour (6:30, 7:30, 8:30).

But, after entering the reading room and closing the door, she exits with a puzzled look on her face.

"I thought I was going on, but the computer didn't cooperate," she relates. "It didn't program me in to read now, so I can't. Oh well..."

6:33 a.m. — Ms. Hurtes is running late with last-minute corrections.

"As soon as Hettie gets in here, we'll have the news," says an impatient John London. "Hey, here she is, and she even showered this morning, too. Just kidding, Hettie."

She answers, "I was wondering what that was."

After the news, Ms. Hurtes says, "I try to read a bright, fun item at the end of every cast, unless it's a tragedy day. I have to listen to the news, basically, all

day and all night, to live it so I know what to look for. My car radio is always tuned to it.

"I have to know what the headlines are before I see the headlines, because I'm on my own."

6:37 a.m. — "Is Highway 57 closed?" London rushes in to ask Ms. Hurtes.

"What is this? You expect me to know this stuff right off the top of my head, little miss computer here," she answers with a smile.

"Is it?"

"Yes."

6:58 a.m. — Ms. Hurtes pours her fourth cup of black coffee and talks about pressure.

"I think most real good workers thrive on it," she says. "You have to thrive on that deadline. They have no idea how hard I work here. I guess they'd find out if they had to replace me."

Then she rushes back into the reading room, copy in hand, for the newscast as Ron Engelman amuses himself with a ping-pong ball outside. Her desire for perfection comes through when, after a sound spot is two seconds late coming on, she shakes her head, frowns and looks down at her desk.

7:36 a.m. — "Can you do a Boston accent for us, Hettie?" asks London. "We need a woman with a Boston accent for a bit coming on next."

"Well, I don't know but..."

"Thanks," answers London. "You'll be great."

She whispers, "I can't say no."

7:53 a.m. — She does the bit. To get the proper nasal accent, she squeezes her nose. It sounds more Mississippi than Boston, but at least all goes well.

"They expect me to be an actress along with everything else," says Hettie. "The key thing is organization. If I were a heller-skelter person, there is no way that I could survive what I do. But the attitude here is so neat. The more I do, the more fun it is."

8:04 a.m. — Disaster strikes. Ms. Hurtes wants to push the button on a sound cartridge for Jim David of the Los Angeles Fire Department but accidentally punches the wrong one, and on pops a Jack-In-The-Box ad.

"I've never done that before," she mutters in disbelief. "God, I'm not concentrating or something. And this coffee tastes awful." (She throw it away.)

Then it's back to the typewriter.

8:35 a.m. — Ms. Hurtes has just given her last newscast for the day. So now it's time to relax, right? Wrong.

"I devote the rest of the day, until 12:30 or 1," says Hettie, "to research, making calls, going through the mail, interviewing stars for the Sunday 'Spotlight' show and news people for the public-affairs show on Sunday and filing national movie reviews for the RKO Network."

She has been involved with the Los Angeles news scene since 1974, when she worked as a news anchor at KFWB-AM. In '75 she did weekend work as a newscaster at KHJ-AM, and in '76 she moved to television for a stint as news anchor on KCOP-TV, Channel 13, which lasted until '78.

Another short stint at KFWB followed prior to her taking the KRTH job in April 1979. Ms. Hurtes loves it, she says, because it allows her to do everything. That it does.

"I do have a social life, but nothing steady," she says. "I feel sorry for my dates, because I just can't keep a regular schedule and can never stay out late.

"But I don't consider myself a workaholic. I don't feel guilty when I'm not working, because... I'm never not working."

THE INTERNATIONAL RADIO CLUB OF AMERICA

A non-profit organization devoted to the hobby of listening to distant radio stations on the AM broadcast band (510 to 1630 kHz). IRCA is a member of ANARC, the Association of North American Radio Clubs.

OFFICERS: President: Father Jack Pejza, 3433 Somerset Avenue, Castro Valley, California 94546. Secretary-Treasurer: Rich Segalás, Board of Directors: Phil Bytheway, Nick Hall-Patch, Don Kashey, Paul Mount, Bruce Portzer, Susan Strulnick, Gerry Thomas.

MEMBERSHIP DUES: \$16.50 First Class to the U.S.A., Canada, and Mexico. \$20.00 Air Mail to the rest of the world via Canada. Air mail direct from the U.S.: \$25.00 to Central America, Caribbean, Colombia, and Venezuela; \$30.00 to the rest of the world. Sample copies cost 50¢ each or three International Reply Coupons. Make checks and money orders payable to I.R.C.A. Persons living outside the U.S. should send checks or money orders payable in U.S. funds. DUES AND ADDRESS CHANGES should be sent to Rich Segalás, P.O. Box 26254, San Francisco, CA 94126.

DX MONITOR, the official bulletin of the IRCA, is published $\frac{3}{4}$ times a year: weekly from October to March, twice in September and April, and monthly from May to August. PUBLISHING STAFF: Bruce Portzer (editor-in-Chief), Dave Korinek (Publisher), Evelyn Portzer, Nick Hall-Patch, Jef Jalsun, and Phil Bytheway. Phone: 206-522-2521 (Portzer)

THE IRCA GOODIE FACTORY. The IRCA Almanac, Foreign Logs, reprints, and other materials are available for nominal charges. For a complete list, write to P.O. Box 17088, Seattle, WA 98107.

Unless otherwise noted, permission is granted to publish, broadcast, or otherwise reproduce non-copyrighted material appearing in DX Monitor, provided credit is given to IRCA and the original contributor.

Opinions expressed in DX Monitor are those of the contributors and do not necessarily reflect those of the IRCA, its publishing staff, editors, or officers.

DX Monitor is printed by Save-on Printing, Seattle, WA.

IRCA

**P.O. BOX 21074
SEATTLE, WA**

U.S.A.

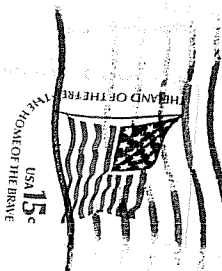
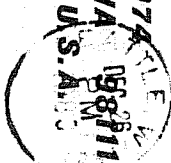

First Class

D.A. Nyholm
2071 Cedar Street
San Carlos, CA 94070

1981

**7 ISSUES LEFT
ON YOUR MEMBERSHIP
PLEASE RENEW EARLY.**