



# DX Monitor

Devoted Exclusively to  
Broadcast Band DXing

October 24, 1981

Volume 19, Number 6

Issue Number 593

## In This Issue

Eastern DX Roundup .....	2	500,000 Watt Station in Cuba? ...	9
President's Report .....	2	Western DX Forum .....	10
Central DX Roundup .....	3	Radio Rebus .....	13
Western DX Roundup .....	4	Phasing Unit Design Modifications	14
DX Worldwide East .....	6	Canadian Twins Revisited .....	19
DX Worldwide West .....	7	Unreported Stations List .....	22
CADX Announcement .....	20	Swap and Shop .....	20

## What's Happening?

NEW EASTERN DX FORUM EDITOR. Effective immediately, send your EDXF reports to our new editor, Rick Evans, P.O. Box 1294, North Wales, PA 19454. And not a moment too soon --- there's no EDXF this week because Paul Mount is swamped with school work. Our thanks go out to Paul for the excellent work he's done as editor during the past couple of years and our best wishes go out to Rick as he takes on the duties of editor.

WANTED: NEW VERIE SIGNERS EDITOR. Don Moore is joining the Peace Corps and moving to Honduras soon. His last verie signers column will be typed sometime around November 8. In the meantime, if you'd like to edit the column, get in touch with Don Kaskey.

SPOTLIGHT ON NEVADA. Steve Wittman reports that the deadline for Spotlight on Nevada will be two weeks from this issue (Nov 7). So far he's gotten two reports, so get with it gang.... For details on what to send in, see the Spotlight on Idaho in last week's DX Monitor.

FOREIGN LOG. The Ninth Edition of the IRCA Foreign Log came back from the printer's a few weeks ago. If you ordered one before October 15 or so, then it should be in your hot little hands by now. This year's Log has more information in it than ever before, including up-to-date lists of stations in Mexico, China, and Korea, Great Circle Bearings & Distances, articles on foreign DXing, plus summaries of schedules, programming, slogans, where heard, and how well heard, for hundreds of stations in more than a hundred countries. If you haven't yet ordered your copy, do it now...at \$5.50 for IRCA & NRC members, it's a real bargain, and it's available from the IRCA Goodie Factory, P.O. Box 17088, Seattle, WA 98107.

LITTLE BOXES. No, they're not made of ticky-tacky, but they all look just the same and they're great for storing DX Monitors. In case, you haven't heard, the Goody Factory also sells boxes which can be used for storing your DX Monitors. Each box measures about 10x7x4 inches, is open at the top, and will easily hold a year's worth of DX Monitors or similarly sized publications. If you want one (or a bunch), they're available for \$2.00 each from the Goody Factory. Order yours today, and never again worry about your DXMs falling on you in the middle of the night.

OTHER TRIVIA. Rob Harrington would like to hear from DXers who own a TRS-80 home computer and/or have used them for DX-related applications. His address is at the top of his forum report (inside....).....congratulations to Pete and Kristine Taylor on the birth of their son, John, on October 5.....Brian Vernon reports hearing KSKO-870 in McGrath, AK, a new station, with 0200 PDT s/off; also, KFRB-900 is now KCBF.....and as a repeat of last summer's announcement, the Canadian Coast Guard stations on 1630 kHz will be decommissioned on or before December 31, 1981.

I think that does it for this week's front page. For more news, look inside. 73, bp.

# EASTERN DX ROUNDUP

Bob Lazar, 1711 Wainwright Dr., Reston, VA 22090

Deadlines: Tuesdays

- 540\*WGTO\*FL\*Cypress Gardens, 10/12 0009 "WGTO on the air testing at 50kw.." by male CE. Xlnt. (WPT-DC)  
CBK SK Regina, 9/25 0213 fair w/ classical & MoR mx, ID. (RSR-ON)  
590 WOW NE Omaha, 9/9 0428 fair w/ Larry King show, ID. (RSR-ON)  
600 KSJB ND Jamestown, fair 9/9 0430 w/ time given 0330 CDT at KSJB, Jamestown wx. 3rd ND stn. (RSR-ON)  
730 CKAC PQ Montreal, 9/1 0341 fair w/ f FF singing, m FF talk. Mixing w/ XEX. (RSR-ON)  
780\*WABS\*VA\*Arlington, 10/10 2200 noted on w/ OC for several hours, maybe AN. (WPT-DC)  
850 KOA CO Denver, 9/27 0529 fair w/ m DJ w/ ID into mx "Venus". (RSF-ON)  
930 CKNS ON Espanola, 9/1 0348 good w/ rock mx, ads for Ellictt Lake, ID as KKNR. (RSR-ON)  
940 CJGX SK Yorkton, 9/9 0444 fair w/ m DJ w/ ID, into C&W mx, sports.(RSR)  
1060 WNOE LA New Orleans, 9/20 2351 good w/ C&W mx, wx, sports, ID. (RSR-ON)  
1260\*WEZE\*MA\*Boston, 10/5 0110 "This is WEZE Boston testing on 1260 kHz" by male CE. Good. (WPT-DC)  
(WWDC)DC Washington, 10/5 0107 noted off air. (WPT-DC)  
1280 CJJD ON Hamilton, 10/5 0135 ID by male DJ, library promo, C&W mx. Fair to good. (WPT-DC)  
1320 WJAS PA Pittsburgh, 9/20 2358 fair w/ "As it is" ID & into nx. Ex-WKTQ. (RSR-ON)  
1340 WAIR NC Winston-Salem, 10/12 0059 ID by woman. Fair then QSBEd into mudpile. (WPT-DC)  
1500\*WTOF\*DC\*Washington, 10/12 0119 noted on w/ OC. (WPT-DC)  
1510\*WPSI\*PA\*Monroeville, 9/22 0022 fair w/ TT, ID by m DJ. (RSR-ON)  
1560 WFSP WV Ringwood, 9/24 0630 fair w/ s/on ID, stn data by m DJ. (RSR-ON)

## EASTERN DXERS

RSR - Robert S. Ross, Box 4373, Stn C, London, ON N5W 5J2

(Realistic TRF, Marantz 2226, 40 m dipole antenna)

WPT - Bill Townshend, 4500 Connecticut Ave. NW #901, Washington, DC 20008

(Realistic TRF)

---

## PRESIDENT'S REPORT

Getting the ball rolling the BoD has received the routine proposals for re-confirmation of editors. Also sent to the BoD was a request for confirmation of Richard C. Evans as the new EDKF Editor. Two proposals by Rob Harrington & Chris Knight were submitted to the Board, one to move the Longitudinal line from 110 to 105 degrees, thereby allowing the Denver Area DXers to report to WDXR instead of CDXR. The other, submitted later, was to change our reporting procedures from longitudinal lines to time zones; i.e. MST-PST to WDXR, CST to CDXR & EST to EDXR.

St. Louis & Quad-Cities have submitted informal bids for our 1982 convention. After formal bids are received these will be submitted to the BoD.

To be submitted soon is another proposal from Rob Harrington to change the publishing schedule to be weekly September through March, twice in April & August and once a month in May, June & July + raising the dues to \$19.00.

Still needing a chairman are the following committees: Membership, CFC, Elections & DXWW-II. Anyone interested should contact me as soon as possible.

My family & I will be back in N.W. Iowa November 4-20 should anyone out that way be interested. Vacation address will be: c/o Lloyd Luce, Galva, IA 51020. Phone (712) 282-4414. *dkk*

# CENTRAL DX ROUNDUP

Robert Kramer  
6416 N. Richmond  
Chicago, IL 60645

## UnIDed, Special, Changes, et. al.

- 590 UNIDED 10/8 0126 call in pgm. RH-CO-F  
1320 WLOH OH LANCASTER, 10/7 0600 poor-fair W/S/On, ex-WHOK. KDF-IL
- All da Rest
- 570 WNAX SD YANKTON, 10/8 0120 W/ID, SID. RH-CO-F  
580 KOBH SD HOT SPRINGS, 10/8 1337 ID & RR mx, ad. RH-CO-FM  
590 KCSJ CO PUEBLO, 10/8 1331 Wx & ID. RH-CO-FM  
610 KCSR NE CHADRON, 10/8 1333 ad. RH-CO-FM  
680 KPEQ MO ST. JOSEPH, 10/8 1159, ID, nx. RH-CO-B  
690 KGGF KS COFFEYVILLE, 10/8 0111 S/Off good. RH-CO-F  
KEYR NE TERRYTOWN, 10/8 1146 C&W mx, ID. RH-CO-B  
730 KLOE KS GOODLAND, 10/8 1139 ID. RH-CO-B  
750 KMMJ NE GRAND ISLAND, 10/8 1138 ad. RH-CO-B  
770 KOB NM ALBUQUERQUE, 10/8 1346 ID "77 KOB", 5 S units. RH-CO-FM  
790 KKKX KS COLBY, 10/8 1136 ID. RH-CO-B  
880 KRVN NE LEXINGTON, 10/8 1133 ad & nx. RH-CO-B  
920 KIMR CO LAMAR, 10/8 1132 wx & ID. RH-CO-B  
930 KOGA NE OGALLALA, 10/8 1130 ID & wx. RH-CO-B  
1050 WYSJ OH CINCINNATI, 10/3 0755 in SRS mess W/rel., ads, TC, & legal ID. New, ex-WZIP. WC-KY (Sorry, this should have been in top section, ed.)  
1130 WCXI MI DETROIT, 10/3 0804 running Ai nx 1/2 word ahead of WISN, ad & sports. WC-KY  
1130 KESR ND BISMARK, 10/8 1347 ID. RH-CO-FM  
WISN WI MILWAUKEE, 10/3 0804 Ai nx, took Over freq. 1210 W/PSA, DJ tLk, Barry Manilow mx, fair-good O/mess, new. WC-KY  
1210 KGYN OK GUYMAN, 10/8 1349 ID. RH-CO-FM  
1250 WTAE PA PITTSBURGH, 10/3 ad for beer (no I don't drink) & sports show, fair in mess, new. WC-KY  
1270 WLIK TN NEWPORT, 10/2 1855 stn promo, C&W mx, good, new. WC-KY  
1280 WANS SC ANDERSON, 10/2 1902 sneaked through WDMN S/Off W/legal ID, then took over channel W/black mx, good, new. WC-KY  
WDNT TN DAYTON, 10/2 1900 nx, S/Off W/ment. of FM, fair W/WANS, new. WC-KY  
1290 WKLB KY MANCHESTER, S/On 9/26 1200 W/ad, C&W format. Sked is 0600-ISS (Sun. 0700-ISS), address is: 109 Richmond Rd. 40962. WC-KY  
1300 WERE OH CLEVELAND, 10/3 1955 broadcast live from an "Octoberfest", ID, stn promo, fair-good, new. WC-KY  
1330 WTRO TN DYERSBURG, 10/12 1930 poor W/S/Off SSB. KDF-IL  
1350 KIDN CO PUEBLO, 10/8 0205 weak ID U/mess. RH-CO-F  
1390 WANY KY ALBANY, 10/10 0659 1/2 fair W/S/On. RK-IL  
1420 WIMS IN MICHIGAN CITY, 10/3 0820 ad, wx info, T40 mx, good O/slop, new. WC-KY  
1440 KPUR TX AMARILLO, 10/8 0211 very strong (30 db) RR mx, ID. RH-CO-F  
1450 WDNG AL ANNISTON, 10/10 2326 fair W/ID. RK-IL  
1480 WTHI IN TERRE HAUTE, 10/3 1908 C&W mx, TCS, ads, IDs, good, new. WC-KY  
1500 KIEL AR JACKSONVILLE, 10/12 1946-1954, good W/KEZQ-FM ID, spots, BFL mx, @ 1954 about 30 secs. of dead air then S/Off by BFL mx jock. Me thinks they forgot to S/Off. RK-IL  
1550 WCTW IN NEW CASTLE, 10/2 1925 fade up W/lcl ad & ment. of New Castle, ad, wx, ID, PSA, fair in mess, new. WC-KY  
1590 WVNA AL TUSCUMBIA, 10/2 fade up W/several lcl ads & ment. of Tuscombua, good. WC-KY  
1600 WEUP AL HUNTSVILLE, 10/3 0825 SID, sports scores, ment. of AL A&M FB broadcast, good & gone to UNIDED T-40. WC-KY

## Responsible Parties

- WC... WHEELS CONOVER RR #8, Box 344B, MANCHESTER, KY 40962  
(RP-2800, LW, cow)  
KDF... KARL FORTH 2714 N. LECLAIRE CHICAGO, IL 60639  
(HQ-160, loop, hog)  
RH... Rob Harrington 3181 S. York Englewood, CO 80110  
Laying down rubber in the following locations:  
F.... Ft. Collins W/R-1000, LW & loop  
B.... Briggsdale W/R-1000 & LW  
FM... 20 miles north of Ft. Morgan on side od Highway 52 W/R-1000, LW  
RK... Boy, I never thought I'd get to him  
(R-1000, HQ-129X, Radio West loop, spiral loop, chicken)

## RK'S PROGRESS REPORT

	<u>LAST WEEK</u>	<u>THIS WEEK</u>	<u># NEW</u>	<u>TO GO</u>
HEARD	2944	2949	5	51
QSLD	1995	1997	2	3

Nancy Hardy  
2301 Pacific Avenue  
Aberdeen, WA 98520

# WESTERN DX ROUNDUP

All times are  
Eastern Local

Phone for hot WDXR tips: (206)532-6827 till 10:30pm(PLT)--no collect calls

DEADLINES: Thursdays 10/29, 11/5, 11/12, Wednesdays 11/18, 11/25

## REPORTERS FOR THIS ISSUE:

(WJH) Bill Harms-University Station P.O. Box 7428-Provo, UT 84602

TRF

(WJH-UTA) DX'ing at Deer Creek Reservoir, UT w/20000' E Bev.

(Rth) Ric Heald-19050 Ridgecrest Dr.-Guerneville, CA 95446  
Hammarlund 129X, SM-2

(EH) Ed Horiman-P.O. Box 125-Burlington, WA 98233  
RF-2900, SM-2

(RW) Robert Wien-1309 Dentwood Drive-San Jose, CA 95118  
GE long-range portable, SM-2

\*\*\*\*\*

## OF SPECIAL INTEREST:

1340 KLVR UT, Heber City first heard this new stn on 10/9. Operating hours 0800-0200. Pop mx format, a few PSA's, but no ads yet. (WJH-UT)

\*\*\*\*\*

- 550 KBOW MT, Butte 10/6 0635 good w/ID into C&W mx. (EH-WA)
- 590 KHQ WA, Spokane 10/12 0500 ID & into net nx. 1st time hrd in o/a year. (Rth-CA)
- 630 KIDG ID, Boise 0527 fair w/promo for square dancing contest into C&W mx. (EH-WA) (Date?--NH)
- KOH NV, Reno 10/9 0531 "440 at K-O-H." Ment. of CBS nx, into Mutual nx. Fair signal. (EH-WA)
- 680 KOMW WA, Omak 10/5 1606 good w/nx & wx into song. (EH-WA)
- 710 (KIRO) WA, Seattle 10/12 0430 noted totally off. KMPC in weak. (EH) (----) 10/12 0444 everybody off. OC noted but too noisy to sit w/it. (Rth-CA)
- 720 (KDWN) NV, Las Vegas 10/5 0232-0300 noted totally off during this period for unknown reason. WGN/Cuban/KUAI in, KDWN back on as normal at 0300 w/relig. Regular 0400 MM s/off hrd as well. (RW-CA)
- +10/12 off at 0443. Faint trace of WGN thru high noise level.
- +10/12 0504 noted w/OC. Off at 0530 re-check. (EH) (Rth-CA)
- 740 (KCBS) CA, San Francisco 10/11 noted w/OC. UnID in weak--tent. KRMG. (EH-WA)
- 780 KCRL NV, Reno 10/12 0440 what the heck are they doing on MM? Thought they have MM SP. (Rth-CA)
- 790 KGHL MT, Billings 10/9 0514 good w/C&W mx. KGMI off (but back on at 0545 re-check). (EH-WA)
- 860 \*KTRB\* CA, Modesto 10/12 0745 w/TT, "This is KTRB Modesto" ID. Also, man speaking w/mentions of modulation. (EH-WA)
- 920 KOLO NV, Reno 10/9 0429 good w/rr mx into sports. "KOLO Reno 92" slogan. (EH-WA)
- 930 KAGI OR, Grants Pass 10/13 0419 spot for Golden Rule clothing store, into mx. (EH-WA)
- 970 KYTE OR, Portland 10/11 0430 good w/"97 Country" ID into song. (EH)
- 1010 \*KIQT\* CA, San Francisco 9/30 0330 ET of SS mx. Heavy ET'ing lately.
- 1070 \*KNX\* CA, Los Angeles 10/12 0438 ET'ing w/lively mx. (RW) (RW) (KNX) +10/12 off 0426. CFAX in w/good signal, nobody else. (Rth-CA)
- 1190 (KEX) OR, Portland 10/12 0507 what are they doing off on a MM? KEZY w/good signal, no one else. (Rth-CA)
- 1220 CJOC AB, Lethbridge 10/13 0730 very strong at times w/C&W mx in CKDA null. (EH-WA)
- 1270 KCOK CA, Tulare-Visalia 10/12 0427 w/ID into rr mx, u/unID OC.(EH)
- 1280 KWMS UT, Salt Lake City as of 10/5 changed to all-talk w/some nx spots. Still has Mutual nx & Larry King. (WJH-UTA)
- 1290 KHSL CA, Chico 9/29 0405 & 9/30 0408 noted both these days on RS. May be experimenting w/an AN sked, but not definitely AN yet, as noted off as normal rest of week. Full ID's & ads lead me to believe above were not ET's. (RW-CA)
- +10/9 0630 very good signal w/C&W mx into ID "K-H-S-L nobody does it better." That's what they all say. (EH-WA)
- 1310 KLIK ID, Twin Falls 10/9 0645 very good signal w/C&W song, "Click's" slogan, ABC nx. (EH-WA)

- 1310 KFLA KS, Scott City 10/10 0710 Kansas Radio network nx, Farm News into mx. (WJH-UTA)
- 1350 KIVM HI, Lihue 10/8 0343 just fading o/KIDN at the right time, clear phone no. given w/"245" prefix which fits Lihue perfectly, plus a clear ID "...here on 1350, KIVM." into rr mx. New, most-wanted. No sign of KRLC, KSRO off as usual. (RW)
- 1370 KIKS KS, Iola 10/10 0800 ID & Kansas wx. Fair o/a potent KGNO. (WJH-UTA)
- 1380 WAOK GA, Atlanta 10/10 0459 ID & soul mx. O/QRM, surprisingly strong. (WJH-UTA)
- 1390 KKCM MN, Waite Park 10/10 0502 ID & ment. of serving the Greater St. Cloud area. Good o/QRM. (WJH-UTA)
- 1430 \*KNFA\* CA, Santa Clara 10/12 0328 noted w/TT, doesn't ET often on WW's except for OC. (RW-CA)
- KARM CA, Fresno 10/12 0500 Fair w/C&W song into satellite nx. No KLO, local KBRC s/off 0300 nightly. (EH-WA)
- 1460 KDON CA, Salinas 10/8 0717 mixed w/KMXX at top of the hour w/NBC nx. Uses "K-Don" slogan. (EH-WA)
- 1480 KYOS CA, Merced 10/8 0656 o/u KAAR w/rr mx. (EH-WA)
- 1490 KAIR AZ, Tucson 10/5 0323 making very rare appearance w/local spot u/heavy jumble in KKLK null during KOWL fadeout. KXR-1500 off. (RW-CA)
- 1500 (KXR) CA, San Jose 9/29 0354, 9/30 0334, 10/5 0300-? noted totally off during these periods. Reg. WW SP again; at least for time being. (RW-CA)
- +10/12 Off 0545, carrier on 0551, ID & mx 0555, buried KSTP and KROQ. Still KXR call letters. (Rth-CA)
- 1550 KVAN WA, Vancouver 10/12 0531 for call change, w/"K-Van recreational Forecast." When did they go country? (Rth-CA)
- 1560 KABI KS, Abilene 10/10 0806 ID & Kansas nx. Fair but o/QRM. A nice surprise. (WJH-UTA)

DX TEST:

- 1170 (KUAD) CO, Windsor 10/12 0200-0230 tried, not hrd due to a nearby local, hi. Hoped to hear it during a few second pause in programming, but no such luck. Oh, well. (RW-CA)

OCT. f/c's:

- 1st MM KQTK-1230 OR 0300-0315 (RW-CA)  
 KMCL-1240 ID 0300-0310 (RW-CA)

UNID's:

- 1220 10/12 0303 unID TT'er looping N/S. Pretty strong but not strong enuf to be KIBE, as faded out occasionally. Most likely KLIT, but KLIP, KCCS, or KASY possible. On later w/beautiful mx, off at 0455 re-check. (RW-CA)
- 1400 10/10 2302 noted carrying Idaho State Bengals football. No affil. listed on 1400, but has to be KART who is common here that time of evening in KRE's null. (RW-CA)

Welcome to WDXR, Ed. We hope you'll report often. A much better WDXR this week compared to the one last week! Let's try for three pages next week. ♡

Stil ind på

## DEUTSCHLANDFUNK

alle hverdage  
 fra kvart i til kvart over otte  
 på mellemølge 1269 kHz/236,4 m

Det danske informationsprogram fra Köln - Tyskland rundt på en halv time - med nyt om politik, erhvervslivet, sociale forhold, teknik og kultur, garneret med masser af turiststof og lidt underholdning. Vind plader og bøger i DLF's quizprogrammer, i Peters Top Pop eller i ugens rejsetip. Send en musiklisten til vennerne via torsdagens brevkasseprogram Hallo Danmark! Og husk fredagens DX-program.

**Tyskkursus nu året rundt  
 - og to gange om ugen!**

På grund af den overvældende interesse sendes tysk-kurset »Familien Hanmann« nu året rundt. Der er tysk-kursus hver mandag kl. 19.30-19.45 med gentagelse af lektionen den følgende søndag kl. 20.00 - 20.15.

Skriv efter gratis lærebog til sprogkurset og få tilsendt lytterbladet Ekko Köln med programoversigt og nyt fra redaktionen.

**Deutschlandfunk  
 Dänemark-redaktion  
 D-5000 Köln 51**

# DX WORLDWIDE EAST

Neil Kazaross, Editor  
518 E. Grand Ave.  
El Segundo, CA 90245  
(213)322-3119

Times are GMT

DXWW-E is for DXers in the East & Central time zones & all locations further east.

All DX this week is from Matt Stutterheim in Glenford, NY.

## TRANS ATLANTIC ROUNDUP OF DX

693 ENGLAND BBC assumed w/male ballad in ~~EE~~ Sep.20 0520-0522.  
1566 t SWITZERLAND assumed Oct.3 2320-American type folk mx, man in unID lang. 2325 fade out; heard again later 0033-0040 w/ more American pop mx.

## PAN AMERICAN DX ROUNDUP

555 ST. KITTS - good Sep.13 0208-0212 w/BBJ nx.  
701 UNID Oct.4 0008 weak signal "killing me softly", then fade out. (what was killing you softly?- the fact that the signal faded so you couldn't ID it, or was it that beautiful Roberta Flack hit- hi! I assume this is a drifting LA although the possibility that it's a TA back on the old channel can't be discounted-ed)  
UNID noted again w/weak carrier 2337 Oct.4  
705 ST. VINCENT Sep.12 0130-0200-various ~~EE~~ talk, some LA mx, regular DJ patter; w/OR splatter.  
735 UNID weak carrier, looped south Sep.5 0135-0140, no audio. --It's Ecuador which is likely to be better in a couple of months-ed  
905 UNID weak carrier 0432 Sep.13. --YXQJ probably-ed  
914 UNID weak carrier 0110-0115 Sep.19-- should be Surinam, Matt -ed.  
915 UNID weak carrier 0515 Sep.13-- I think it's HCRO3 -ed.  
1005 COLOMBIA Neiva HJDP Sep.13 0437-weak ss talk, mx sounded Guatemalan  
1163.6 UNID weak LA, unable to copy much Sep.13 0246.--'tis HRGF- ed.  
1165 ANTIGUA Oct.4 0047-0051-religious pgm in ~~EE~~, followed by drama, "Unshackled" @ 0100. Good signal.  
1315 UNID Oct.4, weak LA, male vocal ss 0113 & later. --Should be HIAV-ed  
1328.5 UNID weak carrier here (het against 1330)(HJAD?) No audio Oct.4 0115.-- HJAD was right on 1330 recently. This is prob. from the off channel R. Angulo Cuban that Chuck Hutton heard here-ed.  
1555 CAYMAN ISLANDS Georgetown-~~EE~~ nx in British accent Oct.4 0004, some splatter from my employer, w/QAR.  
1580 ANTIGUA VOX in Sep.13 0250-0303 w/what sounded like Jasper Citron show w/nx @ 0300 // SW 15205. Noted w/11 Oct.4 2350-then symphonic treatment of "Yankee Doodle" @ 2358; VOX nx @ 0000.

Beginning next week, when only a carrier has been heard (detected) w/out any audio, I will list the station under the title of JARRIER rather than UNID which will be reserved for unID stations yielding at least traces of audio. This is to distinguish between barely detectable receptions and receptions which may have been audible had the signal been just a bit stronger.

## CONTRIBUTOR TO THIS FINE PUBLICATION

Matt J. Stutterheim-RW#1 Box 702, Glenford, NY 12433: Roomful of RA's & antenna farm; K390, FRG-7, two K390A's, two 51J3's w/ Sanserino Loop, 800' E-W LW, 1350' N-W-SW terminated Bev. & 1200' N-S unterminated Bev.

I hope this type is dark enough to read. I'll try to find a new ribbon for next week. CX out here in CAL. are improving; heard a few TP's, some Caribbean stuff, & some of my former eastern pests.

73's & good DX - KAZ -

  
**ADVENTIST WORLD RADIO**  
 IN ASIA

AWR-ASIA STUDIO & OFFICES, BOX 15, POONA 411001-INDIA

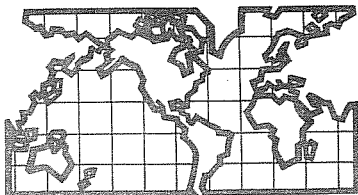

## DX WORLDWIDE - WEST

Pat Martin - Editor

P.O. Box 843, Seaside, Oregon 97138

(503) 738-3198 - deadline Tuesday

DX has really improved here!!! I finally logged 8DR-Darwin,N.T.,Australia! Sent a taped report (See 657 KHZ). Also logged a couple new Western Australian (see 531 and 558). On to the reports:

### PAN-AMERICAN DX ROUNDUP

- 650 MEXICO, Los Mochis-YETNT, strong on 9/18 from 0245-0300 s/off. (GK-Ca)  
660 MEXICO, Mexico City-XRRFM strong on 9/16 at 0630 w/Tropical del Oro" ID. (GK-Ca)  
725 COSTA RICA, San Jose-TILX hrd on 9/16 at 0729 w/Radio Columbia" ID. (GK-Ca)  
825 t ST. KITTS, Basseterre-Radio Paradise is possibly the one noted here after 0902 9/29 with hymns. (GK-Ca)  
1210 VENEZUELA, Radio Coro-a regular now after Midnight LT-9/28 at 0610,caught ID w/AM and SW calls and freqs. (GK-Ca) (Wish they would verify.PM)

### TRANS-PACIFIC DX ROUNDUP (The Big One!) (All PM, unless otherwise noted)

- 531 AUSTRALIA/NEW ZEALAND, 2MC/4XC, here mixing, both w/Pop music, noted 2MC and 2UE ID's at 1345 on 10/11, and New Zealand wx at 1350. Apparently 2MC and 2UE-954-Sydney are // in the evenings (Australia Time).  
AUSTRALIA, Dalwallinu-6DL hrd, w/talks on Australia and the ABC at 1415 on 10/12, noted o/2MC at sun-up, also noted // to 558 KHZ-6WA,soon faded along with 2MC by 1510. New. Reported.  
540 AUSTRALIA, Longreach-4QL heard with s/off ABC news at 1356 on 10/9, o/Canadians, Tone left on after 1401 and National anthem, unneeded but nice to hear, about s/4.  
549 AUSTRALIA, Orange-2CR heard w/Australian National Anthem at 1401 on 10/8, causing somewhat of a het on KMVI.  
550 HAWAII, Wailuku-KMVI, has been heard all week 10/4-10/12 extremely strong. They normally are s/9 or better, but by 0300 or so, have been under KOAC, and by 0500 mixing or o/KOAC and by 0600-0630, completely wiping out KOAC and pegging the S/Meter and slop down to 530 and 560, really local like!!!  
558 AUSTRALIA, Wagin-6WA heard with Talk show on Australia and the ABC at 1416 on 10/12 and // to 531, about equal in signal. New! Reported.  
NEW ZEALAND, Gore-4ZG, heard w/brief ID and back into classical mx at 0811 on 9/29. Didn't have recorder on, and now not enough for a report, will keep trying. New.  
567 AUSTRALIA, Julia Creek-4JK all alone here w/light Jazz and into s/off mx at 1355 on 10/1. Where was 2YA??  
576 AUSTRALIA, Sydney-2FC noted w/usual classical mx at 1410 on 10/2. Vy strong, about S/7, but low modulation.  
585 UNID, station here on 10/11 with Rel. pgm (Organ mx), and UNID language at 1430, listened until near 1450,when fade-out, but still couldn't raise any idea who?? DU's were very good that AM, no JJ, not even a peep from 828,774,etc. Infact noted DXCC-828 after 1500, but no sign of JJ, strange! Taped, will keep checking. Papua/New Guinea presumed had signed off by 1400, not noted before on 864,either.  
590 HAWAII, Honolulu-KSSK hrd with blip ID on 9/30 at 0710, o/KHZ-KUGN.  
594 AUSTRALIA, Horsham-3WV hrd. with ABC and Light Jazz at 1336 on 10/1.  
603 AUSTRALIA, Hobart-7ZL hrd. here // to 576 with Clasical mx, all alone at 1445 on 10/12. Good signal.  
612 AUSTRALIA, Brisbane-4QR-good with ABC news at 1357 on 10/8.  
621 AUSTRALIA, Melbourne-3AR, fair w/Classical mx, w/KGW slop at 1440 on 10/2.  
630 t AUSTRALIA, Townsville-4QN, possibly the one, which sounded like ABC mx at 1359 on 10/10, soon lost to Domestic, again unneeded, but nice to hear.  
639 AUSTRALIA, Mossman/Crystal Brook-4MS o/5CK until 1401 and 4MS s/off, then 5CK alone w/Jazz, at 1425 5CK into ABC mx, followed by local news at 1428, then s/off wx and Anthem, Tone noted after 1432 on 10/8.  
648 AUSTRALIA, Tamworth-2NU presumed the ABC station here // to 639 w/nx on 10/8 at 1357.  
650 HAWAII, Honolulu-KORL zapping the s/Meter on 9/29-0814 w/Music of Your Life. (GK-Ca)  
657 UNID, Man and Woman in Oriental language vy/ strong 9/30 from 1208-1210 as it seemed to beat w/another TP. Also 10/1-1200 w/brief annc. by man,short piece of March mx, Then woman ancr. Is this North Korea?? (Yes, it does sound like it. PM)

- 657 AUSTRALIA, Byrock-2BY here with usual Jazz and s/off nx at 1355-10/12, followed by National anthem at 1401, very strong, could even hear transmitter hum.hi.
- \*\*\* AUSTRALIA, Darwin-8DR, finally after trying hours and hours to hear this one, I run into it accidentally, tuning across the dial at 1428-10/12, where I hear this DU ancr giving local news about a Motorcyclist who was killed near Darwin, into other local news, Plane down,etc.sounded like a wx cast at 1429.30, but hard to tell, then ments. of 8DR and said that they join Radio Australia, which checked with the Australia/New Zealand Guide. I guess the ID would have been good enough, but I like to make sure.hi. Was gone by 1432, leaving just a hum, which may have been 2BY's carrier. Taped and reported. I have now heard all Australian States, in only 2½ yrs of trying. Was really pleased about this one.
- 666 NEW CALEDONIA, Noumea-really good carrier (s/6), but poor audio as usual at 0645 w/ OM in FF, into Light Pops on 10/9 and several other mornings.
- 675 NEW ZEALAND, Christchurch-3YA heard fair w/KNBR slop and EZL mx, into New Zealand news at 1300 on 10/8.
- 684 AUSTRALIA, Kempsey-2KP, here // to 657 at 1358 on 10/11, ABC nx.
- 690 HAWAII,Honolulu-KKUA-vy strong o/XETRA at 0700 with quick KKUA-Honolulu ID,into Billy Joel song on 10/11.
- 693 t AUSTRALIA, Streaky Bay??-possibly the one here w/OM talking at 1427 on 10/5, sounded like ABC news, but too much 690 slop to tell,soon faded.
- 702 AUSTRALIA, Sydney-2BL in like gangbusters all week, noted S/7 the AM of 10/12.
- 711 AUSTRALIA, Launceston-7NT, here mixing with 4QW-St. George at 1337 on 10/11, thought both were // at this time, but either 7NT or 4QW wasn't // with the net, prob. 7NT, hrd earlier in the week (7NT), with local news at 1358 from local studeos.
- 720 NEW ZEALAND, Invercargill-4YZ-hrd. w/EZL mx and TC at 1325 on 10/10.
- 729 AUSTRALIA, Adelaide-5GL good w/classical mx at 1415 on 10/12. 5GL is always much stronger than 3AR for some reason, as CKLG-730 is about as strong as KGW-620, maybe stronger, if anything.
- 738 AUSTRALIA, Grafton-2NR noted // to 2BL-702, but somewhat weaker w/EZL mx and light Jazz from 1305 on-10/11.
- 747 AUSTRALIA, Toowoomba-4QS hrd. // to 612 at 1358 On 10/8, ABC nx.
- 756 AUSTRALIA, Mackay-4QA, heard with ABC mx at 1355 on 10/9, o/NZ, local items after 1358,drowning near Mackay,etc, wx and sign/off with anthem at 1401, leaving 1YA. New. Reported.
- 765 t AUSTRALIA, Bega-2BE possibly the one here with rr mx and fact paced ancr. But 22K is also Pop mx at 1300 or so, so who knows???, noted at 1316-10/8.
- 774 AUSTRALIA, Townsville,Melbourne-4TO/3LO-4TO w/singing jingle, 3LO usual Jazz at 1410 on 10/7.
- 783 UNID, strange station here at 1415 On 10/8 w/OM in unid language, again no signs of Northern Asians that AM, strange Oriental mx. Taped,will keep checking.
- 792 AUSTRALIA, Brisbane-4QG here // to 576 at 1412 on 10/2, noted in every AM lately, with s4 or better.
- 801 t AUSTRALIA, Cairns-4QY??, UNID station here w/OM in EE at 1335 on 10/7,but soon lost to slop.
- 819 AUSTRALIA/NEW ZEALAND, Glen Innes/Rotorua-2GL/1YZ heard mixing at 1340, tuning back after 1403, 1YZ alone with Tone, presumed from 2GL-10/7.
- 828 AUSTRALIA, Sale-3GI // to 819 at 1341 w/Jazz, with unid rr behind, presumed 2XS-w10/7.
- 830 HAWAII,Honolulu-KIKI-vy strong by 0500 on 10/12, almost local-like, but KNVI still stronger, noted with YL ancr, rr mx.
- 837 AUSTRALIA, Rockhampton-4RK-vy good w/sign off ABC nx at 1356 on 10/11, one of the stronger ABC stations on the 11th. NZ under.
- 846 AUSTRALIA, Canberra-2CY presumed the station w/classical mx most AM's this past week, from 10/4 on, unid behind, NZ??.
- KIRIBATI, vy strong all week w/Gilbertese language and EE at 0630, American Pop tunes, noted on 10/10, little 850 slop.
- 855 AUSTRALIA, Maryborough/Eidsvoid-4QS/4QO, heard // to 837 at 1357 on 10/11,ABC nx.
- 864 AUSTRALIA, Hobart-7HC, hrd poorly, o/unids, presumed NZ at 4GR? at 1234 on 10/12, w/Pop mx and ("7hc" ID's,Shotgun jingles),lost under jumble soon.
- 873 AUSTRALIA, Sydney-2GB-hrd well w/YL on phone with OM ancr (talk show), talking about Child care at 1416-10/12.
- 882 AUSTRALIA, Brisbane-4BH-heard w/Eagles song at 1419-10/12, apparently have changed to a Rockier sound, from the old MOR/EZL mx, another good station hits the dust.
- 891 AUSTRALIA/NEW ZEALAND, SAN/2XW here mixing with possibly a 3rd station at 1256 on 10/4, SAN with Mor/Jazz and 2XW w/ rr mx, running a little fast (Turntables at 35-40 RPM).
- 900 HAWAII, KNUI-strong almost every night after 0600, way o/CJVI or totally wiping off the dial. Noted with K-900 ID's and Pop mx as usual.



- 954 AUSTRALIA, Sydney-2UE hrd // to 531 with 2MC/EUE ID's at 1345 on 10/11. Pop mx noted. What happened to the old talk format?? apparently changed, at least at the time hrd, as last year and 1979 they were telephone talk during the DU eves. Maybe they changed after 2GB changed to talk. See 873.
- 963 NEW ZEALAND, Christchurch-3YC noted w/weak audio, 960 sloop at 0815 on 10/8 w/Clas. mx and // 657 and 882.
- 981 t NEW ZEALAND, Kaikohe-1YE, possibly the one with clas. mx at 0819-10/8, could have been // to 963, but too much 980 QRM to tell.
- 1008 NEW ZEALAND, Tauranga-1ZD, really strong o/hIP at 1330 on 10/12, both with rr mx, but 4IP much harder and quick 4IP ID's, noted TC on 1ZD.
- 1017 AUSTRALIA, Sydney-2KY hrd w/Racing and talks at 1317 on 10/11, all alone.
- 1026 AUSTRALIA, MacKay-4MK, wiping out everyone else on 1026 with Pop mx and hMK ID's, s/off w/Anthem at 1400, leaving 3DB/NZ fighting it out.
- 1035 NEW ZEALAND, Wellington-2ZB-here w/ Pop mx and // to 1026 and 1044 at 0745 on 10/11.
- 1044 NEW ZEALAND, Dunedin-4ZB-here w/Pop mx and // to 1026 and 1035 at 0745.30 on 10/11.
- 1053 NEW ZEALAND, New Plymouth-2ZP also // to 1044 with Pop mx, weaker at 0747-10/11.
- 1062 AUSTRALIA, Thursday Island-4TI heard with Jazz and ann. at 1353, ending mx and into Fanfare music (news from ABC) at 1355, Pips at 1400 and anthem, leaving tone on at 1402 On 10/9. New. Reported.
- 1071 t AUSTRALIA, Maryborough-3CV may have been the weak signal w/Pop mx at 1350 on 10/7, but too much CFAX/KNX sloop to tell. Unneeded.
- 1107 AUSTRALIA, Sydney-2UW, heard with Pop mx and Spot (Sydney business) at 1347 on 10/10. Fair but with 1110/1100 sloop.
- 1116 t AUSTRALIA or NEW ZEALAND, hBC or 2YX may have been the station with OM talking in EE? at 1349-10/10. vy poor, too much KFW sloop. hBC unneeded, but could use 2YX.
- 1134 NEW ZEALAND, Queenstown-4YQ, heard with TC and light mx at 1351-10/10
- 1161 AUSTRALIA, Naracoorte-5PA hrd // to 639 w/sign off mx at 1426 on 10/8, after Tone at 1428, scunded like another ancr took over with local news, but was going back and forth between 639 and 1161, so hard to tell, both had anthem at 1401.
- 1179 AUSTRALIA, Melbourne-3KZ, heard with quick "KZ" ID into rr mx at 1234-10/10.
- 1104 WESTERN SAMOA-Apia-2AP good here with OM in Samoan, into Island mx at 0910-10/7, good s/s signal at peaks.
- 1503 t NEW ZEALAND, Christchurch-3YG?? Possibly the one with a Minister and rel. mx at 0930 on 10/4, soon lost to sloop.
- 1593 AUSTRALIA, Renmark-5MV heard with ABC pgm at 1330, but too much sloop and LXP QRM, tuned back at 1410, but not noted; sloop from 1590, at 1422, noted again under LXP with Jazz, into Fanfare mx at 1425, ABC mx, lost again under sloop, but back again at 1429, caught parts of South Australian wx, and anthem at 1431 on 10/9. New. Reported.

During the last couple of weeks, I've had the tape recorder going almost continually when DXing, which really has been a help with all the stuff coming in. On to veries:

#### VERIES:

- 828 NEW ZEALAND, Palmerston North-2XS-sent 2 Vqs in a month, also nice letter from manager, saying that this has been their farthest report since they signed on in May/81. Verie signers: Jeremy Mills-Ancr/Duty Technician (can't read)/ Manager: John Duffy. (FM-Or)
- 963 NEW ZEALAND, Christchurch-3YC sent Vq in 2 weeks, along with a Vq (not filled out) for 3YB (One of their short term low power stations, presumed), nice hand written letter from R. Mason-Service Manager. Also sent some stickers from 3ZB-1098. (PM-Or)

#### REPORTERS:

GK-Ca Glen Kippel-3394A G Street-Merced, California 95340  
 PH-Or Yer Editor  
 E.H. Scott (RBO-2) 600 foot LW running NE/SW, Ground system.

#### 500,000-Watt Radio Believed in Cuba

MIAMI — Cuba plans to operate high-power radio stations that could blast broadcasters off the air in the southern United States, the Caribbean and in Central America, an attorney representing Miami broadcasters said.

"The word is they have a new 500,000-watt station finished and ready to start broadcasting any time on 850-AM," said attorney Matthew Leibowitz.

Miami AM stations, restricted to 25,000 watts by the Federal Communications Commission, are already suffering from the interference of existing Cuban stations. WASH. POST 7/31/81



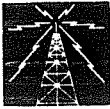

# Western DX Forum

★ ★ ★ ★

IRCA—Serving the Broadcast Band DX'er Since 1964

Editor: Ric Heald, P.O. Box 4861, Santa Rosa, CA 95402—4861 (707) 865-1260

1981/2 Deadlines—Weekly on *Wednesday*, 10 Days Prior to Publication Date  
(Note: Tuesday Deadlines Prior to U.S. 3-Day Weekends)

TODD SKATNE, 2215 CLAY ST., CEDAR FALLS, IA 50613

Howdy all. Well, Rth, satisfied? I'm typing instead sloppin', hi. (I'll let you know your grade at the end of this forum, hi-Rth.)

Totals are really shooting up around here. Right now I'm up to 981 with the latest one being at SSS: 1410 WRDC Cleveland, MS.

Got a new receiver. It's one of those put-together Heathkits. Bought it for \$75 and believe me, it's worth it. It's sensitivity and selectivity is excellent. Results of the radio is in the CDXR.

Congrats to Don Kaskey on your election as President. And congrats to all who got on the BoD.

Went down to Cedar Rapids for the Labor Day weekend. The only real DX'ing was after KHAK s/off and heard the s/off from WISV. I thought they were full-time. Tried to reach J.C. Kelleher, but he must have been out of town. Excluding KXEL, KCFI was the strongest during the day. Of course I couldn't hear KLEU because they null toward Muscatine to protect KWPC. Because I was on the eleventh floor of the Roosevelt Hotel, FM was almost all spurs. (Why? Was there a tower atop the hotel? You're leaving something out here-Rth.)

I don't understand why people believe that summertime is a break from BCB DX. Just because that is FM/TV time (In your part of the country-Rth) doesn't mean quit BCB DX for a while. From my experiences, the main time FM/TV signals come in is around 0600-100 and 2200-0200, with the multiskip coming in during early afternoon to around 0500 CLT.

Latest newbies are 570 WSYR, 850 WKBE and 825 St. Kitts, bringing the total up to 984. That's all for now. 73 de FTS. (Big improvement, Todd; a B-, hi-Rth)

GENE MARTIN, 3303 E. EVANS AVE., DENVER, CO 80210

Relatives of mine in the Dallas and Minneapolis areas have to be visited now and then, and in recent years I always take the GE Superadio with me to check out reception conditions away from home. Both places offer substantially less local trouble for a DX'er than Denver with its long list of AM stations, but I noted a few things of interest about the Superadio. At Shoreview, Minnesota, a St. Paul suburb, that radio delivers a quite clear signal from WBAP 820 while WCCO is operating ten kHz away. Noted this in June '79, again a year later. That same radio in Richardson, Texas, about 12 miles from WBAP's transmitter, delivers WCCO with no trouble with WBAP on the air. Noted this on Texas visits in December '80, February and June '81.

The WCCO transmitter used to be in Anoka, Minnesota, but am not sure it's still there.

Now that same radio in Denver suffers severe cross-talk from KOA while trying to hear WCCO although the separation there is 20 kHz rather than ten. Of course it has no trouble hearing WBAP's fine signal 30 kHz away.

It's my guess that the main reason for the difference is that KOA modulates at 125% while WBAP and WCCO are still using 100% modulation. In the early '70s, KOA, owned by General Electric, used a GE transmitter with 100% modulation and during that time with the HQ180 I could null it well enough to find Tarawa's carrier, sometimes with audio making it through, on 844 kHz, six kHz from KOA. The KOA transmitter is about 12 miles from my digs. But four or five years ago, KOA acquired a new Continental transmitter with modulation 125%, and that monster emits stray emissions on 822, 835, 865 and 878. And a fanfare KOA uses in introducing their newscasts is heard on weak signals from 900 to 750. (I wonder if super compression is adding to some of your problems?—Rth.)

Would be interesting to know which of the major stations around the nation are still using 100% modulation. I would guess that list would include: WOAI, KSL, WWL, WSB, WSM, WLW, WCAU, WGN, WBZ, KDKA, KRLL and the CBS o & o stations. 73.

DOUG PIFER, 2506 S. RITA WAY, SANTA ANA, CA 92704

Hi again, Been a while since I last forumed. I've still been listening all this time, but not so much as when I was on second shift at work. Even if I can't listen all the time, I always try for the TESTS, with good luck too.

As far as IRCA issues are concerned, no thanks to FM. Things are being run perfectly just the way they are. An excellent club and publication.

One technical feature I would like to see sooner or later is something concerning car radio DX. I like it, my fiance hates it. (So brainwash her, hi-RtH.) My radio could sure use some improvements, maybe there are some good car radios (DX-wise) on the market. Anyone know? 73.

MARK STRICKERT, BOX 931, SAN FRANCISCO, CA 94101-0931 (415) 652-1875

It sort of amazes me that few non-DX'ers I know in this area know that it is possible to hear "distant" stations; people would ask, "What do you listen to?" "KFI." "Huh?" "You know, in Los Angeles." "You mean you can hear L.A. from here?" I guess I'm still used to the midwest, where every 12-year-old knows where WLS is and most sports teams don't need a network to cover its regional audience. (What scares me is that there are some IRCA members who believe L.A.-Bay Area is DX, hi-RtH.)

Meanwhile, while I don't make it a point to catch any comedy acts featuring traffic reporters. What I saw last night (08 October) was different. Was KFRC's Jane Dornacker, who some may know as a member of some group called the Tubes. Some time back the show took place in the dingy, cramped "music room" at KPFA 94.1, a non-commercial outfit that's best described by its city of license (Berkeley), with a cast of characters right out of 1968. (You may be hearing from Jaisun, real soon, hi-RtH.)

Have actually DX'ed. Almost exclusively sunrise (this from a confirmed late-sleeper, but it's my work schedule you understand. (From where you live, you must know Boris Karloff, hi-RtH.)

KXL 750 puts in an amazing signal in here next to KCBS. They are, so far, the only station I've heard carrying the NBC Network National Weather Report; they mentioned a Pennsylvania station so I gather it's more spread than I've noticed.

Lastly, a purely California joke (courtesy of KPFA restroom wall)... "How can you tell the difference between port and starboard? Easy, you can't drink starboard." (Mark, that's a southern CA joke, hi-RtH.) 73 de MaS.

ROB HARRINGTON, 3181 S. YORK ST., ENGLEWOOD, CO 80110

Hello again. How would it be if we discontinued the boundary lines between CDXR and WDXR and replaced it with time zone boundaries? Mountain and Pacific report to WDXR, Central to CDXR. That's my suggestion to solve the current problem.

I also agree with you, Ric, it probably would not be a good idea to reprint proposals to the BoD in DXM.

I might be moving in early 1982 to Parker in southeast Colorado. I'll have to apply for a \$69,000 loan to buy my three acres with a small house. I'll then build a 2,000-foot longwire antenna and a 150-foot SW antenna. Only in the early planning stages. Will have to get on with the post office in Parker, Castle Rock or some other community near Parker. I would be great to move from the Denver area. I hate the big city, and would love country living where I'd be one-quarter mile from my nearest neighbor and away from all types of interference.

Maybe some IRCAn could donate the money, like as a Christmas gift. How about you, Terry Klasek, hi.

Suggestions regarding the number of issues, here's my thoughts on it. One issue in May, June and July, two issues in April and August, and weekly remainder of time. Forty issues per year would be great. (And of course, you're also offering to pick up the tab for the club too, right?-hi-RtH.)

RIC HEALD, P.O. BOX 4861, SANTA ROSA, CA 95402-4861 or 19050 RIDGECREST DR., GUERNEVILLE, CA 95446 (707) Topaz 5-1260 to 2300 PLT and prepaid

Greetings. Pulitzer once told his newspaper reporters that he didn't care how they got their story, but make sure it's 100% accurate. Greg Monti, you got taken by one of your contributors who didn't check for accuracy. In the Broadcasting Information in 10 October 1981 DXM, there's a format change for KJOY-1280 and KSTN 1420 Stockton. Absolutely not true.

This morning (14 October) I checked KJOY and they were playing the Stones. Drifted up to 1420, heard KSTN's 20-20 news, then top 40. Recognizing the voice of my buddy and former KPLS jock, now production director at KSTN, Mike McGregor, I called him, related the information, nearly dropping the phone while laughing. His response, "What kind of club is it, the Mickey Mouse Club?" KSTN has no intentions of changing format to news/talk, and he said KJOY just hired Terry Nelson (ex-KFI/KFRC), so they are not going religious. Of course I question the quality of new jock if he went to Stockton after working major markets, hi.

Greg, I know you had no way of knowing what with a 3,000-mile handicap, but if you are a contributor to Broadcasting Information, or for that matter, please verify your information before submitting it.

As an aside, KWG 1230 Stockton went country on 01 January, hardly new news. I mentioned the change in my forum last late winter.

Regarding CPC. I recently received a sample letter from a member who wished to send it to prospective stations for future TESTS. I've sent it back to him with my usual major journalistic mark-ups, hi. When requesting a station to come with a special test in the wee hours, remember that the GM might wonder what's in it for him (financially) and will probably have to pay the CE overtime. So it's going to cost him to test for IRCA. The days of a CE understanding DX'ing is fading fast and could probably care less about a group of crazies tuning their receivers in the middle of the night. Also, many stations have turned to a consulting engineer, so he might be working for several stations (i.e. Alan Roycroft in Honolulu) and may not have the time. So I would go after the station's PoP and tie that into an IRCA TEST. But, if trying for a special test just for IRCA, how about just prior to their scheduled s/on? Say 0400-0500 if station's s/on is 0500. That would be especially beneficial for us in the west so we could try for those eastern stations.

One other suggestion. Unless an NSP'er uses different day/night power/pattern, and would be willing to up power or change pattern and keep on programming minus the spots, for say 15-30 minutes, then back to night power/pattern, don't even approach them. I've seen NSP'ers in the past listed for TESTS with the promise they'd mention the club. Look. . .if ya can't hear it any other time if they're NSP, ya won't have any advantage by asking them to mention us.

Ah yes, DX, hi. Up for awhile MM 12 October, results in WDXR. OK Nancy, you now owe me one, hi. What's that you say? Coming by carrier penguin? Hi.

Rob, I like your solution to the CDXR/WDXR reporting situation for you guys in the Mountain zone. You got my vote.

Meanwhile, back in Country Plusland; I'm back on as outside sales. Have also landed an outside sales job for a travel agency (I can travel again!) and some other things in the works. This way, you see, I can live like all the other "River Rats" around here (read laid-back, hi).

Why do I keep going on? I'm try to use up this page so that there'll be no room for Jaisun and his comments taken from a radio DJ joke service, hi. But alas, plenty of room for Seattle. Take it away Bruce! 73 de Rth. .

BRUCE PORTZER - 6546 19th Avenue Northeast - Seattle, WA 98115

Hi gang, and thanks for the space Ric. I came back from vacation expecting to find out about all the rare African, Filipino, and Indonesian stations logged here in my absence. Instead, Phil and Nick assure me that I didn't miss much. Foreign DX, at least, was the pits, and my return hasn't helped it any. It seems like every time I turn on WWV's propagation report lately, that they're describing some recent flare-up, X-ray event, or other heavy solar activity. One day, the person giving the report had so much to say, he ran out of time and was chopped off in the middle of a word! Hopefully, the season is just getting a late start this year, but then again. . . . Pat Martin's loggings in this weeks DXWWW raise one's hopes just a bit, though. Nice going on the Darwin logging, Pat.

Some varies have shown up recently; KSYC-1490, KNSE-1510, and 4RK-837. Not much has been happening on the local radio scene, except KKFV-1250, which seems to have finally settled down into a format (I think!)--- mostly pre-1964 rock hits, with about 20-25% current stuff.

Gene Martin's comments on Denver radio sound all too familiar. Our news/talk station, KIRO-710, has been known to splatter down to 640, and many other locals put out a lot of sideband energy (KJR-950 splatter has been known to extend up to 1050!). I'd be inclined to drop KSL from the list of stations using 100% modulation, they sound more like 125% to me and frequently interfere with 1150 reception when local KAYO is off.

Mark Connelly, nice going on the article on longwire phasing units! I've heard all sorts of enticing stories on phased longwires, enough to make me want to build one soon (as soon as I find the time that is!).

Enough for this week! 73, bp.

# Radio Rebus

ACROSS

1. dx'ers technical term (abb.)
4. stillwater, mn., 1220 khz.
8. abilene, tx., 1280 khz.
10. time zone in waiipahu
11. pronoun
12. who replies to a rec. rpt.? (abb.)
14. sanserino or box
15. what wfat/kdor is
17. what a certain brand of toilet paper is, or the type of cx dx'ers rate?
22. what many dx'ers claim to have
24. many 'newies' are logged when a station does this
25. part of an rx (ab.)
29. a dx'ers best friend?
31. what stations broadcast for free (abb.)
33. abb. on a mexican verie?
34. yaesu 5-7
35. what dx'ers feel when they missed the id of that rare catch!
36. many a dx'er claims he's the best around, but he probably \_\_\_\_\_.
38. poke
39. a twitching

DOWN

1. sunset, sunrise, or 'to my low'
2. against
3. dx'ers 'greeting'
4. an 870'er
5. type of index
6. amt. of time usually associated w/sp's (roman num.)
7. what most stations seem to be, at least to dx'ers
9. annual irca 'tradition'
13. the goal of every dx'er is to learn \_\_\_\_\_
16. \_\_\_\_\_ rope comes in w/good to cx.
18. what does a dx'er do after a long m session?
19. overtime (abb.)
20. type of antenna (abb.)
21. xevy id's with this
22. home of idelo station on 1260, or with 'bud', what dx'ers get 'bombed' on at conventions?
23. see 11-across
26. station operation w/normal format (abb.)
28. this orassis could afford a 1000 w/s
29. an african colony dx'ers log
30. canadian radio agency (abb.)
31. soda, what firecrackers do, or a type of test.
32. man's nickname, or abb. for sung call letters.
37. wwar/kfku is an example of such a station (abb.)

Prepared by Robert Wien.  
See page 18 for the solution.

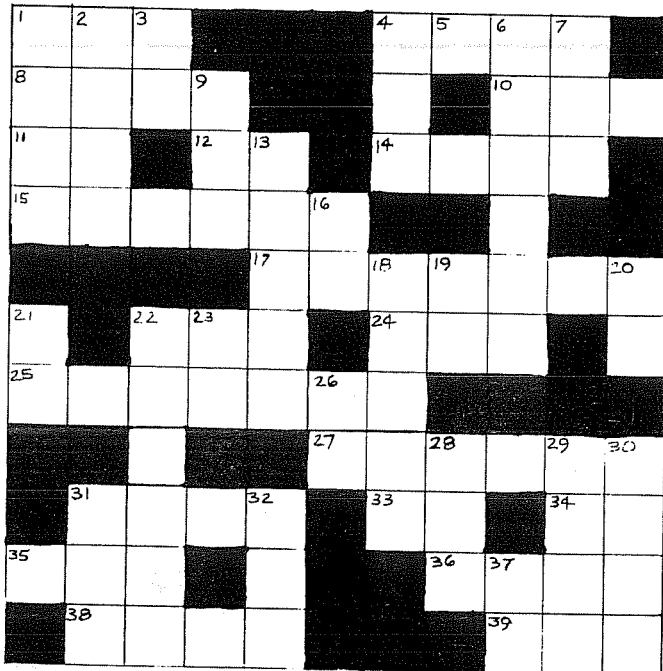

# PHASING UNIT DESIGN MODIFICATIONS

by Mark Connelly, W4LION

This article is presented for two purposes: (1) to improve upon existing designs of phasing units presently in use by several active international DXers. (2) to serve as a prelude to an upcoming phasing-unit construction article. The construction article to be released soon will also deal with a new concept, Amplified Phased Shortwires.

DXers who have used phasing units in recent years include Chuck Hutton, Nick Hall-Patch, Bill Bailey, Neil Kazaross, Gordon Nelson, and Mark Connelly. Most of the units in use have a schematic similar to that of Figure 1.

Figure 1 a conventional phasing unit

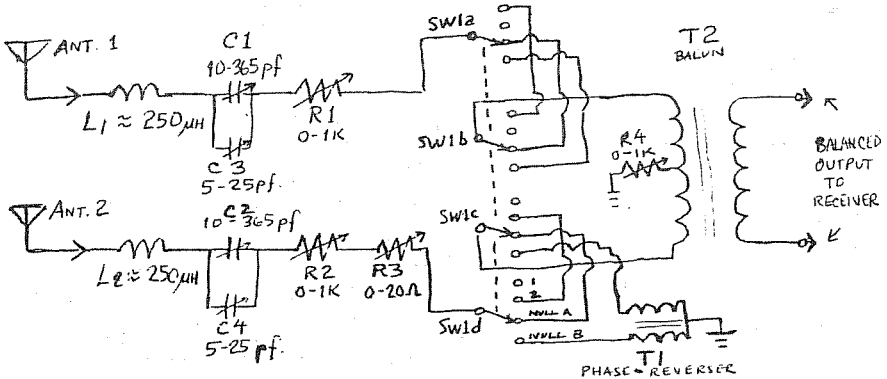

The phase-reversing transformer and the balun are wound on toroidal cores such as J. W. Miller #F-125-1, F-87-1, or T-106-2.

Coil winding details will be supplied in a subsequent construction article.

Figure 2 block diagram of conventional phasing unit

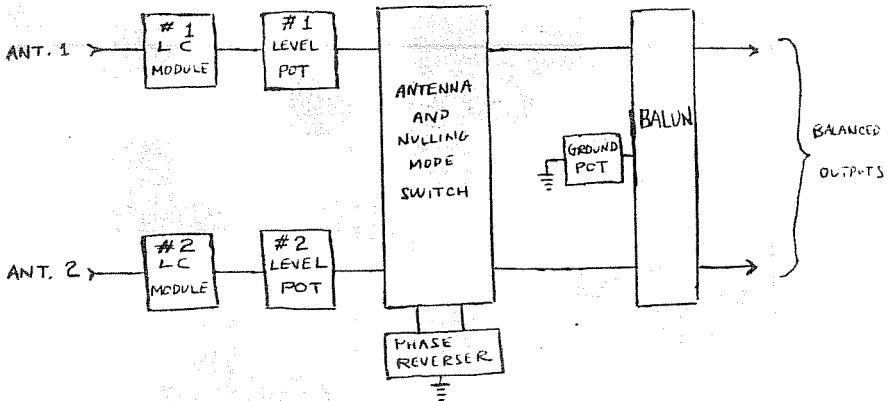

Nulling (using the unit of Figures 1 & 2) is accomplished by the following procedure: (1) initialise by setting all pots to zero ohms. (2) with antenna 1 switched in, peak the antenna 1 main tuning capacitor, C1, for maximum composite signal on the frequency of interest (3) with antenna 2 switched in, peak the antenna 2 main tuning capacitor, C2, for maximum composite (i. e. interfering signal to be nulled mixed with desired station signal) signal (4) switch between antenna 1 & antenna 2; note which switch position produces the strongest level of the undesired (interfering) station (5) switch to "null a" mode. (6) adjust the series potentiometer on the line which had produced the stronger "pest station" signal. (7) if a dip, or point on the pot where a distinct drop in signal occurs with a rise in level on either side of that point, is attainable, set the pot at that dip point and finely tune the main & vernier capacitors (C1, C2, C3, C4) and the ground resistor R4 for further dipping until the best null is achieved (8) if satisfactory nulling could not be obtained in steps 6 & 7, re-iterate steps 1 through 4 and then switch to "null b" (9) re-do steps 6 & 7 (in the "null b" mode).

Some shortcomings of conventional phasing unit design

(a) The series L-C "modules" each consisting of a 250 uH inductor in series with the parallel main (10-365 pf.) and trim (5-25 pf.) capacitors seem inadequate to peak-tune wires with lengths less than 30 metres. This problem is most acute on the lower frequencies, 520 - 900 kHz.

A two-pronged approach to this problem turned out to be most advantageous. The first step is to make a switchable 3-value inductance unit for each antenna line. Three inductors and a SPDT (centre-open position) switch are used in each of the two L-units.

Figure 3: three-value inductance unit

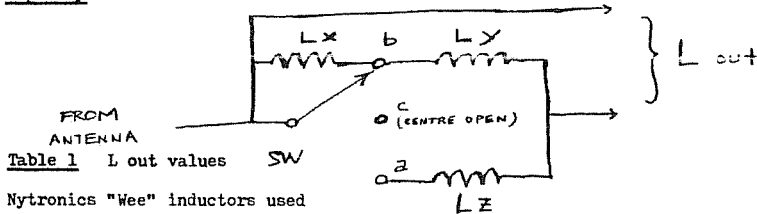

Table 1 L out values

Nytronics "Wee" inductors used

L values, uH			L out, uH		
Lx	Ly	Lz	switch pos.: a	b	c
			$Lz // (Lx+Ly)$	Ly	Lx+Ly
390	220	100	86	220	610
470	270	120	103	270	740
560	270	120	105	270	830

J.W. Miller video-peaking type inductors used

L values, uH			L out, uH			J. W. Miller part #'s	
Lx	Ly	Lz	switch pos.: a	b	c	L, uH	#
			$Lz // (Lx+Ly)$	Ly	Lx+Ly		
420	200	100	86	200	620	100	6112
470	250	120	103	250	720	120	6153
550	275	120	105	275	825	200	6154
						250	6173
						275	6130
						420	6136
						470	6138
						550	6144

The Q of the coils listed in Table 1 is somewhat below that of the shielded can-type antenna coils used by Gordon Nelson and Chuck Hutton, but only a very slight decrease in tuning sharpness & signal transfer occurs. The small size of the coils used makes them ideal to be connected in a switched multiple L-value arrangement. The phasing unit's tuning range is extended considerably by this scheme.

The author recommends that two separate SPDT switches for each antenna line L-unit should be utilised. If a DPDT switch were used to switch the inductance in the Antenna 1 leg & that in the Antenna 2 leg simultaneously, stray coupling from the Antenna 1 coils to those for Antenna 2 (and vice versa) could occur. The Antenna 1 L-unit should be located at least 10 cm./4" from the Antenna 2 L-unit.

The switchable inductance scheme has indeed extended the usefulness of the phasing unit in working with wires shorter than those commonly phased.

The second concept applied to extend the tuning capabilities further is the ability to switch between series L-C (as in the conventional phasing unit of Figure 1) and parallel L-C. Parallel L-C tuning seems to work well with shortwires, especially in the lower half of the band.

We shall incorporate the inductance-unit and switchable series/parallel L-C concepts in a subsection of the phasing unit to be referred to hereafter as the "LC module". Each antenna line has an LC module: the Antenna 1 LC module should be isolated from the Antenna 2 LC module by at least 10 cm. to prevent stray coupling or 'crosstalk'.

Figure 4 schematic of LC module (2 per phasing unit)

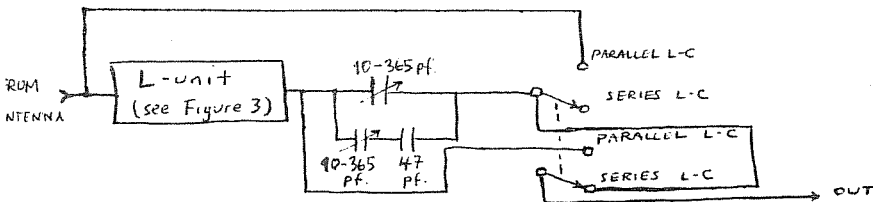

The 10-365 pf. capacitors used are the cheap miniature variety (e. g. Calectro/CC Electronics # A1-232, priced at about \$ 2.70 each). The trim capacitor section, 10-365 pf. in series with 47 pf., is effectively a 8-42 pf. trimmer. The expensive air variable capacitors used in previous phasing units can be dispensed with.

(b) Even before switching to null, it is noticed that tweaking the controls for Antenna 2 effect the Antenna 1 control settings (and vice versa).

This indicates inadequate isolation within the phasing unit. Stray capacitance between the LC modules, between wires on the mode switch, and directly from the antennae to the output of the phasing unit may be the contributing factor.

Re-configuring the antenna-line (mode) switch such that antennae are connected or disconnected directly at their inputs is the logical way to attack this problem. As a side benefit, this eliminates the need for the clumsy, expensive 4-pole 4-position switch used in previous phasers. That "kluge" is replaced by a 2-pole 3-position switch and a DPDT toggle switch (see Figure 5). The Antenna 2 line can be peaked with the phase-reverser in line if desired (null mode b); any peak-skewing effects of the phase-reverser can thereby be compensated out prior to the initiation of the actual nulling sequence.

Figure 5 antenna mode/null mode switching to improve isolation/reduce crosstalk

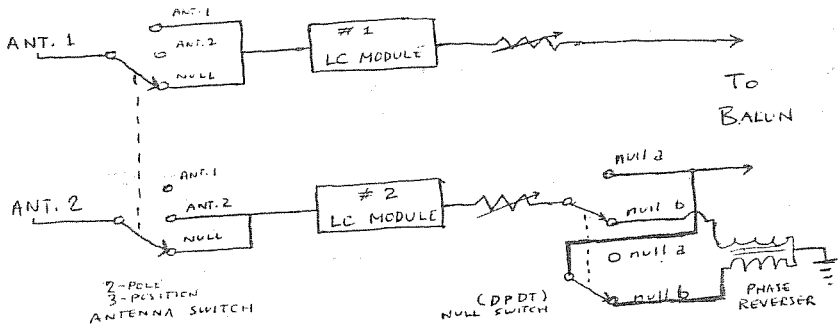

If you wanted to keep to one-switch operation while improving isolation, the 4-pole 4-position switch could be wired-in as in Figure 6.

Figure 6 single antenna/null mode switch configured to reduce crosstalk

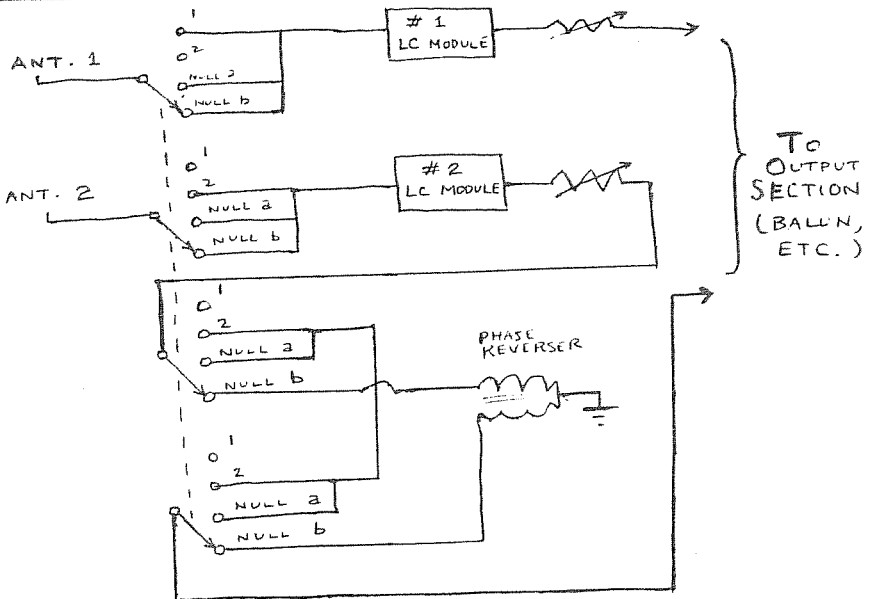



(c) Conventional phasing unit has no provision for unbalanced output.

There are two philosophies regarding the provision of an unbalanced output. One is to disconnect the two tuned lines from the balun primary, short these together, and feed them out to an unbalanced output jack, as in Figure 7.

Figure 7 one method of obtaining an unbalanced output

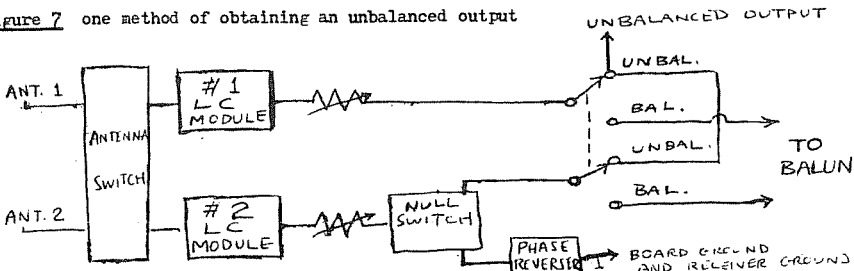

An alternate method is to leave the balun in the operating system and to connect one side of the balun output to ground/the other balun output to the unbalanced output jack, as in Figure 8.

Figure 8 an alternate method to obtain an unbalanced output

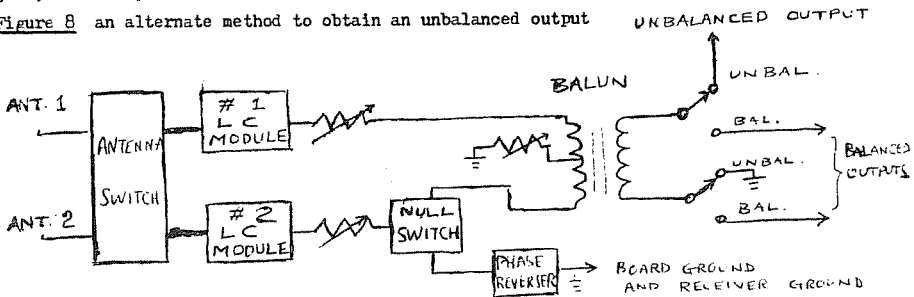

Perhaps the best solution to obtain unbalanced output is to build both approaches into the output section of the phasing unit, as in Figure 9.

Figure 9 versatile approach to unbalanced output

(Note: the 4-pole 3-position switch is GC Electronics # 35-380, retailing for \$ 2.15)

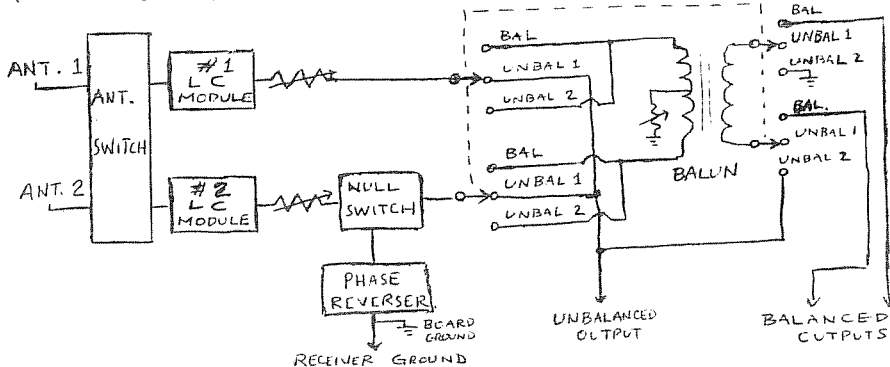

(d) Metal case is expensive; isolating the tuning capacitors and other components from case ground requires much mechanical layout work.

Worry not .... you can build the phasing unit on a standard epoxy-glass vectorboard; this will be discussed in a soon-to-be-released construction article.

(e) The 1K series pots don't always effect the signal levels on their respective antenna lines. Two reasons are postulated for this: (1) in some cases 1K may be too low a maximum resistance value to have any meaningful attenuating effect. One remedy may be the use of higher resistance pots in series with the 1K pots. The 1K pots would then become fine-tune pots. (2) leakage capacitance across pots negates the effect of their

resistances. Several schemes may be initiated to remedy this: (a) pots could be placed right at the antenna inputs (between input jacks and antenna switch, ahead of LC modules) (b) try a different brand of pot (c) keep all leads short to minimise stray pickup.

Summary - The modular approach to phasing unit design

In this article several operator conveniences and tuning aids were discussed. A phasing unit need not have all of these "bells & whistles". The block diagram below (Figure 10) points out the modular concept of phasing unit development; actual contents of modules will be determined by the user's particular needs.

Figure 10 modules of a phasing unit

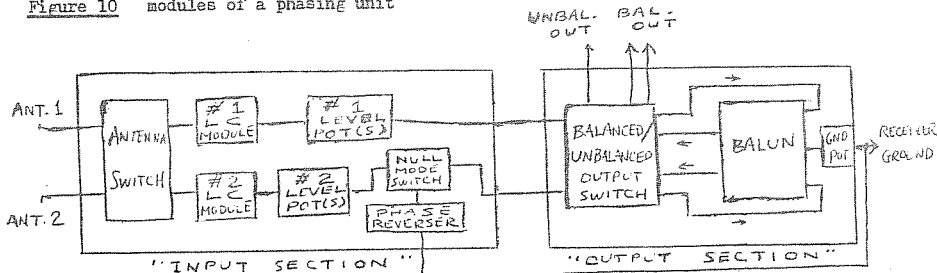

If only true longwires or Beverages are to be used, the LC modules can be reduced to the simple single-L-value (e. g. 250 uH) in series with 10-365 pf. The balun might be omittable if only an unbalanced output is desired, although this might decrease some null capability. Others may retain the balun, but they'll eliminate the phase-reversing toroid - again, nulling flexibility may be decreased slightly. In my experience, you have to have either the phase-reverser or the balun to have even minimal nulling power: having both, obviously, is the optimal situation.

The author believes that as phasing units come into more general use, they will take their place alongside loops as worthy weapons in the DXer's arsenal to combat both interference from "pest stations" and that from non-broadcast sources such as light-dimmers, TV sync. oscillators, power lines and the like.

The serious DXer should evenly blend the use of a good amplified loop with the use of a phased-wire system. Each setup may offer unique DX possibilities: the experienced DXer will soon learn which setup to use to "milk" a specific type of opening or to hunt for specific target stations. The ability of the phased-wire system to produce unidirectional nulls may open up new DX possibilities for many. Similarly, a loop might catch some DX not possible with a particular phased-wire setup. With ever-increasing levels of interference plaguing the DX efforts of us all, it seems wise to have as much antenna (and receiver) diversity as possible at our disposal.

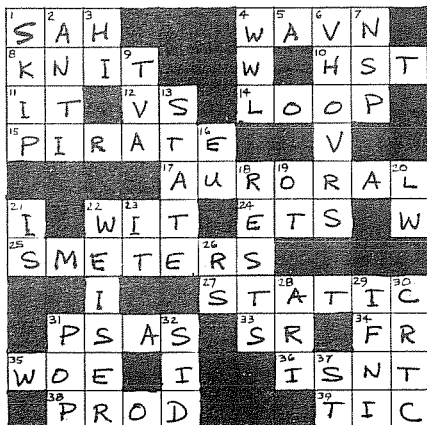

RADIO EXITOS

# CANADIAN TWINS REVISITED

Canadian Family Life—It's Twins!

October 1, 1989

\* Mother Station      \* local studio

BC British Columbia:

- \*CFOP-1440 & CFWB-1490s & CFMI-1240s "Coast Radio"  
Courtenay/Campbell River/Port Hardy
- \*CHUD-1570 & CHPQ-1370s Nanaimo/Parksville-Qualicum
- \*CHWK-1270 & CKGO-1240s & CFVR-850s & CKGO-FM 106.1  
Chilliwack/Hope/Abbotsford/Boston Bar "FVR-Fraser Valley Radio"  
CFVR twins only the AM show. Watch for separate IDs & local ads.
- \*CKBK- 570 & CPBK-1340s Cranbrook/Fernie "BK-East Kootenay Radio"  
CKBK applied for 2-FM twins at Elkford & Sparwood
- \*CKKR- 580 & CKOR-1340s & CKGR-1400 Salmon Arm/Revelstoke/Golden  
"R Country-First Voice West of the Rockies" Calls not presently used.
- \*CKKC-1390 & CKKD-1340s Nelson/Creston "KC-Kootenay Country"
- \*CKOK- 800 & CKOO-1240s & CKOO-1-1490 & CKOP-1450s "OK-Okanagan-Boundary"  
Penticton/Osoyoos/Oliver/Summerland May use pre-timed separate IDs.
- \*CHHL- 610 & CHRL-1-1400 & CHLL-2-1340 & CJLL-1230s & CHLL-1400s  
Kamloops/Glaswater/Ashcroft-Cache Creek/Merritt/Princeton  
"HL Radio in BC's South Central Interior". Note 2 twins on 1400.
- \*CKKQ- 920 & CKWL- 570s & CKBY-1240s "Cariboo Radio Network"  
Quesnel/Williams Lake/100 Mile House.
- \*CKKG- 550 & CKMK-1240s Prince George/Mackenzie
- \*CJDC-1350 & CHEH-1450s Dawson Creek/Chetwynd
- \*CJCI- 620 & CIVH-1340s & CIPJ-1480 & CIFI-1450 Last 2 are 50 watt lprts.  
Prince George/Yamdenhoof/Ft. St. James/Fraser Lake
- \*CFEV-1230 & CFID-1400s & CHEV-1450 & CHLD-1480 & CKBV-1490 Last 3 50w.  
Smithers/Burns Lake/Houston/Granisle/Hazleton BV-Bunkley Valley
- \*CJCI & CFIV (same owners) join all of their 9 stations on the AM show.  
"CI-Central Interior Network" 0130-0900 EST. Note 2 twins on 1450/1480.
- \*CKFK- 590 & CKTK-1230s Terrace/Kitimat "TK Radio" Also 5 FM mini-twins.
- \*CKHL- 560 & CFHL- 590s Ft. St. John/Ft. Nelson "HL-Alaska Highway"
- \*CJSL- 940 & C -1600s? Richmond/Delta-Surrey on in 1982. Has a CP.
- \*CJOC/CJPR Lethbridge/Crownest Pass, AB want a 50 watt twin 1340 Elkford

CBC Vancouver(CBU-690) has a short wave relay, CKZU-6160 khs.

Calls used only at s/on & s/off.

CKWX-1150 Vancouver has a short wave relay, CKFX-6080 khz. Call not used

AB Alberta:

- \*CHEG-1090 & CKTA-1570s Lethbridge/Taber "Check 10-90"
- \*CJOC-1220 & CJPR-1490s & C -1340 Lethbridge/Crownest Pass/Elkford, BC  
Elkford is a 50 watt lprnt application. CKRK-540 also has application.
- \*CJVD- 510 & CKBR-1340s & CHOA-1400s Drumheller/Drooks/Stettler  
CHUM now owns "Big Country Radio". Watch for changes to twins.
- \*CJYR- 970 & CKYR-1450 & CIYR-1230s & CFYR-1400 & CKYR-1-1450 Last 2 50w.  
Edson/Jasper/Hinton/Whitecourt/Grande Cache "YR Radio" "Yellowhead Radio"  
CIYR Hinton now lkw. & studio hours 0800-1400 EST Note 2 on 1230.
- \*CFOK-1370 & CIOK-1310s & CIOK-1-1340 Westlock/St. Paul/Grande Centre "OK"
- \*CFOH-1060 Calgary has a short wave relay, CFVR-6630 khz. No call used..

SK Saskatchewan:

- \*CJNB-1050 & CJNS-1240s North Battleford/Meadow Lake "Plus Two Radio"
- \*CFSL-1190 & CJSL-1280s Weyburn/Estevan "SL-See Line Radio"
- \*CKSW- 570 & CJSH-1490s Swift Current/Shanavon "SW-SN" "Southwest Sask"

MB Manitoba:

- \*CFAR- 590 & CJAR-1240s Flin Flon/The Pas "Arctic Radio"
- \*CFAM- 950 & CFMS-1250s & CJRB-1220s "FSM-Radio Southern Manitoba"  
Altona/Steinbach/Boissevain Watch for separate ads & ID inserts.
- \*CHBA-FM Winnipeg feeds its AM show to 9 stations in Ontario

ON Ontario:

- \*CHEM-FM Winnipeg "Stereo 97.5" feeds its AM show to:  
CJHL CFOP CFAN CKDR & twins: CKIG CKHD CKRE CKZF CFSI
- \*CKDR- 900 & CKIG-1340 & CKHD-1450 & CFSI-1400 & CIEP-1490 & CKRE-1340s  
Dryden/Ignace/Hudson/Sioux Lookout/Ear Falls/Red Lake Two on 1340.  
CKDR twins are just 50 watt lprts except CKRE. Some local ID & ads.

\*CFOB- 800 & CFAK-1240 Ft. Frances/Atikokan CFAK is a 50 watt lprt.  
\*CFIX-1170 & CHBR-1110d Cornwall/Hawkesbury French daytimers have  
a OP for night as soon as they can find a freq!  
\*CFOS- 560 & CFPS-1490s Owen Sound/Port Elgin  
\*CJTL- 560 & CJTT-1230s Kirkland Lake/New Liskeard  
\*CKBE- 950 & CKGE-1400s Barrie/Collingwood  
\*CFBK- 630 & CFBQ-1340s Huntsville/Harry Sound  
\*CJTC- 800 & CJNH-1240s & CJTN-1270s Belleville/Danecroft/Trenton  
\*CFPL- 620 & CFNL-1340s & CFLK-1230s Timmins/Hearst/Kapuskasing French.  
\*CJHR- 730 & CKHR-1340s & CKGS- 930s Blind River/Elliott Lake/Spanola  
\*CFYN-1050 & CJVA-1240s Sault Ste. Marie/Wawa....may no longer twin  
\*CKAP- 580 & G -1450s Kapuskasing/Timmins...application 2nd try.

\*CFRB-1010 Toronto has a short wave relay, CFRE-6070. Call not used.

#### NB New Brunswick/Nouveau Brunswick:

\*CKCW-1220 & CJCW- 590s Moncton/Sussex CJCW studio time: 0500-1200 EDT  
\*CJGJ- 920 & G - 730s Woodstock/Grand Falls...application  
\*CJEM- 570 & CKMV-1490s Edmundston/Grand Falls (Grand Sault)  
\*G -1300 & CJVA- 810  
plan to twin at times with CJEM/CKMV  
Note that NB is now an officially bilingual Province.

#### NS Nova Scotia:

\*CKAD-1350s & CKDY-1420s & CKBN-1490s & CPAB-1450s  
Middleton/Digby/Kentville/Windsor  
\*CHNS- 960 Halifax has a short wave repeater, CHNX-6130 kHz.  
\*CJCE-1270 Sydney has a short wave repeater, CJCK-6010 kHz.  
\*CKWV-1000 Bridgewater has 2 FM twins & may apply for All.

#### PQ Quebec:

All are French except CFCF, which is English.

\*CHYC- 610 & C -1150s & C -1450 New Carisle/Caspé/Murdochville  
\*CKNE-1460 & CIRD-1240s St.-Georges (de-Beauce)/Lac-Étchemin  
\*CKVM- 710 & CJVT-1340s Ville-Marie/Témiscaming  
\*CJBR- 900 & CJBM-1450 now CBC (SRC) owned...will just relay CBGA.  
\*CJFP-1400 & CJAP-1240s & CHRE-1450s Rivière-du-Loop/Cabana/Fohéna/gamook  
\*CHCB-1310 & CHAF-1350s & CKVD-1370s La Pocatière/St.-Lamphille/Dégelis  
\*CFCH- 580 & CFCG- 710s Sept.-Îles/Port-Cartier  
\*CHVD-1230 & CJMD-1240s & CFED-1340s Dolbeau/Chibougamau/Chapais  
\*CHRN-1400 & CKLS-1240s & CHAD-1340s & CKVD- 900s  
Rouyn/La Sarre/Amos/Val-d'Or  
\*CHRL- 610 & CKHG-1340s & CISJ-1400s & CILR-1490s  
Mont-Laurier/Maniwaki/St.-Jovite/L'Association "Réseau des Laurentides"  
\*CHLC- 580 & CFFR- 620s Haute-riève/Forestville  
\*CKLD-1330 & CPDA-1380s & CHLL-1420s & CJAN-1340s & CJLP-1230s & CKFI-1400s  
\*Thetford Mines/Victoriaville/Plessisville/Asbestos/Diaraïli/Lac-Mégantic  
\* "Réseau de Apalaches"  
\*CFEP-1000 & CFVM-1220s Rimouski/Amqui  
\*CFCE- 600 Montreal has a short wave relay, CFCX-6005 kHz.no call used

#### NF Newfoundland and Labrador:

\*CJYQ-930 & CFYQ-1010s & CIYQ-680s & CHYQ-670s & C -970s & CKYQ-610s  
St. John's/Gander/Grand Falls/Musgravetown/Harbour Grace/Grand Bank  
"Q Systems"

\*VOCH-590 & CKGA-730s & CHCM-560s & CKCM-620s & CKVO-710s & CKHI-1240s  
Newfoundland Broadcasting & CHVO- 850s  
St. John's/Gander/Maryshtown/Grand Falls/Clareville/Ernie Verte/  
CHCM part twins live CHVO. Spaniard's Bay--Harbour Grace

\*CFCE-570 & CFX-1230s & CFNW-790s & 4 twins on FM  
Corner Brook/Point aux Basques/Point aux Choix  
\*CFEL-1340 & \*CFEG-1230 Wabush/Happy Valley--Goose Bay Each twins 50%.  
\*CJN - 640 St. John's has a short wave relay, CKZH-6160 kHz.

Thanks to your tips sent to columns in NRC/IRCA, and to René L. of PQ  
(Province Quebec) for telling me where to put all these -- & '...'

73 John Oldfield, 7135 129A Street, Surrey, BC V3W 6T4

# SWAP & SHOP

Tim O'Hare

20023 84th West

Edmonds, WA 98020

FOR SALE ZENITH ROYAL D7000 RECEIVER. COVERS LW , MW , SW , FM , AND VHF WEATHER IN 11 BANDS: EXCELLENT CONDITIION. \$ 325 OR BEST OFFER.  
PAUL WARDELL, 2104 SE 28th Pl. , PORTLAND , ORE 97214 - PH 503-236-0826

WANTED . COPY OF THE GENEVA PLAN FOR CHINA; PREFERABLY ONE OBTAINED FROM THE ITU WHICH INCLUDES GEOGRAPHIC COORDINATES FOR STATIONS. A COMPLETE LIST IS DESIRED EVEN IF STATIONS LISTED ARE ONLY PROJECTED RATHER THAN ON THE AIR. WILL PAY ALL XEROX, POSTAGE, ETC. COSTS. LISTING IN ORDER OF FREQUENCY DESIRED BUT NOT REQUIRED.  
ART PETERSON , 851 31st St. , RICHMOND CALIF - 94804

FOR SALE REALISTIC DX - 300 COMMUNICATIONS RECEIVER - VERY GOOD CONDITION FOR \$ 220.  
ROB HARRINGTON , 3181 S. YORK St. , ENGLEWOOD COLO - 80110

WANTED TRF 12 / 655 STOCK OR MODIFIED IN EXCELLENT CONDITION. STATE PRICE WANTED.  
JAMES VERNON , 1942 DEERPARK - 78 , FULLERTON , CALIF - 92631.

FOR SALE G.E. SUPERADIO MODEL 7-2880B. USED ABOUT 10 HOURS. IF'S PEAKED FOR FOREIGN DX. WITH HEAVY DUTY ( NON-ALKALINE ) BATTERIES. \$ 55 PLUS U.P.S. SHIPPING.  
GLEN KIPPEL , 3394A G St. , MERCED, CALIF - 95340

FOR SALE McKAY-DYMEK AM5 TUNER- 2 YEARS OLD IN GOOD CONDITION - \$ 250 U.S.  
BEN KLIPPENSTEIN - P.O. BOX 1545 - JASPER, ALBERTA, CANADA T0E 1 E0.

FOR SALE LAFAYETTE HA - 600A RECEIVER. AM / CW / SSB. INCLUDES 2 MATCHING HE-48C SPEAKERS & MANUAL. SHIPPED JUST LIKE NEW IN ORIGINAL BOX U.P.S. ANYWHERE IN CONTINENTAL U.S.A.

TRADE SWAP 1 FOR 1 AM STATION BUMPER STICKERS.  
TOM BUTAS - 5083 SKIPPY DR. - MEMPHIS, TN 38116

FOR SALE AMECO RADIO LICENSE GUIDE.: ELEMENTS 1, 2 and 9 - .30¢  
ARCHER TRANSITOR SUBSTITUTION GUIDE ( 1974 ) .50 ¢  
ARRL RADIO AMATEURS OPERATING MANUAL ( 1969 ) .50¢  
A BRIEF HISTORY OF THE CBC AND PETITE HISTOIRE DE LA SOCIETE RADIO CANADA - BOTH FOR \$ 1.00  
99 WAYS TO IMPROVE YOUR HI-FI ( 1973 ) SAMS BOOK \$1.25  
CQ MAGAZINE, DECEMBER 1955 AND DECEMBER 1954 , BOTH FOR \$ 2.50  
HISTORY OF STATION CKUS .50¢  
BROADCASTING MAGAZINE- 25 ISSUES RUNNING FROM FEB. TO NOV. 1978 ( NOT A COMPLETE SET ) FOR \$ 7.50  
COMMUNICATIONS WORLD : FALL -WINTER 1975; SPRING - SUMMER 1976; FALL-WINTER 1976;SPRING-SUMMER 1977; 1978 EDITION; .75¢ EACH OR ALL FOR \$ 3.25  
ALL ABOVE IN EXCELLENT CONDITION AND PREPAID.  
FRANK ADEN Jr. - 4514 S.E. 83rd; Apt 5 - PORTLAND, ORE. - 97266

WANTED COLLINS R 389URR RECEIVER - MUST BE WORKING. CALL COLLECT 212-828-5182 IF YOU HAVE A LEAD ON THIS FOR ME, OR WRITE.

FOR SALE MIDLAND 1L - 500 SW RADIO. ( ALSO COVERS ECB ). A TRANSISTORIZED VERSION OF THE HALICRAFTERS S - 38 L. NOT A GREAT RADIO, BUT PRICED CHEAP. IT HAS A JACK & SWITCH INSTALLED FOR 12 VOLTS, BUT RUNS ON 117 VAC NORMALLY. 330 PINS UPS.

MATT STUTTERHEIM - 510 MAIN St. - NEW YORK, N.Y. 10044

#####  
CADX XXII

The 12th edition of the CADX Holiday GET TOGETHER will take place at the home of Robert Kramer from anytime on 12/26 to only Mike Hogan knows when on the 29th (give him a call to find out) & again resuming with the "World Famous" DXathon weekend (complete with New Year's Eve Party) starting at 6:00 PM on 12/31 & stretching to Sun. 1/3. To JJ, that, as I count it, makes 6 days plus part of 2 more, how did you get 5 out of that ? As to CADX fund raising, you'll have to wait until after the holidays, the beer cans to put the money in won't be empty until then. Which reminds me, there will be plenty of beer at the affair & the 2nd annual Mike Jeziorski Look-alike contest. Its a contest that everyone hopes to loose. For more info on the GT of the Look-alike contest, call me at (312)-262-6299. The affair will feature several AN DX sessions, so bring a receiver, but also headphones. Also bring radio junk to trade.

Anyone with a 1979 or newer Broadcasting Yearbook that wants to get rid of it, please write Robert Kramer 6416 N. Richmond Chicago, IL 60645, and name your price. My 1974 edition is way out of date & is barely holding together.

IRCA--UNREPORTED STATIONS TO DXR & DXW SINCE VOLUME 11 (Aug 74)  
by state

AL--25-WWLX--620, WTKN--910, WTVR--920, WLTV--1080, WACQ--1130, WJBB--1230, WHOD--1230, WBUZ--1230, WOFP--1290, WBSA--1300, WHEP--1310, WKUL--1340, WERK--1340, WKOR--1340, WFEB--1340, WELR--1360, WRAB--1380, WBYV--1380, WPPA--1400, WZZA--1410, WFHK--1430, WMSG--1430, WSMQ--1450, WBLO--1470,  
AK--13-KVOK--560, KYUK--580, KHAR--590, KGTL--620, KBRV--680, KOTZ--720, KRKA--950, KIAK--970, KABN--1150, KJNF--1170, KIFW--1230, KLAN--1450, KSKO--870  
AZ--4-KAPR--930, KSUN--1230, KPFR--1240, KPBR--1340,  
AR--20-KVMA--630, KBBA--690, KOSY--790, KAYR--1060, KAAB--1130, KJEM--1190, KCON--1230, KBTM--1230, KWAK--1240, KCAT--1340, KBOT--1350, KWYN--1400, KTOG--1410, KJWH--1450, KCCL--1460, KYAR--1490, KDRS--1490, KACJ--1510, KELC--1530, KOTT--1530,  
CA---0-  
CO---0-  
CT---0-  
DE---1-WNRK--1260,  
DC---0-  
FL--38-WsBR--740, WSWN--900, WGAM--920, WLQH--940, WVSI--1000, WHBO--1050, WGGG--1230, WGNH--1230, WINK--1240, WNER--1250, WIYD--1260, WNOG--1270, WIFC--1280, WDLF--1310, WGKR--1310, WAMR--1320, WPTP--1330, WTAN--1340, WWFL--1340, WFSH--1340, WDCF--1350, WCAI--1350, WZNG--1360, WIRA--1400, WPRY--1400, WUJB--1450, WSPB--1450, WBAR--1460, WAFG--1480, WVCF--1480, WTRT--1490, WXVQ--1490, WKCC--1490, WPKB--1490, WTTB--1490, WSIR--1490, WRKB--1590,  
GA--25-WGBH--610, WTRP--620, WPIQ--790, WBLW--810, WVCH--920, WCHL--990, WCGA--1050, WBTA--1230, WELI--1230, WPAX--1240, WGAA--1340, WBBT--1340, WULF--1400, WSGC--1400, WCOH--1400, WGFS--1430, WWSG--1440, WGFC--1450, WBHF--1450, WQQT--1450, WOLA--1470, WYYZ--1490, WSPB--1490, WLEJ--1560, WTGA--1590,  
HI---0-  
ID---0-  
IL--2-WRMS\*\*790, WGFA--1360,  
IN--2-WCBK--1540, WNDI--1550,  
IA---1-KLEA--1370,  
KS---6-KINA--910, KRSL--990, KMAN--1350, KOYY--1360, KNCK--1390,  
KY---8-WSRG--1070, WGBR--1110, WEGG--1220, WANC--1230, WBFA--1460, WGRK--1540, WSKK--1550, WFJT--1590,  
LA--17-KREH--900, KTOG--920, KXLA--990, KQKI--1170, KNEK--1190, KSLO--1230, KASO--1240, WKPL--1260, KVCL--1270, KEZM--1310, KUZN--1310, KVBO--1340, KTLD--1360, WFPN--1400, KMRC--1430, KCKW--1480, WIKC--1490,  
ME---6-WQDY--1230, WSJR--1230, WTKR--1240, WLVC--1340, WHOU--1340, WLKN--1450,  
MD---1-WTHU--1450,  
MA---0-  
MI---3-WNRS--1290, WWPZ--1340, WMMI--1350,  
MN--12-WMIN--1010, KMRS--1230, KPRN--1240, KDUZ--1260, KDLE--1340, KCHK--1350, KQDS--1390, WELY--1450, KTTH--1470, KLLR--1600,  
MS---20-WRKN--970, WBCP--1080, WCKA--1230, WHSY--1230, WAZF--1230, WMPA--1240, WGRM--1240, WTAL--1240, WUSA--1260, WNOG--1270, WJUN--1290, WZCK--1310, WJMB--1340, WKOZ--1340, WARD--1340, WYQ--1410, WQIC--1450, WBBR--1520, WBSF--1520, WSLI--1580,  
MO---7-KJED--1080, KWIX--1230, KFMC--1240, KNEH--1240, KBTC--1250, KSNO--1340, KBCB--1410,  
MT---0-  
NE---1-KGFV--1340  
NY---0-  
NH---2-WMOU--1230, WLTN--1400,  
NJ---3-WDVL--1270, WJJZ--1460,  
NM---5-KLEA--630, KMIN--980, KSRC--1290, KRDD--1320, KCHS--1400,  
NY--11-WKAJ--900, WCHN--970, WKSX--1340, WBSA--1340, WBNY--1350, WVIN--1380, WDNY--1400, WSLB--1400, WCLI--1450, WKAL--1450, WBTA--1490, WSCR--1190,

J--37-WDLV--550, WWSK--580, WCAB--590, WRGC--680, WTNC--790, WPTL--920, WKYY--940, WAAF--960, WAAA--980, WWSX-1010, WCOK-1060, WRNA-1140, WCFR-1230, WNNC-1230, WFNF-1240, WTGB-1340, WCBQ-1340, WAIR-1340, WBNS-1350, WHIF-1350, WJRN-1350, WSHB-1400, WSIC-1400, WQYN-1420, WDJR-1430, WGNR-1450, WIZS-1450, WHKF-1450, WHIT-1450, WRFB-1460, WTOE-1470, WLOE-1490, WSTP-1490, WBWL-1500, WYRU-1510, WYNC-1540, WBZQ-1550,

ND---2-KPOK-1340, KFJE-1370,

OH---7- WCPM-1130, WILE-1270, WPAH-1310, WCLT-1430, WINW-1520, WTPF-1600,

OK---11-KADA-1230, WBBZ-1230, KBEL-1240, KKCC-1320, KIHN-1340, KRHD-1350, KTHC-1400, KALV-1430, KGFF-1450, KVIN-1470, KKOJ-1550,

OR---1-KRNS-1230,

PA---8-WTGG-1010, WTIV-1230, WBRX-1280, WWCH-1300, WAGB-1380, WANQ-1400, WPDG-1600,

RI---0-

SC--22-WQXI--710, WALD-1060, WAIN-1230, WMAP-1230, WKDK-1240, WOKM-1250, WCKI-1300, WKSC-1300, WAGS-1380, WGTN-1400, WEDY-1400, WYVE-1410, WJMR-1430, WKHJ-1440, WCRS-1450, WDOG-1460, WREB-1490, WVGB-1490, WVAE-1510, WCPH-1510, WFTS-1600, WRZK-1600,

SD---6-KOBH--580, KIJV-1340, KQKD-1380, KBJT-1400, KBRK-1430,

TN--19-WFSO--630, WIRJ--740, WSVQ--740, WLUP-1000, WORL-1010, WSVG-1190, WMLR-1230, WERL-1270, WLSB-1400, WGAP-1400, WNBC-1400, WTNR-1410, WLAJ-1450, WTNE-1500, WBHT-1520, WRBA-1520, WKVL-1550, WTBP-1550, WLSH-1600,

TX--78-KRLB--580, KERB--600, KURV--710, KFST--860, KNAF--910, KVRN--980, KANL--990, KSTA-1000, KPXE-1050, KCLT-1060, KQTI-1130, KSKS-1140, KISV-1150, KJBC-1150, KIXC-1150, KPHH-1150, KVLB-1220, KSIH-1230, KDLK-1230, KERV-1230, KLVT-1230, KEEB-1230, KSEY-1230, KWTX-1230, KVLV-1240, KXYL-1240, KSOX-1240, KSPL-1260, KHEM-1270, KEPS-1270, KEAN-1280, KTTX-1280, KLUE-1280, KRAN-1280, KVVW-1280, KIVY-1290, KTUB-1300, HKAS-1300, KOYL-1310, KBUC-1310, KRBA-1340, KTEO-1340, KCAK-1340, KACT-1360, KMUL-1380, KBOP-1380, KULP-1390, KBYG-1400, KUNO-1400, KQVL-1400, KEBE-1400, KEYE-1400, KVOP-1400, KDWT-1400, KTEH-1400, KAIT-1410, KBAL-1410, KGNB-1420, KSTB-1430, KEBS-1430, KBEN-1450, KCTI-1450, KABL-1450, KCYL-1450, KMHT-1450, KRME-1460, KWKC-1490, KSAH-1490, KVOZ-1490, KDOK-1490, KKOO-1510, KRJH-1520, KEDA-1540, KBYP-1580, KBUS-1590, KIKN-1590,

UT---0-

VT--2-WJOY-1230, WYKR-1490, WYNR-1340,

VA--9-WODI-1230, WKEY-1340, WJFA-1340, WHWV-1400, WHLF-1400, WBBL-1480, WPAK-1490, WBLB-1510, WSBV-1560,

VA---0-

WV--13-WHAZ--980, WCST-1010, WLOG-1230, WDNE-1240, WVMR-1370, WETD-1380, WPQZ-1400, WRON-1400, WSGW-1410, WPCR-1420, WWBB-1450, WTGS-1490, WSGB-1490,

WI--1-WRIG-1400,

WY---0-

WV---0-

WV---5-CFTK--590, CKTK-1230, CPBV-1230, CHET-1450, CHFG-1490,

WV---3-CPAR--590, CHTM--610, CHFC-1230,

WV---1-CKMV-1490,

WV--16-CFCB--570, CBNA--600, BKYQ--610, CKCM--620, CKGA--730, VQWR--800, CPLE-1230, CKLE-1240, CBDF-1240, CFBG-1340, CPLE-1340, CBYQ-1350, CBG--1450, VOUS-1480, CBDQ-1490, VOHF-1490,

WV--5-CFCT--600, CHAK--860, CFFB-1210, CJCD-1240, CRYK-1340,

WV---1-CPAB-1450,

WV---3-CFLK-1230, CFLH-1340, CFCR-1490,

WV---0-

WV--18-CFRP--620, CIPK--710, CKBH--790, CPMV-1220, CBGN-1230, CJAF-1240, CJND-1240, CHAD-1340, CPED-1340, CHGS-1340, CBGN-1340, CKVT-1340, CFVD-1370, CKRV-1400, CKRN-1400, CJEM-1450, CHRT-1450, CKLR-1490,

WV---0-

WV---0-

THE INTERNATIONAL RADIO CLUB OF AMERICA

A non-profit organization devoted to the hobby of listening to distant radio stations on the AM broadcast band (510 to 1630 kHz). IRCA is a member of ANARC, the Association of North American Radio Clubs.

OFFICERS: President--Don Kaskey, 465 Burnett, Apt. 1, San Francisco, CA 94131 Secretary--Treasurer--Rich Segalas, Board of Directors--Phil Bytheway, Nick Hall-Patch, Ric Heald, Ernie Cooper, Jef Jaisun, Bruce Portzer, Niel Wolfish.

MEMBERSHIP DUES: \$16.50 First Class to the U.S.A., Canada, and Mexico. \$20.00 Air Mail to the rest of the world via Canada. Air mail direct from the U.S.: \$25.00 to Central America, Caribbean, Colombia, and Venezuela; \$30.00 to the rest of the world. Sample copies cost 50¢ each or three International Reply Coupons. Make checks and money orders payable to I.R.C.A. Persons living outside the U.S. should send checks or money orders payable in U.S. funds.  
DUES AND ADDRESS CHANGES should be sent to Rich Segalas, P.O. Box 26254, San Francisco, CA 94126.

DX MONITOR, the official bulletin of the IRCA, is published 3 1/2 times a year; weekly from October to March, twice in September and April, and monthly from May to August. PUBLISHING STAFF: Bruce Portzer (editor-in-Chief), Dave Korinek (Publisher), Evelyn Portzer, Nick Hall-Patch, Jef Jaisun, and Phil Bytheway. Phone: 206-522-2521(Portzer)

THE IRCA GOODIE FACTORY. The IRCA Almanac, Foreign Logs, reprints, and other materials are available for nominal charges. For a complete list, write to P.O. Box 17088, Seattle, WA 98107.

Unless otherwise noted, permission is granted to publish, broadcast, or otherwise reproduce non-copyrighted material appearing in DX Monitor, provided credit is given to IRCA and the original contributor.

Opinions expressed in DX Monitor are those of the contributors and do not necessarily reflect those of the IRCA, its publishing staff, editors, or officers.

DX Monitor is printed by Save-on Printing, Seattle, WA.

**IRCA**

**P.O. BOX 21078  
SEATTLE, WA 98188**

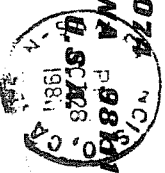

**First Class**

**D.A. Nyholm  
2071 Cedar Street  
San Carlos, CA 94070**

