

SERIAL NO. 71-0082



NATIONAL RADIO COMPANY
37 WASHINGTON STREET • MELROSE, MASSACHUSETTS

*K0ZZR
6201 Morgan Ave. S.W.
Mpls
Felt on Jan 1958
867-1887
Call No. 3021*

NCL 2000 LINEAR POWER AMPLIFIER



ONE YEAR GUARANTEE

You now own a product manufactured by one of the world's oldest and most highly respected manufacturers of quality communications equipment. National has manufactured superb communications devices for nearly half a century. Our experience is unequalled. More than 75 per cent of our highly skilled test and assembly people have been with us for more than 25 years — an astonishing record in the relatively young electronics industry. Our people know their business . . . take pride in their fine workmanship — workmanship so outstanding that many National receivers purchased over 30 years ago are still in daily use.

We manufacture most of the components used in our equipment . . . and, in fact, National has been a prime supplier of electronic components to other important electronic manufacturers and government agencies for many years. As a result, we enjoy unusual control of component part quality.

We strongly recommend that you carefully study the instruction manual before attempting to use your new equipment. We are sure you will find that maximum performance will be achieved with complete understanding of its controls and operating features.

Your new National equipment has undergone an intense series of rigid quality control tests. However, as with any complex electronic equipment, it is possible that a defect may appear as a result of rough handling during shipment or through circumstances beyond our immediate control. For this reason, we suggest that you inspect your new equipment for such damage as soon as it is unpacked. In all cases of in-transit damage a claim must be filed against the carrier.

The component parts of this equipment (exclusive of vacuum tubes and transistors) are guaranteed to be free from defective material and workmanship, and repair or replacement will be made on any part found to be defective upon examination, provided that the unit is delivered to your dealer, authorized service agency or to the company, pursuant to the instructions below, within one year from the date of sale to original purchaser. On units returned during the initial 90 day period, National Radio Company, Inc. will absorb the labor cost of installation; for the remainder of the guarantee period the customer will be charged for such cost. The enclosed guarantee card must be returned to National Radio Company, Inc., within ten days from date of purchase in order to validate the guarantee. Naturally, this guarantee does not extend to any product

which has been subjected to misuse, neglect, accident, improper installations, or use in violation of instructions furnished by us. Nor does it extend to units which have been repaired or altered outside of our factory or its authorized agencies, nor to units where the serial number has been removed or defaced.

Should your new National equipment require servicing please do one of the following, whichever is most convenient:

1. Return it to the dealer from whom you purchased it.
2. Bring it to one of our authorized service agencies.
3. Write to the Service Manager, National Radio Company, Inc., 37 Washington Street, Melrose, Mass. and describe the difficulty. State type of unit and serial number. Describe as completely as possible the apparent defect. If we feel that the unit should be returned to the factory we will give you written authorization to ship the unit to us. Notify us that you are returning the unit and ship prepaid and fully insured in the original specially designed shipping carton.

Your unit will receive prompt and careful attention. If, in our judgment the unit is indeed defective, repair or replacement will be made at no cost to you if the unit is returned within 90 days after date of original purchase. Should the unit be returned to us after 90 days from date of purchase but before 365 days have elapsed, again, if in our judgment the unit is indeed defective, National Radio Company will provide a replacement of any such defective part (except vacuum tubes or transistors). If you wish us to install the part, you will be billed only for labor costs involved. At the end of one year, after expiration of guarantee, service will be billed to you at cost of parts and labor only.

This extended guarantee supersedes all previous warranties of National Radio Company, Inc. and is in lieu of all other warranties expressed or implied. Damages arising out of a breach of this guarantee are limited to repair or replacement of the defective part as stated above. We naturally reserve the right to change or improve our products without imposing any obligation upon ourselves to so modify products previously manufactured. Your new National Radio Company equipment is the finest of its type. It was skillfully designed, carefully manufactured and thoroughly tested. We are confident that your choice of our equipment will result in many years of pleasure.





NCL-2000

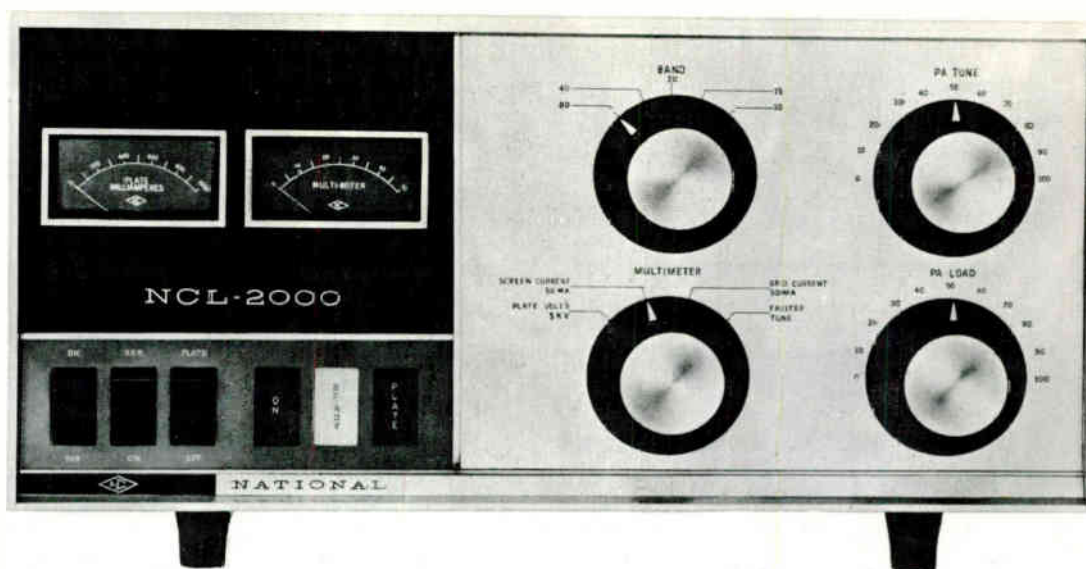

The National NCL-2000 is a true 1000 watt "D.C.", 2000 watt PEP linear amplifier in a desk top cabinet with self-contained power supply. It provides every feature for operating convenience and safety that an amplifier designed to commercial specifications should have -- and many features that no other amplifier of comparable power, at any price, possesses.

The NCL-2000 utilizes output tubes designed for high power SSB service with 800 watts of available plate dissipation to provide true 2000 watt PEP operation at high efficiency. Output at 2 KW input, key down, is as much as 1400 watts on 10 meters. Output tubes and power supply components allow AM, CW, or RTTY service at a full kilowatt all day long.

The NCL-2000 may be driven by any exciter providing 20 to 200 watts of peak output, and all necessary controls and relays are incorporated for use with transceivers such as the NCX-3 or separate transmitter-receiver combinations. The antenna is automatically switched to the exciter when plate voltage is removed, providing instant choice of high or low power to meet band conditions, and an internal 50 ohm dummy load allows easy exciter tune-up (with amplifier plate voltage off) with relative exciter power indicated on the NCL-2000 multi-meter.

ALC output is provided for use with exciters incorporating such provisions, and protective features for the safety of the operator and the equipment are complete -- positive cabinet interlock and automatic B+ shorting bar, one-minute time delay and separate overload relay.

The National NCL-2000 is the finest amateur amplifier it is possible to buy, and yet costs very little more than run of the mill 1000 watt PEP rigs. Compare its features with any equipment on the market, at any price, and you'll agree.

SPECIFICATIONS

1. Frequency Range: 80, 40, 20, 15, and 10 meter bands plus overlap at band edges.
2. Power Input (SSB): 1000 watts average, 2000 watts PEP.
Power Input (AM, CW, RTTY): 1000 watts.
Power Output (SSB): 1300 watts minimum on all bands.
Power Output (CW, RTTY): 600 watts minimum on all bands.
Power Output (AM): 300 watts minimum on all bands.
3. Output Impedance Matching Range: 40–60 ohms minimum.
4. Input Impedance: 50 ohms nominal, unbalanced.
5. Drive Requirements: 20 to 200 watts PEP, adjustable.
6. Component Ratings: All components specified to best commercial practice; all power components rated at 1000 watt average input i.c.a.s.
7. Power Supply: Bias voltage electronically regulated, plate supply utilizes solid state rectifiers in full wave voltage doubler configuration for better ripple & regulation, rated to deliver 2500 volts at 800 ma. key down.
8. Distortion Products at Full Rated Output: 30–45 db signal to distortion ratio.
9. Noise: NLT 40 db down.
10. ALC: Rear panel output for use with equipment incorporating such provision.
11. Ambient Temperature Range: To 45° C.
12. Ambient Humidity Range: To 90%.
13. Altitude: To 8,000 ft.
14. Tune-up Provisions: SSB-CW switch permits tune-up at 1000 watts to comply with F.C.C., built-in dummy load for exciter permits tune-up of exciter into amplifier grid circuit with amplifier plate voltage removed and with relative exciter power indicated on amplifier multi-meter.
15. Safety Provisions: Primary power fuses, one minute time delay, plate current overload (one ampere), hinged cover utilizes Dzus fasteners with plate power interlock, automatic shorting bar connects plate power to ground (when cover is raised) in case of interlock or bleeder failure.
16. Internal Relays: Plate power time delay, plate current overload, plate power, antenna relay.
17. Metering: Precision plate milliammeter, rear illuminated, 0–1000 ma., precision multi-meter, rear illuminated; 0–5000 plate volts, 0–50 screen milliamperes, 0–50 grid milliamperes, Exciter Relative Power output.
18. Front Panel Controls: Power On-Off, SSB, CW, plate power On-Off, power pilot light, amplifier Ready light, plate power light. Bandswitch, Multi-meter switch, P.A. Tune, P.A. Load.
19. Rear Panel: Amplifier Output, Transceiver Input, Transmitter Input, Receiver Input, ALC Output, control relay terminals, Grid Bias Adjust, Grid Bias Test Jack, fuses, primary power input.
20. Tube and Semi-Conductor Complement: Two RCA 8122 output tubes, 13 semi-conductors for rectification and regulation.
21. Size: 7 5/8'' H, 16 1/2'' W, 12 3/4'' D.
22. Weight: 62 lbs.
23. Primary Power Requirements: 115 V. A.C. 60 cycle single phase, or 230 V. A. C. 60 cycle single phase, 3 wire neutral ground. Current 15 amperes maximum at 230 V. May be operated with 50 cycle source at reduced input or with 60 cycle source for fan.
24. Warranty: Tubes, transistors and labor warranted for three months, all other components for 12 months after date of purchase.



INDEX

SECTION 1 GENERAL DESCRIPTION..... 3

SECTION 2 INSTALLATION 4

2.1 CAUTION

2.2 Unpacking and Tube Installation

2.3 Power Connection

2.4 Antenna Connection

2.5 ALC Connection

2.6 Exciter Requirements

2.7 Exciter Connections

2.8 RF Exciter Connection (Transceiver)

2.9 RF Exciter Connection (Separate Transmitter and Receiver
With External Antenna Transfer Relay)

2.10 RF Exciter Connection (Separate Transmitter and Receiver
Without External Antenna Transfer Relay)

2.11 Relay Connection

2.12 Ground Connection

SECTION 3 OPERATION 8

3.1 Explanation of Controls

3.2 Preliminary Adjustment

3.3 CW Tune-Up Procedure

3.4 SSB Tune-Up Procedure

3.5 AM Tune-Up Procedure

SECTION 4 THEORY OF OPERATION 12

4.1 Class of Operation

4.2 Grid Bias Supply

4.3 Input Circuit

4.4 ALC

4.5 Output Circuit

4.6 Metering

4.7 Primary Power Circuits

4.8 CW-SSB Mode Selection

4.9 Antenna and Transmit – Standby Switching

4.10 Cut-Off Bias

SECTION 5 SERVICE INSTRUCTIONS..... 15

5.1 Tube Replacement

5.2 Filter Capacitor Board Removal

5.3 Cabinet Removal

5.4 Front Panel and Side Gusset Removal

5.5 Regulator Transistor Change

5.6 Air System Cleaning

5.7 Grid Resistor Tap Change

SECTION 6 TROUBLE SHOOTING 17

SECTION 7 PARTS LIST 19

SECTION 1

GENERAL DESCRIPTION

The NCL-2000 is a 1000 watt average, 2000 watt PEP linear amplifier for the 80 through 10 meter amateur bands, housed in a desk-top cabinet with self-contained power supply. It utilizes two type 8122 miniature ceramic tetrodes (in parallel) in its output circuit, which provide 800 watts of available plate dissipation to allow operation at the maximum legal input with high efficiency and excellent linearity. The output circuit components, power supply, and other components in the NCL-2000 are rated to allow operation at 1000 watts steady carrier input for AM, CW, FM and RTTY service.

The NCL-2000 utilizes a passive untuned grid circuit which allows the amplifier to be driven to full output from any exciter providing from 20 watts to 200 watts of power output. In addition, the use of a 100 watt non-inductive swamping resistor in the grid circuit provides the operator with the ability to load and match his exciter into the amplifier grid circuit without placing a signal from either the exciter or the amplifier on the air. The grid swamping resistor functions as a dummy load in this instance, and relative power output from the exciter is indicated as final grid current on the NCL-2000 multimeter.

The NCL-2000 incorporates a built-in antenna transfer relay with all contacts and coaxial jacks necessary to allow inter-connection with either transceivers such as the NCX-3 or the NCX-5, or separate transmitter-receiver combinations, without the necessity for additional controlled relays. Instantaneous selection of either high power (using the amplifier) or low power straight-through operation of the exciter is possible by simply turning the PLATE switch of the NCL-2000 ON or OFF. Two screwtype connections are available at the rear of the amplifier to allow control of its internal antenna transfer relay by an external switch. The internal antenna transfer relay of the NCL-2000 utilizes a separate pair of contacts to automatically bias off the output tubes when the amplifier is in

the standby mode to prevent tube noise from appearing in the receiver and to reduce standby dissipation in the amplifier.

ALC circuitry is incorporated in the NCL-2000, with an output jack to allow ALC control of an exciter incorporating ALC input. The ALC voltage from the amplifier is developed whenever grid current exceeds the point at which limiting or "flat-topping" of the amplifier occurs.

The NCL-2000 incorporates two D'Arsonval precision meters — a plate current meter with a 0 to 1000 ma. scale and a multimeter with readings selected by a front panel MULTIMETER switch. Plate voltage, screen current, grid current, and exciter relative output (grid current) may be selected by the MULTIMETER switch. Front panel switches are provided for primary power, plate voltage, and choice of either SSB or CW mode. Pilot lamps are provided to indicate primary power ON, plate power ON, and operation of the one-minute time delay relay. In addition to this protective relay, a 1200 ma. plate overload relay is incorporated in the NCL-2000, as well as primary fusing. Two separate safety interlocks are built in — a lid interlock which breaks power to the plate relay, and a spring-actuated mechanical shorting bar which discharges residual plate voltage to ground when the lid is raised. The mechanical shorting bar also serves as added protection against the remote possibility of plate interlock failure or an open bleeder resistor. Should either failure occur, no damage will be done to the amplifier by the action of the mechanical shorting bar since the overload relay will immediately open.

The NCL-2000 may be operated from either a 230-volt, 3 wire single-phase supply or from a 115-volt, 2 wire line. All power supply components are rated for 50 cycle operation, but in such instances the cooling fan must be operated from a separate 60 cycle source for full power rating.

INSTALLATION

SECTION 2

2.1 CAUTION

- 2.1.1 THE VOLTAGES USED IN THE NCL-2000 ARE LETHAL. NEVER DEFEAT THE ELECTRICAL OR MECHANICAL SAFETY INTERLOCKS. NEVER WORK INSIDE THE EQUIPMENT WITH PRIMARY POWER CONNECTED.
- 2.1.2 THE OUTPUT TUBES USED IN THE NCL-2000 REQUIRE A CONSTANT SUPPLY OF AIR FROM THE COOLING FAN AT ALL TIMES. TO PREVENT OVERHEATING AND SUBSEQUENT DAMAGE, DO NOT PLACE OBJECTS ON TOP OF THE NCL-2000 CABINET; DO NOT ACCIDENTALLY BLOCK THE AIR INTAKE UNDERNEATH THE CABINET.
- 2.1.3 BE EXTREMELY CAREFUL WHEN INSERTING OR REMOVING THE 8122 OUTPUT TUBES; CAREFULLY NOTE THE WAY THE BASE AND THE SOCKET ARE KEYED, AND INSERT THE TUBES GENTLY INTO THE SOCKETS WITHOUT USING FORCE.
- 2.1.4 NEVER OPERATE THE NCL-2000 WITHOUT AN ANTENNA OR ADEQUATE DUMMY LOAD CONNECTED. LIGHT BULBS WILL NOT PRESENT THE PROPER LOAD IMPEDANCE. DAMAGE TO THE OUTPUT CIRCUIT IS CERTAIN TO OCCUR IF THE NCL-2000 IS RUN UNLOADED. DO NOT OPERATE THE NCL-2000 INTO AN ANTENNA SYSTEM WITH A HIGH VSWR.
- 2.1.5 PERSISTENTLY BLOWN INPUT FUSES OR CONSTANT OVERLOAD RELAY TRIPPING INDICATES A MALFUNCTION OR FAULTY INSTALLATION. CEASE OPERATION AND DETERMINE THE DIFFICULTY BEFORE PERMANENT DAMAGE OCCURS.
- 2.1.6 MAKE CERTAIN THAT THE PRIMARY WIRING TO THE STATION IS ADEQUATE TO HANDLE THE RE-

QUIREMENTS OF THE NCL-2000. 30 AMPERE 115 V.A.C. SERVICE OR THREE WIRE 20 AMPERE 230 V.A.C. SERVICE IS NECESSARY TO COMPLY WITH FIRE LAWS AND INSURANCE REQUIREMENTS IN MOST PARTS OF THE UNITED STATES.

2.1.7 REFER AGAIN TO 2.1.1. ABOVE.

2.2 UNPACKING AND TUBE INSTALLATION:

Carefully unpack the NCL-2000, its plugs, tubes and chimneys, setting aside all packing material for possible future use. Lift the lid by turning the fasteners counter-clockwise one-quarter turn, and inspect for visible shorts or other damage which may have occurred during shipping. If damage is evident, immediately notify and file claim with the carrier. Place the tube chimneys, narrow end up, under the tube clamps, carefully insert the tubes to prevent damage to their pins, and tighten the tube clamps. Also, check to see that the time delay relay (which looks like a miniature tube) located just behind the front panel is seated in its socket.

2.3 POWER CONNECTION:

The NCL-2000 is designed for operation from either 115-volt, 2-wire, or 230-volt, 3-wire single phase service. Under peak power input conditions, the NCL-2000 may draw in excess of 10 amperes from a 230-volt service or in excess of 20 amperes from a 115-volt service. This latter power requirement will exceed the capabilities of most home 115-volt circuits. We therefore strongly recommend operation of the NCL-2000 from a 230-volt, 20 ampere supply circuit. Such a circuit will, in addition, generally have superior regulation to a 115-volt circuit. In the event that a 230-volt circuit cannot be supplied, a special 115-volt circuit rated at 30 amperes should be provided. Operation on the 230-volt, 2-wire service available in many countries will necessitate the use of a 2-wire to 3-wire 1:1 conversion transformer. 50 cycle operation is permissible provided that the cooling fan is operated from a separate 60 cycle supply. If such a supply is unavailable, the NCL-2000 may be operated at reduced input.

The NCL-2000 is shipped with the primary power connections wired for 230-volt operation and a power cord for 230-volt operation is supplied. No power plug is supplied because the enormous variety of 230-volt sockets makes it impossible to supply a single plug to meet all possibilities. Procure a suitable 230-volt plug and wire the red and black wires of the cable to the hot sides of the plug and the white wire to the neutral.

If 115-volt operation is contemplated, a separate power cord and plug should be obtained. Number 8/2 cable is recommended to minimize line drop under the 25 ampere peak load of the NCL-2000. To install the 115-volt cable, remove the four self-tapping screws of the primary power junction compartment cover, the cover itself, and the 230-volt cable. Prepare the new cable by connecting the plug, stripping the sheath of the other end back five inches and stripping and tinning the conductors approximately one inch. Then, insert the new cable far enough so that it bottoms in the compartment, dressing the conductors to the right and below the barrier strip. Remove the existing jumper and wire new jumpers and the new cable as shown in Figure 1 or as shown in the diagram on the compartment cover.

2.4 ANTENNA CONNECTION:

The antenna to be used with the NCL-2000 should present a 50 ohm impedance and a VSWR of 2:1 or less. It should be fed with 50 ohm cable (RG-8A/U size minimum), and provided with a PL-259 UHF series coaxial plug. Connect it to the coax jack marked "ANT."

2.5 ALC CONNECTION:

The NCL-2000 contains an ALC circuit that provides a negative voltage at the rear panel phono jack whenever the NCL-2000 is overdriven or "flat-topped." This may be used with exciters incorporating an ALC input. Connect the ALC output to the exciter ALC input, using a shielded cable with suitable connectors. See paragraph 4.4 for description of this circuit. Use of the ALC connection is optional.

2.6 EXCITER REQUIREMENTS:

The NCL-2000 is shipped with the output tube grids tapped down on the grid swamping resistor for use with exciters providing 80 to 200 watts of peak output. If the exciter peak output is less than 80 watts, see paragraph 5.7 which describes the alteration of the tap on the grid swamping resistor for use with low power driver sources.

PRIMARY POWER CONNECTIONS

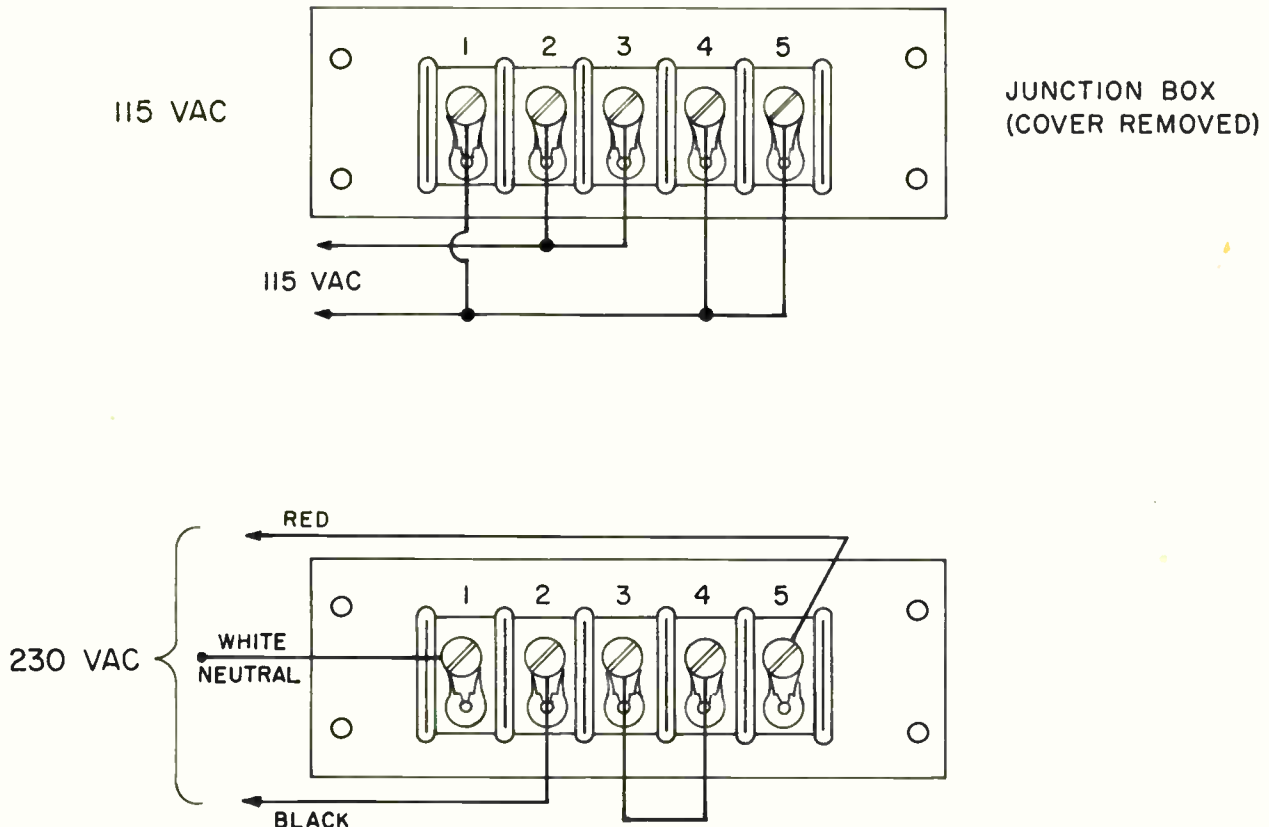

FIGURE 1

2.7 EXCITER CONNECTIONS:

The NCL-2000 incorporates all necessary antenna change-over relay terminals to allow its use with either transceiver or transmitter-receiver combinations. When used with a transceiver or with a transmitter-receiver combination with their own separate antenna change-over relay, high-power or low-power "straight through" operation may be selected by simply turning the amplifier plate voltage ON or OFF. The NCL-2000 requires no separate antenna change-over relay when used with transmitter-receiver combinations, but in this case the NCL-2000 must be used at all times, since no straight-through connection is available.

2.8 RF EXCITER CONNECTION (Transceiver)

(See figure 2)

The NCL-2000 has been designed to provide for automatic connection of the antenna directly to the exciter during receiving periods or when the NCL-2000 plate supply is off. This eliminates the usual necessity for a separate "extra" antenna change-over relay, and further provides straight-through operation of the transceiver without the linear when desired. A transceiver such as the NCX-3 or the NCX-5 should have its antenna input/output connected directly to the NCL-2000 coaxial jack marked "XCVR" with a 50 ohm cable and PL 259 connectors. The input swamping resistor of the linear presents a constant 50 ohm resistive load to the exciter so that the length of coaxial cable connecting the exciter to the NCL-2000 is not critical and no special matching devices or cable lengths are necessary.

2.9 RF EXCITER CONNECTION

(Separate Transmitter and Receiver
with External Antenna Transfer Relay)

(See Figure 3)

When a separate transmitter and receiver are used with their own separate antenna transfer relay, a direct connection may be made from the antenna connection of the separate relay to the NCL-2000 coaxial jack labeled "XCVR" and operation will be identical to that described in paragraph 2.8.

2.10 RF EXCITER CONNECTION

(Separate Transmitter and Receiver
Without External Antenna Transfer Relay)

(See figure 4)

The NCL-2000 has been equipped with a separate receiver output (RCVR) and transmitter input (XMTR). The receiver output is connected through the antenna switching relay of the NCL-2000 so that the antenna will be connected to the receiver during receiving periods and disconnected from the receiver during transmitting periods. *The transmitter input is directly connected to the input circuit of the NCL-2000 at all times.* When this connection is used, the linear plate power must always be ON to provide proper operation. In the event that the linear plate power is removed, the receiver will perform normally but the transmitter output will not be connected to the antenna line. Therefore, it is not possible to operate the separate transmitter and receiver without the linear under these conditions.

2.11 RELAY CONNECTION:

Automatic transmit-receive operation of the NCL-2000 is afforded by energizing the NCL-2000 antenna-transfer relay during transmitting periods by connecting together the relay terminals on the rear apron of the linear chassis. Most transceivers, transmitters and receivers have such switching contacts available. The NCL-2000 relay terminals should be connected to the normally open (on receive) terminals available on the exciter. Since the current through the transfer relay is small, "zip cord" or hook-up wire may be used for this connection.

2.12 GROUND CONNECTION:

It is strongly recommended that the chassis of the NCL-2000 be grounded to a cold water pipe or a good earth ground, as well as to other equipment in the station. A stud is provided on the rear apron of the chassis for this ground connection. If the ground is inadequate, the chassis of the linear may be "hot" with RF, which can cause operating difficulties and danger to the operator. If this occurs, check the ground connections and change the ground location until satisfactory operation is obtained.

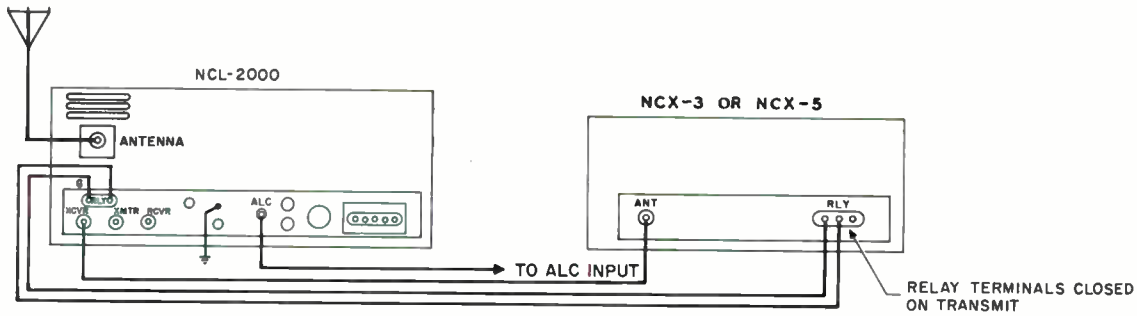

CONNECTIONS FOR USE WITH A TRANSCEIVER

FIGURE 2

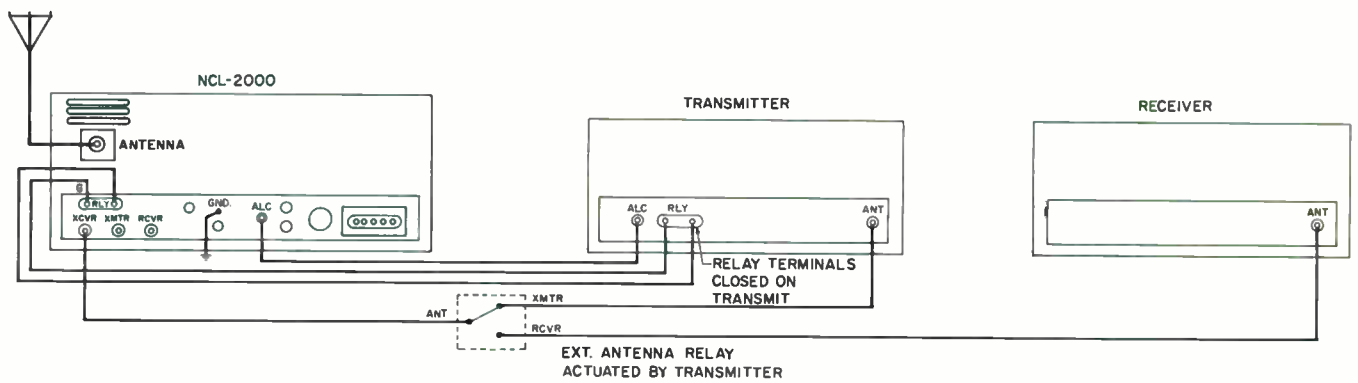

CONNECTIONS FOR USE WITH A SEPARATE TRANSMITTER AND RECEIVER USING AN EXTERNAL ANTENNA RELAY

FIGURE 3

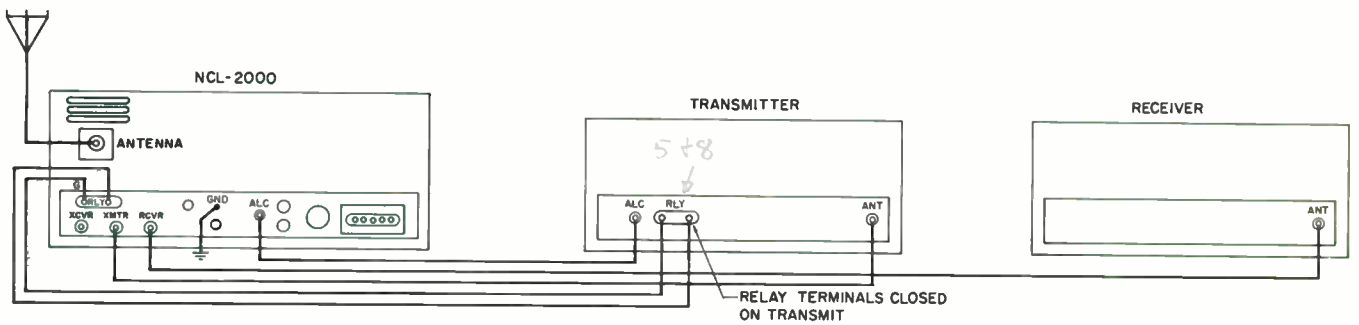

CONNECTIONS FOR USE WITH A SEPARATE TRANSMITTER AND RECEIVER

FIGURE 4

SECTION 3 OPERATION

3.1 EXPLANATION OF CONTROLS:

The main power switch, labeled ON-OFF, energizes filaments, the grid bias supply, the blower and the 60-second time delay that prevents application of grid drive and plate and screen voltage until the tubes are fully warmed up. When the main switch is pushed, the green ON lamp will light, and approximately one minute later, the ivory READY lamp will light indicating the tubes are warmed up and plate power may be applied.

The plate power switch is a center neutral, momentary-each-side-of-center, switch, labeled PLATE-OFF, which operates the latching type plate relay. After the READY lamp is on, plate power may be applied by pushing the switch up and releasing it. The red PLATE light indicates that the plate and screen supplies are operating.

The CW-SSB switch changes the plate voltage under load from about 1800 volts in the CW position to 2500 volts in the SSB position. The screen voltage also changes from 290 to 400 volts. This allows selection of 1000 watt operation for tune-up, CW and RTTY or 2000 watt PEP operation for SSB.

The MULTIMETER switch allows measurement of the following parameters as read on the multimeter: Plate voltage 0-5000 volts, screen current 0-50 ma., grid current 0-50 ma., and exciter tune (relative output) 0-50 ma. When the MULTIMETER switch is in the EXCITER TUNE position, and the amplifier plate voltage is off, power from the exciter is applied to the 100 watt input swamping resistor in the NCL-2000 which then acts as a dummy load for optimum tune-up of the exciter. Relative exciter output power is indicated as final grid current on the multimeter and the exciter is adjusted for maximum multimeter indication. This unusual feature of the NCL-2000 allows optimum independent adjustment of the exciter without the usual necessity for a separate dummy load or the alternative procedure of attempting to simultaneously adjust both the amplifier and the exciter.

3.2 PRELIMINARY ADJUSTMENT:

— CAUTION —

DO NOT ATTEMPT TO TURN ON THE NCL-2000 OR TO OPERATE ITS SWITCHES

OR CONTROLS UNTIL YOU READ AND COMPLETELY UNDERSTAND THE FOLLOWING PARAGRAPHS. EXPENSIVE DAMAGE MAY RESULT IF THE NCL-2000 IS IMPROPERLY CONNECTED TO OTHER STATION EQUIPMENT OR IMPROPERLY OPERATED.

Carefully double-check to make certain that the power cable is wired correctly for your power source, that the proper coaxial cable connections are made between the NCL-2000 and your antenna and exciter and that the proper connections are made between the NCL-2000 relay terminals and the controlling terminals on the exciter. If a high power dummy load is available, it is strongly suggested that initial adjustment and tune up be made with the dummy load instead of the antenna. Tune-up of the NCL-2000 quickly becomes second nature and may be totally accomplished when changing bands within 15 or 30 seconds after a little practice, but until complete familiarity is achieved it is wise to go only one step at a time, removing drive and/or amplifier plate voltage after each step so that you have time to relax and review previous steps without worry.

3.2.1 PRELIMINARY CONTROL SETTINGS. CHECKS AND ADJUSTMENTS:

1. Turn on exciter and allow it to warm up *in standby or receive mode.*
2. Set NCL-2000 controls as follows:
 - a. POWER: OFF
 - b. PLATE: OFF
 - c. CW-SSB Switch: CW
 - d. BAND: to desired band
 - e. PA TUNE and LOAD: to approximate setting in Figure #5
 - f. MULTIMETER: PLATE VOLTAGE
3. Insert NCL-2000 power plug into power source and press power switch to ON. The green ON lamp will light, as well as the two rear-illuminated meters. Check to see whether the blower is operating.
Note: The blower operates at all times, not just when plate power is applied.

4. After approximately one minute, the ivory **READY** lamp will light, indicating that the time delay relay is operating and plate voltage may now be applied. The **READY** lamp remains lit once the time delay relay has closed.
5. Press the **PLATE-OFF** switch to **PLATE**. The red **PLATE** lamp will light and the multimeter should read 2000 volts.
6. Press the **CW-SSB** switch to **SSB**. The multimeter should now read 3000 volts. No plate current will be indicated on the plate meter since the output tubes are cut off when the exciter is in the receive mode.
7. Press the **PLATE-OFF** switch to **OFF**, and put exciter in transmit mode. Adjust exciter for zero output in transmit mode, preferably by depressing push-to-talk switch with microphone gain backed down, or with the **NCX-3**, by placing the function switch in the **CW** position and depressing the key with the carrier completely balanced out.
8. Return exciter to receive mode, and press the **NCL-2000 PLATE-OFF** switch to **PLATE** with the **CW-SSB** switch still in the **SSB** position. Put exciter in transmit mode with zero output as above. You should hear the **NCL-2000** antenna transfer relay click, and idling plate current should now be indicated on the plate meter.
9. Adjust the rear panel **BIAS ADJUST** control for 225-250 ma. idling plate current.
10. Return exciter to receive mode, press **CW-SSB** switch to **CW**, and press **PLATE-OFF** switch to **OFF**. Check for proper straight through operation of the driver transmitter or transmitter-receiver. This completes the preliminary checks and adjustment of the **NCL-2000**.

— CAUTION —

DO NOT OPERATE THE NCL-2000 WITH BADLY MISMATCHED ANTENNAS OR WITH NO ANTENNA CONNECTED, SINCE EXPENSIVE DAMAGE TO THE NCL-2000 TANK CIRCUIT WILL OCCUR.

IT IS NOT ADVISABLE TO SWITCH THE MULTIMETER TO EXCITER TUNE WHILE THE UNIT HAS BOTH PLATE VOLTAGE AND FULL DRIVE APPLIED SINCE A MOMENTARY NO-LOAD CONDITION OCCURS WHEN THE ANTENNA RELAY THROWS,

WHICH MAY CAUSE A MOMENTARY ARC-OVER IN THE PLATE CIRCUIT

3.3 CW TUNE-UP PROCEDURE:

1. Set Controls as in paragraph 10 above.
2. The exciter, whether transceiver or transmitter-receiver combination, should now operate conventionally as a low power station when either the **NCL-2000** primary power or plate power switch is off, except when the **MULTIMETER** switch is in the **EXCITER TUNE** position or when no separate antenna transfer relay is used with a transmitter-receiver combination as noted in paragraph 2.10.
3. Place **MULTIMETER** switch in **EXCITER TUNE** position (**PLATE-OFF** switch still **OFF**). Place the exciter in the transmit mode. You should hear the **NCL-2000** antenna transfer relay click, indicating that the exciter output has been switched from the antenna to the 100 watt input resistor in the **NCL-2000** which will now act as a dummy load providing optimum exciter adjustment.
4. Place the exciter in the transmit mode and adjust it for normal CW loading and output as indicated on the **NCL-2000** multimeter, which is reading 0-50 ma. grid current in the **EXCITER TUNE** position. At least 15 ma. should be indicated. If not, check for proper exciter operation or, if necessary, adjust the tap on the **NCL-2000** input resistor per paragraph 5.7.
5. Adjust the exciter so that CW output may be varied continuously from zero to full output by insertion of more or less carrier in the **CW** mode in equipment such as the **NCX-3** and the **NCX-5**, or by whatever means is available. It may be found easiest in some equipment to detune an early transmitter stage.
6. Note carefully that the **NCL-2000** screen current will be your most valuable tuning and loading indication during the following steps. The object of the tune-up procedure, as you will see, will be to strike the proper balance between plate current, drive, and screen current for maximum output. Excessive screen current (above 25 ma.) indicates insufficient loading, and in addition, the screen current will act as an extremely accurate indication of plate circuit tuning by reading maximum at resonance. The **NCL-2000** is so designed that maximum efficient output may be accurately determined by proper adjustment of plate and screen current. In the following CW tune-up procedure, the objective is to achieve a plate current at resonance of 550 to 650 ma. with 10-25 ma.

of screen current. Remember, screen current will increase with light loading, and will decrease as the NCL-2000 is loaded more heavily. Screen current will be maximum at resonance.

CAUTION

AT NO TIME SHOULD SCREEN CURRENT BE ALLOWED TO EXCEED 40 MA. BECAUSE OF THE DANGER OF EXCESSIVE SCREEN DISSIPATION.

7. Adjust the exciter for minimum output in the transmit mode, and then place the exciter in the receive mode. Move the MULTIMETER switch to SCREEN CURRENT and adjust PA TUNE and PA LOAD to approximate settings shown in figure 5.
8. Press the plate switch of the NCL-2000 to ON and then place the exciter in the transmit mode. Increase drive from the exciter until the NCL-2000 plate meter reads approximately 200 ma. Quickly adjust the PA TUNE control for a plate current dip while observing the screen current.
9. If there is a screen current indication, you will note that it is maximum when the amplifier is in resonance and there is a plate current dip. If there is no screen current indication, increase drive from the exciter until screen current is 10 to 25 ma. at amplifier resonance. Note that as the PA LOAD control is increased so that the amplifier is loaded more heavily, plate current increases at resonance, or plate current dip, and screen current *decreases*.
10. At this point you should note plate current of approximately 500 to 650 ma. and screen current of 10 to 25 ma.

CAUTION

AT NO TIME DURING TUNE-UP OF THE NCL-2000 SHOULD THE AMPLIFIER BE ALLOWED TO REMAIN OUT OF RESONANCE FOR MORE THAN A FEW SECONDS.

11. Return the exciter to the receive mode and review the following before proceeding further: Plate and screen current in the NCL-2000 depend upon the amount of drive supplied from the exciter, as well as upon the adjustment of the PA TUNE and PA LOAD controls. To adjust drive correctly, and thus eliminate this variable from the tune-up procedure, the amount of drive will be increased from the exciter while monitoring plate and screen current *until an increase in drive does not result in an increase in plate current*. This amount of drive from the exciter is the correct amount for proper final tune-up of the amplifier.

12. Return the exciter to the transmit mode and increase drive while monitoring screen current to the point where further drive from the exciter does not result in an increase in plate current. Adjust PA TUNE and PA LOAD controls of the NCL-2000 during this process to keep screen current (at resonance) between 10 to 25 ma.
13. Slightly decrease drive from the exciter to the point where NCL-2000 plate current begins to decrease.
14. Adjust PA TUNE and PA LOAD for screen current at resonance of approximately 10 ma. At this point the proper amount of drive is being supplied to the NCL-2000 and it is properly tuned and loaded. Plate current should be 550 ma. for one kilowatt CW operation (550 ma. x 1800 volts = 990 watts). If plate current should be under 550 ma., the amplifier should be loaded more heavily (slightly less screen current, greater plate current). If plate current should be over the legal maximum of 550 ma., the amount of drive should be reduced slightly.
15. This completes the tune-up of the NCL-2000 for one kilowatt CW operation. Return exciter to receive mode.

It may be noted that the 8122 tubes in some NCL-2000 amplifiers are driven so easily that with a resonant plate current of 550 ma., the amplifier is still not fully loaded. This condition will be apparent in that the grid current will be much less than 15 ma., with loading and drive adjusted for 550 ma. plate current, and it will be possible to drive hard enough to exceed the nominal 25 ma. maximum screen current. In such instances, the NCL-2000 should be loaded more heavily, so that screen and grid currents are both about 15 ma., with the screen current peaked and the plate reading slightly higher than 550 ma. This will assure peak plate efficiency and proper ALC action, when the amplifier is placed in the SSB mode.

3.4 SSB TUNE-UP PROCEDURE:

1. Follow CW tune-up steps 1 through 15 above.
2. Press PLATE switch to OFF and place CW-SSB switch in SSB position.
3. Press PLATE switch to PLATE, which increases plate and screen voltages to allow 2000 watt PEP operation. If a dummy load is available (to prevent putting illegal 2000 watt DC signal on the air), it is advisable to briefly recheck the screen current for proper loading as follows:
4. Place the exciter in transmit mode, still adjusted for proper output as per paragraph 3.3.13. An increase in screen current should be noted, and the PA TUNE

and PA LOAD controls should be adjusted to bring the screen current at resonance to between 25 to 35 ma.

5. If a power output meter is available, slight adjustment of PA TUNE and PA LOAD controls may be made for optimum output. Under no circumstances may the screen current be allowed to exceed 40 ma.
6. Press the PLATE switch to OFF and adjust the exciter for SSB operation. If exciter drive adjustment was performed in earlier steps by detuning the EXCITER TUNE control as in the NCX-3 and the NCX-5, place the NCL-2000 MULTIMETER switch in the EXCITER TUNE position and adjust the exciter for normal maximum CW output and for SSB operation.
7. Place the MULTIMETER switch in GRID CURRENT position, and press PLATE switch to PLATE.
8. While speaking into the microphone, advance exciter audio gain until the NCL-2000 grid current just flicks off zero occasionally or until plate current kicks up to 400 ma. on speech peaks. Plate voltage is 2500 volts under full instantaneous peak current of 800 ma., or 2000 watts peak input.

Remember that the mechanical inertia of the MULTIMETER in the GRID CURRENT position requires strict adherence to the instructions concerning grid current indication during SSB operation. When the GRID CURRENT meter just occasionally flickers off zero on voice peaks,

the NCL-2000 is being properly operated. Should the NCL-2000 be driven so hard that there is a constant grid current indication, no matter how small, actual peak grid current will be excessive and "flat-topping" and consequent splatter will occur.

CAUTION

YOUR NCL-2000 IS A MAXIMUM KILOWATT IN EVERY SENSE OF THE WORD. UNDER THE ABOVE CONDITIONS YOUR POWER IS A "DC" KILOWATT, 2000 WATTS PEAK. INCREASE IN MICROPHONE GAIN SO THAT SPEECH PEAKS EXCEED 400 MA. MAY RESULT IN FLAT-TOPPING AND SPLATTER AS WELL AS ILLEGAL EXCESSIVE POWER INPUT.

9. If your exciter contains an ALC input and it has been connected to the NCL-2000, microphone gain should be advanced until:
 - a. the exciter ALC indication is correct, or
 - b. speech peaks reach 400 ma. on the NCL-2000 plate current meter.

3.5 AM TUNE-UP PROCEDURE:

For AM operation, adjust the NCL-2000 for SSB operation as in steps 1 through 7 above, and increase exciter carrier output until 400 ma. of plate current is indicated by the NCL-2000 plate milliammeter. Increase the exciter audio gain until the NCL-2000 plate current flickers slightly upward on voice peaks, and then reduce exciter audio gain to just below this point.

TABLE OF NCL-2000 CONTROL SETTINGS FOR 50 OHM LOAD

FREQUENCY	P. A. TUNE		P. A. LOAD	
	<i>Approximate</i>	<i>Actual</i>	<i>Approximate</i>	<i>Actual</i>
3.50 MC.	25		30	
3.75 MC.	45		50	
4.00 MC.	60		65	
7.00 MC.	20		35	
7.30 MC.	40		50	
14.00 MC.	40		40	
14.35 MC.	45		45	
21.00 MC.	65		50	
21.45 MC.	70		55	
28.00 MC.	80	80	55	50
29.70 MC.	90		60	

The above tables are based on average NCL-2000 control settings when operated into a purely resistive 50-ohm load. They will, of course, vary with many installations and it is suggested that you note in the appropriate column the final control settings required for use with your own antenna to facilitate faster initial adjustment when changing bands.

FIGURE 5

SECTION 4

THEORY OF OPERATION

4.1 CLASS OF OPERATION:

Modern linear amplifiers are typically operated in Class B, Class AB₁, or Class AB₂ service.

The Class B amplifier has the distinct advantage of drawing negligible current and dissipating no power when no drive is present. It also has the advantage of relatively high efficiency, particularly when operated with grid current flow and with grids driven well into the positive region. The Class B amplifier does, however, have the disadvantage of being relatively non-linear because of non-linearity of the amplifier tube characteristics in the cut-off region. This will, of course, vary with the type of tube selected for the amplifier. A second (less well-known) disadvantage of the Class B amplifier appears when excessive drive is available and the linear is heavily loaded. Under these conditions, increasing input will drive the grid, screen, and plate currents to higher and higher levels and the amplifier stage can be easily damaged.

Class AB₁ operation overcomes these disadvantages. By allowing idling current, the effects of non-linearity near cut-off are avoided, thus causing a reduction in amplifier distortion. By definition, the Class AB₁ amplifier does not draw grid current and the grid bias supply can have relatively poor regulation (or high internal impedance). In the event of over-drive, the amplifier tubes will draw grid current and make the bias voltage more negative. The result is effective limiting of plate and screen currents to safe operating levels even under conditions of severe over-drive. Unfortunately, these advantages of AB₁ operation are only gained with a loss of amplifier efficiency.

The Class AB amplifier operates with the same idling current as the AB₁ amplifier, and therefore offers the same low distortion and excellent linearity, providing a well-regulated bias supply and sufficient driver power are available. The well-regulated bias supply is necessary to prevent change in bias voltage as the grids are driven positive. The ability to drive the grids positive offers the important advantage of higher efficiency than the Class AB₁ amplifier. However, the presence of the necessary well-regulated bias supply presents the same disadvantage apparent in the

Class B amplifier — increasing input may result in dangerously high grid, screen and plate currents.

The NCL-2000 operates in grid-current-limited Class AB₂ — a National development (patent pending) which combines the advantages of Class AB₂ operation in terms of high efficiency and linearity with the effective limiting of plate and screen currents typical of the Class AB₁ amplifier. This is accomplished by the use of an electronically series-regulated grid bias supply designed to hold constant grid bias with normal driving levels, but which allows grid bias to abruptly increase when grid current exceeds the pre-determined value of 15 ma.

The NCL-2000 bias supply has a constant 15 ma. bleed. When grid current flows, it causes the regulator output current to decrease toward zero; and when the grid current reaches 15 ma., the amount of the bleed, there is no longer any current flow in the series regulator and the circuit loses regulation. As more drive is applied beyond this point, grid voltage will become more negative and plate current is limited just as in Class AB₁ operation.

4.2 GRID BIAS SUPPLY:

The grid bias supply is a conventional full-wave center-tapped circuit using rectifiers CR1 and CR2 and filtering network R36 and C6. Output of this supply is fed to the collector of the series regulator transistor Q1. Operating bias, in turn, is obtained from the emitter of the regulating transistor. The 15 ma. bleed is obtained through R40, R41 and R42. A sample of the output voltage is obtained from the bleed network and applied to the base of the control transistor Q2. The collector of the control transistor is fed through resistor R38 from the -80 volt supply and the emitter of the control transistor is returned to ground through zener diode CR9. This zener diode is kept in its regulating range by current through resistor R39 from the negative supply. When the grids of the final amplifier draw current, the bias voltage will tend to go more negative. This will result in a negative change at the base of the control transistor and will result in more collector

current flow through Q2. This will make the base of the regulator transistor go more positive, which results in less current flow through the regulator in such a manner as to cancel any change of bias to the final until grid current exceed 15 ma. and the regulator can no longer function. Adjustment of R41, the bias potentiometer, will result in a variation of bias from -25 to -45 volts to set proper idling current.

4.3 INPUT CIRCUIT:

Input power from the exciter is applied directly to a 50-ohm non-inductive metal film swamping resistor (R1 through R14). This swamping resistor is capable of absorbing more than 100 watts continuously for short periods of exciter tune-up. Nearly all modern exciters develop in excess of 80 watts PEP output which will develop *excessive* driving voltage across the resistor. Therefore, the NCL-2000 has been designed so that only one-half of the voltage across the resistor is applied to the final amplifier grids. When a low power 20 watt to 80 watt peak output exciter is used to drive the NCL-2000, an internal re-connection may be made to provide the full driving voltage of the exciter to the final grids (See paragraph 5.7 under Service Instructions). The low resistive impedance of the NCL-2000 input circuit presents a constant load to the exciter even under peak signal conditions, so that operation in Class AB₂ service does not result in non-linearity due to poor exciter regulation. Also, this low resistive grid-to-ground impedance eliminates the need for neutralization and results in an amplifier that is extremely stable under all operating conditions. The use of this grounded-cathode tetrode circuit with a swamped grid input, instead of the more common grounded-grid circuit, prevents tuning of the final from affecting tuning of the exciter, allows lower driving power, and provides maximum useful power, since the exciter power does not have to be added to the amplifier power when input power measurements are made to assure legal operation.

4.4 ALC:

The RF input signal is coupled to the 8122 grids through capacitors C21 and C30. Bias is supplied to the grids through L5 and metering resistor R15. Excessive drive applied to the final tubes (modulation peaks producing more than 15 ma. of grid current) will cause an audio voltage to appear on the bias circuit. This voltage is coupled through C19 to voltage doubler rectifiers CR10 and CR11 to develop negative DC voltage for use as ALC information. This may be fed back by means of output jack J5 to exciters provided with ALC input circuits capable of accepting negative ALC voltage.

4.5 OUTPUT CIRCUIT:

The plate circuit of the 8122 final tubes is a conventional pi-network. High voltage is supplied through plate choke L2 and the output circuit is isolated from this plate voltage by blocking capacitor C48. The PA tune capacitor C42 is a double section unit. The smaller section of this capacitor is in the pi-network at all times and the remaining section is used only on the 80 meter band to provide full coverage. In addition, a 100 pf. capacitor C45 is switched into the input to provide additional tuning capacity on 80 and 40 meters. The pi-network coil is tapped by means of the bandswitch for operation on 80 through 10 meters. The PA load capacitor C43 is used on all bands, and the additional load capacitor C47 is used on 80 meters together with C46 which is also used on 40 meters to allow matching loads from 40 to 60 ohms.

Plate voltage is developed by a *full wave* voltage doubler using rectifiers CR7 and CR8. Filtering is accomplished by a bank of electrolytic capacitors C32 through C39. Screen voltage is developed by a full wave bridge circuit operating from another winding on the plate transformer, and screen filtering is accomplished by choke L2 and capacitor C31. Resistors R18, R19, R24 and R43 provide for short circuit surge limiting in the plate and screen circuits of the final amplifier.

4.6 METERING:

The negative return of the high voltage supply is connected through a 1 ampere overload relay and a 1 ohm metering resistor to ground. A 0 to 1 volt DC meter connected in parallel with the 1 ohm metering resistor provides continuous plate current measurement. A separate 1 volt Multimeter is connected through the MULTIMETER switch to the multiplier resistors R20 through R23 for 0 to 5 KV plate voltage measurement, to resistor R16 for screen current measurement or to resistor R15 for grid current measurement and exciter tuning indication.

4.7 PRIMARY POWER CIRCUITS:

Primary power may be provided from either a 115-volt, 2-wire, or 230-volt, 3-wire line. In either connection, 115 volts is supplied through the main power switch S1 to the blower and the primary of the bias transformer which also provides low voltage A.C. for the final amplifier filaments, the ON lamp, and to the one minute time delay relay and the control circuits. After the time delay relay has closed (lighting the READY lamp), and if the cabinet interlock in the plate relay ground return is closed, the plate power relay may

be energized by pushing plate power switch S2. The plate relay in turn will apply A.C. to the plate/screen transformer and to the plate lamp. One contact of this plate relay acts as a holding contact and will keep the plate relay closed until the coil circuit is interrupted by pushing the plate power switch off. It may also be interrupted by a momentary trip of the plate overload relay, by an interruption of the cabinet interlock, or by interruption of the primary power switch. An important additional interlock, provided in the high voltage circuit, is a spring-actuated mechanical shorting bar which grounds the high voltage as soon as the cabinet lid is opened.

4.8 CW-SSB MODE SELECTION:

In single sideband operation, peak plate current is the controlling parameter with a given plate voltage. The amplifier must be capable of accepting proper peak input at high efficiency if maximum output is to be obtained without flat topping. The NCL-2000 is designed so that at the peak input of 2000 watts (2500 v. at 800 ma.), output efficiency is 60% minimum and peak output is as high as 1400 watts. In CW operation it is necessary to operate the NCL-2000 at only 1000 watts input. If this is done by operation at 2500 v. at 400 ma., the efficiency will drop and the power output will be less than optimum. It is possible to provide optimum efficiency for 1000 watt CW operation by matching the load impedance of the tubes to the load impedance of the amplifier. This may be done by altering the plate voltage and plate current of the final amplifier tubes. The NCL-2000 includes a front panel switch marked CW-SSB. When thrown to the CW position, the plate and screen voltage on the 8122 output tubes is reduced from 2500 v. and 400 v. to 1800 v. and 290 v. respectively. The amplifier can now be loaded to 1000 watts (550 ma. at 1800 v.) and the load impedance will be properly matched because of the lower plate voltage and current. The efficiency will now be back to 60% minimum and

output will be in excess of 600 watts. There is an added advantage in this switching arrangement. The NCL-2000 is so designed that if it is properly loaded to 1000 watts in the CW position, it is only necessary to switch to SSB and the amplifier is correctly loaded and tuned for 2000 watt PEP SSB operation without the necessity of tuning up at an illegal key-down 2000 watts.

4.9 ANTENNA AND TRANSMIT — STANDBY SWITCHING:

An internal antenna transfer relay is incorporated in the NCL-2000 to switch the antenna from the linear output to the transceiver or separate receiver during receiving periods. When the plate relay is energized, power may be supplied to this antenna relay by shorting the "relay" terminals at the rear of the chassis with switching contacts on the exciter. During transmitting periods, the "relay" terminals are shorted, the antenna relay will be energized, the exciter input will be transferred to the linear input, and the antenna to the linear output.

If the plate power relay is open, whether as a result of intentional switching or if primary power is not applied to the amplifier, the antenna relay is de-energized and the exciter is automatically connected directly to the antenna.

4.10 STAND-BY CUTOFF:

Idling current in the final amplifier tubes is approximately 250 ma. for the pair, which results in over 600 watts of plate dissipation. It is undesirable to draw this power during receiving periods. In addition, current flow in the final amplifier tubes will result in noise generation which may be heard in the receiver. During transmission, the screen supply return is connected to ground by a contact on the antenna relay. While receiving, the 8122 screen supply return is open and the screen voltage is approximately zero. This disables the final amplifier tubes and eliminates the idling current.

SECTION 5

SERVICE INSTRUCTIONS

5.1 TUBE REPLACEMENT:

The NCL-2000 (like all linears with parallel output tubes) requires matched tubes for efficient operation.

Should one of the output tubes fail, it is necessary to match its replacement to the remaining good tube. This may be done by measuring the grid bias voltage of the good tube at rated idling current. Remove the bad tube and connect the negative lead of a high impedance voltmeter with a 50-volt scale to the tip jack on the rear apron of the chassis. The other lead should be grounded. With the NCL-2000 adjusted for no-signal idling and with the CW-SSB switch on SSB, adjust the bias control for 125 ma. idling current as indicated by the plate milliammeter. Read the voltage at the tip jack. This test should be performed as quickly as possible since the air supply of the tube is reduced drastically with the other tube removed. The National Radio Company Service Department must be advised of this voltage measurement, together with the Multimeter plate voltage reading taken at the same time, in order to supply a properly matched replacement tube. Should both tubes fail, the replacement pair will be automatically matched correctly by National. Many amplifiers contain tubes on which a matching number has been written, in which case it is only necessary to provide National with this number instead of

making the above measurement.

To change the tubes, loosen the wing nuts on the tube clamps and the screws holding the clamps to the stand-off insulator. Carefully remove the tubes and replace with the new ones, then tighten the wing nuts securely.

The 8122 output tubes used in the NCL-2000 are guaranteed against failure for a period of 90 days from date of purchase. Tubes will be replaced under the terms of the warranty provided they are returned to National for examination and such examination indicates that they are indeed defective from causes other than abuse, mechanical damage, or from failure resulting from excessive temperature due to mistuning or operation out of rating.

5.2 FILTER CAPACITOR BOARD REMOVAL:

The filter capacitor board is held in place by the four sheet metal screws near the corner of the board. It is not necessary to disconnect wires to the board in order to remove it — simply remove the four sheet metal screws and swing the board free for examination.

5.3 CABINET REMOVAL:

The cabinet is held in place by self-tapping

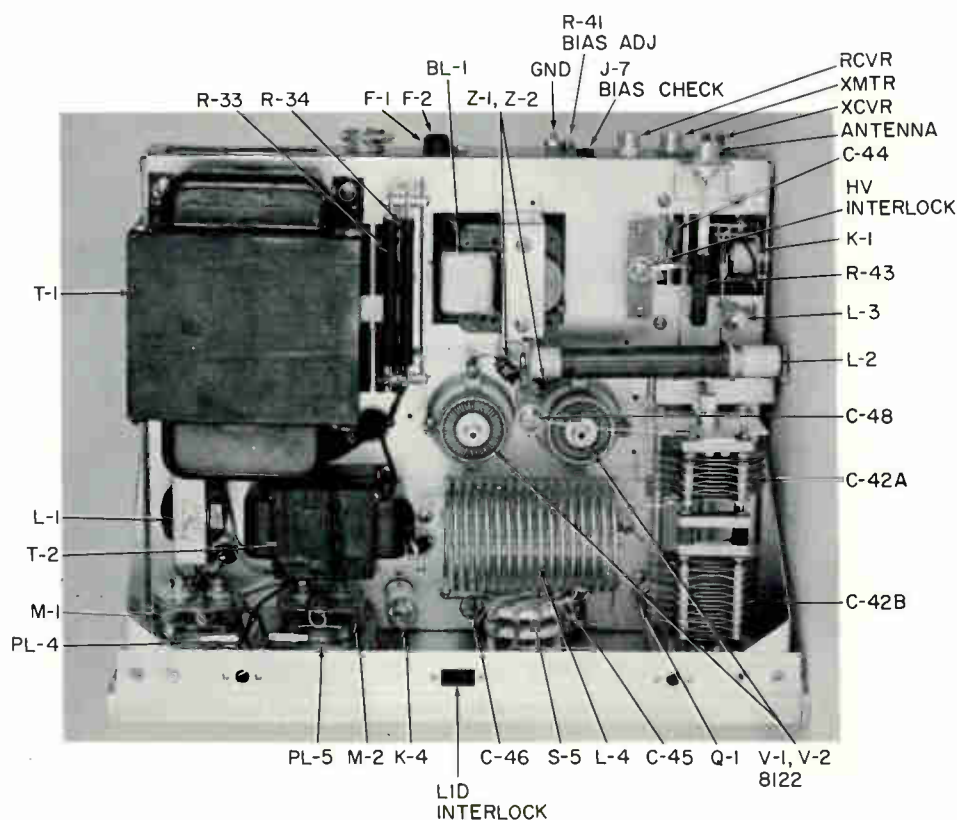

FIGURE 6

screws around the opening in the rear of the cabinet and by four screws in the bottom of the cabinet. To remove the cabinet, open the lid and remove the high voltage interlock rod. Remove all of the retaining screws and pull the chassis and front panel forward out of the cabinet. It may be convenient to simultaneously exert pressure on the chassis through the opening at the rear of the cabinet.

5.4 FRONT PANEL AND SIDE GUSSET REMOVAL:

The side gussets are held in place by the four screws at the top and bottom of the front panel and by the sheet metal screws holding the gussets to the side of the chassis. To remove the front panel, remove the cabinet, the side gussets, the interlock socket on the top lip of the front panel, the knobs, the palnuts on the MULTIMETER switch, BAND switch and PA LOAD shafts, and the three screws near the PA TUNE shaft. Pull the front panel forward and remove the meter mounting plate and the three pilot light sockets, noting their relative positions so that they may be replaced correctly.

5.5 REGULATOR TRANSISTOR CHANGE:

The regulator transistor cases are insulated from ground by a very thin mica washer. CAUTION! — Care must be exercised to avoid destroying this insulation. To change a regulator transis-

tor, remove the cabinet and the right side gusset, unsolder the wires to the base and emitter pins and remove the screws that hold the transistor to the chassis. This will also free the collector (case) connection. Pull the transistor out of the chassis and replace with a new one by reversing the above procedure. Before replacing transistor connections, check the collector-to-chassis resistance to see that the insulation is intact.

5.6 AIR SYSTEM CLEANING:

It is recommended that the air system be cleaned every three months and more frequently in dusty locations. Remove the cabinet and the cover of the pressurized compartment beneath the tubes. Clean all areas of dust accumulation with a small brush or with a household vacuum cleaner; also clean the inside of the blower squirrel cage and the tube plate radiators. An air jet, if available, will speed air system cleaning.

5.7 GRID RESISTOR TAP CHANGE:

If less than 80 watts PEP of exciter power is available, it is necessary to change the tap on the grid resistor. Remove the cabinet and locate the tinned wire running from a feed-through bushing on the pressurized compartment to the swamping resistor bracket nearest the side of the chassis. Move this wire to the bracket nearer the center of the chassis. This bracket also has the wire from the coaxial jack marked "XMTR" connected to it.

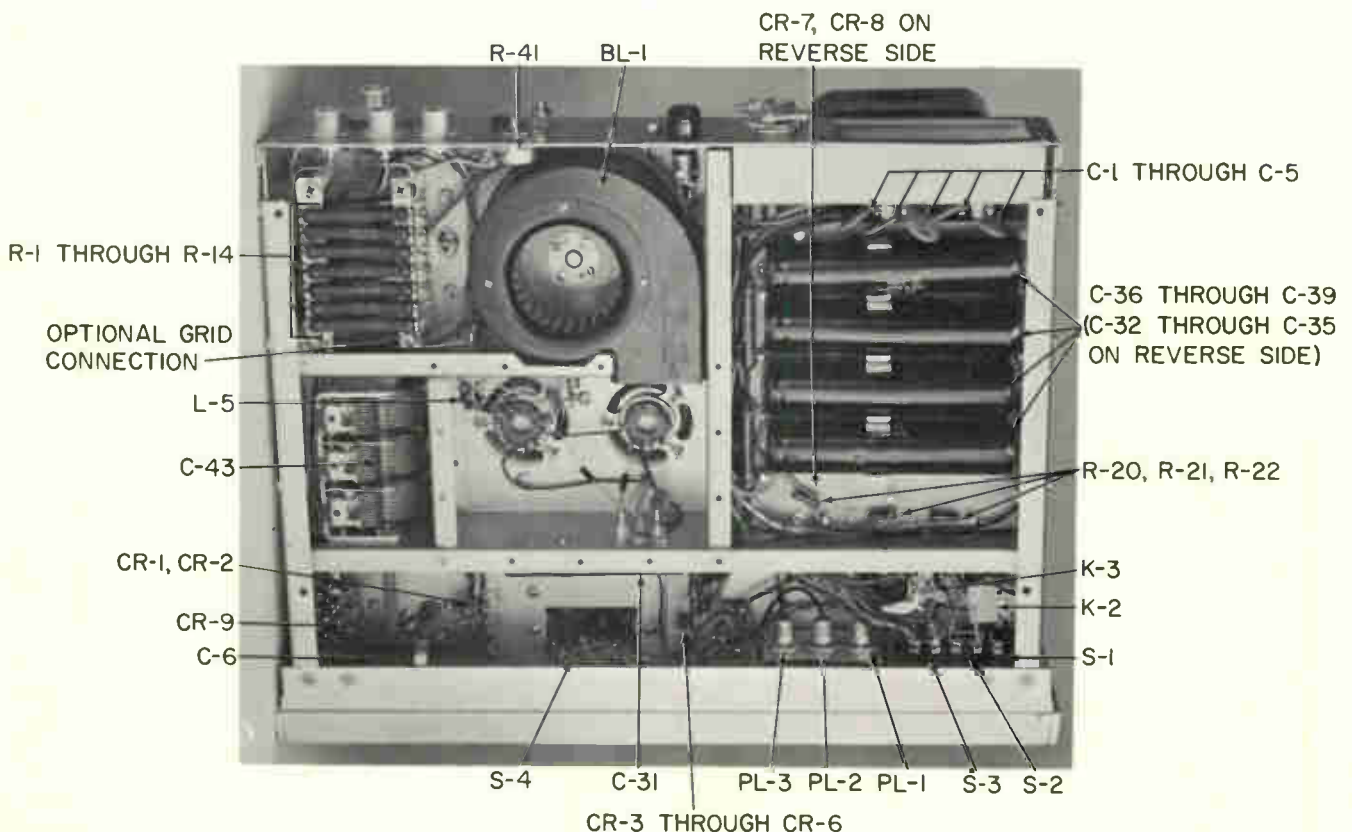

FIGURE 7

VOLTAGE AND RESISTANCE CHECKS

Note: Resistance measurements are made with all power disconnected, and with the negative ohmmeter lead grounded. Since many of the measurements are made across semiconductors, the readings may vary moderately from those given here. Voltage measurements are made with the MULTIMETER switch in EXCITER TUNE position with the relay terminals shorted. The bias should be set to -35 volts at the rear-apron BIAS CHECK jack, and line voltage is 117 or 234 volts.

Measurement point	Resistance to ground	Voltage to ground
Junction of R36 and C6	47K Ω	-80
Q1 base	4K Ω	-35.2
Q1 emitter	800 Ω	-35
Q2 base	1300 Ω	-18.2
Q2 emitter	4K Ω	-18
V1, V2 pins 3, 8, 11	650 Ω	-35
V1, V2 pins 2, 7, 10	11.5K Ω	Zero. Do NOT attempt to energize the plate and screen supplies with the cabinet lid open.
V1, V2 pin 6	0-1 Ω	13.5 ac
V1, V2 pins 1, 4, 9	0 Ω	0
Junction of R25 and R34	1.5 Ω	Zero. Do NOT attempt to energize plate and screen supplies with the cabinet lid open.
Junction of C39 and R20	15 Ω	Zero. Do NOT attempt to energize plate and screen supplies with the cabinet lid open.
Junction of C22 and L5		-35

FIGURE 8

SECTION 6 TROUBLE SHOOTING

— CAUTION —

VOLTAGES USED IN THE NCL-2000 ARE LETHAL. MAKE CERTAIN THAT ALL INTERLOCKS ARE OPERATIVE AND THAT PRIMARY POWER HAS BEEN REMOVED BEFORE MAKING INTERNAL ADJUSTMENTS.

6.1 MALFUNCTION CHECKS

It is assumed that, if possible, the Linear has been correctly tuned and loaded before any operation checks are made.

SYMPTOM	PROBABLE CAUSE AND CURE
Overload relay trips with no drive	<ul style="list-style-type: none"> a. Bias supply failed: Check regulation and range by means of rear-panel tip jack; check semiconductors in regulator circuit. b. Tube failed: Check tubes with ohmmeter for shorts.
Arcing in plate tank components	<ul style="list-style-type: none"> a. Antenna is mismatched: The NCL-2000 tank circuit will handle 2000 watts with a 50 ohm load with VSWR less than 2:1. Try changing antenna feedline length or use an antenna coupler. b. Dust accumulation: Clean all components of dust accumulation.
No plate voltage; screen current zero (without excitation)	<ul style="list-style-type: none"> a. Failure in primary or plate power transformer: Check mode switch, fuses, wiring, relay, interlock, Make certain lid is fully closed.

No plate voltage; screen current off scale (without excitation)	a. Failure in plate supply: Check rectifiers and filter capacitors. Check meter circuit.
No idling plate current, proper plate voltage	a. Failure in screen supply: Check screen supply components. b. Check antenna transfer relay operation.
Overload relay buzzes when plate switch held on	a. Extreme mistuning b. High voltage supply shorted c. Plate blocking capacitor C48 shorted d. Defective overload relay: Check relay pull-in current. Relay should operate at 1.2 amperes of coil current.
Output waveform clipped	a. Overdriven or under-loaded. Note: <i>slight</i> clipping of voice peaks does not introduce appreciable inter-modulation distortion.
Screen current falling with single-tone drive at full power.	a. Normal condition caused by screen grids heating up and expanding, which changes the internal geometry of the tube.
Insufficient loading range	a. In many instances, antenna loads will be presented to the NCL-2000 which are outside the 40 to 60 ohm range of the pi-network. Antennas presenting this type of impedance should, if at all possible, be adjusted to present a proper load at the NCL-2000 antenna terminal. This can be done through the use of matching networks and, in many instances, through the simple expedient of tailoring the length of the antenna transmission line to modify its terminal impedance. b. Insufficient loading will be evidenced by high screen current or low plate current at maximum PA LOAD setting. It may be possible to take care of insufficient loading on 80 and 40 meters through slight alteration of the NCL-2000 pi-network by removing either C46 or C47 or both. c. Excessive loading as evidenced by low or zero screen current and high plate current at minimum PA LOAD setting may sometimes be corrected by adding high quality transmitting capacitors in parallel with C43, C46 and C47.

SECTION 7 PARTS LIST

All commonly available resistors and capacitors are fully identified on the Schematic and are not included in this parts list.

PART DESIGNATION	DESCRIPTION	NATIONAL PART NUMBER
BL 1	Blower	C51713
C1 through C5 and C53 through C55	Capacitor, Ceramic; .01 μ f. (Special AC line rating)	A51457
C6	Capacitor, Electrolytic; 150 μ f., 150 v.	C19411-5
C31	Capacitor, Electrolytic; 80 μ f., 450 v.	C19411-4
C32 through C39	Capacitor, Electrolytic; 80 μ f., 450 v. (Special ripple current rating)	C51447-1
C42	Capacitor, PA Tune	A51400-Pg. 19
C43	Capacitor, PA Load	C51441
C44	Capacitor, Ceramic; .001 μ f., 6 kv.	A50849-9
C45	Capacitor, Ceramic Transmitting; 100 pf., 5 kv.	A51403-1
C46	Capacitor, Ceramic Transmitting; 750 pf., 5 kv.	A51403-2
C47	Capacitor, Ceramic Transmitting; 450 pf., 5 kv.	A51403-5
C48	Capacitor, Ceramic Transmitting; 1000 pf., 5 kv.	A51403-3
CR1, CR2	Rectifier, Silicon; 400 p.i.v., 500 ma.	A51407-3
CR3 through CR6	Rectifier, Silicon; 1000 p.i.v., 500 ma.	A51407-1
CR7, CR8	Rectifier, Silicon Stack; 5000 p.i.v., 1000 ma.	A51431
CR9	Diode, Zener; Type IN1777	IN1777
F1, F2	Fuse; 12 amps, 250 v.	A51444
J1 through J4	Connector, Coaxial	A51479
K1	Relay, Antenna; DPDT and SPST-NO contacts; contact rating 10 amps at 30 mc.; 12 v.a.c. coil	B51416-1 ✓ 9.50
K2	Relay, Overload; SPST-NC contacts; contact rating 2 amps; relay pulls in at 1.2 amp coil current	B51416-3 ✓ 8.00
K3	Relay, Plate Power; 3PST-NO contacts; contact rating 10 amps; 12 v.a.c. coil	B51416-2 9.50
K4	Relay, Time Delay; 75 sec. delay; SPST-NO contacts; 12 v. heater	A51411
L1	Choke, Swinging; 6 H. at 35 ma.; 3 H. at 70 ma.; 1500 v. insulation; 150 Ω d.c. resistance.	B51428
L2	Choke, RF Plate; 165 μ H.; 800 ma. d.c.	B51448
L3	Choke, RF; 2.5 mH.; National Radio Catalog Number R100S-2.5	D50530-12
L4	Coil, Final Tank	B51473-3
L5	Choke, RF; 750 μ H.; National Radio Catalog Number R33-750	C50527-5
M1	Meter, Plate Current; 0-1 v.d.c.; 1000 ohms per volt	C51442-1
M2	Meter, Multimeter; 0-1 v.d.c.; 1000 ohms per volt	C51442-2
Q1, Q2	Transistor, Type 2N1159	2N1159
R1 through R14	Resistor, Swamping; 180 Ω , 7 w., 10%; metal film type	A51401-1
R15, R16	Resistor, 20.5 Ω , 1/2 w., 1%	A51402-1
R17	Resistor, 1 Ω , 2 w., 1%	A51402-5
R20, R21, R22	Resistor, 1.66 meg., 1 w., 1%	A51402-3
R25 through R32	Resistor, 50 k., 5 w., 10%	A51401-2
R33, R34	Resistor, 75 k., 55 w., 10%	A51412
R35	Bleeder, 11.5 k., 15 w., 10%	B17436-18
R42	Potentiometer, Bias Adjust; 1.2 k., 1/2 w	B51378
R43	Resistor, 15 Ω , 10 w., 10%; special surge current rating	A51332
S1	Switch, Rocker; SPST; 6 amps	B51424-1
S2	Switch, Rocker; Special switching configuration; 6 amps.	B51424-3
S3	Switch, Rocker; DPDT; 20 amps	B51424-2
S4	Switch, Meter	B51476
S5	Switch, Band	B51446
T1	Transformer, Power	D51455
T2	Transformer, Filament	C51440
V1, V2	8122 Tube (See Service Instructions for Replacement procedure)	8122
Z1, Z2	Chokes, Parasitic Suppression; 2 turns #16 wire on 33 Ω , 2 w., resistor	B51430
	Front Panel Assembly	E51498-6
	Cabinet	E51496-5
	Cover, Cabinet	E51495-4
	Terminal Board, High Voltage	C51434-2
	Power Cord	A51482
	Knob	A51200-NPS17F2L
	Socket, Tube; Elevenar	A51406
	Feedthrough; National Catalog Number TPB	SA 481

SPECIFICATIONS

1. Frequency Range: 80, 40, 20, 15, and 10 meter bands plus overlap at band edges.
2. Power Input (SSB): 1000 watts average, 2000 watts PEP.
Power Input (AM, CW, RTTY): 1000 watts.
Power Output (SSB): 1300 watts minimum on all bands.
Power Output (CW, RTTY): 600 watts minimum on all bands.
Power Output (AM): 300 watts minimum on all bands.
3. Output Impedance Matching Range: 40-60 ohms minimum.
4. Input Impedance: 50 ohms nominal, unbalanced.
5. Drive Requirements: 20 to 200 watts PEP, adjustable.
6. Component Ratings: All components specified to best commercial practice; all power components rated at 1000 watt average input i.c.a.s.
7. Power Supply: Bias voltage electronically regulated, plate supply utilizes solid state rectifiers in full wave voltage doubler configuration for better ripple & regulation, rated to deliver 2500 volts at 800 ma. key down.
8. Distortion Products at Full Rated Output: 30—45 db signal to distortion ratio.
9. Noise: NLT 40 db down.
10. ALC: Rear panel output for use with equipment incorporating such provision.
11. Ambient Temperature Range: To 45° C.
12. Ambient Humidity Range: To 90%.
13. Altitude: To 8,000 ft.
14. Tune-up Provisions: SSB-CW switch permits tune-up at 1000 watts to comply with F.C.C., built-in dummy load for exciter permits tune-up into amplifier grid circuit with amplifier plate voltage removed and with relative exciter power indicated on amplifier multi-meter.
15. Safety Provisions: Primary power fuses, one minute time delay relay, plate current overload (1.2 ampere) relay, hinged cover utilizes Dzus fasteners with plate power interlock, automatic shorting bar connects plate power to ground (when cover is raised) in case of interlock or bleeder failure.
16. Internal Relays: Plate power time delay, plate current overload, plate power, antenna relay.
17. Metering: Precision plate milliammeter, rear illuminated, 0—1000 ma., precision multi-meter, rear illuminated; 0—5000 plate volts, 0—50 screen milliamperes, 0—50 grid milliamperes, exciter relative power output.
18. Front Panel Controls: Power On-Off, SSB, CW, plate power On-Off, power pilot light, amplifier ready light, plate power light. Bandswitch, Multi-meter switch, P.A. Tune, P.A. Load.
19. Rear Panel: Amplifier Output, Transceiver Input, Transmitter Input, Receiver Input, ALC Output, control relay terminals, Grid Bias Test Jack, fuses, primary power input.
20. Tube and Semi-Conductor Complement: Two RCA 8122 output tubes, 13 semi-conductors for rectification and regulation.
21. Size: 7 5/8" H, 16 1/2" W, 12 3/4" D.
22. Weight: 62 lbs.
23. Primary Power Requirements: 115 V.A.C. 60 cycle single phase, or 230 V.A.C. 60 cycle single phase, 3 wire neutral ground Current 15 amperes maximum at 230 V. May be operated with 50 cycle source at reduced input or with 60 cycle source for fan.
24. Warranty: Tubes, transistors and labor warranted for three months, all other components for 12 months after date of purchase.

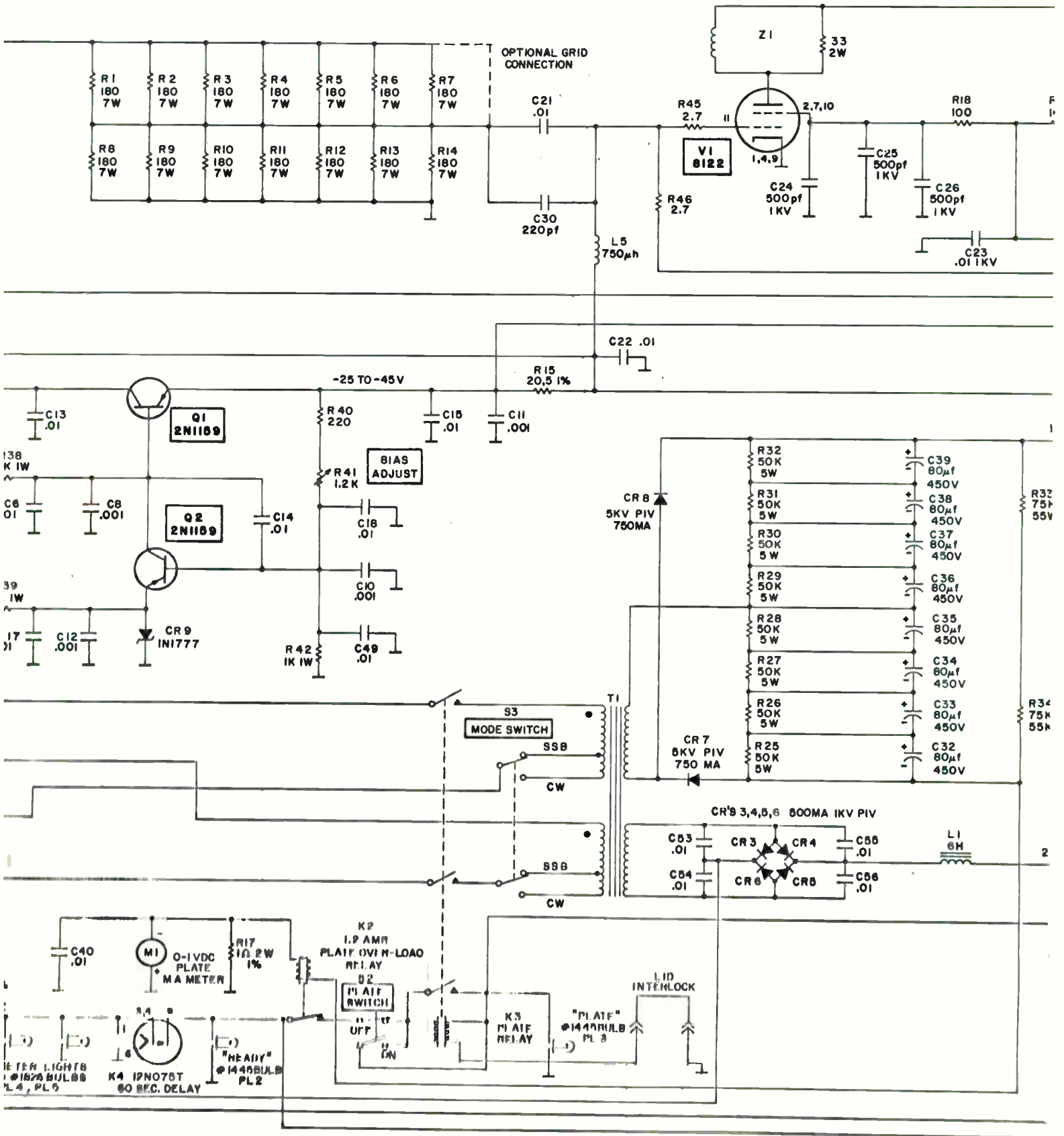

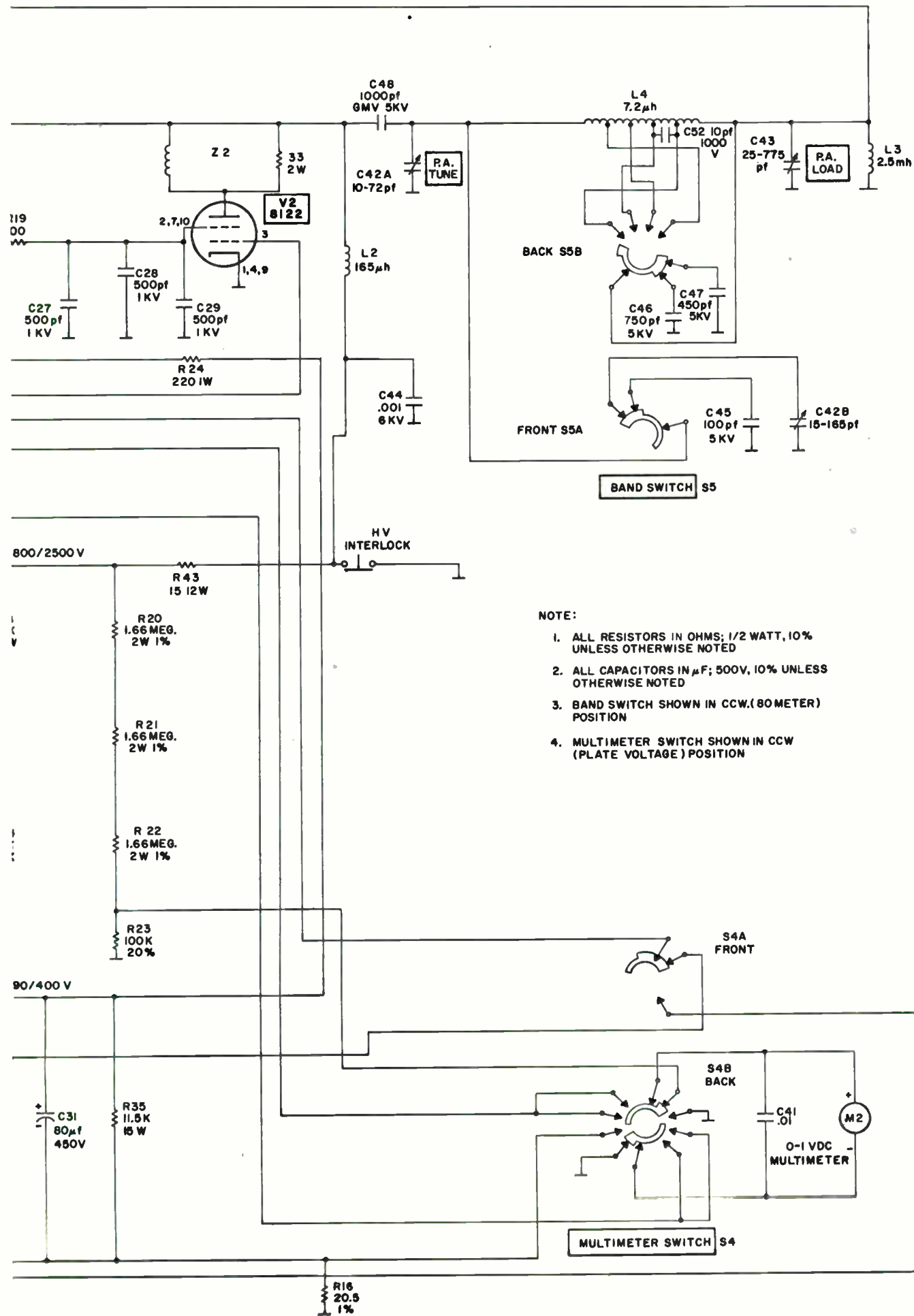

NOTE:

1. ALL RESISTORS IN OHMS; 1/2 WATT, 10% UNLESS OTHERWISE NOTED
2. ALL CAPACITORS IN μ F; 500V, 10% UNLESS OTHERWISE NOTED
3. BAND SWITCH SHOWN IN CCW.(80METER) POSITION
4. MULTIMETER SWITCH SHOWN IN CCW (PLATE VOLTAGE) POSITION

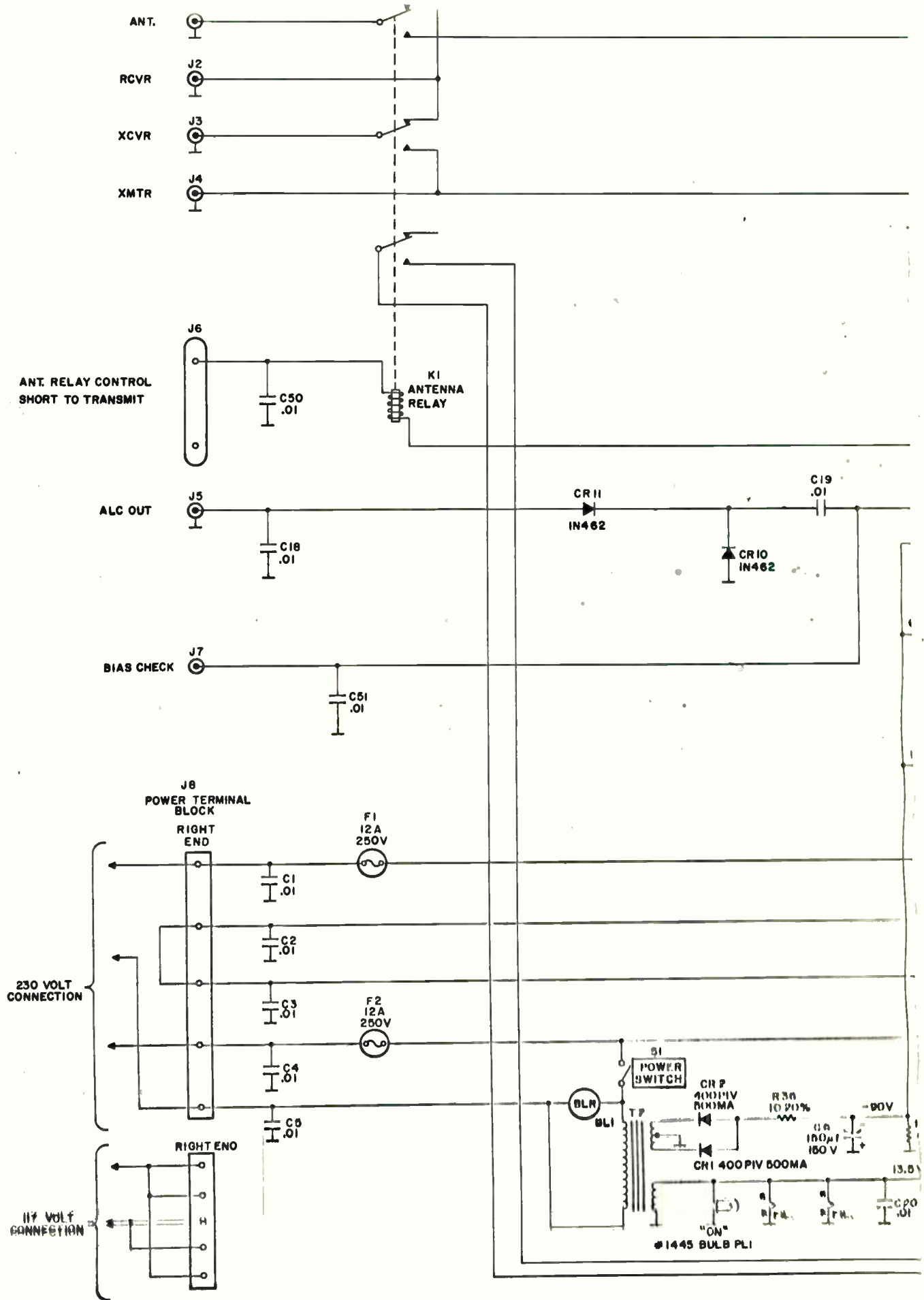



CUSTOMER SERVICE BULLETIN

July 6, 1966

NCL-2000

CSB 66-4

National Radio Customer Service Bulletins are provided free to all registered owners of our equipment. Information contained herein is gathered from our factory and field service organizations as well as from National owners.

We do not recommend the "automatic" incorporation of modifications except when the trouble description is identical to your problem, or when suggested for preventive maintenance.

PREVENTIVE MAINTENANCE

It has been found that in some installations, switching transients exceed the PIV ratings of the screen diodes. It is therefore recommended that .01uf, 1KV, special AC rating disc capacitors (National part A51457) be placed across each screen diode. Designate these C53, 54, 55, and 56. These have been installed in production on Series 80 and higher. These parts are \$.50 each and are available through our Service Department.

SCHEMATIC CORRECTIONS

- a. On all NCL-2000 schematics, the screen diodes are shown incorrectly. The correct wiring is as follows:

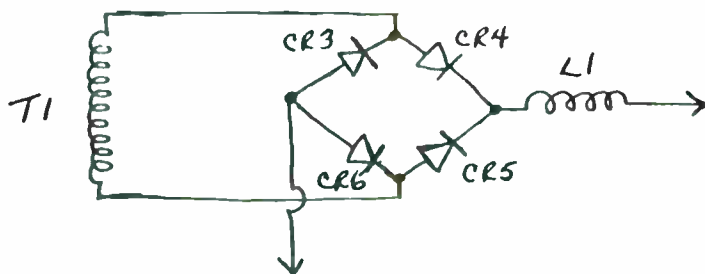

- b. On Series 71 schematics, draw a line from the top of R-15 to the bias checkpoint directly to the right.

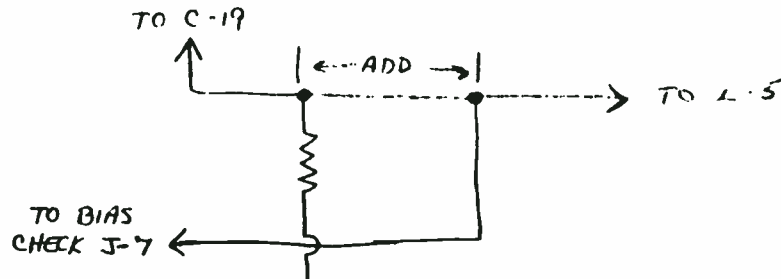

- c. On Series 80 schematics, reverse the polarity of CR-10.
- d. On Series 80 schematics the lower terminal of the relay control panel should be shown as grounded.

IMPROVED LOADING

For improved loading on 80 meters on Series 71 sets, change C-47 from 300 pf to 450 pf 5 KV.

8122 TUBE REPLACEMENT

Should it be necessary to replace a defective 8122, it is essential that both tubes be returned to the factory. This is to assure that correct matched replacements are returned to our customers. 8122 tube pullers are available free of charge through the Service Department.

PILOT BULB REPLACEMENT

To eliminate possibility of pilot bulb failure due to high filament voltage, we recommend that types 363 and 1815 be replaced with types 1445 and 1826 respectively.

LONGER 8122 TUBE LIFE

Heavier loading will increase 8122 reliability without appreciably reducing power output. This heavier loading may be achieved by increasing loading to achieve 15 or 20 ma screen current (not by reducing drive) at resonance while maintaining grid current over 15 ma.

TO AVOID SERIOUS DAMAGE

- A. The bottom cover on the grid compartment must always be securely fastened.
- B. Never change bands with the NCL-2000 plate voltage on.
- C. Clean the air system at regular intervals as set forth in paragraph 5.6 on page 16 of the instruction manual.
- D. Never operate the NCL-2000 without a proper antenna or dummy load.
- E. Do not place the NCL-2000 in a position where the air flow will be impeded. Never place anything on top or under the unit or remove the cabinet feet.

SERVICE HINTS

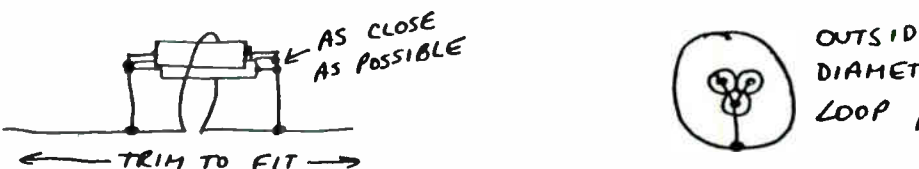
SYMPTOM	PROBABLE CAUSE AND CURE
<p>Parasitic suppressor failure due to extended key-down use on 10 meters</p>	<p>Construct new heavy duty choke as shown below:</p>  <p>Parts required: 7" #14 tinned wire; 3 120 ohm 2 watt carbon resistors.</p> <p><u>Note:</u> Resistors soldered together and then centrally located in loop as shown.</p> <p><u>CAUTION:</u> Operation of NCL-2000 with burned out parasitic suppressors may cause failure of bias supply.</p>
<p>Ready light on. H.V. will not come on. No indication of malfunction (such as buzzing relay).</p>	<p>Remove the time delay relay, K-4, and look for an internal break between pins 8 and 9.</p>
<p>Removal of 8122 tubes</p>	<p>Do not use pliers. Loosen all clamps at tube and also loosen stand-off insulator. A tube pulling tool is available free of charge to all NCL-2000 owners.</p>

SERVICE HINTS

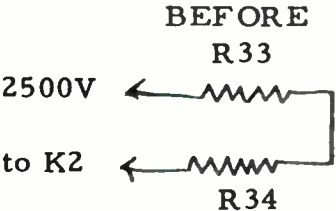
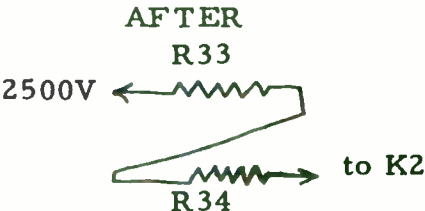
SYMPTOM	PROBABLE CAUSE AND CURE
Overload relay trips with no drive	Shut off immediately. Check screen diodes for possible shorts. For heavy-duty replacement, order NATIONAL part A50876.
Plate meter shunt resistor and overload relay shunt resistors burn out	Check the high voltage bleeder resistors R-33 and R-34 for opens. Check coil of overload relay for open. Open bleeder resistors would also cause excessive high voltage. NOTE: In Series 71 sets, overload relay with Magnecraft 88X-151A will be replaced by 88X-151B, NATIONAL part B51416-3. The new type relay will not require R-44. Remove and discard R-44.
Plate voltage will not shut off	Check contacts of plate relay K3. Burnish contacts or replace relay as necessary.
Arc over of high voltage bleeder resistors	<p>Caused by insulation breakdown. Replace if necessary and re-wire as shown:</p> <div style="display: flex; justify-content: space-around; align-items: flex-start;"> <div style="text-align: center;"> <p>BEFORE</p>  </div> <div style="text-align: center;"> <p>AFTER</p>  </div> </div> <p>The new lead between R-33 and R-34 should be 10kv test wire. To extend the black wire to the opposite end of R-34, splice in 4-1/2" piece of insulated hook-up wire. Cover the splice with good insulation, such as shrinkable tubing, teflon sleeve, etc.</p>
Insufficient idling current or excessive idling current with any setting of bias control	Check range of bias control. Should be -25 to -45V. Check Q-1, Q-2, and CR-9. If any one of these three semiconductors are found to be shorted, replace <u>all three</u> .
Low plate voltage	The NCL-2000 is designed around a nominal AC input voltage of 117 or 234 VAC. Should there be excessive voltage drop on 117 VAC due to insufficient current capacity of the house wiring, it would be advisable to switch to 234 VAC.
Low plate voltage with correct AC supply voltage	Check R-25 through R-32 for opens. Also check C-32 through C-39 for shorts or excessive leakage.

Service Dept.
 Technical Services Section
 Distribution: All NCL-2000 Owners
 List "F"
 List "L"

Carl W. Huether
 Carl W. Huether K1UHY/K2QJM