

1940

CATALOG

SALES & SERVICE CO.  
813 E. G. WESEBEE ST.  
SYRACUSE, N. Y.



P. R. MALLORY & CO. INC.  
**MALLORY  
YAXLEY**



APPROVED PRECISION PRODUCTS

P. R. MALLORY & CO., INC. • INDIANAPOLIS, INDIANA  
NEW YORK • CHICAGO • PHILADELPHIA • DETROIT



# Approved PRECISION PRODUCTS

SINGLE CARBON CONTROL

## Standard Replacement Controls

● Mallory-Yaxley control design incorporates exclusive mechanical features, which have added more to the convenience of the service man than any other replacement control on the market. The many universal features are directly responsible for minimizing the time required for replacing controls in receivers and providing additional profits for service men. Their use in any radio equipment insures the owner of long life and satisfactory performance.

- Highest current-carrying capacity of any carbon control.
- Low humidity coefficient permits satisfactory operation in all climates.
- Long Life—25,000 to 50,000 and over complete cycles, borne out in over four years' testing.

Mallory-Yaxley "Universal" application answers every service need. See page 7 for Yaxley precision-engineered volume control accessories that provide extreme flexibility and quick, sure, satisfactory replacements. See bottom of page 6 for etched dial plates of matched rotation.

All Mallory-Yaxley Standard (or large size) Universal Controls—both wire wound and carbon types—incorporate:

### Explanation of Tapers

Taper Number 1 is a modified logarithmic left hand taper in the carbon type of control and an approximation to this logarithmic taper in the wire wound type. Should always be used in shunt circuits as in usual antenna and audio circuits, or where only the center and left hand terminals are used.

Taper Number 2 is a right hand logarithmic taper in the carbon and an approximation in the wire wound type. Used in series circuits, as in cathode voltage controls, or where only the center and right hand terminals are used.

Taper Number 3 is a combination left and right hand taper. Has a limited use in circuits where the control must perform both as a shunt and as a series circuit control as in combination antenna shunt plus bias circuits. This is the most common use for such a taper.

Taper Number 4 is a linear taper. Strictly speaking it is not a "taper" although commonly referred to as such. A linear "taper" is used wherever a control should be such that voltage is proportional to the degree of rotation.

Taper Number 4A is a modification of the regular linear taper Number 4.

Taper Number 5 is a general outline of the taper used on a large number of the tapped controls. However, the actual curve varies due to the location of the tap. In general, it is identified by 20% total resistance at 50% rotation.

Taper Number 6 is a special variation of the Number 1 taper for use where control is tapped at a low value.

Taper Number 7 is made only in the wire wound type of control and is a form of left hand taper. This taper is desirable for the antenna shunt plus bias control, wherein greater attenuation is obtained by increasing the bias voltage. The slight left taper then suffices to gradually reduce the signal to zero volume by the shunting action in the antenna circuit.

- Universal shaft and insert to fit all type knobs.
- Instantly attachable switches—no screws—no clamps to bend.
- Easily cut aluminum shaft—three inches long.
- Rugged assembly with dust-proof case completely enclosing control.
- High-quality plated finish to protect metal parts.
- Uniform characteristics—controls are held to rigid, detailed specifications and are manufactured to the same exacting specifications that are required by original equipment users.
- Permanently identified—a non-removable ink assures permanent identification for your convenience.

Mallory-Yaxley Silent Universal Carbon Controls have all of the above features that have made Yaxley famous. In addition, they incorporate other features that contribute to their silent and stable performance, such as:

- "The Roller That Does Not Roll." This exclusive Yaxley contact design (U. S. Pat. No. 2,135,809) maintains a constantly dust-free surface element and is further protected by Yaxley's dust-proof shield.
- Pure Silver Short-outs. Used for clean-cut, quick, positive switch action.
- Silver-to-Silver Contacts. Used between all moving current-carrying parts.
- Perfect Contact. Mallory-Yaxley controls have perfect contact between moving arm and carbon element. A true and uniform area of contact is effected on the element at all points.

Mallory-Yaxley Silent Universal Carbon Controls also embody:

- Perfect, smooth taper controlled by geometric design: no sudden changes in resistance value. Tapers are feather-edged to insure electrical smoothness.

2. Entire contents copyrighted 1939 by P. R. MALLORY & COMPANY, INC., Indianapolis.

DUAL CARBON CONTROL

SINGLE CARBON CONTROL

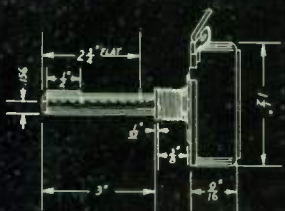

DUAL CARBON CONTROL

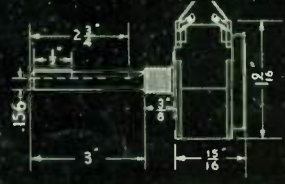

SINGLE WIRE WOUND CONTROL

SINGLE WIRE WOUND CONTROL

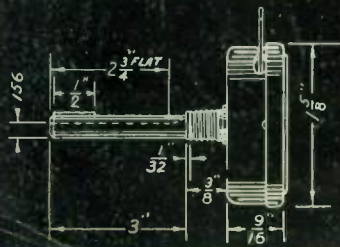

WIRE WOUND TAPERS

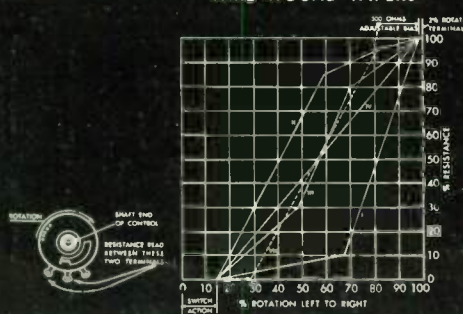

TAPERS for Carbon Controls

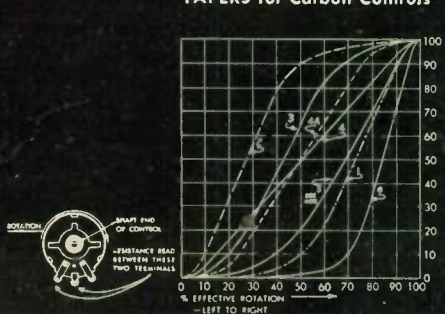



## Midget Replacement Controls

● Through the development of the new Mallory-Yaxley Midget Volume Controls (Types UM and TM) and the introduction of the new Mallory-Yaxley Plug-In Shaft (Type SS), Mallory-Yaxley offers a great advance in volume control servicing.

A single set of Mallory-Yaxley Plug-In Shafts multiplies the usefulness of any one of these controls by 17—or more.

For example—10 new Mallory-Yaxley Midget Controls plus 17 shafts give you the servicing equality of 170 ordinary Exact Replacement Controls with fixed shafts. Now—let's go a step further! Multiply seventeen or more exact replacement possibilities by the fifty-six known basic type controls. To cover such a service range with fixed shafts (so-called "specials") would mean you would need one each of 952 individual controls. Mallory-Yaxley Midget Volume Controls with Plug-In Shafts provide the same service stock with only 56 controls and 17 Plug-In Shafts.

The line of MR Midget Controls will be found satisfactory for many applications where special shafts and couplings are unnecessary.

For complete details see your distributor or the Mallory-Yaxley Radio Service Encyclopedia, 3rd Edition, for correct replacement control recommendations by make of set and model number of over 23,000 receivers.

### Midget Tapped Controls, Type TM

Complete with selection of SS Shaft desired. In placing order, be sure to specify the Mallory-Yaxley SS Type Plug-In Shaft desired. For example: "TM229 with SS4."

Res. Value	Tap at	Taper	Catalog Number	List Price Less Shaft	List Price With Shaft
250M	50M	5	TM219*	\$1.25	\$1.50
250M	50M	5	TM220	1.25	1.50
250M	125M	5	TM221	1.25	1.50
250M	125M	5	TM222*	1.25	1.50
350M	75M	5	TM225	1.25	1.50
500M	5M	6	TM228	1.25	1.50
500M	125M	5	TM229*	1.25	1.50
500M	125M	5	TM230	1.25	1.50
500M	250M	5	TM231	1.25	1.50
500M	250M	5	TM232*	1.25	1.50
1 Meg.	200M	5	TM240	1.25	1.50
1 Meg.	200M	5	TM241*	1.25	1.50
1 Meg.	150M	5	TM242*	1.25	1.50
1 Meg.	500M	5	TM243	1.25	1.50
2 Meg.	5M	6	TM245	1.25	1.50
2 Meg.	25M	5	TM246	1.25	1.50
2 Meg.	50M	5	TM247	1.25	1.50
2 Meg.	200M	5	TM248	1.25	1.50
2 Meg.	500M	5	TM249	1.25	1.50
2 Meg.	1 Meg.	5	TM251	1.25	1.50
2 Meg.	1 Meg.	5	TM252*	1.25	1.50
2 Meg.	5 & 500M	Spec.	TM253	1.25	1.50
3 Meg.	1 Meg.	4	TM257	1.25	1.50
2 Meg.	500M	4	TM258	1.25	1.50
2 Meg.	1 Meg.	4	TM259	1.25	1.50

\*Clutch type controls—no provision for attachable switch. †Right hand switch action.

### Midget-Single Universal Controls Type UM

Complete with selection of SS Shaft desired. In placing order, be sure to specify the Mallory-Yaxley SS Type Plug-In Shaft desired. For example: "UM122 with SS4."

Res. Value	Taper	Catalog Number	List Price Less Shaft	List Price With Shaft
5M	4A	UM114	\$1.25	\$1.50
10M	1	UM118	1.25	1.50
10M	2	UM119	1.25	1.50
10M	4	UM120	1.25	1.50
15M	1	UM121	1.25	1.50
15M	2	UM122	1.25	1.50
20M	1	UM124	1.25	1.50
25M	2	UM128	1.25	1.50
25M	4	UM129	1.25	1.50
50M	1	UM133	1.25	1.50
50M	2	UM134	1.25	1.50
50M	4	UM135	1.25	1.50
75M	1	UM137	1.25	1.50
75M	2	UM138	1.25	1.50
100M	1	UM140	1.25	1.50
100M	2	UM141	1.25	1.50
100M	4	UM142	1.25	1.50
100M	1	UM143*	1.25	1.50
150M	1	UM144	1.25	1.50
250M	1	UM147	1.25	1.50
250M	4	UM149	1.25	1.50
250M	1	UM150*	1.25	1.50
350M	1	UM151	1.25	1.50
500M	1	UM151	1.25	1.50
500M	4	UM156	1.25	1.50
500M	1	UM157*	1.25	1.50
750M	1	UM158	1.25	1.50
1 Meg.	2	UM160	1.25	1.50
1 Meg.	1	UM161	1.25	1.50
1 Meg.	1	UM162*	1.25	1.50
2 Meg.	1	UM163	1.25	1.50
3 Meg.	1	UM165	1.25	1.50
100M	Spec.	UM180†	1.25	1.50
2 Meg.	Spec.	UM181†	1.25	1.50

### Special Midget Controls

Res. Value	Tap at	Taper	Cat. No.	List Price
350M	75M	5	SM300	\$2.00†
2 Meg.	500M	4	SM301	2.00†
500M	No Tap	1	SM302	2.00†
6 Meg.	§	1	SM303	1.50

†Includes SPST switch permanently attached to control. ‡Has stop provision.

### Special Midget Dual Controls with Fixed Concentric Shaft and Switch

Res. Front	Res. Rear	Tap at	Catalog Number	List Price
2 Meg.	2 Meg.		SMD500	\$3.00
2 Meg.	1 Meg.	Front 500M	SMD501	3.00
250M	1 Meg.	Rear 250M	SMD502	3.00
2 Meg.	1 Meg.	Front 500M	SMD503	3.00
250M	500M	Front 50M	SMD504	3.00

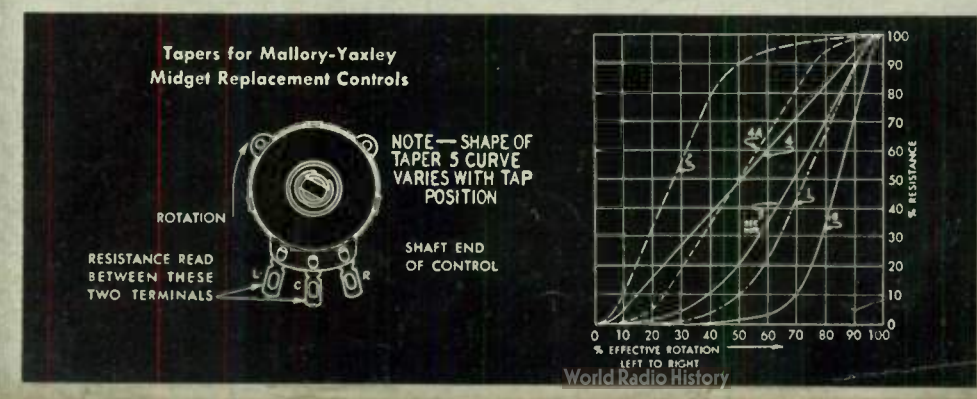
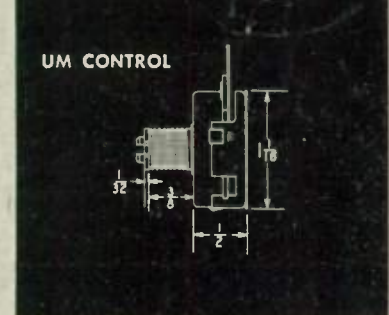
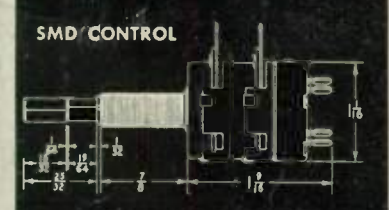
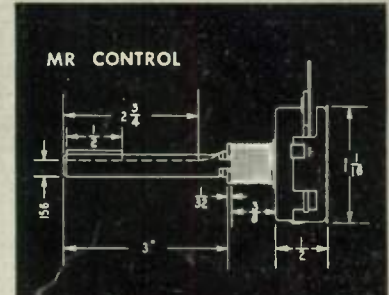

## Midget Replacement Controls and Accessories







### Universal and Special Plug-In Shafts for Use with Types UM and TM Controls

● The purchaser of each Mallory-Yaxley Type UM or TM control at the complete price indicated on the carton is entitled to the selection of the desired Plug-In Shaft for the intended application. At the right is a complete list of a selection that will serve any special shaft length, size, plain or insulated coupling required to replace original equipment.

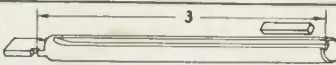
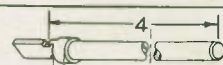
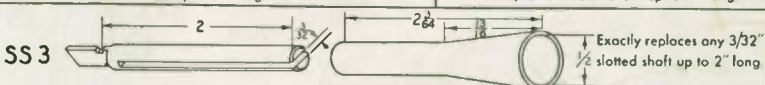
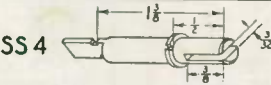
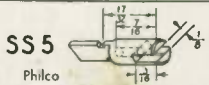
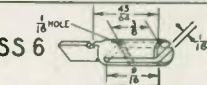
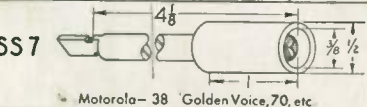
Extra Type SS shafts are available at 25 cents list each.

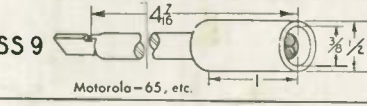
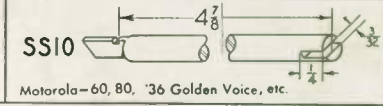
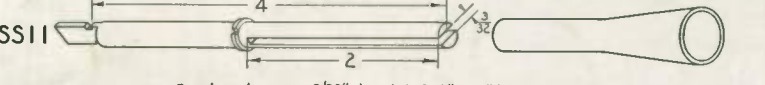
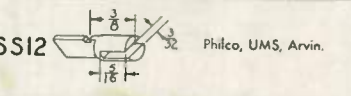
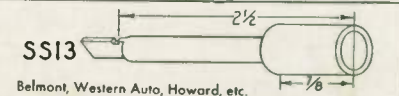
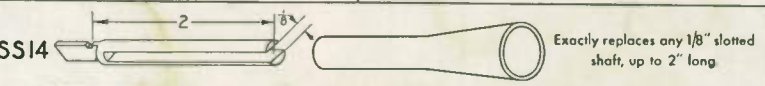
### Midget Controls with Fixed Shafts, Type MR Conservatively rated at 1/2 watt.

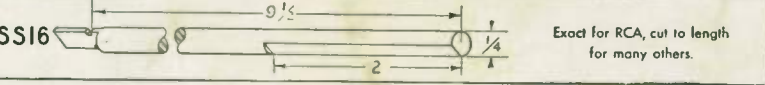
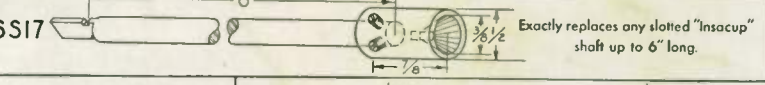
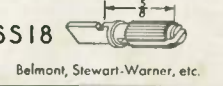
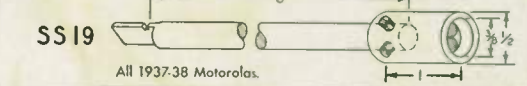
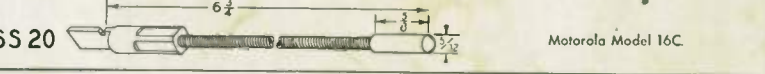
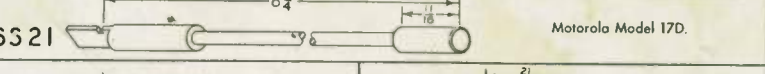
Resistance Value	Taper	Catalog Number	List Price
5M	4A	MR14	\$1.00
10M	1	MR18	1.00
10M	2	MR19	1.00
10M	4	MR20	1.00
15M	1	MR21	1.00
15M	2	MR22	1.00
20M	1	MR24	1.00
25M	2	MR28	1.00
25M	4	MR29	1.00
50M	1	MR33	1.00
50M	2	MR34	1.00
50M	4	MR35	1.00
75M	1	MR36	1.00
75M	2	MR37	1.00
100M	1	MR39	1.00
100M	2	MR40	1.00
100M	4	MR41	1.00
150M	1	MR42	1.00
250M	1	MR44	1.00
250M	2	MR45	1.00
500M	1	MR48	1.00
500M	4	MR50	1.00
750M	1	MR51	1.00
1 Meg.	1	MR53	1.00
2 Meg.	2	MR55	1.00
3 Meg.	1	MR57	1.00

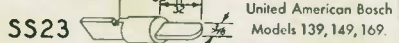
<b>SS 1</b>  Exactly replaces any 1/4" round shaft or 1/32" or 3/32" flatted shaft up to 3" long	<b>SS 2</b>  3/16" diameter shaft up to 4" long
<b>SS 3</b>  Exactly replaces any 3/32" 1/2 slotted shaft up to 2" long	
<b>SS 4</b>  RCA-Part numbers 12240, 12365, etc.	<b>SS 5</b>  Philco '36, '37, '38 household receivers
<b>SS 6</b>  RCA-Hudson H6, etc.	
<b>SS 7</b>  Motorola-38 'Golden Voice', 70, etc.	<b>SS 8</b>  Motorola-35, 45
<b>SS 9</b>  Motorola-65, etc.	<b>SS 10</b>  Motorola-60, 80, '36 Golden Voice, etc.
<b>SS 11</b>  Exactly replaces any 3/32" slotted shaft 2" to 4" long	
<b>SS 12</b>  Philco, UMS, Arvin.	<b>SS 13</b>  Belmont, Western Auto, Howard, etc.
<b>SS 14</b>  Exactly replaces any 1/8" slotted shaft, up to 2" long	
<b>SS 15</b>  Exactly replaces any 3/32" slotted shaft, 4" to 6" long.	
<b>SS 16</b>  Exact for RCA, cut to length for many others.	
<b>SS 17</b>  Exactly replaces any slotted "insacup" shaft up to 6" long.	
<b>SS 18</b>  Belmont, Stewart-Warner, etc.	<b>SS 19</b>  All 1937-38 Motorolas.
<b>SS 20</b>  Motorola Model 16C.	
<b>SS 21</b>  Motorola Model 17D.	
<b>SS 22</b>  Motorola & many others.	<b>SS 23</b>  United American Bosch Models 139, 149, 169.

### Midget Attachable Switches

● Where necessary, UM, TM and MR controls are designed with switch cover and cam to accommodate attachable switches. A complete line of exclusive Mallory-Yaxley Midget Control Switches are available in the following types and circuits:

Cat. No.	Circuit Arrangement	List Price
M-26	Single-Pole, Single-Throw	\$0.50
*M-26T	Single-Pole, Single-Throw	.60
M-27	Double-Pole, Single-Throw	.60
M-28	Single-Pole, Double-Throw	.60
M-23	Three-Pole, Single-Throw, Shorting	.60
M-24	Four-Pole, Single-Throw, Shorting	.60

\*Has dummy terminal identified by copper rivet.

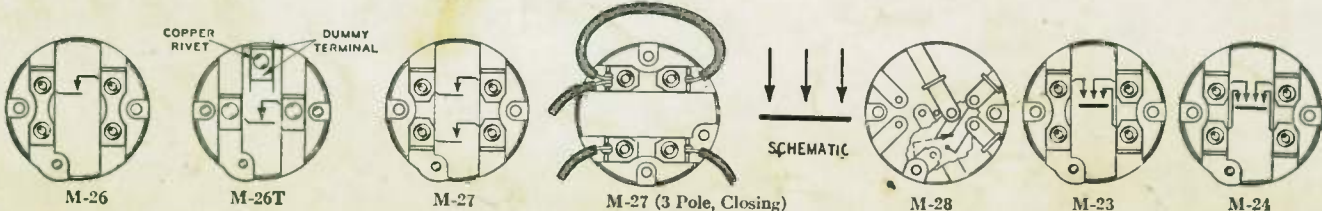



## Standard Universal Single Controls

Prices do not include Switch or Accessories.  
Two No. 232 Nuts, one No. 225 Washer and a Terminal are included.

Ohms Resistance	Taper	General Use	Type Element	Catalog Number	List Price	Ohms Resistance	Taper	General Use	Type Element	Catalog Number	List Price
2	IV	Filament	W.W.	Q	\$1.00	15M	II	Bias	W.W.	*H	\$1.00
6	IV	Filament	W.W.	R	1.00	15M	VII	Ant.-Bias	W.W.	*H7	1.00
10	IV	Filament	W.W.	S	1.00	20M	IV	Voltage Divider (Bias)	W.W.	*A20MP	1.00
20	IV	Filament	W.W.	T	1.00	20M	I	Ant. Shunt, Ant.-Bias, Screen	Carbon	*Y	1.00
30	IV	Filament	W.W.	U	1.00	25M	IV	Voltage Divider (Screen)	Carbon	Y25MP	1.00
60	IV	Filament	W.W.	V	1.00	25M	II	Bias	Carbon	*J	1.00
100	IV	Misc.	W.W.	W	1.00	50M	IV	Batt. Bias, Screen	Carbon	Y50MP	1.00
200	IV	Misc.	W.W.	X	1.00	50M	I	Screen Voltage, Tone	Carbon	K12	1.00
400	IV	Misc.	W.W.	A400P	1.00	50M	II	Bias	Carbon	*K	1.00
500	I	Ant. Shunt	W.W.	A	1.00	75M	I	Screen Voltage, Tone	Carbon	Z12	1.00
550	IV	Bias	W.W.	A550P	1.00	75M	II	Bias	Carbon	*Z	1.00
1M	IV	Voltage Divider (Bias)	W.W.	A1MP	1.00	100M	IV	Voltage Divider (Bias, Screen)	Carbon	Y100MP	1.00
1M	I	Ant. or Pri. Shunt	W.W.	B	1.00	100M	I	RF or AF Shunt, Screen, Tone	Carbon	L	1.00
1M	II	Bias	W.W.	UC500	1.00	100M	II	Bias or Ant.-Bias (AC-DC)	Carbon	*UC510	1.00
2M	IV	Voltage Divider (Bias)	W.W.	*A2MP	1.00	150M	I	Tone, RF or AF Shunt	Carbon	UC502	1.00
2M	I	Ant. or Pri. Shunt	W.W.	*C12	1.00	200M	IV	Voltage Divider, Misc.	Carbon	Y200MP	1.00
2M	II	Bias	W.W.	*C	1.00	250M	IV	Voltage Divider, Misc.	Carbon	Y250MP	1.00
3M	IV	Voltage Divider	W.W.	*A3MP	1.00	250M	I	Audio Tone, RF or AF Shunt	Carbon	M	1.00
3M	I	Ant. or Pri. Shunt	W.W.	*D12	1.00	250M	I	Audio (Automobile)	Carbon	*UC511	1.00
3M	II	Bias	W.W.	*D	1.00	250M	II	Bias, Ant.-Bias (AC-DC)	Carbon	*UC509	1.00
3M	VII	Ant.-Bias	W.W.	*D7	1.00	500M	IV	Voltage Divider, Misc.	Carbon	Y500MP	1.00
5M	IV	Voltage Divider	W.W.	*A5MP	1.00	500M	I	Audio, RF or AF Shunt	Carbon	N	1.00
5M	IV	Voltage Divider (Bias, Screen)	Carbon	Y5MP	1.00	500M	I	Audio (Automobile)	Carbon	*UC512	1.00
5M	I	Ant. Shunt or Ant.-Bias	Carbon	*E12	1.00	500M	I	Audio (Automobile)	Carbon	*UC515	1.00
5M	II	Bias	W.W.	*E	1.00	500M	II	Bias, Ant.-Bias, Bias-Audio	Carbon	UC513	1.00
5M	VII	Ant.-Bias	W.W.	*E7	1.00	750M	I	Tone, Audio, Audio Shunt	Carbon	UC503	1.00
7500	I	Ant. Shunt or Ant. Bias	Carbon	*F12	1.00	1 Meg	IV	Misc.	Carbon	Y1000MP	1.00
7500	II	Bias	W.W.	*F	1.00	1 Meg	I	Audio, Audio Shunt, Tone	Carbon	O	1.00
7500	VII	Ant.-Bias	W.W.	*F7	1.00	1 Meg	I	Audio (Automobile)	Carbon	*UC514	1.00
10M	IV	Voltage Divider (Bias, Screen)	W.W.	*A10MP	1.00	2 Meg	I	Audio, Audio Shunt, Tone	Carbon	P	1.00
10M	IV	Voltage, Divider (Bias, Screen)	Carbon	Y10MP	1.00	3 Meg	I	Audio Shunt, Tone	Carbon	UC504	1.00
10M	I	Ant. Shunt or Ant.-Bias, Tone	Carbon	*G12	1.00	4 Meg	I	Tone	Carbon	UC505	1.00
10M	II	Bias	W.W.	*G	1.00	5 Meg	I	Audio Shunt	Carbon	UC506	1.00
10M	II	Bias	Carbon	UC501	1.00	5 Meg	II	Series Screen Control	Carbon	UC507	1.00
10M	VII	Ant.-Bias	W.W.	*G7	1.00	9 Meg	I	Audio Shunt	Carbon	UC508	1.00
15M	I	Ant. Shunt or Ant.-Bias, Tone	Carbon	*H12	1.00						

\*Wire wound controls have exclusive Yaxley adjustable bias feature. Carbon controls have external adjustable resistor. †Has Slotted Shaft for Automobile Receivers. ††Has long, adjustable Slotted Shaft for Automobile Receivers and Special Shaft Coupling. W.W.—Wire Wound Element.

## Standard Universal Dual Controls

Prices do not include Switch and Accessories.  
Two No. 232 Nuts, one No. 225 Washer and a Terminal are included.

Ohms Resistance	Taper	Type Element	General Use	Cat. No.	List Price	Ohms Resistance	Taper	Type Element	General Use	Cat. No.	List Price
Front 2M Rear 5M	Front I Rear I	Front W.W. Rear W.W.	Ant. Shunt and Bias	CE	\$2.50	Front 100M Rear 100M	Front I Rear I	Front Carbon Rear Carbon	Audio Shunt in Push Pull	LL	\$2.50
10M 5M	VII IV	W.W. W.W.	Ant. Shunt Bias or Screen	*GE	2.50	100M 250M	I I	Carbon Carbon	Audio Shunt, Tone, Screen or RF Shunt	LM	2.50
10M 10M	VII IV	W.W. W.W.	Ant. Shunt Bias or Screen	GG	2.50	250M 250M	I I	Carbon Carbon	Audio Shunt in Push Pull	MM	2.50
10M 50M	I IV	Carbon Carbon	Ant. Shunt Bias or Screen	GK	2.50	250M 500M	I I	Carbon Carbon	Audio Shunt and Tone Compensation	MN	2.50
50M 50M	IV IV	Carbon Carbon	Grid Shunt and Cathode Control	†KK	2.50	500M 500M	I I	Carbon Carbon	Audio Shunt in Push Pull	NN	2.50

## Standard Universal Tapped (TRP) Controls

Prices do not include Switch or Accessories. Two No. 232 Nuts, one No. 225 Washer and a Terminal are included.

Catalog Number	Total Ohms Resistance	Tapped at Ohms	Used As	List Price	Catalog Number	Total Ohms Resistance	Tapped at Ohms	Used As	List Price
TRP600	6M	2500	Vol.	1.50	TRP612	2 Meg.	25M	Vol.	1.50
TRP601	30M	6M	Vol.	1.50	TRP613	2 Meg.	450M	Vol.	1.50
TRP602	63M	3M	Vol.	1.50	TRP614	350M	75M	Vol.	1.50
TRP603	250M	125M	Vol.	1.50	TRP615	3 Meg.	1 Meg.	Vol.	1.50
TRP604	350M	25M	Phono.	1.50	TRP616	500M	50M	Vol.	1.50
TRP605	350M	75M	Vol.	1.50	TRP617	60M	10M	Vol.	1.50
TRP606	500M	100M	Phono.	1.50	TRP618	2 Meg.	200M	Vol.	1.50
TRP607	500M	250M	Vol.	1.50	TRP619	500M	100M	Vol.	1.50
TRP608	1 Meg.	200M	Vol.	1.50	TRP620	2 Meg.	1 Meg.	Vol.	1.50
TRP609	1 Meg.	500M	Phono.	1.50	TRP621*	2 1/2 Meg.	250M	Vol.	1.50
TRP610	1 Meg.	20M	Vol.	1.50	TRP622	44M	7M	Vol.	1.50
TRP611	1 Meg.	170M	Vol.	1.50	TRP623	250M	50M	Vol.	1.50
					TRP624	2 1/2 Meg.	250M	Vol.	1.50

\*No provision for switch; where switch is desired use TRP624

Dial plates with matched rotation are available. See page 6. Nominal rating of carbon type controls, 1 watt; wire wound controls, 5 watts.

**Standard Special Single (SRP) Controls**

Prices do not include Switch or Accessories. Some Controls have Special Nuts and Washers where required. Minimum of One No. 232 Nut and One No. 225 Washer included.

Catalog Number	Ohms Resistance	Type Element	Used As	List Price	Catalog Number	Ohms Resistance	Type Element	Used As	List Price
SRP133	.2M	Carbon	Vol.	\$1.50	SRP262	1500	W.W.	Vol.	\$1.50
SRP134	4500	W.W.	Vol., Sen	1.50	SRP263	32M	Carbon	Vol., Tone	1.50
SRP138	450	W.W.	Vol.	1.50	SRP264	650	W.W.	Vol.	1.50
SRP139	550	W.W.	Vol.	1.50	SRP265	200	W.W.	Hum.	1.50
SRP141	1200	W.W.	Vol.	1.50	SRP266	600	W.W.	Hum.	1.50
SRP142	2900	W.W.	Vol.	1.50	SRP267	8M	W.W.	Tone Beam	1.50
SRP144	.2M	Carbon	Vol.	1.50	SRP268	15	W.W.	Vol.	1.50
SRP145	.2M	Carbon	Vol.	1.50	SRP269	10M	Carbon	Vol.	1.50
SRP150	50M	Carbon	Vol.	1.50	SRP271	150	W.W.	Vol.	1.50
SRP152	.60	W.W.	Phono., Vol.	1.50	SRP272	300	W.W.	Vol.	1.50
SRP153	13M	W.W.	Vol.	1.50	SRP273	500M	Carbon	Vol.	*2.00
SRP154	50M	Carbon	Vol.	1.50	SRP274	10M	W.W.	Vol.	1.50
SRP160	3200	Carbon	Equal.	1.50	SRP275	500M	Carbon	Vol.	1.50
SRP170	.75M	Carbon	Vol.	1.50	SRP276	.3M	Carbon	Regen.	1.50
SRP179	125M	Carbon	Vol.	1.50	SRP277	.2M	Carbon	Vol.	1.50
SRP185	1500	Carbon	Vol.	1.50	SRP278	500M	Carbon	Vol.	1.50
SRP188	32M	Carbon	Vol.	1.50	SRP279	50M	Carbon	Vol.	1.50
SRP213	250M	Carbon	Vol.	1.50	SRP280	500M	Carbon	Vol.	*2.00
SRP216	500M	Carbon	Vol.	1.50	SRP281	500M	Carbon	Vol.	1.50
SRP223	.1M	W.W.	Vol.	1.50	SRP282	350M	Carbon	Vol.	1.50
SRP239	.450	W.W. Strip	Vol.	.50	SRP283	2500	W.W.	Vol.	1.50
SRP241	.6M	W.W. Strip	Vol.	.50	SRP284	100M	Carbon	Vol., Tone	1.50
SRP245	.32M	Carbon	Vol.	1.50	SRP285	500M	Carbon	Vol., Tone	1.50
SRP249	20M	W.W.	Vol.	1.50	SRP286	250M	Carbon	Vol., Tone	1.50
SRP251	250M	Carbon	Vol.	1.50	SRP287	.5M	Carbon	Vol., Tone	1.50
SRP252	500M	Carbon	Vol.	1.50	SRP288	100M	Carbon	Vol., Tone	1.50
SRP253	.400	W.W.	Hum	1.50	SRP289	.50M	Carbon	Vol.	1.50
SRP254	3500	W.W.	Vol.	1.50	SRP290	1 Meg.	Carbon	Vol.	1.50
SRP255	15M	W.W.	Vol.	1.50	SRP291	750M	Carbon	Vol.	1.50
SRP256	10M	Carbon	Vol.	1.50	SRP900	20M	Carbon	Vol.	1.50
SRP257	.3M	W.W.	Vol.	1.50	SRP901	.10M	Carbon	Vol.	1.50
SRP258	15M	Carbon	Vol.	1.50	SRP960	.800	W.W.	Vol.	1.50
SRP259	50M	Carbon	Phono.	1.50	SRP961	.10M	Carbon	Vol.	1.50
SRP260	.1M	W.W.	Vol.	1.50	SRP962	250M	Carbon	Vol.	1.50
SRP261	100M	Carbon	Vol.	1.50					

\*Price includes Switch. † Right Hand Switch Action.

**Standard Special Dual (DRP) Controls**

Prices do not include Switch or Accessories. Some Controls have Special Nuts and Washers where required. Minimum of One No. 232 Nut and One No. 225 Washer included.

Catalog Number	Ohms Resistance		Type Element		Used As	List Price	Catalog Number	Ohms Resistance		Type Element		Used As	List Price
	Front	Rear	Front	Rear				Front	Rear				
DRP114	.250	.5M	W.W.	W.W.	Vol.	\$2.50	DRP301	.5M	2500	Carbon	W.W.	Vol.	\$2.50
DRP115	3800	3800	Carbon	Carbon	Vol.	2.50	DRP302	100M	250M	Carbon	Carbon	Vol.	2.50
DRP116	25700	10000	W.W.	W.W.	Vol.	2.50	DRP303	2500	100M	Carbon	Carbon	Vol.	2.50
DRP117	.500	2500	W.W.	W.W.	Vol.	2.50	DRP304	1 Meg.	3 Meg.	Carbon	Carbon	Vol.	2.50
DRP119	.3M	10M	W.W.	W.W.	Vol.	2.50	DRP305	25M	25M	Carbon	Carbon	Vol.	2.50
DRP122	.645	10M	W.W.	W.W.	Vol.	2.50	DRP306	.5M	10M	W.W.	Carbon	Vol.	2.50
DRP169	7500	10M	W.W.	W.W.	Vol.	2.50	DRP307	.3M	12M	W.W.	Carbon	Vol.	2.50
DRP221	10M	100M	Carbon	Carbon	Vol.	2.50	DRP308	.50M	.50M	Carbon	Carbon	Vol.	2.50
DRP222	.75M	.32M	Carbon	Carbon	Vol.	2.50	DRP309	.12M	.65M	Carbon	Carbon	Vol.	2.50
DRP232	3 Meg.	3 Meg.	Carbon	Carbon	Vol.	2.50	DRP310	.25M	.25M	Carbon	Carbon	Vol.	2.50
DRP239	25M	25M	Carbon	Carbon	Vol.	2.50	DRP311	150M	250M	Carbon	Carbon	Vol.	2.50
DRP240	250M	10M	Carbon	Carbon	Vol.	2.50							
DRP241	.5M	150M	Carbon	Carbon	Vol.	2.50							
DRP242	10M	500M	Carbon	Carbon	Vol.	2.50	DRP312	.75M	500M	Carbon	Carbon	Vol.	2.50
DRP243	.3M	750M	Carbon	Carbon	Vol.	2.50	DRP313	.1M	500M	Carbon	Carbon	Vol.	2.50
DRP244	.25M	.6M	Carbon	Carbon	Vol.	2.50	DRP314	500M	2500	Carbon	Carbon	Vol.	2.50
DRP245	1 Meg.	3 Meg.	Carbon	Carbon	Vol.	2.50	DRP315	2 Meg.	2500	Carbon	Carbon	Vol.	2.50
DRP246	.32M	.50M	Carbon	Carbon	Vol.	2.50	DRP316	200M	.1M	Carbon	Carbon	Supp.	2.50
DRP250	.50M	.1M	Carbon	Carbon	Vol.	2.50	DRP317	500M	.1M	Carbon	Carbon	Vol.	2.50
							DRP318	250M	3 Meg.	Carbon	Carbon	Vol.	2.50

**Standard Universal Hum Controls**

Prices do not include Switch or Accessories. One No. 232 Nut included.

Ohms Resistance	General Use	Type Element	Catalog Number	List Price	Ohms Resistance	General Use	Type Element	Catalog Number	List Price
6	Hum	W.W.	HU6	\$1.00	50	Hum	W.W.	HU50	\$1.00
10	Hum	W.W.	HU10	1.00	75	Hum	W.W.	HU75	1.00
20	Hum	W.W.	HU20	1.00	100	Hum	W.W.	HU100	1.00
30	Hum	W.W.	HU30	1.00	200	Hum	W.W.	HU200	1.00

**Etched Dial Plates for Controls, Rheostats and Potentiometers**

Marking	For Type of Control	Diameter	Cat. No.	List Price
0 to 10	For all Mallory-Yaxley Standard Silent Carbon Controls with switch type cover	2 1/4"	398	\$0.25
0 to 10	For all Mallory-Yaxley Standard Silent Carbon Controls with plain cover	2 1/4"	397	.25
0 to 10	For all Mallory-Yaxley Standard Wire Wound Controls with switch type cover	2 1/4"	396	.25
0 to 10	For all Mallory-Yaxley Standard Wire Wound Controls with plain cover; also "M" Type Rheostats and Potentiometers	2 1/4"	395	.25
0 to 10	For all Mallory-Yaxley "C" Type Rheostats and Potentiometers	2 1/4"	393	.25
0 to 10	For all Mallory-Yaxley "E" Type Potentiometers	2 1/4"	399	.25
0 to 100	All Mallory-Yaxley Rheostats and Potentiometers	2 1/4"	369	.25
Increase Volume	All Mallory-Yaxley Rheostats and Potentiometers	1 1/2"	391	.15

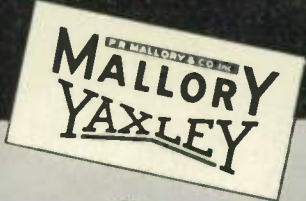

## Standard Control Accessories

Complete and detailed instructions for the use of Mallory-Yaxley Universal Control Accessories and Switches are given in the Mallory-Yaxley Radio Service Encyclopedia.

	Catalog Number	List Price
<b>Attachable Volume Control Switches:</b>		
Single-Pole—Single-Throw	6-9	\$0.50
Single-Pole—Single-Throw	6T	.60
Double-Pole—Single-Throw	7	.60
Single-Pole—Double-Throw	8	.60
Three-Pole—Single-Throw Shorting	13	.60
Four-Pole—Single-Throw Shorting	14	.60
<b>Universal Extension Shafts:</b>		
4" long x 1/4" dia. x 3/32" flat	RS242*	.30 ea.
4" long x 1/4" dia. x 3/32" flat	RS243*	.30 ea.
4" long x 3/16" dia. x 1/64" flat	RS244*	.30 ea.
2" long x 1/4" dia. with 3/32" slot (Enclosed in tight-fitting tube) For adapting Universal Controls to automobile receivers when slotted shaft is needed.	RS245*	.35 ea.
2" long x 1/4" wide x 3/16" Thick (Tongue shape and fitted with tube) For adapting Universal Controls to automobile receivers where tongue-shaped shaft is needed.	RS246*	.35 ea.
	*Packed 5 to Envelope	
<b>Universal Flexible Coupling Shafts:</b>		
For Universal replacement of all flexible wire shafts, coupling to 1/4" solid shafts.	FS250	.60
Shaft Coupling has 1/32" hole, 1/2" deep, with transverse pin, and is for use (with the correct Mallory-Yaxley control) as a replacement for Philco Models 805, 806, 808, 809 and PHD and PHXD, Studebaker AC266, Pierce-Arrow MT-3, Reo RT-3, etc.	FS251	.60
Shaft Coupling has 3/32" hole, approximately 1/2" deep, and has 2 set screws opposite each other. It is used as a replacement for Philco Model D, Nash AC-989 (Code 122).	FS252	.60
Shaft Coupling has 1/4" dia. hole, 1/2" deep, equipped with 2 screws at 90 degrees. This is to be used with the correct Mallory-Yaxley Control as a replacement for Chevrolet No. 364441.	FS253	.60
<b>Universal Combination Extension Shaft Coupling and Reducer:</b>		
Will couple two 1/4" shafts or one 1/4" shaft and one 3/16" shaft.	EC240	.25
<b>Universal Extension Bushing:</b>		
Designed to screw on the present bushing of Mallory-Yaxley controls and switches, so that the body of the control or switch will be held 5/8" away from the mounting surface. For example, it is used with the correct Yaxley Universal Control to service Philco Models 28, 29, 45 and 45C.	EB247	.20
<b>Universal Bushing and Nut:</b>		
Designed to accommodate 1/4" shaft wherever a panel bushing is desired. Includes one No. 232 nut.	UB241	.75 for 10 Packed 10 in Envelope
<b>Hexagon Shoulder Mounting Nuts:</b>		
For 1 1/2" Panels	255	.10
For 1 1/4" Panels	A11260-12	.15
For 3/4" Panels	A11260-2	.20
<b>Volume Control Wrench:</b>		
For all standard Volume Control Hexagon Nuts	178	.20
<b>Adjustable Mounting Brackets:</b>		
1 3/4" Mounting Centers	RB248†	.20 ea.
2 1/2" Mounting Centers	RB249†	.20 ea.
	†Packed 5 to Box	

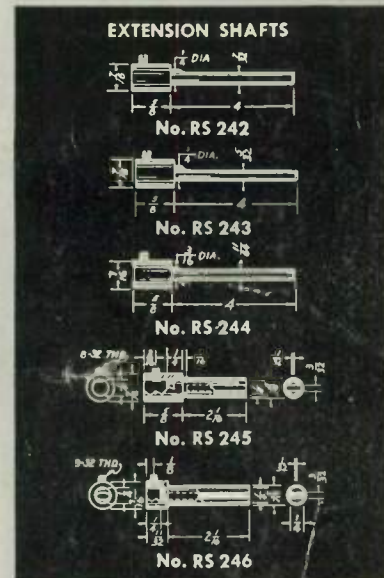

ATTACHABLE VOLUME CONTROL SWITCHES

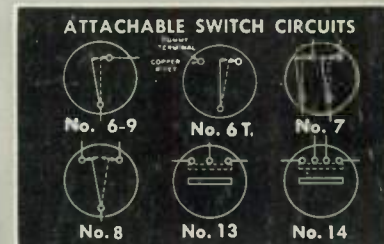

ADJUSTABLE MOUNTING BRACKETS

UNIVERSAL BUSHINGS—COUPLINGS

VOLUME CONTROL WRENCH



# Approved PRECISION PRODUCTS

## Rheostats • Potentiometers • Attenuators

(Wire-Wound Only)

### "M" Type Variable Resistor

Dissipates 4 Watts—Insulated Contact Arm  
Use Dial Plate No. 395. See page 6.  
294° total rotation; 281° effective electrical rotation.

"M" TYPE RHEOSTATS—Prices include one No. 232 Nut but no Knobs. See page 18 for Knob prices.

Ohms Resistance	Carrying Capacity in Amperes	Catalog Number	List Price
1/2	2.80	M05R	\$0.75
1	2.00	M1R	.75
2	1.4	M2R	.75
3	1.15	M3R	.75
4	1.00	M4R	.75
6	.82	M6R	.75
10	.63	M10R	.75
15	.52	M15R	.75
20	.45	M20R	.75
25	.40	M25R	.75
30	.37	M30R	.75
40	.32	M40R	.75
50	.28	M50R	.75
60	.26	M60R	.75
75	.23	M75R	.75

"M" TYPE POTENTIOMETERS—Prices include one No. 232 Nut but no Knobs. See page 18 for Knob prices.

Ohms Resistance	Carrying Capacity in Amperes	Catalog Number	List Price
15	.52	M15P	\$1.00
20	.45	M20P	1.00
25	.40	M25P	1.00
30	.37	M30P	1.00
40	.32	M40P	1.00
50	.28	M50P	1.00
60	.26	M60P	1.00
75	.23	M75P	1.00
100	.20	M100P	1.00
200	.14	M200P	1.00
400	.10	M400P	1.00
500	.09	M500P	1.00
600	.082	M600P	1.00
1M	.063	M1M	1.25
2M	.045	M2M	1.25
3M	.037	M3M	1.25
4M	.032	M4M	1.25
5M	.028	M5M	1.25
10M	.020	M10M	1.50
15M	.016	M15M	1.50
20M	.014	M20M	1.50
25M	.013	M25M	1.50
50M	.009	M50M	2.00
70M	.0075	M70M	2.00

### "E" Type Potentiometers

Dissipates 9 Watts—Contact Arm Grounded  
Use Dial Plate No. 399. See page 6.  
318° total rotation; 301° effective electrical rotation.  
Prices include one No. 232 Nut but no Knobs. See page 18 for Knob prices.

Ohms Resistance	Carrying Capacity in Amperes	Catalog Number	List Price
5M	.042	E5MP	\$2.50
10M	.03	E10MP	2.50
20M	.021	E20MP	2.50
25M	.019	E25MP	2.75
50M	.0135	E50MP	2.75
75M	.011	E75MP	2.75
100M	.0095	E100MP	2.75
125M	.0085	E125MP	2.75
150M	.0078	E150MP	2.75

### "C" Type Variable Resistor

Dissipates 2 Watts—Grounded Contact Arm  
Use Dial Plate No. 393. See page 6.  
284° total rotation; 266° effective electrical rotation.

The Yaxley "C" Type Variable Resistor is the smallest wire wound control manufactured, finding its greatest application where space is at a premium. The contact arm is grounded to the shaft.

"C" TYPE RHEOSTATS—Prices include one No. 232 Nut but no Knobs. See page 18 for Knob prices.

Ohms Resistance	Carrying Capacity in Amperes	Catalog Number	List Price
6	.58	C6R	\$0.75
10	.45	C10R	.75
15	.37	C15R	.75
20	.32	C20R	.75
30	.26	C30R	.75
40	.22	C40R	.75
50	.2	C50R	.75
100	.14	C100R	.75

"C" TYPE POTENTIOMETERS—Prices include one No. 232 Nut but no Knobs. See page 18 for Knob prices.

Ohms Resistance	Carrying Capacity in Amperes	Catalog Number	List Price
6	.58	C6P	\$1.00
10	.45	C10P	1.00
15	.37	C15P	1.00
20	.32	C20P	1.00
30	.26	C30P	1.00
40	.22	C40P	1.00
50	.2	C50P	1.00
100	.14	C100P	1.00
200	.1	C200P	1.00
400	.07	C400P	1.00
1M	.045	C1MP	1.25
3M	.025	C3MP	1.25
5M	.02	C5MP	1.50
6M	.018	C6MP	1.50
10M	.014	C10MP	1.50
15M	.011	C15MP	1.50

### "T" and "L" Pad Attenuators

Specially designed to provide a convenient and simple method of controlling the level of low impedance audio circuits, and for volume control of microphones, electrical phonographs, talking picture amplifiers, and many varied sound amplifying and audio distribution systems.

Individually cartoned complete with No. 366 Bar Knob, No. 395 Dial Plate with matched rotation, two No. 232 Mounting Nuts, and one No. 225 Washer.

Ohms Impedance	Catalog Number	List Price
6	T6	\$5.00
8	T8	5.00
15	T15	5.00
50	T50	5.00
200	T200	5.00
250	T250	5.00
500	T500	5.00
2000	T2000	5.00

Ohms Impedance	Catalog Number	List Price
6	L6	\$3.50
15	L15	3.50
50	L50	3.50
200	L200	3.50
250	L250	3.50
500	L500	3.50
2000	L2000	3.50

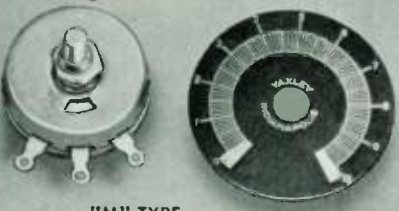

"M" TYPE

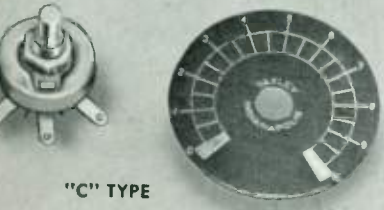
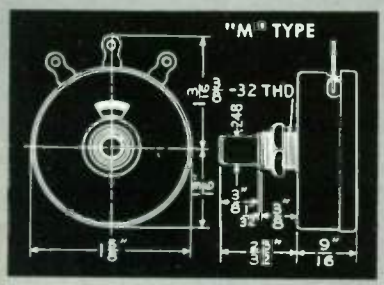

"C" TYPE

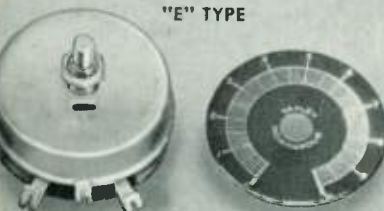
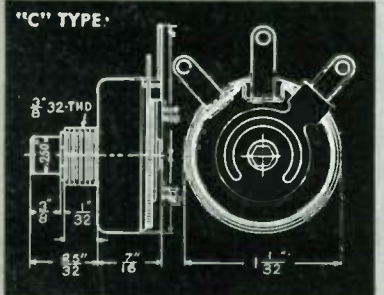

"E" TYPE

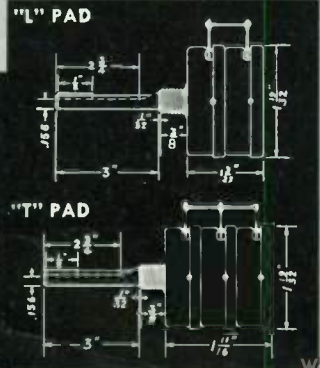
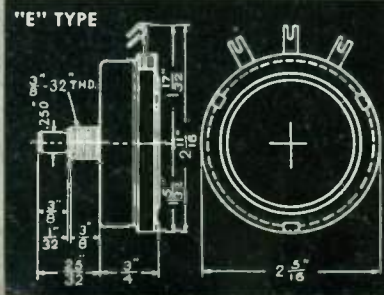

"L" PAD

"T" PAD





## Special "Hamswitches" Multiple Push Button Selector Switches

### "Hamswitch"\* No. 151L

This Mallory-Yaxley "Hamswitch" provides a simple method of using a single meter to measure currents or voltages up to and including five circuits of an Amateur Transmitter. It is less expensive, more reliable, compact and convenient than the conventional cord, plug and jack system.

Two-gang construction with  $2\frac{1}{4}$ " spacing between sections, permitting multiplying resistors to be soldered directly to switch terminals when wired into the circuit.

Has 2-inch notched shaft, shakeproof washer, Bar Knob No. 366, one No. 232 Nut and one No. 227 Lockwasher.

"Hamswitch" No. 151L. List Price...\$1.80  
Dial Plate for above, numbered 1 to 5, with markings spaced  $60^\circ$ .

No. 487. List Price.....\$0.15

### "Hamswitch"\* No. 152L

The 152L "Hamswitch" is a special unit built to specifications provided by the American Radio Relay League for use in the "Two-Tube, Coil Switching Receiver" described on pages 108 to 111 of "The Radio Amateurs Handbook," fifteenth edition.

Supplied complete with universal threaded bushing, two-inch notched shaft, No. 232 nut, No. 225 lockwasher, No. 366 Bar knob, and adjustable stop.

"Hamswitch" No. 152L. List Price...\$2.25

### Multiple Push Button Switches • Types 2160, 2180 and 2190

Mallory-Yaxley has fulfilled a very definite requirement of the radio service engineer, amateur, and experimenter with a line of switches unique in design and universal in application, for such fields as:

*Automatic Station Selector Tuning, Inter-Office Communication Systems, Telephone and Annunciator Systems, Signal Generator Frequency Selection, Set Analyzers, Tube Checkers, Multimeters, Transmitter Crystal Switching,* or the many applications requiring a device for making, breaking, or transferring multiple circuits in any desired sequence.

The Type 2190 non-shorting switch provides new convenience, simplicity and economy in the construction and operation of radio test equipment. Through it a single current reading meter may be used to measure a number of circuits . . . the insertion of the meter in the circuit being accomplished merely by depressing a button. Other circuits connected to the switch remain closed and uninterrupted. Type 2190 switches are also suitable for meter switching

### HamBand Switches No. 160C

Now you can change bands with the turn of your wrist . . . as conveniently as you change bands on your communications receiver. Now you can enjoy the advantages that different amateur bands offer over certain distances during certain times of the day.

HamBand Switches are rated for use in transmitter plate circuits using up to 1000 Volts DC with power up to 100 watts inclusive. Convenient terminal arrangements, wide spacing of current carrying parts, heavy silver-plating on contacts, and low-loss magnesium silicate ceramic insulation are features especially designed for high frequency applications.

Prices include Mallory-Yaxley 366 Knob, one No. 232 Nut, and one No. 227 Lockwasher.

No. of Sections or Gangs	Circuits per Switch	Spacing between Sections	No. of Points or Contacts per Circuit	Cat. No.	List Price
1	1	2"	4	161C	\$1.70
2	2	2"	4	162C	2.70
3	3	1"	4	163C	3.90
4	4	1"	4	164C	4.90
5	5	1"	4	165C	6.10

All switches employ  $90^\circ$  indexing (4 index positions) with  $\frac{7}{16}$ " spacing between the index plate and first switch section.

Dial Plate for above, numbered 1 to 4, with markings spaced  $90^\circ$ .

No. 488. List Price.....\$0.15

on low and medium power radio transmitters, and public address systems where they replace with added safety, conventional jack and plug systems.

Mallory-Yaxley Multiple Push Button Switches are available in three distinct circuit combinations. The No. 2160 types are designed for circuit closing, the No. 2180 types for circuit transfer, and the No. 2190 types for circuit transfer, non-shorting.

Type	Number of Buttons	Cat. No.	†List Price
Circuit Closing.....	4	2164	\$4.00
Circuit Closing.....	6	2166	5.00
Circuit Closing.....	8	2168	6.00
Circuit Transfer.....	4	2184	4.00
Circuit Transfer.....	6	2186	5.00
Circuit Transfer.....	8	2188	6.00
†Circuit Transfer.....	4	2194	4.00
†Circuit Transfer.....	6	2196	5.00
†Circuit Transfer.....	8	2198	6.00

†List price includes brown bakelite knobs, one attractive stately bronze escutcheon plate supplied with blank designation inserts, and transparent strip for windows.  
†Non-shorting.

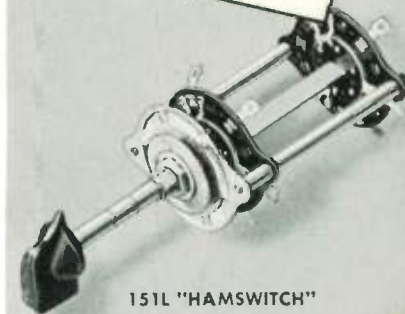

151L "HAMSWITCH"

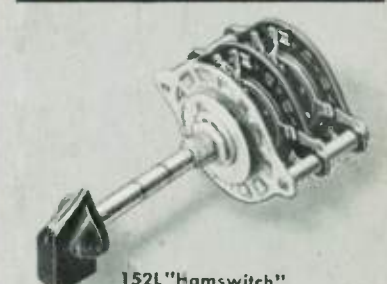
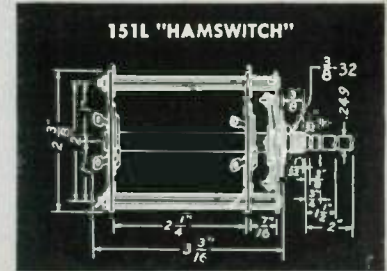

152L "Hamswitch"

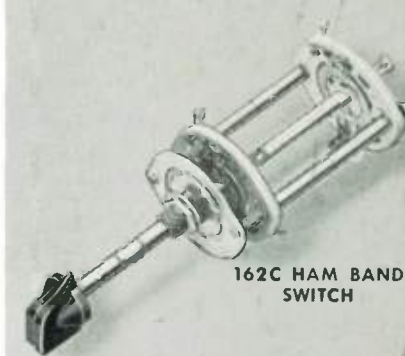

162C HAM BAND SWITCH

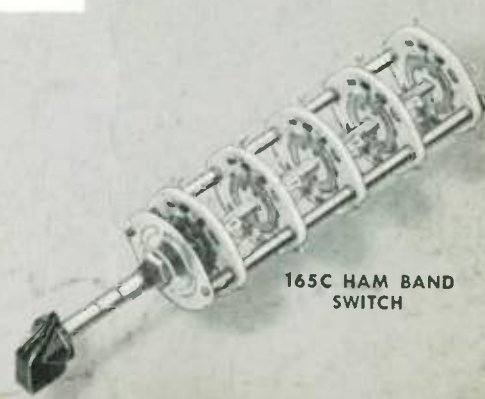

165C HAM BAND SWITCH

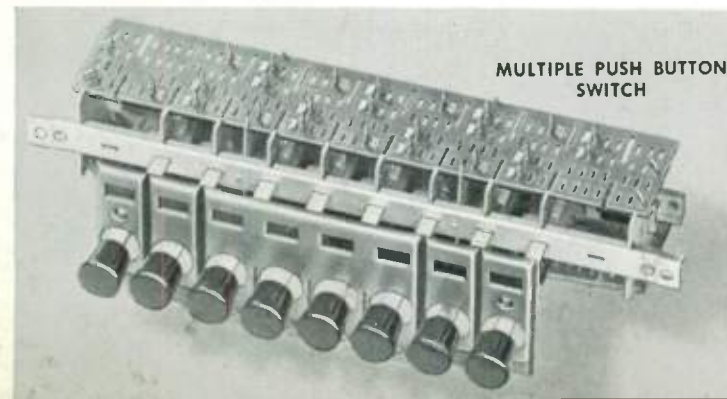

MULTIPLE PUSH BUTTON SWITCH



# Approved PRECISION PRODUCTS

## Single-Gang Circuit Selector Switches

—TYPES 3100J SERIES and 3200J SERIES

● The value of Mallory-Yaxley's experience in manufacturing and selling many millions of all-wave switches is best demonstrated by the Type 3100J Switch. This switch, engineered for short-wave, tone control and tap switch applications, provides small size and compactness—extreme flexibility in circuit and coil combinations—low capacity—low resistance. All contacts are silver to silver and are plated according to the exclusive and time-proved Mallory-Yaxley formula. The new contacting arrangement has been shown by test to yield a longer quiet life than other methods.

A newly designed indexing feature, entirely separated from switch circuits, provides positive action.

Mallory-Yaxley Type 3100J Switches are available only in single gang and in two sizes—one with 1 1/4-inch diameter base, the other with 1 1/16-inch diameter base. The circuit combina-

tions shown below indicate respective sizes. They are made in both shorting and non-shorting types. Adjustable stop feature is available only in the 1 1/16-inch base size. These switches are equipped with new universal shaft—a standard feature in all Mallory-Yaxley circuit selector switches. This new shaft is 2 inches long and notched to provide easy cutting at popular lengths. Mallory-Yaxley purposely avoids milling a flat on all switch shafts—provides a standard 1/4-inch round shaft to give extreme flexibility in mounting with relation to other components. A flat may be quickly and easily filed at any desired position.

Where longer shafts are required, use Mallory-Yaxley Extension Shafts No. RS242, RS243, or RS244. Shakeproof washer is supplied with all circuit selector switches to provide secure mounting on metal panels. Standard 3/8-inch threaded bushing is also provided.

3100-J SERIES  
1 1/4-INCH BASE



3100-J—3200-J SERIES  
1 1/4-Inch Base

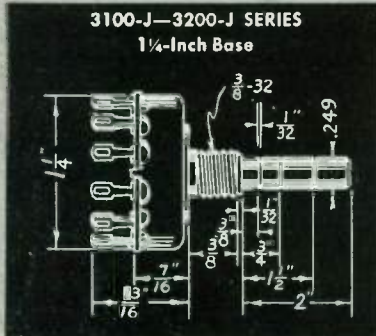

3100-J SERIES  
1 1/16-INCH BASE



3100-J—3200-J SERIES  
1 1/16 Inch Base

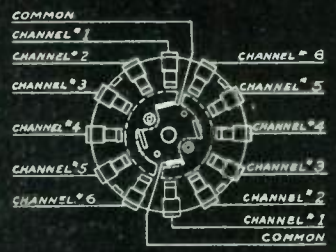
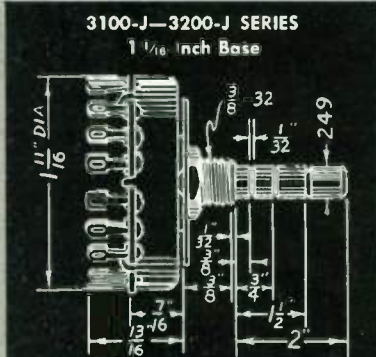

Arrangement of circuits and terminals on a 2-circuit switch. 6 contacts per circuit.

### Mallory-Yaxley 3100J and 3200J Shorting and Non-Shorting, Single-Gang Tap and Circuit Selector Switches

(Prices include one Mallory-Yaxley No. 366 Knob, one No. 232 Nut, and one No. 227 Lockwasher, but no Dial Plate. See page 12 for special Dial Plates.)

Number of Circuits	Number of Contacts per Circuit	Diameter of Base	Adjustable Stop	Shorting Type Catalog No.	Non-Shorting Type Catalog No.	List Price
One	5	1 1/4"	No	3115J	3215J	\$0.75
One	12	1 1/4"	No	31112J	32112J	.75
Two	2	1 1/4"	No	3122J	3222J	.75
Two	3	1 1/4"	No	3123J	3223J	.75
Two	6	1 1/4"	No	3126J	3226J	.75
Three	4	1 1/4"	No	3134J	3234J	.90
Four	2	1 1/4"	No	3142J	3242J	.85
Four	3	1 1/4"	No	3143J	3243J	.90
One	17	1 1/16"	Yes	31117J	32117J	1.35
Two	9	1 1/16"	Yes	3129J	3229J	1.35
Three	6	1 1/16"	Yes	3136J	3236J	1.50
Six	3	1 1/16"	Yes	3163J	3263J	1.50

\*Replaces No. 2742.

†Replaces No. 2762 by using adjustable stop.

### The Difference Between "Shorting" and "Non-Shorting" Switches

● There seems to be some confusion in the minds of service men regarding Mallory-Yaxley switch type designations of "shorting" and "non-shorting." Some service men think of a shorting switch as a switch with a shorting shoe.

The following explanation points out the essential difference between shorting and non-shorting switches and should serve to clear up any confusion that may exist.

On a shorting type switch the moving arm slightly over-laps each contact, so that when the switch shaft is rotated from one position to another the second circuit is closed before the first circuit is opened. This type of construction is used in band change switches to prevent an

annoying "pop" in the loudspeaker which otherwise would occur when the grid circuit was momentarily opened during the operation of the switch.

Non-shorting switches do not have this overlap and are preferred for test equipment service. With this type of switch, adjacent circuits are not momentarily contacted during rotation of the switch.

Switches with shorting shoes are special, and must be built to order. Quotations will be gladly given on receipt of information as to the exact switch action required, and quantity of switches needed.



## Multi-Gang Circuit Selector and All-Wave Switches — TYPES 1200L SERIES and 1300L SERIES

● The design used in the Mallory-Yaxley 1200L and 1300L type Switches is identically the same construction as used and specified by the largest percentage of manufacturers making all-wave receivers. Set designers demand the lowest contact resistance and capacity between circuits, which requirements are supplied in this type of Mallory-Yaxley Switch.

All contacting members of Mallory-Yaxley Circuit Selector Switches are heavily silver-plated with a hard finish that will withstand the wear throughout the life of the apparatus in which the switch is used. The high lift of the contact springs gives a wiping and self-cleaning contact.

The design of 1200L and 1300L type switches provides circuit combinations on each section which answers practically every requirement. They supply these circuits in a minimum amount of space.

The special Bakelite Insulation in these switches is of the best quality obtainable for

switch purposes. It has the lowest moisture absorption of any Bakelite available.

Mallory-Yaxley's "hill-and-valley" index provides the most perfect and positive indexing action available and definitely eliminates possibility of "drag" between contacts.

The new adjustable stop feature provides for additional combinations in each switch and makes it possible to use a single switch for many different specifications. Switches may be wired in a circuit experimentally, then the stop may be adjusted for permanent installation.

Three and four-gang switches have one-inch spacing, all others one-half inch. If necessary, these switches can be disassembled, the spacers cut down to meet the requirements as to length of the switch and the spacings of the sections.

A standard universal threaded bushing is supplied on all 1200L and 1300L switches, as well as the new universal 2-inch long notched shaft and shakeproof washer.



1200-L SERIES (2-GANG)

### Mallory-Yaxley 1200L and 1300L, Shorting and Non-Shorting, Multi-Gang, Tap, Circuit Selector, and All-Wave Switches

(Prices include Mallory-Yaxley No. 366 Knob, one No. 232 Nut, and one No. 227 Lockwasher, but do not include Dial Plates. See page 12 for special Dial Plates.)

No. of Circuits per Section or Gang	Total No. of Circuits per Switch	No. of Points or Contacts per Circuit	No. of Sections or Gangs per Switch	Shorting Type Catalog No.	Non-Shorting Type Catalog No.	List Price
One	One	6	One	1216L	1316L	81.00
One	One	11	One	1211L	1311L	1.15
Two	Two	5	One	1215L	1315L	1.25
Three	Three	3	One	1213L	1313L	1.35
Four	Four	2	One	1212L*	1312L*	1.45
One	Two	6	Two	1226L	1326L	1.60
One	Two	11	Two	1221L	1321L	1.75
Two	Four	5	Two	1225L	1325L	2.00
Three	Six	3	Two	1223L	1323L	2.10
Four	Eight	2	Two	1222L*	1322L*	2.25
One	Three	6	Three	1236L	1336L	2.20
One	Three	11	Three	1231L	1331L	2.35
Two	Six	5	Three	1235L	1335L	2.50
One	Four	6	Four	1246L	1346L	2.75
One	Four	11	Four	1241L	1341L	3.00
Two	Eight	5	Four	1245L	1345L	3.50
One	Five	11	Five	1251L	1351L	3.75
Two	Ten	6	Five	1256L	1356L	4.60
One	Six	11	Six	1261L	1361L	4.40
Two	Twelve	6	Six	1266L	1366L	5.60

\*A third, or "off," position with all circuits open is available by using adjustable stop.

### Universal Mounting Bracket RB254

Ideal for baseboard or rear support mounting for all Mallory-Yaxley circuit selector switches, volume controls, jacks—in fact, any device having a standard 3/8" bushing requiring a supporting bracket for mounting at right angles to a baseboard.

The height is specially convenient for mounting circuit selector switches in building short wave receivers, because of easy accessibility to the underneath terminals or actual mounting of coils beneath the switch.

Universal Mounting Bracket No. RB254 packed five to the carton. List Price \$0.20 each.

11.

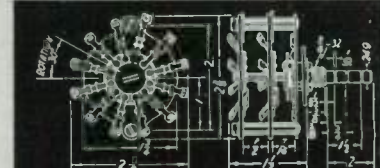

A 2-section circuit switch on which 1 to 11 points can be used by means of the adjustable stop.



11 Holes, 160" Diameter for Adjustable Stop.

Locating plate, staff and bushing assembly of Yaxley Circuit Selector Switches, showing the details of the bushing, spring and roller.

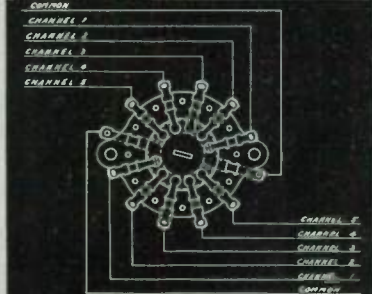

The illustration above represents a single section switch with two circuits, 5 points each circuit commonly used as a radio selector switch for public installations, and also for short wave purposes.

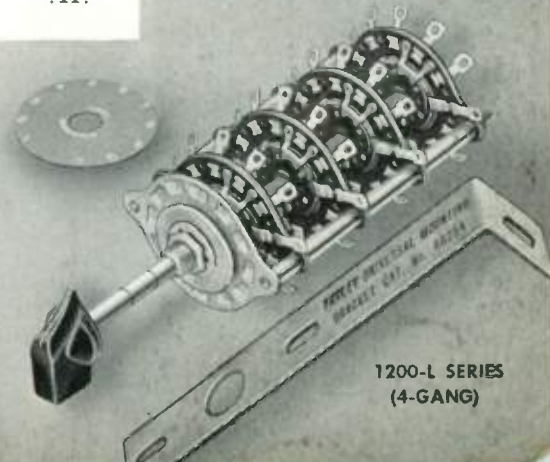
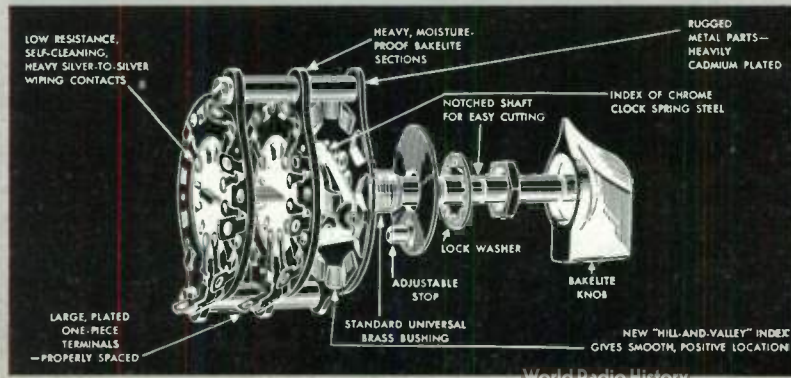

1200-L SERIES (4-GANG)



# Approved PRECISION PRODUCTS

## Special Switches • Dial Plates

● Mallory-Yaxley specializes in unusual selector switch problems. If any of the single-section, multi-section or special switches listed cannot be adapted to your application, submit complete details and specifications for quotations. The laboratories, facilities and experience of Mallory-Yaxley switch engineers are available to help solve any specific requirement. Mallory-Yaxley will custom-build a switch that will have the same quality of sturdy construction, careful and correct assembly that the famous line of Mallory-Yaxley stock switches is noted for.



1400 L

### Circuit Opening Switch No. 1400L

● Mallory-Yaxley No. 1400L Switch will "open" any one of twelve "lines" for the insertion of a current reading meter and maintain a "Through" circuit on the other eleven lines. This switch has found wide application in the construction of test sets, tube checkers, analyzers, and other apparatus where it is desirable to use only one meter.

One particular advantage is that multiplying resistors for those circuits wherein a different range is needed for each line can be wired to the switch, so that the switch not only opens the line but also automatically cuts in the proper multiplying resistor for the range needed on that particular line.

Small size, 1 3/4" long, 2 1/2" wide, 3/8" bushing, 2" notched shaft "hill-and-valley" index and shakeproof washer.

Special Circuit Opening Switch complete with Mallory-Yaxley Bar Type Knob No. 366, one No. 232 Nut, one No. 227 Lockwasher, and Mallory-Yaxley Etched Dial Plate No. 382—No. 1400L. List Price.....\$4.50

### 15-Point Tap Switch No. 150J

● An improved special switch—shorting type, single-gang only. Has 2-inch notched shaft and shakeproof washer. Special 15-Point Tap Switch, complete with Mallory-Yaxley Bar Type Knob No. 366, one No. 232 Nut, one No. 227 Lockwasher and Mallory-Yaxley Dial Plate No. 465—No. 150J. List Price.....\$1.50

### 24-Point Tap Switch No. 13124

● A special single circuit, 24-point non-shorting switch with notched shaft and other quality features found in the 1300L Series. Particularly useful in test equipment applications. No stops—switch is capable of continuous rotation if desired.

Special 24-Point Tap Switch, complete with

Mallory-Yaxley Bar Type Knob No. 366, one No. 232 Nut, one No. 227 Lockwasher, and Mallory-Yaxley Dial Plate No. 394—

No. 13124L. List Price.....\$2.65

### Etched Dial Plates

For Mallory-Yaxley Circuit Selector, Tap and All-Wave Switches. (Plates to match rotation of Mallory-Yaxley Variable Resistors on page 6.)

Neat-appearing Dial Plates with easy-to-read aluminum figures clearly etched on solid black background. Dimensions are 1 3/16" in diameter with 7/16" hole, with figures 3/64" high. .020" aluminum stock.

Marking	For all Switch types 1200L, 1300L and 1 1/4" base 3100J, 3200J. 30 degree spacing between numerals.	For all type 3100J, 3200J Switches with 1 1/4" base. 20 degree spacing between numerals.	List Price
	Cat. No.	Cat. No.	
1 to 2.....	372.....		\$0.15
1 to 3.....	373.....	453.....	.15
1 to 4.....	374.....	454.....	.15
1 to 5.....	375.....	455.....	.15
1 to 6.....	376.....	456.....	.15
1 to 7.....	377.....	457.....	.15
1 to 8.....	378.....	458.....	.15
1 to 9.....	379.....	459.....	.15
1 to 10.....	380.....	460.....	.15
1 to 11.....	381.....	461.....	.15
1 to 12.....	382.....	462.....	.15
1 to 13.....		463.....	.15
1 to 14.....		464.....	.15
1 to 15.....		465.....	.15
1 to 16.....		466.....	.15
1 to 17.....		467.....	.15
1 to 18.....		468.....	.15
Off 1 to 2.....		472.....	.15
Off 1 to 3.....	383.....	473.....	.15
Off 1 to 4.....	384.....	474.....	.15
Off 1 to 5.....	385.....	475.....	.15
Off 1 to 6.....	386.....	476.....	.15
Off 1 to 7.....	387.....	477.....	.15
Off 1 to 8.....	388.....	478.....	.15
Off 1 to 9.....	389.....	479.....	.15
Off 1 to 10.....	390.....	480.....	.15
Off 1 to 11.....		481.....	.15
Off 1 to 12.....		482.....	.15
Off 1 to 13.....		483.....	.15
Off 1 to 14.....		484.....	.15
Off 1 to 15.....		485.....	.15
Off 1 to 16.....		486.....	.15
1 to 24.....	394 Special 15° Spacing Between Numerals		.15

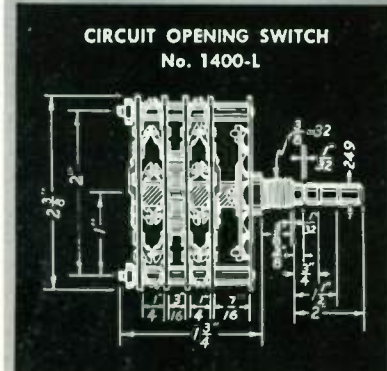

CIRCUIT OPENING SWITCH No. 1400-L



150-J

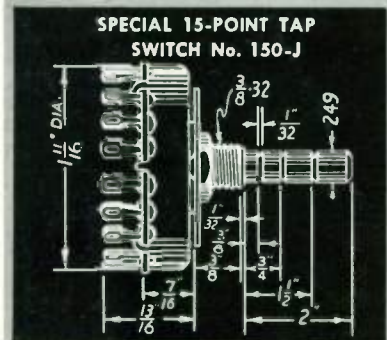

SPECIAL 15-POINT TAP SWITCH No. 150-J



13124

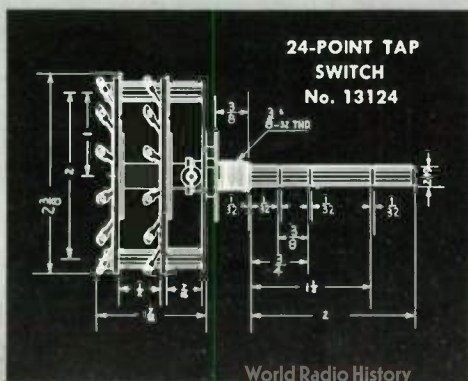

24-POINT TAP SWITCH No. 13124





## Long Frame, Junior, Midget, "X" Type Jacks

● Mallory-Yaxley experience in the manufacture of Jacks and Jack Switches dates back to the early days of the telephone. The excellent design of these parts insures years of constant service. Special metals selected for their spring qualities, supplied to our own specifications, provide uniform tension and wiping action of the contacts in all spring assemblies. Contacts are made of pure silver and are furnished in all spring assemblies except where special alloys are required to meet individual specifications.

Bakelite separators, ground to uniform thickness, give a well-balanced assembly regardless of the number of springs required.

The "X" Type Jack incorporates a special dust protector frame construction common to telephone applications and general use in special equipment. Has same high-quality springs and contacts used in Mallory-Yaxley Long Frame Jack, and fits the standard line of Mallory-Yaxley Phone Plugs.



Circuit Arrangement	Long Frame Types		Junior Jacks		Infant and Midget Jacks		"X" Types	
	No.	List Price	No.	List Price	No.	List Price	No.	List Price
Open Circuit	1	\$0.50	701	\$0.40	*A-1	\$0.25	XP1	\$0.65
Circuit Closing	2	.60	702	.55	A-2	.35		
Two Circuit	2A	.60	702A	.55	A-2A	.40	XP2B	.75
Three Circuit Microphone	2B	.60	702B	.55				
Single Circuit Filament Control	3	.70	703	.65				
Circuit Reversing	3A	.70	703A	.65	A-3A	.60		
Single Circuit Make Before Break							XP3B	1.00
Three Circuit Microphone, One Circuit Closing	3B	.70	703B	.65				
Double Circuit	3C	.70	703C	.65				
Interstage	4	.80	704	.75				
Two Circuit Filament Control	4A	.80	704A	.75				
Three Circuit Microphone, Two Circuits Closing	4B	.80	704B	.75				
Two Circuit Filament Lighting	5	.90	705	.85				
Interstage Filament Control	6	1.00	706	.95				

\*Commonly referred to as "Infant" Jack.

Spring combinations are illustrated at the right. All Long Frame and Junior Jacks are supplied with one each No. 255 Nut and No. 226 Washer. All A1 (Infant) Jacks supplied with one each No. 232 Nut and No. 225 Washer. All Midget Jacks have two No. 232 Nuts and one No. 225 Washer.

## Phone Plugs • Microphone Plugs • Extension Jacks

● Mallory-Yaxley Phone Plugs, Microphone Plugs and Extension Jacks can in no way be compared with imitations or inferior products. Exclusive insulation of bakelite positively prevents current leakage. Patented feature—in-

sulating tip from sleeve prevents shorting between these parts. The 77S Universal Phone Plug Shield is designed to convert Nos. 75, 75TC or 76 plugs to the shielded type.

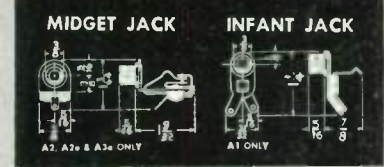
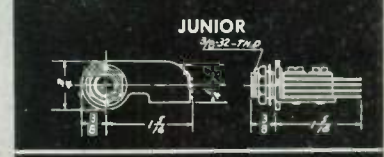
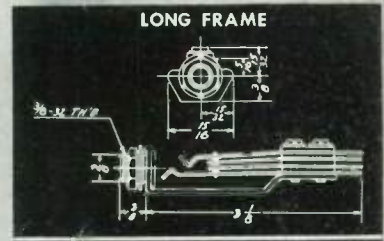

Description	Cat. No.	List Price
Two-Way Phone Plug (Bakelite Shell)	75	\$0.50
Two-Way Phone Plug (Shielded Nickel Shell)	75N	.75
Two-Way Phone Plug (Bakelite Shell) (Tie Cord Type)	75TC	.50
Two-Way Phone Plug (Shielded Nickel Shell) (Tie Cord Type)	75NTC	.85
Two-Way Phone Plug (Shielded Nickel Shell) (With Built-in Cable Clamp)	75A	1.25
Three-Way Microphone Plug (Bakelite Shell)	76	.75
Three-Way Microphone Plug (Shielded Nickel Shell) (With Built-in Cable Clamp)	76A	1.50
Universal Phone Plug Shield	77S	.25
Two-Way Extension Jack (Fiber Shell) for No. 75 and 75TC Phone Plugs	100	.75
Two-Way Extension Jack (Shielded Nickel Shell) for No. 75N and 75NTC Phone Plugs	100N	1.25
Two-Way Extension Jack (Shielded Nickel Shell) for No. 75A Phone Plug (With Built-in Cable Clamp)	100A	1.75
Three-Way Extension Jack (Fiber Shell) for No. 76 Microphone Plug	101	1.50
Three-Way Extension Jack (Shielded Nickel Shell) for No. 76A Microphone Plug (With Built-in Cable Clamp)	101A	2.25

.13.

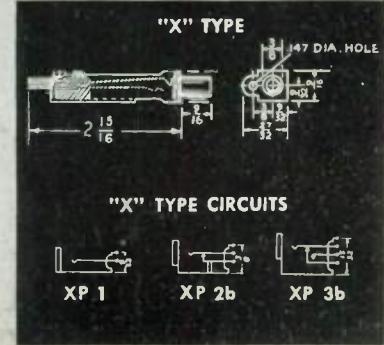
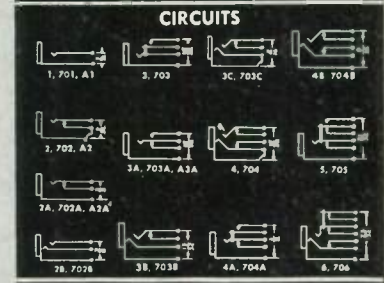





## Jack, Slide, Push Button Switches (Single)

Standard and Junior Jack Switches (Made under Yaxley Patent No. 1,443,604)

Circuit Arrangement	Two Position			
	Standard		Junior	
	No.	List Price	No.	List Price
Single-Pole, Single-Throw	20	\$0.75	720	\$0.70
Single-Pole, Double-Throw	30	.90	730	.85
Double-Pole, Single-Throw	40	1.00	740	.95
Five Springs, two make and one break	45	1.15	745	1.10
Double-Pole, Double-Throw	60	1.25	760	1.25
Three-Pole, Single Throw	73	1.25	733	1.25
Four-Pole, Single-Throw	74	1.60	744	1.60
Circuit Arrangement	Three Position			
	32	.90	732	.85
	62	1.25	762	1.20
Three-Pole, Double-Throw Center off Position	63	1.60	763	1.55
Four Pole, Double-Throw Center off Position	64	2.00	764	1.95

Mallory-Yaxley Jack Switches and Junior Jack Switches are furnished complete with Black Knob, Pointer, and one each No. 255 Nut and No. 226 Washer. Two-position switches only are furnished with "Off-On" name plate. Mount in a single hole,  $\frac{1}{16}$ " diameter, on panels up to  $\frac{1}{4}$ " thick.

### Midget Jack Switches

Mallory-Yaxley Midget Jack Switches are of the same general construction as the Junior types but require less space. Furnished complete with one each No. 255 Nut, No. 226 Washer, Black Knob and Pointer. Mount in single hole,  $\frac{1}{16}$ " diameter on panels up to  $\frac{1}{4}$ " thick.

	List Price
Single-Pole, Single-Throw, with "On-Off" Plate—No. 10	\$0.50
Single-Pole, Double-Throw, for long and short antenna switch. Furnished with "L and S" Plate—No. 11	.65

### Push Button Switches (Single)

Mallory-Yaxley Push Button Switches are made in locking and non-locking types. Especially adapted for use in laboratories, test panels, meter circuits and where permanent or momentary contact is desired.

The non-locking switch operates only when the button is pushed in and releases on removal

### Slide Switches

Very useful on varied low current applications. Positive snap action. Rated at .75 amperes, 125 volts.

	No.	List Price
Single-pole, single-throw	S1	\$0.30
Single-pole, double-throw	S2	.35
Double-pole, double-throw	S3	.40

of the pressure. The locking type maintains its position when the button is pushed in and is released when button is pulled out.

Furnished with polished black Bakelite Knob, one each No. 255 Nut, No. 226 Washer and Set Screw. Mounts in single hole  $\frac{1}{16}$ " diameter on panels up to  $\frac{1}{4}$ " thick.

	Cat. No.	List Price
S. P. Make contact—Non-locking type	2001	\$0.90
S. P. Make contact—Locking type	2001-L	.90
S. P. Break contact—Non-locking type	2002	.90
S. P. Break contact—Locking type	2002-L	.90
S. P. Double-Throw—Non-locking type	2003	1.00
S. P. Double-Throw—Locking type	2003-L	1.00
2-Pole—Make two contacts—Non-locking type	2004	1.20
2-Pole—Make two contacts—Locking type	2004-L	1.20
2-Pole—Break two contacts—Non-locking type	2005	1.20
2-Pole—Break two contacts—Locking type	2005-L	1.20
2-Pole—Double-Throw—Non-locking type	2006	1.50
2-Pole—Double-Throw—Locking type	2006-L	1.50
2-Pole—Make two—Break one—Non-locking type	2007	1.30
2-Pole—Make two—Break one—Locking type	2007-L	1.30
Double-Throw—Make before break—Non-locking type	2008	1.65
2-Pole—Double-Throw—Make before break—Locking type	2008-L	1.65

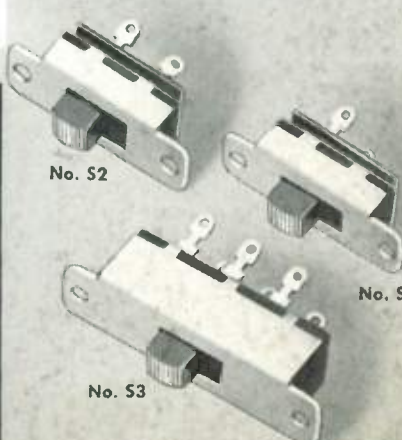
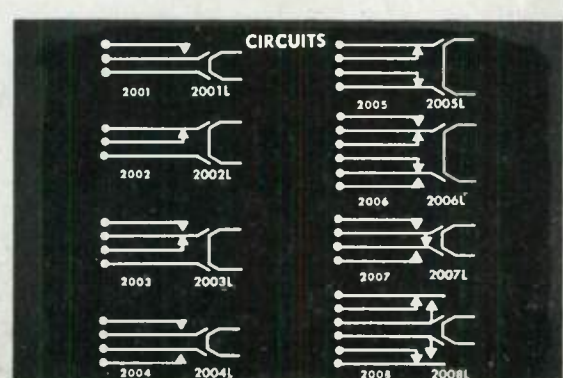
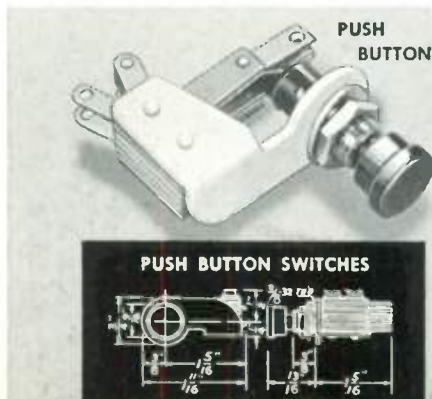
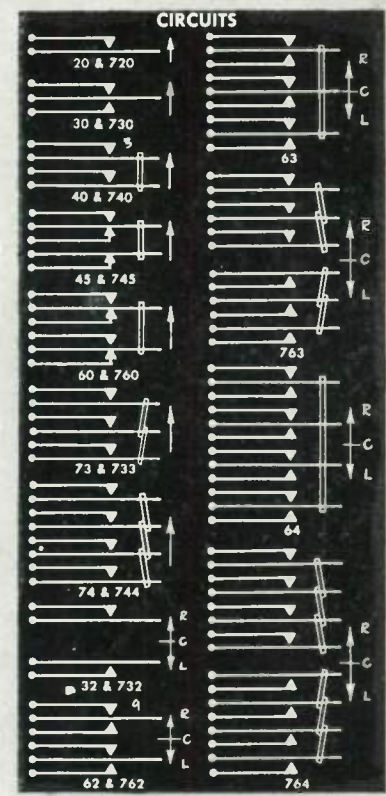
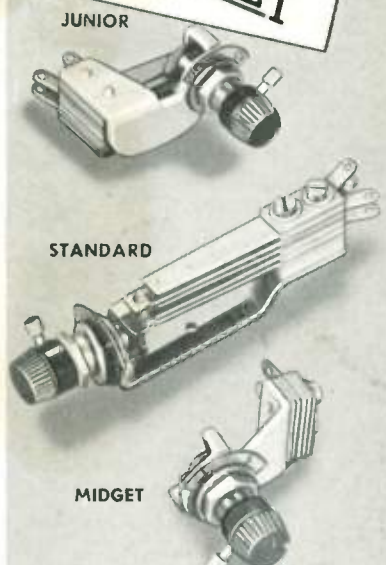

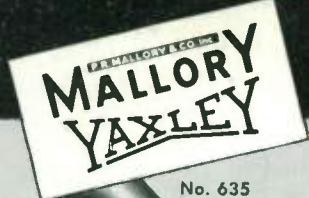

# Approved PRECISION PRODUCTS

## Cable • Cable Connectors • Markers

● The Cable Connector is a most convenient means of making or separating multiple connections quickly and easily. The design of Yaxley Cable Connector devices is such as to give numerous combinations, including up to twelve points in the moulded Bakelite type. Several different types of mounting for both the receptacle and pin plugs can be supplied. Yaxley Cable Connector Plugs are polarized with contacts clearly marked for convenience.

The connectors are specially useful on "Rack and Panel" work for amplifiers, P.A. systems and for Amateur Transmitting equipment. They are also useful on portable equipment, Transceivers, Sound Trucks, Boat Installations, and especially battery driven radio and associate equipment.

### Cable Connectors

	No.	List Price
7 Conductor Cable Connector Plug with 5-foot cable, receptacle plug and mounting plate.....	660	\$3.00
12 Conductor Cable Connector Plug with 4-foot cable, receptacle plug and mounting plate.....	612	5.00
Pin Plate, 7 conductor.....	680	.75
Pin Plate, 12 conductor.....	682	1.00

### Pin Plugs

	No.	List Price
Pin Plug, with cover, 7 conductor.....	635	\$1.00
Pin Plug, with cover, 12 conductor.....	625	1.25
Pin Plug, with mounting ring, 7 conductor.....	631	1.00
Pin Plug, with mounting ring, 12 conductor.....	617	1.25

For mounting on panels up to  $\frac{1}{16}$ " thick.

### Receptacle Plugs

	No.	List Price
Receptacle Plug, with cover, 7 conductor.....	645	\$1.00
Receptacle Plug, with cover, 12 conductor.....	615	1.25
Receptacle Plug, with mounting ring, 7 conductor.....	644	1.00
Receptacle Plug, with mounting ring, 12 conductor.....	614	1.25
Receptacle Plug with Radio Convenience Outlet Mounting Bracket, 7 conductor.....	139	1.50
Receptacle Plug with Radio Convenience Outlet Mounting Bracket, 12 conductor.....	141	2.00

For mounting on panels up to  $\frac{1}{16}$ " thick.

.16.

### Multiple Cable

	List Price
7 Conductor Insulated Cable... ..	\$0.25 per ft.
12 Conductor Insulated Cable... ..	.50 per ft.

### Stamped Metal Clamp Cable Markers

Designation	Catalog Number	List Price per 100
Not Stamped.....	A11268-1.....	\$1.00
A-.....	A11268-17.....	1.00
A+.....	A11268-48.....	1.00
A-C+.....	A11268-18.....	1.00
-A-B.....	A11268-110.....	1.00
A-B-C+.....	A11268-68.....	1.00
A+B-.....	A11268-9.....	1.00
A+6.....	A11268-96.....	1.00
ANT.....	A11268-65.....	1.00
GND.....	A11268-59.....	1.00
B-.....	A11268-24.....	1.00
B+.....	A11268-70.....	1.00
B-C+.....	A11268-53.....	1.00
B+22 $\frac{1}{2}$ .....	A11268-74.....	1.00
B+45.....	A11268-58.....	1.00
B+67 $\frac{1}{2}$ .....	A11268-67.....	1.00
B+90.....	A11268-14.....	1.00
B+135.....	A11268-62.....	1.00
B+180.....	A11268-8.....	1.00
C-.....	A11268-66.....	1.00
C+.....	A11268-41.....	1.00
C-41 $\frac{1}{2}$ .....	A11268-23.....	1.00
C-22 $\frac{1}{2}$ .....	A11268-55.....	1.00
C-45.....	A11268-38.....	1.00
INPUT.....	A11268-47.....	1.00
OUTPUT.....	A11268-52.....	1.00
NEG.....	A11268-71.....	1.00
POS.....	A11268-11.....	1.00
SPEAKER.....	A11268-12.....	1.00
SPKR-FLD.....	A11268-75.....	1.00

Other special designations are available on special order at slightly higher prices.

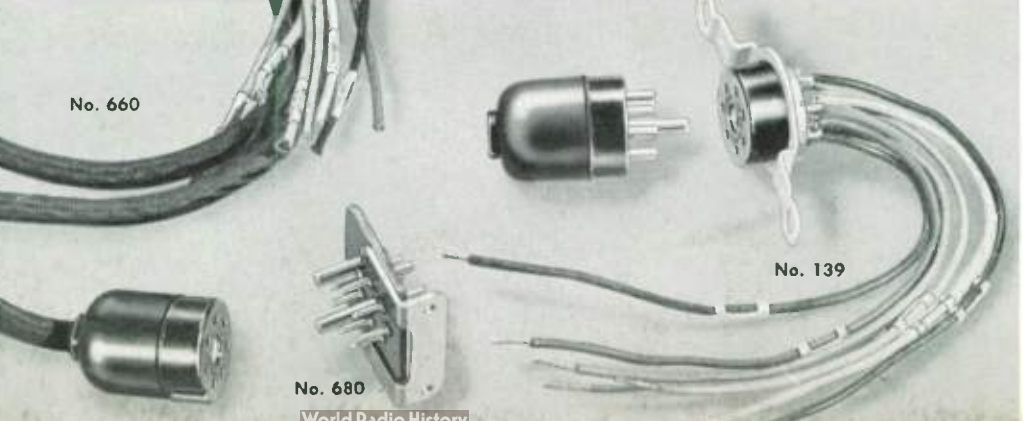
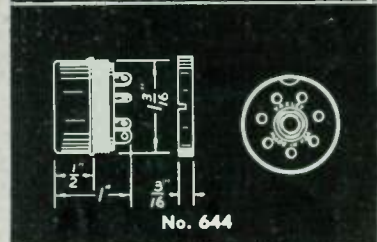
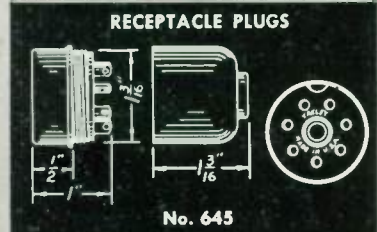
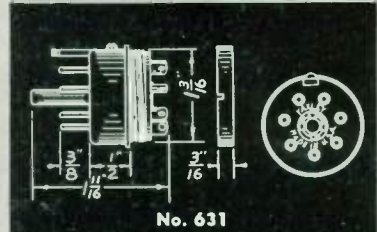
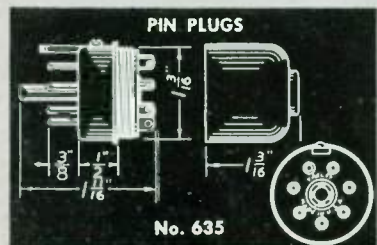





## Cable Connectors · Terminal Strips

### Pin Plugs

	Cat. No.	List Price
With cover, 2-conductor.....	632	\$0.20
With cover, 3-conductor.....	633	.25
With cover, 4-conductor.....	634	.30
With cover, 6-conductor.....	636	.35

(Note—Covers are easily attached by crimping)

### Receptacle Plugs

	Cat. No.	List Price
With cover, 2-conductor.....	642	\$0.15
With cover, 3-conductor.....	643	.20
With cover, 4-conductor.....	647	.25
With cover, 6-conductor.....	646	.30

### Chassis Mounting Receptacle Plates

Useful for loud speaker connections and other applications.

	Cat. No.	List Price
2-conductor plates.....	681	\$0.10
3-conductor plates.....	683	.12
4-conductor plates.....	684	.15
6-conductor plates.....	686	.17

### Terminal Clip

A convenient and substantial clip hot tin dipped for easy soldering use as antenna and ground connections and power terminals. Furnished complete with 2 screws.

	Cat. No.	List Price
Envelope of five.....	112E	\$0.25

### Terminal Connector

The Mallory terminal connector A-016 described on page 29 is invaluable for many applications. Where cable or harness wiring was originally used, it affords a neat and effective anchor between the flexible leads from the condenser and the cable, making it unnecessary to splice and tape these connections. A-016 \$0.05

### Grid Clips

	Cat. No.	List Price per 100
Small, for metal tubes.....	GC1	\$1.50
Large, for glass tubes.....	GC2	1.50

### Solder Lug Strips

	Cat. No.	List Price per 10
1 terminal strip.....	SL1	\$0.25
2 terminal strip.....	SL2	.35
3 terminal strip.....	SL3	.50

### Terminal Strips

	Cat. No.	List Price
2 terminal strip, plain, no marking.....	113	\$0.10
3 terminal strip, plain, no marking.....	114	.15

### Multiple Connection Plug Outlet

● There has been a considerable call for a multiple connection Plug with more than 12 contacts. To meet this demand, the Mallory-Yaxley No. 122 Radio Outlet with 22 conductors is available. This Outlet will find a wide application in remote control service and wherever a many-contact receptacle is required.

The Outlet presents a neat appearance. The Pin Plug, which is furnished with each Outlet, is equipped with a convenient handle. The receptacle and pin plug go together and come apart with ease and they cannot be used incorrectly as the plug is polarized.

Brass—No. 122.....\$5.00  
This Outlet is available with brass plate only.

### Radio Convenience Outlets

● Mallory-Yaxley can supply custom-built radio convenience outlets for various applications. These are not stock items, but are built only to order. Send us your specifications and quantity desired, and we will submit suggested design and quotations.

Mallory-Yaxley radio convenience outlets not only insure dependable radio reception through efficient connections, but also save damage to property. The proper installation makes any home more desirable from a renting, selling, or living standpoint. Mallory-Yaxley also makes a specialty of furnishing radio convenience outlets for hotels, schools, and institutions.

.17.

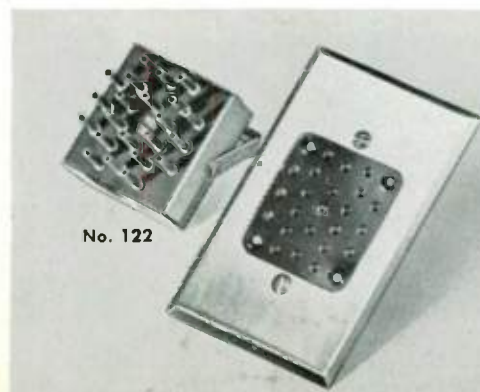
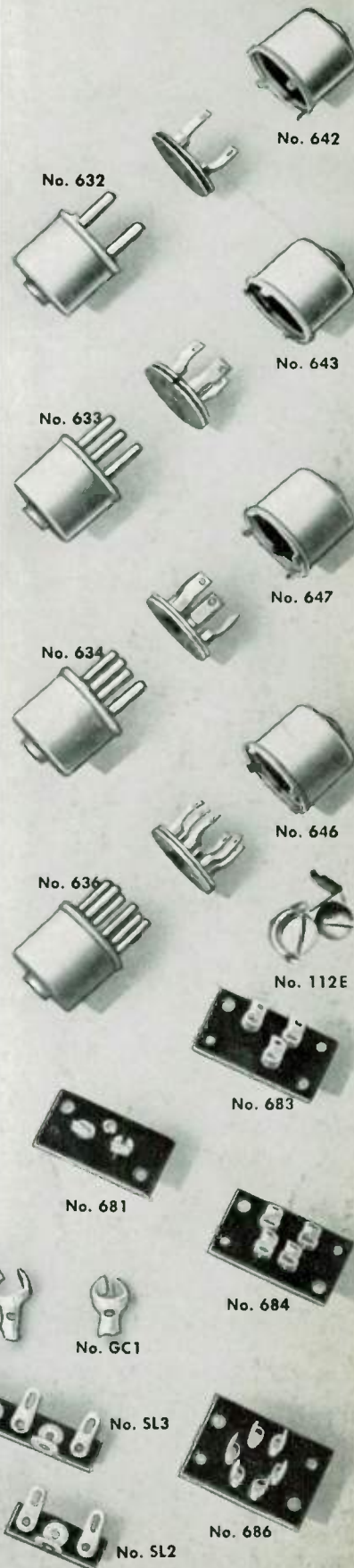

## Knobs • Nuts • Washers • Screws • Grommets

**Insulating Washers**—Mallory Yaxley Washers are made from selected stock. Dimensions in inches are shown in drawing at the left.



Description and Dimensions	Cat. No.	List Price Per 10
Extruded Washer—Fiber—1 O.D. x 3/8 I. D. x 1/16; Extruded 1/2 x 1/32	202	\$0.25
For Set See No. 212 Flat Washer.		
Extruded Washer—Fiber—3/4 O. D. x 3/8 I. D. x 1/16; Extruded 1/2 x 1/32	203	.25
For Set See No. 212 Flat Washer.		
Extruded Washer—Fiber—1/2 O. D. x 5/16 I. D. x 3/32; Extruded 3/8 x 1/32	204	.25
For Set See No. 214 Flat Washer.		
Extruded Washer—Fiber—1/2 O. D. x 1/4 I. D. x 3/64; Extruded 3/8 x 1/32	205	.25
For Set See No. 213 Flat Washer.		
Extruded Washer—Fiber—7/16 O. D. x 1/8 I. D. x 1/16; Extruded 7/32 x 1/32	1139	.25
Flat Washer—3/4 O. D. x 3/8 I. D. x 1/32; Bakelite	212	.15
Flat Washer—1/2 O. D. x 1/4 I. D. x 1/64; Bakelite	213	.15
Flat Washer—1/2 O. D. x 5/16 I. D. x 1/32; Bakelite	214	.15
Metal Washer—Nickel Finish—5/8 O. D. x 3/8 I. D. .010 Brass	225	.15
Metal Washer—Nickel Finish—5/8 O. D. x 7/16 I. D. .010 Brass	226	.15
Lock Washer—Cadmium Plated Steel—11/16 O. D. x 25/64 I. D.	227	.15
Lock Washer—for No. 6 Screws	228	.08
Lock Washer—for No. 8 Screws	229	.08

### Hexagon Head Mounting Nuts

Description	Thread	Dimension	Catalog No.	List Price
Flat Hex Mounting Nut	3/8-32	1 1/2 x 3/32	232	\$0.10 per pkg. of 10
Flat Hex Mounting Nut	5/16-40	7/16 x 3/32	233	.10 per pkg. of 10
Flat Hex Mounting Nut	1/4-32	3/8 x 3/32	234	.10 per pkg. of 10
Hex Mounting Nut	6-32		N235	.08 per pkg. of 10
Hex Mounting Nut	8-32		N236	.09 per pkg. of 10
Hex Mounting Nut	3/8-32	1 1/2 x 7/64 x 7/64	255	.10 each
Hex Mounting Nut	3/8-32	shoulder nut	A-11260-2	.20 each
Hex Mounting Nut	3/8-32	shoulder nut	A-11260-12	.15 each

For Volume Controls, Jacks, Jack Switches, Junior Jacks, Tap and Selector Switches, use No. 232 flat hex nuts or Catalog Nos. 255, A-11260-2 or A-11260-12 shoulder nuts.  
For #17 Tip Jacks use No. 234 Flat Hex Nut.  
For #16, #18, #19 Tip Jacks use No. 233 Flat Hex Nut.  
Nos. 232, 233 and 234 are packed in standard packages of 10.

### Bar Type and Round Bakelite Knobs

Description	Cat. No.	List Price
2 1/4" Bar Type Knob, Black	365	\$0.20
2 1/4" Bar Type Knob, Brown	365-B	.20
2 1/4" Bar Type Knob, Red	365-R	.20
1 1/4" Bar Type Knob, Black	366	.15
1 1/4" Bar Type Knob, Brown	366-B	.15
1 1/4" Bar Type Knob, Red	366-R	.15
1 1/2" Dia. Round Knob, Black	367	.20
1 1/2" Dia. Round Knob, Brown	367-B	.20
1 1/2" Dia. Round Knob, Black	368	.15
1 1/2" Dia. Round Knob, Brown	368-B	.15

### Round Head Machine Screws (Brass, Nickel-plated)

Description	Cat. No.	List Price Per 10
1/4 x 6-32	S237	\$0.10
3/8 x 6-32	S238	.12
1/2 x 6-32	S239	.14
3/4 x 6-32	S240	.16
1/4 x 8-32	S241	.12
3/8 x 8-32	S242	.14
1/2 x 8-32	S243	.16
3/4 x 8-32	S244	.18

### Headless Steel Cup Point Set Screws

Description	Cat. No.	List Price Per 10
1/8 x 6-32	S245	\$0.30
1/4 x 6-32	S246	.35
3/8 x 6-32	S247	.40
1/2 x 8-32	S248	.30
3/4 x 8-32	S249	.35
1 x 8-32	S250	.40

### Grommets—Black Rubber

3/8 I.D. x 5/8 O.D., 1/2-inch mounting hole.  
No. 283, list price per 10 ..... \$0.30  
1/2 I.D. x 7/8 O.D., 5/16-inch mounting hole.  
No. 284, list price per 10 ..... .20

.18.

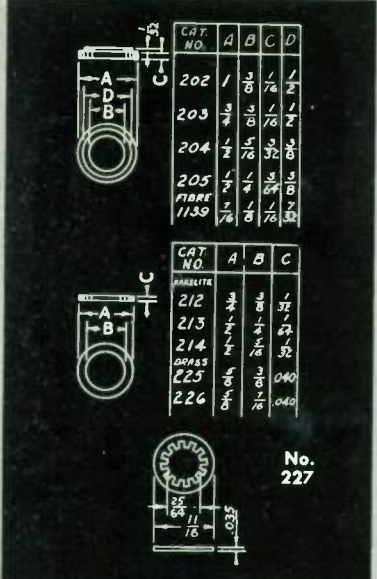

NUTS		
CAT. NO.	A	THREAD
255	7/64	3/8-32
A11260-2	15/32	3/8-32
A11260-12	7/32	3/8-32

FLAT NUTS		
CAT. NO.	HEX.	THD.
232	1/2	3/8-32
233	7/16	5/16-40
234	3/8	1/4-32





303-AH

## Dial Lights • Panel Lights • Jewels • Bulbs

### Pilot and Dial Light Brackets and Sockets

DESCRIPTION	Miniature Screw Base Types		Miniature Bayonet Base Types		Candelabra Base Types		List Price
	Faceted Jewel Cat. No.	Smooth Jewel Cat. No.	Faceted Jewel Cat. No.	Smooth Jewel Cat. No.	Faceted Jewel Cat. No.	Smooth Jewel Cat. No.	
Both terminals are insulated from bracket							
Pilot Light Bracket, 1/2" Amber Jewel	310A	320A	B310A	B320A			\$0.30
Pilot Light Bracket, 1/2" Clear Jewel	310C	320C	B310C	B320C			.30
Pilot Light Bracket, 1/2" Green Jewel	310G	320G	B310G	B320G			.30
Pilot Light Bracket, 1/2" Red Jewel	310R	320R	B310R	B320R			.30
Pilot Light Bracket, 1/2" Blue Jewel	310B	320B	B310B	B320B			.30
Pilot Light Bracket, 1/2" Opal Jewel	310F	320F	B310F	B320F			.30
Pilot Light Bracket, 1" Amber Jewel	340A	350A	B340A	B350A	C340A	C350A	1.00
Pilot Light Bracket, 1" Clear Jewel	340C	350C	B340C	B350C	C340C	C350C	1.00
Pilot Light Bracket, 1" Green Jewel	340G	350G	B340G	B350G	C340G	C350G	1.00
Pilot Light Bracket, 1" Red Jewel	340R	350R	B340R	B350R	C340R	C350R	1.00
Pilot Light Bracket, 1" Blue Jewel	340B	350B	B340B	B350B	C340B	C350B	1.00
Pilot Light Bracket, 1" Opal Jewel	340F	350F	B340F	B350F	C340F	C350F	1.00
	With 2 Lug Terminals Cat. No.	With 1 Lug Terminal and 1 Rivet Terminal Cat. No.	With 1 Lug Terminal and 1 Rivet Terminal Cat. No.	With 1 Lug Terminal and 1-6" Flex. Lead Cat. No.			
Dial Light Slip-on Bracket	303AH	303AR	B303AR				.10
Dial Light Slip-on Bracket				B303AL			.15
Dial Light Slip-on Bracket (Inverted Type)	304CH	304CR	B304CR				.10
Shell Assemblies	†317E	317R	B317R				.10
Shell Assemblies	†317H			B317L			.15
Rubber Sleeves for Insulating All Dial Light Base Assemblies	Cat. No. 300		Per Env. of 10				.50

†Lugs at 60° angle. ‡Lugs at 180° angle.

### Jewels Only

DESCRIPTION	1/2" Size			1" Size		
	Faceted Cat. No.	Smooth Cat. No.	List Price	Faceted Cat. No.	Smooth Cat. No.	List Price
Clear Jewel with Mounting Nut	311C	321C	\$0.15	313C	323C	\$0.85
Red Jewel with Mounting Nut	311R	321R	.15	313R	323R	.85
Green Jewel with Mounting Nut	311G	321G	.15	313G	323G	.85
Amber Jewel with Mounting Nut	311A	321A	.15	313A	323A	.85
Blue Jewel with Mounting Nut	311B	321B	.15	313B	323B	.85
Opal Jewel with Mounting Nut	311F	321F	.15	313F	323F	.85
Clear Jewel with Clamping Ear	312C	322C	.15			
Red Jewel with Clamping Ear	312R	322R	.15			
Green Jewel with Clamping Ear	312G	322G	.15			
Amber Jewel with Clamping Ear	312A	322A	.15			
Blue Jewel with Clamping Ear	312B	322B	.15			
Opal Jewel with Clamping Ear	312F	322F	.15			

### Pilot and Dial Light Bulbs

	Cat. No.	List Price
2.5 V. Screw Base Type	170	\$0.15
6.3 V. Screw Base Type	171	.15
6.3 V. Bayonet Base Type	172	.15

### Panel Lights

A convenient reflector for panel mounting. Mounts in single 1/2" hole. Panel Light Catalog No. 330. List Price \$0.65

.19.

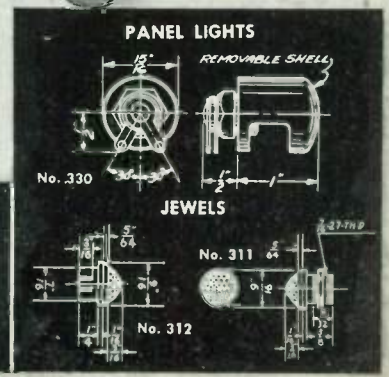
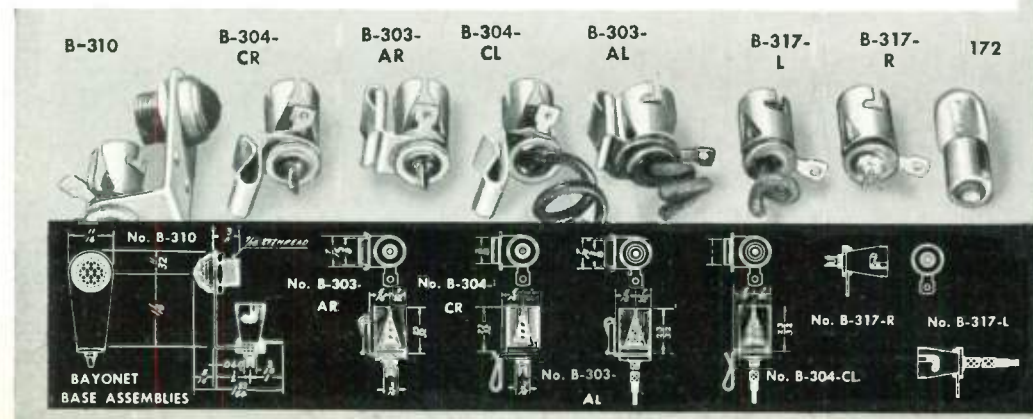

**Vitreous Enameled Fixed Resistors**

**†10 Watt Rating**

(†On Values to 10,000 Ohms) Size: 5/8 x 1 3/4 Tube

Resistance Ohms	Current Milli-amperes	Volts Max.	Catalog Number	List Price
1	3150	3	1HJ1	\$.40
2	2200	4.5	1HJ2	.40
3	1800	5.5	1HJ3	.40
4	1580	6.3	1HJ4	.40
5	1400	7	1HJ5	.40
7.5	1150	8.5	1HJ7.5	.40
10	1000	10	1HJ10	.40
12	910	11	1HJ12	.40
15	812	12	1HJ15	.40
20	707	14	1HJ20	.40
25	630	16	1HJ25	.40
30	575	17.3	1HJ30	.40
35	530	19	1HJ35	.40
40	500	20	1HJ40	.40
50	447	22	1HJ50	.40
75	360	27	1HJ75	.40
100	315	31	1HJ100	.40
125	280	35	1HJ125	.40
150	260	39	1HJ150	.40
200	220	44	1HJ200	.40
225	210	47.5	1HJ225	.40
250	200	50	1HJ250	.40
300	180	55	1HJ300	.40
350	170	59	1HJ350	.40
400	158	63	1HJ400	.40
450	150	67	1HJ450	.40
500	141	70	1HJ500	.40
600	130	77	1HJ600	.40
700	120	83.5	1HJ700	.40
750	115	85	1HJ750	.40
800	112	89	1HJ800	.40
900	105	95	1HJ900	.40
1000	100	100	1HJ1000	.40
1100	95	105	1HJ1100	.40
1200	91	110	1HJ1200	.40
1250	89	111	1HJ1250	.40
1500	81	122	1HJ1500	.40
1750	75.5	132	1HJ1750	.40
2000	70	141	1HJ2000	.40
2250	66.5	150	1HJ2250	.40
2500	63	158	1HJ2500	.40
3000	56	173	1HJ3000	.40
3500	53	185	1HJ3500	.40
4000	50	200	1HJ4000	.40
4500	47	212	1HJ4500	.40
5000	45	224	1HJ5000	.40
6000	40	240	1HJ6000	.40
7000	38	264	1HJ7000	.40
7500	36	270	1HJ7500	.40
8000	35	282	1HJ8000	.40
8500	34	291	1HJ8500	.40
10000	32	316	1HJ10000	.40
11000*	18	195	1HJ11000	.40
12000*	17	204	1HJ12000	.40
12500*	16.5	210	1HJ12500	.40
13500*	16	217	1HJ13500	.40
14300*	15.5	224	1HJ14300	.40
15000*	15	225	1HJ15000	.40
16000*	14.8	236	1HJ16000	.40
17500*	14.3	246	1HJ17500	.40
18000*	14	250	1HJ18000	.40
20000*	13	260	1HJ20000	.40
22500*	12.5	280	1HJ22500	.40
25000*	12	300	1HJ25000	.40
30000*	11	330	1HJ30000	.40
35000*	10	350	1HJ35000	.40
40000*	9	360	1HJ40000	.40
45000*	8.8	385	1HJ45000	.40
50000*	8	400	1HJ50000	.40

**†20 Watt Rating**

(†On Values to 12,500 Ohms) Size: 1/2 x 2 Tube

Resistance Ohms	Current Milli-amperes	Volts Max.	Catalog Number	List Price
5	2000	10	2HJ5	\$0.55
10	1415	14	2HJ10	.65
25	895	22	2HJ25	.65
50	633	31	2HJ50	.65
75	517	38	2HJ75	.65
100	447	44	2HJ100	.65
150	365	54	2HJ150	.65
200	316	63	2HJ200	.65
300	258	77	2HJ300	.65
400	224	90	2HJ400	.65
500	200	100	2HJ500	.65
750	163	122	2HJ750	.65
1000	141	141	2HJ1000	.65
1250	126	157	2HJ1250	.65
1500	115	173	2HJ1500	.65
1750	107	187	2HJ1750	.65
2000	100	200	2HJ2000	.65
2250	94	211	2HJ2250	.65
2500	89	222	2HJ2500	.65
2750	85	235	2HJ2750	.65
3000	81	243	2HJ3000	.65
3500	75	262	2HJ3500	.65
4000	71	284	2HJ4000	.65
4500	66	300	2HJ4500	.65
5000	63	315	2HJ5000	.65
6000	57	345	2HJ6000	.65
7500	51	387	2HJ7500	.65
10000	44	440	2HJ10000	.65
12500	40	500	2HJ12500	.65
15000*	23	346	2HJ15000	.65
20000*	20	400	2HJ20000	.75
25000*	18	447	2HJ25000	.75
35000*	15	529	2HJ35000	.75
40000*	14	566	2HJ40000	.75
50000*	13	632	2HJ50000	.75
75000*	10	773	2HJ75000	1.00
100000*	9	894	2HJ100000	1.00

**†100 Watt Rating**

(†On Values to 50,000 Ohms) Size: 1 1/8 x 6 1/2 Tube

Resistance Ohms	Current Milli-amperes	Volts Max.	Catalog Number	List Price
25	2000	50	10HJ25	\$1.50
50	1414	70	10HJ50	1.50
75	1155	85	10HJ75	1.50
100	1000	100	10HJ100	1.50
150	815	120	10HJ150	1.50
250	632	158	10HJ250	1.50
500	447	220	10HJ500	1.50
750	365	275	10HJ750	1.50
1000	316	315	10HJ1000	1.50
1500	258	385	10HJ1500	1.50
2000	223	447	10HJ2000	1.50
2500	200	500	10HJ2500	1.50
5000	141	700	10HJ5000	1.50
7500	115	865	10HJ7500	1.75
10000	100	1000	10HJ10000	1.75
15000	81	1200	10HJ15000	1.75
20000	70	1400	10HJ20000	1.75
25000	63	1580	10HJ25000	1.75
30000	57	1724	10HJ30000	2.00
40000	50	2000	10HJ40000	2.00
50000	44	2200	10HJ50000	2.00
75000*	23	1732	10HJ75000	2.25
100000*	20	2000	10HJ100000	2.50

**†50 Watt Rating**

(†On Values to 25,000 Ohms) Size: 3/4 x 4 1/2 Tube

Resistance Ohms	Current Milli-amperes	Volts Max.	Catalog Number	List Price
10	2240	22	5HJ10	\$1.10
25	1415	35.4	5HJ25	1.10
50	1000	50	5HJ50	1.10
100	707	70	5HJ100	1.10
250	447	111	5HJ250	1.10
500	316	158	5HJ500	1.10
750	258	192	5HJ750	1.10
1000	224	224	5HJ1000	1.10
1500	183	275	5HJ1500	1.10
2000	158	316	5HJ2000	1.10
2500	141	354	5HJ2500	1.10
5000	100	500	5HJ5000	1.10
7500	81	610	5HJ7500	1.25
10000	70	700	5HJ10000	1.25
12500	63	790	5HJ12500	1.25
15000	57	850	5HJ15000	1.25
20000	50	1000	5HJ20000	1.25
25000	44	1100	5HJ25000	1.25
30000*	26	774	5HJ30000	1.45
40000*	22	894	5HJ40000	1.45
50000*	20	1000	5HJ50000	1.45
75000*	16	1223	5HJ75000	1.45
100000*	14	1414	5HJ100000	1.45

**†200 Watt Rating**

(†On Values to 75,000 Ohms) Size: 1 1/8 x 10 1/2 Tube

Resistance Ohms	Current Milli-amperes	Volts Max.	Catalog Number	List Price
25	2830	70	20HJ25	\$2.50
50	2000	100	20HJ50	2.50
75	1635	120	20HJ75	2.50
100	1414	140	20HJ100	2.50
250	894	220	20HJ250	2.50
500	632	315	20HJ500	2.50
750	515	385	20HJ750	2.50
1000	447	445	20HJ1000	2.50
1500	361	447	20HJ1500	2.50
2000	316	541	20HJ2000	2.50
2500	283	705	20HJ2500	2.50
3000	258	770	20HJ3000	2.50
5000	200	1000	20HJ5000	2.50
7500	163	1200	20HJ7500	2.50
10000	141	1400	20HJ10000	2.50
20000	100	2000	20HJ20000	3.00
30000	81	2400	20HJ30000	3.00
40000	70	2800	20HJ40000	3.00
50000	63	3150	20HJ50000	3.00
75000*	51	3820	20HJ75000	3.00
100000*	28	2828	20HJ100000	3.00

\*Low temperature enamel is used on these sizes because it affords better protection to the small diameter wire that must be used to make the higher resistance values.

Type 10HJ

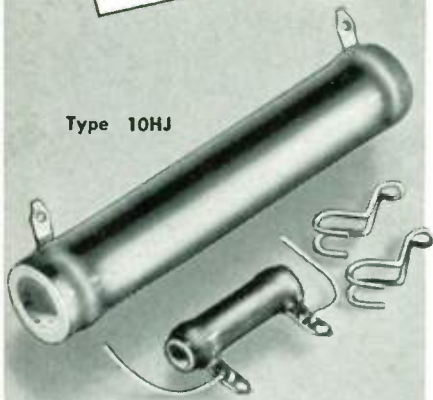

Type 1HJ

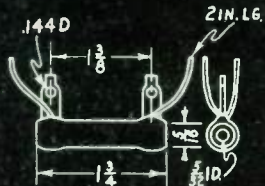

TYPE 1HJ

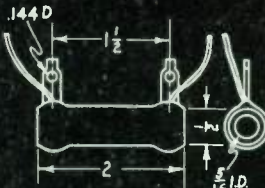

TYPE 2HJ



TYPE 5HJ

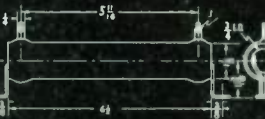

TYPE 10HJ

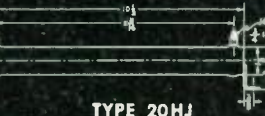

TYPE 20HJ



## Variohm Adjustable Resistors

†10 Watt Rating (†On Values to 10,000 Ohms)  
Size: 5/16 x 1 1/4"

Resistance Ohms	Current Milli-amperes	Volts Max.	Catalog Number	List Price
1	3150	3	1AV1	\$0.60
2	2200	4.5	1AV2	.60
3	1800	5.5	1AV3	.60
5	1400	7	1AV5	.60
7.5	1150	8.5	1AV7.5	.60
10	1000	10	1AV10	.60
15	812	12	1AV15	.60
20	707	14	1AV20	.60
25	630	16	1AV25	.60
50	447	22	1AV50	.60
75	360	27	1AV75	.60
100	315	31	1AV100	.60
150	260	39	1AV150	.60
200	220	44	1AV200	.60
250	200	50	1AV250	.60
300	180	55	1AV300	.60
350	170	59	1AV350	.60
400	158	63	1AV400	.60
500	141	70	1AV500	.60
600	130	77	1AV600	.60
750	115	85	1AV750	.60
800	112	89	1AV800	.60
1000	100	100	1AV1000	.60
1250	89	111	1AV1250	.60
1500	81	122	1AV1500	.60
2000	70	141	1AV2000	.60
2250	66.5	150	1AV2250	.60
2500	63	158	1AV2500	.60
3000	56	173	1AV3000	.60
3500	53	185	1AV3500	.60
4000	50	200	1AV4000	.60
4500	47	212	1AV4500	.60
5000	45	224	1AV5000	.60
6000	40	240	1AV6000	.60
7000	38	264	1AV7000	.60
7500	36	270	1AV7500	.60
8000	35	282	1AV8000	.60
8500	34	291	1AV8500	.60
9000	33	303	1AV9000	.60
10000	32	316	1AV10000	.60

†25 Watt Rating (†On Values to 12,000 Ohms)  
Size: 5/8 x 2 1/2" Tube

Resistance Ohms	Current Milli-amperes	Volts Max.	Catalog Number	List Price
1	5000	5	2AV1	\$0.85
3	2890	8.6	2AV3	.85
5	2240	11	2AV5	.85
10	1580	15	2AV10	.85
15	1290	19.3	2AV15	.85
25	1000	25	2AV25	.85
50	707	35	2AV50	.85
75	575	43	2AV75	.85
100	500	50	2AV100	.85
150	400	60	2AV150	.85
200	353	70	2AV200	.85
250	316	79	2AV250	.85
300	288	86	2AV300	.85
400	250	100	2AV400	.85
500	224	112	2AV500	.85
750	182	137	2AV750	.85
1000	158	158	2AV1000	.85
1250	141	176	2AV1250	.85
1500	129	194	2AV1500	.85
2000	112	224	2AV2000	.85
2500	100	250	2AV2500	.85
3000	91	274	2AV3000	.85
3500	84	296	2AV3500	.85
4000	79	316	2AV4000	.85
5000	71	354	2AV5000	.85
6000	64	394	2AV6000	.95
7500	57	431	2AV7500	.95
10000	50	500	2AV10000	.95
12000	44	537	2AV12000	.95
15000*	26	387	2AV15000	.95
20000*	22	447	2AV20000	1.10
25000*	20	500	2AV25000	1.10

†100 Watt Rating (†On Values to 50,000 Ohms)  
Size: 1 1/8 x 6 1/2" Tube

Resistance Ohms	Current Milli-amperes	Volts Max.	Catalog Number	List Price
50	1413	71	10AV50	\$2.00
100	1000	100	10AV100	2.00
500	447	223	10AV500	2.00
1000	316	316	10AV1000	2.00
2000	223	447	10AV2000	2.00
3000	182	547	10AV3000	2.00
4000	158	633	10AV4000	2.00
5000	141	707	10AV5000	2.00
7500	115	860	10AV7500	2.25
10000	100	1000	10AV10000	2.25
15000	81	1200	10AV15000	2.25
20000	70	1400	10AV20000	2.25
25000	63	1580	10AV25000	2.25
30000	57	1700	10AV30000	2.50
35000	53	1850	10AV35000	2.50
40000	50	2000	10AV40000	2.50
50000	44	2200	10AV50000	2.50
75000*	23	1732	10AV75000	2.75
100000*	20	2000	10AV100000	2.75

†50 Watt Rating (†On Values to 40,000 Ohms)  
Size: 5/8 x 4 1/2" Tube

Resistance Ohms	Current Milli-amperes	Volts Max.	Catalog Number	List Price
5	3160	15	5AV5	\$1.35
10	2230	22	5AV10	1.35
25	1410	35	5AV25	1.35
50	1000	50	5AV50	1.35
75	816	61	5AV75	1.35
100	707	70	5AV100	1.35
150	577	86	5AV150	1.35
200	500	100	5AV200	1.35
250	447	111	5AV250	1.35
300	408	122	5AV300	1.35
400	354	140	5AV400	1.35
500	316	157	5AV500	1.35
750	258	192	5AV750	1.35
1000	224	224	5AV1000	1.35
1500	182	275	5AV1500	1.35
2000	158	315	5AV2000	1.35
2500	141	350	5AV2500	1.35
3000	129	387	5AV3000	1.35
4000	112	448	5AV4000	1.35
5000	100	500	5AV5000	1.35
7500	81	610	5AV7500	1.50
10000	70	700	5AV10000	1.50
12000	64	768	5AV12000	1.50
15000	57	855	5AV15000	1.50
20000	50	1000	5AV20000	1.50
25000	44	1100	5AV25000	1.50
30000	41	1240	5AV30000	1.70
40000	35	1415	5AV40000	1.70
50000*	20	1000	5AV50000	1.70
60000*	18	1080	5AV60000	2.00
75000*	17	1275	5AV75000	2.00
80000*	16	1265	5AV80000	2.00
100000*	14	1414	5AV100000	2.00

†80 Watt Rating (†On Values to 40,000 Ohms)  
Size: 5/8 x 6 1/2" Tube

Resistance Ohms	Current Milli-amperes	Volts Max.	Catalog Number	List Price
10	2830	28.3	8AV10	\$1.75
15	2310	34.6	8AV15	1.75
25	1790	44.8	8AV25	1.75
50	1265	63.2	8AV50	1.75
100	894	89.4	8AV100	1.75
250	566	141.5	8AV250	1.75
300	517	155	8AV300	1.75
400	495	178	8AV400	1.75
500	400	200	8AV500	1.75
750	327	245	8AV750	1.75
1000	283	283	8AV1000	1.75
1500	231	346	8AV1500	1.75
2000	200	400	8AV2000	1.75
2500	179	448	8AV2500	1.75
3500	152	530	8AV3500	1.75
5000	126	632	8AV5000	1.75
7500	103	775	8AV7500	2.00
10000	89	894	8AV10000	2.00
15000	73	1092	8AV15000	2.00
20000	63	1270	8AV20000	2.00
25000	57	1414	8AV25000	2.00
30000	51	1530	8AV30000	2.25
40000	44	1790	8AV40000	2.25
50000*	25	1265	8AV50000	2.25
60000*	23	1385	8AV60000	2.50
75000*	21	1575	8AV75000	2.50
80000*	20	1600	8AV80000	2.50
100000*	18	1789	8AV100000	2.50

200 Watt Rating Size: 1 1/8 x 10 1/2" Tube

Resistance Ohms	Current Milli-amperes	Volts Max.	Catalog Number	List Price
50	2000	100	20AV50	\$3.00
100	1414	140	20AV100	3.00
500	632	315	20AV500	3.00
1000	447	447	20AV1000	3.00
1500	361	541	20AV1500	3.00
2000	316	632	20AV2000	3.00
2500	283	700	20AV2500	3.00
5000	200	1000	20AV5000	3.00
10000	141	1414	20AV10000	3.00
20000	100	2000	20AV20000	3.50
25000	89	2225	20AV25000	3.50
30000	81	2437	20AV30000	3.50
50000	63	3150	20AV50000	3.50
75000*	51	3825	20AV75000	3.50
100000*	28	2828	20AV100000	3.50

\*Low temperature enamel is used on these sizes because it affords better protection to the small diameter wire that must be used to make the higher resistance values.

### Extra Adjustable Clips

List Price  
Type No. 3V—  
For 25, 50, and 80-Watt Variohms..... \$0.10 each  
Type No. 6V—  
For 100 and 200-Watt 1 1/8" Variohms..... .15 each

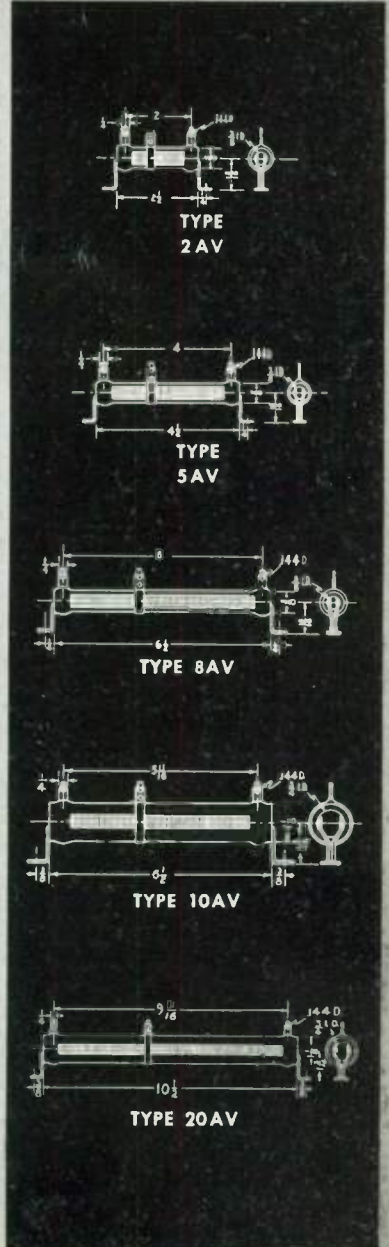
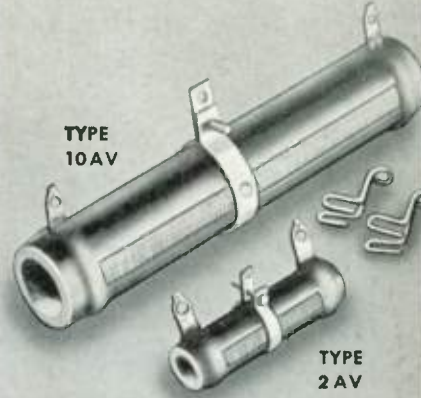

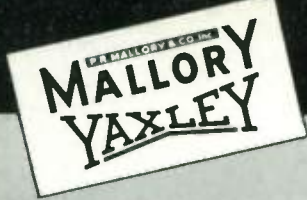

# Approved PRECISION PRODUCTS

## Truvolt Resistors

● Because of their unique design and merit, Truvolt Resistors have long been a favorite of service men and experimenters. Truvolt construction provides:

1. Greater radiating surface.
2. Cooler operation.
3. Better distribution of heat because of the heat conducting copper core.
4. Larger wire size for a given resistance value.
5. Negligible inductance at broadcast frequencies.

The end terminals of Mallory Truvolt Resistors are adjustable, permitting the use of standard value resistors for the replacement of odd value original equipment resistors in amplifiers and receivers. A removable full-length fiber insulation guard protects each resistor.

Type B Truvolt Resistors are provided with one mounting bracket. Types C and D Truvolt Resistors are provided with two mounting brackets. One extra adjustable clip is supplied with types C and D—additional clips for all types are available.



### †10 Watt Rating—1000 Volt Insulation (†On Values to 15,000 Ohms) Size: 3/8 x 1 3/4 Tube

Resistance Ohms	Current Milli-amperes	Volts Max.	Catalog Number	List Price
.5	4500	2.2	A.005	\$0.50
1	3150	3	A.01	.50
2	2200	4.5	A.02	.50
3	1800	5.5	A.03	.50
5	1400	7	A.05	.50
7.5	1150	8.5	A.075	.50
10	1000	10	A.1	.50
15	815	12	A.15	.50
20	700	14	A.2	.50
25	630	16	A.25	.50
30	570	17	A.3	.50
50	450	22	A.5	.50
75	360	27	A.75	.50
100	315	31	A1	.50
200	220	45	A2	.50
300	180	55	A3	.50
400	158	63	A4	.50
500	141	70	A5	.50
750	115	86	A7.5	.50
800	112	89	A8	.50
1000	100	100	A10	.50
1500	81	112	A15	.50
2000	70	141	A20	.50
2500	63	158	A25	.50
3000	56	173	A30	.50
4000	50	200	A40	.50
5000	45	222	A50	.50
7500	36	274	A75	.50
10000	31	316	A100	.50
15000	26	388	A150	.50
20000	20	395	A200	.50
25000	16	400	A250	.50

### †50 Watt Rating—1000 Volt Insulation (†On Values to 20,000 Ohms) Size: 1 1/8 x 4 Tube

Resistance Ohms	Current Milli-amperes	Volts Max.	Catalog Number	List Price
25	1420	35	C.25	\$1.35
50	1000	50	C.5	1.35
100	700	70	C1	1.35
200	500	100	C2	1.35
300	406	123	C3	1.35
400	353	142	C4	1.35
500	316	158	C5	1.35
750	258	193	C7.5	1.35
1000	224	223	C10	1.35
1500	182	274	C15	1.35
2000	158	316	C20	1.35
2500	141	353	C25	1.35
3000	129	386	C30	1.35
4000	112	446	C40	1.35
5000	100	500	C50	1.35
7500	82	612	C75	1.50
10000	71	707	C100	1.50
15000	58	865	C150	1.50
20000	50	1000	C200	1.50
25000	45	1000	C250	1.50
30000	41	1000	C300	1.70
40000	35	1000	C400	1.70
50000	32	1000	C500	1.70
80000	25	1000	C800	2.00
100000	22.5	1000	C1000	2.00

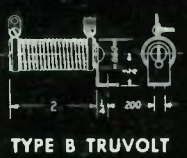
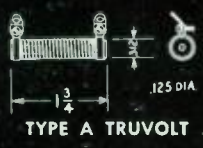

### †25 Watt Rating—1000 Volt Insulation (†On Values to 40,000 Ohms) Size: 1 1/8 x 2 Tube

Resistance Ohms	Current Milli-amperes	Volts Max.	Catalog Number	List Price
2	3500	7	B.02	\$0.85
5	2200	11.4	B.05	.85
10	1580	15.8	B.1	.85
25	1000	25	B.25	.85
50	719	35	B.5	.85
75	575	43.5	B.75	.85
100	500	50	B1	.85
200	353	71	B2	.85
300	289	86.5	B3	.85
500	250	100	B5	.85
750	182	137	B7.5	.85
1000	158	158	B10	.85
1500	129	194	B15	.85
2000	112	223	B20	.85
2500	100	250	B25	.85
3000	91	275	B30	.85
4000	79	316	B40	.85
5000	71	352	B50	.85
7500	58	430	B75	.95
10000	50	500	B100	.95
15000	41	610	B150	.95
20000	35	715	B200	1.10
25000	32	780	B250	1.10
30000	29	860	B300	1.30
40000	25	1000	B400	1.30
50000	22.5	1000	B500	1.30

### †75 Watt Rating—1000 Volt Insulation (†On Values to 10,000 Ohms) Size: 1 1/8 x 6 Tube

Resistance Ohms	Current Milli-amperes	Volts Max.	Catalog Number	List Price
50	1220	61.5	D.5	\$1.75
100	865	87	D1	1.75
200	610	123	D2	1.75
300	500	150	D3	1.75
400	432	174	D4	1.75
500	387	194	D5	1.75
750	316	237	D7.5	1.75
1000	274	274	D10	1.75
1500	224	335	D15	1.75
2000	194	387	D20	1.75
2500	173	434	D25	1.75
3000	158	475	D30	1.75
3500	146	514	D35	1.75
4000	137	550	D40	1.75
4500	129	582	D45	1.75
5000	122	615	D50	1.75
7500	100	750	D75	2.00
10000	86	865	D100	2.00
15000	71	1000	D150	2.00
20000	61	1000	D200	2.00
25000	55	1000	D250	2.00
30000	50	1000	D300	2.25
50000	39	1000	D500	2.25
80000	31	1000	D800	2.50
100000	27	1000	D1000	2.50

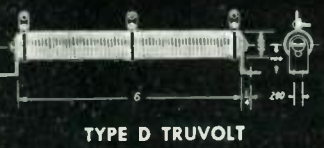
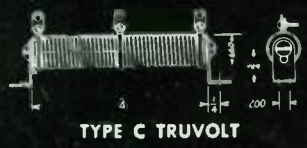

**Extra Truvolt Adjustable Clips** List Price  
 Type 1V—For Truvolt Type A.....\$0.10 each  
 Type 2V—For Truvolt Types B, C, and D......10 each



## Yard-Ohm Resistance Kits • Wire Wound Resistors

● Each Yard-Ohm Resistance Kit consists of an envelope containing all necessary materials to construct flexible resistors of a wide range of values. The Yard-Ohm Kit provides a real solution to the odd-value resistor problem. In addition to replacement applications, resistors made from the Yard-Ohm Kit are ideal for meter shunts, and for use wherever a high quality flexible resistor is desired.

Each Mallory-Yaxley Yard-Ohm Kit consists of an envelope containing the following:

- 1 yard spiral wound resistance wire
- 1 yard insulated braid
- 10 spiral wire leads

The kit is available in four resistance values:

Cat. No.	Resistance Value	List Price
YO-1	1 ohm per inch . . . . .	\$0.75
YO-10	10 ohms per inch . . . . .	.75
YO-100	100 ohms per inch . . . . .	.75
YO-500	500 ohms per inch . . . . .	.75

Dissipation—all types: ½ watt per inch. The accuracy is sufficient so that for all ordinary applications, the correct resistance may be obtained by simply cutting the spiral resistance wire to measurement.

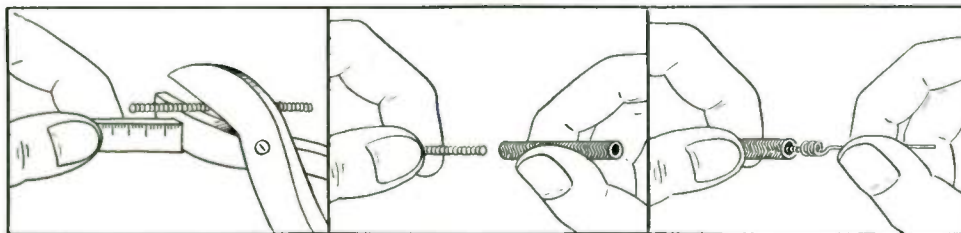

**FIRST**—Determine length by dividing "ohms per inch" into the resistance value desired. Add ¼ inch to this for terminals and cut.

**SECOND**—Cover element with the required length of insulating braid

**THIRD**—Insert wire leads over ends of resistance elements and clench tightly with pliers.



YARDOHM RESISTANCE KIT

### "700" Type Wire Wound Fixed Resistors

¾ Watt Dissipation per Running Inch of Active Winding, which is ⅜" Less than Mounting Centers.

Ohms Resistance	Carrying Capacity in Amps.	Mounting Centers	Cat. No.	List Price
10	.28	1 13/16"	710	\$0.15
15	.23	1 13/16"	715	.15
20	.2	1 13/16"	720	.15
25	.17	1 13/16"	725	.15
30	.16	1 13/16"	730	.15
40	.14	1 13/16"	740	.15
50	.12	1 13/16"	750	.15
100	.09	1 13/16"	7100	.15
200	.05	1 3/8"	7200	.20
300	.04	1 21/32"	7300	.20
400	.03	1 11/16"	7400	.20
500	.028	1 13/16"	7500	.20
600	.029	1 13/16"	7600	.20
700	.029	1 21/32"	7700	.20
800	.029	1 3/4"	7800	.20
900	.028	1 1/4"	7900	.20
1000	.028	1 13/16"	71000	.20
1500	.028	2 13/32"	71500	.20

### "800" Type Wire Wound Fixed Resistors

2 1/2 Watts Dissipation per Running Inch of Active Winding Space Which is 1/4" Less than Mounting Centers

Ohms Resistance	Carrying Capacity in Amps.	Mounting Centers	Cat. No.	List Price
1	1.25	1 3/32"	801	\$0.20
2	1.	1 17/32"	802	.20
3	.75	1 13/32"	803	.20
4	.7	1 13/32"	804	.20
5	.75	1 13/32"	805	.20
6	.7	1 13/32"	806	.20
7	.45	2 1/32"	807	.20
8	.45	1 5/16"	808	.20
10	.45	1 1/8"	810	.20
15	.45	1 1/8"	815	.20
20	.4	1 1/2"	820	.20
25	.4	1 25/32"	825	.20
30	.4	2 1/16"	830	.20
40	.35	2 1/16"	840	.20
50	.18	1 5/16"	850	.20
200	.14	1 29/32"	8200	.25
400	.08	3 3/4"	8400	.35
1000	.075	3 3/4"	81000	.35

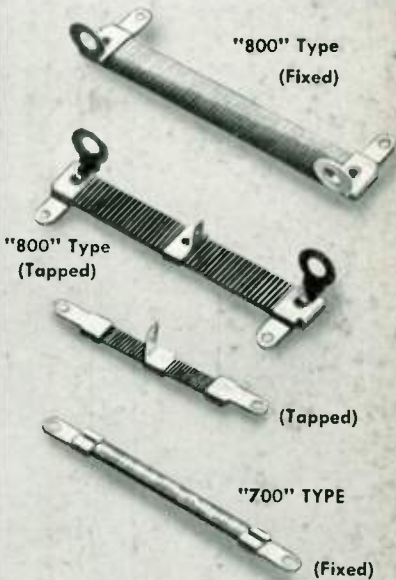

### CENTER TAPPED

¾ Watt Dissipation per Running Inch of Active Winding Which is 1 1/16" Less than Mounting Centers.

Ohms Resistance	Carrying Capacity in Amps.	Mounting Centers	Cat. No.	List Price
6	.33	1 13/16"	706C	\$0.15
10	.25	1 13/16"	710C	.15
15	.21	1 13/16"	715C	.15
20	.18	1 13/16"	720C	.15
40	.13	1 13/16"	740C	.15
60	.10	1 13/16"	760C	.15
100	.08	1 13/16"	7100C	.20
200	.06	1 13/16"	7200C	.20
400	.04	1 13/16"	7400C	.20

### CENTER TAPPED

2 1/2 Watts Dissipation per Running Inch of Active Winding Space Which is 1/16" Less than Mounting Centers.

Ohms Resistance	Carrying Capacity in Amps.	Mounting Centers	Cat. No.	List Price
6	.6	1 7/8"	806C	\$0.25
10	.45	1 13/16"	810C	.25
12	.45	1 9/16"	812C	.25
15	.45	1 25/32"	815C	.25
20	.4	1 11/16"	820C	.25
30	.4	2 9/32"	830C	.25
50	.2	1 5/16"	850C	.25
64	.2	1 3/8"	864C	.25
100	.22	2 3/8"	8100C	.35
300	.08	3 1/4"	8300C	.35
400	.08	2"	8400C	.35

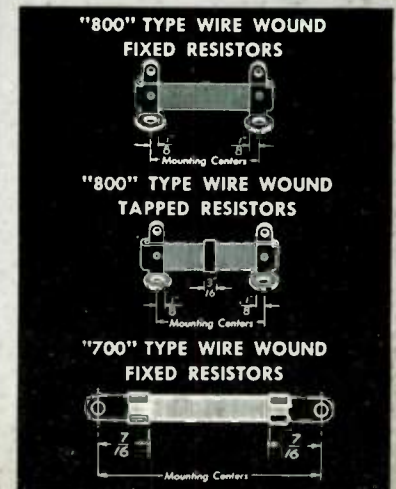

## Dry Electrolytic Tubular Condensers

### SINGLE METAL TUBULARS—TYPE BB

● Type BB condensers are made with FABRICATED PLATE, the latest Mallory development, and are housed in hermetically sealed metal tubes. An insulating cover is furnished and all units have bare wire leads.

Smallest sizes, without sacrifice of quality or performance, provide ideal units for all applications.

Mallory BB units are packed five to a carton and stack well on the shelf.

See other tubular listings for additional sizes and multiple section units.

Capacity	DC Working Voltage	Max. Surge Voltage	Size	Catalog Number	List Price
10	25	40	1 7/8 x 1 1/16	BB12	\$0.40
25	25	40	1 7/8 x 1 1/16	BB15	.50
50	25	40	1 7/8 x 1 1/16	BB17	.60
5	50	75	1 7/8 x 1 1/16	BB11	.40
10	50	75	1 7/8 x 1 1/16	BB13	.45
25	50	75	1 7/8 x 1 1/16	BB14	.55
50	50	75	1 7/8 x 1 1/16	BB19	.70
4	150	200	1 7/8 x 1 1/16	BB20	.40
8	150	200	1 7/8 x 1 1/16	BB21	.45
12	150	200	1 7/8 x 1 1/16	BB22	.50
16	150	200	1 7/8 x 1 1/16	BB24	.55
20	150	200	1 7/8 x 1 3/16	BB25	.60
30	150	200	1 7/8 x 1 3/16	BB26	.65
40	150	200	1 7/8 x 1 5/16	BB27	.70
8	250	300	1 7/8 x 1 1/16	BB31	.50
12	250	300	1 7/8 x 1 3/16	BB33	.65
16	250	300	1 7/8 x 1 3/16	BB34	.75
4	350	425	1 7/8 x 1 1/16	BB40	.50
8	350	425	1 7/8 x 1 3/16	BB41	.55
12	350	425	1 7/8 x 1 3/16	BB42	.70
16	350	425	1 7/8 x 1 5/16	BB44	.80
4	450	525	1 7/8 x 1 1/16	BB60	.55
8	450	525	1 7/8 x 1 3/16	BB61	.60
10	450	525	1 7/8 x 1 3/16	BB62	.70
12	450	525	1 7/8 x 1 5/16	BB63	.75
16	450	525	1 7/8 x 1 5/16	BB64	.90

### CARDBOARD TUBULAR CONDENSERS TYPES ST, TN, 2N, 2P, 2S, 3N, 3S, 4N, 4S

● During the past two years a definite trend towards standardized condensers has been evident in the radio field. This welcome change, from the standpoint of simplification of servicing, has developed new types such as the Mallory FP metal-cased units (described on page 27) and tubular cardboard units.

Almost without exception, radio chassis made during this period, and currently, utilize one or both of these types. Since millions are in actual use, there is a definite need for proper replacement units.

Mallory has conducted a careful survey of the cardboard tubular ratings and has prepared the complete universal listings on the opposite page.

Because of the requirements of the compact AC-DC radio, with its low sales price, all Mallory tubulars have been made extremely small in size and are available at lower prices.

Mallory recognizes the universality of multiple separate section units and, wherever size permits, has included them in the listing. It is important to note, however, that separate section units are larger in size and more costly to manufacture than common negative types. For this reason, and the fact that original equipment in AC-DC receivers did not include them, the common negative or common positive type will be found most useful.

All Mallory tubular condensers are furnished in a neat, permanently marked well-sealed tube and provided with six-inch flexible leads.

Types indicated as "Fig. A" have insulated leads all at one end and a self-contained mounting feature for vertical or horizontal mounting.

Types indicated as "Fig. B" have insulated leads at both ends and are provided with an adjustable circular mounting strap for easy horizontal mounting.

Types indicated as "Fig. C" have bare wire leads at both ends and depend on these leads for mounting since these units are small in size.

An instruction sheet, packed with each unit, gives details of mounting features and lead color code.

.24.

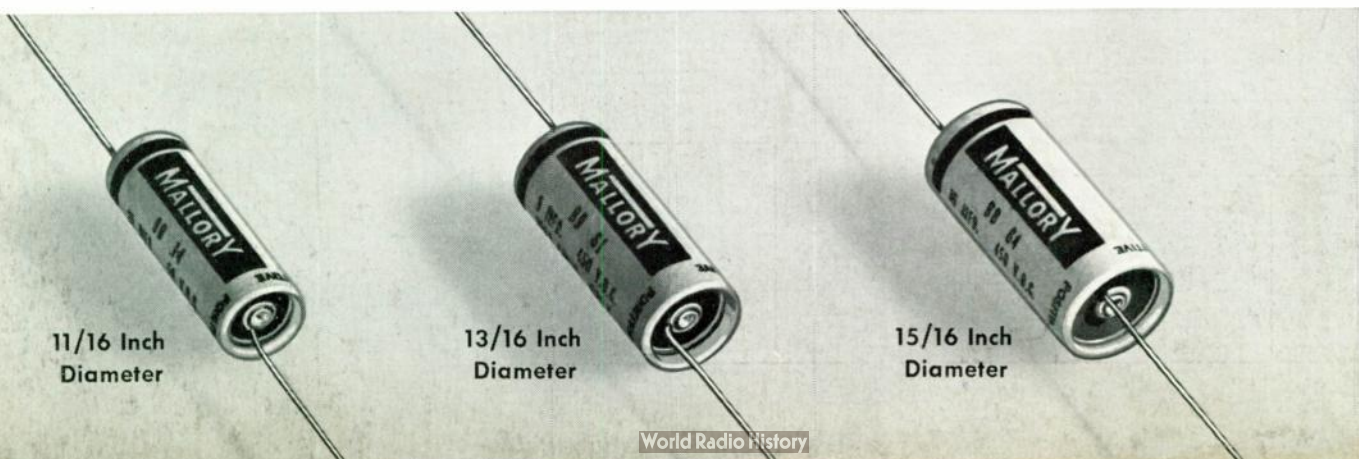





## Dry Electrolytic Tubular Condensers

(CONTINUED)

### CARDBOARD TUBULAR CONDENSERS—TYPES ST, TN, 2N, 2P, 2S, 3N, 3S, 4N, 4S

Capacity Mfd.	DC Wkg. V.	Fig.	Size	Catalog No.	List Price
<b>SINGLE UNITS</b>					
8.....	250	A	7/8 x 2 1/2	ST585	\$0.50
16.....	250	A	1 x 2 1/2	ST587	.75
24.....	250	A	1 1/16 x 2 3/4	ST589	.85
8.....	350	A	1 5/16 x 2 1/2	ST590	.55
12.....	350	A	1 5/16 x 2 3/4	ST591	.70
16.....	350	A	1 x 2 3/4	ST592	.80
24.....	350	A	1 x 3 1/2	ST593	1.00
8.....	450	A	7/8 x 2 3/4	ST595	.60
12.....	450	A	1 x 2 3/4	ST596	.75
16.....	450	A	1 1/16 x 2 3/4	ST597	.90

<b>DUAL COMMON NEGATIVE UNITS</b>					
10-10.....	25	C	5/8 x 1 3/4	TN111	.70
10-10.....	50	C	3/4 x 1 3/4	TN113	.80
4-4.....	150	B	1 1/16 x 1 3/4	2N500	.70
8-8.....	150	B	3/4 x 2 3/8	2N502	.80
16-8.....	150	B	1 3/16 x 2 3/8	2N504	.85
16-16.....	150	B	7/8 x 2 3/8	2N506	.95
20-10.....	150	B	7/8 x 2 3/8	2N507	.95
20-20.....	150	B	1 3/16 x 2 5/8	2N509	1.05
30-10.....	150	B	7/8 x 2 5/8	2N512	1.05
40-20.....	150	B	1 3/16 x 2 5/8	2N514	1.15
8-8.....	250	A	1 x 2 3/4	2N516	.85
8-8.....	350	A	1 5/16 x 3 1/2	2N517	.95
8-8.....	450	A	1 x 3 1/2	2N518	1.05

<b>DUAL COMMON POSITIVE UNITS</b>					
8-4.....	150	B	3/4 x 2 1/2	2P541	.95
8-8.....	150	B	1 3/16 x 2 1/2	2P542	1.00
12-4.....	150	B	1 3/16 x 2 1/2	2P543	1.00
16-8.....	150	B	1 5/16 x 2 1/2	2P544	1.10
16-16.....	150	B	1 x 2 1/2	2P546	1.25
20-20.....	150	B	1 5/16 x 2 7/8	2P549	1.35
30-10.....	150	B	1 5/16 x 2 7/8	2P552	1.35
30-20.....	150	B	1 x 2 7/8	2P553	1.40

<b>DUAL SEPARATE SECTION UNITS</b>					
8-8.....	250	A	1 3/8 x 2 3/4	2S560	1.10
16-16.....	250	A	1 3/8 x 3 3/4	2S562	1.65
8-8.....	350	A	1 3/8 x 3	2S564	1.25
12-12.....	350	A	1 3/8 x 3 3/4	2S565	1.55
16-16.....	350	A	1 3/8 x 4 3/4	2S566	1.80

Capacity Mfd.	DC Wkg. V.	Fig.	Size	Catalog No.	List Price
<b>DUAL SEPARATE SECTION UNITS—Continued</b>					
8-8.....	450	A	1 3/8 x 3	2S567	\$1.35
8-16.....	450	A	1 3/8 x 3 3/4	2S563	1.65
12-12.....	450	A	1 3/8 x 3 3/4	2S568	1.65
16-16.....	450	A	1 3/8 x 4 3/4	2S569	2.00

<b>TRIPLE COMMON NEGATIVE UNITS</b>					
8-4, 10.....	150, 25	B	3/4 x 2 1/2	3N520	1.10
16-10, 10.....	150, 25	B	7/8 x 2 1/2	3N525	1.25
16-16, 20.....	150, 25	B	1 5/16 x 2 3/4	3N526	1.35
24-16, 20.....	150, 25	A	1 x 3	3N528	1.45
30-10, 20.....	150, 25	A	1 x 3	3N532	1.45
40-20, 20.....	150, 25	A	1 1/16 x 3	3N534	1.50
8-8-8.....	150	B	1 3/16 x 2 1/2	TN120	1.15
16-8-4.....	150	B	7/8 x 2 1/2	TN122	1.20
20-10-10.....	150	B	1 x 2 1/2	TN125	1.40
30-20-10.....	150	A	1 1/2 x 2 3/4	TN127	1.50
40-20-20.....	150	A	1 1/2 x 3	TN129	1.65
15-10, 20.....	350, 25	A	1 1/8 x 3 1/2	TN136	1.65
20-10-25.....	400-350-25	A	1 3/8 x 3 1/2	TN139	1.85

<b>TRIPLE SEPARATE SECTION UNITS*</b>					
8-8, 20.....	250, 25	A	1 3/8 x 3	3S570	1.50
16-16, 20.....	250, 25	A	1 3/8 x 3 3/4	3S572	2.00
8-8, 20.....	350, 25	A	1 3/8 x 3 3/4	3S575	1.50
12-12, 20.....	350, 25	A	1 3/8 x 3 3/4	3S577	1.90
16-16, 20.....	350, 25	A	1 3/8 x 4 3/4	3S578	2.10
8-8, 20.....	450, 25	A	1 3/8 x 3 3/4	3S579	1.65
12-12, 20.....	450, 25	A	1 3/8 x 4 3/4	3S581	2.00
8-8-8.....	250	A	1 3/8 x 3	3S582	1.50
8-8-8.....	350	A	1 3/8 x 3 3/4	3S583	1.65
8-8-8.....	450	A	1 3/8 x 3 3/4	3S584	1.85

<b>QUAD COMMON NEGATIVE UNITS</b>					
8-8, 10-10.....	150, 25	A	1 x 2 3/4	4N701	1.45
30-20, 10-10.....	150, 25	A	1 3/16 x 2 3/4	4N708	1.80

<b>QUAD SEPARATE SECTION UNITS*</b>					
16-16, 10-10.....	150, 25	A	1 3/8 x 3	4S715	1.90
8-8, 10-10.....	450, 25	A	1 3/8 x 3 3/4	4S718	2.00

Adjustable Strap No. 90686.....\$0.05 list

\*First section separate, other sections common negative.  
Capacities at same voltage separated by hyphen; comma indicates change in voltage.

All diameters plus or minus 1/16".

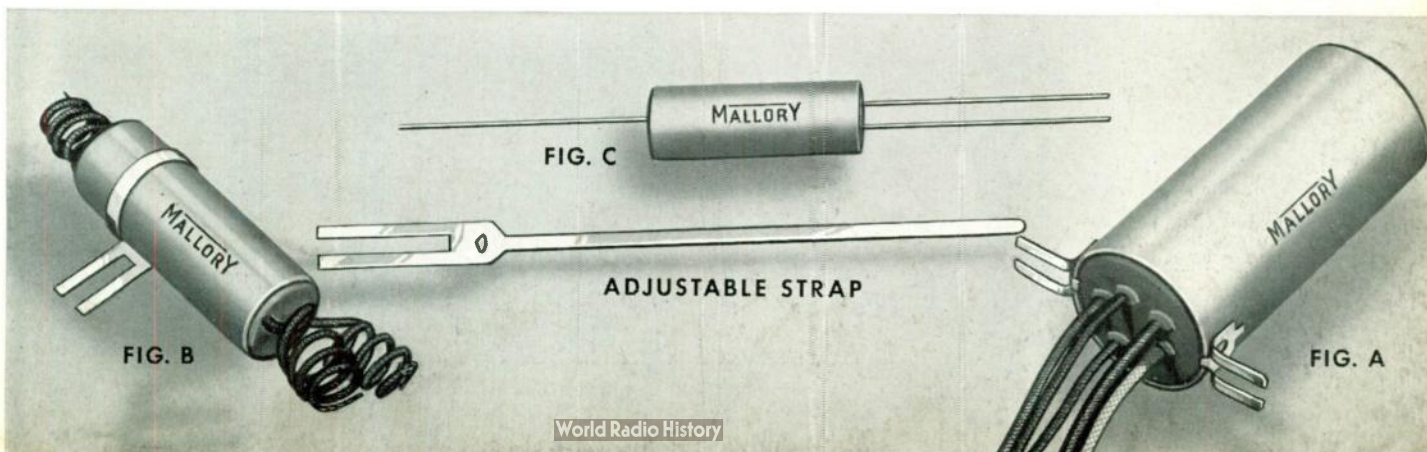

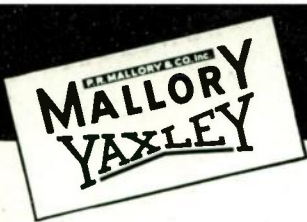

## Dry Electrolytic Filter Condensers

### CARDBOARD CARTON TYPES CS, CN AND CM

● These Mallory carton-type dry electrolytic condensers have been the accepted standard universal replacement type for four years.

**INTERNAL METAL SEAL**, a Mallory innovation, protects them from atmospheric changes and assures long life.

Metal mounting ears provide easy installation.

Capacity	Wkg. V. DC	Max. Surge V.	Size	Catalog No.	List Price
----------	------------	---------------	------	-------------	------------

#### CS—Single Section Type

8.....	250	300	$\frac{5}{8}$ x $\frac{7}{8}$ x $2\frac{1}{16}$	CS123	\$0.80
12.....	250	300	$\frac{5}{8}$ x 1 x $2\frac{1}{16}$	CS125	1.00
16.....	250	300	$1\frac{1}{16}$ x $1\frac{1}{8}$ x $2\frac{1}{16}$	CS126	1.10
2.....	450	525	$\frac{1}{2}$ x $\frac{3}{4}$ x $2\frac{1}{16}$	CS130	.65
4.....	450	525	$\frac{5}{8}$ x $\frac{7}{8}$ x $2\frac{1}{16}$	CS131	.75
8.....	450	525	$\frac{5}{8}$ x 1 x $2\frac{1}{16}$	CS133	.95
12.....	450	525	$1\frac{1}{16}$ x $1\frac{1}{8}$ x $2\frac{1}{16}$	CS135	1.30
16.....	450	525	1 x $1\frac{1}{4}$ x $2\frac{1}{16}$	CS136	1.45

#### CN—Common Negative Type

8-8.....	250	300	$\frac{3}{4}$ x $1\frac{1}{8}$ x $2\frac{5}{8}$	CN142	1.30
8-8.....	450	525	$\frac{7}{8}$ x $1\frac{1}{4}$ x $2\frac{5}{8}$	CN152	1.50

#### CM—Separate Section Type

4-4.....	250	300	$\frac{3}{4}$ x $1\frac{1}{8}$ x $2\frac{5}{8}$	CM160	.90
4-8.....	250	300	$\frac{3}{4}$ x $1\frac{1}{8}$ x $2\frac{5}{8}$	CM161	1.15
8-8.....	250	300	$\frac{7}{8}$ x $1\frac{1}{4}$ x $2\frac{5}{8}$	CM162	1.30
16-16.....	250	300	$1\frac{3}{8}$ x 1 x $2\frac{5}{8}$	CM164	1.80
8-8-8.....	250	300	$1\frac{3}{8}$ x 1 x 3	CM165	1.95
4-4.....	450	525	$\frac{3}{4}$ x $1\frac{1}{8}$ x $2\frac{5}{8}$	CM170	1.20
4-8.....	450	525	$\frac{7}{8}$ x $1\frac{1}{4}$ x $2\frac{5}{8}$	CM171	1.35
8-8.....	450	525	$1\frac{3}{8}$ x 1 x $2\frac{5}{8}$	CM172	1.50
4-4-4.....	450	525	$1\frac{3}{8}$ x 1 x 3	CM173	1.80
8-8-8.....	450	525	$1\frac{1}{2}$ x $1\frac{1}{4}$ x 3	CM175	2.20

### ROUND METAL CAN TYPES RS, RN AND RM

● The Mallory round aluminum container units shown in the chart are compact in size and ideal for all applications requiring upright mounting.

Supplied with 8" push-back wire leads. Containers are marked with complete color code for easy reference.

Capacity	Wkg. V. DC	Max. Surge V.	Size	Catalog No.	List Price
----------	------------	---------------	------	-------------	------------

#### RS—Single Section Type

50.....	25	40	$2\frac{3}{4}$ x 1	RS200	\$1.05
8.....	250	300	$2\frac{3}{4}$ x 1	RS203	.95
12.....	250	300	$2\frac{3}{4}$ x 1	RS205	1.10
30.....	250	300	$3\frac{1}{2}$ x 1	RS207	1.50
50.....	250	300	$3\frac{3}{4}$ x $1\frac{3}{8}$	RS208	2.75
8.....	450	525	$2\frac{3}{4}$ x 1	RS213	1.05
12.....	450	525	$2\frac{3}{4}$ x 1	RS215	1.40
16.....	450	525	$3\frac{1}{2}$ x 1	RS216	1.55

#### RN—Common Negative Type

8-8.....	250	300	3 x 1	RN232	1.45
4-8.....	450	525	3 x 1	RN241	1.45

#### RM—Separate Section Type

8-8.....	250	300	3 x $1\frac{3}{8}$	RM252	1.45
8-8-8.....	250	300	$3\frac{1}{2}$ x $1\frac{3}{8}$	RM255	2.10
8-8-16.....	250	300	$3\frac{1}{2}$ x $1\frac{3}{8}$	RM257	2.35
8-16-16.....	250	300	$3\frac{1}{2}$ x $1\frac{3}{8}$	RM259	2.60
4-8.....	450	525	3 x $1\frac{3}{8}$	RM261	1.45
8-8.....	450	525	3 x $1\frac{3}{8}$	RM262	1.60
8-8-8.....	450	525	4 x $1\frac{3}{8}$	RM265	2.30

## Large Round Can Condensers

### TYPE MN

● Mallory Type MN condensers are designed primarily for replacing old style multiple section wet electrolytics.

For this reason, the original size has been maintained in order that they will properly fit original hardware peculiar to this type.

Actually, the power factor or filtering efficiency of these old style units cannot compare with modern dry electrolytic condensers, and, therefore, much less total capacity is required than originally specified. The five ratings listed will satisfactorily replace all the former ratings with equal or even better results.

.26.

Capacity	Wkg. V. DC	Max. Surge V.	Size	Catalog No.	List Price
8-8.....	450	525	$4\frac{1}{8}$ x $2\frac{1}{2}$	MN272	\$1.80
5-15.....	450	525	$4\frac{1}{8}$ x $2\frac{1}{2}$	MN273	2.30
8-8-8.....	450	525	$4\frac{1}{8}$ x 3	MN275	2.70
8-8-8-8.....	450	525	$4\frac{1}{8}$ x 3	MN277	3.60
9-9-18-18.....	450	525	$4\frac{1}{8}$ x 3	MN278	5.25

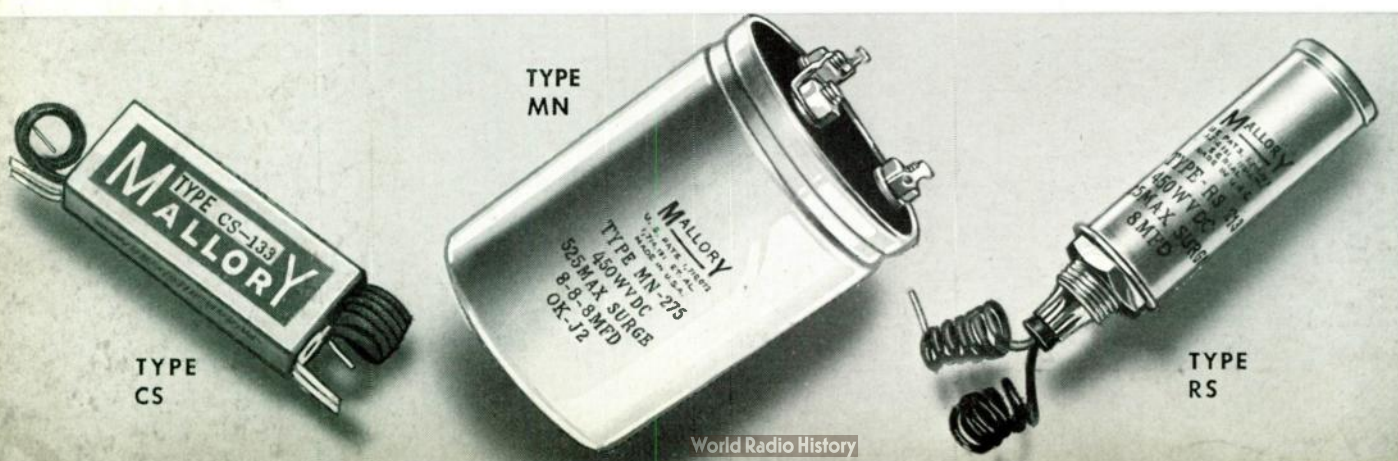



## Standard FP (Fabricated Plate) Capacitors

Capacity	DC Working Voltage	Can Size	Catalog Number	List Price
<b>Single Units</b>				
40	25	2 x 3/4	FPS102	\$0.85
100	25	2 x 1	FPS105	1.05
30	150	2 x 3/4	FPS113	.75
50	150	2 x 1	FPS115	.90
20	250	2 x 3/4	FPS120	1.00
40	250	2 x 1	FPS122	1.35
15	300	2 x 3/4	FPS127	.95
30	300	2 x 1	FPS129	1.30
50	350	3 x 1	FPS137	1.90
125	350	3 x 1 3/8	FPS140	3.70
10	450	2 x 3/4	FPS142	.85
15	450	2 x 1	FPS143	1.05
20	450	2 x 1	FPS144	1.25
40	450	3 x 1	FPS146	2.00
80	400	3 x 1 3/8	FPS149	3.40

<b>Dual Units</b>				
40-40	25	2 x 1	FPD202	1.20
20-20	150	2 x 1	FPD208	1.20
30-30	150	2 x 1	FPD211	1.35
50-50	150	3 x 1	FPD214	1.50
20-20	250	2 x 1	FPD217	1.70
40-40	250	3 x 1	FPD221	2.30
15-15	300	2 x 1	FPD225	1.60
30-30	350-300	3 x 1	FPD228	2.25
10-10	450	2 x 1	FPD231	1.30
20-20	450	3 x 1	FPD234	2.20
40-40	450	3 x 1 3/8	FPD238	3.10
80-10	400	3 x 1 3/8	FPD245	3.60

<b>Duals Plus Bypass</b>				
30-20, 20	150, 25	2 x 1	FPT306	1.65
50-50, 20	150, 25	3 x 1	FPT311	2.00
15-15, 20	250, 25	2 x 1	FPT316	2.00
30-30, 20	250, 25	3 x 1	FPT319	2.50
40-15, 20	300, 25	3 x 1	FPT324	2.60
10-10-20	450-350-25	2 x 1	FPT332	1.90
20-20, 20	450, 25	3 x 1	FPT339	2.70
30-10, 20	450, 25	3 x 1	FPT342	2.50
40-10, 20	450, 25	3 x 1 3/8	FPT346	3.60

<b>Triple Units</b>				
20-20-20	25	2 x 1	FPT351	1.50
20-20-20	150	2 x 1	FPT354	1.80
40-40-40	150	3 x 1	FPT357	2.10
30-15-10	250	3 x 1	FPT362	2.40
10-10-10	300	2 x 1	FPT368	2.10
20-15-10	450-300-300	3 x 1	FPT374	2.60
15-20-20	450-350-250	3 x 1	FPT381	2.70
10-10-10	450	3 x 1	FPT389	2.10
15-15-10	450	3 x 1	FPT390	2.50

<b>Triples Plus Bypass</b>				
40-40-30, 20	150, 25	2 x 1 3/8	FPQ409	2.55
50-50-50, 20	150, 25	3 x 1 3/8	FPQ410	2.75
40, 40-20, 20	350, 300, 25	3 x 1 3/8	FPQ416	4.05
20, 15-15, 20	450, 350, 25	3 x 1 3/8	FPQ421	3.20
10-10-10, 20	450, 25	2 x 1 3/8	FPQ424	2.60
20-15, 20-20	450, 25	2 x 1 3/8	FPQ426	3.00
40-30-10, 20	450, 25	3 x 1 3/8	FPQ429	4.30

<b>Quad Units</b>				
10-10-10-10	450	2 x 1 3/8	FPQ434	2.80
20-20, 30-30	450, 300	3 x 1 3/8	FPQ439	4.10
20-20-20-20	450	3 x 1 3/8	FPQ444	4.10

Capacities at same voltage separated by hyphen; comma indicates change in voltage.

### HARDWARE FOR FP CONDENSERS

Item	Description	Catalog Number	List Price	Item	Description	Catalog Number	List Price
Wrench	Special for FP Mounting	A-93436	\$0.75	Mounting Clip	For 3/4" FP	A-93434	\$0.10
Bakelite Washer	For 3/4" FP	A-93416	.05	Mounting Clip	For 1" FP	A-93443	.10
Bakelite Washer	For 1" FP	A-93410	.05	Mounting Clip	For 1 3/8" FP	A-93435	.10
Bakelite Washer	For 1 3/8" FP	A-93423	.05	Insulating Tube	For 3/4 x 2" FP	A-93280-6	.05
Metal Washer	For 3/4" FP	A-93431	.05	Insulating Tube	For 1 x 2" FP	A-93280-3	.05
Metal Washer	For 1" FP	A-93403	.05	Insulating Tube	For 1 x 3" FP	A-93280-2	.05
Metal Washer	For 1 3/8" FP	A-93424	.05	Insulating Tube	For 1 3/8 x 2" FP	A-93280-5	.05
				Insulating Tube	For 1 3/8 x 3" FP	A-93280-4	.05

● The new standard Mallory FP (Fabricated Plate) capacitors, which have been so popular in the original equipment field, are now carried in stock in a wide variety of universal ratings.

These remarkably small capacitors deserve their nation-wide endorsement, as evidenced by the millions already in use, because of their long life and stable characteristics under extreme heat and humidity conditions.

Since the FP capacitor is typically a Mallory development, it is our intention to make available a complete universal listing of these units for future replacement and experimental use. Avoid imitations.

It is important to note that the method of rating FP capacitors differs considerably from former types and this should be understood in reviewing the universal listings provided. Since FP capacitors are completely standardized mechanically, the only variables are the capacity and voltage ratings. These ratings, while variable, are also standard insofar as odd capacities, such as 4, 8, 12, etc., are not available.

The FP capacitors listed are the result of a six months' survey of ratings in actual use but carefully selected to serve every known application with a minimum number of units. By this method, approximately 60 FP ratings satisfactorily replace over 1000 combinations and thereby eliminate the complications involved should an attempt be made to duplicate each original rating.

In making replacements by this universal method, it is expected that capacities or voltages higher than the original ratings will sometimes be substituted. This is obvious since it is impractical and uneconomical to attempt listing every possible rating. FP capacitors may be used on lower than rated voltage with no change in characteristics. Over-capacity is, of course, desirable in most instances. Since FP capacitors are low-priced, the system described will prove advantageous from all angles.

Mallory FP capacitors are individually packed in display cartons and may be mounted directly to the chassis for replacement use.

Metal and bakelite mounting washers may be secured for experimental mounting, as listed.

A special wrench for twisting the FP mounting ears is also listed. However, the ears may be twisted by ordinary pliers, if care is taken to allow a scant 1/8" clearance between the nose of the pliers and the chassis (or plate).



1 3/8" x 2" Size



1" x 2" Size



3/4" x 2" Size

WRENCH

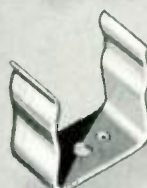

MOUNTING CLIP



METAL WASHER



BAKELITE WASHER



INSULATING TUBE



# Approved PRECISION PRODUCTS

## Universal Replacement Condensers

TYPES UR AND SR

● Types UR and SR are special compact-size Universal Replacements for original condensers that are not readily serviced with the regular standard units. Pictures show approximate appearance only.

Capacity	Working Voltage DC	Container	Size	Fig.	Cat. No.	List Price
8-8	250-300	Carton	1 1/8 x 1 1/8 x 2 1/4	5	UR180	\$1.30
3-2-1-1	450	Can	1 3/8 x 2 3/4	8	UR181	2.10
5-25-10	150	Carton	1 3/16 x 1 3/8 x 2 3/8	1	UR182	1.60
4-4-4	150	Carton	5/8 x 1 1/4 x 2 1/4	2	UR183	1.35
8-8-8, 5-5	200, 25	Tube	1 3/8 x 3 3/4	11	UR188	2.50
8-8-8, 5-5	200, 25	Carton	1 1/4 x 1 1/2 x 3	1	UR189	2.50
8-8-8-8	250	Carton	1 1/4 x 1 1/2 x 3	1	UR190	2.60
8-8-8-8	450	Carton	1 3/8 x 1 3/4 x 3	1	UR191	2.95
20-20	150	Carton	1 3/16 x 1 3/8 x 2 3/8	1	UR192	1.65
5-8-16	150	Carton	1 x 1 1/4 x 2 1/2	1	UR193	1.80
16-12	200	Tube	1 3/8 x 3 1/4	11	UR194	1.55
8-12	300	Carton	1 1/4 x 1 7/8 x 2 3/8	15	SR601	1.55
6-4-6	300-300-25	Can	1 3/8 x 2 5/8	9	SR602	1.70
8-30	300-30	Tube	1 1/4 x 4 5/8	18	SR603	1.35
3-5-6	300-300-12	Carton	1 1/8 x 3 1/8 x 2	12	SR604	1.50
8-8	350	Can	1 3/8 x 3 1/8	9	SR605	1.55
6-6	350	Carton	1 1/16 x 1 9/16 x 2 7/8	4	SR606	1.35
6-4-6	300-300-12	Carton	1 1/16 x 1 9/16 x 2 7/8	4	SR607	1.55
65	30	Tube	1 1/4 x 2 1/4	20	SR608	1.10
8-8-25	100-100-25	Can	1 3/8 x 2 3/4	7	SR609	2.10
8-8-25	400-400-25	Carton	1 9/16 x 1 9/16 x 2 3/8	22	SR610	1.90
8-8-25	350-300-25	Carton	2 x 2 x 2 1/2	13	SR611	1.85
8-8, 16-16	350, 100	Can	1 3/8 x 4 3/4	8	SR612	2.90
16-30-16	200	Carton	1 3/4 x 1 15/16 x 4	5	SR613	2.75
8, 8-8, 12-12	450, 250, 25	Carton	1 7/8 x 2 3/4 x 2 13/16	1	SR614	2.90
8-8-8	450-450-350	Can	1 3/8 x 2 3/4	7	SR615	2.25
8-8-8	450-450-350	Can	1 3/8 x 4 3/4	7	SR616	2.25
16-16-10	150-150-25	Can	1 3/8 x 2 3/4	8	SR617	1.95
5-20-10, 5	150-150-150-25	Carton	1 11/16 x 1 15/16 x 2 7/16	14	SR618	2.25
5-5	35	Carton	3/4 x 3/4 x 1 1/2	2	SR619	.75
30-10	150	Carton	3/4 x 1 3/4 x 3 1/2	3	SR620	1.55
8-16-5-5	200-200-50-50	Tube	1 3/8 x 2 3/4	10	SR621	2.15
8-8-12	350-350-25	Carton	1 5/8 x 1 5/8 x 2 5/32	21	SR622	1.75
16-2-2-25	450-450-450-25	Tube	1 1/2 x 3 1/2	10	SR623	2.60
4-4-10-4	300-300-150-25	Carton	1 9/16 x 1 9/16 x 3 13/16	16	SR624	2.05
8-8-5-5	450-450-50-50	Carton	1 7/8 x 1 11/16 x 4 1/8	3	SR625	2.20
8-4-4-12	450-300-150-25	Carton	1 9/16 x 1 5/8 x 3 7/8	3	SR626	2.05
4-4	450-150	Carton	1 x 1 9/16 x 3 3/4	19	SR627	1.05
8-8-10	300-300-25	Can	1 1/2 x 2 3/4	9	SR628	1.85
6-4-10	350-300-25	Carton	1 1/4 x 1 3/8 x 4 1/2	6	SR629	1.65
16-8-10	150-150-25	Carton	1 1/2 x 1 1/2 x 4	6	SR630	1.75
4-12-16	150	Carton	1 1/4 x 1 1/4 x 2 3/4	17	SR631	1.85
6-4-16	350-350-25	Tube	1 x 3 3/4	10	SR632	1.60
6-6	250	Tube	1 1/4 x 3 1/4	11	SR633	1.15
12-8	400	Tube	1 3/8 x 4	10	SR634	1.75
12	150	Can	1 x 2 19/32	8	SR635	.95
12-4	150	Can	1 x 2 19/32	8	SR636	1.10
8-8-20	350-350-25	Tube	1 3/8 x 2 1/2	10	SR637	1.85
8-8	450	Can	1 3/8 x 3 1/4	7	SR638	1.60
8-8	450	Can	1 3/8 x 3 3/4	8	SR639	1.60
16-8-10-10	450-450-25-25	Tube	1 1/2 x 4	11	SR640	2.90
12-8-8-10	450-450-350-25	Tube	1 3/8 x 5	10	SR641	2.55
8-8	450	Can	1 3/8 x 2 3/4	8	SR642	1.60
10	450	Can	1 3/8 x 2 1/4	8	SR643	1.25
12	450	Can	1 3/8 x 3	7	SR644	1.40
8-8	450	Can	1 3/8 x 3 1/4	7	SR645	1.60

.28.

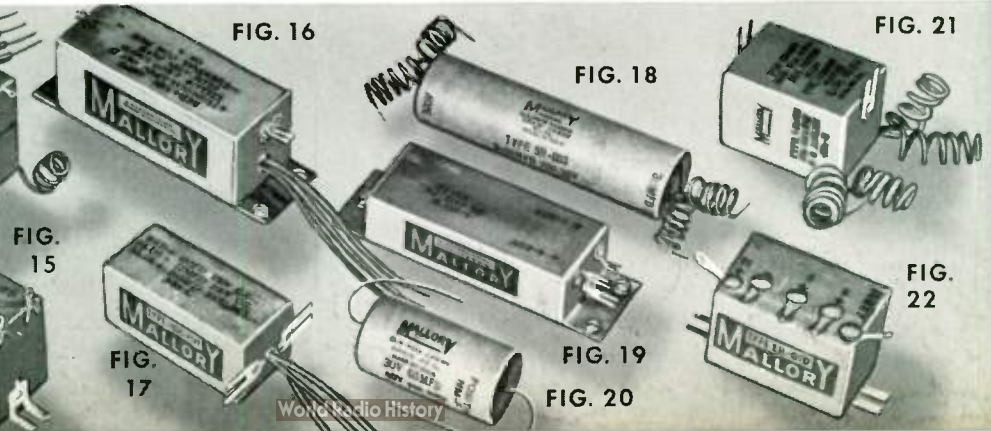
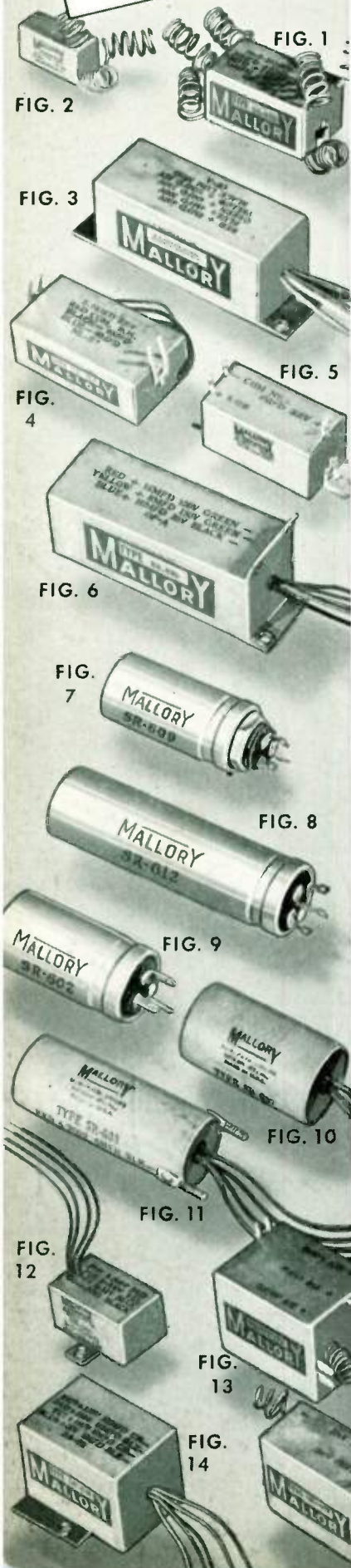



## Heavy-Duty Capacitors TYPES HD AND HS

● Type HD and HS condensers are ideal for all heavy-duty filter applications. Designed primarily for public address and theater applications, they may be used wherever extra safety factor is desirable.

Type HD units are for use on working voltages of 450 and 500 maximum according to their actual rating and where the maximum surge voltage does not exceed 525 and 550 respectively.

Type HS units may be used on working voltages as high as 600 and surges up to 700 volts. Type HS condensers represent the best units obtainable for high voltage applications.

Capacity	Wkg. V. DC	Max. Surge V.	Size	Fig.	Catalog Number	List Price
8.....	450	525	3 $\frac{3}{4}$ x 1 $\frac{3}{8}$ .....	1	HD684	\$1.05
8.....	450	525	4 $\frac{7}{16}$ x 1 $\frac{3}{8}$ .....	2	HD685	1.05
8-8.....	450	525	4 $\frac{7}{16}$ x 1 $\frac{1}{2}$ .....	3	HD686	1.65
8.....	500	550	1 $\frac{1}{16}$ x 1 $\frac{1}{8}$ x 2 $\frac{7}{16}$ .....	4	HD682	1.50
8.....	500	550	1 x 3 $\frac{1}{16}$ .....	2	HD683	1.75
4.....	600	700	$\frac{7}{8}$ x 1 $\frac{1}{4}$ x 3.....	4	HS690	1.75
4.....	600	700	3 $\frac{1}{2}$ x 1 $\frac{3}{8}$ .....	2	HS691	1.85
8.....	600	700	1 $\frac{1}{4}$ x 1 $\frac{1}{2}$ x 3.....	4	HS692	2.45
8.....	600	700	4 $\frac{1}{4}$ x 1 $\frac{3}{8}$ .....	3	HS693	2.60

## Wet Electrolytic Condensers

### TYPE WE

● Mallory wet electrolytic units include latest features specified in original equipment. Non-forming containers and efficient vents are standard on all types.

Type O is standard, Type R is voltage regulating type.

Hardware for insulated mounting consists of one flat and one extruded fibre washer and cathode grounding lug.

1" Can Insulating Washers and Lug, Catalog No. WE-S, List Price, \$0.07.

1 $\frac{3}{8}$  x 1 $\frac{1}{2}$ " Can Insulating Washers and Lug, Catalog No. WE-L, List Price, \$0.10.

Capacity	Peak Voltage	Type	Size	Catalog Number	List
8	250	O	1 x 3 $\frac{7}{16}$	WE325	\$0.80
16	250	O	1 x 3 $\frac{7}{16}$	WE1625	.90
24	250	O	1 x 3 $\frac{7}{16}$	WE2425	1.15
18	300	R	1 $\frac{3}{8}$ x 2 $\frac{15}{16}$	WE1830	1.15
40	300	R	1 $\frac{3}{8}$ x 4 $\frac{7}{16}$	WE4030	1.35
18	350	R	1 $\frac{3}{8}$ x 3 $\frac{7}{16}$	WE1835	1.25
30	350	R	1 $\frac{3}{8}$ x 3 $\frac{15}{16}$	WE3035	1.60
4	500	O	1 x 2 $\frac{15}{16}$	WE450	.80
8	500	O	1 x 3 $\frac{7}{16}$	WE850	.95
8	500	O	1 $\frac{3}{8}$ x 3 $\frac{15}{16}$	WE851	.95
12	500	O	1 $\frac{3}{8}$ x 3 $\frac{7}{16}$	WE1250	1.15
16	500	O	1 $\frac{3}{8}$ x 3 $\frac{15}{16}$	WE1650	1.35
20	500	O	1 $\frac{3}{8}$ x 4 $\frac{7}{16}$	WE2050	1.50
30	500	O	1 $\frac{3}{8}$ x 4 $\frac{15}{16}$	WE3050	1.70
40	500	O	1 $\frac{1}{2}$ x 4 $\frac{15}{16}$	WE4050	1.90
4	600	O	1 $\frac{3}{8}$ x 3 $\frac{7}{16}$	WE460	1.30
8	600	O	1 $\frac{3}{8}$ x 4 $\frac{7}{16}$	WE860	1.50
16	600	O	1 $\frac{1}{2}$ x 4 $\frac{15}{16}$	WE1660	2.00

## Hardware and Accessories

### FOR ALL TYPES OF DRY ELECTROLYTIC CONDENSERS

Description	Cat. No.	List Price
Mallory Terminal Connector.....	A-016	\$0.05
Washer for Clamp Mounting 1" Cans.....	A-017	.05
Washer for $\frac{7}{8}$ " Hole Mounting 1" Cans.....	015-1	.03
Washer for Spade Bolt Mounting 1" and 1 $\frac{3}{8}$ " Cans.....	015-2	.03
Ring Clamp for 1" Round Unit.....	105-1	.07
Ring Clamp for 1 $\frac{3}{8}$ " Round Unit.....	106-1	.08
Ring Clamp for 1 $\frac{1}{2}$ " Round Unit.....	107-1	.10
Ring Clamp for 2 $\frac{1}{2}$ " Round Unit.....	108-1	.15
Ring Clamp for 3" Round Unit.....	109-1	.15
Special Mounting Bracket.....	104-1	.10

FIG. 1



FIG. 2



FIG. 3



FIG. 4



TYPE WE





# Approved PRECISION PRODUCTS

## High Capacity Low Voltage Condensers

TYPE HC

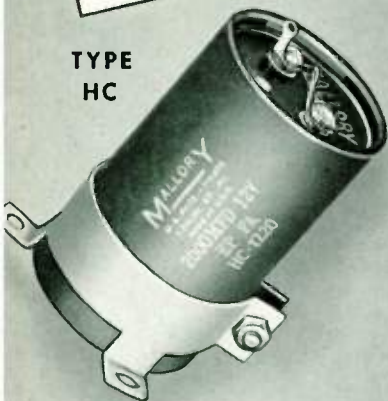

● Mallory HC condensers are designed for talking movie equipment, low voltage signalling devices and other applications requiring this type of unit.

Supplied in round aluminum externally-insulated containers complete with vertical mounting bracket.

Designed primarily for choke input filters, they may also be used as input condensers providing the AC ripple current does not exceed the maximum shown in column "Maximum Ripple Current."

Type RC2520 is in a rectangular container and the section is internally insulated.

TYPE HC

Cap.	Wkg. V. DC	Maximum Ripple Current ma.	Size	Catalog Number	List Price
500	12	750	1 3/8 x 2 3/4	HC1205	\$2.40
1000	12	1000	1 3/8 x 3 1/4	HC1210	3.55
1500	12	1500	2 x 3 1/8	HC1215	4.95
2000	12	1750	2 x 3 1/8	HC1220	6.30
4000	12	3000	2 1/2 x 4 1/8	HC1240	11.95
500	25	900	1 3/8 x 4 1/4	HC2505	3.75
1000	25	1500	2 x 3 1/8	HC2510	6.50
2000	25	2500	2 1/2 x 3 1/8	HC2520	12.45
2000*	25	2500	3 x 3 x 5 5/8	RC2520	12.45
500	50	1250	2 x 3 1/8	HC5005	6.55
1000	50	2500	2 x 4 1/8	HC5010	12.45

\*Rectangular, internally insulated container.



TYPE CB

## Cased Bypass Condensers

TYPE CB

Cap.	Wkg. V. DC	Size				Fig.	Catalog Number	List Price
		A	B	C	D			
.1	400	1 3/4 x 7/8	3/4 x 2 1/8	1	CB301	\$0.65		
.25	400	1 3/4 x 7/8	3/4 x 2 1/8	1	CB302	.75		
.5	400	2 x 1 3/4	7/8 x 2 3/8	1	CB303	.95		
1.0	400	2 x 2	1 x 2 3/8	1	CB304	1.25		
2.0	400	2 x 2	1 1/4 x 2 3/8	1	CB305	1.55		
2 x .1	400	1 3/4 x 1	7/8 x 2 1/8	2	CB306	.80		
2 x .25	400	2 x 1 3/4	7/8 x 2 3/8	2	CB307	1.00		
2 x .5	400	2 x 2	1 x 2 3/8	2	CB308	1.25		
3 x .1	400	1 3/8 x 1 1/4	7/8 x 2 1/8	2	CB309	1.05		
3 x .25	400	2 x 2	1 x 2 3/8	2	CB310	1.30		
3 x .5	400	2 x 2	1 1/8 x 2 3/8	2	CB311	1.85		
4 x .1	400	2 x 1 3/4	7/8 x 2 3/8	3	CB312	1.40		
.1	600	1 3/4 x 7/8	3/4 x 2 1/8	1	CB313	.75		
.25	600	1 3/4 x 1	7/8 x 2 1/8	1	CB314	.90		
.5	600	2 x 1 3/4	7/8 x 2 3/8	1	CB315	1.20		
2 x .1	600	2 x 1 3/4	7/8 x 2 3/8	2	CB316	.90		
3 x .1	600	2 x 1 3/4	7/8 x 2 3/8	2	CB317	1.55		

● Cased bypass units are seldom used in modern radio chassis but there is still a demand for them as replacements and for experimental purposes.

Those units rated at 400 volts are the same physical size as original 200-volt units which eliminates the necessity of specifying the old 200-volt type.

Single units (Fig. 1) have both terminals insulated from case. Dual units (Fig. 2) have center lug common and container insulated from all sections. Triple units (Fig. 2) have common grounded to case. Quad unit (Fig. 3) has common grounded to case.

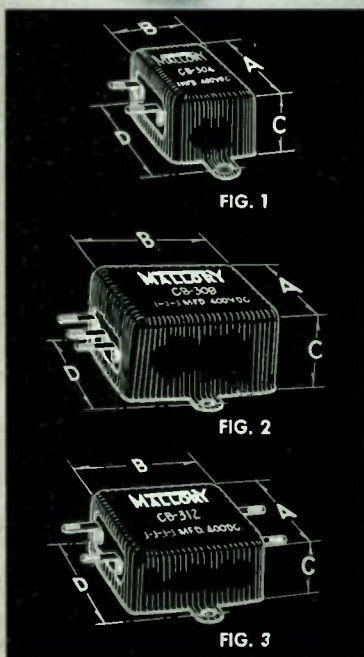

## Uncased Condensers

TYPE UB

● Uncased condensers are convenient for replacing sections in paper condensers, filter blocks and for other applications requiring low-priced uncased units of this type. For long life, however, these units should be potted and not left unprotected from moisture.

### Sealing Compound

For sealing new or repaired condenser banks, chokes, and transformers. Pouring temperature, 425 degrees F.

Cat. No. Net Weight Price  
 RW2, 2 lbs., \$0.40 list per pkg.  
 RW5, 5 lbs., .75 list per pkg.

.30.

Capacity	Wkg. V. DC	Size	Catalog Number	List Price
1	200	2 1/8 x 1 3/8 x 7/16	UB351	\$0.60
2	200	2 1/8 x 1 1/16 x 1 1/16	UB352	.95
4	200	2 1/8 x 2 1/16 x 1 1/8	UB353	1.70
1	400	2 1/8 x 1 9/16 x 9/16	UB354	.75
2	400	2 1/8 x 1 13/16 x 7/8	UB355	1.15
4	400	4 3/8 x 1 9/16 x 1 3/16	UB356	2.00
.5	600	2 1/8 x 1 7/16 x 7/16	UB357	.60
1.0	600	2 1/8 x 1 11/16 x 1 3/16	UB158	.90
2.0	600	2 1/8 x 2 1/4 x 1 1/16	UB359	1.35
1	800	4 3/8 x 1 1/2 x 5/8	UB360	1.25
2	800	4 3/8 x 2 1/16 x 7/8	UB361	2.00
1	1000	4 3/8 x 1 7/8 x 3/4	UB362	1.50
2	1000	4 3/8 x 2 1/8 x 1 3/16	UB363	2.50



TYPE UB



## Transmitting and Television Capacitors

### TYPES TZ, TR AND TX

● These new Mallory transmitting capacitors incorporate the latest design and manufacturing methods plus exclusive Mallory innovations. All units are conservatively rated and compact in size.

Types TZ are for low power transmitting and television circuits as well as power amplifier applications. They may be mounted upright or inverted and have insulated can construction.

Clamp included in price.

Types TR are special low-cost small-size round units for amateur transmitting and other applications where size and cost are paramount. Furnished with mounting clamp.

Types TX are general-purpose units for amateur, broadcast and television applications. Available from 600 to 6000 volts as shown.



FIG. 1



FIG. 2



FIG. 3



FIG. 4

Capacity	Working V. DC	R.M.S. Rect. AC	Size			Fig.	Catalog Number	List Price
			A	B	C			
<b>Small Round Can—Type TZ</b>								
2	600	440	3 1/4 x 1 3/8			1	TZ382	\$2.75
4	600	440	4 3/4 x 1 3/8			1	TZ383	3.75
1	1000	660	2 3/4 x 1 3/8			1	TZ384	2.50
2	1000	660	4 1/4 x 1 3/8			1	TZ385	3.25
.5	1500	1000	2 3/4 x 1 3/8			1	TZ386	3.00
1.0	1500	1000	4 1/4 x 1 3/8			1	TZ387	3.25
<b>Large Round Can—Type TR</b>								
1	1000	660	2 1/8 x 2			2	TR760	2.75
2	1000	660	2 3/8 x 2			2	TR761	3.75
4	1000	660	3 7/8 x 2			2	TR762	4.75
1	1500	1000	2 3/8 x 2			2	TR766	3.50
2	1500	1000	3 5/8 x 2			2	TR767	4.75
1	2000	1500	3 1/8 x 2			2	TR770	4.50
2	2000	1500	4 7/8 x 2			2	TR771	5.00
1	2500	1800	3 7/8 x 2			2	TR775	6.00
<b>Rectangular Can—Type TX</b>								
1	600	440	2 1/4 x 1 3/4 x 1			3	TX801	3.50
2	600	440	2 3/4 x 1 3/4 x 1			3	TX802	4.25
4	600	440	3 1/4 x 2 1/2 x 1 3/16			3	TX803	5.50
.5	1000	660	2 1/4 x 1 3/4 x 1			3	TX822	3.00
1	1000	660	2 1/4 x 1 3/4 x 1			3	TX804	3.75
2	1000	660	3 7/8 x 1 3/4 x 1			3	TX805	5.00
4	1000	660	4 3/4 x 2 1/2 x 1 3/16			3	TX806	6.25
1	1500	1000	3 7/8 x 1 3/4 x 1			3	TX807	4.50
2	1500	1000	4 3/4 x 2 1/2 x 1 3/16			3	TX808	6.25
4	1500	1000	4 5/8 x 3 3/4 x 1 1/4			3	TX809	8.50
1	2000	1500	3 1/4 x 2 1/2 x 1 3/16			3	TX810	5.50
2	2000	1500	4 3/8 x 3 3/4 x 1 1/4			3	TX811	6.50
4	2000	1500	4 3/8 x 3 3/4 x 2 1/4			3	TX823	9.00
1	2500	1800	3 1/8 x 3 3/4 x 1 3/4			3	TX812	8.00
2	2500	1800	4 3/4 x 3 3/4 x 1 3/4			3	TX813	13.00
1	3000	2200	4 7/8 x 3 3/4 x 1 3/4			3	TX814	12.00
2	3000	2200	4 5/8 x 3 3/4 x 3 3/16			3	TX815	15.00
1	5000	3300	4 3/4 x 5 1/8 x 3 1/2			4	TX818	25.00
2	5000	3300	8 1/8 x 5 1/8 x 3 1/2			4	TX819	32.00
.5	6000	4400	4 3/8 x 5 1/8 x 3 1/2			4	TX820	40.00
1.0	6000	4400	7 x 5 1/8 x 3 1/2			4	TX821	50.00

.31.

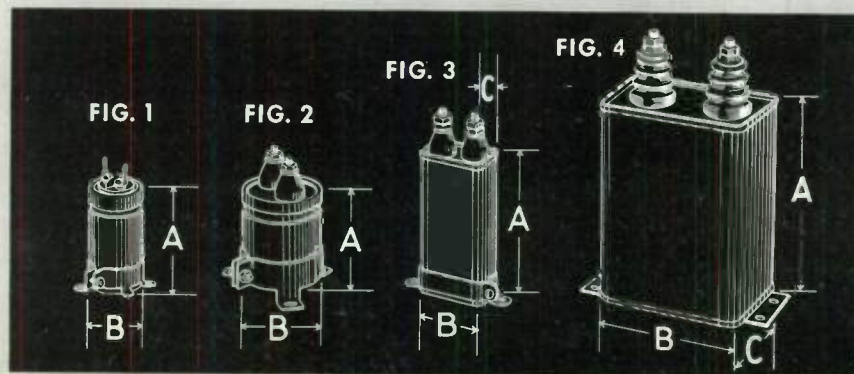



# Approved PRECISION PRODUCTS

## Mallory Paper Dielectric Tubular Condensers

TYPES TP AND OW

TP = Wax Impregnated Wax Filled.

OW = Oil Impregnated Wax Filled.

Cap. Mfd.	200 V. DC			400 V. DC			600 V. DC			1000 V. DC			1600 V. DC		
	Cat. No.	S	List Price	Cat. No.	S	List Price	Cat. No.	S	List Price	Cat. No.	S	List Price	Cat. No.	S	List Price
.0001							TP401	1	\$0.15						
.00025							TP402	1	.15						
.0005							TP403	1	.15				OW340	4	\$0.35
.001							TP404	1	.15	TP455	1	\$0.20	OW341	5	.35
.002							TP405	1	.15	TP456	2	.20	OW331	5	.35
.003							TP406	1	.15	TP457	4	.20	OW342	6	.35
.004							TP407	1	.15	TP458	4	.20	OW343	6	.35
.005							TP408	2	.15	TP459	4	.20	OW332	6	.35
.006							TP409	2	.15	TP460	4	.20	OW344	8	.35
.007							TP415	3	.15	TP461	5	.20	OW345	8	.35
.008							TP450	3	.15	TP462	5	.20	OW333	8	.35
.01				TP421	2	\$0.15	TP410	3	.15	TP434	8	.30	OW334	10	.35
.015				TP400	2	.15	TP411	4	.15	TP463	8	.30	OW335	11	.35
.02				TP423	4	.15	TP412	5	.15	TP435	9	.30	OW336	11	.35
.025							TP451	5	.20						
.03				TP424	6	.15	TP413	7	.20	TP464	9	.35	OW337	15	.35
.04				TP425	6	.15	TP414	8	.20	TP465	10	.35	OW338	19	.40
.05	TP436	7	\$0.15	TP426	8	.15	TP415	8	.20	TP437	13	.35	OW339	21	.45
.06				TP427	8	.20	TP416	8	.25	TP466	13	.35			
.075							TP452	9	.25	TP467	14	.40			
.1	TP438	9	.20	TP428	9	.20	TP418	12	.25	TP439	19	.40			
.15							TP417	14	.30						
.2				TP429	11	.25	TP419	15	.35						
.25	TP440	17	.25	TP430	14	.25	TP420	16	.35						
.3				TP444	14	.30	TP453	16	.45						
.4				TP442	15	.35	TP454	21	.50						
.5	TP441	18	.35	TP431	20	.35	TP432	22	.50						
1.0	TP443	22	.50	TP422	23	.50	TP433	24	.80						

TYPE TP

TYPES TP, OW



TYPE TP (Dual)

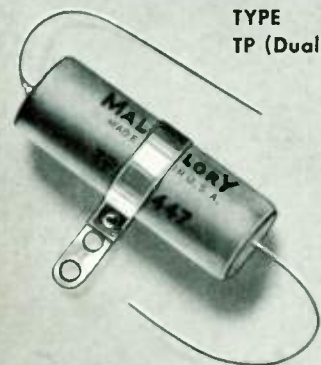

TYPES TP (Dual) and OT

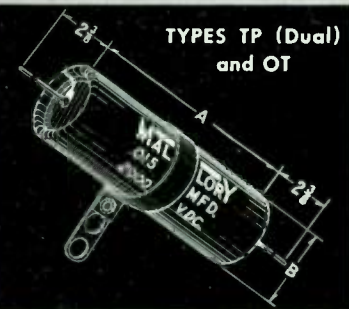

TYPE OW

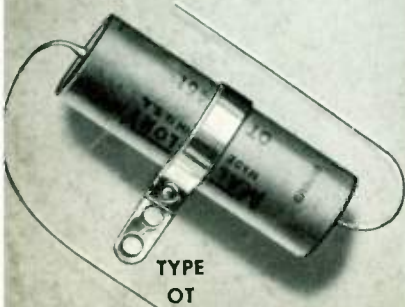

TYPE OT

### TYPES TP AND OW

● Small in size for easy installation. Moisture-proof seal for long life. Non-inductive—provide low RF impedance regardless of rating.

A complete selection of tubular ratings now in use in the radio field is listed. Additional tubular condensers of the oil-filled type for special applications will also be found on this page.

Mallory Type TP condensers are wax-impregnated and wax sealed at the ends, the accepted standard construction for maximum protection from atmospheric conditions.

Mallory Type OW condensers are oil-impregnated and wax sealed, providing extra safety factor for voltage applications higher than usually recommended for the wax impregnated type.

### DUAL TP CONDENSERS

● Mallory Dual TP units are packed 5 to a carton. Outside foil is common and connected to mounting strap.

### METAL CASED OIL-IMPREGNATED CONDENSERS TYPE OT

● Mallory OT tubular condensers represent the finest quality obtainable. Impregnated in oil and housed in hermetically sealed leak-proof metal tubes, they are ideal for vibrator buffers and high voltage coupling applications.

All OT units are externally insulated with cardboard tubes and supplied with a mounting strap which may be removed if not required. Packed in individual cartons.

### Size Chart

S No.	Size	Box	S No.	Size	Box
1	1 x 5/16	10	13	1 7/8 x 5/8	10
2	1 x 3/8	10	14	1 7/8 x 11/16	10
3	1 1/16 x 7/16	10	15	1 7/8 x 3/4	10
4	1 1/4 x 3/8	10	16	1 3/8 x 13/16	10
5	1 1/4 x 7/16	10	17	2 x 5/8	10
6	1 1/4 x 9/16	10	18	2 x 3/4	10
7	1 3/8 x 7/16	10	19	2 x 7/8	5
8	1 1/2 x 1/2	10	20	2 3/8 x 13/16	5
9	1 1/2 x 9/16	10	21	2 3/8 x 7/8	5
10	1 1/2 x 5/8	10	22	2 3/8 x 1	5
11	1 5/8 x 3/4	10	23	2 1/2 x 1	5
12	1 11/16 x 5/8	10	24	2 1/2 x 1 1/4	5

All diameters are plus or minus 1/32".

Listing gives rating, catalog number and list price. Column S refers to size and standard package quantity as outlined above.

Certain capacities in 200 and 400-volt ratings are not listed because they are too small in size for practical manufacture. If such ratings are required, always use the next higher voltage rating. There is no premium in price.

Capacity	Wkg. V. DC	Size	Catalog Number	List Price
.01-.01	400	1 1/2 x 7/16	TP446	\$0.35
.05-.05	400	1 7/8 x 5/8	TP447	.40
.1-.1	400	2 1/4 x 1 1/16	TP448	.45
.25-.25	200	2 1/2 x 3/4	TP449	.50

Capacity	Wkg. V. DC	Size	Catalog Number	List Price
.002	1600	1 1/4 x 5/8	OT370	\$0.45
.003	1600	1 1/4 x 5/8	OT377	.45
.005	1600	1 1/4 x 5/8	OT371	.45
.008	1600	1 1/4 x 5/8	OT372	.50
.01	1600	1 1/4 x 5/8	OT373	.55
.0125	1600	1 3/4 x 5/8	OT374	.60
.015	1600	1 3/4 x 5/8	OT375	.60
.02	1600	1 3/4 x 5/8	OT376	.60
.0025	2000	1 5/8 x 3/16	OT458	.60
.005	2000	1 11/16 x 11/16	OT459	.65
.0075	2000	1 7/8 x 11/16	OT460	.70
.01	2000	1 7/8 x 11/16	OT461	.75
.0125	2000	2 1/4 x 11/16	OT462	.75
.015	2000	2 1/4 x 11/16	OT463	.75
.02	2000	2 3/8 x 13/16	OT464	.80
.03	2000	2 3/8 x 13/16	OT465	.85
.04	2000	2 5/8 x 13/16	OT466	.85
.05	2000	2 5/8 x 13/16	OT467	.90





## Auto Radio Condensers—Paper Dielectric Type

### VIBRATOR BUFFERS—TYPES VB, VD, VL, VO

Capacity	Wkg. V. DC	Size	Fig.	Cat. No.	List Price
.0075	1600	$\frac{7}{8}$ x $\frac{5}{8}$ x .3	2	VB470	\$0.45
.01	1600	$\frac{7}{8}$ x $\frac{5}{8}$ x .3	2	VB471	.45
.0125	1600	$\frac{5}{8}$ x 1 x .3	1	VB472	.45
.015	1600	$\frac{7}{8}$ x $\frac{11}{16}$ x .3	2	VB473	.45
.02	1600	$\frac{7}{8}$ x $\frac{11}{16}$ x .3	2	VB474	.45
.03	1600	1 x $\frac{15}{16}$ x $\frac{13}{32}$	2	VB475	.50
.04	1600	1 x $\frac{15}{16}$ x $\frac{7}{16}$	2	VB476	.60
.05	1600	1 x 1 x $\frac{1}{2}$	2	VB477	.70
.01-.01	1600	$\frac{3}{4}$ x $\frac{7}{8}$ x $\frac{3}{4}$	14	VD490	.85
.01	2000	3 x $\frac{17}{32}$ x $\frac{3}{8}$	3	VL478	.75
.5	200	3 x $\frac{27}{32}$ x $\frac{3}{8}$	3	VL479	.65
.5	120	$2\frac{1}{8}$ x $\frac{3}{4}$ x $\frac{7}{16}$	4	VO480	.45

● Mallory types VB, VD and VL (478) condensers are oil-impregnated and designed especially for vibrator buffer applications.

This service requires extreme quality since high temperature conditions, excessive vibrations and unusually high peak voltages are encountered.

Types VL479 and VO480 are low voltage units and are of the wax-impregnated type.

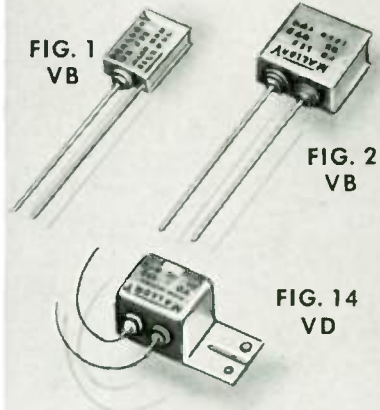

### RF CHOKES

Turns	Wire	Size	Fig.	Cat. No.	List Price
90	16	1 x $1\frac{1}{2}$	10	RF581	\$0.65
55	16	1 x $1\frac{3}{16}$	10	RF582	.50
55	12	$1\frac{3}{16}$ x $1\frac{5}{8}$	10	RF583	.75

● Mallory chokes, Type RF, are designed for use wherever RF chokes are needed for hash or other radio frequency suppression. Complete particulars and detailed instructions for their use will be found in the Mallory-Yaxley Radio Service Encyclopedia.

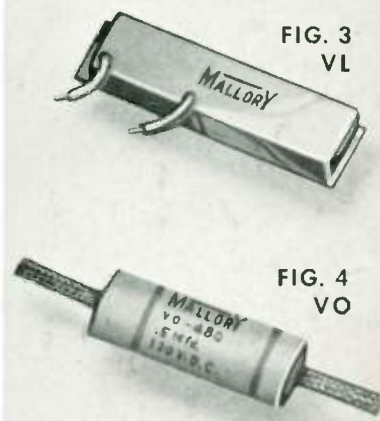

### MISCELLANEOUS AUTO TYPES AG, AM, FM, DL, RF

.05	100	$\frac{7}{16}$ x $1\frac{3}{16}$	5	AG443	.50
.25	100	$\frac{5}{8}$ x $1\frac{15}{16}$	5	AG444	.50
.5-.5	100	$\frac{7}{8}$ x 2	5	AG450	.75
.5	100	$\frac{3}{4}$ x 2	5	AG451	.50
1.0	100	1 x $2\frac{3}{16}$	5	AG452	.70
.5*	100	$\frac{3}{4}$ x $1\frac{3}{4}$	11	AG453	.75
.5	100	$\frac{5}{8}$ x 2	6	AM454	.45
.5	100	$\frac{11}{16}$ x $1\frac{7}{8}$	12	FM441	.50
.5	100	$\frac{11}{16}$ x 2	7	FM442	.50
.5	100	1 x $2\frac{3}{8}$	9	DL445	.85
.5	100	$\frac{13}{16}$ x $1\frac{5}{16}$	13	RF480	.40
.5	100	$\frac{3}{4}$ x $1\frac{3}{8}$	8	RF481	.60
1.0	100	$\frac{13}{16}$ x $1\frac{5}{8}$	8	RF482	.75

● This group is designed for various car radio applications.

Types AG are for noise suppression at the generator, oil and gas gages, etc.

Type AM is for suppression at the ammeter and other instruments.

Types FM are especially designed for Ford generators.

Type DL is a dome light interference suppressor and includes an RF choke.

Types RF are for general vibrator hash and noise suppression and have a very low RF impedance.

\*Has shielded lead.

FIG. 10 RF CHOKE



**MALLORY  
YAXLEY**

Approved **PRECISION PRODUCTS**

## Mica Condensers

### TYPE MC—600 Wkg. Volts

● Only the finest grade of clear India mica is used in Mallory type MC mica condensers.

Lead wires are soft tinned metal which may be bent or twisted without breaking.

Mallory type MC condensers are compact, mechanically strong and moisture proof.

Packed ten to the carton. Fig. A—1000 volt test, Fig. B—1500 volt test.

### COLOR CODE

● Mallory Mica Condensers are marked directly in capacity figures. The color coding used on original equipment mica condensers and consisting of three colored dots is explained herewith for convenience in making replacements.

The color of the first dot designates the first digit of the capacity value in micro-microfarads. The color of the second dot designates the second digit of the capacity value. The color of the third dot designates the number of ciphers following the second digit. Below is a chart showing the corresponding color for each digit.

0—Black	5—Green
1—Brown	6—Blue
2—Red	7—Violet
3—Orange	8—Gray
4—Yellow	9—White

This color code is the same as that used on fixed resistors and a standard resistor color code chart may be used to identify the capacity of any original condenser. The value of ohms indicated on a resistor chart corresponds to capacity in mmf.

Capacity ratings in mmf. (micro-microfarads) are one million times the mfd. (microfarad) rating. Therefore, a condenser rated .0005 mfd. would be 500 mmf. The color code refers to mmf. ratings.

There is but one exception to this code. The .0000075 mfd. (7.5 mmf.) is coded black, violet and green.

Capacity	Fig.	Catalog Number	List Price
.000005	A	MC831	\$0.20
.0000075	A	MC832	.20
.00001	A	MC833	.20
.000025	A	MC834	.20
.00003	A	MC835	.20
.00004	A	MC836	.15
.00005	A	MC837	.15
.000075	A	MC838	.15
.0001	A	MC839	.15
.00015	A	MC840	.15
.0002	A	MC841	.15
.00025	A	MC842	.20
.0003	A	MC843	.20
.0004	A	MC844	.20
.0005	B	MC845	.20
.0006	B	MC855	.20
.0008	B	MC854	.20
.001	B	MC846	.25
.0015	B	MC847	.25
.002	B	MC848	.30
.0025	B	MC849	.35
.003	B	MC850	.40
.004	B	MC851	.45
.005	B	MC852	.50
.006	B	MC853	.60

TYPE MC

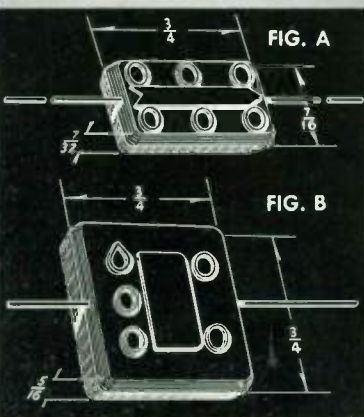

TYPE  
BT

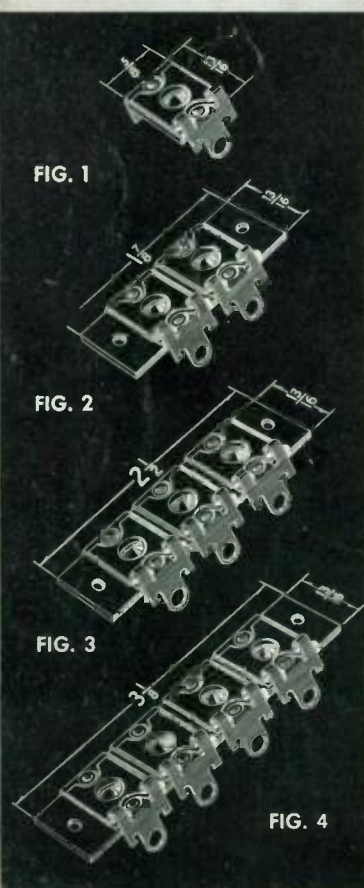

## Trimmer and Padding Condensers

### Types BT, CT, CTX, CTD

● Made with the finest India ruby mica and designed to prevent drift, or change with temperature or moisture. Adjusting screws are equipped with fine threads for accurate setting. Types BT—Popular low-priced bakelite base units having a wide field of application. Efficient and satisfactory for many applications that do not require the superior qualities of the ceramic types.

Type CT—A midjet ceramic base trimmer condenser that is excellent for any application within its capacity range. Applications requiring dual, triple, or quadruple units should be made by combining single units.

Types CTX—Single capacity ceramic base units. Recommended where higher capacities are required than available in type CT959.

These are single hole mounting types and may be adjusted from either the top or bottom of the unit.

Types CTD—Ceramic base dual condensers

having wide application because of their small size and high capacity range. Capacity listings refer to capacity of each section. Dual hole mounting and adjustable from top of unit only.

Cap. in mmf.		Fig.	Catalog Number	List Price
Min.	Max.			
3	30	1	BT961	\$0.20
3	30	2	BT962	.35
3	30	3	BT963	.50
3	30	4	BT964	.65
3	30	5	CT959	.25
20	100	6	CTX954	.50
60	240	6	CTX955	.70
180	560	6	CTX956	.80
480	1640	6	CTX957	.90
660	2100	6	CTX958	1.00
18	100	7	CTD951	.60
60	230	7	CTD952	.70
240	670	7	CTD953	.95

.31.



TYPE  
CT



TYPE  
CTX



TYPE  
CTD



FIG. 5



FIG. 6



FIG. 7



## Vibrators

● When you buy a Mallory Replacement Vibrator you are assured of the following benefits: 1. Lowest cost per hour of actual use 2. Trouble-free long life. 3. Positive starting. 4. Easy installation. 5. Freedom from lead breakage. 6. Freedom from failures due to lead corrosion. 7. Absolute freedom from broken reeds.

Mallory Replacement Vibrators are built by the most highly specialized group of technicians in the vibrator industry. The majority of these employees have been with Mallory since the beginning of the vibrator industry. Such a highly trained personnel can only assure the highest quality of workmanship possible.

For recommendations by receiver make and model number, see your distributor for Folder E-552, or consult the Mallory-Yaxley Radio Service Encyclopedia (3rd Edition).

### Mallory Replacement Vibrators for Auto Radio and Household Receivers

Cat. No.	List Price	Cat. No.	List Price	Cat. No.	List Price	Cat. No.	List Price
<b>200 Series</b>		216	\$1.95	292	\$3.45	<b>700 Series</b>	
201	\$6.50	246P	4.95	294	2.95	716	\$4.95
F204	6.75	W246	4.95	294C	2.95	722A	4.95
205	6.50	247	4.95	294SW	2.95	725	5.50
210	7.50	F247	5.50	F294	4.45	G725	6.50
F211	7.50	248	4.95	296	2.95	728A	4.95
220B	4.00	249	4.95	297	3.95		
F220C	5.00	F251	4.45	F297	4.95	<b>800 Series</b>	
221	3.95	253	3.95	299	3.95	825	4.50
F221	4.45	253T	3.95	<b>300 Series</b>		F826	4.75
222	5.50	253Y	2.95	302S	6.50	850	2.95
223	5.95	G253	6.00	311S	7.50	851	2.95
F223	5.95	270B	5.95	F312	7.50	852	2.95
224	7.00	271	5.95	<b>500 Series</b>		853	2.95
225	5.95	271HD	5.95	500P	2.95	854	2.95
226	5.95	273C	5.50	501P	2.95	860	2.95
230	7.50	273D	5.50	F502P	5.95		
231	7.25	275XS	7.50	503	3.95	<b>900 Series</b>	
235	5.95	277S	5.95	504	3.95	901M	2.50
H240	6.50	285XS	7.00	505P	2.95	902M	2.50
245	4.95	P285Y	4.95	506P	3.95	903M	2.50
245A	4.95	286S	5.50	507P	2.95	951P	5.25
245C	4.95	G286S	7.50	508P	2.50	952W	4.95
W245	4.95	289Y	4.95	510P	3.00	953W	4.95
W245A	4.95	F290	5.50	514	4.95	954	4.95

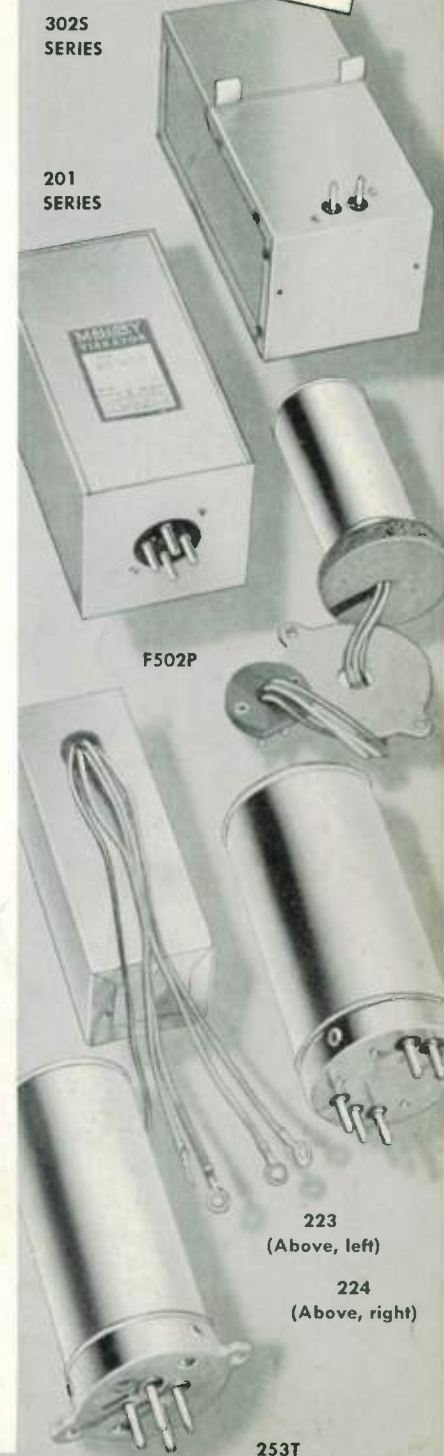

.35.

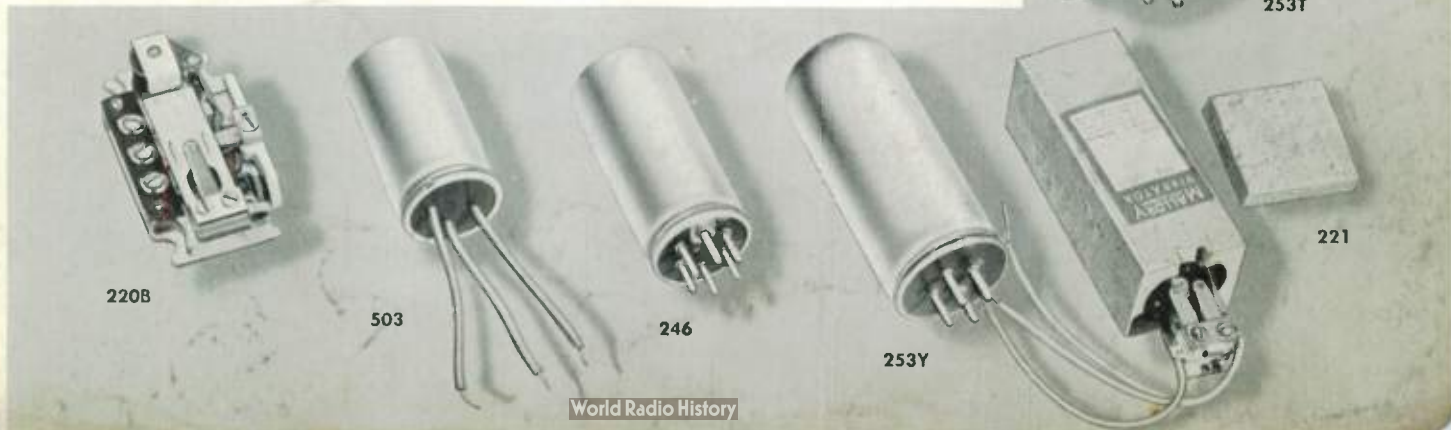



# Approved PRECISION PRODUCTS

VP552

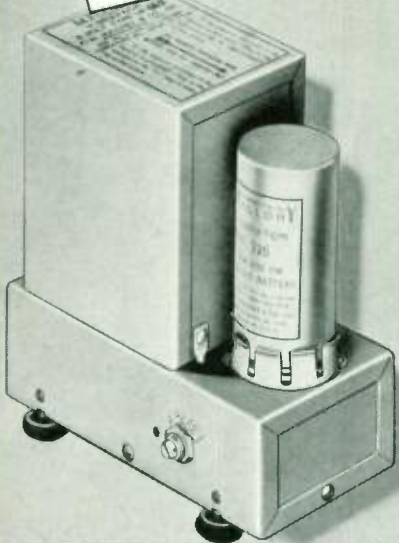

## Vibrapacks (Reg. U.S. Pat. Off.)

● Vibrapacks are flexible, HEAVY-DUTY vibrator power supplies designed to provide the most dependable and low cost method of obtaining high voltage direct current from a low voltage storage battery. Proved efficient and dependable by more than two years of actual field service. Available in various types and sizes, with outputs up to 60 watts at 300 and 400 volts.

### Outstanding Advantages:

1. High efficiency.
2. Dependable—trouble free—time-tested in thousands of installations.
3. Low cost—low maintenance.
4. Compact—light in weight.
5. Ease of installation.
6. Flexibility. Single unit Vibrapacks can be adjusted to give 4 output voltage ranges each.

The dual units are designed for a single voltage range in order to secure the maximum efficiency necessary to maintain satisfactory performance and life standards.

Radio engineers, amateurs, and P. A. men long have sought an economical means of obtaining plate voltage for portable and mobile equipment. The Vibrapack provides just that. Vibrapacks may also be used for the conversion of 110-volt A.C. receivers for battery operation.

### MALLORY VIBRAPACKS—TYPE VP

Catalog Number	Nominal Operating Voltage	Nominal Output Voltage	Maximum Output Current	Type	List Price
VP-551.....	6.3	125-150-175-200	100 ma.	Self-Rectifying	\$15.00
VP-552.....	6.3	225-250-275-300	100 ma.	Self-Rectifying	18.50
VP-553.....	6.3	125-150-175-200	100 ma.	Tube Rectifier	16.50
VP-554.....	6.3	225-250-275-300	100 ma.	Tube Rectifier	20.00
VP-555*.....	6.3	300	200 ma.	Tube Rectifier	37.50
VP-557*.....	6.3	400	150 ma.	Tube Rectifier	37.50
VP-G556.....	12.6	225-250-275-300	100 ma.	Self-Rectifying	20.00
VP-F558.....	32.	225-250-275-300	100 ma.	Tube-Rectifying	20.00

\*Special Dual Packs for high output. Output voltages indicated are nominal. Actual average output voltages at various loads will be found in the graphs. Figures 11, 12, and 13, of our Form No. E-555B, when operated at rated terminal voltage. Tube rectifier types permit "B—" to be isolated from ground if desired. Vibrapacks are supplied complete with special Mallory vibrator. Rectifier tubes are included in the interrupter types.

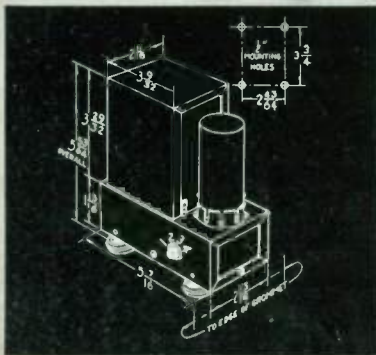

VP554



Vibrapacks are equipped with complete built-in noise suppression equipment. Type VP-555 also includes an efficient low-frequency hum filter. Type VP-557 incorporates the first input filter condenser only. Other Vibrapacks do not include the high voltage hum filter. High voltage filter requirements are similar to equivalent A.C. power packs. The design will depend on the application.

NOTE—Previous to the introduction of the Mallory Vibrapack it was necessary that vibrator power supplies be specifically engineered for each application. This was required so that there would be an exact match between the vibrator, transformer, buffer condensers, and load; otherwise, operating conditions might be such that low efficiency and short vibrator life would result. This handicap has been entirely overcome. The Vibrapack is truly flexible. It is adaptable to all applications within its power ratings. Any amateur, radio service man or experimenter who can connect and apply a com-

mon A.C. power supply can apply and use the Vibrapack with complete satisfaction.

Purchasers are urged to discuss special applications and uses of Mallory Vibrapacks with our Engineering and Development Laboratories. Address communications to Application Engineering Section, Wholesale Division, P. R. Mallory & Co., Inc., Indianapolis, Ind.

Manufactured under the following U.S. Patent Numbers 1943240, 2032624, 2049310, and patents pending.

### No. 754-1 Relay

For remote control of all single-unit Vibrapacks. With 12 and 32-volt Vibrapacks, operate relay from 3 cells only of storage battery. Coil resistance, 120 ohms. Contact capacity, 10 amperes maximum at 6.3 volts. Has other radio applications.

No. 754-1 Relay. List price ..... \$0.85

.36.

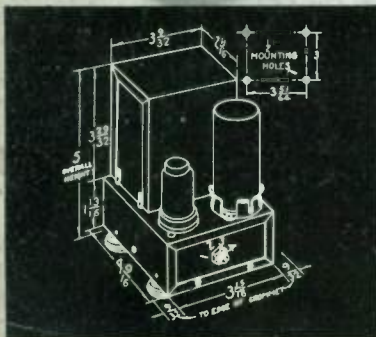

VP-557

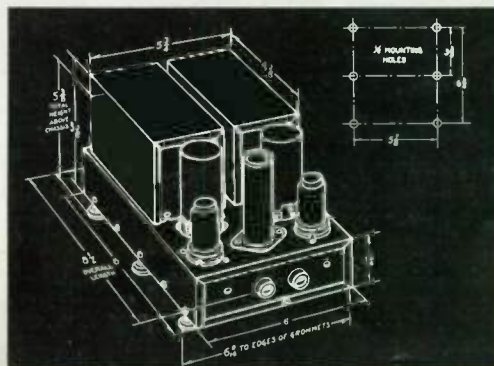



## Dry Disc Rectifiers · Battery Chargers

### REPLACEMENT RECTIFIERS

● Because of their proven dependability, long life, compact construction and low cost, Mallory Copper Sulphide Rectifiers are widely used in a variety of different applications ranging from automobile battery chargers, "A" eliminators, auto radio demonstrators, to such heavy-duty applications as: electroplating, motion picture projector arc power supplies, etc. Information on Mallory Rectifiers for these various applications is available upon receipt of a request addressed to our Rectifier Application Division.

New Catalog Number	Replacement for Type Number	List Price
B8C3M	8A3, 4A3, W8A3	\$3.20
IB12C1M	12C1, F12C1, F12C1E, F12C1B, 12C1F, F12C1K, 1B12CX1, X112, X12, U12, 3C Booster	
F16C3M	16C3, X116, X16, ME16	
F16C3MB	16C3B, XB16, M16	5.10
F16C3B	16C3B	6.55
F16C1	W16A1	5.50
IS16C17M	For 5535 B Charger	4.65
IF16C17M	For 5535 A Charger	6.35
IS16B7M	For 107 Charger	6.50
F20C1	W20A1, 20A1, X20	8.00
F24C1	W24A1	5.80
		6.40

### BATTERY CHARGERS AND BOOSTERS

● Mallory Chargers and Boosters provide a simple, economical and dependable method of keeping an automobile storage battery fully charged to give prompt starting on cold mornings and to provide an abundance of current for lights, radio and other automobile accessories. To install Mallory Chargers and Boosters it is only necessary to attach a simple, universal clamp-on dash receptacle and

connect the 2 wires from the receptacle to the ammeter and the frame of the car. Additional dash receptacles are available so that one charger may be alternately used with several cars.

Mallory Chargers and Boosters are designed to operate from 115 volts, 50-60 cycles, and use a conservative oversized transformer to insure dependable, trouble-free battery charging over a wide range of operating conditions. All chargers are designed to automatically provide a tapering charge; that is, a high charging rate into a discharged battery, the rate gradually decreasing as the battery becomes charged and a safe charging rate when the battery is fully charged. Mallory Chargers and Boosters are the only line equipped with the new thermal bi-metallic circuit breaker which protects the charger from improper connection to the battery and from serious overloads. No fuses are used, which are inconvenient and costly to replace, and it is only necessary to push in the bi-metallic strip until it catches should the circuit breaker open for any abnormal reason.

They are compact in construction and use a chimney type housing of black wrinkle-finish. The D.C. cords terminate in a plug which fits a polarized dashboard receptacle also provided. In this way it is extremely simple to remove the charger from the car after having completed the charge.

Chargers are designed so they may be placed on a window sill, bench, floor, or running board of the car. They may either be left in the garage or carried in the car.

Chargers No. 5535B and No. 107 are equipped with charging meters which indicate that the charger has been properly connected to the car and that the charger is actually charging the battery.

Although designed especially for battery charging, Mallory Chargers and Boosters may be used for a wide variety of other applications not using batteries, such as: electroplating, toy and model train operation, with or without a Mallory dry electrolytic condenser in shunt with the D.C. terminals of the rectifiers, in combination with a filter for operating exciter lamps, loud speaker fields, as a dry battery substitute for operating coin machines, relays, solenoids, door bells, scientific apparatus, small generator and alternator fields and other applications requiring a low voltage direct current.

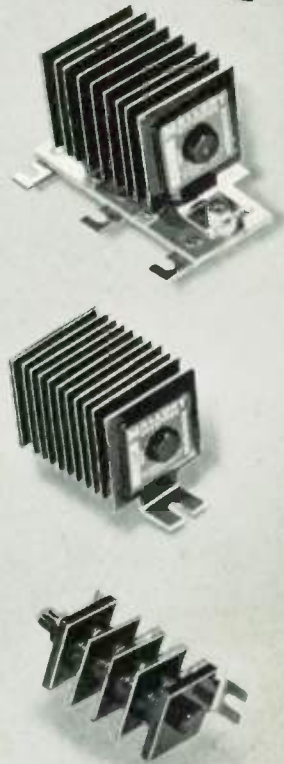

Type Charger	Max. Charge Rate	Tapered Rate	Charging Meter	Height	Width	Depth	Approx. Shipping Weight	Length A.C. Cord	Length D.C. Cord	List Price
3C	4	2	No	6	3 3/4	3 3/4	4 3/4	6	4	\$ 7.95
5535B	6	4	Yes	7 1/4	4 1/2	4 3/4	7 1/4	6	6	11.50
107	10	7	Yes	9 1/4	6 1/4	5 3/4	11	6	6	15.00

All chargers are equipped with one No. 652 dash receptacle.

### Charger Accessories

No. 652—Extra dash receptacle and plug for Mallory 3C, No. 5535A, No. 5535B and 107 charger..... \$1.50

No. 651—Extra dash receptacle and plug for the Mallory No. 3 and No. 5535 charger..... 1.50

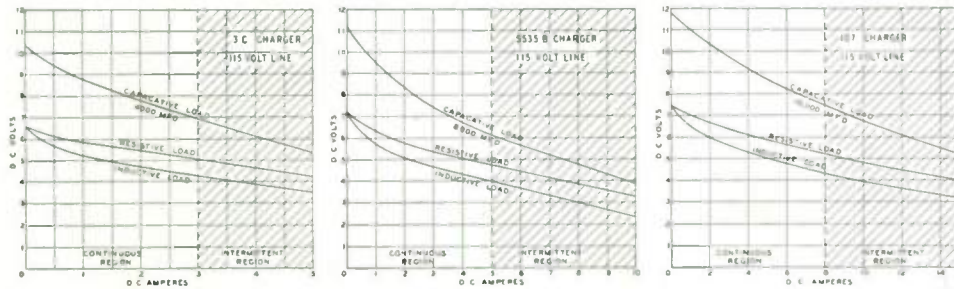

Approximate performance curves of Mallory Chargers for other than battery charging applications.

### TYPICAL APPLICATION OF MALLORY DRY DISC RECTIFIER

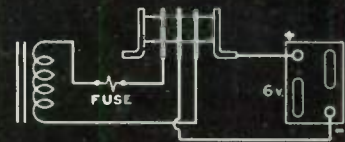

### 6-VOLT BATTERY CHARGER

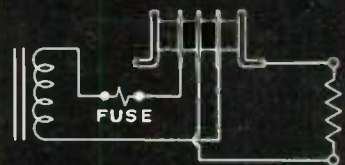

### RESISTANCE LOAD



No. 3C  
Booster



No. 5535B  
Charger



No. 107  
Charger



# Approved PRECISION PRODUCTS

## Grid Bias Cell—An Exclusive Mallory Development

(U. S. Letters Patent 1,920,151; 2,063,524; 2,116,091; Des. 106,163; et al.)

● The Mallory Grid Bias Cell is a small acorn-shaped, self-contained device with dimensions as shown at left. The metal container or cup is the negative electrode. The black disc is the positive electrode. Various styles of holders, with their dimensions, are also shown at left.

Mallory Bias Cells are available in two types—the original 1-volt cells and the new 1¼-volt cells. For new installations, the choice of Bias Cell types will depend on the voltage desired. Replacements should be made with the type of Bias Cell used as original equipment.

The 1¼-volt Bias Cells may be distinguished from the 1-volt unit by the concave depressions in both the upper electrode and bottom of the shell case.

### Application

The principal use of Mallory Grid Bias Cells are in the biasing of the first audio amplifier tube in modern high-gain receivers. A wiring diagram of a proven circuit is shown at left. The bias cell does not need to be bypassed to ground.

The number of Mallory Bias Cells required depends on the bias voltage necessary for distortionless amplification. Information on specific tube operating conditions will be found in the hand books issued by the various tube manufacturers; or by reference to the charts covering resistance coupled amplifier design in the Mallory-Yaxley Radio Service Encyclopedia, 2nd Edition.

Advantages in using Mallory Grid Bias Cells for biasing the first audio amplifier tube are, first of all, the elimination of a number of components, namely resistors and condensers. The second important advantage is the provision of a fixed bias voltage remaining independent of varying tube characteristics. This results, of course, in distortionless amplification. Another important advantage is the simplification of the circuit resulting in freedom from degeneration, audio howls, and other noises frequently found in high-gain amplifiers.

An application similar to the biasing of the first audio tube is the use of Grid Bias Cells in biasing the high-gain amplifier tubes such as those used in pre-amplifiers. Bias cells have a particular advantage in pre-amplifier circuits inasmuch as they provide a simple method of isolating the grid return circuit of the various tubes, minimizing hum pick-up and permitting a more economical and efficient design.

Another application where Mallory Grid Bias Cells can be used to good advantage is in the

provision of the normal bias voltage in AVC receivers. The use of bias cells permits the grounding of the RF and IF amplifier tubes thereby eliminating the customary grid bias resistors and condensers.

Correspondence is invited regarding the application of Mallory Grid Bias Cells. Special folders and instruction sheets may be obtained on request.

### Characteristics

The no-current potential of Mallory Grid Bias Cells is within plus or minus 10% of their rated voltage.

**Current**—The cell is strictly a potential or voltage cell for biasing class "A" amplifier tubes and should not be used for biasing power tubes or oscillators; or for any circuit where an appreciable direct current may flow through the cell.

**Temperature**—The cells may be used in ambient temperatures from 40° below zero to 120°F. The voltage of the cell remains reasonably constant throughout this wide temperature range. It is recommended, however, that wherever possible the bias cell be placed in the coolest location.

**Humidity**—The cell exhibits no change in characteristics when exposed to a relative humidity of 90% at 120°F.

**Impedance**—Mallory Grid Bias Cells are non-reactive at audio frequencies. For the 1-volt cell, the DC resistance ranges between 11,000 and 50,000 ohms. The DC resistance of the 1¼-volt cell ranges between 10,000 and 40,000 ohms.

**Noise**—The cells do not cause the development of any noise.

### PRICE LIST

Mallory Grid Bias Cells, 1-volt type (Packed 10 to the box) .....	\$0.30 per cell
Mallory Grid Bias Cells, 1¼-volt type (Packed 10 to the box) .....	.30 per cell
Mallory Grid Bias Cell Holder, Cat. No. GB11A, 1-cell capacity .....	.10 each
Mallory Grid Bias Cell Holder, Cat. No. GB11B, 1-cell capacity .....	.15 each
Mallory Grid Bias Cell Holder, Cat. No. GB12, 2-cell capacity .....	.20 each
Mallory Grid Bias Cell Holder, Cat. No. GB13, 3-cell capacity .....	.25 each
Mallory Grid Bias Cell Holder, Cat. No. GB14, 4-cell capacity .....	.35 each

.38.

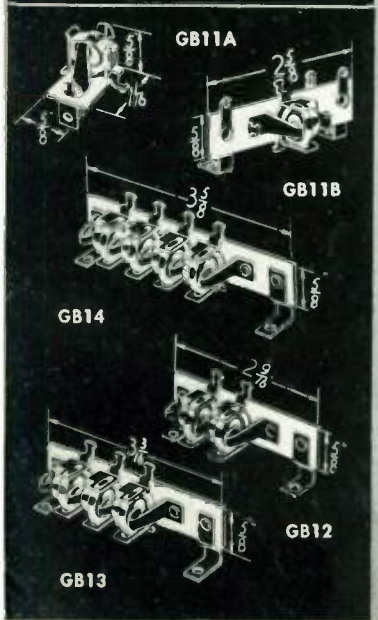
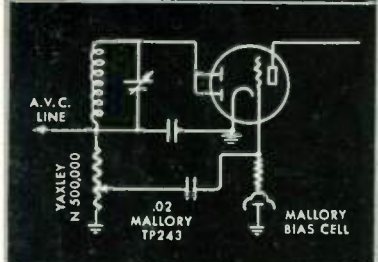
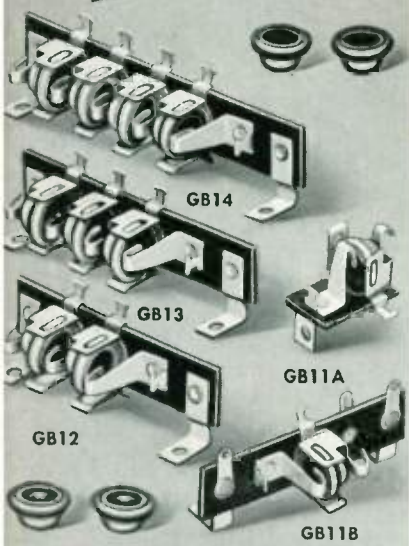

# You Can't Afford to Do Without **MALLORY Supplemental MYE Monthly Technical Service**

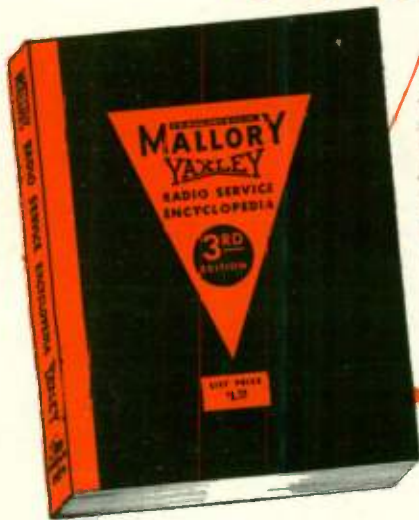

Covering combined  
 Receiving Tube  
 characteristics  
 with complete  
 Tube charts.

Complete  
 engineering  
 data on  
 dry electrolytic  
 capacitors.

Useful  
 servicing  
 formulae.

New  
 Receiver  
 listings...  
 covering all  
 sets announced from  
 June to December,  
 1939.

At a cost of less than ½ a cent a day . . . less than 15c a month—It's the Biggest Bargain You Ever Bought! Look at the monthly releases scheduled—starting with October and through to January of 1940.

←**SUPPLEMENT No. 1**  
**OCTOBER 1st**

Every new tube that's been released this year is included—and that's quite a bunch. It's information you'll need to use daily. The only compilation of its kind.

←**SUPPLEMENT No. 2**  
**NOVEMBER 1st**

Vital facts you should know to use the new types of condensers. Greater progress has been made in the condenser art in the past 18 months than ever before. A 44-page booklet—not only a valuable reference, but a volume you simply cannot do without.

←**SUPPLEMENT No. 3**  
**DECEMBER 1st**

Data you'll need and use frequently. We know because service engineers have told us what they wanted. This supplement is exactly that!

←**SUPPLEMENT No. 4**  
**JANUARY 1st**

A service no progressive radio service engineer can do without. Considerably over 1500 sets analyzed. Information on current sets when you need it . . . not a year later.

**Important Notice.** The 3rd Edition MYE is published wholly for the use of technicians engaged in radio servicing. Its contents are valuable to them alone.

Mallory Supplemental MYE Monthly Technical Service is designed for anyone interested in Radio.

If you are a radio service engineer and do not own a copy of the 3rd Edition MYE, see your Mallory-Yaxley distributor. He may still be able to supply you with a copy.

Use  
**P. R. MALLORY & CO. INC.**  
**MALLORY**  
 REPLACEMENT  
 CONDENSERS . . . VIBRATORS

Use  
**YAXLEY**  
 REPLACEMENT  
 VOLUME CONTROLS

P. R. MALLORY & CO., Inc., Indianapolis, Indiana

Enclosed is \$1.50 { Do not send cash or stamps—use personal }  
 check, cashier's check, Postal or Exp. M. O. }

which entitles me to receive 12 issues of the Mallory Supplemental MYE Monthly Technical Service.

PLEASE PRINT

Name \_\_\_\_\_

Address \_\_\_\_\_

City \_\_\_\_\_ State \_\_\_\_\_

**Plus 8** (eight) other equally valuable issues . . . one a month . . . right through to September of 1940. Twelve big reasons why you can't afford to miss the service . . . at a cost small in comparison with its real worth.

Mallory research work is carried on every single day of the year. Mallory Supplemental MYE Monthly Technical Service is your only means of keeping up to date.

Whether student, "ham," or radio amateur, you won't want to miss a single issue. Use the coupon and mail your order today.

# INDEX TO MALLORY-YAXLEY CATALOG

	PAGE		PAGE
Attenuators	8	Jack Switches	15
Battery Boosters	37	Junior	15
Battery Chargers	37	Midget	15
Bias Cells, Grid	38	Standard Long Frame	15
Binding Post Strips	17	Knobs	18
Cable—Multi Conductor	16	Bar Type	18
7 Conductor	16	Round	18
12 Conductor	16	"L" Pad Attenuators	8
Cable Connectors	16, 17	Multiple Outlet and Plug Connector	17
Pin Plates	16	Nuts	18
Pin Plugs	16, 17	Hexagon Flat Type	18
Receptacle Plugs	16, 17	Hexagon Shoulder Type	18
Cable Markers	16	Panel Lights	19
Condensers, Dry Electrolytic	21-34	Phone Plug Shield	13
Cardboard Carton Filter Units	26	Plugs	13, 14
Common Cathode Type "CN"	26	Microphone, Three-Way	13
Multiple Separate Section Type "CM"	26	Phone, Two-Way	13
Single Section Type "CS"	26	Tip Type	14
Fabricated Plate (FP) Capacitors	27	Portable Power Supplies (Vibrapak)	36
Heavy Duty Capacitors HD and HS	29	Potentiometers	8
High-Capacity Low-Voltage Units	30	"C" Type	8
Single Section Type "HC"	30	"E" Type	8
Large Round Can Filter Units	26	"M" Type	8
Multiple Section Common Cathode type "MN"	26	Precision Resistors	23
Round Can Filter Units	26	Push Button Switches (Single)	15
Common Cathode Types "RN"	26	Push Button Switches (Multiple)	9
Multiple Separate Section Types "RM"	26	Rectifiers, Dry Disc	37
Single Section Types "RS"	26	Resistors	20-23
Special Universal Units	28	Fixed (Wire Wound)	23
Types "UR" "SR"	28	Tapped (Wire Wound)	23
Tubular Audio Bypass Unit	24, 25	Truvolt Adjustable	22
Single Section Types "BB"	24	Variohm Adjustable	21
Condensers, Mica	34	Vitroous Enameled	20
Type "MC"	34	Yardohm Kits	23
Condensers, Paper	30-34	Rheostats	8
Cased Bypass Units Type "CB"	30	"C" Type	8
Tubular Paper Bypass Units Type "TP"	32	"M" Type	8
Tubular Paper Bypass Units Type "RF"	33	Screws, Round Head and Set	18
(For RF Interference Suppression)		Slide Switches	15
Auto Generator Suppressor Units	33	Solder Lug Strips	17
Types "AG," "AM," "FM," "DL," and "RF"	33	Switches	9-12
Auto Vibrator, Oil-Impregnated Units	33	Circuit Selector, Multigang	11
Types "VB," "VD," "VL," and "VO"	33	Types 1200L and 1300L	11
Tubular Types "OW" and "OT"	32	Circuit Selector Single Section	10
Unsealed Units Type "UB"	30	Types 3100J and 3200J	10
Transmitting and Television types "TX," "TZ" and "TR"	31	Circuit Opening Type 1400L	12
Condensers, Trimmer and Padding	34	Hamswitch Type 151L	9
Types "BT," "CT," "CX" and "CTD"	34	Hamswitch Type 152L	9
Condensers, Wet Electrolytic	29	Multiple Push Button	9
Wet Electrolytic Types "WE"	29	Slide	15
Mounting Accessories for Round Can Units	29	Special 15-Point Tap Type 150J	12
Mounting Brackets	29	Special 24-Point Tap Type 13124	12
Mounting Rings	29	"T" Pad Attenuators	8
Mounting Washers	29	Terminal Connector Clips	17
Terminal Connector, Condenser	29	Terminal Strips	17
Controls (See Volume Controls and Hum Controls)		Truvolt Resistors	22
Dash Receptacle (for Battery Chargers)	37	Variohm Resistors	21
Dial or Pilot Light Assemblies	19	Vibrapacks	36
Bayonet Shell Type	19	Vibrators (Auto Radio and Household)	21
Screw Shell Type	19	Vitreous Resistors	21
Dial or Pilot Lights	19	Volume Controls	2-8
Brackets	19	Linear Types	5
Jewels	19	Midget Types—Universal, Dual, Fixed Shaft and Tapped	3, 4
Sockets	19	Special Duals (DRP's)	6
Bulbs	19	Special Singles (SRP's)	6
Dial Plates	6, 12	Special Tapped (TRP's)	5
For Selector Switches	12	Universal Duals	5
For Rheostats and Potentiometers	6	Universal Singles	5
Grid Clips	17	Volume Control Accessories	4, 7
Grommets	18	Attachable Switches	4, 7
Ham Band Switches	9	Extension Bushing	7
"Hamswitch" Types 151L and 152L	9	Extension Shafts	4, 7
Hum Controls (HU's)	6	Extension Shaft Coupling and Reducer	7
Jacks	13, 14	Flexible Coupling Shafts	7
Extension	13	Mounting Brackets	7
Junior	13	Shoulder Mounting Nuts	7
Long Frame	13	Universal Bushings	7
Midget	13	Wrenches	7
Tip Type Hexagon Bakelite Head	14	Washers	18
Tip Type Round Bakelite Head	14	Insulating Flat Type	18
Tip Type Hexagon Metal Head	14	Insulating Extruded Type	18
Tip Type Round Metal Head	14	Metal Lock Type	18
Twin Tip Jacks, Moulded and Plain	14	Metal Flat Type	18
"X" Type	13		

P. R. MALLORY & CO., Inc., INDIANAPOLIS, INDIANA