

# Radio Instructor

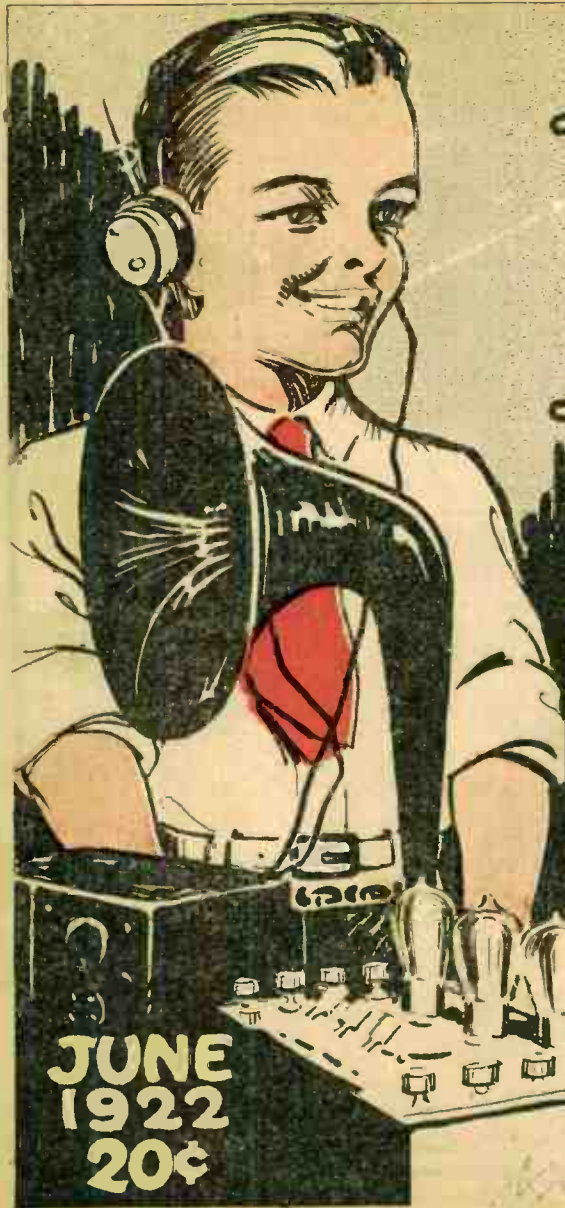

*In this issue-*

**The Theory of the  
Vacuum Tube  
Single Circuit Receivers  
Radio (high) Frequency  
Amplification**

**VALUABLE RADIO MAP  
and Many Other Features**



**JUNE  
1922  
20¢**

**CIRCULATION THIS ISSUE 135,000 COPIES**

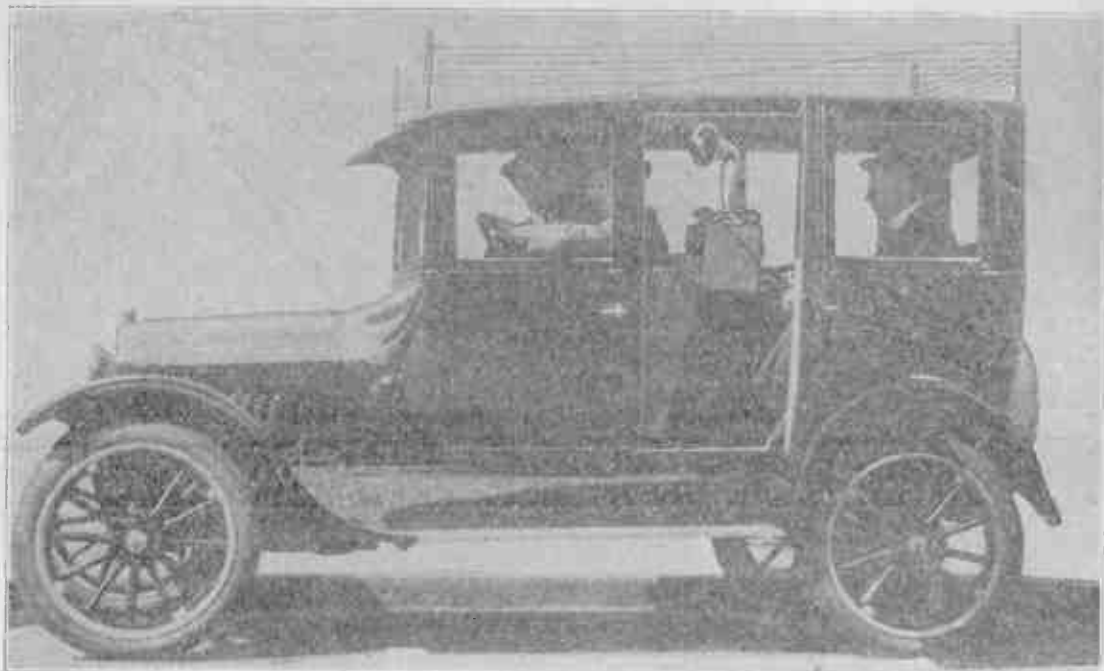

One of the latest radio developments is the radio car. The Chevrolet Motor Company has proved that radio equipment operates satisfactorily in an automobile without the use of a "ground."

The possibilities that this portable radio receiving station offers include an almost limitless field of use and with such tremendous strides as these made in its development, it is bound to become one of the indispensable utilities of modern civilization.

With a car equipped in this fashion it is possible for a family to drive anywhere within 100 miles or so of a broad-casting station and picnic while the radio in their car amuses or instructs them with music, sermons, or wireless telegraphy. Education and entertainment can be transported to wherever people congregate. With a few cars equipped as this one is, a minister could talk to a dozen congregations at once. If the United States Department of Agriculture had similar radio equipment in the hands of its county agents, department experts could talk to thousands of farmers at once and thus bring the tremendous added benefits to our agriculture that would be made possible through a greater broad-casting of its work.

If the political candidate had a broad-casting station available he could send a radio equipped car to every voting area in his state, and talk to all of his constituents at the same time, thus saving his vocal chords and making it possible for his hearers to stop listening when they were tired.

The installation of this equipment in the Chevrolet car is so simple that it is possible to adapt it to many uses, and therefore we may expect to see many cars similarly equipped in the future. It is also only a matter of a few moments to remove the radio equipment from the car when it is not desired for use there. It can then be used in the home or the office, or any other place desired.

Just as anywhere on the high seas ships can keep constantly in touch with ports and other ships through the use of the radio, now the automobile—the land ship—can immensely facilitate distribution of information to the great benefit of mankind.

One ingenious amateur, by utilizing the power of the generator on his car, not only receives messages, but also transmits them.

Such equipment makes possible the use of motor cars as scouts or reports of crop, weather or news messages from any part of the country.

The reporter need no longer be obliged to beat his rivals to the wire. With a car equipped to talk instantly and directly with the radio office of his paper, he is free of all restrictions or competition.

## A RADIO MAP OF UNITED STATES

SIZE 32 by 36, IN COLORS

SHOWING, in addition to general features, with principal cities and railroads

### RADIO INFORMATION

UP TO DATE

*Broadcasting Stations and Their Radii, Registered Call Letters, Wave Lengths Time Differences, Mileages, Hours of Broadcasting, Programs, etc., etc.*

This all-around *Radio* and *Reference Map* is invaluable to the individual for Home, Business or Radio Use.

PRICE 50c POSTPAID

**THE GEORGE F. CRAM COMPANY**

Radio Map Headquarters

111 No. Market Street,

Chicago

# RADIO INSTRUCTOR

"The Magazine of Radio Instruction"

Editorial and Business Offices

800 N. Clark St.

Chicago, Illinois

Vol. 1

JUNE, 1922

No. 2

Published monthly by The Rural Publishing Corporation, 800 North Clark St., Chicago, Ill. Application made for entry as second class matter at the postoffice at Chicago, Ill., Single copy, 20c. Subscription price, \$2.00 per year.

Articles dealing with radio in any form solicited. All manuscripts must be accompanied by return carrier. Not responsible for manuscripts lost in the mails.

**COPYRIGHT, 1922, BY THE RURAL PUBLISHING CORPORATION**

**IMPORTANT NOTICE:** Due to a conflict in names which would naturally cause confusion, two publications appearing in this city under the same name: Radio Digest, we decided to adopt the above name and we feel that the cover design of this issue will readily portray to the buyer that this is the second issue of what was formerly Radio Digest. Our policy and aim will continue the same: to give the reader the latest and most authentic information pertaining to the now all-absorbing subject, Radio.

## The Theory of the Vacuum Tube

*By Daniel E. Moore*

Associate American Institute, Electrical Engineers,  
Associate Institute of Radio Engineers.

We are led to believe from the great number of questions asked about it that an explanation of the operation of the vacuum tube in radio work is not amiss.

The theory of operation is based on the emission of electrons and the control of such electrons. That may sound a bit technical but really is not quite as bad as it appears to be.

Scientists have come to the conclusion that when a metal is heated a vibration is set up in the small particles which constitute the metal; they are disturbed and are shuffled around and if a certain degree of heat is attained some of them are pushed off the metal—it would be better to say they are "flipped" off, much as the fellow on the end of the "whip" is flipped off when boys crack the whip on the ice. These particles which are "flipped" off are called electrons and are really small negative charges of electricity. In being flipped off the heated metal they attain a very high speed. Certain metals are capable of "flipping" off more electrons for

a given temperature than others. Mr. Edison noticed this effect during his experiments with the incandescent lamp.

Consider for a moment the ordinary electric lamp with which we are all pretty familiar. It consists of a glass bulb, inside of which there is a loop of wire, the ends of which come through the glass and are fastened to a suitable base for connecting it to a source of electricity. Figure 1 shows such a lamp connected to a battery and also

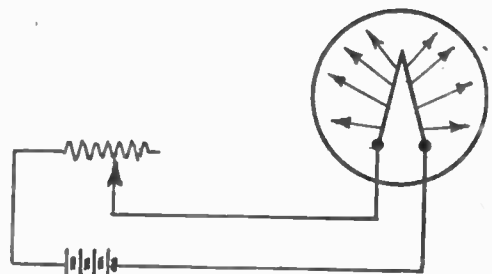

FIG. 1

shows a device called a rheostat which is used for controlling the amount of current we allow to flow through the filament.

Now when the current is allowed to flow through such a circuit as shown in Figure 1, the lamp can be made to light brightly or dimly by varying the rheostat and just as soon as it is lighted it starts to emit or "flip" off these electrons we have spoken of. If the filament is allowed to be bright there is a great discharge of electrons and if it is dimmed down, the discharge of electrons falls off.

If we light the lamp brightly and allow it to remain so lighted for a few minutes, this is what occurs: the electron emission commences as soon as we light the lamp, the electrons flying toward the inside of the glass and pretty soon the discharge will fall off because the inside of the bulb becomes charged with negative electricity and a negative electric field is established around the filament, which will repel any electrons which have a tendency to fly off the filament. (Like charges repel, unlike attract.)

### The Plate

However, if a second element is introduced into the bulb at the time of its manufacture, a continuous stream of these electrons can be cared for as follows:

At the time of manufacture, beside the filament and its terminals, a metal plate is built in the bulb and a terminal brought out from this plate and connected to a source of E.M.F., such as a battery, in such a way that the plate is at a positive (+) potential with respect to the filament, then the negative charges (electrons) from the filament will be attracted toward this plate. So dense is this stream of electrons when the proper relation is established between the filament temperature and the voltage of the plate, that if a sensitive current measuring device (milliammeter) is introduced into the circuit as shown in Figure 2, it will be noticed that quite a perceptible current flow is established between the filament and the plate.

If the battery which is in the plate circuit ("B" battery) is provided with means for varying the potential of the plate, by tapping the battery or other means, it will be noticed that as the voltage of the plate is increased the milliammeter will show an increase in current and as the voltage is decreased the current will fall off. This, within certain limits, as it will be found that

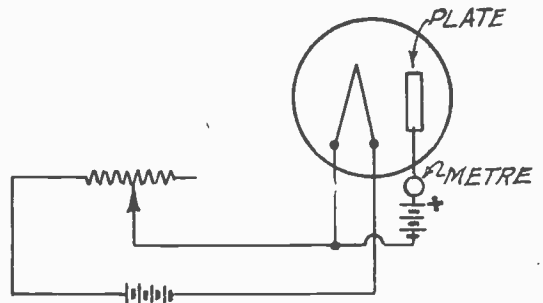

FIG. 2

when a certain plate potential is reached any further increase in the plate voltage will not cause an increase in current between the filament and plate. When this point is reached it is known as the "saturation" point and indicates that all the electrons which are emitted by the filament are being absorbed by the plate. However, if the filament temperature is now raised slightly, then by increasing the plate potential, a further increase in current is indicated by the milliammeter.

All bulbs have a potential filament temperature at which the electron emission is best and this is found by experimentation.

A curve showing the current flow described above is shown in Figure 3.

### The Grid

It is readily seen that if some means can be used to prevent some of the electrons from reaching the plate and this means controlled, we can vary the filament plate current without changing the filament temperature or the plate voltage. This is what is done in the modern three element (or electrode) vacuum tube by introducing at the time of manufacture a third element known as the "grid". This "grid" takes any one of several forms; sometimes it is made up as a metal screen or rather fine mesh; sometimes as a spiral of metal and sometimes as a ladder-like frame, but regardless of its shape or style of structure, it is always be-

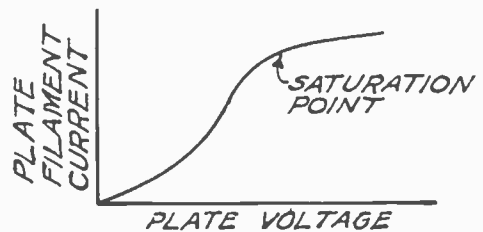

FIG. 3

tween the filament and the plate. It is connected into the circuit in such a way that it is at a negative potential with respect to the filament in its normal condition. This is shown in Figure 4.

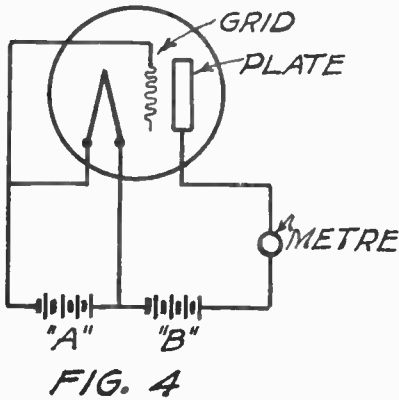

FIG. 4

However, if means are provided to change the potential of the grid with respect to the filament so that at one instant it is more negative than the filament and the next it is less negative than the filament, the milliammeter will indicate a change in current flow in accordance with these changes in potential. This is due to the fact that as the grid becomes more negative than the filament, the electrons are repelled by the grid and prevented from reaching the plate, while if the grid is made less positive than the filament, the electrons pass through it to the plate, some of the electrons, of course, clinging to the grid.

Figure 5 is a curve showing the change in plate filament current with a change in grid voltage.

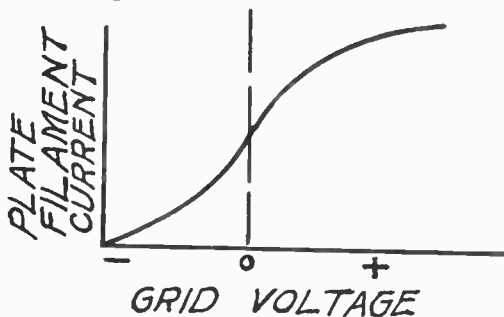

FIG. 5

Advantage is taken of these characteristics of the vacuum tube and cause its widespread use in radio work.

By referring to Figure 4 we notice the similarity between it and the ordinary simple vacuum tube receiving circuit. If we

modify it slightly as shown in Figure 6, we have a simple radio receiving circuit. As will be noticed, we have inserted a grid condenser and a primary and secondary inductance and substituted a telephone receiver for the milliammeter.

Now as electromagnetic waves sweep across the antenna and through the primary inductance coil, they induce a current in the secondary inductance, and as they are alternating currents their potential changes from zero to positive and back through zero

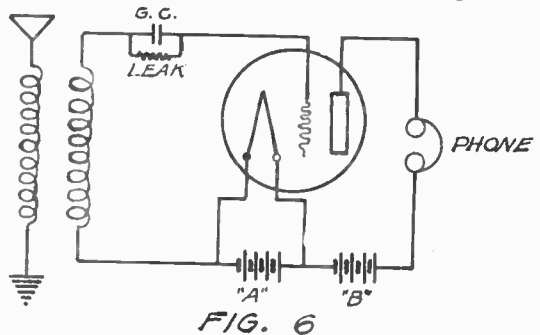

FIG. 6

to negative and so on, inducing changes in the secondary and thus the grid. If these pulses or changes in potential are at an audible frequency, the changes in the current flow between the filament and the plate, through the receivers will be at an audible frequency and will be detected in the telephones.

There is a particular value of normal grid potential which is best for radio work, and the simplest method we can use to obtain this value is by means of the grid condenser and grid leak shown in Figure 6. The leak is used to allow excess negative charges to flow away from it, since if means to allow this is not provided, the vacuum tube becomes "paralyzed" and no signals are obtained and the electrons are repelled by the excessively negative grid. These leaks are best determined for each tube by experiment and may be made by fastening a strip of paper across the terminals of the grid condenser and drawing pencil lines between the terminals until the proper value is found.

### Regeneration

It will be seen from the foregoing that the greater the change in potential of the grid or controlling device, the greater will be the change in current flow through the receivers and since we know that the energy received on the antenna is comparatively small, other means which would allow greater changes to take place in the grid potential,

would give stronger signals. One of the means which is utilized to accomplish this is by means of the "tickler" coil. This is an inductance coil introduced into the plate circuit of our receiving set and arranged so that it can effect the secondary coil. Now whatever current flows through the filament plate circuit, also flows through the tickler coil, setting up a field which will induce

stronger or weaker changes in the secondary and hence the grid. In this way very small primary circuit potential changes can be made to produce large changes in the grid and consequently the plate circuits.

It is to be hoped that the foregoing will clear up some of the mystery which has surrounded the workings of the vacuum tube.

## The Part Played by the Antenna in Radio Transmission

Every transmitting set consists of an oscillatory circuit containing capacity and inductance and the necessary apparatus to produce a high voltage for charging the capacity.

The antenna is a part of the oscillatory circuit and its mission as applied to transmission will be discussed here.

In order that the range of transmission be as great as possible, it is necessary to arrange the oscillatory circuit in such a way that the electric field which is established when oscillations are set up in the circuit, will be of suitable shape, and of appreciable strength at great distances. This is accomplished by making either the condenser or the inductance of the oscillatory circuit of large physical dimensions. Generally it is the condenser which is made large—this takes the form of the antenna.

There are various shapes and forms of antenna—the "L" type, the "T" type, the "Cage" and the "Loop". The dimensions as well as the shape and style vary in practice.

About the simplest type is the "L", and may consist of a single horizontal wire, supported at a predetermined height above the earth and insulated therefrom. This is the aerial part of the antenna and forms one side of the condenser of the oscillatory circuit. The ground is the other side or plate of the condenser or this second plate may take the form of a counterpoise, i. e., a second wire like the aerial may be laid on the ground or close to it, directly under the aerial. Both the aerial side of the antenna and the ground or counterpoise are connected to the ends of the inductance coil which is included in the oscillatory circuit.

One of the important features of the antenna is the so-called "directional" effect. When the antenna circuit is made to oscillate the range of transmission due to the in-

tensity of the electric field is decidedly greater in the direction of the end at which the lead in wires are connected than in any other direction.

Advantage may be taken of this when erecting an antenna so that the greatest benefit may be derived if there is a choice of stations with which one wishes to work, by pointing the aerial wire toward that station with which it is desired to communicate and connecting the lead in wire at the end closest to that station. A noticeable falling off in range occurs with any other method of installation.

The "V" type antenna consisting of two diverging horizontal wires is another which is quite decided in its directional effect. This effect is in the direction of the apex of the "V" where the lead-in should be connected.

The umbrella type consists of a number of wires supported at their upper ends by a mast and radiating outward from the mast much the same as the ribs of an umbrella. The lead is attached to the upper ends of the ribs and the outer ends of the ribs are insulated from the ground. This type of antenna in connection with the transmitting aerial.

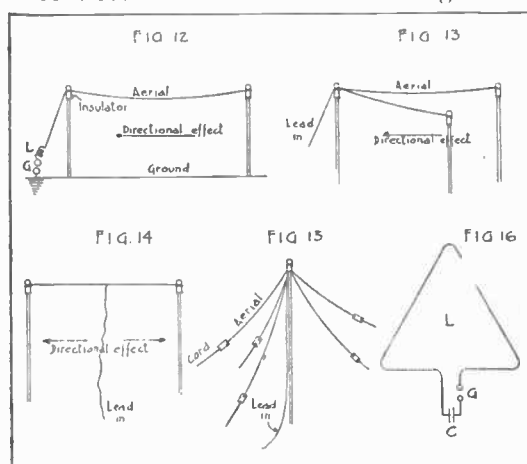

has no directional effect, the field strength being equal in all directions.

The "Loop" antenna usually consists of one or a few more turns of wire around a special frame and is generally used for short wave transmission. They are directional in their plane.

## Single Circuit Receivers

About the first things a person does after deciding to enter the radio field is to look up some friend who has a receiving set and obtain dope on just what kind of a set, the materials necessary and how to wire it, generally following pretty closely in his friend's footsteps. However, after once being able to receive signals his natural inquisitiveness leads him to investigate on his own hook with an idea toward getting better results out of his equipment or as good results with less equipment or greater ease of operation.

With the advent of honeycomb coils on the market, it is rather easy for different circuit combinations to be hooked up which will allow the entire band of wave lengths now in use in this country and in foreign countries to be tuned in, and this without a particularly apparatus layout, and without a great deal of expense.

With this in mind the circuits accompanying this article are submitted. They use a single coil at a time, and by changing coils stations transmitting on any wave length in use at present may be "tuned in", amplifiers be used to bring the signals up to the desired strength. These circuits will, no doubt, suggest others to the mind of the investigator. With honeycomb coils ranging from twenty-five to one hundred turns, used with different antenna, these circuits are very well adapted to the reception of radio telephone signals.

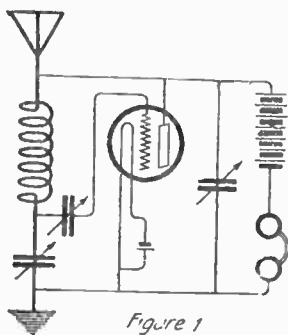

Figure 1

Too much cannot be said about the importance of keeping the resistance of the open oscillating circuit as low as possible. One of the best ways to accomplish this is by using the "counterpoise" instead of ground. At most of the stations which are reaching out and covering the greatest distances, will usually be found a counterpoise

The condensers shown may be fixed condensers except the one in the antenna-ground lead which must be variable in order to get the best out of the circuits and to allow tuning to the different wave lengths.

No. 1 is an excellent oscillator, tuning being very sharp, but when receiving spark signals regeneration is not so easily controlled as with some of the other circuits.

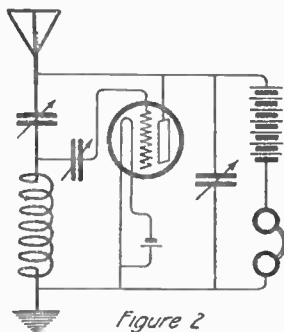

Figure 2

No. 2 seems at times slightly more sensitive than No. 1, but it is not so good an oscillator.

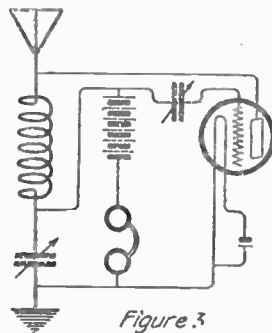

Figure 3

No. 3 is a good oscillator and is sensitive, but requires more A and B battery than either of the circuits No. 1 and No. 2. No. 4 requires less A and B battery than the other circuits and is the best oscillator of all the circuits tried. One prominent radio engineer states that with this circuit a single Marconi V.T. has brought in several trans-oceanic stations. Of all the circuits tried

employing a capacity feedback, No. 5 was far superior to the rest. Arc signals are

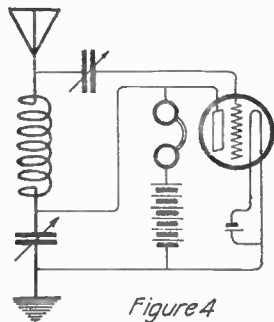

Figure 4

strong and clear; spark signals are strong but the circuit is better for the reception of undamped waves.

It is well to mount the various apparatus on a panel and "screen or shield" it to remove the capacity effects of the operator's hand in making adjustments. This is done by installing a copper or zinc plate behind the panel and grounding it, being careful that it does not touch any of the apparatus parts.

Very satisfactory results will be obtained with these circuits and although some difficulty may be experienced in selectivity, still the ease with which various stations may be found compensates for this disadvantage to a considerable extent.

## An Easily Made "B" Battery

The average experimenter with vacuum tubes is always looking around for a "B" battery which he may readily put together himself and renew as he finds necessary.

If one is possessed of a charging outfit, a good "B" battery can be easily constructed and kept in condition without much trouble, but there are apt to be a good many who do not happen to have access to a suitable charging set and would have to depend upon someone else to keep their high voltage battery supply up. It is for the latter that this description is given.

This battery will give plenty of current and will last a year or more under average operation. The first thing to obtain is a set of glass test tubes 4" long and 1" in diameter. These may be obtained from a supply house at a cost of about five cents each. One tube will be required for each volt and a quarter needed in the battery so that for a detector "B" battery about eighteen tubes are required. Then obtain some carbon rod such as used for arc lamps and cut into sections four and one-half inches long, and flat sheet zinc, one-eighth inch thick, and cut it into strips four inches long and three-eighths inches wide. One carbon rod and one strip of zinc will be required for each cell of battery. Bore an eighth inch hole through one end of the carbon rod and bore a hole slightly larger than the carbon in a block of wood. Fill the hole with molten lead and dip the end of the carbon which has the hole in it, into the lead, thus forming a cap on the carbon or the end of the carbon may be fitted with a binding post by drilling for an 8/32 screw and locking up with nuts. A wire

can be soldered to the zinc and we are now ready to assemble.

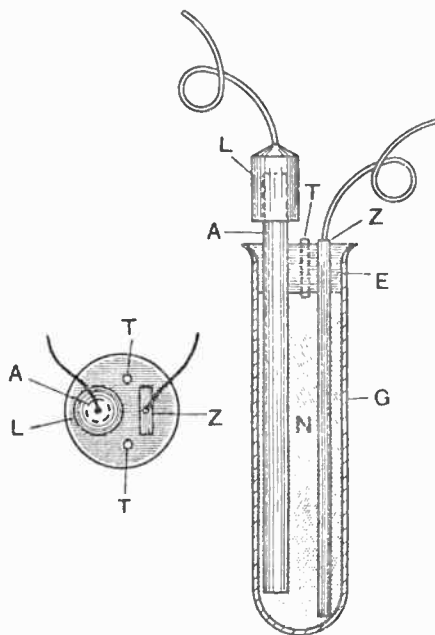

Place the zinc and the carbon in the test tube and fit a disc of bakelite in the tube, allowing the carbon and zinc to project through about one-half inch or the tube may be filled with fine sand to a half inch from the top and asphaltum compound melted and poured into the tube filling it. While the asphaltum is melted fit a small glass tube in the top or allow it to cool and then drill a small hole through it to allow the removal of the fine sand and also the pouring in of the electrolyte.



After the desired number of cells are made up a box may be built which will accommodate any number of the cells. Old cigar boxes are very useful for this purpose. Pour

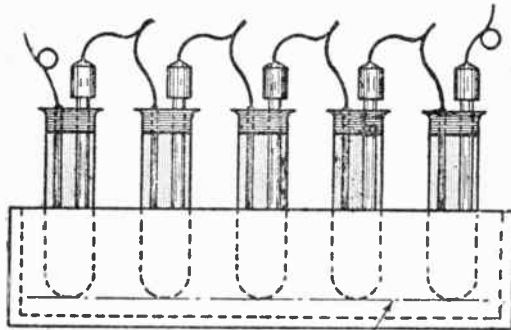

FIRST LAYER OF WAX  
Fig. 2.

in a layer of wax and stand as many cells as will be readily accommodated in it and then fill the box with more wax of asphaltum compound. The electrolyte, consisting of a weak solution of salammoniac and water may be poured into each tube. Connect the cells in series and the units are ready for work. Figure 1 shows details of the cell and Figure 2 an assembly in a box.

In Figure 1, G is the test tube, A is the carbon rod; Z the zinc; T, small tube or hole in the top filling.

Any number of these cells may be connected up and will be found perfectly reliable for drain up to one hundred fifty milliamperes for several hours at a time without any great drop in voltage.

## A Further Discussion of Wired Wireless

So many requests have reached this office concerning the "wired wireless" which was mentioned in a former issue of this paper that it is proposed to satisfy those interested by describing a little more in detail this system of transmission.

It seems that during the war it was found to be a good plan to try out some method of communication which would be reliable and at the same time save wire and the labor attending the laying of such wire deep in the ground in order to protect it from damage. It was known that communication by radio was possible between submarines when they were submerged so that radio waves evidently passed through water. With this end in view the Signal Corps of the United States Army began experimenting with bare copper wire laid in the water, using radio instruments for the transmitting and reception of the signals.

The set was tuned to a wave length corresponding to 600,000 cycles per second.

Further experiments were made by burying a strip of wire netting in the snow outside the C.S.O. office in Washington, and bringing one end into a vacuum tube receiving set located on the second floor. Signals from various points in the United States were readily received. During these experiments the type of antenna called the "resonance coil" was developed. This is in the form of a helix with a large number of turns of wire, having a metal band around it which may be slid along to any point on the coil, the point of highest potential being connected to the grid of a vacuum tube. This resonance coil has decided directional effects when used as an antenna and may be used as part of the antenna or as the antenna itself. The sliding band may be seen in the accompanying photograph.



Using a No. 18 phosphor bronze antenna wire laid in the Potomac River near Washington and reaching from shore to shore, satisfactory results were obtained with both telegraph and telephone signals.

One of the Signal Corps sets in use at the time was connected at each end. The receiving end set had its grid connected directly to the bare wire from the opposite shore but had the usual ground connection left open.

Mr. Paul F. Godley, a foremost radio expert, proposes the passage of a law which will prohibit the indiscriminate use of the "ether" for the purpose of free advertising and we heartily endorse his proposition.

Capt. Leroy Boylan is in charge of the organization of 33rd Signal Co., a new unit of the Illinois National Guard. The company will have an elaborate radio equipment.

# The Construction of an Efficient Radio Receiving Set

*(The first article of this series appeared in the May issue.)*

*(A limited number of the May issue may be had from publisher.)*

(Continued from the May Issue)

The problem of assembling the apparatus now confronts the builder.

Various layouts of the apparatus suggest themselves to one's mind but the one to be described has been found to be a good one.

Toward the right-hand side of the panel, along one of the short edges, the tuning coil may be mounted so that it is inside the edge of the panel about one-half inch when standing on end.

Three inches from the bottom of the panel and two and one-half inches in from the edge, drill a hole large enough to take the shaft of the switch lever specified in our first article. Insert the switch lever shaft and press down on the blade, turning the

the close adjustments which must be obtained at times are more readily had than if the hand has to be held high as the natural tremble prevents critical adjusting.

The mounting of the vacuum tube socket is best accomplished by drilling two holes through the panel and two corresponding holes in the edge of the socket, the last two being tapped for a 6/32 flat head machine screw. This allows a safe clearance between the vacuum tube and the back of the panel.

The rheostat for controlling the filament current may be fitted to the panel immediately below or to the side of the vacuum tube socket.

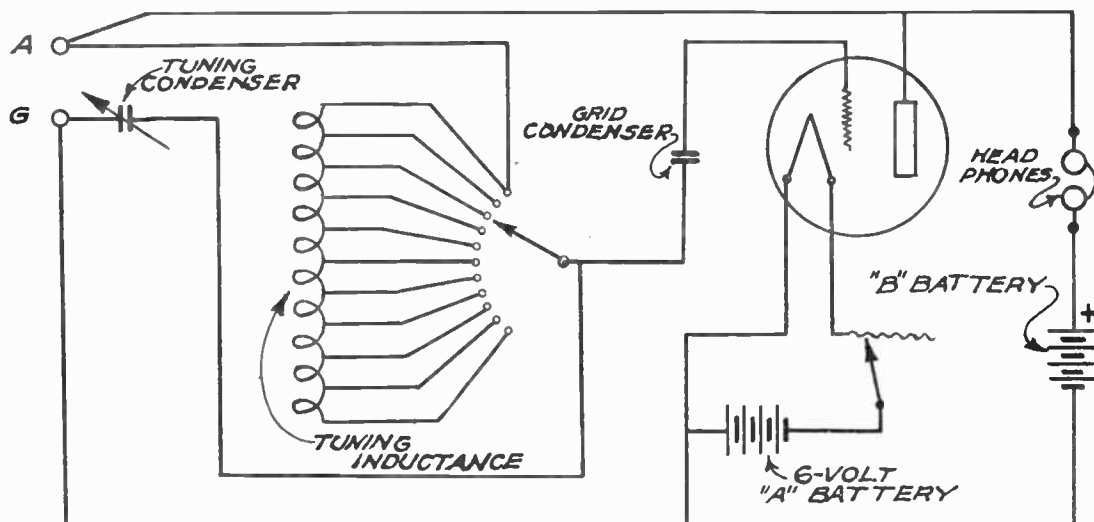

switch lever through half a circle, thus marking the panel slightly. Then lay off on this semi-circle points where the holes will be drilled for the switch points (or screws).

At the opposite side of the panel a hole must be drilled for the shaft of the variable condenser.

It is a good practice to mount the condenser low enough on the panel to allow the operator's arm to rest on the table as

A hole  $\frac{3}{4}$ " in diameter should be drilled in the panel directly in front of the vacuum tube to allow for ventilation and observation of the tube.

Holes must be drilled for the binding posts, the arrangement of which is left to the fancy of the constructor.

However, one thing which must be kept in mind, is to keep the various leads as short as possible and endeavor to not run

wires parallel to each other for any great distance.

If one of the new vernier rheostats which have lately appeared on the market can be obtained it is advisable to do so, as they allow a very close regulation of the filament and it has been found that with the modern vacuum tubes, a very critical adjustment is necessary to obtain the proper relation between filament and plate potential, which adjustment is readily obtained with a vernier rheostat.

After the various small parts are assembled on the panel, the last step is to mount the coil, using the brass brackets described in our first issue.

We are now ready for wiring and a good place to start is right at the coil itself by soldering the "taps" to the switch points.

The remainder of the wiring is readily done by following the diagram.

By using a cabinet eight or nine inches deep to enclose the set when completed, the "B" battery can be enclosed with the balance of the apparatus and a very portable receiving set is obtained.

The circuit shown and used in the set which has been built in the laboratory of this magazine has proved very sensitive and is well adapted to long wave reception by increasing the size of the inductance coil.

One must be careful that the moving plates and stationary plates of the condenser do not short circuit as this will exhaust the "B" battery in short order.

### The Operation of the Set

Connect the aerial and ground leads to the proper binding posts, also the six-volt storage battery and the head receivers.

Turn the rheostat lever around until the filament of the vacuum tube is brightly lighted at which time a sound is heard in the phones. If this is in the form of a strong hiss, reduce the filament current slightly. Move the switch lever over the points and as each new point is reached, revolve the condenser slowly until signals are heard. Once a signal is heard, careful adjustment of the rheostat and condenser is necessary to bring it in loud and clear.

Patience is rewarded by the results obtained.



*International*

### Selected Men Learn Radio Work at Chicago High Schools

Selected men due for the second and following drafts, who have passed a physical examination, are being instructed in radio and buzzer work in three of Washington's high schools.

The U. S. Army is looking to these men, trained in the proper course, to furnish 15,000 men needed for the signal corps.

The student at these radio classes who has reached the required standard of sending and receiving twenty words a minute will receive a certificate giving the name of the student, his draft number, residence, number of hours of attendance at the course. This will serve him when he is called to appear for examination at the second and succeeding draft.

Photo shows an expert radio operator instructing class of selected men in one of the Washington high schools.



*International*

### College Students Have Radio School

Students at Union College, Schenectady, N. Y., enjoy the privileges of the Radio School at the college, and have extended the privileges to high school students of the city. The radio class is part of the college work, there being no charge for those outside the college who wish to attend the radio classes, at which operation and receiving of radio sets are taught. The only requirement is the ownership of a pair of receivers, so that all may get in on the same connection. Here's the class in session.

# Radio (High) Frequency Amplification

The average "Radio Fan" is not long in the game before he finds it desirable to equip his station with some form of amplifying apparatus. Usually this apparatus is of the so-called "audio" frequency type. That is, the radio signals are detected and rectified with some form of detecting device, a crystal set or a vacuum tube and then amplified to the desired volume with additional vacuum tubes and iron core transformers.

There is one very good thing about audio frequency amplifying apparatus; it is simple to construct and operate and is adapted to a wide range of wave lengths.

For the benefit of those who are not familiar with this type of equipment, a brief description is not out of place.

The ordinary vacuum tube detector circuit will be taken as a base. We see from Figure 1 that the head receivers are in series with the plate of the detector tube, the "B" batteries and the filament. To provide the first stage of amplification, the head phones are removed from the detector circuit and in their place the primary winding of an amplifying transformer is connected. There are several types of these transformers on the market, which range in price from three dollars and a half to seven dollars. They consist of an iron core around

impregnated paper or other insulating material and on top of this a "secondary" winding consisting of several thousand turns of wire, is wound.

If the number of turns of wire in each winding is the same, a coil known as a one to one (1/1) ratio coil is obtained but if the primary winding has only one-half as many turns as the secondary, we obtain a so-called two to one ratio and so on.

The coils on the market range from three to one ratio to ten to one ratio.

There seems to be quite a difference of opinion among experimenters as to the best ratio coil to use. However, a great deal depends upon the particular vacuum tubes one is using for amplifiers.

The writer has experimented considerably with the two most generally used tubes now on the market in a two stage amplifier and has obtained very satisfactory results using a ten to one coil in the first stage and a three and one-half ratio coil in the second. This arrangement gives a high voltage amplification in the first stage and a fairly high power output from the second stage. From ninety to one hundred and thirty volts are used on the plates of the amplifier tubes.

But we are getting away from our story. The secondary of the amplifying transformer is connected as follows: one terminal

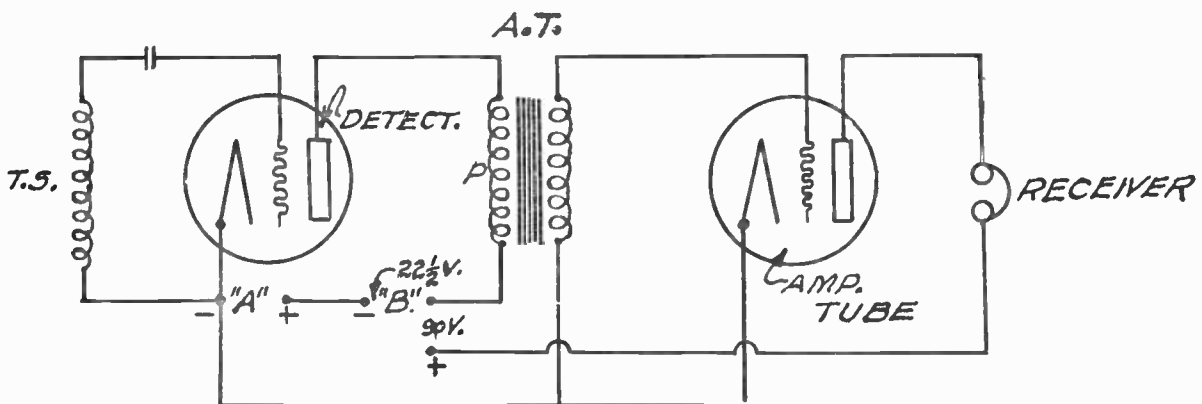

FIG. 1

which is first wound several thousand turns of copper wire (the size varies with the manufacturer's idea) forming a "primary" winding. Around the primary is wrapped

is connected to the grid of the amplifying tube and the other terminal of the secondary is connected to the negative side of the "A" battery.

This is the type of amplifying apparatus found to-day in thousands of radio stations. giving, if not the best results, very satisfactory ones. (Fig. 1.)

Certain circuit refinements may be instituted in the above described method which will improve the quality of the signals obtained. One of these is to experiment toward finding out just where the terminal of

fication. With this method the incoming signal is amplified before it is rectified (or detected), then detected and heard direct or may be then amplified with one or several stages of audio frequency amplification and finally heard through the phones or loud speaker. This is a method which has been used by the more advanced experimenters for some time but is little known

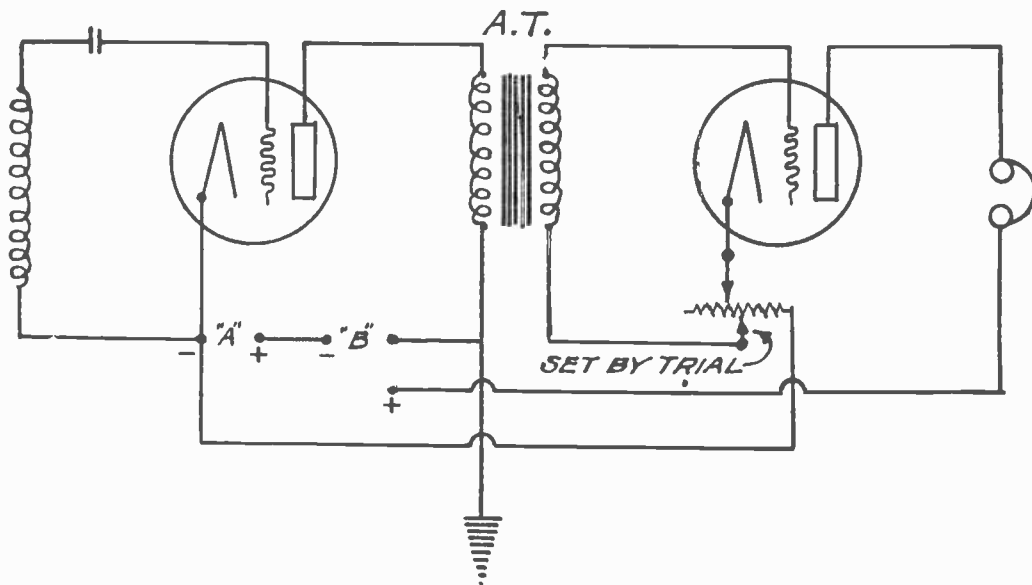

FIG. 2

the secondary winding which goes to negative "A" battery should be connected to give the best results by trying out different points on the filament rheostat and when the proper point is found soldering the secondary lead to it. This will probably vary with different tubes, some requiring one and a half volts negative potential on the grid and some more.

Another improvement is obtained as follows: connect a retardation coil in parallel with the primary winding of the amplifying transformer and a one microfarad condenser in series with it. (Figure 2.)

However, audio or low frequency amplification has its limitations also. It has not proved to be the best form of amplification for the high frequencies corresponding to the shorter wave lengths, that is, those ranging from 180 meters to 1,000 meters. The best way to handle these higher frequencies is by "radio" frequency ampli-

to the more recent entrants into "Radio-

dom." There are several ways in which radio frequency amplification may be accomplished but the method about to be described is about the simplest all round method which the writer has found and about which data is at hand.

The circuit diagram is shown in Figure 3 and is self-explanatory. The high frequency transformer is the only part of the equipment with which the experimenter may not be familiar and so the following data is supplied:

This consists of a coil with an air core and may be wound on a solid rod of bakelite or other like material or on a tube one inch in diameter and two and one-half inches long. On the tube or rod chosen, wind a single layer of No. 36 B. & S. gauge insulated copper wire, preferably silkwound. After the first layer is wound, a layer of insulating paper or linen is put on and then

a second layer of the wire. These two windings form the primary and secondary of the transformer.

A transformer so constructed will cover a range of wave lengths from 200 meters to 1,000 meters and will be found to give

place of the tubular form of coil a disc may be used to wind the primary and secondary on.

A station equipped with radio frequency amplifiers is better equipped to operate during the summer months than one which is

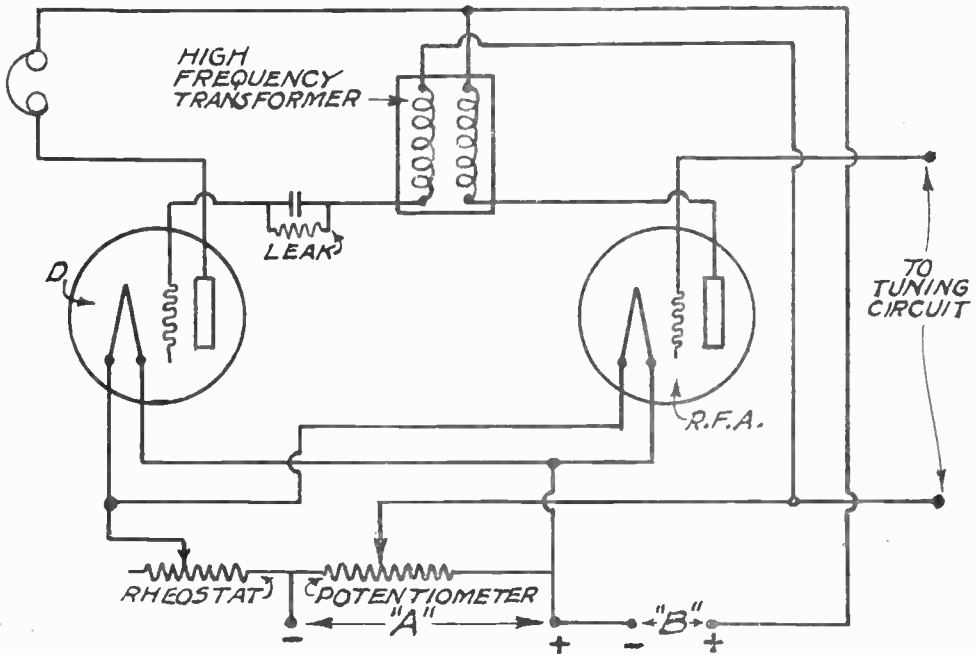

FIG. 3

very good results. It is well for the reader to know that windings other than the ones given may be constructed on larger or smaller cores and substituted in the circuit shown so that a very wide band of frequencies may be covered with sets of coils wound for the different bands of wave lengths.

The chief point is that the radio frequency amplification demands that the amplifying coil used be constructed with enough inductance and capacity to give it a natural frequency close to the frequency of the signal which it is desired to receive. In

not, as greater freedom from "static" disturbances is obtained with this system. It is well to "shield" the different parts of a receiving circuit from each other and especially important is to where radio frequency amplifiers are used. This is accomplished by surrounding the coils and other apparatus, each with a metal box of copper, zinc or aluminum and grounding all the boxes. Although this causes losses due to the "shield" absorbing energy from the apparatus, more stable operation is obtained as well as freedom from disturbances outside the receiving set.

It is said that red hair and large ears are an asset to those desiring to become wireless operators.

Young women of Radcliffe College have installed a radio set to keep in touch with their home towns.

For the first time in history election returns were broadcasted by several stations in Chicago, Tuesday, April 11.

Song hits from the student opera were broadcasted in advance of the performance by the students of the University of Illinois.

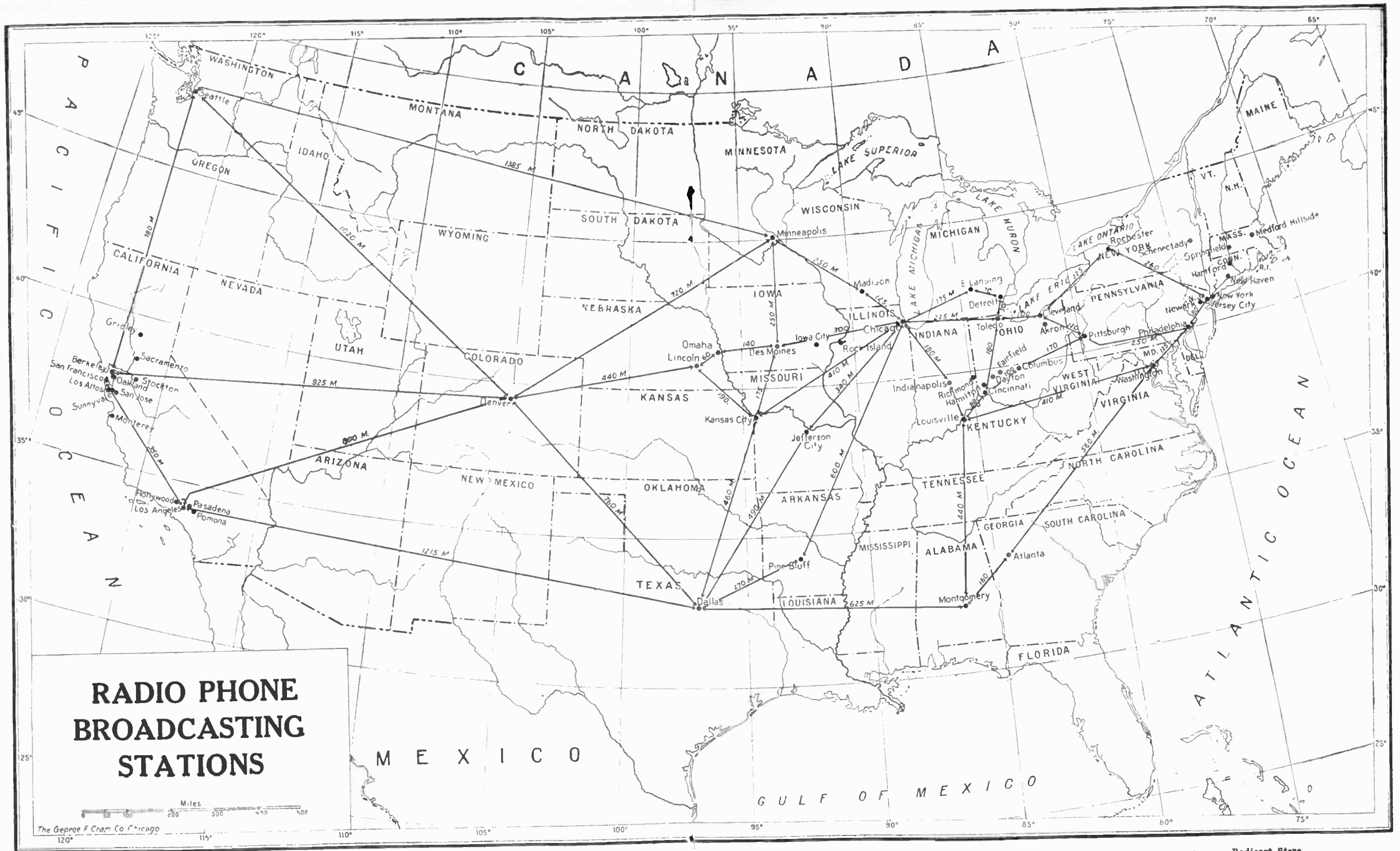

# RADIO PHONE BROADCASTING STATIONS

Call Letters	Wave Length	Location	Company
WKH	360	Montgomery, Ala.	Montgomery Light & Power Co.
WOK	360	Pine Bluff, Ark.	Pine Bluff Co.
KFU	360	Berkeley, Cal.	Maxwell Electric Co.
KFY	360	Gridley	The Precision Shop
KGC	360	Hollywood	Electric Lighting & Supply Co.
KLP		Los Altos	Colin B. Kennedy Co.
KJS		Los Angeles	Bible Institute of Los Angeles
KOG		Los Angeles	Western Radio Electric Co.
KQL		Los Angeles	Arno A. Kluge
KYJ		Los Angeles	Leo J. Meyberg
KZC		Los Angeles	Western Radio Electric Co.
DDV	360	Monterey	Noble Electric Works
KLS		Oakland	Warner Bros.
KZM		Oakland	Hotel Oakland
KZY		Oakland	Atlantic Pacific Radio Sup. Co.
KLB		Pasadena	J. J. Dunn Co.
KGF		Pomona	Pomona Fixture and Wiring Co.
KVQ		Sacramento	J. C. Hobrecht (Sacramento Bee)
AGI		San Francisco	Signal Corps Presidio
KDN		San Francisco	Leo J. Meyberg Co.
KGF		San Francisco	E. C. Lordan

KUO		San Francisco	Examiner Printing Co.
KYY		San Francisco	Radio Telephone Shop
KJW		San Jose	Chas. D. Herrold
KJQ		Stockton	C. O. Gould
KJG		Stockton	Portable Wireless Telephone Co.
KJJ		Sunnyvale	The Radio Shop
KIZ		Denver, Colo.	Reynolds Radio Co.
WQB		Hartford, Conn.	C. D. Tuska Co.
WCI		New Haven	A. C. Gilbert Co.
WDM		Washington, D. C.	Church of the Covenant
WDW		Washington, D. C.	Radio Constr. & Electric Co.
WJH		Washington, D. C.	White & Boyer
WWK1160-1980		Washington, D. C.	P. O. Dept.
3YN	360	Washington, D. C.	National Radio Inst.
4OD	200-375	Atlanta, Ga.	Carter Electric Co.
KYW		Chicago, Ill.	Westinghouse Elec. & Mfg. Co.
WBU		Chicago, Ill.	City of Chicago
WOC	360-485	Rock Island, Ill.	Karlwa Radio Co.
WLK	360	Indianapolis, Ind.	Hamilton Mfg. Co.
WOH	360	Indianapolis, Ind.	Hatfield Electric Co.
WOZ	360-485	Richmond, Ind.	Palladium Printing Co.
WGF	360	Des Moines	Register Tribune

8YA	360	Iowa City	University of Iowa
9ABU	200	Louisville, Ky.	Darrel A. Downard
WGI	360	Medford Hillside, Ms.	American Research & Radio Corp.
WBZ	360	Springfield	Westinghouse Elec. & Mfg. Co.
WWJ	360-485	Detroit, Mich.	The Detroit News
485		East Lansing, Mich.	Stuart Seelye
WHW	360	Minneapolis, Minn.	University of Minnesota
WLB	360	Jefferson City, Mo.	Missouri State Marketing Bureau
WOS	485	Kansas City, Mo.	Western Radio Co.
WOQ	360-485	Lincoln, Neb.	University of Nebraska
9YY	360	Omaha, Neb.	Metropolitan Utilities District
WOU	360-485	Omaha, Neb.	R. B. Howell
WVO	360	Jersey City, N. J.	Jersey Journal
WNO	360	Jersey City, N. J.	Jersey Journal
2AJ	200	Newark, N. J.	L. Bamberger and Co.
WCR	360	Newark, N. J.	Westinghouse Elec. & Mfg. Co.
WJZ	360	New York City, N. Y.	Ship Owners Radio Service
WDT	360	New York City, N. Y.	DeForest Rad. T. & T. Co.
WJX	360	New York City, N. Y.	Amateur Radio Reserve
WYCB	1450	Rochester, N. Y.	Rochester Times Union
WEQ	860-485	Schenectady, N. Y.	General Electric Co.
WGY	360	Schenectady, N. Y.	Union College
WRL	360	Schenectady, N. Y.	Union College

8UX	360	Akron, Ohio	Radioart Store
WLW	360	Cincinnati, Ohio	Crosley Mfg. Co.
WMH	360-485	Cincinnati, Ohio	Precision Equip. Co.
WHK	360	Cleveland, Ohio	Warren R. Cox
8BYV	200	Columbus, Ohio	Electrical Specialty Co.
8YO	275	Columbus, Ohio	Ohio State University
WFO	360-485	Dayton, Ohio	Rike Kumlir Co.
WAI	360	Dayton, Ohio	U. S. Army
WLS	360	Fairfield, Ohio	U. S. Army
WRK	360	Hamilton, Ohio	Doron Bros. Electric Co.
WHU	360	Toledo, Ohio	Wm. B. Duck Co.
WJK	360	Toledo, Ohio	Service Radio Equip. Co.
WSZ	360-485	Toledo, Ohio	Marshall-Gerken Co.
WGL	360	Philadelphia, Pa.	Thos. F. J. Howlett
KDKA	360	Pittsburgh, Pa.	Westinghouse Elec. & Mfg. Co.
KQV	360	Pittsburgh, Pa.	Doubleday Hill Elec. Co.
WEB	360	Pittsburgh, Pa.	Newspaper Printing Co.
WRE	450	Dallas, Texas	Police & Fire Signal Dept.
KFC	360	Seattle, Wash.	Northern Elec. & Radio Co.
KHQ	360	Seattle, Wash.	Louis Wasmor
KJR	360	Seattle, Wash.	Vincent I. Kraft
WHA	360-485	Madison, Wis.	University of Wisconsin
800			

all, making a total of 109 feet 7 inches of wire, but it is best to obtain about 125 feet of wire, which will leave a sufficient amount of wire for the starting and finishing ends. After the wire is all wound on the form, it should be given a coat of shellac. Just before the wire gets firm and solid on the form, wedge apart the wires over the hold so as to allow the shaft to be pushed in tight. This secondary shaft

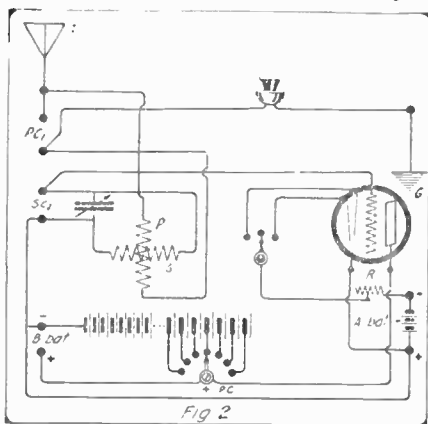

Fig 2

should be about five and one-half inches long and one-eighth inch in diameter. On the front end of it should be soldered a one and one-quarter inch knob and pointer. In front of this pointer have a 180 degree celluloid or brass scale. In back of the panel this shaft is threaded its entire length. It will have nuts drawn up close to the secondary form at the back and front at each end on the secondary form as this will serve to hold the secondary coil very firm and tight, thereby allowing it to revolve very easily within the primary form. At the front of the panel the pointer will indicate on the scale the degrees revolved.

The contacts used for the filament control, and the B battery plate control switches are one inch long with a head  $3/16$ -inch long and  $1/4$ -inch diameter, of either copper or brass. The switch knob is one and three-eighths inches in diameter and swings in a radius of one and one-half inches. This three-contact switch is for the purpose of using either filament of the Audiotron at will and the seven-contact switch is for the purpose of regulating the positive flow of the B battery to the plate. Six of these contacts are connected with six different taps on the B battery in the back of the panel, the seventh contact is idle.

The transmitter used is of the ordinary carbon type.

The binding posts can be either copper or brass, whichever the constructor prefers; it is advisable to have a screw about 2 inches long and  $3/16$  of an inch in diameter; use plain brass washers, there are 15 binding posts in all.

The purpose of the two binding posts at the B battery is meant for testing out B battery, but the average B batteries are test them unless you disconnect them. The primary coil has two binding posts so that if the operator would like to shunt a condenser across the posts, it could easily be done. It is best to use one with .005 mfd. capacity. If a condenser is used, the secondary has two binding posts in order to shunt a condenser with a capacity of 0.001 mfd. This condenser is essential as otherwise the outfit would not prove a success.

Figure 2 gives a good description of the general hook-up and connections of this outfit.

The writer has used a rheostat with a resistance of from 6 to 15 ohms, and in fact the ordinary battery rheostat will do very nicely. The filament is lighted with a 6-volt storage battery.

The writer used from 10 to 15 No. 703 Eveready flashlight batteries wired in series. There are six taps taken from the last six batteries, these taps running to switch contacts on the front of the panel, thereby regulating the B battery current. In Figure 3 is shown the method of mounting the B batteries at the back of the panel between the two bracket braces as well as the method of mounting the telephone transmitter. As will be seen in Figure 2 the wiring is very simple and there are not many wires to contend with.

The Department of Commerce has published a book for the benefit of "ether talk" enthusiasts. It is called "The Principles Underlying Radio Communication". Elementary electricity dynamo-electric machinery, radio circuits, electro-magnetic waves, apparatus for transmission and reception, electron tubes, are the titles to some of the subjects treated. It may be obtained at the Government Printing Office, Washington, D. C. The price is One Dollar.

The word "volt" so commonly used in electricity is derived from the name of the inventor, an Italian—Alexandro Volta.

## A Radio Phone Transmitting Set

The operator who has confined his work to the transmission of radio telegraph signals and the reception of both radio telegraph and radio phone, will sooner or later break into radio phone transmitting. Here he will encounter greater difficulties than he has experienced in radio telegraphy due to the different character of the waves he has to handle.

It is the purpose of this article to describe the general construction of a radio phone transmitting set which will allow anyone interested to get started.

The apparatus can be mounted on a panel 12"x12" in a manner shown or modified to suit the constructor's ideas. Figure 1 shows a panel laid out to include one of the old audio iron tubes, but any tube which proves to be a good oscillator is satisfactory.

The best material to use for the panel is bakelite, three-eighths or one-quarter inch thick.

Provision should be made for the "B" batteries in the rear of the set. From sixty to two hundred volts will be required and the transmitting range will be found to differ with the voltage applied to the plate.

The primary form of the variometer is of heavy cardboard or bakelite, and its dimensions are respectively 2 inches long,  $1/8$  inches in diameter, and with walls  $1/8$  of an inch thick. It is advisable to paint the form with a good coat of shellac and let it stand to dry before winding the wire on it. After the form has dried, drill an eighth inch hole through the center, allowing the placing of a one-eighth inch shaft for the purpose of rotating the secondary coil within the primary coil. There is also a small hole drilled at each end of the coil to permit two small screws with nuts to be fastened on. To these screws will be connected the start and the finish of the coil windings. Connected from these screws will run a flexible wire to the binding posts on the panel, thereby eliminating the possible chance of the wires getting broken off short. These flexible wires may be made of No. 18 lamp cord.

Now we are ready to pass on to the winding of the primary coil. It will be wound with No. 26 S.S.C. magnet wire and the winding will start one-eighth inch in and continue to one-eighth inch from the end. There will be 91 turns of wire in all,

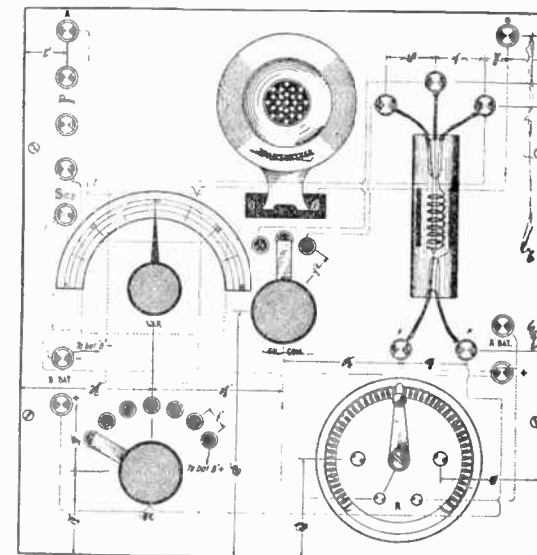

making a total of 98 feet 8 inches of wire, but it is best to obtain about 120 feet of wire, which will leave a sufficient amount for the starting and finishing ends. It is also advisable to purchase one-eighth pound of wire in case the constructor would like to make up several of these coils. After the wire is all wound on the form, it should be given a coat of shellac. Just before the wire gets firm and solid on the form wedge apart the wires over the hole so as to allow the secondary rotating shaft to be pushed through, allowing plenty of freedom for the shaft to work. Now that the coil is ready to mount on the panel, it is best to mount it with two small brass wood screws. There is an eighth-inch space at each end, which will give plenty of room for the two screws. These screws should be about one-half inch long, that length being ample enough to hold the coil very nicely.

Now for the make-up of the secondary coil which is similar to the primary coil. The secondary form of the variometer dimensions are respectively 2 inches long,  $3/8$  inches in diameter, and with walls of  $1/8$  inch thickness. It should be shellacked, drilled, etc., just as was done before on the primary coil form. After this coil is dry it is ready for the winding, and it should be wound with No. 30 S.S.C. magnet wire. The winding will start one-eighth inch in and continue to one-eighth inch from the end. There will be 134 turns of wire in



# Fundamental Principles of Radio

(Continued from the May issue.)

In a previous article we saw the two fields (electromagnetic and electrostatic) which exist around a conductor which is carrying a current of electricity.

If the current in the conductor is an alternating one the fields surrounding the conductor will be alternating, varying in intensity and direction with great rapidity and spreading outward from the conductor at the rate of 186,000 miles per second or 300,000,000 meters. (Let us keep the speed in meters in our mind.)

It is generally conceded at present that a medium known as "ether" pervades all space, surrounding the conductor much the same as water would surround an object placed in it.

For a moment, think what happens when a rock is dropped into a still pool of water; quite a splash occurs in the immediate vicinity of the spot where the rock was dropped and circles of ripples start out, spreading in all directions, apparently traveling across the water toward the shore.

Now, some parts of them are intercepted by obstacles and never reach the shore, but it is evident that the water has been disturbed.

Just so when an alternating current is caused to flow in the conductor which we have under consideration. Invisible ripples or waves spread out in all directions causing

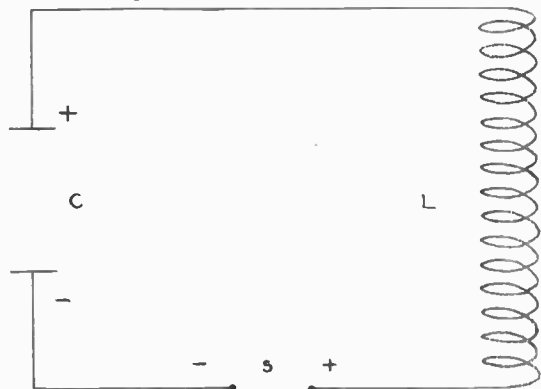

FIG. 4.

a disturbance in the "ether" and carrying with them charges of electricity.

If the conductor happens to be the antenna of a radio transmitting station the alternating current is interrupted by means of a

key for sending code or modulated by means of a telephone transmitter and the waves in the ether vary in accordance with the interruptions.

When these electromagnetic waves come in contact with the antenna at a receiving station they produce an alternating current in it and if suitable receiving apparatus is connected to the antenna, it is possible to hear the signals produced at the transmitting station.

## Oscillatory Currents

Alternating current is divided into three general classes—low frequency, moderately high frequency and high frequency.

High frequency currents are called "oscillatory currents". Currents having a frequency of twenty thousand cycles per second and up, come under this head.

In order to get a picture of what occurs in an electric current which has an oscillatory current in it, let us consider for the moment the following:

If one end of a steel spring is clamped in a vise and the free end is pulled to one side and then released, it will not only return to its normal position but continue past the center point for quite a distance and then reverse, coming back almost to the point where it started from. This vibration will continue for some time, gradually dying down until finally the spring will come to rest.

When the spring was released after having been pulled to one side it returned to normal because of its elasticity. It did not stop at the center point the first time it arrived there but continued past, because of its inertia.

It gradually came to rest after the energy which had been stored up in it had been expended in friction.

In an electrical way the storing of the energy corresponds to capacity and the inertia is called inductance.

We find an electrical analogy to the vibrating spring in Figure 4, where C is a condenser, L is an inductance coil and S is a spark gap, the three comprising an oscillatory circuit.

Considering Figure 4, if we gradually apply electric charges to the condenser C, raising its potential, a potential will finally

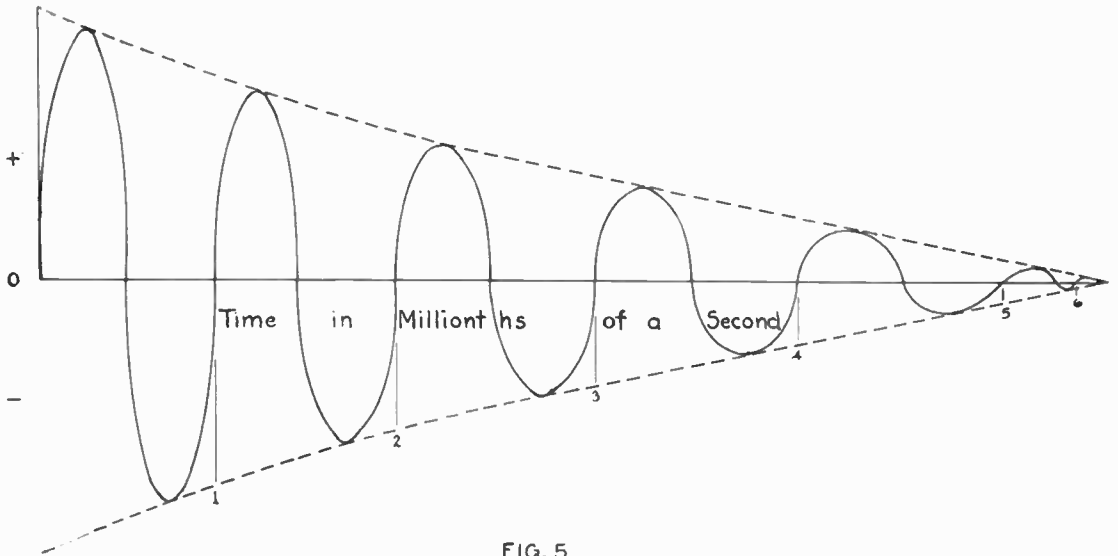

FIG. 5.

be reached which will cause a spark to jump across the gap S. Once the gap breaks down the energy stored in the condenser causes the current to rush across the gap to the other side of the condenser and on account of the inductance L (inertia) it really overshoots the same as the steel spring did and then starts to surge back, this occurring several times before the energy is used up in heat and the potential between the two sides of the gap is equalized so that the jump across the gap ceases.

This discharge across the gap takes place in a series of decreasing oscillations much the same as the spring gradually reduced its swing from side to side. When

the oscillations die down very rapidly they are called "highly damped" oscillations; when they die down gradually they are known as "slightly damped" oscillations and if they persist in amplitude and do not die down they are known as "undamped" oscillations.

Figure 5 shows a wave train of highly damped oscillations.

Figure 6 represents a train of slightly damped oscillations and in Figure 7 is seen a train of "undamped" or "continuous" oscillations. Special means, other than the spark gap must be used to produce "undamped" oscillations.

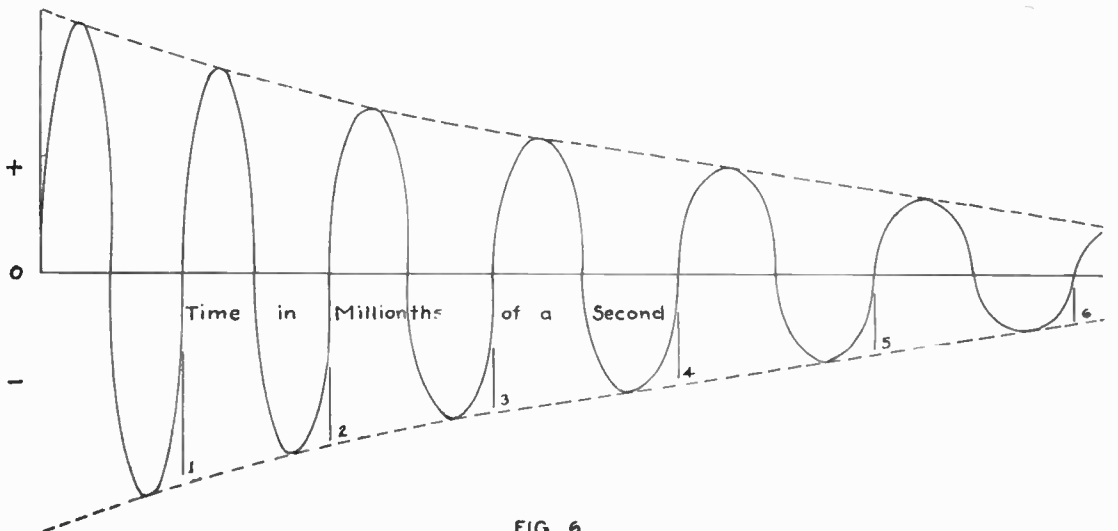

FIG. 6.

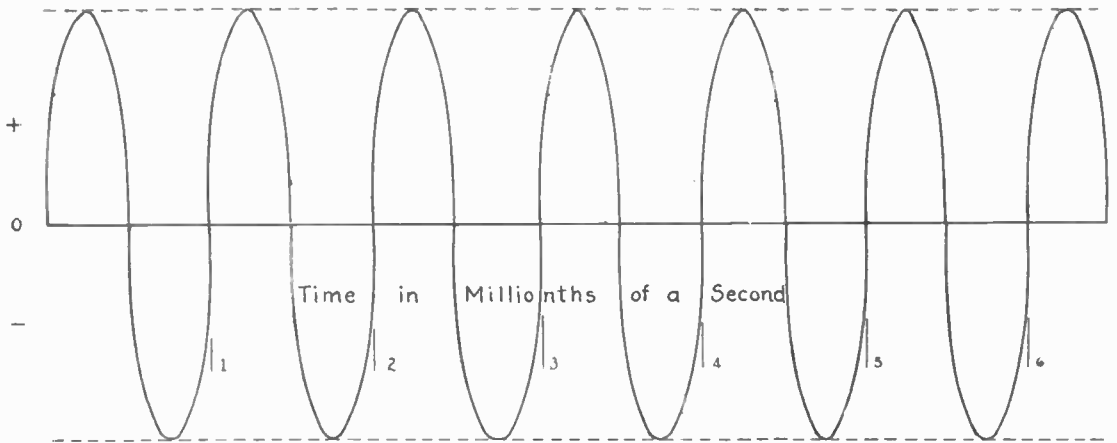

FIG. 7.

**Frequency of Oscillation**

As the frequency of vibration of the steel spring depends on its elasticity, weight and distribution, so the oscillation frequency or "period" of an electrical circuit depends upon several things, namely: the inductance in the circuit and the capacity.

If the product of the inductance and capacity is large, the frequency of oscillation

will be low. The reverse is also true; a small product will give a high frequency.

A simple formula, used for determining the frequency of a circuit is  $1 \div 6.2832 \times \text{square root } LC$  where C is the capacity of the circuit in Farads and L is the inductance in Henries ( $2 = 6.2832$ ).

*(To be continued.)*



*International*

**Pershing "Listens In" at the Radio**

General John J. Pershing, commander of the American army, is another victim of the radiophone. General Pershing has had a set installed at his office in the War Department, and so is able to get in on all the news floating around in the air.

Senator Harry S. New addressed the "New for Senator" club over the radio telephone and intends to do much of his future campaigning by radio.

The S. S. Yale plying on the Pacific coast has installed a powerful receiving set for the benefits of her passengers. Comfortably seated in the salon they may "listen in" to market reports, weather and entertainments which are broadcasted from Los Angeles and San Francisco.



*International*

**Hammond's Wireless Laboratory**

# Inductance Coils for use in Radio Work

The experiments carried on by the average radio fan from time to time require the construction of inductance coils of various sizes. These may be required in receiving circuits, transmitting circuits or for use with wave meters. In order that information may be readily available, the following tables and formulae are given which will enable anyone to construct proper coils to meet the requirements of the moment.

The inductance of a solenoid (single layer coil) may be calculated from the Nagaoka formula,

$$L = (3.1416)^2 d^2 n^2 l k, \text{ where}$$

L=desired inductance

d=the diameter of the coil in centimeters

l=the length of the coil in centimeters

n=number of turns per centimeter

K=a constant depending upon the ratio of d/l.

The calculation of the required inductance to allow tuning to a certain wave length may be done by using the formula wave length=1,885  $\sqrt{LC}$  where L=inductance in M. H. and C=Capacity in microfarads.

Where dimensions are given in centimeters multiply by 2.54 to obtain inches.

Table one gives the inductance of single layer coils ranging in diameter from four to eighteen centimeters and wound with wire twenty turns to the centimeter. If the wire varies from twenty turns per centimeter, calculate as for twenty turn wire and multiple by  $X^2$ .

20<sup>2</sup>

For working with short wave lengths the single layer coil is well adapted but when it is desired to tune in the longer wave lengths from six thousand to thirty thousand meters, single layer coils become of such size that they are very unwieldy and so recourse must be had to some other type of coil.

If one wishes to purchase the so-called honeycomb type of coil, he will find them well adapted to these higher wave lengths. but if it is desired to make the coils, some method other than winding in a single layer must be used. Data for constructing honeycomb coils has appeared in various publications from time to time so that by reference to it, it is perfectly possible to construct that type.

However, there are other designs of winding which give satisfactory results if care is used in winding. It must be borne in mind that the method of winding one layer

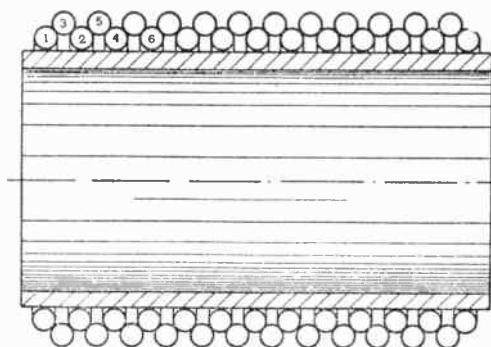

Fig. 1. Two-layer Banked Winding.

of wire on a tube for its entire length and then starting back to wind a second layer is not satisfactory on account of the distributed or rather self-capacity of the coil which results from such a winding.

One method of winding a coil which will result in a very satisfactory coil is what is known as "banked winding". This may be carried through several layers although if more than five or six layers of winding are put on, capacity asserts itself and some of the desired gain in efficiency is lost.

In the case of "banked" winding a layer is not wound complete before passing on to the next, but the wires are arranged to pass from one layer to the other and back again with the result that the voltage set up between adjacent turns will not be that of an entire layer, but will be the voltage across a few turns. In this way the capacity of the coil is kept fairly low.

Various methods of winding such coils are shown in Figures one and two. A two-layer and a four-layer bank winding being shown. The successive turns in these windings are numbered so that their order of winding can be easily followed and the drawings self-explanatory. Variations may be tried but the results will probably not be as good as if the diagrams are followed.

An ordinary multilayer coil, that is one made by winding a complete layer and then another layer and so on may be greatly im-

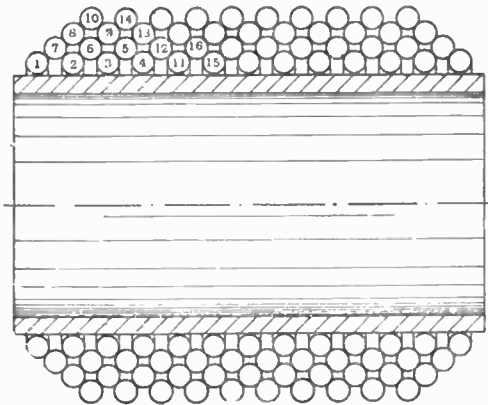

Fig. 2

proved if it be broken up into section as shown in Figure three.

One of the effects of high frequency currents, which must be kept constantly in mind in radio work is that known as "skin effect". This causes the resistance of a coil or any conductor to be higher at high frequencies than when low frequency or direct current passes through the conductor. "Skin Effect" is caused by the forcing out from the center of the wire toward a comparatively thin "skin" near the surface, of the current in the conductor. It will therefore be seen that the entire cross section of the conductor is not available for carrying current. but only this outside "skin".

Moreover, the effective resistance of a conductor when it is wound into coil form is considerably greater than it would be

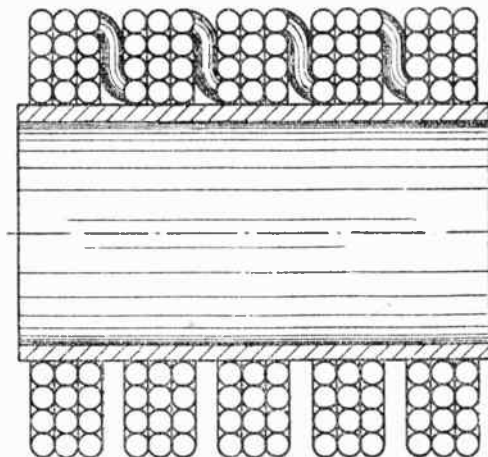

Fig. 3

were it stretched out straight, when high frequency current passes through it, owing to the proximity of the several turns of the coil to each other. This causes an increase in the skin effect and one of the reasons for it is the self-capacity of a conductor or a coil.

If we think of the self-capacity of a coil acting as a condenser connected across the terminals of the coil, it may be shown that self-capacity causes another increase in the resistance of the coil to high frequency currents.

TABLE I.  
Inductance of a solenoid wound 20 turns per cm. Inductances in microhenries.  
Diameters of solenoid in cms.

Length cms.	Diameter of solenoid.										
	4.	5.	6.	7.	8.	9.	10.	12.	14.	16.	18.
1	23	32	41	50	60	70	80	—	—	—	—
2	66	93	122	155	185	218	253	324	399	478	559
3	119	169	224	283	346	389	480	623	784	932	1095
4	174	252	338	432	531	636	745	974	1221	1480	1745
5	232	340	460	590	719	881	1040	1370	1725	2095	2482
6	292	430	587	761	945	1201	1350	1790	2270	2795	3300
7	351	523	717	932	1165	1415	1680	2240	2850	3490	4180
8	413	617	850	1109	1390	1695	2016	2710	3454	4250	5110
9	474	711	985	1291	1624	1980	2360	3200	4080	5025	6050
10	537	807	1120	1472	1858	2275	2720	3680	4725	5857	7050
12	666	997	1395	1842	2345	2870	3440	4700	6074	7546	9130
14	786	1193	1673	2216	2810	3475	4185	5740	7450	9310	11290
16	911	1390	1951	2593	3300	4090	4940	6800	8880	11140	13600
18	1037	1583	2231	2972	3800	4711	5700	7880	10310	12980	15850
20	1162	1779	2512	3352	4290	5330	6460	8970	11780	14860	18190
22	1287	1975	2794	3734	4820	5960	7230	10060	13250	16750	20560
24	1414	2170	3005	4115	5290	6590	8000	11160	14730	18670	22940
25	1536	2370	3357	4502	5790	7390	8780	12270	16230	20610	25370
25	1656	2565	3642	4883	6290	7840	9680	13390	17730	22550	27810
30	1782	2761	3922	5264	6790	8480	10330	14500	19230	24500	30260
32	1920	2958	4207	5652	7290	9110	11100	15620	20750	26460	32730
34	2044	3155	4490	6040	7800	9519	11930	16730	22260	28650	35200

Referring to Figure four we see an inductance coil  $L_0$  having the capacity  $C_0$  bridged across it and connected to the terminals A and B. Such an arrangement may

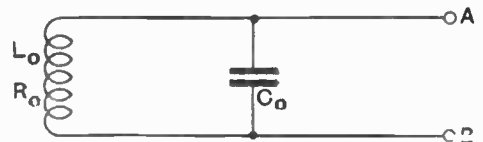

Fig. 4.

at certain frequencies behave as an enormously high resistance between A and B. Thus no current could flow through it between A and B.

Suppose such a combination should be connected in a receiving circuit, it may be

TABLE 2

Ratio  $\frac{d}{D}$  diameter bare to diameter covered.

Gauge	Single Silk $\frac{d}{D}$	Double Silk $\frac{d}{D}$	D.C.C. $\frac{d}{D}$
20	0.947	0.905	0.781
22	0.94	0.911	0.737
24	0.934	0.879	0.687
26	0.915	0.855	0.643
28	0.899	0.83	0.597
30	0.888	0.804	0.553
32	0.88	0.81	0.545
34	0.86	0.783	0.535
36	0.838	0.773	0.487

TABLE 3

Turns per cm.—covered wire.

Gauge	Single Silk	Double Silk	D.C.C.
20	10.4	9.9	8.6
22	13.2	12.8	10.7
24	16.7	15.7	12.3
26	20	18.7	14.1
28	23.9	22.1	15.9
30	28.2	25.5	17.6
32	32	29.6	19.9
34	36.8	33.6	22.9
36	43.3	40	25.2

seen that at the natural frequency of the combination no current would flow through because of the infinitely high resistance.

It is to be hoped that this information may be beneficial to those who wish to experiment with coils of different inductance values.

A radio telephone license has been issued by the Department of Commerce to the University of Texas. The equipment is very complete and a corps of students are organized to keep the station open at all times of the day and night to receive communications. The call assigned is U.M.C. and the operator is authorized to use 485 meter wave length.

Secretary of the Navy, Denby, has suspended the use of the naval radio for the broadcasting of political addresses and lectures.

Miss Rachel Thompson, of Cambridge, Mass., is, as far as we know, the only woman instructor in radio in this country. She is a licensed operator and one of the best authorities in the east.

The Gimbel store of Milwaukee will broadcast programs from 2 to 5 P. M., and 7:30 to 9:50 P. M. This station will cover a radius from 800 to 1000 miles and will be the only privately owned and operated broadcasting station in this station.

Radio telephony played detective in the search for Rulif Martin, a Kansas City war veteran who disappeared from home on March 27. Descriptions of the missing man were broadcasted from several stations.

The purpose of this section is to enable those interested to keep abreast of the developments in radio. It is hoped that engineers and others will avail themselves of our records and possibly save themselves time and effort thereby.



International  
Receiving Crop Reports by Wireless

No science in recent years has made such rapid strides with the general public since the advent of automobiles as radio. The Chicago Board of Trade has inaugurated a system of broadcasting market reports for the information of farmers and those directly interested in the production and marketing of America's grain crops in the great grain producing sections of the Central West. The University of Illinois, under the management of its electrical society, is instructing farmers in the use of radio. Photo shows Mr. Charles Daugherty, who is a farmer in Champaign, Ill., receiving crop reports by wireless over an instrument which was perfected for him by members of the Electrical Engineering Society of the University of Illinois.

# A Relay Recorder for Remote Control By Radio

By F. W. Dunmore

## RADIO LABORATORY, BUREAU OF STANDARDS

Review of the Subject.—Relays have been used for many years in wire telegraphy and other electrical work. The practical operation of relays actuated by received radio signals is a comparatively recent development, and has been made possible by the development of the electron tube amplifier.

This paper describes the development and the operating principles of a type of relay recorder which is designed to operate from the output terminals of a radio receiving set and which may also be operated by any other source of audio-frequency signal.

By the use of special electron tube circuits, the audio-frequency signal is caused to operate an ordinary telegraph relay.

In order to avoid the necessity for using a very sensitive relay, designed to operate on currents of a milliampere or less, which would have delicate adjustments and light contacts and spring tension, advantage was taken of an electron tube amplifier, which has now become a reliable radio instrument, to increase the input voltage to the relay circuit thus making possible the use of a simple ordinary high-resistance telegraph relay. The relay device has therefore been developed to operate from the output circuit of any suitable amplifier in place of the ordinary telephone receivers.

The operation of the relay may serve to work a sounder, buzzer, tape register or any mechanism for remote control by radio.

Two types are described. One type is designed to be operated from batteries. The other type is designed to operate entirely from any 60-cycle 110-volt lighting circuit and this feature makes this type simple and inexpensive to operate, durable and practical. Another unique feature is described which is that of tuning to different audio-frequencies whereby any one of three signals, each of a different audio pitch, may be caused to operate the relay to the exclusion of the others.

Curves and diagrams are shown illustrating the principles of operation.

By the use of two of these relay recorders connected in series across the output terminals of a single receiving set, two messages sent on practically the same wave length of different audio-frequencies, have been accurately received simultaneously.

### Contents

Type A—For Use with Batteries.

1. Object of Development. (20 w.)
2. Requirements. (100 w.)
3. Circuit Used. (280 w.)
4. Principle of Operation. (275 w.)
5. Method of Increasing Sensitivity and

Selectivity. (275 w.)

6. Speed of Operation. (75 w.)
7. Sensitivity. (100 w.)
8. Durability. (40 w.)
9. Portability. (25 w.)
10. Uses. (230 w.)

Type B—For Use on the 60-Cycle, 110-volt A-C Supply. (330 w.)

### Type A—For Use with Batteries

1. Object of Development. The object of this investigation was to develop a relay which would operate by received radio signals.

2. Requirements. To be satisfactory as a relay recorder the device should have the following characteristics: (1) it must be of simple construction with few adjustments; (2) it must be easy to adjust and capable of being put into operation quickly; (3) it must be selective and as free from static and such disturbances as possible; (4) it must be capable of operating at a speed of at least 12 times per second; (5) it must respond to weak signals; (6) it must be of strong design, durable and capable of maintaining its adjustments; (7) it must be portable.

3. Circuit Used. In order to avoid the use of a very sensitive relay designed to operate on currents of an adjustment necessary is that of an ordinary telegraph relay.

Fig. 1 shows the wiring diagram. A is a telephone plug for connecting the relay de-

vice to the amplifier output. B is a phone socket, so that if desired the operator may listen to the received signal in the ordinary way. C is an audio transformer of the type

fact that  $-30$  volts is already sufficient to reduce the plate current to zero. The result will be a pulsating direct current of 10 milliamperes, maximum amplitude, in the plate circuit. This current, flowing through the plate circuit and condenser F causes an increase in the plate current at the keying frequency, which change, passing through the relay coil will pull the relay armature over, making contact at T, which contact may control any mechanism desired. With the "C" battery grid voltage adjusted for maximum sensitivity it was found that static induction, etc., operated the relay. When these disturbances are not as strong as the signal their effect on the relay may be overcome as shown in Fig. 3. For example, the

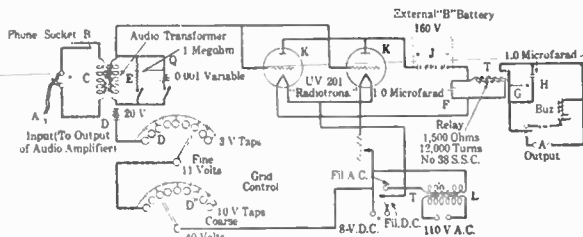
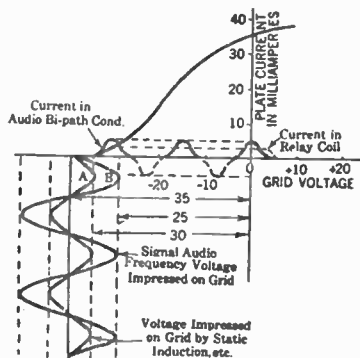

Fig. 4—Type A Relay Recorder for Use with Batteries  
 Fig. 6—Type B Relay Recorder for Use on the 110 Volt A-C Supply  
 Fig. 1—Circuit Diagram of Relay Recorder for Use with Batteries  
 Fig. 2—Tube Characteristic Showing Principle of Operation of Relay Recorder  
 Fig. 5—Circuit Diagram of Relay Recorder for Use on the 110-Volt A-C Supply

used in audio amplifiers, the type used at present being a Signal Corps Type C-21. E is a two-megohm, grid leak. Q is a 0.0006-microfarad variable condenser or 0.0003-microfarad fixed condenser. D is a 60-volt variable "C" battery variable insteps of approximately three volts. J is a 160-volt dry "B" battery self-contained within the set. K. is a type UV-201 Radiotron. F and H are each a one-microfarad paper condenser. T is an ordinary telegraph relay rewound with 12,000 turns of number 38 S.S.C. enamel wire. A is the output to be connected to the apparatus to be controlled. L is a step-down transformer for operating the tube filaments from the 110-volt a.c. supply when such a supply is available.

4. Principle of Operation. The principle of operation is illustrated in Fig. 2. By means of the variable "C" battery D, the



"C" battery is shown increased to  $-35$  volts, the critical value for maximum sensitivity being  $-30$  volts. The disturbances due to stray currents, etc., merely reduce the "C" battery voltage to  $-30$  which is not sufficient to cause plate current to flow. However, the signal, being of greater intensity than the stray currents, reduces the voltage to  $-25$  which causes a plate current of five milliamperes. It will be seen therefore that all disturbing effects, if of less intensity than the signal, do not affect the relay.

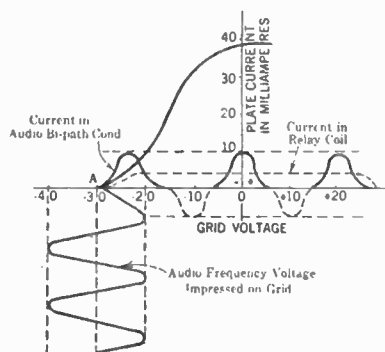

5. Method of Increasing Sensitivity and Selectivity. During the development of this relay it was found that the rectified audio-frequency current in the plate circuit caused the relay armature to chatter rapidly and make a poor contact with the fixed contact point through which the circuit is closed. This was overcome completely, however, by the addition of a one-microfarad condenser across the relay coils. This served the purpose of an audio-frequency by-path for the highly inductive winding of the relay, thus greatly decreasing the resistance of the circuit. The change of plate

grid voltage is adjusted to approximately 30 volts at which value the plate current is from  $-30$  to  $-40$  volts is not effective in causing a plate current to flow due to the



current due to this audio-frequency caused a second change which occurred at the keying frequency. This latter change passes readily through the relay coils and exerts a strong steady pull on the relay armature without the least chattering.

It was also found that the 0.0006 microfarad variable condenser, Fig. 1, across the secondary of the input audio transformer made possible audio tuning, which increased the selectivity considerable. This tuning was very sharp and it was found that European stations could be made to operate the relay while a high power station here in the United States would fail to operate it, although the high power station was coming in on the same wave length and slightly stronger. This was made possible by adjusting the heterodyne note of the European station to a frequency different from that of the local station and then tuning the secondary of the audio transformer to that frequency. The 0.0006 microfarad variable condenser may be replaced by a 0.0003 microfarad fixed condenser and the audio tuning accomplished by adjusting the heterodyne note to the resonant frequency. By means of this audio tuning one of three stations transmitting simultaneously has been selected and caused to operate the relay although all were of equal intensity. By the use of two relay recorders connected in series across the output terminals of a single radio receiving set, two messages sent on practically the same wave length, but of different audio frequencies, have been accurately received simultaneously.

6. Speed of Operation. Tests showed that with a signal strength sufficient to produce a plate current of 10 milliamperes the relay could be operated at a speed of 48 contacts per second, the contact being sufficient to operate a buzzer. With three milliamperes in the plate circuit a speed of 27 contacts per second was obtained. With one milliampere a speed of 19 per second. In each case the relay armature spring tension was adjusted for the best operation.

7. Sensitivity. As stated above, this relay was designed primarily with the intention of obtaining a device which should be durable, simple in operation, and strong in construction. Sensitivity is obtained by means of radio-audio amplification thereby increasing the voltage input to the relay circuit and eliminating the necessity of extreme sensitivity in the relay. Tests at 600

cycles showed that the relay circuit was fairly sensitive, as approximately 1.3 volts at the input terminals of the audio transformer in the relay circuit, caused a current of five milliamperes to flow through the relay coil in the plate circuit.

8. Durability. As the relay instrument used in this recorder is of the ordinary telegraph type its durability is well established. The only elements requiring occasional renewal are the two electron tubes, the 60 volt "C" battery, and the 160 volt "B" battery.

9. Portability. The complete recorder with the exception of the filament lighting battery is contained in a cabinet 7 in. by 13 in. by 11 in. as shown in Fig. 4.

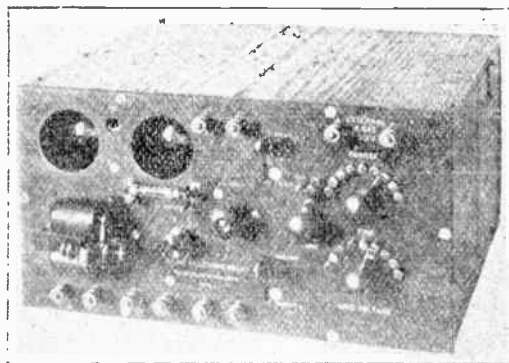

#### 10. Uses.

1. As an ordinary receiver it has advantages over reception with telephone receivers, for one may receive by buzzer or sounder with all induction and interfering noises eliminated (if not louder than the signal.)

2. A tape or drum-type recorder may be used and a copy made without a trained radio operator.

3. Time signals may be recorded.

4. A call system may be worked by a time switch connected to close the filament circuit for a given time at set calling intervals.

5. Any form of mechanism may be operated by an incoming signal.

6. A receiving station may be located remotely from the transmitting station and the radio signals relayed by wire to the operating room some miles distant.

In conclusion it may be stated that a relay of this type should operate satisfactor-

ily, without attention, on an airplane where mechanical vibration may be excessive as the pull on the armature with three milliamperes, or over, in the relay coil makes possible the use of a spring tension on the relay armature sufficient to keep it from moving due to mechanical vibration of the relay.

It would seem that the above mentioned feature makes this remote control relay more serviceable than those now on the market which require delicate adjustment of spring tension, contact points, and suspended vibrating elements.

**Type B—For Use on the 60-Cycle, 110-Volt A-C Supply**

This recorder is similar in construction and operation to the Type A recorder, except that the plate and grid voltages (B and C battery) are supplied from the 60-cycle, 110-volt a-c supply. The current for operating the tube filaments is also obtained from this source, so that the recorder is operated entirely independent of any form of batteries. It is only necessary, therefore, to connect to the 110-volt a-c line and the recorder is ready to operate.

The method of operating the recorder from the a-c supply consists in the use of the two receiving tubes as rectifiers as shown in Fig. 5. The tubes Y and Z are

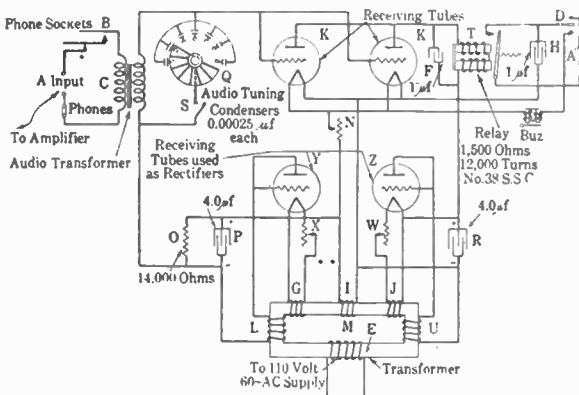

used as half wave rectifiers, one supplying the plate voltage, and the other grid voltage. When used as rectifiers, receiving tubes should have the grids and plates electrically connected together. A special transformer M with six windings is used. Two of the windings G and J, supply the filaments of the two rectifier tubes. A third,

I, the filaments of the recorder tubes. A fourth, U, the high voltage for the plate. The fifth, L, supplies the grid voltage, and the sixth, E, is the 110-volt primary winding. The rectified alternating current is smoothed out by means of four microfarad condensers P and R, connected across the output terminals. As the currents in the grid and plate circuits are small, smoothing out inductance was found unnecessary. It was found necessary to put 40,000 ohms as shown at O, across the output circuit of the rectifier tube supplying the voltage to the grid, as the grid is otherwise insulated from the filament of tubes K by the rectifier tube. By means of the filament rheostat, X and W, the grid and plate voltages may be varied over any ranges desirable for the most efficient operation of the recorder. By the use of binding posts with straps as shown in Fig. 6, the type B recorder may be operated

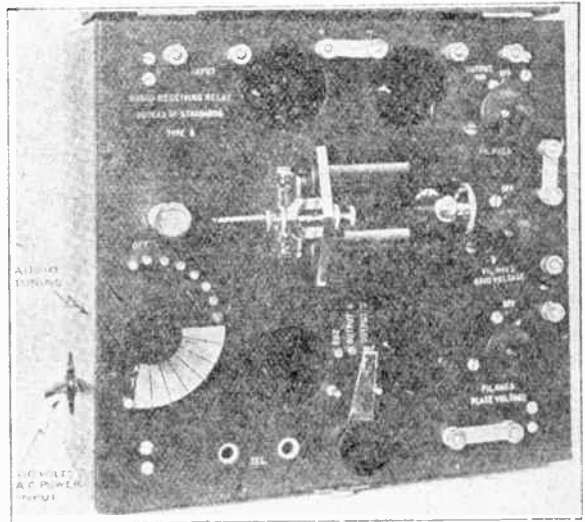

from A, B and C batteries for supplying the filament, plate and grid voltages respectively in cases where the a-c. supply is not available.

In cases where very high-speed operation is desired, the ordinary relay may be replaced by one designed for high-speed operation.

(Presented at the Spring Convention of the A. I. E. E., Chicago, Ill., April 19-21, 1922.

Reprinted from the Journal of the American Institute of Electrical Engineers.)

## Questions and Answers

Q. Can a 3500 meter receiving transformer be used in the circuit described in the article by C. Y. Davis in your May issue, instead of the variometer? (Various other apparatus is listed which is being used with a crystal detector at present.)

I. F. Michol'sky, Forest Park, Illinois.

A. Yes, the primary of your transformer can be connected as shown for the stator of the variometer and the secondary as the rotor, but provision must be made to "loosely" couple the two coils. All the other apparatus you mention may well be used with a tube set.

Q. R. L., Batavia, Ill., asks if the set described in our May issue can be used for receiving Newark and Paris radiophone messages.

A. Yes, it will receive Newark if used with an aerial of 125 feet or over. The signals will be weak but clear. However, I do not think you will be able to get Paris without the use of amplifiers. I know of no set on the market which has reached out that far from Batavia on radio telephone signals without using amplifiers, however, I have in front of me a set like the one described, a tuning and detector unit without amplifiers on which I regularly get Detroit, Schenectady, Pittsburgh and Newark.

Thanks for the boost you gave our publication.—Ed.

The Electrical Contractors Association of Brooklyn, N. Y., have announced plans for their first radio and electrical exposition to be held May 6 to May 20, inclusive.

The Indiana state prison has installed a radio receiving set for its inmates.

It is said that Floyd Hanson, a barber of Neillsville, Wis., can hear radio messages without the aid of an electrical device whatsoever. Hanson has intercepted messages sent on a 360 meter wave length.

It is estimated that the radio army is growing at the rate of 3,000 daily.

Q. 1. Is a loose coupler better than a double slide tuner? If so what size wire would you use and method of connecting.

2. What determines the receiving distance?

3. Is enameled wire all right for winding couplers?

H. M. Woods, Madison, Wis.

Answer—

1. A loose coupler is better for receiving than a double slide tuning coil as it is more selective than the tuning coil. The primary may be wound with the No. 22 D.C.C. and the secondary with No. 26 or No. 28 D.C.C.

2. The receiving range is determined usually by the location of the station, the care used in making the installation and the character of the apparatus used.

3. Enameled wire may be used but cotton or silk insulated wire is better for the purpose you mention.

Q. W. R. Fairgrieve, Hillsdale, Michigan, wishes data on a crystal set to enable him to hear Detroit.

A. On a tube 4" in diameter wind 50 turns of No. 18 bare copper wire spacing the winding in order that a second winding of No. 24 D. C. C. may be wound in between the turns. Attach a sliding arm to operate over the bare copper winding connecting ground to the slider and the aerial to one end of the No. 18 bare coil. Connect the ends of the secondary to a crystal detector set and you are all set to hear stations farther away than Detroit if they are not using a wave over 400 meters.

Cyrus Pierce & Co., a bond concern of Stockton, Cal., will transmit the latest financial news, bond quotations and advice to their branch office and customers.

The University of Yale Publicity Department announces that the results of football games and other events may soon be broadcasted by radio.

The Chicago Public School system is instituting the instructorless class room. One instructor through the agency of radio can listen to several classes in various locations at the same time.

## Causes of Distortion in Amplifier Circuits

The output or amplified current may be distorted by any one of the following four conditions:

1. If the normal grid voltage is positive a current will flow from the filament to the grid and this will reduce the maximum value of the voltage of the positive half cycle of the incoming oscillation, resulting in distortion of both input and output currents.

2. If the incoming signal voltages are excessive, the plate current will not oscillate within the straight line part of the characteristic.

3. If the input voltage is not applied to the straight line portion of the plate current-grid voltage characteristic.

4. If the transformers and associated apparatus are improperly designed distortion will result.

Freedom from distortion requires a tube having a substantial straight line plate current-grid voltage characteristic at negative grid voltages. An amplifier cannot be operated at a normal grid voltage of 0 without distortion, but must be operated at some negative value of grid voltage so that this value, plus the maximum positive voltage of the incoming signal will not produce a positive voltage on the grid.

The results from the operation of a vacuum tube depend largely on the operating position on the plate current-grid voltage characteristic curve as determined by the normal grid voltage. This value can be

fixed by the use of a C battery with potentiometer between the grid and filament. These facts are presented with the thought that many experimenters will find it interesting to conduct experiments with vacuum tubes as detectors and amplifiers using a C battery. Some of the results obtained will prove very surprising. The vacuum tube can be operated as a detector without grid condenser or grid leak by using a C battery to locate the operating point at the point of maximum curvature on the plate current-grid voltage characteristic.

### Internal Impedance

The current flow across the filament plate space is maintained by the difference of potential between the plate and heated filament, the plate being maintained positive by the B battery. As an electron is emitted from the filament it is subjected to the electrostatic field between the plate and filament and travels at an increasing speed until it collides with the plate where its kinetic energy is surrendered to the plate as heat. The heat liberated at the plate represents an expenditure of energy on the part of the plate battery of a nature similar to that due to the ohmic resistance of a metallic conductor. The internal resistance of a vacuum tube is a function of grid and plate potentials and filament temperature. If the capacities of the plate to the filament is neglected the internal plate impedance of a three member vacuum tube can be construed as a pure ohmic resistance.

## Special to New Subscribers

The reception accorded Radio Instructor in its initial issue was most gratifying. Few new magazines ever received so many voluntary subscriptions. We are holding 500 copies of the May issue which we will send free to every subscriber who sends us \$2.00 for a year's subscription beginning with the July issue. Send your name and address with remittance to

## RADIO INSTRUCTOR

800 N. Clark Street

Chicago, Ill.

## "Chi-Rad" Storage "B" Battery

The hit of the season—a real Storage "B" Battery with pasted plates which can be re-charged as easily as your "A" Battery. 22 Volt Battery, \$6.00. (Add postage on 8 lbs.)

### Specifications

Block size, 2 $\frac{3}{4}$ " $\times$ 9".

Tubes, 1" Diam. 5" high.

Voltage per cell, 2 volts.

Shipped dry with simple directions for setting up and charging.

Capacity 2 Amp. Hours—will operate 1 tube 1000 hours on one charge.

Chicago Radio Apparatus Co., Inc.

415 S. Dearborn St.

Chicago, Ill.

# Radio Conference in Washington

On February 28th of this year, the Commission which has been chosen by the Secretary of Commerce, for the purpose of making a study of the radio situation and submitting new regulations as well as modifications in the old for the control of radio in the United States, met in Washington, D. C. This committee had for its members the following: Dr. Alfred N. Goldsmith, Secretary of the Institute of Radio Engineers; Dr. S. W. Stratton, Director of the Bureau of Standards; Major E. H. Armstrong, Columbia University; Mr. Hiram Percy Maxim, President of the American Radio Relay League; Senator F. B. Kellogg, Representative W. H. White, Jr.; Prof. L. A. Hazelting of Stevens Institute, Hoboken; Prof. C. M. Jansky, University of Minnesota; Mr. R. B. Howell, Omaha; the Army, Navy, Dept. of Agriculture and Post Office being represented by Major General George O. Squier, Captain G. W. Bryant, Mr. W. A. Wheeler and Mr. J. C. Edgerton.

The above committee did what every old soldier calls "making an estimate of the situation" and then called upon representatives of the larger commercial companies and representatives from among the amateurs to answer questions.

Representatives from the Radio Corporation, Westinghouse, American Telephone and Telegraph, Western Electric, Ship Owners Radio Service and various other trade companies were on hand the first day.

The patent situation or rather existing agreements concerning patent rights and exchanges of those rights between some of the companies were discussed. The amateur's case was ably presented by Mr. Paul F. Godley of "Trans-Atlantic Test" fame. The final recommendations of the Commission simmered down to the following:

There are to be four classes of broadcasting:

Government, Private, Public and Toll.

## Wave Lengths

Below 150 meters—Reserved	
150- 275	" —Amateurs
200- 275	" —Technical and Training Schools.
275- 280	" —City and State Broadcasting
310	" —Special Amateur Telegraphy
310- 435	" —Private and Toll Broadcasting
500- 525	" —Aircraft
525- 650	" —Mobile Radio Telegraphy
650- 750	" —Mobile Radio Telephony
700- 750	" —Government and Public Broadcasting, 700 miles inland
750- 850	" —Radio Compass
850- 950	" —Aircraft Radio
950-1050	" —Radio Beacons
1050-1500	" —Government and Public Broadcasting
1500-1550	" —Aircraft Radio
1550-1650	" —Fixed Station Telephony
1850-2050	" —Government Broadcasting
2500-2650	" —Mobile Radio Telephony
2850-3300	" —Fixed Station Telephony
5000-6000	" —Transoceanic Telephony

It is to be hoped that the present law will be strengthened by the adoption of some such change in the allocation of wave lengths, resulting in less interference with its attendant complaints.

## ADVERTISING RATES

### Radio Instructor

Per line agate.....	\$ .60
Page rate (254 lines).....	\$150.00
Classified, 8c per word in advance.	

Above figures based on 115,000 circulation for May issue. For space discounts address Advertising Manager.

National Commander Hanford MacNider of the American Legion, addressed all members of the Legion Auxiliary on April 15 by radio from Station W.W.J of the Detroit News.

Mrs. Aimee McPherson, a noted evangelist, delivered a sermon by air on April 3rd from the Rock Ridge Radio Station at Oakland, Calif.

# MAGNET WIRE

*at lowest prices yet*

The prices we quote below are per  $\frac{1}{4}$  lb. and include cost of spool and parcel post charges.

— REMIT WITH ORDER —

B. & S. GAUGE	SINGLE COTTON	DOUBLE COTTON	ENAMEL	SINGLE SILK	DOUBLE SILK
No. 20	.35	.40	.30	.52	.56
No. 22	.48	.53	.33	.57	.62
No. 24	.52	.57	.36	.62	.68
No. 26	.58	.63	.39	.68	.75
No. 28	.68	.73	.42	.75	.88
No. 30	.80	.90	.45	.88	1.00
No. 32	.95	1.05	.48	1.00	1.20

## ANTENNA WIRE

No. 14	Enamel per 100 feet	.....	65c	post paid
No. 15	“ “ 100 “	.....	60c	“ “
No. 16	“ “ 100 “	.....	50c	“ “

*All other kinds, sizes and quantities.*

*We supply dealers at  
attractive discounts*

## RADIO SUPPLY STORES CO.

P. O. BOX 896

NEW HAVEN, CONNECTICUT

*(The Wire City)*