

BUDGET Electronics

GUARANTEED TO SAVE MONEY

1978 EDITION \$1.35 © 02040

by the Editors of ELEMENTARY ELECTRONICS

HOUSEHOLD PENNY-PINCHERS

High-technology burglar protection
Bargain Hi-Fi beats yesterday's best
Install energy-saving ventilation
Keep those appliances running

PLUS MONEY-SAVING PROJECTS

No-meter light meter
Pro power from salvaged parts
Customized switches and relays
Paper-saver for color darkrooms



KIT SAVES CASH

Space-age TV now with Heath GR-2001

Get DX with that old FM portable



BUDGET Electronics

GUARANTEED TO SAVE MONEY

1978 EDITION \$1.35 © 02040

by the Editors of ELEMENTARY ELECTRONICS

HOUSEHOLD PENNY-PINCHERS

High-technology burglar protection
Bargain Hi-Fi beats yesterday's best
Install energy-saving ventilation
Keep those appliances running

PLUS MONEY-SAVING PROJECTS

No-meter light meter
Pro power from salvaged parts
Customized switches and relays
Paper-saver for color darkrooms



KIT SAVES CASH

Space-age TV now with Heath GR-2001

Get DX with that old FM portable





wire wrapping center...

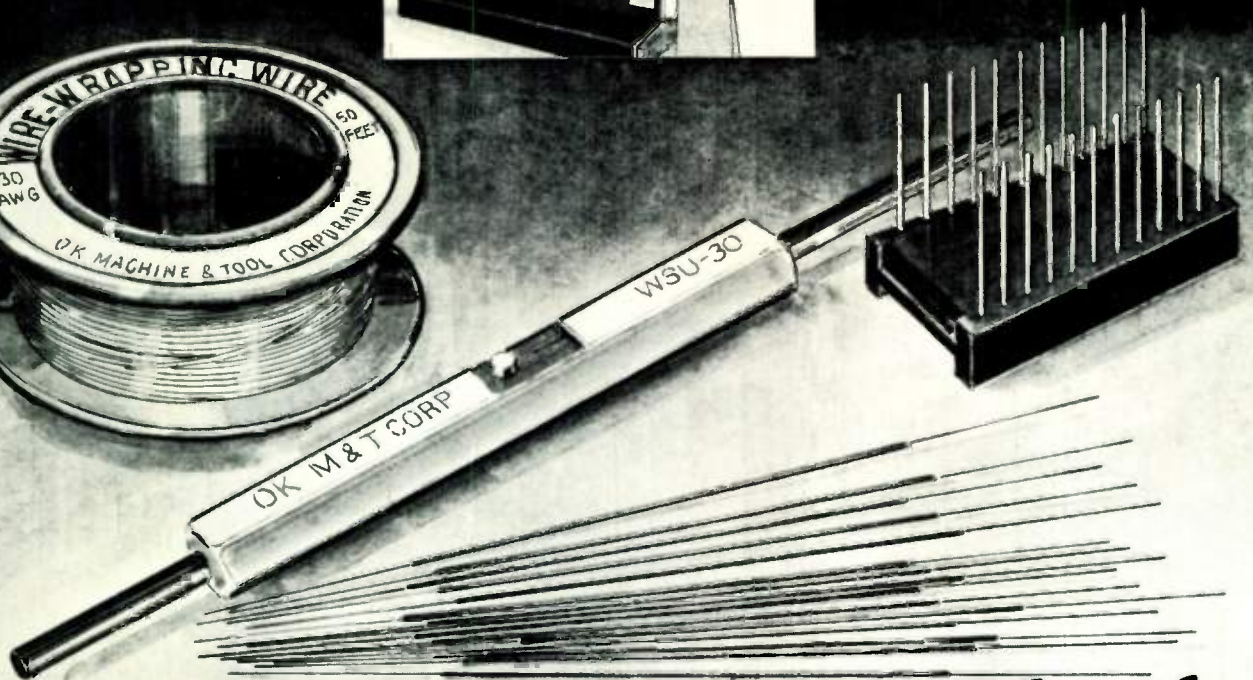

for quality electronic parts and tools.

OK MACHINE & TOOL CORPORATION
3455 Conner St., Bronx, N.Y. 10475 / (212) 994-6600 / Telex 125091



wire wrapping center...

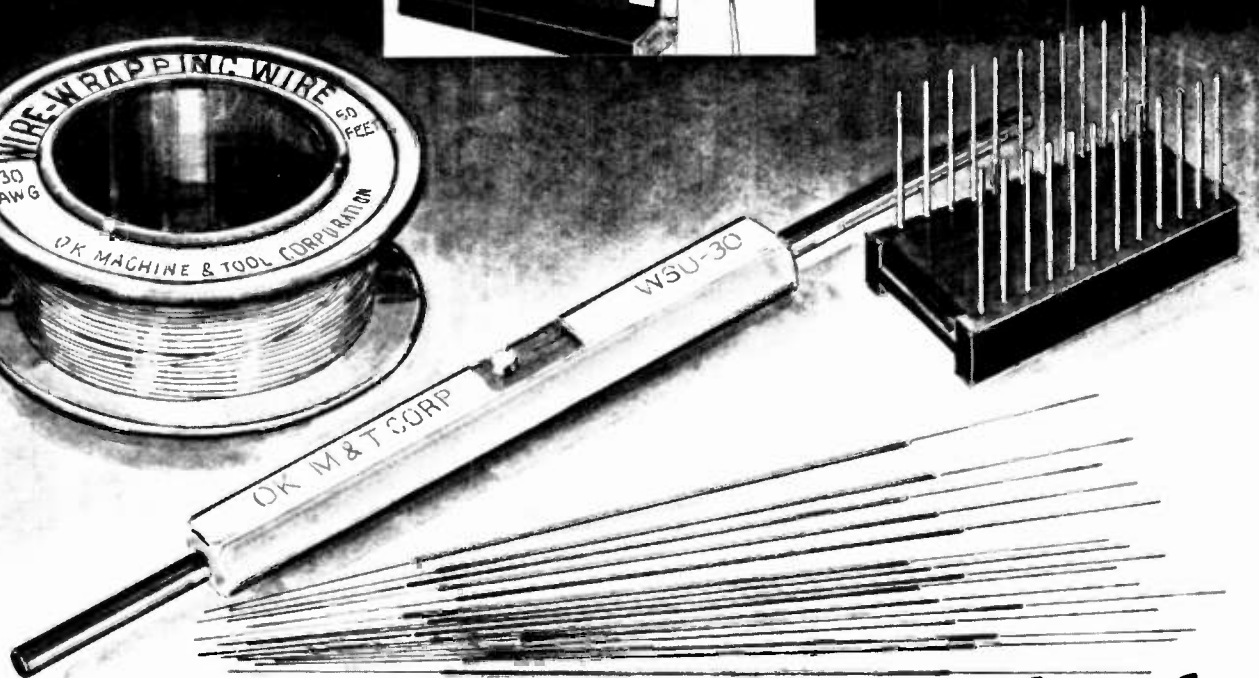

for quality electronic parts and tools.

OK MACHINE & TOOL CORPORATION
3455 Conner St., Bronx, N.Y. 10475 / (212) 994-6600 / Telex 125091



You can turn the CB boom into income... with NRI's Complete Communications Course

NRI can train you at home for a part-time job or a full-time career in communications.

The field of communications is bursting out all over. More than 25 million CB sets are in operation with millions more being sold annually. That means countless careers in design, installation, and maintenance. Start training at home now, the NRI way.

Get your all-important FCC License.

FCC rules require that CB transmitters be serviced only by the holder of a First or Second Class FCC Radiotelephone License, or under the supervision of a license holder when the transmitter is connected to a "radiating antenna." NRI will give you the necessary training to get that all-important First or Second Class FCC Radiotelephone License so that you can qualify for one of the many available openings.

Learn on your own 400-channel digitally-synthesized VHF Transceiver.

The 48-lesson NRI Complete Communications Course teaches you to service and adjust all types of two-way radio equipment (including CB), using the one unit that is best equipped to train you for CB, Commercial, and Amateur Communi-

cations...a "designed-for-learning," 400-channel, two-meter VHF Transceiver and AC power supply. Then we help you get your FCC Amateur License, with special instructions so you can go on the air. The unit can be mounted in your car, or you can use it as a base station.

The complete program includes 48 lessons, 9 special reference texts, and 10 training kits. Also included are: your own electronics Discovery Lab™, a new Antenna Applications Lab, an Optical Transmission System, CMOS Digital Frequency Counter, and TVOM. The course covers AM and FM Transmission Systems; Radar Principles; Marine, Aircraft, and Digital Electronics; and Mobile Communications. You must earn your First Class Radiotelephone FCC License or you get your money back.

TM McGraw Hill CEC



CB Specialist's Course also available.

NRI now offers a special 37-lesson course in CB Servicing. You get your own 40-Channel CB Transceiver AC power supply and multimeter, for hands-on training. Also included are 8 reference texts and 14 coaching units to make it easy to get your Commercial Radio-tele-

phone FCC License—enabling you to test, install and service communications equipment.

Over a million have enrolled with NRI.

Send for the free NRI catalog and discover why more than a million people like yourself have chosen the NRI way as the right way to get ahead. You learn at home with bite-size lessons, progressing at your own speed to your FCC License and then into the communications field of your choice. There's no obligation and no salesman will call.



If insert card has been removed, write:



NRI SCHOOLS
McGraw Hill Continuing
Education Center
3939 Wisconsin Avenue
Washington, D.C. 20016

THE STAFF

Editor-in-Chief and
Electronics Group Coordinator
Julian S. Martin, WA2CQL

Managing Editor
Alan H. Rose, K2RHK

Technical Editor
Neil Shapiro, WB2KQI, KAFA7222

Audio Editor
Christine Begole, KFC3553

Citizens Band Editor
Kathi Martin, KGK3916

Workbench Editor
Hank Scott

Art Director
Ralph Rubino

Assistant Art Director
Augustus Ginochio

Cover Art Director
Irving Bernstein

Art Assistants
Caroline Imparato
Robert Modero
Joni Erlon

Advertising Director
David J. Miller, KCX1268

Advertising/Research Associate
Jyll Holzman, KAKZ1490

Production Director
Carl Bartee

Production Manager
Carole Dixon

Assistant Production Manager
Mary Carfagno

Newsstand Circulation
Director
Don Gabree

Subscription Circulation &
Marketing Director
Robert V. Enlow

Subscription Circulation Manager
Eugene S. Slawson

Director of Market
Development
James C. Weakley

President and Publisher
Joel Davis

Vice President and
General Manager
Leonard F. Pinto

Vice President and Treasurer
Victor C. Stabile, KBP0681



BUDGET ELECTRONICS is published annually by Davis Publications, Inc. Editorial and business offices: 229 Park Avenue South, New York, N.Y. 10003. Advertising offices: New York, 229 Park Avenue South, 212-OR-3-1300; Chicago, 520 N. Michigan Ave., 312-527-0330; Los Angeles: J. E. Publishers' Rep. Co., 8732 Sunset Blvd., 213-659-3810.

EDITORIAL CONTRIBUTIONS must be accompanied by return postage and will be handled with reasonable care; however publisher assumes no responsibility for return or safety of manuscripts, artwork, or photographs. All contributions should be addressed to the Editor-in-Chief, BUDGET ELECTRONICS, 229 Park Avenue South, New York, N.Y. 10003. Copyright 1978 by Davis Publications, Inc.

BUDGET Electronics

1978 EDITION

FEATURES

Silent Sentry	11
TV-2001: Space Age TV from Heath	14
Custom Relays . . . at Mass-Produced Prices	18
Custom Switches . . . You Couldn't Afford to Buy	20
Budget Installs a . . . Radio/Cassette Player In-Dash	24
Mod-X, the Simplest Clock Yet	30
Cut in a Wall Fan and Save Cool Cash	33
Build Time Tally	36
Bargain Basement Recordings	37
Hi-Fi Systems that Trade Off the Extras	41
Hi-Fi DX	43
Sound Cookie Speaker	45
Super SCA Soother	47
RF From Your Calculator	51
Depression Reflexes	56
Eliminate the Mystery and Expense of Costly TV Repair	58
CB Battery Charger Saves \$\$\$	61
Put New Life Into that Old Car Radio	63
High Band Monitor	66
Beat the Antenna Spiral	67
Add Tone to Your Phone	69
Low-Cost Filter Improves Code Reception	72
Troubleshoot Your Appliances Like a Doctor	73
Lone Ranger Light Meter	79
Heath's Hot New HR-1680 Receiver	83
Study Your Way Into the Big Money in Electronics	85
Build a Heat Controller for your Soldering Gun	88
Junk Box Special Power Supply	89
Darkroom Color Analyzer	91

COLUMNS AND FEATURETTES

New Products	5
Literature Library	9
Ask Hank, He Knows!	10
Easy Way to Record	50
Computer New Products	52
CB New Products	55
CB XCVR Checkout	78
Audio Fun-damentals with the 741	82
Classified Ads	101

New Products

Childproof Plug Lock

Unattended AC plug-in equipment, especially power tools or electronic gadgets, pose a real hazard to naturally curious children! Now this needless risk can be eliminated with a simple new device called Plug-Safe. It snaps over any electrical plug prong (the kind with a hole), thus preventing its being plugged in. It

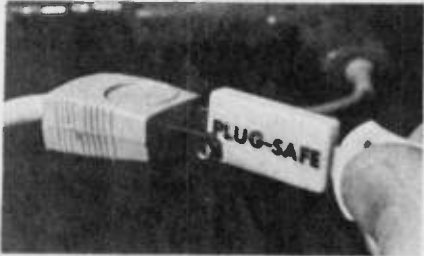

CIRCLE 50 ON READER SERVICE COUPON

releases easily with the unique key. Any unauthorized use of electrically powered equipment can be discouraged with this inexpensive device. Plug-Safes are available through mail-order dealers or direct from the manufacturer. Packaged in sets of three (3) locks with two (2) keys, they are \$1.79 per set. QUESTCO, Box 515, Milton, WA 98354.

AM/FM-Stereo Cassette Recorder

Superscope's new CRS-1800 is an AM/



CIRCLE 57 ON READER SERVICE COUPON

FM stereo radio cassette recorder featuring Total Mechanism Shutoff (TMS) which, when the end of the tape is reached, completely turns off all modes of operation. The CRS-1800 features matrix and discrete stereo. The matrix stereo uses a unique circuit which enhances the stereo separation of the unit's internal speakers. Additional built-ins include PA/Play mixing capability, convenient referential 3-digit tape count-

er, a useful 3-way meter and automatic record level control. Power can be provided in one of four ways; regular AC, DC batteries, auto adaptor, or an optional rechargeable battery pack (RBD-1). Sells for \$209.95. For more information on the CRS-1800, write to Superscope, Inc., 20525 Nordhoff St., Chatsworth, CA 91311.

Universal PC Board

Model H-PCB-1 is the first in a new series of top quality PC Boards for the serious amateur. The 4-in. x 4.5 in. x 1/16-in. board is made of glass coated epoxy laminate and features solder coated 1 oz. copper pads. In addition, the board has a 22/22 two sided edge connector, with contacts on standard .156 spacing. The board contains a matrix of .040-in. diameter holes on .100 inch centers. The component side contains 76 two-hole pads that can accommodate any

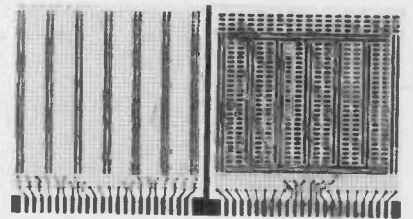

CIRCLE 60 ON READER SERVICE COUPON
(Continued on page 8)

NEW

FROM



THE

HOBBY~WRAP

COMPLETE WITH BIT AND SLEEVE

ONLY \$34⁹⁵

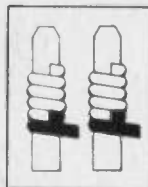

Now you, the hobbyist, can do wire-wrapping professionally with our easy to use Hobby-Wrap gun.

Model
BW-630

OK MACHINE & TOOL CORPORATION

3455 Conner St., Bronx, N.Y. 10475 / (212) 994-6600 / Telex 125091

.025 sq. post,
AWG 30 wire
(batteries not included)

EVERY PROJECT IS ANOTHER REASON

Design and test circuits as fast as you can think — with CSC Proto-Board® Solderless Breadboards.

As quick as pushing in or pulling out components, you can design, test, and modify all kinds of circuits, with CSC Proto-Boards. Sockets are *already mounted*, on sturdy metal ground/baseplates with non-marring feet. They're great for a wide variety of audio and digital projects, and you save money by using components over and over again.

PB-101—940 solderless tie points: ten 14-pin DIP capacity, 140 five-point terminals plus 8 bus lines of 30 tie-points each. 4.5"W x 5.8"L x 1.4"H (114 x 147 x 35mm); 9 oz. (.26 Kg). Price: \$29.95

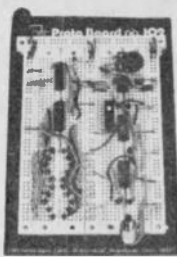

PB-102—1240 solderless tie points: twelve 14-pin DIP capacity, 188 five-point terminals plus 6 bus lines of 40 tie-points each and 2 bus lines of 30 points. 4.5"W x 7"L x 1.4"H (114 x 178 x 35mm). 10 oz. (.31 Kg). Price: \$39.95

PB-6 Kit—630 solderless tie points: six 14-pin DIP capacity. Economical way to get Proto-Board speed and convenience. 94 five-point terminals plus 4 bus lines of 40 tie-points. Comes with pre-assembled sockets, four 5-way binding posts, base-plate, all hardware. 10 minute assembly with pliers and screwdriver. 6"L x 4"W x 1.4"H (152 x 102 x 34mm). 7 oz. (.20 Kg). Price: \$15.95



PB-100 Kit—760 solderless tie points: ten 14-pin DIP capacity, 140 five-point terminals plus 2 bus lines of 30 tie-points each. Comes with pre-assembled sockets, two 5-way binding posts, base-plate, all hardware. 4.5"W x 6"L x 1.4"H (114 x 152 x 35mm); 7.5 oz. (.21 Kg). Price: \$19.95

EXTRA LARGE CAPACITY FOR MORE COMPLEX CIRCUITS!

PB-103—2250 solderless tie points: twenty-four 14-pin DIP capacity, 354 five-point terminals plus 14 bus lines of 50 tie-points each, plus 2 bus lines of 40 points. 6"W x 9"L x 1.4"H (152 x 229 x 35mm); 1.25 lb. (.57 Kg). Price: \$59.95.

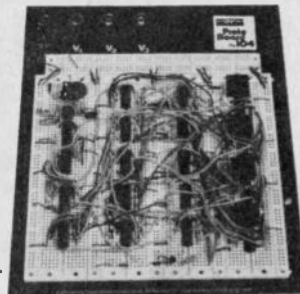

PB-104—3060 solderless tie points: thirty-two 14-pin DIP capacity, 472 five-point terminals plus 14 bus lines of 50 tie-points. 8"W x 9.8"L x 1.4"H (203 x 248 x 35mm); 1.75 lb. (.79 Kg). Price: \$79.95.

Now, breadboard in any direction! With EXPERIMENTOR™ sockets, the breadboarding system that gives you more flexibility for less dollars!

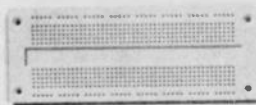

Top View



Bottom View



Sockets lock together, snap apart to handle any circuit

Arrange EXPERIMENTOR sockets to suit your circuit instead of rearranging your circuit to fit the breadboard.

Discover the ease and convenience of solderless breadboarding. CSC EXPERIMENTOR® sockets let you design, assemble and modify circuits as fast as you can push in or pull out components.

- **Large Capacity**—Large sockets have 550 solderless tie points (94 five-point terminals) plus two 40-point bus strips.
- **Full Fan-Out**—A CSC exclusive. The only solderless breadboard sockets with full fan-out capabilities for microprocessors and other larger (0.6") DIP's.

- **Snap-together in a domino pattern**—Arrange EXPERIMENTOR sockets to suit your circuit. Expand or contract at will.
- **Simple Mounting**—Vinyl insulated backing lets you mount EXPERIMENTOR sockets anywhere without shorting. Mount to any flat surface with 4-40 flat head screws or 6-32F self-tapping screws for behind-the-panel mounting.
- **Accepts All Standard Components**—Sockets conform to 0.1" grid and are DIP compatible. Accepts IC's, diodes, resistors, capacitors, transistors, etc. Use #22-30 solid AWG wire interconnections.

*U.S. Pat. No. D235 554



← EXPERIMENTOR™ 300
3" centers, perfect for smaller DIP's
Ideal mate for peripheral microprocessor IC's
6.0" x 2.1" overall
Just \$9.95

EXPERIMENTOR™ 600 →
6" centers, perfect for microprocessors, clock chips, RAM's, ROM's, and PROM's
6.0" x 2.4" overall
Just \$10.95

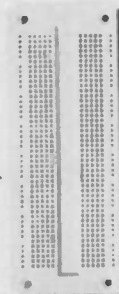

SPECIFICATIONS

TIE POINTS

Model	Length	Width	Center Channel	5 Tie Points Terminals†	Bus Strips†	Price
300	6.0"	2.1"	3"	94 (470)	2 (80)	\$9.95
600	6.0"	2.4"	6"	94 (470)	2 (80)	\$10.95
350	3.5"	2.1"	3"	46 (230)	2 (40)	\$5.50
650	3.5"	2.4"	6"	46 (230)	2 (40)	\$6.25
Quad	6.0"	0.75"	—	—	4 (160)	\$4.00

Both units are 375" deep

† Number in parentheses refers to total number of tie-points

CALL OR WRITE FOR FULL LINE CATALOG AND THE NAME OF YOUR CSC DEALER.

All Prices Shown are Manufacturer's Recommended List. Prices and Specifications Subject to Change Without Notice.

IN THIS BOOK TO READ THIS AD.

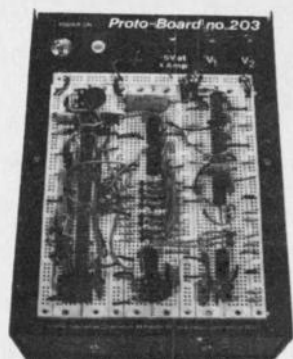

Proto-Boards with Built-In Regulated Power Supplies!

For extra
convenience
and
breadboarding
speed!

PB-203—Same capacity and layout as PB-103 plus short-proof fused 5VDC, 1A regulated power supply. Ripple and noise are a low 10mV at 0.5A. Has on/off toggle switch and pilot light plus four 5-way binding posts (2 for power). 9.75" L x 6.6" W x 3.25" H (248 x 168 x 83mm) weighs 5 lb (2.27 Kg). For 117VAC, 50/60Hz (220VAC available at slightly higher cost). Price \$80.00

PB-203A—All PB-203 features plus separate regulated +15VDC and -15VDC, 0.5A supplies, with internally and independently adjustable output voltage. Same size as PB-203. 5.5 lb. (2.5 Kg). For 117 VAC, 50, 60 Hz (220 VAC, 50/60 Hz at slightly higher cost). Price: \$129.95

All Prices Shown are Manufacturer's Recommended List.
Prices and Specifications Subject to Change Without Notice.

LOGIC PROBE LP-1.

Compact, self-powered, multi-family probe with pulse stretching and latching (memory) capability for DTL, TTL, HTL, and CMOS.



By means of unique circuitry that combines the functions of a pulse detector, stretcher and memory, the LP-1 makes one-shot, low-rep-rate, narrow pulses—nearly impossible to see, even with a fast scope—easily detectable and visible.

Input events—positive and negative level transitions, pulses, etc.—are automatically detected by the LP-1's specially-designed input circuits. Pulses as narrow as 50 nanoseconds are stretched to 1/3 second and by simply setting the PULSE MEMORY switch to the MEMORY position, single-shot as well as low-rep-rate events can be stored indefinitely.

To insure long trouble-free service, the LP-1 incorporates a rugged, high-impact plastic case, built-in strain relief power-cable, reverse polarity and over-voltage protection. Price: \$44.95.

HIGHLIGHTS:

- HI and LO LED's blink on and off, "tracking" "1" and "0" states at square wave frequencies up to 100Hz.
- PULSE LED blinks on for 1/3 second during pulse trains.
- With square waves of up to 100KHz both HI and LO LED's will be activated; PULSE LED will blink continuously at 3Hz rate to indicate level transitions.
- With duty cycles of less than 30%, LO LED will light, in addition to PULSE LED blinking at 3Hz.
- With duty cycles of more than 70%, HI LED will light, in addition to PULSE LED blinking at 3Hz.
- Input impedance is 100,000 ohms for minimum circuit loading.
- Maximum input signal frequency is 10MHz.

MEET MAX-100

CSC's 100 MHz 8-digit Audio/CB/RF/Digital counter. At \$134.95, nothing else does so much for so little.

- * MAXimum frequency range—20Hz-100MHz
- * MAXimum CB performance—ideal for CB applications
- * MAXimum visibility—big, bright, 0.6" 8-digit LED display
- * MAXimum accuracy—crystal-controlled timebase
- * MAXimum operating ease—automatic, no controls to set
- * MAXimum range of applications—use for audio through ultrasonic through RF: AM, FM and digital
- * MAXimum portability—completely self-contained
- * MAXimum versatility—use with clip-lead cable, in-line tap, mini-whip antenna, etc.
- * MAXimum flexibility—choice of four power sources



MAX-100 is a portable, high-precision frequency counter that sets new standards in performance and value. In a compact, portable case, it gives you continuous readings from 20Hz to a guaranteed 100MHz, with 8-digit accuracy. Fast readings with 1/6-sec. update and 1-sec. sampling rate. Precise readings, derived from a crystal-controlled time base with 3ppm accuracy. High-sensitivity readings from signals as low as 30 mV, with diode overload protection up to 200V peaks.

Input signals over 100MHz automatically flash the most significant digit. And to indicate low-battery condition and extend remaining battery life, the entire display flashes at 1 Hz. Price: \$134.95

SPECIFICATIONS

Range: 20 Hz to 100 MHz, guaranteed. **Gate time:** 1 sec. **Resolution:** 1 Hz. **Accuracy:** ± 1 count + time base error. **Input Impedance:** 1 MΩ/56pF **Coupling:** AC. **Sine Wave Sensitivity:** 30 mVRMS @ 50 MHz **Internal Time Base Frequency:** 3 579545 MHz x tal osc. **Setability:** ± 3 ppm @ 25°C **Temp-Stability:** Better than 0.2 ppm/°C, 0-50°C. **Max. Aging:** 10 ppm/year. **Display:** Eight .6" LED digits. **Lead-zero blanking:** decimal point appears between 6th and 7th digit when input exceeds 1 MHz. **Overflow:** with signals over 99,999,999 Hz, most significant (left hand) digit flashes, allowing readings in excess of 100 MHz. **Display update:** 1/6-second plus 1 sec. gate time. **Low Battery Indicator:** When power supply falls below 6.6 VDC, all digits flash @ 1 Hz. **Power:** 6 AA cells (internal); **External:** 110 or 220 VAC Eliminator/charger: Auto cigarette lighter adapter; 7.2-10VDC ext supply; **Bat. Charging:** 12-14hr. **Size (HWD):** 1.75" x 5.63" x 7.75" (4.45 x 14.30 x 19.69cm.) **Weight:** Less than 1.5 lb. (0.68 Kg) w/batteries.

CONTINENTAL SPECIALTIES CORPORATION



70 Fulton Terrace, Box 1942, New Haven, CT 06509
203-624-3103, TWX 710-465-1227
West Coast: 351 California St., San Francisco, CA 94104
415-421-8872, TWX 910-372-7992

New Products

(Continued from page 5)

speakers, as well as cabinet speaker systems and tape and record care accessories. Get all the facts from Audio-tex, Division of GC Electronics, 400 S. Wyman, Rockford, IL 61101.

Isolation Autotransformer

B&K-Precision's combination isolation and autotransformer, the TR-100, has three isolated and three direct outlets providing high, medium and low (130, 115, 105 VAC) line voltages. The isolated outlets are rated at 400 VA continuous, while the direct outlets are rated at 500 VA. The TR-100 allows safe testing of transformerless equipment, elim-



CIRCLE 51 ON READER SERVICE COUPON

inating a potential shock hazard. In addition, the TR-100 can be used to vary the input line voltage applied to an electrical device or instrument under test. This feature is ideal for quality control testing. The TR-100 may be set for input line voltages ranging from 105 to 130 VAC. Suggested user price is \$55.00. For further information, write to B&K-Precision, Dynascan Corporation, 6460 W. Cortland Avenue, Chicago, IL 60635.

Two in One for Lab

The Logiklab Model 151 by Integral Electronics features the innovative combination of a digital signal source together with a logic power supply. The supply is highly regulated, short-circuit proof and capable of delivering 1 A at 5 VDC. The



CIRCLE 58 ON READER SERVICE COUPON

signal source, in the Astable Mode, simultaneously provides true and complementary TTL compatible square waves and pulses over the frequency range from 10 Hz to 100 KHz. Manual and remote gating of the oscillator is available. In the Monostable Mode, single pulses, con-

tinuously variable from 5 microseconds to 50 milliseconds are produced, either by manual or remote trigger. Fail-safe design procedures and full power burn-in guarantee a highly reliable and versatile instrument at a moderate unit price of \$79.50. For further information, write to Integral Electronics Corp., P.O. Box 286, Commack, NY 11725.

Electroplating System

A new, low-cost portable electroplating system, specifically designed for plating craft and hobby projects, has been introduced by Micro Materials. Designated the Ranco EP-1, the advanced unit provides complete electroplating capability and can be used in total safety. Unlike conventional methods that require a series of expensive and toxic plating baths, the Ranco EP-1 uses patented felt-tip pens. Advantages of the Ranco EP-1 system include: complete portability, no special skills required, total plating capability, non-polluting, completely non-toxic, no baths or solutions, disposable plating pens for 10 different metals, and low cost. Completely contained in its own case, the EP-1 allows anyone to produce professional quality electroplating the very first time. The Ranco EP-1 Portable Electroplating System is available at \$410. Non-toxic, disposable plating pens are available in 24K gold, silver, nickel, chrome-color, rhodi-



CIRCLE 53 ON READER SERVICE COUPON

um, black nickel, copper, tin, and zinc. A pure chromium pen is available on special order only, since it contains toxic chromic acid. Each pen will produce more than 10 square feet of electroplating. Additional pens are currently under development. For more information, write to Micro Materials Corporation, 100 Grand Street, Westbury, NY 11590.

Programmable Scanner

As a hobby, shortwave listening has kept pace with the boom in CB. One of the problems of the SWL in the past has been the need for manual tuning, a difficulty that is completely eliminated in Surveyor's new Model 10P, three-band, VHF hi/lo UHF scanner. The Surveyor 10P Scanner, in addition to its numerous other features, has two facilities with great appeal to SW listeners. The 10P has a top level programmable switch,



CIRCLE 63 ON READER SERVICE COUPON

letting the listeners program easily and quickly to any and all bands. There is also a priority switch that is the listener's assurance of hearing transmission on channel 1, even though a signal is being received on another channel at the same time. And, of course, a fully tunable squelch for complete noise control. Completely solid state throughout, the 10P can be used at home or mobile with a power converter. Its dual conversion circuit is an assurance of high selectivity, working against spillover from one channel to the next, and it has a 10-channel capacity. The 10P comes equipped with an AC and DC power cord, mounting bracket, hardware and an antenna for indoor use. The 10P Scanner sells for \$189.00. For further information, please write to Surveyor Manufacturing Corporation, 7 Electronics Court, Madison Heights, MI 48071.

Siren-Equipped Weather Radio

Weatheralert offers 24-hour protection against loss of life and property from tornados, severe thunderstorms and other weather emergencies. The receiver sounds a siren—triggered by a signal from the local U.S. Weather Service Transmitter—whenever dangerous conditions threaten. A complete report on the emergency is broadcast directly after,

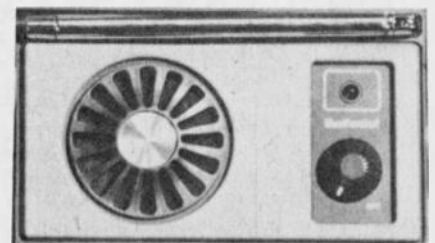

CIRCLE 66 ON READER SERVICE COUPON

and the warning sequence is repeated. During normal conditions, the unit picks up the weather station's continuous report. Operates within 40 to 50 miles of a transmitter. Optional Antenna Kit extends range up to 80 miles. AC-powered, with battery back-up feature. Should an electrical failure result from a weather emergency, unit automatically becomes powered by an internal 30-hour battery. Sells for \$39.95. Write or phone Weather-alert Co., 639 South Dearborn Street, Chicago, IL 60605. Enclose \$2.50 additional for shipping and handling. ■

LITERATURE LIBRARY

301. Get acquainted with the new *EICO* products, designed for the professional technician and electronics hobbyist. Included in brochure are 7 IC project kits, *EICO's* "Foneaids," security products and many varied kits.

302. *International crystal* has illustrated folders containing product information on radio communications kits for experimenters (PC boards; crystals; transistor RF mixers & amplifiers; etc.).

303. *Regency* has a new low cost/high performance UHF/FM repeater. Also in the low price is their 10-channel monitorradio scanner that offers 5-band performance.

304. *Dynascan's* new *B & K* catalog features test equipment for industrial labs, schools, and TV servicing.

305. Before you build from scratch, check the *Fair Radio Sales* latest catalog for surplus gear.

306. Get *Antenna Specialists'* catalog of latest mobile antennas, test equipment, wattmeters, accessories.

307. Want a deluxe CB base station? Then get the specs on *Tram's* super CB rigs.

308. Compact is the word for *Xcelite's* 9 different sets of midget screwdrivers and nutdrivers with "piggyback" handle to increase length and torque. A handy show case serves as a bench stand also.

310. *Turner* has two booklets on their Signal Kicker antennas. They give specifications and prices on their variety of CB base and mobile line. Construction details help in your choice.

311. *Midland Communications'* line of base, mobile and hand-held CB equipment, marine transceivers, scanning monitors, plus a sampling of accessories are covered in a colorful 18-page brochure.

312. *The EDI (Electronic Distributors, Inc.)* catalog is updated 5 times a year. It has an index of manufacturers literally from A to X (ADC to Xcelite). Whether you want to spend 29 cents for a pilot-light socket or \$699.95 for a stereo AM/FM receiver, you'll find it here.

313. Get all the facts on *Progressive Edu-Kits* Home Radio Course. Build 20 radios and electronic circuits; parts, tools, and instructions included.

316. Get the *Hustler* brochure illustrating their complete line of CB and monitor radio antennas.

317. *Teaberry's* new brochure presents their complete lines of CB and marine transceivers and scanners for monitoring police, fire and other public service frequencies.

318. *GC Electronics* offers an "Electronic Chemical Handbook" for engineers and technicians. It is a "problem solver" with detailed descriptions, uses and applications of 160 chemicals compiled for electronic production and packaging. They are used for all types of electronic equipment.

319. *Browning's* mobiles and its famous Golden Eagle base station, are illustrated in detail in the new 1977 catalog. It has full-color photos and specification data on Golden Eagle, LTD and SST models, and on "Brownie," a dramatic new mini-mobile.

320. *Edmund Scientific's* new catalog contains over 4500 products that embrace many sciences and fields.

321. *Cornell Electronics'* "Imperial Thrift Tag Sale" Catalog features TV and radio tubes. You can also find almost anything in electronics.

322. *Radio Shack's* 1977 catalog colorfully illustrates their complete range of kit and wired products for electronics enthusiasts—CB, ham, SWL, hi-fi, experimenter kits, batteries, tools, tubes, wire, cable, etc.

323. Get *Lafayette Radio's* "new look" 1977 catalog with 260 pages of complete electronics equipment. It has larger pictures and easy-to-read type. Over 18,000 items cover hi-fi, CB, ham rigs, accessories, test equipment and tools.

327. *Avanti's* new brochure compares the quality difference between an Avanti Racer 27 base loaded mobile antenna and a typical imported base loaded antenna.

328. A new free catalog is available from *McGee Radio*. It contains electronic product bargains.

329. Semiconductor Supermart is a new 1977 catalog listing project builders' parts, popular CB gear, and test equipment. It features semiconductors—all from *Circuit Specialists*.

330. There are nearly 400 electronic kits in *Heath's* new catalog. Virtually every do-it-yourself interest is included—TV, radios, stereo and 4-channel, hi-fi, etc.

331. *E. F. Johnson* offers their CB 2-way radio catalog to help you when you make the American vacation scene. A selection guide to the features of the various messenger models will aid you as you go through the book.

332. If you want courses in assembling your own TV kits, *National Schools* has 10 from which to choose. There is a plan for GIs.

333. Get the new free catalog from *Howard W. Sams*. It describes 100's of books for hobbyists and technicians—books on projects, basic electronics and related subjects.

334. *Sprague Products* has L.E.D. readouts for those who want to build electronic clocks, calculators, etc. Parts lists and helpful schematics are included.

335. The latest edition of the *TAB BOOKS* catalog describes over 450 books on CB, electronics, broadcasting, do-it-yourself, hobby, radio, TV, hi-fi, and CB and TV servicing.

337. *Pace* communications equipment covers 2-way radios for business, industrial and CB operations. Marine radiotelephones and scanning receivers are also in this 18-p. book.

338. "Break Break," a booklet which came into existence at the request of hundreds of CBers, contains real life stories of incidents taking place on America's highways and byways. Compiled by the *Shakespeare Company*, it is available on a first come, first serve basis.

342. *Royce Electronics* has a new 1977 full line product catalog. The 40-page, full-color catalog contains their entire new line of 40-channel AM and SSB CB transceivers, hand-helds, marine communications equipment, and antennas and accessories.

344. For a packetful of material, send for SBE's material on UHF and VHF scanners, CB mobile transceivers, walkie-talkies, slow-scan TV systems, marine-radios, two-way radios, and accessories.

345. For CBers from *Hy-Gain Electronics Corp.* there is a 50-page, 4-color catalog (base, mobile and marine transceivers, antennas, and accessories). Colorful literature illustrating two models of monitor-scanners is also available.

350. Send for the free *NRI/McGraw Hill* 100-page color catalog detailing over 15 electronics courses. Courses cover TV-audio servicing, industrial and digital computer electronics, CB communications servicing, among others G.I. Bill approved, courses are sold by mail.

352. Send for the free descriptive bulletin from *Finney Co.* It tells all about their new auto FM radio signal booster (eliminates signal fading).

353. *MFJ* offers a free catalog of amateur radio equipment—CW and SSB audio filters, electronic components, etc. Other lit. is free.

354. A government FCC License can help you qualify for a career in electronics. Send for information from *Cleveland Institute of Electronics*.

355. New for CBers from *Anixter-Mark* is a colorful 4-page brochure detailing their line of base station and mobile antennas, including 6 models of the famous Mark Heliwhip.

356. Send for *Continental Specialties* new bread-boarding prototest devices. They vary in prices from a mini-budget kit at \$19.95. Featured is the new logic monitor, giving information on what it does, how it works, and how to use it.

358. *PixTronics* announces its new Model 200 Super Sensitive Electronic Darkroom Exposure Meter, used to determine the correct exposures of all black-and-white and color negatives. Useable with any enlarger.

359. *Electronics Book Club* has literature on how to get up to 3 electronics books (retailing at \$58.70) for only 99 cents each . . . plus a sample Club News package.

360. *Cornell-Dubilier* has a 4-color, 4-page, brochure on its Ham II, CD-44, and Big Talk rotor communication systems. Exploded half tones detail interior rotor construction, and tables list specs.

361. "Solving CB Noise Problems" is published by *Gold Line* and tells you how to reduce the noise and get a clearer signal. In discussion and diagram you can find out about the kinds of noise, their sources, and the remedies.

BUDGET ELECTRONICS Box 1849, G.P.O. New York, NY 10001

1978 EDITION

Void After February 4, 1978

Please arrange to have the literature whose numbers I have circled below sent to me as soon as possible. I am enclosing 50¢ for each group of 5 to cover handling. (No stamps, please.) Allow 4-6 weeks for delivery.

- | | | | | | | | | | | | |
|-----|-----|-----|-----|-----|-----|-----|-----|-----|-----|-----|-----|
| 301 | 302 | 303 | 304 | 305 | 306 | 307 | 308 | 310 | 311 | 312 | 313 |
| 316 | 317 | 318 | 319 | 320 | 321 | 322 | 323 | 327 | 328 | 329 | 330 |
| 331 | 332 | 333 | 334 | 335 | 337 | 338 | 342 | 344 | 345 | 350 | 352 |
| 353 | 354 | 355 | 356 | 358 | 359 | 360 | 361 | | | | |

NAME (print clearly) _____

ADDRESS _____

CITY _____

STATE _____

ZIP _____



**ASK HANK,
HE KNOWS!**

Got a question or a problem with a project—ask Hank! Please remember that Hank's column is limited to answering specific electronic project questions that you send to him. Personal replies cannot be made. Sorry, he isn't offering a circuit design service. Write to:

**Hank Scott, Workshop Editor
BUDGET ELECTRONICS
229 Park Avenue South
New York, NY 10003**

For Better Contact

Do I have to add an external speaker to my CB to make it sound better?

—C.Y., Salt Lake City, UT

Yes, because there's not much you can do inside of a CB—they're too compact. You could add a CB accessory speaker, and that would be best. You could also connect the CB audio output to your car radio's speaker through a selector switch which will let you pick either radio or CB without interacting electrically.

Test Reports

I've looked all over for an equipment test review for the Superscope R-1240 AM/FM stereo receiver. Can't find anything. Are audio magazines pushing top-of-the-line equipment only?

—R.F., Milwaukee, WI

You didn't look in the right place. Pick up a May/June 1977 copy of Hi/Fi Stereo Buyers' Guide. It has a review on the R-1240 and 27 other high fidelity components. The Guide also gives valuable buying information for the hi-fi buff.

Bubbles Does It

What is the best device to clean LP's? I don't mean a brush down on the turn-

table. It's the embedded grease I want to take out.

—S.S., Reno, NV

Soap suds and not too much! Make some soapy water, low on suds, in a pan or pot. Place in a deep sink and run the tap water luke warm, in a spray if possible. Wet the record grooves and keep the label dry. With a clean soft sponge, work the soapy water into the grooves, then flush it out with the tap water. Repeat. Do both sides of the disc. Allow the disc to drip dry. Shaking will help and a light blotting with a lint-free cloth or towel. Dry by letting disc lean in an almost upright position. Put in clean record jacket and store.

Sound Equality

I have eight old loudspeakers that I connected in a series-parallel combination to get 4 ohms. I'm sure the connections are correct, but not all speakers work at full volume, and one, the loudest, finally blew. What did I do wrong?

—J.F., Erie, PA

You mixed oranges and apples. Interconnecting loudspeakers in series-parallel combination is a good idea only when the loudspeakers are electrically matched in all ways. For example, two different eight ohm loudspeakers can operate at different

efficiency levels. Thus, for the same input, each would produce a different sound and level. If you raised the lower sounding speaker to a loud volume, the more efficient speaker may destroy itself. As you well know!

Economics Does it Again

I can't seem to find the multigang tuning capacitors I need for the projects I build. Why?

—S.M., Carson, CA

Multigang capacitors are not standard stock items anymore for two reasons. These are expensive items to keep on the shelves of parts stores, and the demand for them has waned. A few stores and mail-order houses keep them in stock for hams and radio builders.

Where's My Lawyer

The 20-ampere circuit breaker in my house line did not protect my washing machine when it jammed. The motor burned out. Who could I sue?

—W.H., Northfield, IL

No one! The 20-ampere circuit breaker is there to protect the No. 12 gauge wiring in the walls of your home. If you want to protect an appliance that plugs into a receptacle, then fuse the appliance. Some plugs come with slots for 3AG-size fuses. Otherwise, mount a fuse on or in the appliance to protect it. Find the rated current for a washing machine, and use a slow-blow fuse that's rated slightly higher. Washing machines, and most motor appliances have high starting currents.

Long Life to You

Hank, I predict Citizens Band radio will die. What I mean is that interest in the band will diminish and instead of 10,000,000 CBers, we'll have 100,000 or so. What do you think?

—F. Y., Drain, OR

I'll believe it when they take the squelch control out of the CB transceiver. We are entering an era of personalized two-way radio communications which will be as big as the land-line telephone. Both communication forms will be with us for a long, long time, until someone develops ESP with a private channel for everyone.

Fix the Trouble

Would a shortwave radio receive CB signals better than a CB could? My rig gets a lot of cross-channel and sideband interference.

—J. T., Montreal, Canada

By cross-channel, I assume you mean adjacent channel reception. If this were the case, the receiver section of your CB is out of alignment. Most modern day CB rigs have an adjacent channel rejection of 45 dB. I don't know whether your shortwave receiver can do better. As for SSB interference, if it's on your channel, your rig, or any other receiver cannot eliminate the trouble. I'd suggest you have a pro tune-up the receiver section of your CB rig and check out the antenna system carefully. ■

for the Experimenter!

INTERNATIONAL CRYSTALS and KITS



OF-1 OSCILLATOR

\$3.25
ea.

The OF-1 oscillator is a resistor/capacitor circuit providing oscillation over a range of frequencies by inserting the desired crystal.
2 to 22 MHz, OF-1 LO, Cat. No. 035108. 18 to 60 MHz, OF-1 HI, Cat. No. 035109. Specify when ordering.

.02% Calibration Tolerance

EXPERIMENTER CRYSTALS

(HC 6/U Holder)

\$4.25
ea.

Cat. No.

031300

Specifications

3 to 20 MHz — For use in OF-1L OSC
Specify when ordering.

031310

20 to 60 MHz — For use in OF-1H OSC
Specify when ordering.



MX-1 Transistor RF Mixer
3 to 20 MHz, Cat. No. 035105
20 to 170 MHz, Cat. No. 035106

\$4.50 ea.

SAX-1 Transistor RF Amp
3 to 20 MHz, Cat. No. 035102
20 to 170 MHz, Cat. No. 035103

\$4.50 ea.

BAX-1 Broadband Amp
20 Hz to 150 MHz, Cat. No. 035107

\$4.75 ea.

Enclose payment with order (no C.O.D.). Shipping and postage (inside U.S., Canada and Mexico only) will be prepaid by International. Prices quoted for U.S., Canada and Mexico orders only. Orders for shipment to other countries will be quoted on request. Price subject to change. Address orders to:

M/S Dept., P.O. Box 32497
Oklahoma City, Oklahoma 73132

WRITE FOR BROCHURE

International Crystal Mfg. Co., Inc.
10 North Lee Oklahoma City, Oklahoma 73102



CIRCLE 5 ON READER SERVICE COUPON



**Don't be penny-wise
and pound-foolish.
Secure your home with a...**



SILENT SENTRY by Jorma Hyypia

FORCED ENTRY INTO PRIVATE HOMES continues to increase at an alarming rate each year. At last estimate, a burglary-motivated break-in occurs somewhere in the country every twelve seconds, and sixty percent of these invasions of private property occur in residential neighborhoods. Human lives as well as material possessions can be lost, as grim statistics adequately attest.

If you have so far neglected to install an intruder alarm system, perhaps because of the high cost of a professional installation, or because running wires all over the house seems like too much work, there's an easy solution to your security problem. Use a radio-controlled alarm system like the Nutone Wireless Home Security System, Model S-2255. You can have it operative within a few minutes after removal from its packaging.¹

The heart of the system is an attractive receiver/control unit that looks much like a quality table radio or other hi-fi audio equipment. Three slide

switches on the front panel control all functions. To make the unit operative, simply plug the power cord into a wall socket. You can add a 12-volt battery to an inside compartment as standby power; it takes over if there is an AC power failure or if an intruder cuts your power lines before attempting entry into your home. A built-in alarm sounds when this control unit is activated by radio signals emanating from a small transmitter/detector system located at a protected door or window.

Easy Installation. Just mount the small transmitter unit on the wall, above or next to a door, using an adhesive pad already attached to the rear of the transmitter. Then run a short wire to a detector switch, attached to the door or window frame by means of two screws (or by means of double-stick adhesive pads if mounting is on glass or metal). A passive magnet unit is attached to the door, or moving part of a window, close to the switch.

When the door or window is closed,

the magnet keeps the switch contacts closed. When the door or window is opened, and the magnet moves a few inches from the detector, the switch opens. This activates the transmitter unit which immediately beams a radio signal to the main receiver/control unit.

The basic Nutone alarm system comes with two transmitters, and you can purchase as many additional transmitters as you need. You don't need a separate transmitter for every door or window, because you can run wires from one transmitter to virtually any number of magnet/detector switch locations.

To protect a bank of sliding glass doors, locate detector switches at both end doors and run wires to a common transmitter. If other doors or windows are to be protected, run additional wires to them from the sliding door detectors, or directly from the transmitter unit.

A double-hung window needs two sets of magnets, one for each half of

SILENT SENTRY

the window. If you install a second passive magnet unit a few inches below the first one, on the double-hung window sash, you can leave the window cracked for ventilation and still have alarm protection.

Operation. To activate the system, simply push a "Disarmed/Armed" slide switch to the "armed" position and set a second slide switch to its "exit" position. You then have 25 seconds time to leave your home and lock the door. After that the system automatically becomes operational.

You also have a little time to get to the control unit to shut it off after entering your home. This delay interval can be adjusted from 15 seconds to as much as three minutes just by moving a control knob accessible from the bottom of the receiver/control unit. Whenever the alarm sounds, it can be turned off just by depressing a third slide switch for a few seconds.

Obviously, the receiver/control unit should be placed where an intruder would not spot it immediately on entry into the house. Even if he finds it after the alarm sounds, he is not likely to hang around to deactivate it because attention has already been drawn to his presence. You can make the unit less conspicuous just by positioning it with hi-fi audio components in a bookcase; or you may have an even better location elsewhere in your home. In an average home you can place the receiver in just about any convenient location. The only thing that would make any particular spot unusable would be the presence of a metal object large enough to block radio energy beamed by one of the transmitters. A quick test will determine whether a chosen location is suitable.

If you want the system operative while you remain inside the house, move the "Home/Exit" slide switch to "home." This eliminates the time delay sequence and the alarm will sound the moment a door or window is disturbed.

The system has simple test controls to facilitate periodic checking of the small nine-volt batteries that power the individual transmitters. Just press a small button on the bottom of a transmitter; if a pilot light comes on you know the battery has enough juice to power the transmitter. If the receiver/control is turned on when this test is made, the alarm will sound. Thus you can check the entire system in a few seconds.

Optional Equipment. There's a port-

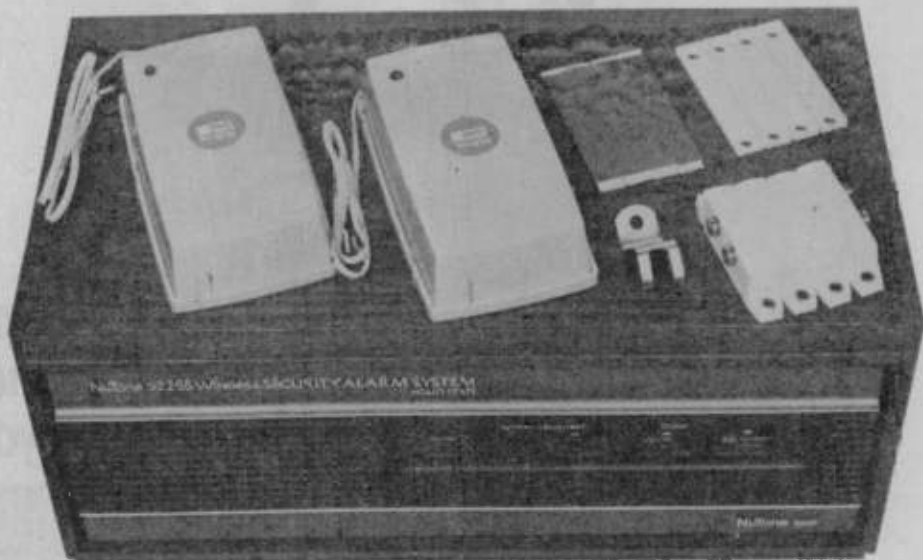

NuTone's basic security system has transmitters for two locations, plus two sets of magnets, filler blocks, adhesive strips and power plug clamp. A single transmitter can be wired to protect several doors and windows.



Even if the AC power should fail, you're still protected as 12-volt battery power automatically takes over security duty.



The control unit is designed to blend in unobtrusively with typically styled audio and high-fidelity equipment. It's easy on the eyes—and easy to "hide."

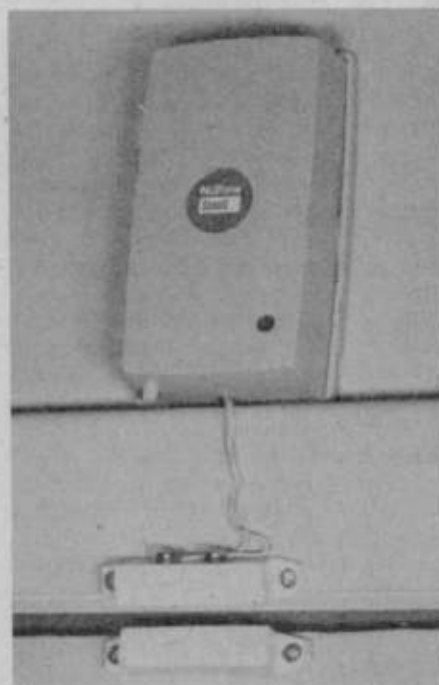

A transmitter and two magnets can be mounted in minutes. Only wiring is from the box to the active part of the magnet switch.



The main body of each transmitter is easily removed from the wall. A 9-volt battery can be quickly and easily replaced.

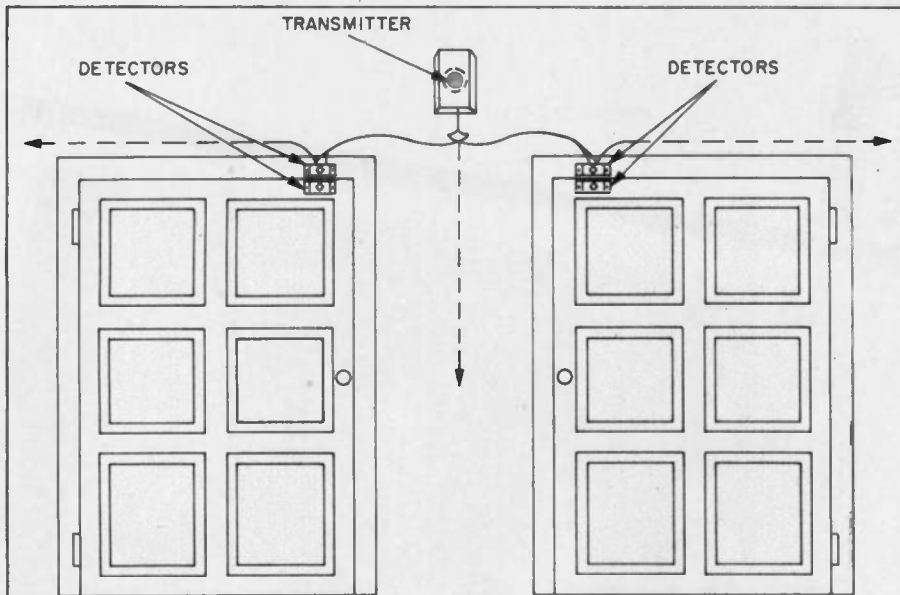

A single transmitting unit can be connected to more than one detector unit. All that has to be done is to run parallel connections from existing detectors directly to the single transmitter. Any number of sensors may be so attached.

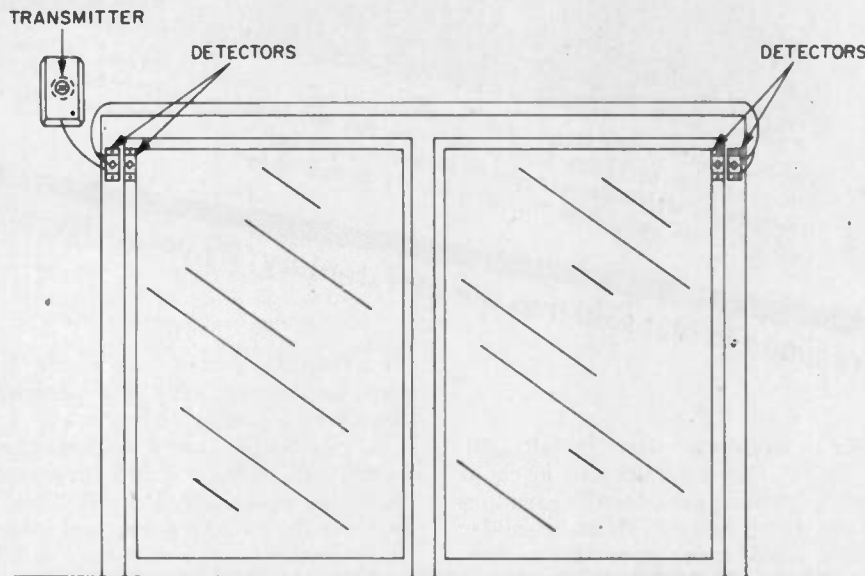

Sliding glass doors can be protected by installing detectors on both end doors. Use double stick adhesive—not screws—on metal frames and glass.

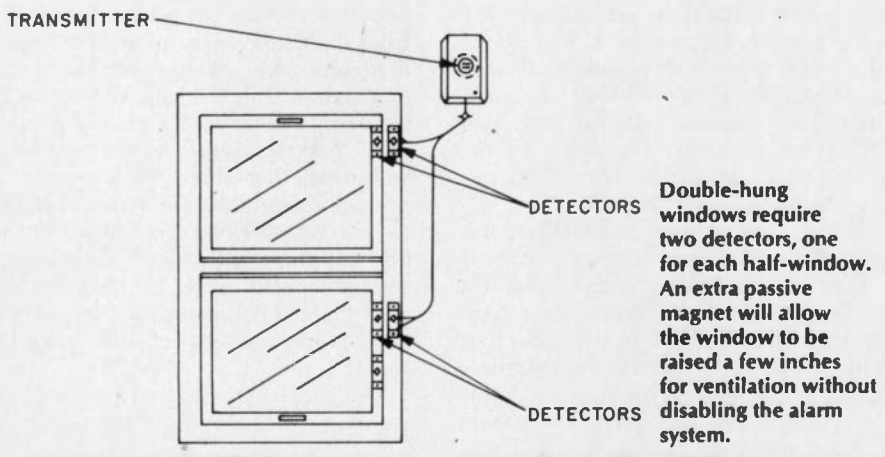

able transmitter that slips easily into a pocket or purse; you even gain a degree of *personal* protection because the alarm can be sounded just by pushing a button on the transmitter. Keep it by your bedside as a panic alarm. The effective range of the portable unit is about 150 feet.

Actually, if you need such personal protection only now and then, you can make temporary use of one of the regular door/window transmitters if you mount it so that it can be removed from the wall. There's no need to remove the magnet/switch detector on the door; just detach the connecting wires.

There are times when you might wish to carry the *receiver/control* to some other location, out to a patio or pool-side, for example. Since it can be battery powered, there's no need of an outside AC power source. You might want the alarm unit to be near at hand if, for some reason, you might not be able to hear the alarm if it were to sound while in its normal inside location.

The S-2255 control unit has its own built-in alarm horn, but you can install additional noise-makers if you wish. There are two different types of add-on optional equipment. Model SA-2335 consists of an alarm that is similar to the one built into the control; it can be used only inside the home. Model S-2340 is an alarm bell for use indoors or outdoors. For outside use, mount it in a weatherproof box (Model S-2349). Installation is simple. All that's needed is to run a two-conductor cable from the bell to terminals at the rear of the receiver/control.

Another option to consider is a Floor Mat entry detector (Model S-2271). This is placed under a floor mat in a strategic location, just inside a door, or at the foot of stairs leading to a second floor, for example. Run a concealed wire to any nearby transmitter. When an intruder steps on the mat, the alarm sounds.

Protective and preventive security can now be considered a household word. Maybe it's time your own household was electronically secured.

One of the finest things about this silent sentry system is its versatility. It can literally be used anywhere you might be living—just as long as there is a 117 VAC line.

In the past, a system of such reliability and performance value would likely be a built-in and so expensive as to be beyond the means of all but the most wealthy homeowner.

Circle number 68 on the Readers Service Coupon for more information about this product. ■

TV-2001

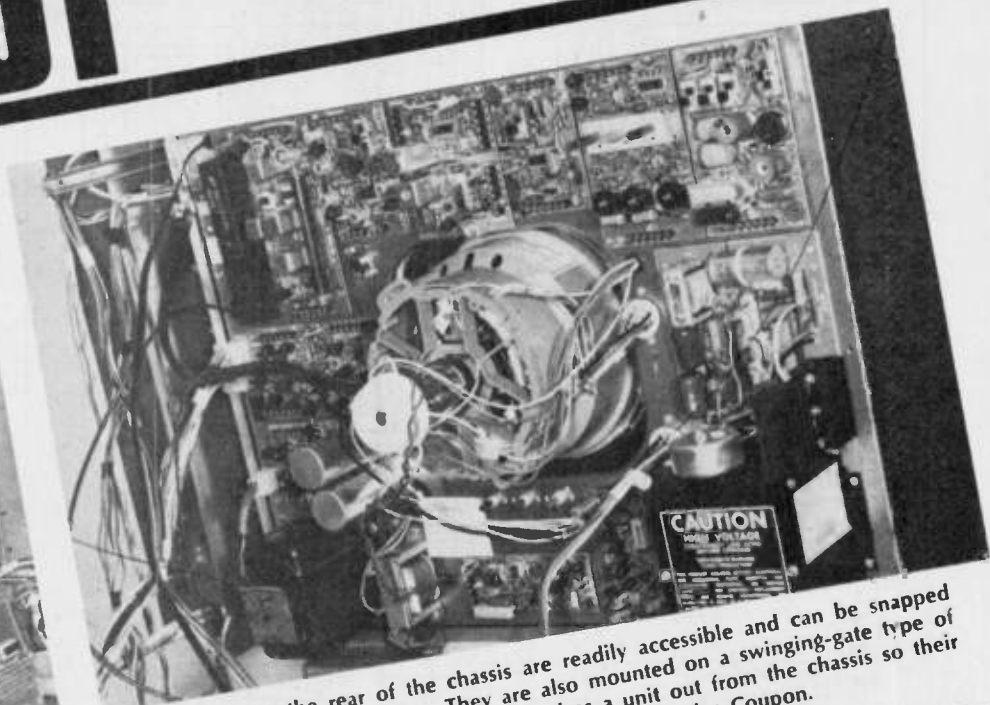
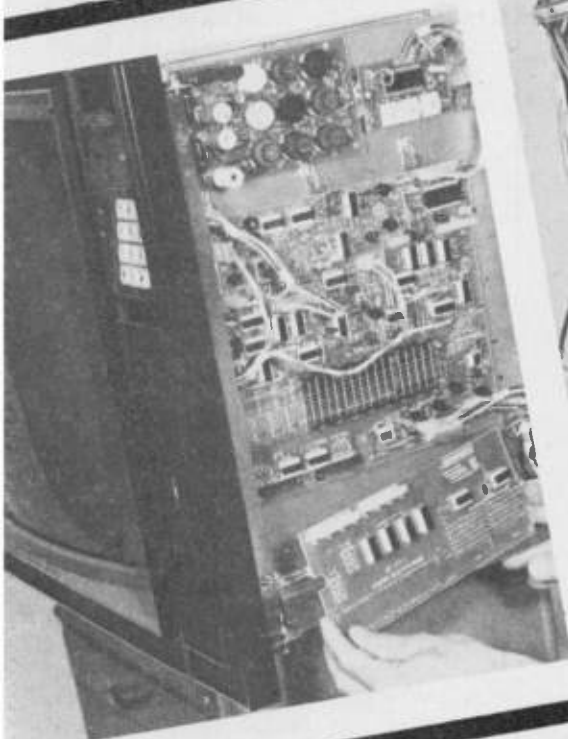

The PC boards at the rear of the chassis are readily accessible and can be snapped out in seconds for bench testing. They are also mounted on a swinging-gate type of arrangement which allows them to be moved as a unit out from the chassis so their foil sides may be worked on. Circle No. 31 on Reader Service Coupon.

This new Heath color TV kit is programmed to last well into the 21st Century / By Jorma Hyypia

WHAT'S A NICE COLOR TV SET like this doing in a BUDGET ELECTRONICS neighborhood?

That's a good question. To obtain this superlative, state-of-the-art Heathkit GR-2001 equipment you must pay more for parts than for a good ready-made set, and then spend weeks assembling the more than 2,000 components. That doesn't sound cheap.

It isn't. But it can be *economical*. A supposed "bargain" can turn out to be expensive because of breakdowns, costly repairs, and unsatisfactory service. That's cheapness, at high cost; but by paying a little more you stand a better chance of acquiring something that performs better, lasts longer and requires fewer and less expensive repairs. That's economy. Also part of the reason why this classy GR-2001 TV equipment deserves space in BUDGET ELECTRONICS.

To be convinced that the GR-2001 delivers as fine a picture as you could hope to obtain, visit a Heath showroom for a demonstration. Then, consider what it would mean to be able to handle your own TV maintenance and repair jobs. You may be among those who pay up to \$90 every year for a TV service contract, whether or not repairs are needed; or, you may already have been victimized by a TV rip-off artist who charges fifty bucks or more for replacing a three dollar tube or a thirty cent transistor. Doing your own repairs can save you a bundle over the years and keep your set at peak operating condition at all times.

It all sounds very convincing, yet you may have reservations about your ability to assemble a complicated TV set, especially if you have never handled a soldering iron. In that case, test your ability—and interest—in electronic kit building by putting together some other simple and inexpensive item from a Heath store or catalog. Be sure that

it's a Heathkit because you want to become acquainted with that particular company's assembly directions.

If you already are a dedicated and experienced soldering-iron jockey, you'll find that assembling the GR-2001 is basically the job of building and joining many smaller kits. You'll have a ball!

When the editor of BUDGET ELECTRONICS decided to reveal the "true experiences" of an actual GR-2001 builder, he wisely sought someone who admittedly had no prior expertise in color television work. Your author qualified admirably, having failed miserably to repair a simple black-and-white TV set despite three weeks of intensive effort. Yet this same novice was able, within another three week period, to not only assemble the basic GR-2001 to perfect working condition, but to also add three options—the digital clock, remote control and TV programmer. And there was time enough left over to photograph the project and write this report.

There are two basic reasons for this gratifying success: The high quality of Heath equipment, and the incredibly



When you build your Heath TV, you also have the opportunity to assemble the small VOM, shown here. The meter is specially calibrated to align, check, and troubleshoot the Heath line of televisions.

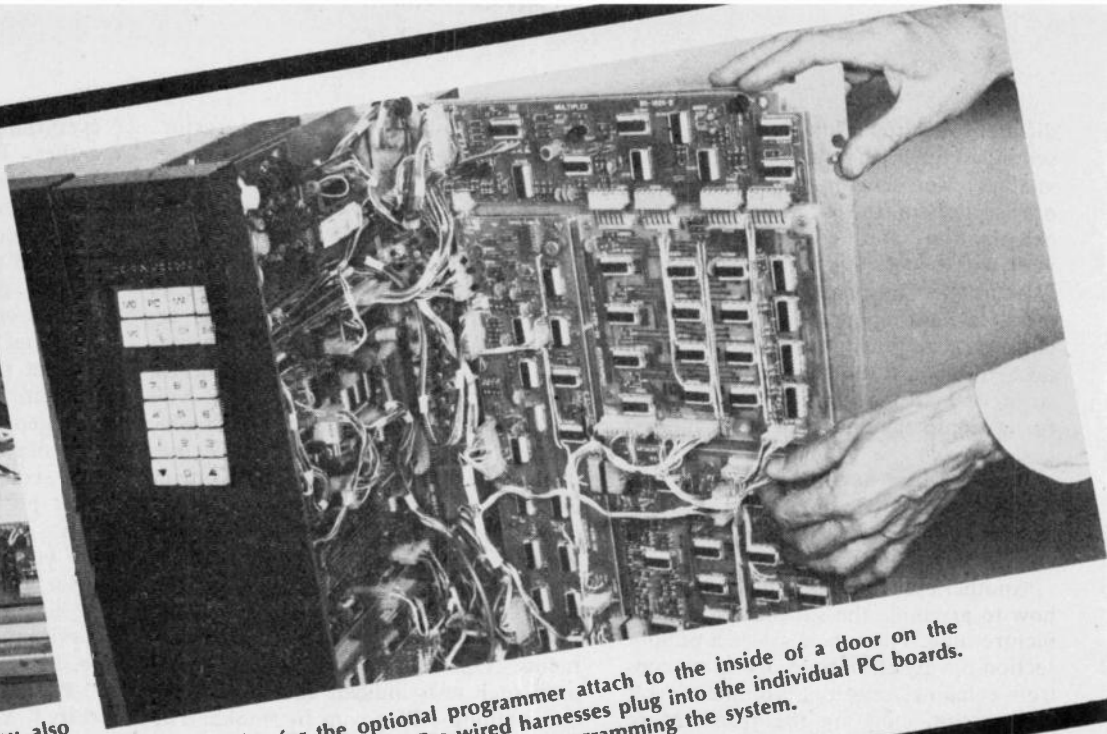

The four boards for the optional programmer attach to the inside of a door on the pull-out section of the chassis. Pre-wired harnesses plug into the individual PC boards. The top bank of pushbuttons (left) are for programming the system.

well-planned and wholly reliable assembly instructions. Throughout the complicated project I half-way hoped to find at least one minor error or point of confusion in the Heath manuals. No way!

The only mistakes I found were those that I made myself. That is a very significant observation! Thanks to an ingenious troubleshooting procedure worked out by Heath engineers, I was able to find my construction errors in short order and make them right. It was proof positive that I would be able to service my GR-2001 during the years ahead.

Many Options. In addition to the top-of-the-line GR-2001, there's its somewhat less expensive predecessor, the GR-2000, which also is a 25" model. At still lower cost, there are 21", 19" and 17" versions. If you want the best, but without special conveniences, you can skip the clock, remote control and programmer options available for the two top models. On the other hand, if you want to shoot the works, you can add an antenna rotating system that automatically aims your antenna in the proper station direction each time you switch channels.

Five different styles of fine-furniture cabinet are available for the GR-2001 or GR-2000 receivers. Some have provision for twin speakers for improved

sound. It's just possible you won't have to purchase any of these cabinets because the Heath TV receivers are ideal for custom installations into cabinetry you may already own, into built-in cabinetry, or even mounting into a wall. That's something you cannot do with ready-made TV sets, at least not nearly as easily.

So why did we choose to feature the most expensive version, with most of the options, in BUDGET ELECTRONICS, although less expensive versions are available? For two reasons. We can thereby talk to the most ambitious kit builders as well as to the economy minded. More importantly, a full-scale project put Heathkit to the toughest test because it has been that company's policy to plan things so that I, and other non-experts like me, will not get lost along the way.

According to a spokesman at one Heath store, a very small percentage of people who buy the TV kits come back screaming for help. The guy who gets into trouble usually is someone who "buys a kit on Friday and tries to have it ready for a Monday ball game!" It just won't work. You don't need above-average intelligence to build your TV, just a reasonable amount of patience and the determination to stick to the letter of the assembly instructions.

The Basic TV Set. Four profusely illustrated manuals are your guides through assembly. There's a fifth manual dealing with special alignment in-

formation that you will probably never have to use. You need *no* electronics experience to understand the assembly procedures; all components are clearly identified by code numbers, values and pictures.

Book One shows how to put together 19 PC (printed circuit) boards, each of which has a specific electronic function; for example, power, chroma, luminance, video output, convergence, tuning. When a bit of wire needs to be cut to specific length there's no need to hunt for a ruler; there's a handy scale at the bottom of the page.

A great many transistors and integrated circuits (ICs) are used in the circuitry, but you need have no fears about damaging them with a hot soldering iron. They simply plug into sockets attached to the PC boards. The transistors and ICs can be removed instantly for testing or replacement.

Avoid short cuts, however reasonable they might appear. I found that transistor legs were regularly cut a little shorter before installation. So I would measure one out of each batch and use that to trim others to identical lengths. This worked fine until I discovered that *one* transistor required longer legs in order to hold a ring called a ferrite bead. It was no calamity, but I had to make a trip to the Heath shop for a replacement transistor.

All component parts needed for any one particular PC board are contained in a single, clearly marked paper bag. There is no need to hunt for the right parts from a confusing general stock.

The use of separate PC boards for

different electrical functions makes assembly simpler and there's another advantage. You can quickly remove any one section of the circuitry for easier examination and troubleshooting at your workbench. If you suspect a problem in the luminance circuitry, for example, just snap the board off its clips. If you can't find the problem, take the board to the nearest Heath store, or mail it to Heath headquarters, for a complete check at very modest cost.

Book Two is devoted to the chassis, the rear panel that contains most of the PC boards, and a pre-assembled high voltage power pack.

Another manual (un-numbered) shows how to assemble the subchassis and the picture tube. The subchassis is a pullout section having all normal operating controls (channel selectors, volume on/off switch, tint, etc.) on the front. More PC boards (convergence, tuning control, display and channel selector) are mounted inside the pullout chassis. Such options as a digital clock, remote control and programmer also go into the subchassis. Anytime you want to check a component on any of these PC boards just pull the subchassis out of the TV cabinet. Cutouts even let you get at solder connections on the rear sides of key PC boards so they need not be removed should components require changing.

The large 25" picture tube is much heavier than you might expect, so have someone else around to help you ma-

neuver it out of the packing carton. Work on the floor where you can get to all sides of the tube. Follow directions carefully, and you will have no problems with the tube installation.

Book Three gets you into adjustment and operation of your set. A special volt/ohmmeter (which you also assemble from a kit) is provided for adjusting the TV circuitry and for general trouble shooting. Even if you already own a multimeter or VTVM, you'll want to use the Heath tester because letter codings that relate to manual instructions make reading the meter much faster and easier than if you were to use a meter with a conventional dial.

You begin checking your assembled set by making key resistance measurements. You do not turn on the power until such tests indicate that all is well, and nothing will go up in smoke. The procedure is delightfully logical and simple. A block diagram clearly shows just where to attach the meter probes and what kind of reading to expect. If you get a correct reading you follow a "Yes" arrow to the next step; if you obtain an incorrect reading a "No" arrow directs you to a different section of the test procedure. When resistances check out properly, you use similar flow-sheet instructions to make voltage tests.

There are all sorts of controls and switches to push, turn or adjust to get

everything in the circuitry to work together. But here again you are led along, step by step, in a very clear and logical manner. You might think that adjustment of the "convergence"—getting the red, green and blue beams to merge properly to eliminate color fringes—would be a tough problem. But a special "dot generator" built into the TV set makes the job quite easy and, in fact, a lot of fun. Remember, the dot generator will be there whenever you need it. As electronic components age, color balances tend to degrade. You probably have noticed this happen with older sets. But with a Heathkit TV you need never put up with inferior color because it would be too costly to have it perked up by a professional serviceman. Just use your dot generator to do the job in a few minutes.

Book Four is titled "In Case of Difficulty." You'll treasure this manual because it contains extremely useful, and again very methodically presented, information that will enable you to hunt down the causes of malfunctions. And you will have these gremlins, no matter how carefully you work, unless you are extraordinarily skillful and very lucky. Just be reassured that when a malfunction is observed, there is no need to panic.

I'll give you an example. I discovered

TV-2001

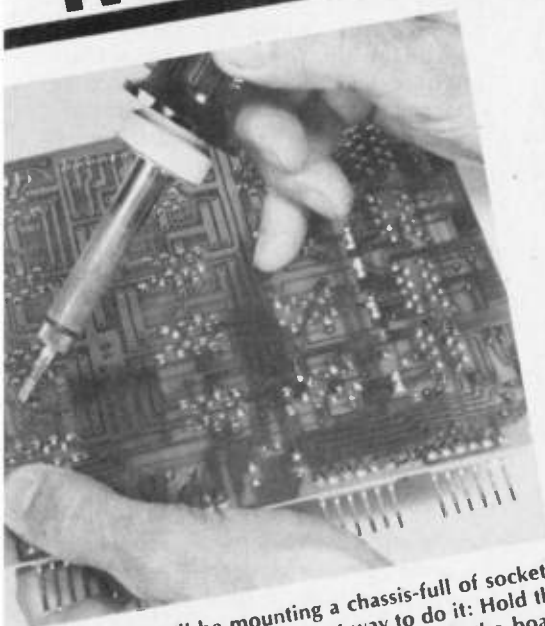

You'll be mounting a chassis-full of sockets, and here's the easiest way to do it: Hold the socket in place from underneath the board while you bring the point to be soldered up to the tip of the wire solder. Do two legs, then solder in the usual manner.

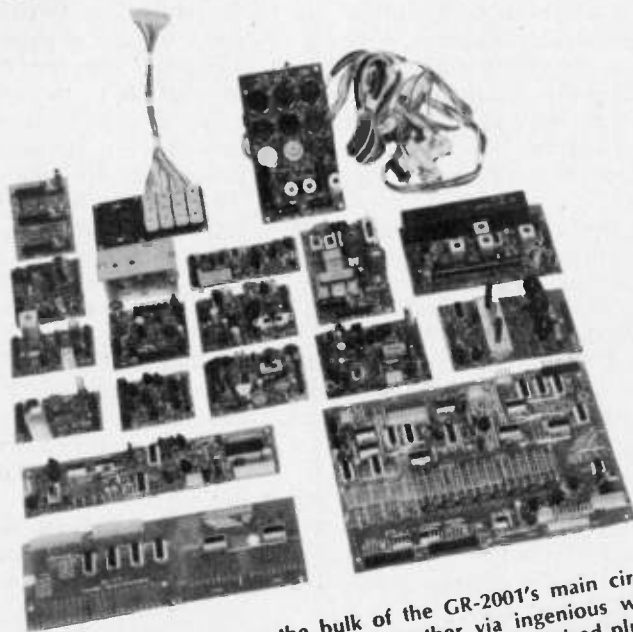

These nineteen PC boards make up the bulk of the GR-2001's main circuitry. Once individually wired they are connected one to another via ingenious wire-harnesses which come complete with sockets that fit onto the PC boards' raised plugs.

that the "scan" buttons would not work. These are depressed to sequentially run channels to lower or higher numbers. The scan section in the manual indicated the trouble might be in the keyboard switches or in any one of five identified ICs. A quick meter test revealed that the button circuits were functional. The hunt for a bad IC was begun by removing one suspect at a time and substituting an identical IC borrowed from an unused (for the moment) PC board. When the third IC was being removed from the scan circuitry, the big discovery was made. The IC socket was still loose. Although I had checked all solder joints with a magnifying glass, I had somehow missed this one. A few minutes with a soldering iron put things to rights and the scan system worked perfectly. The important point is that the Heath manual told me exactly where to look for a solution.

Incidentally, before you start pulling out suspected components for testing (according to instructions provided in the manual) check your solder joints! This cannot be over-emphasized. I had problems with the hand-held remote

control unit, hence made the voltage checks specified by the manual. The voltages were all wrong, but there was no visible evidence as to which component might be defective. I anticipated a prolonged hunt for the cause of the problem; but, on a hunch, resoldered all connections even though they all looked good. The control worked properly on the first test!

This corrective action, too, was achieved relatively easily because the Heath manual showed how to determine whether the hand-held control, or the receiver circuitry inside the TV set was at fault.

Incidentally, handle the PC boards carefully because they contain many delicate components—in particular the transistors that stand on rather spindly wire legs. It's easy to brush these transistors with the back of a hand while installing other wiring or components and bend them so that the legs short circuit or pop out of the sockets. Make a habit of periodically checking the condition of the transistors.

Accessories. To avoid confusion, you probably should concentrate completely on building the basic unit first. Then go on to install the clock remote control or programmer, buying them later. You will have to remove some parts, here and there, that you had painstakingly installed, to replace them with others needed for the optional equipment. Still, if you try to make these changes by working with two or three manuals simultaneously you can get into a real mess.

I'd make one exception to the generalization that you leave optional equipment in their packing cartons until the basic TV is fully operational. If you have a programmer, check to see what additional sockets must be added eventually to the tuning and display PC boards and install them when you first prepare the boards.

The most useful accessory is the re-
(Continued on page 98)

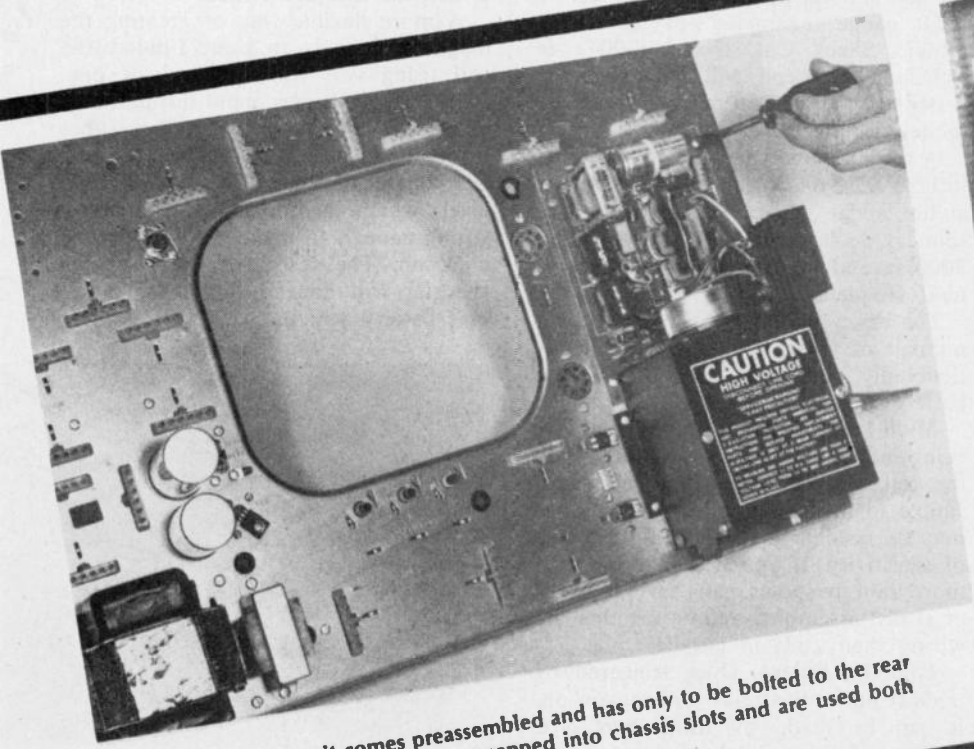

The high-voltage power unit comes preassembled and has only to be bolted to the rear panel. The white bars you see have been snapped into chassis slots and are used both to hold PC boards and make contacts.



A close-up of a section of PC board shows how the IC's are mounted in sockets. Note also the transistor in the socket at the center of the photo. Component values are marked on the board for quick reference (resistor values are marked beneath the resistors).

CIRCLE 31 ON READER SERVICE COUPON

□ Custom build your experimental relays from magnetic reed switches and save a bundle. The reed switches are very inexpensive and all other components can be found in your junk box. The simplest relay will run you about thirty cents. There are even other advantages. The relays are highly sensitive and can be coupled directly to audio circuits for experimental purposes, their light weight and tiny size make them ideal for model applications, and they are even applicable to high speed switching circuits because of their extremely short response times.

The Basic Relay. Wrap a coil of wire around a reed switch (Radio Shack Cat. 275-034 "Mini" or 275-035 "Micro Mini") and hold it on by end pieces cut from some thin, rigid material such as cardboard. The reed switches—especially the "Micro Mini" size—are quite fragile, so play it safe and wrap the coil around a form of the same diameter as the reed switch (coat hanger wire, for example, for the "Micro Mini") then replace the form with the actual switch when the coil is complete. The length of wire used to wind the coil is not critical; about five feet of #24 gauge enameled magnet wire (Radio Shack Cat. No. 278-004) is sufficient. The coil will hold together better if you coat it with lacquer or model airplane dope.

A relay of this type will respond to as little as 0.5 volt. When connected to an audio signal generator, the relay responds to frequencies approaching 3000Hz and to somewhat higher resonant frequencies.

The basic relay can be modified in a number of ways. Though you will undoubtedly find more, here are a few basic examples.

Multi-Pole Relays. Make these by using additional reed switches inside the coil. Four and five pole relays are simple to make, though extra windings may be needed to retain a high degree of sensitivity. If you need a relay with more than five poles, gang several smaller, fully assembled relays together by wiring their coils in parallel.

Latching Relays. Once triggered by a short pulse, this relay will remain on, it can be made by using two reed switches in the coil (see diagram). One switches the load, while the other is wired into the coil power circuit. When the momentary-on switch is pressed, the coil is energized, closing the two reed switches. Once the left-hand reed switch is closed, current will continue to flow

through the coil even after the momentary-on switch is released. To turn the relay off, a normally-on, momentary-off switch is pressed to break the flow of current to the coil, thereby cutting off both reed switches.

Biased Relays. In the simplest, basic relay the only magnetic field around the switch is that created by the trigger current flowing through the coil and it is this magnetic field that activates the reed switch. The sensitivity of the relay to the trigger current can be increased by biasing the magnetic field with either a permanent magnetic field or an electro-magnetic field.

The permanent magnetic bias is made simply by mounting a small magnet at the proper distance from the coil. To find the best positioning, move the magnet close to the relay until you hear the reed switch click on, then back off a tiny distance. The field created by the permanent magnet should be *almost* strong enough to turn the switch on, but not quite. Now any weak trigger current sent through the coil will be strong enough to kick the magnetic field above the threshold level needed to activate the reed switch.

A more flexible way of creating the magnetic bias is to double wind the coil using two wires instead of one. Connect your trigger input through one, as shown, and connect the other through the bias battery. The rheostat lets you set the bias field to the correct level, which, again, should be almost strong enough to make the reed switch click on. The resistance value of the rheostat will depend on what voltage bias battery you use.

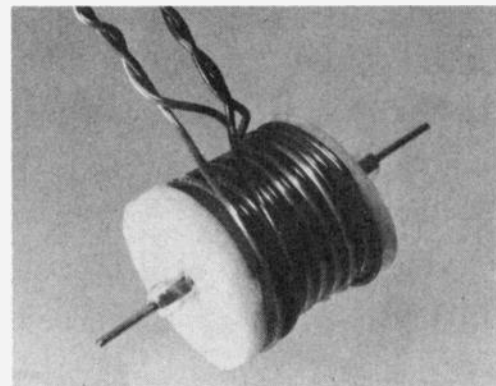

The basic relay is as tiny as many commercial sub-miniature units, a whole lot cheaper, can be designed with greater versatility, and is a lot of fun to build. The basic relay, shown here, is nothing more than a coil of wire wound around a magnetic relay switch.



CUSTOM RELAYS ...AT MASS PRODUCED PRICES

By Erik Hyypia

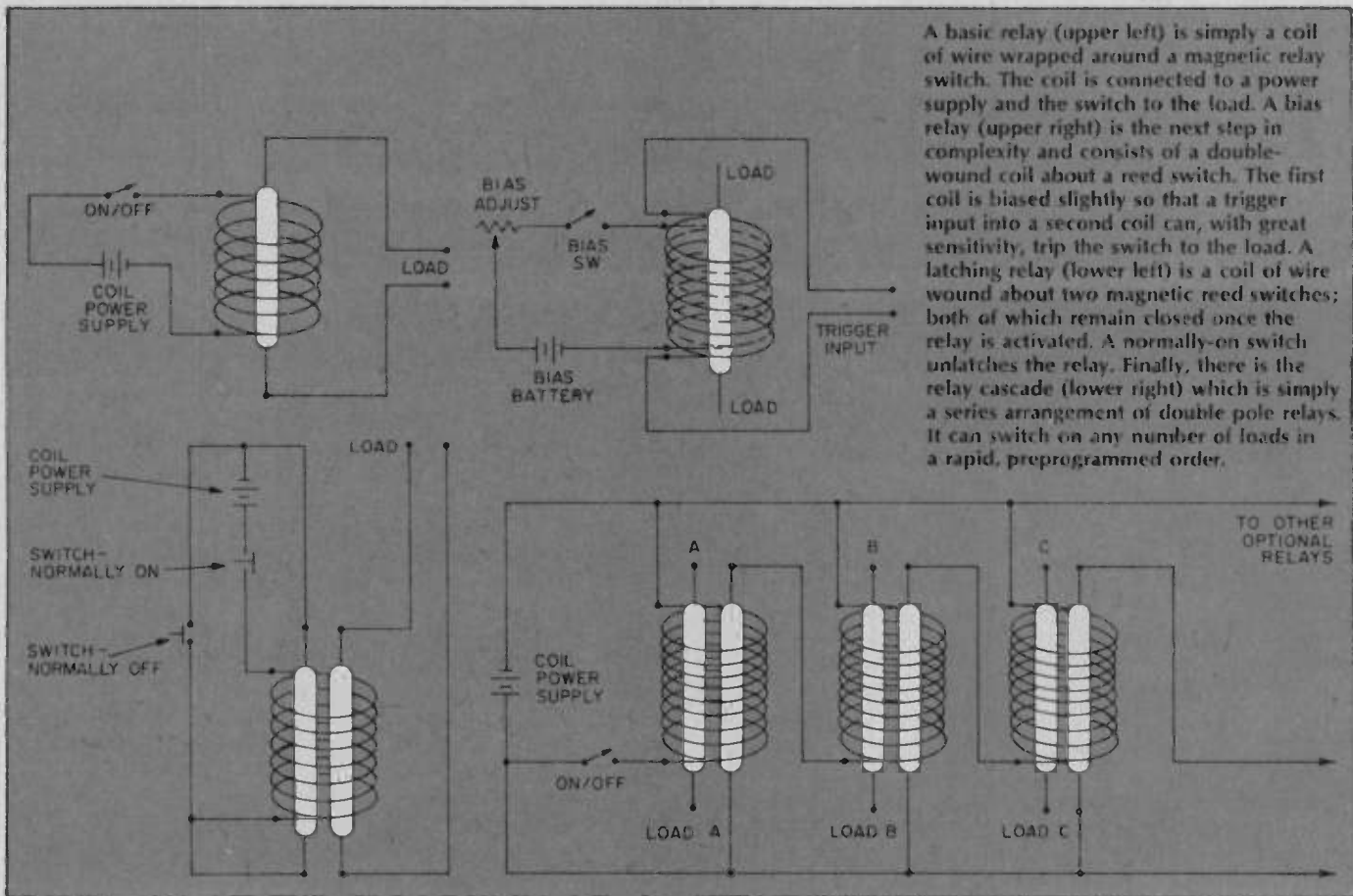

A basic relay (upper left) is simply a coil of wire wrapped around a magnetic relay switch. The coil is connected to a power supply and the switch to the load. A bias relay (upper right) is the next step in complexity and consists of a double-wound coil about a reed switch. The first coil is biased slightly so that a trigger input into a second coil can, with great sensitivity, trip the switch to the load. A latching relay (lower left) is a coil of wire wound about two magnetic reed switches; both of which remain closed once the relay is activated. A normally-on switch unlatches the relay. Finally, there is the relay cascade (lower right) which is simply a series arrangement of double pole relays. It can switch on any number of loads in a rapid, preprogrammed order.

One side note to all of this: if you use a transformer instead of a battery to power the relay coils, use a full-wave rectifier between the transformer and the relays. Alternating current or half wave D.C. will make the relay buzz on and off at 60Hz.

A Relay Cascade. This device lets you turn several items on with one flip of a switch, and have them come on in

a specific order, one after another. The coil of relay A (diagram) is wired to the start switch, and the coil of each consecutive relay is wired through the reed switch of the previous relay. Thus, when the On/Off start switch is closed, relay A will come on, then relay B, then relay C, and so on. Theoretically, there is no limit to the number of relays you can cascade this way, although

the power source may have to be increased to supply enough current. The current carrying capacities of both types of reed switches is 0.5 amps at 125 VAC.

The relays close and open extremely quickly—a "Micro-Mini" can cycle up to at least three thousand times per second, according to my rough tests, and will respond to resonant frequencies even higher. Thus, the closing time of the relay is, obviously, very short.

In closing. The applications of these relays are limited only by your imagination and the type of projects you build. Once you design something using one of these miniature marvels you may never again want to use one of the store-bought, bulky variety.

One tip: do *not* forget coating the coil of each relay with at least one good coat of lacquer or model airplane dope. Nothing is more aggravating than, sometime after the project is already built and functioning, having to rewind a relay coil which has spilled out of the form.

You're sure to find that switching with these relays is nearly as much fun as building them.

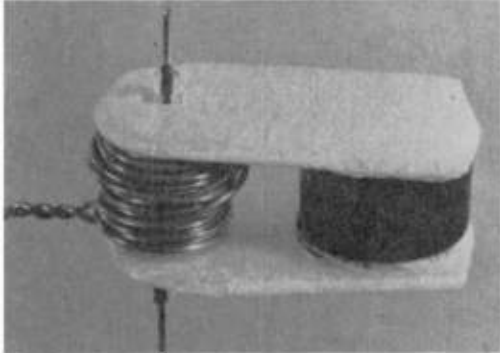

Here's a permanently biased relay, one of the more sensitive types you can design. Positioning the magnet nearby to the coil reduces the voltage necessary to trip the relay.

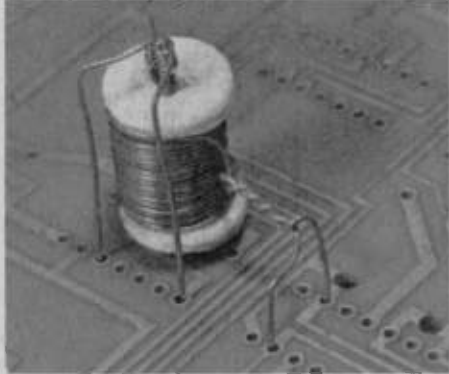

Because of their compactness, these home brew relays are easy to mount on a PC board. This particular double pole relay uses two switches within one coil.

HOW OFTEN HAVE YOU searched fruitlessly for a special switch? Probably dozens of times—if you're at all an active builder. The next time this happens, consider custom-building your own complex switches using inexpensive magnetic reed switches and small ceramic magnets. Such do-it-yourself switches offer several advantages. They are relatively inexpensive, silent, and long lasting, as there are no rubbing contacts and the reed contacts are sealed in glass, away from corrosive atmospheric gases.

You can purchase two sizes of magnetic reed switches and the ceramic magnets from Radio Shack. The larger switch (Cat. No. 275-034; 1 $\frac{3}{4}$ " overall length) comes in a 4-for-79¢ blister package. The smaller "Micro Mini" switch (275-035; 1 $\frac{1}{8}$ " long) comes 10 to a package, for \$2.99. The magnets cost 10 cents each, regardless of size. The smallest, $\frac{1}{2}$ " diam. disc ("button") magnet is the most useful, but you may need the larger 1 $\frac{1}{8}$ " disc or 1" x $\frac{3}{4}$ " rectangular magnets to build really large, complex switches.

The several custom-built switches shown in this article only hint at the virtually limitless design combinations that are possible. Study the drawings to

learn how magnet orientation and direction of travel past the reed switches affect switching action.

Carpetak Tape, a cloth tape with adhesive on both sides that is used to hold down carpets, is excellent for mounting the reed switches to panels. The switches adhere firmly, yet can be removed without damage. For greater permanence, you may wish to use epoxy cement for mounting once you know exactly where to locate the reed switches. Generally, it is best to locate the magnet and reed switches on the same side of the panel; however, it is also possible to put the switches on one side of a non-magnetic panel and orient the magnet on the other side. The ceramic magnets are of extremely hard material, and you may have poor success if you try to hacksaw them smaller. Try breaking the magnet by clamping in a vise and striking with a chisel; it may not break cleanly across, but grinding on an emery wheel may be practical. When possible, just use the magnets as they are. Mount them in aluminum holders as shown here, or glue to support arms with epoxy adhesive.

The following brief descriptions of various switch types should help clarify the principles of building switches:



CUSTOM SWITCHES ... THAT YOU COULDN'T AFFORD TO BUY.

By Jorma Hyypia

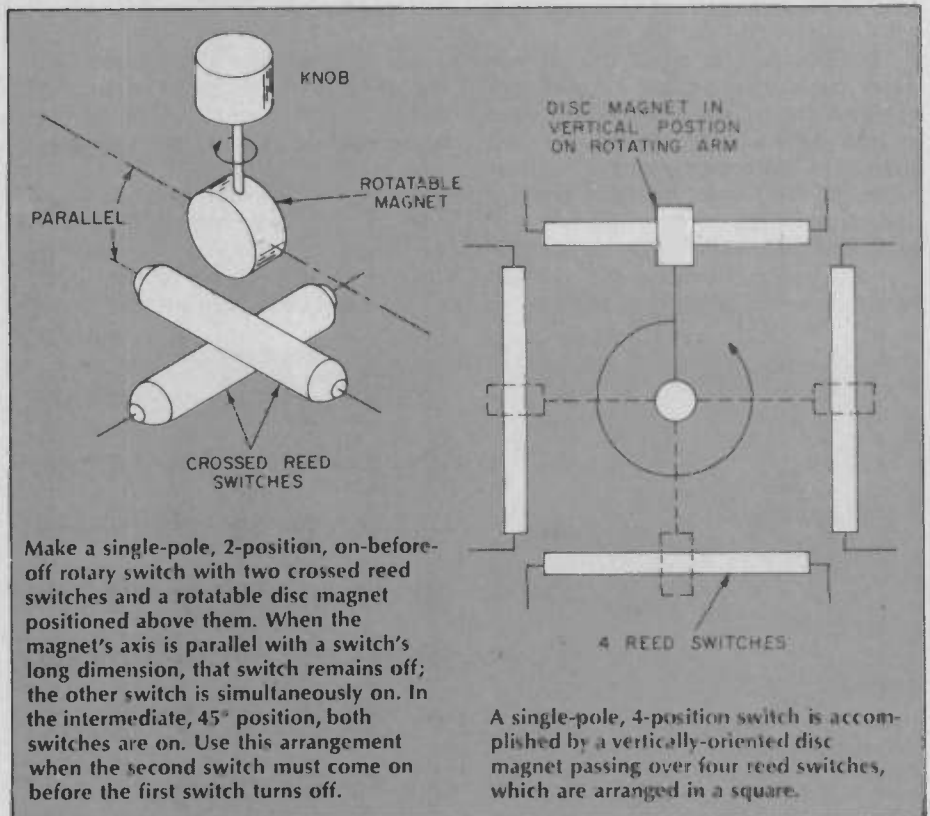

Make a single-pole, 2-position, on-before-off rotary switch with two crossed reed switches and a rotatable disc magnet positioned above them. When the magnet's axis is parallel with a switch's long dimension, that switch remains off; the other switch is simultaneously on. In the intermediate, 45° position, both switches are on. Use this arrangement when the second switch must come on before the first switch turns off.

A single-pole, 4-position switch is accomplished by a vertically-oriented disc magnet passing over four reed switches, which are arranged in a square.

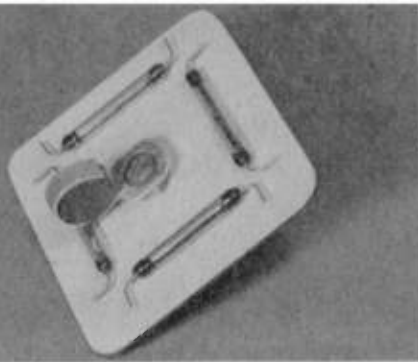

A rotary switch with a 1/2" diam. ceramic magnet mounted vertically turns the switches on individually. The magnet arm is turned by a knob on the other side of the panel, or can be turned continuously with a small motor drive for constant scanning applications.

Single-throw, multi-pole. These can be constructed simply by mounting reed switches in parallel, and passing the *edge* of a vertically-mounted magnet over them to trip all switches simultaneously. If you need a sequential switching action, just angle the magnet about 30 degrees so that the parallel reed switches are tripped in 1, 2, 3, 4 order. If the magnet movement con-

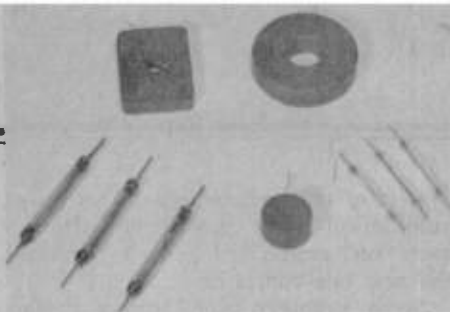

Magnetic reed switches, available from Radio Shack, come in two convenient sizes; the overall lengths, including leads, are 1 1/8" and 1 3/4". Both are rated at 0.56 amperes at 125 volts. The small, 1/2" diam. disc magnet is handiest, but the 1" diam. disc and 1" x 3/4" rectangular magnets may be desirable for building complex, multi-pole switches.

tinues in the same direction, the switches will go off in the same 1, 2, 3, 4 sequence, on the other hand, if magnet movement is reversed when all switches are on, the switches will go off in the reverse 4, 3, 2, 1 order.

Multi-position, single-pole. Arrange the reed switches one after the other, like cars of a train. You can keep the switch smaller by using two lines of

staggered switches, as shown. As the vertically-oriented disc or rectangular magnet passes over the switches, each "on" switch goes off before the next switch comes on.

A photograph shows a sliding switch of this general type, but one made to function as a double-pole, single-pole, double-pole sequencer. A simple locking device consisting of a lock washer under the knob on the other side of the panel permits locking the movement at any desired position. Note the "guide" strip near the slot; a square nut that holds the magnet support arm on the knob shaft bears against this guide to keep the magnet properly aligned over the reed switches.

Rotary switches. These are easier to build than slide switches, and there are many ways to achieve special switching characteristics. Note that when the edge (diameter axis) of a disc magnet is aligned with the long axis of a reed switch there is no switching action.

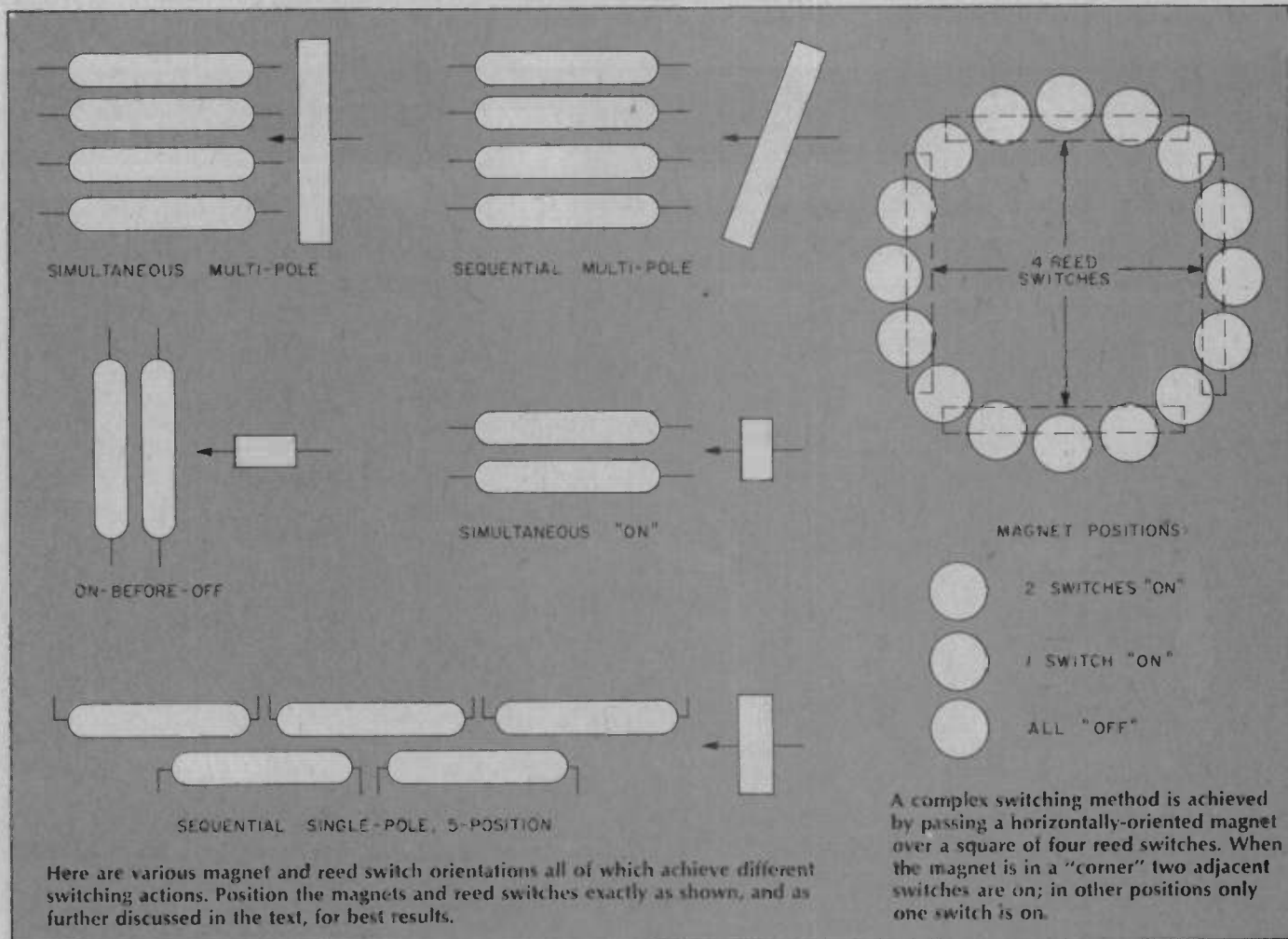

CUSTOM SWITCHES

Thus if you mount several reed switches next to each other, and rotate the magnet directly over the center of the switches, you obtain more or less simultaneous on-off action.

If two switches are crossed a vertically-mounted rotating magnet will turn one switch on and the other off when the magnet axis is parallel to the long axis of one reed switch. In the intermediate position, both switches are on; thus you can have on-before-off action with a very simple physical arrangement. To make a double-pole version, cross four reed switches in pairs.

A 4-pole, 4-position rotary switch can be made by arranging four reed switches in a "square" and adding a vertically-oriented disc magnet so that it can be swung in a circle over the

centers of the reed switches. This provides an off-before-on switching action, each "on" switch first going off before the next one comes on.

Some strangely useful things begin to happen if you mount the disc magnet horizontally instead of vertically. As the magnet passes over a corner of the square of reed switches so that it is partly over the ends of two adjacent switches, both switches go on. Rotate the magnet a little further, so that it is over just one switch and that switch stays on while the other goes off. Curiously, when the *horizontally* mounted magnet is over the center of a switch, that switch goes off. This is exactly the opposite of the on-action caused by a vertically-mounted magnet. Consequently, this type of rotary switch provides sequential double-pole and single-pole action, with four fully off positions.

Multi-pole Rotary. Such switches can be constructed by stacking additional reed switches atop the first four that make up a basic square. Mount

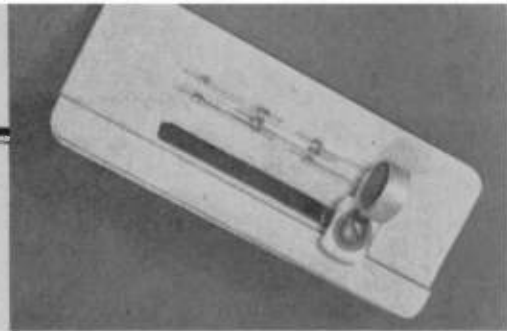

The ceramic magnet of this sliding switch passes over five 1 1/8" size reed switches to provide double-pole, single-pole sequencing. Separate diagram shows a simple mechanism which permits locking the magnet "on" or any "off" position.

the rotatable magnet inside the "box" formed from the stacked reed switches. When the long dimension of the magnet is perpendicular to stacks on opposite sides of the box, all of those switches will go on; other stacks at 90° to these will remain off because the magnet axis is parallel to them. By using one of the larger rectangular magnets, you can easily stack at least a half dozen switches on a side, for a total of 24 switches; 12 would be on at any one time, 12 off. When the magnet is in the intermediate, 45° position, all switches are off.

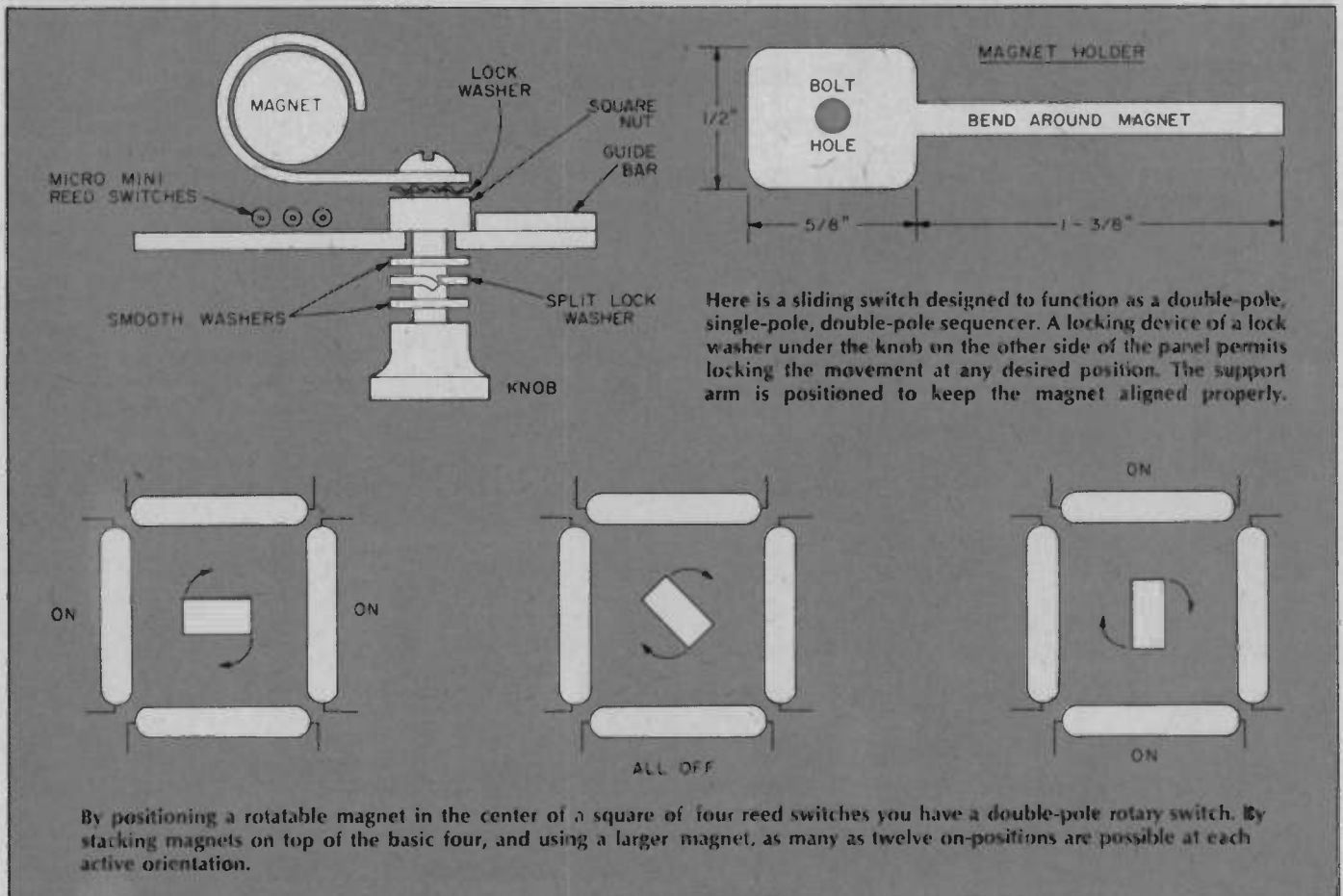

Linear Off-Before-On. Mount parallel switches far enough apart so that, as a vertically positioned magnet approaches the switches from one side, the first switch will go on and off before the next switch is affected. Here's a handy trick that enables you to pull the parallel reed switches much closer together to form a more compact switch: Position a small disc magnet over the center of the first switch so that its long axis (diameter) is parallel to the long axis of the switch. If you have been paying attention, you already know that in this position the magnet has no effect on the switch. Now slowly rotate the switch away from this parallel orientation until you hear the switch click on. Mount the magnet in its sliding holder so that it passes over the center of the reed switch in this slightly angled position. This deliberately weakened magnetic action permits location of the next switch much closer to the first—as close as about $\frac{3}{16}$ "—and still obtain off-before-on switching.

There's no problem, of course, if you want on-before-off action because then you can mount the reed switches as close to each other as you like. A magnet approaching from the side will turn the first on, then the second, before turning the first off. Bear in mind that if the magnet approaches the pair of switches from the end directions, you obtain approximately simultaneous double-pole switching.

If you have but one reed switch, and the vertically-oriented magnet approaches from one side of the reed switch, it has a longer "reach" and switching action occurs while it is relatively far from the center of the switch. This relative sensitivity, relating to direction of magnet travel, could be an important factor in some switch-design problems.

Special Designs. As you play around with your reed switches and magnets you will undoubtedly discover many variations on the ideas given here. For example, suppose you wanted a sliding multi-pole switch that always switches the reed switches on in the same sequence. As the magnet travels over the parallel reeds, the switches come on in 1, 2, 3, 4 order. But as you slide the magnet back to its original starting position, the reeds would go on in reverse 4, 3, 2, 1 sequence—which is what you do *not* want. So what's the answer? Simply mount the magnet on a holder

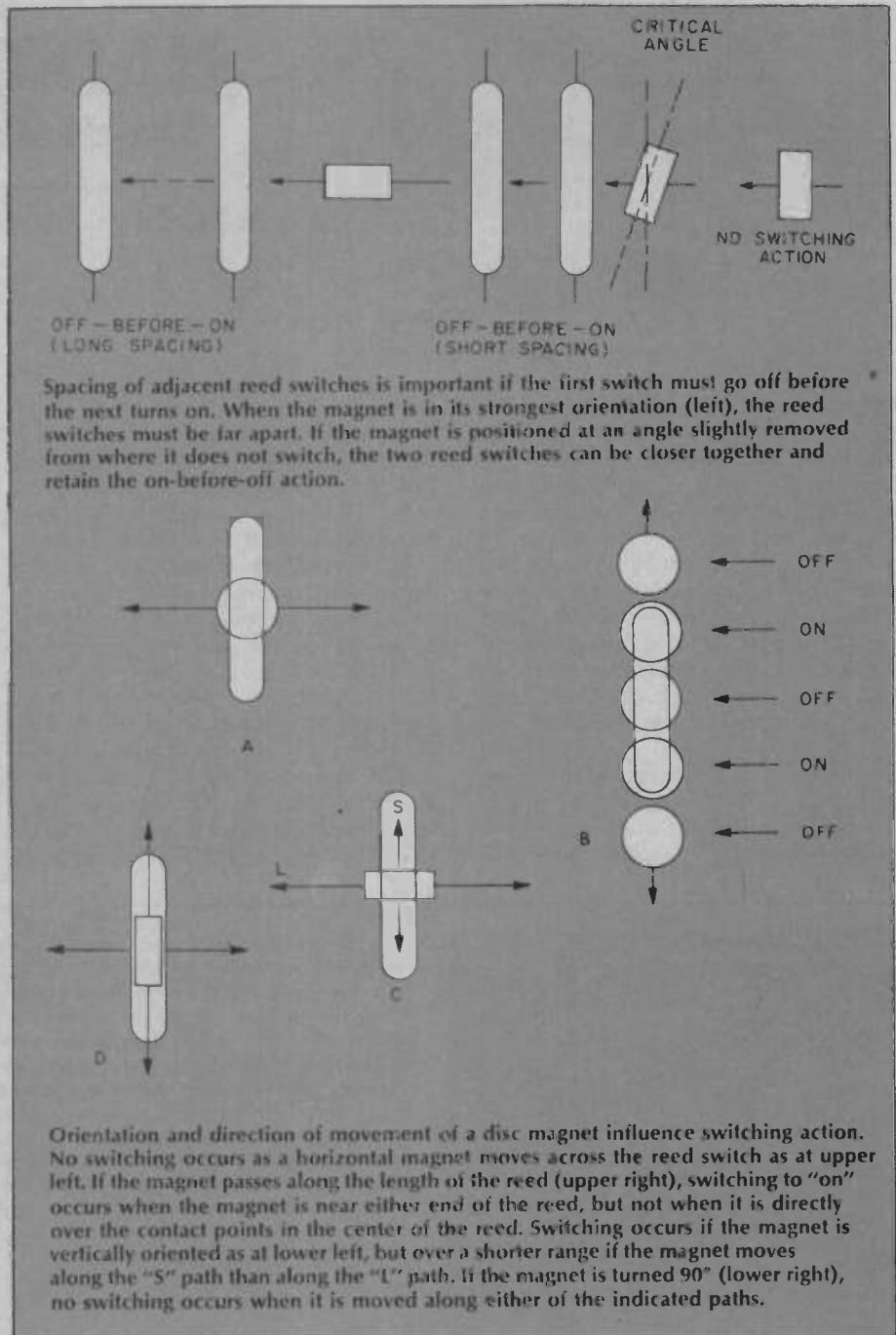

that permits it to be turned 90° at the end of each sweep. This way the magnet can be in its "active" orientation going one way, and in its "dead" orientation going the other way. Thus it is possible to return the magnet to the starting position, for subsequent normal switching order, without affecting the switches on the return sweep.

I have not tested these ideas, but it seems likely that you could construct

such truly off-beat switches as, for example, a level-indicating switch by suspending the magnet on a short pendulum so that it will swing close to either of two parallel magnets to electrically signal tilting. And it may be feasible to create a vibration-detector in much the same manner, but mounting the magnet on the end of a flat or coil spring so that vibrations will swing it in-and-out of the switching range. ■

Budget installs a...

RADIO/CASSETTE

In-dash installation can save

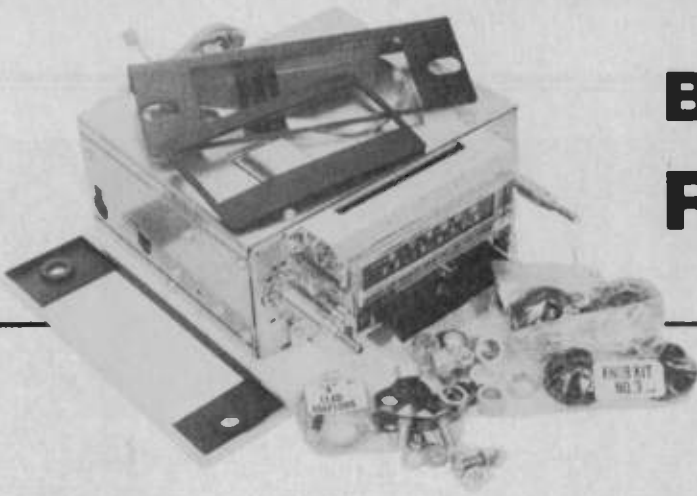

THERE ARE TWO MAJOR WAYS you can save from \$100 to \$200 by simply installing your auto radio or tape player in the dash so it becomes an integral part of the car, van, or RV. The first way you save money on an in-dash mount is through your insurance. If you've read the latest rider your auto insurance company has buried deep within the incomprehensible legalese that explains the wherebys and wherefores, it is more than likely that equipment for the recording and reproduction of sound aren't covered against theft unless they are a permanent part of the vehicle. As many stereophiles discover after the theft, some insurance companies don't con-

sider four sheet metal screws that secure a mobile bracket to the dash as a "permanent part of the vehicle." But there's no question that a tape player, radio, FM stereo, or radio/tape player is *permanent* if it is mounted in-dash:

To Save More Money. The way to save even more money—often even up to \$200 or more—is to do your own installation at the time you purchase a new car or van. Just look at some typical figures for a new car. An ordinary AM radio costs from \$60 to \$90 depending on the particular car and dealer. An AM/FM radio runs from about \$109 to \$190. An AM/FM stereo installation runs upwards from \$200, and if you want AM/FM stereo with

8-track or cassette tape you first have to find a car for which the manufacturer will provide the equipment (many won't sell tape players for their smaller, lower priced cars), and then figure \$300 or more. Then you must hope he provides the right radio/tape combination. One of the major manufacturers supplies only radio/8-track; if you want cassette you're out of luck.

But if you're willing to spend three or four hours doing your own in-dash installation you can save quite a bundle over the new car prices, as well as having exactly the equipment you want.

For example, figuring in good quality speakers worth about \$12 each, and talking about the highest quality auto equipment, an AM radio will cost you about \$40, an AM/FM radio installation will run around \$60, AM/FM stereo will be about \$90 (don't forget you need two speakers), an AM/FM Stereo/8-Track will cost about \$120,

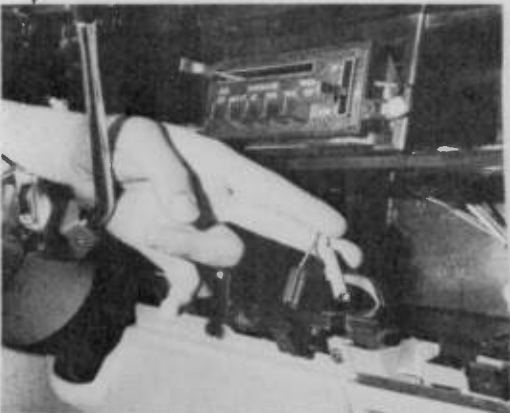

The "hot (+12 VDC) lead from the car's electrical system is usually red. At left you can see it and the ground lead which hook onto back of player. Lower left shows the unit sliding into place after removal of dashboard plate. Faceplate (lower right) fits over metal supporting plate (bracket). At right is shown separate ground wire which goes to chassis of car. Plastic dash hardware prevents many sets from being automatically grounded as they used to be in the good old days (when cars were all 6 volts DC).

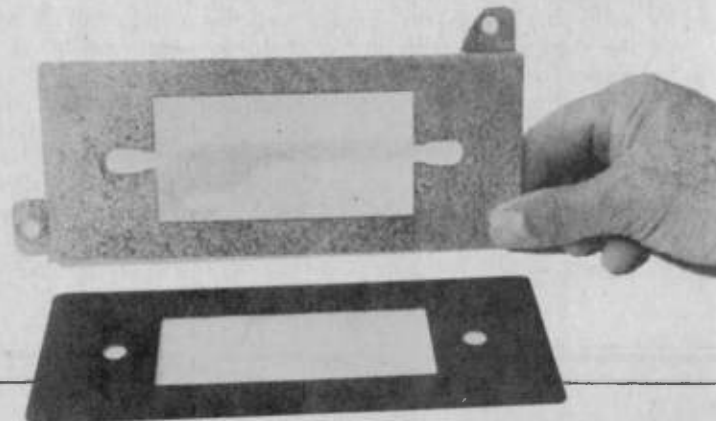

PLAYER IN-DASH

you money two ways.

and an AM/FM Stereo/Cassette will run a little higher, about \$140, again including two excellent quality loudspeakers.

Now any way you look at it, those are big savings, often more than enough so you can get a deluxe combination unit instead of an ordinary AM radio. But, you must do the installation yourself to get so much sound and so many features for so little money.

Easier Than It Looks. At first glance, substituting a tape or combination player for the existing car radio, or starting from scratch with all-new in-dash equipment, might appear formidable, and in the old days it was one hell of a job. Often, at the very least the glove box had to be removed, also part of the ductwork if your car had an air conditioner. But most manufacturers can no longer tie up their assembly line for a radio installation, nor can they make it extremely difficult for their

dealer to do an after-sale installation, so you'll find many dashboards literally come apart for easy installation. You just have to locate the few, usually concealed, screws that hold everything together.

All American cars are pre-cut for radio. Either the dash is pre-punched for a rear mount radio, that is, the radio slides in from behind the dash. Or there is a concealed cut-out that permits the radio to slide in from the front. A trim plate usually conceals either opening. If the car is designed for a behind-the-dash installation there is generally enough room so you can reach up and install a speaker behind the top of the dash. The radio simply slips into its cutout from the rear. Almost all radios and many tape players have a common size bezel so you have your choice of almost anything you want from at least two handfuls of brands—many you never heard of. Most of the

better quality brands such as Audiovox and Automatic Electric have controls with adjustable shafts so you can match almost all radio cutout openings. And all of the better equipment comes with an extra trim plate, so your installation looks like a factory job when you're finished. The popular Radio Shack AM/FM Stereo/Cassette unit with *Fast Forward* and *Reverse* (almost unheard-of-features in combination units) has a universal mount and trimplate.

How To Front Mount. Front mounting takes a bit more trouble if you're starting from scratch because an adaptor plate is required. Also, no two front-installation cars or vans are alike, and your in-dash radio kit requires a lot of special bits and pieces so you can customize your particular installation.

The photographs show how easy it is to install an in-dash radio/tape player. Though a front mount installation is shown, many of the installation



Antenna installation is a snap if you have a Greenlee punch to make the single hole required for most aerials. At right is a standard antenna mounted on typical ball swivel. Lower right shows pre-cut speaker hole (6 x 9-inches) which is generally found (two of 'em) in rear deck. There's often one of these under decorative trim in the front also. Put a ladies stocking over speaker to keep dirt out. At right the set has been installed and the final trim is being replaced and secured. At left is typical oval car speaker.

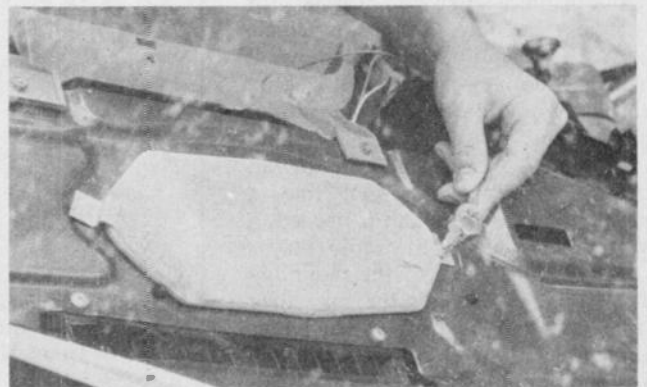
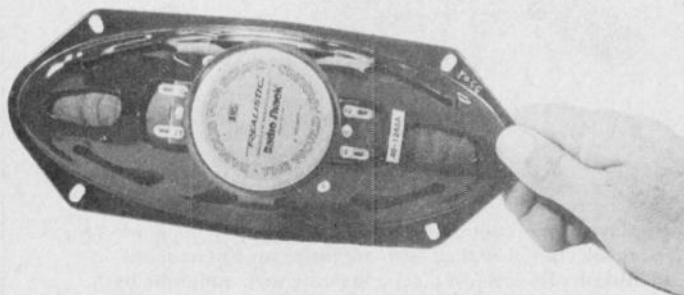
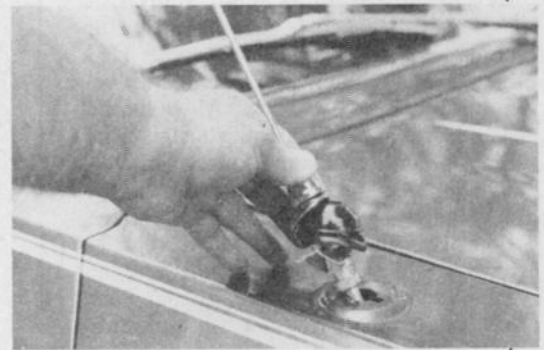

PLAYER IN-DASH

procedures apply to rear mount equipment also.

Perhaps your most formidable problem will be the speaker. Many smaller cars make no provision for front stereo; the dash has a factory opening for only one (mono) speaker. There is often room for stereo speakers on the rear deck. But just because the dash has room for only one speaker is no reason you can't have a stereo radio or tape player. Just use one of the Radio Shack dual voice coil speakers. As shown in the photographs, these speakers have two independent voice coil connections. If you connect one set of terminals to the radio's right output, and the remaining terminals to the left output, you will hear the full mono equivalent of the stereo output. And you can still feed stereo to two rear speakers.

As you can see from the illustration, the speaker in this car mounts from the top of the dash after the dash cover is removed. To prevent small objects from settling into the speaker and rattling, slip a lady's *Ped* (about 55-cents) over the speaker(s) before installation. A section cut from an old pantyhose or stocking can also be used. Solder the connecting wires to the speaker terminals before mounting the speaker.

Antenna Installation. Next, install the antenna and route the wire all the way to the radio's location. Many cars have a pre-drilled fender hole for the antenna. Others you can cut with 1½-inch chassis punch (some antennas require other holes sizes). All standard AM and AM/FM antennas install from the top, and have some form of universal or 8-ball mount that allows the antenna to be vertical regardless of the slope of the fender. Most vehicles have a rubber grommet for the antenna cable somewhere behind the fender; just pierce the grommet with a knife and feed the cable through.

Okay, you have the speaker(s) and antenna in place, now you're ready for the radio/tape player. If your vehicle already has a radio simply remove it and install the new model. If it doesn't have a radio and it's a front mount you've found a gaping hole behind the trimplate. You need an adaptor kit.

In the adaptor kit you'll find a mounting plate, screws and if needed, a new trimplate. Secure the radio/player to the mounting plate, or the mounting and trim plates if that's the way they go into your car. If you have a better quality in-dash unit it comes with male and female connectors on all the con-

necting leads, and matching connectors are supplied for splicing into the speaker wires. Apply all the splice connectors first, then connect the wires all together. You'll find most cars are already pre-wired for a radio power connection, and the connector is floating behind the dash somewhere near the radio cutout. If your vehicle isn't pre-wired simply pick up the (12-volts positive) radio power terminal at the fuse block. (Audiovox in-dash units come with an assortment of connectors to match virtually any make or model.)

Because many cars now have plastic dashboards make certain you connect a well-grounded wire to one of the screws on the radio/player.

Plug in the antenna connector and then slide the unit into the cutout, taking care that no wires are crimped behind the radio. Secure the adaptor mounting plate with the supplied screws (never substitute adaptor screws) and then secure the ground wire under a dashboard screw you are certain connects to the metal vehicle body. (Use a meter to test for continuity to be sure.) Finally, apply the dash trim, or the radio's trimplate, and your installation is completed. If you have rear speakers install a front/rear fader in any convenient location so you can control the sound levels in the front and rear of the car independently.

Final Steps. If you've installed a

radio your final step is to trim the antenna tuning for maximum AM sensitivity. On an AM-only radio the trimmer screw might be on the side, in which case you'll have to make the adjustment before the radio is installed in the cutout. On almost all AM/FM sets, and all radio/tape players, the trimmer is accessible from the front, usually behind one of the knobs, or inside the tape slot. To adjust the trimmer, tune in an AM station on the high end of the dial, preferably a very weak signal. If you cannot get any very weak signals try in the late evening hours. Adjust the trimmer screw for maximum signal strength—the loudest possible volume. That's the one and only adjustment as there is no adjustment for FM reception or tape. Many tape units have an accessible *azimuth* adjustment. Take care not to adjust this screw. Normally, there is a label warning the azimuth is a factory or service adjustment, but labels do fall off. If your home recorded cassettes and 8-tracks don't track properly check the auto player with a commercial pre-recorded tape. If the pre-recorded tape tracks properly the auto player is okay, it's your recording equipment that's out of alignment with the auto unit. If the pre-recorded tape doesn't track the player needs an azimuth adjustment—let a serviceman do the job under the unit's warranty. ■

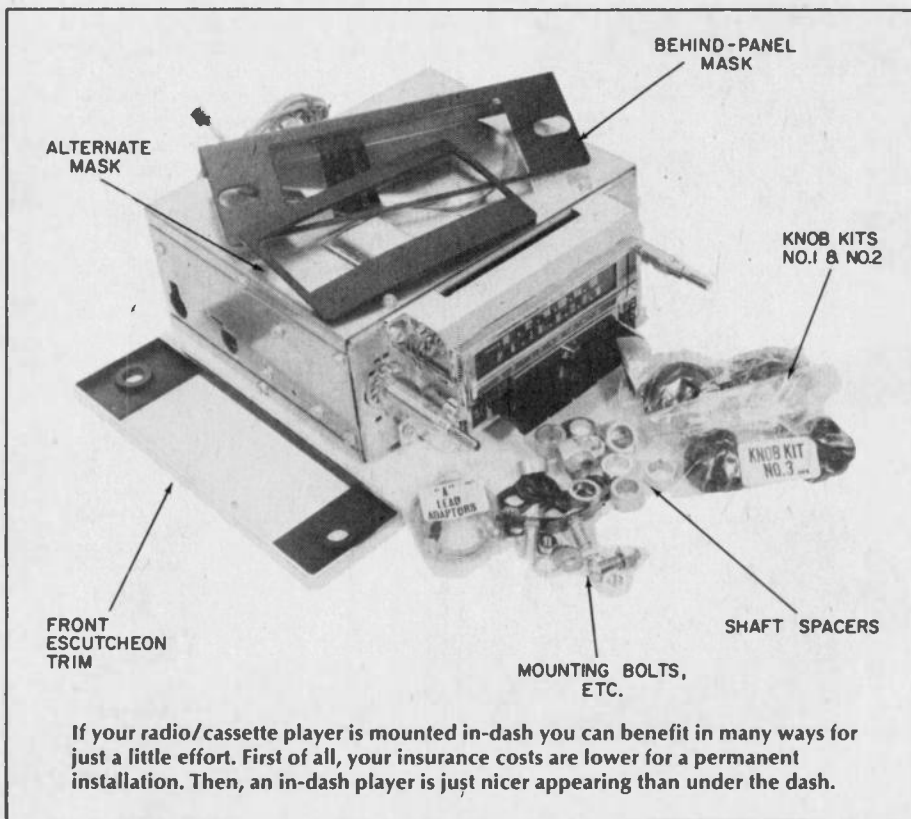

FREE

THE NEW HEATHKIT CATALOG!

World's largest selection of fun-to-build money-saving electronic kits

Read about all the exciting new electronic products you can build yourself! Our world-famous assembly manuals guide you every step of the way, with crystal-clear diagrams and illustrations that show you exactly what to do and how to do it. Our famous "We won't let you fail" pledge is your assurance of assistance should you need it. All you need is a soldering iron and a few ordinary tools you probably already have.

- Hi-Fi Components
- Audio Test Equipment
- Programmable Digital Color TV
- Learn-at-home Electronics Courses
- Amateur Radio Equipment
- Digital Clocks and Weather Instruments
- Radio Control Equipment
- Auto, Marine and Aircraft Accessories



Send for
your **FREE** copy
TODAY ➡

Heath Co., Dept. 312-32, Benton Harbor, MI 49022

Heath Company, Dept. 312-32 Benton Harbor, Michigan 49022		HEATH Schlumberger
Please send me my FREE Heathkit Catalog. I am not on your mailing list.		
Name _____		
Address _____		
City _____		State _____
CL-631		Zip _____

CIRCLE 1 ON READER SERVICE COUPON

MOD-X, THE SIMPLEST CLOCK YET

by Norman Myers



Take just 8 parts, and a couple of switches, connect this module to make an alarm clock in less than two hours.

□ Dozens of clock projects have been published in the past three or four years, and they all have two things in common: an integrated circuit which contains most of the counting and timing circuits for making a digital clock, and *lots* of wiring, especially between the integrated circuit chip and the read-out devices. These range from Numitron or other multisegment display tubes for each number to the more-recent, and easier, all-in-one, 7-segment LEDs which have four or six digits in one compact assembly.

Even with their maze of interconnecting wires many of these clocks offer only time, and (usually) an alarm. Some, but not all, permit you also to read the seconds as they elapse, and more and more have the Cat-nap (snooze) feature.

Now, thanks to today's improved methods of IC manufacture and mass-

production, which continue to bring prices down, down, down. National Semiconductor Corp. has brought out a *complete* clock-on-a-chip, including the readout display—the numbers which show the time. You no longer have to connect the outputs of the circuit chip which does the computations to the display digits, because the display and the clock chip are all on one small assembly, ready to build into a case and connect to a simple power supply, a couple of switches, and if you like, to an alarm.

If you want to add a couple more switches you can have a clock which displays the seconds, on command, or which includes the cat-nap (snooze) feature. Finally, if you want to add one more switch you can include the *hold* feature, which makes setting the clock a bit faster. The wiring for these extra features is shown in the spec sheet

which comes with the clock module. This module is made in several versions by National, depending on whether the clock is intended for use in 50 Hz or 60 Hz countries, and on whether or not it's intended to display 24-hour or 12-hour time.

In addition to these features, this clock can tell you if there's been a power failure. To tell you that the time it shows is incorrect it flashes on and off once every second until you stop it. When it's telling time the colon between the hours and the minutes numbers flashes once every second. Chip-X also tells you whether it's AM or PM. It does this by showing a dot in the upper left hand corner in the PM. Finally, when the alarm is set to go off, a period at the lower right is lit. Press the alarm button to be sure the alarm is enabled (ready). put S4 on *Alarm*, and go to sleep. After the alarm goes off, touch

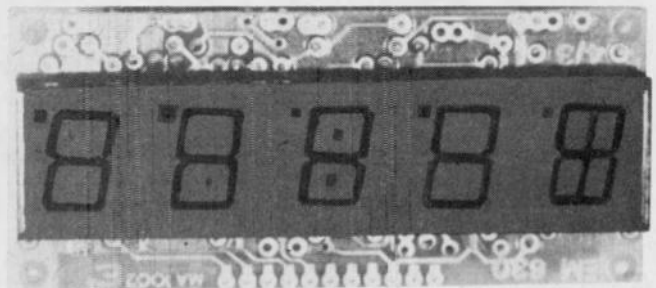
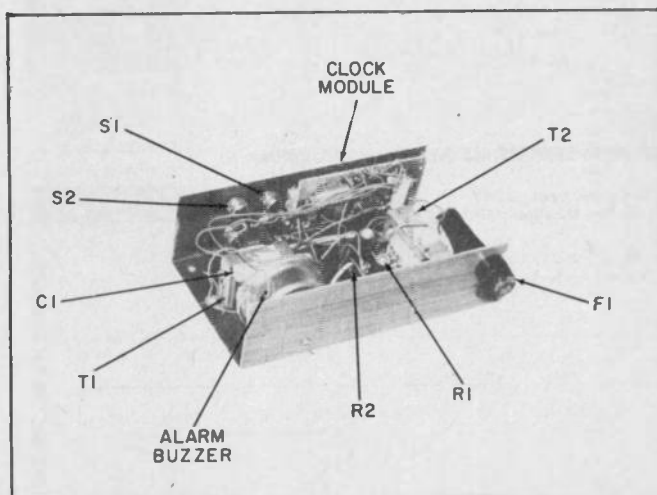
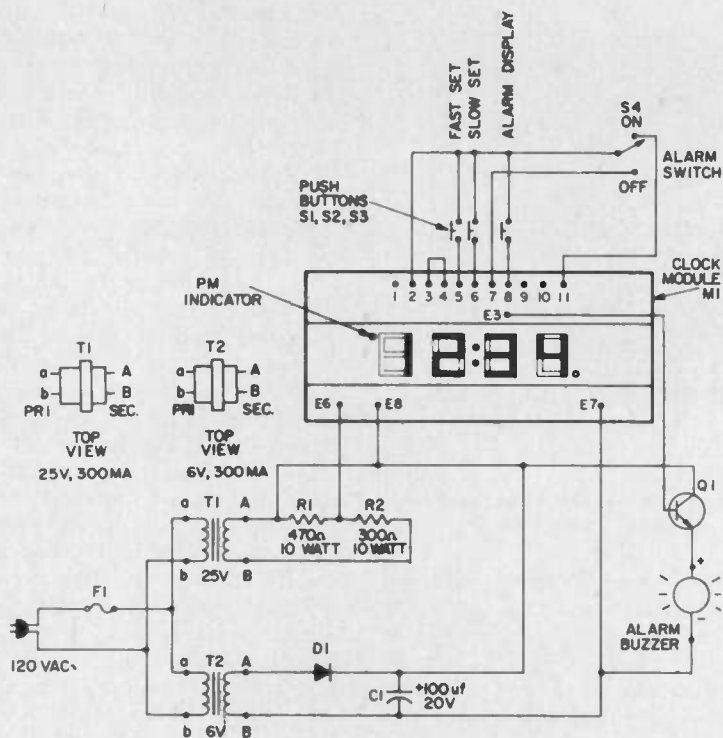

Photo at left shows placement of parts in author's clock. Placement is entirely uncritical and you can use any convenient arrangement, depending on the space you have in the case you select. Picture above shows the actual module. Mod-X has six 7-segment LED numerals (they all look like eights here since no segments are lit up). Connections to the module are made via the 11 terminals (holes) in the bottom edge of the board, plus a few others at the top.



PARTS LIST FOR MOD-X

- C1—100-uF, 20-VDC or better electrolytic capacitor
 D1—1-A, 200-V diode
 F1— $\frac{1}{2}$ -A, 125-VAC fuse
 M1—Clock module, National Semiconductor MA-1002A (Digi-Key Corp. See below for address)
 R1—470-ohm, 10-watt resistor (part number 962-9302, Allied Electronics, see below for address)
 R2—300-ohm, 10-watt resistor (part number 962-9270, Allied Electronics)
 S1, 2, 3—Single-pole, momentary-On switch, normally open
 S4—SPDT toggle switch
 T1—120-VAC primary, 24-26 VAC, 300 mA secondary, power transformer (Radio Shack 273-1386 or equiv.)
 T2—120-VAC primary, 6 VAC, 300 mA secondary, power transformer (Radio Shack 273-1384 or equiv.)

- Q1—NPN general purpose transistor
 Misc. Fuse holder, panel type for F1; Buzzer for alarm, 3-volt type; Aluminum "wood" look cabinet $2\frac{3}{4}$ x 6 x 4 inches or larger; AC line cord, available at hardware stores; wire, hardware, solder, etc.

ADDITIONAL PARTS FOR CLOCK OPTIONS

- S5, 6, 7—Switches same as S1, 2, 3, above, for Hold, Catnap (snooze) or Seconds Display options.
 To obtain the clock module and specification sheet, write to Digi-Key, Dept. E, Box 677, Thief River Falls, MN 56701. Ask for Mod-X MA1002A. Price is \$11.55, plus 75 cents for postage and handling. Minn. residents add 46 cents state tax. Order module before other parts to be sure of module availability at this price.
 Allied Electronics' address is 401 E. 8th St. Ft. Worth, TX 76102.

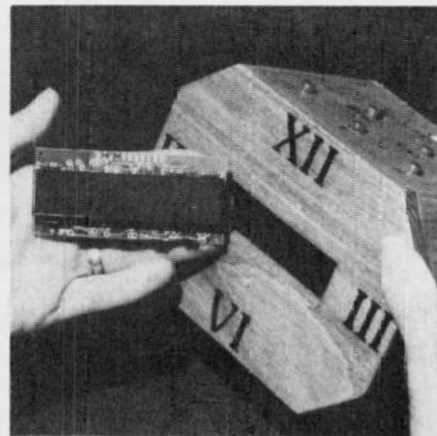

Author also built this handsome wooden case to house another Mod-X clock. He included optional additional functions which can be seen in the schematic diagram in the middle of the next page.

that the unit is built in a safe container. For example, if the clock is to be in a wooden box, be sure that the resistors have plenty of ventilation room around them and that the box has ventilation holes in the top and the bottom. And after building the clock, let it run for a while then unplug it and feel around to see how warm the box is inside. Keep wires from resting on R1 and R2, which tend to get warm, and remember that good ventilation is important. Finally, all connections going to the fuse and to the primary side of T1 and T2 must be wrapped with tape because there will be 120 volts on those points.

All the components can be mounted on a perf board about 2-in. by 4-in. First place all the components on the board by sticking the leads through the holes and bending the leads back to hold the components in place. Transformers T1 and T2 are small but are too heavy to put on the perf board so it is best to mount them on the bottom of the cabinet. Likewise, it is most convenient to mount the fuse on the cabinet so that the 120 V wire coming into the cabinet can go directly to the fuse and then to the transformers. Of course switch S4 has to stick outside of the cabinet, as do the pushbuttons.

With the components mounted on the board, all you have to do is run connecting wires between the components. 18- or 20-gauge wire works well. When soldering wires to the clock module, be very careful. You must use a low-heat iron (25-30 watts as recommended for all integrated circuit projects). The pin connections on the module are actually holes that the wires are placed into and then soldered. You can get to these holes from either the front or the back of the module, but you will probably

the Alarm button and you will be able to snooze for nine more minutes

Construction. Now comes the easy part—building the clock. Remember two things here. First, the clock module fits in the palm of your hand and is therefore a nice compact unit that can be mounted in almost anything from a cabinet or workbench to a wall. Second, if you choose not to use the alarm feature your project will have eight components and three switches, so your construction time will be very short. But

they will not get too hot. Be sure, also, the pleasure that comes from those few short construction hours is fantastic, especially when you first turn on the power and see those big, bright numbers staring back at you.

Play It Safe. Now for safety's sake we have to get a few things straight. Remember that this unit is going to be plugged in all day long, day after day, so be sure all your solder connections are good and be sure to use resistors with the correct wattage rating so

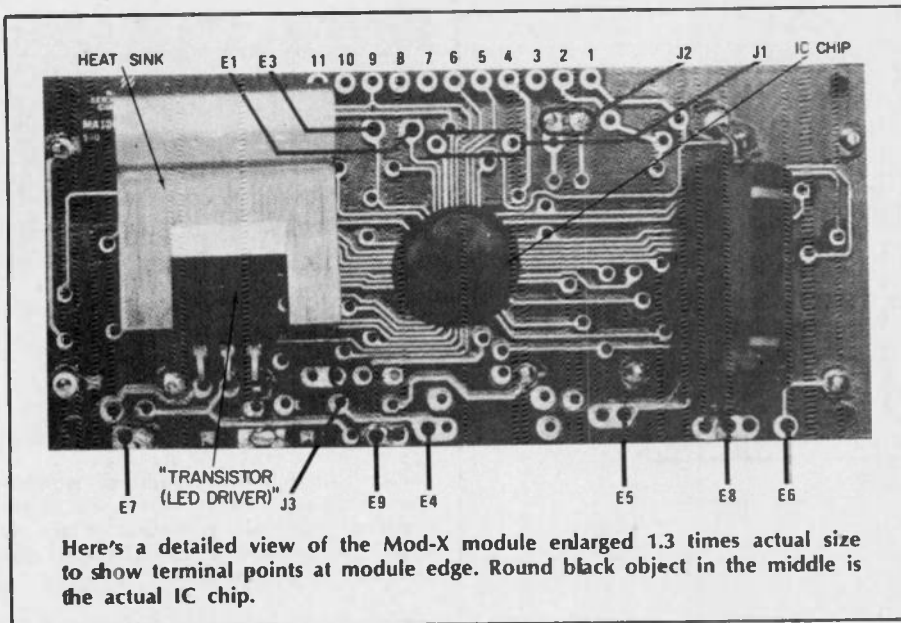

Here's a detailed view of the Mod-X module enlarged 1.3 times actual size to show terminal points at module edge. Round black object in the middle is the actual IC chip.

find that the back is best because it makes mounting of the module very simple. Be sure to check the soldered connections. The solder balls should only be on their own connection points and not short-circuited to any printed circuit wires.

More on Construction. Note on the schematic that transformers T1 and T2

have their primary leads marked a and b, and the secondary leads marked A and B. The leads are not actually marked this way on the transformer itself, but I have designated them this way for the project. As shown on the schematic, if you look down on the top of the transformers, with primary to the left and secondary to the right, the

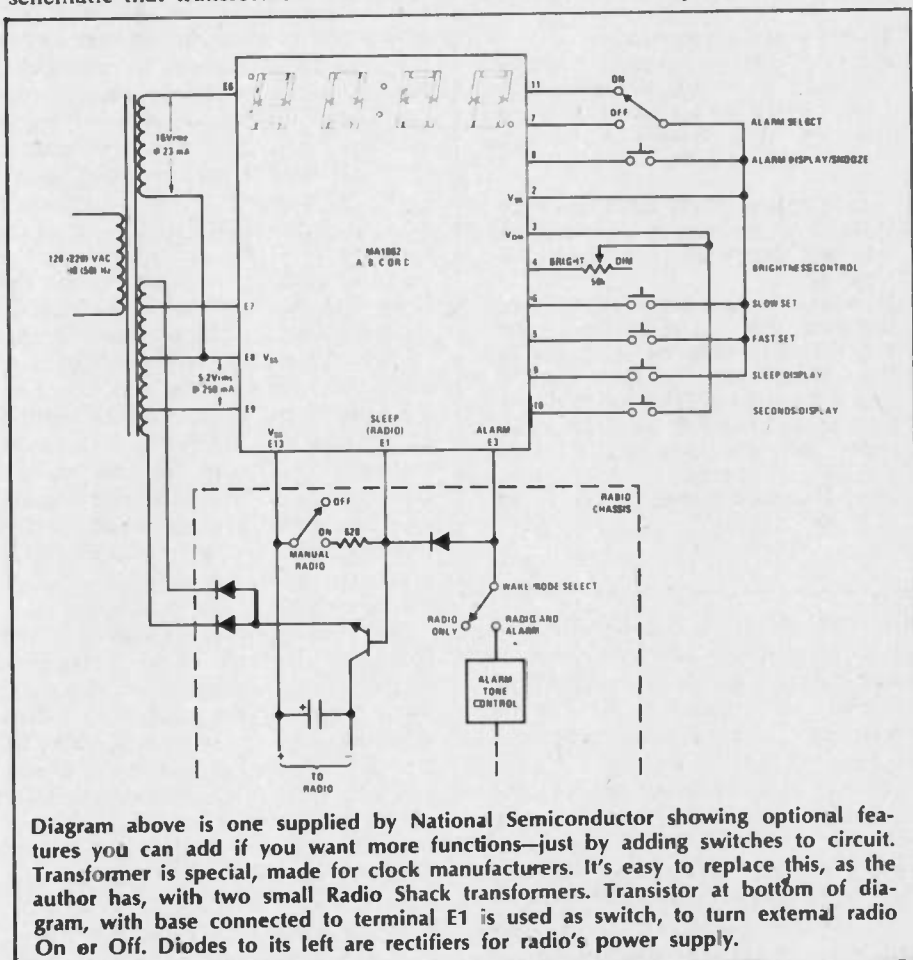
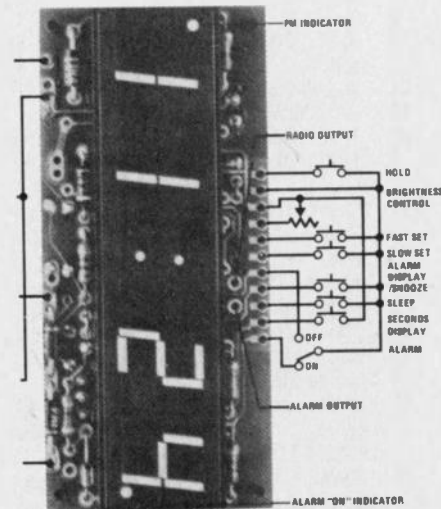

Diagram above is one supplied by National Semiconductor showing optional features you can add if you want more functions—just by adding switches to circuit. Transformer is special, made for clock manufacturers. It's easy to replace this, as the author has, with two small Radio Shack transformers. Transistor at bottom of diagram, with base connected to terminal E1 is used as switch, to turn external radio On or Off. Diodes to its left are rectifiers for radio's power supply.

"a" and "A" leads will be towards your hair and the "b" and "B" leads will be toward your chin. Follow the schematic when connecting these leads. Also, do not forget to use a heat sink when soldering to transistor Q1. Finally (important!) watch out for tricky S4. Most DPDT switches, including the ones on the parts list, are "backwards." When the toggle is up, the *bottom* contacts are engaged. So watch how you do the wiring and labeling of the switch, or you will be confused later on.

Testing. Your clock should work well the first time you try it—so before you plug it in go through the thing everybody hates: Check and double check your wiring. If the display fails to light, you have probably forgotten to connect pin 3 on the clock module to pin 4. The voltage (AC) between E6 and E8 on the module should be about 15 volts. The DC voltage reading between E8 (positive) and E7 (negative) should be about 5 volts. If these voltages are not correct, check out T1 and T2 to see if they have AC output voltage coming from their secondaries when disconnected from the circuit. If the clock portion works but the buzzer will not sound, check E3 to see if the voltage at



Additional optional functions diagrammed at left in schematic are shown above connected to the module.

that point goes high relative to E7 when the alarm is supposed to go off. Do not be tricked by the AM/PM capability of this clock when checking the alarm. If your clock is set to go off at 6:00 AM, do not expect it to go off at 6:00 PM when testing it. Pay attention to the little AM/PM dot in the upper left corner.

National makes eight different modules in the MA 1002A through E series. Be sure you use only the one with "A" when you're building *this* project. ■

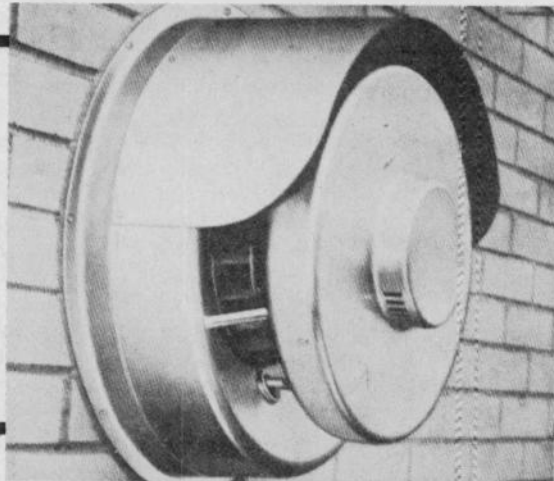

Cut In a Wall Fan and Save Cool Cash

by Dan Gannon

IN THIS TIME of soaring prices and costs one of the best ways to save a buck is to install a wall fan. No, we're not kidding. Wall fans can give you a couple of extra years on a paint job, eliminate the need for an air conditioner or two, keep your basement shop supplied with fresh air to cut down on tool rust, exhaust chemical fumes from your darkroom or printed circuit board preparation area, and even get rid of stale household odors (though odors don't generally cost you money).

Still think we're joking? Okay, let's take a closer look at how a wall fan works for you. First the kitchen. Any family cooking introduces grease molecules into the air. Unless it's sucked out

by a well-ducted range hood (not one of those recirculating filters) the grease spreads throughout the house, darkening wall and ceiling paint and wallpaper. Quite often the house that needs re-painting every three or four years can get six years or more on a paint job (or wallpaper) if there's a good wall fan in the kitchen.

And when it comes to saving power, a good fan is king. Say you've got a good size air conditioner in the living room or den. But the kitchen and dining area steams from the oven when you cook. There's no need to invest in extra air conditioners—and the extra electric cost; just install a moderate size wall fan in the kitchen or dining area

—about 600 to 650 cfm (cubic feet per minute). It will pull in just enough cool air to keep the kitchen and dining area comfortable. You won't need a sweater, but you won't be supporting the local electric company with extra—unnecessary—air conditioners. You can pull off the same trick if you have a small bedroom or den opposite an air conditioned room. A small wall fan will generally pull in enough cool air to keep you comfortable without exhausting all the cold air in the next room. Just keep in mind that a wall fan takes a lot less electric power than an air conditioner, and a kilowatt saved pays for the next increase in gasoline and home heating oil.



Fig. 1. Pick a location for the grille-damper, and make certain it's between two wall studs. Using the duct as a template, scribe the outline on the wall and then use a razor to cut away the wallpaper.



Fig. 2. If the wall is sheetrock (drywall) score the outline with a knife, a narrow chisel, or an old screwdriver, then cut all the way through and punch out the circle.



Fig. 3. If the wall is plaster, scribe the outline and then chip out the plaster until the lath is exposed. The lath can be either strips of wood, wire mesh, or plasterboard—a sheetrock-type material with a pattern of large holes into which the plaster locks when dry.

WALL FAN SAVES COOL CASH

Down in your shop a wall fan will expel damp moist air and suck in drier air from upstairs. It's not as efficient as a dehumidifier, but a dehumidifier is really a small air conditioner and costs almost as much to run. Not every basement is damp enough for a dehumidifier; often, a fan is all that's needed to keep rust off your tools. And don't overlook the fact that a fan will suck out the fumes from printed circuit chemicals, Krylon-type spray paints, and plastic solvents. The lungs you save

might be your own.

"Fine," you say, "I'm ready for a wall fan." Unfortunately, a commercial installer will charge the cost of his next vacation to install any fan. And if your house has brick walls, he'll take his next *two* vacations on you. But the truth is a wall fan installation can be done by anyone familiar with tools, and you as an electronics hobbyist should be perfectly able to do a professional installation. After all, you have most of the tools, and what you don't have can be

rented for well under \$10 a day.

Before we show you how easy it is to install a wall fan, the first step is to get the right fan. Virtually every hardware and discount store sells wall fans; there are more models than politicians looking to raise your taxes. We suggest the type where the fan itself is outside the house (in a waterproof housing), so it sucks the air through a duct, rather than pushing it through. What's the difference? Almost maintenance-free ducts. When the fan is inside the house



Fig. 4. If you have made a measuring error and find a stud running past the hole, don't panic. The wall will stand even if you cut through one stud. Use a saber saw to trim the stud so the cuts correspond to the circular duct pattern.



Fig. 5. Remove any insulation between the inner and outer walls and then drill through the exact center of the outer wall. The hole will be the pilot when you're working on the outside. If the wall is masonry or brick use a carbide tipped bit. A standard bit is okay for a frame construction (wood siding).

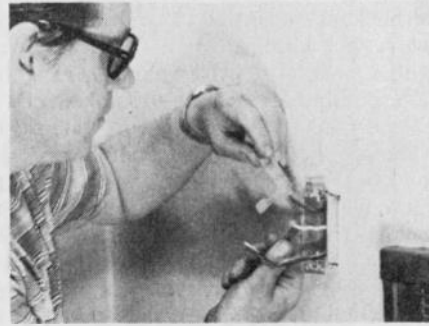

Fig. 6. Before cutting the outer wall and mounting the fan unit, install all the necessary electrical wiring. While you can use a simple on-off switch, a multi-speed selector switch or variable speed control can be a great help when you want to move air slowly, in small quantities.



Fig. 10. If you have no one to help when mounting the fan assembly, cut down the overall weight by removing the motor and fan from the rain shield. Secure the shield to the wall and then install the motor and fan. Note the electric wires from inside the house coming up through the shield.



Fig. 11. Install the motor, making certain the BX cable armor runs all the way to the motor connection box to provide a solid electrical ground. If you're using Romex wire make certain you use the type with the ground wire, and double-check that the ground is secure at the motor.

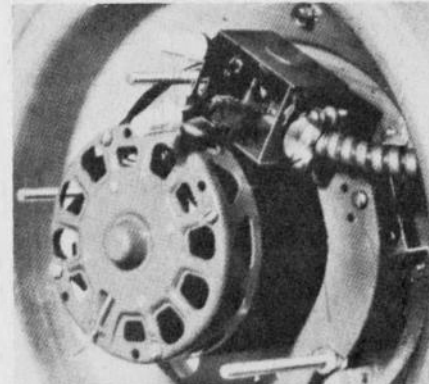

Fig. 12. Here is a close-up of the fan motor and electrical connections. BX cable comes from house wiring and connects to an electrical box mounted on the motor. Wire nuts cover the splices.

at the start of the duct to the outside, the fan pushes the air into the duct. The air pressure decreases along the duct and the grease drops off along the duct. Eventually, the duct will have a heavy grease layer that will have to be cleaned out.

When the fan is on the outside, at the end of the duct, the air velocity builds as it travels through the duct to the fan, and much more grease is discharged—less settles along the duct.

When the fan is mounted outside,

the input to the duct has automatic damper doors that keep out the cold air in winter and bugs in summer. When the fan starts, air velocity (suction on the duct side) causes the doors to automatically open.

One of the best choices in fans from a budget and ease-of-installation viewpoint is the NuTone WF-1N for wall mounting, or its cousin the RF-1N roof fan. Both are rain-proof and are the same type as used at your local pizzeria—and you know what kind of ex-

haust problems a pizzeria has, or for that matter, any restaurant.

Both fans take a multi-speed control, standard 8-in. round ducts, automatic damper, and a mesh grease filter. To show how easy a wall fan installation can be, we've taken on the most difficult of all: a house with a brick wall. Just follow the steps shown in the photographs and you'll have as little trouble as our installer—an electronics hobbyist with little in the way of carpentry experience. ■

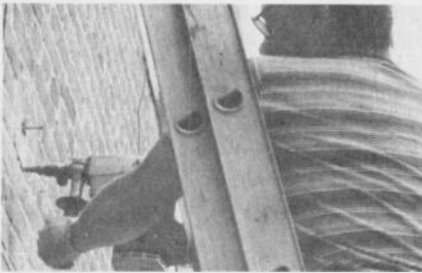

Fig. 7. While a saber saw can be used to cut through a frame outer wall, something a lot heavier is needed for brick. You can hack away at the brick with a cold chisel and sledge, but a few dollars spent to rent an electric hammer (with chisel bit) will let you bust out the wall in minutes. Note the screw sticking through the pilot hole, used to center the duct circle scribed with chalk.



Fig. 8. The final trim is done by hand with a cold chisel and small sledge. The sheet metal duct should just slide through the hole without bends or a force fit. Chip away small bits of brick until the duct can slide in and out easily.



Fig. 9. The damper assembly is generally long enough to pass through thin-walled buildings. If you need extra length, standard 8-in. flue pipe obtainable at local plumbing outlets can be cut to size.

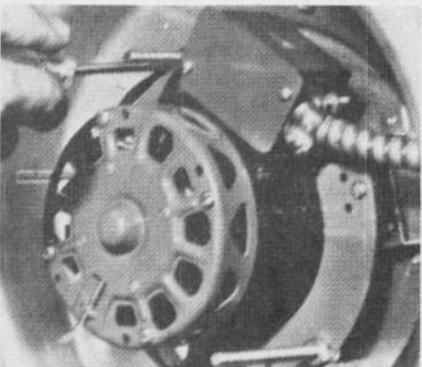

Fig. 13. After the connection has been made, the box cover is screwed in place. Now check that the fan rotates freely and the housing is secured firmly to the wall. Some weatherproofing caulking is necessary. Less than one half a cartridge from a grease-gun squirter is needed.

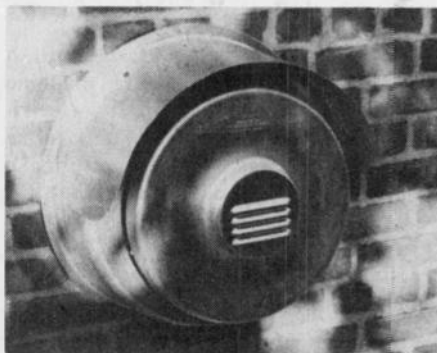

Fig. 14. Finally, secure the motor's cover in place to complete the outside installation. Turn the power on and check that the fan rotates quietly without hitting any obstruction in the 8-inch duct. The neat appearance and low noise level of the fan will not be offensive to your neighbors.



Fig. 15. After the fan is checked out for operation and multi-speed control (if so equipped), install the automatic damper doors and grille on the inside. Be very careful not to bend or force the damper doors into the duct. Make certain the dampers swing open at all settings of the fan's multi-speed control. The wire screen should be removed periodically for cleaning. Don't wait too long; if you do, you'll be wasting valuable electricity.

Nutone offers an interesting fan catalog you can obtain by circling No. 68 on the Reader Service Coupon.

Stop Wasting Energy!

BUILD TIME TALLY

With electric power at top price, you will want to conserve it more than ever!

by Thomas R. Fox

SOMETHING's been hanging in there too long drawing current all the time, and it's costing you a bundle! What is it? Who knows? But *you* can find out with this simple electromechanical counter driven by a single integrated circuit and connected to the "on" switch of an electrical device, or appliance, or any electric-start engine.

By combining an up-to-the-minute integrated circuit with the old reliable electromechanical counter, you can make an ultra-simple and inexpensive elapsed time meter. The 555-type timer used here is a very handy IC because it is amazingly stable and accurate; its timing isn't significantly affected even if the supply voltage varies widely.

The circuit, (see Fig. 1), centering around the 555 timer, emits half-a-second negative pulses once every 60 seconds. This short, power-stingy pulse triggers the electromechanical counter whose memory requires no power whatever. The 555 output is sufficient to

drive the counter directly, which simplifies things quite a bit.

Put It Together. Since the entire project minus the power supply has fewer than ten parts, construction is a snap. If the meter is to be used in outdoor equipment, one of the first things to be done is to find a protected spot in the equipment to mount the circuit.

If the meter is to be used indoors to count the minutes a TV is on per month, for instance, a case should be used to mount the counter. An IC socket can be used for the 555 or connections can be soldered directly to its leads if proper precautions against overheating are taken. Use a 20-ohm, 1/2-watt resistor in series with one lead of counter Z1 if the meter is to be built into outdoor equipment that uses a 12-volt battery. With 6-volt systems or with one of the AC power supplies, eliminate the series resistor.

Connect a 6 or 12-volt battery used on the machine being tested or, if it is to be built for indoor use, use four "D" cells in series or a 6-volt lantern battery to calibrate the meter.

With R1 set near its mid-point, the counter should advance one step every 55-60 seconds. Adjust R1 so that the counter clicks exactly every 60 seconds (decreasing the resistance of R1 decreases the time).

For Outdoor Engine Use. Since it is the most common, your machine probably has a negative ground electrical system (negative battery terminal connected to chassis). However, make sure by either examining the electrical wiring diagram or by using a voltmeter.

In negative ground systems, connect a wire to a terminal on the key switch (not to a terminal that is connected

directly to the battery) to point "A" on the schematic. Connect a wire from point "B" to the negative terminal of the battery or to any convenient ground. If the timer runs even with the switch off, you've connected point "A" directly to the battery, bypassing the switch. Try another terminal on the key switch (a voltmeter comes in handy when tracing circuitry). Before making the final installation, make sure the Time Tally works only when the key switch is on.

With positive ground systems, connect point "B" to a terminal on the key switch and point "A" to a ground. The counter itself can be mounted in any location where the numbers can be read. It is not necessary to mount it in the front panel.

Since the Time Tally records minutes, not hours, the "hours" usually referred to in the owner's manual should first be converted to minutes by multiplying the hours by 60. For instance, a 25 hour maintenance schedule should be changed to a 25X60 = 1500 minute schedule. It is most convenient to make the change right in the manual. It is also helpful to record the last minute you serviced the engine.

For Indoor Appliance Use. Use the Time Tally to find out which appliances are gobbling up those expensive kilowatt-hours. The following formula finds the exact costs of those "suspected" appliances:

$$D = \frac{W(0.05) m}{60,000}$$

where

W is wattage of appliance

m is minutes in use

D is dollars per month

The above equation is based on an
(Continued on page 102)

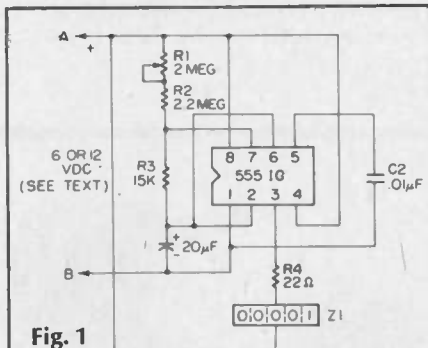

Fig. 1

PARTS LIST FOR TIME TALLY

C1—20-VDC or better, 20-uF Tantalum capacitor.

Note: Common electrolytic capacitors may be used with some loss of timing accuracy.

C2—0.01-uF capacitor, any type, 12 VDC or better

IC1—555-type timer

R1—2-Megohm potentiometer, linear taper

R2—2.2-Megohm, 1/2-watt resistor

R3—15,000-ohm, 1/2-watt resistor

R4—22-ohm, 1/2-watt resistor

Z1—Electromechanical counter, 6-VDC, 5-digit, surplus type

Note: Author used ITT type CE50BN5014U. These units are available for \$4.95 each plus postage for 10 oz. from BA, 3199 Mercer, Kansas City, Mo 64111.

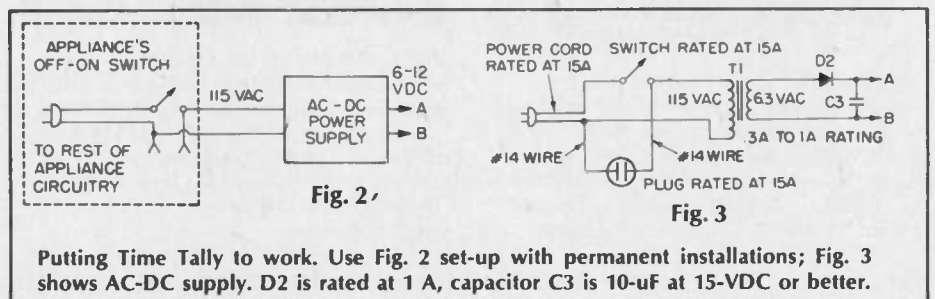

Fig. 2

Fig. 3

Putting Time Tally to work. Use Fig. 2 set-up with permanent installations; Fig. 3 shows AC-DC supply. D2 is rated at 1 A, capacitor C3 is 10-uF at 15-VDC or better.



A Bargain Basement Beginning

A basic library for the classical record collector on a budget

by Dick Flanagan

□ If you're one who believes that so-called "classical" music has nothing to offer, then "lay off, Macduff," as Shakespeare more or less put it. This article is not for you. If, on the other hand, you're willing to concede that there just might be something in the "classics," then consider Longfellow. To him, music was the "universal language of mankind." And we tend to think he's got something there.

Depending on the extent to which you've been exposed to the "classics," your knowledge of serious music will vary. This article is a guide to getting into serious music. It will provide some guidelines as well as a list of basic recordings to help you as you go.

The Three B's. There was a time when newcomers to serious music were told to brush shoulders with the "Three B's"—Beethoven, Bach, and Brahms. But the Three B's often proved to be a cold, difficult dip

into music which can be a warm and exciting experience.

There is one crucial key to developing a deeper appreciation of "classical" music: concerted listening. In the home, this means more than tuning in to the odd classical programs that can be found on FM radio.

True listening requires total involvement. It requires playing a recording again and again until it becomes part of you—and you part of it. In short, if music is to be a universal language, it requires letting the music speak for itself.

An audiophile we know who was on the old Three-B approach once subjected himself to the entire four movements of Brahms' *Symphony No. 4*. Having done so, he confided to a friend that it was no go, that regretfully Brahms to him was a man he couldn't dig.

"Oh, you will," his friend said with a knowing smile, explaining in

her dulcet tones that it would take time.

In time, he did learn to like Brahms, and it may have been that smile and the friend that did it. For like most of the good things in life, an appreciation for serious music doesn't happen overnight. It frequently takes time, perseverance, and plenty of exposure. An interested friend or two doesn't do any harm, either.

Getting Started. Our dip into the classics concentrates on three other B's—a Bargain Basement Beginning, and with good reason. The reason is that we think Tchaikovsky may be a better beginning than the proverbial "Three Bs'."

"Classical" music, by one definition, is music that has stood the test of time. It has endured while countless other creations have faded into oblivion. In the case of Peter Tchaikovsky, the man has been dead for decades, yet his music is sought,

To start you off, here are two of the ten we recommend to get you going: Offenbach's "Orpheus In Hades" and other Selections (RCA) and a Seraphim record which includes works by Ravel, Debussy, Dukas, Saint-Saens, Chabrier.



Bargain Basement

heard, and enjoyed again and again, year after year, decade after decade. The reason lies in the fact that his music has an appeal that wins almost any listener almost immediately. Better yet, it holds him for a lifetime, assuming the listener gives old Peter half a chance.

Tchaikovsky's "lyricism"—the fact that his melodies are hummable and singable—probably explains what lies behind the immediacy of his appeal. Therefore, anyone wanting to get into the classics would do well to start with the handful of Tchaikovsky discs on our lists. These include two of his greatest ballets—*Swan Lake* and *Sleeping Beauty*—as well as his famed *1812 Overture*.

Tchaikovsky was quick to admit that his favorite composer was Mozart. Anyone who knows Tchaikovsky's music wouldn't doubt it for an instant, since Mozart is another composer whose music is highly lyrical. It was Mozart who wrote the theme from "Elvira Madigan," for example, and this is only one of dozens of themes of equally haunting beauty. There are any number of ways to be introduced to the music of Mozart, but we think getting to know his *Piano Concerto No. 21* is an excellent beginning.

The first thing anyone wanting to get into the classics should do is pick up a copy of "Schwann-1." As you probably already know, this is a monthly magazine listing currently available LPs. It's obtainable at most record stores and is easily worth the \$1.00 it will cost you. Probably *not* available at your dealer's is Schwann's "Basic Record Library" booklet, a small 16-pager which can be yours by sending 50¢ (to cover postage and handling) along with your name and address and a note requesting the "Basic Record Library" booklet to W. Schwann Inc., 137 Newbury St., Boston, MA 02116.

To be sure, there are other lists of so-called basic record libraries, but this one strikes us as being as

TEN TO GET STARTED

Composer: Title	Conductor	Label
BIZET: Carmen (excerpts)	Bernstein	Deutsche Grammophon 2530534 Turnabout 34504
MOZART: Piano Concerto No. 21 (includes Piano Sonata No. 11)	Klien	
OFFENBACH: Selections	Fiedler	RCA VICS-1466
RAVEL: Bolero (includes Chabrier: Espana, Debussy: Prelude à l'Apres-midi d'un Faune, Dukas: Sorcerer's Apprentice, Saint-Saens: Danse Macabre)	Dervaux	Seraphim S-60177
RIMSKY-KORSAKOV: Scheherazade	Ansermet	London STS-15126
ROSSINI: Overtures	Giulini	Seraphim S-60058
SMETANA: Moldau (includes Dances from the Bartered Bride Dvorak: Carnival Overture, Slavonic Dances—excerpts)	Szell	Odyssey Y-30049
TCHAIKOVSKY: 1812 Overture (includes Marche Slave, Romeo and Juliet)	Sargent	Seraphim S-60023
TCHAIKOVSKY: Sleeping Beauty (excerpts)	Monteux	London STS-15179
TCHAIKOVSKY: Swan Lake (excerpts)	AbraVanel	Westminster 8133

FIFTEEN TO GROW ON

Composer: Title	Conductor	Label
BEETHOVEN: Piano Concerto No. 5	Casadesus	Odyssey 32160328
BEETHOVEN: Symphony No. 5 (includes Schubert: Symphony No. 8)	Walter	Odyssey Y-30314
BRAHMS: Academic Festival Overture (includes Variations on a Theme by Haydn, Tragic Overture)	Walter	Odyssey Y-30851
DVORAK: Symphony No. 9	Kubelik	London STS-15101
FRANCK: Symphony	Beecham	Seraphim S-60012
GRIEG: Piano Concerto (includes Schumann: Piano Concerto)	Fleisher	Odyssey Y-30668
HANDEL: Water Music Suite (includes Royal Fireworks Music)	Paillard	RCA VICS-1690
HAYDN: Symphony No. 104 (includes Mozart: Symphony No. 40)	Karajan	London STS-15106
MENDELSSOHN: Midsummer Night's Dream, Incidental Music (includes Humperdinck: Hansel and Gretel—excerpts)	Kempe	Seraphim S-60056
MOZART: Serenade "Eine Kleine Nachtmusik" (includes Masonic Funeral Music, Overtures)	Walter	Odyssey Y-30048
RACHMANINOFF: Piano Concerto No. 2 (includes Rhapsody on a Theme of Paganini)	Anievas	Seraphim S-60091
TCHAIKOVSKY: Capriccio Italien (includes Rimsky-Korsakov: Capriccio Espanol, Borodin: Prince Igor: Polovtsian Dances, Mussorgsky: Khovantchina: Intro)	Szell	Odyssey Y-30044
TCHAIKOVSKY: Piano Concerto No. 1 (includes Weber: Konzertstück)	Arrau	Seraphim S-60020
TCHAIKOVSKY: Symphony No. 5	Solti	London STS-15060
TCHAIKOVSKY: Violin Concerto	Oistrakh	Odyssey Y-30312

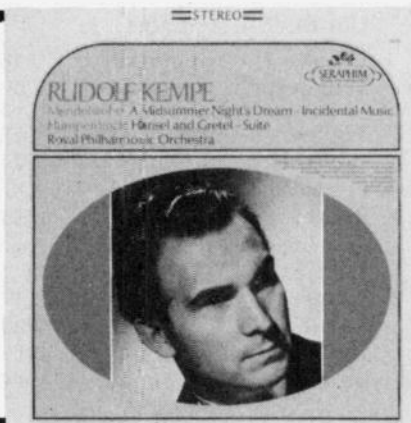

Our Fifteen To Grow On collection includes Rudolph Kempe conducting Mendelssohn's "Midsummer Night's Dream" (Seraphim) and George Szell conducting Tchaikovsky's "Capriccio Italien" and other works (Odyssey).

good as any. The thing to remember is that the Schwann catalog contains so many thousands of LPs that it will be of little help to you in separating the basics from the extras for your initial investment. However, it will show you what is available and it will serve as a guide as you plan ahead. Similarly, Schwann's "Basic Library" booklet lists literally hundreds of recommended works, although only 150 are described as "really basic." Again, it can be used as a guide as you plan ahead.

Our BB Beginning. The next step is to look over our three charts—"Ten To Get Started," "Fifteen To Grow On," and "Twenty-Five To Round It All Off." With one exception (which we'll have more to say about later), every record we include carries a list price of about \$3.98, which is roughly half the price of non-budget LPs. And some record shops in larger cities occasionally offer some of these discs at even lower prices in special sales.

Why have we selected cheapies? Simply because most offer outstanding value in both performance and sound. And there's another, even more important reason. Until the newcomer has truly digested Tchaikovsky's *Swan Lake* ballet music or Beethoven's *Symphony No. 5*, for example, he's not going to be much interested in the subtleties of interpretation and performance which are so important to record reviewers and music critics. The old adage that "you have to crawl before you can walk" holds in this case. Later, with both feet firmly on the ground, there'll be plenty of time to compare performances for nuance and shading.

You'll note that our "Ten To Get Started" listing includes excerpts from an opera: Bizet's *Carmen*. This particular disc will cost twice the price of the others in our lists, but we've included it nonetheless because we think a little *Carmen* is important for anyone getting started in the classics. Unfortunately, there simply isn't a good bargain-base-ment recording of this opera available.

Concertos and Sonatas. Also included is one concerto (Mozart's *Piano Concerto No. 21*) to serve as an introduction to the concerto repertoire as well as a piano sonata (Mozart's *Piano Sonata No. 11*). The Offenbach selections are highly enjoyable, the Rossini overtures are lots of fun, and the Rimsky-Korsakov *Scherherazade* is a work almost everyone appreciates. But it is the Tchaikovsky selections we think you'll want to spend the bulk of your listening time on, since it is Tchaikovsky more than any other composer who can open the door to the classics.

Not too surprisingly, our "Fifteen To Grow On" listing contains more Tchaikovsky, a Mozart symphony (his *Symphony No. 40*), his ever-popular serenade *Eine Kleine Nachtmusik* (which translates from the German as "a little night music"), as well as Schubert's so-called "Unfinished" symphony (his *Symphony No. 8*).

Of the proverbial "Three B's," Beethoven makes his appearance with his well-known *Symphony No. 5* and his *Piano Concerto No. 5* (subtitled "The Emperor"). Brahms is represented by two concert overtures: his *Academic Festival*, which

includes the theme from an old school song, "Gaudeamus Igitur," and his *Tragic*. Hardier fare comes in the form of Dvorak's popular *Symphony No. 9* (once known as his *No. 5* and still subtitled "From The New World"). Franck's only symphony is included, as are two piano concertos of extreme beauty: Grieg's sole offering in this field and the *Concerto No. 2* by Rachmaninoff.

In our "Twenty-Five To Round It All Off," you'll find two works for harpsichord. One is Bach's *Goldberg Variations*, and the second recording consists of sonatas by Domenico Scarlatti, a contemporary of Bach's.

Another Bach work (his *Tocatta and Fugue in D*) was written, like many of his compositions, for organ and will give you an opportunity not only to test your reaction to what many people consider to be the greatest of all instruments, but also to test your system. The organ, by way of explanation, is usually considered the most difficult instrument to reproduce and poses a challenge of the first order to the best of stereo setups.

Operas and a Quintet. Also to be found in our "Twenty-Five" listing are two more operas—Mozart's *Magic Flute* and Puccini's *La Boheme*. The great Polish composer Frederic Chopin is represented by a selection of his piano music, and there is also a disc which includes songs by Schubert, Schumann, and Richard Strauss. To whet your appetite for chamber music, we've included a recording of Schubert's famous "Trout" quintet (so-called because the theme of one of its movements also appears in a song by Schubert called "Die Forellen," which, in

Bargain Basement

translation, means "The Trout.")

Although we've mentioned that the music must speak for itself, when listening to those recordings it's nonetheless a good idea to profit from whatever the line notes may offer. It's entirely possible to add a little French, Italian, or German to your vocabulary while listening to an opera. Study the libretto while listening to the recording and see how really easy it is to pick up some of the original language. Liner notes can also reveal much about the composer, offer some background on the performers, and generally round out your musical experience.

Onward and Upward. In closing, we should mention that if classical music can be compared with an iceberg, we've revealed almost nothing save the dimmest of forms. In limiting our Bargain Basement Beginning to a mere fifty items, we have ignored some of the greatest works ever written. But we have every con-

(Continued on page 97)

TWENTY-FIVE TO ROUND IT ALL OFF

Composer: Title	Conductor	Label
BACH: Goldberg Variations	Galling	Turnabout 34015
BACH: Toccata and Fugue in D for Organ	Wunderlich	Nonesuch 71252
BEETHOVEN: Symphony No. 3	Walter	Odyssey Y-33925
BEETHOVEN: Symphony No. 6	Walter	Odyssey Y-33924
BEETHOVEN: Violin Concerto	Francescatti	Odyssey Y-30042
BERLIOZ: Symphonie Fantastique	Beecham	Seraphim S-60165
BRAHMS: Piano Concerto No. 2	Fleisher	Odyssey Y-32222
BRAHMS: Symphony No. 1	Karajan	London STS 15194
BRAHMS: Symphony No. 4	Walter	Odyssey Y-32373
BRAHMS: Violin Concerto	Milstein	Seraphim S-60265
CHOPIN: Piano Music	Iturbi	Seraphim S-60186
HAYDN: Concerto for Trumpet and Orchestra (includes Albinoni: Sonatas for Violin and Continuo, Hummel: Concerto for Trumpet and Orchestra, Torelli: Sinfonie for Trumpet, Strings, and Continuo)	Berinbaum	Vanguard C-10098
LISZT: Piano Concerto No. 1 (includes Piano Concerto No. 2, Reminiscences de Lucia di Lammermoor)	Brendel	Turnabout 34581
MOZART: Magic Flute	Bohm	Richmond 63507
MOZART: Symphony No. 35 (includes Symphony No. 41)	Krips	London STS-15058
MUSSORGSKY: Pictures at an Exhibition (includes original piano version)	Szell	Odyssey Y-32223
PUCCINI: La Boheme	Beecham	Seraphim S-6099
RAVEL: Daphnis et Chloe: Suite No. 2 (includes Pavane pour une Infante Defunte, Debussy: La Mer)	Szell	Odyssey Y-31928
SCARLATTI: Sonatas for Harpsichord	Payne	Turnabout 34434
SCHUBERT: Piano Quintet in A ("Trout")	Kentner	Turnabout 34140
SCHUBERT: Songs (includes Schumann: Songs, Richard Strauss: Songs)	Hotter	Seraphim S-60025
SCHUBERT: Wanderer Fantasie for Piano (includes Fantasia in F)	Brendel	Turnabout 34479
TCHAIKOVSKY: Symphony No. 6	Martinon	London STS-15018
VIVALDI: Four Seasons	Janigro	Vanguard HM-15
WAGNER: Gotterdammerung: Rhine Journey (includes Funeral Music, Rheingold: Entry of the Gods into Valhalla, Walkure: Magic Fire Music and Ride of the Valkyries)	Steinberg	Westminster 8130



Liszt's "Piano Concerto No. 1" (Turnabout), Songs of Schubert, Schumann, and Strauss (Seraphim), and Brahms' "Piano Concerto No. 2" (Odyssey) are all included in our Twenty-Five To Round It All Off collection.





TRADE OFF THE EXTRAS

(And Get Remarkably Good Sound With Budget-Priced Equipment)

by Herb Friedman

□ With unlimited funds it's easy to assemble a high fidelity system of excellent quality while knowing little about equipment or performance. If you walked into any reputable top-of-the-line audio salon and put upwards of three thousand dollars on the counter the salesman would instantly assemble "the best" component system available from the product lines his store carries. He'd probably also send a technician to your home to install the system. In fact, if you tried this sales approach in five different audio salons you would most likely wind up with five completely different component systems, yet each system would be "the best" in the salesman's eyes.

When dealing with top-of-the-line audio components from reliable manufacturers, there's really little difference in performance levels. In general, an \$800 receiver from one brand is essentially similar in performance to its major competitors. Competition being what it is in high fidelity, one brand cannot let another get a large lead. If *Super Colossal Sound Products* introduces an amplifier we rate as "among the finest ever tested," rest assured that by the time the next issue of *Hi-Fi STEREO BUYERS' GUIDE* comes out, *Super Colossal's* competitors will be right in there with a new model whose performance is "among the finest." At the top of the line, all the major component manufacturers deliver top value for the dollar; that's why you can get in performance when price is no object.

But what do you do when the latest cost of living squeeze doesn't leave room in the budget for any luxuries? Just remember that it is still possible to get quality hi-fi components at budget prices. True, you won't be impressing neighbors two blocks away with 250-watts-per-channel, but if you're willing to compromise here and there you can get a quality sound for relatively little money. In fact, if you're willing to sacrifice a few operating fea-

tures or performance levels right at the very beginning, you can initially purchase the overall level of sound quality you might be trading up to at a later time. (See *Stepping Up Your Component System For Better Sound*, elsewhere in this issue).

You start assembling your high-quality budget-priced hi-fi system by referring to the test report section of this magazine. Unlike other publications, *Hi-Fi STEREO BUYERS' GUIDE* does not limit itself by testing only the top-of-the-line equipment; our test reports cover virtually every price range, and we report on any equipment that will deliver a reasonable level of performance. A particular amplifier might not be the ultimate in low distortion, but 0.5% THD isn't bad if the price is under \$200, and more people look for, and purchase, \$200 amplifiers than buy the gold-plated specials.

Okay, then what's needed when looking for components is a minimum performance level to be traded for price and/or operating features. For example, many low cost FM tuners and receivers can be properly tuned using only a signal strength meter. It would be nice to also have a center-of-channel FM tuning meter, but the extra meter can represent as much as \$20 of the final retail price. In budget equipment the extra \$20 spent for the center-of-channel meter won't necessarily insure better tuning of an FM station. In many instances—particularly in the budget price range—an ordinary signal strength meter is perfectly adequate as a reliable FM tuning aid. As most readers of this magazine are aware, often we indicate that center-of-channel tuning meters are inaccurate, and best results are attained with the tuning meter indicating other than "center channel". So if you're willing to trade off a center channel tuning meter, you've got up to twenty extra dollars to spend on hi-fi.

But let's back up for a moment and start with the basic question: "How

much output power?" because each additional watt of output power costs a little bit more. When we talk budget prices, high fidelity in a typical home at moderate volume levels is about 20 watts rms per channel into efficient speakers—anything with greater efficiency than the typical "acoustic suspension" speakers. Acoustic suspension gives excellent sound quality in small and medium sizes but takes somewhat more than 20 watts per channel for loud volume levels. So if you're thinking budget keep in mind you'll ask the salesman to demonstrate the amplifier, or receiver, with *more efficient speakers*.

Less than 20 watts per channel puts us in the class of "general entertainment." This means a slightly limited amplifier frequency response of per-



Less than 20 watts per channel puts us in the class of general entertainment.

haps 40 or 50 Hz to 15,000 or 20,000 Hz rather than the usual 20 to 20,000; but 40 or 50 Hz on the low end is satisfactory for just about all "general entertainment" listening. Another characteristic of "general entertainment" equipment is a power output between 7 and (usually) 15 watts per channel. Using the high efficiency speakers generally provided with entertainment equipment, the sound quality is quite good at moderate levels. Overall, you get much better sound than you would from "stereo sets" selling for the same price. By the way, *Hi-Fi STEREO BUYERS' GUIDE* reports on "entertainment equipment" of particular value for those

TRADE OFF THE EXTRAS

looking for decent sound at rock bottom prices.

In general, substantial savings can be made by simply dropping features you'll never, or rarely use. Few stereophiles need or use a high filter, an FM mute, multiple speakers, or automatic tape duplication. These are nice features to have when you can afford them or need to use them, but it's amazing how you can do without them. Often, however, a manufacturer loads up a low cost model with features and sacrifices performance for these "convenience features." But if you want good sound you must go the other way, sacrificing convenience for sound quality. For example, we have tested a virtually stripped AM/FM receiver selling for under \$225 with FM performance and sound quality the equal of receivers in the \$500 class. It has no MPX filter and no auto-dub, but it delivers a lot of performance at a rock-bottom price.

Turntables and pickups are another area you can trade off features for performance. Do you really need automatic or record changer operation? Do

the same price range. So take the best of what you can get the dealer to include in the turntable sale. Some dealers will include a reasonably good pickup for a dollar, sometimes even just one cent when you buy a turntable. Unless you're using the very best in turntable equipment, the very best in pickups will probably sound worse than a medium or low cost pickup.

Trade off convenience features and you can get an especially good value in a cassette deck.

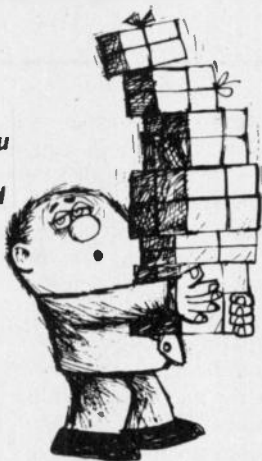

When it comes time to get rid of that portable cassette recorder you've been using to a full-fledged hi-fi cassette deck, you can make some trade offs which can represent a hundred or more dollars. While there's no question that the newer decks in the \$300 to \$500 price range offer outstanding performance, comparing favorably with high quality reel-to-reel records, it is also true that because of recent developments in tape formulations it's possible to get darn good sound quality from a deck on the \$125 to \$175 price range. You'll probably have to give up automatic switching to chromium dioxide bias and equalization, a record level limiter, a peak record level indicator lamp, Dolby noise reduction at the lower end of the price range, a memory type reset counter, front loading, microphone/line input signal mixing, possibly a microphone pan-pot, remote control, and maybe even super-low wow and flutter (below 0.1%). Except for the Dolby, none of these features contribute anything to the recorded sound. Even wow and flutter below 0.1% is gilding the lily because wow and flutter need be only less than 0.2% to be unnoticed (yes, there's always some expert who can hear the difference). In fact, the performance from a modern tape gives a typical signal-to-noise ratio slightly better than 50 dB without Dolby, and that's a value accepted as "hi-fi" a couple of years back when using Dolby.

So you see, if you're ready to trade off convenience features you can get a particularly good value in budget-priced cassette decks.

Trade offs are even possible in FM tuners, particularly within the budget to moderate price range. Getting the frequency response "flat" below 50 Hz, and getting good 19 kHz pilot suppression without affecting the 10 kHz to 15 kHz response costs money. Yet, there is essentially no program information transmitted below 30 Hz and very little below 50 Hz. If you're using budget speakers they won't reproduce below 50 Hz in the average living room so why pay for FM response below 50 Hz. Similarly, very little program information is transmitted above 10 kHz, particularly between 13 kHz and 15 kHz, the range most affected by low cost pilot filter designs. You can therefore get better sound from a tuner with a 50 to 13,000 Hz "flat" response and less than 1% distortion, than you will from a tuner with a 20 to 15,000 Hz response with 1% or higher distortion.

Trading off FM tuner sensitivity also saves. High sensitivity in the order of 4 to 8 uV mono, 50 uV stereo, isn't really needed if you live in an area of relatively high transmitter signal



If you're willing to lift the tonearm to the record you can save another \$25.

you really need pitch control and electronic speed regulation? Since the electric utilities used the brownout ploy several years ago to get steep increases in rates we haven't really had problems with voltage regulation in this country, and an AC synchronous motor does just fine in a budget system. And if you're willing to physically lift the tonearm to the record, rather than pulling a lever or pressing a button, figure you can save another \$25 off the store price.

Once you skim off the cream of phono pickups, in general one is similar to any other from a brand name in

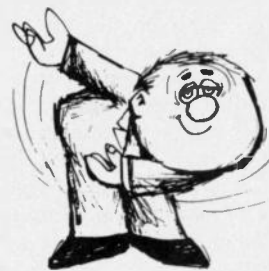

The secret in a nutshell: put your money into sound quality rather than into convenience features.

strength. If you're not out for deep-fringe FM reception a stereo sensitivity up to 100 uV is perfectly satisfactory, and the difference in cost between 50 and 100 uV sensitivity can represent a carton of cassette tape.

We've shown just a few examples of the places you can make substantial savings when assembling a high fidelity system by trading off unnecessary features or performance for overall sound quality. As a general rule, you get the most value for your dollar by placing emphasis on and eventually putting your money into the required or desired sound quality rather than on convenience features. ■

HI-FI DX

Your FM is good for a lot more than local music—even portables can pull in distant stations if you play them right.

by Harry L. Helms, Jr.

□ You say you have a problem? Feeling low over Radio Moscow? The standard AM band getting pretty bland? Ah yes, you have a case of the "DX blahs," which is the result of getting into a rut with your SWL activities. The only cure, my friend, is to try the "higher Hertz"—88 to 108 MHz to be specific, the home of FM broadcasting and FM DXing!

FM DXing is now *the* "in thing" among DXers in the know. You can't tune the world anytime you want, like on shortwave, nor can you easily tune in distant stations like on the AM broadcast band—but where else can you DX in stereo or quadraphonic sound? And FM DXing is trailblazing—we are still unraveling the mysteries of long-distance reception at FM frequencies. Finally, you can DX without a kilodollar receiver or monster antenna system. If you have an ordinary portable or table radio that covers the FM band you have all you need to start FM DXing today.

As one example, on a July afternoon in 1975 your author heard FM stations from New Hampshire to North Dakota on a simple \$30 AM-FM portable using only its built-in whip antenna. Such an experience is actually *common* in FM DXing. The secret lies not in your equipment or in an extensive knowledge of radio. Rather, FM DXing depends upon being in the right place at the right time!

Propagation Possibilities. There are four main ways in which FM signals

are propagated, or reach the receiver from the transmitter. *Meteors* provide one way, as the ionized trails left by meteors entering the Earth's atmosphere can actually reflect FM signals over great distances. *Auroral reflection* is another method, and is associated with the Northern Lights. FM signals are actually reflected off the auroral curtain.

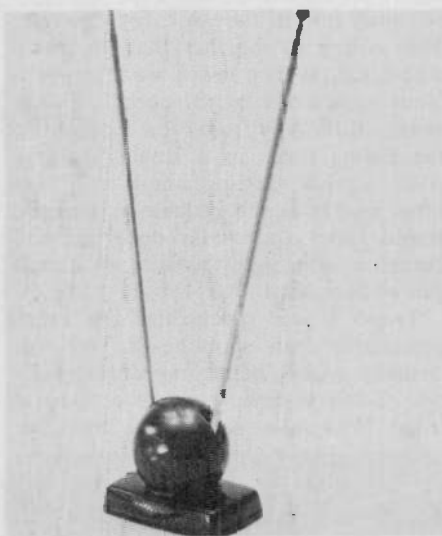

The simplest type of FM antenna, the old "rabbit ears." It can get some amount of directivity by the easy technique of just rotating the two elements by hand. When conditions are right, it will give surprisingly good results. Just remember, if you want this type of antenna, don't go for elaborate knobs and slides. They don't do anything at all to help reception.

Both of these methods, however, involve techniques and methods of interest to advanced DXers. Fortunately, most FM DX is the result of propagation modes that are easier to use.

Sporadic-E is by far the most spectacular method of FM DX reception that the beginner will encounter. Sporadic-E takes place in the E layer of the Earth's atmosphere approximately 50 miles above sea level. For reasons not yet completely understood, scattered patches of intense ionization form in the E layer of sufficient intensity to reflect FM signals over long distances. A typical range for sporadic-E skip is between 40 to 1200 miles. Sometimes the FM signals will reflect off more than one cloud, resulting in reception at distances of 2500 miles! Sporadic-E skip is also one of the kindest DX methods for the FM newcomer, for it is often just as good (and sometimes even better) on portables and table radios as it is on expensive receivers and fancy antenna systems. When sporadic-E is taking place, stations over 1000 miles away blast through at local levels, even overpowering semi-local stations!

A more subtle method of propagation is *tropospheric bending*. Tropo, as it is called, takes place when two differing air masses meet. A typical case is where cool Pacific air from the West encounters warm, moist air from the Gulf of Mexico. At the boundary point where the two air masses meet, a "duct" is formed that traps FM signals and

HI-FI DX

bends them over the horizon along the length of the boundary. The FM signals are trapped in the troposphere, the layer of our atmosphere that extends from sea level to about six miles. Ranges for tropo DX are not ordinarily as long as for sporadic-E, usually only a few hundred miles, but tropo charting has produced reception of FM stations from Houston in New York.

When to DX. Sporadic-E is highly unpredictable, and may take place any time of year. However, peak activity is

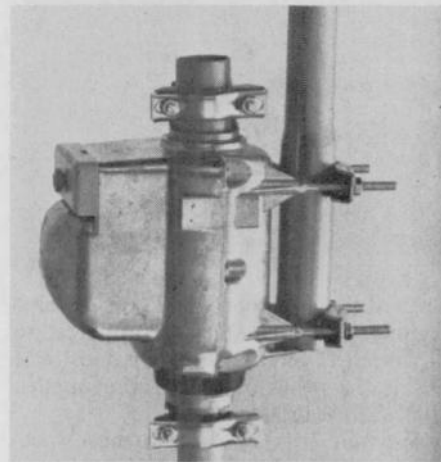

The servo-rotor unit for an outdoor antenna rotator. This control, mounted indoors, determines the direction to which the rotator will point the antenna.

from early May to early August, with a lesser period of activity from late December to early January. Daylight hours are best, with mornings and early evenings at your DX site usually best. However, most top FM DXers make it a point to check the band every chance they get during the busy summer FM DX season.

Sporadic-E starts on lower frequencies and works its way up the frequency spectrum into the FM band. Smart FM DXers keep a check on television channels 2 through 6 for signs of sporadic-E activity on television. Sporadic-E on the

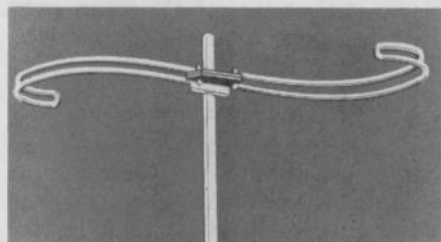

Two different types of omnidirectional antennas. Each one provides a pattern of sensitivity that is as nearly circular as possible. With these units an antenna rotator is unnecessary since nothing is gained by turning them, although the lack of a reception pattern concentrated in one direction means that a lot of sensitivity is lost.

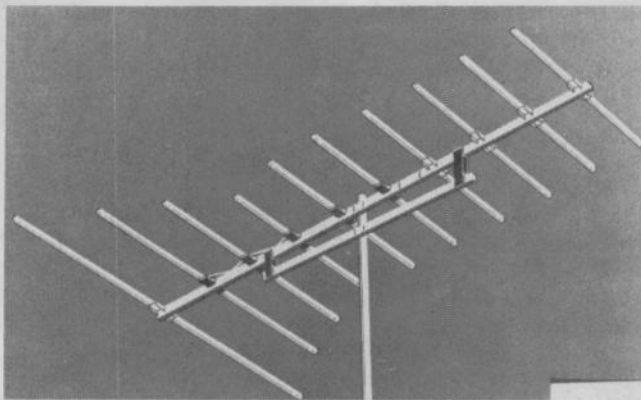

A ten element yagi FM antenna. This design is able to receive very distant signals because virtually all of its sensitivity is concentrated along the axis.

TV channels can be identified by rolling black bars across the TV picture, garbled audio, ghost pictures on local TV stations, and the appearance of TV signals on channels normally empty. When sporadic-E becomes noticeable on channels 5 and 6, it is a sign that sporadic-E is about to reach the FM band.

Generally, sporadic-E does not cover the entire FM band. It reaches a certain frequency, called the *maximum usable frequency* (MUF), the highest frequency on which sporadic-E can produce long distance reception. Sporadic-E skip is generally first noticed in the 88-92 MHz educational portion of the band. This is where to start DXing if sporadic-E is present. Many DXers work their way up the band, logging new stations as they go, and follow the sporadic-E until it reaches the MUF.

Changes of direction are frequent in sporadic-E, with DX signals first coming from the north and then abruptly swinging toward the west, for example. This is due to the fact that the sporadic-E clouds themselves are in motion. Your author has heard sporadic-E skip swing all the way from New England to the Plains states in a single opening. Also, signals via sporadic-E skip are often loud but quite variable in strength. Rapid fades and audio distortion are common. It is highly erratic but superb fun while it lasts!

Tropo is less spectacular but more predictable than sporadic-E. Tropo is virtually a daily happening during periods of fair weather because of sunrise tropo. When the sun rises, it heats the

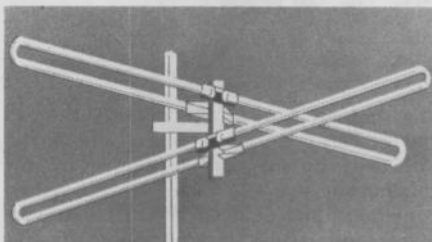

cool down air and causes atmospheric inversions. Such conditions last until approximately 9:00-10:00 a.m. local time and enable listeners to log stations within a two hundred mile radius or less.

Long-haul tropo of several hundred miles is most common in autumn. A check of your newspaper's weather maps can provide important tips as to when tropo might be present. A key



The motor and gear assembly for an outdoor antenna rotator. The unit must be sturdy enough to withstand strong winds, and to be able to swing the long beam of the FM antenna around. It also must not be affected by weather extremes.

clue is a slow moving high pressure system followed by a cold front. Ducting which permits long-distance FM reception will exist where the cold front and high pressure area meet, and the duct will run the entire length of the boundary line between the two air masses.

Tropo is also common in coastal areas. Listeners along both the Atlantic and Pacific coasts will note enhanced reception of stations up and down both coasts during summer evenings. Tropo openings are also frequent between the coastal areas of the Gulf of Mexico.

Tropo is fairly common in the eastern two-thirds of the United States, but is rare in the more arid and mountainous areas of the West. Tropo is excellent, however, up and down the Pacific coastline west of the mountains.

(Continued on page 100)

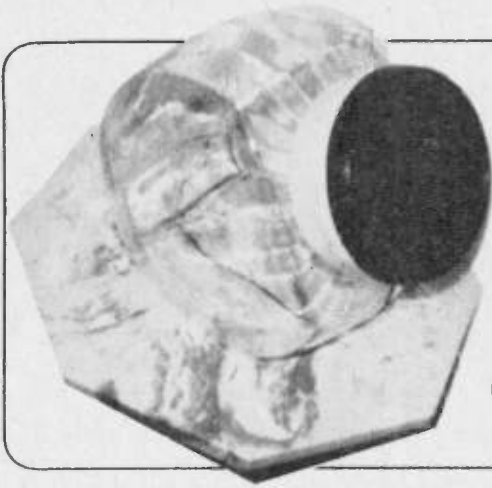

It's A Sound Cookie

Invest a few crumbs and get great sound that can go anywhere.

□ Here is an unusual loudspeaker system that employs a two-gallon food jar, the kind usually called a cookie jar, as the enclosure for a small loudspeaker system. Depending on the particular driver speaker unit you use, you can get high fidelity sound from this very compact speaker system, or you can use a less expensive speaker and still get very pleasant sound for background music, or mostly listening to talk programs at high sound levels.

Since the enclosure is made of clear glass, it can be used as a terrarium for display of an artificial floral arrangement or a miniature garden. Or, favorite pictures and photographs can be mounted to the inside surfaces with glass insulation filling between, similar to the display made by a photo cube. Another idea—the enclosure can be decorated by filling the inside with small cut cubes of fiberglass. Fiberglass insulation is available in shades of yellow and pink. White cotton balls can also be used for additional color variety.

Construction. You will note in the illustrations that the speaker driver is positioned in the neck of the enclosure at an angle of 45 degrees from horizontal. Thus the speaker can be placed on

a low table or on the floor to provide good dispersion of the treble sound in the listening area. An airtight seal between the driver and the enclosure is assured because we use the top section of a cylinder-shaped plastic food container and its cover.

The photographs and drawings show how the parts that make up the adaptor fit into each other. The inside diameter

of the food container, at the cut-off section, is slightly less than the outside diameter of the glass around the opening. When installed, it is stretched over the glass opening and pressed down, all around, to the body of the jar enclosure. Note that the plastic screw-on cover is placed between the back flange of the speaker unit and a masonite stiffening flange and serves as a gasket. These parts are clamped together by four screws and nuts.

The glass jar and the plastic food container are available in supermarkets and variety drug stores. The two-gallon container has a 5-inch inside diameter opening. The outside diameter is 6-inches.

Making the Parts. Stick a length of masking tape around the food container an inch and one-half from the open end to serve as a guide for sawing the plastic body as indicated in the drawing. Screw the cover on tightly before sawing, to add rigidity. Hold the round body over an open vise or other double-edged support. Now rotate the body as you make the cut, and scrap away the ragged edges with a file.

Scribe the straight and the circular lines on the smooth face of a piece of

MATERIALS LIST FOR COOKIE JAR SPEAKER SYSTEM (quantities shown for stereo pair)

- 2—Food storage container, glass, two-gallon size, used as enclosure (Anchor Hocking or equiv.)
 - 2—Freezette food containers, no. 117 soft plastic, 6-in. diameter, 7-in. high, with cover.
 - 2—Hardboard 6-in. square or larger, ¼-in. thick (Masonite or equiv.)
 - 2—Speaker grille, automotive type, 6½-in. diameter, including metal retaining ring.
 - 2—Loudspeaker driver unit, 5-in. diameter (Radio Shack 40-1292, 40-1284, 40-1909, 40-1240 or equiv.)
 - 8—Machine screws 1-in long, round head, no. 8-32, with nuts and washers.
 - 8—No. 6 sheet metal (self-tapping) screws, ¾-inch long (similar wood screws are acceptable).
- Speaker hookup wire, two-conductor, 24 gauge.

This exploded view shows the speaker driver and five associated parts, all ready to go together just before being set around the neck of the cookie jar enclosure. Metal ring next to the top grille comes with it. A four-inch driver could also be used, with the Masonite piece and the cover using a smaller center cutout in that case.

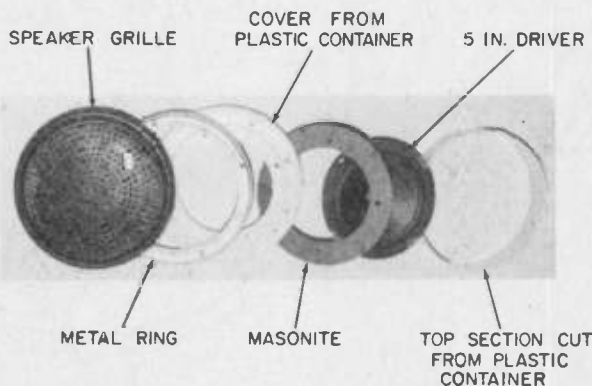

Plastic food container gets cut off near top to secure cover which seals speaker.

Sound Cookie

¼-inch hardboard to make the stiffening flange. If you make the circular cut with a saber saw, cut slightly inside the line for the 3¾-inch diameter cutout first, then cut outside the 5⅞-inch diameter line. You can obtain an almost-perfect round opening by use of a drum sander chucked into a drill, to remove excess material or by hand with sandpaper. The outside cut is best smoothed by turning the flange against a disc sander or by hand filing to the line.

When you have completed these cuts, place the speaker driver face down on a clean flat surface. Place the masonite piece, smooth side down, over the speaker to determine that it fits the

speaker frame all around. When you are satisfied with the fit, turn them over and rotate the speaker to locate the mounting holes, to the straight lines you have scribed on the masonite. Since the speaker unit extends below the flange, in this position, it is a good idea to support them on two blocks of wood so that the speaker unit will hang between the blocks. Accurate center marks can then be punched for drilling the holes for the four mounting screws. The large opening and screw holes to be made in the plastic cover are shown in the drawing. To make a visible line on the soft plastic of the cover, use a sharp pencil lead with a school compass adjusted to 1 & 15/16-inch radius. A groove can be made in the plastic surface to scribe the outline of the cutout. Then, trace the groove with a felt marking pen to make it more visible. The

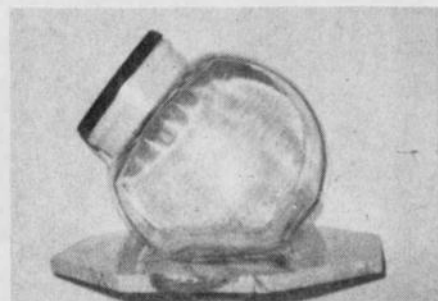

Completed speaker system looks like ordinary cookie jar when viewed from side.

opening can now readily be cut with a sharp knife. Template the mounting holes in the cover from the speaker frame or the Masonite piece.

Putting It Together. Bolt the assembly together with the machine screws and nuts, using washers on the

(Continued on page 102)

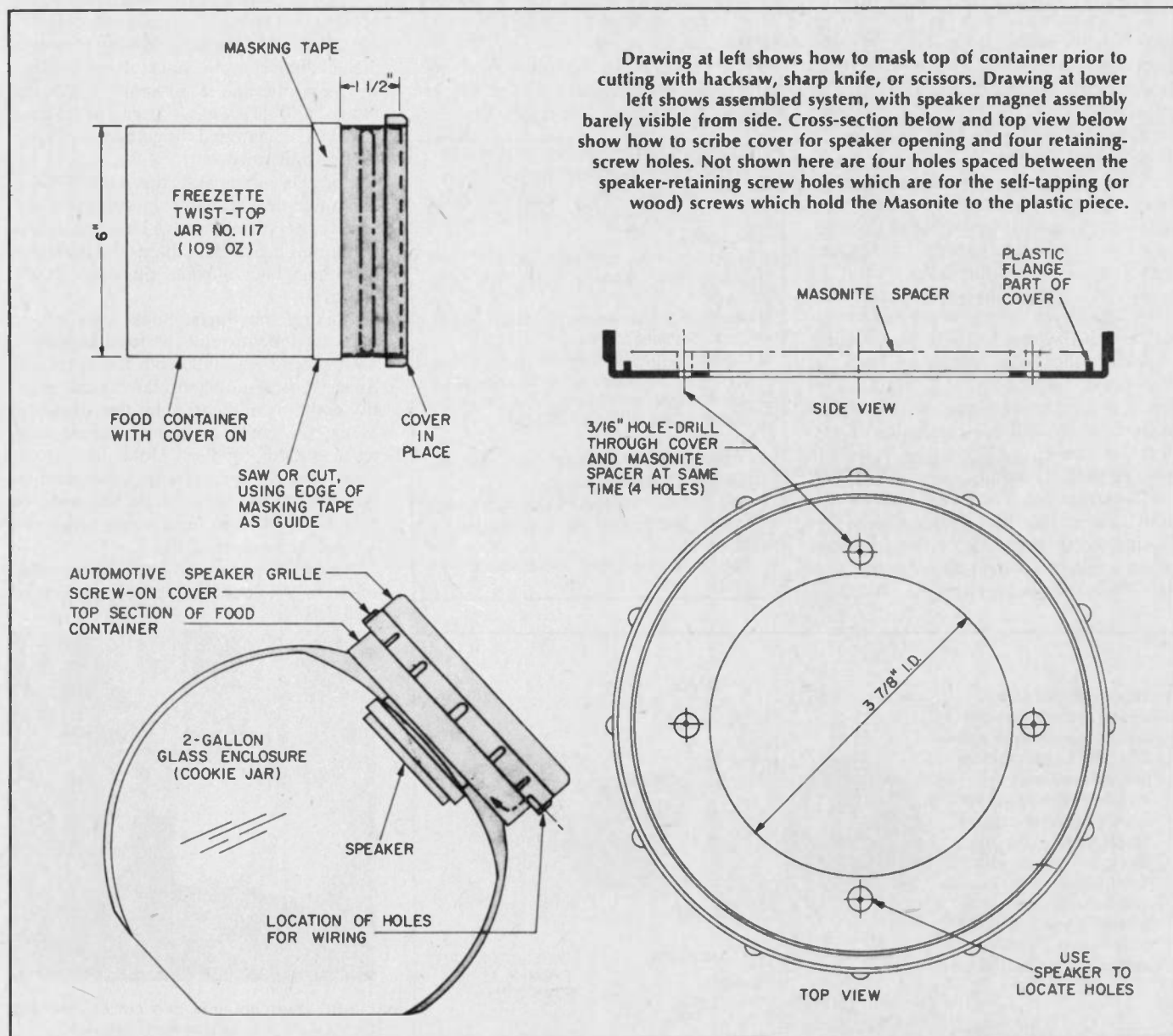

SUPER SCA SOOTHER



Get fancy restaurant music for down-home kitchen prices with your own FM tuner.

by Herb Friedman

YOU CAN LISTEN TO SCA BROADCASTS at far greater distances with this SCA (Subsidiary Communications Authorization) adapter for your FM receiver or tuner than with previous designs, even those costing many times more. The secret lies in a new integrated circuit now available at very low prices which decodes the ultrasonic frequency the SCA signal is on. This IC is a PLL (Phase-Locked Loop) which acts as the detector of the 67 kHz SCA carrier wave which the subsidiary signals are transmitted on.

Although most people are unaware of it, many FM stations transmit not just the two signals of a stereo program, but one, two, or even three other programs, usually music, which cannot be heard by the owners of normal FM tuners or receivers. These programs can be heard only if you have a special SCA receiver, or if you have an SCA adapter, similar to the one described in this article.

Our SCA Super-Soother is so-called because the most common use for SCA is to transmit Muzak-like background music into stores and factories. It uses two ICs which cost \$6.00 (total, including postage) plus a handful of resistors and capacitors. Because of the advanced design made possible by the PLL IC, Super-Soother can grab SCA signals which ordinary SCA adapters would lose completely, or at best receive with lots of hash and/or distortion—and who needs that with soothing background music, music to lull you by . . . or whatever?

Using a two IC circuit in an amplifier / (PLL)-detector configuration Super-Soother will actually permit you to DX your FM-SCA programs. No

longer will your SCA listening be restricted to local FM stations. You can now monitor *fringe reception* FM stations with SCA programming.

But before going further let's take a look at what SCA is all about. When a *Subsidiary Communications Authorization* is granted to an FM station by the FCC the station is permitted to transmit up to *three more programs* in addition to its regular program (called the main channel program) by a special method of modulation. A standard FM radio—either mono or stereo—cannot detect the SCA programs. The regular listening audience hears only the main channel programming. In fact, there is no way a listener with a standard FM radio can tell the station is transmitting an SCA program(s). Only listeners with FM radios equipped with an SCA adaptor can hear the SCA program.

If you would like to tune in to these "phantom broadcasts" you can do so with Super-Soother SCA Adapter. It's super because its extra-high sensitivity

permits reception of SCA programs that other low cost SCA adaptors can't detect.

What You Can Hear. For many years SCA has been used to transmit educational programs and weather reports to specialized audiences; it has been used for reading to the blind, and even for broadcasting some school tests. The most common use of SCA, however, is the transmission of background music—the type heard in restaurants and shopping centers—and ethnic music. For example, in the New York City area there are FM stations with SCA programs of the music of China, Greece, Ireland, and many others.

Best of all, this pleasant, interesting music is rarely, if ever, interrupted by an endless barrage of commercials or the patter of an announcer in love with his or her own voice.

How It Works. SCA programming is transmitted by a 67 kHz FM sub-carrier (or sometimes 65 kHz impressed on the main FM carrier). When a station broadcasting SCA is received

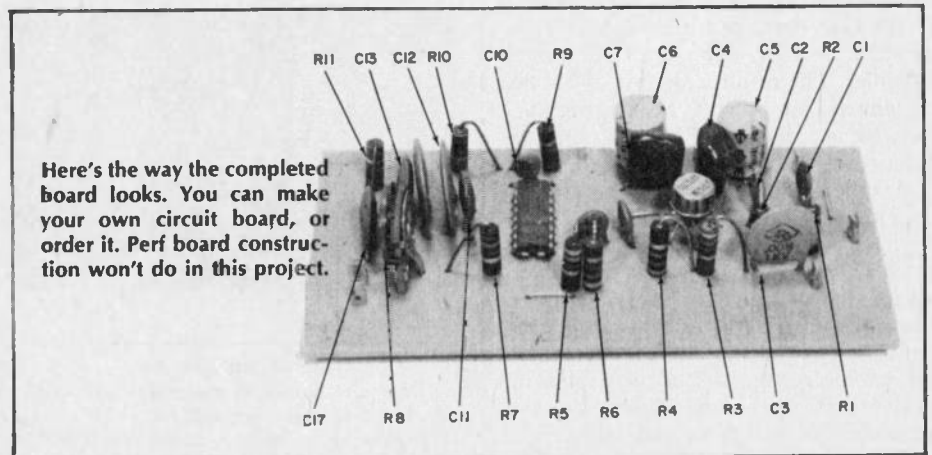

SOOTHER

by a standard FM radio or tuner the SCA subcarrier is simply wiped out in the radio's detector and the listener has no idea it exists.

To receive SCA the regular FM detector output must be fed into a 67 kHz detector before the 67 kHz subcarrier is eliminated by the standard FM detector's de-emphasis network.

Until recently it took a lot of expensive hardware to receive SCA programs: a very sensitive receiver and a rock-steady detector. (A good receiver is usually only 10% of the total FM signal.) Though many low-cost SCA adaptors have been available in projects, or in wired form, most had a tendency to burp, gargle or distort on weak SCA levels.

While the radio astronomy crowd had a great weak-signal detector known as the *phase-locked loop* or PLL, it was also true that the astronomical-use PLL was astronomical in price. Thanks to modern solid-state techniques, however, the Signetics Corp. has come up with a PLL specifically intended for SCA detection that's priced well under \$5.

Available in both the standard 8-pin round and the 14-pin DIP IC packages the Signetics SE/NE565 requires virtually no external hardware for SCA detection. Most important, since the PLL automatically locks onto the incoming SCA subcarrier frequency the SE/NE565 will demodulate subcarriers of either 67 or 65 kHz without need for individual adjustment.

Combination Gets Results. Unfortunately, the phase-locked SCA detector requires at least 80 mV input from the FM detector for good reception, and this usually means that only one or two very strong, or local SCA stations can be received. To make our Super-Soother the best there is we have combined the PLL with a high gain operational amplifier. The result is the Super-Soother which can receive SCA programs even using a cheapie FM radio and an indoor (rabbit-ears) antenna.

Another plus feature of Super-Soother is that no large filter coils are needed to suppress the main channel program. Even SCA programs on stereo stations are received cleanly, with no trace of *stereo hash*. And because large coils aren't need the entire adaptor can be assembled on a 2¼-in. x 4¼-in. printed circuit board which you can purchase, or make, as you wish.

Because the gain of the adaptor is

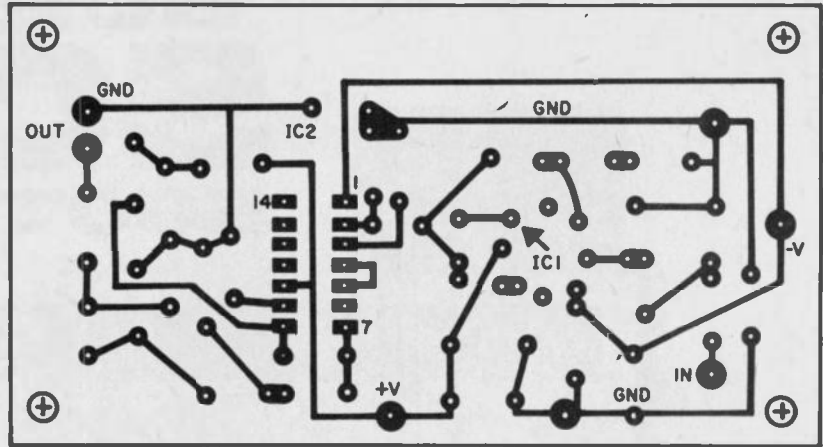

Exact-size printed circuit board layout is shown here. Transfer the image to copper clad board using carbon paper. This is the bottom (copper) side.

unusually high it must be assembled on the circuit board exactly as described to insure stability. You can't build this project on perfboard.

How The Circuit Works. The signal from your FM tuner's detector, before de-emphasis, is applied to operational amplifier IC1 through a high-pass filter consisting of C2, R1 and R2. The filter's effective frequency is 60 kHz, which removes just about all of the main-channel information. The frequency response of the amplifier is tailored by the feedback loop through R3 and C3 to further suppress main-channel information.

IC1's output is fed through high-pass

filter C9 and R5 to IC2, the PLL detector. IC2's output is passed through a low-pass filter consisting of C12, C13, C14, R9, R10 and R11 which provides SCA de-emphasis and noise suppression. The output level at C15 is about 50 to 100 mV depending on the particular signal, and can then be fed to your hi-fi amplifier.

Since SCA audio response is limited to a maximum of 7 kHz just about any amplifier can be used.

Note that Super-Soother requires a bipolar power supply in the range of ± 6 to ± 9 VDC. The supply can be either batteries or a power-line bridge rectifier using a center-tapped 12-volt

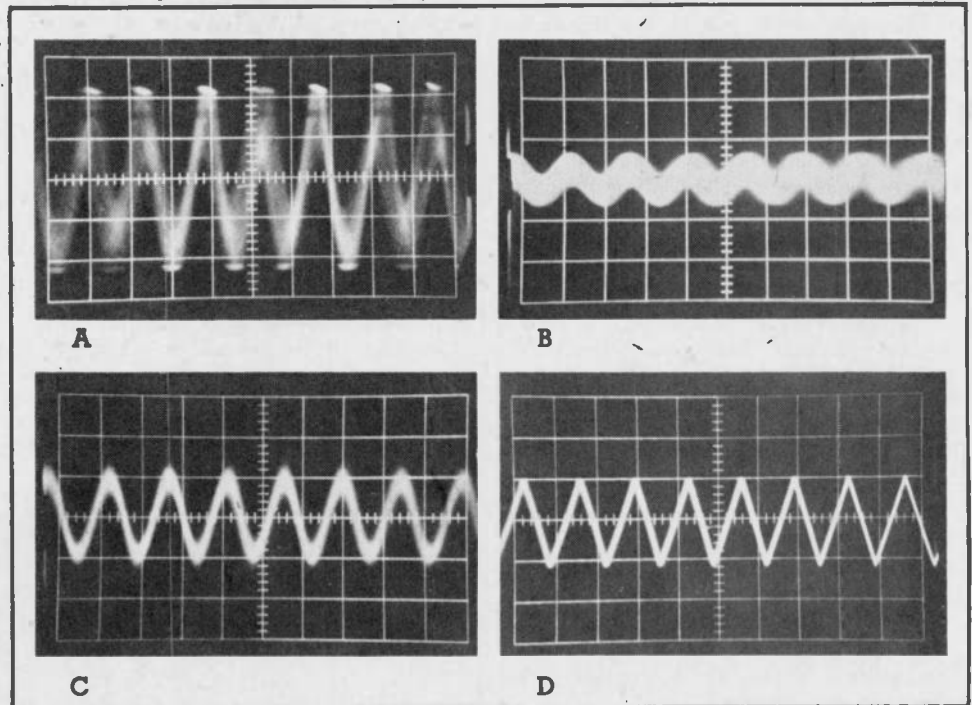

Oscilloscope patterns will pinpoint any possible difficulty. You can use a general purpose scope since the signals are under 100 kHz. With "triggered" scopes, set the time base to μ sec/cm. Photos B and C are input and output of IC1, the 67 kHz amplifier. If signal is clipped as in A, main channel program may break through—see text for curves. Normal IC2 pin 9 waveform is shown in the waveform of D. Vertical sensitivity B, 20mmV/cm; C, IV/cm.

filament transformer as shown on the schematic. Since the SCA adaptor requires only about 10 mA of current any small power transformer can be used.

Assembly. If you cannot make your own circuit board, you can purchase a drilled and plated board. See the parts list for information.

If you make your own board use a #56 bit to drill the holes for the push-in connecting terminals and trimmer potentiometer R8. Drill the corner mounting holes to clear a #4 screw. Drill the component holes with a #58, #59, or #60 bit.

Install IC1 and IC2 before any other components. Note that the IC1 lead opposite the case tab is #8. Insert the leads—beginning with #8 and push IC1 within 1/4 to 3/8-inch of the board. Solder the leads and cut off the excess.

If this is your first IC project it would be wise to use IC sockets.

Hold the board so you are looking at the top, with IC1 to your left. Hold IC2 so the notch is away from you and insert IC2's leads into the matching holes. *Doublecheck the notch before soldering.*

Install trimmer potentiometer R8 and solder. Then install the three wire jumpers, and finally, the remaining components, taking extreme care the polarity of capacitors C5 and C6 is correct. Note that C5 has the positive lead connected to ground.

While capacitors C12 and C14 are indicated as 0.02 uF they aren't the easiest to obtain in miniature size. You can substitute two parallel-wired 0.01 uF capacitors.

The three oscilloscope traces show what you can expect to get if you are tuned to an SCA station. Photo B is the input, IC1 pin 2; note the presence of a 67 kHz carrier. Photo C is IC1 pin 6; note the very strong 67 kHz carrier. Photo D is IC2 pin 9, the phase lock detector's voltage controlled oscillator triangular wave output.

If you don't get photo B, the trouble is the connection between the tuner and the adaptor. If you get photo B but not

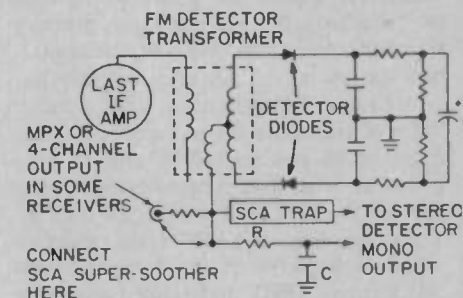

The Super-Soother (or any other SCA adaptor) is connected after the FM detector, but before the deemphasis network, as here.

photo C, the trouble is in the IC1 circuit. If you get photo C but not photo D, the trouble is in IC2.

If you don't get photos C and D, there is most likely a major fault in the assembly; we have specifically designed the adaptor so one defective IC cannot disable another IC.

Setup And Checkout. Either a bipo-

lar battery power source or an AC supply can be used. Since there is no difference (in this case) in performance between a ± 6 and ± 9 VDC supply use whatever you have available. For long-term battery life Burgess Z4 6-volt batteries are suggested. However regular (or long-life) 9-V transistor batteries will work fine.

PARTS LIST FOR SUPER-SOOTHER

- C1,9—470-pF capacitor (Radio Shack 272-125 or equiv.)
- C2—47 or 50-pF capacitor (Radio Shack 272-121 or equiv.)
- C3—005-uF capacitor (Radio Shack 272-130 or equiv.)
- C4,7—.1-uF capacitor (Radio Shack 272-135 or equiv.)
- C5,6—100-uF, 16-VDC or better electrolytic capacitor (Radio Shack 272-1005 or equiv.)
- C8—.7 or 10-pF capacitor (use two Radio Shack 272-120 capacitors wired in parallel)
- C10,11—.001-uF capacitor (Radio Shack 272-126 or equiv.)
- C12,14—.02-uF capacitor (use two Radio Shack 272-1065 in parallel)
- C13,17—.05-uF capacitor (Radio Shack 272-134 or equiv.)
- IC1—op amp integrated circuit Signetics NE 531T (available from supplier listed below)
- IC2—phase-locked-loop SCA detector integrated circuit Signetics NE 565A (available from supplier listed below)
- R1,5,6—4700-ohm, 1/2-watt resistor (Radio Shack 271-000 or equiv.)
- R2,4—47,000-ohm, 1/2-watt resistor (Radio Shack 271-000 or equiv.)
- R3—470-ohm, 1/2-watt resistor (Radio Shack 271-000 or equiv.)
- R7—1800-ohm, 1/2-watt resistor (Radio Shack 271-000 or equiv.)
- R8—5000-ohm potentiometer, circuit-board mounting (Radio Shack 271-217 or equiv.)
- R9,10,11—1000-ohm, 1/2-watt resistor (Radio Shack 271-000 or equiv.)

- S1—SPST switch (Radio Shack 275-602 or equiv.)
- Misc.—Cabinet 6-in. x 4-in. x 2 3/8-in. or larger (Radio Shack 270-252), two batteries 9-VDC or 6-VDC unless power supply is used, battery connecting clips, phone jacks, wire, solder, etc.

An etched, drilled, printed circuit board for the Super-Soother SCA Adapter is available from Electronic Hobby Shop, Box 192, Brooklyn, NY 11235 for \$6.95. US orders add \$1.50 for postage and handling; Canadian orders add \$3.00. No foreign orders, please. Postal money orders will speed delivery; otherwise allow 6-8 weeks for delivery. NY state residents must add sales tax.

The two ICs for this project are available from Circuit Specialists Co., Box 3047, Scottsdale, Ariz. 85257 for \$6.00 which includes shipping and postage.

PARTS LIST FOR POWER SUPPLY FOR SUPER-SOOTHER

- C15, 16—2000 or 2200-uF, 20 VDC or better electrolytic capacitors (Radio Shack 272-1020 or equiv.)
- SR1—4-Bridge rectifier, or separate diode rectifiers—anything over about 15 mA will do (Radio Shack 276-1151 is an inexpensive bridge rectifier rated more than enough.)
- T1—Small 12.6-VAC filament transformer (Radio Shack 273-1385 is more than adequate.)

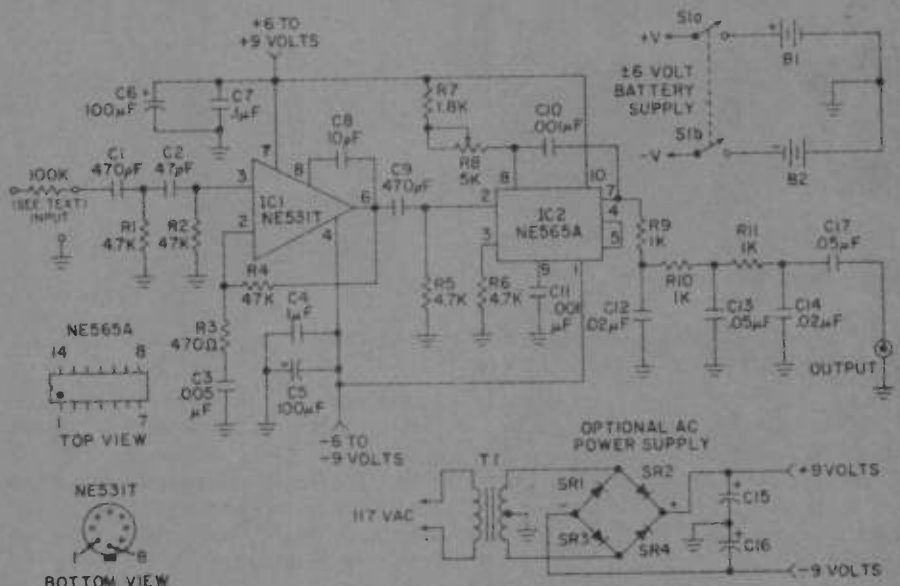

SOOTHER

Super-Soother connects to your radio or tuner between its FM detector and de-emphasis filter. If you connect after the de-emphasis filter you will find the 67 kHz subcarrier has been filtered from the detector's output signal and you will get nothing but noise from the Super-Soother. The drawing shows a typical FM detector output, the de-emphasis network, and the correct connecting point for the adaptor. Since it is possible the Super-Soother will load down the detector for normal FM reception I suggest a switch be installed so it can be removed from the circuit when not being used for SCA listening.

Super-Soother is most conveniently connected through a phono jack installed on the rear apron of the tuner or radio, though you can use a direct wire connection.

If you have one of the older FM tuners with an MPX output you already have the correct connection because the MPX output is the non-deemphasized detector output. Similarly, if you have a modern FM tuner with an FM detector, 4-channel, or FM Quadrasound output jack you also

have the correct connection as they are all FM detector outputs from before the de-emphasis network.

Connect the tuner's detector output to the Super-Soother with the shortest possible length of shielded cable, or install it directly inside the tuner or receiver if there is sufficient room. Connect Super-Soother's output to any high-gain amplifier such as the microphone input of a hi-fi or general-purpose amplifier.

Locking The Loop. Tune in a station you know (or believe) is transmitting an SCA program (a call to the station should get you the info) and adjust trimmer potentiometer R8 for best SCA sound quality. Normally, the reception will be almost completely garbled and then fade into a clean signal as R8 is adjusted. As R8 is adjusted further the sound will again garble. Set R8 so it is approximately midway between the two settings that produced garbled sound. Usually, the adjustment is quite broad so don't be too fussy.

If you don't know which stations are transmitting SCA set R8 to its mid-position and tune the station very carefully and very, very slowly. When you hear anything that sounds like distorted music try adjusting R8—if it's real SCA it will turn into clean sound as R8 is

adjusted. Note that some stereo stations can cause sound bursts that appear to be SCA. If adjusting R8 doesn't clean up the bursts it's not SCA. Note that once R8 is properly adjusted there is no stereo hash interference with SCA signals; hash will only be heard from non-SCA signals.

Problems? The high sensitivity of this system may require that the overall gain be reduced. In the event you cannot receive any SCA stations you either have none in your area or you have made a construction error. Here are some hints to help.

1) If your problem is a weak signal resulting in high frequency noise try changing C12 and C14 to 0.05 uF.

2) If your problem is background breaking through from the main channel the problem is probably caused by adaptor overload (clipping). Simply change C1 and C9 to approximately 300 pF. This will attenuate the subcarrier and clean up the breakthrough on very strong signals, though very weak signal might get lost (you can't grab, or hear, them all). A second, simple corrective procedure is to install a 100k ohm resistor in series with the input from the radio or tuner's detector. This effectively cuts down the input signal and eliminates overload. ■

EASY WAY TO RECORD



Save while you pick up CW, or hold onto that rare DX without even trying.

Have you ever wanted to record shortwave broadcasts, the code practice sessions that are transmitted daily by W1AW while you are studying for your ham license or maybe you wanted to capture the action of the local VHF police band?

If you use headphones for listening there is a very easy way to record these

broadcasts. Use the type of telephone pick-up coil that has a suction cup on it. These pick-ups are designed to record telephone conversations when placed on a telephone's earpiece but they work equally well when placed on a pair of earphones.

I used an Arista model 321 telephone pick-up coil but similar pick-ups are

available from Radio Shack (part no. 44-533, \$1.49), and others, including Lafayette and Calectro.

Have fun with your new gadget. Recording short wave broadcasts and other transmissions you tune in on can add a lot to the pleasure of your listening. If you're not sure of a station's identity or something else that's said, just play back the tape until you've got it. You can also impress your friends by letting them hear that rare one from Mongolia you logged last night after digging for it for the past year or so.

Listening to recordings is one of the best ways to learn the code, and, if you or a friend have a receiver that can receive code, you can have an almost unlimited supply of practice material by recording the regular code practice transmissions from W1AW, headquarters station of the American Radio Relay League, Newington, Connecticut. W1AW transmits on a number of frequencies so you should be able to hear it on at least one regardless of what part of the U.S. or Canada you live in. The complete W1AW code practice schedule appears in the League's official journal, QST, and is also available on request from the Communications Department, ARRL, 225 Main Street, Newington, Connecticut 06111. ■



RF from your Calculator

Your pocket calculator can save you sums, when you use it as an RF signal generator.

by Bob Baxter



□ The virtues of portable electronic calculators are by now so well-known and their prices have dropped so low that the units are found almost everywhere. Many presently-available machines—especially those employing LED displays—can be used as quick troubleshooting aids in addition to performing their usual day-to-day calculating chores. Whenever you need a fast, convenient, and portable amplitude-modulated RF source for equipment check-out, your calculator can often fill the bill.

Here's why. Just about all battery-powered calculators emit strong, wide-band RF signals which extend well up into the tens of megahertz. These signals are generated primarily as side-effects by the operation of two components of the calculator: the power supply's DC-to-DC converter and the multiplexed LED digital readout.

Not every calculator has a DC-to-DC converter. But those operating from two or three penlight or nicad cells usually do, using it to step the low battery voltage up to a higher level more suitable for operating the MOS ICs which do the arithmetic. The converter produces a harmonic-rich square-wave output at a fundamental frequency typically between 20 kHz and 100 kHz—but the harmonics extend well up into the megahertz region.

Even if your calculator is one of those without a DC-to-DC converter, it's still almost certain to use a multiplex system to drive the output digital display. Multiplexing means that each selected segment of the digital readout is rapidly turned on and off many times each second rather than staying on continuously. When this switching is done rapidly enough, the readout appears to stay on all the time because of the relatively slow response time of the human eye. Readout devices are multiplexed for two reasons. First, multiplexing drastically reduces the power required to operate the readout at any given *apparent* brightness level because the readout is actually on and drawing current for only a small percentage of the time. As a consequence, batteries last much longer. Secondly, multiplexing permits a great reduction in the

total number of IC's needed to actuate the calculator's readout display with an attending cost reduction at the time of purchase.

With a standard calculator's seven-segment LED readout and anywhere from 8 to 12 display digits, the multiplexing frequency is typically around 100 kHz. When currents of 20 mA or so are abruptly switched on and off through the LED display segments, significant amounts of RF energy at multiples of the multiplexing frequency are generated. These harmonics may extend well into the tens of megahertz. In fact, this harmonic radiation is one of the main reasons there are so few AM clock radios with LED time displays on the market today. The standard AM broadcast band is almost totally obliterated if the receiver's RF sections are within a foot or so of the multiplexed readout display unless extensive shielding is employed. Fortunately, there are two more practical and less expensive solutions than shielding. The first is the addition of resistance-capacitance networks to slow the rise and fall times of the multiplex waveform—and consequently filter out most of the higher-order harmonics. The second method is to drive each display digit directly and not use multiplexing at all. This second technique is much more practical in a clock radio than in a calculator for two reasons. First, clock radio displays normally have considerably fewer digits than most calculators; hence, the circuit

problem isn't nearly so complex. And secondly, with a clock operated from the AC power line, the problem of rapidly discharging the batteries unless the output is multiplexed is eliminated. National Semiconductor Corporation has recently introduced a clock chip with direct drive of all readout segments to eliminate RF interference. It was designed with clock radio applications in mind.

But now back to your calculator, which almost certainly is multiplexed and unfiltered and produces a rich harmonic output. Turn it on and slowly bring it near a standard AM radio which is tuned either to a weak station or between stations. You should hear a mixture of buzzes and tones as the calculator is brought within several inches of the radio or its antenna. These tones probably will shift in frequency if you key different numbers into the display.

Now that you've verified that your calculator is a portable, wideband, RF source, what can you use it for? Well, a number of applications are obvious. Anytime you need a quick check to see if the RF and IF stages of an AM receiver are working, your calculator can provide a test signal. Probably its handiest use, though, is in continuity testing antennas and connecting cables. Auto antennas and their accompanying cables and connectors are easily tested for opens and shorts by bringing the calculator near the antenna while monitoring the radio output. Perhaps the ultimate example of this technique you can perform in your automobile. Place a calculator near the windshield antenna of a late model General Motors car. In cases of poor or non-existent reception, one or both of the two thin antenna wires imbedded inside the glass may be broken. By carefully tracing the path of each individual wire, a break or faulty connection can be located when the radio's output changes abruptly.

And one final thought. Those of you with LED digital watches might experiment with them. The power is much lower, and the metal watch case provides a lot of shielding, but there just might be enough RF coming from the display to be useful. ■

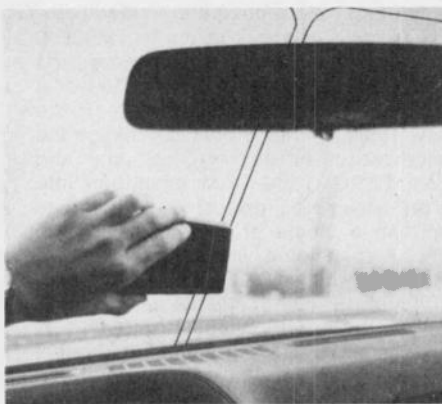

One of the many uses for your calculator other than calculating. Here it is being used to check a windshield antenna.

COMPUTER NEW PRODUCTS

Here in one place BUDGET ELECTRONICS presents the latest advances in the fast-moving field of home and hobby computers.



Touch-Switch Control Panels—American Microsystems, Inc., (AMI) offers single off-the-shelf microcircuit touch-switch (capacitance) control panels capable of handling up to 32 switching functions economically. AMI offers a TouchControl switching evaluation and demonstration kit (TCK 100) to product designers looking for fresh approaches to switching controls. The kit is available from AMI distributors for \$29.95; it consists of a pre-wired control panel, an AMI S9263 integrated circuit (permits up to 16 touch-switches) and an instruction package.

With the addition of some readily available standard components—LEDs, a transformer, and a few other standard parts—the unit is a stand-alone demonstrator of AMI's TouchControl switching. The kit can also be connected to products to demonstrate the technique. TouchControl switching offers ultra-reliability, improved styling, ease of cleaning, safety. The switches can be used on toys, games, electronic organs, computers, TV sets, appliances, power tools and thousands of other devices. Circle 65 on Reader Service Coupon for further information about this product and others marketed by this company.

Personal Computer Terminal—Heath Company's new line of computer kits includes this 12-inch CRT Terminal, Model H9, designed for personal computer use. It's an alphanumeric video system designed to accompany the firm's new H8 and H11 digital computers; however, it can be used with any available digital computer. The H9 utilizes a full 67 key ASCII keyboard with a 12-line, 80 character format on a 12-inch CRT. Other features include a format option of four columns of 12 lines, 20 characters wide, cursor control, a batch transmit feature, and a plot mode. Standard serial interfaces



include EIA, 20 mA loop and TTL input/output. The Baud rate is selectable from 110 to 9600. The mail order price of the H9 terminal, in kit form, is \$530. Circle 31 on Reader Service Coupon for information about this product and others in the Heath computer line. In addition, the company will furnish you with a copy of their newest catalog.

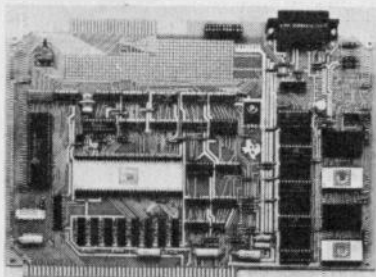

Low-Cost Microcomputer Modules—Texas Instruments is using its TMS9900 family of 16-bit microprocessors and peripheral circuits to enter the low-cost microcomputer module business. These new TM990 Series modules package the microprocessor unit, I/O circuits and both EPROM and RAM memories into a pre-assembled, pretested ready-to-use unit on a single printed circuit board. The first module available will be a TMS9900-based CPU, designated

TM990/100M, which includes a 1K x 16 bits of EPROM capacity and a self-contained software monitor (TIBUG). The 256 word by 16-bit Static RAM which is included is expandable to 512 x 16-bits. Sixteen lines of programmable parallel I/O and a selection of either a TTY current loop or an RS 232 terminal interface are available. The TM990/100M offers two programmable interval timers, 15 external hardware interrupts, and a blank board area and extra sockets for user prototyping. Price, including on-board memory: \$450. Circle 55 on Reader Service Coupon for more information about this product and others concerning micro-computer technology marketed by Texas Instruments.

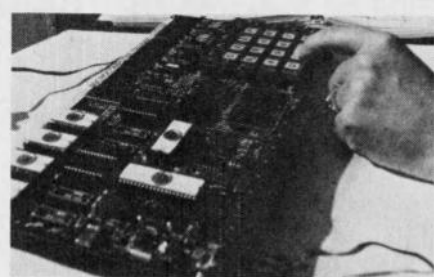

Self-Study Microcomputer Training—Integrated Computer Systems, Inc., offers a beginner-oriented, 8080A-based Self-Study Microcomputer Software/Hardware Training Course for \$545 (power supply optional). With a built-in keyboard and display, no expensive teletype or CRT terminal is required. You get all system hardware, software and information for learning to program and fully use an 8080-type microcomputer system. The 650-page workbook/text teaches 8080 instructions 1-by-1, programming, debugging and hardware interfacing through 33 hands-on exercises. The memory includes 512 bytes of CMOS RAM (maximum 1K on board) and 1K electrically erasable PROM. There are I/O ports for hardware experiments, cassette interface, and the like. Circle 62 on Reader Service Coupon.

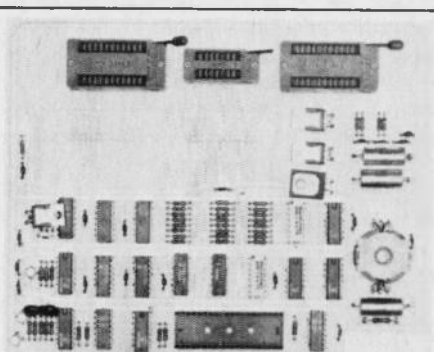

Programmer Boards for MCB Family—Zilog, Inc., expands its series of Z80-based microcomputer boards by adding three programmer boards that allow users to program EPROMs, PROMs, or a combination of the two memory types. The Z80-PPB/EPROM Programmer Board programs 24-pin EPROMs of the 2708 or 2704 variety. This board sells for \$475 in single quantities, with delivery in 30 days. The Z80-PPB/PROM Programmer Board, priced at \$475, programs 16- and 24-pin Harris PROMs of the 7620, 7621, 7640 or 7641 types. A composite of these two boards is the Z80-CPB/PROM Combination PROM/EPROM Programmer Board which allows users to program 2708/2704 EPROMs and Harris 7620, 7621, 7640 and 7641 type PROMs. The combination is priced at \$575. Circle 54.



CB NEW PRODUCTS



e/e puts together in one neat package some of the newest CB rigs, antennas and accessories for you to use in CB contacts this year!

AC Line Filter For CB

Designed to overcome the problem of infrequent but annoying television interference caused by transmission of the CB radio signal through AC power lines, the Avanti AV-820 AC line filter, installed at



CIRCLE 49 ON READER SERVICE COUPON

the CB transmitter or at the TV set, prevents the signal from entering the TV through the AC line. The unit plugs into a wall receptacle and has a receptacle for the TV or CB plug-in. Sells for \$19.95. Avanti Research & Development, Inc., 340 Stewart Avenue, Addison, IL 60101.

CB DC Power Supply

The Hickok Model 244 Mobil/Comm is a DC power supply designed for CB service application. It has a fully-adjustable voltage range of 10.5 to 14.5 volts and is accurately metered on large 2½-in. meter with the standard 13.8 volt setting clearly indicated. Full adjustability and 0.5% regulation permits duplication of actual storage-battery operating conditions such as low-voltage and over-voltage operation. Continuous-duty three ampere output is protected against short circuits by fold-back current limiting. During high current-load conditions, that may exist in malfunctioning transceivers, the power supply will not shut off, but will auto-



CIRCLE 52 ON READER SERVICE COUPON

matically reduce the current output to a relatively safe level so troubleshooting can continue with current flowing at a reduced level. Output connections to the Model 244 are convenient 5-way binding posts. The Hickok Model 244 Mobil/Comm Power Supply is available now at Hickok distributors for \$125.00. For further information on the Hickok Model 244 Mobil/Comm Power Supply or other Hickok equipment contact: Hickok Electrical Instrument Company, 10514 Dupont Avenue, Cleveland, OH 44108.

Computer-Controlled CB

Two new CB rigs—a new 40 channel single sideband/AM mobile CB radio and base station—by Texas Instruments are each controlled by two microcomputers or "computers-on-a-chip." All operating controls are in a small, lightweight handset for instant fingertip command. The handset also provides memory-stored and push-button selec-



CIRCLE 55 ON READER SERVICE COUPON

tive calling. TI mobile CB radio model SM-172 and base station model SB-173 introduce new dimensions to personal communications. Of handheld size, the control head comprises a keyboard for digital control; five-digit LED display that provides quick data response on channel and SSB mode selection; signal strength and standing wave ratio (SWR); a microphone and rocker switches for squelch, channel select, volume control and push-to-talk (PTT). A separate speaker is designed for under-the-dash mounting. The other microcomputer controls the transceiver by performing commands forwarded by the microcomputer in the control head. The transceiver can be mounted either in a trunk or under a seat to provide security. TI's exclusive selective calling system allows TI CBers to monitor pre-selected channels in total silence and lets them place and receive calls on these channels by predetermined personal selective call numbers. In the transmitter, automatic level control

(ALC)/compression constantly maintains near 100 percent modulation. Special processor circuitry in the transceiver automatically regulates input signals that may vary from a whisper to a shout. SSB transmitter output is always close to the maximum allowable 12 watts of peak envelope power (PEP) output, and AM is always near four watts. Computer monitoring of the SWR prevents transmitter damage caused by mismatched signals resulting from a faulty antenna, cable or connection. Each time PTT is activated, SWR is instantly checked. If the brain senses too high a SWR, it automatically shuts down the transmitter and dispatches the distress signal, "AAAAA," to the LED display and alerts the operator. Pushing the SWR key verifies the actual SWR causing transmitter "lockout." Augmenting these features is an automatic, antenna sampling noise blanker (NB) that detects such extraneous sounds as ignition noise and static and deletes them from the receiver output. In essence, TI's automatic noise blanking system serves as a second receiver since it receives noise, intercepts it and blanks it out. No loss of signal results and no manual ANL or NB switching is necessary. Suggested retail price for the mobile CB radio will be \$325.00 and \$375.00 for the base station. For more info, write to Texas Instruments, Inc., P.O. Box 5012, M/S 308 (Attn: SM-172, SB-173) Dallas, TX 75222.

New 40-Channel AM/SSB

Adding to its Citizen's Band radio line, Panasonic now offers the Model RJ-3700 40-channel mobile CB transceiver with SSB (single sideband) that adds upper and lower sideband capability to regular 40-channel operation. The RJ-3700 offers such features as an AM/LSB/USB mode selector and LED indicator, and a quick-release anti-theft reversible mounting bracket. Controls on the RJ-3700 include continuous RF gain, wide



CIRCLE 48 ON READER SERVICE COUPON

clarifier tuning, narrow clarifier tuning (separate), PA/Variable squelch control and noise blanker/ANL (Automatic noise limiter) switch. Other features include an illuminated S/RF power meter, AM modulation LED indicator, "On-the-air" LED transmission indicator, a 3-in. self-contained 8-ohm speaker and a dynamic microphone with push-to-talk switch. Model RJ-3700 has a 4 watt AM, 12 watt PEP SSB power output. Sells for \$299.95. Get all the facts direct from Panasonic, One Panasonic Way, Secaucus, NJ 07094. ■

Depression Reflexes

How radio listeners in the 1930s got more for less money.

by James Fred

□ One of the most interesting of the circuits used in the history of AM radio is the reflex circuit. Technical information about the different variations on this principle is difficult to obtain, but in this article a number of the most popular circuits have been brought together, and analyzed. Some of the circuits which will be discussed were used by deForest, Harkness, Erla, and other long vanished manufacturers of early receivers.

In most amplifier circuits a vacuum tube has only one duty to perform. When it is used as an audio frequency (AF) amplifier, it amplifies the audio frequencies after detection, and in a radio frequency (RF) amplifier it amplifies the radio frequencies before detection. Thus if 2 stages of RF amplification are desired, and 2 of AF amplification are desired, four tubes are needed in addition to the detector. In a reflex circuit with a crystal detector, all this is accomplished with 2 vacuum tubes, or if a tube detector is used, with 3 tubes.

One Tube Circuits. Two different reflex circuits are shown using only 1 tube. In the Acme reflex circuit shown the RF current flows from the antenna through the primary of the antenna coil to ground. RF is induced into the secondary winding which has C1, a variable condenser, across it which tunes in the station we want to listen to. R is used to prevent oscillation in the circuit. The RF current is impressed on the grid of the tube which controls the current flowing in the plate circuit of the tube. When the RF current flows through the primary winding P of the RF transformer T1 current is induced

into the secondary winding S. It does not proceed through the headphones because the impedance is too high. The RF current applied to the crystal D is rectified into pulsating direct current. C2 is a bypass for RF currents. The pulsating current then flows through the primary winding P of the AF transformer T2. A voltage is induced into the secondary winding S which flows through the antenna transformer secondary to the grid of the tube. The tube now greatly amplifies the audio frequencies. The AF flows through winding P and into the headphones which produce the sounds we can hear.

More Tubes. There were many variations of the one tube circuit such as that shown in the circuit diagram of the Harkness reflex receiver. There were also many reflex receivers built using three or four tubes. One of these was the Grimes Inverse Duplex set whose circuit is shown. There were problems associated with the reflex circuits such as uneven loading on the tubes, feedback due to magnetic coupling, and the amplification of power line noise and interference due to rotating machinery such as electric motors using brushes. The Grimes Inverse Duplex circuit is designed to overcome some of these problems. This circuit uses two tubes for amplification and one tube as a detector. These three tubes provide two stages of RF amplification and two stages of AF amplification. A crystal could have been used as a detector instead of a tube.

In the Grimes circuit shown the RF current flows through the tubes in the conventional way, through tubes 1, 2, and 3, in the following order. From the detector the AF is amplified first by tube 2, then tube 1, and then to the telephone receiver or headphones in the plate circuit of tube 1. In this circuit stability is increased, overloading of the tubes is reduced, and AF interference is reduced. The location of the by-pass capacitors allows the RF currents to return directly to the tube without going through the "B" battery or around the AF transformers. The set is simple to operate since there is one control for tuning, one for the vacuum tube filaments, and one for stability. Even though they were perfected, reflex circuits were abandoned in favor of neutrodyne and superhetrodyne receivers until the Great Depression of the 1930's forced set manufacturers to pro-

duce cheaper radio sets.

Multi-element Circuits. In an effort to cut the cost and the size of radio receivers multi-element tubes were developed. The circuit shown of the Kadette Jr., made by the International Kadette Radio Corp., of Ann Arbor, Michigan was one of the first AC-DC receivers made. In other words there was no power transformer and the tube filaments were connected in series much like the Christmas tree lights of that day. The line voltage was rectified to supply the radio B voltages. It was advertised as a "Pocket Portable" and the first advertisement I ever saw for this radio showed a man putting the Kadette Jr. into his overcoat pocket. The radio used 2 dual purpose tubes, one a 6F7 with 1 cathode, 2 plates and 4 grids. The cathode was common to all the elements. Actually the glass envelope contains two tubes: a pentode and a triode with a common cathode. Reading from bottom to top the elements are: triode plate, triode control grid, cathode, pentode control grid, pentode screen grid, suppressor grid and plate.

In this circuit the RF signal is fed to the pentode control grid by way of the antenna coil. Amplified it appears in the pentode plate circuit. The plate circuit contains a winding which links the pentode plate with the input of the audio output tube. At the same time the plate circuit is coupled to another tuned circuit through capacitor A-502-A. The RF signal finds it easy to pass through this capacitor to the grid leak capacitor part of the triode grid. This is the detector input circuit. The rectified signal then appears in the plate circuit of the triode and is fed to the control grid of the 6F7 pentode via the coupling capacitor A-339. The volume control, R137,

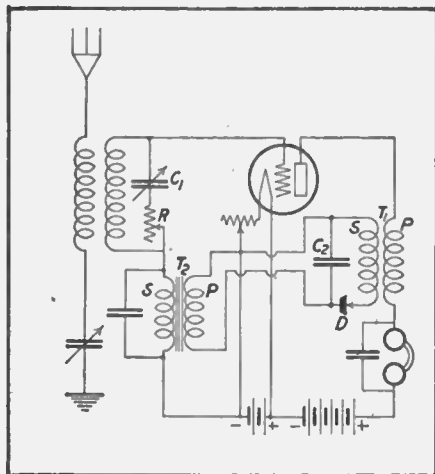

Circuit of the Acme Reflex receiver.

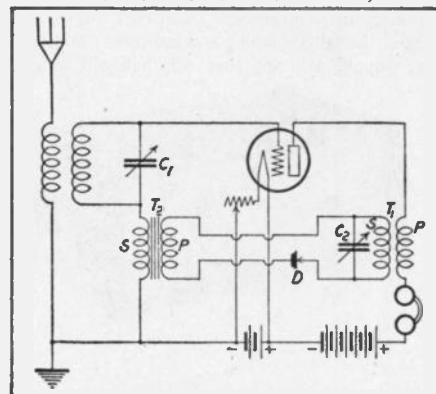

Circuit of the Harkness Reflex set.

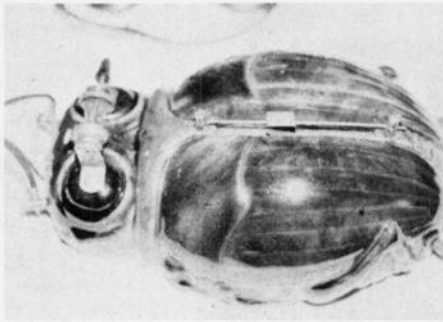

Photo by Frank Heathcote

One of the most unique crystal radios made. It is in the shape of a large beetle, and you can see the way in which the detector, binding posts, etc. are mounted.

is a variable resistor across the control grid to chassis.

The amplified AF signal again appears in the plate circuit of the pentode section, but in this case, its path is through the winding, through the capacitor A-338 and to the grid of the output tube control grid. The AF signal does not flow through capacitor A-502-A because its impedance at AF is very much greater than that of the winding.

Thus the 6F7 acts as an RF amplifier, detector, and as an AF amplifier. The 12A7 pentode section is the audio power amplifier, while the diode section rectifies the line voltage to supply the B voltages. This is in fact a TRF receiver with a grid leak detector, and one stage of AF amplification.

The "Mickey Mouse" Set. Another interesting receiver is the Emerson "Mickey Mouse," models 409, 410, 411, and 412. This receiver has a unique cabinet with a molded Mickey Mouse on the front of the cabinet. A 6F7 is used in circuit as a triode detector and a pentode AF amplifier. The AF signal appears at the plate of the triode section through the .002 uF capacitor. It is amplified and fed back to the grid of the type 38 audio output tube through the .004 uF capacitor.

One more example of reflexing in a 6B7 shows how, in the Emerson model 678, 4 functions are accomplished in one tube. The circuit shown provides IF (intermediate frequency) amplification, detection, delayed AVC (Automatic Volume Control) and AF ampli-

fication. The IF transformer feeds the IF signal into the pentode portion of the tube, and the amplified signal is transferred across the IF transformer to the upper diode plate. It is also fed to the lower diode plate via the .0005 uF capacitor. The AF signal is developed across the 200,000 ohm volume control potentiometer. The AF signal is then passed on to the control grid of the 6B7 pentode by way of the .01 uF capacitor and the IF transformer secondary. The amplified AF signal travels from the plate through the secondary of the IF transformer and then through the primary of the AF transformer. Note that in this circuit both the IF and AF signals are amplified by the same tube.

The final example of reflex action is in the Majestic chassis 500. The first IF tube, a 6F7S is used for both IF and AF amplification. You can trace the path of the signal into the first IF tube, into the 2nd IF transformer, and then into the control grid of the pentode. The amplified IF signal travels through the 3rd IF transformer and is detected in the diode section of the 6B7S. The AF signal is fed back to the control grid of the triode section of the 6F7S, and then to the grid of the audio output tube.

Further Reading. If you are interested in learning more about the way old radios work, it is best to start at the beginning, with the first of the consumer receivers, the old crystal sets. There is a book titled *Vintage Crystal Sets*, by Gordon Bussey, covering 1922 to 1927.

Mr. Bussey's aim in publishing this book was to create a reference book for the collector of crystal radio receivers. Even though many of its photos are of English made sets it will add to the knowledge of all radio collectors. There are over 50 photos of crystal radios plus many reprints of old advertisements for crystal sets. Some will remind you of similar sets made in the United States. There is also a long list of manufacturers of crystal radios with their trade

(Continued on page 102)

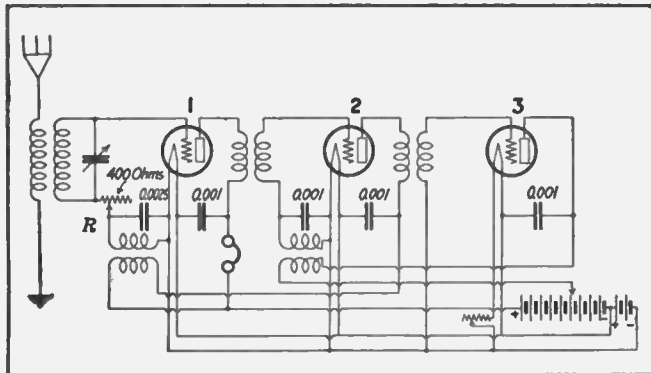

Circuit of the Grimes Inverse Duplex receiver, which uses three tubes to overcome problems of feedback, power line noise, and interference from electric motors.

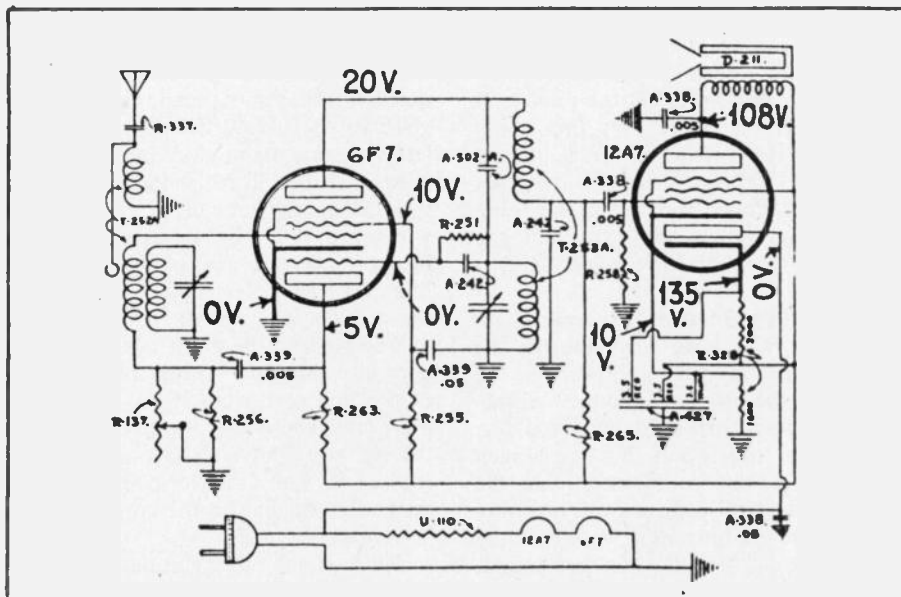

The Kadette, Jr. was one of the first AC-DC receivers made. The tube filaments are in series.

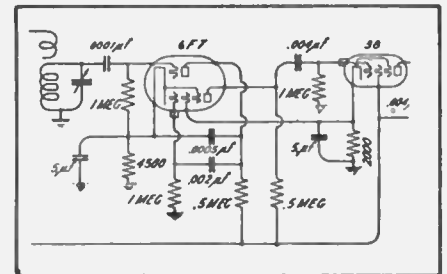

The Emerson "Mickey Mouse" receiver circuit, using a 6F7 as detector and AF amplifier tube simultaneously.

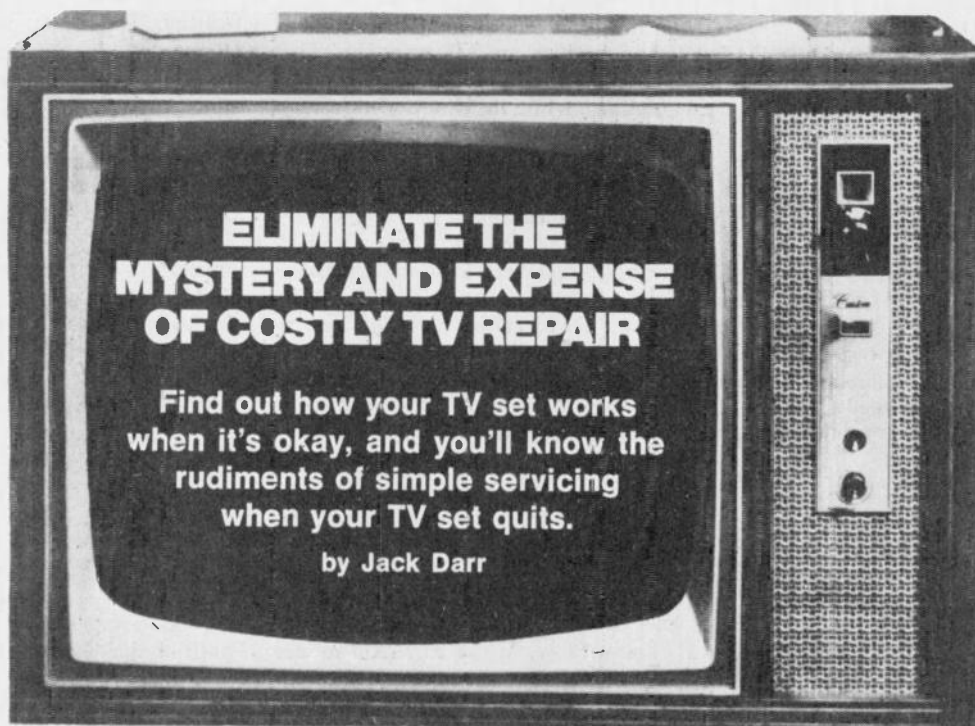

EVERY PROFESSIONAL television technician knows that a certain percentage of his service calls are going to be "nuisance calls." There won't be any *real* trouble with the TV set. It will be the simple things: set not plugged in, antenna lead-in unhooked, controls not set properly, and so on. The technicians call these "nuisance" calls because they really are to him. He doesn't like to have to charge you for a service call, but he has to; it costs him money to make it.

If you know how your TV set works, and how to check for the simple things, you can save yourself a lot of time and money. So we'll tell you about all of the nuisance-things, and how to find them yourself. It's easy. We will also tell you how to know when you *should* call a technician; you'll see, hear, and *smell* things that mean trouble. Besides these, we'll tell you several things that you should *not* do, to keep from doing further damage to the TV set. This will be confined to tube and hybrid type TV sets, for the solid-state TV sets can't be serviced by anyone but a pro. However, a whole lot of these tests will apply to all types.

Using the Controls. A lot of this will deal with the various controls on the TV set. We'll tell you how to check these controls for proper operation. You can use these tests to tell whether the set is working or not. In many cases, these controls will have been set wrongly, either by accident or by someone who didn't know how to set them. (Small-type kid brothers are very good at this; for the women's libbers, so are

small-type kid sisters!) So we'll tell you how to set them. If you know what each of these controls is supposed to do, you can tell whether the trouble is a simple misadjustment or some real problem in the set. We'll also tell you about the ones you must *not* adjust. Fiddling with these can mean that you will have to have a service call. There are also some conditions that mean "turn it off quick." If the set is left on when these things happen, it can cause more damage, and make the bill higher. We'll get to these later on.

Power. If the complaint is, "The set doesn't light up at all," the first thing to check is the AC line cord. Be sure it's plugged in. Cleaning around the back of the set can accidentally pull the line plug. If the screen of the set doesn't light up, check to see that the pilot light (if any) is on. If it isn't this, could mean that there is no power at all getting to the set. Peep in through the holes in the back cover and see if the tubes are lighting up. If they are, but the pilot light isn't on, the pilot light is burned out.

No Light on Screen. If the pilot light is on, but you have no light on the screen, you are getting power to the set. Check the brightness control. Someone may have turned it down too far. If you hear the sound, but the screen doesn't light, this could mean that the brightness control is turned off, or something more serious. Here is one of the main "no-nos." If you can get sound, but the screen refuses to light up at all, turn it off *quick*. Leaving a TV set on in this condition can cause quite a bit of

extra damage to tubes and parts, in certain conditions. There is one thing you can check: Look on the back of the set for a small red shaft coming out of the chassis, usually near the place where the line cord goes in. This is the circuit breaker. Push this in, and see if this brings back the light on the screen. If so, and it stays on, OK. However, if you push this and the set lights up but goes out in about one minute or less, *don't* push it again. You have some kind of short-circuit in the set, and it will need a service call. Repeated setting of the breaker can cause more unnecessary damage.

TV Set Goes Off and On. If the picture, sound, and pilot light go off and on at irregular intervals, check the line cord and the AC outlet. If everything quits at the same time, this is a very good suspect. Hold the plug in the outlet with one hand and move the line cord back and forth with the other. If this makes the set cut in and out, the wires are probably broken inside the insulation. Get a new plug, and cut the line cord at a point about 3 inches from the original plug. Most of these breaks will be right at the point where the wire goes into the plug. Check the other end of the line cord, too. If the break is at the point where the line cord goes into the set, you'll have to have a technician replace it. The "interlock" plug on the set end is molded on the cord and can't be replaced.

There is one other common cause for this. Check to see if the plug fits tightly into the outlet. When you push it in, you should feel a good deal of friction.

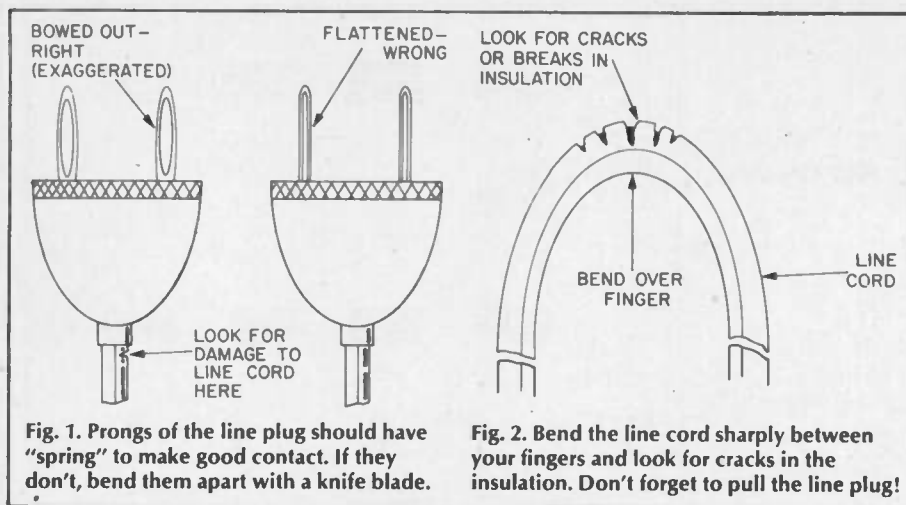

Fig. 1. Prongs of the line plug should have "spring" to make good contact. If they don't, bend them apart with a knife blade.

Fig. 2. Bend the line cord sharply between your fingers and look for cracks in the insulation. Don't forget to pull the line plug!

If it slips in easily it can fall out just as easily. Check the prongs of the plug. Many of these are "doubled" to give a spring action to make good contact. If they're flattened out, push the tip of a knife blade between them, to give them more "spring." Fig. 1 shows how to do this. If the plug is still very loose in the outlet after you do this, the outlet itself is worn out and will have to be replaced. Try the plug of a lamp in the same outlet to find out if it will light up.

Check that Line Cord! While you're working on the line cord, check its condition very carefully. You've probably heard of the alarming number of "fires caused by TV sets" in the media. This is exaggerated very badly, but it is quite possible for a bad line cord to cause a fire. These are almost always near curtains and other flammable materials, so if they should short, it's easy to start a fire. This is due to deterioration of the insulation of the cord. Pull the plug, and look it over very carefully.

The insulation should be smooth and "live." Bend the cord sharply between your fingers, and check it right at the bend. If the insulation has aged, you'll see fine cracks, or perhaps even breaks, exposing the wires. A line cord which has these conditions must be replaced at once. *Don't* tape it up and leave it; get a new one. Fig. 2 shows how this looks.

Bad Pictures. Now let's look at some of the troubles that you can have. If you do have a picture and sound, but they're not as good as they should be (Fig. 3), there are several simple things which can cause this. There are several of these which can fake troubles inside the set, and cause you to call a technician. Let's see about the ones you can check out.

One of these is too much snow in the picture. The sound may be all right, or it may have a blowing or roaring sound if the picture is very weak. This can be caused by trouble in the TV antenna or

the lead-in. Whether you have an outside antenna, rabbit-ears, or a cable, check the connections on the back of the set. The lead-in connects to two small screws on an insulating panel, usually near the top of the set. If one of the wires is off, you'll get snow. Be sure that the wires are tightly held under the screws. If you have one of the "quick disconnect" antenna connectors, called "clothespins," be sure that this hasn't slipped off. The screws should be loosened about two turns so the clothespin can get a grip on them. Most sets now have two sets of antenna connectors, one for VHF and the other for UHF. If the antenna lead-in is fastened to the UHF terminals, and your stations are all VHF, you'll get very bad pictures.

If you have an outside antenna, the lead-in may have broken on one side, due to the constant flexing from the wind. The lead-in is usually a flat ribbon type of wire called "300-ohm twin-lead." It is quite possible for one side of this wire to break, inside the insulation. The fastest way to check this is with an ohmmeter. Take the lead-in off the TV set, and check between the two wires. This should be a complete DC circuit, from one wire up through the antenna and back down the other. You should see about 5-6 ohms in the average lead-in antenna combination. For the rabbit-ears antennas, you may see continuity from one side of the lead-in to the other, or you may not. If you don't, check from each wire to one arm of the antenna; one wire will go to each one.

If you do find the lead-in open, you'll have to lower the antenna and put on a new lead-in. The plastic insulation of the lead-in will deteriorate after a few years of sunlight, and a new line will often improve reception noticeably. Most antennas can be lowered without too much trouble, or reached from a ladder. You should have a lightning



Fig. 3. Snow in the picture. Weak signal. This may indicate antenna trouble.

arrester installed right at the place where the lead-in goes into the house. Take the lead-in off this and check it. If it has been hit by lightning, the arrester itself may be damaged, and shorting out. You should read a completely open circuit across the two terminals of the arrester.

The final test for antenna trouble is to try another TV set on it. If this set too shows too much snow, then you can be pretty sure that the antenna itself is the problem. If the test set shows a good clean picture, then it's time to take the first one to a shop; it has a weak tube or some kind of trouble in the tuner. Make all of the other tests first, of course.

Scrambled Pictures. If you can see that there is a good strong picture signal present, but it's what many people call "scrambled," you have a "sync problem." Every TV set has two controls to hold the picture in place, or "in synchronization" (and from now on it's "sync" for short). Strangely enough, we call these the "hold" controls. One holds the picture vertically, and the other horizontally. In the older sets, these controls will be at the bottom of the front panel; in portables, they may be on the side; and in some sets, on the back apron of the chassis (Fig. 4). They'll be marked "H(orizontal) Hold" or "V(ertical) Hold."

The Vertical Hold Control. The best way of learning how these controls work is to try them out on a set that is in good shape. The vertical hold control, turned one way, should make the picture roll downward. At first, it'll roll slowly, and as you turn the control farther, it'll go faster. Turn the control back to the center, and stop the picture. Now go the other way. Normally, turning this way, the picture should stay locked in until you reach a certain point, and then break out, going upward pretty fast. Technicians usually say "rolling" for a picture moving down, and "flipping" for one that's moving up. Remember how these control-reactions work; we're going to use

ELIMINATE COSTLY TV REPAIRS

them in a minute.

If the vertical hold control is turned away too far in either direction, the picture may be moving so fast that you can see two pictures at once; there will usually be quite a lot of flickering. Now check: Move the hold control very slowly from one end to the other. At some point near the center of rotation, the picture should slow down, then stop and lock, if the set is working all right. Now, here are a few abnormal reactions that mean you must call a technician: One, if you can not make the picture even slow down in its rolling or flipping by turning the vertical hold control. Two, if you can make the picture stop, but it will not lock; it floats up and down. Try this before sending the set to the shop: Roll the picture down very slowly by setting the vertical hold control. Watch the horizontal black bar across the picture. This is the "vertical blanking bar" between each picture. When this bar reaches a point about 2 inches from the bottom of the screen, the picture should suddenly "snap" into hold, even if only for a second. However, if the bar floats smoothly on down without even pausing, or if you can turn the vertical hold control in the other direction and make the picture move *up* very slowly, you have a sync problem. This means a trip to the shop.

Here are a couple of no-nos: On the back of the set you will see two controls marked "V Size" (or "V Height") and "Vert Lin"(earity). Leave these alone. If you get these adjusted so that the picture is *stretched* too far, you can cause a fake sync problem, and an unnecessary trip to the shop.

The Horizontal Hold. Now we come to the control which will show a different reaction. When the picture is rolling vertically, it's easy to see that there is a picture there. However, if the picture is out of sync horizontally, you get an entirely different pattern. Remember that the picture is still being scanned vertically. So if the horizontal hold is out of adjustment, you'll see a pattern that looks like Fig. 5. You won't be able to see a picture at all—nothing but a series of slanting lines. (The fact that there *are* thick, black lines on the screen shows that you *do* have a picture, but it's out of sync horizontally.) These lines may slant from upper right to lower left, depending on which way the horizontal sync is off. If you have only 2 or 3 horizontal lines, you may be

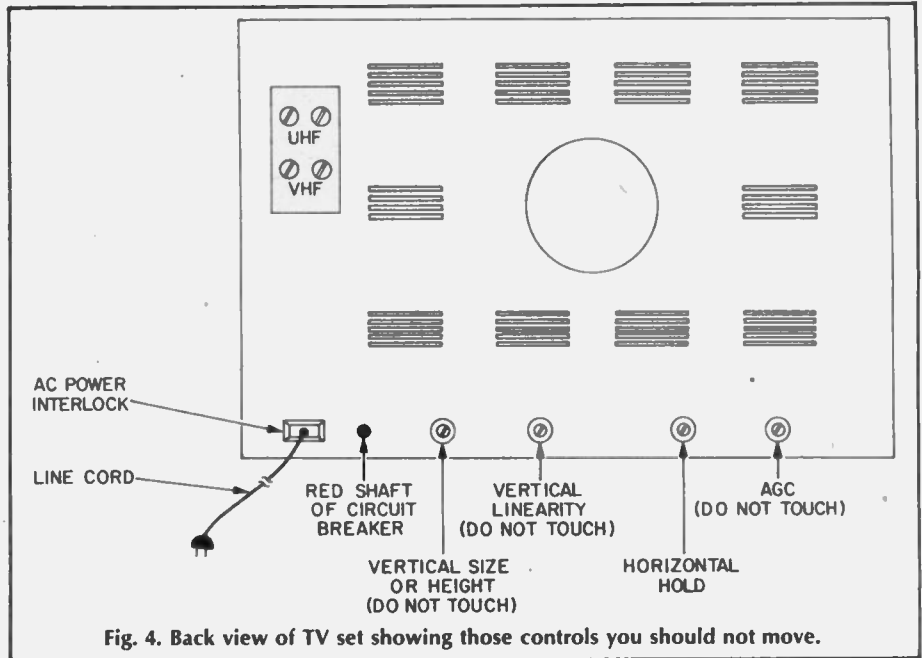

Fig. 4. Back view of TV set showing those controls you should not move.

able to see a distorted picture in there. This means that the horizontal hold control isn't too far off. However, if you see 8 or 10 slanting lines, the hold control is quite a bit off the right setting. The more lines you see, the farther it's off, and the less they'll slant. In some cases they may even look as if they are actually horizontal, but they're not.

To clear this up, turn the horizontal hold control very slowly, watching the screen. If the horizontal hold control is on the back of the set, prop up a mirror in front of the set so that you can check the screen. When you move the hold control, you'll see the lines change. If you get *more* and thinner lines, you're turning the wrong way. Back up, and you'll see the lines get thicker, more slanting, and fewer. This is right. Keep on turning slowly and you should find a point where the picture will straighten up and lock in.

Now, turn the horizontal hold control just a little bit more. To check for correct operation of this control, turn the channel selector to another station, or to a dead channel, then back to one with a picture. If you have it set just right, the picture will snap in, firmly locked. If you see it break up into slanting lines for a second or two and then lock in, it's not quite right yet. Adjust the horizontal hold control just a little bit and repeat the channel-change test. If it's worse this time, you went the wrong way. Turn it just a wee bit in the other direction and repeat. Keep on until you see the picture snap in, tightly locked.

Finding Troubles. Now then: If you can't get the picture to lock in by adjusting the horizontal hold control, but

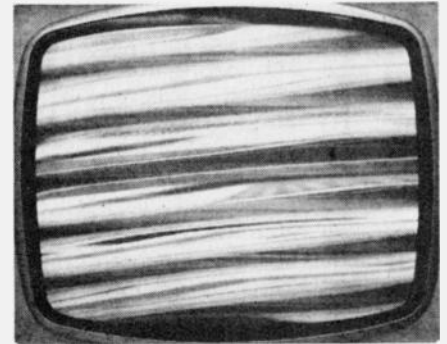

Fig. 5. Slanting lines are a sure sign of horizontal trouble. You may not see a partial picture, just light and dark lines.

it "sits up" for a split second and then falls out slanting the other way, there is trouble in the set. In a lot of these, if you carefully "fiddle" the horizontal hold control, you can make the picture straighten up; it will float off sideways, or fall out of sync again whenever there is a change in the program. This means a trip to the TV shop. All horizontal hold controls should have a "hold range" of about one half of a turn at least before the picture starts to be unstable.

There are two common types of horizontal hold controls. One is a variable resistor like a volume control. These will have a range rotation of about 320 degrees. Normally, you won't be able to get the picture very far out of sync with this type. The other type is actually the adjustable core of a coil. (The horizontal oscillator coil.) This type *should* have a special knob with an "ear" on it, so that it can't be turned more than 320 degrees. How-

(Continued on page 98)

CB BATTERY CHARGER SAVES \$\$\$

Low-cost project charges inexpensive nickel-cadmium cells to keep you on the air for pennies an hour.

by Herb Friedman W2ZLF



□ If you're a typical user of one of those high-power hand-held CB walkie-talkies rated between 3- and 5-watts input, you know that batteries don't come cheap. And if the cost of the batteries doesn't get you, their leakage will. Leave the power switch on overnight by accident and it's a good bet by next morning the hand-held set will be dripping battery *gook*.

But there is a way to beat the problems of high battery upkeep and leakage, and also to insure maximum RF output at the same time. The answer? Switch to nickel-cadmium (NiCad) penlight batteries (AA size). Are they expensive? Not any more. A NiCad should cost about the price of two alkaline batteries, or even less, and the NiCad can be recharged hundreds, possibly a thousand times. If you use a hand-held transceiver you'll break even

on the second or third recharge.

Hold on, don't go running to the parts catalog to look up the price of NiCads, you probably can't afford them at catalog prices. What you need is a surplus dealer. You see, today everyone is in a hurry and most people can't wait the usual overnight period to recharge NiCads—they demand a *fast-charge* battery. So hundreds of thousands of the overnight (or *trickle charge*) NiCads were dumped on the surplus market, and you can buy them for as little as a buck a piece, no higher than \$1.50. And you get a tremendous advantage with the trickle-charge NiCads: they hold their charge much longer than the fast-charge type. Charge 'em up, stash the transceiver in the closet, or the trunk of your car, and a week or two later they will deliver almost full power. Fast charge NiCads

can't hold a charge that long.

You Can Refrigerate 'Em. Speaking of car trunks, if you leave a hand-held CB set in the trunk and the temperature plunges down near freezing ordinary penlight batteries aren't going to deliver much operating time. But NiCads will still be going like gangbusters in cold weather long after standard batteries are too pooped to pop.

Can your hand-held use NiCads? Simply look inside to tell. If your hand-held uses penlight (AA) size batteries there is probably room for twelve cells though only ten are used; a filler takes up the space of two cells. Since the standard battery delivers voltage of 1.5,

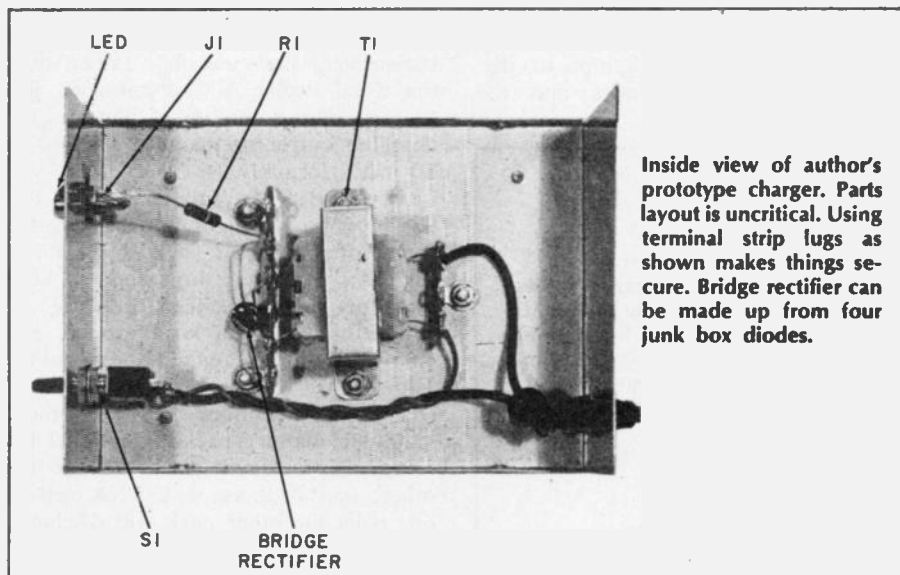

Inside view of author's prototype charger. Parts layout is uncritical. Using terminal strip lugs as shown makes things secure. Bridge rectifier can be made up from four junk box diodes.

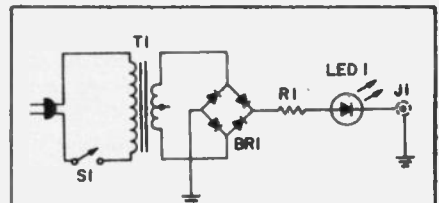

Bridge rectifier with low-cost diodes.

PARTS LIST FOR CB-BATTERY CHARGER

- R1—220-ohm, ½-watt resistor
- T1—24-28-VAC power transformer rated 100 mA.
- BR1—Bridge rectifier, 50 PIV, 100 mA.
- LED1—50 mA.
- J1—Phono jack (Radio Shack 274-1575 or equiv. Includes PL1, below.)
- PL1—Phono plug (see J1, above)
- PL2—Plug to match transceiver power input receptacle
- S1—Switch, SPST
- Misc.—Cabinet, terminal strips, wire, solder, etc.

ten batteries equals a fresh power pack of 15 VDC. But NiCads only deliver 1.2 volts, so twelve batteries are required to produce 15 VDC. The two "extra" NiCads fit in place of the filler. So in order to use NiCads your set must provide room for twelve, rather than ten cells. There must also be a jack on the side of the transceiver to which a charger can be connected. If you have both these conditions (space for twelve cells, and a charger jack) you can use NiCads. The only exception to this rule is a few models which cannot accept NiCads because some NiCads are very slightly longer than a standard penlight AA battery, or the CB set manufacturer did not allow for the extra size even though he provided a charger connection. Make certain your hand-held set will accept NiCads before you buy them.

Really Low-Cost. Finally, you need a NiCad charger, and that's where you can spend real money, but really! One of the top instrument companies charges \$30 for a NiCad charger you can build for less than \$8. They get this exorbitant price because they manufacture one of the very few chargers that can handle all twelve batteries at the same time. Most chargers handle only four to eight cells at a time, taking two to three days to recharge a complete set of NiCads. If you can recharge all twelve cells at once you plug it in in the evening, and you're ready to go the following morning.

The diagram shows a simple but effective charger circuit that will handle up to twelve cells simultaneously. It needs no regulation or control because it trickle-charges any type of NiCad. You can even leave it plugged in continuously without fear of damage to the cells, thereby insuring the NiCads are always in a state of full charge. The charging current is 40 to 50mA regardless of the number of cells (in case some become defective), or their state

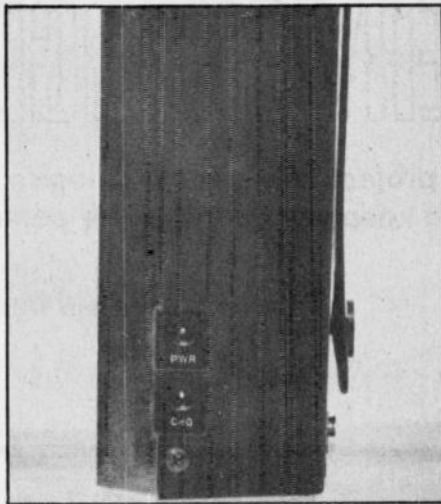

Side view of author's CB transceiver shows two inputs, one for charging internally-contained Nicad batteries.

of discharge. From full-discharged to fully-charged the charging current is always a safe 40 to 50mA.

Use These Parts. Excepting the cabinet, if you select surplus components the whole thing will cost less than \$8. If you buy all new, you'll run up unnecessary expense, which have no effect bearing on the performance.

Transformer T1 is 24-to-28 VDC at no less than 100 mA. It doesn't have to be more than 100 mA. Don't waste your money on a high current filament transformer. If you use a 28-volt transformer increase R1's value to 270 ohms. BR1 is a 50 PIV bridge rectifier rated 100 mA or better. Use the least expensive type you can get. If you have four discrete silicon diodes lying about simply connect them as the bridge circuit.

LED 1 serves as both a pilot light and Charge indicator. If the LED doesn't light the batteries aren't being charged. The LED also serves as a fuse. If the rectifier and R1 short out the NiCads will attempt to discharge through the diodes and the

high discharge current could cause considerable damage. But the LED will burn up almost instantly, thereby opening the circuit to the batteries.

The LED is the only critical component, in the sense you must be certain it is rated for a *maximum* of at least 50 mA. We suggest a diffused LED be used as its light can be seen from the sides. If possible, use a Radio Shack 276-026 for LED 1.

To mount the LED simply push it through a hole in the front panel of whatever you use for the cabinet. If you connect R1 between the LED and a terminal strip as shown in the photographs the LED will be held in position without need for glue or a lamp mounting kit. The cabinet can be plastic or metal; the one shown in the photographs is Radio Shack 270-252.

How To Connect It. The charger's output is through phono jack J1 rather than a direct cable. In this way different patch cords can be connected to accommodate the several styles of plugs required for transceivers charging jacks. Just make certain you get the charger plug polarity correct. Before PL2 is wired, insert it in the transceiver's charging jack and measure the voltage across the jack noting the plug's polarity. Normally the shield is ground (-) and the tip (center conductor) is positive, but it can sometimes be the other way round. Make certain the charger's positive output connects to PL2's positive terminal. You can damage the NiCads badly if you get it reversed.

Note that most transceivers are disconnected when the charger plug is inserted, so don't expect to operate the transceiver while charging the batteries.

Using The Charger. Resistor R1 limits the charger's output to 40-50 mA even if the output jack is shorted, so the charger can be used with hand-held transceivers that use ten, rather than the usual twelve NiCad batteries. Regardless of the number of batteries the charging current remains a safe 40 to 50 mA. Normally 14 to 16 hours will be required for a full charge, so this can be done overnight. If you want the batteries maintained fully charged and ready for use at any time you can keep them on continuous-trickle charge.

The only caution is not to try and charge two or more hand-helds at the same time. Don't make up a "Y" adaptor that connects two or more hand-held battery packs in parallel because one pack will discharge into the other, and if there is a weak cell in one pack the other pack will discharge with excessive output current. Charge only one set at a time. ■

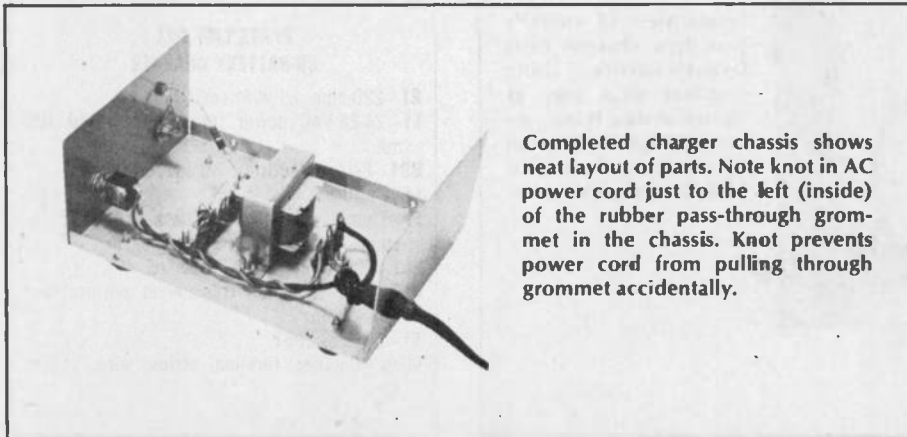

Completed charger chassis shows neat layout of parts. Note knot in AC power cord just to the left (inside) of the rubber pass-through grommet in the chassis. Knot prevents power cord from pulling through grommet accidentally.

Put NEW LIFE Into That OLD CAR RADIO

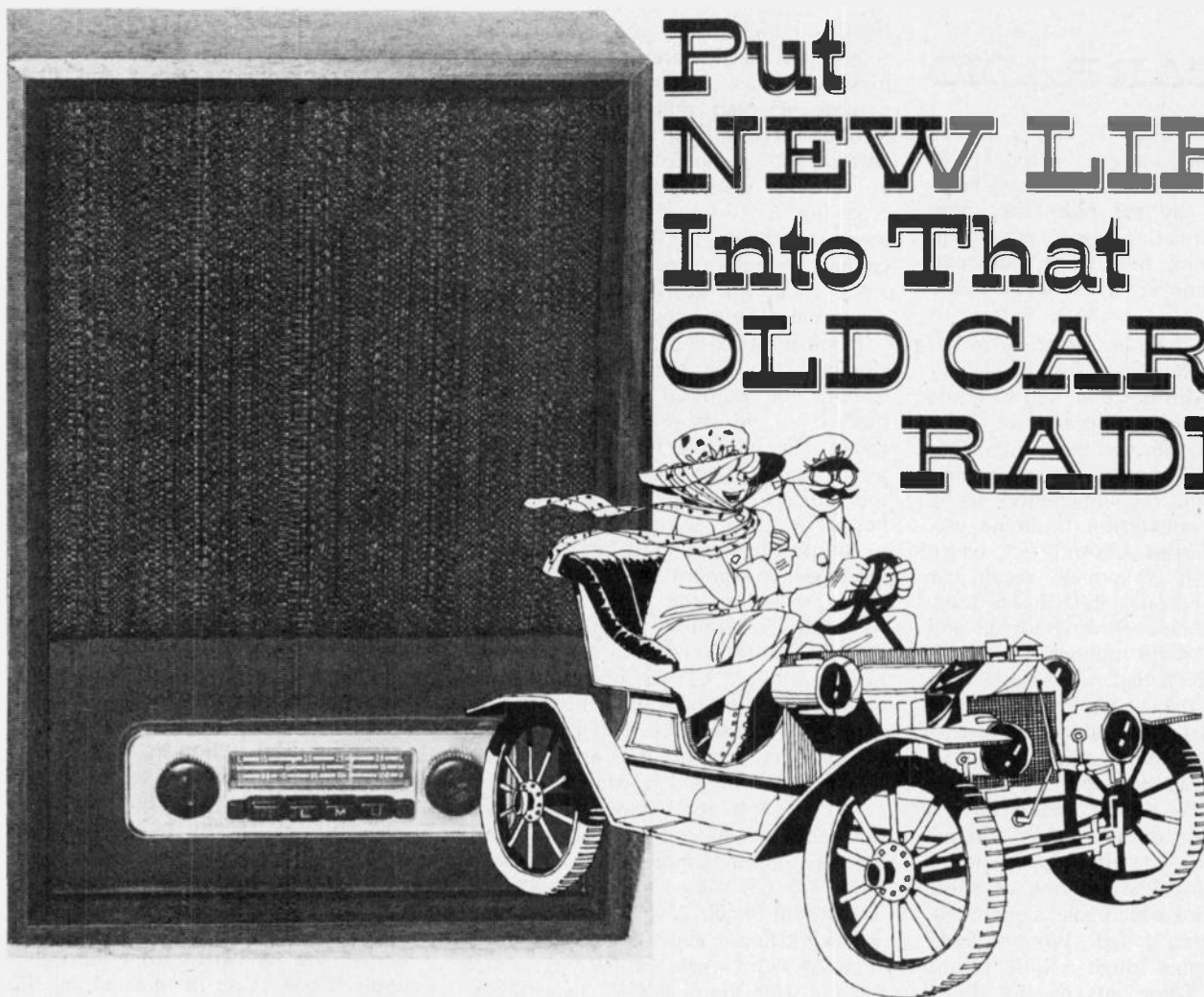

Those worthless used-car radios can become high-quality home receivers for pennies in parts.

by Gary McClellan

□ For years now Americans have bought 10 million or so new cars every year, and most of those cars have radios in them when new. As a result millions of used cars are sold by their original owners each year. Now the price a car dealer will pay, or allow you on a used car is a combination of the so-called "book" value, which he gets from a little blue book, and of the bargaining. He doesn't care whether your used car has a radio or not, and many people, knowing this, take out the car radio before trading in the old bus on a new one. The result is that there are hundreds of thousands of used car radios lying around in garages, attics and cellar storehouses, waiting to be thrown out some year in the annual spring cleaning.

Most of these radios are perfectly good, but won't be used because it's usually too much trouble to install them in a car other than the one they were

originally set up for.

But there's no reason such sets can't be put to work as house radios, especially since they will almost always work better than most table model radios, and even most console sets you can buy today. Their tone is as good or better than most home sets—obviously we're not comparing them with high fidelity component sets, which cost many times more than regular table or console radios. Their selectivity and sensitivity is also better than that of most home sets because they have an RF (radio frequency) amplifier stage ahead of the converter stage, and most home sets don't bother with an RF amplifier stage which car sets need.

Going for AM DX? DX fans can have a ball with converted car radios. The sensitivity and selectivity of most car sets, when combined with a good outside antenna can get you AM stations from all over the country. Here in Cali-

fornia I've been able to get stations like KOMA, Oklahoma City, WLS Chicago, and many others regularly, at night. For more on AM DXing see **ELEMENTARY ELECTRONICS** Sept./Oct. 1976 "The Secrets of Split-Frequency DX." White's Radio Log, regularly published in our sister publication, **COMMUNICATIONS WORLD**, is an excellent source of info on the super DXing you can do on AM radio.

Car Radios Are Better. The typical car radio was built to perform in one of the toughest environments—your car. The set has to work with a ridiculously small antenna, and yet get distant stations. It also must have enough volume to overcome road noise and tone quality to offset the shortcomings of the small, poorly baffled speakers found in most cars. And to top it off, the car radio must perform well over a wide temperature range.

Conversion is easy and inexpensive.

OLD CAR RADIO

All you have to do is add a power supply, antenna, and a good speaker to a car set and you are in business! So, if you have an old car radio, or know where you can get one, don't pass it up. You won't know how good radio can be until you convert a car set to home use.

First Get Your Radio. What car radios are best for conversion? Just about any old car radio can be converted to home use, provided it's a *transistor set*. Tube sets will be too old, and more important to us, they use much too much current (to heat up the tube filaments) to be practical for conversion to home use.

You can use an AM-only set, or an FM/AM set. If it's a really recent car radio it may be one which has a four- or eight-track tape player built in, and with a stereo radio section. If it has a tape player you'll have to use a heavier power supply than if it's just a radio receiver, but that's the only other restrictions (besides no tube sets).

Of course the car radio should be a 12-volt unit. 6-volt car radios haven't been made for quite a while, though it's possible you might happen across one. And don't convert one of those fancy car radios which has "signal seeking" (sometimes called "Wonder Bar," because you just touch a little bar to activate it). These sets have a motor inside the set to drive the tuning mechanism and the tuning dial. The motor draws several amperes of current, and would require a heavy power supply costing much too much. In addition, these automatic-tuning units are likely to get out of whack, and they're not easy to repair. In fact many car radios have been consigned to the junk box just because the auto tune failed and it was too expensive to repair.

And another thing. Try to use a radio which has all its knobs and the dial plate. It'll save you the trouble of scrounging around to find matching knobs and a dial escutcheon plate later. However, if you happen to already have a good car radio—for example, one with separate bass and treble tone controls, don't let the absence of knobs

hold you back. They *are* available at some specialized stores. And you *can* make up a new escutcheon plate from a piece of scrap aluminum.

Check It Out First. Before you convert the car radio to home operation, be sure it's working OK, or is worth repairing. To do this make up an antenna as shown in the diagram, and connect it and a speaker (just about any speaker will do) and a power supply to the radio as shown.

Hook up a 12-volt battery or battery eliminator to the radio, being careful to hook the positive (red) side, usually marked +, to the "hot" lead of the radio. The negative (ground, or common) nearly always goes to the case of the radio. Check the markings first to be sure.

Adjust the antenna trimmer capacitor to get maximum sensitivity. This is done by setting the tuning dial to a weak station around the high end of the dial (1400 kHz is ideal) and adjusting trimmer C2 for maximum volume. The setting of C2 will be different when you connect the final antenna to the set, later. Measure the current drawn by the radio. Most solid state sets draw ½ amp or less—if it draws much more than this we suggest you use a commercial power supply such as those made for CB radios and tape players. The Radio Shack 22-127 power supply will work fine in most cases. Make sure that the radio works properly. Clean it off and wipe the dial glass clean. Spray

the volume/tone controls with a good control cleaner, and remove the dial lamp. This will save power and allow the power supply to run cooler.

Making the Conversion. Start by building the power supply shown unless you buy one. If you use the commercial power pack mentioned, skip this section. I built my supply on a 4-in. x 3½-in. piece of U-shaped aluminum. The components, with the exception of transformer T1 are all mounted on the sides of the "U", which are about 1½-in. high. You can build yours in the same way, or mount the parts in a commercial chassis instead. Or you can mount the power supply on the top or back of the radio. But just be sure if you do this that you can install the radio in a cabinet. Install the components and wire them up, being careful of the connections of IC1, a voltage regulator. The case is ground so you don't have to isolate the case from the chassis. When you complete the component wiring, add leads at least three feet long so that the power supply may be easily attached to the radio.

You have an option at this point as to how you connect the AC power switch. You may use a separate unit as I did with the second radio shown, or open up the set and use the existing switch. If you choose this method, be sure to carefully remove the existing wires and solder them together. Then connect the AC wires from the power supply. Connect up the ground and 12-volt positive wires to complete the job. Check the radio out again with speaker and antenna. If all's well, install the radio.

Selecting a Loudspeaker. You can generally use any of a wide variety of loudspeakers with a car radio. The smaller speakers supplied with car sets are four or five inches in diameter, while the better ones, which usually have much better tone, are oval-shaped units either 4-in. x 6-in., or 6-in. x 9-in.

You can use one of these, if the impedance is correct, or you can go to a small high fidelity speaker for even better tone. First you should carefully examine the radio to see if it uses a special-impedance speaker. For many years most car sets used 3.2-ohm speakers. This is the nominal value if there

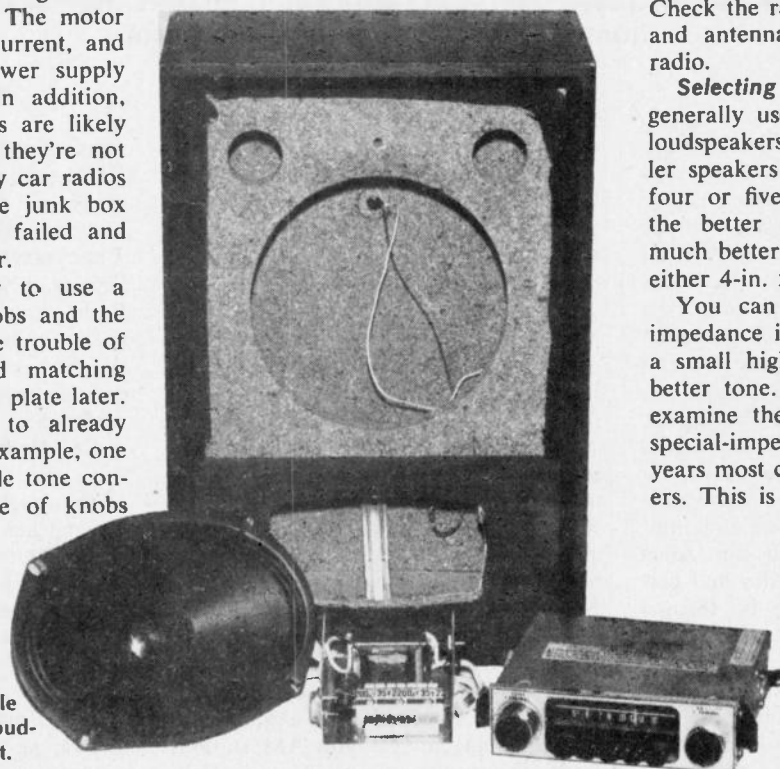

Car radios may be converted for home use using any convenient enclosure, a simple power supply, a better loudspeaker, as shown at the right.

is no special indication. Many of today's sets use higher impedances, however, such as 10, 20, or even 40 ohms. If the set you're converting is so marked, you can use one of the Radio Shack multi-impedance speakers listed in the Parts List. If it's not specially marked, use any speaker of 3.2, 4, or 8 ohms. Choose the largest speaker, with the heaviest magnet (and costing the most, generally) for the best tone.

Installation. This is where you get to exercise your creative talents. There are many different places you can mount your converted car radio. You can go my route and install it in a speaker cabinet. This worked great because reject cabinets were available from a local speaker company for \$1.00 each. I installed both radios in reject cabinets. I bought speakers to match the cut-outs (8 inches in both cases). Then I added grille cloth to cover the speaker

area and installed it. If you do this you will find the going very easy as most of the work has been done for you by the cabinet manufacturer.

Some other places you can put your radio are in a room divider or end table. Or how about the wall in your kitchen? What about under a shelf in a cabinet? The choice is up to you. If you have room for the radio only, you can locate the speaker somewhere else.

Operation. After you have installed the radio, power supply, and speaker, connect the antenna. Place C2 in a convenient spot where you can get at it. Then turn on the radio and tune in a weak station around 1400 KHz on the dial. Adjust C2 for maximum volume. The antenna lead may be stapled around the back of the cabinet. If you've converted an AM/FM set you might wind several turns of the antenna around the AC cord for better reception. The lead

may also have to be carefully positioned for best results on FM. This was necessary for the two radios that are seen here. That's all there's to it! Sit back and enjoy your new radio. You'll be amazed at the performance; it will far outstrip the radio receivers you buy in the drugstores, and the AM sections of all but the best stereo sets, too!

If You Don't Have A Car Radio. If you don't have one, a good place to get car radios is from junk yards and used car dealers. Better yet, check out flea markets, garage sales, and other similar places. You'll generally be able to bargain and get a set for a lower price from the former sources. You shouldn't have to pay over \$10.00 for a set. You might get a radio that needs repairs and cut the price even farther. I bought several broken radios for fifty cents each, fixed them, converted them and gave them away as gifts! ■

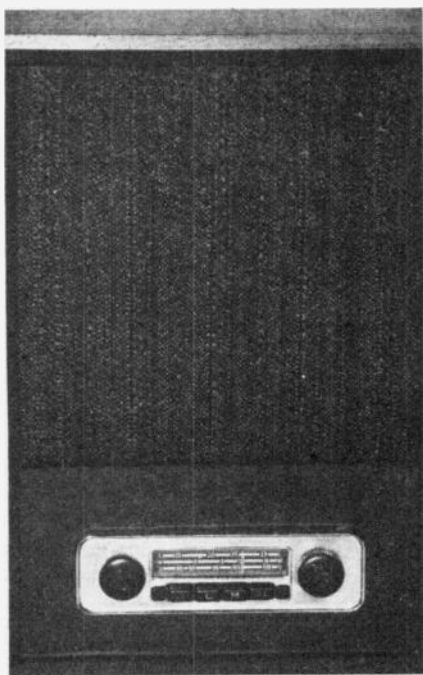

Another loudspeaker cabinet (cost: \$1.00!) houses this converted car radio. Sounds great!

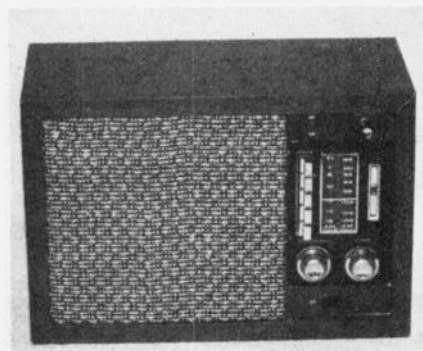

Out of a VW and into a reject speaker cabinet goes this car radio. AM, FM, and short-wave.

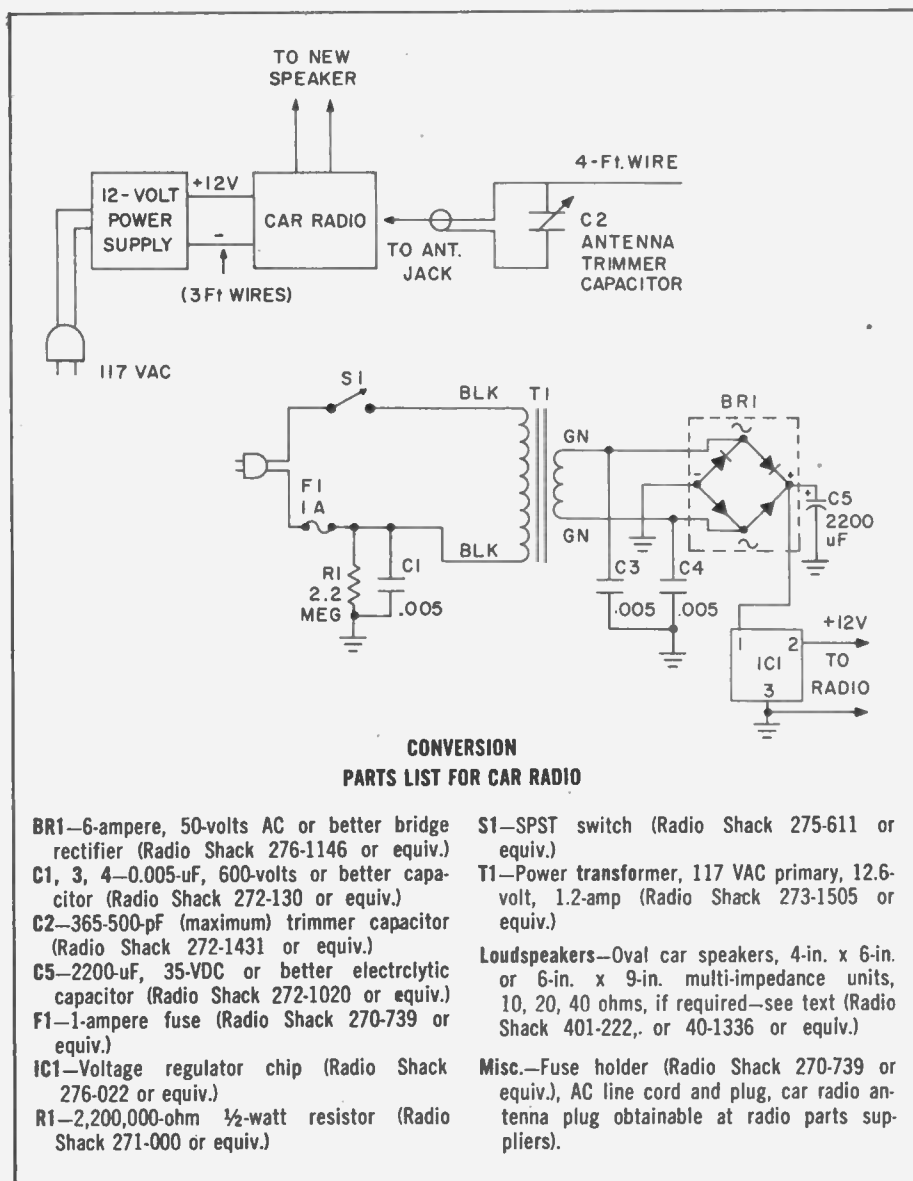

ROCK BOTTOM COST HIGH BAND MONITOR

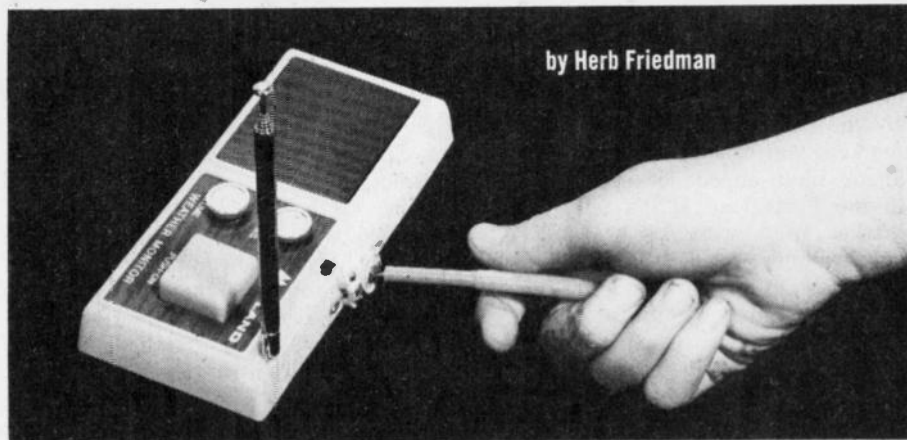

Getting bored by the temp-humidity index? Slide an inexpensive weather monitor up or down for some exciting signal hunting!

BECAUSE they're priced so low, generally from \$10 to \$20, the "weather monitor" has been a hot gift item for the electronics experimenter, so you probably have one. Tuning the weather station frequencies of 162.40 and/or 162.55 MHz, these small, inexpensive radios are supposed to keep you up to date on the latest weather conditions. But as you've probably discovered yourself, unless you're a boat owner with need for tide and sea conditions, you get a more up-to-date report from your local news station—AM or FM.

Also, reception is probably not all that great. The recommended receiver sensitivity for weather station reception is 0.6 μ V for a 50-mile range, and these inexpensive weather receivers can't get anywhere near this kind of sensitivity.

But there's no need to let an unused weather receiver sit on the shelf. Fortunately, very few models use crystal control tuning, and they are easily converted to a police or fire monitor, or even a sound channel receiver for the higher VHF TV stations. But remember, there won't be any super-sensitivity. TV stations might be received some 30 or 40 miles from the transmitter, but you'll have to be within 2 miles or so of the average police or fire transmitter to pick them up. If you live near an airport you might get coverage of the aircraft frequencies above 108 MHz, but with sharply reduced sensitivity.

The weather monitors are generally similar in electronic design, though the packaging might be anything from a cube to a desk-top pen holder. The circuits are bare-minimum superhet receivers with a local oscillator tuned over a limited range by a panel control. Generally, there are two panel controls, one for *volume* and one for *fine tuning*. The fine tuning knob might have calibrations for *both* weather frequencies, or no calibration at all. It doesn't make

any difference as long as the local oscillator is tunable.

To change the weather monitor tuning range, all you need do is connect a small external trimmer capacitor across the oscillator tuning capacitor—the fine tuning control. The value of capacitor will determine which frequencies are tuned. Keep in mind that as you tune lower in frequency the sensitivity is sharply reduced, particularly below about 160 MHz. A capacitor with a maximum value of 7 pF will get you down to the police/fire frequencies. A 60 pF maximum trimmer will get you about to the top of the FM band, but tuning will be extremely critical and sensitivity will be very low.

A 60 pF trimmer will also get you some of the TV sound carriers above 162 MHz. How can you receive signals above 162 MHz if the tuning range is lowered? Simple. The harmonics of the local oscillator are used to receive the TV stations. For example, if you lower the monitor's oscillator to, say, 100 MHz, the oscillator's harmonic output is also 200 MHz, and a very weak 300 MHz. (The monitor's front end appears to pass the frequencies above the design-range, 162 MHz, with greater sensitivity than lower frequencies.)

Tear It Down. To experiment you must first get the circuit out of its cabinet. Keep in mind these weather monitors are inexpensive and designed to be assembled quickly by unskilled workers. Don't go looking for tricky or difficult assembly sub-systems. Generally, one or two screws are all that's holding the cabinet together. If necessary, unsolder the speaker wires, battery wires and on-off switch wires, and remove the circuit board from the cabinet. Locate the trimmer capacitor used for the fine tuning and its two solder terminals. Solder a 3-in. length of solid, insulated wire to each terminal.

Check how the board fits the cabinet and mark the outside of the cabinet nearest the fine tuning. Drill two small

holes at the mark and then install a trimmer capacitor on the cabinet near the holes. Or, you don't have to secure the trimmer if you feel you will experiment with different capacitor values, but it will be difficult to tune the stations with a "floating" trimmer. You can't hand-hold the trimmer because the capacitance from your hand will affect the tuning adjustments.

Slip the wires from the fine tuning control through the holes you've drilled in the cabinet and seat the circuit board. Then reassemble the monitor.

Connect the wires protruding through the cabinet to the trimmer capacitor using the shortest possible leads (cut off the excess).

That's the whole bit. Use an insulated alignment-type screwdriver to adjust the trimmer. You'll probably be able to tune a few TV stations immediately. Tuning police/fire calls or anything else will be more difficult because transmissions in these services are short and fast. You can preset the tuning by using a signal generator or a well calibrated grid dip oscillator.

Remember, this is a fun project. Don't hope for more than acceptable reception. But then who knows, you might be able to tune your favorite TV channel and keep track of the program while working in your shop. ■

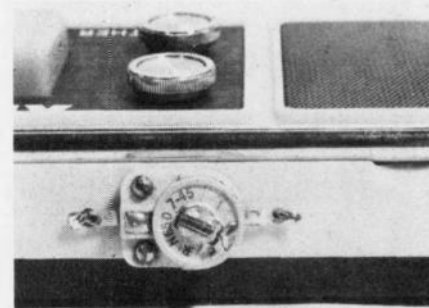

Install a small trimmer on the cabinet at a point just outside the internal trimmer.

Beat the Antenna Spiral

These low-cost antenna shortcuts get results.

by Lennie Loeb

□ BEGINNERS to the shortwave listening (SWL) hobby have no difficulty in obtaining good receivers, either budget jobs or gold-plated specials, when starting their first listening shack. Putting up antennas is their downfall.

Antenna theory is beyond the grasp of most novices. It is very complex at the beginning and rapidly becomes incomprehensible as different antenna types are introduced. So, why not take a shortcut approach to your first antenna installation. Get your new receiver pulling weak signals as you pile up listening hours with exotic DXing. What about antenna theory? It'll come if you work at it by reading theory books, but in the meantime here are three recorded case histories to low-cost antenna shortcuts which may be profitable.

Case No. 1—The Dangler. Harry is a youngster I met while giving a talk to the local high school student body during Science Fair Week. Harry was fascinated by the idea of English language newscasts from far-away places, so he bought a Realistic DX-160 receiver and set up a listening corner in his upstairs room in his folks' Colonial-style house. For an antenna, he dangled an odd length of wire out the window, letting it drop to the ground. The BBC and Radio Moscow came in fine except on rainy nights. In fact, it was a rainy evening when he rang my doorbell for help.

Harry's long wire was long and that's all it had going for it. It was vertically polarized (wrong) by hanging down and shorted out to ground (not good either) on damp nights. What Harry needed was a length of wire extended from the window to a distant pole, out-building, garage, or tree. In Harry's case, some sturdy trees outlined the houses's property line and he could run a 60-foot antenna with no difficulties. The antenna pointed due North-West and in his area of the U.S. was able to pull in Europe, North Africa, and the Near East with ease. Here's how we went about licking Harry's problem.

First, I told Harry that a good long-wire antenna should be at least 30 to 100 feet long for good reception performance on 2 to 30 megaHertz (MHz). As mentioned earlier, a 60-foot run was possible. A sturdy tree was selected because it hardly swayed in strong winds at the 20-foot level where the antenna would be secured. Some

slack (one foot of droop) was left in the antenna to compensate for tree sway and strong winds. Harry's antenna details can be seen in Fig. 1.

Antenna wire and antenna long wire kits are available everywhere. Harry actually used the Radio Shack shortwave antenna kit (278-758) which consists of 75 feet of bare copper antenna wire, 50 feet of lead-in wire, four insulators, and instructions. Harry had no trouble at all getting the antenna up.

Harry was a little smarter than me. He remembered to protect against lightning. Since shortwave lightning arrester kits are usually not available locally, Harry made do with lightning arrester parts made for TV. The parts available from Radio Shack include the arrester (15-911), ground rod (15-530), 40 feet of aluminum wire (15-035), and other small parts. The TV arrester has two screw-tight terminals with star washers for the 300-ohm TV line, however Harry only used one for his antenna and the other was left unused. The whole lightning installation bit came to about \$5.00. That's cheap. To bring the antenna lead-in into the house, Harry used a "Wall-Thru" tube (Radio Shack 15-1200).

Now I don't see much of Harry. Maybe once in a while he's at the Pizza joint with a date, but you can be sure Harry's getting a lot of DXing and veries every week.

Case No. 2—The Specialist. I've known Mort for over 20 years. We knocked about through high school and

somehow the paths of our lives are forever crossing. At one such juncture, Mort invited me to his home to see his new shortwave listening shack which sported a brand-new freshly assembled Heath GR-78 receiver. The GR-78 is a hot receiver. Unfortunately, I couldn't say the same for Mort's antenna. Mort was always inclined to specialize, and he had rigged up a dipole antenna with 300-ohm TV antenna lead-in wire. Mort wanted to log the 41-meter band and found it offered poor reception in his area. Besides, the noise was too high. He was asking, if not pleading, for advice.

First of all, I told Mort that dipole antennas are cut to exact dimensions for specific frequency bands as shown in Fig. 2. The dipole consists of a wire of a specific length which is cut in half. At the mid-point and both ends, each half of the wire is insulated from each other and insulated from ground. The lead-in cable from the antenna is actually two wires, and it's best to use a 73-ohm coaxial cable (coax) because it is inexpensive and commonly available. Without getting into theory, let me say that a 73-ohm coax lead-in cable "matches" a dipole antenna with less signal loss than does a 300-ohm TV twin-lead cable. On the design board, dipoles have a 75-ohm impedance and match pretty well into 73-ohm coaxes. The 300-ohm cable Mort was using was a bust.

The equation for determining the overall length for a dipole antenna at a

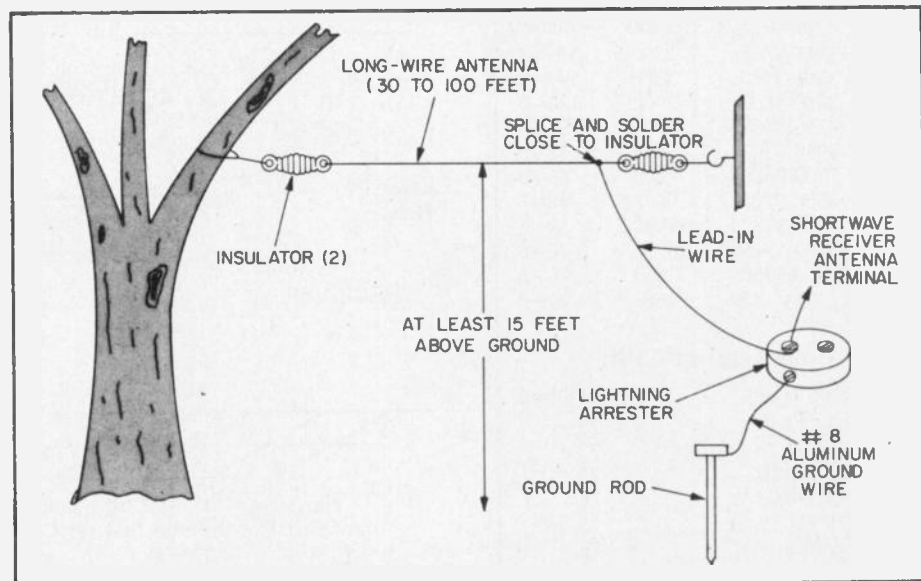

Antenna Spiral

given frequency is determined by dividing the given frequency in kiloHertz into the number 468,000. Or, as seen in the text books:

$$L = \frac{468,000}{f}$$

Where L is the overall length of the dipole in feet and f is the desired reception frequency in kiloHertz (kHz). I computed the overall length for dipole antennas to receive the international shortwave broadcast bands using the mid-frequencies of each band and listed them in a table that appears on this page.

When buying materials for a dipole antenna, wire and insulators are the same type as required for the long wire antenna. The lead-in coaxial cable should be RG-59/U or RG-11/U, each of which exhibits 73-ohms impedance. Stay away from unknown coax types or those with different impedances (ohms). As a guide, a table given on this page lists commonly available coax cables and their impedances. Any coax exhibiting an impedance in the 70's is good for the purpose. Let price dictate your selection.

I did not forget the lightning arrester in Mort's antenna. At the window, out of reach of the rain, I installed a Radio Shack coax static discharge unit (21-1049). This gadget requires PL-259 connector on the coax lead-in cable.

Dipole Overall Length for the Shortwave Broadcast Bands

Band	Frequencies (kHz)	Mid-Frequencies (kHz)	Length (feet— inches)
120	2300-2495	2397.5	195—2
90	3200-3400	3300	141—10
75	3800-4000	3900	120—0
60	4750-5060	4905	95—5
49	5950-6200	6075	77—0
41	7100-7300	7200	65—0
31	9500-9775	9637.5	48—7
25	11700-11975	11837.5	39—6
19	15100-15450	15275	30—8
16	17700-17900	17800	26—3
13	21450-21750	21600	21—8

Coax Lead-in Cable

Cable Type	Typical Ohms
RG-11/U	75
RG-59/U	73
RG-59A/U	75
RG-59B/U	75
F-11/U	75
F-59/U	73

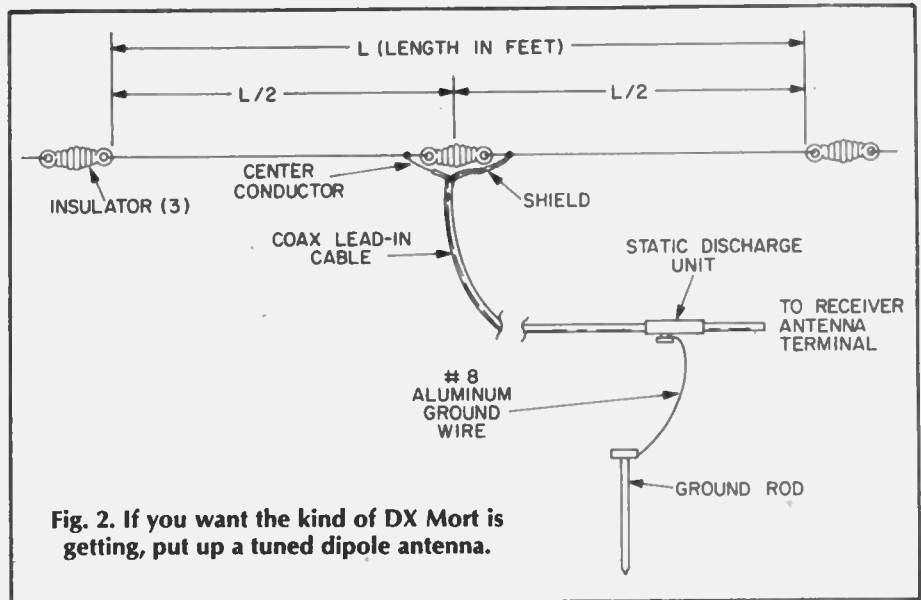

Fig. 2. If you want the kind of DX Mort is getting, put up a tuned dipole antenna.

It's worth the trouble. A grounding screw on the connector attaches to the grounding wire and ground rod. An ounce of prevention can save your home.

A dipole has some bonuses. For example, a dipole works equally as well on frequencies three times the designed frequencies. Thus, a 41-meter band dipole which will pull in 7100-7300 kHz signals will also receive 21300-21900 kHz which covers the 13-meter band. Or, if there is sufficient space to string a 195-ft. antenna for the 120 meter band (2300-2495 kHz), then you could pull in the 120, 41 and 13-meter bands. Of course, if you want all the shortwave bands, then your best bet is a commercial dipole antenna with built-in wave traps.

Don't see much of Mort anymore except at the supermarket. Seems he's a "stay-at-home" type lately. Happy DXing, Mort.

Case No. 3—The Cliff Dweller.

Carl is a fun guy to know except when he's upset. For example, Carl drove over on Sunday afternoon to tell me a story he was barely capable of getting out. He had picked up a used Drake SPR-4 receiver at a fantastic price at a flea market and wanted to get involved with DXing in a hurry. It was important to Carl since he teaches French and German, and shortwave DXing would keep his foreign language skills sharp. Unfortunately, Carl lives on the 14th floor of a 24-story apartment house near the city center. His land-

(Continued on page 98)

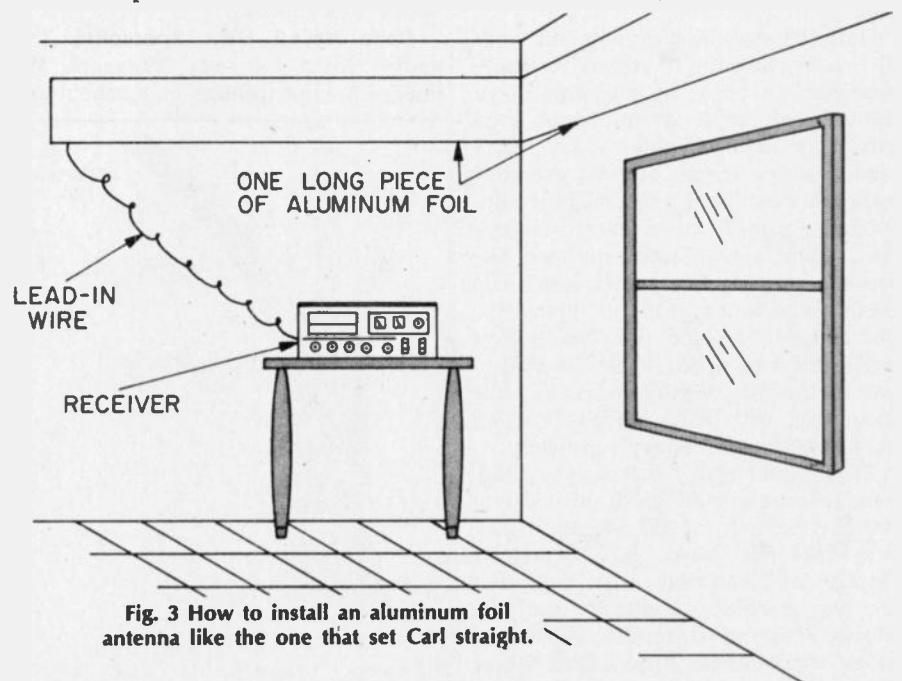

Fig. 3 How to install an aluminum foil antenna like the one that set Carl straight.



ADD TONE TO YOUR PHONE

With your own Touch Tone Pad you can key a phone, computer, or transceiver for peanuts.

□ One of the most popular hobbyist items—appealing to hams, experimenters, *phone phreaks* and thousands of other experimenters—is the Touch-Tone Pad or Encoder, that two-tone generating device used on Touch-Tone Telephones. It seems the uses for the Touch-Tone signals are almost endless: hams use them to activate and use autopatches that permit telephone calls from a mobile transceiver to a landline, experimenters use them in conjunction with the Signetics touch-tone decoder ICs for remote control applications, and *phone phreaks* use them to help make “free” (though illegal) long distance calls. Some people use them to access hobby and time shared computers, and others simply connect them to standard dial phones to get additional Touch-Tone service without paying Ma Bell a lifetime’s worth of extra charges for a relatively inexpensive extension phone.

In actual fact there is a difference between a Touch-Tone Pad and an Encoder. Though they eventually do the same thing you can be stuck for some rather expensive, unusable hardware if you can’t get them straight. The original telephone pad, the one used in Touch-Tone phones, generates a two-tone signal when a key is depressed and is called a Touch-Tone Pad. On the other hand, when a keyboard device resembling the telephone keyboard is used to control an electronic tone generator—usually an integrated circuit pur-

chased as an independent component—the keyboard is also called a Touch-Tone Pad but it is really only a switching matrix; it does not generate any tones. When this keyboard is combined with an electronic circuit that generates the tones—usually at a signal level slightly higher than normal microphone level—the entire device is called a Touch-Tone Encoder.

The encoder is a rather small, somewhat fragile device generally used by radio amateurs for controlling autopatch repeaters. The pad—which is made by Western Electric and other telephone equipment manufacturers—is built like a battleship, produces a relatively high level output that can be used for just about anything, and until re-

cently the only way to get one was to go directly to a telephone equipment dealer and pay list price, or hope one fell off the back of a truck.

But now the telephone-type Touch-Tone Pad has flooded the surplus market and anyone can pick one up for between \$8 and somewhat less than \$20, depending on condition. For an extra couple of dollars you can also get a beige plastic cabinet pre-punched to fit the pad. About the only problem you’ll have is that some of the pads have only numerals, not letters; but this should create no problems since most touch-tone coding, and even telephone numbers, are now predominantly numerals.

Probably the most flexible pad is the Western Electric type shown in the pho-

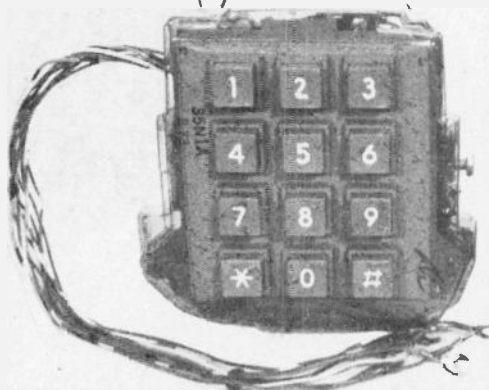

This is what you can get from the surplus dealers: a Western Electric Touch-Tone pad and plastic housing.

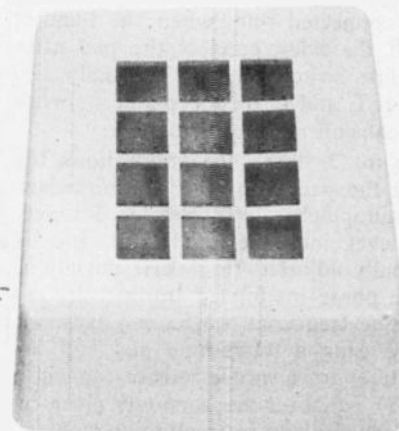

TONE TO PHONE

tographs. This model is available from several surplus dealers.

Wiring. The Western Electric pad comes jam packed with attached color coded wires which are generally used for connecting into telephones. For many hobbyist uses most of these wires are simply ignored. There is some variation in color coding between different models of Western Electric pads, but most models are very similar and some general color coding can be used. Also, most reliable suppliers will send connecting instructions and so specify in their ads.

In fact, before undertaking this project, you might want to check your ability to discern colors. It often happens that people who ordinarily would have no trouble seeing colors find it difficult to distinguish between color-coded wires in electronic equipment. A problem in this area could make it impossible to wire the Touch Tone Pad properly. So why not compare your reading of the wires with one or two friends', just to make sure.

The schematics show the hobbyist connections for the Western Electric type 35N1A and 35N3A pads—or dials as they are called by Western Electric—the most common type of pads available. The circuit shown in Fig. 1 can be connected directly across the telephone terminals of a telephone where touch-tone is already provided by the local telephone company. You will hear the tones in the receiver (handset). If you don't hear a tone simply reverse the connections to the line.

A normally open switch which is built into the pad is closed each time a key is pressed. This switch closes the circuit between the pad and the line, simultaneously applying power from the line to the pad (an external power supply isn't needed). If you want the pad connected only when the handset is off the hook connect the pad after the line switch terminals; usually terminals F and C on the phone network (repeat coil or transformer).

Figure 2 shows the connections for using the pad with an FM transceiver for autopatch. Potentiometer R1 sets the level into the modulator and is normally adjusted for 5 kHz deviation. Some phase modulated transceivers require a frequency correcting network when using a touch-tone pad and instructions for a simple resistor-capacitor (R/C) equalizer are generally given in the transceiver's instruction manual.

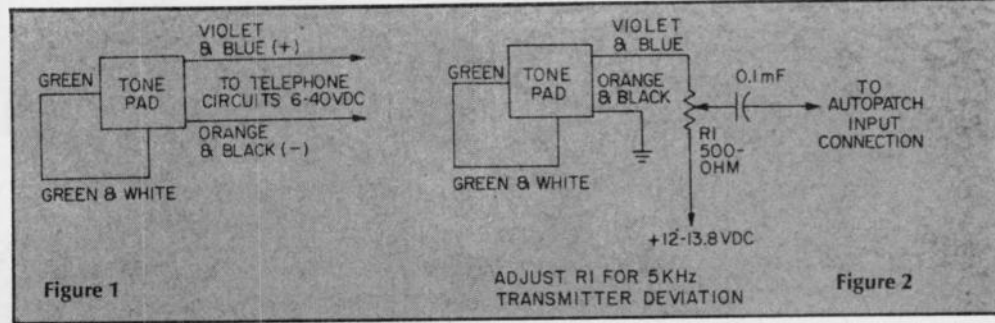

The circuit in Fig. 2 requires the transceiver's PTT (push to talk) be held down when the tones are keyed in. We will show later how to modify a pad so it also provides automatic transmitter keying each time a tone is keyed.

Mounting the pad. The best way to mount and wire a pad is in one of the plastic cases usually available from the same dealer who supplies the pad. As shown in the photographs there's plenty of room inside the cabinet for a terminal strip and associated components. To avoid short circuits clip the unused pad leads short, or tape the lugs on the end of each wire. The pad wires are standard stranded type—not litz silk wound—so you can clip off the lugs, strip the insulation and solder just as you would any other stranded hook-up wire.

If you need or want automatic PTT, or control circuit switching each time a pad key is depressed, you can easily modify the pad to provide the circuit control shown in Fig. 4. Note that switch S1 is the normally open switch

that is part of the pad and applies the power to the pad as well as connecting the pad's output signal. Switch S2 is the modification and can be wired directly across a PTT switch, or used as control wires for a keying or switching circuit.

First step is to remove the plastic covers of the pad. They snap right off. Remove the front one first, the one over the keys. Then remove the rear cover taking care to snake the wires carefully through the opening in the plastic cover. You will find the rear of the pad looks like the photograph, with a set of multi-switch terminals at the upper left. If you look carefully at the switch you'll find almost all the sections are normally closed, opening when a pad key is depressed. But two sets of contacts are normally open and close only when a key is depressed. The bottom set of contacts is S1 and should not be disturbed. Counting down from the top, the second set of contacts is also normally open and usually is the only set of contacts to which no wires are connected. (Note that some pads might

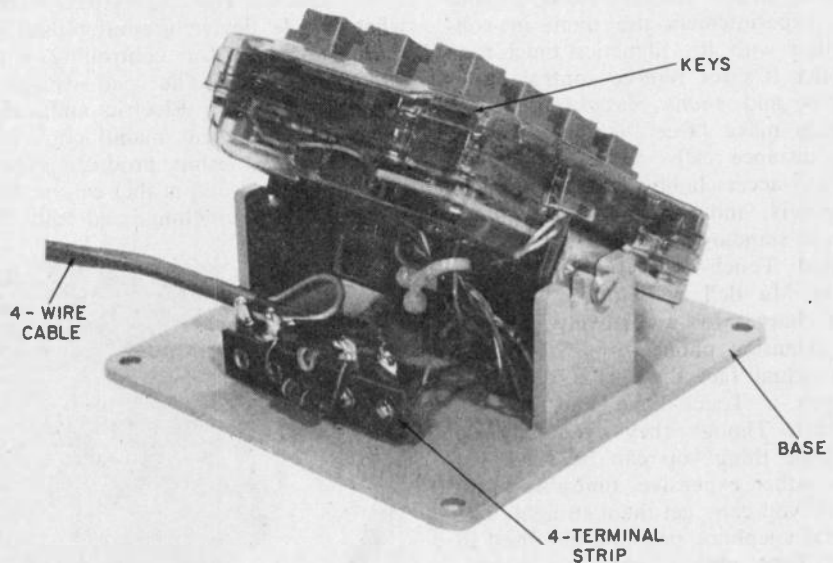

With the pad installed in the cabinet mount there's plenty of room in the back for a terminal strip and some components. This 4-terminal strip installation provides the connections shown in Figs. 1 and 2 through a 4-wire cable. The user simply selects the right set of color-coded wires.

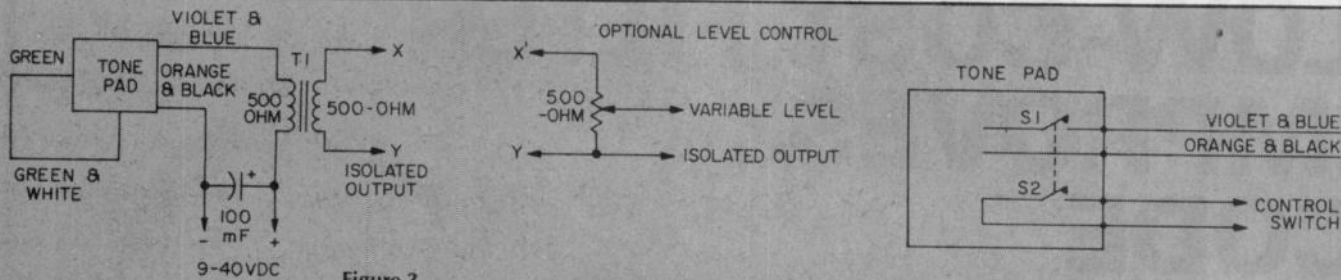

Figure 3

have one wire connected to one of the normally open terminals, and the wire is generally brown. Simply cut the wire off at the terminal and leave it alone.)

Carefully cut off the unused wires from the top set of normally closed contacts and move them to the normally open contacts using a very small soldering iron (about 20 watts) and as little heat as is possible. Use a tiny drop of solder to prevent a solder bridge. If you don't want to cut the wires from the top contacts use #22 stranded wire for the normally open connections.

Carefully slip the plastic cover over the wires, seat it on the pad and then install the front plastic cover. You now have a touch-tone pad with an extra set of normally open switch contacts.

Get Out the Grinder. For some unaccountable reason a few of the plastic touch-tone pad cabinets do not make allowance for pointed projections on the mounting ear located on each side of the pad. Each ear has two projections with a mounting screw in between.

The plastic cabinet has been pre-formed to accommodate the screw and one projection; the remaining projection gets in the way and can result in damage to the cabinet when the mounting screw is tightened. For best results use a hand grinder or file and remove the projection towards the bottom when the pad is held upright. When the pad is installed in the cabinets don't tighten the two mounting screws; let the pad float on its mount. When the top of the cabinet is secured with the four mounting screws provided, the pad will be rigidly locked in position without damage to the cabinet.

Correct Voltages. The Western Electric touch-tone pad will work with an applied voltage between 6 and 40 VDC at the orange/black and violet/blue terminals. If the voltage is less than 6 volts the oscillator won't "start," or the output signal will be highly distorted. Keep in mind that if you use the circuits shown in Figs. 2 and 3, there is a voltage drop across R1 and T1, and less than the applied voltage arrives at

Figure 4. Power switch S1 is part of the pad and is connected in series with the violet-blue (positive power) lead. It automatically closes each time a key is pressed. Switch S2 is connected to S1's operating lever but is not normally used in the pad. You can connect a pair of wires, as shown, to provide a set of isolated control terminals. S2's terminals can be used to operate the PTT switch of a transceiver whenever a key is depressed, or to lift the 500-ohm potentiometer off a microphone circuit with connection shown in Fig. 2 or the optional circuit that is included in Fig. 3.

the pad. In Fig. 2 about 3 volts is dropped across R1; you can normally get good operation if the voltage applied to the power supply end of R1 is no less than 9 VDC. Of course, if Fig. 2 is used for an autpatch the normal transceiver power supply of 12 to 13.8 VDC is available and you'll have no problems.

The transformer shown in Fig. 3 has less of a voltage drop than the resistor load of Fig. 2, so the applied voltage can be closer to 6 volts and still insure proper operation of the pad.

The pad has build-in Zener diode voltage regulation so the output voltage is more or less constant over the power supply. The maximum output voltage measured across R1 in Fig. 2 is nominally 0.77 volts RMS when indicated by a standard VOM; 3.5 volts peak-to-peak when measured by an oscilloscope. If you plug these values into a calculator nothing comes out the way you expect because two tones are involved.
(Continued on page 98)

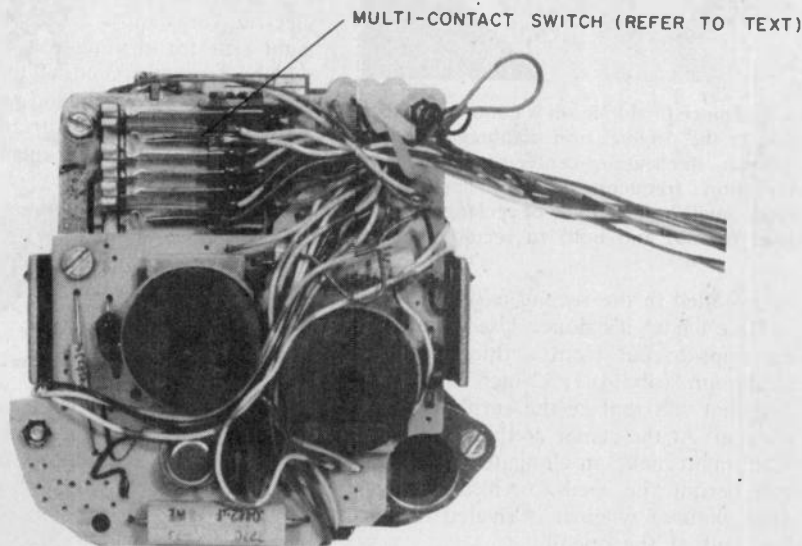

PAD CHASSIS IS WITH PLASTIC GUARD REMOVED

Switch arrangement to secure the control function shown in Fig. 4. Switch S1 is part of the pad wiring and controls both the power and pad connection. The set of contacts labeled S2 is the second down from the top and can be connected as in Fig. 4 to provide an isolated control circuit.

PARTS LIST

- 1—0.1- μ F capacitor (Radio Shack 272-135 or equiv.)
- 1—100- μ F, 50-VDC electrolytic capacitor (Radio Shack 272-1044 or equiv.)
- 1—500-ohm adjust potentiometer (Radio Shack 271-226 or equiv.)
- 1—Isolating transformer, primary 500-600-ohms, secondary 500-1000-ohms (Calectro D1-728 or similar) Calectro-GC Electronics, Rockford, IL 61101.

Touch tone pads can be purchased from: Telephone Equipment Co., P.O. Box 596, Leesburg, FL 32748.

LOW-COST FILTER IMPROVES CODE RECEPTION

A few snips of aluminum and an old reed make headphones into high quality filter.

by George X. Sand

Amateur radio operators and short wave listeners often find CW (continuous-wave code) reception difficult, if not impossible, when several radiotelegraph stations are transmitting on, or near, the same frequency. Such interference can be eliminated, or at least greatly reduced, by a narrow band electronic filter circuit that can be installed in the radio receiver or transceiver. However, this extra equipment can cost up to \$150.

What You Need. A mechanical filter that will do the job can be built for \$15, or less. In fact, should you already own a pair of earphones—the old-fashioned kind with metal diaphragms—and have access to a music store that will sell a used steel reed removed from an accordion (the writer was given his at no cost by such a store) you can build this effective filter for practically nothing.

A low-frequency reed should be used. A 440-Hertz (A) reed will work well. In fact, anything from about 300 to 1000 Hertz will be ok.

Should you have access to a steel (not brass) reed from an old harmonica, that could be used, too.

The removed reed is installed in one earphone of the headset so that it vibrates only when an incoming CW signal sets up a beat note at the reed's resonant frequency. All other interfering signals will automatically be eliminated since they will be of a different beat frequency, and the reed will not respond (audibly) to them.

To Get More Volume. Should you wish to have both earphones of the headset operate in this manner, the *matching* reed of the same length (they come in pairs in the instrument) must

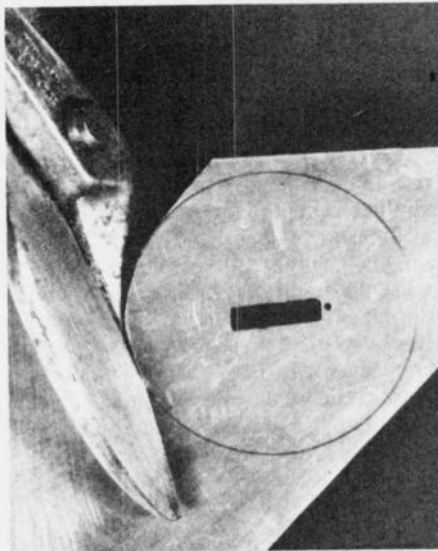

A thin piece of aluminum is cut to same size disc as the original iron diaphragm of the 'phones. Rectangular center opening is for the iron frequency-resonant instrument reed. Small hole at right of rectangle is for rivet (or nut and bolt) to secure reed.

be installed in the second earphone.

Here's how it's done: Use a pair of tin snips to cut from a thin sheet of aluminum (about 1/32-inch thick) a disc that will replace the earphone diaphragm. At the center of the aluminum diaphragm make an elongated hole that will permit the reed to vibrate freely (see picture) when it is riveted fast at one end of the opening.

In installing the reed it is important that the little strip of steel extend into its opening for the *same* vibrating distance that it did when it was in the musical instrument.

The operation is simple. The alu-

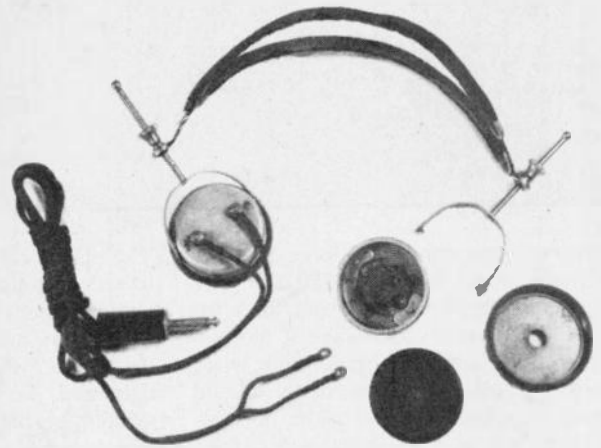

minum diaphragm, being non-ferrous metal, will not be influenced by the magnets in the earphone. Only the reed will vibrate, instead. In use, only the desired CW signal will be heard loudly as the receiver or transceiver is tuned. The resulting silence can be uncanny!

PARTS LIST FOR CW FILTER

Communications-type headphones, 1000-ohms or more. (Not stereo headphones, which are all wrong for this project).
Steel reed(s) from accordion or harmonica.
One (or two) small rivets of the same size as were used to hold the reed in place in the instrument.

Use These Tools. You'll need a pair of tin snips or metal cutting shears. An electric (or hand) drill, with bits the right size for drilling out the rivet(s) which secure the reed(s) in the instrument will be needed, and you'll find a small square-edge (or triangular) file good for dressing the opening in the aluminum disc. ■

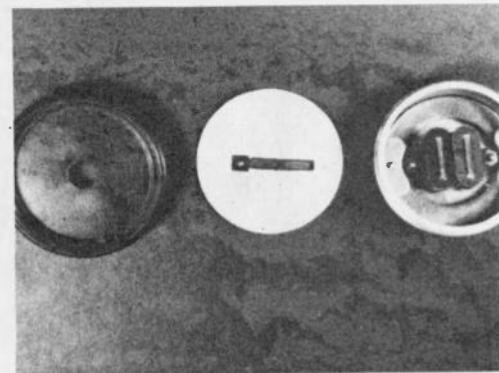

Original hard rubber cap (left), original magnet and coil assembly (right) and new aluminum diaphragm (center) with steel reed in place.

Troubleshoot your Appliances like a Doctor

Take a tip from your last physical checkup and do as your doctor does if you want to pocket the big repair bills and replacement costs.

by Jorma Hyypia

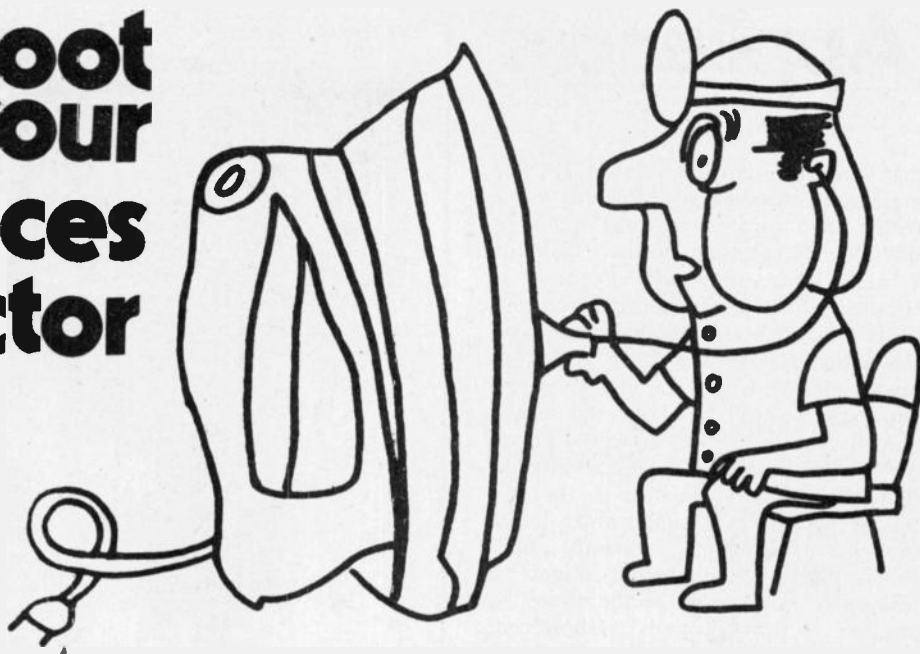

YOU MAY HAVE been pronounced perfectly healthy during your last physical checkup, and yet your doctor may have advised that you have an electrocardiogram (EKG) made. Why? To provide a record of the *normal* electrical characteristics of your heartbeat. If diagnostic EKGs need to be made in the future, they can be compared with the normal EKG for faster and more accurate evaluation of your health problems. In like manner, troubleshooting your small appliances when they break down will be much easier if you now prepare a set of appliance ECGs—*electroconductivitygrams*—while the gadgets are still in good working condition.

Actually, you'll measure the *resistance* to conductivity exhibited by the total circuitry of each appliance because resistance is faster and easier to measure

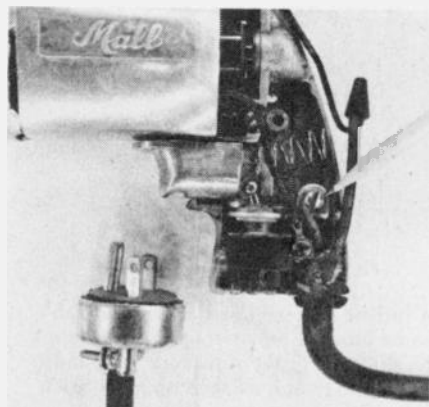

Old style power tools that do not have insulating plastic housings should be fitted with three-conductor grounding cords. Here the ground wire is attached to a bolt used to hold the switch in place. Worn grommet where power cord emerges from the tool should be replaced.

than is conductivity. All you need for the job is a volt-ohmmeter (VOM) that can be purchased from a retail audio supply store. Prices start below ten dollars.

Measuring Resistance. To measure the total circuit resistance of an appliance, unplug it from the wall socket and apply the meter probes to the prongs of the power cord plug. Adjust the meter control to provide an easy-to-read resistance value when the appliance switch is turned on. If the appliance has several settings (cool, hot, low, medium, high) take a reading at each setting.

You should end up with a "Typical Appliance Resistance Chart" much like the one shown here. So why not just file away this ready-made chart for your own use? Because your brands and models of appliances may have different resistance characteristics, although in most instances they probably will be fairly close to those indicated here. And you can't always be wholly certain that each unit of the identical brand and model will behave in the same manner; for example, two seemingly identical cool-mist humidifiers exhibited resistances of 14 and 25 ohms respectively.

If you don't get around to making up your own chart before something breaks down, use our chart as a rough guide to the *probable* resistance your similar appliance should have. Note that in some cases a resistance range is indicated. The resistance of a power drill may climb from 12 ohms up to an apparent "infinity" reading as the speed control is adjusted. A food mixer may have several separate resistances (32/60/90 ohms, for example) for the high, medium, and low speed settings.

Resistance Interpretations. By comparing the measured resistance of a defective appliance against the same unit's normal resistance, you can speed diagnosis of the problem. If the appliance still has the proper resistance, look for *mechanical* rather than electrical trouble—stuck gears, for example. If the measured resistance is zero, you would suspect a short circuit in the power cord or elsewhere. If the resistance is very high (infinity) when it should be in the tens or hundreds of ohms, search for an open (break) in the circuit; this could be a broken wire, a wire worked loose from a terminal connection, a defective component such as a resistor or thermostat, or maybe nothing more than the accumulation of corrosion products

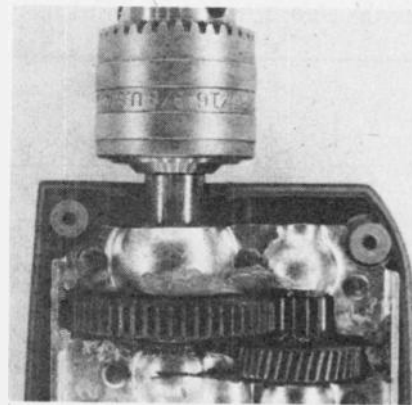

Cause of malfunction of a tool or appliance can sometimes be mechanical rather than electrical. For example, drill gearing systems may reveal damaged gear teeth, or grease may have dried out or become dirty. Replacement of damaged gears would be a factory or service shop job, but you can easily clean out old grease and pack with fresh lubricant.

Appliances

that impede current flow. If the measured resistance is a readable value (other than zero or infinity) but considerably higher than normal, look for a break where only part of the total circuit is affected, thus allowing current to flow through an alternate route having a higher resistance than the combined normal routes. In this case you could pretty well rule out the power cord because a break here would knock out the entire circuit and exhibit "infinity" resistance. Finally, if the observed resistance is significantly lower than normal (but still not zero), hunt for a place where current might be leaking from one part of the circuit to another to flow through a shortened, lower resistance path than normal.

Once you learn the very simple technique of making resistance measurements with a VOM, and get the hang of interpreting the results, your troubleshooting skills increase greatly. Obviously the VOM provides much more significant information than you could obtain with a simple continuity tester (such as the battery-bulb tester shown in this article) which usually shows only whether a given circuit will or will not pass current of low voltage. However, the continuity tester is worth building because a great many appliance problems can be found with this simple device.

Continuity Testing. If you have reason to suspect the power cord of a defective appliance, either the VOM or bulb continuity tester can be used to check the cord. If the cord can be sep-

arated from the appliance, hold one probe of the continuity tester or VOM to a contact in the plug-in section, and touch the other probe to each of the wall plug prongs, one at a time. If the bulb lights when touched to one prong, but not when touched to the other, you know that one conductor is free of breaks and has no short circuit to the other conductor. Now move the probe to the other contact in the plug-in section, and test the prongs again. If the bulb lights when touched to one prong,

but not when touched to the other, the second conductor is OK. If the bulb fails to light when the probe is touched to either prong, a break in the wire or a loose connection inside one or other of the end sections is indicated. If the bulb lights no matter which prong is touched, look for a short circuit. The

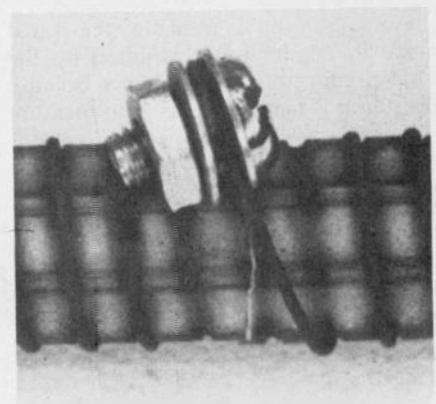
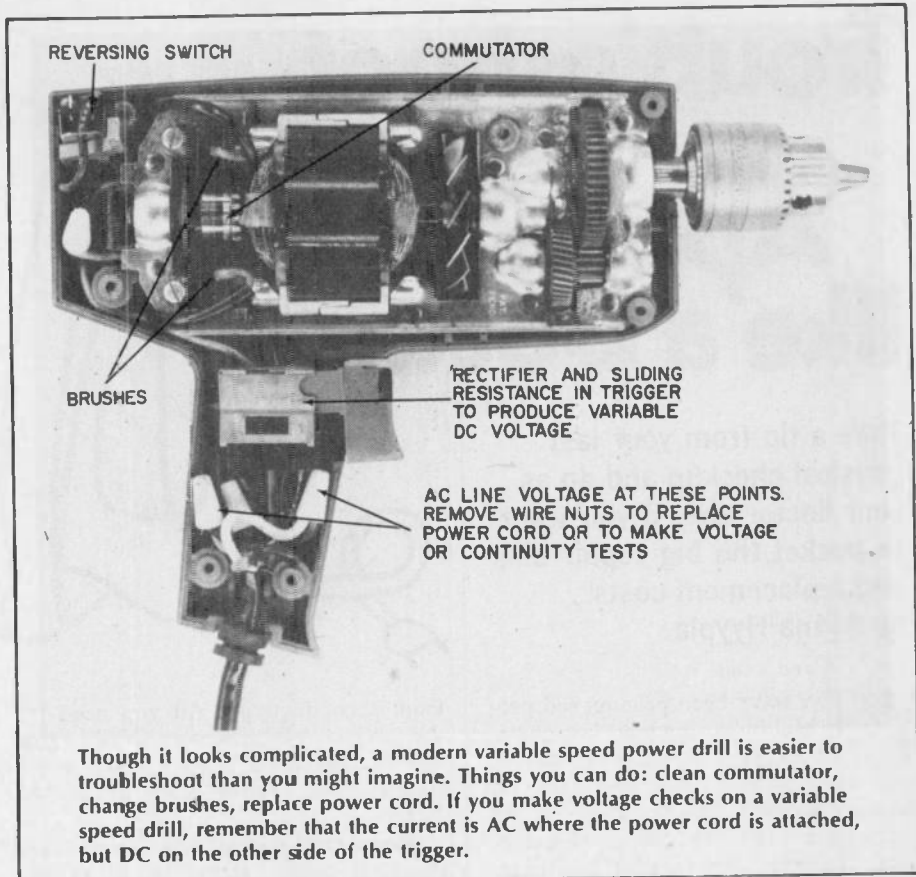
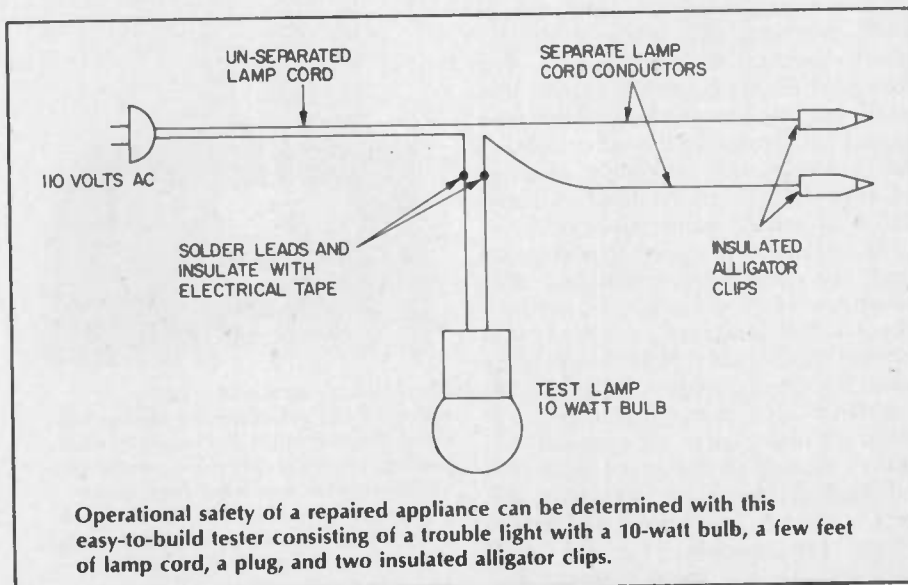

A broken wire coil heater element can sometimes be repaired by forming loops on the ends of the resistance wire and bolting together, using washers on each side of the loops. Very old resistance wire may be too brittle to permit forming the loops. Heater elements consisting of metal ribbon, rather than wire, can sometimes be repaired by clamping ribbon ends together with special clamps that can be obtained from appliance repair shops.

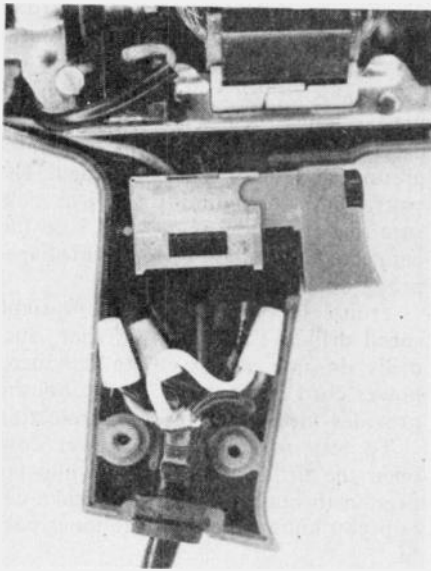

Trigger of a variable speed power drill contains a silicon-controlled rectifier (SCR) to convert incoming AC current to DC current, and a slide resistor to vary the voltage and thus vary speed of the drill motor. If malfunction is traced to this component, replace with a new trigger unit.

VOM provides the same information, except that a break is indicated if you get an infinity resistance reading no matter which prong of the wall plug you touch while the meter's other probe is held against one contact at the other end of the power cord. If you get a zero resistance reading at both plug prongs while the other probe remains in contact with the same terminal at the other end of the cord, a short circuit is indicated.

If the power cord is permanently wired to the appliance, open the appliance and disconnect the power cord before making the tests. Be sure to reconnect the wires as they were before—black to black and white to white in most cases. If the cord has a three-conductor grounding cord that terminates in a plug with three prongs, be extra careful to reconnect the ground conductor to its proper place inside the appliance. Otherwise you may feed lethal current to the outer body of the appliance.

Safety Checks. Before a repaired appliance is plugged in for a final performance test, you should make some sort of safety check to be certain that there isn't a short to the outer body or other metal part of the appliance or tool. The VOM can be used by touching one probe to the metal housing of the appliance and the other alternately to each of the prongs of the power cord plug. If you get anything other than an infinity reading on the meter as you dial through the various multiplier settings

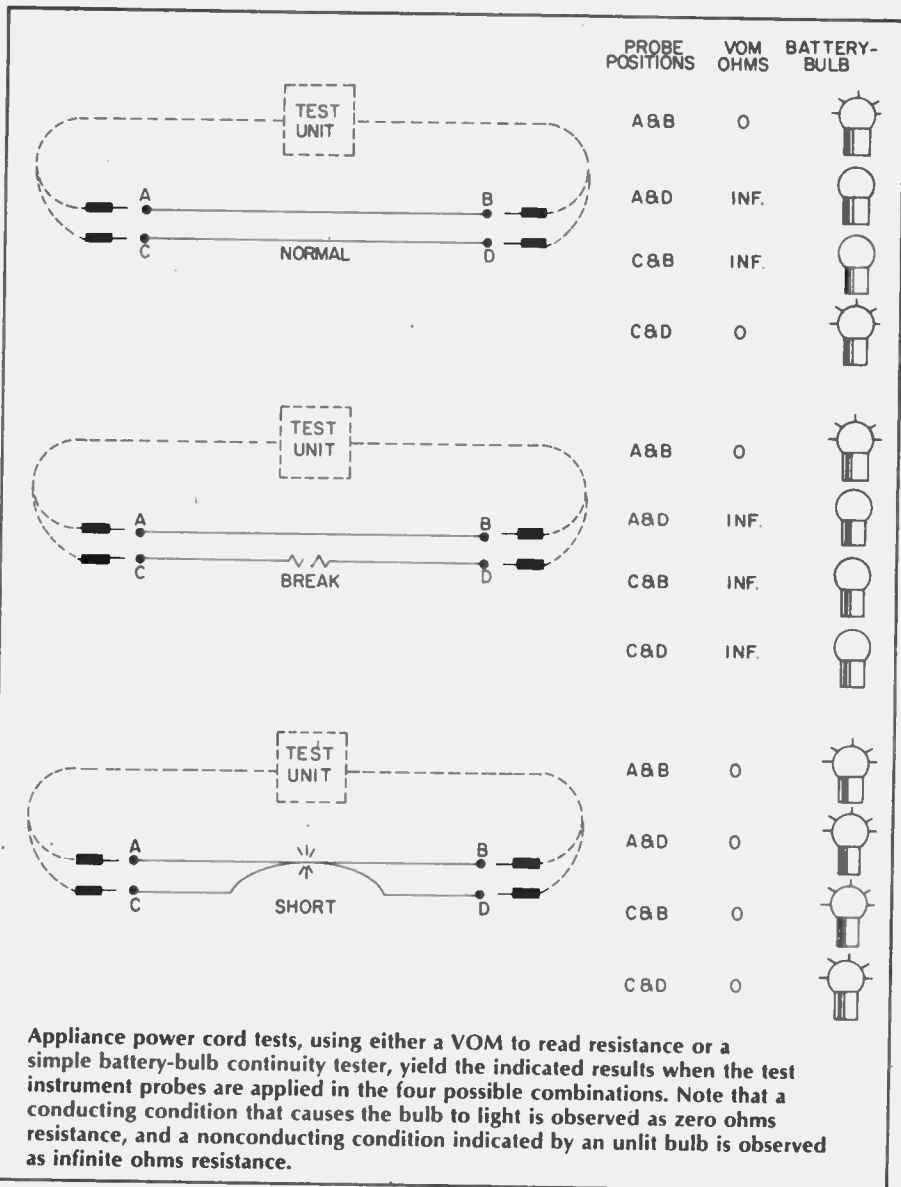

Appliance power cord tests, using either a VOM to read resistance or a simple battery-bulb continuity tester, yield the indicated results when the test instrument probes are applied in the four possible combinations. Note that a conducting condition that causes the bulb to light is observed as zero ohms resistance, and a nonconducting condition indicated by an unlit bulb is observed as infinite ohms resistance.

of the ohmmeter portion of the VOM, repair the indicated short before you apply full 110 volts to the appliance.

The VOM safety check is better than none at all, but not as reliable as the test you can perform with the simple tester shown in the drawing, because the higher, 110-volt test voltage can "punch through" a poorly insulated place to reveal a potential hazard that the very minute voltage generated by the VOM cannot do. Before using the tester, be certain that the bulb is good. Then attach one alligator clip to the metal housing of the appliance (in an unpainted area) and the other clip to one of the prongs of the power cord plug. *Momentarily* insert the tester plug into a wall socket while you keep clear of the appliance and tester. If the bulb glows you have a hazardous short. Perform this test with the appliance switch in both on and off positions. **Caution:** Do not leave the tester plug in the wall

socket even for a moment; withdraw it as you take your hand away so that you won't accidentally get a shock from the alligator clips. The tester can also be used as a continuity tester for power cords. Observe the same safety rules: make the proper clip connections, stand clear, then plug the tester into a wall outlet momentarily.

Power Tools. Troubleshooting a single speed portable power drill is quite simple. First check the power cord in the manner already described. If the cord is good, make resistance or continuity tests from the power cord terminals to the brush terminals. If there's no indication of current flow, look for a break between the power cord and brushes. Unloosen and retighten any connecting screws, bolts, or nuts; the scraping action can cut through corrosion that may be impeding current flow.

If the brushes look worn, replace

Appliances

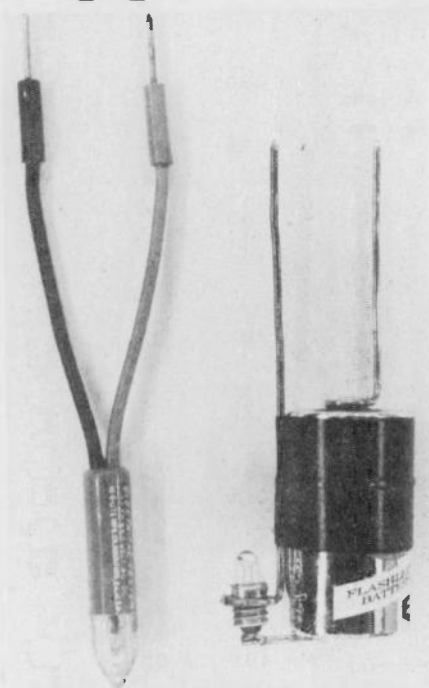

A handy continuity tester can be made by soldering a stiff copper wire to the end terminal of a size D flashlight battery, and taping a second wire to the body of the battery after forming a loop to hold a 1½-volt flashlight bulb. Solder a short length of wire from the end contact of the battery to the bottom of the battery. Other ready-made neon test lamp is handy for checking 110-volt circuits, as in home wall outlets to make certain that fuses or circuit breakers have not blown to cause seeming malfunction of appliances.

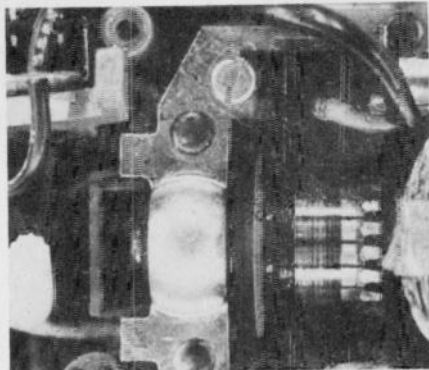

Good place to check DC current in a variable speed drill is at the terminals of the reversing switch, which in this case is located in the top left corner of the drill housing. Worn brushes are easily replaced by taking out the two bolts that hold down plastic brush sleeves. Avoid using harsh abrasives when cleaning commutators of appliance and tool motors.

them with new ones you can obtain from an appliance repair shop or from some hardware stores. Accumulated dirt on the commutator, which could impede current flow from the brushes, should be cleaned off carefully with a piece of rough cloth. Avoid the use of sandpaper, steel wool, or other harsh abrasives that could scratch the commutator or leave gritty or gummy particles in the works.

If your old-fashioned drill with a metal housing does not have a three-conductor grounding cord, it would be wise to add one. Connect the current-

carrying conductors of the new cord in the same manner as were those of the old cord. Attach the ground lead to the metal body of the drill. Usually you can find a hold-down screw or bolt (*not* used to connect a wire) to which the ground conductor can be added. Use your VOM or continuity tester to make sure that the body of the drill is in fact connected to the third, odd-shaped prong on the power cord plug.

Troubleshooting a modern, variable speed drill is somewhat different. Such drills do not need a three conductor power cord because the plastic housing provides virtually foolproof protection.

To test or replace the power cord, open the drill casing *slowly* while you peer in through the crack to make certain you know where all the inner parts fit.

Resistance measurements made at the prongs of the power cord will vary, depending on how the speed control is set; expect a reading of about 12 to 25 ohms at the higher speed settings, and a seeming infinity reading at very low speed settings.

To make voltage checks, lay the opened drill on a pad of towels (to keep it from sliding around), preset the speed control to a low level, lock the trigger into the "on" position, and then carefully plug the tool to the power source. *Caution:* Do not attempt to run the open drill at any but a low to medium speed.

You should find 110 to 120 volts AC at the power cord terminals. But on the other side of the trigger switch you will be measuring variable DC voltage, so

TYPICAL APPLIANCE RESISTANCE READINGS

(Measured Across Power Cord Plug Prongs)

	Ohms		
Shop Tools		Food mixer, hand-held	32/60/90
Power drill, single speed	55	Food mixer, hand-held	65 to 110
Power drill, variable speed	12 to ∞	Coffee maker, 12 to 32 cups	20
Power drill, variable speed, heavy duty	6 to ∞	Personal Items	Ohms
Soldering gun, 30 watts	28	Shaver, man's	1250
Soldering gun, 240/325 watts	4	Shaver, woman's	150
Saber saw	12	Hair dryer, table model	8/7/6/6
Radial arm saw	1.5	Hair dryer, hand-held, 275 watts	28/55
Circular saw, portable	3.8	Hair dryer, hand-held, 215 watts	21/26
Belt sander, portable	2	Face massager	90
Belt sander, non-portable	2	Electric blanket, 2-contact jack	115
Orbital sander	28	Electric blanket, 5-contact jack	48/60/90/150
Router	2.5	Misc. Appliances	Ohms
Drill press	1.5	Steam iron	12
Shop vacuum	3	Vacuum cleaner	13
Tool grinder	5	Space heater	17
		Hedge clipper	22
Kitchen Appliances	Ohms	Humidifier, cool mist	14 and 25 (see text)
Toaster, 2-slice	12	Humidifier, hot mist	3000 to 4000
Toaster, 4-slice	8	Dehumidifier	7
Toaster oven	10 to 18	Slide projector, 300 watts	2
Waffle iron, 550 watts	24	Shoe buffer	32
Knife sharpener	10	Timer clock	900

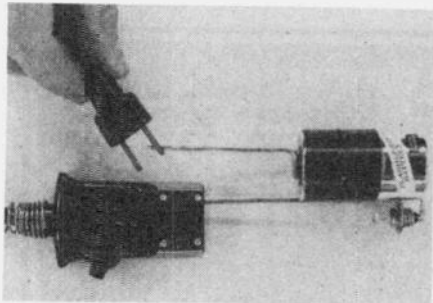

Continuity tests on appliance power cords are easy with the battery and bulb tester. This plug-in unit has its own on-off switch which cuts off current in one conductor only, leaving the other conductor "alive" (as indicated by a glowing test lamp) even when the switch is in the "off" position.

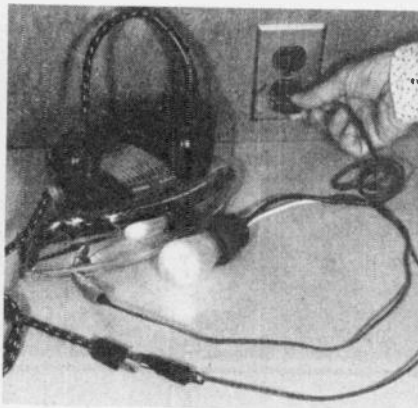

Safety check revealed that this steam iron had a dangerous current leak to the exposed metal surfaces. Note one alligator clip attached to the iron, the other to a power cord plug prong. Lamp should not light. Caution: keep hands away from appliance during test, and withdraw tester plug from wall outlet when you take your hand away to avoid shocks from alligator clips.

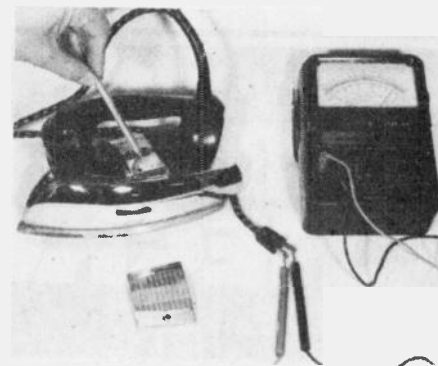

Simple resistance reading off power cord prongs can provide some indication of an appliance's condition. Hole in steam iron under nameplate provides access to thermostat adjustment screw.

reset your VOM to the DC section, beginning with a high voltage setting and working down until the meter needle provides a reading somewhat away from the end of the scale. If you get no measurable voltage on the DC side, the SCR (silicon-controlled rectifier) or the slide resistance built into the trigger unit is probably defective. The only solution is to obtain a replacement trigger.

A convenient place to make DC voltage checks is at the terminals of the double - pole - double - throw reversing switch (if your drill is reversible). At very low speeds you might find only about 4 volts DC at these terminals. The voltage increases gradually as you cautiously increase the speed of the drill. You should also be able to read DC voltage across the brush connections. If the voltage is lower than at the reversing switch, look for poor contacts, bad brushes, dirty commutator. When the power is on, jiggle suspected parts only with a non-conducting tool such as a plastic swizzle stick or a length of dry wood dowel.

Basically the same troubleshooting methods would be used to find defects in any other powered shop tools. Single-speed tools will surely have AC motors. Look for DC currents in tools that feature variable speeds that are electrically rather than mechanically speed-controlled.

Household Appliances. Motorized household appliances, and the motorized sections of other appliances (the fan circuit of a space heater, for example), would be tested in like manner. But many appliances also have heater circuits requiring different troubleshooting methods.

If the appliance is completely dead, you first check the power cord. If that is good, take the appliance apart far

enough to get a good look at the inner components. Trace each circuit carefully, looking for breaks or bad contacts.

If you discover a break in a heating element, it usually means that you will have to obtain a replacement part. Remove the old element from, say, the steam iron or toaster, and take it to your appliance repair shop to aid in the selection of the proper replacement. Also take along the model number of the appliance. If the appliance is quite old, and an exact replacement is not available, the professional repairman may be able to make a simple wattage test of your defective element and suggest an alternative replacement (assuming that it would physically fit into your appliance).

If the appliance uses a coil-type heating element, a break can be repaired if the broken ends can be formed into small loops. (Sometimes the heater coil is so brittle that it keeps on breaking as you try to form the loops, in which case replacement of the entire coil is the only answer.) If you do succeed in forming loops, bolt them together as shown in the photo. Obviously the connection must be mechanical (bolt or rivet) because solder and cements wouldn't last even a few seconds when the coil heats up again.

Thermostat Repairs. Heat-producing appliances usually have thermostats that turn power on and off automatically to maintain desired heat levels. Sooner or later the thermostats begin to show signs of wear because of the pitting and corrosion that result from the inevitable arcing.

In many appliances the thermostats are adjustable, so if the appliance behaves normally except that it runs too hot or too cold, first try adjusting the thermostat with a control screw that increases or decreases tension on the contact points, depending on which direction the screw is turned. Usually, a clockwise turn will decrease the temperature, but this is not always the case—so experiment. If the thermostat has no adjustment screw, try bending the arms holding the contact points to increase or decrease the contact tension.

Incidentally, you may not even have to take the appliance apart to make thermostat adjustments. For example, many steam and dry irons have a nameplate on top of the iron, just below the handle, that is removable by prying at one edge to get at the assembly bolts. Next to the bolt you are likely to see a hole through which you can insert a screwdriver to the thermostat adjustment screw.

If the thermostat contacts are moderately corroded, gentle cleaning may help. If badly pitted, replacement may be the only answer. Dress the contacts gently with a fine file *only* as a last resort before buying a replacement, because the filing might only aggravate the problem by removing what still remains of the original hard metal contacts. However, sometimes the dressing can significantly lengthen the life of the thermostat.

You can use a small AM radio to test an appliance thermostat without even opening the appliance. Just place the radio near the appliance and tune clear of any very strong station, then operate the appliance. A good thermostat, when it goes on and off, will cause a short click in the radio; a bad thermostat will create a prolonged, raspy sound. ■

CB XCVR CHECKOUT

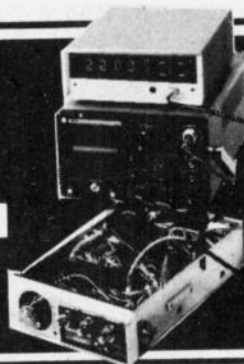

- COBRA 21XLR
- COURIER BLAZER 40D
- HY-GAIN I
- KRIS XL-40
- MOTOROLA 4000

BUDGET ELECTRONICS has been able to obtain some low-priced 40-channel CB transceivers for review, and presents the test reports here. These units are not prototypes, but are "stock standard," the same as the transceivers that you can buy over the counter. If you don't find the particular unit you are interested in reported on here, check the newsstands for the 1978 edition of the CB YEARBOOK.

• COBRA 21XLR

\$179.95 (Dynascan Corp.)

General Description: A 40-channel AM transceiver for mobile, P.A. operation. Power supply is 12 to 13.8 VDC with negative or positive ground. Overall dimensions are 2 1/8-in. H x 6 1/4-in. W x 9 3/8-in. D. There are front panel controls for channel selection, volume, squelch, dynamike, and L.E.D. dimmer. Switches for PA/CB and ANL. Standard accessories include a microphone, mobile mount, DC power cable.



CIRCLE 56 ON READER SERVICE COUPON

Receiver Section Test:

Input sensitivity	0.5 μ V
Adjacent channel rejection	53 dB
AGC action	5 dB
Input level for S9	
meter indication	50 μ V

Transmitter Section Test:

AM RF output	3.7 Watts
Modulation to 85%	yes
Relative sensitivity for 85% Mod.	-45 dB Maximum
Modulation limited to 100%	yes

Editorial Remarks: A double conversion receiver with jacks for external and P.A. speakers. L.E.D. digital channel indicator. The S-meter has a 6 dB per S-unit scale calibration. ■

• COURIER BLAZER 40D

\$149.95 (Fanon/Courier Corp.)

General Description: A 40-channel AM transceiver for mobile, PA operation. Power supply 12 to 13.8 VDC with negative or positive ground. Overall dimensions are 2 3/8-in. h x 5 7/8-in. w x 8 1/2-in. d. Front panel controls and switches for Channel Selector, Volume, Squelch, RF Gain, PA/CB, ANL. Standard accessories are microphone, mobile mount, DC power cable.



CIRCLE 67 ON READER SERVICE COUPON

Receiver Section Test:

Input Sensitivity	0.28 μ V
Adjacent Channel Rejection	57 dB
AGC Action	10 dB
Input Level for S9	26 μ V

Transmitter Section Test:

AM RF Output	4.0 watts
Modulation to 85%	yes
Relative Sensitivity for 85% Modulation	-32 dB
Modulation Limited to 100%	no

Editorial Remarks: The Courier Blazer 40D has an S-meter that reads 5 dB per S-meter, double conversion receiver, external and PA speaker jacks, LED digital channel indicator, and S/RF output meter. ■

• HY-GAIN I

\$129.95 (Hy-Gain Electronics Corp.)

General Description: A 40-channel AM transceiver for mobile operation. Power supply 12 to 13.8 VDC with negative or positive ground. Overall dimensions are 2 1/4-in. h x 6 3/8-in. w x 8 7/8-in. d. Front panel controls for Channel Selector, Volume, Squelch. Standard accessories are microphone, mobile mount, DC power cable.

Receiver Section Test:



CIRCLE 64 ON READER SERVICE COUPON

Input Sensitivity	0.3 μ V
Adjacent Channel Rejection	58 dB
AGC Action	12 dB
Input Level for S9	70 μ V

Transmitter Section Test:

RF Output	4.2 watts
Modulation to 85%	yes
Relative Sensitivity for 85% Modulation	-18 dB
Modulation Limited to 100%	yes

Editorial Remarks: The Hy-Gain I has a relative reading S-meter, double conversion receiver, jacks for external and remote (telephone handset) speakers, and S/RF output meter. ■

• KRIS XL-40

\$179.95 (Kris, Inc.)

General Description: A 40-channel AM transceiver for mobile, PA operation. Power supply 12 to 13.8 VDC with negative or positive ground. Overall dimensions are 2.3-in. h x 6.5-in. w. x 8.4-in. d. Front panel controls and switches for Channel Selector, Volume, Squelch, ANL,

(Continued on page 97)

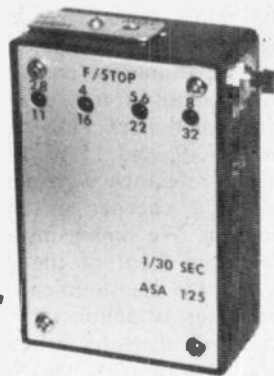

LONE RANGER LIGHT METER

LED readout saves meter cost, and is more rugged too.

by Walter Sikonowiz

□ Lone Ranger is a photographic light measuring instrument without the usual (needle-and-scale) mechanical meter. Instead, it uses light-emitting diodes (LEDs for short) to tell you what lens opening to use. In addition to cutting the cost by more than 50 percent, eliminating the meter has other advantages. The chance of damage from dropping is much less. People with no knowledge of photography can easily use this exposure indicator once taught the significance of the displays.

Finally, because the readout is on LEDs, it's always easy to see, even in low light where an ordinary meter's needle might be hard to read accurately.

This comparator-LED light meter is ideal for the serious beginning or intermediate photographer because most people shoot with the same speed film most of the time. And if you do use two or three different speed films, it's easy to apply a conversion factor to the Lone-Ranger's lens-opening scale.

It's a one-speed-range photographic light meter which tells you at what f-stop diaphragm opening to set your 35

mm or other precision camera lens. It provides readings for setting your camera lens opening between f-stops as large as 2.8 and as small as 32. These are based on the most popular black-and-white film for 35 mm use. Plus-X, a widely available fine-grain film.

Photo Basics. First before showing how the meter works, let's review some basic photography. The photographer is concerned with three numbers when making an exposure: 1) the ASA rating (the speed) of his film, 2) the f-stop of the lens aperture, and 3) the speed of the shutter. Let's see how these factors interrelate. Suppose you take a correctly-exposed picture under light of intensity I , with f-stop n and exposure time equal to T . If the intensity suddenly jumps to $2I$, you must compensate by either reducing the aperture (multiplying the f-stop by 1.4) or by reducing the exposure time by half— $T/2$. And if the light intensity is reduced by half you would compensate either by making the f-stop 1.4 times larger, or by increasing the exposure time to $2T$. This assumes, naturally, that the film's speed (ASA) remains constant.

Now suppose that a correctly-exposed photograph is made under light of intensity I , with f-stop = n , and exposure time = T . To take the same picture with a film whose ASA rating is twice that of the original, you'd compensate by making the f-stop = $1.4 n$ or by making the exposure time = $T/2$. To take the same picture with a film whose ASA rating is half that of the original film, make the f-stop = $n/1.4$, or make exposure time = $2T$. Now let's look at an electronic circuit to measure the ambient light.

Use a High-Gain Amplifier. Suppose we take a high-gain differential amp and place a known voltage on one input, an unknown on the other. Since

we're using the amp open-loop (without the usual feedback), only a small voltage difference at the two inputs is required to send the output either to saturation, or to cut-off. Specifically, if the voltage at the non-inverting (+) input is a few millivolts greater than that on the inverting (−) input, the output will go high. Likewise, if the voltage on the inverting input is the greater, the output will go low.

There are limitations to the size of the voltages which may be compared. For the LM339, input voltages should be less than supply voltage (V)— 1.5V. Furthermore, these input voltages should be much greater in magnitude than a few millivolts, to swamp out measurement errors due to the inherently imperfect nature of the comparator itself. Between these extremes a comparator can give a very accurate answer to the question, "Is the unknown voltage above or below the reference voltage?"

The LM339 incorporates four comparators on a single chip. If one input of each comparator reads some common, unknown, voltage, while the other four inputs connect to different reference levels, then the size of the unknown voltage can be estimated by observing the output states of the comparators.

Figure 1 shows the LM339 as the

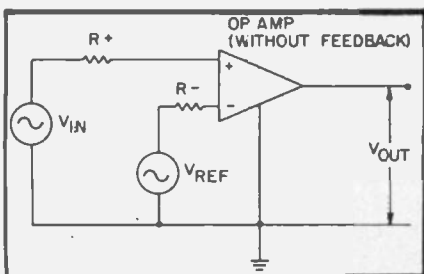

Operational amplifier without feedback has extremely high gain. It can be used to compare an input signal voltage (unknown) with a known (reference) voltage, and indicate clearly (by its output's going to saturation, or by staying at its initial (very low) voltage) that the unknown voltage is either below or above the reference voltage. This makes it a "comparator."

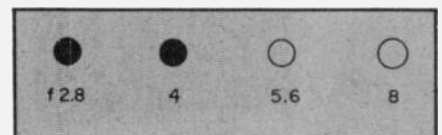

This is the way the LED readout of the Lone Ranger would look if the amount of light being measured was enough for a camera opening of F-stop 5.6. The two LEDs at the left are dark, the two on the right are lit up.

LONE RANGER LIGHT

heart of a light meter. All the inverting inputs go to the junction of PC1 and R1, and thus sense a voltage whose magnitude increases as the intensity of the light being measured increases. C2 bypasses any interference caused by fluorescent lighting in the vicinity. The non-inverting input of each comparator goes to a reference voltage,

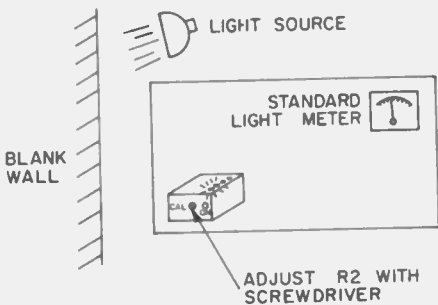

This is the setup you use to calibrate the Lone Ranger light meter. You'll need to borrow an old-fashioned (analog) light meter for this procedure.

with section A connected to the lowest reference voltage and section D to the highest. Consequently, in very dim light all four comparator outputs will be at cutoff, hence all four LEDs will be extinguished.

As the light intensity increases, section A will be the first to change state (rise toward saturation) and thus cause LED1 to light. At higher intensities LED1 and LED2 will both be turned On. The reference voltages I used were chosen to correspond to differences in lens aperture of one f/stop. Thus, a display like the one shown here would indicate that the correct photographic exposure is between f/4 and f/5.6.

Extending the Meter's Range. Notice that in contrast to the continuous readout of an analog meter, this comparator system of voltage measurement indicates proper exposure as being between two levels. In order to get better reso-

lution (more detailed information as to lens opening) we would need more comparators. We would also need more comparators if a larger measurement range is desired. To accomplish such a range expansion we could add another LM339—inputs 4, 6, 8, and 10 would go to the junction of PC1 and R1, while pins 5, 7, 9, and 11 would go to new (added) reference voltages. However, there is a cheaper method of range expansion. We simply install a variable aperture in front of the photocell. In this way the measurement range of the photometer is doubled to 8 stops, by using two apertures whose areas are in the ratio of 16:1. This is the scheme I adopted for Lone Ranger.

The total measuring range of this instrument thus spans from f/2.8 to f/32 with ASA 125 film (such as Plus-X) at a shutter speed of 1/30th second. Later on we'll discuss the simple mathematical conversion necessary to allow use of the light meter with different film speeds and different exposure times.

Building Lone Ranger. Actual construction of the Lone Ranger meter is non-critical, but will require some care because of its small size. A printed circuit board was used in my Lone Ranger prototype, and although it is not neces-

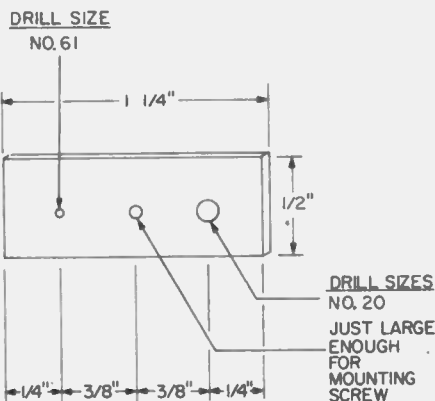

Dimensions of the range-extender for Lone Ranger are shown above. It's a simple piece of aluminum with two different-size holes in it. The middle hole is for mounting the strip to the front of Lone Ranger.

sary that you use the printed circuit, it would be wise to copy the same general layout as the prototype. My Lone Ranger is housed in a 3 1/4 x 2 1/8 x 1 1/8-inch plastic minibox. If you use the same box, note that the mounting post in the upper-right-hand corner must be removed to make room for S1. A soldering gun with a cutting tip was used to slice out the mounting post, leaving three posts to hold down the metal cover of the box. If you are inexperienced in small-scale construction, by all means use a larger box. Regard-

WRAP BLACK ELECTRICAL TAPE AROUND CELL PERIMETER TO BLOCK STRAY LIGHT

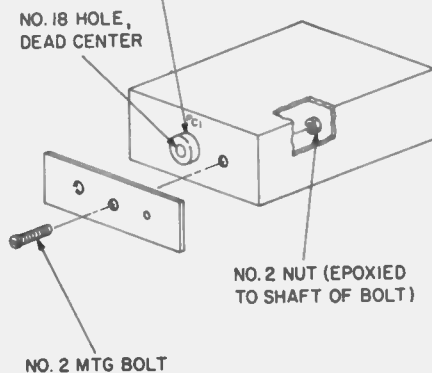

Here are the details for mounting the range extender to the front of the case, and for taping around the photocell to keep it from receiving stray light which can cause misreading of the ambient light.

less of the box size used, however, the following construction details given will still apply.

When the board has been completed, mount the IC socket, trimmer R2, and all resistors and capacitors. Next, solder the negative lead from the battery clip to its hole near pin 12 of the IC socket. Solder a 2-in. length of flexible wire to the hole indicated in the upper-right-hand corner of the board. This wire will later be connected to S1. Now mount the photocell so that its light-sensitive face is perpendicular to the board and facing toward its upper border. Finally, mount the four LEDs into the circuit board, but be sure to observe proper orientation. The tops of the LEDs should all extend the same distance above the board—about 7/8-in. if you have a cabinet of the same depth. Now plug IC1 into its socket and set the board aside temporarily.

The range selector is just a simple aluminum plate (about 18 gauge) with the dimensions shown in the diagram. Note that two holes, one #20 and one #61, must be carefully drilled. Further note that the plate must be absolutely flat. Don't cut it out with tin snips. Use a nibbling tool or hacksaw, which will cut the aluminum without distorting it. Now use a file to round off all the edges, and then buff it with steel wool. This will make the range selector rotate readily when you're out shooting.

More On Construction. The drawing of the cabinet shows how to mount the photocell relative to the range selector. When the proper holes have been drilled, mount the range selector with #2 hardware and tighten until the fit is just snug. Use a drop of epoxy to

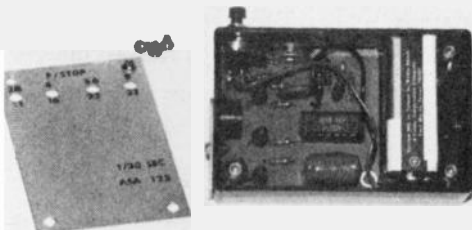

Here's how author's Lone Ranger looks inside. To keep it small, make a printed circuit board like his. Perf board is OK too, but requires bigger box.

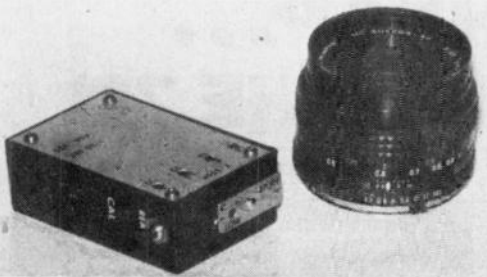

Lone Ranger light meter is about the size of a good lens, as shown here (Pentax Rokkor $f=1.7$, 50 mm).

lock the nut to the shaft of the bolt, and let the cement dry.

S1 may be placed wherever it is convenient. Be sure to drill a hole to allow calibration-adjustment of trimmer R2 from the outside. Now locate and drill four holes in the cover to allow the LEDs to be visible. The exact location of these holes will depend upon the dimensions of your case and the dimensions of your board. Simply insert the board into the bottom of the box and measure how far from the sides each LED's center is located. Transfer these dimensions to the cover and drill four #22 holes.

Mount the board in the cabinet so that the photocell lies directly behind and flush against its mounting hole. If you used the same size box as I did the 1/4-in. spacers will be needed between the board and the bottom of the case to allow the LEDs to protrude slightly through the thin metal cover. After the board has been securely mounted, take a 1/4-in. wide, 1 1/2-in.-long strip of black electrical tape and wrap it around the perimeter of the

(Continued on page 99)

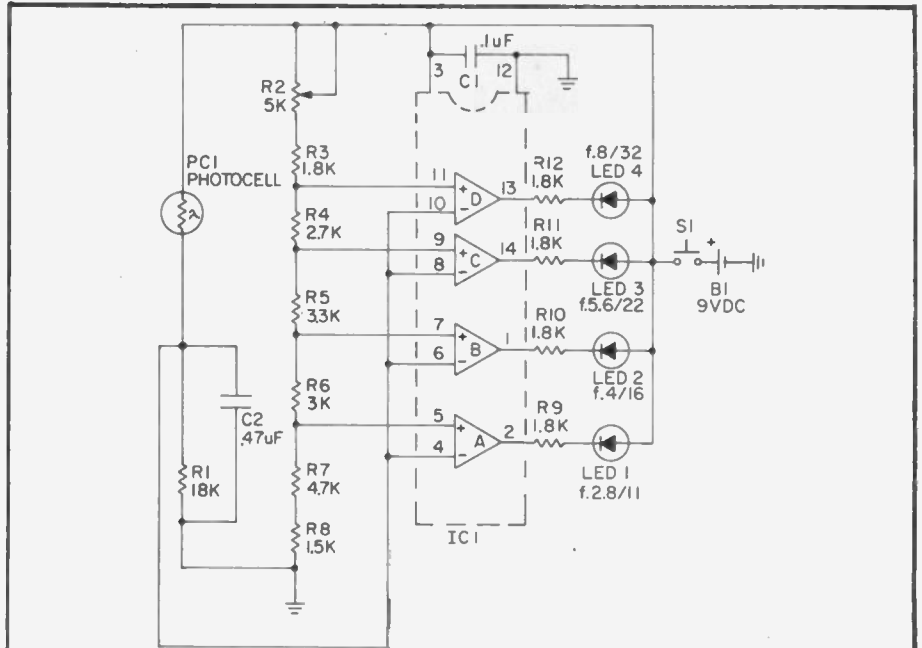

LONE RANGER PARTS LIST

- C1—1-uF capacitor (Radio Shack 275-135 or equiv.)
- C2—.47-uF capacitor (Radio Shack 272-1071 or equiv.)
- IC1—Quad comparator integrated circuit LM 339 (Radio Shack 276-1712 or equiv.)
- LED1,2,3,4—Light-emitting diodes
- PC1—Cadmium sulfide photocell (Radio Shack 276-116 or equiv.)
- R1—18,000-ohm, 1/2-watt resistor (Radio Shack 271-000 or equiv.)
- R2—5,000-ohm potentiometer, printed circuit board-mounting (Radio Shack 271-217 or equiv.)
- R3,9,10,11,12—1800-ohm, 1/2-watt resistor (Radio Shack 271-000 or equiv.)
- R4—2700-ohm, 1/2-watt resistor (Radio Shack 271-000 or equiv.)
- R5—3300-ohm, 1/2-watt resistor (Radio Shack 271-000 or equiv.)
- R6—3000-ohm, 1/2-watt resistor (Radio Shack 271-000 or equiv.)
- R7—4700-ohm, 1/2-watt resistor (Radio Shack 271-000 or equiv.)
- R8—1500-ohm, 1/2-watt resistor (Radio Shack 271-000 or equiv.)
- S1—SPST momentary on switch (Radio Shack 275-609 or equiv.)
- Misc.—Minibox 3 1/4-in. x 2 1/8-in. x 1 1/8-in. (or larger) (Radio Shack 270-230 or equiv.), socket for IC1 (Radio Shack 276-1999 or equiv.), 9-VDC transistor radio battery (Radio Shack 23-464 or equiv.), clip for battery (Radio Shack 270-325 or equiv.), wire solder, printed circuit board kit, etc.

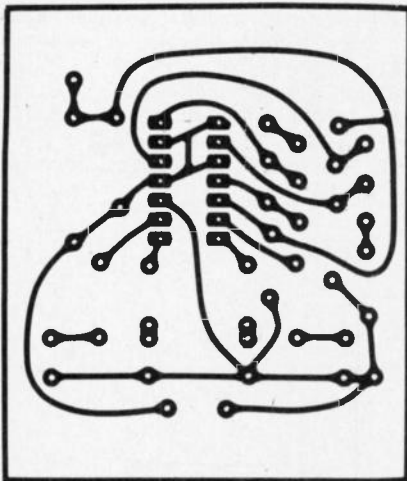

This is a full-size template for the printed circuit board, if you want to make yours just like the author's. See the text for suggestions on making printed circuit boards if this is your first.

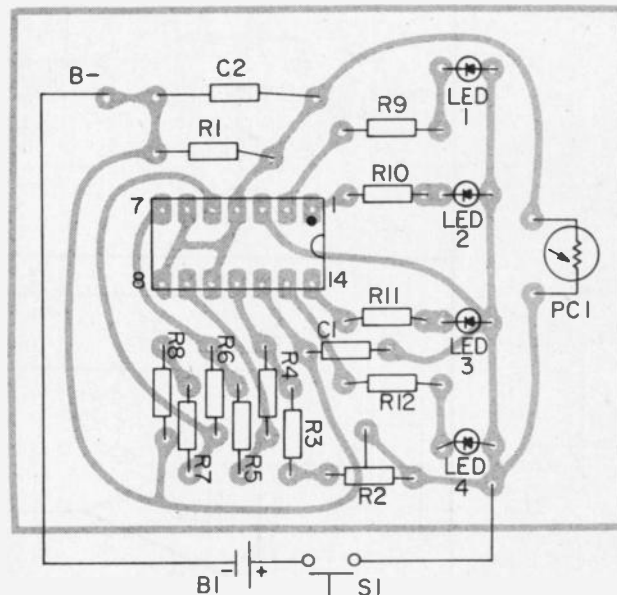

Placement of parts on Lone Ranger's printed circuit board. If you use perf board instead you can put the parts wherever you want, but you'll find this general arrangement most convenient.

BUILD IT FAST AND CHEAP... AUDIO FUN-DAMENTALS WITH THE 741

TELEPHONE VOICE

□ The "telephone voice" effect is usually created by passing a voice signal from a high quality microphone through a bandpass amplifier—a device that attenuates the frequencies on both sides of a selected frequency. Bandpass amplifiers are also effective at providing mid frequency boost—presence, as it's called in hi-fi terms.

The center frequency of this bandpass amplifier is determined by the values of C1, C2, C3, R2, R3, and R4. The exact frequency can be determined from the formula shown. To start, assign a value of 100,000 ohms to R2 and R3 (use ½-watt resistors). To avoid hum pickup, the unit should be assembled in a metal cabinet. Potentiometer R1 serves as the Q-control; it determines the degree of boost at the center frequency.

R5 connects to the non-inverting (+) input of the IC, R1 between ground and the inverting (-) input. No pin connections are given because the IC is available in many different configurations.

Of course, you could find a carbon microphone "button" and matching transformer to create the effect naturally, but that's not how it's done in the big city, bub!

PARTS LIST FOR TELEPHONE VOICE

C1, C2, C3—(C1 equals C2 equals C3, see formula)

IC1—Type 741 opamp

R1—10,000-ohm pot

R2, R3—(R2 equals R3, see text)

R4—R4=R2/12

R5—10,000-ohm, ½-watt resistor

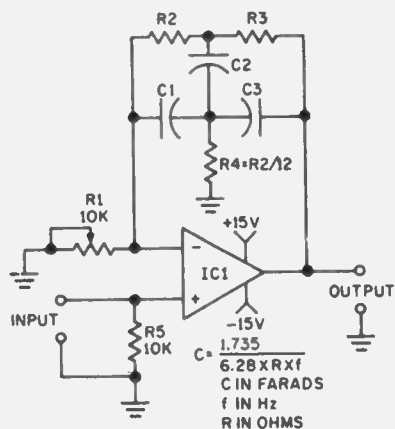

MAG TAPE AMP

□ From time to time surplus dealers offer complete tape or cassette mechanisms—everything ready-to-go except for the electronics, and at rock-bottom prices of \$10, \$15 or \$20. Often, all the mechanism needs is this equalized tape head preamplifier.

Though the power supply is rated at ±15 VDC, almost optimum results will be obtained with supply voltages as low as ±7 VDC. Two ordinary 9-volt transistor radio batteries will power the preamp for many hours.

As with all these projects, the 741IC is internally compensated and no special wiring practices are needed; the preamp can be built in just about any enclosure.

PARTS LIST FOR MAG TAPE AMP

C1—22-μF electrolytic capacitor, 25-VDC or better

C2—0.005-μF disc capacitor, 25-VDC or better

C3—0.01-μF capacitor, 25-VDC or better

IC1—Type 741 opamp

R1—100-ohms, ½-watt resistor

R2—100,000-ohms, ½-watt resistor

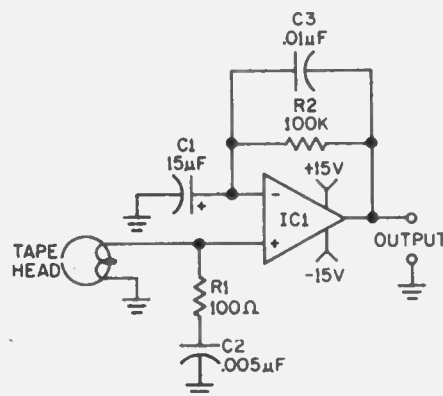

PARTS LIST FOR RC FILTER OSCILLATOR

C1, C2, C3—0.005-μF, 75-VDC (Radio Shack 272-130 or equiv.)

C4—0.1 μF (see text)

IC1—741-type operational amplifier (Radio Shack 276-010 or equiv.)

R1—10,000 ohms pot

R2, R3—47,000-ohms, ½-watt

R4—3,900-ohms, ½-watt

R5—10,000-ohms, ½-watt (see text)

R6—Potentiometer, 100,000-ohms, audio taper (see text)

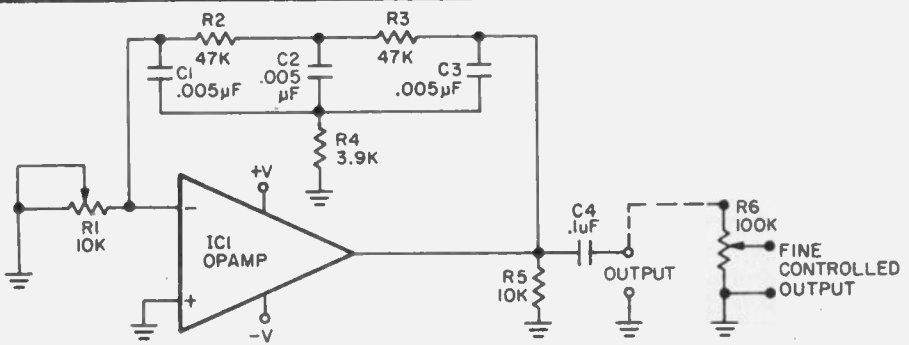

□ An experimenter has many uses for a basic 1000-Hz oscillator. If you're an experimenter you know how many and can make up more. Even audio buffs find an increasing interest in test signals for speaker balance and phasing. In this circuit, a resistor/capacitor filter tuned to 1000 Hz is connected between input and output of IC1 to sustain selective (1000 Hz) feedback. It's suitable for testing audio equipment, signal tracing or tape recorder bias adjustments.

The 1-kHz "notch filter" from the amplifier output to the inverting or negative (-) input determines the output frequency. Non-inverting or positive (+) input is grounded. The power supply is bi-polar; use any voltage up to ±15 VDC. While resistor R5 is not needed, in many instances its use insures your project's success.

If fine output control is desired, add potentiometer R6. When your oscillator is connected to a DC circuit, connect a DC blocking capacitor in series with R6's wiper arm. If the oscillator is to drive circuits of less than 10 k-ohm impedance, substitute a 1 μF non-polarized capacitor for C4, rated to the power supply's voltage.

**BUDGET'S
Best Buy**

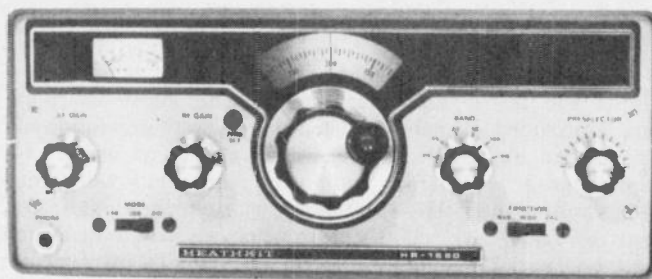

Heath's Hot New HR-1680

STATE-OF-THE-ART RECEIVERS often carry astronomical prices, but Heathkit has helped to bring ham radio costs back down to Earth with their hot little HR-1680 SSB/CW receiver. This item is the first to be released in a proposed line of equipment, which just may become a standard of reference as to excellence in a Novice/CW/Beginner station.

Priced at \$199.95 in kit form (mail order price) the HR-1680 features coverage of the 80, 40, 20, 15 and 10 meter bands in 500 kHz segments (10 meters, to 29 MHz, in two bands), dial calibration in 5 kHz intervals that can be estimated with moderate accuracy to 2 kHz, double conversion using a crystal controlled first local oscillator for low drift (spec'd at less than 100 Hz on all bands), a crystal filter, an ultra-selective audio filter for CW, a 100 kHz crystal calibrator with a means for mechanically re-calibrating the dial to match the calibrator, and inputs for transmitter control. The transmitter control circuits are a sidetone input and

a mute. Sidetone from the CW transmitter is fed directly into the receiver's volume control wiper so it is automatically heard when the transmitter is keyed. The mute is activated by a simple ground which can be provided by an extra (grounding) circuit on the transmitter's T/R switch or T/R relay.

The receiver is housed in a cabinet 12¾-in. high x 6¾-in. wide x 12-in. deep. It is normally powered from the AC mains through a voltage regulator, though there is a 13.8 VDC power socket on the rear apron that permits portable operation from an ordinary auto battery. The rear apron also contains phono type jacks for the speaker output, sidetone input, mute control, the antenna, and a spare (unconnected).

The front panel has a tuning control with a special recess that allows the dial to be comfortably spun at high speed with a finger, a band selector, preselector tuning control, RF gain control, AF gain control/power switch, mode switch (LSB, USB, CW), and a function switch that provides for *wide* (standard) audio selectivity, *narrow* audio selectivity, and *calibrator on*. The front panel also has a phone jack, S-meter, and a push-button labeled *zero set* that permits the dial to be "zeroed" to the calibrator.

Circuits Galore. Though the HR-1680 handles like any other receiver there's a lot of modern design that insures long-term stability. For example, the

bandswitch does not switch any RF; rather, it simply applies voltages to diodes which are in turn used as switches to change RF coils, and crystals in the high frequency oscillator. In this way the switching is done right at the associated circuit with no need to run "hot" RF wiring to the band switch. The improvement in operation is evidenced by a relatively inexpensive receiver free from objectional spurious radiations.

The RF input is an FET, as is the first and second mixer. The FETs handle unusually high input signals without overload and its resultant cross-modulation, and they permit the use of ordinary parallel-resonant (non tapped) circuits, providing optimum "matching" and tuning.

The audio selectivity is provided by operational amplifiers in an active band-pass filter arrangement. AGC is derived from the audio signal, as is the S-meter reading.

Construction. The HR-1680 is a roomy relief from the modern nightmare of kits which call for a shoehorn during final assembly. Every circuit section is on a separate printed circuit board which generally plugs into connectors on an unusually heavy chassis. The critical PC boards, such as the front end and oscillators, are additionally secured by screws to supports so there can be no movement caused by external shock and vibration to the cabinet.

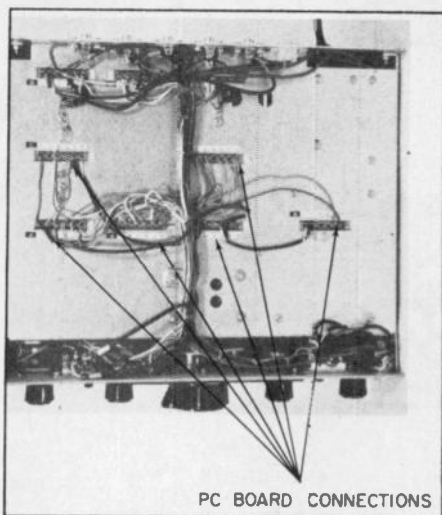

The underside of the main chassis is similarly wide open. Most of what's there is the main wiring harness and its connections to the PC board connectors.

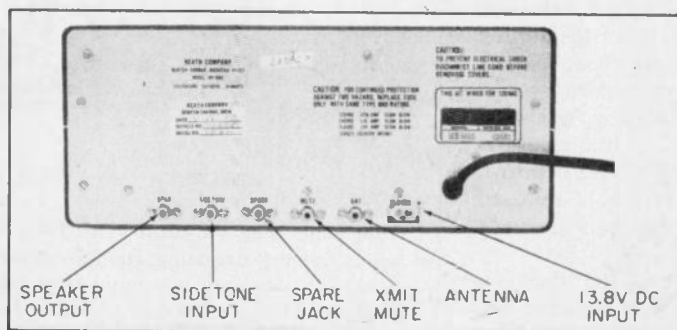

The rear apron of the HR-1680 presents a clean and functional layout. The receiver may be powered from a 13.8 VDC source, there are phono jacks for speaker output, transmitter sidetone, transmitter muting of the receiver, a spare jack is also furnished to accommodate user modifications.

Hot New HR-1680

To permit convenient tests and adjustments a set of extenders is provided which allows the builder to extend the critical PC board above the chassis.

As shown in the photographs the chassis layout is wide open; there's virtually no tight corners and no special mini-tools, clamps, or holders are required for final assembly. It goes together like those big tube-type kits from "the good old days."

Operating the controls. There is nothing unusual or confusing about the HR-1680's operation. To tune a station you simply select the desired band, adjust the preselector for maximum signal or noise, set the mode switch to LSB, USB, or CW and tune. The mode switch automatically sets the attack and release time for the AGC. In both side-band modes the attack time is less than 1 mSec with a release time of about 1-second. In the CW mode the release time switches to 100 uSec.

If you are receiving a CW signal being strongly interfered with you can shift to extremely narrow audio selectivity by moving the function switch to *NAR* (narrow). In this position the center, or pass frequency is 750 Hz with a bandwidth of only 250 Hz 6 dB down, 2.5 kHz 60 dB down. As you can imagine, tuning gets very critical for just a slight touch of the tuning knob can shift the desired station right out of the passband. But, when the QRM gets really rough, the extreme selectivity can pull the desired station right out of the pile-up.

Finally, we come to the *zero set* for the dial calibration, a clever mechanical device that works a lot better than it reads.

Pushing the zero set button on the front panel locks the dial but permits the tuning knob to adjust the local (tuning) oscillator. To calibrate at 100 kHz check-points the function switch is set to *CAL* (100 kHz oscillator on), the tuning knob is adjusted so any 100 kHz dial mark is directly under the hairline cursor, and the zero set button is held down to lock the dial while releasing the tuning adjustment. Then the tuning knob is adjusted for "zero beat" in the speaker or phones, or a more precise alignment can be made by adjusting the tuning knob until a frequency of approximately 500 to 1000 Hz is heard. When the zero set button is released the dial is automatically "reconnected" to the tuning drive.

Overall Performance. The final result here depends on how well the kit-builder has done the alignment. First

we followed Heath's method for not using a VTVM or signal generator. The performance was good, and would probably please all but the most discriminating listener. We then followed Heath's plan for alignment using external equipment, and that's when the HR-1680 really started working!

Every parameter we could measure met or exceeded Heathkit's own specifications: The frequency stability before warmup was the 100 Hz/hour specified, and the stability, once things were settled in, exceeded the specs of receivers costing many more dollars; we found the dial accuracy to be easily estimated even closer than the 2 kHz Heath advertised; and the dial backlash seemed virtually non-existent.

The HR-1680 is more than worth the modest price Heathkit has given it. Not only is it one of the best novice receivers around, but it's a great deal of fun to build.

Extra! Just as we went to press, Heathkit announced in an exclusive interview with the editors of *ELEMENTARY ELECTRONICS* that they will soon be releasing the HX-1675—a matching

transmitter for the HR-1680.

The HX-1675 will feature the same styling and dial mechanism of the HR-1680, and will be completely solid-state. Though it is still on the Benton Harbor drawing boards, specifications so far show that it will be CW-only, 75-watt input, 80-10 Meters.

One of the nicest tidbits Heath plans on building into the HX-1675 is full broad-banding. This will eliminate much of the tuning-up chores associated with less state-of-the-art designs.

Another feature that Heath's engineers plan on incorporating is that of diode switching. This removes all possibility of RF getting into the band-switch and, thus, improves the purity of the transmitter's performance.

Heath will have to go some to match the performance characteristics of the HR-1680 receiver, but it looks like the HX-1675 transmitter will make a fitting match. If so, and there seems no reason not to think so, this could be the finest 'first-station' any Ham ever loaded into a wire!

For additional information circle No. 31 on the reader's service coupon. ■

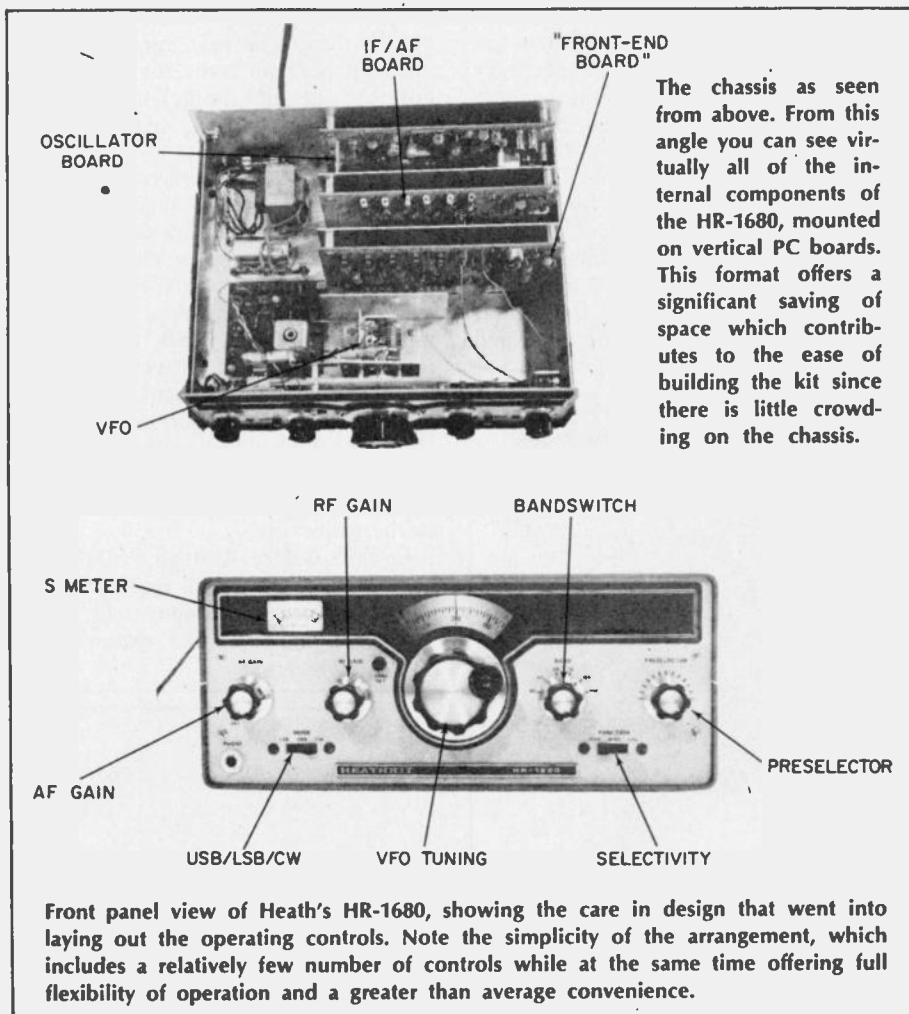



STUDY YOUR WAY INTO THE BIG MONEY IN ELECTRONICS

by Jorma Hyypia

Enrolling in a correspondence course to train yourself for a career in electronics could be one of the most important moves you will ever make. Be sure to pick the right school and best study program for your needs.

YOU'VE SEEN the ads many times, and you will see them again in this very publication. "Step into the digital age," they coax. "Don't envy the man with skills in electronics . . . become one!" "Prepare now for a rewarding career in electronics," they beckon. And you are sorely tempted to at long last take that big step and sign up for a course that will free you from your present drab, low-paying job with no future. Boy! Won't it be sweet one day to tell you boss what he can do with his . . . (you complete the sentence).

If you aren't yet fully convinced that a correspondence course in electronics is your escape hatch to a better future, you might be thinking: "What the heck, even if I don't go all the way, I'll at least get myself a new color TV set and enough training to keep it in good shape." If that's the best argument you can muster, back off and re-think your plans. If you are willing to settle for a

TV set "if things don't work out," you'll save money in the long run by just buying a set from your nearest dealer and letting professional servicemen take care of it; you can buy a lot of service with the money you will save by not wasting it on a correspondence course that is the wrong one for you. However, if you pick the right course, for the right reasons, you may truly be on the way to the kind of career the school ads offer. You won't find any pat answers to questions like "Which school is best?" in this article because there are no such answers to give. Every prospective student has different personal needs to satisfy, so each must decide for himself what training will best meet those needs at lowest possible cost. However, we can point you in the right direction by underscoring some of the things you should evaluate as you pore over the fascinating promotional brochures that the various correspondence schools are

eager to send to you.

Bucket of Parts. The lure of kit building is undeniable, and the schools see to it that you are made aware of the mouth-watering kits you will build, including a yours-to-keep color TV set. Practical hands-on kit assembly and electronic experimentation is indeed an important part of a good training program, but you must be aware that kit-building cannot be a substitute for basic book learning. The schools can make the learning of theory as easy as possible by use of carefully prepared texts, but you will still have to work to grasp and remember the fundamentals that you *must* acquire to become a professional in any electronics field.

The building of a color TV set can be a very worthwhile part of your training if you are aiming for a career in TV repair or some related field. For certain other career objectives such set building would be a waste of time and money,



Some of the ads for electronics correspondence schools are shown above. As you can see, many of them feature big-size color TV kits, as well as various other pieces of electronic equipment—from simple to sophisticated—for your training use. Some of the schools feature tear-out cards in their ads to make it easier for you to get various catalogs, course offerings, and other information right away. Which school is right for you? It's easy to find out!

SCHOOL DAYS PAY

and in fact you would not get the set with such study programs. You should also know that your school probably won't ship the TV set, if it is included in the course, until you have progressed far enough to have paid at least 75 percent of the cost of the program—in which case you are by then *obligated* by contract to pay the *full* course fee whether or not you complete the course. So there's no way you can go "just far enough" to grab a TV set and then pull out—except at a stiff price.

If you read the promotional literature of competing schools carefully, you will detect the in-fighting that has developed around the TV bit. While one school emphasizes that you will get a "complete" TV, rather than a stripped down version used only for teaching, another school proclaims that it doesn't stoop to using "hobby" type TV kits, but instead uses a TV set specially designed to aid in the teaching process. So there you have it—the same situation argued from two points of view to draw diametrically opposite conclusions. If you want the most for your tuition money, do your best to find out—in advance of signing the contract—just how thoroughly the TV set building is integrated with the teaching of both electronic theory and TV troubleshooting. If all you do is put together a kit without direct correlation with textbook learning, you gain precious little practical experience from all the work except the ability to plug things together and solder A to B in follow-the-directions cookbook style. You don't need a course in electronics to do that; just buy a kit and soldering iron.

We should qualify these comments about kit-building when dealing with test instruments. Here again you hope to learn some theory through the kit assembly process; but even if you don't, you are at least putting together instruments that you will be able to use in practical manner to test and troubleshoot electronic equipment.

Finally, don't be swayed too much by the numbers game sometimes used to suggest that "our" course offers more fascinating "experiments" than does some other school's course. You will undoubtedly perform 200 or some other number of experiments if the school in question says so, but not all of the experiments will involve the use of sophisticated electronic equipment. Some of the experiments will require the use of very simple pieces of equipment—a magnet and some iron filings, for example.

This does not mean that the simple experiments have no purpose; in fact, you may be learning very important electronic principles through such experimentation. All we are doing here is to warn you not to get too starry-eyed about the presumed truckload of equipment you must need to do so many experiments.

Also note that some schools offer the use of very expensive, specialized equipment needed for some types of course work. You can use the equipment at the school's laboratories, or have it shipped to your home for a week or two, but you must return it within the specified time and pay all shipping and insurance charges. If you can get the same type of equipment on loan locally, you should be free to do so.

How Much Will Your Training Cost?

The usual magazine advertising used by electronic correspondence schools doesn't even begin to reveal, much less describe, the many different types of courses that are available. So don't be surprised that you can pay anywhere from about \$100 for a "basic" electronics course to as much as \$1700 for a course that leads to an engineering degree as well as a diploma. A course

LEADING ELECTRONICS CORRESPONDENCE SCHOOLS

Cleveland Institute of Electronics,
Inc. (CIE)
1776 East 17th Street
Cleveland, OH 44114

Grantham School of Engineering
2000 Stoner Avenue
Los Angeles, CA 90025

National Technical Schools (NTS)
4000 South Figueroa Street
Los Angeles, CA 90037

NRI Schools
McGraw-Hill Continuing Education
Center
3939 Wisconsin Avenue
Washington, DC 20016

International Correspondence
Schools (ICS)
Scranton, PA 18515

Technical Home Study Schools
Electronics Technical Institute Div.
1500 Cardinal Drive
Little Falls, NJ 07424

A letter or postcard to these schools will bring you a quick reply, and all the appropriate information about their programs of instruction.

that involves the building of a color TV set can run anywhere from about \$700 to \$1800.

These approximate quotes are for *cash* payment of the full tuition at the time of enrollment. If you opt for time payments, know exactly how much extra you will pay in interest—in both actual dollars and the *true annual interest* rate (which enables you to realistically compare the time payment offerings of different schools even if the total course fees are substantially different). You will probably be required to keep up regular monthly payments even if you fall behind in your studies. So don't count on slowing down your study program just to avoid putting off a monthly payment when you happen to be financially strapped.

If you pay cash on the barrelhead, you avoid the additional charges. On the other hand, you will lose out on savings bank interest you could be earning on part of the money. Thus, if you have the money to pay cash, figure out how much more you would actually pay using the time payment plan as compared to the cash payment plus lost interest.

If you are a veteran eligible for benefits under the GI bill, be sure to file the necessary applications on time or you could lose out on some payments. After expiration of ten days following your enrollment in a school program (provided by a school recognized by the Veterans Administration, of course), submit a written affirmation of your enrollment with the VA. Don't assume that the school will do this for you. The VA will not authorize payment for any lessons you might have completed before the filing of the affirmation. The VA pays 90 percent of the cost of tuition. You (not the school) are paid quarterly, and the size of each VA check is calculated by multiplying the number of completed lessons by the cost per lesson. This means that you must have the money to pay the school on time, even though you will get 90 percent of it back from VA months later.

Termination and Refunds. The best laid plans can go awry, so know in advance what it will cost you to drop out of your training program at any point along the way.

You are given a brief initial time period in which to examine the first package of course material and send it back without suffering a monetary penalty. Usually this examination period is ten days, but it could be as short as five days, so check it out. After that the amount you are obligated to pay depends on how much course material has been sent to you. A typical con-

dition involves the payment of \$50 or 10 percent of the total tuition charge (whichever is the smaller amount) as a "registration fee," if you drop out after the initial free examination period but before any assignment has been graded by the school. If less than a quarter of the program is completed, you pay the registration fee plus 25 percent of the total tuition. If you've completed more than 25 percent but less than 50 percent of the program, you pay the registration fee plus 50 percent of the tuition. If you have completed more than half of the program when you decide to quit, you are obligated to pay the full tuition. Also bear in mind that you would be obligated to return any unused equipment and pay for the insurance and shipping charges.

Be sure to check out the actual contract conditions specified by the school you choose. Also bear in mind that even when a school uses a refund plan much like this one for most of the offered courses, the refund may be substantially less if you happen to enroll in one of certain "introductory" courses having relatively low tuition fees.

Some schools will give a *full refund* even after you have completed one of the courses designed to prepare you for an FCC First Class license. If you fail to pass the government examination, after graduation from the school, you may be entitled to a full refund. But watch the conditions because they are not the same for every school. The time in which you can take advantage of the refund opportunity may be as short as 90 days or as long as six months. One school insists that you try again, after undergoing additional no-charge training specified by the school, at a location also specified by the school. If you still can't pass the FCC exam, you get the refund.

No Job Guarantees. Aside from the just-mentioned warranty concerning the acquisition of an FCC license, offered by some schools but not all, there is no guarantee that you will automatically get a well-paying and exciting new job. No one could possibly guarantee anything like that. The only reasonable assurance you can expect is that your school will prepare you to compete effectively for the jobs that may be available in any given location at a given time, or prepare you to go out and establish your own business with adequate technical preparation (you would still have to acquire management and other business skills if you work for yourself).

Although we will be living in an "electronic age" for a very long time, it does not follow that job opportunities

will be equally good in all areas of electronic technology. So you should do some thoughtful crystal-balling to determine where your best opportunities might lie about the time you complete a correspondence course. For example, even if you figure that there already are plenty of TV servicemen around, it does not follow that there are enough really *competent* servicemen in all localities; if you excel in this type of work, you will probably find work. And think also about the new technologies that are opening up. There are expectations, for example, that within a few years millions of people will be buying movies on discs much like phonograph records to play them through their TV sets. Someone will have to service all that equipment. Computers are finding new applications constantly. Many libraries now check out books and keep track of book inventories with computers. And Supermarkets are fast moving to use of computerized food checkout systems. So perhaps your best opportunities lie in electronic fields far different from the one you might now imagine. Reading course description contained in the brochures distributed by correspondence



Some of the schools include amateur radio communications equipment kits, such as this Heath HW-2036 VHF FM transceiver.

schools can be a real eye-opener.

Better Than a Pen Pal. You'll need a friend now and then as you work your way through your chosen electronics course. You may already have discovered that one of the most frustrating ways to spend your time is to attempt carrying on an intelligent conversation with someone else's computer. So even if the school of your choice uses computers to check out the answers on your examination papers, be sure that there are real, living and breathing human beings you can turn to for advice when you get bogged down on some technical problem. You may be asked to send your questions to the school by letter; however, at least one school has a toll-free telephone number you can call from anywhere in the U.S. when you want a quick answer to a problem.

One school offers "Saturday Help Sessions" at eight or more locations in

the U.S. which could be very useful if you live near enough to take advantage of them. Or you may be offered "after graduation" classroom training at no extra cost. One school allows you to attend such classes as often as you wish over a period of one full month. You of course must pay your own transportation and living costs if you must travel to another town for the extra training.

In order to attract more students, one school offers to pay you ten bucks for every "friend" you can talk into taking a correspondence course in the same school. It's pointed out that if you and a friend take a course at the same time, you can bounce ideas back and forth to clear up technical points and increase the fun of learning. There's much to be said for this work-with-a-friend idea, even if the friend insists on taking a course offered by another school. In fact, there might even be some advantages to the different-school approach because if school A doesn't make a particular concept crystal clear, school B might do better—and vice versa.

Throughout your training you will be filling out periodic examination papers to test your learning progress. You will do this at home where you can refer to your study materials. For this reason, a future employer isn't likely to be too impressed by the grades you get on the tests, and will want some additional proof that you really do know your stuff. So if your school provides an opportunity to take a *supervised* final examination after completion of the course, by all means take advantage of it if at all possible. Not only do you have something more meaningful to show a prospective employer but, even more importantly, *you* will have a clearer measure of your personal achievement.

Do You Have the Drive? Many students drop out of correspondence training programs for many different reasons. But one of the main causes has to be the failure of some students to objectively evaluate their own personalities and drive. You should be enthusiastic and inspired by real hopes of a better life; but you should not kid yourself, because it will cost you both time and money.

Will you be able to settle down and work on a regular daily basis for many months to achieve your ends without having someone else pressure you constantly? If the lure of the beer parlor or movie theatre is greater than the lure of a new profession, save your money. If you just aren't sure how you would hold up, look around for a school that will allow you to transfer to a regular

(Continued on page 99)

Build a Heat Controller for Your Soldering Iron

By John Keidel and Frank Cicchiello

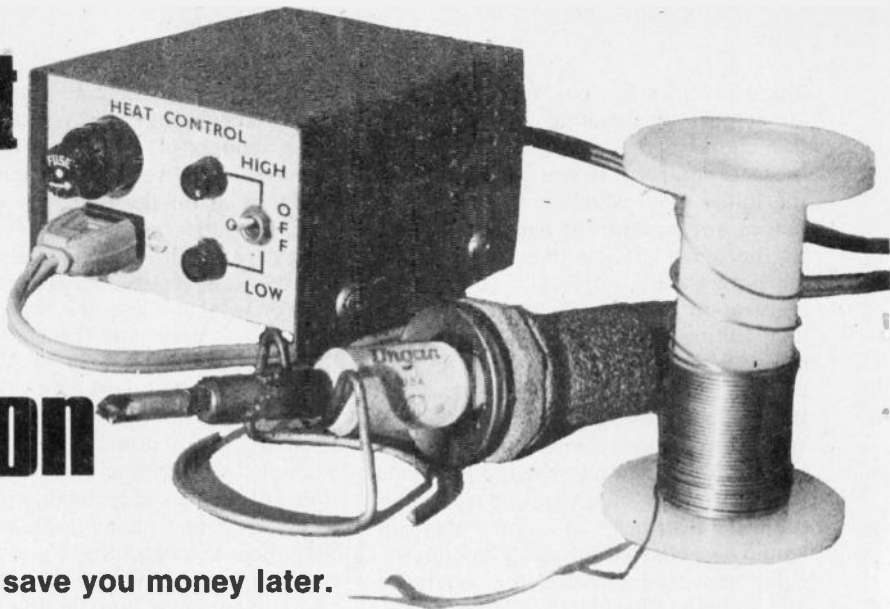

Inexpensive and easy to build, it will save you money later.

One trick that old timers have used for years is to connect a diode in series with a medium-to-heavy duty soldering iron. This halves the value of the iron's wattage rating, making it especially use-

ful for soldering transistors, integrated circuits and low-wattage resistors.

But this arrangement limits the versatility of the iron, since there are times when one may wish to solder to a metal

chassis or make other heavy-duty type connections. The soldering iron Heat Controller described here provides low/high-wattage versatility in a compact case, with a convenience outlet.

How It Works. Diode D1 shown in Fig. 1 provides half wave rectification of the AC line voltage when switch S1 is in the *Low* position. Throwing switch S1 to the *High* position allows full line voltage to be applied to the soldering iron receptacle. The center *OFF* position removes power from the outlet. Fuse F1 prevents any harmful effect if the iron's element should become short-circuited. Indicator lamps I1 and I2 add a professional touch to the equipment, and also act as On-Off pilot lights.

Construction. All components except diode D1 are mounted on the case. Diode D1 is soldered to a terminal strip, which also provides terminal points for the various interconnecting wires. Wiring is point-to-point and not critical. The photo illustrates the location of the components. Transfer letters are used for the individual panel markings.

This is a very easy project, and the hour or so it takes to assemble it (once you've got the parts together) will be quickly repaid by the added convenience of having two different iron heats to work with.

Using the Heat Controller with a 50-watt soldering iron which takes various tips will handle about 95 percent of all your soldering iron work. It's only the very occasional super-heavy job that will require anything else, and that would require a much bigger iron anyhow. ■

Mechanical layout of heat controller. Putting this project together is not only good practice for beginners—it gives you a versatile tool which will make future projects easier.

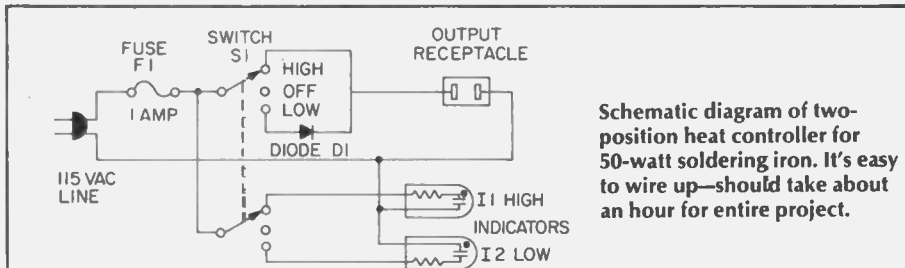

Schematic diagram of two-position heat controller for 50-watt soldering iron. It's easy to wire up—should take about an hour for entire project.

PARTS LIST FOR HEAT CONTROLLER

D1—1-amp, 200-volt silicon diode (Radio Shack 276-1137 or equiv.)

F1—1-amp, fast-acting fuse (Radio Shack 270-1273 or equiv.)

I1, I2—Panel Lamp Indicators, 115-volt AC (Radio Shack 272-1501 or equiv.)

S1—SPDT, Neutral Center, switch (Radio Shack 275-325 or equiv.)

Hardware Items and Misc.—Case 3¼-in. x 2¼-in. x 4-in. (Radio Shack 270-251), 4-lug terminal strip (Radio Shack 274-687), Fuse Holder (Radio Shack 270-364), AC Outlet (Radio Shack 270-642), Line cord with plug, strain relief or grommet, solder, wire.

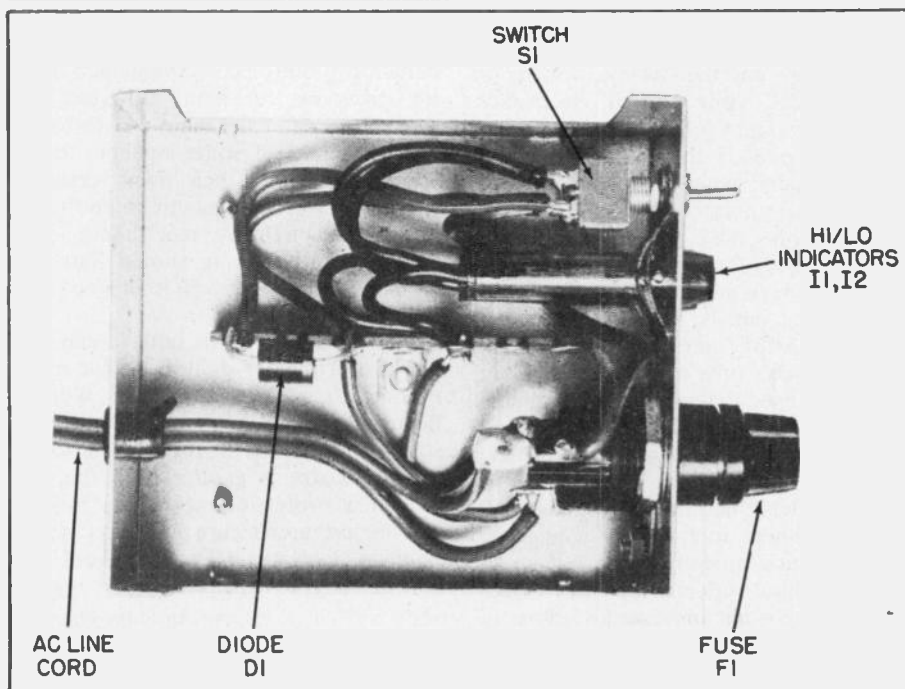

THE JUNK BOX SPECIAL

Power your projects, spend pennies for parts.

by Herb Friedman



Between 555 timers, TTL, CMOS, opamps and run of the mill transistor projects, the average experimenter is often faced with the need for a regulated power supply with a range of about 5 to 15 volts—just to try out a breadboard project. If you've priced any regulated supplies lately you know they don't come cheap. Maybe, just maybe, you might get one for \$30 or \$35.

With a little careful shopping, a reasonably stocked junk box and one or two "brand new" components you can throw together a regulated supply costing less than \$10 that will handle most of your experimenter power supply requirements. One of these Junk Box Specials is shown in the photographs and schematic. The range of this model is 5 to 15 volts DC at currents up to 1 ampere. One of the common, 3-terminal regulators which are now flooding the surplus market provides everything in the way of regulation. Depending on the source, the regulator will cost you from \$1 to \$2.50; the higher prices often include an insulated mounting kit (worth about 25-cents).

5 to 15 volts from one 3-terminal regulator? Correct. If regulator IC1's collector terminal is connected to a voltage divider across the output—R1 and R2—the output voltage will be that at the junction plus the voltage rating of the regulator, which in this instance is 5 volts. So, when potentiometer R2 is adjusted so its wiper is grounded the power supply's output is that of the regulator, 5 volts—perfect for TTL projects. As R2 is advanced, increasing the resistance from IC1's collector to ground, the voltage output increases.

Getting the parts. There are plenty of parts around to build this supply for

under \$10. If you go out and round up "all new" components the cost is likely to go well over \$30, so forget about new parts. Power transformer T1 can be 18 volts at 1 ampere (or rated at higher current, though the supply's maximum output is 1 ampere), or 36 volts center-tapped at 1 ampere or more. Both the 18 volt and 36 volt transformers are glutting the surplus market. If you get an 18 volt transformer use the bridge rectifier shown in the schematic. If you get a 36 volt C.T. transformer use the full-wave recti-

fier shown below the schematic. The diode rectifiers, SR1 through SR4, are type 1N4001, 1N4002, 1N4003, or 1N4004, which are also glutting the surplus market. Just to show you the savings possible, at the time this article is being prepared you can buy fifteen surplus 1N4001s for \$1. Just one single "general replacement" for the 1N4001 from a national supplier is selling for over 40-cents. Get the idea how to save costs on this project?

Capacitor C1 can be anything from 2000 to 4000 uF at 25 volts or higher. Look for an outfit selling surplus computer capacitors. If worse comes to worse you can get the value specified in the parts list in a Radio Shack store.

The 3-terminal, 5 volt regulator is another item easily found on the surplus market. With an adequate heat sink—such as the cabinet itself—the device can safely deliver 1 ampere. The unit shown in the photographs is a Motorola MC7805 (though you can substitute any similar type) obtained for \$2.50 from Circuit Specialists. We have seen similar devices from other manufacturers selling for \$1. The terminals B, C and E are indicated directly on the device or on the terminals—where they join the case. The collector (C) lead is connected to the IC's metal tab, and is normally grounded. Note that in this project, however, the collector terminal, and therefore the tab, is not grounded. You must use an insulated mounting kit consisting of a mica insulator and a shoulder washer. Place the insulator between the IC's body and the cabinet, or the tab and cabinet, and slip the shoulder washer into the opening (hole) in the body or tab. Pass the mounting screw from outside the cabinet through the mica washer, through the IC, and

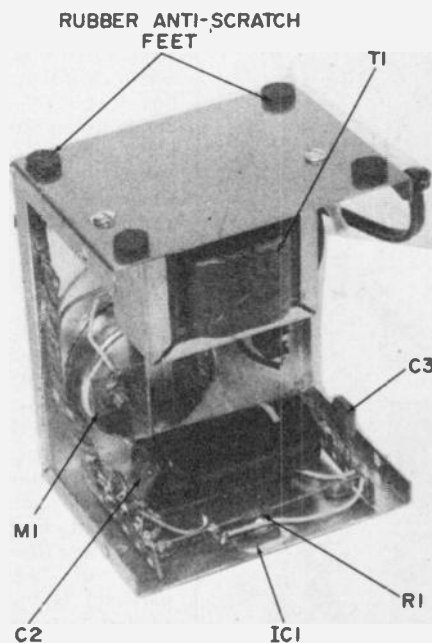

To prevent scratching your workbench apply rubber anti-scratch feet or bumpers on the bottom of the cabinet. They are available in most hardware and houseware stores.

JUNK BOX

through the shoulder washer. Secure with a ¼-inch (or smaller, not larger) nut hand-tightened against the shoulder washer. Before going any further check with an ohmmeter to be certain the collector terminal is insulated from the cabinet.

Connecting wires are soldered directly to IC1's terminal leads; use a heat sink such as an alligator clip on each terminal if you have a large (greater than 40 watts) iron. Since the layout is not important, we suggest the arrangement shown, with IC1 positioned between two mounting strips so R1 can span across the strips and be soldered to IC1's collector terminal.

Finally, we come to the meter, a device that has become slightly more expensive than a barrel of Arabian oil. Any meter that can indicate at least the range of 0 to 15 VDC is adequate. The EMICO 0-30 VDC meter shown in the photographs was selling in one local store for \$7.95, while we bought ours almost down the block as "surplus" for \$2.99. A good source for surplus meters is Fair Radio Sales. You might not end up with a meter case that looks

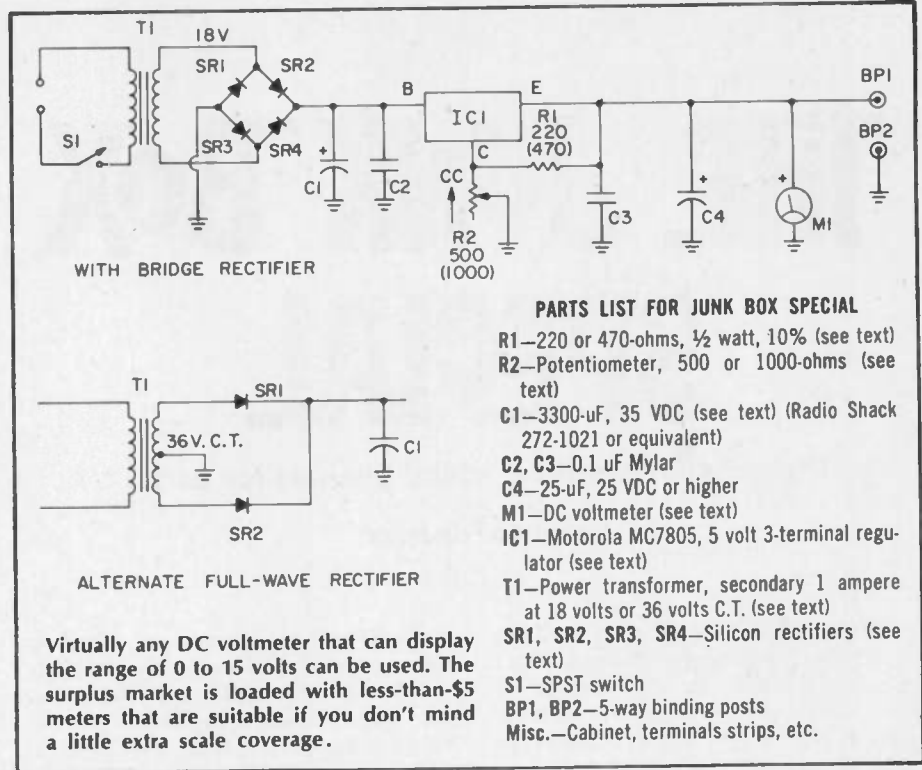

Virtually any DC voltmeter that can display the range of 0 to 15 volts can be used. The surplus market is loaded with less-than-\$5 meters that are suitable if you don't mind a little extra scale coverage.

suitable for NASA, but the output voltage doesn't care two hoots whether the meter is a modern \$25 dollar model or a surplus-special for a buck ninety-nine. Power switch S1 can be a separate

SPST as shown in our project, or it can be part of R2. But keep in mind that a separate S1 allows you to turn the supply on and off without affecting voltage control R2's adjustment.

Finally, we come to R1 and R2. You will note that the schematic shows two values for each. One value for each resistor is in brackets (parenthesis). You can use either set of values as long as they are matched. If R2 is 500 ohms R1 is 220 ohms; if R2 is 1000 ohms R1 is 470 ohms. The reason we show both sets of values is because 500 and 1000 ohm potentiometers appear on the surplus market from time to time, but usually not together. This way, you can use whatever is available at low cost.

CHECKOUT. Set potentiometer R2 so the wiper shorts to the end connected to IC1's collector terminal, thereby connecting the collector directly to ground.

(Continued on page 98)

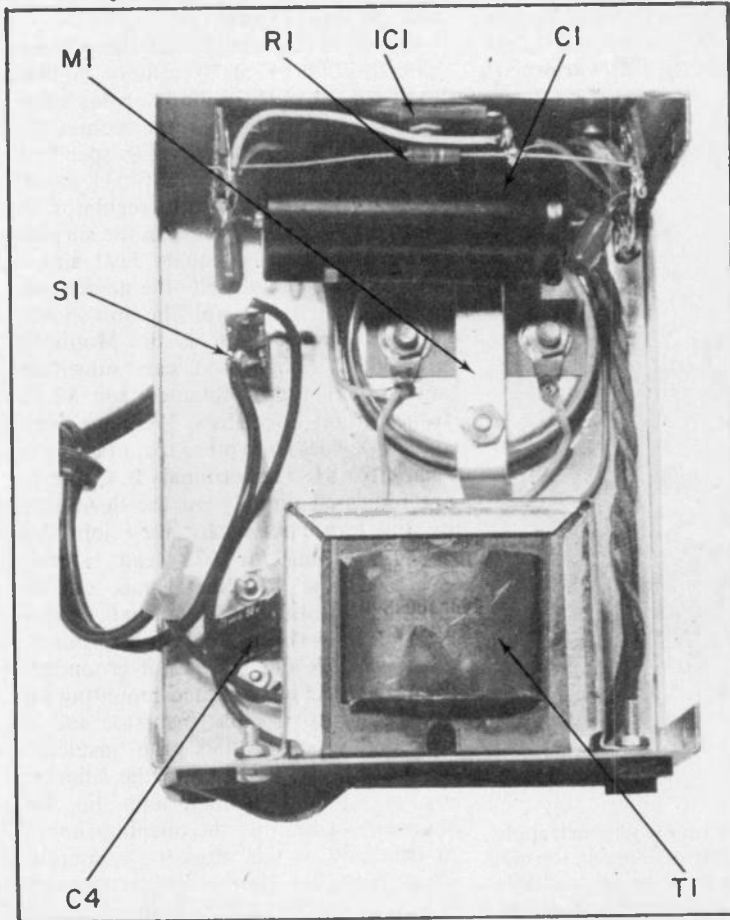

If you've had experience with assembly in tight quarters, you can shoe-horn the power supply into a standard 3 x 4 x 5-inch Mini-box. If your soldering iron is so big it burns adjacent wires when you make a connection, use a larger size cabinet.

In order to handle a full ampere, the IC regulator must be heat sunk to the cabinet. Make certain the collector and its attached sink tab (the back of the package) is insulated from the cabinet. Use silicon grease to insure heat transfer from the IC to the cabinet.

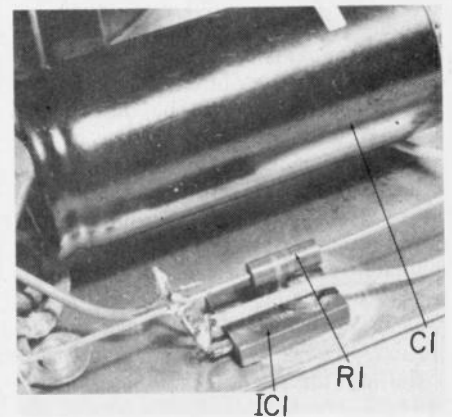

Darkroom Color Analyzer

by Herb Friedman



It's easy to make quality, bright color prints at home with modern color chemistry and this electronic color analyzer!

ONE OF THE SHUTTERBUG'S most satisfying accomplishments is producing his own color prints. For years the time spent on and the cost of making color prints were discouraging, but with modern color chemistry, such as the Beseler system, you can turn out quality color prints *in less time than for*

black and white (about 3 minutes), and the prints will be far superior to anything you're likely to get from a color lab.

One thing that takes the drudgery out of color work—besides the chemistry—is a color analyzer, a device that gives you the correct filter pack and

exposure time at the very first crack. Most often, the very first print made with the analyzer will be *good*. At most, it will take perhaps 0.10 or 0.20 change of filtration for a *superb* print. This is a lot less expensive and time-consuming than making test print after test print. In fact, it's really the color analyzer that puts the fun into making your own color prints!

Color Analyzers Are Not Cheap.

A decent one costs well over \$100, and a good one runs well over \$200. But if you've got even a half-filled junk box you can make your own color analyzer for just the junk parts and perhaps \$10 to \$15 worth of new components.

A color analyzer is basically a miniature computer. You make a "perfect" print the hard way—by trial and error—and then calibrate the analyzer to your filter pack and exposure time. As long as you use the same box of paper and similar negatives, all you need to do to make a good color print is focus the negative, adjust the filter pack and exposure so the analyzer reads "zero," and hit the enlarger's timer switch. Even if you switch to a completely different type of negative, the analyzer will put you well inside the ballpark, so your second print is a winner. (And even if

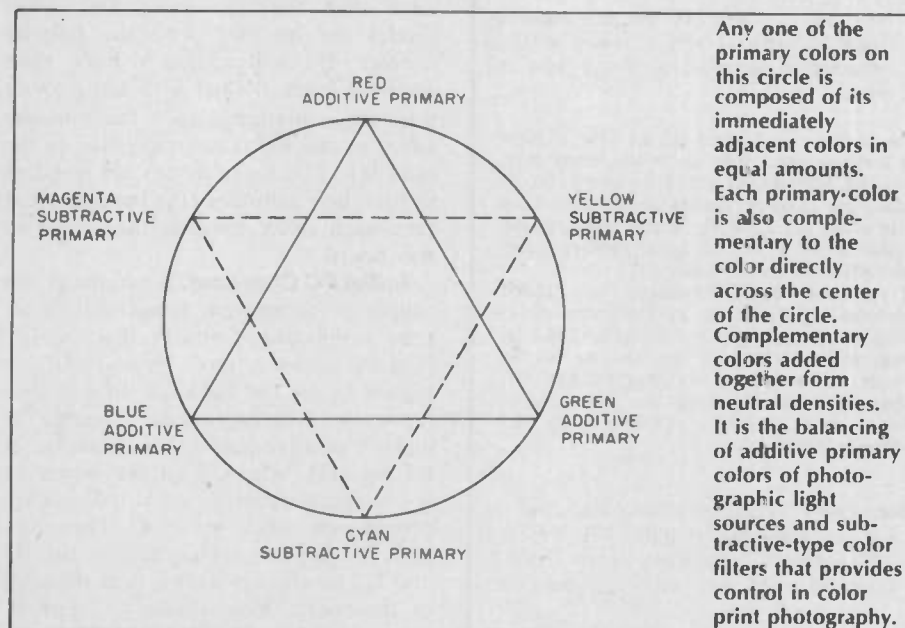

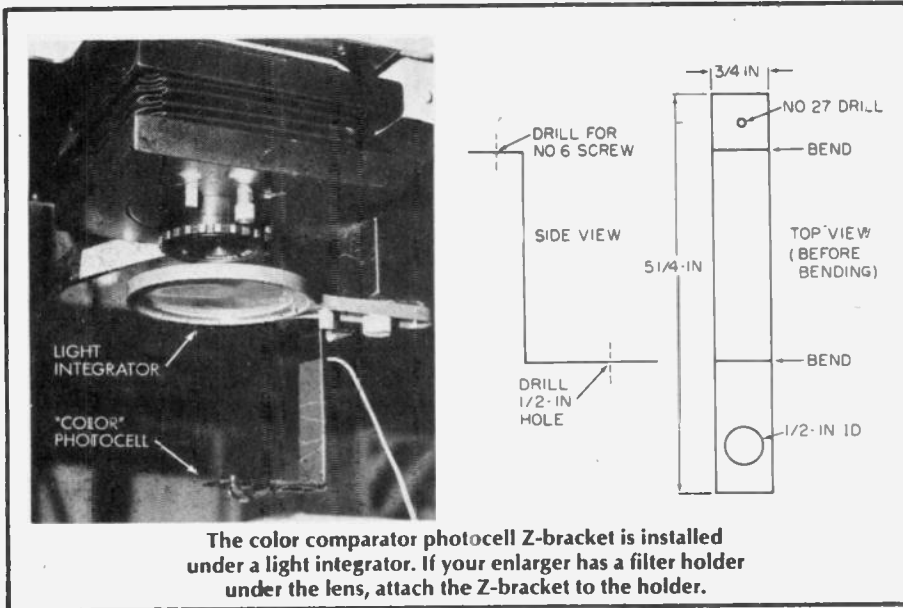

The color comparator photocell Z-bracket is installed under a light integrator. If your enlarger has a filter holder under the lens, attach the Z-bracket to the holder.

are far apart in value, or if the polarity is wrong, make certain you find the mistake *before* installing IC1.

Disconnect the linecord and complete the PC assembly. If you use a 24 or 28-volt pilot lamp to illuminate the meter you connect to the holes adjacent to T1's secondary (24-V) leads. If you plan to use a neon illuminator, install a 100,000-ohm resistor (R9) on the PC board and connect the lamp to the holes marked "neon." The lamp must have as little illumination as possible. Incandescent 24 or 28-volt lamps must be the miniature or "grain of wheat" type rated approximately 30 to 60 mA; the lamps come with attached leads. Do not use pilot lamps of the 100 to 500 mA variety. The excessive light will confuse the analyzer.

To install IC1 when it is the metal can TO5 type, fan out the #1 to 4 leads and #5 to 8 leads so they form two straight lines. Note that the lead opposite the tab on a TO5 package is #8. Insert the leads into the board leaving about 1/4 inch between the IC and the board. The IC is correctly installed if the tab faces *away* from the transformer

towards the nearest edge of the PC board. Solder IC1 and cut off the excess lead length.

The edge of the PC board nearest IC1 has four sets of paired foil terminals. These are provided as mounting terminals if you connect the photocell comparator and sensor without the use of a plug and jack. However, we strongly suggest the use of the specified DIN-type connectors as they allow for easy repairs if the connecting wires break. (The connectors aren't *that* costly).

Potentiometers R2 through R5 can be linear or audio taper, though audio taper gives a slightly smoother adjustment; use whatever you have in stock.

The analyzer shown is built in a Bud 7-inch AC-1613 Universal Sloping Cabinet. This is the least critical item and you can substitute whatever cabinet you prefer. Just be certain the cabinet will accommodate the type of meter you use.

Meter M1 should be 0-1 mA with a zero-center scale. But these are expensive, so you can substitute any standard 1-mA meter you want. You will simply calibrate the instrument for zero-center.

If you use a neon pilot lamp mount it directly above the meter and shield the forward brilliance with a piece of black tape; the lamp should radiate straight down onto the meter scale. If you use the meter in the parts list, remove the front cover by pulling it forward. Then remove the meter scale. As shown in the photographs, place a black dot approximately 3/16-inch wide at the center of the scale. If you want, you can also modify the meter for the incandescent lamp. Drill a 1/4-inch hole in the lower right of the meter *from the rear*. Position the meter in the cabinet and mark the location of the meter hole on the panel. Remove the meter and drill a 3/8-inch hole in the panel. When the meter is installed you can pass a "grain of wheat" lamp through the panel into the meter. Reassemble the meter and complete assembly.

The Comparator. The photocells used for the comparator and exposure sensor, P1 and P2, must be Clairex type CL5M5L. Make no substitutions. From a piece of scrap aluminum 3/4 to 1 inch wide, fashion a Z-bracket to the dimensions shown. Drill a 1/2-inch hole close to the end of the longer Z-leg. Fasten the other end of the Z-leg to your enlarger's under-lens filter holder. If your enlarger does not have a filter

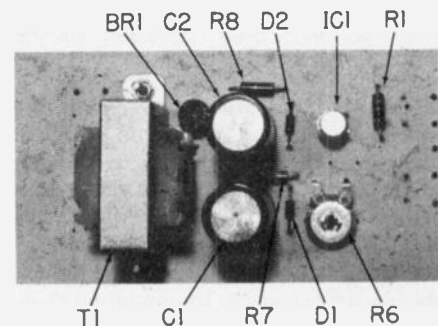

This is the parts location when our PC board is used. To get a free template of the PC board, send a Self-Addressed Stamped Envelope to: Davis Publications, Dept. T, 229 Park Ave. South, New York, NY 10003.

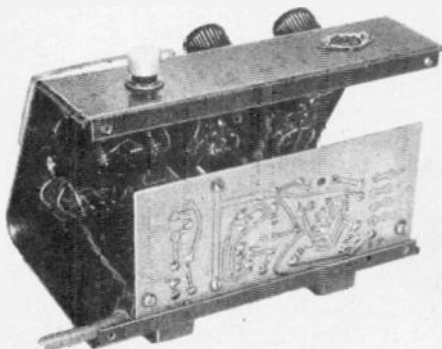

Rear view of author's color analyzer shows vertical mounting of the circuit board.

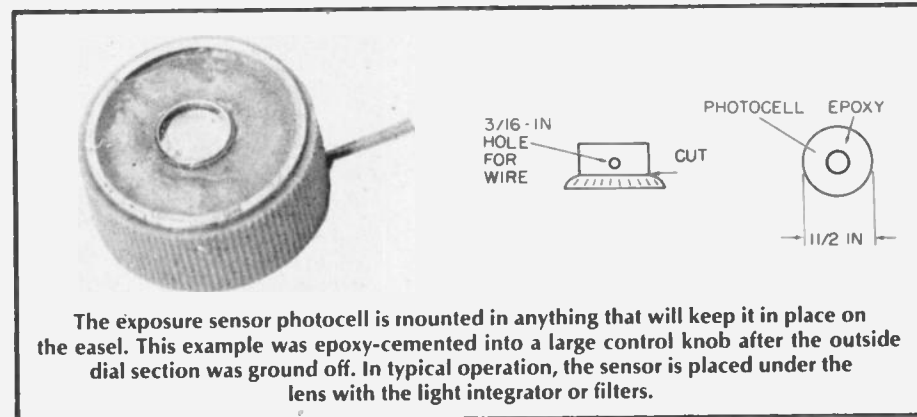

The exposure sensor photocell is mounted in anything that will keep it in place on the easel. This example was epoxy-cemented into a large control knob after the outside dial section was ground off. In typical operation, the sensor is placed under the lens with the light integrator or filters.

COLOR ANALYZER

holder, or if it has a permanent swing-away red filter under the lens, mount a Paterson swing-away light integrator (available from local photo shops) under the lens. Fasten the short leg of the Z-bracket to the integrator—which has pre-drilled holes—so that the 1/2-inch hole is on the optical center of the lens. Then cement photocell P2

the switch and the control "C" for cyan. (We suggest you paint the cyan knob insert a blue-green. Also paint the other knobs the appropriate color.) Advance S1 one position clockwise, find the correct knob and label both "M" for magenta. Advance the switch another position clockwise, find the knob and label both "Y" for yellow. The last switch position and knob is labeled "W" for white (white light exposure). Make certain the C, M, and Y controls are read-



Close-up of meter face showing a small scale-illumination lamp in lower right corner. This lamp should not be operated at full voltage to avoid fogging the film.

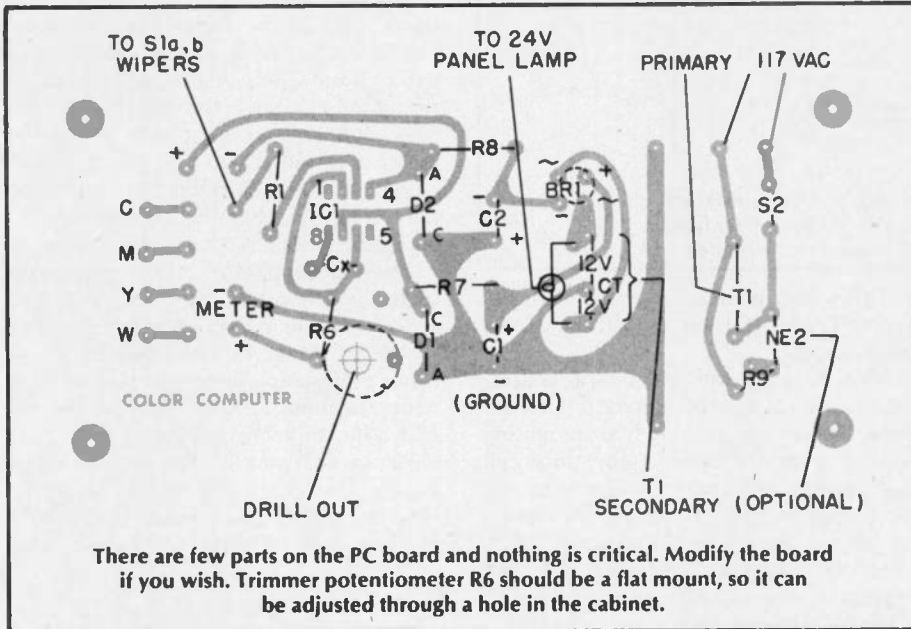

dark or very low light). This is normal and there will be no damage to the circuit or the meter. (Note: If you use a zero-center meter the pointer will barely pin on both sides.)

Install the Z-bracket under the lens. If your enlarger uses a filter holder under the lens insert a diffusion screen or glass, or a Beseler Light Integrator or similar ground glass in the filter holder. You are now ready to make color prints.

The first thing you need to make fine quality color prints is a high speed chemistry, such as the two-step Beseler system which can produce a finished print in two minutes. The second item you need is the electronic color analyzer for which we've already given you the plans.

Color Variables. Color materials such as the negative, printing paper, enlarger lamp, and even color correction filters vary in their sensitivity to light colors from batch to batch, roll to roll, and time to time. Even the enlarger's optical system can have a color cast. For this reason it is generally impossible to place a negative in your enlarger, expose the paper, and develop a good—let alone decent—color print.

in the hole and attach the connecting wires; these can be extra-thin zip cord such as used for short-length speaker connections. (This whole bit reads a lot more complicated than it is. Use the photographs as a guide.)

Photocell P1, which measures the exposure light, can be mounted in anything heavy enough to hold it in place on the easel. The photographs show the photocell epoxy-cemented in an oversize control knob.

When the complete analyzer is assembled, attach oversize calibrated knobs such as the Calectro E2-715 to R2 through R5. The knob calibrations are important so they should run out to the very edge of the knob skirt. If the calibrations don't run to the edge you won't be able to preset the controls with any reasonable degree of accuracy. Place a fine line or other indicator directly above each knob.

Checkout. Connect the photocells to the control unit and apply power. Don't worry if the meter pins at either end of the scale. Set switch S1 to the extreme clockwise position and adjust R2 through R5 until you find the control that changes the meter reading. Mark

ing P2, the color comparator mounted under the enlarger lens.

Set S1 to any position, set all other controls to their mid-position, and turn on bright room lights. If the meter pins out or approaches full scale deflection, adjust trimmer control R6 so the meter pointer just pins (don't be afraid to pin the meter). Depending on the amount of light the meter pointer will pin right (for bright light) and left (for



To avoid upsetting a control setting while groping for the on-off switch in the dark-room, mount switch S2 as far as possible from the controls.



Provides a wealth of worthwhile info for photographers interested in the color print techniques available from Kodak or your photo dealer. Their publication No. E-66.

One way we can correct for these variables is through an *additive* exposure, exposing the paper through blue, green, and red filters for differing lengths of time. Since blue, green, and red create all the colors in additive printing, any correction can be obtained by controlling the precise timing of each exposure. The additive system is a pain in the neck for the hobbyist, for the slightest desired change in the color rendition or saturation (exposure) can involve changes in the exposure through all three filters.

A printing system that's easier to use and more favored by hobbyists is the *subtractive* exposure. A single filter pack made up of two of the filters known as YELLOW, MAGENTA, and CYAN makes all the color corrections at the same time. This filter pack is placed between the enlarger lamp and the negative; virtually all modern enlargers have a drawer in the lamphouse to accommodate a filter pack. A single exposure through the filter pack is all that's required to make a color print. Some of the more expensive enlargers have what is termed a "dichroic head" with variable filters as part of the light system; the exact value of filtration is simply dialed by the user. Again, all the color correction is provided at one time by the dichroic head so only a single exposure is needed.

More Info. A full and complete treatment of both types of color printing is contained in the Kodak publication *Printing Color Negatives*; this book is a required reference for anyone who wants to make quality color prints. The book also gives the most convenient operating procedures for electronic color analyzers.

The subtractive printing procedure is particularly well adapted for use with a color analyzer, is the easiest method for the amateur, and is exceptionally fast-handling, so the illustrations to follow will refer to the subtractive system.

An electronic color analyzer basically consists of a photocell (vacuum tube photomultiplier or photoresistor) positioned under the lens, blue, green, and red filters mechanically positioned over the photocell (or positioned over the cell by hand) and a meter that indicates the amount of light falling on the cell. The meter is connected to the photocell through independent potentiometers as shown in the figure. Color analyzer readings will be accurate for most negatives and lighting situations as long as the same box of printing paper is used. The system needs to be recalibrated only when the printing paper is changed (so purchase boxes of at least 100 sheets to avoid extra work).

The first step is to make a really fine print from a decent negative. You can do it the hard way, one print at a time, or use a Beseler Subtractive Calculator which puts you inside the ball park on the first try. When you have made a print with satisfactory flesh tones and color saturation don't disturb the enlarger or timer controls.

To Continue. . . . Place the color analyzer's probe on the easel or swing it under the lens (if it is mounted on the enlarger). Install a light integrator—which is nothing more than a piece of ground glass or its equal—under the lens, between the lens and the analyzer's probe. The light integrator scrambles the picture into a diffused "white light" which contains all the color elements of your negatives and the filter pack. Place a blue filter (Kodak Wratten No. 98) on top of the light integrator. (Note that most hobbyist analyzers have a selector switch that also mechanically positions the correct filter over the photocell.) Turn on the enlarger and adjust the analyzer's yellow control for a convenient reference meter reading. (Usually, center-scale or "null" is used as the reference reading, but any meter reading can be used as a null.)

Remove the blue filter, install a green

filter (Kodak Wratten No. 99), switch the analyzer to MAGENTA and adjust the *magenta* control for a null meter reading. Remove the green filter, install a red filter (Kodak Wratten No. 70), switch the analyzer to CYAN and adjust the *cyan* control for a null meter reading (the color controls yellow, magenta, and cyan refer to the color of the subtractive filters in the filter pack). Finally, remove all filters from under the lens, switch the analyzer to WHITE and adjust the *white* control (exposure control) for a null meter reading.

(The color analyzer in this project uses a separate photocell for the exposure. If you look at the easel you'll

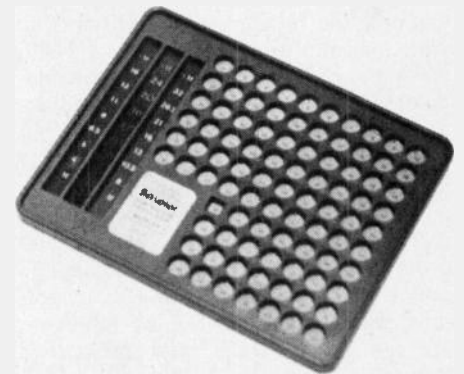

Modern color print chemistry techniques from Beseler include this subtractive color calculator to aid filter selection.

see a shadow cast by the Z-bracket holding the color comparator cell. Position the exposure cell on the easel so it is just off the edge of the shadow. If you prefer, you can place several thicknesses of opaque paper over the color comparator cell and use it for the white measurement, though we suggest you use the separate cell.)

When all the controls are adjusted you have programmed the color characteristics and exposure of your "reference" print into the analyzer, and you should note the control settings and exposure time for future use.

Down to Business. Now assume you want to make a print from another negative. Put the new negative in the enlarger. Then set the degree of enlargement and focus, leaving the lens wide open. Place the analyzer's probe under the lens, install the light integrator and set the analyzer's switch to CYAN. Install the red filter on top of the light integrator and adjust the lens aperture until the meter indicates null. Switch the analyzer to MAGENTA, install the green-reading filter and note the meter reading. If it is not at null, add or remove magenta filters (from the filter pack) until the meter shows a null. Then switch the analyzer to YELLOW, install the blue-reading filter and

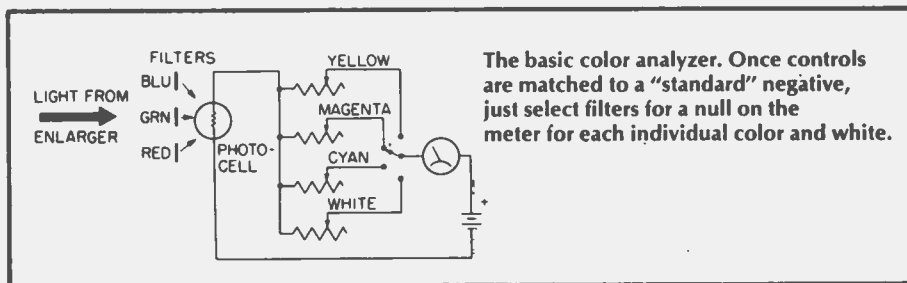

The basic color analyzer. Once controls are matched to a "standard" negative, just select filters for a null on the meter for each individual color and white.

COLOR ANALYZER

modify the yellow filtration in the filter pack until the meter shows a null. Finally, set the analyzer to **WHITE**, remove all reading filters and adjust the lens aperture for a null indication.

Through the color analyzer you have now established a new filter pack and exposure for the new negative. If the new negative uses similar lighting to the reference negative the print should be perfect. If the lighting was considerably different the print will be good—acceptable to most people, but requiring just a slight filter pack modification for a great print.

Swinging Filters. In the previous example the filter pack would wind up with magenta and yellow filters—which is what is generally needed. Some Kodacolor negatives, however, might require cyan filters plus magenta or yellow (but never all three). This information will have been programmed into the color analyzer, so you will have no difficulty if you make a slight modification in procedure. The first meter reading, the one where you adjust the lens's aperture, should be made for the filter you are *not* using in the filter pack. For example, if your basic filter pack has cyan and magenta, switch the analyzer to **YELLOW**, place the blue-reading filter in position on the light integrator, and close down the lens for a null indication. Then proceed with the other readings. If your reference negative did not require cyan in the filter pack, if it had yellow, magenta, or both, and you find a new negative just can't be pulled in for null meter readings with yellow and magenta filters, it indicates the new negative requires cyan filtration, so start with the assumption that yellow is not



Kodak color printing filters. Typical filter designation CP20Y means color filter with a .20 density; the color is yellow.

required. If you still can't null the meter, it means magenta should *not* be in the filter pack.

As we mentioned, a more thorough discussion and procedure for using a color analyzer is found in Kodak's *Printing Color Negatives*.

Most, but not all, commercial color analyzers use photomultiplier tubes which have no light memory, nor are they confused by infrared from the enlarger lamp. These units are, as you would expect, relatively expensive. Low cost models use photoresistors.

More Data. Photoresistors are infrared-sensitive and they have a light memory, both of which can confuse the meter. The infrared is easily handled by installing a heat or infrared filter glass in your enlarger (it should be there to protect the negative anyway). The light memory is handled by using a consistent measurement procedure. The best way is to turn the enlarger off, install the reading filter and the light integrator, turn off the bright room lights, count to five, and then turn the enlarger *on*.

Take the meter reading, or adjust the appropriate color control, slide the new reading filter in place before withdrawing the old one, switch the analyzer, and make the new meter reading. Repeat this for the third reading filter. You'll note that this procedure keeps bright white light from falling on the photocell between meter readings. If you want to change filters under room lights, make certain there are about five seconds of darkness between turning the room lights out and turning the enlarger on.

The whole bit might sound somewhat complicated, but after you've run through the procedure once or twice to get the hang of things it shouldn't take you more than a minute or so for a full color analysis of a new negative.

The Kodak Wratten filters needed are available from professional camera shops. For the construction project, color analyzer 2-in. or 3-in. Kodak Wratten filters Nos. 98 (blue), 99 (green), and 70 (red) are recommended. If you have difficulty obtaining these specific filters you can make the following substitutions, through the analyzer's precision will be slightly reduced: 47B (blue), 61 (green), and 92 (red).

The Pro Shop. We could not close without some words on commercially processed color prints such as you might order from a drugstore or camera shop. Commercial color labs have as high (if not higher) a remake rate than the amateur if *quality* color prints are desired. As a general rule, it takes two tries to get a decent color print, so the hobbyist with a color analyzer is way ahead of the game because he can turn out, at worst, two *good* prints for each three first tries. The average is even higher than this as the hobbyist gets skilled in the use of a color analyzer.

Commercial labs come close to a hobbyist's results only when they are equipped with a video analyzer such as the Kodak Video Color Negative Analyzer Model 1-K; and Kodak only claims a 75%+ first try acceptance rate for their analyzer. The video analyzer is a 5-in. x 5-in. TV display. The operator views the color negative as a positive color TV image, and adjusts the TV's controls for proper color balance and brightness (saturation). The control settings are translated to the printing equipment's filter adjustments so that the final print is similar to the image displayed on the TV.

The video analyzer is a fast and easy way to get good color prints on the first try, but since video analyzers cost in the thousands, the color analyzer is the best thing going for the hobbyist. ■

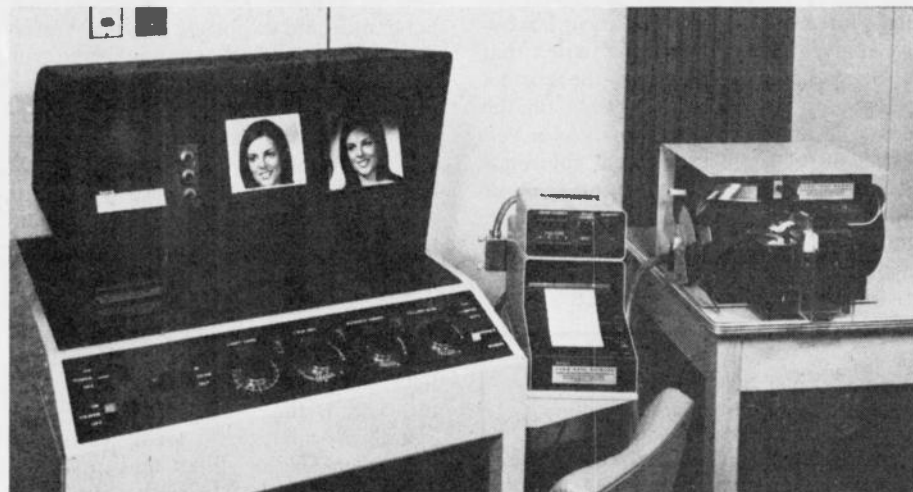

Professional equipment used by color labs includes this Kodak Video Color Negative Analyzer. It uses a 5-in. color TV screen to assist an operator in selecting the correct filter.

Record Bargains

(Continued from page 40)

vidence that more and more of the classics will find their way into your consciousness as your library grows.

We've also ignored the bulk of Twentieth-Century offerings by acting as though Mahler's *Symphony No. 5* didn't exist or as though Stra-

vinsky's *Sacre du Printemps* didn't count. Each of these works dates back to the very early Twentieth-Century and a wealth of important compositions has followed. However, we're again confident that the Twentieth Century will take care of itself once you've mastered a number of Bargain-Basement Beginnings into the serious side of music.

Good listening! ■

CB XCVR Checkout

(Continued from page 78)

PA/CB, Internal/External Speaker Selector (feeds CB through PA speaker). Standard accessories are microphone, mobile mount, DC power cable.



CIRCLE 59 ON READER SERVICE COUPON

Receiver Section Test:

Input Sensitivity 3.5 μ V
 Adjacent Channel Rejection 51 dB
 AGC Action 3.5 dB
 Input Level for S9 15 μ V

Transmitter Section Test:

RF Output 3.7 watts
 Modulation to 85% yes
 Relative Sensitivity for

85% Modulation —20 dB
 Modulation Limited to 100% yes
Editorial Remarks: The Kris XL-40 has an S-meter that reads 5 dB per S-unit, double conversion receiver, external and PA speaker jacks, S/RF output meter, and jack for external S-meter. ■

● MOTOROLA 4000 (MOCAT 40)

\$149.95 (Motorola, Inc.)

General Description: A 40-channel AM transceiver for mobile, PA operation. Power supply 12 to 13.8 VDC with negative or positive ground. Overall dimensions are 2½-in. h x



CIRCLE 61 ON READER SERVICE COUPON

7¼-in. w x 9½-in. d. Front panel controls and switch for Channel Selector, Volume, Squelch, PA/CB. Standard accessories are microphone, mobile mount, DC power cable.

Receiver Section Test:

Input Sensitivity 0.35 μ V
 Adjacent Channel Rejection 50 dB
 AGC Action 4 dB
 Input Level for S9 6,000 μ V

Transmitter Section Test:

RF Output 3.5 watts
 Modulation to 85% yes
 Relative Sensitivity for
 85% Modulation —20 dB
 Modulation Limited to 100% no

Editorial Remarks: The Motorola 4000 has a relative reading S-meter, double conversion receiver, external and PA speaker jacks, and S/RF meter. Internal speaker mounted on top facing driver. ■



"That's strange, in America
 it brings forth pictures from the air!"

WHAT'S THE FASTEST GROWING NEW SCIENCE FICTION MAGAZINE?



192 PAGES IN EACH ISSUE.

Reserve your subscription today, and we'll mail your copies to your doorstep.

Be sure you don't miss this "first" by one of the world's leading science fiction writers.

ISAAC ASIMOV'S
 SCIENCE FICTION MAGAZINE
 Box 1855 GPO
 New York, NY 10001

I enclose \$4.00 which includes shipping and postage for a 4-issue subscription.

In Canada, all other countries, \$5.00.

Name _____
 (please print)

Address _____

City _____

State _____ Zip _____

BELEC78

Junk Box Special

(Continued from page 90)

If you wired R2 correctly it should be full counterclockwise. Then set S1 to on. The meter should rise instantly to 5 volts DC. As R2 is adjusted clockwise the output voltage should increase to 15 VDC or slightly higher. If R2 can adjust the output voltage only over the range of approximately 12 to 15 VDC, or 12 to 15+ VDC, IC1 is defective, or has been damaged. ■

Add Tone to Phone

(Continued from page 71)

The meter indicates RMS in terms of the average voltage of a sine waveform so the reading is slightly off because there are two sine waves. The scope sees the vector addition of the two tones, and when the tones are in phase the peak value is greater than the peak value of the individual tones. So to avoid blowing any associated transistor equipment just remember that the maximum pad output is nominally 3.5 volts peak to peak regardless of what your VOM or VTVM indicates.

No Adjustments. Unlike some of the electronic touch-tone encoders the Western Electric telephone dialer pads require no adjustment, nor do they drift. Just install one and it works. Ma Bell's equipment will give two or three decades of reliable performance. ■



TV Repair Savings

(Continued from page 60)

sets, can cause damage to quite a few transistors. This can happen quite rapidly, so always be sure that you do have light on the screen; if it goes out, turn the set off as fast as possible.

Here is a final hint for color TV sets, especially some of the older types. If you have a problem with intermittent loss of the color, and you also see some horizontal instability, try adjusting the horizontal hold control *just a little bit*. If this control is set "right at the edge" of its holding range, this can cause the color to drop out now and then. You'll often see color drop out just a little before the picture itself falls out of horizontal sync.

Just the Beginning. So there you are. These are the normal reactions of the hold controls. If you have trouble, the first thing to do is check these to see if they are reacting the way they ought to. In a great many cases, you'll find that this is all that you need. If you can readjust the controls, and the set works normally, fine! You don't need to call a service technician. However, if you can't get a normal reaction, or make the picture stand still by adjusting these controls, then it's time to ask for some professional help. You can help the technician find the trouble faster by telling him exactly *how* the set is acting: "Falling out of horizontal sync," "vertical rolling," and so on. This helps him get to the cause of the trouble in a little less time. ■

Calculator RF

(Continued from page 51)

for opens and shorts by bringing the calculator near the antenna while monitoring the radio output. Perhaps the ultimate example of this technique you can perform in your automobile. Place a calculator near the windshield antenna of a late model General Motors car. In cases of poor or non-existent reception, one or both of the two thin antenna wires imbedded inside the glass may be broken. By carefully tracing the path of each individual wire, a break or faulty connection can be located when the radio's output changes abruptly.

And one final thought. Those of you with LED digital watches might experiment with them. The power is much lower, and the metal watch case provides a lot of shielding, but there just might be enough RF coming from the display to be useful. ■

Assemble GR-2001

(Continued from page 17)

mote control. It enables you to change channels, change sound volume, adjust tint, and turn the set on and off.

The programmer puts you into the real avant garde of TV fanciers. Add this option and you will never again miss a desired program because you forget to turn the channel on in time. The computer memory does all your remembering and automatically chooses the right channel at the right time. You can program up to 16 such turn-ons during either of two switch-selected 12-hour or 24-hour periods. (You'll have to invest in the digital clock to make the programmer function. The digital clock, whether used to time the programmer, or purchased for itself, periodically indicates the time of day.

I've been able to find absolutely nothing to complain about, either in terms of the performance of the equipment or about the way assembly instructions are presented. Heath has done a truly old-fashioned craftsman-like job all the way. There's just one problem for which Heath offers no solution. I actually may not watch the TV programs very much, at least for a while. Why? Because those thousands of colorful electronic components I have assembled have a fascination all their own. I just can't bear the thought of hiding them out of sight inside a walnut cabinet. Maybe Heath should come out with one more option: a transparent plastic cabinet. Circle No. 31 on the Reader Service Coupon for more information about the GR-2001 ■

Beat Antenna Spiral

(Continued from page 68)

lord, actually an agent representing the owner, refuses to let any tenant hang anything out of the windows, let alone permit Carl to install an antenna on his patio.

I heard his sad story and told him to have his lease available when I visited him the following weekend. When I came to visit, I could see that the lease was "ironclad," so much so that it made baseball's reserve clause seem wishy-washy. That was it, no outdoor antenna for Carl.

I did make him somewhat happy by showing him an old trick. I connected the antenna lead-in wire to the metal finger stop on his phone's dialing mechanism. Reception was good considering the construction of the building, which killed reception even for parts of

the AM broadcast band. This was a temporary measure since Carl was soon to get pushbutton phones.

Carl was all set to return to the flea market and unload his Drake receiver. He even told me he had planned to panel his room to give the listening shack a comfortable air, but now he wouldn't. "Now just a minute, before you quit," I said to Carl, "let's give

it a try." We swiped his wife's kitchen roll of wrapping aluminum and hung it on the wall with masking tape. Two walls were outside walls, so this is where we placed the foil. Fig. 3 shows what we did. It looked kind of silly until we attached a clip lead from the foil to the antenna post of the receiver. Wow! Carl practically cried as he tuned the bands. His wife practically cried too

when she saw the wall but calmed down once she realized that wall panels were going up. This antenna cost only 59¢ for the aluminum foil and \$45 for the wall panel job.

The last I heard from Carl was he was planning to move to the suburbs where he had purchased an old home- stead on six acres. I wonder what he had in mind. ■

Electronics Schools

(Continued from page 87)

classroom program if you find that you are weak on self-discipline. Check out where the classes are held, and how much extra you would have to pay.

On the other hand, you may be a completely different sort of individual. Maybe you didn't make out too well in your former schooling because classroom work made you restless. It could be that if you can choose your own working hours, and concentrate on the kind of subject that really turns you on, you may turn out to be a far better student than you ever dreamed possible. You might have been completely bored and confounded by Byron and Keats in your English class, yet be a whiz at analyzing the invisible migrations of electrons through complex circuits.

Some individuals learn quickly. Others only seem to learn quickly because their learning is superficial. But it's the slow learner, even one who nonetheless learns thoroughly, who can be really handicapped in a conventional

classroom. Given adequate time, he may in fact become more competent in a given job than a fast learner.

This is why you should not only consider the "average" times schools say students require to complete various courses, but also how much extra time you are given if you can't breeze through because of difficulties with the course, or because wholly unrelated personal problems force you to suspend study temporarily.

By the same token you should not be held back because some computer isn't in the mood to correct your examination paper or send the next lesson on time. Find out how promptly the school will send back your test papers. It's important. If you goof on some concept covered in lesson ten, you need to know this before you get too far into the next lessons because that misconception could lead you to further errors. Don't be satisfied with a vague promise that "Your papers will be graded and returned as promptly as possible." Try to get a more definite normal time period—in writing. If it should turn out that you are forced to terminate the

study program because of confusion caused by some individual in a school failing to do his job properly, you should be required to pay less than the usual penalties. If you intend to become a businessman in electronics or any other field, now is the time to learn how to protect your rights.

Actually, the intense competition among schools for new students makes such laxity rather unlikely because satisfied students are the best salesmen for the schools. In any case, you should be sure to choose a school that has been accredited by a reliable accrediting agency. Accreditation means simply that the agency has examined the way the school is operated and has judged it to be all that it's represented to be. State education boards sometimes provide accreditation of schools chartered within their states. Approval by the Veterans Administration is also a good sign. But the agency that is usually considered to be the top accrediting agency in this field is the National Home Study Council because the NHSC itself has been approved by the U.S. Office of Education. ■

Lone Ranger Light

(Continued from page 81)

and the case is covered. Solder the positive lead from the battery clip to one side of S1. To the other terminal of S1 solder the short lead from the circuit board. Finish off by mounting the cover and applying press-on decal labels as desired.

Calibrating Lone Ranger. Set the range selector to the low-light measurement position (the larger hole), then point the meter towards a bright light bulb and depress S1. One or more LEDs should light, depending upon the brightness of the source. If not, go back and check whether any components have been improperly oriented. When all is working well, only the calibration of the meter remains. Borrow a good light meter for this task. Choose a large, preferably blank wall and evenly illuminate it (avoid using

fluorescent light sources, however). Adjust the light source and the distance until your reference meter indicates f/8 at ASA 125 and 1/30 sec. When you have obtained the correct reading on your reference meter, hold your Lone Ranger in the same spot and point it in exactly the same direction that the reference meter had been facing. Press S1 and adjust R2 so that LED4 (the one farthest) extinguishes. Now turn R2 back the other way until LED4 just comes back ON. The meter is now calibrated. To use the meter with different film and shutter speeds, consult the Table.

Film Speed	Exposure Correction
ASA	
400	+2
250	+1
125	0
65	-1

Shutter Time	Exposure Correction
250	1/8
125	1/15
30	1/30
15	1/60
—	1/125

ASA = 125

+ — go to higher f-stop

— — go to lower f-stop

Additional Circuit Uses. You may have noticed that the comparator circuit presented here has great potential. A thermistor might be submitted for photocell PC1 and the circuit becomes an electronic thermometer. Or mount a potentiometer so that its control shaft spins as another shaft rotates. The LED display would then indicate angular position, perhaps for an antenna rotor. The information here plus your own imagination should produce many new devices. ■

WRITE NOW FOR **McGEE'S**
BIG SPEAKER CATALOG

1001 BARGAINS IN

SPEAKERS—PARTS—TUBES—HIGH FIDELITY
COMPONENTS—RECORD CHANGERS
Tape Recorders—Kits—Everything in Electronics
1901 McGee Street, Kansas City, Missouri 64108

PARTS! CORNELL TUBES!
FREE Send For FREE
CORNELL'S New Color Catalog
48 Pgs. New Items
33¢ per tube
36¢ per tube
ORDER FREE IF NOT SHIPPED IN 24 HOURS!
4219 E. UNIVERSITY AVE. SAN DIEGO, CALIF. 92105

F.C.C. EXAM MANUAL
PASS FCC EXAMS! Memorize, study—Tests—Answers for FCC 1st and 2nd class Radiotelephone licenses. Newly revised multiple choice questions and diagrams cover all areas tested in FCC exams, plus Self-Study Ability Test. \$9.95 postpaid. Money-back guarantee.
Yests—Answers for FCC First and Second Class Commercial Licenses
COMMAND PRODUCTIONS P.O. BOX C
RADIO ENGINEERING DIV. SAN FRANCISCO, CAL. 94126

Build the REAL THING -Yourself!

Whether your thing is nautical, a Pow'r Pup or a Suburban Tractor, the CRAFT PRINT DO-IT-YOURSELF Division of Davis Publications has it for you. Order your new Craft Print Catalog today and go a-crafting!

If you can't afford it—make it yourself.

Get Top Mileage from your own craft skills.

GREAT EASY-TO-BUILD PLANS

ONLY \$1.00



MAIL TODAY

BOAT BUILDER, Craft Print Division
Davis Publications, Inc., Dept. BE77
229 Park Avenue S., New York, N.Y. 10003

Please send me _____ copy(ies) of the Craft Print Catalog for only \$1.00 each... COMPLETELY REFUNDED WITH FIRST ORDER.

NAME _____

ADDRESS _____

CITY _____ STATE _____ ZIP _____

Hi-Fi DX

(Continued from page 44)

Foreign DX Too! While most FM DX is restricted to the United States and Canada, some foreign DX is possible. DXers within 1000 miles of the Mexican border have a shot at logging Mexican stations. DXers in the Southeast can expect to hear stations in the Caribbean. Bermuda is frequently reported from states on the Atlantic coast.

Equipment and Such. Any radio capable of receiving FM can be used for sporadic-E work. In fact, many DXers actually prefer portables and rabbit ears antennas due to their directional characteristics. The strength of most sporadic-E skip makes high sensitivity and high-gain antennas unnecessary.

For serious tropo work most DXers prefer an outside antenna as high as possible. The aim here is that the antenna reach into the tropospheric duct.

DX Strategies. Since FM DX openings do not last as long as those on medium or short wave, a strategy for DXing must be devised. For sporadic-E, it is wise to listen only long enough to get sufficient material for a verifiable report. Once this is done, tune to another frequency. You may like to send hour-long reports to shortwave broadcasters, but that's a luxury that you cannot afford on FM.

Tropo DX openings often last for several hours or even days. Also, tropo affects the entire 88 to 108 MHz equally, in contrast to sporadic-E and its maximum usable frequency. In addition, if tropo is in from a certain area on one frequency, all other stations in

FM DX REPORTING DO'S AND DONT'S

Do enclose return postage with each report.

Do address your report to the Chief Engineer.

Do use plenty of readily verifiable material in your reports, such as names of announcers, commercials and public service announcements, station slogans, song ratings on record surveys, and any other item that seems to be unique to that station.

Do describe reception quality in plain English.

Do politely request a verification.

Do ask if any reports more distant than yours have been received.

Don't use any SWL jargon as "QSL," "QRM," or the SINPO code.

Don't rely solely on song titles or a list of records played to prove your reception.

Don't demand a verification—ask for one!

Don't report a station unless you are absolutely certain that you indeed heard it! If you can't be certain, report it as a tentative reception.

FOREIGN FM DX TARGETS

BERMUDA

ZBM-FM, Hamilton, 89.1
ZFB-FM, Hamilton, 94.9

CUBA

CMQ-FM, Havana, 90.5
CMHW-FM, Santa Clara, 90.5

DOMINICAN REPUBLIC

HIZ-FM, Santo Domingo, 89.1
HION-FM, Santo Domingo, 92.5
HIJP-FM, Santo Domingo, 94.9
HIJB, Santo Domingo, 95.7

HAITI

4VUE-FM, Port Au Prince, 88.1

JAMAICA

Radio Jamaica, Spur Tree, 90.5
Jamaica Broadcasting Corp.,
Coopers Hill, 91.1
Jamaica Broadcasting Corp.,
Montego Bay, 92.1
Radio Jamaica, Coopers Hill, 92.7

the same general area should also be heard, unless you have locals on their frequency. Therefore, if you have the relatively stable tropo signal of a station a few hundred miles away, check the latest edition of White's Radio Log (an exclusive feature of our sister publication, COMMUNICATIONS WORLD) for other stations in the same general area. Tune to their frequencies and odds are they'll be heard!

Sure They QSL! FM broadcasters are excellent verifiers. In fact, your author has found that they are generally better verifiers than standard AM broadcasters.

Forget all about SINPO, QSL, QRM, 73, and all the rest of that SWL lingo. FM broadcasters have no idea what it means, so write your report in plain English. Reports should be addressed to the chief engineer, and always include return postage if you want a QSL.

Record titles may be good material for reports to shortwave stations, but American FM stations don't keep lists of songs played. Include music played anyway, for it can't hurt. The best material is commercials and public service announcements you heard and the time when you heard them. Commercial broadcasters must keep lists of these and the time at which they are aired. Other good items are announcer's name, that station's record survey, and anything that seems to be unique to that station. Keep your reports concise and to the point.

Include details on your listening gear. If other stations were audible from the same general area, you might want to mention that fact. Be sure to ask if they have received any reports more distant than yours, for quite often you will find yourself the most distant reporter to a station!

Is there anyone who doesn't have a radio capable of receiving FM somewhere in their home? There's no reason then not to start FM DXing, so begin today. Discover what DXing's in crowd has found out!

CLASSIFIED MARKET PLACE

BUDGET ELECTRONICS—PUBLISHED ANNUALLY. The rate per word for Classified Ads is \$1.00 each insertion, minimum ad \$15.00 payable in advance. Capitalized words 40¢ per word additional. To be included in next issue, write to: R. S. Wayner, DAVIS PUBLICATIONS, INC., 229 Park Ave. So., N.Y. 10003.

ADDITIONAL INCOME

SENSATIONAL NEW Money-making Opportunity. Free Details. Group, Box 309, Brooklyn, New York 11230.

AUTHOR'S SERVICE

PUBLISH YOUR BOOK! Join our successful authors in a complete, reliable publishing program: publicity, advertising, promotion, beautiful books. All subjects invited. Send for fact-filled booklet and free manuscript report. Carlton Press, Dept. 10G, 84 Fifth Avenue, New York, NY 10011.

BATTERIES & GENERATORS

REPAIR Alternators! Generators! Batteries! Motors! Modelc. Box 7286, Kansas City, MO 64113.

BLUEPRINTS, PATTERNS & PLANS

NEW CRAFT PRINT CATALOG—Choose from over 100 great easy-to-build plans. Send \$1.25 (completely refunded with your first order). **BOAT BUILDER.** (CF Div.)—229 Park Avenue South, New York, NY 10003.

BUSINESS LOANS

BUSINESS loans for any purpose \$25,000 to \$10,000,000. Quick reply. James Ambrose Co., 2619 La Mesa Way, Sacramento, CA 95825.

BUSINESS OPPORTUNITIES

MAKE Magnetic Signs. Big profits. Details, Universal, Lenora, KS 67645.

\$25.00 DAILY possible stuffing envelopes! Details Free. Service, Box 715-D, Lynbrook, NY 11563.

HOW to make money writing short paragraphs. Information free. Barrett, Dept. C-427-Z, 6216 N. Clark, Chicago, IL 60660.

\$30.00 HUNDRED Stuffing Our Circulars into Stamped Addressed Envelopes. Immediate Earnings. Beginners Kit \$2.00. **COLOSSI,** 1433-61 Street, DC-10, Brooklyn, NY 11219.

HOMEWORK! BIG MONEY addressing mailing envelopes. Exciting offer! 10¢. Linco Services, 3636 Peterson, Chicago, IL 60659.

1000% PROFIT Bronzing Baby Shoes. Free Literature. NBC, Box 1904-DG, Sebring, FL 33870.

\$3000.00 MONTHLY. Immediate income. Stuff envelopes at home. Information, send self-addressed stamped envelope. Cottage, Box 730-DPK, Baldwin Park, CA 91708.

\$500.00 profit stuffing 1,000 envelopes. Details \$1.00 (Refundable). Elanco, Bel3337 D11, Waldo, AR 71770.

'999 SUCCESSFUL LITTLE KNOWN BUSINESSES information write, Gentry Distributors, Dept. DP Box 511, Pascagoula, MS 39587.

GUARANTEED \$178.00 WEEKLY. Work one hour daily. Free Brochure. FAS, Box 13703, San Antonio, TX 78213.

\$350 weekly mailing letters. Free details. Bronxville House, Box 311 D, Bronxville, NY 10708.

HOW TO RECRUIT COMMISSION SALES-PEOPLE! Free details! Success publications, 35 Interlachen Place, Excelsior, MN 55331.

CABLE/FM Broadcast station. No investment. Operate from home, church, school. Excellent income. Free Details. CAPM, Box 5516-GK, Walnut Creek, CA 94596.

AMAZING! Home Enterprise Opportunity guaranteed. Details 35¢. Ivanna, 5052 North Ashland, Chicago, 60640.

\$200 weekly mailing circulars. Start Immediately. Complete program—\$2.00. Guaranteed! M/L, Box 68011, Seattle, WA 98188.

SPECTACULAR home business opportunity. Details Free! Brandon, P.O. Box 2013, Newport News, VA 23602.

COLLECT names for \$1. each, instructions \$2. Leroy Williams, 81 South Sixth, Newark, NJ 07107.

STARTING NEW REPORT CAN CHANGE YOUR LIFE! BIG MONEY can be YOURS! Includes tips on creative thinking, how to PROTECT and MARKET your ideas. Send \$1.50. Moneygetters, Dept. 117-BE, 5906 Dryad, Houston, TX 77035.

BUSINESS OPPORTUNITIES—Cont'd

AMAZING profits in real estate. New report tells how, where. Tips for buying rural land. Only \$1.50. Wesley Leonard, 187 North Main, Hancock, Maine 04840.

BUY IT WHOLESALE

SAVE money! Buy low cost quality Christmas Gift Items (5) catalogs \$3.00. Winchester Enterprises Inc. 2807 SS Hargrave Street, Phila., PA 19136.

DETECTIVES

POLICE SECURITY INVESTIGATIVE schematics and equipment listings. Quimtronix, Box 548-DV, Seattle, WA 98111.

EDUCATION & INSTRUCTION

UNIVERSITY DEGREES BY MAIL! Bachelors, Masters, Ph.D.s. . . . Free revealing details. Counseling, Box 389-BE11, Tustin, CA 92686.

ELECTRICAL EQUIPMENT & SUPPLIES

GIANT Bargain Packed Canadian Surplus Catalogs \$1.00. Etco Electronics Dept. DC, 183G Hymus Blvd., Pointe Claire, Quebec H9R 1E9.

GIFTS THAT PLEASE

DISCOUNT gift catalog! 1,500 items. \$2.00 Kel-Rico, RFD, Box 400, Anacoco, LA 71403.

STARFISH JEWELRY. Designed by Mother Nature every detail intact as if frozen in gold. Earrings pierced or screwback. Pendant \$7.95, earrings \$7.95. Midwest Mail-Order, 716 North Third Street, Aberdeen, SD 57401.

OPTICAL ILLUSION PICTURES. What you see is not necessarily what it is. A closer look will show you a completely different picture. Great conversation item 8 1/2 x 14, \$2.00 each or four different for \$5.00. **Rodger's Illusion's.** Box 59, Sparta, NJ 07871.

HANDSOME SOLID BRASS CRAB ASHTRAY. 7 1/2". \$10.95. **SATISFACTION GUARANTEED. POST-PAID. KEN-BAR GIFTS.** IO, 4452 NORTH ASHLAND, CHICAGO, IL 60640. **ILLINOIS RESIDENTS 5% SALES TAX.**

HOME WORKSHOP SUPPLIES

VINYL care kit, \$12.95, send check, money order, master charge, Bankamericard numbers, and expiration date to: Jim's Vinyl Restoral, 35040 Renfrew, Mt. Clemens, MI 48045.

HYPNOTISM

FREE Fascinating Hypnosis Information! Startling! DLMH, Box 487 Anaheim, CA 92805.

MISCELLANEOUS

OLDTIME Radio Programs on quality tapes. Free catalogue. Carl D. Froelich, Route One, New Freedom, Pennsylvania 17349.

WARBLE ALARM—10W kit—\$4. TERRY, Box 209A, Park Ridge, IL 60068 (Out-of-state orders only).

EXPERTLY avoid income taxes. Postcard with name brings details. Jon Tanizaki, 12215 Aneta Street, Culver City, CA 90230.

MONEYMAKING OPPORTUNITIES

\$3 Hourly stuffing envelopes. Easy work. Details free. Feldco, Box 228 Ryder, Brooklyn 11234.

\$1000 MONTHLY POSSIBLE, mailing commission letters. Information—Free! **OPPORTUNITIES** Box 721D, Lynbrook, NY 11563.

\$250.00 profit/thousand possible—stuffing—mailing envelopes. Offer: Rush stamped addressed envelope: Universal-ADVS X16180 Fort Lauderdale, FL 33318.

\$300.00 WEEKLY, Mailing Circulars. Write: McGuire, Box 144, Tacoma, WA 98412.

\$30.00 HUNDRED STUFFING our circulars into stamped addressed envelopes. Beginner's Kit \$2.00. Mustachi, P.O. Box 46D11, Brooklyn, NY 11219.

NEW! Stuff letters for \$48. Details free! Carlos, 1724 Kimberly, Klamath Falls, OR 97601.

\$2,000 MONTHLY selling information by mail. Exper tells how. Writer: Sverready, 422G Clermont Ave., Brooklyn, New York 11238.

\$500.00 WEEKLY! IMMEDIATE Home Income Stuffing Envelopes. FREE supplies! Guaranteed! Send 25¢. Stamp. ALCO, B19110-DPN, Las Vegas, NV 89119.

MONEYMAKING OPPORTUNITIES—Cont'd

TOP EARNINGS! Mailing circulars. Start immediately. KAMI, 1431 Deslonde, N. O., LA 70117.

MAKE MONEY! 25 ways! Two 13¢ stamps: Wayo, Box 127-BI, Wayzata, MN 55391.

\$500.00 profit stuffing 1000 envelopes. 25 cents details: Canapro Enterprises, Box 215, Station "H", Montreal, Que., Canada.

\$60 HUNDRED GUARANTEED PROVEN MAILING PROGRAM. FREE DETAILS WRITE: MURPHY, 35040 Renfrew, 1207, Mt. Clemens, MI 48045.

\$500 weekly with mail orders, most dynamic program. Send \$1.00 for details. Box 1912, Fort Worth, Texas 76101.

\$500 per thousand stuffing envelopes, free supplies, rush stamped envelope: Moseley, 14 Rodney, Seaford, DE 19973.

PERSONAL

JAPANESE introduction! Girl's photographs, descriptions, brochure, details. \$1.00. **INTER-PACIFIC,** Box 304-SC, Birmingham, MI 48012.

SINGLE? Widowed? Divorced? Nationwide introductions! Identity, Box 315-DC, Royal Oak, MI 48068.

JAPANESE Girls Make Wonderful Wives. We have large number of listings. Many interested in marriage. Only \$1.00 brings application, photos, names, descriptions, questionnaire, Etc. Japan International, Box 156-AA, Carnelian Bay, CA 95711.

BEAUTIFUL Mexican-Oriental girls Needing American Boy-Friends. Free Details, "actual" photos. World, Box 3876-DC, San Diego, CA 92103.

DATES GALORE! Meet singles-anywhere. Call DATELINE, toll-free (800) 451-3245.

NEED financing? Credit? Investments? Send \$3.00 for booklet. FRECO, P.O. Box 5025, Alexandria, VA 22306.

LATIN AMERICAN GIRLS appreciate their men. Let us introduce you to a dark-eyed, unspoiled beauty. Complete application package and photo selection \$2.00; Maria Garcia, Box 50801D, San Diego, Calif. 92138.

BEAUTIFUL MEXICAN GIRLS! Friendship, marriage. Photos information free! "Latinas," Box 1716-DF, Chula Vista, CA 92012.

ADULT Pleasure Products—over 600 items! Giant catalog \$1.00. Clifton's D-1068, Saugus, CA 91351.

SWEDISH girls. Details, photos \$1., Sweden International, Box 7425-DC, Chicago 60680, USA.

ADULT products directory! \$5.00, Box 4937 d, Yuma, Arizona 85364.

PRINTING, MIMEOGRAPHY & MULTIGRAPHY

WHOLESALE, Printing Office Supplies, Equipment, Free Catalog, Atlantic, DP-11, Box 1678, Florence, South Carolina 29503.

PROFITABLE OCCUPATIONS

GET INTO BROADCASTING! Become a DJ, get free tapes-records, start your own station. Free details, Broadcasting, Box 5516-GK, Walnut Creek, CA 94596.

RADIO & TV

LINEAR AMPLIFIER, 2-30 MHz, 60-150 watt. Construction plans, \$3.00. **FREQUENCY COUNTER,** 30/300 MHz with memory, portable. Construction plans \$5.00, both plans \$6.00. Kits available. PAN-AXIS Productions, Box 5516-GK, Walnut Creek, CA 94596.

SPECIAL SERVICES

BUYERS, SELLERS, TRADERS DON'T WASTE TIME, money. You've found it. Yes, fellow members from all fifty states anxious to buy, sell, trade; daily, weekly, monthly contacts. For information package, membership card, send \$5.00 check or money order to: B. S. T. P.O. Box 12204, Minneapolis, Minnesota 55412.

For Greater Classified... Savings... Results... and Profits...

Place your ad in one of our **SPECIAL COMBINATIONS:** Combo #1, Combo #2 or Combo #3. Each Combination is designed to give your ad the largest audience available, for further information write to R. S. Wayner, Classified Advertising Manager, Davis Publications, Inc., 229 Park Avenue South, New York, N.Y. 10003.

Sound for Crumbs

(Continued from page 46)

plastic end of the screws. Now place the metal retaining ring from the grille assembly on top of the plastic cover and mark the four holes for securing the ring to the speaker assembly (cover). Remove the ring and make holes in the plastic, right through into the Masonite, with a sharp nail, a scriber, or a small drill. Make the holes only about half the depth of the Masonite. Now take the four self-tapping metal screws, and, after replacing the retaining ring right side up on the assembly, with the holes lined up, screw the whole thing together. The self-tapping screws will bite into the masonite nicely. Don't screw them tight enough to strip the holes. If you do, by mistake, you can always rotate the top assembly (metal ring) a few degrees and start over on the holes for the self-tappers.

Now drill a hole for the speaker wire through the side of the plastic cover, right at the very top, just under the retaining ring. Angle this hole so it comes out inside the diameter of the plastic cover near the speaker, but outside the speaker frame. It may be easier to drill two holes, one from the inside of the Masonite (side near the speaker) and one from the outside of the plastic. Be sure to use a drill no larger than absolutely necessary to pass the speaker wire through.

Install the top section of the food container over the neck of the enclosure and screw the cover on tight.

Run about 6-inch length of no. 24 speaker wire through the hole and solder to the speaker terminals. Reinstall the speaker unit and dope the hook-up wire around the hole at the under side of the stiffening flange with plastic cement, to insure air tightness. Before you install the grille over the speaker unit you can if necessary, file a 1/8-inch wide slot in the edge of the

grille and the retaining ring to clear the hook-up wire where it passes.

Driver Units. For best results I suggest you use the Radio Shack number 40-1292 acoustic suspension speaker driver, which costs just under \$17. You can also get good sound if you use the slightly-less expensive Radio Shack driver number 40-1284, which costs under \$10. If you really must save money and get the best sound (for the money) use number 40-1909, which is under \$6.00. Finally, you can shave some money off this (not much) by using number 40-1240, which goes for \$5.79 apiece. You'll get as much sound, probably more, with this unit, but the bass won't be as good.

These speakers can be used in pairs for stereo music listening, or as remote speakers in the bedroom, kitchen, etc., when larger, more elaborate speakers are used in the living room or music room for serious listening. You can also use one such speaker to make a table radio or TV set sound better. ■

Time Tally

(Continued from page 36)

average utility cost of \$.05 per kilowatt hour.

There are two ways of connecting the Time Tally to the appliance being timed. The simplest way, in theory at least, is to connect a 6 or 12-volt power supply directly to the appliance on-off switch as shown in Fig. 2. However, because the switch is often in a tight corner,

this approach is sometimes difficult. Another approach, which makes the Time Tally even more versatile, is shown in Fig. 3. With this set-up, one merely plugs the appliance into the Time Tally plug. The appliance switch is left *on* so that the appliance can only be turned on or off by using the Time Tally switch.

Other Uses. The Time Tally can also be used in an auto to time the length of driving time for a trip. Here the Time Tally should be connected as

described in the outdoor-engine use section.

The indoor version of the Time Tally, if used with the power supply shown in Fig. 3, can be used as a digital cooking timer. Just flick the switch the minute an egg goes into boiling water or a TV dinner goes in the oven, and watch for the recommended minute to show up. Here a resettable 6-volt counter would come in especially handy, but you can mentally note the present reading and watch for the desired one. ■

Depression Reflexes

(Continued from page 57)

names, some description of each set, and the price of the set when new.

This book may be purchased from Tudor Rees, 64 Broad Street, Staple

Hill, Bristol, Great Britain BS16 5NL. The price is 3.00 English pounds which is around \$6.00 in United States funds. This includes shipping by surface mail, which takes 4 to 6 weeks. You can purchase an International Money Order at the larger Post Offices. I consider the book a very good buy.

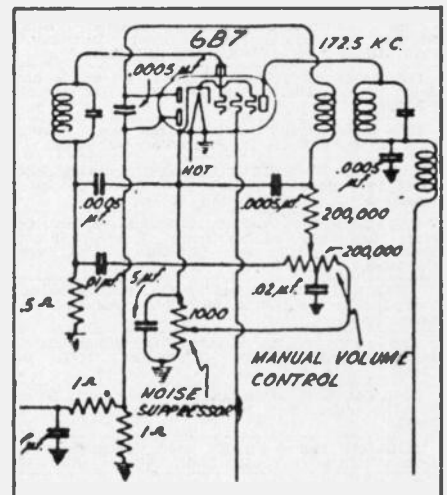
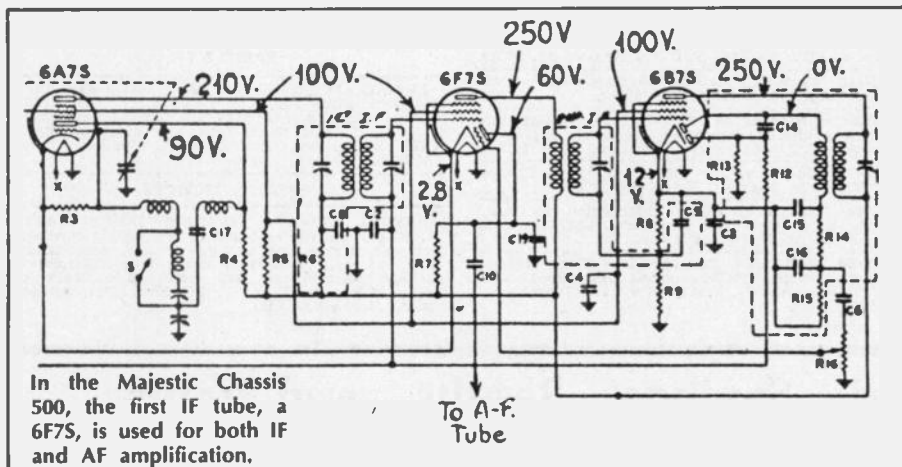

Partial circuit of the Emerson model 678.

With this book, and the material contained in this article, you can get a good idea of the sort of equipment available in the early years of radio. Considering the technology, it produced fine results. ■

If you want a career in servicing two-way radio communications equipment...you'll have to get a First or Second Class FCC Radiotelephone License.

One good way to prepare for your license exam is a specialized home-study course from CIE...the FCC License school."

There's a gigantic potential market out there for communications equipment service skills. (For example, there are about 4 million mobile transmitters that are licensed by the FCC.) And that's just the beginning. Radio systems are also used in air and railroad traffic control; police, fire-fighting, and rescue vehicles; ship-to-shore communications; dispatching of fleet vehicles, such as taxis and trucks; assigning field service specialists; security networks; satellite communications; and many other new and growing applications. But before you can start a career servicing any radio system, you must have at least a Second Class FCC Radiotelephone License.

How CIE Can Help You

We've been helping people prepare for the government-administered FCC License examinations since 1934. Our record speaks for itself: in continuing surveys, nearly 4 out of 5 CIE graduates who take the exams get their FCC Licenses. No wonder the people who know us best think of us as "the FCC License school."

CIE independent study courses combine the necessary FCC License preparation with a thorough education in electronics technology. In fact, one course... "FCC License and Communications"... includes that in-depth instruction plus intensive training in the specific career skills needed to maintain and repair two-way FM radio equipment. In addition, CIE offers five other career courses which include FCC License preparation. Some even provide valuable "hands-on" training with professional equipment such as a solid-state oscilloscope, a Zenith color TV, and a color bar generator.

Learning New Skills Is No Picnic

But, don't kid yourself. You really have to want success if you're going to build your skills properly. CIE independent training is no snap even with our Auto-Programmed® Lessons. It takes work and it takes time. But when you make it, the rewards can be worth it all.

So, if communications troubleshooting looks like the career field you want... and want it enough to roll up your sleeves and work for it... let us know.

Send for CIE's FREE School Catalog

Mail the card or coupon or write and mention the name and date of this magazine. We'll send you a

copy of CIE's FREE school catalog — plus a complete package of independent home-study information. For your convenience, we'll try to have a representative contact you to answer your questions. Mail the card, coupon, or your letter to: CIE, 1776 East 17th St., Cleveland, OH 44114.

CIE **Cleveland Institute of Electronics, Inc.**
 1776 East 17th Street, Cleveland, Ohio 44114
 Accredited Member National Home Study Council

I WANT MY FCC RADIOTELEPHONE LICENSE
 I want to earn an FCC License so I can service radio communications equipment. Send me my FREE CIE school catalog... which includes complete FCC License information: BG-07

PRINT NAME _____ APT. _____
 ADDRESS _____ STATE _____ ZIP _____
 CITY _____ PHONE (area code) _____
 AGE _____

All CIE career courses are approved for educational benefits under the G.I. Bill.
 Check box for G.I. Bill information: Veteran Active Duty

BUILD 20 RADIO and Electronics Circuits

Reg. U. S.
Pat. Off.



Training Electronics Technicians Since 1946

PROGRESSIVE HOME RADIO-T.V. COURSE

Now Includes

- ★ 12 RECEIVERS
- ★ 3 TRANSMITTERS
- ★ SQ. WAVE GENERATOR
- ★ SIGNAL TRACER
- ★ AMPLIFIER
- ★ SIGNAL INJECTOR
- ★ CODE OSCILLATOR
- ★ No Knowledge of Radio Necessary
- ★ No Additional Parts or Tools Needed
- ★ Solid State Circuits
- ★ Vacuum Tube Circuits

**YOU DON'T HAVE TO SPEND
HUNDREDS OF DOLLARS FOR A RADIO COURSE**

The "Edu-Kit" offers you an outstanding PRACTICAL HOME RADIO COURSE at a rock-bottom price. Our Kit is designed to train Radio & Electronics Technicians, making use of the most modern methods of home training. You will learn radio theory, construction practice and servicing. THIS IS A COMPLETE RADIO COURSE IN EVERY DETAIL. You will learn how to build radios using regular schematics; how to wire and solder in a professional manner; how to service radios. You will work with the standard type of punched metal chassis as well as the latest development of Printed Circuit chassis.

You will learn the basic principles of radio. You will construct, study and work with RF and AF amplifiers and oscillators, detectors, rectifiers, test equipment. You will learn and practice code, using the Progressive Code Oscillator. You will learn and practice trouble-shooting, using the Progressive Signal Tracer, Progressive Signal Injector, Progressive Dynamic Radio & Electronics Tester, Square Wave Generator and the accompanying instructional material.

You will receive training for the Novice, Technician and General Classes of F.C.C. Radio Amateur Licenses. You will build Receiver, Transmitter, Square Wave Generator, Code Oscillator, Signal Tracer and Signal Injector circuits, and learn how to operate them. You will receive an excellent background for television, Hi-Fi and Electronics.

Absolutely no previous knowledge of radio or science is required. The "Edu-Kit" is the product of many years of teaching and engineering experience. The "Edu-Kit" will provide you with a basic education in Electronics and Radio, worth many times the low price you pay. The Signal Tracer alone is worth more than the price of the kit.

THE KIT FOR EVERYONE

You do not need the slightest background in radio or science. Whether you are interested in Radio & Electronics because you want an interesting hobby, a well paying business or a job with a future, you will find the "Edu-Kit" a worth-while investment. Many thousands of individuals of all

ages and backgrounds have successfully used the "Edu-Kit" in more than 79 countries of the world. The "Edu-Kit" has been carefully designed, step by step, so that you cannot make a mistake. The "Edu-Kit" allows you to teach yourself at your own rate. No instructor is necessary.

PROGRESSIVE TEACHING METHOD

The Progressive Radio "Edu-Kit" is the foremost educational radio kit in the world, and is universally accepted as the standard in the field of electronics training. The "Edu-Kit" uses the modern educational principle of "Learn by Doing." Therefore you construct, learn schematics, study theory, practice trouble shooting—all in a closely integrated program designed to provide an easily-learned, thorough and interesting background in radio.

You begin by examining the various radio parts of the "Edu-Kit." You then learn the function, theory and wiring of these parts. Then you build a simple radio. With this first set you will enjoy listening to regular broadcast stations, learn theory, practice testing and trouble-shooting. Then you build a more advanced radio, learn more advanced theory and techniques. Gradually, in a progressive manner, and at your own rate, you will find yourself constructing more advanced multi-tube radio circuits, and doing work like a professional Radio Technician.

Included in the "Edu-Kit" course are Receiver, Transmitter, Code Oscillator, Signal Tracer, Square Wave Generator and Signal Injector Circuits. These are not unprofessional "breadboard" experiments, but genuine radio circuits, constructed by means of professional wiring and soldering on metal chassis, plus the new method of radio construction known as "Printed Circuitry." These circuits operate on your regular AC or DC house current.

THE "EDU-KIT" IS COMPLETE

You will receive all parts and instructions necessary to build twenty different radio and electronics circuits, each guaranteed to operate. Our Kits contain tubes, tube sockets, variable, electrolytic, mica, ceramic and paper dielectric condensers, resistors, tie strips, hardware, tubing, punched metal chassis, Instruction Manuals, hook-up wire, solder, selenium rectifiers, coils, volume controls, switches, solid state devices, etc.

In addition, you receive Printed Circuit materials, including Printed Circuit chassis, special tube sockets, hardware and instructions. You also receive a useful set of tools, a professional electric soldering iron, and a self-powered Dynamic Radio and Electronics Tester. The "Edu-Kit" also includes Code Instructions and the Progressive Code Oscillator, in addition to F.C.C. Radio Amateur License training. You will also receive lessons for servicing with the Progressive Signal Tracer and the Progressive Signal Injector, a High Fidelity Guide and a Quiz Book. You receive Membership in Radio-TV Club, Free Consultation Service, Certificate of Merit and Discount Privileges. You receive all parts, tools, instructions, etc. Everything is yours to keep.

PRINTED CIRCUITRY

At no increase in price, the "Edu-Kit" now includes Printed Circuitry. You build a Printed Circuit Signal Injector, a unique servicing instrument that can detect many Radio and TV troubles. This revolutionary new technique of radio construction is now becoming popular in commercial radio and TV sets.

A Printed Circuit is a special insulated chassis on which has been deposited a conducting material which takes the place of wiring. The various parts are merely plugged in and soldered to terminals.

Printed Circuitry is the basis of modern Automation Electronics. A knowledge of this subject is a necessity today for anyone interested in Electronics.

FREE EXTRAS

• SET OF TOOLS

- SOLDERING IRON
- ELECTRONICS TESTER
- PLIERS-CUTTERS
- VALUABLE DISCOUNT CARD
- CERTIFICATE OF MERIT
- TESTER INSTRUCTION MANUAL
- HIGH FIDELITY GUIDE • QUIZZES
- TELEVISION BOOK • RADIO TROUBLE-SHOOTING BOOK
- MEMBERSHIP IN RADIO-TV CLUB: CONSULTATION SERVICE • FCC AMATEUR LICENSE TRAINING
- PRINTED CIRCUITRY

SERVICING LESSONS

You will learn trouble-shooting and servicing in a progressive manner. You will practice repairs on the sets that you construct. You will learn symptoms and causes of trouble in home, portable and car radios. You will learn how to use the professional Signal Tracer, the unique Signal Injector and the dynamic Radio & Electronics Tester. While you are learning in this practical way, you will be able to do many a repair job for your friends and neighbors, and charge fees which will far exceed the price of the "Edu-Kit." Our Consultation Service will help you with any technical problems you may have.

FROM OUR MAIL BAG

J. Stataitis, of 25 Poplar Pl., Waterbury, Conn., writes: "I have repaired several sets for my friends, and made money. The "Edu-Kit" paid for itself. I was ready to spend \$240 for a course, but I found your ad and sent for your Kit."

Ben Valerio, P. O. Box 21, Magna, Utah: "The Edu-Kits are wonderful. Here I am sending you the questions and also the answers for them. I have been in Radio for the last seven years, but like to work with Radio Kits, and like to build Radio Testing Equipment. I enjoyed every minute I worked with the different kits: the Signal Tracer works fine. Also like to let you know that I feel proud of becoming a member of your Radio-TV Club."

Robert L. Shuff, 1534 Monroe Ave., Huntington, W. Va.: "Thought I would drop you a few lines to say that I received my Edu-Kit, and was really amazed that such a bargain can be had at such a low price. I have already started repairing radios and phonographs. My friends were really surprised to see me get into the swing of it so quickly. The Trouble-shooting Tester that comes with the Kit is really swell, and finds the trouble, if there is any to be found."

Progressive "Edu-Kits" Inc., 1189 Broadway, Dept. 503 GT Hewlett, N.Y. 11557

Please rush me free literature describing the Progressive Radio-TV Course with Edu-Kits. No Salesman will call.

NAME

ADDRESS

CITY & STATE ZIP

PROGRESSIVE "EDU-KITS" INC.

1189 Broadway, Dept. 503 GT

Hewlett, N.Y. 11557

CIRCLE 9 ON READER SERVICE COUPON