

BEST REPORTS

hi-fi stereo

BUYERS' GUIDE

MAY-JUNE 1980 \$1.35

BEAT THE HI-FI HUSTLE

Learn to Spot Those Stereo Store "Bargains" That Save You Nothing

CASSETTE TAPE ON TRIAL

How the Top Back Up

NOISE

For Digital Has It Now

S NEW

Low-breaking News From the Dashboard Revolution



FDMDZPLE138U C-C-0 01 129NOV80*
FRED D'AMOUR
136 PLEASANT
AUBURN ME 04210
25



Better Than Any Pusher

**No matter how fine the fibers or how soft the "plush"
—everything other than the Discwasher system is a pusher.**

Pushers only line up dirt and microdust into an even line of contamination. Run your pusher off the record at a tangent—and you spread these particles into a tangent line. And microdust becomes permanently welded into vinyl by a tracking stylus.

Only the Discwasher system has the patented micro-tipped fibers which are directional—slanted—to pick up, hold and thus remove particles from your discs. These same directional fibers also remove fluid and solubilized contaminants by capillary action.

**The superior record cleaner—
better than any pusher.**



discwasher, inc.

1407 N. PROVIDENCE RD.
COLUMBIA, MISSOURI 65201

**Now Available with DC-1
Pad Cleaner at no extra charge.**

YOU ALREADY KNOW THAT DENON

OFFERS THE FINEST LINE OF TURNTABLES AND
CARTRIDGES IN AMERICA.

The DP-30L turntable and the DL-303 cartridge



WHAT YOU MAY NOT KNOW IS THAT WE
OFFER THAT SAME LEVEL OF QUALITY IN
CASSETTE DECKS.

WE INVITE YOU TO COMPARE OUR MODEL
DR-250 TO ANY MACHINE IN ITS PRICE RANGE.



Consider these advantages:

1. Two motors, servo-controlled
2. Two heads (yes, this is an advantage*)
3. Auto-rewind and play
4. Full logic solenoid controls
5. Metal tape capability
6. Denon's unique pause/mute mechanism
7. 3-layer Sendust head

All this adds up to better sound. See your Denon dealer and hear it for yourself.

DENON The Difference
Is Simplicity

*For a thorough explanation, drop us a line. We'll send you Technical Bulletin 34A. For the name of your nearest Denon dealer, write Denon America, Inc., P.O. Box 1139, West Caldwell, NJ 07006. Distributed in Canada by Tri-Tel Associates Ltd., Ontario.

hi-fi/stereo

BUYERS' GUIDE

FEATURES

24/THE CLASS OF '80

by **Fred Petras** The latest in new hi-fi technology that will soon be graduating on to the dealer's shelves.

31/WHAT'S NEW IN CAR STEREO

by **Fred Petras** Our auto audio correspondent keeps us up to date with the latest news from the dashboard revolution.

35/FOR YOU I'VE GOT THIS DEAL

by **Paul Kalasnik** How to spot those stereo store bargains that make the dealer rich.

37/ENCODED DISCS

by **Alfred Meyers** With a new dbx black box and some slightly special LPs you can get near-digital sound today.

43/CASSETTE TAPE TRYOUTS

by **Herb Friedman** A look at how the major brands and formulations stack up with each other.



PARTICULARS

4/AUDIO SHOWCASE

A close-up look at the latest new product introductions from the hi-fi equipment manufacturers.

18/OPERA

by **Speight Jenkins** Jenkins pays tribute to some of opera's greats. He'll take you along the career paths of several top artists.

22/JAZZ

by **J.R. Taylor** In this first of a two part series, Miles Davis, jazz's extraordinary yet secretive trumpet master, is profiled with his early recordings.

20/STEREO RECORDINGS

by **Thomas D. Kelley** Bernstein's interpretation of a Beethoven quartet arranged for string orchestra highlights the reviews of special interest to music lovers.

16/POP DISCS

by **Ken Irsay** The latest LPs in the world of country, pop and rock are reviewed, with a special look at the songs of artist Dan Fogelberg.

EQUIPMENT TESTS

47/TEST REPORTS

Our laboratory checks out the latest in hi-fi components and reports on them using our brand new test report format.

48/RECEIVERS

Alwa AX-7800U
Akai AA-R-50

Yamaha CR-240

51/TUNERS

Crown FM-1

52/AMPLIFIERS

Harman Kardon hk770

53/PREAMPLIFIERS

Harman Kardon hk725

Heathkit AP-1800

55/INTEGRATED AMPLIFIERS

Denon PMA-630
Marantz PM-300

SAE "TWO" A7

60/TURNABLES

Denon LP-30L

Scott PS-18

62/CASSETTE DECKS

Dual C-830
TEAC A-510 Mk II

Sansui SC-1330

41/SOUND PROBE

by **Hans Fantel and Christopher Greenleaf**

Our chief audio-evaluators report on the Dahlquist DQ-10 audiophile speaker, and the Realistic Optimus 23, a budget speaker that really delivers.



Cover Photo: by Leonard Studios

All the top tapes and some cassette decks to play them on. The tape machines shown (from top down): Toshiba PC-X20, TEAC A-510 Mk. II, Kenwood KX-2060, and the Dual C-830.



hi-fi/stereo[®] BUYERS' GUIDE

Associate Publisher

Julian S. Martin

Editor

Gordon Sell

Editorial Assistant

Cynthia McClean

Art Director

Ralph Rubino

Cover Design Director

Irving Bernstein

Associate Art Director

David Pindar

Assistant Art Director

Celeste T. Barbera

Production Director

Carl Bartee

Production Manager

Carole Dixon

Production Assistant

Annette Simon

Advertising Director

Edmund M. Lassus

Subscription Circulation Director

Robert B. Enlow

Subscription Circulation Manager

Eugene S. Slawson

Newsstand Circulation Director

Donald L. Gabree

Classified Advertising Director

Rose Wayner

Marketing Director

James C. Weakley

President and Publisher

Joel Davis

Vice President and General Manager

Leonard F. Pinto

Vice President and Treasurer

Victor C. Stabile

HI-FI/STEREO BUYERS' GUIDE is published bimonthly by Davis Publications, Inc. Editorial and business offices: 380 Lexington Ave., New York, NY 10017. All subscription orders and mail regarding subscriptions should be sent to P.O. Box 1855 GPO, New York, NY 10001. One-year subscription (six issues) in the U.S. and its possessions: \$7.95. Outside U.S. and its possessions, add \$1 per year. Advertising offices: East Coast—380 Lexington Ave., New York, NY 10017, 212-557-9100. Midwest—Dier & Broderick, 550 N. Frontage Road, P.O. Box 337, Suite 288, Northfield, IL 60093, 312-446-9571. West Coast—Montague/Bass Media 5900 Wilshire Blvd., Suite 1145, Los Angeles, CA 90036, 213-933-9217. For change of address, please advise 4 to 6 weeks before moving. Send your current mailing label with new address to HI-FI Stereo Buyers' Guide, P.O. Box 1855 GPO, New York, NY 10001. Second class postage paid at New York, NY and at additional mailing office. Copyright 1980 by Davis Publications, Inc.

ISSN 0018-1218

No matter how good your present stereo system, we can improve it! Here's proof.



Add effortless clarity and transparency with our new Omnitec™ series Vector-Aligned™ dual magnet cartridge or AT30E moving coil cartridge with user-replaceable stylus.



Laboratory precision is the hallmark of every A-T tone arm for home, studio, or disco.



You might pay \$1000 or more for speakers almost as good as these remarkable electret stereophones.



Use our complete line of record and stylus cleaners to keep your collection sounding great years from now.



LIFESAVER is the first truly complete record preservative. Stops static and record wear for years.



Create your own award-winning tapes with Audio-Technica studio-quality microphones.



Make it all worthwhile with thrilling direct-to-disc and digitally-mastered performances from around the world.

When you add Audio-Technica, you multiply listening enjoyment. At leading audio stores. Write for catalog and dealer list, today.

audio-technica.
INNOVATION □ PRECISION □ INTEGRITY

AUDIO-TECHNICA U.S., INC., Dept. 50BG
33 Shiawassee Avenue, Fairlawn, Ohio 44313

THE LATEST HI-FI COMPONENTS IN OUR... AUDIO SHOWCASE

"Radical Departure" Turntable

Technics SL-10 is a compact, quartz direct-drive turntable that represents a notable departure from conventional design. Although the unit has the same width and depth dimensions as an LP record jacket, it is fully automatic and plays discs in a totally sealed cabinet. A linear tracking tonearm with its drive system and a micro-computer electronic control block are contained in the lid section of the cabinet. The lower section contains a unique integral rotor platter DD motor plus its driving and quartz-phase-locked control circuit. To

use the SL-10, just place a record on the turntable, close the lid and press the start button. Stylus contact points are determined by a precision opto-electronic detection system. Perhaps the most amazing aspect is that the unit can be stood upright, as well as kept in the usual horizontal position, during record play. The SL-10 can also be stored in upright position, along with records, when not in use. An advanced coreless DC motor drives the arm and an optical sensor located near the stylus tip determines operation. The opto-electronic system utilizes deflection

Audio Pulse Digital Time Delay is possibly the greatest advance in sound reproduction since stereo. A strong statement indeed, but we feel strongly about it. By means of time delay, the ambience of the live performance is returned to the music in a way not possible with ordinary stereo reproduction.

Stereo gave us left and right imaging—Audio Pulse gives us the realism of depth and spatial perception by digitally processing, delaying and

recirculating program material through a secondary set of rear speakers. The apparent size and acoustic treatment of that area can be adjusted by simple front-panel functions.

Digital time delay must really be heard to be appreciated... but once you do, you won't want to listen without it.

Audio Pulse offers complete digital time delay systems. Model Two, the new Model 1000 and two sets of specially designed secondary speakers.

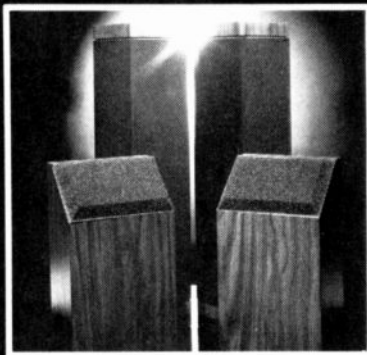

Audio Pulse

YOU WON'T MISS IT UNTIL IT'S GONE...

© 1979 Audio Pulse, Inc., 4323 Arden Drive, El Monte, CA. 91731 (213) 579-4873

Why Wait, Delay Now.



Circle No. 19 On Reader Service Card

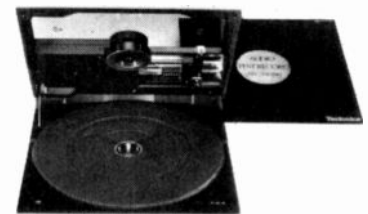

Circle No. 98
On Reader Service Card

angle detection and is said to be far more accurate than systems that operate near the suspension. Thus cartridge/groove geometry is always maintained near the ideal relationship, says Technics. There is no lateral tracking error since the SL-10's linear tracking arm has the same geometry as the cutter heads used to make records. Works off 12-volt DC car battery as well as regular AC power. Price: \$600.

Tape Noise Reduction System

This dbx Model 224 Type II Tape Noise Reduction System is designed for stacking or rack mounting. In addition to its simultaneous encode/decode function, it provides up to 40 dB increase in usable dynamic range. Model 224 is suitable for use with two-head recorders, and provides full monitoring



Circle No. 118
On Reader Service Card

capability with three-head units. It features a special decoding function enabling decoding of commercially available dbx Encoded Discs; compatible with standard record playing equipment, these dbx discs provide full dynamic range music reproduction against "a background of silence," according to dbx. The 224 allows simultaneous monitoring of the noise reduced signal off tape while recording, and it can be used for recording live, tape-to-tape and record-to-tape, in addition to tap-

Introducing TDK's Optimum Dynamic.TM

Normal bias tape taken to the optimum.



TDK's answer to the need for a normal bias reference standard.

Optimum Dynamic is the outcome of the same, sophisticated technology which set the high bias reference standard with TDK's SA cassette. Its tape formulation consists of Optima Ferric particles. A needle-shaped, pure iron oxide that has been ultra refined to cover the tape surface evenly and densely. The result is a cassette with a sensitivity and MOL audibly superior to any normal bias cassette available in the market today.

Well balanced sound.

Optimum Dynamic has all the sound characteristics you've been looking for. Super flat frequency response and sensitivity with a wide dynamic range. Lower noise and higher output at critical levels. For example, you'll now be able to capture the full dynamic complexity of a classical performance as well as the sustained higher output characteristic of contemporary music. In every way, Optimum Dynamic will deliver a well balanced, reference quality normal bias performance. And you'll hear it, unfailingly, for years to come.

Optimum Dynamic has the same Super Precision Mechanism as the SA cassette, protected by TDK's full lifetime warranty.*



Supplier to the U.S. Olympic Team

*In the unlikely event that any TDK cassette ever fails to perform due to a defect in materials or workmanship, simply return it to your local dealer or to TDK for a free replacement.

The test of success.

We believe we've been highly successful in fulfilling the need for a normal bias reference standard. But there's a simple test. Listen to an Optimum Dynamic just once. Compare it to anything else you've been using. From then on, you may want to use it as a reference.



TDK
The machine for your machine

© 1980 TDK Electronics Corp., Garden City, New York 11530

AUDIO SHOWCASE

ing off radio. Complex level matching and alignment procedures are unnecessary because the system operates as a linear decibel compander. Specifications: fixed compression ratio, 2:1; fixed expansion ratio, 1:2; dynamic range, 110 dB; input impedance, greater than 100K ohms; input level, 300 mV nominal to 6V RMS maximum; frequency response, 30 to 20,000 Hz \pm 1 dB; slew rate, greater than 10V/microsec; total harmonic distortion, less than 0.5% typical; IM distortion, less than 0.2%; power consumption, 7 watts. Price: \$275.

100 Watts-per-Channel Amp

Optonica's slim-styled ebony Model SX-9305 power amplifier provides 100 watts per channel, minimum RMS at 8 ohms from 20 to 20,000 Hz with no

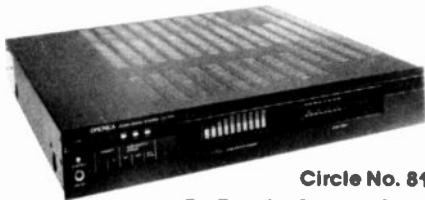

Circle No. 81
On Reader Service Card

more than 0.01% total harmonic distortion. The unit incorporates pure FET amplifier circuitry, pure DC circuitry, dual FET cascode differential input and drive stages, toroidal power transformer and a gas/liquid heat radiation system. Features include: detented volume control; speaker selector A, B, A+B; three colored LED power meters; two colored LED indicators for protection circuitry; a three-color audio spectrum analyzer. The suggested price is \$850.

"Optimum Performance" Tonearm

Ultracraft by Osawa offers this AC-30 tonearm at the "fabulously low price" of \$299.95. For that outlay you get an oil-damped model featuring a single needle-point support which reduces resonance effects. Other features in-



Circle No. 117
On Reader Service Card

clude: an adjustable antiskating control; oil-damped cueing lever; locking rest stop; 7mm black brass stem. The counterweight is calibrated in grams to indicate stylus pressure, and the shaft is decoupled from the arm to minimize vibration transmission. A large tonearm mounting nut provides mass at the base to maximize stability.

Discrete Three-Head Cassette Deck

Nakamichi's Model 680ZX cassette deck is at the top of the line and makes use of the firm's Auto Azimuth Alignment "breakthrough." This is claimed to be the world's only cassette deck (along



Circle No. 116
On Reader Service Card

with its first cousin Model 680) capable of high-fidelity performance at 15/16 ips "half speed." The achievement of 15,000 Hz response at slow speed now makes it possible to record a full opera or 8 to 10 record sides on a single C-90 cassette. The specs are the same as for the 680 model, but the new version provides the additional convenience of automatic record-head-azimuth alignment. The Auto Azimuth-Alignment system utilizes a fourth servo motor that manipulates the record-head mounting base until the record-head gaps are precisely parallel to those of the playback head. Upon activation of the A-Z-A system, a 400-Hz signal is recorded on each track. A sophisticated phase comparator measures the phase error between the two reproduce channels and drives a servo motor until precise alignment is achieved for the particular cassette in use. The entire process takes about two seconds. During the alignment procedure, the play-button LED blinks; when alignment is achieved, the LED glows steadily. Specs: response at 15/16 ips, 10 to 15,000 Hz, +3 dB; S/N, better than 60 dB; THD, less than 1.5%; wow/flutter, less than 0.14% WTD Peak and 0.08% WRMS. Price: \$1,550.

Moderately-Priced Quality Cartridges

Shure's M97 Era IV Series of "moderately-priced" phono cartridges incorporate many design innovations formerly found only in the company's top cartridge, the V15 Type IV. There's a viscous-damped dynamic stabilizer and a telescoped stylus shank structure, for example. These design elements are said to dramatically increase trackabil-

ity at minimum tracking forces. One model in the line, the M97HE, is also fitted with a hyperelliptical stylus. The stabilizer improves trackability by maintaining a constant cartridge-to-record



Circle No. 93
On Reader Service Card

distance and uniform tracking force even on severely warped records. More than 10,000 electrically conductive carbon fibers built into the stabilizer also discharge static electricity while sweeping away dust particles. Like the M97HE, two other cartridges in the series are designed to track at $\frac{3}{4}$ to $1\frac{1}{2}$ grams; the M97ED has a nude biradial (elliptical) stylus while the M97GD has a nude spherical stylus. If slightly heavier tracking forces are advantageous, consider the M97EJ with a biradial stylus and the M97B with spherical stylus (track at $1\frac{1}{2}$ to 3 grams). Prices: M97HE, \$112.50; M97ED, \$99.50; M97EJ, \$82.50; M97GD, \$79.50; M97B, \$67.50.

High Velocity Stereophones

Koss offers High Velocity HV/X Series Stereophones that feature special lightweight construction and a "unique" approach to psychoacoustic performance. A variable-density contoured ear-cushion is claimed to retain low fre-



Circle No. 76
On Reader Service Card

quency bass notes like a standard dynamic stereophone, but allows mid and high frequency sound waves to vent for a more transparent high velocity type sound. Instead of actually resting on the ear, the Koss stereophones fit around the ear in a circumaural configuration. The variable-density feature refers to use of a very porous material which is acoustically transparent at its perimeter but is compressed as it reaches the center of each earcushion. This design also helps reduce the overall weight of the stereophones. Frequency response is put at 15 to 35,000 Hz, and



The secret of Onkyo.

An incredible sound experience awaits you. An experience that technology alone finds hard to explain. You'll hear music of such stunning purity and sensual richness, that you'll wonder how any turntable could make that much of a difference.

That's the secret of Onkyo. The unique ability to take you several steps beyond pure technology ... to a world of more exciting sound. And we provide it in all our components ... including all five of our turntables.

The Onkyo CP-1030F Fully Automatic Turntable is an outstanding example. Its unique design lets you take much fuller advantage of today's most sensitive high-compliance cartridges ... providing more perfect record groove tracking and more perfect damping of the vibrations that destroy perfect sound quality.

The Onkyo CP-1030F utilizes a uniquely designed low mass, straight-line carbon fiber tonearm and headshell. Its construction assures purer sound even with warped records.

Infrared sensors replace the usual mechanical devices that detect the end of record play ... returning the tonearm more silently

to the OFF or REPEAT position. Manual cueing is also smoother and more precise ... with far less lateral drift during stylus descent.

A Quartz-locked DC direct-drive motor ... with an LED illuminated strobe ... assures rotational speed accuracy. And a separate motor controls automatic tonearm movement functions.

The entire turntable rests on a highly stable triple-insulated suspension system to isolate it from room vibrations and sound vibrations from your speakers.

Styling is superb. Silver-grey with black, low lustre metal and a crystal dust cover. Feather-touch control buttons are front-panel mounted, with a full array of LEDs indicating all function settings.

The CP-1030F is just one of five remarkable new turntables from Onkyo. All built for more perfect sound ... both today and into the future.

Experience "the secret of Onkyo" now, at your Onkyo dealer. Hear audio components so advanced, they transcend mere technology. Onkyo USA Corporation
42-07 20th Avenue
Long Island City, N.Y. 11105
(212) 728-4639



The Onkyo CP-1030F

A remarkably advanced turntable that makes every record sound better, even when warped.

AUDIO SHOWCASE

weight is 7.8 ounces. Model HV/X retails for \$69.95 while the HV/XLC version featuring volume-balance controls costs an additional ten bucks. All models in the series include dual suspension headbands, adjustable slide bars and removable earcushions to facilitate cleaning.

Metal Tape Cassette Deck

Kenwood's KX-500 cassette deck offers metal tape capability along with fluorescent peak meter convenience. This "popular-priced" deck (\$225) was designed for operating ease through use of a new, exclusive "soft touch" mechanism which actually feels like the more expensive solenoid switches. Also featured is Kenwood's dual-belt design drive system which is claimed to provide wow and flutter below 0.05% WRMS. A stabilized tape path ensures

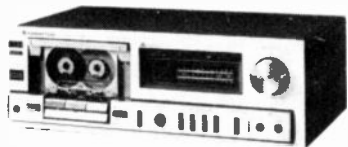

Circle No. 75 On Reader Service Card

accurate and smooth tape flow during the life of the deck, and sendust-coated tape heads minimize wear. The tape selector in the KX-500 is combined with a variable bias-adjust control to optimize the performance of each individual tape. With metal tape and Dolby, frequency response is 30 to 16,000 Hz, and signal-to-noise ratio is 62 dB. Additional features include: two microphone jacks with built-in preamps to record in stereo from wide-band dynamic microphones; a single Record button instead of a conventional—often awkward to use—two-lever system.

130-Watt Power Amplifier

This Audiovox Hi-Comp HCB-860 130-watt stereo power amplifier puts out 65 watts per channel from 15 to 20,000 Hz

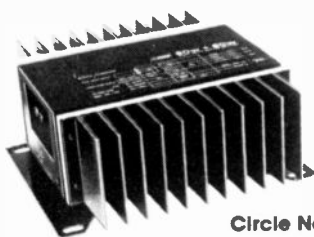

Circle No. 111
On Reader Service Card

into 4 ohms at less than 0.3% total harmonic distortion. Features include dual 4 to 8 ohm output impedance connections, remote on/off power switch, selectable high or low level inputs and a 15 to 50,000 Hz response range. List price: \$200.

Bass Reflex Two-Way Speaker System

Aiwa's model SC-61R bass reflex 2-way speaker system for mini components features: a 6-5/15 inch diameter woofer; 2-inch tweeter; frequency response from 50 to 18,000 Hz; 8 ohms impedance; 40 watts maximum input



Circle No. 63 On Reader Service Card

power. Measures 6-5/16 inches wide by 13 inches high by 9 1/2 inches deep. Weighs 9.3 lbs. each. Price: \$150 per pair.

Entertainment Center Cabinets

A full line of "entertainment center" Status Pro Collection hi-fi cabinets provide room for everything you might own in the way of audio/visual equip-



Circle No. 110
On Reader Service Card

ment. Model 1930 shown here, selling for about \$300, is 20 1/4 inches deep by 21 1/2 inches between sides on the left by 27 inches between sides on the right by 46 inches high. This "finest of electronic furniture" reveals no external fasteners and provides strength by virtue of 1 1/2 inch thick sides. One section, the entire height of the unit, is covered with bronze toned tempered safety glass doors behind which there are four infinitely-adjustable shelves for safe storage of audio components and records. A slip-in section for TV has back panels to conceal the wall and create a custom look. Below, double-doored cabinet space reveals a unique Gusdorf VCR slide-out shelf. Separations in the back allow heat escape. Avail-

able in a rich walnut tone finish with Rendura coating. From Gusdorf Corp.

Metal-Biased Deck With Search Feature

TEAC's model CX-370 tape deck, retailing for \$279, features a new "Computomatic™" program system. No-signal intervals of two seconds or more between program selections enable the user to program the deck to begin playback from any one of ten predetermined positions. This automatic search function can be activated from any place on the tape. Additionally, the deck offers three-position bias and equalization settings for metal particle tape, as well as chromium and standard tapes. Using metal tape and integral Dolby noise reduction, the signal-to-noise ratio is 65 dB, and the frequency response is from 30 to 18,000 Hz. A stable drive

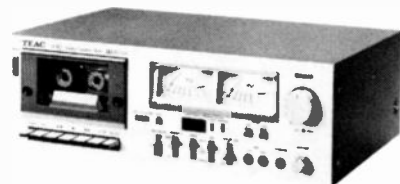

Circle No. 10 On Reader Service Card

mechanism is accurate to within 0.05% wow and flutter deviation. Other features include VU-type meters, record mute function and independent input-output level controls.

Smallest Stereo Cassette Player

Soundabout, Sony's model TPS-L2 stereo cassette player is billed as the world's smallest such stereo tape machine capable of providing "full quality hi-fi sound." The portable unit is about the size of a pocket dictionary—only 5-5/16 inches in its longest dimension—yet able to play standard size cassettes. It's said to be the perfect companion for commuters, joggers, roller disco addicts and library freaks (others aren't bothered because listening is done with featherweight headphones weighing only 1 1/2 ounces). The headphones (model MDR-3LR) retail for \$50 while the deck itself is price-pegged at \$199.95. Deck features include: carrying case with strap; two headphone jacks for head-to-head listening; hot line feature to permit talk or singing over ▶



Circle No. 94
On Reader Service Card

MOST MUSIC LOVERS HAVE A PROBLEM.

Overweight. The kind that chews up records and distorts the music.

Easy solution. An Ortofon low mass (LM) cartridge weighs a miniscule 2.6 grams. It can actually reduce the effective tonearm mass of any turntable by up to 40%!

The patented Ortofon Variable Magnetic Shunt system not only makes low-mass design possible, it also reduces distortion to the vanishing point.

Low mass and the VMS system solve a lot of problems: low frequency distortion, sound coloration, inaccurate transient performance, inability to track record warps, unwanted resonant frequency. All solved.

Write to us for full information. Better yet. Visit your Ortofon Dealer's Weight Reduction Center now.

ortofon 122 Dupont St.
Plainview, N.Y. 11803



AUDIO SHOWCASE

the music (except in libraries); optional plug adaptor to connect with a home stereo system; four different power sources; separate right/left channel volume controls; tone selector; cue and review; counter-inertial flywheel tape drive; coreless motor. Frequency responses: 40 to 12,000 Hz.

"Most Expensive" FM Receiver

The suggested list price of Revox's Model B780 FM stereo receiver is a cool \$2,699 for which you get such goodies as a 75-watt-per-channel integrated amplifier with a quartz-controlled synthesizer FM tuner plus a "highly sophisticated" microprocessor on a sin-



Circle No. 86
On Reader Service Card

gles chassis. Revox claims the high cost is justified for this new state-of-the-art receiver. For example, the tuner section features completely push-button actuated tuning with accuracy of $\pm 0.005\%$. Eighteen pre-set stations can be stored in the unit's electronic memory, and recall is instantaneous at the touch of any one of 13 buttons on the tuner panel. Knob tuning is completely eliminated, and even manual tuning is a push-button operation that provides sweep-and-stop action to pause at each listenable frequency until one is selected. An alternative system provides faster sweeping when you are in a hurry. Specifications (tuner section): IIF sensitivity, $2.5 \mu\text{V}$ (13.2 dBf IIF T-100); sensitivity for 50 dB stereo quieting of $30 \mu\text{V}$ (34.8 dBf); alternate channel selectivity, 78 dB; stereo harmonic distortion, 0.25%; ultimate signal-to-noise ratio, 78 dB; capture ratio, 2 dB; AM suppression, 70 dB. The power amp puts out 75 watts per channel, both channels driven into 8 ohms, with no more than 0.04% THD from 20 to 20,000 Hz. IM distortion is put at 0.04%.

Low Cost Satellite Speaker System

You don't have to rearrange a room around your sound system if you go for this Satellite Speaker System, according

to maker Essex Group. The system consists of two small satellite speakers (popularly called "minis") plus a sin-



Circle No. 115
On Reader Service Card

gle larger cabinet sub-woofer. Computer modeling methods were used to make the speakers as free of distortion as possible using ported enclosures to improve low-frequency performance of the woofer. Sub-woofer models SX-110 and SX-210 feature low frequencies from 20 to 200 Hz which by nature are non-directional; hence the sub-woofers can be placed anywhere in the room. The SX-110 uses one dual voice coil, 10-inch woofer while the SX-210 offers two dual voice coil, 10-inch woofers. One speaker faces inside the cabinet and the other outward to provide a push-pull effect that is claimed to decrease harmonic distortion by as much



**Introducing
Nagaoka Accessories.**
**To preserve the
sound of music.**

For all the big advances in record pressing and record playing, record preservation and care hasn't gone very far. Now there's a company with new ways to conquer the old problems of noise, warpage and dirt. Nagaoka.

KILAVOLT is the first static eliminator that really works! It uses a battery-powered positive ion generator to completely neutralize dust-attracting static charges.

The CRYSTAL STABILIZER is a heavy non-resonant pure glass cylinder that sits on the center of a warped record, applying even downward pressure without contacting the grooves, to make the record playable.

There's no finer record cleaner than the SUPER CHEMICC, with two pads of fine velvet flanking a gentle cleaning brush. It's used with our special CHEMICC solution to loosen grit without harming the grooves.

You've probably spent a lot of money on records. Your Osawa dealer has a full line of Nagaoka products to help you preserve your investment.

NAGAOKA by
OSAWA

OSAWA & CO. (USA) Inc.,
521 Fifth Avenue, New York, New York 10017

Circle No. 28 On Reader Service Card

HI-FI/STEREO BUYERS' GUIDE

EPICURE PRODUCTS INCORPORATED INTRODUCES A SPEAKER FOR COMPACT CARS WITH ANYTHING BUT A COMPACT SOUND.

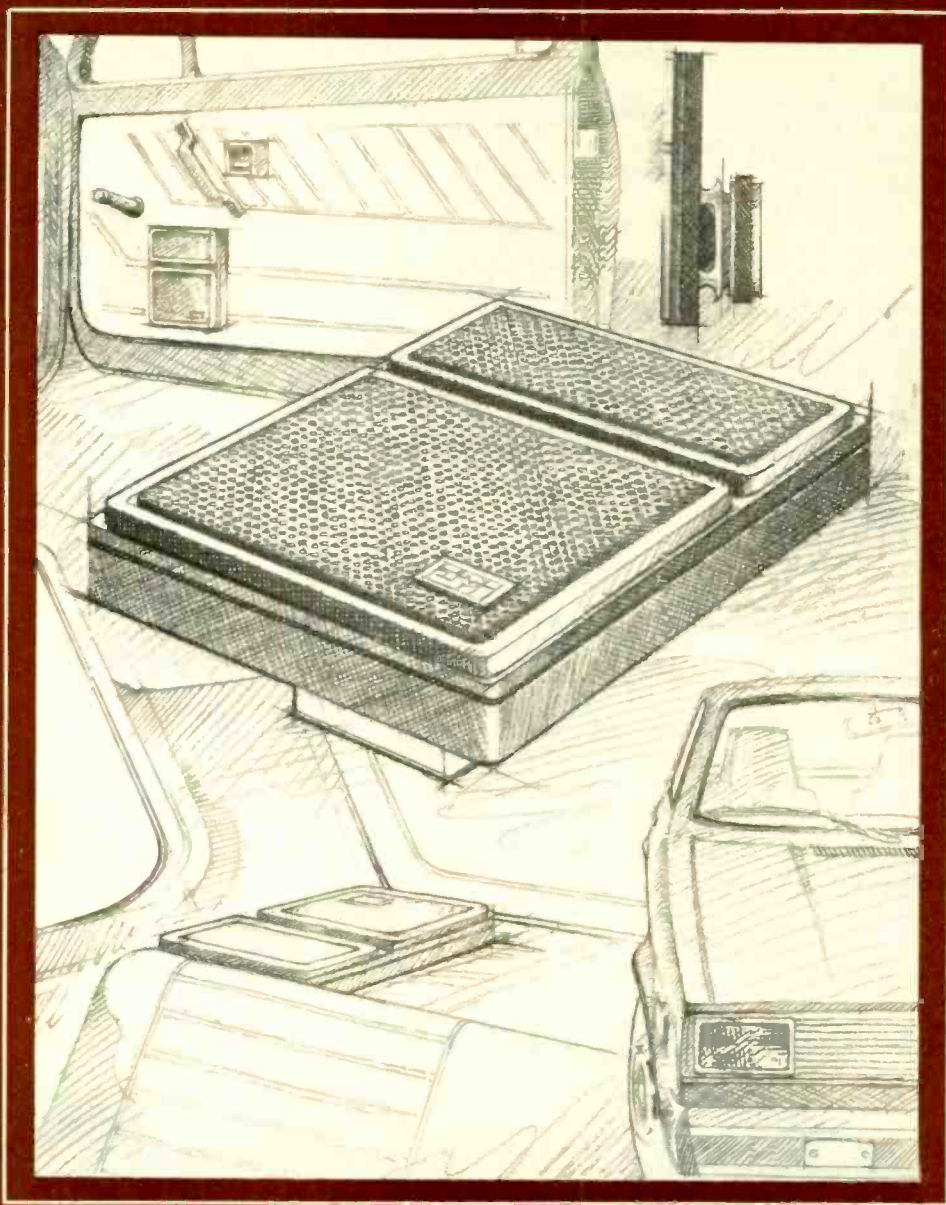

With the coming of the 1980's, automakers have accelerated their construction of smaller cars. And while that's great for full economy, it doesn't leave a whole lot of room for audio components.

Enter the new EPI LS81. The first speaker designed specifically for compact cars, it delivers rich, deep, accurate sound yet fits comfortably in a space as small as 5.125" x 7.875" x 2".

The key to the LS81's superior

performance is a remarkable 4" bass driver. As you know, the reproduction of sound at the bass level depends upon the distance the woofer cone can travel ("cone excursion"). Special features in the LS81 like a long voice coil, low-loss cone suspension and a vented center pole allow its cone to move freely. The result: deeper bass than ever thought possible in a speaker this small.

The LS81's midrange is equally

impressive, as it should be: it's the product of a specially constructed crossover, one of the most complex we've ever assembled. Couple these features with the proven performance characteristics of EPI's celebrated 1-inch air-spring tweeter, and you've got a car speaker made for the 80's:

Small enough to fit in almost any automobile. With a sound big, rich and accurate enough to be called



THE LS81.

For the biggest little idea in car speakers, visit us at Booth 1411 in the Convention Center.

Epicure Products, Incorporated Newburyport, Mass. 01950 A Subsidiary of Penril Corp.
Circle No. 14 On Reader Service Card

AUDIO SHOWCASE

as 15 dB. Models SX-425, SX-525 and SX-625 are designed to clearly reproduce frequencies from below 200 up to 20,000 Hz. System prices including a sub-woofer and two satellite speakers range from \$440 to \$630. Photo shows the SX-625 satellite model.

100 Watts-per-Channel Integrated Amplifier

Lux Audio of America offers this Model L-580 integrated amplifier that provides a power output of 100 watts per channel, both channels driven into 8 ohms, at any frequency from 20 to 20,000 Hz with no more than 0.03% total harmonic distortion. IM distortion is less than 0.08% (8 ohms, 100W, 60 Hz: 7kHz = 4:1). Input sensitivity: phono (MM), 1.5 MV; phono (MC-1), 1.5 MV direct to equalizer circuit; phono (MC-2), 0.05 MV (2 ohms) to 0.15 MV (40 ohms), auto gain control head amp; tuner, 220 MV; Aux 1, 2 and Main-In, 220 MV. Input impedance: phono (MM), 50K ohms; phono

(MC-1), 100 ohms; tuner and Aux 1, 2-40 K ohms; Main-In, 800 K ohms. Signal-to-noise ratio: phono MM, 20 to



Circle No. 114
On Reader Service Card

20,000 Hz (within 0.3 dB): phono MC-1, 20 to 20,000 Hz (within 0.03 dB); tuner, aux and main-in, 10 to 100,000 Hz (within 1 dB). Tone control (Lux style NF type): bass range, 150 Hz, 300 Hz or 600 Hz; treble range, 1.5 kHz, 3 kHz or 6 kHz. Pre-amp output level is 220 MV (impedance: 220 ohms). Price: \$795.

Biggest Little Speaker

Mini-Mesa 75 is Mesa Electronics' "biggest" mini speaker yet offered. This three-way speaker handles a full 75 watts RMS, with a 1-inch soft hemispherical dome tweeter, 3½-inch mid-range, and 6½-inch rubber surround woofer. It's all packed into a modest space measuring 9 inches wide by 12½

inches high by 6½ inches deep. The Mini-Mesa 75, retailing for 175 each,



Circle No. 113
On Reader Service Card

offers a compromise between "awkward size" large speakers and inadequate miniature speakers. Available in both sleek, solid black or wood grained walnut vinyl cabinets.

Low-Level Signal Processing Preamp

Several unique operating configurations are said to be employed in Threshold's model SL-10 low-level signal processing preamplifier. For example, input transistors of the phono and high level circuits are operated in the cascade mode to increase bandwidth through a reduction of Miller capacitances and to provide additional isolation between the source, the power supply, and the gain circuitry. In addition, the active input devices are biased to current levels an order of magnitude beyond those normally applied to solid-state preamps. These very large bias currents substan-



Circle No. 112
On Reader Service Card

tially reduce the distortions in the gain transistors, yielding a "super class A" operating mode wherein the idling currents are many times larger than the current called for in actual operation. This provides extremely high linearity and increases the phono input transistor overload to about 2 volts, at 20 kHz for the high live magnetic cartridge input, and greater than 70 millivolts peak, at any frequency, for the low level "moving coil" cartridge input. Specifications: preliminary phono gain stage frequency response, +0 dB, -3 dB, 0.5 to 200,000 Hz; square wave rise time, 0.5 microsec.; distortion, 0.015% second harmonic at 50 millivolts out; noise, -85 dB. Price: \$990.▲

 **NAGATRON**
TM

The music starts here!



Hear for yourself the live, lush, luxurious sound of this exquisitely handcrafted super induced magnet cartridge...incredibly low distortion...extra long stylus life...very low record wear and more...If you love music...any music...you'll love the NAGATRON 9600.

 **NAGATRON** CORP. BALDWIN, NEW YORK 11510

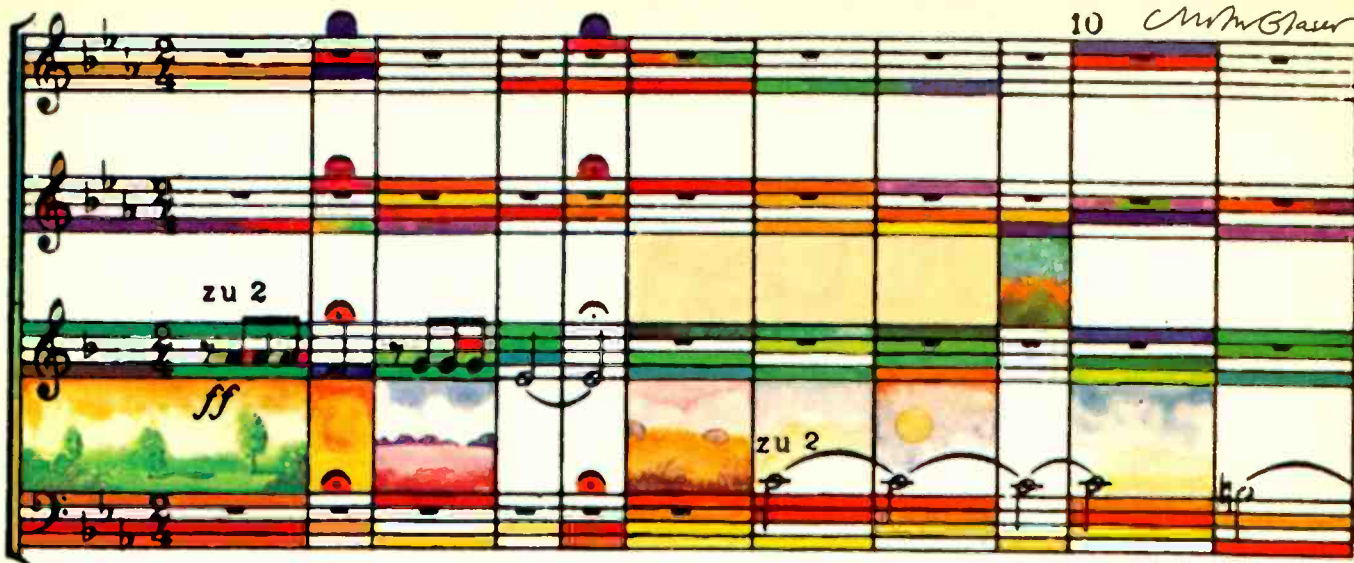

Sony Tape. Full Color Sound.

Music is full of color. Incredibly beautiful color. Color that you can hear... and (if you close your eyes) color you can almost see. From the soft pastel tones of a Mozart to the blinding brilliant flashes of hard rock to the passionately vibrant blues of the Blues.

In fact, one of the most famous tenors in the world described a passage as "brown... by brown I mean dark... rich and full"

Music does have color. Yet when most people listen to music they don't hear the full rich range of color the instruments are playing. They either hear music in black-and-white, or in a few washed-out colors.

That's a shame. Because they're missing the delicate shading, the elusive tints and tones, the infinite hues and variations of color that make music one of the most expressive, emotional and moving arts of all.

Music has color. All kinds of color. And that is why Sony is introducing audio tape with Full Color Sound.

Sony tape with Full Color Sound can actually record more sound than you can hear.

So that every tint and tone and shade and hue of color that's in the original music will

be on the Sony tape. Every single nuance of color, not just the broad strokes.

Sony tape with Full Color Sound is truly different. Full Color Sound means that Sony tape has a greatly expanded dynamic range — probably more expanded than the tape you're using. This gives an extremely high output over the entire frequency range, plus a very high recording sensitivity.

There's even more to Sony tape with Full Color Sound, however. Sony has invented a new, exclusive SP mechanism for smoother running tape, plus a specially developed tape surface treatment that gives a mirror-smooth surface to greatly reduce distortion, hiss and other noise. Each type of tape also has its own exclusive binder formulation, that gives it extra durability.

Any way you look at it — or rather, listen to it, you'll find that Sony tape with Full Color Sound is nothing short of superb.

If you're not hearing the whole rainbow on your audio tape, try recording on Sony tape with Full Color Sound. Then you'll be hearing all the glorious full color that makes every kind of music, music.



If you read the specs, you won't believe the prices:

*MS-10 Loudspeakers:
\$330.00* a pair*

*DA-C7 Tuner-
Preamplifier:
\$360.00**



*DP-EC7 Turntable: \$300.00**

*DT-10
Cassette Tape Deck:
\$370.00**

*DA-A7DC
Power Amplifier:
\$330.00**

**Manufacturer's suggested retail price.*

If you read the prices, you won't believe the specs:

DP-EC7 Turntable:

Drive	20-pole direct-drive DC Servomotor
Speeds	33 $\frac{1}{3}$ and 45rpm
Speed selection	Automatic/manual
Wow and flutter	Less than 0.03% (WRMS)
Speed adjustment	$\pm 3.0\%$
Signal-to-noise ratio	Better than 73dB
Tone arm, S-type	static balance
Effective length	227mm (9")
Overhang	14mm ($\frac{9}{16}$ ")
Tracking error	$+2.9^\circ - 1.5^\circ$
Offset angle	22°
Headshell	fiber reinforced plastic (FRP)
Anti-skating mechanism	Dial setting
Possible cartridge weight	5.0-10.5 gr.
Tracking force adjustment	0-3.0 gr. (0.1 gr. step)

Special functions: Auto lead-in, Auto return from lead-in, Auto lead-out, Free lift/cue, Free L-R traverse, Cue prevention in absence of record, Auto speed change.

MS-10 Loudspeakers:

System/cabinet finish	2-way/walnut
Impedance	6 Ω (min. 5 Ω at 2kHz)
Power handling capacity	100W (IEC rated power)
Frequency response	35-20,000Hz ± 4 dB
Speakers	
Woofer	25cm (10") cone, GFRP honeycomb
Tweeter	5cm (2") cone
Output acoustic (pressure level)	87dB/W @ 1 meter

DA-A7DC Power Amplifier:

Note: All measurements are for 8 ohms output unless otherwise stated.
Minimum continuous output power 75W per channel, both channels driven, from 15Hz - 20kHz, with no more than 0.01% total harmonic distortion.
Total harmonic distortion 20Hz - 20kHz At 40W per channel 0.004%
Intermodulation distortion (70Hz: 7kHz, 4:1)

DA-A7DC Power Amplifier: (cont.)

At rated power	0.008%
Power bandwidth (IHF) (10Hz - 60kHz)	(0.05% THD)
Frequency response	
At rated power	+0, -0.1dB 20Hz - 20kHz
At 0.5W per channel	+0, -1dB DC - 150kHz
Input sensitivity	1V
Damping factor	100, 20Hz - 20kHz
Channel separation	
At 1kHz	80dB
At 20kHz	60dB
Signal-to-noise ratio at rated power	
IHF-A closed circuit	122dB

DA-C7 Tuner-Preamplifier:

FM Tuner Section	
Usable sensitivity	
Mono	11.2 dBf (2.0 μ V)
Stereo	23.1 dBf (7.8 μ V)
50 dB quieting sensitivity	
Mono	20dBf (5.5 μ V)
Stereo	40dBf (55 μ V)
Signal-to-noise ratio	
Mono: 76dB	Stereo: 73dB
Frequency response	+0.5, -1dB 30Hz - 16kHz
Total harmonic distortion at 1kHz, 65dBf (figures in brackets for 'narrow' setting)	
Mono	0.08% (0.25%)
Stereo	0.1% (0.5%)
Capture ratio	1dB (2dB)
Alt. channel selectivity	50dB (75dB)
Stereo separation (1kHz)	45dB (35dB)

AM Tuner Section

Usable sensitivity	200 μ V/m (bar ant.)
Selectivity	25dB
Total harmonic distortion	1%
IF response ratio	40dB

Preamplifier Section

Input sensitivity/impedance	
Phono 1/2	2.5mV/50k Ω
Aux, Play 1/2	150mV/50k Ω
Output level/impedance	

Preamplifier Section (cont.)

Rated	1V/600 Ω
Maximum	10V
Rec 1/2	150mV/600 Ω
Signal-to-noise ratio, IHF-A network	
Phono 1/2	87dB (10mV)
Aux, Play 1/2	99dB (closed circuit)
Total harmonic distortion at rated output, attenuator at -20dB, 1kHz	
All inputs	0.003%
RIAA deviation	± 0.2 dB, 20Hz - 20kHz
Tone controls boost/cut	
Bass	± 10 dB at 100 Hz
Treble	± 10 dB at 10kHz
Subsonic filter	18Hz (-6dB/oct)

DT-10 Cassette Tape Deck:

Tape speed	4.75cm/sec (1 $\frac{7}{8}$ ips) $\pm 1\%$
Wow and flutter (playback)	0.06% wrms
Fast forward/rewind	80sec (C-60 tape)
S/N ratio ± 3 VU, weighted, 400Hz (200pwb/mm)	
Dolby out: 56dB	Dolby in: 64dB*
Erasure ratio (1kHz)	70dB
Crosstalk	
Between channels (500 - 6,300Hz)	35dB
Between tracks (1kHz)	65dB
Harmonic distortion, 400 Hz (160pwb/mm)	1%
Frequency response	
Normal tape	40 - 12,000Hz ± 3 dB
Special tape	40 - 15,000Hz ± 3 dB

*Dolby is a registered trademark of Dolby Laboratories, Inc.

The "Economy" audio system from Mitsubishi. Hear it at your dealer's now. And don't bring a lot of money.

MITSUBISHI
AUDIO SYSTEMS

For the name of your nearest dealer, please call (800) 447-4700 (in Illinois, (800) 322-4400). For more information write Melco Sales, Inc., Dept. 44, 3010 East Victoria Street, Compton, California 90221. In Canada, contact: Melco Sales Canada, Markham, Ontario.

Circle No. 20 On Reader Service Card

pop discs

A review of the latest popular music releases

Dan Fogelberg: "Phoenix." Full Moon/Epic. \$8.98.

The title cut is a country-rocker that harkens back to the very best of Crosby, Stills and Nash with its smooth, yet intense, vocal harmonies and hefty guitar strums. The multi-talented Fogelberg plays synthesizer, all acoustic



and electric guitars and sings lead and background vocals throughout this set of ballad and folk-rock compositions (all self-penned). Top sidemen comprise the rhythm section.

Molly Hatchet: "Flirtin' With Disaster." Epic. \$7.98.

A common feature of many so-called "Southern rock" bands is a stinging twin-guitar instrumental attack. Well, that feature is apparently too common for Jacksonville's Molly Hatchet. The sextet sports three electric guitars, buzzing, humming and careening through-



out their powerful boogie-rock music. Bass and drums provide a solid bottom, and Danny Joe Brown's gritty lead vocals are tough as nails.

ZZ Top: "Deguello." Warner Bros. \$8.98.

This is your basic, gut level, Texas-trio rhythm and blues tour de force, played by one of the most critically acclaimed, highest grossing concert acts in the country. Billy Gibbons' "ruff-tuff" vocals and razor sharp classic guitar riffs are supported by bassist Dusty Hill and Frank Beard on drums. An Elmore James tune and a racy little



ditty called "Hi Fi Mama" highlight the album of mostly original compositions.

Dr. Hook: "Sometimes You Win." Capitol. \$7.98.

Considering the weird rock and roll this group championed when they began ten years ago, it's hard to believe they're at the threshold of superstardom offering up the highly appealing mid-



level, love-oriented rock presented here. Much of the credit for their current success goes to longtime producer/musical director Ron Haffkine. (Continued on page 65)

The New Shape of Sound

The new Stereohedron Series XSV/4000 carries on the tradition of excellence pioneered by the critically acclaimed XSV/3000. It features the Stereohedron® stylus tip, a major innovation in low mass tip technology that assures exceptionally quick rise time to trace high frequency information in the groove.

The Pickering XSV/4000 with low mass samarium cobalt magnet is the ideal choice for playback of today's most advanced direct-to-disc and digital recordings.

Pickering & Co., Inc., Sunnyside Blvd., Plainview, N.Y. 11803.

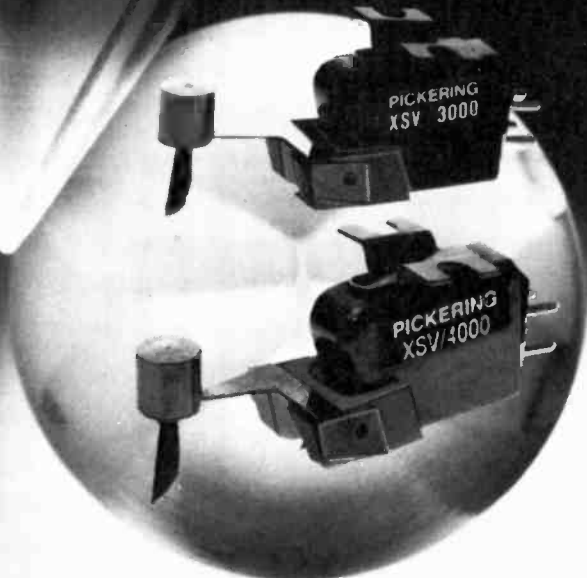

These records were reviewed using the following equipment: Technics SL-5300 turntable with a Discwasher anti-static mat; three interchangeable phono cartridges—Shure V-15 IV, Stanton 681-EEE/S and Audio Technica AT-25; Kenwood KA-8500 integrated amplifier; ADC Sound Shaper 3 parabolic equalizer; BIC F-4 speakers; and Koss Pro-4 AAA headphones.

Introducing
the new
Dual 839
cassette deck.

Consider
what it
would be like
to own one.



The new Dual 839 is so different from all other cassette decks that, rather than list its many features, we'll guide you through them as if the 839 were in front of you.

First, the 839 is bi-directional in record and playback. This doubles the length of every cassette.

You'll notice there's no door between you and the cassette compartment. Insert a cassette and it will lock in precise alignment. That's Dual's Direct Load and Lock system. (A subtle but important touch; any slack in the tape is immediately taken up.)

Follow us carefully on this next one. Even when the tape is in motion, you can pull it out and replace it with another . . . and the previous mode resumes automatically. Useful? When the tape nears the end at a crucial moment, you can have a new tape in place without missing a beat.

The 839 is just as innovative in playback. If a tape made on another

deck is too sharp or too flat, no problem. Playback pitch can be varied over an 8 percent range.

And previously recorded tapes with clicks, pops and disc jockey interruptions can be cleaned up electronically—smoothly and permanently. Dual's fade/edit control lets you do that with complete confidence, because it functions in playback.

Back to recording. The peak-level LED indicators react faster than any other metering system. And more accurately, because they're equalized. They read the full processed signal—including the high frequency boost other decks add but only Dual reads. No more risk of overloading a tape into distortion.

There's still more. Much more. Full metal record and playback. 6-way bias/equalization. Two-motor, twin-capstan drive system. Computer logic solenoid-activated controls. Switchable multiplex filter. Switchable limiter. Line/mic mixing. Two-way memory stop with automatic replay. Headphone level controls. And operation by external timer or optional wireless remote control.

What about the 839's audible performance? The specifications can give you a hint. Wow and flutter ± 0.03 percent WRMS. Frequency response from 20 to 20 kHz, ± 3 dB. Signal-to-noise better than 69 dB.

Of course, there's a price for all the 839 offers: \$850. If that seems to be more deck than you really need, there are three other new Dual cassette decks. They start at \$330, and they all feature the Direct Load and Lock system, DC servo motors, twin-belt drive systems, tape-motion sensor/protectors and equalized meters.

For complete details on all four Dual cassette decks, please write to us directly: United Audio, 120 South Columbus Avenue, Mt. Vernon, NY 10553.

Dual

Write directly to Manufacturer for Literature.

Opera

For Today

by Speight Jenkins

□ These past few years have seen fifteen opera personalities profiled in this column. As a finale to the series, an update on those who have made important gains in their recording careers has been compiled.

The first singer profiled over two years ago was Placido Domingo, who has recorded a tremendous amount of material since that time. Domingo's tenor voice, now a trifle more full and rich than before, is in prime estate. Though some recordings, such as his *Damnation de Faust* (DG 2709087) or his *Andrea Chénier* (RCA ARL-3-2046) show him in less than ideal voice, most seem to capture an immensely rewarding sound. The most important is his landmark *Otello* (RCA CRL-3-2951), which proves conclusively that a lyric tenor with power can effectively realize Verdi's most dramatic

role. Domingo lives the passions of the Moor with the vocal variety that is present in the music. He has the power necessary for the fierce moments—no closing duet to Act II has ever had more fire—and yet the lyricism of the Act I duet is spun out superbly. His greatest moment is the soliloquy in Act III when, in the tenor's expressed perception, *Otello* in reality dies. Live *Otellos* at the Metropolitan earlier this season proved the recording to be totally realistic.

Another enormously successful recording was *La Fanciulla del West* (DG 2709078) in which the lyrical gold and sensuality of the tenor's voice took on a feeling never expressed before. Domingo's greatness comes partly from the individual and appealing sound of his tenor and equally from his musical genius. In Puccini his taste raises the composer's work to its highest level. Two recordings made earlier this season also demand mention: *Faust* (Angel SZX-3868) and *Cavalleria Rusticana* (RCA CRL-1-3091). The first has the right ardor and a wonderful style. Maybe the tenor's voice could be more French sounding for the ideal interpretation of Gounod's hero, but his line could not be improved. No reservation can be voiced about Domingo's Turiddu for RCA. Here is a full rich reading with more subtlety and musicality than the role usually receives.

Ohm's Law 9:

It is possible to make a loudspeaker that gets loud and still sounds good.



Ohm introduces another new loudspeaker that defies the traditional laws of loudspeaker design. The new Ohm I.

Used to be, if you liked listening to music as loud as life in your home, you had a tough choice to make. You could buy high efficiency "monster" loudspeakers, and put up with the boom and shriek. Or, if you wanted something smoother, you could buy low efficiency systems. But then you'd need an amplifier big enough to power Toledo. Until now.

Introducing the new Ohm I. It can

achieve concert hall levels in your home, effortlessly. With no sacrifice in bandwidth, linearity, or imaging ability. It gets amazingly loud with as little as 10 watts input. But it will handle 1000.

It's the world's first good and loud loudspeaker. And it's already earning rave reviews. *Hifi Stereo Buyer's Guide* (8/79) says that the Ohm I "...is one of the finest speakers we've ever heard. There is nothing it couldn't do, and do it superbly... It will bring you the best from any program material... This is

clearly a speaker with a future - for the future".



We make loudspeakers correctly
241 Taaffe Place, Brooklyn, N.Y. 11205



In the title role of *Otello*, Placido Domingo vividly captures Verdi's Moor.

The tenor tears out one's heart as he sings the farewell to his mother, without resorting to a harsh vocal texture.

Another singer who has recorded much over recent years is soprano Renata Scottò. A lyric soprano with a powerful, expressive voice, she has the same level of musical perception as Domingo, and both are frequently joined on disc. Miss Scottò joined Domingo in the *Cavalleria*, in which her Santuzza proved fascinating in its femininity and love for Turiddu who had deserted her. Her passion made the role

(Continued on page 65)

Tomorrow is here early.

Now, a line of audio components which is truly ahead of its time. Introducing the SAE TWO R6 and R9 Receivers, matching T7 Tuner and A7 Integrated Amplifier, and C4 Cassette Deck—a collection of engineering masterpieces meticulously blending unique features with impressive specifications.

SAE TWO Receivers and Tuners have a Quartz-Lock reference of the type used by radio stations in beaming their signal. This system actually locks in the station, eliminates drift, lowers distortion and provides performance limited solely by the station's broadcast quality.

The R9 Receiver features a Digitally Synthesized touch tuning section, first developed for the space program, which precisely advances the tuner to every FCC assigned position with pinpoint accuracy.

Additional features include Digital Readout of the exact station frequency taking the guess work out of finding your favorite stations. And, a massless multi-functional Bar Graph Display which responds instantly

and accurately, providing information on signal strength, multipath and power output.

All SAE TWO Receivers and Integrations feature a Single-Strata Voltage Amplifier which utilizes the hybrid technique of selecting active components from the same production batch and mounting them on a uniform thermal base. The result is superior thermal tracking and gain linearity, unobtainable in conventional designs.

The new C4 Cassette Deck has Metal Tape capability, the latest breakthrough in recording technology. It provides greater high end response with lower distortion. And, with the tape deck's adjustable bias feature you can optimize its performance with any brand of tape available now...or in the future.

Unique features? Yes! Impressive specifications? You Bet!

SAE TWO—see tomorrow's line of components today at your SAE dealer.

SAE TWO

For the latest information, fast, write:
SAE TWO, P.O. Box 60271, Terminal
Annex, Los Angeles, CA 90060.
In Canada, The Pringle Group,
30 Scarsdale Rd., Don Mills,
Ontario, Canada M3B 2R7.



Fact:
the ultimate
...made more
affordable



SHURE

SME

**Series IIS
tone arm**

The designers of the award-winning Series III tone arm took on the challenge of developing a tone arm with essentially *the same* outstanding performance characteristics as the Series III, but at a significant reduction in price.

The Series IIS tone arm is an instrument that is still definitely in the connoisseur class employing state-of-the-art materials and technology for unsurpassed strength-to-weight ratios in critical areas. Perfectionists will achieve the same flawless performance they have come to expect only in the SME Series III.

The tone arm and shell are combined into a one-piece "carriage carrier," which is removable and interchangeable. Coupling is close to the fulcrum so the carrying arm makes a minimum contribution to the Series IIS total effective mass.

Tracking force and bias adjustments are controlled by a sliding weight adjustment. A fluid damping system is available separately.

SHURE

Shure Brothers Inc., 222 Hartrey Ave., Evanston, IL 60204
Manufacturers of high fidelity components, microphones,
sound systems and related circuitry

A GUIDE TO RECENT STEREO RECORDINGS

by THOMAS D. KELLY

An avid record collector for almost a quarter of a century, Thomas D. Kelly has a keen ear for both live music and full-fi sound. Mr. Kelly played the records he reviews here on equipment consisting of a Tanoy/Micro Turntable with a Shure V15 IV cartridge, a C/M Labs 911 stereo amplifier, a Marantz 7T pre-amp, and two Bozak B-400 speakers.

© Operatic Arias: *Sylvia Sass*, soprano; National Philharmonic Orch., cond. Lamberto Gardelli, London OS 26609.

This young Hungarian soprano has already been pushed far beyond her capabilities by managers, recording companies, and possibly by her own determination to become another Callas, Tebaldi and Sutherland all rolled up in one admittedly very attractive package. Her first aria disc on London (OS 26524) offered excerpts from *Turandot*, *Tosca*, *Manon Lescaut*, *Madama Butterfly*, *Aida*, *Macbeth* and *I Lombardi*, in generally strained, unattractive performances, although not without moments of beauty. This second disc contains more of the demanding soprano repertory, particularly "Casta Diva" from Bellini's *Norma*, Violetta's Act I aria from *La Traviata*, "Suicidio" from Ponchielli's *La Gioconda*, "D'amour sull'ali rosee" from



Strained performance

Verdi's *Il Trovatore*, and "La luce langue" from the same composer's *Macbeth*. Sass is heard to best advantage

in the *Trovatore* aria, with some lovely pianissimo singing; but as soon as she sings at full volume in the upper register she is decidedly harsh and unfocused. The Bellini aria is a particularly trying episode for the discerning listener. There are moments when a Callas-like intensity is effective, but generally this is a disappointing disc that will add little to the lustre of Sass's up-and-down career.

© Beethoven: *String Quartet in C Sharp Minor, Op. 131* (version for string orchestra). Vienna Philharmonic Orch., cond. Leonard Bernstein, Deutsche Grammophon 2531 077.

Bernstein seems to have a particular fondness for this score, and it has apparently played an important part in his career. In 1937 he attended a Boston Symphony concert with Dimitri Mitropoulos conducting, a program that



Live chamber music

included the Greek conductor's arrangement of this Beethoven quartet, adapted for the full strings of an orchestra. Bernstein later conducted the work with the New York City Symphony Orchestra, and, according to the recording's liner notes, felt that the recorded performance was "the proudest conducting achievement" of his life, and has dedicated it to the memory of his wife, Felicia Montealegre Bernstein. This quartet is highly effective when performed by massed strings, and one can only have praise for the precision and warmth of tone displayed by the Vienna Philharmonic. The recording, made during a live concert performance, is unusually vivid sonically. There is no question that this will be one of the major facets of Bernstein's projected complete Beethoven series for DG.

© Mahler: *Symphony No. 4 in G Major*. Edith Mathis, soprano; Berlin Philharmonic Orch., cond. Herbert von Karajan, Grammophon 2531 205.



Impressive performance

Why yet another recording of this popular Mahler symphony? Already there is almost an embarrassing number of fine recordings, including versions by Abbado, Bernstein, Horenstein, Klemperer, Reiner, Solti and Szell. But there is always room for another one, if the quality is sufficiently high, all of which make the choice for the collector even more difficult. Karajan has come to Mahler very late in his career, and only recently did he make his first recordings of some of the Austrian master's works—"Das Lied von der Erde," the fifth and sixth symphonies, as well as some leieder—all superlative disc accomplishments. The new recording of the Symphony No. 4 is equally impressive. This is perhaps the most refined, exquisitely-etched performance yet recorded, leisurely but not slow, immaculately precise, recorded with the sumptuous natural Berlin Philharmonic sound that DG has been achieving lately. Edith Mathis' contribution in the final song is all one could ask, and one can have only praise for this enterprise.

© Schumann: *Fantasia in C, Op. 17.* Artur Rubinstein, pianist, RCA ARL1-3427.

This is a major release of Schumann's masterpiece recorded in Rome in April of 1965, for some reason unreleased until now. Rubinstein no longer performs publicly and it is doubtful that he will make any recordings. Thus, this album finds him in top form technically as well as interpretively, making it of unusual interest. Rubinstein always had an affinity for Schumann's music, already having to his credit outstanding recordings of Kreisleriana, Carnival, and the Fantasiestucke, Op. 12. There are competing recordings of the Fantasia that offer a more generous coupling than the eleven minutes of the first two Novelettes, Op. 21, also issued

ARTUR RUBINSTEIN



Special first release

as fillers on Rubinstein's recording of the A minor concerto. Ashkenazy's fine London disc offers the Symphonic Etudes, Arrau and Kempff offer Carnival, Pollini the Sonata Op. 11, and Weissenberg the Liszt sonata. However, Rubinstein's performance is very special, and has been well engineered.

© Mahler: *Symphony No. 9 in D.* Philadelphia Orch., cond. James Levine, RCA Victor ARL2-3461, two records.

Levine continues his Mahler series with this very fine performance of the Symphony No. 9. Earlier releases in this series have not always been suc-



Well-captured sound

cessful; I found most of the others rather disappointing sonically, even though other critics praised them highly on this point. But there is no question that this new Symphony No. 9 set is first-rate, with the sound of the Philadelphia Orchestra well-captured and with a splendid dynamic range. Levine's reading is impassioned as well as sensitive, and the result is a Mahler Ninth equal to the finest other recordings of the score, notably those by Leonard Bernstein on Columbia, Bernard Haitink on Philips, and Carlo Maria Giulini on Deutsche Grammophon. ▲

fact:
five new Shure Cartridges feature the technological breakthroughs of the V15 Type IV

the M97 Era IV Series phono cartridges



Shure has written a new chapter in the history of affordable hi-fi by making the space-age technological breakthroughs of the incomparable V15 Type IV available in a complete line of high-performance, moderately-priced cartridges: the M97 Era IV Series Phono Cartridges, available with five different interchangeable stylus configurations to fit every system and every budget.

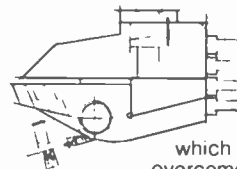

Dynamic Stabilizer—which simultaneously overcomes record-warp caused problems, provides electrostatic neutralization of the record surface, and effectively removes dust and lint from the record.

SIDE-GUARD, which responds to side thrusts on the stylus by withdrawing the entire stylus shank and tip safely into the stylus housing before it can bend.

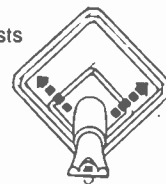

And, the unique telescoped stylus assembly which results in lower effective stylus mass and dramatically improved trackability.

There is even an M97 cartridge that offers the low distortion Hyperelliptical stylus!

NEW! M97 Series Era IV Phono Cartridges... Five new invitations to the new era in hi-fi.



Shure Brothers Inc., 222 Hartrey Ave., Evanston, IL 60204
In Canada: A.C. Simmonds & Sons Limited
Outside the U.S. or Canada, write to Shure Brothers Inc., Attn: Dept. J6 for information on your local Shure distributor
Manufacturers of high fidelity components, microphones, sound systems and related circuitry.

McIntosh

"A Technological Masterpiece..."



McIntosh C 32

"More Than a Preamplifier"

McIntosh has received peerless acclaim from prominent product testing laboratories and outstanding international recognition! You can learn why the "more than a preamplifier" C 32 has been selected for these unique honors.

Send us your name and address and we'll send you the complete product reviews and data on all McIntosh products, copies of the international awards, and a North American FM directory. You will understand why McIntosh product research and development always has the appearance and technological look to the future.

Keep up to date.
Send now - - -

McIntosh Laboratory Inc.
Box 96 East Side Station
Binghamton, NY 13904

Name _____

Address _____

City _____ State _____ Zip _____

If you are in a hurry for your catalog please send the coupon to McIntosh. For non-rush service send the Reader Service Card to the magazine.

Circle No. 13 On Reader Service Card

JAZZ



Miles Davis/by J.R. Taylor

□ Miles Davis has not performed for the jazz public since 1975. Still, his audience has remained in tune to his brilliant career, waiting to hear word of a come back as a performer, yet, only hearing through interviews of his long-time illness. The lack of any new Davis recordings has been partly offset by releases of previously unissued material, therefore, Miles Davis remains as he has been since the 1950s, a sort of minor celebrity—an odd position for a jazz musician, and stranger still for one who has helped to break trails for several generations of improvisors. But Davis has never been typical.

He was born in a town near St. Louis in 1926, studied trumpet in grade school and high school, and after a couple of years of semi-professional playing, embarked for New York City at the age of 18. There he studied briefly at the Juilliard School of Music; but his real purpose in leaving home was first-hand study with his elders in jazz—Dizzy Gillespie and Charlie Parker—whom he had met when both were passing through St. Louis with the Billy Eckstine band. Within months of his arrival in New York, Davis was out of Juilliard and playing professionally with Parker and other artists.

When Parker and Gillespie left for an engagement in Los Angeles at the end of 1945, Davis arrived there soon after, having crossed the country with Benny Carter's

big band. Davis worked with Charles Mingus following Parker's collapse in the summer of 1946, and after some months as a member of the Eckstine orchestra, rejoined Parker when the saxophonist returned to New York in the spring of 1947.

The Parker quintet of 1947-1948 was Davis's last long-term employment. During this period he led his own pickup groups (which included the later famous Sonny Rollins and John Coltrane). By 1949, he was co-leading a band with pianist-composer Tadd Dameron, and recording with an otherwise little-heard nine-piece group featuring widely influential arrangements by Gil Evans and others.

At this time, Davis had established himself as an individual voice. Lacking the range and speed of a Gillespie or a Fats Navarro, he yet had a personal attack, a sparseness of phrase, and a restrained timbre that made him his own man. A modernist, his work somehow recalled the songfulness of earlier soloists.

Through the early 1950s Davis
(Continued on page 73)

J. R. Taylor is with the Smithsonian Institution's Jazz Program. He has written on music for the *Washington Post Book World*, the *Village Voice* and others.

SANSUI SELECT SYSTEMS

Now it's easy to buy great hi-fi.

Until now, buying a fine audio system hasn't been easy. You had to learn about components. And take time to match them for looks and for sound.

Sansui has changed all that.

Our expert engineers have used advanced Sansui technologies to produce a new series of Select Systems that give you purest high fidelity with minimum fuss.

In our **Select System 70**, great sound starts with the new **R-70 receiver**, as versatile as it's easy to use. You can listen to one music source at the same time as you're taping something else. The bright and precise LED displays help you find your station quickly, and monitor both signal strength and output power. The DC-Servo amplifier section delivers lots of power, virtually without distortion. And radio reception of even the weakest stations is superb.

Sansui's new direct-drive automatic **FR-D3 turntable** tracks your records with unusual precision, and its controls are conveniently outside the dustcover. The Dolbyized **D-90 cassette deck**, a convenient front-loader, has bias and EQ switches to match standard and high performance tapes. And when you connect it to a timer, it'll make recordings while you're away.

To deliver the music, we've provided a pair of our fine 3-way acoustic suspension **SPA-3700 speakers**, with great power and clarity over the entire frequency spectrum and special controls to match the sound to your listening environment.

Everything (except the speakers, of course) is conveniently mounted in a handsome walnut veneer cabinet with smoked glass doors, swivel casters, and plenty of room for your records.

Ask your Sansui authorized dealer to show you the Select System 70 and the other fine Systems, turntables and speakers in the Select line.

When your friends listen to the great sound of your Sansui Select System, they'll wonder how you did it. Tell them it was easy — with a little help from another friend. Sansui.



Sansui

SANSUI ELECTRONICS CORP.

Lynchhurst, New Jersey 07071 • Gardena, Ca. 90247
Sansui Electric Co., Ltd., Tokyo, Japan
Sansui Audio Europe S.A., Antwerp, Belgium
In Canada: Electronic Distributors

SUPERCOMPO
SELECT SYSTEM 70

Circle No. 9 On Reader Service Card

THE CLASSES OF '80

The hi-fi industry graduates a small but interesting 'class' of new products on to the dealers' shelves

BY FRED PETRAS

Audio buffs worrying about possible obsolescence of their present equipment in the face of new product introductions at the recent Winter Consumer Electronics Show can breathe

easier. While there was an outpouring of new goods at the industry-only show, it was largely in the form of models incorporating incremental advances in existing technology, rather than dramatic new technology. A good example of the latter, for example, was the debut of scores of cassette tape decks in "Mark Two" versions, i.e., models with the additional capability of accommodating metal particle tapes, at a small increase in price over earlier models without metal tape capability.

Trends. Highlights of the show and main trends that surfaced at the twice-a-year industry event were:

- Remote controlled audio component systems.
- The burgeoning of frequency synthesized tuning systems.
- A sharp increase in the number of tuners and receivers with electronic scanning.
- The appearance of memory station pre-sets in many tuners and receivers.
- The accelerated use of LED power

REMOTE CONTROLS



Kenwood was one of a number of companies that introduced remote control systems. The RC-500 remote control system controls: power; volume; selection of tuner, phono, aux and tape; six AM and six FM presets; phono play/cut, repeat and record size. \$235. Circle No. 75.

output displays in amplifiers and receivers.

- The coming of age of the moving coil cartridge, evident in the form of more preamps, integrated amps and receivers offering inputs for moving coil cartridges.

- The decreased use of VU meters in cassettes equipment; the increased use of LED, fluorescent or liquid crystal recording level displays.

- A sharp drop in the pricing of metal-tape-capable cassette decks.

- An increase in the number of cassette decks offering totally adjustable bias controls, rather than fixed-point switches.

- Logic controls in cassette equipment at lower prices.

- The virtual "takeover" of straight tonearms and front controls in turntables.

- The wider availability of turntables with factory-installed cartridges.

- A slight increase in the number of micro or mini audio components, but a

marked increase in the number of components reflecting a concern with down-sizing of audio equipment.

- A growing interest in subwoofers specifically, and as adjuncts to compact or mini speaker systems to form three-model ensembles.

- A developing interest in single-brand audio component systems, most "packaged" with vertical furniture-style housings that also provide record storage space.

- Continuance of the "more for your money" trend that has prevailed in the audio industry for the past decade, but now more noticeable in the light of soaring prices of other consumer products.

Remote-controlled Audio. While the concept of remote controls has been around for decades in TV and the mono console era, only recently has it appeared to any extent in stereo components, initially in cassette equipment, and more recently also to a handful of turntables. But now you can control an

The T-1000 digitally synthesized FM tuner from Eumig has two-mode tuning with ten preset stations and push-button up/down scan. The station memory circuit has a built-in NiCad battery to prevent memory loss in the event of a power failure. There is an LED digital frequency read-out, plus LED signal strength, station select, and stereo indicators. Sells for \$795. Circle No. 131 for more information.



Toshiba's new ST-445 FM/AM tuner features six AM and six FM channel preset stations plus pushbutton up/down band scanning tuning. The digitally synthesized tuner locks on to any frequency with 0.0025 percent accuracy, according to the manufacturer. The ST-445 has digital displays, LED signal level indicators, FM muting to suppress interstation noise and stereo indicator. \$260. Circle No. 99.

TUNERS

THE CLASS OF '80

entire audio component system. And not just with a foot-tangling, long-cable control, but a wireless, completely separate and portable infra-red control that can do its duties more than 20 feet from the equipment.

The latest offerings of this nature come from JVC, Kenwood and Technics. JVC's remote control ensemble consists of two-piece control center, digital tuner and turntable. Both the tuner and turntable connect to the infra-red receiving unit, which accepts operating signals from the remote control. The infra-red signal, unlike others, can pass through glass doors of cabinets that house the audio components. The control can also function with four JVC metal-tape-capable decks that have special outputs. It can also accommodate any integrated amplifiers with tape monitor connections. The four-piece outfit is list priced at \$1,029.25.

Kenwood's remote controlled system consists of two-piece control ensemble,

tuner, 43-watt-per-channel integrated amplifier, and automatic direct-drive turntable at a combined price of \$1,034. A distinguishing feature of the amplifier (KA-500) is the absence of any rotary controls; feather-touch bars are used instead for manual operation. In remote operation, LEDs above each function bar are activated, to show from a distance what is happening. The tuner (KT-500) also has no rotary controls, employing touch bars instead. It can pre-set six AM and six FM stations, available via the remote control. The turntable (KD-4100) can be activated for play, cut and repeat operations. The entire system can be controlled from a distance of 22 feet.

A tuner/preamp, 40-wpc power amplifier, direct-drive fully-automatic turntable, and direct-drive cassette deck, along with control units make up the remote control system from Technics at \$1,560. It offers program input selection (FM, AM, phono, and tape); tuning control over eight FM and AM pre-set



Technics SA-101 AM/FM receiver delivers 18 watts per channel from 40 to 20,000 Hz with no more than 0.04 percent distortion. Other features include: FM muting, two speaker system output, and LED signal strength indicator. \$180. Circle No. 98.

Sony introduced a new line of AM/FM receivers at the show. The STR-V35 has an output of 35 watts per channel from 20 to 20,000 Hz with 0.04 percent THD. Its "Acute Servo Lock" tuning is said to pinpoint a station and hold it. \$310. No. 94.



RECEIVERS

SEPARATES

stations; turntable start, stop, tonearm up/down cueing, automatic record size selection; tape deck mode control (play, stop, rewind, fast forward, record, pause, and rec-mute); volume control; and power on/off switching.

Tuners. Tuning ease coupled with tuning accuracy are the ongoing goals of audio manufacturers producing tuners and receivers. The former is a composite of minimum effort and time in "bringing in" stations, and easy readout of station frequencies. Tuning accuracy is a desired corollary. Happily, state-of-the-art technology is bringing all this into reality, as a look at recent and new offerings will prove. Figuring heavily are automatic tuning systems, electronic-scan, station pre-setting, digital station readouts, and quartz-crystal-controlled FM tuning systems.

Some interesting examples of the above appearing at the Winter Consumer Electronics Show were the following: Optonica Model ST-9405, a

new digitally-synthesized tuner with digital frequency display and an analog scale with 44 LEDs in place of conventional tuning needle; auto search system which scans the frequency range at variable speeds and automatically stops at each station it reaches; direct frequency tuning; and last-station memory (of 10 pre-sets) which maintains all tuning functions when power is turned off. Price, \$1,000. Toshiba Model ST-445, a new FM/AM stereo tuner utilizing digital frequency synthesizer circuitry that locks in on the desired frequency with an accuracy of 0.0025 percent. It also features 12 station pre-sets, digital frequency display, and LED signal level indicators. Price, \$260. Rotel Model RT-1010 at \$370 is an FM/AM stereo tuner with PLL (phase locked loop) digital synthesizer circuitry, 7 FM/7 AM station pre-sets, automatic or manual scanning tuning, with moment-hold switch in automatic tuning, LED digital signal strength and center-tune indica-

Onkyo has a new, fully-automatic quartz locked direct drive turntable, model CP-1280F. It features a low-mass carbon fiber tonearm and plug-in headshell. Carbon fiber is appearing on more and more turntables because of its high strength and rigidity, combined with low weight. \$450. For more information please circle number 80.



TURNTABLES

Optonica's new RP-9705 micro-processor-controlled turntable is a quartz-locked unit with infrared remote control. An optical detector on the end of the tonearm identifies breaks between songs and enables the head to move to specific, pre-programmed cuts. All functions can be controlled on either the front panel or the remote control. Wow and flutter, 0.028%. Price \$950. No. 81.



Tandberg's new component series is typified by this model TCA-3002 control preamp. \$1000. Circle No. 97.

Lux's L-480 70-watt per channel integrated amp has an MC input and low THD circuitry. \$495. Circle 114.



THE CLASS OF '80

tors. Harman-Kardon HK715 digital synthesized quartz-locked tuner priced at \$369 marks a company effort to regain its position as a high-technology audio component supplier (the firm was responsible for the classic "Citation" series, well known in elite audio circles). The slim-line model features a seven-LED signal-strength readout, memory pre-sets for eight FM or AM stations, no-knob manual scanning up and down the frequency scale, and digital station readout. Harman-Kardon also has three "stackable" matchmates for the tuner—the HK725 ultrawideband preamp at \$279, the HK770 65-wpc DC amplifier at \$399, and the HK705 metal tape deck at \$449 featuring a unique loading system (described in cassette section). For H-K aficionados on a budget, this series can be obtained with an analog tuner, the HK710 at \$229 rather than digital synthesized HK715.

Receivers. With one or two exceptions there are few new developments

in receivers. Most were second or third generation developments adopting features from related tuners, preamps and integrated amplifiers.

Sony, however, arrived with a brand new line of four AM/FM receivers ranging from the \$260, STR-V25 with 28 watts per channel to the \$500, STR-V55 with 55 watts per channel. The V45 and V55 have a microprocessor that allows station scanning and selection by frequency, by available station, by eight pre-set channels and by scan of the pre-set channels.

Pioneer introduced four receivers that had adopted many features from the company's line of separate components. All four receivers feature "Fluroscan" power meters similar to those found in Pioneer's line of integrated amplifiers introduced last year. Two top-priced models (\$500 and \$800) also have Fluroscan signal strength and tuning meters, as well as digital readouts for all stations. The latter two also have Pioneer's exclusive non-

CASSETTE DECKS

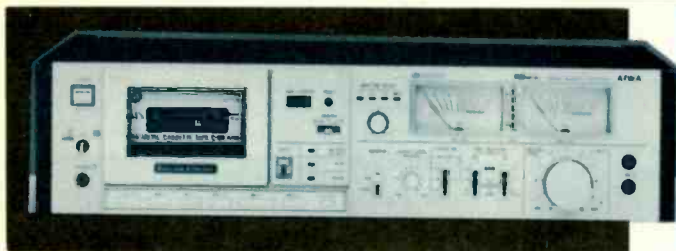

Aiwa's AD-M700U has metal capability, adjustable bias control, three heads, touch controls and double Dolby. \$490. No. 63.

Scott has introduced a low-priced \$250 metal capable deck, model 671DM, with a wow and flutter of 0.07%. Circle No. 90.

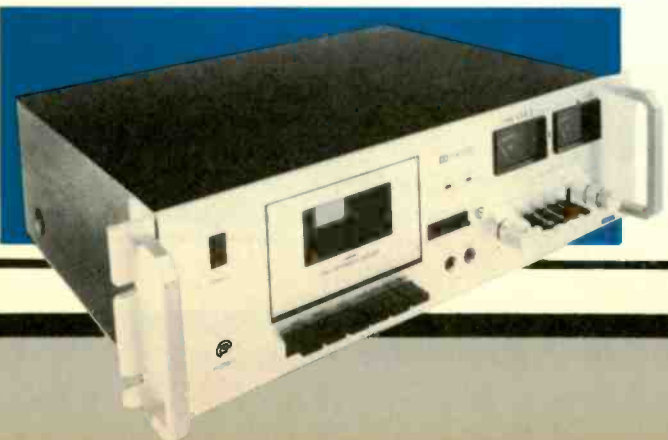

Nikko's ND-790 cassette deck has metal capability with bias selector switches and fine adjust; LED peak meter. Circle 79.

Hitachi's D-3300M is a budget version of the famous D-5500 with the same automatic bias adjust feature. \$699. Circle 72.



switching DC amplifiers, first incorporated in the firm's 1979 integrated amps.

While receivers combining cassette transports have been around for a few years, such combinations have not generally been regarded as "audiophile" equipment, good as they might be. Fisher Corp., in an attempt to decimate such thought patterns, has come up with a cassette receiver, Model MC-4580, priced at \$700. The 40-wpc unit features LED station readouts, quartz PLL signal-locking circuitry, auto-scan tuning, manual touch-bar tuning, five AM and five FM station pre-sets with memory and station indicator lights. The cassette section has metal tape capability, dual LED bar graph level meters and solenoid transport mechanism. The low-profile, no-knob set features touch bars and slide controls for all operations.

Representing a new high in technology—and price (\$2,700), is Revox's 75-wpc micro-computer-controlled syn-

thesizer, FM-only receiver, Model B780. Marking the firm's entry into this product category, it has a tuner section that features completely push-button-actuated tuning, with a claimed accuracy of plus/minus 0.005%. Eighteen pre-set stations can be stored in the unit's electronic memory. Even manual tuning is done electronically; two push-buttons command the tuner to sweep right or left in 25 kHz (instead of the traditional 200 kHz) steps, stopping at each listenable frequency until one is selected. Another control, behind a fold-down panel, allows the user to sweep more rapidly in either direction of the dial. Other tuner features include signal strength and centertune meters, and controls for muting-off, mode, and high blend. An optional (\$130) plug-in Dolby FM circuit card is available for Dolby broadcast reception. The set's preamp is electrically separated from the amplifier when connection is made to the "Preamp Out/Pow. Amp. In" jacks on

(Continued on page 68)

LOUDSPEAKERS



The Wharfedale TSR-108 two-way speaker system is recommended for use with 15 to 80 watt amplifiers. It is said to offer a 35 to 25,000 Hz frequency response. It has a walnut veneer cabinet. \$375 each. No. 134.

The Infinity RSb (RS "sub-b") is a three-way speaker with a 10-inch woofer, 5-inch midrange and the company's electromagnetic induction tweeter. Response from 42 to 32,000 Hz with crossovers at 600 and 4,000 Hz. Carries a suggested price of \$240 ea. No. 132.

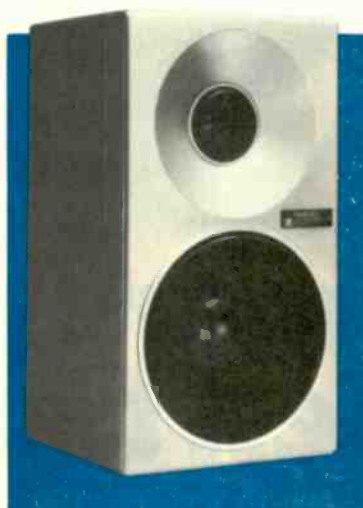

Technics' new line features three mini speakers, the SB-F1, SB-F2 and SB-F3 (shown) with 60, 75 and 90 watts respectively of power handling capacity each. \$340/pair. Circle 98.



ReVox's Triton speaker system has two, 2-way satellite speakers and a subwoofer with two 10-inch drivers. The subwoofer cabinet is isolated from the drivers so that it can be used as a component stand. Frequency response: 30 to 25,000 Hz. Circle 86.



Our recording tape is considered by most audiophiles to be the world's finest tape.

Our tape window is welded in to keep dust out.

Our pressure pad is locked into a special four-sided retainer to maintain perfect tape-to-head contact.

Our slip sheet is made of a substance that's so slippery, even glue can't stick to it.

Our leader not only keeps you from making recording errors, it also keeps your tape heads clean.

Our special guide rollers make sure our tape stays perfectly aligned with your tape heads.

Our cassette is held together by steel screws to assure precise alignment and even distribution of pressure on all sides of the cassette.

Our standard cassette shell is finished to higher tolerances than industry standards.

Our tape is anchored to our hub by a special clamping pin that makes slippage impossible.

There's more to the world's best tape than the world's best tape.

Our reputation for making the world's best tape is due in part to making the world's best cassettes.

and more work into our cassettes than most manufacturers put into their tape.

we believe in a simple philosophy. To get great sound out of a cassette takes a lot more than just putting great tape into it.

In fact, we put more thought

We do all this, because at Maxell

maxell



Circle No. 18 On Reader Service Card

Maxell Corporation of America, 60 Oxford Drive, Moonachie, N.J. 07074.

What's New In CAR STEREO

BY FRED PETRAS

H

ome hi-fi quality and performance, more automation, and miniaturization—these are the three main trends in car stereo. They were quite evident at the recent Winter Consumer Electronics Show, debut point for the new car stereo equipment you'll be seeing on store shelves just about now.

Among our discoveries at the event were the following: The entry into the car stereo field of home audio giants Kenwood and Aiwa, plus several smaller companies; the proliferation of new radios and tuners featuring digital readouts, electronic scanning, station pre-sets; at least a score of cassette models with metal tape play capability; the wider use of automatic reverse in cassette equipment; a deeper stress on higher power for smoother reproduc-

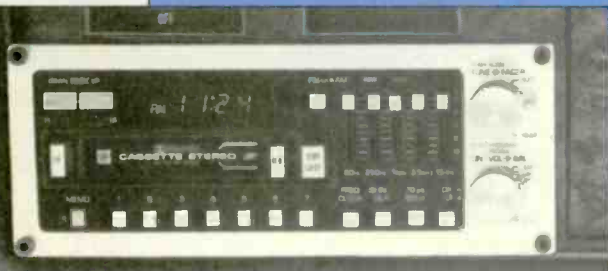

The Fujitsu Ten Dashboard Wizard (model EP-820) is a computerized, all-in-one receiver with a built-in graphic equalizer, cassette deck, clock, 7 memory channels. \$570. No. 109.



Alpine's 7308 computerized car stereo receiver has PLL frequency synthesized tuning, 10-station memory, digital readout/tape counter, and other features. \$700. Circle 120.

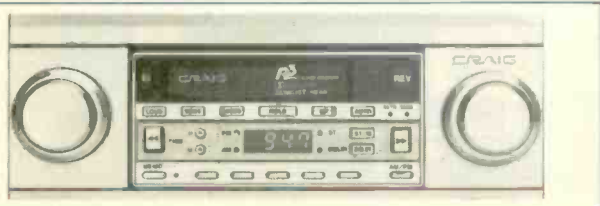

Craig's new T687 features all the normal channel scanning features, memory pre-sets, digital readout with clock, automatic reverse, dolby and sendust heads. \$500. Circle 122 for info.



The Kenwood KRC-711 is a good bet if you have station-fade problems in your area. If the FM signal falls below a certain level the cassette drive will kick in automatically. \$449. 121.

COMPUTERIZED RECEIVERS

CAR STEREO

tion; a widening of interest in bigger (or smaller) speakers of higher quality; and a strong trend toward the use of multi-driver speaker systems, rather than three-way individual drivers, to optimize the performance of the electronic segments of car stereo rigs. The general overall trend in the industry is toward refinement of existing technology and improvement of product quality.

Perhaps the most dramatic new offerings of the show were at the Kenwood display. The deluxe line, which tops out at \$450, consists of 13 models. The in-dash segment is made up of a tuner/cassette player and four receiver/cassette players. The under-dash group encompasses a tuner, cassette deck, graphic equalizer, equalizer/amp, and two power amps. For use with either group are two enclosed speaker systems, as well as six individual drivers, the latter priced from \$50 to \$120 per pair.

Automation. Among touches of automation in the new Kenwood line is ACL—for automatic cassette load-

ing. This system draws a partially-inserted cassette farther into the deck, and eases it into place for playback. Another is AAER—for automatic antenna extension and retraction. A third is key-off eject, a system of automatic pinch roller release that is activated by removal of the ignition key. It prevents deformation of the pinch roller. A fourth is electronic automatic scan/stop/recall tuning.

But the most intriguing aspects of the new line are embodied in three Kenwood "firsts," typical of the many

firsts for which Kenwood is noted in home audio technology. One is ABSS—for automatic broadcasting sensor system. Available in the Model KTC-767 under-dash tuner at \$269, it permits programming the tuner to activate the automatic seek mode to search for the next available FM channel when reception of the station tuned in falls to less-than-desirable levels. ABSS helps attain the best FM reception possible under difficult signal conditions, by continuously adapting

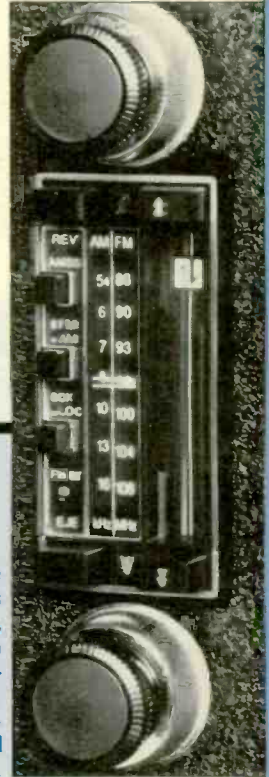

Grundig's GCM 9200 AM/FM/cassette/receiver feature three-band equalization, metal tape capability, Dolby noise reduction circuitry, and auto reverse. \$369. Circle number 123 for info.

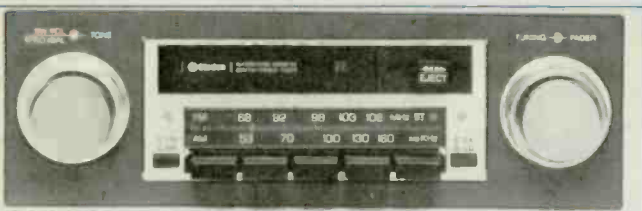

Clarion's PE-765A is an AM/FM receiver/cassette unit with five push-button preset channels, automatic reverse and a wow and flutter figure of 0.13 percent. \$285. Circle 130 for info.



Blaupunkt's CR-5001 auto-reverse cassette/receiver has metal tape capability, an LED digital readout and clock and separate 4 x 15-watt amp. \$450. Circle 124 for more information.



The Concord HPL-515 is a cassette receiver with digital readout, variable tape speed, three-way bass and treble equalization, 25 watts per channel output. \$430. Circle No. 125.

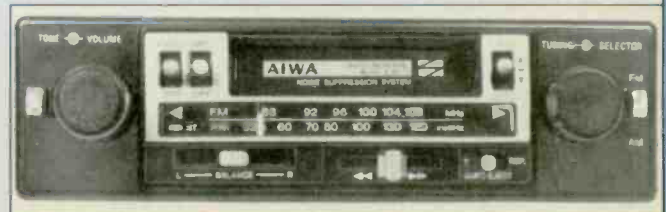

The Aiwa CTR-2060 cassette/receiver has an auto reverse cassette drive that allows continuous play or shut off after playing both sides. Has FM noise suppressor. \$190. Circle 63.

RECEIVERS

to changing signal conditions, as needed, without attention from the driver.

Another Kenwood first is ANRC—for automatic noise reduction circuit, available in the above tuner and in the KRC-711 in-dash cassette/receiver priced at \$449, and the KRC-721 cassette/tuner at \$399. ANRC is a computer-guided system that continuously monitors FM reception and automatically adjusts the mode of operation for optimum listening pleasure in travel. When reception is ideal, the set operates in the stereo mode, with full separation. If signal fading occurs to the degree that reception is noisy, the tuner automatically switches to a high-blend, combined-channel operation which cuts noise sharply but with minimal loss of stereo separation. If signal strength drops lower, the tuner switches automatically to mono operation, for maximum freedom from background noise. Finally, if the FM signal becomes too weak to enjoy, the tuner goes mute. It stays so for five seconds, then reassesses reception conditions. If the signal is still too weak, the tuner then takes further action—based on earlier instructions, to switch to the tape deck mode for automatic play of a selected tape.

The final first, Cassette Stand-By, available in five Kenwood models, is an electronic solenoid control system. It holds the tape transport cued for instant operation if tuner reception falls below acceptable limits. Should reception be blanked by a series of large obstructions or passages through a long tunnel, the onset of muting triggers the tape deck into play.

Aiwa's entry into the car stereo field embraces two in-dash cassette/radio combinations, and under-dash cassette player, a 15-wpc booster at \$40, and a three-way semi-enclosed speaker system for rear deck installation at \$80 each. Model CTR-2060 at \$190 is an automatic-reversing cassette/AM/FM stereo radio with 7 watts per channel output. Among features is a REP/AUTO selector that provides a choice between continuous cassette play or automatic ejection after both sides of the tape have been completed. Model CTR-2030E at \$170 is also a cassette/radio combination. It has 5-wpc output, and features a continuous automatic reverse that changes the direction of the tape when play ends. The under dash player, CT-1060Y at \$120 features automatic cassette ejection when ignition is turned off.



Jensen's EQ-400 equalizer is designed for under dash, flip-out mounting or hump mounting. Five, three-way equalizers. \$130. No. 129.



As a part of Pioneer's full line of car stereo equipment the BP-320 offers consumers a chance to boost overall output power as much as 20 watts per channel RMS and 13 wpc into 4 ohms with no more than 0.8% THD at 1 kHz. \$100. No. 106.



Looking more like home audio equipment, this Magtone FGT 4100 graphic equalizer is designed to fit in an 8- by 1½-inch slot in a dashboard. It has five bands; L&R volume; balance; and level indicators. \$240. Circle 126 for more information.



Designed for mounting anywhere, the Zeff PEQ equalizer has 9 bands (50, 100, 200, 400, 800, 1600, 3200, 6400, and 12800 Hz), some unique input and output clipping indicators to help tune-out distortion, and a preamp. \$250. Circle 127.



Sparkomatic's GE-1000 Equalizer/Amplifier has, according to the manufacturer, an output of 50 watts per channel RMS with 0.01% THD. The equalizer has seven bands and there is a fader control. \$190. Circle 128 for more information.

ADD ONS

CAR STEREO

New Name. Among other new brand names appearing at the Winter Consumer Electronics Show was "Soundio," offered by Mobile Audio Development Co. Initial offering was the deluxe Model RX-70 AM/FM cassette deck at \$429, along with a companion "60-watt" amplifier/equalizer, EX-30, priced at \$300. The RX-70 features digital frequency and time display, Dolby, Sendust head to handle metal tapes, two-position tape switch, noise filter, and 5-LED field-strength indicator. The EX-30 equalizer/amp has six frequency bands -60, 200 and 500 Hz, 1.5, 4 and 12 kHz, each with three small rotary controls for adjustments. It also

has two power level meters, fader control, and separate headphone amplifier.

Handic, a Swedish firm, well known in the European car stereo market, is making a bid for American consumers. The line it showed was made up of six cassette/radios, a cassette player, a cartridge/radio, an equalizer/amp, a power amp, and a selection of speakers. Reflecting state-of-the-art technology is the Handic "Monte Carlo," priced at \$550. It features electronic tuning in automatic and manual modes, 14 station presets, digital LED station readout, four independent audio output stages with balance and fader controls, automatic reversing, and touch-bar operation. Each amplifier channel has 7.5 watts output. The set can be operated in two-channel form with an output of 15

(Continued on page 66)



Epicure Products has introduced its LS-81 two-way speaker. Designed for compact cars it has a 1-inch tweeter and a 4½-inch woofer to provide a 80 Hz to 20 kHz ± 3 dB frequency response. The impedance is 4 ohms. \$200 per pair. No. 68.



Jensen's Series II Coaxial speaker has a 6½-inch woofer and a 2-inch tweeter. It can handle as much as 50 watts and is designed for low-profile installations. The back can fit in cut-outs as small as 5½ inches. \$100/pair. Circle No. 129.

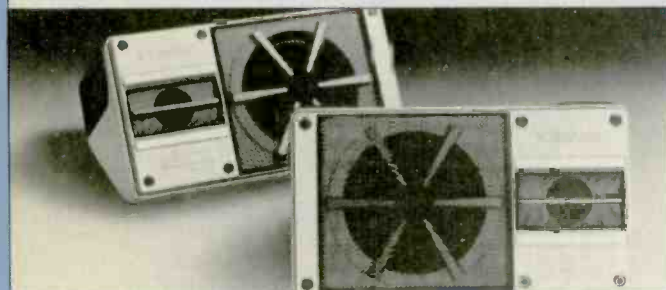

Fujitsu Ten introduced a two-way speaker utilizing a 4-inch woofer and a one-inch tweeter. The speaker, Model SSB-4B37, is rated to handle up to 40 watts and have a frequency response from 70 Hz to 22 kHz. impedance: 4 ohms. No. 109.



Altec Lansing AL 1 system features separate tweeters, mid-range speakers and a single power bass. Allows speakers to be placed for maximum performance; directional high-frequency speakers face listener, woofers don't. Circle No. 64.

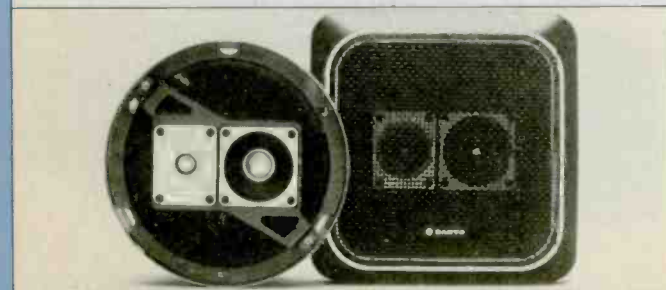

The Sanyo SP-738 three-way speaker system has a 4-ohm impedance, a claimed frequency response of 70 Hz to 20 kHz and a power handling capacity of 30 watts. "Char-proof" aluminum bobbin dissipates heat. \$70 each. Circle No. 95.



The SK-89C from Clarion is a heavy-duty two-way coaxial speaker that will fit in a 6- by 9-inch cutout. The woofer has a hefty 20-ounce magnet and the speaker's design is notable for the lack of a tweeter support bridge. \$67. Circle No. 130.

SPEAKERS



FOR YOU I'VE GOT THIS DEAL

How to spot those 'deals' you can't afford not to refuse

● "Buy one speaker and get the other one free!" "Buy this stereo receiver for one penny!" "Buy this complete stereo system and we'll pay you to take it away!" You've undoubtedly heard hundreds of claims like these, but have you ever wondered how the audio dealer can honor these offers and still stay in business? Have you ever marvelled at those marketing miracles or did you just write

a check, load up your car with the advertised goods, and hustle home as quickly as you relinquished your money?

The high fidelity industry is unique. With the exception of a neighborhood tag sale, or a Barcelona open-air produce market, no other business offers the consumer such apparent bargains. **BY PAUL KALASNIK**



Was your purchase the result of an intelligent decision, or was it merely an impulse brought on by a "last chance" deal that would be offered weeks later at the same store? Although you may be equipped with a thorough knowledge of technical information, specification details, and product familiarity, you may wind up dumping your car-load of bargains into the nearest refuse receptacle.

By being aware of a few facts concerning the battle strategies employed by those involved in stereo price warfare, you, the consumer, can avoid the pitfalls that are camouflaged by that lucrative "deal." You can reap the spoils of this war rather than become its victim. You can save money and get high quality equipment. First, you must be aware of some immutable facts about the audio industry.

Prior to 1975, it is unlikely that you would have seen such outrageous advertising claims as you do today. A fossil called "Fair Trade" hovered over the heads of dealers, preventing them from discounting the manufacturer's list price of an item. Thirty-six of the fifty states were bound by the Fair Trade Law. Some dealers were even taken to court for violating it. The law had been instituted some thirty-five years earlier in order to encourage the growth and well-being of post WW II business. Since a turntable at store "A" was the same price as the identical machine in store "B," the consumer's choice was based upon personality, service, and salesmanship. Price competition did not exist.

In 1975, the government decided that repeal of the Fair Trade Law would benefit the consumer. The original intent of the law had long since been realized by the dealer and now should be revised or dissolved to ensure better prices for the buyer. By the beginning of 1976, all participating states had repealed the law. Prices dropped. The consumer bought, and bought, and bought. As a result, the audio industry blossomed from a 1.7 billion dollar business in 1975 to an awesome 4 billion dollar enterprise in 1978.

"...the life-time warranty... is now void because the manufacturer has changed its name and now only markets funeral caskets."

With the former protected profit margins now gone, how does the dealer survive? Was the repeal of the law an actual benefit to the consumer? The staggering growth figures of the audio industry indicate that the consumer has aided the growth. How could you be getting such a great deal and still enable the industry to flourish? Be aware.

The most notorious method of maintaining a respectable profit margin in the hi-fi industry is the sale of "black box" or "house brand" speakers. These inflated list, low dealer cost items are designed to offset the declining profits realized in receivers, amplifiers, and other electronic components. A "black box" may bear a

list price that quadruples the dealer's cost. Thus, a dealer may offer a "sale" that allows him to sell one speaker at regular retail price and give the matching counterpart away free of charge. He can still maintain a healthy 100% profit.

Some of these speakers can be recognized by a series of letters that indicate their "brand." These letters are often the initials of the selling firm. Joe's Bargain Stereo sells JBS speakers. But be aware that many highly reputable hi-fi companies, such as JBL, JVC, KLH and BIC, use their initials on their products. It is this confusion factor that enables dealers to claim high prices for house brands. It seems so obvious when put into print, but many consumers are confounded, or just don't make the association at the point of purchase. The best

"Beware of the \$50 cartridge that is 'thrown in' with the deal..."

way to unmask these great pretenders is to familiarize yourself with the names mentioned in this and other quality hi-fi magazines, since the only units mentioned are from recognized manufacturers. If it isn't mentioned, it ought to arouse your curiosity or encourage further research.

"Black box" speakers are not fundamentally poor sound reproducers. In fact, some are rather good. They are conceived with a marketing idea in mind rather than the pursuit of sonic excellence. They are often the brain-children of company executives who supervise the construction of boxes, shipping cartons, and wooden crates. The executives of these companies, observing the potential in the expanding audio industry, direct the construction of boxes, arrange for the provision of raw components from various driver manufacturers, and merchandise the finished product as their own "high fidelity" loudspeaker. Have you ever wondered how you could have purchased that impressive looking six-way tower for the same price as your friend's modest two-way bookshelf speaker? You paid only for the raw materials. The extensive cost of research and development required to manufacture a first-rate piece of audio equipment did not have to be figured into the price. If you think that you got a great deal on the monoliths that dwarf your friend's cufflink containers, try to sell those hulks in five years. Their resale is difficult, and the life-time warranty that was offered with them at the time of the sale is now void because the manufacturer has changed its name and now only markets funeral caskets.

Try buying one of those high quality receivers for one cent without the purchase of the advertised set of speakers. Try substituting a pair of name brand speakers for those in the printed ad. Can you still take advantage of the one penny receiver ad? No, you can't.

Massive profits for the dealer are also concealed within the tiniest stereo component, the phono cartridge. A cartridge listing for as much as sixty dollars may cost the dealer as little as eight bucks. There are many reasons for this seemingly unfair profit enjoyed by the dealer.

Many consumers don't realize that the cost of a cartridge is not included in the cost of a turntable. Therefore, the cartridge manufacturer accommodates the dealer by providing him with a virtual give-away item. If the consumer is aware of this separate component, it enables the dealer to (continued on page 67)

The ultimate goal of audio engineers is to recreate the sound of a live performance on a home hi-fi system. To be able to produce the front-row-center volume of a symphony orchestra or rock group, or the breathless silence of a musical pause without distortion or loss of response.

To do this audio engineers are constantly trying to expand the dynamic range (the sound distance between the softest and loudest sounds) and to kill the background noise (tape hiss or the sound you hear when the stylus is on a part of the record with no musical content).

During the past few years, one particular audio equipment manufacturer has gained prominence in this field of tape noise reduction and the area of dynamic range expansion. That company is dbx, and it must be pointed out that the lower case letters is the way they spell their name—not a series of repeated typo errors.

The equipment marketed by dbx includes their professional series of tape reducers (the 150 series), the "consumer" series of tape noise reducers (120 series), a variety of user adjustable dynamic range expanders (the 1, 2, and 3BX) as well as the sub-harmonic synthesizer, named the "Boom Box." Although another tape noise reduction system (Dolby) is widely used in recording studios and is "standard equipment" on cas-

sette decks, the Dolby system is meant solely to eliminate (or mask) tape hiss and does nothing to retain the available dynamic range of a live performance for a given source (tape, disc or FM radio).

dbx has recently added a new item to their line of consumer equipment, and if what this listener heard is any indication, then dbx's hopes (and my predictions) will

surely come true: tens of thousands of audiophiles will want to own one of the new "dbx little black boxes," and they will be as common with hi-fi enthusiasts as direct-cut records are today. The new unit is a straight dbx decoder, Model 21, and is meant only to be used with discs or tapes that have been dbx encoded. It can not be used to reduce tape noise (or retain dynamic range) while making a tape recording—but then, it is not meant to.

To fully appreciate the way this new unit performs, it is necessary to briefly explain the way the entire dbx encode-decode process

operates and how it applies to both tape recording and the Model 21.

Let us assume that a symphonic recording is being made, and that the producer and engineer have decided to use the professional dbx noise reduction system. As the orchestra plays, the musical signal is fed through the dbx encoder and is recorded on tape. The first benefit is the elimination of tape hiss. Secondly, it allows the full dynamic range of the performance to be captured on tape, albeit in a specially encoded format. This is done by a system of linear compression. An extremely loud passage of music, which might have a level of, say, 100dB is compressed and recorded at a level of 50dB. Likewise a signal of 85dB would be compressed to

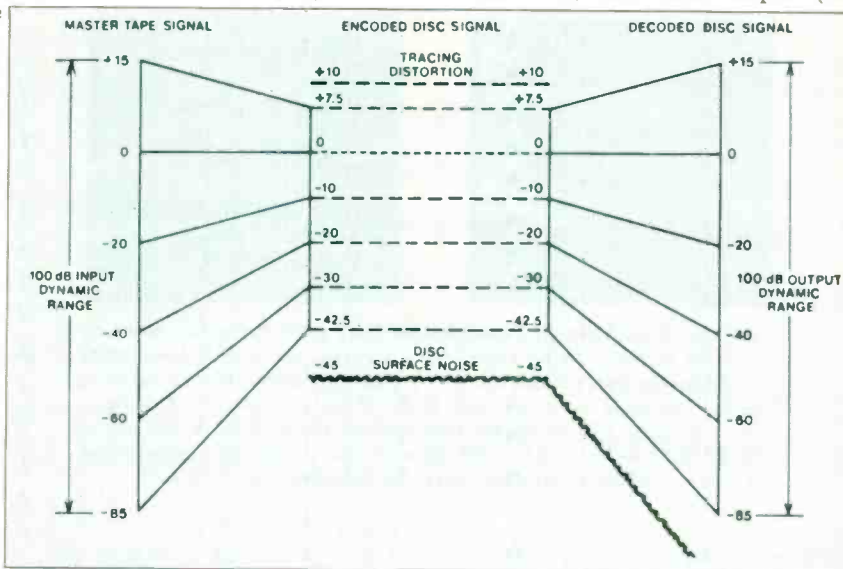

The dbx system takes a full-range input from a musical source and compresses the dynamic range by 50 percent. The compressed signal is then put on the record album. The Model 21 (below) re-expands signal to its full range.

ENCODED DISCS



Circle No. 118
On Reader Service Card

The dbx system—if you didn't know better, you would swear it was digital

by Alfred Meyers

ENCODED DISCS

42.5dB. The entire performance is compressed on a 2:1 ratio prior to taping.

Since even the best studio tape recorders can not handle a dynamic range of 100dB and since they all introduce a certain amount of tape noise, the advantages of the dbx system become obvious. Tape noise is still being generated by the tape recorder, but it being put on the tape with a compressed musical signal. During playback, the dbx unit is switched to the expansion mode, and the compressed signal is expanded on a complimentary 1:2 ratio—the exact opposite of compression. Since expansion makes loud sound louder and soft sounds softer, the non-encoded tape hiss is reduced in level to being virtually inaudible. So, the tape is noise free and has a full, wide-opened dynamic range.

All of this is fine for tape. But, the master tape still has to be transferred to a disc, and a whole new set of problems are encountered. When the disc master is cut, the decoded tape is played and, sure enough, there is no tape noise and there is a wide dynamic range—often much too wide. Because the disc format simply can not accommodate

a dynamic range of 100dB, the recording engineer must still employ some electronic trickery to squeeze all of the sound onto the record. These steps can include gain riding and limited compression—steps that must be taken because too quiet a sound would be lost in disc surface noise and a signal that is too loud would cause distortion.

Furthermore, since a loud musical passage requires wider grooves, a disc with an unusually wide dynamic range usually results in either less music per side and/or cutting closer and closer to the label area, often resulting in inner groove distortion. The end result is a disc with sound that rarely equals that of the decoded dbx master tape. Additionally, the listener now has to contend with disc surface noise which may be a series of tiny pops and clicks or the more general surface noise

which Jim Comacho of dbx calls "Whooshing sounds caused by the granular composition of even the best vinyl." Oh yes, if all that were not enough, there is still turntable rumble and groove echo. And, while most audiophiles (myself included) are often impressed by the improvements found in digital and direct-cut discs, it is only with the finest of these pressings that there is a total absence of surface noise. The crux of the problem is to have a

(Continued on page 73)

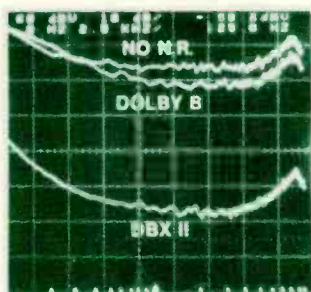

These oscilloscope photos (provided by dbx) show the noise reduction of the dbx system. The lefthand photo is a constant 125 Hz bandwidth of cassette tape noise relative to 0 VU. The three traces are (from top to bottom): no noise reduction, with Dolby B and with the dbx II system. Total wideband (20 to 20,000 Hz) noise is reduced from -48 db to -56 dB with Dolby and to -84 dB with dbx. Photo right shows noise levels for a conventional disc (top) dbx encoded disc (bottom).

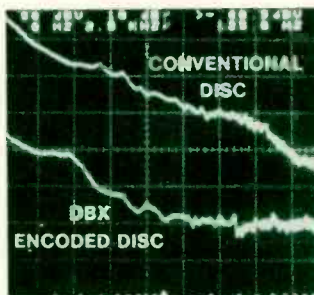

Thomas D. Kelley comments on some early dbx releases

dbx has released an initial batch of classical recordings licensed from various companies and all remastered utilizing the dbx encoding process. An advantage of this process is that all that is required to incorporate it into a component system is a relatively inexpensive disc decoder unit which plugs easily into the tape monitor circuit of your preamplifier. The initial group of classical recordings offers a rather unique listening experience. After the initial sound of setting the needle in the groove there is no surface noise whatever. It is as if one were listening to a Digital master tape, with no background noise and a dynamic range that is obviously far greater than that of conventionally-recorded discs. Sometimes during high loud passages you can sort of hear the decoder adapting to the signal: doubtless as the process is refined there will be some way to cut this back.

Three of the initial releases are sonic blockbusters. Holst's *The Planets*, as recorded by the St. Louis Symphony under Walter Susskind might not interpretively be among the more sensitive of recordings of this popular symphonic suite, but sonically it is a knockout. The conventional disc (Turnabout 34598) is superb; the dbx version even better for its lack of extraneous noise and wider dynamic range. Skrowaczewski's performances with the Minnesota Orchestra of Stravinsky's *Petrushka* and a suite from Prokofiev's *Love*

for *Three Oranges* is an ideal demonstration disc by any standards. Percussion is scintillating, there is plenty of depth and warmth, the dynamic range amazes (SS3006). Louis de Froment conducts the City of Birmingham Symphony Orchestra in a delightful Massenet collection featuring *Scenes Pittoresques* and *Le Cid Ballet Music*, all recorded in a splendid live hall; big orchestral sound at its best (GS 2011). Leopold Stokowski's sensuous string sonorities are vividly conveyed on an LP with the Royal Philharmonic Orchestra featuring Dvorak's *Serenade in E Major* and the *Fantasia on a Theme by Thomas Tallis* of Vaughan Williams (GS 2001). Less demanding sonically are *The Art of Laurindo Almedia* (SS 3003), and *The Art of Richard Stoltzman* (SS 3010) each respectively displaying the sound of guitar and clarinet in an aural atmosphere totally devoid of extraneous sounds.

SS records retail at \$8.00, GS at \$12.00 and announced super-deluxe digitally-mastered DBX Encoded Series shortly to become available will list at \$16.00, still less than the cost of most premium-priced digital or direct-to-disc recordings. At this time the records are available at audiophile outlets, although some mass-market stores will soon have them. What a pleasant world it would be for the audiophile and the record collector if a system such as this were unanimously adopted throughout the industry! ▲

Revox B760. One touch tunes it. Perfectly.



Now there's a tuner that works as accurately as a radio transmitter and as easily as a car radio.

You can tune the B760 manually in increments of 25 or 50kHz, or program up to 15 stations in memory for instant selection. Just touch a button for the station you want, and in less than a second the muting light goes off and the digital readouts and tuning meters confirm your station selection.

Both memory and manual tuning are controlled by an advanced digital-frequency-synthesizing circuit with a differential phase-locked loop that compares the output of the master oscillator with a quartz crystal reference frequency. If there's any difference, corrections are made instantaneously, maintaining an accuracy of $\pm 0.005\%$. (That's better than many radio stations can achieve!)

The B760's CMOS memory is so sophisticated that it can automatically direct an antenna rotator toward each memorized station, and even has a battery pack to pro-

tect the memory if you unplug the tuner or lose AC power.

Other features include an optional plug-in Dolby circuit board, oscilloscope outputs to help you minimize multipath distortion, selectable 25, 50 or 75 microsecond FM de-emphasis, adjustable-threshold interstation muting, a headphone jack with level control and a high-blend switch to optimize reception of distant stations.

It's all put together with attention to detail and durability for which the Studer Revox company is so well known. With things like plug-in circuit boards, RF shields plated to resist oxidation and even a coaxial delay line to maintain proper phase, everything is made just a bit better than it has to be. Because we want everything to be perfect.

Studer Revox America, Inc.,
1819 Broadway, Nashville, TN. 37203 (615) 329-9576
Offices: Los Angeles (213) 780-4234
New York (212) 255-4462
In Canada: Studer Revox Canada, Ltd.

STUDER REVOX

Listen To Reason.



The RX-73 In-Dash AM/FM/MPX Cassette

Value.

A word you don't hear as much as you'd like. But the RX-73 has it written all over it.

It's an in-dash AM/FM cassette deck with 8 watts per channel, left-to-right balance and front-to-rear fader control, low-level outputs for easy hook-up to control amplifier or graphic equalizer and a short chassis depth.

Some of these features you might find on other units, but it's unlikely to find them all. And even

more unlikely to find it priced like the RX-73.

"Value" is again becoming a household word. Sounds reasonable. If you've been considering a new car stereo system, listen to reason. Listen to the RX-73.

 **MITSUBISHI[®]**
CAR AUDIO
SOUND US OUT

© 1980 Melco Sales, Inc., 7045 N. Ridgeway Ave., Lincolnwood, Ill. 60645, 800-323-4216 (Outside Ill.) 312-973-2000 (Within Ill.)
In Canada: Melco Sales Canada Inc., Ontario

Circle No. 23 On Reader Service Card

SOUND SOUND SOUND SOUND SOUND

DDOBE DDOBE DDOBE DDOBE DDOBE

PROBE PROBE PROBE PROBE PROBE

emphasis both on *frank* and on *personal*. It is our hope that this approach will give you more of a clue to the "personality" of the speakers we discuss than you could glean from a set of lab data.

by HANS FANTEL and CHRISTOPHER GREENLEAF

Dahlquist DQ-10

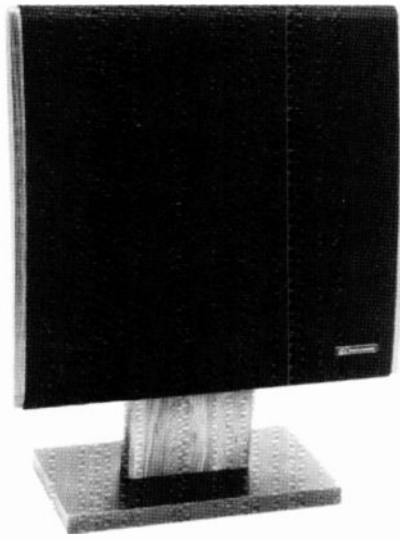

Circle No. 119
On Reader Service Card

The Dahlquist DQ-10 looks utterly unlike most speakers, taking the form of a single curved panel, leaning slightly backward, with walnut edges on each side and three short legs supporting it. It stands 32 inches high and is 30½ inches wide. Being only nine inches in depth, it takes up remarkably little space. The paired speakers come in left and right units and must be placed accordingly to maintain correct phase relations within the astoundingly precise stereo image they project.

Peering through the mesh of the black grille, one sees four of the five drivers comprising the system. The unseen one is a 10-inch woofer concealed in a sealed enclosure attached at the rear to the lower part of the curved panel. The other speakers are a 5-inch midrange cone, a 2-inch upper midrange dome, a ¾-inch dome tweeter plus a horn-loaded super-tweeter activated by a piezo-electric element—a crystal vibrating under the influence of

the audio signal. The crossover points between these drivers lie at frequencies of 400, 1000, 6000, and 12,000 Hz, with overall response extending from 35 Hz to an ultrasonic 27,000 Hz.

All these speakers are mounted in what is called a phased array, meaning that their voice coils are all in the same vertical plane. The object is to make the sound from each speaker element arrive at the listener's ears at precisely the same instant. This "phase-coherent" arrangement is said to contribute to better stereo imaging. To maintain this effect, the crossover network also has been designed to eliminate any phase shift between the various drivers.

With the exception of the enclosed woofer, each of the other drivers is mounted on separate flat baffles that are open both in front and back. According to Jon Dahlquist, who designed this unique speaker in collaboration with Saul Marantz, the famous audio pioneer, "The size of each baffle is large

Realistic Optimus-23

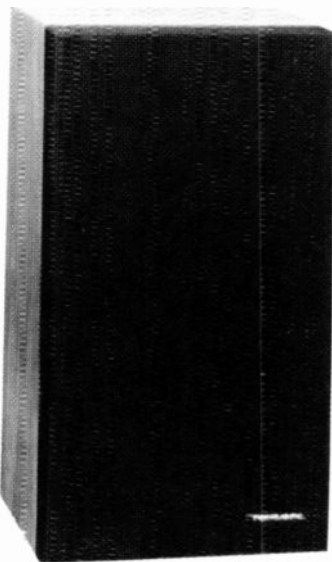

Circle No. 32 On Reader Service Card

Just looking at it, you'll find nothing exceptional about this speaker. It is a moderately sized bookshelf model with nothing remarkable in its appearance.

Listening to it is something else. After putting Radio Shack's Optimus-23 through its paces—playing all kinds of music on it—we came away convinced that this is one of the best speakers you can buy for less than \$100. Later we'll have more to say about the sound. But first the vital statistics.

The enclosure measures a comfortable 22½ x 12¼ x 11¾ inches, comes veneered in walnut, and the beveled edges of the detachable brown grille give this speaker a pleasantly trim, finished look. Its weight of 24 lbs is safely supportable by a properly anchored bookshelf.

Inside the box nestles a 10-inch woofer, handling the range from 55 to 3500 Hz, at which point a 2-inch cone tweeter takes over and carries the response right up to 20 kHz.

Like other speakers in Radio Shack's

Optimus series—notably the somewhat larger and exceptionally fine-sounding Optimus-10 (\$139.95)—this model uses a duct-loaded vent to obtain remarkably full bass for its size as well as high efficiency. The principle of the vent, as most audio fans know, is to take the sound radiation from the rear of the speaker cone and bring it out of the box in phase with the front radiation. The net effect is that front and rear radiation from the woofer augment each other, giving more effective bass radiation and more sound per watt. In fact, the efficiency of the Optimus-23 is so great that a mere 5 to 10 watts of amplifier power suffices to drive it to normal listening levels in rooms of moderate size—say, up to 3000 cubic feet. For larger rooms, receivers or amplifiers with anywhere from 15 to 25 watts per channel would be more suitable. And if you like your music really loud, you can safely drive these speakers with amplifiers rated at 40 watts per channel. The Optimus-23

SOUND PROBE SOUND PROBE SOUND PROBE



Circle No. 119
On Reader Service Card

enough to supply sufficient loading for its associated driver, yet small enough to cause early diffraction and prevent degradation of transient detail." In other words, the interior baffles are designed to prevent false reflections from their surface that would effect sonic detail the way "ghosts" affect a TV

image. The nominal impedance of the whole array is 8 ohms and it takes a hefty 50 watts of amplifier power to drive it.

Performance:

The Dahlquist came to us with some impressive advance billing, for it enjoys a widespread reputation among hard-bitten audiophiles for its accuracy—that is, its ability to render the music exactly "as is" with nothing added by way of coloration. Being skeptical of such claims, we tried very hard to find faults with this speaker. We didn't succeed. After a few minutes of incredulous listening, we were totally won over.

This speaker doesn't leap at you. No socko bass. No chrome-plated highs. What you get instead is uncannily close to the sound of live music. Once we've said that, what more can we say?

Plenty. For example, we asked ourselves if the design principle of phase coherence between all the speaker elements really made any difference. Apparently it does. At any rate, the stereo image is the most precise we ever heard from any speaker. A solo instrument anywhere within the orchestra seems clearly pinpointed; it comes from just one place—it doesn't wash all across the room. And there is not only a sense of exact left-to-right localization; there

is also an almost visual sense of depth, suggesting to the mind's eye the front-to-back dimension of the imaginary orchestral stage. What's more, the bi-directional radiation from the open baffles lends the sound a pleasing sense of spaciousness that flatters any kind of music you play on these speakers.

The only reservation we have about the Dahlquist is that listeners accustomed to more juicy bass may find that this speaker just isn't gutsy enough to please them. Granted, a low organ note or the thump of an electric bass guitar won't hit you in the stomach. We don't consider this a drawback. Rather, we enjoyed the tight and unobtrusive lows along with the almost magical clarity of the upper range.

This remarkable clarity no doubt owes a great deal to the piezo-electric supertweeter. It is merciless in revealing faulty records or shortcomings in the rest of the system. But it also delineates even the trickiest transients with astounding sharpness—as if the sound were etched in glass, but without being in the least glassy.

The cool transparency of the Dahlquist may not be everyone's dish, but if you have \$449.50 to spend for a speaker, you owe it to yourself to hear this one before plunking down your money. ▲

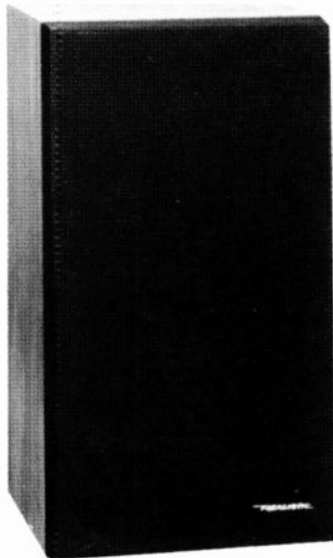

Circle No. 32
On Reader Service Card

takes anything up to a limit of 75 watts and pours out torrents of sound at that level. Or, putting it in the precise term of the standard sensitivity measurement, 1 watt of input produces a sound

pressure level of 91.5 db at a distance of 1 meter—and that's really milking every bit of amplifier energy for maximum sound.

The treble dispersion is listed in the specs as being 6 db down at an angle of 98 degrees off axis at a frequency of 1 kHz. At 8 kHz, the treble dispersion angle is 63 degrees. This isn't the greatest, but it's pretty good, and unless you're standing or sitting way over to the side, it won't bother you.

Performance:

Our surprise came when we socked these speakers with some weighty symphonic orchestrations and found that they weren't at all fazed by it as long as we kept the music at normal listening levels. When we cranked up the volume to full concert level, the bass got a bit muddy—but then this inexpensive speaker isn't meant for a lease-breaker. At more moderate volume, the bass was not only quite clean, but there was more of it than we've ever heard from a speaker in this price class.

It didn't bother us that the Optimus-23 has no tweeter-level control, for it seemed well balanced across the entire spectrum. Any response corrections required by room acoustics could easily

be done by means the amplifier's or receiver's treble control.

The highs were natural, unforced, and had the kind of sweetness that made the sound of string instruments particularly attractive. A clarinet solo played against orchestral background sounded just right—a fat and full reedy sound that is the mark of a good mid-range. One flaw we noticed was a slight chestiness in male voices, probably due to a response hump in the mid-bass region. But this was not obtrusive.

To test for transients, we played some Scott Joplin and found the plunk of the ragtime piano coming through with a nice crispness which blurred only at very high volume levels. Granted, the Optimus-23 does not have the ability to tease out every strand in a complex orchestral score. That's something you find only in costly multi-driver speakers with elaborate crossover networks. But in its class, this speaker has few equals.

In short, here is a loudspeaker offering very enjoyable sound for very little money—and thanks to its unusual efficiency, it does not require an amplifier with eight cylinders and a turbocharger. That makes it an all around bargain. ▲

FERRIC TAPE

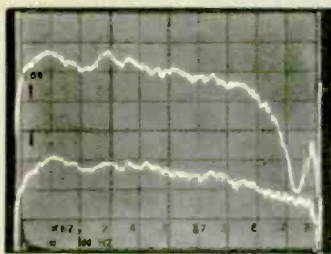

Brand X (fe)

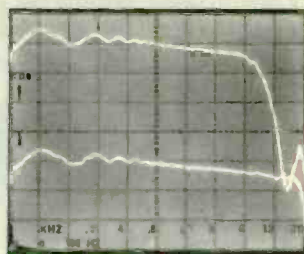

BASF PRO-I

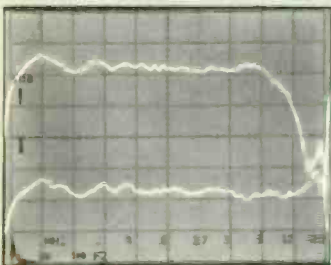

Fuji FX-1

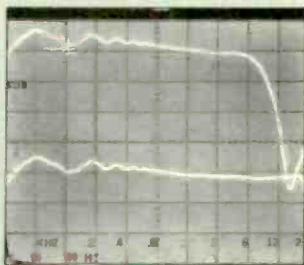

Hitachi UD/ER

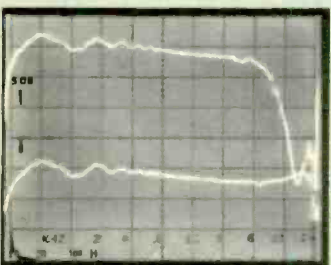

Maxell UC/L

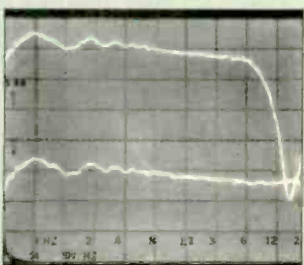

Memorex MRX3

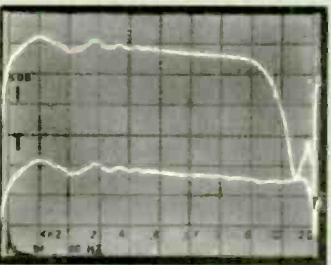

Nakamichi EX

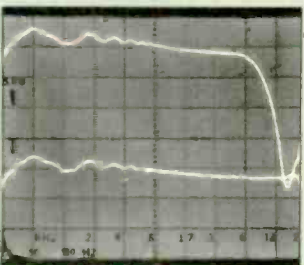

Nakamichi EX I

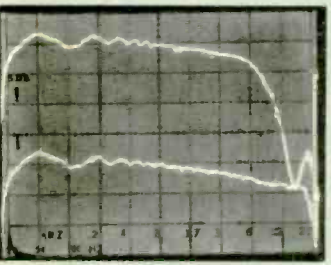

Realistic Low Noise

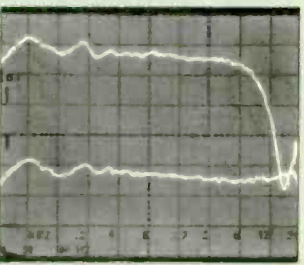

Realistic Supertape Gold

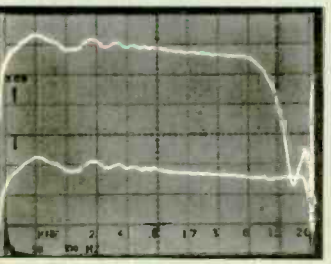

RKO Broadcast I

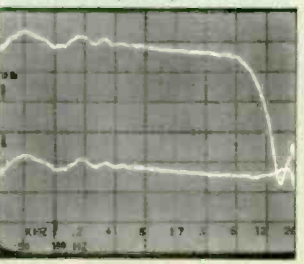

RKO XD/xtradynamic

CASSETTE TAPE TRYOUTS

An unbiased look at the most popular cassette tapes

by HERB FRIEDMAN

The majority of cassette decks used in high fidelity systems provide fixed bias and equalization values for *normal* (ferric) and chromium dioxide tapes; chromium dioxide actually encompassing any tape formulation that utilizes the *high bias* and 70 μ Sec equalization associated with chrome tape. (For our purposes we will henceforth refer to all *high bias* tapes as "chrome.") In addition, many machines also provide bias and equalization values for ferrichrome tape; again, ferrichrome actually encompassing any tape formulation that uses the same bias and equalization. We will refer to these tapes as "ferrichrome."

(Other machines provide bias and equalization for metal tape, which will not be covered in this article.)

Bias. Theoretically, there is a specific bias value which is essentially average for *normal* and ferrichrome tapes, and two bias values theoretically correct for most chrome tapes. As a general rule, the instruction manual for any cassette deck with fixed bias and equalization contains a chart listing recommended tapes for the particular machine, and one can assume that any recommended tape will work well.

As anyone who has experimented with different tapes soon discovers, any recommended tape doesn't necessarily work well. In fact, some can sound downright bad because there is really no such thing as an "average" bias value. Though one or two tapes actually deliver their best performance with similar bias values, finding which two tapes are bias-similar is not the easiest of chores. Then again, what of the tapes which sound poor? Are they "bad" tapes? Not necessarily. As we were to discover through user-oriented checks of some thirty-five commonly available tapes of the ferric, chrome and ferrichrome variety, almost all are good, some are better than good, maybe one or two great; none are spectacular.

Many claims are made for cassette tape: higher fidelity,

These photographs show the playback frequency response of flat, 20 to 20,000 Hz inputs at zero dB (the first major horizontal line down from the top) and -20 dB (the first major horizontal line below the center line). Each major division represents 5 dB with the very top of the screen being +5 dB and the bottom -35 dB. The 2 dB to 3 dB bumps at 50, 200 and 350 Hz, and the spikes at 19 kHz are a function of the tape recorder's performance. The tiny ripples are dropouts on the tape.

FERRIC TAPE

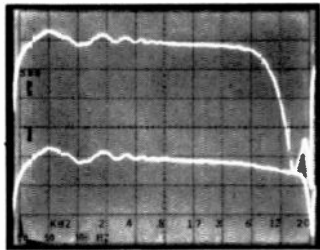

Scotch Dynarange

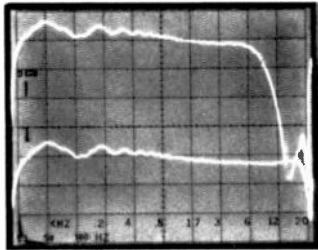

Scotch Master I

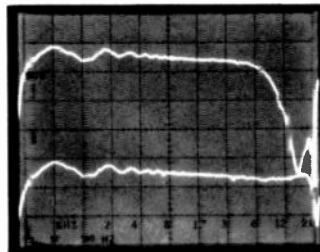

Sany LHX

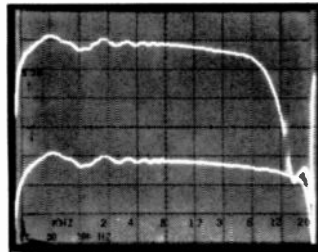

Sany EHF

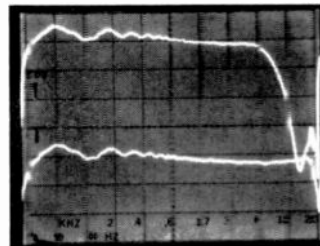

Sany SHF

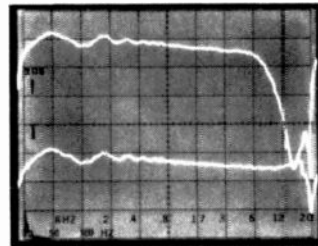

TDK-D

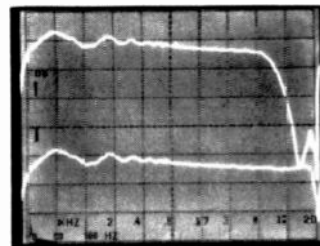

TOK-AD

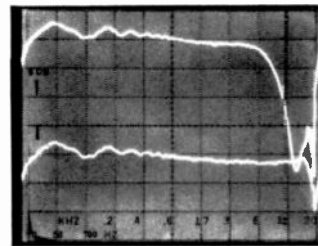

TDK-OD

CHROME TAPE

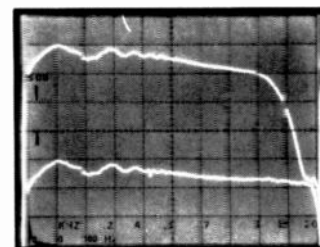

BASF PRO-II

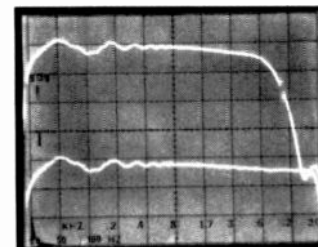

Fuji FX-II

TAPE TRYOUTS

lower noise, greater output than competitive brands, lower distortion, etc., etc. Those of us who get a chance to work with many different cassette machines and tape brands soon discover that any so-called hi-fi cassette tape can be better than any other tape in virtually all categories, depending on the specific recorder being used and the bias value. All things considered, with our present assortment of available tapes, overall performance is determined more by the bias value than by the tape itself.

Optimizing. So our first decision was to optimize the bias value for every tape by using a moderately priced cassette deck with adjustable bias and a built-in test oscillator system for bias adjustments. The Realistic SCT-3000 was selected because it is moderately priced, has a twin-tone bias calibration test oscillator system (which is about the best except for the tri-tone computerized systems), and is

“ . . . performance is determined more by the bias value than by the tape itself.”

an overall excellent machine. The frequency response at the meter indicated zero-VU record level and for -20 dB, the standard cassette tape test level, is shown in the photographs, which are oscilloscope traces representing a 20-20,000 Hz frequency range, with each major vertical division representing 5 dB while each minor vertical division represents 1 dB.

Zero-VU was selected as the maximum record level because it is the generally accepted maximum record level even when the instruction manual might recommend “record at $+3$ dB when using low noise tape,” or “set recording peaks to $+6$ dB when using high energy tape.” *Low noise* and *high energy* are relative terms which serve at best to confuse the average user, and most stereophiles simply peak the record level at the meter indicated zero-VU: Hence, our choice of zero-VU as the maximum record level.

In each photograph the levels are absolute, meaning you can compare one against the other. For example, the .8 kHz (800 Hz) midband level of BASF Pro I tape was 4 dB higher than Fuji FX-1 at the same frequency and record level.

At this point let us digress for a moment and discuss several unusual aspects of our closer look at cassette tape—and it is simply a closer look, not *tests*, for there is no practical way to legitimately test the better quality tapes. Firstly, many manufacturers make a point of the cassette construction, going into seemingly endless details on the slip sheets, rollers, mechanics, and even the outer box. Our closer look started back in the summer of 1979 when we packed several cassettes from each hi-fi manufacturer into an auto's glove compartment. At the end of the summer

we had jammed cassettes, screws falling out inside the auto tape player, and warped tape from everyone. And when the cassette or the tape didn't fail, we had moans and groans from rollers and squeals from the pressure pads. Heat is a cassette-killer regardless of brand, protect your tapes from it.

Secondly, for the electronic check we requested two of the very latest samples of all tapes from every major manufacturer.

Essentially, we had between four and twelve tapes from each manufacturer. Except for Memorex, Hiatchi, and Nakamichi, at least one tape from each manufacturer proved defective in the sense it had relatively high signal dropouts, or the required bias was completely out of the

“ . . . there is no practical way to legitimately test the better quality tapes.”

normal range for its type and beyond the adjustment range of the recorder. (In the past we have never had this percentage of “rejects”—at most, one or two tapes from the entire batch of well over a hundred. Something's amiss with quality control!)

Where the problem wasn't dropouts or bias values, it was simply rotten performance. For example, look at the photo for Brand X tape. The ripples in the display—normally above .8 kHz—are averaged dropouts. Note the dropouts extend into the deep bass, which is highly unusual, a condition almost never seen in quality tape. Also note the pronounced zero-Vu record level saturation; at 6 kHz it is already 5 dB below midband (800 Hz). Now for the surprise. This is the “test mate” of one of the most respected brands whose more typical performance is shown in another photo. (No names are mentioned to save everyone embarrassment because this isn't atypical. We had a few other “test mates” just as bad.)

Back To Performance. Once the bias was adjusted as specified for the recorder, we checked signal to noise ratios. There wasn't more than 3 dB average difference between the tapes, an insignificant value when you consider the Dolbyized S/N (signal to noise) ratio averaged approximately 57 dB with approximately 7-9 dB headroom above zero-VU per tape.

As for headroom, it is midband headroom, which tends to be confusing when using it to imply anything concerning performance.

For example, look at the photo for TDK-SA tape, one of the best in terms of headroom. There is 9 dB headroom above zero-VU record level at midband, but saturation commences slightly above 6 kHz at the zero-VU record level. Increasing the signal another 9 dB to “increase the signal to noise ratio,” as is often implied in recorder instruction manuals, will only drive the higher frequencies further into saturation, causing a “lifeless” sound quality to the playback.

Saturation. Before we go any further we'll cover
(Continued on page 71)

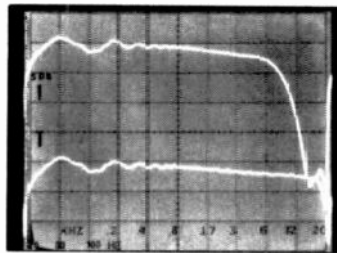

Hiatchi UD/EX

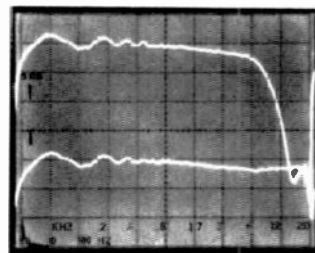

Maxell UD/XL II

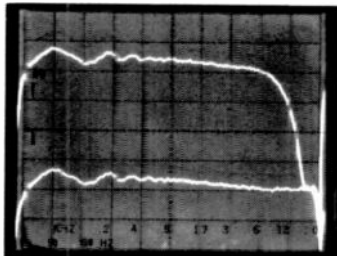

Memorex high Bias

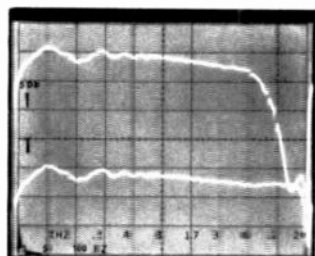

Nakamichi EX

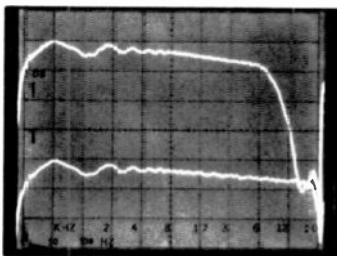

Realistic Sapertape Chrome

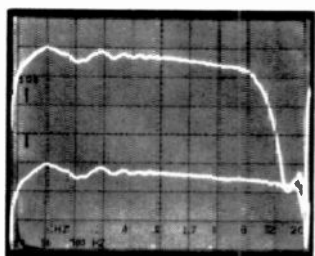

RKC Ultrachrome

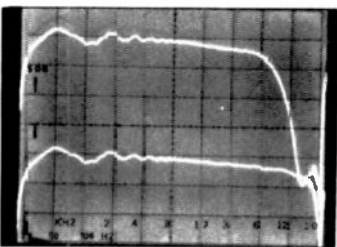

Scotch Master II

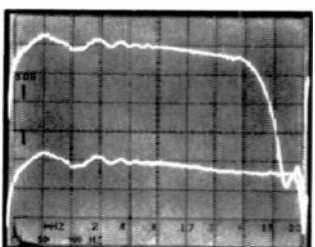

TDK-SA

FERRICHRROME TAPE

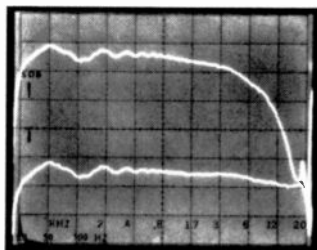

BASF PRO-III

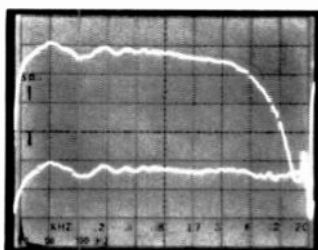

Scotch Master III

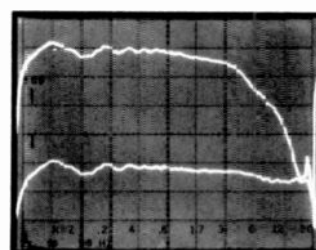

Sony F9Cr

Speaker for higher.



Unique qualifications.

For example, a tweeter mounted directly in the grille.

It's the Jensen 6½" Coax II car stereo speaker. And by putting the 2" tweeter where it is, we've improved the high frequency dispersion. And slimmed down the speaker.

Experienced treble-shooter ... for better dispersion.

High frequencies can be tricky... they usually just want to travel straight forward. But the up-front position of this direct radiating tweeter helps disperse those highs throughout the whole car.

So whether you install these speakers low in your front doors or back in the rear deck, you can be sure you're going to hear all of the treble this unique speaker has to offer.

Beefed up music.

That's what you'll get from the 6½" Coax II. Music with plenty of meat on its

bones. Music with a frequency response that stretches from 50 Hz to 40,000 Hz.

Not only from the tweeter in the grille. But also from the 6" woofer behind it. This woofer's hefty 16 oz. magnet and large 1" Nomex[®] voice

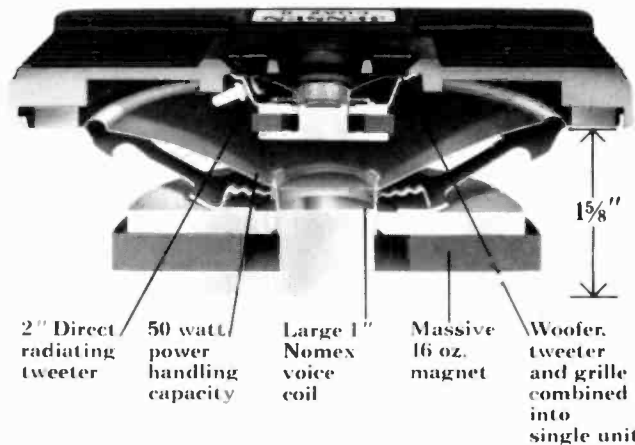

coil serve up a second helping of full, balanced bass. While a responsive rim suspension and meticulous cone design give this speaker extra sensitivity.

This highly efficient, 4 ohm Coax II will handle up to 50 watts of continuous power. And make the very most of it.

A slimmed down speaker.

No extra fat on this speaker... it's only 1½" deep and it fits your current 5¼" cutout. So it will fit in more car doors, more rear decks, and more tight spaces than ever before.

The Jensen 6½" Coax II is also easier to install, thanks to its new uni-body construction. The grille is permanently affixed to the speaker unit. Which not only makes installation easier, but also means a sturdier speaker with less vibration.

Excellent references.

Give a listen to the new Jensen 6½" Coax II's. The speakers with the grille-mounted tweeters.

We think you'll agree that they're just the right speakers to fill the position in your car.

JENSEN
SOUND LABORATORIES
AN ESMARK COMPANY

TEST REPORTS



▲ The equipment reviewed on the following pages has been thoroughly evaluated by our independent electronics testing laboratory. Each piece of equipment is a standard production line model loaned to us by the manufacturer. We do not test prototypes or anything that looks like a "ringer." Since many of our performance tests are more stringent than those specified by the Federal Trade Commission (FTC) our specifications are not directly comparable to those found on manufacturer's spec sheets or to reports in other magazines. At the bottoms of the following pages are explanations of our testing procedures that will help you understand how to relate our test results to those claimed by the manufacturers. Also on the following pages are explanations of audio terms that will help you get more out of these reports. ▲

48/RECEIVERS

51/TUNERS

52/AMPLIFIERS

53/PREAMPLIFIERS

55/INTEGRATED AMPS

60/TURNTABLES

62/CASSETTE DECKS

RECEIVERS



AIWA AX-7800U 60-WATT AM/FM RECEIVER \$590

Circle No. 63 On Reader Service Card

The Aiwa AX-7800U AM/FM synthesized receiver is FTC rated for 8 ohms at 60 watts RMS per channel, 20-20 kHz, at no more than 0.05% THD. Both the AM and FM tuning is determined by a frequency synthesizer; the tuned frequency is indicated by a digital readout. The AM band is tuned in steps of 10 kHz, the standard American station spacing. The FM band is tuned in steps of 200 kHz, also the American standard. The tuning can be stepped through assigned channels, or auto-scanned stopping on active channels only, or scan-held with the tuning stopping for five seconds (unless interrupted) on each active channel before moving on. In addition to manual and auto tuning there are six AM and six FM memories that are programmed to the tuned frequency at the touch of a button; they provide immediate access to a desired channel (frequency). Since the tuning is synthesized it is precise; hence, there are no tuning meters or adjustments. The receiver is muted during frequency changes, so there is essentially no interstation noise.

Tests indicated the synthesized tuning system was convenient, effective, and most important, accurate. All operating modes, from full manual stepping to scan-hold worked perfectly, and tuning was always precise. A 9-step LED indicator serves as both an AM/FM signal strength indicator and combined peak output power indicator (both channels added together) for 8 ohm loads. The output power calibrations are 0.1 to 120 watts. The meter was precisely accurate at the nine calibrated steps, and a high brightness level allows accurate determination of the peak signal power. Other features include an FM stereo beacon, dual range bass (200, 400 Hz) and treble (2.5k, 5 kHz) tone controls, FM muting, loudness compensation, a metal cabinet with wood trim, and output hold-off that prevents power supply turn-on transients from being fed to the speakers, and switched and unswitched AC convenience outlets. The FM antenna input is 75/300 ohms. A rod antenna and external connection are provided for AM.

INPUTS

- Magnetic phono
- Auxiliary
- Tape recorder

OUTPUTS

- Two speaker systems
- Tape recorder
- Headphones

CONTROLS

- Volume
- Balance
- Ganged Bass
- Ganged treble

SWITCHES

- Power
- Tune up
- Tune down
- Auto/Manual tuning (search)
- Scan tuning on-off
- Tuning memory programming on-off
- Six memories
- AM/FM selector
- Input selection
- FM muting

- FM mono/stereo
- Loudness compensation
- Bass turnover frequency
- Treble turnover frequency
- Power/Signal Strength indicator mode
- Tape/Source monitor
- Speaker system A
- Speaker system B

DIMENSIONS

- Width: 20.9 inches
- Height: 4.75 inches
- Depth: 17.4 inches
- Weight: 24.4 pounds

FM TUNER PERFORMANCE

For 300 ohm and "Tee" antennas:

Input level for full limiting	5 μ V
Mono hi-fi sensitivity (60 dB quieting)	7 μ V
Stereo hi-fi sensitivity (55 dB quieting)	45 μ V
Stereo frequency response range	20 to 15 kHz
Stereo frequency response limits	+0.4/-0.1 dB
Mono distortion at standard test level	0.6% THD
Stereo distortion at standard test level	0.2% THD
Signal to noise ratio at standard test level	77 dB
Midband stereo separation	40+ dB
Alternate channel rejection (selectivity)	Very good

AM TUNER PERFORMANCE

Background noise considerably lower than average.
Overall performance much better than average.

AMPLIFIER PERFORMANCE

With both channels driven to the clipping level into an 8-ohm load from 20 to 20,000 Hertz:

Power output	66 watts RMS
Frequency response at 66 watts RMS	+0/-0.5 dB
Total harmonic distortion at 66 watts RMS	0.05%
Tone control range at 50 Hz (200 Hz turnover)	+10/-8 dB
Tone control range at 50 Hz (400 Hz turnover)	+12/-9 dB
Tone control range at 10 kHz (2.5 kHz turnover)	+10/-8 dB
Tone control range at 10 kHz (5 kHz turnover)	+6/-5 dB
Hum and noise—magnetic input (3 Mv in, 10 watts out)	60 dB
Stereo separation—magnetic input into noise level	precise
Power meter accuracy at calibrations	precise
Power meter frequency response within	+0/-3 dB 20 to 20 kHz

RECEIVERS

AKAI AA-R50 62-WATT AM/FM RECEIVER \$450

Circle No. 62 On Reader Service Card



The Akai AA-R50 is an AM/FM stereo receiver FTC rated for 8 ohms at 62 watts rms per channel, 20 Hz to 20 kHz, at no more than 0.04% THD. Features include: a stereo beacon; FM signal strength/AM tuning meter; FM center channel tuning meter; 75 and 25 uSec. FM deemphasis; dual range L & R LED output power indicators calibrated 0.07-6.2 and 0.7-62 watts

into 8 ohms; bass, midband and treble tone controls; low and high filters; tape copy between two recorders; and an output power hold-off that prevents power supply turn-on transients from being fed to the speakers. The FM antenna input is 75/300 ohms. A rod antenna and external connection are provided for AM. Switched and unswitched AC outlets are provided.

INPUTS

- Magnetic phono
- Auxiliary
- Two Tape

OUTPUTS

- Two speaker systems
- Two tape
- Headphones

SWITCHES

- Power
- Speaker system A
- Speaker system B
- Input selection
- Loudness compensation
- Stereo/mono mode
- Tape monitor 1/dub to tape 2
- Tape monitor 2
- Low filter
- High filter
- 75/25 uSec. deemphasis
- FM mute on-off
- Meter range

CONTROLS

- Tuning
- Volume
- Ganged bass
- Ganged midband
- Ganged treble

DIMENSIONS

- Width: 18.9 inches
- Height: 5.9 inches
- Depth: 14.1 inches
- Weight: 25.3 pounds

FM TUNER PERFORMANCE

For 300 ohm and "Tee" antennas:

Input level for full limiting	4.0 μ V
Mono hi-fi sensitivity (60 dB quieting)	10 μ V
Stereo hi-fi sensitivity (55 dB quieting)	65 μ V
Stereo frequency response range	20 to 15 kHz
Stereo frequency response limits	+0.5/-1.2 dB
Mono distortion at standard test level	0.5% THD
Stereo distortion at standard test level	0.2% THD
Signal to noise ratio at standard test level	71 dB
Midband stereo separation	40+ dB
Alternate channel rejection (selectivity)	very good
Stereo frequency response range at 25 μ Sec deemphasis	20 to 15 kHz
25 μ Sec frequency response limits	+0/-1.2 dB

AM TUNER PERFORMANCE

Sensitivity somewhat higher than average.

AMPLIFIER PERFORMANCE

With both channels driven to the clipping level into an 8-ohm load from 20 to 20,000 Hertz:

Power output	61 watts RMS
Frequency response at 61 watts RMS	+0.5/-0 dB
Total harmonic distortion at 61 watts RMS	0.05%
Tone control range at 50 Hz	\pm 10 dB
Tone control range at 1000 Hz	\pm 6 dB
Tone control range at 10 kHz	-10 dB
Low filter attenuation at 20 Hz	12 dB
Hum and noise—magnetic input (3 Mv in, 10 watts out)	-62 dB
Stereo separation—magnetic input	51 dB
Power meter accuracy at calibrations	within 15%
Power meter frequency response within 3 dB estimated	100 to 20 kHz

hi-fi stereo
GUIDE
**TESTING
REPORTS**

PRICES

All prices listed in the test reports section, as well as prices listed elsewhere in this issue, are approximate and subject to change. Use them only as a ballpark guide to what you can expect to pay for a piece of equipment. It is assumed that prices vary at the discretion of individual dealers and that advertised prices may change without notice. Fair trade laws allow the dealer to set the price; usually less than the nationally advertised value. In many cases the price is rounded off to the nearest dollar.

RECEIVERS

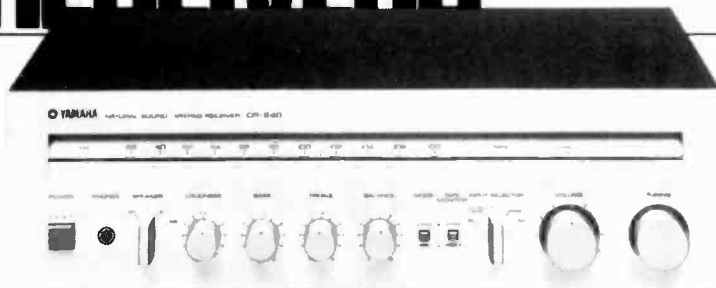

YAMAHA CR-240 20-WATT AM/FM RECEIVER \$250

Circle No. 101 On Reader Service Card

The Yamaha CR-240 is a smaller, relatively low cost receiver that delivers unusually good sound quality for the price. The deep bass is particularly clean. Unit is FTC rated for 20 watts per channel into 8 ohms at less than 0.02% THD from 20 Hz to 20 kHz. The receiver is supplied in a wood grain cabinet. The FM tuning is critical for minimum stereo distortion. The optimum tuning, which is indicated by equal brilliance from two

green LEDs, is a bit tricky to judge. Other features include: stereo beacon, LED signal strength indicator, LED AM/FM tuning indicator, Continuously variable loudness compensation, Auto FM mono/stereo or FM mono operation, Automatic FM mute in the FM Auto mode, 300 ohm FM antenna input, 75 ohm coaxial FM antenna input, Loop antenna and external connection for AM, One switched and one unswitched AC outlet.

INPUTS

- Magnetic phono
- Auxiliary
- Tape

OUTPUTS

- Two speaker systems
- Tape
- Headphones

SWITCHES

- Power
- Speaker selection
- Stereo/Mono mode
- Tape/source monitor
- Input selection/FM mode

DIMENSIONS

- Width: 7.1 inches
- Height: 5.25 inches
- Depth: 11.6 inches
- Weight: 16 pounds

CONTROLS

- Tuning
- Volume
- Balance
- Ganged Bass
- Ganged Treble
- Loudness compensation

FM TUNER PERFORMANCE

For 300 ohm and "Tee" antennas:

Input level for full limiting	4.5 μ V
Mono hi-fi sensitivity (60 dB quieting)	8.5 μ V
Stereo hi-fi sensitivity (55 dB quieting)	75 μ V
Stereo frequency response range	30 Hz to 15 kHz
Stereo frequency response limits	+1.5/—2.7 dB
Mono distortion at standard test level	0.15% THD
Stereo distortion at standard test level	0.15% THD
Signal to noise ratio at standard test level	76 dB
Midband stereo separation	40+ dB
Alternate channel rejection (selectivity)	Good

AM TUNER PERFORMANCE

Background noise somewhat higher than average.

AMPLIFIER PERFORMANCE

With both channels driven to the clipping level into an 8-ohm load from 20 to 20,000 Hertz:

Power output	20.8 watts RMS
Frequency response at 20.8 watts RMS	+0.9/—0.2 dB
Total harmonic distortion at 20.8 watts RMS	0.013%
Tone control range at 50 Hz	+10 dB
Tone control range at 10 kHz	+8/—9 dB
Hum and noise—magnetic input (3 Mv in, 10 watts out)	—70 dB
Stereo separation—magnetic input into noise level	



HI-FI JARGON: Frequency Response

The typical human ear can detect the sound of air vibrating at a frequency as low as 20 Hertz (cycles per second) or as fast as 20,000 Hertz. A good measure of the quality of a hi-fi component is its ability to deliver equal output at all audio frequencies from 20 to 20,000 Hertz. A small speaker will usually have a poor output (low-frequency response) at the 20-Hertz end of the audio spectrum. It will not reproduce the rich, thumping low tones of a pipe organ as well as it does the middle and high frequencies. Cassette tape, on the other hand, has trouble with the higher treble frequencies above 12,000 Hertz. This loss in high-frequency response is heard as a lack of crisp realism: sharp cracking or pinging sounds are muted and dull. The differences in sound level are measured in decibels (dB). One dB is generally considered the minimum detectable sound-level difference, 3 dB is a significant change and 10 dB represents either a doubling or halving of the sound level. A good phono cartridge's frequency response may be said to be within 1 dB from 20 to 20,000 Hz; that means there would barely be any noticeable sound level change at any frequency. If it was said to be —7 dB at 18,000 Hz then you would hear a very significant weakness in the high-frequency response. An ideal frequency response is "flat" (± 0 dB) from 20 to 20,000 Hz.

TUNERS

CROWN FM1 FM STEREO TUNER \$995

Circle No. 136 On Reader Service Card



An FM-only stereo tuner with phase-locked loop digital tuning and LED metering readouts. All tuning functions are touch-controlled for no-moving-parts operation. The memory function allows the pre-setting of five favorite stations for instant recall. The scan search feature allows the listener to sweep up and down the dial, stopping either at every active station or only those broadcasting in stereo automatically. The variable muting

control allows the user to set the tuner to receive only signals of sufficient strength to assure noise-free reception. All phases of operation are handled smoothly and facilitate the highest order of tuning accuracy and convenience. There is LED metering for multipath and signal strength, variable interstation muting control, selectable stereo de-emphasis (75 μ S and 25 μ S) and a multiplex filter.

INPUTS

- 300-ohm balanced antenna
- 75-ohm unbalanced antenna coaxial

OUTPUTS

- Composite (both channels combined) signal
- Multipath detection (for use with oscilloscope)
- Left and right channel fixed level
- Left and right channel variable level

CONTROLS

- Programmable memory entry
- Programmable memory select (5)
- Up/Down scan direction (2)
- Scan mode select
- Search mode select
- Stereo search priority
- Left and right channel output level control (rear apron)

SWITCHES

- Power
- 75 μ S/25 μ S de-emphasis
- Muting
- Stereo/Mono
- Multiplex filter

DIMENSIONS

- Width: 19 inches
- Height: 5.25 inches
- Depth: 15 inches
- Weight: 15.5 pounds

FM TUNER PERFORMANCE

Input level for full limiting	1.8 μ V
Mono hi-fi sensitivity (60 dB quieting)	7.5 μ V
Stereo hi-fi sensitivity (55 dB quieting)	32 μ V
Stereo frequency response range	30 to 15,000 Hz
Stereo frequency response limits	+0.2/-0 dB
Mono distortion at standard test level	0.065% THD
Stereo distortion at standard test level	0.12% THD
Signal to noise ratio at standard test level	64 dB
Midband stereo separation	40+ dB
Alternate channel rejection (selectivity)	excellent
Maximum output level at 100% modulation	1.2 volts
Stereo frequency response range at 25 μ Sec deemphasis	30 to 15,000 Hz
25 μ Sec frequency response limits	+0.7/-0.3 dB



HOW WE TEST: Signal to noise ratio

It is the accepted practice in the high fidelity industry, and virtually only for the hi-fi industry, that signal to noise measurements are weighted; that is, they do not include the hum-carrying lower frequencies on the theory that at lower listening levels the ear is less sensitive to the low frequencies, hence, they should not be included in signal to noise measurements.

The purpose of weighting is to obtain an artificially high signal to noise ratio.

In actual fact, most hi-fi listening is done at loud volume levels where the ear regains its low frequency sensitivity. Alternately, many listeners who prefer a low volume level will utilize loudness compensation to bring up the bass. Either way, the hum components will be brought up in relative volume, and will be heard if the hum components are not better than 55 dB below the signal level.

To avoid presenting signal to noise ratios that have no relevance in the real world, the HFSBG specifies *unweighted*—called "flat"—signal to noise ratios which are direct correlations of what the ear hears at loud volume levels, or at low volume levels with loudness compensation. To show the effect of Dolby noise reduction, we also give the weighted ("narrowband") noise ratio for cassette decks.

AMPLIFIERS

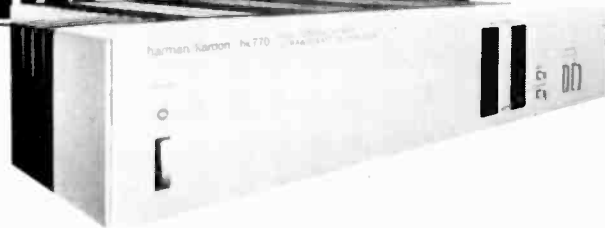

HARMAN/KARDON HK770 65-WATT POWER AMPLIFIER \$399

Circle No. 71 On Reader Service Card

The Harman Kardon hk770 Stereo Power Amplifier is FTC rated for 8 ohms at 65 watts RMS per channel, 20 Hz to 20 kHz, at less than 0.03% THD. Test results were considerably better than even the low claimed distortion, resulting in some of the lowest distortion figures ever attained from a power amplifier. The sound quality reflects the low distortion, being exceptionally clean, particularly in the deep bass. Special construction techniques result in an unusually small cabinet for

an amplifier of this power rating. The front panel has left and right LED dual range output power indicators calibrated 0.05-100 watts and 0.005-10 watts into 8 ohms. The LED power output indications were essentially precise, with a virtually flat 20 Hz to 20 kHz frequency response. An output power hold-off prevents power supply turn-on transients from being fed to the speakers. One unswitched AC convenience outlet is provided.

INPUTS

- Line level

OUTPUTS

- Two speaker systems

DIMENSIONS

- Width: 15.2 inches
- Height: 2.9 inches
- Depth: 12.6 inches
- Weight: 22.2 pounds

SWITCHES

- Power
- Speaker system 1
- Speaker system 2
- Output power display on-off
- Display sensitivity

AMPLIFIER PERFORMANCE

With both channels driven to the clipping level into an 8-ohm load from 20 to 20,000 Hertz:

Power output	68 watts RMS
Total harmonic distortion at 68 watts RMS	0.008%
Frequency response at 68 watts RMS	+0/-0 dB
Input sensitivity for 68 watts output	1.3 volts
Hum and noise—(1.3 V in, 68 watts out)	-96 dB
Power meter accuracy at calibrations	exact
Power meter frequency response	essentially flat
	20 to 20 kHz



HI-FI JARGON: Decibel

The decibel is a mathematical quantity expressing the ratio of two power levels. It is defined as 10 times the common logarithm of the power ratio, that is: $10 \log (P_1/P_2)$. Decibels are also used to express voltage ratios in which case the formula is: $20 \log (V_2/V_1)$. To be precise, the use of the voltage-ratio formula is correct only if the two voltages are measured with respect to the same load impedance, but, in practice, this exactness is often ignored, and we speak of the voltage gain of an amplifier as being, say, 20 dB even though the input impedance and the load impedance differ.

Not that the decibel notation *always* refers to a ratio of two quantities and to have meaning one of the quantities must be known or implied. Thus a voltage gain of 20 dB implies that the output voltage is 20 dB greater than (10 times) the input voltage.

The decibel is especially useful in audio work because we perceive loudness in a roughly logarithmic manner—the same manner as that in which decibels are calculated. The brief chart at right will give you an idea of how decibels relate to power and voltage ratios. Note that negative decibel values imply a fractional ratio and that 0 dB always refers to unity.

dB	Power Ratio	Voltage Ratio
-20	0.010	0.100
-14	0.040	0.200
-10	0.100	0.316
-6	0.250	0.500
-3	0.500	0.707
0	1.000	1.000
+3	2.000	1.414
+6	4.000	2.000
+10	10.00	3.16
+20	100.0	10.0
+30	1000.	31.6
+40	10000.	100.

PREAMPLIFIERS

HARMAN/KARDON HK725 STEREO PREAMPLIFIER

\$279

Circle No. 71 On Reader Service Card



The Harman/Kardon hk725 stereo preamplifier is housed in a relatively small metal cabinet that matches its associated model hk770 power amplifier. Individually, or in conjunction with the power amplifier, the sound quality is best described as "exceptionally clean," particularly with respect to the deep bass. An unusual feature is switch-selected bass and treble equalization, rather than rotary controls. The bass and treble have eight switches each, four providing boost in steps of 2 dB at 50 Hz and 10 kHz; four providing

attenuation in 2 dB steps at the same frequencies. An illuminated switch in the center of each row of buttons provides a tone control defeat. Subsonic and high cut filters round out the equalization. Switching is provided for automatic tape duplication from, or to, either of two recorders. A panel-mounted headphone jack allows the signal to be monitored without going through the associated power amplifier. One unswitched and two switched AC convenience outlets are provided. (See the review of the hk770 in this issue.)

INPUTS

- Magnetic phono
- Auxiliary
- Tuner
- Two tape recorders

OUTPUTS

- Line level
- Two tape recorders
- Headphones

CONTROLS

- Volume
- Balance

DIMENSIONS

- Width: 15.2 inches
- Height: 2.9 inches
- Depth: 12.6 inches
- Weight: 9.25 pounds

SWITCHES

- Power
- Input selection
- Tone control equalization
- Bass tone control defeat
- Treble tone control defeat
- Tape copy selection
- Tape monitor selection
- Subsonic filter
- High filter
- Loudness compensation

AMPLIFIER PERFORMANCE

Tested at 1-volt output, 20 to 20,000 Hz.

Frequency response	+0/-1 dB
Total harmonic distortion	0.008%
Tone control range at 50 Hz	±8 dB
Tone control range at 10 kHz	±8 dB
20 Hz subsonic filter attenuation	3 dB
Hum and noise—magnetic input (3 Mv in, 1-volt out)	-70 dB
Stereo separation—magnetic input	into noise level
Output clipping level	5-volts



HOW WE TEST: Amplifiers

Amplifier output power measurements are made at the verge of clipping; the value attained when the signal peaks, viewed on an oscilloscope, are at the maximum level before the tops of peaks are clipped by the amplifier. Above this level, distortion rises very rapidly, hence, the clipping level is the maximum "undistorted" output. In this way we provide a standard reference value so that amplifiers can be easily compared in terms of output power. Because some manufacturers use the clipping level as a reference value while others do not, output power comparisons should be made only by comparing our test values with each other.

HOW WE TEST: "Average" Performance

Readers often ask what we mean when we say that the performance of a piece of equipment is average. We have established high critical standards for all pieces of equipment that are reviewed on these pages. After all, we are concerned with high fidelity components—not just any gear that produces sound. An average rating means that the component meets our rigid performance standard and is a good buy in its price range. For example, if a \$1000 receiver is rated average this means that it is the equal of other average \$1000 receivers, superior to an average \$600 receiver, and far superior to an average \$200 receiver.

PREAMPLIFIERS

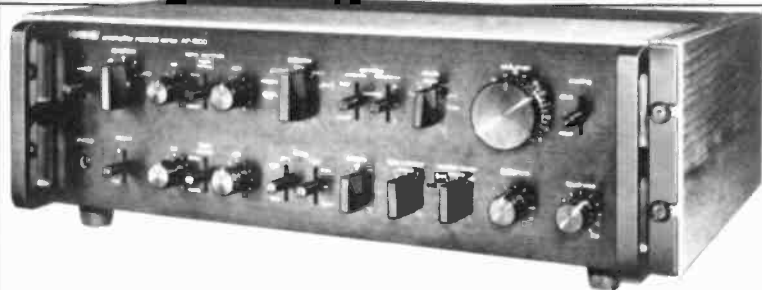

HEATHKIT AP-1800 STEREO PREAMPLIFIER \$379 (KIT FORM)

Circle No. 31 On Reader Service Card

A stereo preamplifier with a full range of control functions suitable for the average audiophile's system requirements. The bass tone control has an unusually flat "shelf" response that permits considerable middle to upper bass boost without excessive boost at the deep bass frequencies. Break-in adaptor jacks allow the use of signal processors without the loss of a tape deck input. These jacks are controlled from the front panel. The variable capacitance phono input selector allows exact matching with existing turntable wiring (including turntables wired for low-capacitance CD-4 cartridges). The unit also includes a special input for moving coil

phono cartridges, a three-level phono input sensitivity selector and an LED phono input overdrive indicator. The three-level phono input capacitance selector can be made to match any of 3 values. The AP-1800 has selectable, dual-range bass and treble frequency turnover controls, dual-range low filter and dual-range high filter controls. It also has automatic tape dubbing to and from two tape decks. There is dual-range audio muting, and an output control center for a power amplifier. The AP-1800 will grow easily with your system's requirements. The assembly instructions are good and it can be put together by anyone who is a bit handy.

INPUTS

- 2 magnetic phono cartridge inputs
- 1 moving coil phono cartridge input
- 2 auxiliary inputs
- Tuner
- 2 tape deck monitor inputs

OUTPUTS

- Right & Left channel output
- 2 tape deck monitor outputs
- 3 front-panel-switched AC outlets
- 3 non-switched AC outlets

CONTROLS

- Volume
- Balance
- Left and right bass level
- Left and right treble level
- Continuous loudness compensation
- Input selector
- Tape deck monitor selector
- Tape deck dubbing selector

SWITCHES

- Power
- Speaker selection
- Preamp output selection

- Treble turnover select/treble defeat
- Bass turnover select/bass defeat
- Low filter
- High filter
- Audio muting
- Input sensitivity select
- Input capacitance select

DIMENSIONS

- Width: 19 inches
- Height: 5.22 inches
- Depth: 11.25 inches
- Weight: 20 pounds

PERFORMANCE

The rated output is 2 volts/0.03% THD and all tests were conducted at this level.

Clipping level	9 volts
Frequency response at 2 volts from 20 to 20,000 Hz	-0/-0 dB
Total harmonic distortion	0.12%
Tone control range at 50 Hz with 500 Hz turnover	±12 dB
Tone control range at 50 Hz with 250 Hz turnover	±11 dB
Tone control range at 10 kHz with 5 kHz turnover	±6 dB
Tone control range at 10 kHz with 2.5 kHz turnover	±11 dB
Low filter attenuation at 20 Hz	3 dB
Hum and noise—magnetic input	-69 dB
Stereo separation—magnetic input	down into noise level
Input level indicator accuracy	±2 dB of clipping level

hi-fi stereo
BUYER'S GUIDE
TEST REPORTS

INTEGRATED AMPS

DENON PMA-630 80-WATT INTEGRATED AMPLIFIER \$465

Circle No. 135 On Reader Service Card



The Denon PMA-630 is a stereo integrated amplifier FTC rated for 8 ohms at 80 watts RMS per channel, 20 to 20,000 kHz, at less than 0.01% THD. Though a dual range (20 Hz and 40 Hz) subsonic filter and loudness compensation are provided, there are no conventional tone controls. Tone equalization, if desired can be provided through an optional accessory equalizer, such as a graphic-type equalizer, for which "break in" preamplifier-poweramplifier connections are provided on the rear. A shorting bar normally connects the preamp and amplifier. To use an accessory equalizer,

the shorting bars are simply pulled out, thereby "breaking" the signal path for the equalizer. Other features include automatic dubbing from and to either of two recorders, a recorder output disconnect (labeled REC OUT) which is supposed to avoid some effect of the recorders on sound quality (though we could not measure nor hear any deleterious effect of the recorders on the speaker sound), and an output hold-off that prevents power supply turn-on transients from being fed to the speakers. The unit is in a metal cabinet. Three AC convenience outlets are provided.

INPUTS

- Two magnetic phono
- Auxiliary
- Tuner
- Two tape
- Direct access to power amplifier

OUTPUTS

- Two speaker systems
- Two tape recorders
- Headphones
- Direct access to preamplifier

CONTROLS

- Volume
- Balance

SWITCHES

- Power
- Speaker system selection
- Input selection
- REC OUT (disable)

- Tape copy selection
- Tape monitor selection
- 20/40 Hz subsonic filter
- Loudness compensation

DIMENSIONS

- Width: 17 inches
- Height: 5.7 inches
- Depth: 15.4 pounds
- Weight: 35.3 pounds

AMPLIFIER PERFORMANCE

With both channels driven to the clipping level into an 8-ohm load from 20 to 20,000 Hertz:

Power output	89 watts RMS
Frequency response at 89 watts RMS	+0.2/-0 dB
Total harmonic distortion at 89 watts RMS	0.08%
20 Hz attenuation of 20 Hz subsonic filter	5 dB
20 Hz attenuation of 40 Hz subsonic filter	9 dB
Hum and noise—magnetic input (3 Mv in, 10 watts out)	-68 dB
Stereo separation—magnetic input	into noise level



HOW WE TEST: Worst Case

The test results that we report within these pages are always the worst case measurement for the piece of equipment being evaluated. For example, if the frequency response of an amplifier's left channel is 20 to 20,000 Hz ± 2 dB, while the response of the right channel is ± 3 dB from 20 to 20,000 Hz, the test report will show the worst case measurement, that is, ± 3 dB. Similarly, if an FM tuner's stereo separation measurement is 40 dB left-to-right and 32 dB right-to-left, the test report will show a separation figure of 32 dB. This method of reporting allows you to be certain that performance in all other cases was equal to or better than the published results.

INTEGRATED AMPS

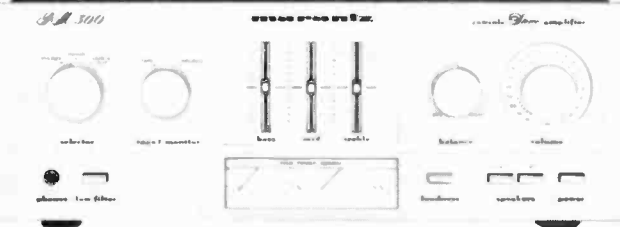

MARANTZ PM 300 30-WATT INTEGRATED AMPLIFIER

\$225

Circle No. 77 On Reader Service Card

The Marantz PM-300 is a stereo amplifier that is FTC rated for 4 ohms at 37 watts per channel, 20 Hz to 20 kHz, at no more than 0.08% THD. At the usual speaker impedance of 8 ohms the rated FTC output power was 30 watts per channel. Overall, this is a nice, moderate cost unit suitable for smaller installations. The output power meters, though having essentially a flat frequency response, had acceptably accurate readings only when the output power was 6 watts/8 ohms, or higher. The meters are calibrated from 0 to 60 watts

into 8 ohms and from 0 to 120 watts into 4 ohms. Its equalization features three tone controls with center frequencies of 50 Hz, 1,000 Hz and 10,000 Hz. There is also a 20 Hz low filter. Another convenience feature is the single switched and unswitched AC outlets. In our specifications we show the power output measured into an 8-ohm load to be 3 watts more than the manufacturer's claimed rating. Marantz emphasizes the 4-ohm rating because they say speaker impedances are usually 5-6 ohms, not 8 ohms.

INPUTS

- Magnetic phono
- Tuner
- Auxiliary
- Tape

OUTPUTS

- Two speaker systems
- Tape
- Headphones

CONTROLS

- Volume
- Balance
- Ganged bass (linear)
- Ganged midband (linear)
- Ganged treble (linear)

DIMENSIONS

- Width: 16.4 inches
- Height: 6.5 inches
- Depth: 11 inches
- Weight: 13.6 pounds

SWITCHES

- Power
- Speaker system #1
- Speaker system #2
- Input selection
- Tape/source monitor
- Loudness compensation
- Low filter

AMPLIFIER PERFORMANCE

With both channels driven to the clipping level into an 8-ohm load from 20 to 20,000 Hertz:

Power output	33 watts RMS
Frequency response at 33 watts RMS	+0/-0.6 dB
Total harmonic distortion at 33 watts RMS	0.025%
Tone control range at 50 Hz	+12/-15 dB
Tone control range at 1000 Hz	+5.5/-6 dB
Tone control range at 10 kHz	+10/-9 dB
Low filter attenuation at 20 Hz	3 dB
Hum and noise—magnetic input (3 Mv in, 10 watts out)	66 dB
Stereo separation—magnetic input	into noise level
Power meter accurate at calibrations 6 watts or higher	
Power meter frequency response essentially flat 20 to 20 kHz.	

hi-fi stereo
BUYERS' GUIDE
**TEST
REPORTS**

HI-FI JARGON: Harmonic Distortion

Ideal high-fidelity components would handle all types of signals without changing their character in any sense. In practice, this ideal is approached but not attained. Any unwanted change in the signal can, in general, be called "distortion."

Harmonic distortion refers to a particular type of change caused by a nonlinearity in gain that is a function of instantaneous signal amplitude. Such a nonlinearity generates "harmonics" in a pure tone (sinewave). These harmonics are additional components at frequencies that are whole multiples of that of the original tone. Thus, when a 1-kHz sinewave is applied to the component, it may add to it a small amount of second harmonic (2 kHz), third harmonic (3 kHz), etc. The ratio of the total power of these unwanted harmonics to the power of the "fundamental" (1 kHz), expressed as a percentage, is the "percent total harmonic distortion" or THD.

MAY/JUNE, 1980

Void after October 23, 1980

AUDIO INFO GUIDE

Free to all readers of HI-FI/STEREO BUYERS' GUIDE

Want more
information on
products advertised
in this issue?

At no cost to you the
Editor will have
information and
literature about
products and
services advertised
sent to you.

Tear out the coupon.

Circle the number
under the ad that
interests you.

Circle the number
identifying products
mentioned in
columns and
articles.

Print or type your
name and address
on the coupon.

Mail before the
expiration date.

Please allow 4-6
weeks for delivery.

Yes!

Please send me **FREE** additional
information on products circled below. Limit is 10

Name _____

Address _____

City _____ State _____ Zip _____ **HOE127**

FREE AUDIO INFORMATION - Please Circle Numbers Carefully

1	2	3	4	5	6	7	8	9	10	11	12	13	14	15
16	17	18	19	20	21	22	23	24	25	26	27	28	29	30
31	32	33	34	35	36	37	38	39	40	41	42	43	44	45
46	47	48	49	50	51	52	53	54	55	56	57	58	59	60
61	62	63	64	65	66	67	68	69	70	71	72	73	74	75
76	77	78	79	80	81	82	83	84	85	86	87	88	89	90
91	92	93	94	95	96	97	98	99	100	101	102	103	104	105
106	107	108	109	110	111	112	113	114	115	116	117	118	119	120
121	122	123	124	125	126	127	128	129	130	131	132	133	134	135
136	137	138	139	140	141	142	143	144	145	146	147	148	149	150

We'd like to know about your prime hi-fi/stereo
loudspeaker system.

What brand? _____ Model? _____ Price? _____
If you were to replace it today, what would you buy?
Brand _____ Model _____ Price _____

Complete Here To Subscribe To
hi-fi/stereo
BUYERS' GUIDE

250

Enclosed is \$5.95 for 6 issues (1 yr)
(Canada, other countries \$6.97)

**SAVE \$2.00 off regular subscription
\$2.15 off newsstand rate**

CREDIT CARD OWNERS

12 issues (2 yrs) \$11.50
(Only this offer is available.)

**SAVE \$4.40 off regular subscription
\$4.70 off newsstand**

(Canada, other countries \$13.50)

Credit Card # _____



Expiration Date: _____

Signature _____

Allow 6 to 8 weeks for delivery of your first issue



NO POSTAGE
NECESSARY
IF MAILED
IN THE
UNITED STATES

BUSINESS REPLY MAIL

FIRST CLASS Permit No. 1050 New York, N.Y.

POSTAGE WILL BE PAID BY

hi-fi/stereo

BUYERS' GUIDE

READER SERVICE DIVISION
BOX # 1849 GPO,
NEW YORK, N.Y. 10001



MAY/JUNE, 1980

Void after October 23, 1980

Yes!

Please send me **FREE** additional
information on products circled below. Limit is 10

Name _____

Address _____

City _____ State _____ Zip _____ **HOE127**

FREE AUDIO INFORMATION - Please Circle Numbers Carefully

1	2	3	4	5	6	7	8	9	10	11	12	13	14	15
16	17	18	19	20	21	22	23	24	25	26	27	28	29	30
31	32	33	34	35	36	37	38	39	40	41	42	43	44	45
46	47	48	49	50	51	52	53	54	55	56	57	58	59	60
61	62	63	64	65	66	67	68	69	70	71	72	73	74	75
76	77	78	79	80	81	82	83	84	85	86	87	88	89	90
91	92	93	94	95	96	97	98	99	100	101	102	103	104	105
106	107	108	109	110	111	112	113	114	115	116	117	118	119	120
121	122	123	124	125	126	127	128	129	130	131	132	133	134	135
136	137	138	139	140	141	142	143	144	145	146	147	148	149	150

Do you currently have an auto high-fidelity
system in your car? YES NO

What is the receiver brand? _____ Price? _____

What is the loudspeaker brand? _____ Price? _____

Complete Here To Subscribe To
hi-fi/stereo
BUYERS' GUIDE

250

Enclosed is \$5.95 for 6 issues (1 yr)
(Canada, other countries \$6.97)

**SAVE \$2.00 off regular subscription
\$2.15 off newsstand rate**

CREDIT CARD OWNERS

12 issues (2 yrs) \$11.50
(Only this offer is available.)

**SAVE \$4.40 off regular subscription
\$4.70 off newsstand**

(Canada, other countries \$13.50)

Credit Card # _____



Expiration Date: _____

Signature _____

Allow 6 to 8 weeks for delivery of your first issue

If you
wish to
subscribe
to

HI-FI/STEREO BUYERS' GUIDE

Check the box in the
shaded area; place
the card with
payment in an
envelope and mail
to the address shown
on the card.

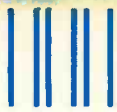

NO POSTAGE
NECESSARY
IF MAILED
IN THE
UNITED STATES

BUSINESS REPLY MAIL

FIRST CLASS Permit No. 1050 New York, N.Y.

POSTAGE WILL BE PAID BY

hi-fi/stereo

BUYERS' GUIDE

READER SERVICE DIVISION
BOX # 1849 GPO,
NEW YORK, N.Y. 10001



AUDIO INFO GUIDE

FREE AUDIO
INFORMATION
— a free service to all
readers of

HI-FI/STEREO BUYERS' GUIDE

who want more
information on
products advertised
in this issue.

For useful
information to help
you make your
buying decisions,
tear out the
perforated card,
carefully print your
name and address
(and zip), then circle
the numbers
corresponding to the
numbers below the
advertisements or
new products that
interest you. No
postage, no charge
at all — for your
convenience and
information.

HI-FI/STEREO BUYERS' GUIDE

— the one magazine
read by the world's
most demanding hi-
fidelity buyers. Now
published six times a
year.



MAY/JUNE, 1980

Void after October 23, 1980

Yes! Please send me **FREE** additional
information on products circled below. Limit is 10

Name _____

Address _____

City _____ State _____ Zip _____

HOE127

FREE AUDIO INFORMATION — Please Circle Numbers Carefully

1	2	3	4	5	6	7	8	9	10	11	12	13	14	15
16	17	18	19	20	21	22	23	24	25	26	27	28	29	30
31	32	33	34	35	36	37	38	39	40	41	42	43	44	45
46	47	48	49	50	51	52	53	54	55	56	57	58	59	60
61	62	63	64	65	66	67	68	69	70	71	72	73	74	75
76	77	78	79	80	81	82	83	84	85	86	87	88	89	90
91	92	93	94	95	96	97	98	99	100	101	102	103	104	105
106	107	108	109	110	111	112	113	114	115	116	117	118	119	120
121	122	123	124	125	126	127	128	129	130	131	132	133	134	135
136	137	138	139	140	141	142	143	144	145	146	147	148	149	150

What cassette deck do you currently own?

Brand _____ Model _____

Which tape(s) do you use with it?

Brand & Type _____ 45 min. 60 min.

Brand & Type _____ 90 min. 120 min.

Complete Here To Subscribe To
hi-fi/stereo
BUYERS' GUIDE

250
 Enclosed is \$5.95 for 6 issues (1 yr)
(Canada, other countries \$6.97)

**SAVE \$2.00 off regular subscription
\$2.15 off newsstand rate**

CREDIT CARD OWNERS

12 issues (2 yrs) \$11.50
(Only this offer is available.)

**SAVE \$4.40 off regular subscription
\$4.70 off newsstand**
(Canada, other countries \$13.50)

Credit Card # VISA MC

Expiration Date: _____

Signature _____

Allow 6 to 8 weeks for delivery of your first issue



NO POSTAGE
NECESSARY
IF MAILED
IN THE
UNITED STATES

BUSINESS REPLY MAIL

FIRST CLASS Permit No. 1050 New York, N.Y.

POSTAGE WILL BE PAID BY

hi-fi/stereo

BUYERS' GUIDE

READER SERVICE DIVISION
BOX # 1849 GPO,
NEW YORK, N.Y. 10001



INTEGRATED AMPS

SAE "TWO" A7 70-WATT INTEGRATED AMPLIFIER \$400

Circle No. 88 On Reader Service Card



The SAE "TWO" A7 is FTC rated at 70 watts per channel into 8 ohms at less than 0.05% THD from 20 Hz to 20 kHz, this amplifier has an unusually accurate fluorescent bar-graph meter that can be switched to measure either output power or the line level fed to the tape recorders. Direct connections are provided for a signal processor that can be switched between the amplifier itself and the tape recorder outputs. Care must be taken to keep the shield wires from the phono pickup

separate because of a ground loop hum when the shields are "common." The A7 has separate bass, midband and treble controls plus a tone-control defeat and a subsonic filter. Other features include: automatic copy between two recorders, automatic speaker protection against transients, automatic muting of unwanted "thumps" and "pops," and break-in connections between the preamplifier output and amplifier input.

INPUTS

- Two magnetic phono
- Tuner
- Auxiliary
- Two tape
- External signal processor
- Main amplifier

OUTPUTS

- Two speaker systems
- Two tape
- Headphones
- External signal processor
- Preamplifier

CONTROLS

- Volume
- Balance
- Ganged bass
- Ganged midband
- Ganged treble

SWITCHES

- Power
- Input selection
- Tone control defeat
- Tape monitor selection
- Tape copy selection
- External signal processor to line/tape

- Stereo/mono modes
- Bar graph display for output/tape
- Low filter
- Loudness compensation
- 20 dB audio mute
- Speaker selection

DIMENSIONS

- Width: 18.25 inches
- Height: 5.25 inches
- Depth: 13.8 inches
- Weight: 28 pounds

AMPLIFIER PERFORMANCE

With both channels driven to the clipping level into an 8-ohm load from 20 to 20,000 Hertz:

Power output	73.8 watts RMS
Frequency response at 73.8 watts RMS	+0/-0 dB
Total harmonic distortion at 73.8 watts RMS	0.02%
Tone control range at 50 Hz	±14 dB
Tone control range at 1000 Hz	±10 dB
Tone control range at 10 kHz	+9/-10 dB
Subsonic filter 20 Hz attenuation	5.0 dB
Hum and noise—magnetic input (3 Mv in, 10 watts out)	-73 dB
Stereo separation—magnetic input	60 dB
Power meter accuracy at calibrations	Perfect
Power meter frequency response accurate within range of each step from	20 to 20 kHz



HI-FI JARGON: Dynamic Range

The dynamic range of a program is the ratio of the power of the strongest section to the power of the weakest section expressed in decibels. The dynamic range of a piece of equipment refers to the program dynamic range it can handle, and so it is synonymous with the signal-to-noise ratio when the reference signal is the maximum output capability of that piece of equipment. The dynamic range of a live program can easily exceed the dynamic range of many components.

TURNTABLES



DENON DP-30L DIRECT-DRIVE TURNTABLE \$290

Circle No. 135 On Reader Service Card

The Denon DP-30L is an electronically controlled direct drive two speed (33, 45 rpm) record player complete with integral base and dust cover; the pickup is provided by the user. Overall performance is exceptionally good: high performance pickups seem to deliver a "little bit extra," and resistance to external shock and vibration is unusually high, even at low tracking forces. No stylus overhang gauge is provided; the user must make the adjustment using a ruler, which can lead to stylus damage. (There is really no good reason why a record player of this quality and price is not provided with an overhang gauge, which costs a few pennies, at

most.) There are controls for main power, 33/start, 45/start, speed adjust (pitch) and stop. 33 and 45 full-time illuminated strobes are provided. The tonearm is manually positioned on the record. At the end of play an optical sensor causes the tonearm to lift and motor to stop. Alternately, pressing stop during play will cause the tonearm to lift and the motor to stop. Pressing a speed selector control restarts the motor and lowers the tonearm. The tonearm has a micro-adjust counterweight that also serves as an 0-3 gram VTF calibrated in 0.1 gram increments. There is a calibrated anti-skate. The pickup mounts in a universal shell.

DIMENSIONS

- Width: 17.75 inches
- Height: 5.0 inches
- Depth: 15.75 inches
- Weight: 20.9 pounds

CONTROLS

- Power
- 33/Start
- 45/Start
- Stop
- Speed adjustment

PERFORMANCE

Line voltage immunity (90 to 140 volts)	Total
Pitch control range at 33 rpm	+5%
Pitch control range at 45 rpm	+8/-6%
Wow and flutter (average)	0.04%
Wow and flutter (peak)	0.1%
Tracking force calibration accurate to	0.1 grams
Output cable capacitance	60 pF



HI-FI JARGON: Power

Power is the amount of electrical energy delivered to the "load" (speaker) per unit time. It is measured in "watts." The rated power of an amplifier indicates the *maximum* power that the amplifier is capable of delivering to a given load impedance (usually 8 ohms) over a stated bandwidth (usually 20 Hz to 20,000 Hz) at a specified total-harmonic distortion (THD) for example, 0.1%. Thus an amplifier may be rated to deliver 100 watts per channel from 20 Hz to 20 kHz into an 8-ohm load at less than 0.1% THD.

The fact that the amplifier carries a 100-watt rating does not mean that it is always delivering 100 watts per channel. At any given time, the power being delivered depends upon the musical signal strength. However, if the signal strength requires more than 100 watts at a particular instant in time, our hypothetical amplifier would not be capable of supplying it without excessive distortion.

With most solid-state amplifiers, the power capability depends upon the load impedance. More power can be supplied into a 4-ohm load than into an 8-ohm load and less-than-rated power is available into a 16-ohm load. While this suggests that a low speaker impedance would improve the power rating of an amplifier, there is a minimum safe load (usually 4 ohms) which the amplifier can handle. If the load is less than this amount, the amplifier's protective circuitry may be triggered on loud passages producing gross distortion.

TURNTABLES

SCOTT PS-18 SEMI-AUTOMATIC TURNTABLE \$130



Circle No. 90 On Reader Service Card

The Scott PS-18 is a belt-driven two-speed (33, 45 rpm) semi-automatic record player complete with factory installed pickup. Overall performance and sound quality is about average for the price, though the system is sensitive to external shock and vibration. The motor starts when the tonearm is moved off its rest. At the end of play the tonearm recycles to the rest and the motor turns off. The tonearm has a micro-adjust counterweight that serves as an 0.4 gram VTF (Vertical Tracking Force) adjustment calibrated in 0.5 gram increments. There is a calibrated anti-skate. The pickup,

rated for 1.5 to 3 grams VTF, is factory installed in a fixed headshell. The stylus overhang gauge is a reference mark on the shell, which isn't sufficiently accurate for user-installed pickups. The tonearm rest has a positive user-applied lock that prevents accidental displacement of the tonearm from its rest, which might result in stylus damage. The PS-18 we tested was from the first production run at the factory. Subsequent units are to be delivered with a universal headshell mount to give the user more flexibility in cartridge selection and easier installation.

DIMENSIONS

- Width: 17.25 inches
- Height: 5.5 inches
- Depth: 13.75 inches
- Weight: 15 pounds.

CONTROLS

- Speed select
- Reject
- Tonearm lift
- Anti-skate
- Vertical Tracking Force

TURNTABLE PERFORMANCE

Line voltage immunity (90 to 140 volts)	Total
Wow and flutter (average)	0.07%
Wow and flutter (peak)	0.1%
Tracking force calibration accurate to	0.25 grams
Output cable capacitance	150 pF

PICKUP PERFORMANCE

Frequency response limits	+5/-1 dB
Frequency response range	20 to 20,000 Hz
Channel balance	1 dB
Stereo separation at 1,000 Hz (worst case)	20 dB
Stereo separation at 15,000 Hz (worst case)	15 dB



HOW WE TEST: FM Sensitivity

Though the generally accepted reference level for FM tuner sensitivity is 50 dB of quieting, in actual fact 50 dB is an artificial value that is not universally accepted as adequate for hi-fi in any other type of equipment. The 50 dB value only serves to provide artificially high sensitivity values. The HFSBG uses 55 dB quieting for stereo, 60 dB for mono, because these are the minimum accepted values for overall system performance of all other equipments: tape and cassette decks, and amplifiers.

This more stringent test results in our sensitivity values being higher (not as sensitive) than those of the tuner manufacturer.

HI-FI JARGON: Dynamic Range

The dynamic range of a program is the ratio of the power of the strongest section to the power of the weakest section expressed in decibels. The dynamic range of a piece of equipment refers to the program dynamic range it can handle, and so it is synonymous with the signal-to-noise ratio when the reference signal is the maximum output capability of that piece of equipment. The dynamic range of a live program can easily exceed the dynamic range of many components.

CASSETTE DECKS



DUAL C 830 STEREO CASSETTE DECK \$499

Circle No. 27 On Reader Service Card

The Dual C 830 is a machine that not only handles ferric, chrome, ferrichrome and metal tapes, it has two values of bias for both ferric and chrome tapes, thereby providing an optimum bias match for all commonly used formulations. Though it has a three-head system with simultaneous record-play, there is no simultaneous Dolby decoder; the simultaneous monitor exactly reproduces the recorded sound. (The Dolby decoder is active only in the play mode.) A record limiter cuts in at 0-dB record level with a fast attack and release,

thereby protecting against unsuspected excessive signal peaks. The record level indicator is not frequency compensated and indicates the true peak value after record preemphasis is applied. The 12-step LED record level indicator is very easy to read. The C 830 has a direct-access front loading mechanism, automatic stop at the end of play and a memory reset counter. It also features adjustable headphone volume, microphone/line input mixing and fade-erase during playback. Comes in a metal cabinet.

INPUTS

- Microphones
- Line

OUTPUTS

- Line
- Headphones

CONTROLS

- Concentric-clutched microphone level
- Concentric-clutched line level
- Headphone volume

SWITCHES

- Power
- Tape type
- Input selection
- Dolby on-off
- MPX filter
- Tape/source monitor
- Fade Edit on-off
- Fade Edit safety interlock
- Counter reset
- Counter memory on-off
- Level indicator on-off

TAPE MECHANISM CONTROLS

- Record interlock
- Rewind
- Play
- Fast forward
- Pause
- Stop

DIMENSIONS

- Width: 17.2 inches
- Height: 5.9 inches
- Depth: 14.2 inches
- Weight: 20 pounds

RECORD/PLAYBACK TAPE PERFORMANCE	Tape Type	Dolby on/off	Frequency Range		Signal Level in dB		Frequency Response			
			Max.	Min.	THD at meter indicated 0-VU level	Headroom to 3% THD	Signal to Noise Ratio	Wide-band	Narrow band	
										40-15k
Maxell UD/XLI	F	off	40-15k	+0.5	-3.0	1.8%	5 dB	50 dB	—	KEY F Ferric C Chrome R Ferrichrome M Metal
Maxell UD/XLI	F	on	40-15k	+0.5	-3.0	1.8%	5 dB	55 dB	59 dB	
Sony FeCr	R	on	40-15k	+1.5	-3.0	1.6%	4 dB	56 dB	62 dB	
TDK-SA	C	on	40-15k	+1.5	-3.5	2.5%	1 dB	55 dB	60 dB	
Scotch Metafine at 0-dB record level	M	on	40-9k	+0	-3.0	1.6%	5 dB	50 dB	62 dB	
Scotch Metafine at -20 dB record level	M	on	40-15k	+0	-1.0	—	—	—	—	

PERFORMANCE

Playback frequency response from standard test tape with a 40 to 12,500 Hz range +0/-3 dB
 Output level corresponding to 0 VU level 600 mV
 Wow and flutter (average) 0.1%
 Wow and flutter (peaks to) 0.1%



CASSETTE DECKS

SANSUI SC-1330 STEREO CASSETTE DECK \$320

Circle No. 89 On Reader Service Card

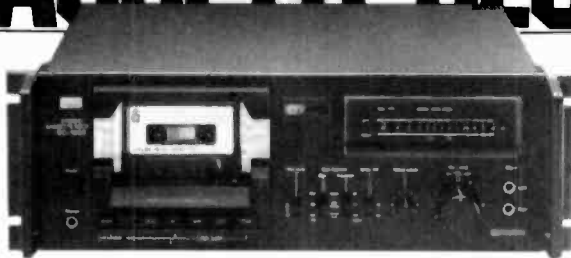

A metal tape compatible Dolby cassette deck with direct cassette loading and a record level indicator with an almost instantaneous peak rise and moderate decay. An unusual feature is automatic wind past the leader at the touch of a button. A record mute disables the input signal while the tape drives, allowing removal of unwanted sounds while recording. The fluorescent bar-

graph record level meter is referenced to 0 dB, representing the signal peaks, rather than the more common 0-VU, though 0-VU is also indicated on the indicator scale. There are selectors for Normal, CrO₂, FeCr and metal tape bias and equalization. Other features include: end of tape stop/disengage, optional timer controlled start or record, reset counter, and record mute.

INPUTS

- Microphones
- Line

OUTPUTS

- Line
- Headphones

CONTROLS

- Concentric-clutched L & R record level
- Ganged L & R output level

SWITCHES

- Power
- Record mute
- Bias selection
- Equalization selection
- Dolby on-off
- Counter reset

TAPE MECHANISM CONTROLS

- Record interlock
- Rewind
- Fast Forward

- Forward
- Stop
- Pause
- Wind past leader

DIMENSIONS

- Length: 17 inches
- Height: 6.4 inches
- Depth: 12 inches
- Weight: 15.1 pounds

RECORD/PLAYBACK TAPE PERFORMANCE	Frequency Response									
	Tape Type	Dolby on/off	Frequency Range in Hz		Signal Level in dB		THD at meter indicated 0-VU level	Headroom to 3% THD	Signal to Noise Ratio	
			Max.	Min.	Min.	Max.			Wide-band	Narrow band
TDK-AD	F	off	20-15k	+1	-2	2.2%	1 dB	52 dB	—	—
TDK-AD	F	on	20-15k	+0.6	-3	2.2%	1 dB	56 dB	65 dB	—
Sony Duad	R	on	20-15k	+1	-3	2.5%	1 dB	55 dB	64 dB	—
Maxell UD/XL II	C	on	20-8k	+0	-3	1.2%	4 dB	57 dB	64 dB	—
TDK-MA at 0-dB	M	on	20-9k	+0	-3	1.5%	3 dB	58 dB	64 dB	—
TDK-MA at -20 dB	M	on	20-15k	+0	-3	—	—	—	—	—

KEY
F = Ferric
C = Chrome
R = Ferrichrome
M = Metal

PERFORMANCE

Playback frequency response from standard

test tape with a 40 to 12,500 Hz range. +1.5/-3 dB

Output level corresponding to 0 VU level (max.) 0.5 V.

Wow and flutter (average) 0.08%



HOW WE TEST: Cassette decks

Cassette decks are tested with the type or brand of tape specified by the manufacturer. When the manufacturer specifies only a generic type, or several brands, we test the machine with a wide assortment of tapes, presenting the values for the tape that gives the best overall results at the lowest possible cost.

Since it is common practice for the user to use the meter indicated 0-VU or 0-dB as the maximum record level, we utilize this value as the maximum record reference for all tests, even when there is considerable headroom above 0-VU. This is because the tape you use might not have the same amount of headroom, and it is almost impossible to provide accurate 0-VU or 0-dB maximum record level "correction values" for each type of tape.

To avoid erroneous test values caused by variations in tape formulations, machines are tested with the tapes available in high fidelity stores at the time the tests are made. We do not use "last years'" tapes, or experimental samples.

CASSETTE DECKS

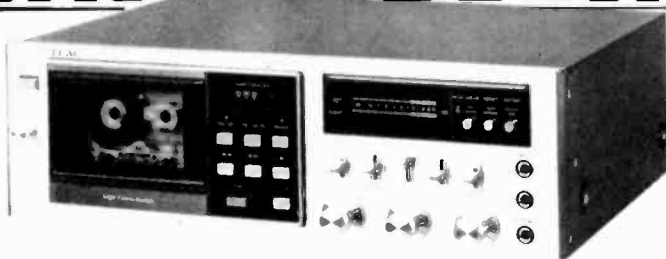

TEAC A-510 MK II STEREO CASSETTE DECK \$475

Circle No. 10 On Reader Service Card

An outstanding feature of the TEAC A-510 Mk II is a peak-indicating bar-graph record level indicator with both instantaneous and peak-hold modes. The peak-hold can be programmed to automatically reset after a few seconds, or maintain its value until manually reset. A pre-wired socket allows full-feature remote control with a plug in remote controller. Unit can be timer started in either the record or play mode. It has bias and equalization selectors for normal, high-bias

(chrome) and meta. tapes and a Dolby noise reduction system. The TEAC A-510 Mk II also has some useful taping controls: a record mute that can be used while the tape is driving, and a "flying start" record switch that allows you to switch to the record mode while the tape is in the play mode. There is also an end-of-tape-stop feature, memory reset counter and timer-controlled record/play to provide maximum operator convenience. Comes in a metal cabinet.

INPUTS

- Microphones
- Line

OUTPUTS

- Headphones

CONTROLS

- Friction-locked belt driven L & R record level
- Ganged output level

SWITCHES

- Power
- Timer control function
- Bias selection
- Equalization selection
- Dolby/mpx filter on-off
- Input selection
- Record level meter peak hold on-off
- Record meter auto/manual peak reading reset
- Record level meter brightness (hi/lo)
- Counter memory on-off
- Counter reset

TAPE MECHANISM CONTROLS

- Record interlock
- Start
- Play
- Rewind
- Fast Forward
- Pause
- Record mute
- Stop
- Eject

DIMENSIONS

- Width 17.3 inches
- Height: 5.8 inches
- Depth: 13.5 inches
- Weight: 20 pounds.

RECORD/PLAYBACK TAPE PERFORMANCE	Tape Type	Dolby on/off	Frequency Response							
			Frequency Range in Hz		Signal Level in dB		THD at meter indicated 0-VU level	Headroom to 3% THD	Signal to Noise Ratio	
			Max.	Min.	Max.	Min.				Wide-band
Maxell UD/XLI	F	off	30-14k	+1.8	-3.0	0.09%	8 dB	50 dB	—	KEY F = Ferric C = Chrome R = Ferrichrome M = Metal
Maxell UD/XLI	F	on	30-12.5k	+1.8	-3.0	0.04%	8 dB	54 dB	60 dB	
TDK-SA	C	on	30-14.5k	+0.5	-3.0	1.3%	4 dB	57 dB	63 dB	
Scotch Metafine at 0-dB record level	M	on	30-10k	+1.0	-3.0	1.2%	5 dB	57 dB	63 dB	
Scotch Metafine at -20 dB record level	M	on	30-10k	+3.0	-3.0	—	—	—	—	

PERFORMANCE

Playback frequency response from standard test tape with a 40 to 12,500 Hz range +0.1/-2.2 dB
 Output level corresponding to 0 VU level . . . max. 500 mV
 Wow and flutter (average) 0.06%
 Wow and flutter (peaks to) 0.1%



take on a much more involved and multi-faceted appearance than found in the acting of other interpreters. One of her best roles on disc—in which Domingo was again her equal—is Cilea's *Adriana Lecouvreur* (Col. M3-34588). The music is *echt-verismo* and pure Italian. Many decry it as trash; I think of it as inspirationally theatrical. And certainly Miss Scotto in her interpretation raises the opera far above itself. One can believe in Adriana as an actress with Scotto in the role, and each of Cilea's melodies pours forth with expression and vivacity.

For all of her variety in repertory, the Italian soprano came to world fame with *Madama Butterfly*, which she has sung everywhere. Her original recording was made with Sir John Barbirolli; recently, she made a new *Butterfly* with Lorin Maazel conducting (Col. M3-35181). The only weakness in the set, in which she is joined by Domingo in superb voice, is Maazel, whose tempos are painfully slow. Miss Scotto brings to *Butterfly* her years of familiarity with the score. Every phrase is considered but sounds natural. A heart wrenching performance, it bursts with passion and emotion in every line. Few performances have the grasp of any character that Miss Scotto brings to her Desdemona in *Otello*. She is Boito's creation—a pure, fragile, unknowing woman, utterly innocent about the thinking processes that could cause Iago to poison *Otello* or that would make her husband believe her as an adulteress. She is an extraordinary singer with countless numbers of interesting albums ahead.

While Miss Scotto and Domingo are often associated, two other artists who have been profiled have also recorded abundantly together, Dame Joan Sutherland and Luciano Pavarotti. Despite the fact that she has few recent recordings, Miss Sutherland's voice, as her two recent concerts televised live from Lincoln Center showed, has much of its original weight and accuracy, and her high E-flat is miraculously secure. Her last opera recording, Donizetti's *Lucrezia Borgia* (London 13129), did not show her in best form. Intermittently, she was slightly out of voice and a little strained, but there

were still wonderful flashes of power and general control. The most interesting of her recent recordings is "Sutherland Sings Wagner" (London 26612), her first essay of the German composer's work since she forsaked heavy repertory in the late 50s. The Australian soprano has always been a miraculous coloratura because of the sheer weight of her voice; this Wagner record shows unsurprisingly that she can sing the composer's lighter soprano line with ease. What is amazing however, is the amount of passion and radiance she brings to Elisabeth, to Eva and to Elsa. Though her voice shows a slight shake in the most sustained passages, it's wonderful to hear every note sung so accurately.

About Pavarotti, much can be said. He is *the* media singer of the age, surpassing even Beverly Sills in his instant, enormous appeal. Pavarotti's name on a record—a new recording or rerun of arias or songs recorded three times before—causes instant buyer mania. His personality—a joyous teddy bear hungering for love—has caught the opera lover as no singer has since Caruso. But he is not a media creation as has sometimes been charged. He has won his popularity by his personality, his art and the hard work of singing recitals throughout the country. On records the best and most troublesome sides of his artistry can be found. His recital programs tend to be quite narrow, but on records his selection of works is narrower still. All of the albums are compendiums of his favorite songs with soupy orchestral accompaniment. His Christmas album "O Holy Night" (London 26473), deservedly popular at Christmas for the last three seasons, is handicapped by the heavy-handed conducting of Kurt Herbert Adler and his "O Sole Mio," (London 26560), which is one of the most popular classical records of all time, has much less than ideal leadership and worse orchestration. In the latter record, however, Pavarotti's lyric tenor sounds forth in rich and pure estate. On many of his recent opera albums, while he sings well, he shows that he has deliberately lost the unique virtue of being the first light lyric tenor in the

world in favor of becoming a heavy lyric who is only one among several. His *Tosca* (London D-12113) and *Cavalleria Rusticana* and *Pagliacci* (London D-13125) are splendid examples of good singing but not equal in superiority to many other pressings of the opera. His tenor is light and effervescent; because it is such an amazingly expressive, personal instrument, it can be made to sing heavier music with point and sufficient power. But to do so Pavarotti often sounds slightly forced and distorts his true vocal character. He is, however, determined to push deeper and deeper into heavy territory.

Régine Crespin has issued many noteworthy albums, her latest being Massenet's *Don Quichotte*. (London 13134). The character of Dulcineé—a courtesan rich in the joys of the sensual who finds the pure love of Don Quixote almost inconceivable, then rewarding—is perfect for the French soprano. She caresses the language and the line with the pure sound and burning sensuality of her voice in rare form. It's a splendid recording all round, with Nicolai Ghiaurov as a superb Quichotte, Gabriel Bacquier a satisfying, artistic Sancho Panza and Kazimierz Kurd a fine conductor.

Another of those profiled has added a capstone to an extraordinary career: Jon Vickers. Philips has now given opera lovers a superb version of Britten's classic (6769014), with Vickers as Peter Grimes. The desolation and agony of Grimes as well as his physical strength and power are completely captured by the tenor. Colin Davis mirrors the artists' performance in seascapes of shattering beauty. It is a wonderful recording of one of the best contemporary operas.

Maria Callas's untimely passing in September 1977 and the retirement of Franco Corelli from the stage brought a sense of loss to opera lovers all over; it is only comforting to know that their brilliant careers will always be with us on disc, as will the artistry of all the bright and promising musicians who have dedicated their lives to the wondrous rich music of opera. ▲

POP DISCS

(Continued from page 16)

Various Artists: "Broadway Magic." Columbia. \$7.98.

This is the Broadway musical album for people who never buy Broadway musical albums. It contains the good stuff and eliminates the filler. Included are "Tonight" from *West Side Story*

(not much filler in that show), "What I Did For Love" from *A Chorus Line* and "Tomorrow" from *Annie*.

Jorma Kaukonen: "Jorma." RCA. \$7.98.

There's nary a drum whack or bass thump to be found on this truly "solo"

solo album by the former Hot Tuna/Jefferson Airplane guitarist. Non-commercial to be sure, this is prime stuff for guitar aficionados. Jorma picks and strums both acoustic and electric instruments.

(Continued on page 71)

watts per channel.

Alpine Electronics of America is a newcomer to the United States car stereo scene under the Alpine designation, but an old-timer relative to sale of its products in the U.S.—under other brand names, such as Motorola. The company showed its current line of 18 radio/cassette combinations and straight cassette players, along with six accessory equalizers and amps, plus five three-way speaker systems. Highlight of the line is the recently-announced Model 7308, priced at \$700. It offers 6 watts per channel output RMS into four channels, Dolby, metal/chrome/ferro-chrome switch, automatic replay at the end of rewind, and electronically activated feather-touch controls. Main features are digital phase-lock-loop frequency synthesizer, digital station readout and tape counter, a 5 FM/5 AM pre-set memory system, automatic seek and scan, and music sensor system that scans a tape for the start of a new song, and a unique cassette loading system that pulls the cassette into playing position then locks it against the tape head.

The Alpine line is notable for an absence of cartridge players. This is but another indication of the decline of the cartridge as an auto/home music program source. Other aspects of the line, reflecting current trends, include metal tape capability in several models, outputs as high as 20 watts per channel RMS, ignition-off-eject, power antenna leads, and auto-reverse.

Blaupunkt, famous in other parts of the world as a major car stereo supplier, is making a bid for a share of the American auto sound market. A Sendust tape head for playing metal tapes is used in two of its new cassette/radio offerings. One is the CR4000 at \$344, featuring 4 by 7-watt RMS amplifier as part of the radio, as well as outputs for attaching a 4 by 15 watt amplifier. The other is the CR5001, priced at \$450, that utilizes a separate 4 by 15 watt amplifier included in the ensemble. Both have a 70-microsecond setting for metal tape. The 5001 has digital station readout, with adjustable brightness.

New Jargon. Concord added a new technological term to car stereo at the show. It is "Dynamic Compliance," a feature (patent pending) incorporated in two new Concord power amps, the 20-wpc-into-4-ohms Model HPA-45 at \$149.95, and the \$350 HPA-70 rated at 50 watts per channel into 4 ohms, with less than 0.06 and 0.05 per cent distortion, respectively. Here's how Concord describes and explains Dynamic Compliance:

"... a major technological advance

in attaining the goal of significantly better high fidelity sound. In the amplifiers with Dynamic Compliance circuitry, a transducer is included in the amplifiers' output circuit to measure the acoustic performance of the speaker cone in the speaker system and feed back the information to the amplifier which automatically increases output levels to compensate for deficiencies in speaker performance. The result is significantly smoother, clearer and wider range sound. The Dynamic Compliance system is in effect an infinite band automatic equalizer which analyzes actual speaker performance based on environmental conditions in the listening area and dramatically improves the speaker performance and the sound."

Concord also introduced three in-dash AM/FM stereo cassette models. All three feature Dolby and metal tape capability. Model HPL-120 at \$400 has a dual gate MOS FET front end with digital station readouts and quartz clock circuitry, and built-in selective bass equalization with equalizer level control. HPL-115 at \$350 has a MOS FET front end with analog tuning, and bass equalizer. Both have power outputs of 12 watts per channel into 4 ohms with less than 0.8 per cent THD. The HPL-515 at \$450 has digital station/time readouts, built-in bass and treble equalizers with equalizer level controls, bi-amplifier capability with built-in 12-wpc amp used to drive mid-range/tweeters, and external amp to drive woofers, and variable speed control to handle tapes recorded at less-than-true-speed.

Another new term surfaced at the show. It was ATSC—for Automatic Tape Slack Canceller. This feature appears in two in-dash auto-reverse radio/cassette models from Pioneer Electronics, the KP-4500 and KP-4502, priced at \$160 and \$200 respectively. This feature was designed to end tape jamming, consequence of the take-up and rewind reels spinning in different directions before the tape engages in the play mode.

Sanyo is responsible for three new technological terms and the features they represent, manifest in its new FI9 AM/FM cassette combination whose price was not available at presstime. SMC—for Soft Muting Circuit, replaces conventional muting circuits. Conventional muting switches the audio signal off completely when signal strength falls below a threshold value. This can cause a staccato on/off effect with rapid fluctuations of signal strength. Below its threshold, Sanyo's SMC gradually reduces volume in direct proportion to signal strength level. The small changes in volume are usually inaudible, and

less irritating than sharp on/off fluctuations.

SNC—for Stereo Noise Control, gradually reduces stereo separation as the signal grows weaker. Because mono FM signals are less susceptible to noise than FM stereo signals, most FM tuners switch to mono below a certain signal strength threshold. SNC replaces this audible sudden switching with a virtually inaudible gradual reduction in stereo separation.

Since FM noise consists mainly of high frequency hiss, Sanyo developed ATQC—for Automatic Tone Quality Control. This system gradually cuts high frequency response in the presence of weak, noisy signals. When signal strength and quality return, ATQC increases high end response to its normal, flat characteristic.

Among new equalizer products introduced at the Winter CES was an 18-control, nine-band graphic equalizer/preamp from Zeff Advanced Products. It comes in a die-cast housing with bracket for mounting in any convenient spot in any kind of a vehicle. Tagged PEQ, it features a high slew rate of 13 v/microsecond, a rating said to be "strictly according to FTC home hi-fi standards." It measures 1½ by 4¼ by 8¾ inches. The unit will sell in the \$220 to \$250 range.

Another new model, a graphic equalizer/amp from AFCO Electronics, the PB-40E, features nine controls for nine frequency ranges. It uses five LEDs per side for power level indication. Output is 15 watts per channel RMS into four ohms. It is styled like a home audio component, with "pro" side handles, and measures 5¼ by 1¼ by 6¼ inches. It will sell in the \$90 to \$100 range.

A third unit, an equalizer/amp reflects some of the miniaturization steadily taking place in car stereo products. It is the EQL5200 from Car-Fi International, priced at about \$100. It measures 1½ by 5 by 1½ inches, and contains five frequency bands with 10 LED readouts. It can be mounted in, on, or under the dash.

Among Jensen's product introductions were two graphic equalizers. The EQ-400 is a 15-band model with separate controls for five primary frequency bands, each with three detent positions spaced a half octave apart for precise frequency turnover selection. It is designed for two or four-speaker operation. Price, \$130. The EQA-3000, priced at \$180 is a five-band model with five slide controls and a total combined power output of 24 watts, for two or four-speaker systems. Mounting brackets on each model allow installation under dash or on the floorboard

hump. When mounted under the dash, the units tilt out and down for easy use. They can be stored with a slight push virtually out of sight under the dash.

Concentric controls are used in a new five-band equalizer/preamp from Magtone Electronics, the MGT 4100 at \$240. Additional features include selector switch, balance control, and left/right LED inputs level indicators, five for each channel. It is styled with "pro" handles and measures 8 by 1½ by 4¼ inches.

A new equalizer/booster from Sparkomatic features seven bands of equalization controlled by sliders, and a series of 12 LEDs per channel in three colors to show power levels. It has 50 watts output per channel RMS at 0.01 per cent distortion. It measures 7½ by 2½ by 9¼ inches. It has a protective relay circuit so power is applied gradually to protect speakers. Price, approximately \$180.

What will *eventually* become a trend in car stereo is graphic equalizers built into radio/players. That's the word from companies that have such equipment, from those who debuted such equipment at the Winter CES, as well as others who intend to have it shortly. Latest, among others, are examples from Boman, a company that introduced two-in-dash models at \$180, one a cassette/radio (SS-1500), the other a cartridge/radio combination (SS-1300). The equalizer segment contains five bands, at 60 and 250 Hz, and 1, 3.5 and 10 kHz control points. A spec sheet describing the two models indicates the power output as: "20 watts per channel @ 10 per cent distortion, maximum power 50 watts, 25 per channel @ 4 ohm."

Grundig's new GCM-9200 at \$369

also features built-in equalization, related to three frequency ranges—100 Hz, 1 kHz and 8 kHz, and using slide controls. This set also features Dolby, automatic reversing, metal tape capability, automatic stereo sensitivity switching, LED tuning dial indicator, and external four-channel amp with 15 watts per channel output at 10 per cent THD.

Lacor International, a newcomer to the America car stereo scene, showed a cassette/radio with built-in graphic equalization. It is the "Audio Flair" Model 4495, priced at \$220. The five-band unit has 20 watts per channel output.

In car stereo amplifiers, the trends are toward models with switchable outputs to accommodate two or four-speaker system installations, better distortion specs, and better heat sinking for long-period, high power operation.

To the best of our knowledge, the only other really new development in amplifier technology came from Sony in the form of its new XM-1 power amp priced at \$300. It is said to be "the world's first digital power amplifier for the car." Using the company's "Pulse Width Modulation" system, it generates 70 watts of power, using a current draw of 8 amps. THD is rated at 0.18 per cent, and the signal-to-noise ratio is 100 dB.

The growing trend to four channels of amplification in car stereos is pointed up in Craig's latest offering. It is the T687, an AM/FM cassette priced at \$550. It features electronic tuning, digital station and time display, 10 station pre-sets, metal/chrome/ferrichrome tape selection, Dolby, Sendust tape head, auto-reverse, and a reverse push-button that allows changing programs at any point without taking the tape

out of the player. It has four independent power amplifiers with 12.5 watts minimum continuous average power per channel into four ohms from 20 to 20,000 Hz at 1.0 per cent distortion. The unit can be mounted in or under the dash.

Countless speakers and speaker systems were introduced at the Winter Consumer Electronics Show—too numerous to delineate. Essentially, the units reflected trends and concerns prevalent in the industry. One is the concern with miniaturization, manifest in models with slimmer "profiles" for mounting in shallower spaces. The miniaturization was also evident in units of smaller diameter, but capable of producing the sound levels of earlier models of larger size. Such improvements are a consequence of advancing technology, and deeper research on the part of manufacturers into the behavior of speakers in a car environment.

Several companies came out with "separates" systems, i.e. groups of speakers meant to work together as a system installed in a car in two or three different areas. Some systems were made up of tweeters and woofers, others of tweeters, midranges, and woofers.

Another aspect of the trend in car speakers is toward greater efficiency, for greater sound levels for a given amplifier output. Yet another is greater power-handling capability, to prevent speaker "blow-outs" at loud listening levels. Sanyo uses Ferro-fluid in its new SP90 two-way speaker system to improve power handling capability (and transient response) and a cast aluminum frame in its new SP69 6 by 9-inch driver that is thermally coupled to the voice coil assembly and acts as a giant heat sink. ▲

FOR YOU I'VE GOT THIS DEAL

(Continued from page 36)

offer an apparent substantial discount on the turntable/cartridge combination.

Unfortunately, recognition of these inflated list phono cartridges does not come as easily as the identification of "black box" speakers. Most or all of these items bear familiar brand names. The intricate technology required to manufacture these micro-reproducers eliminates the mass-merchandising furniture or food chains from participating. The cartridge manufacturers recognize the necessity of maintaining the dealer's profit in order to assure their own existence.

Beware of that fifty dollar cartridge that is "thrown in" with the deal on your stereo system. You can benefit by paying a mere ten to twenty dollars additional investment and get a true hi-fi, rather than promotional, phono cartridge.

There are three types of phono cartridges. The first is the promotional freebie that is included with the purchase of any turntable. The second, though it may bear the same "list" price as the former, offers exceptional performance for a small additional cost. The third type are about the same mark-up as other audiophile equipment and should be considered separately when purchasing a hi-fi system. These are for the avid hi-fi hobbyist. If you are a neophyte in the stereo jungle, avoid the first category. If you are a sound fanatic, go for the third. Phono cartridges in the middle category represent excellent overall consumer value.

Consult reviews in consumer magazines to see if your cartridge has been reviewed. If it hasn't, you may be looking for that proverbial "needle in a

haystack." Unless you are familiar with the product, confront the dealer. If you let him know that you are aware of the cartridge marketing facts, he will most likely lead you in the right direction.

Electronic components, amps, receivers and tuners, pose a different problem for the consumer. These can be selected on a more objective basis than speakers or phono cartridges. Power, distortion, sensitivity, and selectivity claims are carefully monitored by the Federal Trade Commission. The printed specifications of these components are solid, proven facts. Speakers and phono cartridges, on the other hand, possess those qualities which cannot be written down in black and white. "Uncolored," "open," "sweet," "smooth," and "silky" are intangible, subjective descriptions used to identify a speaker or cartridge.

This sonic variation barely exists among receivers. The difference in performance is clearly spelled out in black and white.

What product line should you pursue? Which is the best? The fact is that they are just about all good. You may have to base your decision on features, cosmetics. (Although this is an unpopular reason for choosing a component, remember, *you* have to look at it day after day. The salesperson doesn't.), circuit protection, or the feel of the controls. Suddenly an objective decision becomes subjective.

Subjectivity is not an undesirable attitude to maintain when evaluating a stereo system. In fact, an equal balance between subjectivity and objectivity will yield the most satisfaction for your money. Here are a few hints that may help you to realize this satisfaction:

Avoid amp/receiver lines that are consistently "blown out" by dealers. Although the product may be good, *its* value and *your* investment are constantly declining. The low prices are not necessarily an indication of inferior quality, but rather, an indication of the manufacturer's marketing philosophy.

Be cautious of the dealer who says that he does not carry a certain product line because "they all blew up," "they're quality has gone downhill since 1972 B.C.," or "the specs are over-rated." The first reason is a lie, (today's electronic components are extremely reliable), (FTC preconditioning tests are rigidly observed since the 1974 court ruling). An audio dealer can't carry every line that is available just as a Ford dealer can't sell a Chevy product. Be wary of the salesperson who tries to sell by berating the product that does not grace his shelves. Listen to the

dealer who sells his product on its own merits.

The best values in the hi-fi market can be found in end-of-year close-outs, demonstration units, and trade-ins.

A manufacturer does not discontinue a particular item due to problems. Models change at the rate of one a year and are no different than the changes in the auto industry. Don't worry about obsolescence. If you buy a 1980 Chrysler this year, it will inevitably be superseded by a 1981 model. The changes are primarily cosmetic, even though the manufacturer may introduce the new version as the embodiment of some major technical breakthrough. Actually, the manufacturer is anxious to get rid of his overstock of "old" models and offers a tremendous savings to the dealer. The dealer is anxious to clear his inventory for the advent of the new, "breakthrough" models and passes an *actual* value onto you.

Many consumers avoid the purchase of demonstration units. *You* shouldn't. Because of rapid model changes, a component rarely remains on the shelf for more than six months. In that six month period, the component receives as much use as an individual would give it in a two week period. Keep in mind that the demo unit you are looking at is only one of many on the dealer's shelves. It is not used exclusively as it would be in your home. Another positive benefit is that you know it works.

Trade-in components represent the "tied-up" profit of the audio dealer. The dealer generally wants to cover his cost when a new component is sold, and wants to turn the trade-in unit as quickly as possible. You pay only for

the mark-up that the dealer is trying to retrieve, rather than a price that includes warranty service, advertising costs, and operating overhead. If you choose to buy a trade-in component, make sure that you ask for a warranty of at least thirty days. Most likely, the dealer will agree to this since trade-in gear is generally checked out before his original deal was made. If he refuses, stay clear.

Finally, observe the treatment that you get at various dealerships. The dealer who spends time with you before you have made your final decision is likely to spend the same time if you should have a problem after the purchase. The dealer who points to the price of an item and then shovels it out the door is likely to do the same thing with you if you should encounter any difficulty with the product.

The audio salesperson is, like yourself, a hobbyist and a consumer. He has had the advantage of massive exposure to products that you might not be aware of. He knows . . . or should know all the technical details. Approach him with friendly skepticism, but not outright cynicism. He can become either your ally on the battlefield of stereo warfare or else a ruthless foe. Don't be an antagonist. That can only serve to thwart your potential "good deal." The arrogant question, "What's *my* price?" may not elicit an immediate response, but may manifest itself later in the form of slow service, or reluctant advice. Cooperate.

Rising costs and inflation have created a consumer who is more vigilant than ever. This is a time when you should be thinking about "what you are getting for your money" rather than "how much money you are saving." ▲

THE CLASS OF '80

(Continued from page 29)

the back panel, permitting easy use of an equalizer or other sound-processing device. A standby circuit prevents loss of station memory in the microprocessor when the power is turned off. Unique is the set's "universal" capability; it can be used with European, Asian and American station allocations and demphasis curves, and with all world-standard line voltages and frequencies.

Relative to receiver pricing, the audio industry did itself proud at the Winter Show. A good example is a tab of \$180 for a receiver from Technics, Model SA-101. This 18-wpc model with a THD spec of 0.04% at full power, and phono signal-to-noise ratio of 76 dB, is priced at least \$20 less than a comparably powered big-name-brand model, with substantially lesser specs, of a year ago.

Turntables. A comparison of nine

new turntables from Toshiba and five from U.S. Pioneer shows a major trend in the making. It is the move to front-mounted controls—manifest in all the above models. However, Toshiba elected to go the straight-arm, Dual-pioneered route—which more and more of the industry is adopting, with Pioneer sticking with the "S"-shaped arm. Toshiba's line features a semi-automatic quartz-locked DD model at \$200, and fully-automatic at \$230. Of note in the Pioneer line is coaxial suspension, filtered down from the high end of Pioneer's turntable line. It is said to be highly effective in reducing acoustic feedback and other forms of environmental interference. The platter, motor and arm are mounted on a single bottom plate which is suspended independently from the cabinet via special spring in each insulator. Thus, shocks

to the cabinet are not transmitted to the working parts and cannot spoil music reproduction.

From our check-out of new products at the Winter Consumer Electronics Show, it would seem that the only technologically new turntable product was Technics' SL-10, priced at \$600. This compact quartz-controlled direct-drive unit represents a radical departure in turntable design. For instance, it measures the same dimensions as an LP record jacket—front, back, and side—representing the ultimate in turntable down-sizing. Its operation is totally automatic, and the upper and lower halves of its cabinet are sealed during play.

The SP-10 features advanced gimbal suspension and dynamically balanced linear tracking tonearm design. It has an aluminum diecast cabinet. The up-

per half contains the tonearm, its drive system, and a micro-computer electronic control block. The lower half contains Technics' proprietary integral rotor platter direct-drive motor and its driving and control circuits. To use the SP-10, you place a record on the platter, close the lid, and press a button. The turntable then takes over, using an opto-electronic detection system to determine stylus contact points, and the beginning and end of play.

Especially intriguing is this: The SP-10 can be used in the usual horizontal position, tilted at an angle, or stood upright during playback! After play, it can be stored (if desired) with LP records, in the upright position.

Optonica's deluxe new RP-9705 at \$950 offers two incremental advances in technology. One is a micro-processor-controlled music selector system that allows pre-programming of up to 10 selections, and infra-red remote operation. Features of the front-control model include LED digital readout to show the listener what has been programmed into the system, which portion of the instructions are being followed, and speed accuracy; and direct-read stylus force indicator.

Fisher also came on the scene with an infra-red remote-controllable turntable with micro-processor-controlled track selection and cueing, the Model MT-6360 priced at \$350. The front-control unit comes with factory-installed "integral quality" magnetic cartridge.

Revox, in an attempt to entice consumers to sample its "high-status" wares at lower price levels came up with the Model B795 quartz-controlled direct-stylus force indicator.

Fisher also came on the scene with an infra-red remote-controllable turntable with micro-processor-controlled track selection and cueing, the Model MT-6360 priced at \$350. The front-control unit comes with factory-installed "integral quality" magnetic cartridge.

Revox, in an attempt to entice consumers to sample its "high-status" wares at lower price levels came up with the Model B795 quartz-controlled direct-drive turntable featuring Revox's "Linatrack" straight-line tracking system. Priced at \$599 (versus \$899—including cartridge—for its deluxe predecessor the B790), the unit can accommodate "virtually any cartridge on the market."

ADC (Audio Dynamics Corp.) in a move to please critical—but budget-oriented—audio buffs, introduced a new manual direct-drive turntable at the show that has the capability to accommodate ADC—or other—high quality tonearms through the use of a "universal" type mounting hole. The company explained that "There are no

other reasonably-priced high quality turntables that allow for mounting universal tonearms."

Cassette. The "word" relative to cassette equipment at the show was "not much new." The major thrusts in technology were toward metal-tape versions of existing models, variable, rather than fixed bias controls, more units with micro-processor programming capability, and solenoid or logic operation in more models at lower cost. And the trend to use displays other than VU meters accelerated markedly. A lesser thrust was the move of a few companies to add micro or mini decks for inclusion in micro or mini audio component systems. Note: These loosely used terms mean the same thing in the audio industry—audio components measuring less than 12 inches in the largest dimension, and speaker systems measuring less than 14 inches in the largest dimension.

The debut by 3M Co. of "Metafine," fine metal particle tape two years ago, resulted in a concerted effort by the audio industry to bring out machines at lower prices than those of the first models able to handle the state-of-the-art tape. From a level of about \$500, the industry was able to come down to the \$300 level a year ago, to the \$190 level six months ago. The recent WCES saw the introduction of a metal-tape-capable deck by Sharp Electronics at a startling \$129.95. The front-load model with LED peak level display and Dolby, has a response of 40 to 14,000 Hz, plus/minus 3 dB, wow-and-flutter of 0.09 per cent, and signal-noise ratio of 62 dB in the Dolby position.

Variable, "fine-tune" biasing originally appeared at around the \$500 mark about three years ago, to accommodate the variety of then-new tape formulations. With the advent of metal tape, this feature has become more popular. In fact, many recordists consider it an imperative. And the industry has "come through" in this regard, bringing the price down to a popular level. Latest evidence is in Kenwood's KX-500, a unit featuring variable bias control, plus "soft-touch" operating controls that feel like solenoid types, at a mere \$225.

What may be a new design concept in cassette loading appeared in a new low-profile, slim-line cassette deck from Harman-Kardon, Model HK705 at \$449. This unit has a narrow loading drawer to accommodate cassettes, which are placed in it in a lay-down (rather than vertical) position. Once a cassette is inserted, a simple touch of the finger activates a mechanism that closes the drawer automatically, and draws the cassette down into the machine for horizontal play. The com-

pany claims that this "uniplanar" mechanism reduces wow-and-flutter and tape-to-head misalignment by "eliminating vibration problems created by long shafts and end-play created by extra depth." The set is a match-mate for four other H-K components, previously mentioned. The metal-capable model has a response of 20 to 19,000 Hz, plus/minus 3 dB, and wow-flutter of 0.07%.

A new brand name in cassette equipment appeared at the show. It was Nikko. The company debuted two units, both metal-capable. The top model, ND-790 at \$330, in black finish, features dual vertical-type LED indicator switchable into VU or peak-hold reading modes, Dolby, pilot signal cancellation switch for recording from FM, and fine bias control. The second unit, ND-490, priced at \$250, features vertical VU meters and three-position bias and equalization controls.

Nakamichi, noted for its technological innovativeness, proved that capability again via introduction of "Auto Azimuth Alignment" in three new metal-tape-capable offerings. They are the two-speed 680ZX at \$1,550, the 670ZX at \$1,150, and the 660ZX at \$995, all using the three-head format. The 680ZX has an 18-program random access music memory, the 670ZX and 660ZX have a nine-program music memory. All three feature pitch adjustment and solenoid transport controls.

Nakamichi claims a 22 kHz bandwidth potential as a consequence of automatic azimuth alignment, versus 20 kHz for fixed heads in a three-head format. The AAA system uses a fourth servo motor linked to the record-head mounting base and phase-comparator circuit to achieve precise adjustment of record head azimuth for the particular cassette in use. Merely press a button, and a two-channel signal is recorded/reproduced simultaneously. The comparator checks the relative timing (phase) of the signals and operates the servo motor to pivot the tape head into alignment. The adjustment takes about two seconds. The company claims that "any consumer can be assured of precise head alignment on any cassette with no technical knowledge whatsoever." The two-speed 680ZX has a 15 kHz bandwidth at its slow speed of 15/16 ips.

Sanyo's latest cassette offering is the Plus D64 at \$389.95. This model is notable for its "Automatic Music Selector System" that enables the user to choose nine selections on a cassette in the sequence desired for listening, and "Record Mute Control" that allows the user to insert four-second gaps on a cassette so that the tape can later be used with the automatic music selector system.

New micro/mini additions included Technics' Model RS-MO2 at \$500, featuring metal-tape-capability, and Webcor's 2000DC, a slot-loading model that comes as part of a \$795 system that also includes tuner, integrated amplifier and two three-way mini speakers.

Loudspeakers. The best description of what happened in the loudspeaker category at the show was "mostly more of same." While quite a few new speaker products appeared, no "breakthroughs" were apparent—despite assertions and claims to the contrary. The nearest to a breakthrough came in the form of an off-beat subwoofer from Revox—new entrant in the U.S. speaker market. The model is part of a three-unit system priced at \$1,599. The horizontal subwoofer cabinet measures 40 by 41 by 19 inches, and is segmented into two areas, but covered by a single grille cloth. In each area is a 10-inch woofer, mounted in its own cabinet. This cabinet is suspended within its area by springs. Because of this mounting approach the resonance is less than three Hertz; it cannot be transmitted through the cabinet, or into the floor on which the cabinet stands. A spokesman noted "You can play the system *loud* without worrying about breaking your lease." Because the woofers are isolated, the cabinet top can be used as a shelf for other equipment. The satellite systems, measuring 12- by 8- by 7-inches, each contain 7-inch low/mid-range driver, one-inch dome type mid-range, and a dome-type ¾-inch tweeter. The ensemble's response was given as 30 to 25,000 Hz.

The above satellites are typical of the down-sized offerings of several companies at the show—enough to indicate a trend in the making. Typical are three units from Technics, called Linear Phase Micros, models SB-F3 at \$340 a pair, SB-F2 at \$280 a pair, and SB-F1 at \$220 a pair, each incorporating a woofer—6¼, 5, and 4-inch, respectively, plus horn tweeter of three or two-piece construction. The enclosures are of heavy diecast aluminum alloy.

Another model in this size range—the first from Bozak, is the MCS-80, measuring approximately 12½ by 8 by 7 inches and priced at about \$425 per pair. It uses a 6-inch woofer with aluminum alloy cone to preclude "ringing," and for better heat dissipation, plus a soft-dome tweeter. It comes in ¾-inch oak veneer cabinet.

Mesa, known for its micro and mini models, added a three-way compact bookshelf system, Mini-Mesa 75 at \$350 a pair. It uses a 6½-inch woofer, a 3½-inch midrange, and 1-inch soft-dome tweeter, and comes in solid black or wood-grained vinyl cabinets. Mesa also debuted a micro unit, the Mini-

Mesa 15, measuring 8 by 4 by 4 inches and priced at \$160 per pair. It uses two 3-inch foam-surround woofers and a horn tweeter with ¾-inch voice coil. Its cabinet of metal has a mounting bracket, for wall/ceiling mounting, or installation in a car.

Also in the small-size league was Design Acoustics' Model LDM, priced at \$350 per pair. Using a 5-inch woofer and 1-inch dome tweeter, it features a front panel of one-inch-thick walnut, beveled to minimize diffraction. Approximate measurements: 11 by 7 by 5 inches.

A final "pint-size" introduction was Sansui's SP-M1, priced at \$250 a pair. Measuring 8 by 5 by 4¾ inches, the units use 4-inch woofers and 1-inch dome tweeters, and the cabinet grilles are of wood carved in a lattice pattern.

Notable at the show was the re-entry of Phase Linear into the speaker market with a trio of three-way models priced at \$500, \$750 and \$1,200 each, the latter two featuring ribbon tweeters. Also of note was the entry of 30-year-old Heco of West Germany into the U.S. speaker market with a line of four models called "Precision Series." All four utilize a patented woofer duct that assures accurate bass reproduction, and acoustic suspension cabinets of particle board five times more dense than usually used for speaker cabinets. They range from \$340 to \$600 each.

Of further note was a pair of "honeycomb" disc speakers from Panasonic's new Recording and Broadcast Division. The flat honeycomb speaker diaphragm, offering the advantages of high rigidity and light weight, consists of a very light aluminum honeycomb core sandwiched between two layers of aluminum foil skin. The honeycomb design permits easy alignment of acoustic centers in linear-phased systems. Further, it offers the advantages of low inherent distortion, smooth, flat frequency response, wide frequency range, and strict quality control for unit-to-unit conformity in production.

The systems, bearing the Technics brand name, are the SB-10 at approximately \$680, and the SB-7, at about \$390. The former uses a 12½-inch disc diaphragm woofer, 3½-inch disc mid-range, and leaf tweeter of polymire film that can achieve a response of up to 125 kHz. The latter uses a 9½-inch woofer, plus similar midrange and tweeter units.

Single-Brand Audio. In passing through department store audio departments, and similar departments in "mass merchandise" and discount outlets, you've probably noticed an ever increasing number of "one-name-brand" audio component systems. These are usually offered with a neat, trim, wood-finished vertical housing, perhaps even

sporting elegant glass window-doors.

The "scoop" on these is that they are a popular approach to hi-fi for the person wanting to improve his audio lot, but afraid to get involved in selecting an audio system. Buying such an outfit means no headaches and worry about selection, and total assurance that you're getting a system that will work optimally relative to its individual parts. Further, such systems enable a person who has had good luck with, and been satisfied with a company's products, to buy more of them as a measure of "purchase security." These systems are scaled at various price levels, to accommodate various budgets, various levels of need and aural sophistication. A major attribute of these "package systems" is that they fit into, rather than disrupt, home decor.

Among new entrants in this category at the recent Winter Consumer Electronics Show were four ensembles from Fisher Corp., ranging from \$700 to \$1,100 including speaker systems. The AC1915 is comprised of Fisher's CA-2120 35-wpc integrated amplifier, FM-2121 AM/FM stereo tuner, MT6115 turntable, MS135 speaker systems, and RA190 equipment cabinet, all for \$700. The ICS541 system is made up of the MC4580 40-wpc stereo receiver with built-in cassette deck, MT6115 turntable, and MS157 speaker systems, for \$950. The ACS1920 system at \$78 includes the CA2220 50-wpc integrated amplifier with 5-band graphic equalizer built in, FM2121 tuner, MT6310C turntable, MS14A speaker systems, and RA200 equipment cabinet. The deluxe ACS1925 system at \$1,100 is comprised of the CA2220 50-wpc integrated amp with five-band built-in graphic equalizer, FM2421 digital stereo tuner, MT-6310C turntable, ST440 speaker systems, and RA201 equipment cabinet. There is space in the cabinet to house an optional two-speed cassette deck, the Model CR4031.

For music lovers wanting a total component system bearing the Sansui brand name, there's a new series designed to fill those wants. Under the "Super Compo Series of Select Systems" concept, the consumer chooses his Sansui components independently to fit his or her needs. Components in each system have been carefully pre-matched for style and performance. Special grooved sides make it possible for them to be mounted in any one of four cabinets offered as part of a system. If a person is a bit uncertain, Sansui has a list of recommendations, for a happy purchase. Three new receivers are the heart of the Compo systems—the R70 at \$400 with 65 watts per channel output the R50 at \$300 with 45-wpc output, and the R30 with 25-wpc output. ▲

saturation for those not familiar with the term. The level at which tape saturates, that is, the record level at which a further increase does not produce a corresponding increase in output level is not "flat." The higher frequencies saturate first, usually starting at 6 kHz, and the higher the frequency the lower the record level at which the tape saturates. For example, while zero-VU might be the saturation level at 800 Hz for a particular tape, -12 dB might be the saturation level for 12 kHz when the normal record pre-emphasis equalization at the higher frequencies is taken into account. This is illustrated in the photo for Scotch Master I. As with all tapes the signal into the recorder is flat from 20 to 20,000 Hz. Note that at zero-VU record level (the top trace) the 12 kHz output level is approximately 12 dB below the 800 Hz level. This "loss" is caused by tape saturation.

Now let's return to "headroom." If we are already at or near high frequency saturation, increasing the record level some 9 dB to utilize the "headroom" only drives the tape deeper into high frequency saturation, providing even greater proportional high frequency loss. In short, there's no effective way to utilize headroom unless a frequency-compensated peak record level indicator is provided so you can avoid tape saturation to at least 12 kHz.

Even if you were inclined to accept greater high frequency saturation at maximum record level, you must also be willing to accept the saturation at -20 dB, the standard cassette test level. A logical question is: "How can there be saturation at the normal test level of -20 dB?"

Here's how. The high-frequency saturation level does not necessarily change simply because you can increase the midband signal level 9 dB. For our saturation illustration using Scotch Master I, it remains as shown in the photo. If the user raises the

signal level 9 dB the -20 dB test level must also be raised 9 dB for comparison. If you place a pencil on the -20 dB trace at 12 kHz, and move up 9 dB you'll note it is now on the saturation curve; everything from 12 kHz up will be saturated at -20 dB. Since most record signal peaks are well above -20 dB, along with the average program level for popular, MOR and rock music, the "brilliance" of the sound will be muted.

In short, extra "headroom" is not necessarily a blessing, nor a reason to apply a "correction factor" to the measured zero-VU referenced signal-to-noise ratio.

Distortion. As for distortion products: When talking about high fidelity cassette tape we are talking essentially the same values at the same recording level.

So what's basically left for comparison are the things that have the most effect on how the recording sounds to the ear: frequency response and dropouts; dropouts actually being more of an indication of overall manufacturing quality control than sound quality. A typical bad dropout might be heard as a slight loss of tone.

As far as the normal (ferric) tapes are concerned, there is no significant difference between tapes regardless of price. For example, compare the performance of TDK-D—a rock-bottom priced tape—with just about anything else. Other than a slight sag in the upper highs of 1-2 dB, it compares favorably with many expensive tapes. (In fact, many traces overlap because the tapes are made by the same manufacturer and/or the raw products are the same.)

Moving along to the chrome-bias tapes, only the Memorex high bias tape has significantly less saturation than the average normal tape, though the -20 dB frequency response is significantly smoother for the chrome-bias tapes.

The ferrichrome-bias tapes all had significantly greater high frequency saturation at zero-VU record level than either the normal or chrome tapes. Basically, it means that the ferrichrome bias (or tape) selector should also recalibrate the record level meter to indicate zero-VU at a lower record level because the ferrichromes cannot handle as much record level as normal and chrome tapes. Since no recorder we know of recalibrates the level indicator for ferrichrome tape, it is the reason they tend to "test out" with higher distortion on many recorders.

Finally, we come to the question: What is the correct bias value for optimum performance in terms of frequency response and minimum saturation? There is no answer. Few tapes used the same bias level as other tapes. Some required so little bias the machine could not be adjusted to the required level and the tape is not reported. Others were not optimized until the bias was at maximum. Particularly among the chromes, the bias ranged all over the lot, and no tape worked well at another tape's bias level. (So much for "average" bias values.) An example of what we ran into is Realistic's budget-line low noise tape. The required bias was too low for the machine; the curves shown were made with the lowest possible bias level, which still produced excessive high frequency attenuation. This tape is included only to illustrate this effect. We would recommend the tape only for use on budget priced machines, which tend to run at lower bias values.

If there are any conclusions to be drawn from this closer look at cassette tape, it is that: A) If you want to make true high fidelity cassette recordings you should use a machine with adjustable bias (maybe it's time to upgrade your equipment); B) When you can adjust the bias you get some remarkably good results from even the budget priced tapes. ▲

POP DISCS

(Continued from page 65)

Duncan Browne: "Streets of Fire." Sire. \$7.98.

Surrealistic interplay among guitars, synthesizers and a female chorus heighten the melodramatic mood sung by Duncan "The Wild Places" Browne. The songs are lush and melodic, with subtle jazz influences.

Marianne Faithfull: "Broken English." Island. \$7.98.

Yes, the name is familiar. Marianne is the tremulous woman-child of the

1960's British "invasion," who has matured into a powerful, worldly, and at times Piaf-like singer/songwriter. Her songs range from the sexual jealousy of "Why D'Ya Do It" to the attack on politically-inspired terrorism contained in the title track. A tight, restrained combo featuring Stevie Winwood on synthesizer backs Marianne on this fascinating disc.

Michael Jackson: "Off The Wall." Epic. \$8.98.

Michael Jackson, in this super-glossy Quincy Jones production, comes of age as a talented singer and composer. He no longer needs the cutesy Jackson Five connection. His own composition, "Don't Stop Till You Get Enough," has one of the most catchy disco hooks of the year, and nestled softly amidst all of the up-tempo, fully-instrumented production numbers is a beautiful, simply-arranged vocal solo, "She's Out Of My Life." All musical bases—pop, disco, easy listening, soul—are touched in this fine album. ▲

CLASSIFIED MARKET PLACE

HI-FI STEREO BUYERS' GUIDE—PUBLISHED Bi-Monthly. The rate per word for Classified Ads is \$1.25 each insertion, minimum ad \$18.75 payable in advance. Capitalized words 40¢ per word additional. To be included in next issue, write to R. S. Wayner, DAVIS PUBLICATIONS, INC., 380 Lex. Ave. N.Y. NY 10017.

ADDITIONAL INCOME

EARN EXTRA INCOME stuffing envelopes at home. Free supplies, complete assistance. SSAE: Home Enterprises, Dept. 2802, P.O. Box 1136, St. Helens, OR 97061.

BECOME COMMISSION MAILER. How? Write: Grahams, DPBX 99371, Tacoma, WA 98499.

ANTIQUES, ARTS & CURIOS

INDIAN Relics, Jewelry, Western Americana, Weapons. Mailorder Catalogues, Auctions. Important Opportunity for Investors, Collectors. National Auctions, 6518 Van Nuys, Van Nuys, CA 91401.

BLUEPRINTS, PATTERNS & PLANS

NEW CRAFT PRINT CATALOG—Choose from over 100 great easy-to-build plans. Send \$1.50 (completely refunded with your first order). BOAT BUILDER, (CP Div.)—380 Lexington Ave., New York, NY 10017.

BOOKS & PERIODICALS

AIR-CONDITIONING: Layman's Practical Guide for Air-Conditioning Repair, \$4.95—"You & Your Air-Conditioner," Box 3466, San Antonio, Texas 78211. Money Back Guarantee.

HOW to save tax dollars when you sell your house. \$3.95. J. N. Haynes Inc., Box 74-K, Clear, AK 99704.

SF by mail. Bem's Book Service, 2914 E. Southcross, San Antonio, TX 78223.

STILL BAFPLED? Read "THE KEY to the Assassination of John F. Kennedy," by Edmund Johnston. Fully illustrated by Tom Willis. \$1.00 plus 54¢ postage to THE KEY, P.O. Box 534, Bronx, NY 10462.

MAKE YOUR CLASSIFIED AD PAY. Get "How to Write a Classified Ad That Pulls." Includes certificate worth \$2.00 towards a classified ad in this publication. Send \$1.50 (plus 25¢ for postage) to R. S. Wayner, Davis Publications, Inc., Dept. CL, 380 Lexington Ave., New York, NY 10017.

CBer's! Personalized CB decal with a 1-year subscription to Elementary Electronics only \$3.97. E/E, the magazine that covers CB and all areas of radio communication. Send check: Elementary Electronics, Decal Dept. 380 Lexington Ave., New York, NY 10017.

BUSINESS OPPORTUNITIES

SYNTHETIC LUBRICANTS. Join nation's largest marketer. No investment. No inventory. Bayview, 3230 Minnesota, Duluth, MN 55802.

STAY HOME! EARN BIG MONEY addressing envelopes. Genuine offer 10¢. Lindco, 3636-DA, Peterson, Chicago 60659.

MAILORDER opportunity! Start profitable home business without experience or capital. Write for free book and details. No obligation. Gil Turk, Dept. 572, Montvale, NJ 07645.

\$480 Weekly Possible. Amazing New Mailing Program. Details. Rasmussen DP50, 1747N, 450E, Ogden, Utah 84404.

\$534.00 WEEKLY working three hours daily at home. \$368.00 weekly working two hours daily. \$178.00 weekly working one hour. Start immediately. Paid daily (advance)—\$106.80, \$71.20 or \$35.60. WRITTEN EARNINGS GUARANTEE. FREE Bulletin/Application. PAS, Postal Unit 13703-G, San Antonio, Texas 78213.

MAKE \$1.00 Each Addressing Envelopes. We pay postage. No Limit. Beginners Kit \$2.00. Colossal, Box 318-D, Brooklyn, NY 11204.

\$2000.00 Monthly mailing commission circulars. Experience unnecessary. Free details. American, 1108 Colonial, Inkster, Michigan 48141.

\$480.00 WEEKLY! "Guaranteed Home Mailing Program." Freedom, Box 30224-DP, Denver, CO 80230.

\$58.90 DAILY PAY. \$353.88 WEEKLY HOME-WORK. IMMEDIATE INCOME. EARNINGS GUARANTEE CERTIFICATE. FREE REPORT/APPLICATION. AAHP, UNIT 29309-H, MEDCENSTA, TX 78229.

BUSINESS OPPORTUNITIES—Cont'd

STEREO REPRESENTATIVES NEEDED!!! Lowest possible prices!!! Over 100 brands!!! Krasco Rep., 998 Orange Ave., West Haven, CT 06516.

CABLE FM BROADCAST STATION. Investment/experience unnecessary. Home operation possible. Excellent income reported Free details. CAFM, Box 130-GH5, Paradise, CA 95969.

FREE INFLATION-BEATER BOOK "2042 Unique, Proven Enterprises." Fabulous "Little Knowns." Work home! HAYLINGS-E14, Carlsbad, CA 92008.

FREE Catalog. JEWELRY available wholesale. Big profits. Northway Distributors, 31 King, Dept. A1, St. Charles, Ontario POM 2W0.

\$100,000 YEARLY! Startling new mail order discovery! Executive type business—helping others. Offer limited. Free secrets! Treasure-R3D, Colorado 90465.

\$500 CASH advance available. Stuff 1000 envelopes. Free details. Dept. H, Box 7550, The Woodlands, TX 77380.

CIRCULAR MAILERS needed. Work from home. Earn hundreds \$\$\$ weekly. No experience needed. Department 04-02, Box 1060, Orangepark, FL 32073.

RICHES IN FOUR STEPS! Discover how to select, price, sell, profit from your opportunity. Send 25¢. Dennis, Box 12699C, New Brighton, MN 55112.

\$500 Weekly Cash Advance Possible! Exciting, Easy Mailing Service. Free Details. Dept. B, Box 2505, Wichita Falls, TX 76307.

MAILORDER Business. Complete starter kit \$2.00. Holland, 23300 W. Arata #145, Troutdale, OR 97060.

\$1800 MONTHLY CLIPPING NEWSPAPERS at home!! Spare time. Start immediately! No experience required. Free report. Send self-addressed stamped envelope. Alpha, Box 131-WCBB, Van Nuys, CA 91401.

MAKE money writing and selling simple information. Rush \$11.00. Starts YOU in business. Guaranteed! Falconer, Box 20102-D, Indianapolis, IN 46220.

\$350.00 Weekly Possible! Home Program! Day, 820-A Gleam, Louisville, KY 40214.

TREMENDOUS Profits! Wholesaling specialty items. 2500 items available. Your the Boss. \$10. brings Wholesales Kit. Refundable. Roberts Specialty Merchandise Company, 244 Bernard Drive, Buffalo Grove, IL 60090.

\$1200 MONTHLY CORRECTING STUDENTS' LESSONS at home!! Spare time. Start immediately. No experience required. Free report. Send self-addressed stamped envelope. Horizon, Box 1685-WCBB, Las Vegas, NV 89101.

\$1000 monthly! Home mailing program! Kashkings, Box 485, Randolph, MA 02368.

ADVERTISE "Free" in 95 Magazines—\$6.98. J&R Enterprises, Box 712-IO, Pacoima, CA 91331.

\$350 Weekly Mailing Letters. Free Details. Bronxville House, Box 311-D, Bronxville, NY 10708.

\$500.00 WEEKLY Mailing Circulars! Free Proof. Sunrise, Box 2096-D, Niagara Falls, NY 14301.

BUY IT WHOLESALE

HIGH Profit Cap Gun Key Chains, \$4.80 Dz. Jewelry, \$6.00 Dz. General Merchandise Catalog. RJR, Dept. 507, 18 Church St., Mt. View, CA 94041.

CB RADIO

BOOST POWER! ADD CHANNELS! 100 watt solid-state booster, high gain beam antenna, 200% modulation booster. Plans \$4.00 each, \$10/all. FREE CATALOG—kits, plans, do-it-yourself repairs/modifications. PANAXIS, Box 130-GH5, Paradise, CA 95969.

COINS, CURRENCY & TOKENS

RARE coins market. Send \$2.00 to Jefferson Press, P.O. Box 7055, Phoenix, AZ 85011.

DO IT YOURSELF

CURB Inflation with Booklet First Time Offered. "How to Sell Your Own Home and Save Money." Send \$5: Hejak Enterprises, P.O. Box 245, La Porte, Indiana 46350.

EDUCATION & INSTRUCTION

BECOME ENGINEER, DJ. Start your own radio station, receive FCC license, equipment, records. Free details. "Broadcasting," Box 130-GH5, Paradise, CA 95969.

UNIVERSITY DEGREES BY MAIL! Bachelors, Masters, Ph.D.s. Free revealing details. Counseling, Box 389-HF-5, Tustin, CA 92680.

DO YOU KNOW "How to Write a Classified Ad That Pulls?" Instructive booklet tells how. Also includes a certificate worth \$2.00 toward a classified ad in any of our publications. For your copy send \$1.50 (plus 25¢ postage) to R. S. Wayner, Davis Publications, Inc., Dept. CL, 380 Lexington Ave., New York, NY 10017.

ELECTRICAL EQUIPMENT & SUPPLIES

REPAIR ELECTRIC MOTORS! GENERATORS! ALTERNATORS! Modelco, Box 7288, Kansas City, MO 64113.

FORMULAS & TRADE SECRETS

MAKE ALCOHOL FUEL LEGALLY!! Solar/conventional still plans and formulae. Details about Federal Permits. Only \$10.00. RDA, Box 873, Concord, NC 28025.

FOR SALE—MISCELLANEOUS

GOLD! SILVER! Sell Direct Highest Yield USA Sources \$10.00. Sterling, Box 6631, 23703.

GIFTS THAT PLEASE

FREE GIFT catalog! UNIQUE gifts from around the world. Gifts, Box 11588-HF, Spokane, WA 99211.

CLOSEOUT Jewelry Sample and Price List \$1.00. K&M Distributor, Fiskeville, RI 02823.

GOVERNMENT SURPLUS

JEEPS — \$19.30! — CARS — \$13.50! — 650,000 ITEMS! — GOVERNMENT SURPLUS — MOST COMPREHENSIVE DIRECTORY AVAILABLE TELLS HOW, WHERE TO BUY — YOUR AREA — \$2 — MONEYBACK GUARANTEE — "GOVERNMENT INFORMATION SERVICES," DEPARTMENT E-5, BOX 99249, SAN FRANCISCO, CALIFORNIA 94109.

HELP WANTED

PART time piece work. Webster, America's foremost dictionary company needs home workers to update local mailing lists. All ages, experience unnecessary. Send name, address, phone number to Webster, 175 5th Ave., Suite 1101-1401, New York, NY 10010.

HI-FI EQUIPMENT

REK-O-KUT drive belts. Specify model \$10.45 delivered. QRK Electronic Products, 1568 N. Sierra Vista, Fresno, CA 93703.

SAVE 50% BUILD YOUR OWN SPEAKER SYSTEM. Write McGee Radio Electronics, 1901 McGee Street, Kansas City, MO 64108.

HIGH Performance Loudspeakers. LS3/5A and other equivalents. Dealers only. Box 18009 Seattle, WA 98118. (206) 323-4987.

MORE

For Greater Classified... Savings... Results... and Profits...

Place your ad in one of our SPECIAL COMBINATIONS: Combo #1, Combo #2 or Combo #3. Each combination is designed to give you the largest audience available, for further information write to R. S. Wayner, Classified Advertising Director, Davis Publications, Inc. 380 Lexington Ave., N.Y., N.Y. 10017.

Classified Continued

HYPNOTISM

FREE Fascinating Hypnosis Information! Startling! DLMH, Box 487, Anaheim, CA 92805.

INVENTIONS WANTED

INVENTIONS, patents, wanted cash, royalty. Auto, electro-mechanical, mechanical devices, Housewares, etc. We develop, finance, manufacture and market from an idea to perfected product. Free evaluation and brochure. Request Kit DP, Pixonix Corporation, 22 Walter Street, Pearl River, NY 10965.

LOANS BY MAIL

BORROW \$25,000 "OVERNIGHT" Any purpose. Keep indefinitely! Free Report! Success Research, Box 29263-SR, Indianapolis, IN 46229.

QUICK CASH'S SIGNATURE Loans! Write: NAA, 507-DG Fifth Ave., New York 10017.

BORROW \$1,000-\$50,000 secretly - "overnight." Anyone! Credit unimportant. Repay anytime. Incredibly low interest. No interviews, collateral, co-signers. Unique "Financier's Plan." Full information, \$2 (refundable). Spectrum, 79 Wall St.-16, New York 10005.

GET cash grants—from Government. (Never repay.) Also, cash loans available. All ages eligible. Complete information, \$2 (refundable). Surplus Funds-DG, 1829 K. St. NW, #502, Washington, DC 20006.

MAIL-ORDER OPPORTUNITIES

MAKE \$1500 weekly! New discovery in envelope stuffing! Sensational! Free Secrets. Treasure-118VV, Morrison, CO 80465.

MEMORY IMPROVEMENT

INSTANT MEMORY . . . NEW WAY TO RE MEMBER. No memorization. Release your PHOTOGRAPHIC memory. Stop forgetting! FREE information. Institute of Advanced Thinking, 845DP Via-Lapaz, Pacific Palisades, CA 90274.

MISCELLANEOUS

SAVE TO 90% WEEKLY on groceries! Guaranteed! Information: Rush self addressed stamped envelope plus 25¢! Martens Ent., 1046 Greenwood Ct., Rm'DPG, Oshkosh, WI 54901.

MEET sincere, beautiful people—like YOU. Very low fees. Call DATELINE toll-free: 800-451-3245.

SAVE food costs. Sagacious campers home makers. Ruff recommended insurance you can eat. \$2. Mrs. Pita, Box 87031, Houston, Texas 77017.

MONEYMAKING OPPORTUNITIES

STUFF-MAIL ENVELOPES!! \$250.00 Profit per thousand possible! Offer-details Rush stamped addressed envelope: Worldwide-A 460, X15940, Fort Lauderdale, FL 33318.

EASY, HOMEWORK PLAN. Stuff circulars. Big \$\$\$ Write: A&I, 5343-A Diamond Hts., San Francisco, CA 94131.

\$300 WEEKLY SPARE TIME—Mailing Salesletters. Details: Delta, Dept.-D, Box 2902-CRS, Rock Hill, SC 29730.

MAKE \$100,000 YEARLY! Guaranteed or \$1,000 refund! Executive type business. Free details! Success-689RR, Indian Hills, 80465.

CASH ADVANCE \$500/Thousand envelopes stuffed available. No limit! Information: Rexson 04-01, Box 1060, Orangepark, FL 32073.

\$45,000 in Three Weeks! Guaranteed! Gene Sanders, 1316D Lyric, Fort Worth, TX 76134.

\$350.00 weekly! Home program! Write: Day, 104-E Third, Salem, MI 65560.

SELL Words! Write for Money. Super plan, no experience necessary. Free Report. Publishers, Box 546-AD, El Cajon, CA 92022.

\$356.00 WEEKLY possible in only 2 hours work daily at home. Start immediately. Free. Jayco, Box 742D, Elmhurst, IL 60126.

\$270.00 Weekly Guaranteed. Work ½ day Monday-Friday. Free Details. Start immediately. Homemaker Job Opportunities, 1043 Lone Star Drive, Suite #101, New Braunfels, TX 78130.

HELP PRODUCE PORK and make money doing it. Free detailed brochure. Lorenza Jewell, Box 196, Jamaica, NY 11420.

\$356.00 Weekly possible in only 2 hours! Work daily at home. Start immediately. Free Information. Write: Jay, Box 1229-D, Durant, OK 74701.

\$800.00 WEEKLY POSSIBLE! Earn immediately mailing our 1,500 circulars free. Rush stamped envelope: GOLDEN, P.O. Box 2884A, Wichita, Kansas 67201.

MONEYMAKING OPPORTUNITIES—Cont'd

BIG MONEY! Clip newspaper articles. Free details! V-J, 323 Franklin #804/E-98, Chicago 60606.

\$500 CASH advance available. Stuff 1000 envelopes. Information. Dept. Y, Box 7550, The Woodlands, TX 77380.

OF INTEREST TO WOMEN

CASH from BOX TOPS, LABELS. Information 20¢. Refund Bulletin, Box 503, Cape Girardeau, MO 63701.

OLD JEWELRY WANTED

CASH paid immediately for old rings, watches, Class Rings, gold capped teeth, coins, silver, gold. FISHER ENTERPRISES, Meldon, Dept. 205, New Lenox, IL 60451.

PERSONAL

UNIVERSITY DEGREES BY MAIL! Bachelors, Masters, Ph.D.s . . . Free revealing details. Counseling, Box 389-DP5, Tustin, CA 92680.

NATIONWIDE EXCITEMENT! and COMMUNICATION "Cassette Friendships" DETAILS: JETER, 17 EAST 49, BAYONNE, NEW JERSEY 07002.

LONELY Prisoners Directory (over 300). \$9.95. Chanan, 50-DV, Box 17693, Lockhart, FL 32860.

CANOE Camping on the Delaware. America's newest "Wild and Scenic River" Canoes, Rafts, Kayaks, Transport on 185 miles Portage-free. Family-safe adventure. Free Brochure. Point Pleasant Canoe Outfitters, Box 6, Point Pleasant, PA 18950.

FREE Details about Canada's Fantastic Tax-Free Lotteries. Davis, #232-2025 West 42nd, Vancouver, Canada V6M 2B5.

PRAYER Cloth. Love, health, finances. Donations appreciated. Rev. Robert, Box 377A, Mary Esther, FL 32569.

RECORDS, TAPES & SOUND EQUIPMENT

FREE Promotional albums, concert tickets, stereos, etc. Information: Barry Publications, 477 82nd Street, Brooklyn, NY 11209.

START YOUR OWN BUSINESS

EXECUTIVE mailorder! "\$3,000.00 Weekly!!" Revealing Booklet. Cashbox 457-IO, Alliquippa, PA 15001.

FREE Discount Book Catalog for Business Beginners. Ideas, Plans Galore! Books, Box 144-W, Galway, NY 12074.

JAZZ: MILES DAVIS

(Continued from page 22)

remained in eclipse—partly owing to a passing involvement with drugs, and partly because of misplaced critical attention to the broadly similar Chet Baker. An appearance at the 1955 Newport Jazz Festival, however, redirected attention to Davis, as did his formation shortly thereafter of a new group featuring tenorist John Coltrane. Perhaps most important was the stream of excellent recordings that Davis made from 1954 on. Whatever the reason, Davis soon found himself contracted to a more prosperous circle of friends, and was the object of press notices stressing his excellent taste in clothing and cars, his personal relationships, and his mordant views on life and art. He had become a "star."

Apart from his work with Parker, Davis's earliest records are long out of print. The Parker-Davis collaborations from 1945-1948 are on the five-record

Complete Savoy Studio Sessions (Savoy) and several volumes of the *Charlie Parker on Dial* series (Spotlite). The two-record *Master Takes* (Savoy) collects originally-issued takes from the Savoy series. Among the Dial-Spotlites, Volume One has a bright 1946 session with tenorist Lucky Thompson, and Volumes Four, Five and Six preserve the Parker-Davis quintet from 1947-1948, with trombonist J. J. Johnson added for the Sixth volume.

The 1949 nonet is on *The Complete Birth of the Cool* (Capitol). The cooperative quintet, plus Dameron, Davis in spirited form, and the severely undervalued James Moody on tenor, is on *Paris Festival International 1949* (Columbia). Davis's last appearances as a sideman were at two superior 1951 sessions: one with Parker, on part of *The Verve Years 1950-51* (Verve) and

with Lee Konitz on *Ezzthetic* (Prestige).

Davis-Prestige records from 1951-1956 have been re-issued with admirable accuracy. The twofer *Dig* (Prestige), coincides with *Early Miles* (Prestige) and *Conception* (Prestige). This latter LP, with Jackie McLean on alto and Sonny Rollins, was purportedly the first jazz recording specifically for LP release, and though all participants would later do better work, their sense of liberation from 78 RPM time limits, is worth hearing.

To round out the early 1950s, mention must be made of the 1952-1954 Davis sessions for Blue Note, simply entitled *Miles Davis*. These recordings—particularly the sessions with J. J. Johnson—capture an unusually boppish and extroverted Davis.

Later recordings by Miles Davis will be covered in an upcoming column. ▲

ENCODED DISCS

(Continued from page 38)

disc with the dynamic range of the original performance yet without any tape noise, disc surface noise or (and this is not the disc's fault) turntable rumble.

MAY/JUNE 1980

The dbx solution is to market a low priced (\$109.00) decoder with a series of discs that are properly encoded. In effect, a disc version of the noise free, wide opened un-decoded master tape.

The idea of dbx-encoded discs is not terribly new. Purchasers of their Model 120 series of tape noise units have seen the "disc play" button on these unit's faceplates, and a few dbx discs

Hi-Fi/Stereo BUYERS' GUIDE

gives you the absolute tops in number of equipment test reports per issue.



If you're a "best-buy" buyer, don't miss a single issue!

Mail this coupon to:
**Hi-Fi/Stereo
 BUYERS' GUIDE**
 Box 1855 GPO
 New York, NY 10001

SAVE \$2.00 off regular subscription rate.
 \$2.15 off newsstand rate.

Enclosed is \$5.95 for 6 issues of HFSBG (outside U.S.A., possessions send \$7.00)

Name _____
 Address _____
 City _____
 State _____ Zip _____

CREDIT CARD OWNERS

You may use Master Charge or Visa card.

12 issues for \$11.50

Canada, other countries 12 issues \$13.50.

Credit Card #

EXPIRATION DATE _____

SIGNATURE _____

HOE333

Please support the

leukemia society of america, inc.

211 East 43rd St., New York 10017

HI-FI STEREO BUYER'S GUIDE INDEX TO ADVERTISERS

READER SERVICE NO.	ADVERTISER	PAGE NUMBER
19	Audio Pulse	4
2	Audio Technica, U.S. Inc.	2
6	Bose Corporation	CV3
26	Denon	1
-	Discwasher, Inc.	CV2
14	Epicure	11
37	Jensen	48
18	Maxell	30
23	Mitsubishi (Car Audio)	40
20	Mitsubishi—(Home Audio)	14, 15
13	McIntosh	22
29	Nagatronics	12
12	OHM Acoustics Corp.	18
22	Ortofon	9
28	Osawa	10
-	Onkyo	7
8	Panasonic	CV4
11	Pickering	16
36	Revox	39
36	Studer Revox	39
35	SAE	19
9	Sansui	23
30	Shure Bros. (Cartridges)	21
34	Shure Bros. (Series III Tone Arm)	20
17	Sony Tape	13
25	TDK	5
-	United Audio	17

have been issued earlier on the Klavier Records label for several years. With the introduction of a low priced decoder, with no encode circuitry for taping (not everyone wants or needs tape) the noise free disc becomes more affordable and appealing.

The dbx Model 21 decoder is a small unit with a black and silver faceplate matching other dbx components. There are only two push-button controls on the front: noise reduction in/out and a tape/source monitor switch (to be used if the unit is patched into your system via your existing tape monitor loop). It can also be connected between the pre-amp and power amp or in the external processor loop—a feature becoming increasingly popular on pre-amps and receivers. There is a single red LED to indicate when the unit is on, but there is no on/off switch and it should be powered by a "switched" AC outlet on an amp or receiver. On the rear panel there is a recessed potentiometer for matching the output level of the unit to the rest of your system—the setting of which is not at all critical to the unit's performance.

Once the Model 21 is properly installed, you simply play any dbx encoded disc and sit back to enjoy a truly astonishing musical experience. The first thing you notice is that as the record starts to play the lead-in grooves there is *no noise at all!* In fact, dbx cautions against boosting the volume the first time the unit is used—it seems common practice to tweak the volume when there is none of the usual surface noise before the music starts. And, then suddenly, after the noiseless beginning, totally clean and undistorted music. The lack of disc noise and, depending on the master tape, tape noise greatly enhances the enjoyment of very quiet passages of music.

Now, during the cutting of the master disc, gain riding is not necessary. When gain riding was used, the engineer would slightly boost that low level signals so that the music would not be buried in noise and to avoid high level distortion. A dbx disc provides you with the full and realistic dynamic range and an absence of any surface noise—except in the case of a gross disc defect such as a severe and deep scratch. Let's face it—you can't have everything.

At the present time, in addition to the Klavier dbx discs, encoded records are becoming available on such labels as Vox, Turnabout, Desmar, Sine Qua Non, Chalfont and Orion. Granted, they are not household names in the league of RCA or CBS. But, to audiophiles, Mark Levinson is a household name and he is presenting some of his famous audiophile discs as a "dbx Showcase Series." Miller and Kreisel are going into the production of dbx

encoded discs in a big way and have many offerings.

Under the direction of Direct-Disk's Joe Overholdt, several outstanding D-C albums are being made available with dbx encoding. Granted, they are no longer true D-C albums. What has happened is that a dbx encoded tape was made of the direct-cut performance and is used for the replication of the dbx discs. Available so far are albums which include the Brubeck double det, the Tommy Newsom album and the P.O.W.E.R. disc as well as others. Audiophiles can look forward to *true* direct-to-dbx discs in which the live music is encoded and then direct-cut. The same dbx encoding can be used for digital albums. While digital and D-C discs already possess the ability to deliver outstanding dynamic range they will still benefit from the absence of surface noise. Adding dbx to these processes may very well result in the best sounding record albums ever produced.

During the first stages of the operation, dbx is offering record companies a "no risk" way to get into the act. If a record company has high quality master tape of an exceptional album, dbx borrows the tape and makes an encoded duplicate from which they make the metal disc stampers. All of the costs are absorbed by dbx. Then, the stampers and tape is returned to the record company for pressing the dbx discs, which are *sold* back to dbx for resale to consumers. Naturally, the record company is free to make additional dbx copies for their own distribution. It seems to be as close to a risk-free way of making money as possible, and should insure a wide variety of encoded discs for the consumer.

The prospective buyer may have some questions about the system (as I did) and I'll list the answers below:

- If you already own a dbx series II tape unit (122, 124, 128) you can play the new discs through your present equipment.
- dbx encoded discs are not meant to be played without proper decoding, and sound terrible if it is tried.
- the dbx decoder can do nothing to improve the sound of any non-encoded discs.
- the decoder *will* decode any tapes that have been processed on the 120 series of tape units.

In closing, I can only say that if you've not yet heard a dbx disc played through a dbx decoder, I urge you to run (don't walk) to your nearest dbx dealer for an eye (and ear) opening experience. Regardless of the quality of your audio system—super expensive or modest, the full potential of your equipment will finally be heard. And wait until you hear it!

We submit: the Bose[®] 901[®]
Direct/Reflecting[®] Speaker System
provides more value in
concepts, materials and
performance than
any other
speaker system.



Covered by patent rights issued and/or pending.
© Copyright 1980 by Bose Corporation.
For more information, write Bose Corporation, Dept. BG, 100 Mountain Road, Framingham, MA 01701

BOSE
Better sound through research.

Circle No. 6 On Reader Service Card

Technics

From the grandest opera to the Grand Ole Opry. A lot of FM stations play a lot of different music yet still have one thing in common: The need for uncommonly accurate turntables. That's why so many FM stations use Technics direct drive turntables.

That professionals use Technics direct drive turntables is really not surprising. What is, is that now you can get professional performance in Technics quartz-synthesizer MK2 Series: The SL-1800 manual, the SL-1700 semi-automatic and the SL-1600 fully automatic.

Wow & Flutter	Rumble	Speed Accuracy	Start-up Time
0.025% WRMS	-78 DIN B	$\pm 0.00\%$	1/4 rotation

As you can see, they all have impressive performance. But with Technics MK2 Series, you also get impressive advances in electronics. Like a quartz-synthesizer pitch control. As you vary the pitch it's instantaneously displayed by 13 LED's in exact 1% increments. That makes life easy.

So does the SL-1600 MK2's infrared disc-size sensor. Just place a disc on the platter, press the start button and immediately an infrared ray activates the micro-computer. Then the Technics precision gimbal-suspension tonearm automatically sets down in the lead-in groove.

And for double protection against acoustic feedback, Technics precision aluminum diecast base has a double-isolated suspension system. One damps out vibration from the base, the other from the tonearm and platter.

The MK2 Series. You don't have to be a radio station to afford performance good enough for a radio station.

Your next turntable should be as accurate as the ones many radio stations use.



Circle No. 8 On Reader Service Card