

HiFi/Stereo Review

MARCH 1964 • 50 CENTS

SPECIAL TAPE-RECORDER ISSUE

HOW TO SELECT
A TAPE RECORDER

TIPS ON CHOOSING
A MICROPHONE

AN EVALUATION OF
TAPE-CARTRIDGE
RECORDERS

HOW TO MAKE
LIVE RECORDINGS
AT HOME

SLOW-SPEED
RECORDING:
PROBLEMS AND
PROSPECTS

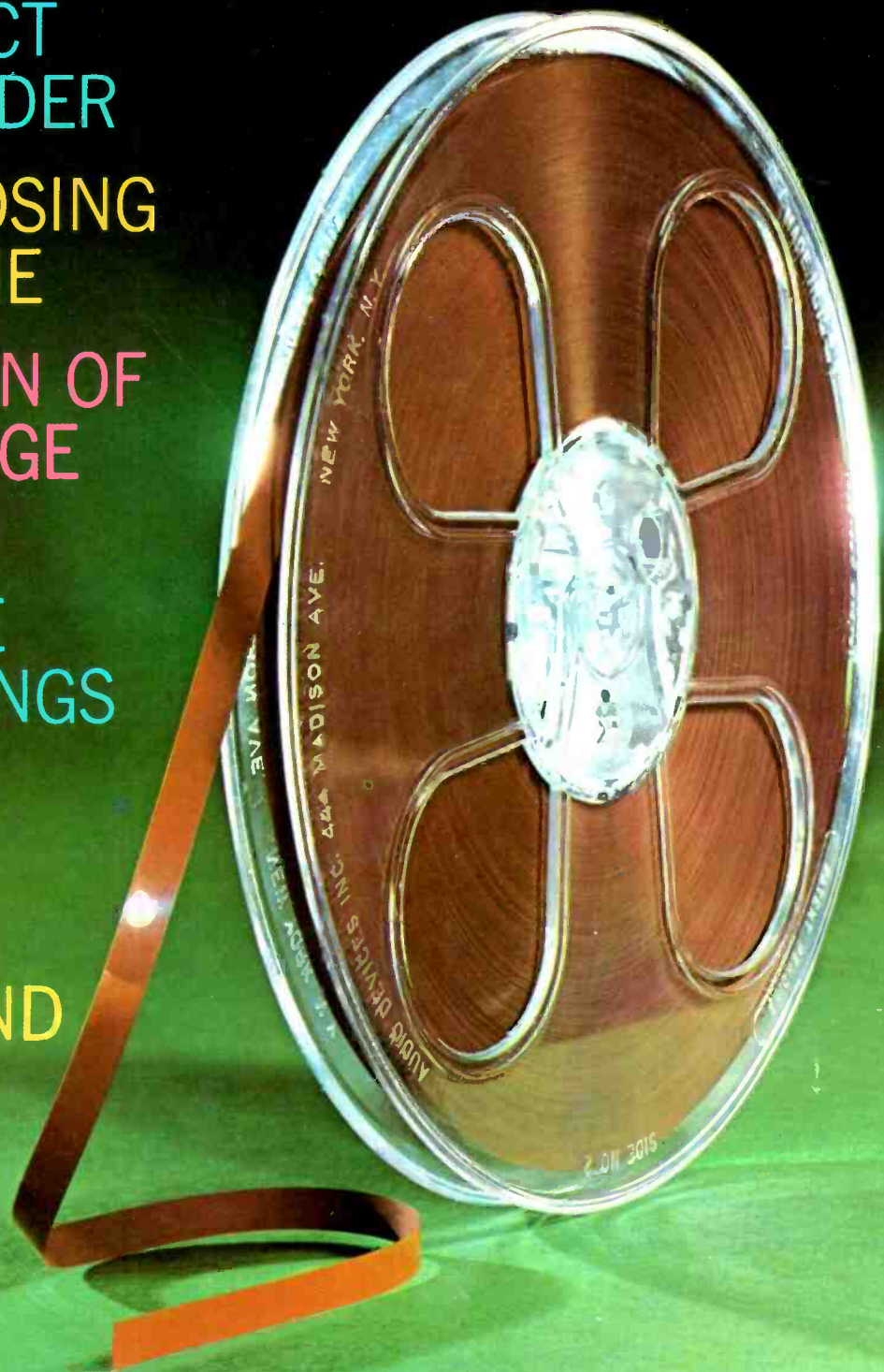

“...one of the finest...stereo tuner/amplifiers we have tested...”

Hirsch-Houck Laboratories — *Electronics World*

“...a caliber of sound which should satisfy the most critical listener...”

*Hi-Fi/Stereo Review**

The experts enthusiastically support Peter Arnow's experience with the remarkable 340. Here is a tuner/amplifier that sets new performance standards. The unbeatable sensitivity of Scott tuners and the solid power of Scott amplifiers have been combined without compromise. Every worthwhile feature is here to satisfy the most demanding audio enthusiast — silver-plated, wide-band front end — oversized output transformers — aluminum chassis for low hum and cool operation. Auto-sensor circuitry swiftly and automatically switches the mode of operation to stereo when you tune to a stereo broadcast. Front panel indicator signals you when this happens.

The 340B may work like a laboratory instrument, but it doesn't look like one. The sculptured front panel, handsome new knobs, the easy-to-read slide-rule dial — will please the most fastidious decorator.

To sum up the merits of this exciting new instrument, in the words of Peter Arnow:

“The 340B is a remarkable achievement. It is extremely sensitive, comparable to the finest separate FM tuners

we've checked. The tuning action is the smoothest I've ever seen. Esthetically the 340B is a perfect piece of hi fi equipment; it performs like a dream! But then we've never had a piece of Scott equipment that didn't.”

SPECIFICATIONS:

Dimensions: 16 $\frac{3}{4}$ "W, 5 $\frac{1}{2}$ "H, 13 $\frac{5}{8}$ "D. Dimensions in accessory case: 17 $\frac{1}{2}$ "W, 6 $\frac{1}{4}$ "H, 16 $\frac{3}{4}$ "D. Tuner Section: Usable Sensitivity (IHF) 2.2 μ v; Signal: Noise Ratio (db below 100% mod) 60; Harmonic Distortion 0.8%; Drift 0.02%; Frequency Response (cps + 1 db) 20-20,000; Capture Ratio 6.0 db; Selectivity 35 db; Spurious Response Rejection 80 db; AM Suppression 55 db; Tuning Range 87 to 109 mc; Accuracy of calibration 0.5%; Separation better than 30 db. Amplifier Section: Music power each channel 35 watts; Steady state power each channel 30 watts; Power bandwidth (IHF) (\pm 1.0 db) 20-20,000; Harmonic distortion 0.8%; Hum and Noise 80 db. Price: \$399.95.

Prices slightly higher west of Rockies. Accessory cases extra.

*For the complete reviews from which these excerpts were taken, refer to *Electronics World*, Feb. 1963, and *Hi-Fi/Stereo Review*, June 1963.

NEW AM-FM MODEL 380



If you desire superb AM as well as FM Stereo reception, the new Scott 380 should be your choice. It provides Scott Wide-Range AM as well as all the features and performance of the 340B. Hirsch-Houck Laboratories acclaimed Scott's AM circuitry as "the finest . . . we know of on the current market." AM reception is virtually indistinguishable from FM thanks to Scott's bandwidth switch. Distant stations can be received with minimal noise and low distortion by moving the bandwidth switch to the distant position. Here is a tuner/amplifier that satisfies every requirement for varied program material combined with superb quality. **\$459.95**



SCOTT®

H. H. Scott, Inc.
111 Powdermill Road
Maynard, Mass.

Dept. 245-03

Send me complete information on the Scott 340B and your new 1964 Guide to Stereo.

Name _____

Address _____

City _____ Zone _____ State _____

Include names of interested friends, and we'll send them duplicate materials.

Export: Morhan Exporting Corp., 458 Broadway, N.Y.C.
Canada: Atlas Radio Corp., 50 Wingold Ave., Toronto

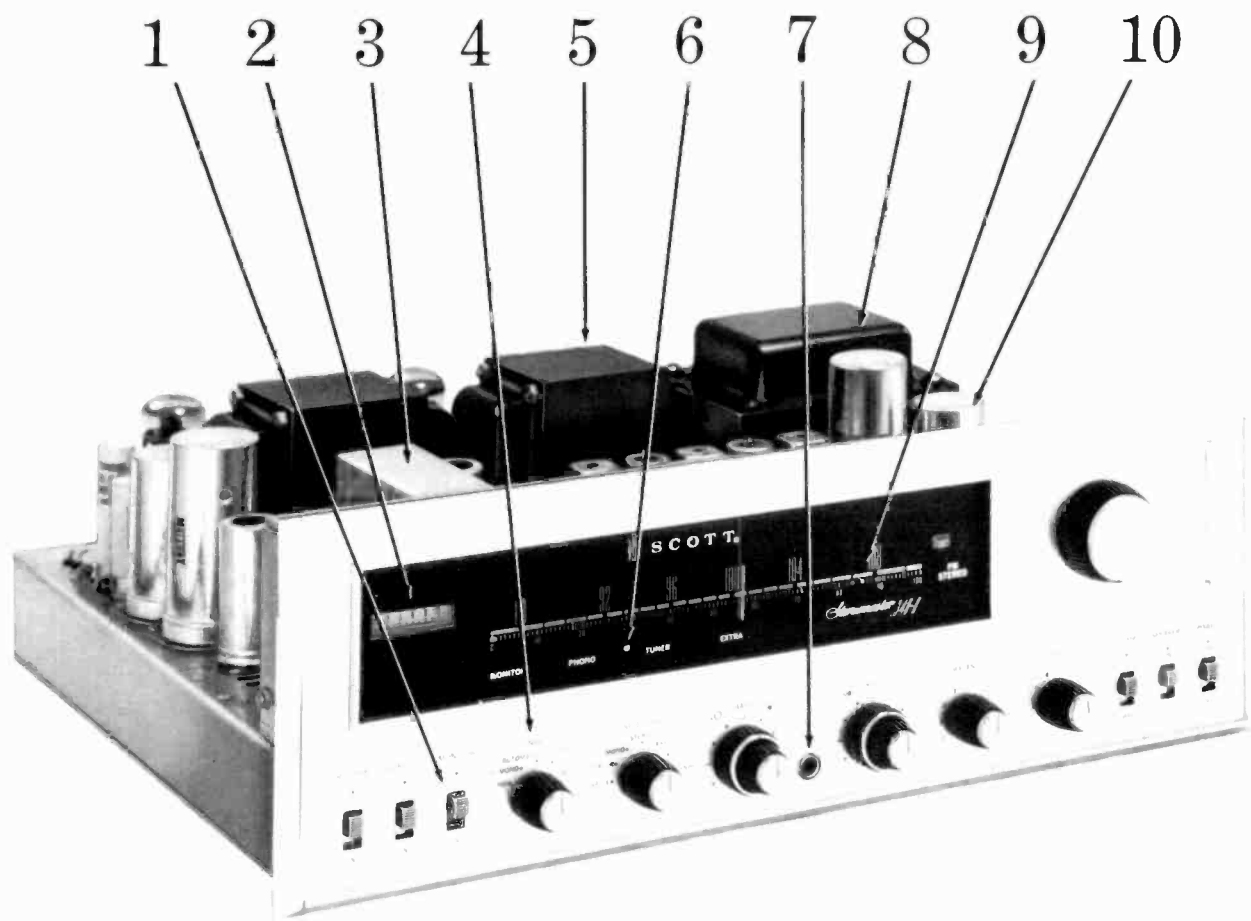

Unique Features of the Remarkable 340B

- 1 Complete tape monitoring facilities. All controls operate on playback.
- 2 Precision illuminated d'Arsonval meter for pinpoint tuning of all signals.
- 3 "Time-Switching" multiplex circuitry provides full frequency response with extremely low distortion. Separation exceeds FCC specifications.
- 4 Auto-Sensor circuitry instantly and automatically chooses correct mode of operation.
- 5 Powered third channel for direct connection of remote speakers or for a three-channel system.
- 6 Unique indicator lights prevent inadvertent use of Tape Monitor control.
- 7 Convenient front panel low level output for monitoring of program.
- 8 Massive power and output transformers to assure the superb performance ordinarily found only with separate components.
- 9 Easy-to-use, easy-to-read precision slide rule tuning mechanism, with convenient logging scale.
- 10 Silver-plated RF circuitry, the same used in the tuner selected by Bell Laboratories for one of their pioneering Telstar experiments.

***“The performance of the
340B was amazing!***

***It's the first tuner/amplifier
good enough to monitor
our broadcasts in
the canyons of Manhattan.”***

Peter Arnow, Director of New York's
pioneer multiplex station WDHA-FM



The remote broadcast station installation of WDHA-FM at the recent New York High Fidelity Show. Mr. Arnow, at the controls, is using the Scott 340B as a station monitor.

WDHA-FM faced a serious reception problem while operating remotely at the New York Hi Fi show. Signals from their transmitter located in Dover, N. J. were extremely difficult to receive due to the surrounding steel-framed buildings, and space was at a premium. Peter Arnow, the station's director, chose a Scott 340B for this critical task. He was able to make perfect off-the-air checks at this remote location.



A Tuner/Amplifier as good as separate components?

“YES”, says AUDIO about the Scott:

“...The Scott 340B...is a top notch tuner/amplifier...in fact a top notch tuner and a top notch amplifier...”

CIRCLE NO. 100 ON READER SERVICE CARD

consider this... with other units
now offering counterweighted tone arms,
oversized turntables, precision motors...
what makes the Garrard

so special?

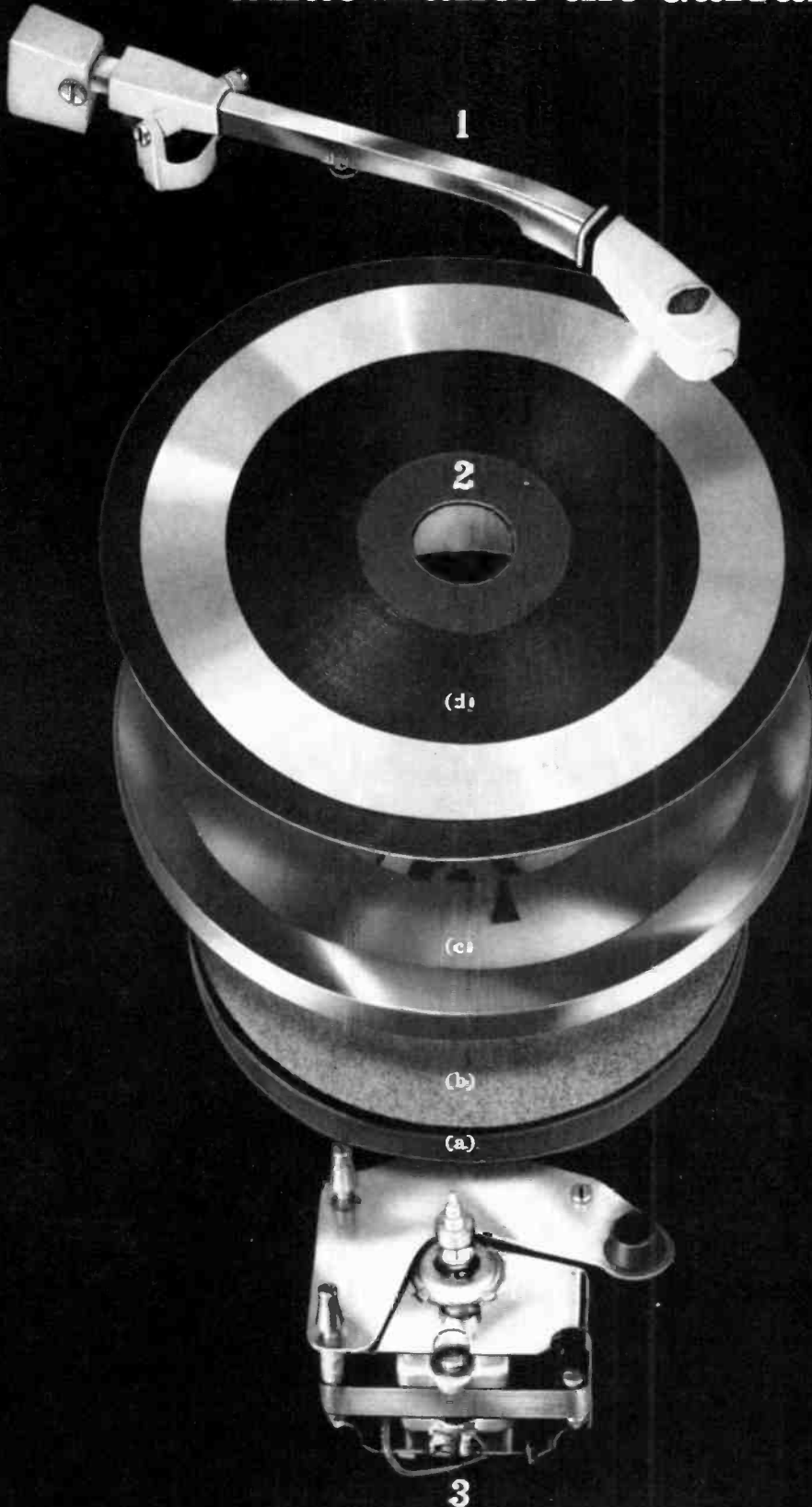

You see before you three parts of the great Type A Automatic Turntable:

1. The counterweight-adjusted, dynamically balanced tone arm (which tracks the cartridge of your choice at the pressure specified by the manufacturer)
2. The exclusive "sandwich" turntable system (a) inner drive table (b) sound-deadening foam cushion (c) heavy, cast, non-ferrous outer turntable (d) ribbed rubber mat... the entire assembly weighted and balanced for rumble-free, fly-wheel action.
3. The Laboratory Series® humless, noiseless, high-torque motor... developed for the Type A, engineered and built by Garrard.

However, these are only parts, and record playing units by other manufacturers offer some features reminiscent of these.

Then what makes the Garrard so special? Simply this... the Garrard is far more than the sum of its parts.

Creative engineering, rigid quality control, and 50 years of experience have joined together to make the Garrard an enduring source of satisfaction and pride to a legion of admirers.

You'll find the Garrard a genuine pleasure to own. Over the years, your dealer has found it the same pleasure to recommend. That's why more people continue to buy Garrard than any other high fidelity component. They buy it for precision, for performance and to enjoy the convenience of single and automatic play, both at their fingertips.

But mainly, they buy it because it's a Garrard, and those who really know fine equipment have confirmed that a Garrard is, indeed, something special.

There is a Garrard Automatic Turntable for every high fidelity system. Type A, \$79.50; AT6, \$54.50; Autoslim, \$39.50. For literature, write GC-124 Garrard, Port Washington, New York.



Garrard[®]
World's Finest

HiFi/Stereo Review

MARCH 1964 • VOLUME 12 • NUMBER 3

THE MUSIC

- 35** THE BASIC REPERTOIRE
Beethoven's Violin Concerto MARTIN BOOKSPAN
- 58** MR. DWIGHT'S DAUNTLESS JOURNAL, Part 2
Assessing a noble publishing experiment RAY ELLSWORTH
- 63** BEST OF THE MONTH
Reviews of outstanding new releases

THE EQUIPMENT

- 14** SOUND AND THE QUERY
Answers to your hi-fi technical questions LARRY KLEIN
- 26** AUDIO BASICS
Definitions, Part Two HANS H. FANTEL
- 29** TECHNICAL TALK
*Lab reports on the Heath AJ-43 AM/stereo FM tuner
and the Hadley 601 power amplifier* JULIAN D. HIRSCH
- 39** A CANDID GUIDE FOR TAPE-RECORDER SHOPPERS
How to select a recorder to meet your needs JOHN MILDER
- 45** TAPE-CARTRIDGE PROGRESS
A critic's evaluation of the two major systems MARTIN BOOKSPAN
- 49** RECORDING LIVE STEREO AT HOME
How to make professional-sounding tapes BENNETT EVANS
- 54** THE LONG-LONG-PLAYING TAPE RECORDER
Slow-speed tape makes haste HERMAN BURSTEIN

THE REVIEWS

- 69** CLASSICAL
- 95** JAZZ
- 105** ENTERTAINMENT
- 121** STEREO TAPE

THE REGULARS

- 4** EDITORIALY SPEAKING
- 6** LETTERS TO THE EDITOR
- 20** JUST LOOKING
- 130** ADVERTISERS' INDEX; PRODUCT INDEX

COVER PHOTO BY BRUCE PENDLETON

Copyright © 1964 by Ziff-Davis Publishing Company. All rights reserved. HI-FI STEREO REVIEW, March 1964, Volume 12, Number 3. Published monthly by Ziff-Davis Publishing Company at 434 South Wabash Ave., Chicago, Illinois 60605. Subscription rates: one year United States and possessions \$3.00; Canada and Pan-American Union Countries \$3.50; other foreign countries \$6.00. Second-class postage paid at Chicago, Illinois and at additional mailing offices. Authorized as second class mail by the Post Office Department, Ottawa, Canada, and for payment of postage in cash.

HiFi/Stereo Review

PUBLISHER
PHILLIP T. HEFFERNAN

EDITOR
FURMAN HEBB

MANAGING EDITOR
WILLIAM ANDERSON

MUSIC EDITOR
ROBERT OFFERGELD

TECHNICAL EDITOR
LARRY KLEIN

ART EDITOR
BORYS PATCHOWSKY

ASSOCIATE EDITOR
ROBERT S. CLARK

CONTRIBUTING EDITORS

CHRISTIE BARTER
MARTIN BOOKSPAN
HANS H. FANTEL
WILLIAM FLANAGAN
JOE GOLDBERG
DAVID HALL
NAT HENTOFF
JULIAN D. HIRSCH
GEORGE JELLINEK
IGOR KIPNIS
PAUL KRESH
GENE LEES

EUROPEAN EDITOR
FREDERIC GRUNFELD

ADVERTISING SALES MANAGER
LAWRENCE SPORN

ADVERTISING SERVICE MANAGER
ARDYS C. MORAN

ZIFF-DAVIS PUBLISHING COMPANY

Editorial and Executive Offices (212 Ortega 9-7200)
One Park Avenue, New York, New York 10016
William B. Ziff, Chairman of the Board (1946-1953)
William Ziff, President
W. Bradford Biggs, Executive Vice President
Herchel B. Sarbin, Vice President and General Manager
N. T. Hranitzky, Jr., Vice President and Treasurer
Robert P. Breeding, Circulation Director
Stanley R. Greenfield, Vice President
Phillip T. Heffernan, Vice President
Midwestern & Circulation Office (312 Wabash 2-1011)
431 South Wabash Avenue, Chicago, Illinois 60605
Advertising: Jerry Sweeney

Western Office (213 CRestview 4-0265)
9025 Wilshire Blvd., Beverly Hills, Calif. 90211
Western Advertising Manager: Bud Dean
Foreign Advertising Representative
D. A. Goodall Ltd., London, England
SUBSCRIPTION SERVICE: All subscription correspondence should be addressed to HiFi Stereo Review, Circulation Department, 431 South Wabash Avenue, Chicago, Illinois 60605. Please allow at least six weeks for change of address. Include your old address, as well as new—enclosing if possible an address label from a recent issue.
EDITORIAL CONTRIBUTIONS must be accompanied by return postage and will be handled with reasonable care; however, publisher assumes no responsibility for return or safety of art work, photographs, or manuscripts.

Member Audit Bureau
of Circulations



EDITORIALLY SPEAKING

by FURMAN HEBB

IT SEEMS appropriate to lead off this fifth annual tape-recording issue with a report on a tape recorder that will likely initiate a new era in home entertainment—the new British-designed Telcan *video* recorder. The following are Technical Editor Larry Klein's eye-witness impressions of the Telcan recorder.

For the past several months, readers of the technical press have been titillated by reports of a newly developed British tape recorder, called Telcan, that was supposedly capable of recording and playing back television pictures. Video recorders are nothing new, of course, but the Telcan unit was said to record pictures on standard 1/4-inch triple-play audio tape, and would have a selling price under \$200. Since detailed information on the unit was difficult to come by, many observers were somewhat skeptical. And so matters stood until Christmas week, when I attended a Telcan press showing in New York City and had a chance to see the unit in action.

In addition to using a standard audio tape, the Telcan unit even looks like a home audio recorder, but the machine's operating speed of 120 inches per second makes the 2-megacycle response claimed by Telcan's developers not quite the marvel that it appears at first glance. Theory indicates that at 120 ips a head gap of 50-60 microinches (such heads are now in production in the U.S.) will suffice to reproduce the 2-megacycle bandwidth claimed. The head has replaceable pole pieces, priced at about \$2, that must be replaced after 200 hours of use. It appears that a cross-field technique is used for recording, since the tape is threaded between two sections of the head.

Any standard television set can serve as the program source and playback unit for the recorder; the necessary interconnections can be made by a service technician in less than an hour. In addition, a television camera (which may be offered as part of a \$300 package) can feed the receiver and the recorder.

The reels employed are eleven inches in diameter and hold about 13,000 feet of tape. This permits twenty-two minutes of recording to be put on each of two tracks (one in each direction), for a total of forty-four minutes. Automatic reversal is to be provided. At present prices, an eleven-inch reel of triple-play tape should cost about \$30.

For the demonstration, the Telcan recorder was connected to a standard portable television receiver. After being switched on, it came up to speed in about five seconds, and a previously recorded program was played back. I found the image to be barely acceptable: definition and contrast were poor, and there was a considerable loss of picture detail. Another program was taped off the air, and its playback quality was about the same. Telcan was at its best when reproducing a well-lit, low-detail picture. Although I did not find the picture quality acceptable, a number of my colleagues at the demonstration did not share my negative reaction.

It is difficult to say at this time whether the Telcan recorder, in its present prototype form, produces the best quality that can be achieved with the techniques used, or whether improvements will be forthcoming. If Telcan can be substantially upgraded—even at double or triple its presently estimated price of \$200—it will be an exceptionally marketable product. Although as of this writing no U. S. manufacturing arrangements have been made, there are plans to have the recorder in retail stores by this summer.

Coming in April's HiFi/STEREO REVIEW—On Sale March 25

**A SPECIAL ISSUE ON BAROQUE MUSIC
INCLUDING
AN ACTUAL RECORDING OF GLENN GOULD'S
"SO YOU WANT TO WRITE A FUGUE"**

(Also see page 93)

COLUMBIA STEREO TAPE CLUB NOW OFFERS YOU

ANY 4 STEREO TAPES

of these exciting pre-recorded 4-track

\$5.98
FOR ONLY
Value up to \$39.80 at regular Club prices

if you join the Club now and agree to purchase as few as 5 selections from the more than 150 to be offered in the coming 12 months

THE BARBRA STREISAND ALBUM
Happy Days Are Here Again
A Sleepin' Bee
Cry Me A River
9 MORE
COLUMBIA

9034. Also: A Taste of Loving Arms, My Hero's Army, etc.

WEST SIDE STORY
Original Soundtrack
COLUMBIA Recording

9004. "The most adventurous musical ever made."—Life

TCHAIKOVSKY: SWAN LAKE Ballet Suite
ORMANDY
Philadelphia Orch.
Includes a Special Booklet and Rare Illustrations
COLUMBIA

9048. "A treat, a delight all over again."—N.Y. Journal-Am.

ANDY WILLIAMS DAYS OF WINE AND ROSES
plus
• Can't Get Used to Losing You
• My Coloring Book
• 9 more
COLUMBIA

9033. Also: What Kind of Fool Am I?, May Each Day, etc.

FREE—if you join now
REVOLUTIONARY SELF-THREADING TAKE-UP REEL



Just drop the end of the tape over this reel, start your recorder, and watch it thread itself! Unique Scotch™ process automatically threads up tape of any thickness, releases freely on rewind.

Cherry Pink AND Apple Blossom White
Jerry Murad's HARMONICATS
COLUMBIA

9060. Ramona, Ruby, Fascination, Mack The Knife, 12 in all

STRAVINSKY conducts The "FIREBIRD" COMPLETE BALLET
COLUMBIA

9047. "Brilliant performance... lush... rich."—Musical Amer.

JOHNNY'S NEWEST HITS
What Will Mary Say
That's The Way It Is - 10 MORE
JOHNNY MATHIS
COLUMBIA

9006. Also: Wasn't the Summer Short?, Marianna, etc.

The New ANDRE KOSTELANETZ
"Wonderland of Sound"
COLUMBIA

9015. Be My Love, Unchained Melody, Volare, 12 in all

DRFF: CARMINA BURANA THE PHILADELPHIA ORCHESTRA
soloists and chorus
ORMANDY conducting
COLUMBIA

9038. "Superb...best of many performances."—Wash. Post

TIME OUT THE DAVE BRUBECK QUARTET
COLUMBIA

9025. "It soars and swings... a breakthrough."—Playboy

LENER & LOEWE Camelot
RICHARD BURTON
JULIE ANDREWS
ROBERT GOULET
and Original Broadway Cast
COLUMBIA

9003. "Most lavish, beautiful musical; a triumph!"—Kilgallen

Rhapsody in Blue An American in Paris
Leonard Bernstein plays Gershwin
COLUMBIA

9035. "Fierce impact and momentum."—N.Y. World-Telegram

Themes for Young Lovers PERCY FAITH
I WILL FOLLOW YOU MY COLORING BOOK
RHYTHM OF THE RAIN
9 more
COLUMBIA

9022. Also: Go Away Little Girl, Up on the Roof, etc.

THE GIANTS OF JAZZ
• BRUBECK
• ELLINGTON
• DAVIS - MONK
• CONDON
• 10 others
COLUMBIA

9031. A truly definitive cross-section of the great combos

BEETHOVEN "Emperor" Concerto
RUDOLF SERKIN
BERNSTEIN
N.Y. Philharmonic
COLUMBIA

9058. Most exciting and thrilling of all Beethoven concertos

TONY BENNETT I Left My Heart in San Francisco
Tender is the Night
Smile - 9 more
COLUMBIA

9028. Also: Love for Sale, Candy Kisses, Mary Young, etc.

GREAT MOTION PICTURE THEMES EXODUS NEVER ON SUNDAY THE APARTMENT
plus 13 more
COLUMBIA

9030. Also: Smile, Some Like It Hot, Magnificent 7, etc.

REX HARRISON JULIE ANDREWS MY FAIR LADY
ORIGINAL CAST RECORDING
COLUMBIA

9001. The best-selling Original Cast recording of all time

The Versatile HENRY MANCINI AND HIS ORCH
LIBERTY

9009. Ebb Tide, The Breeze and I, Sleepy Lagoon, 12 in all

TCHAIKOVSKY Symphony No. 5 LEONARD BERNSTEIN
NEW YORK PHILHARMONIC
COLUMBIA

9057. "A wholly persuasive performance!"—N. Y. Times

MESSIAH
EUGENE ORMANDY
The Philadelphia Orchestra
THE MORMON TABERNACLE CHOIR
COLUMBIA

9044-9045. Two-Tape Set (Counts As Two Selections.) "Zestful... a powerful, vital statement!"—HiFi/Stereo Review

TWIN-PACK
Equivalent To Two Selections
COLUMBIA

Ray Conniff Singers SO MUCH IN LOVE
COLUMBIA

9008. Chances Are, Just Walking in the Rain, 12 in all

THE BLUE DANUBE
A Johann Strauss Festival
PHILADELPHIA ORCH. • ORMANDY
COLUMBIA

9042. "Performances that really sparkle and glow."—High Fid.

A FESTIVAL OF MARCHES
March of the Toredadors
American Salute
Stars and Stripes Forever
Meadowlands
9 more
COLUMBIA
PHILADELPHIA ORCH.
ORMANDY

9059. "Abundance of pulsing rhythms."—St. Louis Globe Dem.

FIRST TIME! DUKE ELLINGTON MEETS COUNT BASIE
COLUMBIA

9024. "Walloping ensembles and stirring solos."—High Fid.

THE NEW CHRISTY MINSTRELS with RANDY SPARKS
This Land Is Your Land
Nine Hundred Miles
12 MORE
COLUMBIA

9007. Also: Railroad Bill, Cotton Pickers' Song, Whistle, etc.

MARY MARTIN in RODGERS & HAMMERSTEIN'S THE SOUND OF MUSIC
COLUMBIA
with Original Broadway Cast

9002. A show that's "perfectly wonderful!"—Ed Sullivan

IF YOU ARE ONE OF THE FORTUNATE PEOPLE who own 4-track stereo tape playback equipment, you know the thrill of the near-perfect fidelity, the unsurpassed sound of tape. Now you have an exceptional opportunity to build an outstanding collection of superb stereo tapes at great savings through the most generous offer ever made by the Columbia Stereo Tape Club!

By joining now, you may have ANY FOUR of the magnificently recorded 4-track stereo tapes described here — sold regularly by the Club for up to \$39.80 — for only \$5.98!

TO RECEIVE YOUR 4 PRE-RECORDED STEREO TAPES FOR ONLY \$5.98 — simply fill in and mail the coupon today. Be sure to indicate which Club Division best suits your musical taste: Classical or Popular.

HOW THE CLUB OPERATES: Each month the Club's staff of music experts chooses outstanding selections for both Divisions. These selections are described in the Club Magazine, which you receive free each month.

You may accept the monthly selection for your Division . . . or take any of the wide variety of tapes offered in the Magazine to members of both Divisions . . . or take no tape in any particular month.

Your only membership obligation is to purchase 5 tapes from the more than 150 to be offered in the coming 12 months. Thereafter, you have no further obligation to buy any additional tapes . . . and you may discontinue your membership at any time.

FREE TAPES GIVEN REGULARLY. If you wish to continue as a member after purchasing five tapes, you will receive — FREE — a 4-track stereo tape of your choice for every two additional tapes you buy.

The tapes you want are mailed and billed to you at the regular Club price of \$7.95 (occasional Original Cast recordings somewhat higher), plus a small mailing and handling charge.

SEND NO MONEY — Just mail the coupon today to receive your four pre-recorded 4-track stereo tapes — ALL FOUR for only \$5.98!

IMPORTANT NOTE: All tapes offered by the Club must be played on 4-track stereo playback equipment. If your tape recorder does not play 4-track stereo tapes, you may be able to convert it simply and economically. See your local service dealer for complete details.

COLUMBIA STEREO TAPE CLUB Terre Haute, Ind.

SEND NO MONEY—mail coupon to receive 4 tapes for \$5.98

COLUMBIA STEREO TAPE CLUB, Dept 424-7
Terre Haute, Indiana

I accept your special offer and have written in the boxes at the right the numbers of the 4 tapes I would like to receive for \$5.98, plus a small mailing and handling charge. I will also receive my self-threading reel — FREE! Enroll me in the following Division of the Club:

CLASSICAL POPULAR

I understand that I may select tapes from either Division. I agree to purchase five selections from the more than 150 to be offered in the coming 12 months, at the regular Club price plus a small mailing and handling charge. Thereafter, if I decide to continue my membership, I am to receive a 4-track, pre-recorded tape of my choice FREE for every two additional selections I accept.

Name..... (PLEASE PRINT)

Address.....

City..... Zone..... State.....

This offer is available only within the continental limits of the U.S.

SEND ME THESE FOUR TAPES
(fill in numbers below)

48-IV

There's no smoke
like a pipe

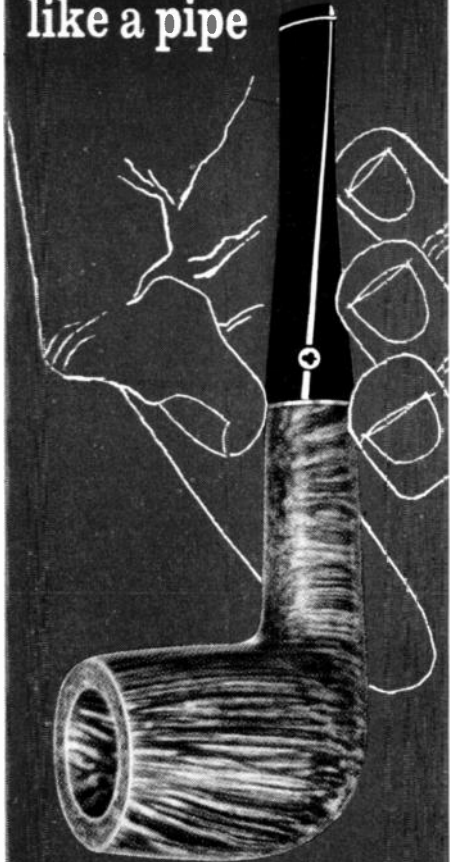

-no pipe like
KAYWOODIE

PIPES AND SETS
\$5.95 TO \$2,500.



Super Grain, Apple, \$7.95

Large pipe above: Straight Grain, Billiard, \$100.

New Kaywoodie Butane Lighter

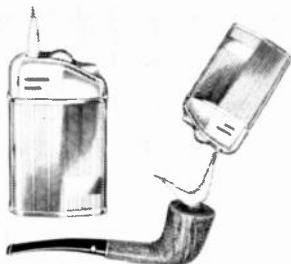

Specially designed for pipes as well as cigarettes. Upright for normal flame. Tilt for large soft flame that won't scorch your pipe. Only \$9.95 with free miniature Butane @Injecta-Refuel cartridge. Table model \$14.95. Guaranteed for life.

KAYWOODIE

Send 25¢ for 48-page catalog and sample of new imported Kaywoodie Tobacco. Tells how to smoke a pipe; shows all shapes and styles. Kaywoodie Pipes, Inc., New York 22, Department Z39.

CIRCLE NO. 30 ON READER SERVICE CARD

LETTERS TO THE EDITOR

Wagner—Man and Musician

● Frederic Grunfeld is, I believe, one of our best writers on music, a knowledgeable and cultured man. Thus, I am somewhat saddened by the distorted image emerging from his well-written article on Richard Wagner in the December 1963 issue of *HIFI/STEREO REVIEW*.

That Wagner was a rather objectionable character is now a matter of general knowledge. Equally established is the fact that this had no influence on the quality of his music, whose style and expressive content were created by the era in which he lived. Those who cannot stomach the music of the late Romantic period—and there are many who cannot—will reject most of Wagner's contemporaries as well.

Wagner's literary writings are often mediocre, sometimes bordering on the absurd, yet they left a considerable impact on the aesthetics of his time. His vision of the "*Gesamtkunstwerk*"—the complete integration of word, tone, and gesture in works for the musical stage—seems today a gross misconception of the principles governing great dramatic creation. Yet he solved the existing difficulties magnificently in his own works—the only man who ever succeeded where all his imitators failed. This makes his work unique, setting it apart from the general development of musical history. Unless one is willing to consider Wagner as a law unto himself, one cannot evaluate this man's work objectively.

For his dramas Wagner tried to create a poetically elevated language to fit the colossal dimensions of his vision. In this he failed. But there are those who claim that Thomas Mann—one of the greatest stylists of the German language—failed equally when he tried to create a special language for each of his great novels, making his writings "unreadable and undigestible" for many. We should also remember that the *Meistersinger* libretto is probably the only good *Lustspiel* or comedy in German literature, a remarkable achievement for any playwright.

The real Wagner craze began to subside before the end of the century, and by 1914 appreciation of his work had reached normal proportions. Since then the public, with few exceptions, has regarded him as one of our great composers, and nothing more. Even the attempt of the Nazis to exploit Wagner politically did not change this public attitude, and it is misleading to re-evaluate Wagner in terms of thirty years ago.

What remains today is a full appre-

ciation of a great composer's achievements, a process neither created nor accelerated by the realization of the man's enormous shortcomings. Mr. Grunfeld's picture is not objective but colored by antipathies that, of course, are understandable and shared by many.

FRITZ A. KUTTNER
New York, N. Y.

● Although one must acknowledge that Frederic Grunfeld's denunciation of Wagner (December) is based upon fact, I disagree with some of the conclusions he draws, and in particular feel that no one has the right to base value-judgments of music upon nonmusical criteria.

I am a music-lover, not a moralist, a psychologist, a sociologist, or a historian. The fact that Richard Wagner was an immoral and egotistical human being, who had an army of followers some of whom were even more despicable than he, cannot affect my opinion that Wagner wrote some of the most sensuous, scraphic, and exciting music I have ever

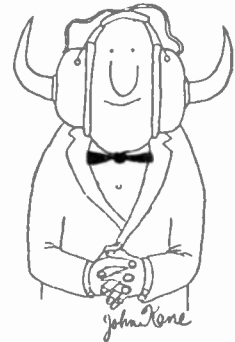

heard. Let those who wish avoid Wagner for any of the many musical reasons they may find, but let them not say "I dislike Wagner's music because he was a pan-Germanist, because he hated Jews, because he wore a tam!"

ROBERT BERBEC
Claremont, Calif.

● Mr. Grunfeld's mean-spirited attempt to denigrate the music and reputation of Richard Wagner has one definitive and compelling answer—the noble list of music-dramas and operas that will always move the emotions and stimulate the intellect. Whose life, be he great or small, could stand the kind of minute scrutiny, the assiduous search for fault that has always been the favorite way with the professional Wagner-haters? Aeschylus, Sophocles, Shakespeare, and

(Continued on page 8)

One-year subscriptions to *HIFI/STEREO REVIEW* may be purchased in Australian pounds (2/16); Belgian francs (310); Danish kroner (433); English pounds (2/4/6); French francs (31); Dutch guilders (22); Indian rupees (31); Italian lire (3,000); Japanese yen (2,100); Norwegian kroner (43); Philippine pesos (25); South African rand (4.50); Swedish kroner (33); Swiss francs (27); or West German marks (23). Ziff-Havis Publishing Company also publishes *Popular Photography*, *Popular Electronics*, *Electronics World*, *Popular Boating*, *Car and Driver*, *Flying*, *Modern Bride*, *Amazing*, and *Fantastic*.



PHOTOGRAPHED IN NEW YORK SHOWROOM OF OUA INCORPORATED

WHO WANTS TO
SEE A TAPE RECORDER
IN A LIVING ROOM

?
YOU DO
(if it's Miranda®!)



Two magnificent new stereo tape recorders featuring major electronic advances... plus the beauty of genuine teakwood cabinetry!

MIRANDA Sorrento Sophisticated solid-state circuitry, comprising an impressive array of 21 transistors and 19 diodes. Electronic matrix-type push-button switching positively and instantaneously controls every mode of tape transport. Tape-handling mechanism includes automatic tape lifters and tension bars. Other features include: built-in 4" x 6" full range dual speakers, automatic shut-off for motors and amplifiers, three motors plus servo motor for remote control, illuminated VU meters, pause switch, electronic switching delay, 3 $\frac{3}{4}$ " and 7 $\frac{1}{2}$ " ips., records and plays 4-track stereo. *Priced at \$400.00*

MIRANDA Nocturne Hysteresis synchronous motor assures unflinching constancy in tape movement. Smoothly operating push-button controls make it a pleasure to operate. Each channel is provided with individual volume and tone controls, VU meter, two input jacks, output jacks for external speakers. Single switch allows the Nocturne to be used for either stereo or mono playback. Ten clean actual watts of audio power (5 per channel) plus matched 4" x 6" speakers give rich, full-bodied reproduction. The Nocturne records and plays 4-track stereo and mono in 1 $\frac{7}{8}$ ", 3 $\frac{3}{4}$ " and 7 $\frac{1}{2}$ " ips. *Priced at \$250.00*

SORRENTO REMOTE CONTROL: All tape transport controls plus separate channel volume controls, and 16 ft. cable. *Priced at \$35.00*

At last... the first truly practical design in tape recorders. Miranda is housed in genuine teakwood cabinetry that blends with and enhances any decor. No glaring chrome trim... no jagged outline disturbs its simple, classic elegance. More than a fine tape recorder, Miranda is also a fine piece of furniture that you can display with pride. Write for free literature to Dept. HFSR-3.

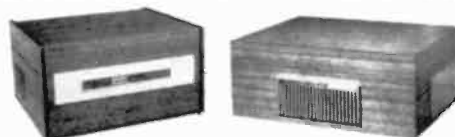

REGISTERED BY ALLIED IMPEX CORP., EXCLUSIVE U.S. IMPORTER
DALLAS 7, TEXAS * LOS ANGELES 16, CALIFORNIA

All
new
from
Sony



a stereo
deck
with
3 heads!



and
stereo
recording
amplifier

Now you can add famous Sony 4 track stereo tape playback to your present hi fi system. Handsomely styled in gold and grey, with 3 heads, 2 speeds, vertical or horizontal mounting, automatic shut-off, tape counter and pause control, the new Sony 263-D is a remarkable value.

Less than \$119.50

For stereo recording, add the new Sony SRA-2L recording amplifier that instantly connects to the 263-D. Its matching gold and grey decor makes a handsome companion for your 263-D. All new from Sony!

Less than \$99.50

■ All Sony Stereorecorders are Multiplex Ready! ■ In New York visit the Sony Salon, 585 Fifth Avenue
■ For literature or name of nearest dealer write Superscope, Inc., Dept. 8, Sun Valley, California.

SONY SUPERSCOPE

The Tapeway to Stereo
CIRCLE NO. 51 ON READER SERVICE CARD

Goethe, to name but a few with whom Wagner ranks in the annals of towering creators, had their detractors who delighted in diminishing these cultural heroes by their views through the wrong end of the telescope. But it is a pity that your magazine had to waste space on such a tired rehash of the anti-Wagner clichés as Mr. Grunfeld's.

RICHARD T. ANDREWS
San Antonio, Texas

● Mr. Grunfeld's article seems to call attention to the defects of Wagner's *Ring* dramas as unique, and of his character as special to him. In truth, the faults of the dramas are the faults of opera as an art form, and Wagner's character was typical of composers of his class and time.

The article says that the music dramas' weakest points were the plots and the language. But these defects seem to be inherent in all opera. Religiosity, the myth, and magic have been part and parcel of opera since its beginnings, so why gag at *Parsifal*? And Hanslick's statement that the music dramas' librettos

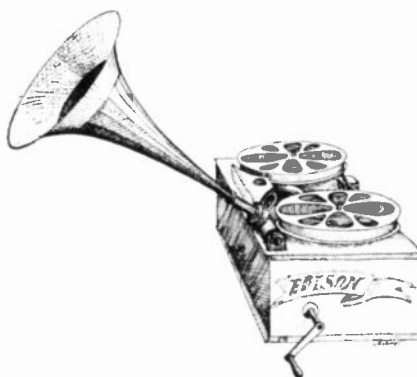

could not stand as theater, unsupported by the music, is true of all opera—most librettos are incredibly poor.

Wagner's defects of character were no doubt numerous, but artists in general and composers in particular have never been notable for morality or stability of character. Wagner's lack of principle was no more offensive than that of Massenet, Debussy, Tchaikovsky, Moussorgsky, or Puccini, to name but a few. And Wagner's nationalism is no greater than that of the Russian school, past and present—his political absurdities do not equal those of Shostakovich, for instance.

TWIFORD C. WILSON
Los Angeles, Calif.

● I find Frederic Grunfeld's "Wagnerdämmerung" cheap and sensational, one more attempt of the Beckmessers of this world to sling slime at a great genius. I hope you will publish an article that will truly evaluate Wagner's contribution to music and all the performing arts. It would point out that the major opera houses now give Wagner's operas without cutting or revision, whereas the librettos of Verdi and Mozart are drastic-

ally revised and cut; and that it was Wagner's criticism and example, mocking the old song-recital "opera" decorated with sets, costumes, and the thread of an absurd story, that paved the way dramatically, musically, and structurally for Richard Strauss and Puccini. Wagner was of the nineteenth century, but he alone of that age points the way in the twentieth. Does Frederic Grunfeld mistake dawn for dusk?

DAVID DODGE
Talesin West, Ariz.

Mr. Grunfeld replies: "By the sound of the outraged Hoyototos, it seems that I have, unawares, stepped on some sacred toes—of clay, presumably, and fragile. I only want to point out, however, that my article was NOT a critique of Wagner's music but a (reasonably) objective account of that curious state of mind known as Wagnerism—how it grew, flourished, and ultimately declined (though it evidently isn't as dead as I thought).

"The music, in any case, must stand or fall on its own merits; what interested me was the use—or misuse—of music as the object of a cult. I did not invent the cult or its history. It was Wagner and his followers who chose to turn art into a social and political weapon, yet the Wagnerites are always first to cry foul if their movement is criticized on any but aesthetic grounds. Moreover, Wagnerism has been an extremely narrow, destructive influence, responsible for the suppression of important works by composers who did not conform. In Liszt's case, for example, it will take a century to undo the damage wrought by Wagner's partisans. The Wagnerism balloon, as these letters testify, has a tendency to reinflate itself, and periodically the record must be set straight to keep it deflated. So—phhhhhhhfffft!"

Musicians' Foundation

● Through the kindness of Miss Rose Bampton and Mr. Walter Toscanini, The Musicians' Foundation, Inc., is able to offer several rare recordings to contributors to its fund for needy musicians.

The Musicians Foundation, Inc., was founded in 1914 by the New York Musicians Club, "The Bohemians," to assist professional musicians and their families when the musician cannot work, temporarily or permanently, because of age, sickness, or infirmity. Grants are made after careful and confidential investigation. Every year the number of musicians to whom we extend our services increases greatly, and our resources are severely strained. For this year's fund drive, Miss Bampton and Mr. Toscanini have graciously made available to us pressings of noncommercial recordings originally intended for their friends. With a donation

(Continued on page 12)

No matter how much you've paid for your high fidelity stereo equipment, you'll never discover its full potential until you've played a Command record on it!

SPECIAL OFFER
COMMAND SAMPLER ALBUMS
 NOT AVAILABLE IN STORES



POPULAR

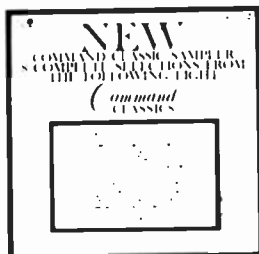

CLASSICAL

The ultimate excellence of performance depends on the record itself. You can get no more from your equipment than the quality and sound of the record being played. To demonstrate the incredible realism in sound Command brings to any stereo set, Command has just released two new special sampler albums.

Discover for yourself how Command helps you enjoy the full potential of musical sound, sound that is virtually free of all mechanical noises, sweeping in its magnitude, astounding in its clarity . . . unbelievably realistic!

Mail coupon below for your sampler albums.

MAIL COUPON TODAY

Command Record, Dept. 32-HSR
 1501 Broadway, New York 36, N.Y.

Please send me the Command Sampler Albums I have checked below, plus the FREE full color brochure of all Command releases. I understand Command pays all postage and handling.

- POPULAR SAMPLER** ... \$2.98 ea. (12 Selections from 10 different Command Popular Albums)
- CLASSICAL SAMPLER** ... \$2.98 ea. (8 Selections from 8 different Command Classical Albums)
- SPECIAL OFFER** (Both Popular and Classical \$5.00)

Please Check: STEREO MONAURAL Enclosed is \$.....

Name _____

Address _____

City _____ Zone _____ State _____

the most
versatile selection
of tape decks
in music history...
bar none!

REVERE-WOLLENSAK PRESENTS four different tape decks . . . four unique custom music applications . . . four of the finest designed and constructed instruments you can buy. Whatever your taste in tape, one of these magnificent custom installations will not only satisfy, but excel even your fondest music expectations. Both the two Wollensak reel-to-reel units and the exciting new Revere Cartridge Systems incorporate traditional long term reliability, ease of operation and precision performance that assure unequaled sound reproduction. Looking for the best in custom installations? You'll find them on the next page. Then take your pick . . . at your nearest Revere-Wollensak dealer.



WOLLENSAK 1981 "SOUND ROOM" STEREO TAPE DECK Designed for the serious tape recordist, incorporating two new module-type recording and playback amplifiers which provide 22 watts output. Superb stereo or mono recordings can be made from any sound source. Vertical or horizontal operation . . . 2 VU recording meters . . . tab control tape drive, speed selection . . . sound on sound and sound with sound . . . digital tape counter . . . automatic tape lifters . . . complete professional sound advantages. **SIZE:** 21½" x 13¾" x 9 5/16". **WEIGHT:** 42 pounds.

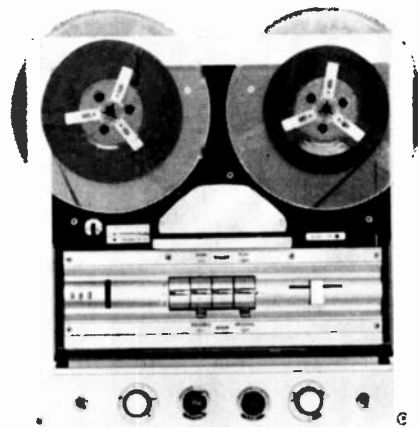

WOLLENSAK 1780 STEREO TAPE DECK For the sound perfectionist who wants to incorporate top quality Wollensak stereo recording and playback facilities in an existing sound system, but does not require playback amplifiers and speakers. Installed either vertically or horizontally. Dual matched record/playback preamplifiers . . . sound with sound . . . cadmium steel enclosure with chrome trim . . . easy-to-operate tab controls . . . volume control for each channel . . . automatic shut-off . . . automatic tape lifters . . . many more outstanding sound-on-tape features. **SIZE:** 13¾" x 14" x 5½". **WEIGHT:** 15 pounds.

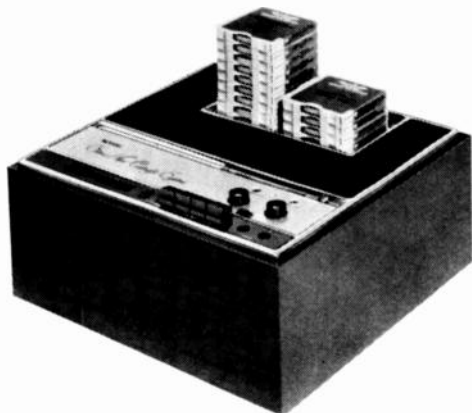

REVERE M20 STEREO TAPE CARTRIDGE DECK (RECORD/PLAYBACK) The newest idea in music now for custom installation! This amazing machine threads, plays, rewinds, changes tapes automatically. Up to 15 hours of uninterrupted music just by touching a button. Dual record/playback preamplifiers (minus power amplifiers and speakers). Record in stereo or mono from any sound source, or choose from a wide assortment of pre-recorded tapes. Keyboard controls . . . digital tape counter . . . high speed search lever . . . automatic and delayed shut-off . . . unsurpassed sound-on-tape reproduction. **SIZE:** 13 11/16" x 13 13/16" x 7". **WEIGHT:** 32 pounds.

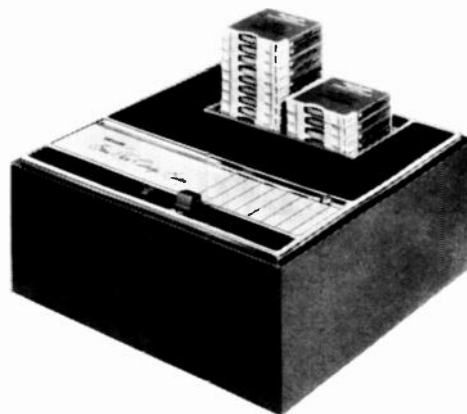

REVERE M30 STEREO TAPE CARTRIDGE DECK (PLAYBACK) The tape player even more convenient than an automatic record player, designed for the custom music aficionado who requires playback only. A beautifully made unit that threads, plays, rewinds, changes tapes automatically! Dual playback preamplifiers (minus power amplifiers and speakers). Simple one key operation that allows up to 15 hours of superb uninterrupted stereo sound. The Revere System is the most exciting development in tape recording history . . . the most automatic means of enjoying stereo tape reproduction at its finest. **SIZE:** 13 11/16" x 13 13/16" x 7". **WEIGHT:** 32 pounds.

Revere-Wollensak Division
ST. PAUL, MINNESOTA 55119





RISÉ STEVENS

Applauds the "Better, Clearer, More Natural Recording Quality" of

RE **Tandberg**®

Model 74/3 speed • 4 track
Complete Stereo
Music System

The sheer brilliance of recording quality . . . from any source, is one of many reasons why the celebrated Miss Stevens favors Tandberg. Add to this the clean, crisp playback and such features as: FM Multiplex Filter, new pause control, "free" position tape threading, precision laminated heads, 4 pole asynchronous motor, lowest tape tension, and a virtual lack of wow and flutter. You, too, will then discover why Tandberg is rated the number 1 quality choice by everyone.

ONE YEAR GUARANTEE

AT FRANCHISED DEALERS
EVERYWHERE . . . \$449.50

RE **Tandberg**® OF AMERICA, INC.,

P.O. Box 171, 8 Third Avenue, Pelham, N. Y.

CIRCLE NO. 53 ON READER SERVICE CARD

12

of \$20 or more, a contributor can receive a long-playing two-disc set of Richard Strauss' complete opera *Daphne*, recorded at the September 1948 performance at the Teatro Colon, Buenos Aires, under the direction of Erich Kleiber, with Rose Bampton, Set Svanholm, and others. With a contribution of \$10 or more, a donor can receive one of the following special 15-rpm 12-inch recordings of Arturo Toscanini performances: Rossini's Sonata No. 3 for Strings backed by Vivaldi's Concerto Grosso in D Minor (*L'Estro Armonico*); Bach's Brandenburg Concerto No. 2 backed by the Bach-Respighi Passacaglia and Fugue in C Minor; or a 33 $\frac{1}{3}$ -rpm 12-inch disc of *Three Songs* by Ildebrando Pizzetti sung by Rose Bampton, accompanied by the Curtis String Quartet, backed by the Brahms String Quintet in G, Opus 111.

Still available are a few copies of the recording "A Memorial Tribute to Arturo Toscanini," which includes excerpts from rehearsals of Beethoven's Ninth Symphony, the *Magic Flute* Overture, and other works. A request for this recording may accompany a minimum contribution of \$25. Contributions are tax-deductible. Checks should be made payable to The Musicians Foundation, Inc.

CLYDE BURROWS, SEC. AND TREAS.
Musicians Foundation, Inc.
131 Riverside Drive
New York, N. Y. 10024

Apostate

● Congratulations to Nat Hentoff for the insight revealed in his December review of Oscar Peterson's "Affinity." His dissenting view, that Peterson is not a god—as most young piano players like myself have been led to believe—opens new vistas for me. Having striven for many years to approach Peterson's technique, I feel I have become a fair technician yet, unhappily, a pianist with no emotional projection. Mr. Hentoff's review persuaded me that I can and should break away from the cult of Oscar Peterson. I should have done it years ago. I hope the *Down Beat* conformists don't burn Hentoff at the stake.

PHIL LEVERING
Batavia, Ohio

McCormack Society

● Word has reached me that a few of your readers have had letters to the John McCormack Society of America returned, apparently because they were addressed to me and did not mention the name of the Society on the envelopes. No such problems will be encountered if correspondents simply include both the Society's and my name in the address. Use of our postal box number 131 will also help guarantee prompt receipt and reply to inquiries.

FREDERICK M. MANNING
Drexel Hill, Pa.

HERE'S ONE WAY TO
COOL A HOT AMPLIFIER



but
here is a
BETTER WAY



Only
\$14.85

the ROTRON

Whisper Fan
KIT

Beat the heat that wrecks the set by installing a Rotron Whisper Fan Kit. Breathing 60 cubic feet of cool air over, under and around every heat-generating component, the Whisper Fan improves performance by minimizing drift due to temperature change within the enclosure. Requires only 7 watts, just pennies a week to operate. Measuring only 4 $\frac{1}{2}$ " square and 1 $\frac{1}{2}$ " deep, it can be set in a corner or mounted on the rear panel in minutes. Comes complete with mounting hardware, plug and cord for electrical connections and installation instructions.

Write for details
or see your local dealer.



ROTRON mfg. co., inc.
WOODSTOCK, NEW YORK
ORiote 9-2401

CIRCLE NO. 82 ON READER SERVICE CARD
HIFI/STEREO REVIEW

To fulfill every musical requirement
in a home music system

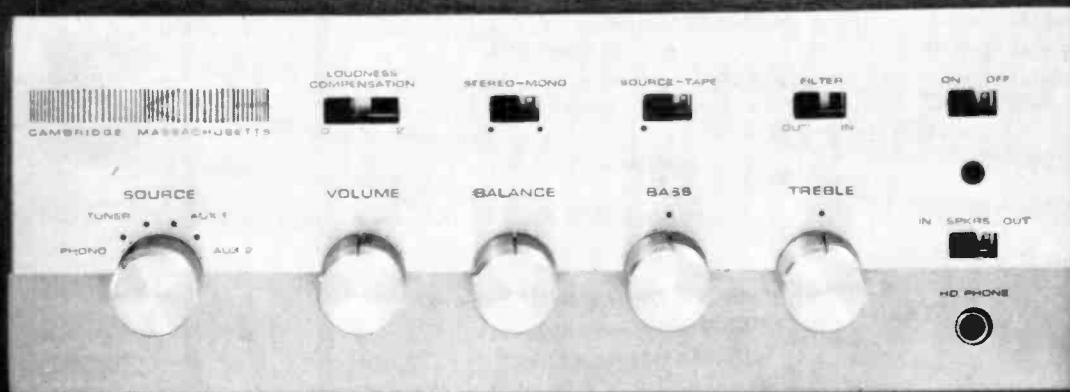

The KLH Model Sixteen Transistorized Integrated Music Amplifier

- The Model Sixteen will satisfy every musical requirement of the knowledgeable home listener, even if he is quite willing to spend more
- 22 transistors, 8 diodes
- 45 watts music power (35 watts steady state) per channel into 8 ohms.
(2 to 3 db less into 4 or 16 ohms)
- Complete protection against accidental shorting or opening of speaker leads
- Controls: On-Off, Program Source, Volume, Balance, Bass, Treble, Loudness Compensation, Stereo-Mono, Tape Monitor, High Frequency Filter, Speakers In-Out
- Inputs: Phono, Tuner, Tape, Aux. 1, Aux. 2
- Outputs: Speakers, Record, Headphones
- Dimensions (in cabinet): 5-1/4"H x 12-9/32"W x 9-5/8"D
- Guaranteed (parts and labor) for 2 years in normal use
- \$219.95; Oiled walnut cabinet \$19.95. Slightly higher in the west

The Model Sixteen is a newly developed, transistorized, stereophonic amplifier-preamplifier, designed to satisfy, without compromise or quibble, the requirements of the great majority of listeners who want high quality music reproduction in their homes. Through a careful selection of the performance characteristics essential to the reproduction of music, and a full exploitation of the advantages now available through the use of transistors, we have been able to produce an amplifier which is moderate in price, yet will meet the needs of listeners who insist on the highest quality. The Model Sixteen is uniquely compact in size, light in weight and simple to use. Since its performance will not deteriorate with use, it is reliable beyond the potential of any tube amplifier. There is no inherent aging process that will cause a transistor to wear out, as vacuum tubes do. Most important of all, the Model Sixteen sounds, while playing music at the same relative levels heard in the concert hall, indistinguishable from the most expensive amplifiers available.

Completely Transistorized

The Model Sixteen delivers the peak load performance and the trouble-free dependability that are now possible with the development of sophisticated solid state devices. It is no accident that the Model Sixteen was created by a company which has already made more high quality transistor amplifiers than all other component manufacturers combined.

KLH designed it. KLH builds it.

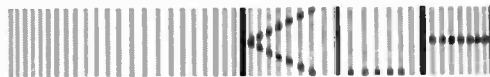

KLH RESEARCH AND DEVELOPMENT CORPORATION
30 CROSS STREET, CAMBRIDGE 39, MASSACHUSETTS

S&Q

SOUND AND THE QUERY

PRACTICAL POINTERS ON THE INSTALLATION AND MAINTENANCE OF HOME MUSIC SYSTEMS

BY LARRY KLEIN

Tuner Output Level

Q. My tuner has a very large audio output and no level control. When I switch from phono to tuner without first turning down the amplifier's volume control, blasting occurs. Is there a simple circuit change I could make that would eliminate the problem?

PERRY MARIS
Arlington, Va.

A. By installing a two-resistor network at the tuner's output jack, you can reduce the audio signal to about 1/10 its original voltage. The tuner's signal-to-noise ratio will not be affected, since its noise will also be reduced by the same factor. If the attenuation is greater than desired, the 100K (100,000-ohm) resistor can be changed to a 68K, 47K, 33K, or 10K resistor for output voltages approximately 1/8, 1/6, 1/4, or 1/2 the original voltage. If there is a capacitor connected

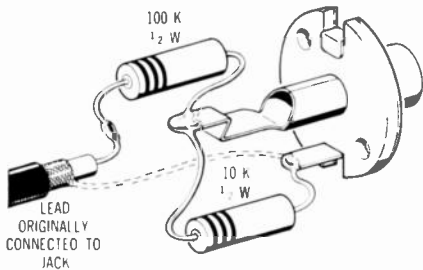

between the lead and the jack, do not remove it; install the resistors on the jack side of the capacitor. If the 100K resistor is reduced to a low value (such as 10K or 33K), it may be necessary to double the value of the capacitor to eliminate bass loss in the output signal. The same type of signal attenuator can also be installed at a tape-recorder's output jack if needed.

Equipment Recommendations

Q. In your opinion, what would be the best tape recorders in the \$200, \$300, and \$400 categories? Also, I would like to know what is the best stereo FM tuner priced at under \$200.

IRWIN MOONEY
Brooklyn, N. Y.

A. The above letter is typical of dozens addressed to Julian Hirsch and myself each month. We do appreciate the confidence readers show in us by asking for our advice on high-fidelity equipment. However, as much as we would like to be of assistance, we cannot honestly evaluate or recommend a piece of equipment without extensive

laboratory testing. It would obviously be unfair to rate equipment on hearsay, manufacturer's advertising copy, personal prejudices, or on any basis other than an objective laboratory test. When we undertake a report on a piece of equipment, the results are presented in HiFi/STEREO REVIEW. The December issues index all equipment reports published in the preceding year; most back issues are available from Mailers Fulfillment Company, 589 Broadway, New York 12, N.Y., at a cost of 65 cents each.

Tape-Recording Publications

Q. I'm interested in expanding my knowledge of tape recording on both practical and technical levels. Can you suggest some inexpensive publications that might be helpful?

PETER LESLIE
Marlboro, N. J.

A. Listed below are a number of inexpensive soft-cover books intended for the hobbyist. All are available from large electronics-parts supply houses or directly from the publishers.

"Elements of Tape Recorder Circuits," by Burstein and Pollack; Gernsback Library, 153 W. 14 St., New York 11, N. Y.; 233 pp., \$2.90. This is the most technical of the books in this list, and it assumes that the reader has some knowledge of basic electronics. Recorder circuits are explained in terms of their problems and the design solutions to them. Ideal for an in-depth understanding of tape recorders and their circuits.

"Getting the Most out of Your Tape Recorder," by Burstein; John F. Rider Publisher, 116 W. 14 St., New York 11, N. Y.; 179 pp., \$4.25. Written for the nontechnical audiophile, this book is divided into four sections: (1) factors to be considered before purchase, (2) accessories for the tape recorder, (3) electrical performance, and (4) stereo considerations. Although the technical depth here is somewhat greater than is found in the usual beginner's book, the interested audiophile should have no difficulty with the concepts.

"ABC's of Tape Recording," by Crowhurst; Howard W. Sams & Co., 4300 W. 62 St., Indianapolis, Ind. 46200; 95 pp., \$1.50. As its title indicates, this is a book written for the beginner. It has six chapters, one of which is devoted to a well-written discussion of basic tape-recording
(Continued on page 16)

The New Empire Grenadier

Divergent Lens Speaker System

Exclusive Sonic Column — Totally Rigid Without Resonance. Two years in the making . . . the Grenadier's shape is a function of its performance . . . its performance, an achievement of design. Virtually, no matter where or how you listen, the new Empire Grenadier gives you acoustically flat frequency response.

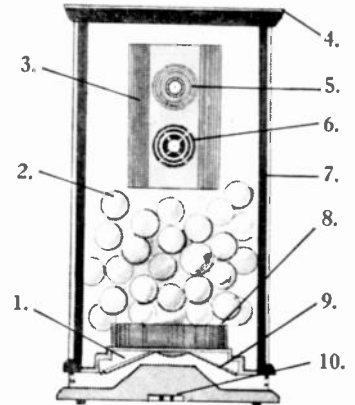

1. Mass loaded woofer with floating suspension and four inch voice coil.
2. Sound absorbent rear loading.
3. Die-Cast Mid Frequency-High Frequency Full Dispersion Acoustic Lens.
4. Polyester Laminate surface.
5. Ultra-Sonic Domed Tweeter.
6. Full Presence Mid Range Direct Radiator.
7. Totally damped acoustic fibre enclosure.
8. World's largest speaker ceramic magnet structure (18 lbs.).
9. Front loaded Horn with 360° aperture throat.
10. Terminals concealed underneath.

Freedom From Distortion. A unique combination of electrical and acoustical cross-overs and cutoffs avoid woofer cone break-up and mid range response dips. The woofer, mid range and tweeter combine at mathematically correct crossover frequencies.

Aesthetically Designed to fit any decor . . . from warm elegance to stark modern. Fits in corners or against walls. Truly a beautiful and functional achievement of sight and sound.

See & Hear the Grenadier today . . . visit your Hi Fi dealer. Grenadier Price: \$180.

Technical Specifications Model 8000 — Frequency Response: 30-20,000 cps • Nominal Impedance: 8 ohms • Power Handling Capacity — Music Power: Maximum undistorted 100 watts • Sine Wave Power: 30-450 cps 60 watts • 450-5000 cps 40 watts • 5000-20,000 cps 20 watts • Components — Woofer: 12 in. High Compliance with 4 inch voice coil • Mid Range: Direct Radiator • Hi-Frequency Ultra Sonic Domed Tweeter • Mid & Hi coupled to Die-Cast Acoustic Lenses • Overall Dimensions — Dia. 15 1/4" x Ht. 29" • Weight 65 lbs. • Rich Satin Walnut Finish with Mar Proof and Stain Proof Surface.

Write for complete literature.

EMPIRE

"World's Most Perfect High Fidelity Components"

Empire Scientific Corp. • 845 Stewart Ave., Garden City
Export EMFC, Plainview, L. I., N. Y. • Canada, Empire
Scientific Corp., Ltd. 1476 Eglinton West, Toronto

The New Empire
Grenadier
 Divergent Lens Speaker System

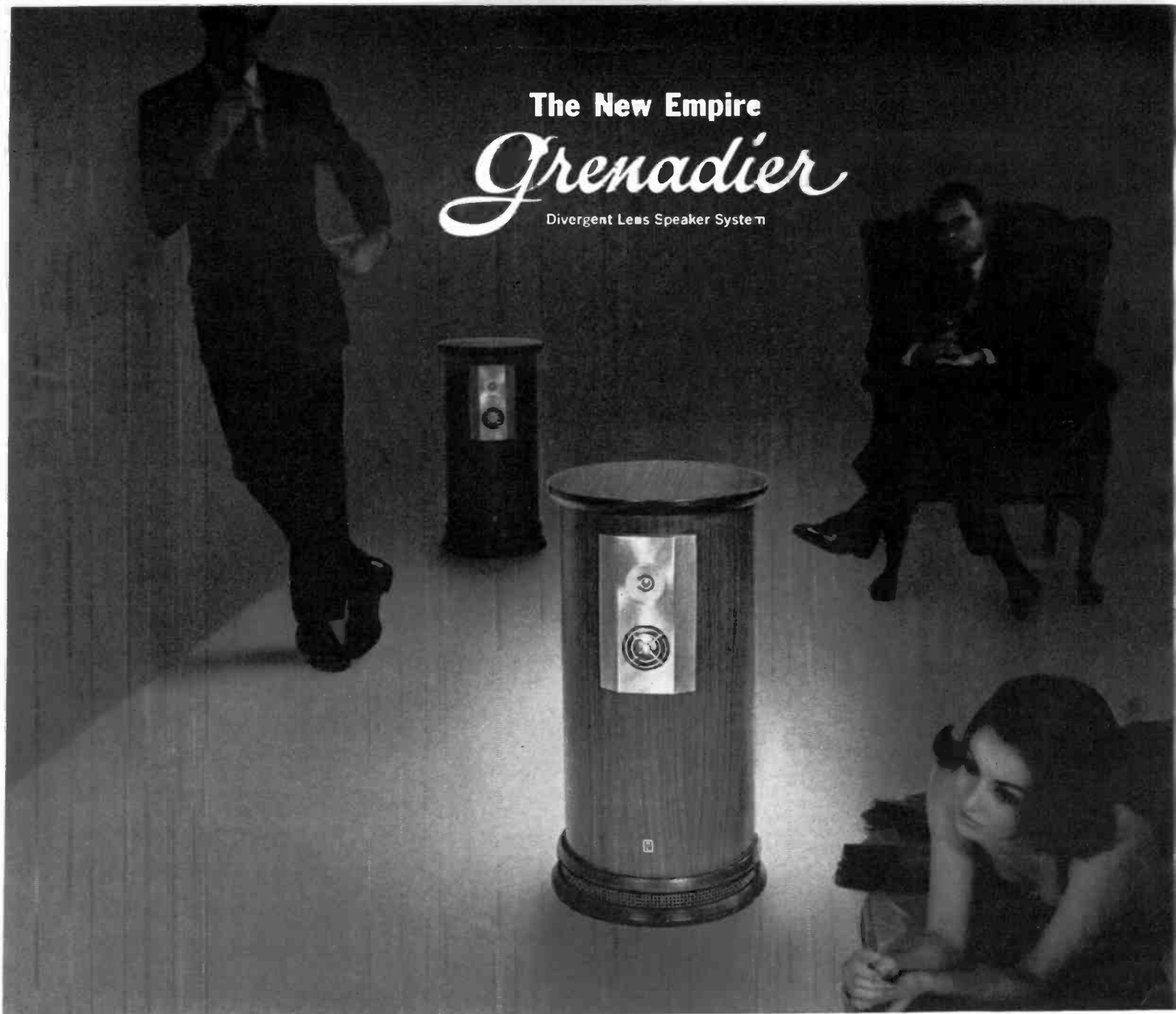

Lets you sit anywhere— Hear everything

The first speaker system designed and engineered for stereophonic sound. Three acoustic lenses allow you to enjoy phenomenal stereo separation and the highest fidelity of music anywhere in the room. Speaker placement non-critical.



The Empire Grenadier cabinet gives you discipline of sound while virtually eliminating cabinet vibration. Formed from acoustic material and completely wrapped with walnut to delight the eye.

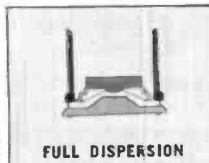

A downward woofer, close to the reflecting floor surface, feeds through a front-loaded horn with full circle aperture throat. This provides 360° sound dispersion and prevents standing waves.



The full presence mid-range direct radiator and the low-mass ultrasonic domed tweeter in combination with the die-cast divergent acoustic lens, achieve broad sound propagation.

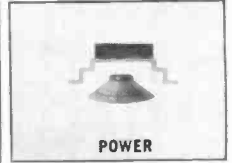

Massive three driver magnetic structure totaling one million lines of force produces the needed high efficiency, yet handles up to 100 watts of music without overload or burn-out.



Command Performance at your fingertips ...

... every time you capture the magnificent world of full fidelity sound on tape.

Taped sound retains full fidelity even after hundreds of playbacks ... yours to enjoy always ... on VIKING tape components, naturally.

A VIKING invests you with unlimited versatility to record live programs or off the air including F.M. multiplex, duplicate, put sound on sound and edit with perfect ease.

Retro-matic 220 — ultimate performance with tomorrow's features for discriminating audiophiles and professionals only.

Two-directional playback, quarter track stereo at two speeds. "Feather-touch" push buttons, remote control, 12 watt amplifier, simultaneous record/playback with 20-25,000 cps frequency response. Independent channel controls, "luma-touch" record buttons and illuminated VU meters. Photo electric run-out sensor, four heads, hysteresis capstan motor plus two reel drive motors and digital counter. Superbly styled with stainless steel face plate this compact operates vertically or horizontally.



88 Stereo Compact—for connoisseurs of the fine things in high fidelity stereo sound.

Two speed tape recorder with choice of half or quarter track stereo. Three new type hyperbolic heads—no more old fashioned pressure pads. New design amplifier with excellent 30-18,000 cps frequency response, lets you monitor off the tape with "A-B" comparison switch. Independent channel controls and VU meters, two motors, record indicator light, counter, automatic tape shut-off. With its attractive, brushed aluminum face panel, the 88 Compact fits any installation for vertical or horizontal operation.

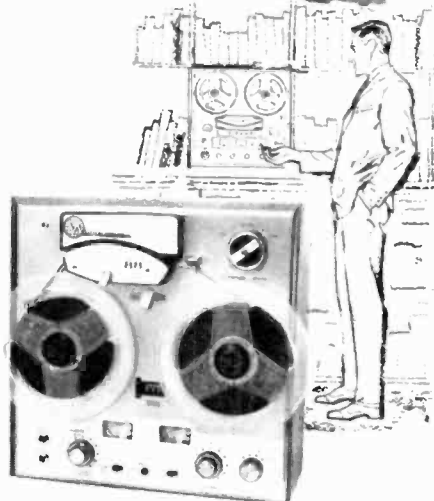

Put Command Performance at your finger tips with VIKING tape components — made by skilled American craftsmen.

Tape recorders, transports, cartridge players—even for your car or boat—at reputable high fidelity dealers most everywhere.



VIKING OF MINNEAPOLIS, INC.

9600 Aldrich Avenue South, Minneapolis, Minnesota, 55420

Your assurance of Quality in Tape Components

theory; another chapter examines the factors to be considered in the purchase of a recorder. The remaining chapters suggest applications for recorders, ranging from the simple to the complex. In an advanced-uses chapter, Mr. Crowhurst describes several simple hook-ups that enable a recorder to take telephone messages or answer a doorbell.

"How to get the Most out of Tape Recording," by Sheridan: Robins Industries, Flushing 54, N. Y.; 128 pp, \$1. This is a how-to-use, rather than a how-to-understand, book, and has a minimum of theory. A good book to accompany anyone's first recorder.

"What You Should Know about Your Tape Recorder," by Anderson and Mooney; Robins Industries; 96 pp, \$1. An excellent companion volume to the one listed above, this little book devotes separate chapters to such subjects as tape-drive mechanisms, bias oscillators, heads, trouble-shooting, and so forth. The language is simple, and the technical explanations are clear and to the point.

Playback Incompatibility

Q. I trade musical tapes with a friend and have run into a frequency-response problem. Whenever I record a disc or FM program and play it back on my machine it sounds fine. However, when played back on my friend's machine, the tape lacks highs. To make things more complicated, we both have the same model recorder, and his tapes don't sound right on my machine either. Are either or both of our tape machines defective?

ROBERT COHEN
Chicago, Illinois

A. The fault is probably due to an incorrect azimuth adjustment of the record-playback head on one of the machines. If one of the record-playback heads is tilted, the high-frequency response recorded on the tape will not be reproduced by the other machine unless the second machine's head is also tilted in the same direction and to the same degree. To determine which machine has the off-azimuth head, use a standard test tape, or play back a commercial prerecorded tape of known quality on both machines. The recorder that best reproduces the highs is the one in correct adjustment. It should be possible to improve the other machine by adjusting the head azimuth for the best reproduction of highs from a prerecorded or test tape.

Because the number of queries we receive each month is greater than we can reply to individually, only those questions selected for this column can be answered. Sorry!

A MAJOR BREAK-THROUGH IN SOUND PURITY

... BY **SHURE**

THE SOUND FROM THE NEW SHURE V-15 STEREO DYNETIC® CARTRIDGE WITH ITS REVOLUTIONARY BI-RADIAL ELLIPTICAL STYLUS HAS NEVER BEFORE BEEN HEARD OUTSIDE AUDIO LABORATORIES

by S. N. SHURE, President, Shure Brothers, Inc.

The sound from the new Shure V-15 Stereo Dynetic Cartridge is unique. The unit incorporates highly disciplined refinements in design and manufacture that were considered "beyond the state of the art" as recently as the late summer of 1963. The V-15 performance specifications and design considerations are heady stuff—even among engineers. They probably cannot be assimilated by anyone who is not a knowledgeable audiophile, yet the sound is such that the critical listener, with or without technical knowledge, can appreciate the significant nature of the V-15 music re-creation superiority. It is to be made in limited quantities, and because of the incredibly close tolerances and singularly rigid inspection techniques involved, it is not inexpensive. Perfection never is.

THE BI-RADIAL ELLIPTICAL STYLUS

The outstanding characteristic is that the V-15 Stylus has two different radii . . . hence the designation Bi-Radial. One is a broad frontal plane radius of 22.5 microns (.0009 inch); while the actual contact radii on each side of the stylus are an incredibly fine 5 microns (.0002 inch). It would be impossible to reduce the contact radius of a conventional spherical/conical stylus to this micro-miniature dimension without subjecting the entire stylus to "bottoming" in the record grooves.

The Shure Bi-Radial elliptical stylus, because of its larger frontal radius of 22.5 microns (.0009 inch), cannot bottom . . . and as you know, bottoming reproduces the crackling noise of the grit and static dust that in practice cannot be eliminated from the canyons of record grooves.

TRACING DISTORTION MINIMIZED

The prime objective in faithful sound re-creation is to have the playback stylus move in exactly the same way as the wedge-shaped cutting stylus moved when it produced the master record. This can't be accomplished with a spherical/conical stylus because the points of tangency (or points of contact between the record grooves and the stylus) are constantly changing. This effect manifests itself as tracing distortion (sometimes called "inner groove distortion"). Note in the illustration below how the points of tangency (arrows) of the Bi-Radial elliptical stylus remain relatively constant because of the very small 5 micron (.0002 inch) side contact radii:

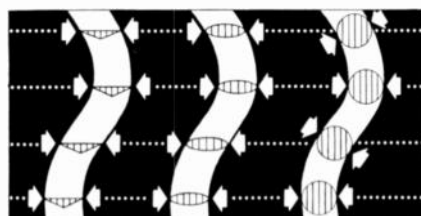

Cutter Elliptical Conical

The Shure Bi-Radial Stylus vastly reduces another problem in playback known as the "pinch effect." As experienced audiophiles know, the record grooves are wider wherever and whenever the flat, chisel-faced cutting stylus changes directions (which is 440 times per second at a pure middle "A" tone—up to 20,000 times per second in some of the high overtones). An ordinary spherical/conical stylus riding the upper portion of the groove walls tends to drop where the groove gets wider, and to rise as the groove narrows. Since stereo styli and cartridges have both vertical and horizontal functions, this unfortunate and unwanted up-and-down motion creates a second harmonic distortion. The new Shure Bi-Radial elliptical stylus, on the other hand, looks like this riding a record groove:

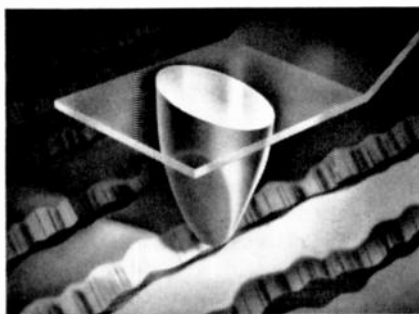

You'll note that even though it has a broad front face with a frontal plane radius of 22.5 microns (.0009 inch), and it measures 30 microns (.0012 inch) across at the point of contact with the groove, the small side or contact radii are only 5 microns (.0002 inch). This conforms to the configuration of the cutting stylus and hence is not as subject to the up-and-down vagaries of the so-called "pinch-effect".

SYMMETRY, TOLERANCES AND POSITIONING ARE ULTRA-CRITICAL

Frankly, a Bi-Radial elliptical stylus, however desirable, is almost impossibly difficult to make CORRECTLY. Diamond, as you know, is the hardest material . . . with a rating of 10 on the Mohs hardness scale. It's one thing to make a simple diamond cone, altogether another to make a perfectly symmetrical Bi-Radial stylus with sufficiently close tolerances, actually within one ten thousandth of an inch! Shure has developed unprecedented controls, inspections and manufacturing techniques to assure precise positioning, configuration, dimensions and tolerances of the diamond tip. It is a singular and exacting procedure . . . unique in the high fidelity cartridge industry. And, unless these inspection techniques and safeguards are used, an imperfectly formed elliptic configuration can result and literally do more

harm than good to both record and sound (as is the case with conventional elliptical styli).

THE V-15 IS A 15° CARTRIDGE

The 15° effective tracking angle has recently been the subject of several Shure communications to the audiophile. It conforms to the effective record cutting angle of 15° proposed by the RIAA and EIA and now used by the major record producing companies and thereby minimizes tracking distortion.

The major features, then, of the V-15 are the Shure Bi-Radial Elliptical Stylus, the singular quality control techniques and standards devised to produce perfection of stylus symmetry, and the 15° tracking angle. They combine to reduce IM and harmonic distortion to a dramatic new low. In fact, the distortion (at normal record playing velocities) is lower than the inherent noise level of the finest test records and laboratory measurement instruments! In extensive listening tests, the V-15 proved most impressive in its "trackability." It consistently proved capable of tracking the most difficult, heavily modulated passages at a minimum force of 3/4 grams (in the Shure-SME tone arm). The entire V-15 is hand-crafted and subject to quality control and inspection measures that result in space-age reliability. Precision machined aluminum and a special ultra-stable plastic stylus grip. Exact alignment is assured in every internal detail—and in mounting. Mu-metal hum shield surrounds the sensitive coils. Gold plated terminals. Individually packaged in walnut box. The V-15 is a patented moving-magnet device—a connoisseur's cartridge in every detail.

SPECIFICATIONS

The basic specifications are what you'd expect the premier Shure cartridge to reflect: 20 to 20,000 cps., 6 mv output. Over 25 db separation. 25×10^{-6} cm. per dyne compliance. 3/4 gram tracking. 47,000 ohms impedance, 680 millihenries inductance per channel. 650 ohms resistance. Bi-Radial stylus: 22.5 microns (.0009 inch) frontal radius, 5 microns (.0002 inch) side contact radii, 30 microns (.0012 inch) wide between record contact points.

But most important, it re-creates music with a transcendent purity that results in a deeply rewarding experience for the critical ear.

Manufactured under U.S. Patents 3,055,988; 3,077,521 and 3,077,522. Other Patents Pending.

\$62.50 net

SHURE BROTHERS, INC.

222 Hartrey Avenue, Evanston, Illinois

Wharfedale

JUST LOOKING ...at the best in new hi-fi components



● **Altec Lansing** introduces a 70-watt solid-state stereo amplifier, the Royale II, which features keyboard-type controls. The controls include clutch-type bass and treble and separate balance and blend adjustments. Located on the rear



of the unit are input jacks for stereo and mono tape, magnetic phono, ceramic phono, tape heads, microphones, radio, and auxiliary. Cabinet dimensions are 15 x 11¼ x 5½ inches. Price: \$366.

circle 178 on reader service card

● **Freeman's** Model 600 is a three-speed tape recorder with built-in power amplifiers and extended-range stereo speakers. The Model 600 also has a hysteresis-synchronous motor, cathode-



follower preamplifier outputs, and illuminated VU meters. The machine can be operated in either horizontal or vertical positions. Price: \$399.50.

circle 179 on reader service card

● **Heath's** latest unit, Model AR-13, is the first solid-state stereo receiver in kit form. The unit comprises a 10-watt stereo amplifier-preamplifier, a wide-band AM section, plus a stereo FM tuner with 3.5 microvolts sensitivity. Other

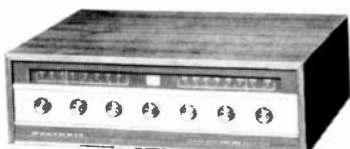

features and specifications include automatic switching to stereo, a stereo indicator light, 25-db channel separation, two filtered tape-recorder outputs for

stereo recording, magnetic phono and two auxiliary inputs, and a full complement of controls, including concealed secondary controls. Dimensions are 17 x 14¾ x 5¾ inches. Kit price: \$195.

circle 180 on reader service card

● **Lafayette's** new LA-200 solid-state integrated stereo amplifier includes fast-acting relays to protect its output transistors from overloads or short circuits in the speaker line. Specifications include a music-power rating of 22 watts per channel,

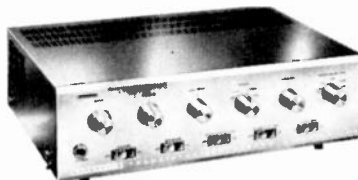

frequency response of 20 to 20,000 cps ±1 db, and 1 per cent harmonic distortion. Stereo inputs are provided for tape head, magnetic phono, ceramic phono, and tuner. Packaged in a brown, textured-metal cage with gold-finished aluminum panel and knobs, the LA-200 measures 13 x 4¾ x 9 inches. Price: \$109.50 including cabinet.

circle 181 on reader service card

● **Miranda's** Nocturne 4-track stereo tape recorder is housed in an oiled walnut cabinet and offers three speeds. 7½, 3¾, and 1⅞ ips. The two built-in 4 x 6-inch speakers are driven by a 5-watts-per-channel stereo amplifier with separate volume and tone controls for



each channel. Among the Nocturne's features are a hysteresis-synchronous motor, two VU meters, push-button controls, and output jacks for external speakers. A dynamic microphone is included. Price: \$249.95.

circle 182 on reader service card

(Continued on page 22)

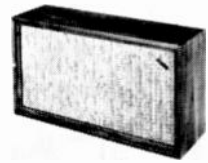

W40—Ultra-compact (24" x 12" x 10") full-range system at a most attractive price. Two superior speakers: A newly developed 8½" low frequency driver with an extremely high flux density magnet—and Wharfedale's outstanding 5" tweeter—the same used in the larger W60 system. Oiled or Polished Walnut or Mahogany. \$79.50. Utility model, \$69.50.

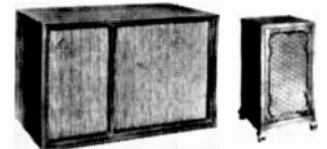

W60—In the stream-lined look of fine modern furniture or handsomely crafted provincial, this full-range two-speaker system provides superlative performance—making it the automatic choice when the finest reproduction is desired. Oiled or Polished Walnut or Mahogany, \$116.50. Utility model, \$101.50. Provincial in genuine Fruitwood, \$134.50.

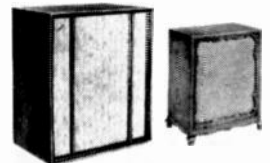

W70—A three-speaker system—handsome by itself, yet still sufficiently compact for shelf or wall integration. The beauty and excellent performance of this remarkable system make it equally impressive to experts and laymen alike. Oiled or Polished Walnut or Mahogany, \$164.50. Utility model, \$146.50. Provincial in genuine Fruitwood, \$189.50.

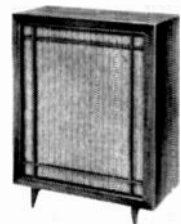

W90—A 6-speaker system with magnificent tone. The meticulously crafted cabinet is built to accommodate the speakers by range in isolated compartments; yet the size (32¼" x 27¾" x 13¼") is sufficiently compact to fit into the modern living room. Oiled or Polished Walnut, \$259.50. Utility model, \$244.50.

COMPONENT SPEAKERS

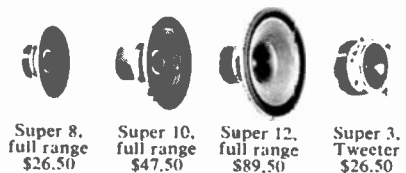

Super 8, full range \$26.50

Super 10, full range \$47.50

Super 12, full range \$89.50

Super 3, Tweeter \$26.50



W12, Woofer \$52.50

W15, Woofer \$89.50

Crossovers available

invites you to look into an Achromatic speaker system

(For purposes of explanation, a model with a transparent cabinet but containing the actual speakers and other components of an Achromatic system has been constructed and photographed from three angles.)

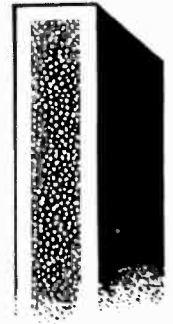

Component ratios: the air relationships and phase relationships of the speakers; their precise physical locations, and methods of mounting are scientifically matched to the shape and cubic content of each cabinet. For example, here you see the two-speaker arrangement of the W60 speaker system, consisting of a 12½ inch low-frequency driver and a 5 inch high frequency cone type driver. In the W60 system specifically, this speaker combination, in its sophisticated tuned port cabinet, produces a distinctively natural, smooth sound.

The high frequency speaker is installed in a felt-sealed isolating compartment, which prevents mechanical crossover and interference between this and the other speaker(s). Even the access holes for wires are airtight, plugged with a dense sealing compound. Each speaker, therefore, operates to its best advantage in its own environment. A low mass aluminum voice coil is used here to give maximum high frequency response. Tuned ultrasonic tinning makes it possible to guarantee the coils for the entire life of the speaker!

A full LC network crosses over at the exact frequencies required for smooth, non-strident response from all the speakers, preserving the natural damping. Telephone grade electrolytic capacitors are used to assure long, trouble-free life. The coils are wound within our own plant to guarantee close tolerances. In the compact W40, W60, and W70, a precision-wound L pad gives 0-100% treble attenuation, and adjusts the highs to room acoustics (in the W90 6-speaker model, each range of speakers may be balanced and adjusted).

The operating function of the enclosure is to preserve the integrity of the speakers' performance through certain constructional features. Chief characteristic of the Achromatic construction is the sand-filled technique, which consists of packing white sand between layers of resinous-bound dense cabinet material, faced in turn, by pure wood veneers. This construction, used on certain prescribed baffle areas, creates an inert mass, incapable of resonating, no matter how deep or strong the bass backwave projected against it.

This exclusive technique, developed by G. A. Briggs, has proven so effective in preventing bass distortion that all Achromatic systems incorporate it despite the relative expense. In addition to the sand-filled panels, absorbent lining is used on some surfaces to eliminate undesirable reflections, and "hangover". *Optimum*, rather than maximum, absorption is considered important.

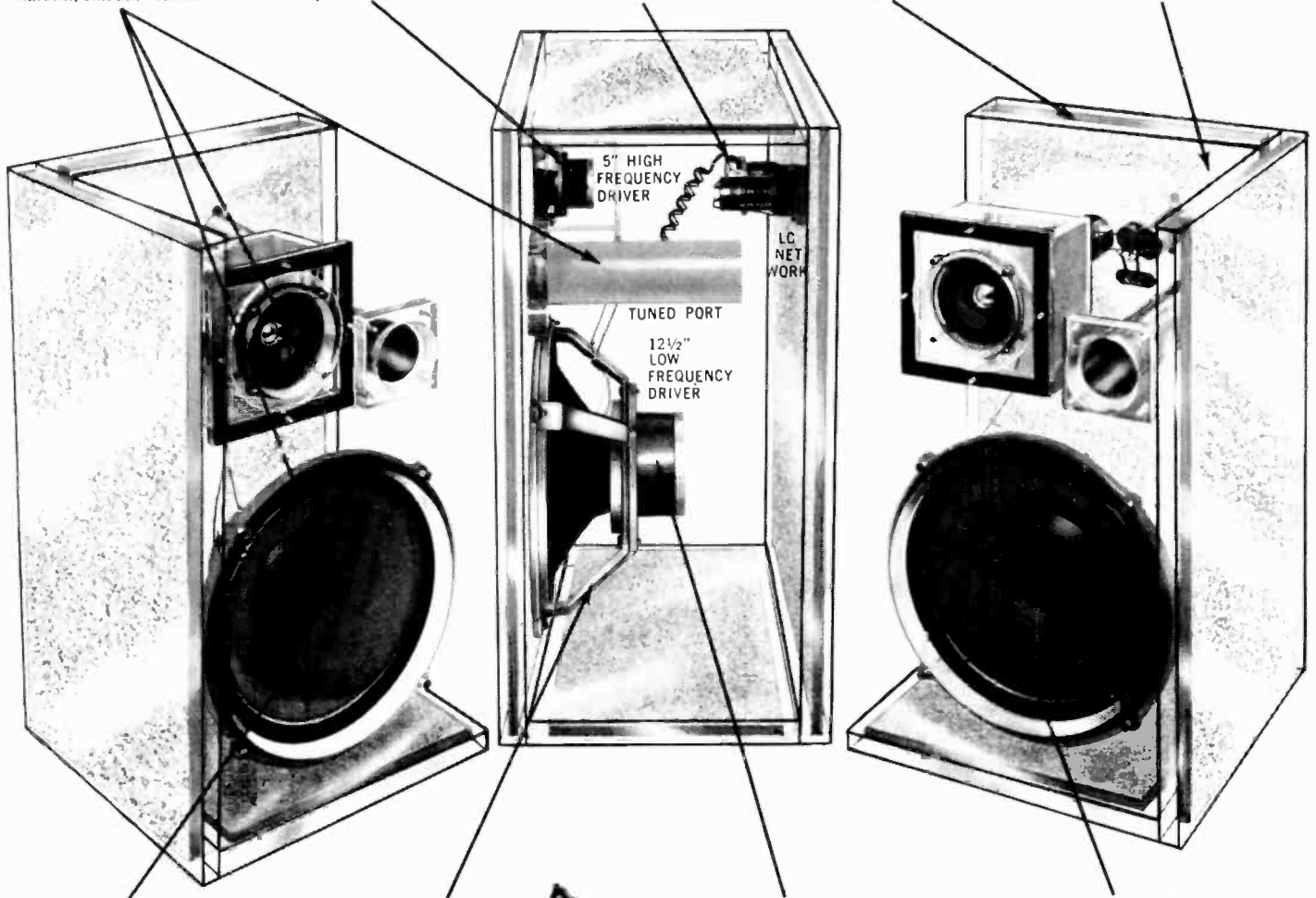

All of the speakers incorporate certain recent advancements. Because of this, it has been possible to achieve the clean, yet impressive sound which emanates from these compact cabinets. For example, the cone material is special... compounded of long fibred wool (traditional to the North of England home of these speakers) and soft pulp! Major purpose of this formulation is to provide natural, enduring resilience. The cone surround is an exclusive rolled-rim design, the latest and most effective form of the traditional Wharfedale soft suspension. One advantage is that this makes the cone capable of the long linear excursions required for true bass energy.



The chassis (baskets) of all speakers in the Achromatic systems are exceptionally heavy, and manufactured by casting. Purpose is to preserve absolute rigidity, maintaining the critical relationship between the moving voice coil and the fixed magnet. Ordinary stamped baskets often lose their rigidity when the speaker is mounted tightly against the unavoidably inexact wooden front baffle. Cast Wharfedale baskets hold their shape and are strong enough to permit the openings which are necessary to maintain correct air loading, essential for the full response of the speaker.



The magnets are truly impressive. Because of the advanced materials (Alcomax and Ferroha) and the special design of the magnetic structure, each provides higher total flux in the gap field than has been true of magnets in any prior speakers. Tolerances are maintained permanently by filling spaces in the magnetic assembly with sulphur. These magnets enable Wharfedale systems to achieve maximum efficiency at low power, and to control high wattage amplifiers with equal ease.



Additional features have been engineered into certain of the speakers to preserve the clean sound of the Achromatic systems. For example, some have a special polystyrene diaphragm to eliminate any possibility of internal resonance. All have completely sealed magnet gaps which keep out foreign matter.



Above and beyond physical considerations, the concept behind the Achromatic speaker systems reflects extensive musical training and respect for musical values.

Division of
British Industries Corp.,
Port Washington, N.Y.

Wharfedale





Do you own one of these fine tape recorders?

If you do — and you don't own a set of Koss Stereophones — you've got a lot of fun still coming!

Koss phones are perfect for monitoring and editing in either stereo or monaural. Now you can group your favorite selections on one tape with no disturbance to or from others in the room.

Check the chart for the Koss phone which plugs directly in to your own recorder. If you don't see your recorder below, write us for a complete listing.

And for playback listening — well, prepare for an emotional lift! Just plug your Koss phones into your recorder's output jack and you'll be soaring on a solo flight of perfect sonic bliss. You'll hear every sound with startling clarity and a new "up-closeness" you've never experienced before.



SP-3X, SP-5NS, SP-5VW
\$24.95

PRO-4 STEREOPHONES
\$45.00



KOSS SP-3X
or PRO-4

SP-5NS
or SP-5VW

	1	2	3	4	5	6	7	8
Viking								
Roberts								
Sony								
Wollensak								
Concertone								
Ampex								
Concord								
Norelco								
KOSS SP-3X or PRO-4		330 770 997	CS300 500				884	
SP-5NS or SP-5VW	220	440 990 1040	200 600 777	1580 T1980	510	970 1270 4470		400 401

KOSS electronics, inc.

2227 N. 31st Street • Milwaukee, Wisconsin 53208

CIRCLE NO. 31 ON READER SERVICE CARD

● **Ruxton** offers an oiled walnut cabinet (Model DY-2) designed to accommodate Dynaco's PAS-3 preamplifier and FM-3 tuner. Developed in cooperation



with Dynaco, the cabinet is approved for use by the company. Dimensions are 14½ x 9 x 8 inches. Price: \$18.

circle 183 on reader service card

● **H. H. Scott** introduces the Model 350C stereo FM tuner, a newly improved version in the company's 350 series. Completely restyled, the Scott 350C has an IIF sensitivity of 2.2 microvolts, a signal-to-noise ratio of 60 db, and harmonic distortion of 0.8 per cent. Capture ratio



is 6 db, selectivity is 35 db, spurious response rejection is 80 db, and separation is 30 db. Dimensions, in accessory case, are: 15½ x 13¼ x 5¼ inches. Price: \$224.95.

circle 184 on reader service card

● **Shure** announces the M44, a new stereo Dynetic cartridge with a no-scratch, retractile stylus that tracks at an effective angle of 15 degrees. Frequency response of the M44 is virtually flat from 20 to 20,000 cps. Channel separation is greater than 25 db at 1,000 cps, and the compliance of the M44-5 (0.5-mil stylus) is 25 × 10⁻⁶ cm/dyne at 1¼ grams tracking force. The compliance of the M44-7 (0.7-mil stylus) is 20 × 10⁻⁶ cm/dyne at 2¼ grams. Price: M44-5, \$49.50; M44-7, \$44.50.

circle 185 on reader service card

● **Superscope** presents the Sony Model 777 Sterecorder as the top unit in the Sony/Superscope line for 1964. The Model 777S-4 records 4-track stereo and 4-track monophonic, and plays back 2- and 4-track stereo and mono. The Model 777S-2 is a 2-track stereo, 2-track mono recorder with 2- and 4-track stereo (as well as mono) playback.

Both models are two-speed (7½ and 3¾ ips), are completely transistorized, incorporate three separate heads, three motors (hysteresis-synchronous drive and
(Continued on page 24)

There is no such thing as the one best tuner.

There are at least six.



The Fisher FM-50-B, \$199.50*



The Fisher FM-100-B, \$249.50*



The Fisher R-200 (AM-FM), \$299.50*



The Fisher FM-200-B, \$299.50*



The Fisher MF-300 (FM/Remote), \$359.50*



The Fisher FM-1000, \$429.50*

The six different tuners currently made by Fisher are *all* capable of reproducing a broadcast signal exactly as monitored by the transmitting station itself, without the slightest loss of quality. By this fundamental audio criterion, each of the six is the best possible tuner. The difference between a lower-priced and a higher-priced Fisher tuner is never one of basic quality but rather of convenience features, professional versatility, and performance under unusually adverse conditions. Fisher has only a single standard.

Thus, the relatively simple and very moderately priced FM-50-B will receive both mono and stereo FM programs with breath-taking fidelity in most locations. But to pluck an exceptionally weak stereo signal out of the noise, with perhaps only an indoor antenna in a steel-frame apartment building at a great distance from the transmitter—that may require the exceptional sensitivity, limiting characteristics

and capture ratio of the FM-200-B or of the fabulous FM-1000. Or, for equally high FM sensitivity combined with unique provisions for remote control, there is the MF-300. And wherever AM is still an important source of music, the obvious choice is the superb R-200.

The Fisher FM-50-B features the exclusive STEREO BEAM†, a Fisher invention that automatically indicates whether or not an FM station is broadcasting in stereo. The five costlier Fisher tuners incorporate the famous STEREO BEACON†, an exclusive Fisher development that automatically indicates the presence of FM Stereo broadcasts by means of a signal light and at the same time automatically switches the tuner between the mono and stereo modes of operation. The unique Fisher warranty — one year, including tubes and diodes—applies equally to all six models.

Looking for the best tuner? Inquire

about the signal strength in your area, consider your antenna, evaluate your requirements in convenience and automation, and decide whether or not you need AM. The Fisher tuner that happens to suit your purpose will be *the* best, bar none.

*Less cabinet; slightly higher in the Far West.
†Pat. pending.

FREE! \$1.00 VALUE!
Send for your free copy of the new 1964 edition of The Fisher Handbook, a lavishly illustrated 52-page guide to stereo.



Use coupon on page 25.

Fisher Radio Corporation
21-40 44th Drive
Long Island City, N. Y. 11101

OVERSEAS RESIDENTS WRITE TO FISHER RADIO INTERNATIONAL, INC., LONG ISLAND CITY, N. Y. 11101. CANADIAN RESIDENTS WRITE TO TRI-TEL ASSOCIATES, LTD., WILLOWDALE, ONT.

The Fisher

CIRCLE NO. 20 ON READER SERVICE CARD

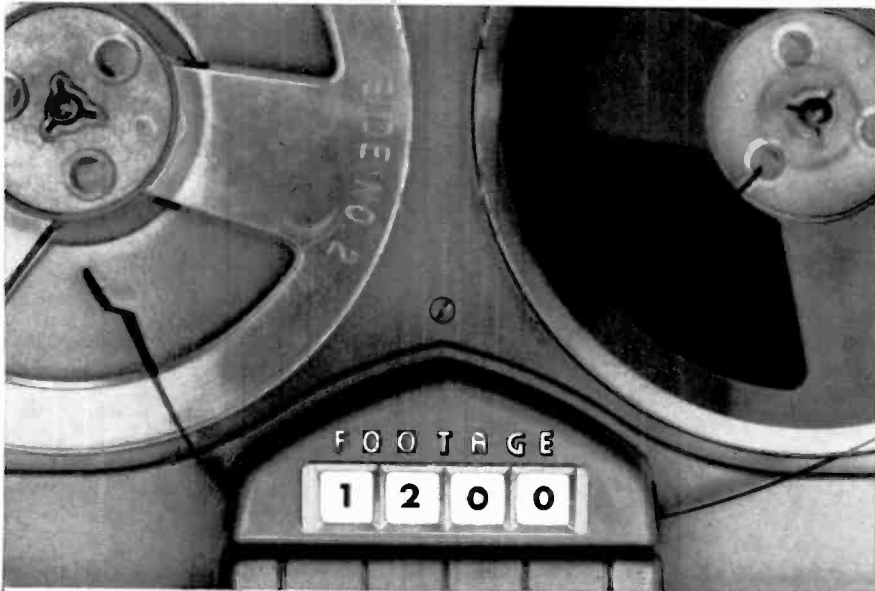

WHEN OTHER TAPES HAVE RUN OUT...

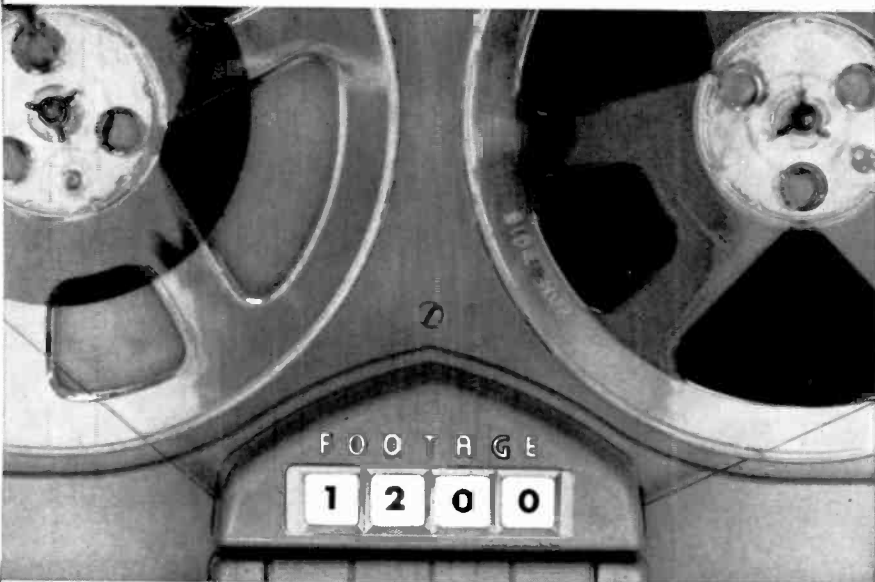

**AMERICAN'S "PROFESSIONAL LENGTH"
STILL HAS 25% MORE ON THE REEL**



Only American's Revolutionary New "Professional Length" Tapes offer up to 25% more tape and 25% more playing time on the standard 7" reel. Available in 1500', 2000', 3000' and 3600' reels at little or no more than you would pay for other leading brands in standard lengths.

See your dealer or write to:

GREENTREE



ELECTRONICS

291 S. LA CIENEGA BOULEVARD
BEVERLY HILLS, CALIFORNIA

two high-torque spooling motors), can be operated either vertically or horizontally, and have solenoid-activated mechanisms.

Other features of the Sony 777 series include stereo mixing of the microphone and line inputs, sound-on-sound record-



ing, remote control for all modes, monitoring of either "source" or "tape," relay-operated pause control, balanced inputs for microphone, separate input and output controls, automatic tape lifters, two large VU meters, and a stereo earphone monitor jack. Both models are furnished with carrying case and remote-control unit. Price: under \$695.

circle 186 on reader service card

● **Superex** announces the Model ST-M stereo headphones, which feature a separate woofer and tweeter element and



miniature crossover network in each earphone. Frequency response is controlled by an adjusting knob located in the rear of each phone. Price: \$29.95.

circle 187 on reader service card

The Institute of High Fidelity has prepared an informative 64-page *Introduction to Hi-Fi & Stereo*. Written for the nontechnical music listener, the booklet is available for 25¢ from the Institute of High Fidelity, 516 Fifth Avenue, New York, N.Y. 10036.

There is no such thing as the one best amplifier.

There are at least five.

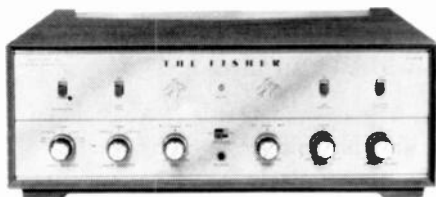

The Fisher X-100-B (50 watts), \$169.50*



The Fisher X-101-C (60 watts), \$199.50*

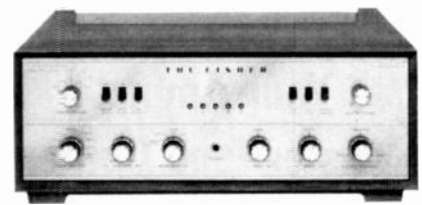

The Fisher X-202-B (80 watts), \$249.50*

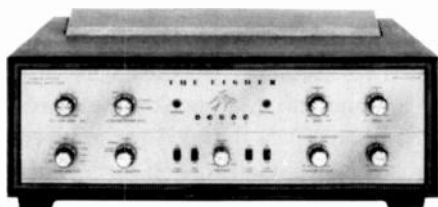

The Fisher X-1000 (110 watts), \$339.50*



The Fisher 400-CX and SA-1000 (150 watts), \$199.50* and \$329.50*

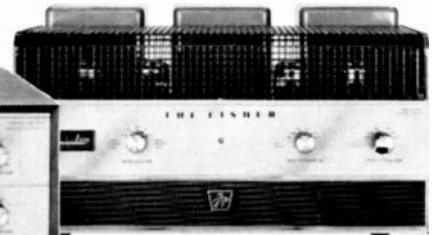

The five different Fisher amplifier systems currently available were *all* engineered to be the best, bar none. A self-contradiction? Not when you get down to fundamentals.

The basic function of an audio amplifier is to effect signal gain without distortion or noise. The lowest-priced Fisher amplifier accomplishes that task as successfully within its power rating as the costliest. There is only a single Fisher standard of amplifier performance: clean, 'open' sound, with complete stability regardless of the load, and virtually non-measurable distortion right up to the clipping point.

Thus, as you go up the scale from the Fisher X-100-B through the other three integrated control-amplifiers to the professional 400-CX/SA-1000 combination, you

will *not* hear cleaner and cleaner sound — at least not at ordinary listening levels in the average room with reasonably efficient speakers. What you *will* experience is the convenience of increasingly elaborate control features, greater flexibility in special situations and — above all — more and more power handling capability. The workmanship and the quality of parts is the same in all Fisher amplifiers. And the unique Fisher warranty (one year, *including* tubes and diodes) applies equally to all models.

You can forget about quality when you choose your Fisher amplifier. Concentrate on your needs with regard to power, flexibility and space. No matter which Fisher you finally select, it will be *the* best.

*Less cabinet; slightly higher in the Far West.

FREE! \$1.00 VALUE!
Mail this coupon for your free copy of the new 1964 Fisher Handbook, a lavishly illustrated 52-page reference guide to stereo.

Fisher Radio Corporation
21-40 44th Drive
Long Island City, N. Y. 11101

Name _____
Address _____
City _____ State _____



OVERSEAS RESIDENTS WRITE TO FISHER RADIO INTERNATIONAL, INC., LONG ISLAND CITY, N. Y. 11101. CANADIAN RESIDENTS WRITE TO TRI-TEL ASSOCIATES, LTD., WILLOWDALE, ONT.

The Fisher

Who has
Sutherland,
Baez,
The Duke,
Ansermet,
Mantovani,
and a thousand
other
stereo tape
selections?

The pick of 16 major recording companies—featuring Peter, Paul & Mary, Stan Getz, Stokowski, Monteux, Sutherland, the D'Oyly Carte—in short just about everybody who is anybody in the popular, jazz, folk, classical, opera and oratorio fields.

Your Ampex
Master Tape Center

ARIZONA
PHOENIX
Bruce World of Sound
2711 E. Indian School Rd.

CALIFORNIA
AZUSA
Rancho Sound Co.
18532 E. Alosta Ave.

BEVERLY HILLS
Discount Record Center, Inc.
8484 Wilshire Blvd.

GARDENA
Stereo Hi-Fi Center
13996 S. Crenshaw Blvd.

HOLLYWOOD
Wallace Music City
Sunset and Vine

LOS ANGELES
California Music Co.
2933 W. Pico Blvd.

Crenshaw Hi-Fi
107 Santa Barbara Plaza

MENLO PARK
McDaniels Hi-Fi, 935 El Camino Real

OAKLAND
Stairway to Music, 4150 Broadway

REDONDO BEACH
Griffley Electric, 235 N. Pacific Coast

SAN DIEGO
Wright's House of Hi-Fi
5140 El Cajon

SAN FRANCISCO
Lakeshore Hi-Fi, 222 W. Portal
Walter Willey, 691 Market St.

WHITTIER
Osbow Electronics
15419 E. Whittier Blvd.

COLORADO
DENVER
Empire Radio & TV, 1100 Broadway

DISTRICT OF COLUMBIA
WASHINGTON
Commissioned Electronics
1776 Columbia Rd., N.W.
Electronic Wholesalers, Inc.
2345 Sherman Ave., N.W.

ILLINOIS
CHICAGO
Allied Radio, 100 N. Western Ave.

MASSACHUSETTS
CAMBRIDGE 38
Minute Man Radio, 28 Boylston St.

WELLESLEY
The Music Box, 58 Central Ave.

MICHIGAN
DETROIT 24
Pecar Electronics, 11201 Morang

MINNESOTA
MINNEAPOLIS 8
Audio King Co., 913 West Lake St.

MISSOURI
KANSAS CITY 6
Burnham-Applebee Co.
1012-1014 McGee St.

NEW YORK
BUFFALO 3
Purchase Radio Hi-Fi, 747 Main St.

NEW YORK
Hens and Bolet, 68 Cortlandt St.
K & K Records, 123 W. 42nd St.
Leonard Radio, 69 Cortlandt St.
Liberty Music Shop
450 Madison Ave.
G. Schirmer, 609 5th Ave.
Wilco-Peer, 114 W. 32nd St.

OREGON
PORTLAND
Oregon Hi-Fi, 340 S.W. 5th
Otis Radio & Hi-Fi,
3780 S.E. Hawthorne Blvd.

PENNSYLVANIA
PHILADELPHIA
Sam Goody,
1125 Chestnut St.

READING
M. Buchert Ent.
155 W. Greenwich St.

WASHINGTON
SEATTLE
Electcraft, 1408 6th Avenue
Westfields, Inc., 800 So. Michigan St.

For a catalog of the complete selection of tapes, write Ampex Corporation, Consumer Products Division, 2201-B Landmeier Road, Elk Grove Village, Illinois. In Canada, Ampex of Canada Ltd., Rexdale, Ontario.



CIRCLE NO. 6 ON READER SERVICE CARD
26

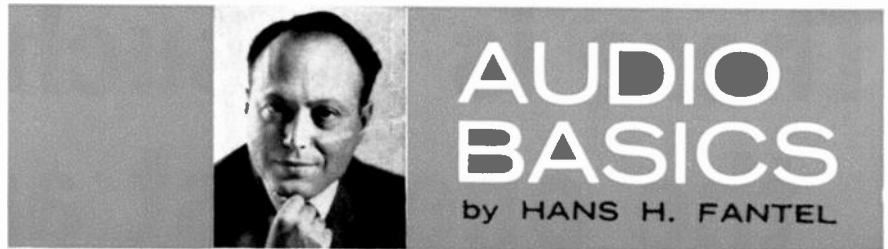

DEFINITIONS—II

ONWARD with our definitions of basic audio concepts, which will continue in alphabetical order for the next several months.

• **Amplitude** refers to the strength, or loudness, of a sound, or of the strength of an electrical signal representing sound. If the sound or signal is represented as a wave pattern on an oscilloscope or graph, the amplitude corresponds to the height of the wave (*i.e.*, the magnitude of the swing in each cycle).

• **Baffle** is an older term, though still used, for any loudspeaker housing. The main job of the baffle, or enclosure, is to keep the sound waves radiated by the rear of the loudspeaker cone from canceling the sound waves projected from the front. Since such cancellation occurs only at the lower frequencies, an unbaffled speaker invariably sounds bass-shy. For optimum performance, the enclosure must be acoustically matched to the loudspeaker it houses. The most common types of speaker enclosures are the infinite-baffle, the bass-reflex, and the folded-horn. Each will be discussed later in this series.

• **Bass boom** refers to an unwanted bass resonance in a loudspeaker system. The effect is like that of speaking into a barrel: the resonance masks the natural tone color of the voice. Similarly, a speaker system whose resonances are too pronounced, or are at the wrong frequencies, falsifies the true character of sound, creating a hollow, thumpy bass that blurs the clarity of the music. Jukeboxes and poorly designed console phonographs are notorious for boomy bass.

• **Bass-reflex** speaker enclosures, which employ a vent or port, operate on the principle of a Helmholtz resonator. When the enclosure's acoustical resonance is properly matched to the speaker's electro-mechanical resonance, the speaker's resonance is damped (or reduced in amplitude), its cone movement and hence its distortion for a given bass output is reduced, and its bass capability is increased. Incorrectly designed bass-reflex enclosures are prone to bass boom (see above), but this fault is not typical of bass-reflex enclosures *per se*.

• **Capture ratio** measures an FM tuner's ability to sort out two stations operating on the same frequency. A tuner with a poor capture ratio will pick up both stations simultaneously, making it impossible to listen to either. A tuner with a good capture ratio will "capture" the stronger station and reject the weaker one. Capture ratio is expressed numerically; the lower the figure, the better the capture ratio. Don't confuse capture ratio with selectivity. Selectivity refers to the tuner's ability to separate adjacent stations on the dial. Capture ratio refers to the separation of stations on the same spot on the dial.

• **Carrier signal** refers to a radio-frequency wave sent out by a radio transmitter on which are superimposed audio frequencies, such as speech or music. The radio-frequency wave, itself inaudible, thus "carries" the sound.

(To be continued next month)



new
low
price:
\$600

FURNITURE DESIGNED BY GEORGE NELSON FOR HERMAN MILLER, INC.

"Handles tape like a \$1000 deck," said one audio editor after an hour with the Vernon 47/26. Most impressive, he found, was the all-electronic keyboard with its computer-type logic circuits that silently masterminded the tape movement in every mode. No relays or electro-mechanical devices. Instead, "one shot multiplex," "flip flop" and diode gate circuits that act with the swiftness of electrons. More than just a superb tape transport, the Vernon is complete with two preamplifiers, two record/playback amplifiers (twenty watts output) and remarkably smooth built-in monitoring speakers. With its impressive complement of 47 transistors and 26 diodes in its highly advanced solid state circuitry, the Vernon offers acoustic performance comparable only to the best of com-

ponent amplifiers. Further, its styling is as functional as it is handsome. All switches and controls are sensibly organized for utmost ease, flexibility and efficiency. The tone/contour, recording and playback level controls function either independently or ganged. Operate the Vernon vertically, horizontally, or at studio-angle. Other notable features: three motors, three tapeheads, multiple intermix inputs (for *authentic sound-on-sound*), automatic shut-off, automatic rewind/replay, one second electronic delay, monitoring from tape or preamp, provision for remote control. Put the Vernon through its many paces at your audio dealer's . . . you'll find it an entirely new experience. Or write for literature. Vernon Audio Division, 144 E. Kingsbridge Road, Mt. Vernon, N. Y.

CIRCLE NO. 58 ON READER SERVICE CARD

vernon
47/26
stereo tape recorder
and audio center

Are separate
tuners and
amplifiers passé 



Nothing duplicates the installation flexibility of separate components. This is one of many reasons why Sherwood sells so many of them. But for those who do not need this flexibility, Sherwood engineers have created an outstanding single component, which without compromise of fidelity, combines both functions.

The new S-7700II AM/FM/FM Stereo Receiver combines the 1.8 microvolt sensitivity and 2.4db capture effect of Sherwood's finest tuner with the 80-watt dual channel music power of Sherwood's highest-rated high fidelity amplifier. The size is a space-saving 16 1/4" x 4" x 14". You enjoy all the tuning surety of Sherwood's D'Arsonval zero-center tuning meter and 8" long professionally calibrated dial scale. And, you have front panel control of all stereo amplifier functions for phono, tape—plus a stereo headset jack. As trim as the size, is the less-than-separate-components price of \$374.50 (slightly more on the West Coast).

An outstanding new combined tuner/amplifier component . . . the S-7700II AM/FM/FM Stereo 80-watt Receiver.

**Sherwood low-distortion speaker systems
for high fidelity music systems**

Ravinia: 3-way/48—17,500 cps/\$139.50 · Newport: 2-way/48—17,000 cps/\$79.50 · Berkshire: 3-way/53—17,500 cps/\$99.50 · Tanglewood: 4-way/29—17,500 cps/\$199.50

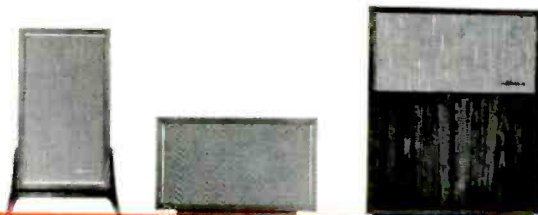

FREE . . . A \$1.00 VALUE
INFORMATION KIT
AT YOUR SHERWOOD DEALER

Take this coupon to your Sherwood dealer and receive:

- Time-Saver Shopping Guide—detailed comparative specifications on components offered by major manufacturers.
- 64-page book, *An Introduction to Hi-Fi & Stereo* published by the Institute of High Fidelity.

- FM & FM Stereo Station Finder—listing current and proposed stations.
- Photo file—a pictorial review of how different systems have been installed.
- Descriptive literature on Sherwood components.

If you prefer, send 25¢ in coin direct to Sherwood, together with your name and address. Your package will be sent by return mail.

Name _____
Street _____
City _____ State _____ Zip Code _____

Sherwood Electronic Laboratories, Inc., Dept. R-3
4300 North California Avenue, Chicago, Illinois 60618

Sherwood
HIGH FIDELITY

STEREO RECEIVERS ■ TUNERS ■ AMPLIFIERS
STEREO INDICATOR LIGHTS ■ SPEAKER SYSTEMS ■ CONTEMPORARY CABINETS



● **DESIGN AND MATHEMATICS:** Engineers tend to pride themselves on their logical and scientific approach to product design. In the case of purely electronic components such as tuners and amplifiers, the basic theory involved is well understood, and may be applied in a straightforward manner with generally good design results. Even so, there are some gaps in our understanding of why amplifiers sound different from each other—differences not accounted for by the measured specifications. It seems that science must be tempered with a touch of art if a truly outstanding end-product is the goal.

In the design of electromechanical transducers (the phono cartridge and loudspeaker), the difference between the purely scientific approach and that of the skilled artisan becomes very apparent. There is, of course, a sound body of data available as a design starting-point. Technical journals have published innumerable articles dealing with the equivalent mechanical circuits, accompanied by reams of calculations “proving” the validity of a particular design approach—or the flaws in someone else’s. But despite all this printed erudition, I have found, in my own testing, remarkably little correlation between the mathematical prowess of the design engineer and the listening quality of his creation. This is particularly true in the case of loudspeakers.

The reasons are not too hard to understand. All mathematical models and equivalent circuits, whether for electromechanical transducers or for simple power amplifiers, involve certain simplifying assumptions, without which the calculations would become hopelessly tedious. In some cases these assumptions are valid, in the sense that we cannot actually hear, or perhaps even measure, effects that can be attributed to the neglected factors. However, this is definitely *not* the case with loudspeakers.

A moving-coil loudspeaker in a ported enclosure is generally represented in the textbooks by a relatively simple equivalent or analog circuit consisting of two or more each of inductances, resistances, and capaci-

tances, representing the mass, mechanical resistance, and compliance of various parts of the system. The response of such a network can be calculated, and when plotted may be a crude replica of the response curve of an actual loudspeaker. Unfortunately, the real electrical-acoustical-mechanical system is not that simple. The walls of the enclosure are not perfectly rigid, the cone does not move as a unit, the restoring forces are not linear, magnetic-circuit imperfections result in a nonlinear driving force, and so on. The true equivalent circuit of even a simple single-cone speaker in an enclosure is probably indefinable, and even if it were known, a large computer would be needed to calculate a speaker’s actual sound on the basis of an electrical analog.

This being the case, the conscientious speaker designer can depend on calculations only up to a point. Eventually he must build a model, measure its performance, and modify the design as necessary. It has been stated often enough that measurements are not the final test; but incredible as it may seem, some speaker systems have reached the market without ever having been listened to by a critical, reasonably impartial audience. Needless to say, the sound of these unfortunate creations (some of which I have had occasion to test) reflects the approach of their makers.

A BASIC problem in speaker design is the extreme difficulty (perhaps impossibility) of making complete, meaningful measurements that can predict or describe the sound of a speaker. There are almost as many theories on loudspeaker measurements as there are workers in the field. Some manufacturers frankly admit that frequency-response curves are of value only for design, and do not make them public. Some others, whatever their private feelings, use such curves as sales aids. A few practically ignore numerical data in their published literature, and emphasize instead the subjective character of the speaker’s sound.

I have tried to develop a meaningful laboratory test procedure for loudspeaker evaluation—as an aid

REVIEWED THIS MONTH

Heath AJ-43 AM/Stereo FM Tuner



Hadley 601 Power Amplifier

to myself if not always to my readers. I must confess that I am thoroughly convinced of the inadequacy of any measurement as an *ultimate* indicator of how a speaker will sound. Certain tests can be a valuable guide to someone who is able to interpret them properly, but can be misleading to the uninitiated. My test methods, which I will describe fully in a future issue, have some value in that all speakers are tested under nearly identical conditions, so that some degree of comparison is possible. The ultimate test instrument, however—at least in the speaker area—remains the trained human ear.

**HEATH AJ-43
AM/STEREO
FM TUNER**

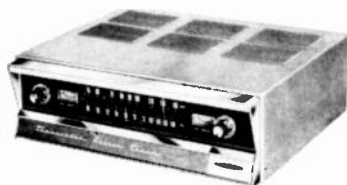

● INTERNALLY generated heat in electronic components can be a serious problem—particularly when the stability of critical tuning circuits is involved. Since a major advantage of transistor circuits is their cool operation, a transistorized FM tuner would seem to be a logical and practical development. The new Heath AJ-43 AM/stereo FM tuner is an impressive effort in this direction. It is attractively styled, matching the Heath AA-21 transistor amplifier in size and appearance. As in the AA-21 amplifier, most of the AJ-43's controls are concealed behind a hinged section of the front panel. Another portion of this panel is a push-type on-off switch. The only visible controls are the separate AM and FM tuning knobs. There are individual slide-rule dial scales, and separate AM and FM tuning meters.

Behind the hinged front panel are a multitude of controls, including level adjustments for the three outputs (AM and stereo FM), and stereo FM separation and balance adjustments. Also provided are an adjustable interstation-noise squelch control and a phase adjustment for the 38-kc oscillator in the multiplex circuits. The latter permits matching the phase of the oscillator to that of the 19-kc pilot carrier in the received signal. This adjustment is made simply by pulling out the knob and setting it for maximum volume. A group of slide switches selects the noise filter, SCA multiplex filter, AM or FM reception (only one operates at a time), and AFC.

One of the limitations of transistor r.f. amplifiers is their tendency to overload on very strong signals and thus to produce spurious responses. However, a three-position sensitivity switch (LOCAL, MEDIUM, DISTANT) permits operation in proximity to strong local stations. In the MEDIUM position, a line-cord antenna

is substituted for the external antenna. This position may also be used where an external antenna is not available. The LOCAL position disconnects the antenna entirely. In my suburban New York location, I found that the DISTANT position worked best, and did not result in overloading from nearby FM stations.

The FM tuner section has an r.f. amplifier, oscillator, mixer, three i.f. amplifiers, a limiter, and a ratio detector. A silicon diode is used for AFC. The interstation-noise squelch amplifier cuts off the first audio amplifier in the absence of a signal. It is actuated by the AGC voltage to turn on the audio stage when a signal is received. A transistor in series with the supply voltage to the 38-kc multiplex oscillator keeps it off until a signal with a 19-kc pilot carrier is received. The 19-kc signal is amplified, switches on the power to the 38-kc oscillator, synchronizes the oscillator, and, through another amplifier, lights an indicator lamp on the panel. Stereo-mono FM switching is thus automatic, and very effective. A manual switch is available to cut off the 38-kc oscillator in case a signal is too weak for good stereo reception.

The AM tuner is very simple, with an r.f. amplifier, a mixer, one i.f. amplifier, a diode detector, and an audio stage. Its output is fed to both stereo outputs. A 10-kc whistle filter is installed between the detector and the audio stage. The power supply uses a full-wave silicon-diode rectifier to supply 13 volts to the stereo-indicator lamp circuit and 9.1 volts (regulated by a Zener diode) to the rest of the tuner.

The Heath AJ-43 essentially equalled or exceeded all of its specifications. Its IHF usable sensitivity was 2.8 microvolts (better than its rated 3.5 microvolts), image rejection was 35 db (better than its rated 30 db), and capture ratio was 4.7 db (better than rated). Hum and noise were 50 db below 100 per cent modulation (as rated). The AGC action was excellent, with no change in audio output level when the input signal was increased from 4 microvolts to 100,000 microvolts. Harmonic distortion (mono) was about 1.5 per cent at 100 per cent modulation between 5 and 1,000 microvolts of input signal, reducing to 1 per cent at 10,000 microvolts and less at higher inputs.

The FM frequency response was ± 1 db between 20 and 15,000 cps. The noise filter introduced a roll-off in the high-frequency response—which reached a maximum of -7 db at 7,000 cps and above. Stereo channel separation exceeded 30 db between 180 cps and 6,500 cps, and was better than 20 db between 40 cps and 13,500 cps. The SCA filter, when switched in, reduced separation at the higher frequencies.

Drift was negligible, and the AFC, although it

CORRECTION: Last month's "Technical Talk" indicated that a tuner's IHF usable sensitivity was the smallest input signal resulting in "a combined distortion, noise, and hum level of 3 per cent (-80 db) at the tuner's audio output." The specification of " -80 db" was a typographical error, and should have read " -30 db." J. D. H.

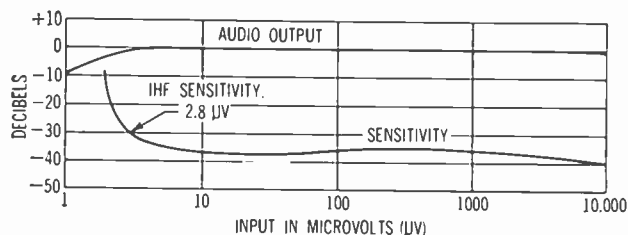



"...by combining this unit, Citation A, with a solid state basic amplifier of comparable quality, a sound path could be set up that approaches the classic goal of amplifier design—a straight wire with gain."

—HIGH FIDELITY MAGAZINE

THE NEW CITATION B

PROFESSIONAL 80 WATT SOLID STATE STEREO BASIC AMPLIFIER

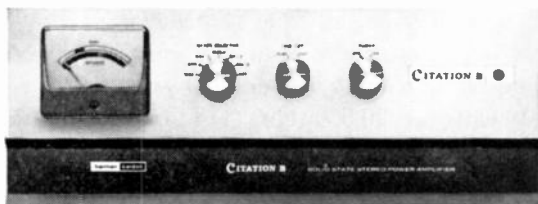

Handsome front panel: facilitates custom installation. Features include current-adjustment meter, on/off switch with pilot light and low-cut filter. Removable bottom panel conceals idling adjustment controls.



Computer-grade silicon output transistors: heavy-duty, solid state devices, virtually impervious to abuse. Will take 100% more power than their use in Citation B will ever demand.

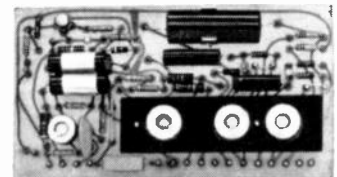

Driver stage: Wideband silicon driver transistors are mounted on rugged, military-type epoxy glass board. Board pivots for easy accessibility or removal.

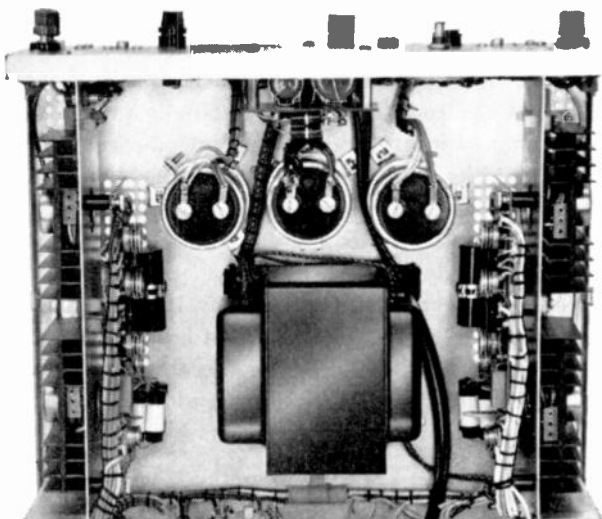

Top view of chassis: computer construction throughout. Five sub-assemblies assure easy accessibility and minimum operating temperature through efficient heat dissipation; laced military wiring harness couples each stage.



Electrolytic capacitors: engineered to computer-grade specifications for unlimited shelf life and consistent, long-term performance.

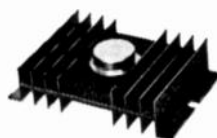

"Heat sink": heavy-duty finned aluminum device which rapidly draws heat away from output transistors—insuring long life, fail-safe performance.

The "classic goal of amplifier design" is now reality. The big "B" is here. The Citation B. A power-packed "brute" loaded with 80 watts of flawless performance—a true product of the computer age. • The "B" has the widest frequency response of any basic amplifier—1 to 100,000 cps. • The "B" has the best square wave response—less than one microsecond rise time. • The "B" has the highest damping factor—50 to 1 at 10 cps. (No other power amplifier is even close.) • The big "B" is the only power amplifier completely free of hangover or clipping at full power output.

The Citation B reflects Harman-Kardon's solid state leadership in every way—performance, design and construction. "A straight wire with gain" when matched with Citation A, the big "B" will also enhance the performance of any other high quality stereo preamplifier. For more information—write Citation Division, Harman-Kardon, Inc., Plainview, N.Y., Dept. R-3.

harman kardon

A Subs. of THE JERROLD CORPORATION

worked well, was superfluous. The tuner comes on within a second or two, and a station can be tuned in immediately, with no need for subsequent retuning. The tuning was smooth and noncritical, with a fly-wheel action as good as any I have used. When used with the AA-21 amplifier, the entire system is ready for operation within a couple of seconds after switching on. The AM tuner performed adequately with its built-in ferrite antenna. The highs were slightly muted, but the over-all sound was pleasing.

Liberal use is made of printed-circuit boards in the AJ-43, and a preassembled wiring harness is supplied to the kit builder. Despite the complexity of this unit, I should judge that it is relatively easy to assemble. The tuner can be aligned without the aid of test instruments. The introductory section of the manual contains an exceptionally detailed description of the operation of each circuit in the tuner, as well as some basic transistor theory. Typical waveforms and voltages throughout the set are shown. All in all, this is one of the best organized kits of this degree of complexity that I have seen. However, I would not suggest that it be attempted by a complete novice.

The AJ-43 is an excellent tuner, and holds its own with any other tuner with comparative ratings. It has a total lack of handling idiosyncrasies—I particularly appreciated being able to stack the AJ-43 on top of the AA-21 amplifier and run them for hours without either one's becoming perceptibly warm. The Heath AJ-43 tuner kit is priced at \$119.95.

HADLEY 601 POWER AMPLIFIER

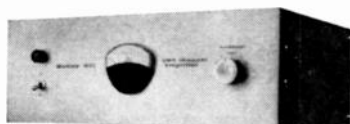

● THERE ARE a very few power amplifiers whose performance is so outstanding that they must be put into a special category for the most discriminating users. The Hadley 601 stereo power amplifier is a recent addition to this group.

The unit is a product of Hadley Laboratories, a relatively new company in the high-fidelity field. The 601 is rated at 40 watts per channel, and is attractively styled. The front panel displays only the power switch, fuse holder, a meter, and the meter's function switch. The input jacks and the output terminal strips are located on the back of the amplifier. The 601 measures $15\frac{3}{4} \times 12 \times 6\frac{1}{4}$ inches and weighs 56 pounds.

No circuit information was supplied with the unit I tested. Each channel has a pair of EL34 output tubes, preceded by two ECC82 (12AU7) dual triodes,

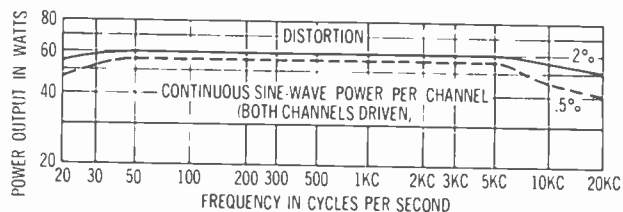
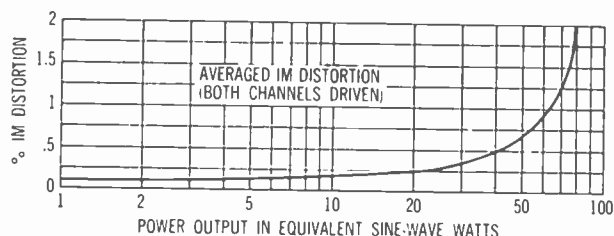

with a single ECC83 (12AX7) being divided between the two channels. Half the chassis is taken up by the two massive output transformers and the power transformer. The underchassis wiring is of noteworthy caliber, with extensive use of such high-quality components as computer-grade electrolytic capacitors for long life and metal-film resistors for low noise. Silicon diodes are used in the power supply.

Each output tube has its own bias adjustment, which is set after the panel meter has been switched to indicate the tube's cathode current. The output tubes are supplied pre-matched and numbered to show which socket they should be used in for optimum results. The a.c. drive voltages are balanced by factory-set adjustments. Each amplifier is accompanied by a test sheet showing its distortion characteristics.

One of the chief characteristics of a truly fine amplifier is its ability to deliver rated power over the entire audio-frequency range at low distortion. The Hadley 601 proved its mettle by developing 60 watts per channel at 1,000 cps, 54 watts at 20 cps, and 52 watts at 20,000 cps. These measurements were made with both channels driven, at 2 per cent distortion. At 0.5 per cent distortion, the output was only slightly less, averaging 56 watts at 1,000 cps, 50 watts at 20 cps, and 40 watts at 20,000 cps. The intermodulation distortion was less than a few tenths of a per cent up to 30 watts per channel, and about 77 watts per channel could be obtained before the distortion reached 2 per cent. These measurements, needless to say, are exceptional, and emphasize that the 40-watt rating of the Hadley 601 is a most conservative one.

Square-wave response was very good, with no ringing; a slightly rounded leading edge on a 10,000-cps square wave reflects Hadley's concern that the amplifier have adequate stability margin for driving electrostatic speakers. Capacitive loads, such as would be imposed by electrostatic speakers, actually improved the wave shape slightly, and without introducing ringing or instability. Hum was an inaudible -86 db, referred to 10 watts. An input signal of 0.6 volt drove the amplifier to 10 watts output, and 1.2 volts developed the rated 40 watts output.

When listening to the Hadley 601, I experienced the same sense of total ease and almost limitless power reserve I associate with the two or three finest amplifiers I have used. The 601, a worthy addition to this select group, is guaranteed for two years (except tubes) and is priced at \$319.50.

For additional product information, use the reader service card. Circle number 188 for the Heath AJ-43 AM/stereo FM tuner, 189 for the Hadley 601 power amplifier.



collector's item



The Concord 884 transistorized stereo tape recorder is designed for the connoisseur of sound, the collector with tastes and demands above the ordinary. No other recorder, regardless of cost, has all the Concord 884 professional quality features.

Three separate heads—one record, one playback and one erase—assure professional quality reproduction from FM multiplexing, stereo records and live performances. Four completely separate preamps—two record and two playback—and full transistorization assure maximum reliability. A flip of the AB monitor switch lets you compare source vs. tape while recording.

A few of the other features are: built-in sound-on-sound switch for effects such as electronic echo chamber; stereo headphones output; automatic reel-end shut-off; 3 speeds; 2 lighted VU meters. All push-button operation; 15 watt stereo power amplifier and separate 7" full range speakers complete your 884 stereo system. Model 884 under \$450.* Other models from \$100.*

*Prices slightly higher in Canada.

For Connoisseurs Of Sound

CONCORD 884

CONCORD  ELECTRONICS CORPORATION 809 N. Cahuenga Blvd., Dept. F, Los Angeles 38, Calif. / In Canada / Regal Industries Ltd., Montreal-Toronto
THE SIGNATURE OF QUALITY ■ Tape Recorders / Industrial Sound Equipment / Dictation Systems / Communications Devices / Closed Circuit Television

CIRCLE NO. 68 ON READER SERVICE CARD

CHOSEN BY **Popular Science** AS THE BEST THAT MONEY CAN BUY
(WITHOUT FRILLS)

This photo and caption (the price is an approximation) appeared in the September 1963 *POPULAR SCIENCE* as part of an article entitled "The Low-Down on Hi-Fi Stereo." It is a picture of those high fidelity components which, according to a panel of experts, provide the best sound possible today.



The panel carefully considered return-for-the-money, but "where there was a more expensive component that produced a detectable improvement in sound, it was chosen."

These components are recognizable to hi-fi enthusiasts as the AR two-speed turntable, the Dynakit PAS-2 preamplifier, the Dynakit Stereo 70 dual power amplifier, and the AR-3 loudspeakers.*

*They have been on demonstration as a system for several years at the AR Music Rooms, on the west balcony of Grand Central Terminal in New York City, and at 52 Brattle St., Cambridge, Mass. No sales are made there; you may ask questions if you like, but most people just come and listen.

More detailed information, including a list of dealers in your area, is available from:

ACOUSTIC RESEARCH, INC., 24 Thorndike Street, Cambridge, Massachusetts 02141

DYNACO, INC., 3912 Powelton Avenue, Philadelphia, Pennsylvania 19104

BEETHOVEN'S VIOLIN CONCERTO



BETTMANN ARCHIVE

An old print of Vienna's Theater an der Wien, where Beethoven's Violin Concerto was given its first performance in 1806.

IN NOVEMBER OF 1792, the twenty-one-year-old Ludwig van Beethoven arrived in Vienna from Bonn. Vienna was then—as it remained for nearly one hundred and fifty years—the musical capital of the world. The musical art was cultivated in its highest forms in the princely Viennese palaces, with orchestral and chamber-music performances an everyday occurrence. With nothing but a letter of introduction from his friend and benefactor Count Waldstein, Beethoven went to work to impress himself upon the community and upon the aristocracy in particular.

For some eight years, until about 1800, Beethoven concentrated on his studies and on making his livelihood as a teacher and piano virtuoso. Yet, thanks

largely to the introductions Waldstein had given him, he quickly penetrated to the center of Vienna's musical life and was a guest at many of the city's most exclusive artistic and cultural events. Surprisingly, his coarse manner seems not to have handicapped him in Viennese society. On April 2, 1800, Beethoven gave his first self-organized and self-financed concert in Vienna, conducting the premieres of his First Symphony and of his Septet. By this time, musical Vienna realized that a new and striking personality was at work in the city. During the next dozen years Beethoven produced seven more symphonies, his opera *Fidelio*, the most famous of his solo piano and violin-piano sonatas, and others of his best-known works. *(Continued overleaf)*

ZINO FRANCESCATTI • BRUNO WALTER

THE BEETHOVEN VIOLIN CONCERTO
COLUMBIA SYMPHONY



STEREO



Intuitive abandon characterizes Francescatti's playing for Columbia of the Beethoven violin concerto, and he is incomparably supported by the late Bruno Walter and the Columbia Symphony Orchestra. Heifetz's detached performance on RCA Victor has many felicities, and Milstein's for Angel is a marvel of commanding ease.

The mid-point in this astonishingly fertile period of Beethoven's genius was 1806, itself a year of extraordinary productivity. The three "Rasoumovsky" String Quartets, the Fourth Symphony, the first revision of *Fidelio*, the "Appassionata" Piano Sonata, and the Variations in C Minor for piano solo all appeared in this year. Finally, there was the Violin Concerto in D Major, which was given its first performance in the Theater an der Wien one week before the year ended. The concerto was composed for Franz Clement, the musical director of the theater and solo violinist for the emperor of Austria. The story goes that Beethoven was so late in delivering the concerto that Clement had to read the solo part at sight at the premiere. The concerto had a great popular success, but there were some grumblings from critics caught unprepared to accompany Beethoven on his rarefied flight into the sublime. One Johann Nepomuk Möser wrote in the publication *Theaterzeitung*: "Concerning Beethoven's concerto, the judgment of connoisseurs is unanimous; its many beauties must be conceded, but it must also be acknowledged that the continuity is often completely broken, and that the endless repetitions of certain commonplace passages may easily become tedious to the listener." But successive generations of listeners have found Beethoven's concerto far from tedious, and it has become, by common agreement, the measure of all other violin concertos. Nowhere else in the literature for violin and orchestra is there a work to equal its radiant purity, glowing spirituality, and disarming humor.

Early in its career, the concerto was somewhat neglected by violinists, but that neglect has been more than compensated for by the attention the concerto receives in contemporary concert life. Nearly every ranking violinist of the past generation or so has recorded the Beethoven concerto at one time or another. Seventeen different discs (at latest count) are now available, of which nine are in both mono and stereo. The oldest performance is the one recorded about thirty years ago by Fritz Kreisler, with John Barbirolli conducting the London Philharmonic Orchestra (Angel COLH 11). Unlike the same artists' collaboration in the Brahms concerto, the Beethoven is a mixed

blessing. Kreisler illuminates the score with his own special—and paradoxical—blend of the coolly aristocratic and the warmly personal, but the playing does not have the ease and spontaneity that usually marked his style. An even earlier recording by Kreisler (with Leo Blech conducting) is far superior to this collaboration with Barbirolli, and I wonder that Angel did not select the former for reissue in the Great Recordings of the Century series.

Among the older performances, that by Menuhin and Furtwängler (Electrola 90065) is also worth singling out. It is a beautifully detailed, finely molded and proportioned account, and it still sounds quite good by current sonic standards.

AMONG modern recordings, six have unusual merit: Francescatti and Walter (Columbia MS 6263, ML 5663); Heifetz and Munch (RCA Victor LSC/LM 1992); Menuhin and Silvestri (Angel SG/G 7229); Milstein and Leinsdorf (Angel S 35783, 35783); Oistrakh and Cluytens (Angel S 35780, 35780); and Stern and Bernstein (Columbia MS 6093, ML 5415). Heifetz adopts generally brisker tempos than his colleagues, and there is an air of detached objectivity about his performance that will not be to everyone's liking. Within this framework, however, Heifetz renders a treasureable account with many felicities of phrasing and subtleties of shading and inflection. Milstein, too, delivers an objective performance. But at the same time I marvel at the violinist's commanding ease with the music technically. I wish for a more personal involvement in its musical and emotional argument. Oistrakh and Menuhin both offer deeply committed, musically penetrating performances that are, if anything, too serious. One misses in both the feeling of intuitive abandon that is found in the playing of Francescatti and Stern. Francescatti has the further benefit of an incomparable statement of the orchestral portion by the late Bruno Walter and the Columbia Symphony Orchestra.

Every one of the six cited stereo recordings of the concerto has virtues that will be attractive to many listeners. My own favorites are the Francescatti and Stern performances.



"A Medallion...

1



is a Medallion...

2

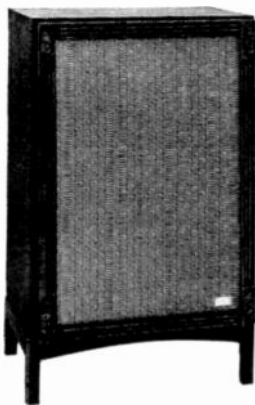

is a Medallion...

3

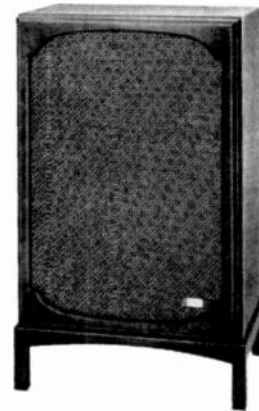

is a Medallion...

4

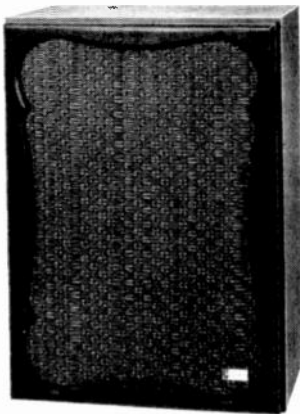

is a Medallion"

5

- 1. *Swedish Modern*
- 2. *Contemporary*
- 3. *Italian Provincial*
- 4. *Early American*
- 5. *French Provincial*

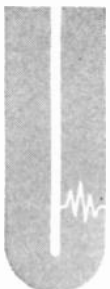

LTV UNIVERSITY
 A DIVISION OF LING-TEMCO-VOUGHT, INC.
 9500 West Reno, Oklahoma City, Oklahoma

They're all Medallions—the only 3-way speaker system with "Select-A-Style" grilles that snap into place to match any decor—may be used vertically or horizontally, with or without base. In the Medallion, University achieves the ultimate performance possible from a 12" woofer, special 8" mid-range and Sphericon Super Tweeter. Undistorted bass (down to 25 cps), highs to beyond the limits of audibility (40,000 cps). If you demand superb cabinetry, freedom of decorative choice and reproduction beyond the capability of ordinary bookshelf speaker systems—then the University Medallion XII is for you. In mahogany, walnut, oiled walnut, fruitwood or unfinished. As low as \$139.95. For free catalog and "Guide to Component Stereo High Fidelity", write Desk D-3, LTV University, 9500 West Reno, Oklahoma City, Oklahoma.

An FM tape stereo system of comparable quality would cost up to \$850



start with the Eico Receiver Kit — only \$154.95

You can build a complete, high quality FM tape stereo system from the new Eico Classic Speed Kit package for only \$445. This system includes the Classic 2400 stereo/mono 4-track tape recorder; Classic 2536 FM MX stereo receiver and two HFS-8 2-way high fidelity speaker systems.

Completely wired you'd save nearly \$300 on this system over other makes of comparable quality—factory wired price \$570. You can also select any individual component at a remarkably low price.

Here's why it's so easy to build these superb components. The 2400 tape recorder comes with the transport completely assembled and tested—only the electrical controls and amplifiers need be wired. The 2536, is without doubt the easiest-to-build receiver ever designed. The front end and the IF strip of the tuner section are supplied completely pre-wired and pre-aligned, and high quality circuit board and pre-aligned coils are provided for the stereo demodulator circuit. Speaker systems are completely assembled in fine oiled finish walnut cabinet.

EICO CLASSIC 2400 STEREO/MONO 4-TRACK TAPE RECORDER Performance on a par with recorders selling at twice the price. 3 motor design enables each motor to be optimized for its particular function.

- 3 heavy-duty 4-pole motors, capstan motor with integral fan □ DC braking of reel motors □ Standby operation between all transport modes prevents tape spillage, provides slur-free starts, permits easy cueing & editing □ Automatic end-of-tape switch & digital counter □ Jam-proof belt shift mechanism selects 7½ or 3¾ ips speed. □ Requires no head wearing pressure pads □ New combination erase and record-play

- 4-track stereo head □ Equalization selector provides uncompromised equalization on both speeds. □ Mixing mike and line level controls □ Dual electron-ray level indicator tubes □ Made in U.S.A. □ Oiled finish walnut base incl. in price of both semi-kit and wired versions. Semi-kit (transport assembled & tested) \$199.95; wired \$269.95.

EICO CLASSIC 2536 FM-MULTIPLEX STEREO RECEIVER Makes every other stereo receiver seem overpriced. Combines stable sensitive FM stereo tuner *plus* a virtually distortion-free 36-watt stereo amplifier with remarkable overload, transient and regulation characteristics.

AMPLIFIER SECTION □ all program sources—magnetic phono, adapted ceramic phono, tuner, tape □ Full control facilities—bass, treble, blend and balance □ Tape monitor switch □ Distortion at 10-w/channel 40 cps—0.5%; IHF, power bandwidth at 1% distortion, 30 cps—20 kc.

TUNER SECTION □ Low noise, shielded & temperature compensated front-end for drift-free performance □ 4 amplifier-limiter stages & ultra-wide-band ratio detector. □ Electron-ray tuning bar & stereo program indicator □ Velvet-smooth rotary tuning □ IHF usable sensitivity 3 μV (30db quieting); 1.5 μV (20db quieting). □ IHF distortion 0.6%; IHF capture ratio 3db. Kit \$154.95; wired \$209.95 (Incl. FET)

EICO HFS-8 2-WAY SPEAKER SYSTEM Compact 2-way speaker system in handsome oiled finish walnut cabinet. Full transparent bass; clean, smooth middles and highs. Two speakers: 8" high-gap energy woofer-mid-range transducer, and matched 2" tweeter. Wired only, \$44.95.

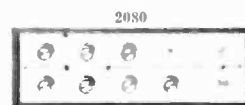
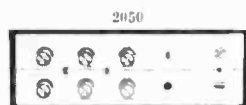

OTHER NEW EICO CLASSIC SERIES COMPONENTS 2036—36-watt stereo amplifier. Kit \$79.95; wired \$109.95. 2200—FM/MX Stereo Tuner. Kit \$92.50; wired \$119.95 (Incl. FET). 2050—50-watt stereo amplifier. Kit \$92.50; wired \$129.95. 2080—80-watt stereo amplifier. Kit \$112.50; wired \$159.95. Optional oiled finish walnut cabinet for the 2536, 2036, 2200, 2050 and 2080 are available for \$19.95. Add 5% in West

Eico Electronic Instrument Co., Inc., 131-01 39th Ave., Flushing, N.Y. 11352 Export: Roburn Agencies, 431 Greenwich St., N.Y. 13, N.Y.

CIRCLE NO. 15 ON READER SERVICE CARD



FREE 1964 CATALOG
Dept. HR-3





A candid guide for TAPE-RECORDER SHOPPERS

By JOHN MILDER

“TAPE RECORDER? Certainly, sir! Just what kind of machine did you have in mind? Mono? Stereo? Full-track? Half-track? Four-track? Portable? Transport only? Deck? With built-in amplifiers? Or would you like a cartridge machine?”

In a hi-fi showroom, questions like these will come—rapid fire—not from a high-pressure, sell-'em-anything-in-sight salesman, but from a helpful, obviously sincere type who wants only to sell you the *right* tape recorder. Part of the difficulty of choosing tape equipment originates in the bewildering variety of recorder *types* available. Add to this the large number of brands on the market, and you have a shopping problem of major proportions.

Fortunately, however, it is possible both to narrow down your range of choice quickly and to make several critical judgments about any recorder after a short demonstration. But if you wish to make the most of your visit to a showroom, it will pay you also to do some pre-shopping investigation. To begin with, keep the answers to these two questions firmly in mind: (1) What are your specific reasons for wanting to own a tape recorder? and (2) How much are you willing to pay for the privilege? You can take care of some of the necessary preliminaries by referring to the boxed sections of this article, in which the types of tape equipment available are outlined, some of the terminology is defined, and the specifications that de-

TAPE-RECORDER SHOPPING



scribe the important criteria of performance are examined. I will concentrate here on what you should look for and pay for in a recorder, what can be expected at various price levels, and how one can gauge the quality of a recorder in a showroom demonstration.

The first question for many is whether to buy a monophonic or a stereo recorder. The best solution, except for special cases, is to buy a stereo model. This is true even when the tape machine is to be connected to a monophonic hi-fi system. From the buyer's standpoint, it makes sense to pay the premium for stereo—even if, for the time being, stereo tapes can be listened to only over a recorder's own amplifier and speakers instead of through a full-fledged stereo component system. And since almost every stereo recorder is four-track, this means that it can record twice as much monophonic material as a standard two-track monophonic machine. As far as quality is concerned, the stereo machines are essentially equal (or superior) to the monophonic models.

A second basic decision must be made: Do you want a tape deck, or a self-contained recorder with power amplifier and speakers? The distinctions between these two types of recorders have become blurred, because all good self-contained machines provide connections to and from hi-fi components, and many decks offer accessory amplifier-speaker combinations for use away from a hi-fi system. Generally speaking, however, a tape deck can be described as a tape recorder that omits the power amplifiers and speakers already built into a home hi-fi system. During playback, a deck serves simply to move the tape, pick up the small signals from it, and supply a small amount of pre-amplification and equalization before a hi-fi system

takes over with its own amplifiers and speakers. The standard tape deck also has its own circuits for supplying bias current for recording and erasing. Once the tape deck has been connected to your regular amplifier, you can record FM programs and stereo discs and play them back without plugging or unplugging connecting cables.

For those who want to buy a tape recorder that is "complete and ready to play," a self-contained recorder is the obvious choice. Some of the self-contained stereo recorders are completely self-sufficient units for recording and playback, often supplied with lid speakers that can be detached and placed for optimum stereo spread. Others, however, although they have a stereo head, will play back only in mono unless a companion amplifier-speaker unit is added. So it pays to make sure just how "complete" any recorder is at the outset of a demonstration. Virtually all self-contained recorders have outputs to external speakers, which usually provide an improvement in sound quality. And all of today's better machines also have outputs for external amplifiers, making it possible to connect them to hi-fi systems.

One factor to recognize is that the piece-by-piece approach to good sound is not necessarily advisable when buying tape equipment. A case in point is the simplest kind of deck, the playback-only tape transport. A tape transport is definitely the cheapest way for a listener to get started with tape, because he doesn't have to pay for recording or playback preamplifiers. But any amplifier that is used with a transport must have tape-head inputs to provide the playback equalization and amplification required. Note that tape-amplifier inputs are not the same thing and cannot be used with a tape transport that has no playback preamplifiers. Of course, it is possible to add tape preamplifiers later to convert the transport into a full-

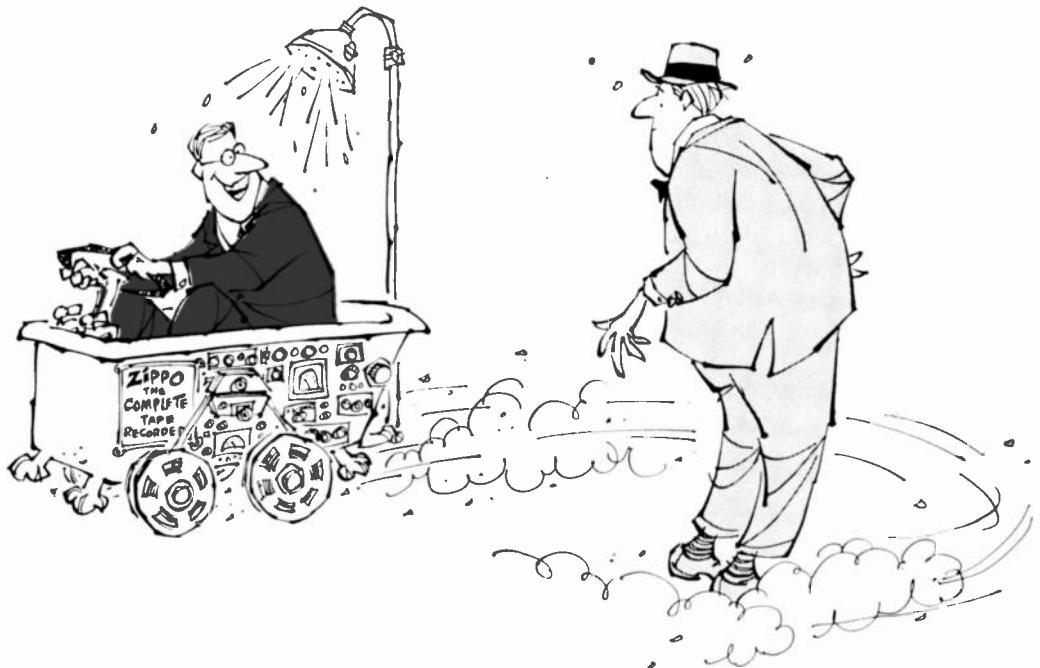

A TAPE-RECORDER GLOSSARY

THE FOLLOWING terms are almost certain to turn up on tape-recorder specification sheets or during conversations with recorder salesmen. All of the technical details may not be of direct importance to you, but they are worth taking a little trouble to understand before you start out on your shopping trip.

Heads. One of the earliest electrical discoveries, that the flow of current through a coil of wire sets up a magnetic field around the coil, is the basis for magnetic tape recording. Tape heads are miniature coils of fine wire wound on a core; they act on, or react to, the magnetism of iron-oxide particles on a strip of recording tape. For recording, a head's fluctuating magnetic field arranges oxide particles into magnetic patterns as tape moves past the head. For playback, the patterns arranged on a tape induce electrical signals in the head. Both of these functions depend on a small break (gap) in the core of the tape head, which permits the action of the coil to be focused on the tape moving past the head. Though a relatively wide gap is best for arranging oxide particles during the recording process, a very narrow gap makes possible the most precise response to a tape's magnetic patterns during playback. Although a single head can serve both for recording and playback, a dual-purpose head obviously cannot be optimum for both functions. For this reason, the best recorders employ separate heads for recording and playback. An erase head is separate in all recorders.

Level indicators. The most critical aspect of tape recording is the setting of the recording level. It must be high enough to get a strong signal on the tape, and yet not so high as to create distortion by overloading the tape. Of the three kinds of level indicators usually found in tape machines, the neon bulb, which indicates only minimum level and severe overload, is the least satisfactory. The magic-eye tube, which is sensitive enough to indicate momentary volume peaks very accurately, is generally both precise and easy to use. The VU meter, used on professional equipment, does not indicate short-term volume peaks as accurately as the magic-eye, but it gives an excellent reading of average recording level. Occasionally, the VU meters used on home recorders are either too small to be read conveniently, or are so badly damped that their needles swing too erratically for the eye to follow.

Mixing. You may want to record two sound tracks simultaneously—perhaps so that you can sing along with a favorite record and record the result. This can be done very simply by assigning each source to a separate channel of a stereo recorder, but the resulting tape will be monophonic. For full stereo mixing, a tape machine must have separate inputs on *each* channel for high- and low-level sources, and separate volume controls for each input. If the recorder that interests you lacks these facilities, however, you can usually buy a separate mixer at reasonable cost.

Sound-on-sound. In addition to providing tape monitoring, separate heads for recording and playback in a four-track machine may permit you to add new material to the sound already on a tape, for such purposes as dubbing in your own commentary on a recorded event, harmonizing with yourself on tape, or comparing your accent with a foreign-language teacher's. By connecting the output of one channel to the input of another and listening over earphones (listening over speakers would cause acoustic feedback), you can dub in your own voice or any kind of new material in perfect synchronization. By repeating the process from channel to channel, you can make a multiple-track monophonic recording. For full sound-on-sound capability, a recorder must have not only separate heads for recording and playback, but independent preamplifiers for recording and playback, and some provision for the connection of earphones. Other arrangements for making sound-on-sound recordings, such as a switch that deactivates the erase head as you record over the older track, are harder to synchronize and are likely to produce poorer sound quality, but they may permit you to dub on two tracks at once for stereo. Sound-on-sound is a marginal feature for many users, but if it interests you, take time to make sure just how a particular recorder accomplishes it.

Speeds. The majority of home tape recorders operate at either of two speeds: $3\frac{3}{4}$ and $7\frac{1}{2}$ inches per second. There is a trend toward incorporating speeds as low as $1\frac{7}{8}$ and $15/16$ ips. In general, the higher the speed, the better the treble response and the less wow and flutter. For the past few years, $7\frac{1}{2}$ ips has been the accepted speed both for high-quality home recording of music and prerecorded commercial tapes—with lower speeds recommended for less critical uses.

Tracks. It is not necessary to record across the entire width of a tape. If only half the width of a tape is in contact with the gap of a tape head as it moves past, two separate programs, or tracks—one for each direction of tape travel—can be recorded on the same tape. If each of the gaps is made to contact only one-quarter of a tape's width, four tracks—a stereo pair for each direction of tape travel—can be put on a single tape. Four-track operation, which uses paired tracks for stereo recording or uses them individually for monophonic taping, is now standard for home use.

Transport. A tape transport consists only of tape heads and a basic mechanism for moving tape. It has no built-in electronic circuits, and simply provides for playback of prerecorded tapes through the low-level tape-head inputs of an amplifier. It is possible to add heads and recording and playback preamplifiers to the basic transport and thereby build a complete deck by stages, but the final product is likely to lack both the features and performance of a deck purchased "complete." The transport's primary appeal is for those interested only in playing prerecorded tapes.



TAPE-RECORDER SHOPPING

fledged recorder. But the problem with this approach is that unless you are an advanced hi-fi do-it-yourselfer, you may run into technical difficulties (including hum and noise) in connecting the preamplifiers to the transport mechanism. And this type of step-by-step assembly usually means that the finished unit still lacks a very important feature: automatic erase interlock (to prevent accidental erasure of recordings).

None of the foregoing is intended to apply to decks that simply omit power amplifiers and speakers. At one time only the expensive semiprofessional-caliber machines lacked built-in playback facilities. Now, however, there are a number of decks in the lower-price range that are worth investigating. These machines are supplied, of course, with their own recording and playback preamplifiers. Unless you definitely need a self-contained recorder that can play back independently of a hi-fi system, a moderately priced deck may very well suit your requirements.

Top-quality decks almost never include power amplifiers and speakers, since even the best of these could hardly do justice to the recorder's potential sound quality. Units in this class include such models as the Sony 777, Viking 86, Ampex F-44, Tandberg 64, and the American Concertone 605. Some companies (notably Ampex and Sony) offer amplifier-speaker combinations in separate portable cases as optional extras. But even these units are meant primarily for on-location monitoring.

In the range between \$250 and \$400, self-contained recorders, or recorders that have built-in amplifiers and speakers, far outnumber decks. The logic here is that the listener who wants good rather than premium quality is likely to appreciate the extra convenience of

self-contained amplifiers and speakers. Although they are hardly capable of making studio-quality recordings, today's self-contained machines exhibit remarkably good performance when connected to a hi-fi system, and most produce generally acceptable sound over their own speakers. Over the past year, the use of transistor amplifiers in some recorders has resulted in better built-in sound quality and has made it possible to design more compact, heat- and hum-free units. With the continuing improvements in self-contained recorders, it is becoming increasingly more difficult to contend (as used to be the case) that their performance suffers in comparison with that of medium-price decks. The value of self-contained recorders in this price range (made by such companies as Norelco, Sony, Miranda, Uher, Concord, and Roberts) is underscored by the inclusion of features (such as sound-on-sound and tape monitoring) once found only in the highest-price decks.

Shoppers for hi-fi equipment are usually prepared to decide which price category of equipment is in line with their expectations and budget. What often puzzles the recorder buyer, however, is the apparent similarity in performance—at least in advertisements and on specification sheets—of recorders in all price ranges. It is not unusual to find virtually identical specifications claimed for recorders selling at \$200 and at \$500. And it is difficult, even for those who are used to discounting inflated claims, to pin down the real differences between disparately priced recorders and to decide which improvements in quality are worth paying for. To try to clarify the situation, let's look at what you can expect in each price category.

WITH a few exceptions, the \$150-\$250 price range is about as low as one can go and still obtain acceptable musical performance in a stereo tape machine. As indicated earlier, the best machines in this range are usually decks. The mechanical performance of these units is sometimes surprisingly good, particularly in terms of low wow and flutter (speed irregularities), but their ability to maintain their initial performance in these respects is not only hard to predict, but often depends on construction details that are impossible to judge in a showroom. Electronically, units in this class generally offer good but unexceptional performance. The main surface differences between recorders in this range and more expensive machines lie in features and conveniences. Most lower-price machines do not have provisions for tape monitoring, sound-on-sound, automatic shut-off, and other convenience functions. For critical recording, the most important lack in some of the very low-price machines is a convenient, easy-to-read recording-level indicator. All in all, there is a good chance of finding acceptable performance

in the low-price category, but it must be balanced against the lack of conveniences and (sometimes) an unpredictable life-span.

The performance and flexibility of a recorder in the \$250-\$400 price range comes quite close to that of the highest-price equipment. For the golden-eared audiophile, however, audible differences remain in the areas of frequency response, signal-to-noise ratio, distortion, and flutter. As for features, you can expect in this range almost everything found in the top-price category.

The decks in the \$400-\$700 range provide performance that comes within a hair's breadth of that of a professional-quality machine. Many of the quality features are unobtrusive. It is likely, for instance, that

the deck plate of a machine in this range will be a cast assembly designed for maximum rigidity to avoid the possibility of a head assembly's shifting out of proper alignment. Motors also are of higher quality and are more dependable over a long period. And there are such amenities as automatic tape lifters and independent volume controls for microphone and high-level inputs. Excellent fidelity at low tape speeds is another feature. In general, the high-price recorders offer a bit more of everything valued by the owner of a high-quality stereo system.

When, in the course of your investigations, you finally do reach the point at which some particular recorder interests you, there are several yardsticks you can apply to measure its performance. When judging machines

INTERPRETING THE SPECIFICATIONS

ALTHOUGH such performance criteria as frequency response, distortion, and signal-to-noise ratio are as applicable to recorders as they are to other audio components, manufacturers' specifications for tape equipment are notoriously vague. The claims made for some machines appear to have been prompted either by wishful thinking or by the checking of a "lab sample" long since tucked in a vault for safekeeping. Such calculated vagueness often makes the specifications of a cheap recorder look more impressive than those for top-quality professional equipment. The usual criteria *do* count, however, and here are the ones to look for in a list of specifications—together with some suggestions for interpreting the figures.

Frequency response. As with all hi-fi equipment, frequency-response specifications for tape equipment are meaningless unless the *uniformity* of response is stated along with the range of response. Without a qualifying "plus-or-minus so many decibels," a claim has no significance. A recorder's *record-playback* response is more important than its playback response alone and should be within ± 3 -4 db over the range stated. A top-quality recorder should hold the tolerance to ± 2 db. Keep in mind that the frequency response given for a complete, self-contained recorder is likely to represent the best the machine can do when used in conjunction with an external hi-fi system.

Signal-to-noise ratio. This specification is virtually useless as a standard of comparison for any but top-quality recorders. The ratio itself, expressed as the difference (in decibels) between a recorder's residual noise and the loudness of a test tone recorded at "standard" level, depends in great part on the meaning of "standard." Manufacturers tend to be flexible in their interpretation of the term, some choosing a recording level that produces as little as 1 per cent harmonic distortion on tape, others picking a higher level at which distortion may be 5 per cent. Fre-

quently, the ratio given for an excellent machine (based on a low-distortion recording level) may seem inferior to the figure stated for a mediocre unit. Rather than attempt to weight the figures for various machines to compare them, it is better to rely on a listening test conducted with wide-range hi-fi equipment.

Speed consistency. Fortunately, the specifications for wow and flutter, the most serious kinds of speed variation in a recorder, are fairly straightforward. Both forms of trouble (whether listed separately or together in a list of specs) should be held to less than 0.25 per cent in a high-quality recorder. In some inexpensive machines, an impressive wow figure may have been measured near the middle of a 7-inch reel, since this will give a better result than a check made at the beginning or end of a reel. In general, however, wow and flutter percentages are reliable standards of comparison. Less likely to be stated in specifications (and often relatively unimportant) is the question of a recorder's long-term speed accuracy. A number of machines, including a few expensive models, run slightly faster or slower than their indicated speeds. This may be completely unimportant to anyone who intends to play back only his own recordings. If you intend to invest heavily in prerecorded tapes, however, a machine's nominal playing speeds should be as accurate as possible. Its long-term speed variation, if stated at all, should be less than 1 per cent—and preferably under 0.5 per cent. If not stated, a machine's speed accuracy can be checked with a strobe device.

Distortion. Specifications for distortion in tape equipment are generally too vague to be meaningful. Even when harmonic distortion at "standard" or maximum recording levels is stated—which is not often—there is no indication of the further distortion added by a recorder's playback preamplifiers. As with signal-to-noise ratio, a listening test through a high-fidelity system provides the most reliable index of quality.

TAPE-RECORDER SHOPPING



in a store, the main precaution to observe is not to let attractive gadgetry distract you from the question of basic performance. Whether high-powered or simply helpful, the salesman who puts a recorder through its paces may very likely leave you dazzled by its seemingly endless features. If you have an idea of what to look and listen for, however, and if you try a few tests on your own, you can make critical judgments quickly, conveniently—and independently.

In making listening tests, be certain to judge a recorder's performance when it is playing through a hi-fi system as well as through its built-in speakers. Whether or not you intend to use a tape machine with hi-fi components for the time being, you can best judge everything from its signal-to-noise ratio to its percentage of wow and flutter over good, wide-range loudspeakers. When a store has a "recorder corner" where machines are played through their own speakers or with mediocre external equipment, ask to listen over a good stereo system. If this is not possible, try another store.

TO PUT any machine through a meaningful test, be certain to make or have made for you an on-the-spot recording from a good record or FM broadcast. If a machine has provisions for monitoring, a direct comparison between the program source and the finished tape will reveal a recorder's sound quality more clearly than any other kind of demonstration. A prerecorded tape, either commercial or made for demonstration (by the salesman), is virtually worthless for in-store listening tests, because it may have been souped up during recording. In listening for excessive noise, the source-*vs*-tape comparison is the best guide. Keep in mind, however, that a noisy recorder, even if it makes a quiet tape of a record or a broadcast, may add an annoying background to recordings made with microphones anywhere near the machine. To judge wow and flutter, play a recording containing some sustained piano chords or a prolonged 3,000-cps tone. Neither of these should waver annoyingly on a good machine.

To check a recorder's mechanical operation, you can run through several quick tests. Check first for performance at normal playing speeds. Does the machine jerk when started? Does it spill tape when brought to a stop? If you are satisfied with a recorder's performance at playing speeds, check its operation during rewind and fast-forward operation. Can you stop the machine from high speed—or switch from rewind to fast-forward—without breaking or spilling tape? Does the machine switch from high speed to playing speed without apparent difficulty?

The more expensive the recorder, the more convenient and well-thought-out its control facilities should be. In evaluating a machine's recording-level indicators, notice how easily they can be read, rather than how impressive and "professional" they appear. The fewer the knobs and switches needed to accomplish a specific function, the better. The ease with which a versatile machine can be operated is one of the best clues to its over-all quality. In judging the quality of any recorder, a little common sense is often more useful than a whole catalog of arbitrary standards. You may find, for instance, that a recorder with only one motor is more satisfactory than a machine that has separate motors for tape-drive, rewind, and fast-forward. And it may well be that a compact, unobtrusive machine is better for your needs than a mammoth, formidable-looking recorder.

It makes sense, too, to check a recorder's "paper" features in actual operation. For example, there is considerable confusion about the meaning of "tape-monitoring." A recorder with separate heads for recording and playback will usually enable you to check the quality of a recording *while* it is being made, by comparing the signal fed to the machine with the same signal immediately after it has been recorded on the tape. To indicate that a machine permits checking the signal that has been impressed on the tape, the specifications should include a phrase such as "source-tape monitoring," "A-B comparison," or "direct tape monitoring." A simple indication of "monitoring" facilities may mean only that an incoming signal can be played as it is being recorded. If the specifications leave you in doubt, keep in mind that true monitoring can be done only if a machine has separate recording and playback heads (for a total of three heads, including the erase head), a feature that will always be mentioned in the specifications. If you are still in doubt when you arrive at a showroom, make sure that what you listen to in a demonstration of monitoring is the sound from the tape. You can check this by touching the feed reel while the machine is running. A quaver in the sound will indicate that what you hear is being monitored from the tape.

Whatever your reasons for buying tape equipment, it is likely that several of today's recorders will prove capable of meeting your particular requirements. Therefore, since you can save an enormous amount of time by narrowing down the field beforehand, do your homework now. Your trip to the showroom will be much more relaxed, pleasant—and profitable.

John Milder, a free-lance writer who has contributed a number of how-to-buy articles to HIFI/STEREO REVIEW, speaks from a background of having sold hi-fi gear in New York City stores.

TAPE-CARTRIDGE PROGRESS

A NOTED CRITIC DISCUSSES AND EVALUATES
THE RCA AND REVERE TAPE-CARTRIDGE SYSTEMS

By MARTIN BOOKSPAN

IN THE two decades that have elapsed since its development, magnetic tape recording has been responsible for revolutionary changes in the entire technology of sound recording and reproduction. Since the late 1940's, magnetic tape has been the medium for making most master recordings, and, indeed, it was the flexibility and the reproduction quality of tape masters that provided the final stimulus for the acceptance by the record industry of the long-playing disc.

But commercial prerecorded tape for home listening is comparatively new. It was only eight years ago

that the first industry-produced prerecorded stereo tapes were released to the public. They were two-track, 7½-ips affairs, with the left channel recorded on the upper track and the right channel on the lower. The pioneer producer was RCA Victor, but other manufacturers soon joined in, anticipating a new market for their products. Two-track stereo tapes were released by Angel, Columbia, Everest, Livingston, Vox (via a concern called Phonotapes), and Westminster (through a division called Sonotapes).

The quality of these two-track stereo tapes was extraordinary—in fact, this was probably the most vivid



TAPE CARTRIDGES

sound ever produced for home listening. However, it soon became apparent that the buying public was simply not investing in two-track stereo tapes and the machines to play them on, and there was widespread gloom in the tape industry. Toward the end of 1957 came the development that seemed to sound the final knell for tape as a medium for reproducing prerecorded music in the home: the introduction of stereophonic records.

The prophets of gloom were premature, however, for manufacturers in the tape industry were hard at work attempting to overcome the public's indifference to their products. One way to attract more buyers, they reasoned, would be to make the handling and playing of tapes less complicated. After all, a certain amount of mechanical aptitude is required if a tape recorder is to be operated properly, and even professional engineers have been known to stand helplessly by while a precious tape was shredded because of a careless operator or a malfunctioning machine.

A tape-cartridge system, such as those used in magazine-loading cameras, was considered to be the solution to the problem posed by an essentially anti-mechanical public. The cartridge would eliminate tape-handling on the part of the user, the tape would be completely enclosed, and a mechanism could be provided to thread, play, rewind, and change the cartridge automatically.

Several different cartridge systems were therefore introduced, among them:

1. A continuous-play unit, made by Magnecord, in which the tape was pulled from the inside of a reel and wound back on the outer circumference of the same reel. Later Mohawk, Viking, and others offered compact models employing this same principle. The National Association of Broadcasters uses cartridge units of this type for broadcast commercials.

2. A multitrack endless-loop machine developed by Armour Research Foundation that could accommodate program material of long duration on a comparatively short tape.

3. An experimental unit produced for the U.S. Government by Brush Development Company.

However, it was not until RCA Victor introduced its cartridges and players in February of 1958 that there seemed to be any genuine public interest. In the RCA Victor system, two side-by-side reels of tape are housed in a rectangular plastic case measuring $5 \times 7 \times \frac{1}{2}$ inches. All one has to do to play the cartridge is put it in place and turn the machine on. In order to accommodate generally accepted program lengths within the compact confines of the cartridge, RCA's engineers elected to use the four-track system and also reduced the speed to $3\frac{3}{4}$ ips.

Soon after the introduction of the RCA cartridge system, another new development sent the proponents of tape cartridges into a tailspin. Four-track stereo tapes were introduced on conventional 7-inch reels, to be played at $7\frac{1}{2}$ ips. The faster speed made possible

Blank and prerecorded tape cartridges for use in the RCA system are shown with a standard stereo tape box for size comparison.



a reproduction brilliance comparable to that obtained with the earlier two-track medium, and the reel-to-reel system also afforded the audiophile a comforting sense of familiarity.

Four-track reel-to-reel stereo tapes are now well established. Dozens of new ones are released each month, and the pages of the Harrison tape catalog are developing a respectable middle-age spread. Most important, there has been a steady improvement in the reproduction quality of four-track stereo tapes, and there is now a considerable public buying them. Indeed, four-track stereo recorders and prerecorded four-track stereo tapes are becoming standard equipment in the home of the sophisticated audiophile.

Four-track reel-to-reel stereo tapes might perhaps have buried the cartridge concept once and for all. However, there is now more vitality in the cartridge field than ever before. Both RCA Victor and the Revere-Wollensak Division of the Minnesota Mining and Manufacturing Company are busily promoting cartridge systems.

THE MOST recent of RCA's cartridge players is a compact, rugged, thirteen-pound unit called the Gordon Bleu. It sells for \$199.95, and is both a player and recorder. A muting switch turns off the built-in speakers when the unit is used as a playback deck in conjunction with an existing high-fidelity component system.

A dozen of the RCA Victor tape cartridges were evaluated for the purposes of this report. (The total

tape-cartridge catalog for the RCA machine includes about two hundred cartridges, priced from \$4.95 to \$6.95; blank cartridges, for home recording, are \$4.50.) In most cases it was possible to make direct A-B-C comparisons among three versions of a given recording: the stereo disc, the four-track 7½-ips stereo tape, and the stereo tape cartridge. All comparisons were made on the same high-quality component playback system.

In general, the stereo-disc and conventional four-track tape releases offered wider frequency response than did the RCA Victor cartridges. In other respects, however, the quality of reproduction from the cartridges compared quite favorably. In one case—Beethoven's Fifth Symphony, as recorded by Fritz Reiner and the Chicago Symphony Orchestra—the cartridge version produced the cleanest sound of all: both the disc and conventional tape versions displayed overload distortion in some heavily scored passages, while the cartridge had considerably less of this. Conversely, the RCA cartridge containing highlights from Verdi's *Aida* (sung by Leontyne Price, Georg Solti conducting) was afflicted with blasting and overloading not heard on either the stereo disc or tape.

The Revere cartridge system was given its first full-fledged public introduction last September at the 1963 New York High Fidelity Music Show. Four models are available: a recorder-player with amplifier and speakers; a player-only version of this unit; a recorder-player without amplifiers and speakers (designed for home installation in existing high-fidelity systems);

The 3¾-inch-square tape cartridges designed for use in the slower-speed Revere system are dwarfed by a standard tape box.



TAPE CARTRIDGES

and a player-only unit. Prices range from \$269 to \$399.

The unique aspect of the Revere cartridge machine is that it changes cartridges automatically—it operates like a record changer. The prerecorded tape cartridges are first stacked in a well on the machine. When the play sequence is activated, a cartridge drops into place, and the tape is automatically threaded past the playback head and onto a built-in take-up reel. When the end of a tape is reached, it is automatically rewound, the cartridge is rejected into an adjoining well, and another cartridge falls into position. The threading-playing-rewind cycle is then repeated; as many as twenty tape cartridges can be stacked on the loading platform to provide up to fifteen hours of stereo music without reloading.

The Revere cartridges measure $3\frac{3}{4}$ inches square and are $\frac{1}{2}$ -inch thick. They play at $1\frac{7}{8}$ ips, and each cartridge can accommodate up to forty-eight minutes of two-track stereo program material. The specially developed magnetic tape in the Revere cartridges is said to represent a breakthrough in tape technology. In physical appearance, the cartridge tape is narrower than the standard recording tape—about $\frac{5}{32}$ inch in width, as compared with the usual $\frac{1}{4}$ inch—and its color is a greenish-gray, as contrasted with the usual brown oxide coating. The polyester base is tensilized by prestretching, so that the tape has a tensile strength similar to that of $1\frac{1}{2}$ -mil. $\frac{1}{4}$ -inch tape.

The number of prerecorded cartridges available for the Revere system is at present small (about 120), but the list embraces serious music, popular, jazz, folk, and Broadway-show material. Most of the Revere tapes currently available are from Columbia, but United Artists, Crescendo, and Elektra are also represented, and others are almost sure to be added in the future. Prerecorded cartridges are priced from \$7.50 to \$8.50, and cartridges of blank tape for home recording are \$4.95.

Two samples were checked of the Revere Model M-2, a complete recorder-player about the size of a typewriter. Mechanically, the unit seemed virtually foolproof. It automatically threaded, played, and rewound enormous stacks of cartridges perfectly. If desired, a cartridge could be rejected at any point in the program, and the machine would automatically rewind, reject, and then play the next cartridge. As for sound quality, most of the prerecorded cartridges suffered from excessive tape hiss, and although the best of the cartridges were about as free of hiss as good reel-to-reel tapes, few reached that standard. Since the excessive hiss apparently originates in the tape-duplication process, and is not inherent in the tape or

in the machine, improvements will probably soon be forthcoming.

The M-2's lack of ganged volume and tone controls complicated channel-balancing and tonal adjustment to some extent. The continuously variable tone controls (one for each channel) had settings marked BASS, HI-FI, TREBLE, and BALANCED TONE (whatever that means), and were difficult to set for good results through the unit's built-in speakers. Of the two samples of the Revere tape-cartridge recorder, one was capable of excellent sound when connected into the same high-fidelity system as was used with the Cordon Bleu unit; the other sample had tonal deficiencies. Tone-control adjustment remained a little tricky, since the Revere's audio signal is tapped off after its tone controls. However, by juggling the tone controls on the amplifier and the tape machine, excellent sound could be achieved if the taped material in the cartridge was of adequate quality. Among the dozen Columbia cartridges checked, one (Copland's *Appalachian Spring*, with Leonard Bernstein and the New York Philharmonic) was afflicted with periodic sound drop-outs; a replacement cartridge of the same recording suffered from no such fault. When the Revere-Columbia cartridges were checked in A-B-C fashion against their stereo-disc and four-track stereo-tape counterparts, the cartridges provided less satisfactory sound in almost every case. The results obtained with the Bernstein-Philharmonic recording of Rimsky-Korsakov's *Scheherazade* were typical. The stereo-disc version of the performance was full and vibrant, with an extended frequency response. The four-track reel-to-reel tape version was even more impressive, with greater presence, a wider dynamic range, and superlative bass response. The cartridge version had a more constricted dynamic range, with traces of distortion in the loudest passages, and some flutter in sustained chords and solo woodwind passages.

IN SUM, then, there is still considerable refining to be accomplished by the cartridge and player manufacturers. Right now the RCA Victor system would seem to have the edge as far as quality of reproduction is concerned. For its part, the Revere system, with its automatic tape-changing feature, could be valuable in restaurants, cocktail lounges, hotels, department stores, and similar establishments requiring continuous background music. For the present, however, the supremacy of disc and reel-to-reel four-track tape reproduction remains unchallenged.

Martin Bookspan, who is most familiar to HiFi/STEREO REVIEW readers as the author of the monthly "Basic Repertoire," is musical director of radio station WQXR in New York City.

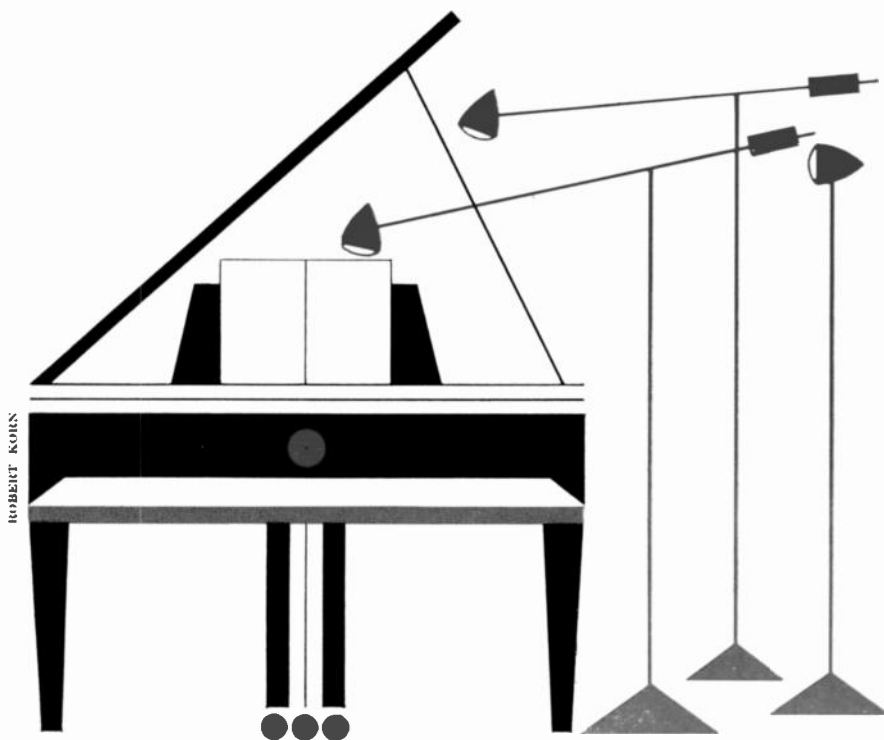

RECORDING LIVE STEREO AT HOME

PRACTICAL ADVICE ON HOW TO MAKE PROFESSIONAL-SOUNDING
TAPES WITH AMATEUR EQUIPMENT

By BENNETT EVANS

Most high-fidelity tape recorders are semi-permanently connected into their owners' sound systems, and are used primarily for preserving FM broadcasts or copying an occasional disc. Their microphone jacks gape emptily most of the time, save when the probably low-quality microphone that came with the recorder is disinterred from the closet to capture baby's gurgles or party giggles.

But there comes a time when the recordist is tempted to try his hand at taping musical members of his family, local folk-song groups, and other amateur music-makers. In seeking to be their passport to posterity, the amateur recordist is faced with a host of new and challenging problems. Foremost among them is—where does one place the microphones? Because of the large

number of factors beyond the control of the recordist in each new recording situation, microphone placement is frequently more art than science, and like any art is mastered only through practice.

Every recording poses different problems, and not even the most experienced recording engineer can tell by eye whether a specific microphone setup is exactly right; you never know until you monitor the results. Ideally, one should monitor as the professionals do, through a wide-range playback system in a room apart from the recording area. But in practice, most amateurs monitor their recordings on headphones in the same room where they are made. Since it is important to be able to differentiate between the sound that reaches your ears through the headphones (via the micro-

RECORDING LIVE STEREO AT HOME

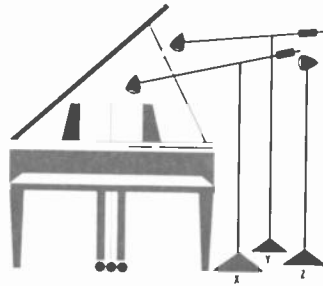

phones) and the sound that leaks in around them, it is advantageous to use a pair of headphones that seals off the direct sound (I have found the David Clarke, Sharpe HA-10, Koss PRO-4, and Permoflux BDHS and HDB to be good in this respect). You must learn to compensate in your mind—not in your recording—for the exaggerated stereo effect you hear through headphones (there will be far less separation when you play back through speakers), or else use a headphone-perspective device such as the Jensen CFN-1. Learn to correct for frequency discrepancies, too: don't be misled by a pair of bass-heavy earphones into microphoning a soprano too closely. Live recording is always a trial-and-error process, but as you acquire more practice, the trials will become fewer, the errors less serious.

When you first connect your microphones, put on your headphones and listen. You will suddenly be conscious of all sorts of noises previously unnoticed: traffic outside, squeaking shoes, odd room reverberations, and so forth. Shut the windows and doors, move your recorder to the dead side of the microphone, and as far away from it as is convenient. Shut off every other noisemaker (talkative spectators included), and you will be ready to face your main problem: microphone placement.

As with most amateurs, the bulk of my live recording has been done in my own or someone else's home. I have taped pianists, alone or accompanied by a vocalist, an occasional recorder (woodwind, not tape) player, guitarists, and so forth. Of these, the piano,

alone or in accompaniment, is the trickiest to capture accurately. Good results have been obtained with the microphone placements indicated at Y and Z to the left. I record grand pianos by suspending a microphone on a boom over the open piano, or on a stand to the right of the piano, where the lid will reflect the sound toward it (I prefer the latter arrangement for stereo microphoning). Upright pianos are a bit harder to record, and I usually open the top and aim my microphone over the pianist's shoulder from above.

When the pianist is also the vocalist, things are more difficult, and a boom becomes a necessity. On a grand piano, I start by suspending the microphone above the music rest, facing it down toward the pianist, as pictured at X (above, left). Then I move the microphone back and forth until voice and piano are balanced. I do the same with uprights, though there is less room for adjustment.

If the pianist is accompanying a singer, violinist, or other soloist, I try to pick them up with a stereo coincident-pair microphone, placing the soloist between the microphone and the piano, and moving him back and forth along the microphone axis until I get a satisfactory balance. If the soloist wants to face the pianist, I use a bidirectional microphone (placed as shown on page 51), which is balanced by varying the distance from the microphone to the piano and from the soloist to the microphone. Within very narrow limits, it is also possible to de-emphasize the piano by rotating the microphone axis away from it—but not completely, or the piano will sound too distant, and there may be a disproportionate loss of the higher frequencies.

Recording a guitarist presents a somewhat different set of problems. Last summer, I taped folk singer Robin Ajay in a rather cavernous hall. As a first trial, I placed my two microphones in front and a little to each side of her, both angled to include her in their pickup pattern. Since I liked the hall's acoustics, I first made a recording with my microphones six feet

The basic stereo microphone arrangements are illustrated at right. The spaced-pair setup shown on this page employs two cardioid microphones, with spacing determined by the size of the performing group. The coincident-pair arrangement (opposite page) uses two cardioid microphones that are angled for an overlapping pickup pattern.

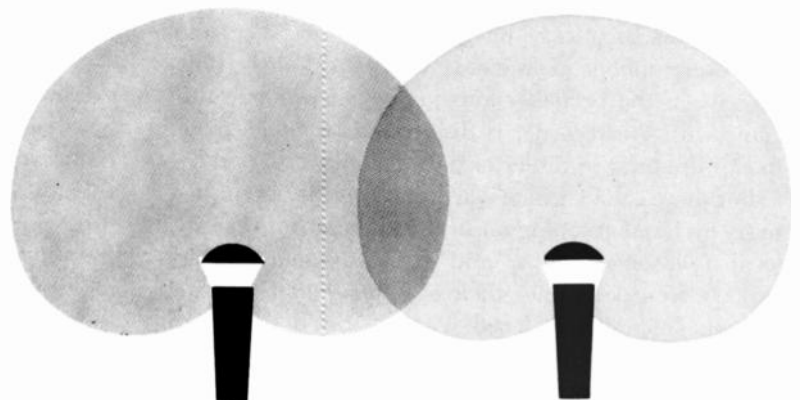

away. (The farther your microphone is from the music, the more reverberation you pick up, and the more distant the recording sounds.) All I got for my trouble was a muddy, rumbling travesty, with Robin's words drowned in the boomy echoes of the room. Six feet, then, was too far for such a reverberant room, so I moved in much closer. When my microphones were placed two feet from Robin, every word came through clearly and distinctly—but so did every scrape of her fingers on the guitar strings. In addition, the voice and the guitar refused to blend, and the atmosphere of the room was completely lost. The compromise microphone position, which was four feet away, produced sound that was clean and clear but still had blend and plenty of atmosphere. The room's hollow-sounding acoustics accented the lonesome quality of the ballads, though the fast numbers—in which note followed note too quickly for the reverberations to die away between—would have benefited from closer microphoning. Of course, if Robin had been recording an intimate song—such as *Cuddle U'p a Little Closer*—very close microphoning would have been appropriate.

In addition to resolving problems of perspective and reverberation, I had to decide how high the microphones should be placed to balance Robin's voice against the guitar. Since her voice is strong and clear, I got a good balance with the microphone about halfway between her guitar's sound board and her mouth.

I also had to decide which of the two basic stereo microphone setups to use: the spaced-pair or the coincident-pair. The spaced-pair setup shown on page 50 is most popular in this country: the two microphones, on individual stands, are spaced from about five to twenty-five feet apart, depending on the width of the performing group and how far the microphones are from the performers (the farther back, the wider the spacing). In the coincident-pair setup, which is most popular in Europe, the microphones are usually mounted one right above the other (on a single stand if possible) and angled as indicated below.

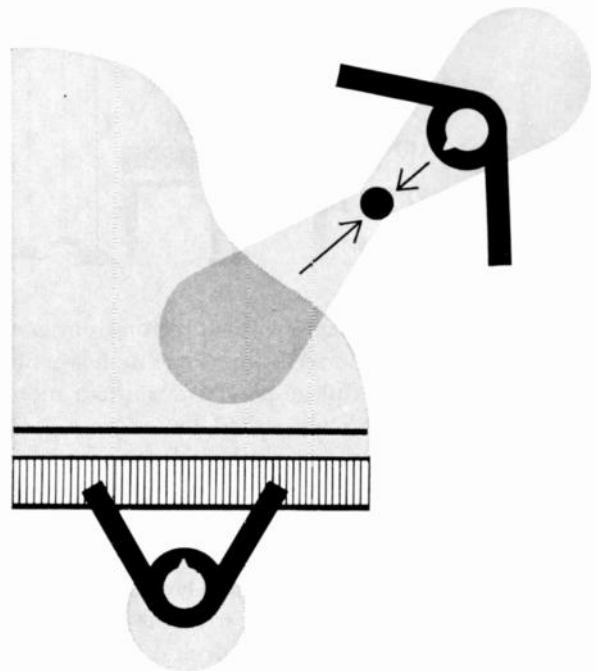
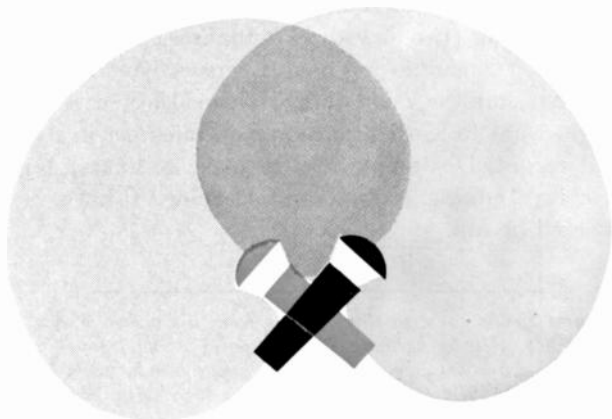

The bidirectional microphone's figure-eight pickup pattern is ideal for taping a vocalist accompanied by a piano. The voice-piano balance is determined by the placement of the microphone.

I have found, in general, that I get a little more separation and sonic spread with the spaced-pair arrangement than with the coincident-pair setup. Since a soloist is a rather narrow program source, I used a pair of Shure 330's, spaced about four or five feet apart, to record Robin. Almost all of the stereo effect, of course, came from reverberation. Since the room was so reverberant, and my microphones were far enough back to register it, the finished tape has a lot more spaciousness than most solo recordings I have heard.

Once the recordist leaves the friendly surroundings of the home, however, a host of new problems is encountered. Last spring, for example, I was doing some recording at the Indian Neck Folk Festival. Because these were not private recording sessions but live performances, I wanted a setup that would be as inconspicuous as possible, and one that could also be quickly readjusted as one group followed another. This dictated the coincident-pair technique.

I didn't want to put the microphone stands on the none-too-solid stage, because the stamping feet of the enthusiastic performers would jar the mikes to a fare-thee-well, so I put the stands on the floor in front of the stage. This put me too far away for good pickup, mostly because of the excess crowd noise (hootenanny audiences are not among the world's quietest). But with two Electro-Voice 664 cardioid-type microphones mounted on Atlas Baby Booms, I found I could not only place them fairly close to the performers, but

RECORDING LIVE STEREO AT HOME

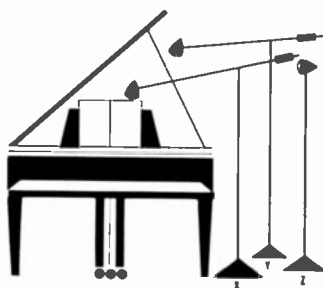

could change their positions without getting onstage.

A few years ago, while recording some monophonic incidental music for a college play, I ran into a more difficult problem. The score called for a drum, two flutes, a trumpet, a trombone, and a cello. No amount of microphone juggling would get the instruments' volume levels in balance—so I rearranged the performers. The drum, being loudest, was situated on one of the dead sides of the bidirectional Dynaco B&O 53. The drum then balanced nicely with the trombone, but the flutes and cello were too soft and the trumpet was too loud. I moved the cello in closer and lowered the microphone stand until the microphone was about four and a half feet off the ground, tilted down to face the cello's *f*-holes. The flutists played into the upturned rear of the microphone, and everything was in balance except the trumpet. I had the trumpeter, who had been behind the flutists and blowing straight toward the microphone, aim his instrument off to one side and stand behind the cellist. With this last change, the balance was acceptable.

Sometimes, though, you can't juggle the performers, and no arrangement of one or two basic microphones will work. What then? I ran into this problem just recently, taping a monophonic sound track for a friend's 16-mm movie about jazz musician Roland Kirk, then playing with his quartet at New York City's Village Gate.

Since I wanted a stereo recording of the proceedings for myself, I selected a Dynaco B&O 200 microphone (which is actually a coincident pair of two bidirectional ribbon microphones in a single, slim housing) and mounted it unobtrusively on a single stand. Coincident-pair recordings usually blend into a good mono recording more satisfactorily than spaced-pair recordings do, and since the movie's sound track would be mono, this was an added advantage. Moreover, the bidirectional ribbon elements picked up just enough noise from the audience to establish the nightclub atmosphere.

In several numbers, however. Mr. Kirk played a flute directly into the Village Gate's public-address microphone, and my microphone was too far away to capture the desired close, breathy effect. To get this, I decided to fasten an additional PML miniature con-

denser microphone to the side of the public-address microphone. This, of course, made it necessary to use a microphone mixer. A mixer is basically a set of microphone preamplifiers on a single chassis, each with a gain control, with outputs connected together. This permits the user to feed several microphones into a single input on the tape recorder and to control the level of each microphone independently. By connecting the PML and the right channel of the B&O to my Olson Electronics RA-502 mixer (an excellent \$35 transistorized unit) I was able to fade the PML in and out as required. The gain on the B&O was held constant on both channels. When the PML was faded in, the spatial perspective was altered somewhat, but not seriously.

The mixer came in handy later in the evening, when I was fortunate enough to be able to tape blues singer Gloria Lynne and the Marvin Jenkins Trio, who were appearing on the same bill at the Village Gate. My problem was that Miss Lynne sang from a platform far to one side of the quartet, so I recorded the quartet with the B&O 200 and mixed in a PML placed in front of Miss Lynne.

In five years of practice, I have learned where to begin placing microphones, but I still make several

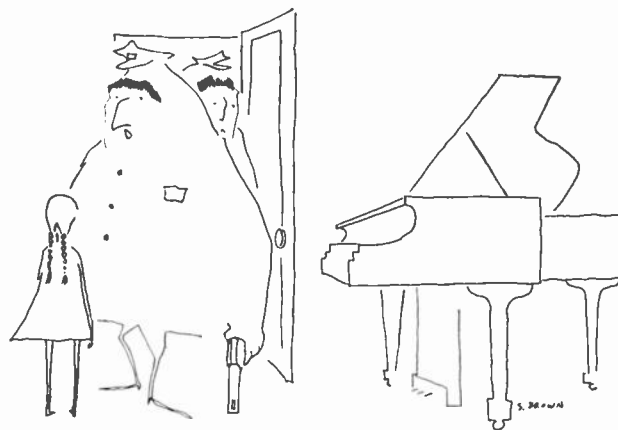

"They told us a guy named Chopin was being murdered here."

trial runs for every setup. Along the way, I have learned a bit about room acoustics, and a bit more about editing (two flawed performances can be spliced to make a single flawless one, if perspective and levels match). But the main thing I have learned is that if you want to learn recording, you must get in there and record. Don't be afraid to make mistakes: tape is cheap, editing is easy, and learning, I have discovered, is fun.

Bennett Evans came to this country from his native Wales in the 1930's. His background in electronics dates from World War Two, when he served in the U.S. Navy as a radar technician. Professionally, Mr. Evans is a New York advertising executive.

SELECTING A MICROPHONE

IT is most important, in selecting a microphone, to match its quality level to that of the recorder you intend to use it with. It is evident that if your microphone's frequency response far surpasses that of your recorder, the microphone will sound no better than a cheaper unit whose response matches the recorder's. On the other hand, a very low-cost microphone will not be able to take advantage of the full response of which a good recorder is capable. In addition to matching quality levels, there are a few other quick and simple checks that should be made before purchase.

Record a voice (not your own) with the microphone about two and one half feet from the speaker's mouth. Then, on playback, listen for alterations in the sound quality—such as a heavy, chesty tone, excessive sibilance (both of which can also be caused by speaking too close to the microphone), or a thin, scratchy tone. The first indicates a rising bass response; the latter two indicate a peaky treble. Jangling some keys close to the microphone can provide a quick check of the range and smoothness of the treble response.

Examine the frequency-response and polar-characteristic diagrams on the microphone's specification sheet. A *smooth* frequency-response curve is as important as an extended one. Though bass response below 50 cycles is comparatively unimportant for most amateurs (in fact, it may even cause trouble under non-studio recording conditions), treble response—especially between 9,000 and 13,000 cps—is very important for lifelike recordings.

There are three basic polar patterns: a microphone may have an omnidirectional (or nondirectional) response, which means that it picks up sound equally well from all sides; a bidirectional (or figure-eight) response, which indicates good pickup from the front and rear but diminished sensitivity at the sides; or a unidirectional (or cardioid) pattern, which is sensitive to sounds originating at the front but is essentially insensitive to sounds originating from the rear.

Omnidirectional microphones are the least suitable for stereo recording. Figure-eights have a narrower pattern and can be aimed more selectively, while cardioids are preferred for applications in which sound pickup from the rear must be suppressed.

Another important specification to check is impedance. All microphone types (and most models) are available in high-impedance versions that connect directly to your tape recorder, but these must be used with short cables (about 6-10 feet for crystals or ceramics; up to 20 feet for others) to avoid high-frequency loss and possible hum pickup. Most better-quality microphones are available in low-impedance versions (usually the standard values of 50, 150, or 250 ohms), which permit long cable runs, but which usually must be used with a matching transformer (such as the \$17.50 Shure A86A) at the recorder input. Low-impedance microphones are not intrinsically better except for the convenience of being able to use

long lines, and many microphones come in versions whose impedance can be changed either by rewiring the connector plug or by setting a switch.

"High" impedance can be any one of a wide range of values, and the microphone and input need not be precisely matched. However, most crystal and ceramic microphones require an input impedance of 1 megohm or higher, or else their bass response will suffer.

Sensitivity is probably the most confusing microphone specification. While an educated guess can be made as to the output-input compatibility of any particular microphone and recorder, it is desirable to buy any expensive microphone with a money-back guarantee in the event the sensitivities do not match.

The question of microphone *type* should also be explored. The four suitable types of microphones are the piezo-electric (crystal or ceramic), the dynamic (or moving-coil), the ribbon (or velocity), and the condenser. Of these, the piezo-electric type usually has the greatest output and the least extended frequency range. However, some new ceramic microphones, such as the Sonotone CM-10A, have a rated frequency coverage of 50 to 11,000 cps and a very smooth response over that range. A pair of the Sonotones matched for stereo recording sells for about \$21.

The dynamic microphone is rugged, reasonably priced (fairly good omnidirectional dynamics are available from about \$30, cardioids from \$50), has fairly high output, and a choice of polar patterns and impedances. Good typical units are the Shure 545 Unidyne and Electro-Voice 664 cardioids (both about \$50) and the Altec 683A omnidirectional (about \$35).

Ribbon microphones offer smooth, extended response and relative insensitivity to mechanical noise or shock, but they are comparatively susceptible to wind noise and damage, and their output is fairly low. Close-talking into a ribbon microphone produces a boomy, exaggerated bass. All bidirectional mikes are ribbons (Dynaco's B&O 50 or 53, Shure's 315—both about \$50), but not all ribbons are bidirectional (e.g., the Shure 330 cardioid, \$72).

Condenser mikes offer the widest and most linear response, with high output and insensitivity to mechanical noise, but they require an external power supply (generally bulky) and are quite expensive. One of the most compact and least expensive condenser microphone and power-supply combinations now available is the PML (\$139.90 for omnidirectional microphone and battery supply; add \$10 for cardioid pattern, \$20 for a.c.-powered supply). Sony has a pair of excellent condenser microphones (the C-17B and C-37A) with a response of 20 to 18,000 cps ± 2 db.

Single-unit stereo microphones for coincident-pair microphoning are available in both bidirectional ribbon (Dynaco's B&O 200, \$150) and dynamic cardioid (Sennheiser MDS 1, \$98) versions; the Sennheisers demount for separate use. Shure, Electro-Voice, and others supply microphones stereo-matched. *B. E.*

THE LONG-LONG-PLAYING

A DISCUSSION OF SLOW-SPEED

UNTIL fairly recently, most home tape recorders were designed to operate only at $7\frac{1}{2}$ and $3\frac{3}{4}$ inches per second—with high-quality results possible only at the faster speed. Today, however, many home recorders have responses up to 10,000 cps at $3\frac{3}{4}$ ips, and several do very well at $1\frac{7}{8}$ (at least one home recorder, the Revere cartridge machine, is designed to operate *only* at $1\frac{7}{8}$ ips).

At the present time, it would be presumptuous to draw hard and fast distinctions between what speeds are suitable for high-fidelity reproduction and what speeds are appropriate only for background music, dictation, conference recording, and other low-fidelity applications, because so much depends on the particular machine and the particular tape being used. What we can do, however, is explore the problems associated with the reduction of tape speed, so that the audiophile will have a technical basis for evaluating present and future developments in the slow-speed tape area.

The major and most obvious problem resulting from tape-speed reduction is loss of treble response. (Less obvious, but also important, is the increase in distortion, noise, wow, and flutter as tape speed is decreased.) Treble loss during the recording process occurs principally—and unavoidably—because of two magnetic phenomena: *self-demagnetization* and *bias erase*. In playback, treble roll-off takes place because of *playback head-gap loss*, *separation loss*, and *azimuth-error loss*. While all of these losses occur at any tape speed, they are intensified disproportionately with each decrease in tape speed. We will discuss each of these problems in turn.

1. *Self-demagnetization*. This is a magnetic phenomenon, inherent in the tape-recording process, that

causes the signals recorded on the tape to be partially self-cancelling, particularly at the higher frequencies. In effect, a recorded signal consists of a series of bar magnets arranged end-to-end. Each magnet has a south pole at one end and a north pole at the other. The higher the frequency of the recorded tones, the more bar magnets there are on a given length of tape. The magnets representing the higher frequencies are necessarily shorter, because so many of them must be fitted in a given space. In addition, and for the same reason,

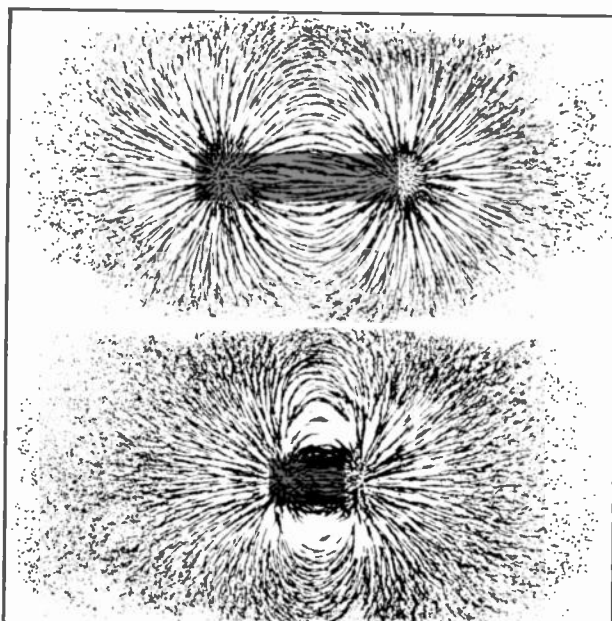

One cause of treble losses is self-demagnetization, which occurs when the "bar magnets" on the tape are so short that their magnetic fields partially cancel each other. Longer magnets (representing lower tones) are less prone to this.

TAPE RECORDER

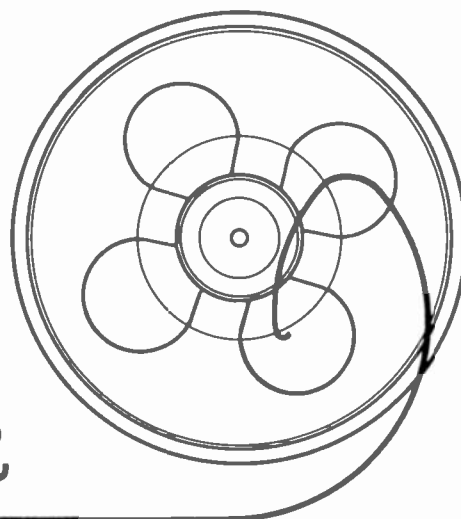

TAPE RECORDING—ITS PROBLEMS AND PROSPECTS

By HERMAN BURSTEIN

the slower the tape speed, the shorter the bar magnets. High frequencies recorded on a slow-speed tape will therefore produce very short magnets indeed. It is here that we come to the crux of the problem, for the shorter a bar magnet, the closer together are its north and south poles, and hence the greater will be the cancellation of their opposing magnetic fields. This self-demagnetization tends to weaken all signals, but it particularly affects the high-frequency signals.

2. *Bias Erase.* The erase head operates by subjecting the magnetic particles on the tape to an alternating magnetic field that diminishes to zero as the tape leaves the area of the head gap. The purpose of this process is to neutralize any magnetism previously imposed on the oxide particles. The record head, owing to the bias current flowing through it, also has a tendency to erase—in this case, the signal being recorded. (The purpose of the record-head bias current is to reduce tape distortion and increase the recorded signal level; its eras-

ing action is an unfortunate side effect.) Bias-current erasure is greatest for high frequencies, because these are recorded closest to the oxide surface and therefore are most easily erased. The lower frequencies penetrate the oxide more deeply and hence are more resistant to erasure.

A recent innovation to counter the problem of bias erasure is the cross-field head: (a development of the Illinois Institute of Technology Research Institute), which has appeared in at least one tape recorder, the Roberts 770. An extra head, mounted opposite the record head, applies bias from the base side of the tape rather than from the oxide side. It is claimed that bias current so applied maintains its benefits but results in less high-frequency loss.

3. *Playback Head-Gap Loss.* To achieve response to 15,000 cps or higher, the gap of the playback head (not the record head) must be extremely narrow. At $7\frac{1}{2}$ ips, the gap must be no wider than 250 microinches

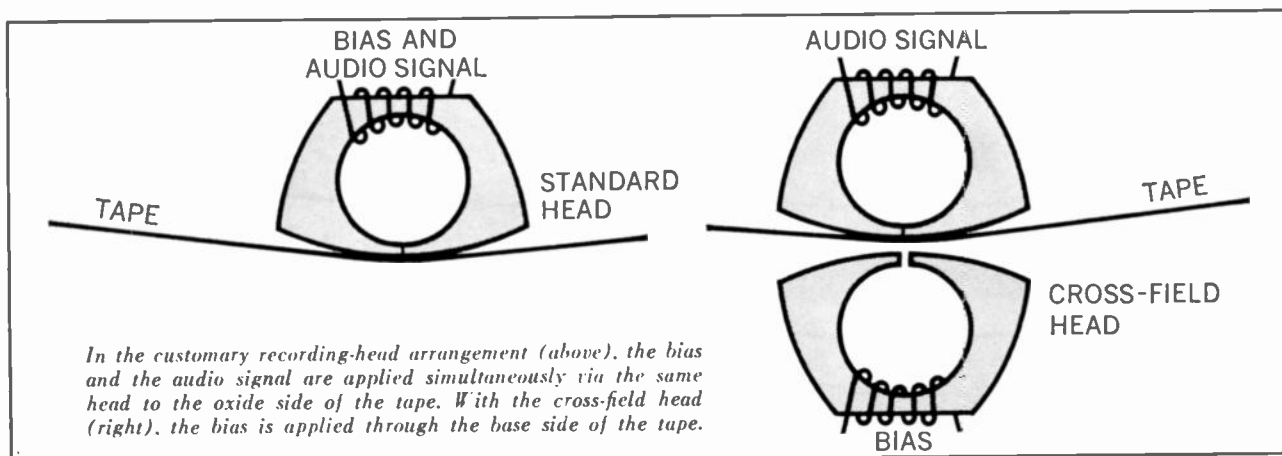

SLOW-SPEED TAPING

(millionths of an inch) ; at $3\frac{3}{4}$ ips, 125 microinches ; at $1\frac{7}{8}$ ips, 63 microinches ; at $15/16$ ips, 31 microinches. For comparison, a human hair is about 40 times as wide as the 100-microinch gap of a typical modern playback head. Not only must the gap be fantastically narrow, but it must have sharp, straight edges, or it tends to behave like a wider gap. Heads with the gap characteristics necessary for extended high-frequency response at the very slow tape speeds are difficult to manufacture, are costly, and tend to wear out much more quickly than wider-gap heads. In addition, a head tends to deliver less signal output as its gap is narrowed, resulting in a poorer signal-to-noise ratio.

4. *Separation Loss.* The tape must hug the playback head tightly, or treble response suffers. To illustrate, at $1\frac{7}{8}$ ips, a loss of more than 3 db occurs at 15,000 cycles if there is $3/100,000$ ths of an inch separation between the tape and the playback-head gap. Similar losses occur in recording. Therefore the tape machine must incorporate a suitable means of keeping the tape firmly against the heads, but without the excessive pressure that causes wow and flutter, squeal, excessive rub-off of tape oxide, and accelerated head wear. The tape manufacturer, for his part, must provide a product that has extremely smooth surfaces, sufficient flexibility to be contoured to the heads, and a binder that minimizes oxide-shedding. And the user of the machine must clean the heads regularly to remove tape oxide and dirt that would otherwise hold the tape away from the heads and cause treble loss.

5. *Azimuth-Error Loss.* Azimuth denotes the angle of the head gap with respect to the long dimension of the tape. This angle should be 90 degrees, in keeping with standard practice. In regard to any one machine, it is of prime importance that the azimuth angle be the same for the playback and record head. For exam-

ple, when operating a quarter-track recorder at $1\frac{7}{8}$ ips, an azimuth difference of only one-sixth of one degree between the recording and playback heads could produce about a 25-db loss at 15,000 cps. To minimize azimuth loss, the tape-transport mechanism must provide for precise orientation of the heads, and the tape guides must be made to fine tolerances and properly mounted to prevent the tape from skewing from its proper angle with respect to the head gaps. Stereo machines must have the two gaps colinear—that is, in a straight line, or it will not be possible to achieve extended high-frequency response from both channels simultaneously.

It bears repeating that the causes of treble loss described above grow more formidable in their effects with each reduction of tape speed.

REDUCING tape speed also intensifies noise and distortion problems. As pointed out above, bias-erase causes increasing treble loss as tape speed is lowered. Additional treble boost in recording and playback can overcome the loss, but this leads to greater distortion due to the overloading of the record head and of the tape ; it also leads to greater emphasis of the high-frequency noise produced by the tape and the tape machine. The signal-to-noise ratio is further reduced because the slow speeds demand different record and playback equalization than do the high speeds, resulting (for reasons too technical to explain here) in lower recorded level and greater emphasis of tape and machine noise.

Improvements in tubes and transistors, as well as in amplifier circuits, have helped reduce the noise of tape record and playback amplifiers. Also, the tapes themselves have become quieter. The 3M Company, for example, recently introduced a tape (Scotch 202) that is said to result in about 6 db (50 per cent) less noise than conventional tapes, providing at the same time a slightly improved treble response. With

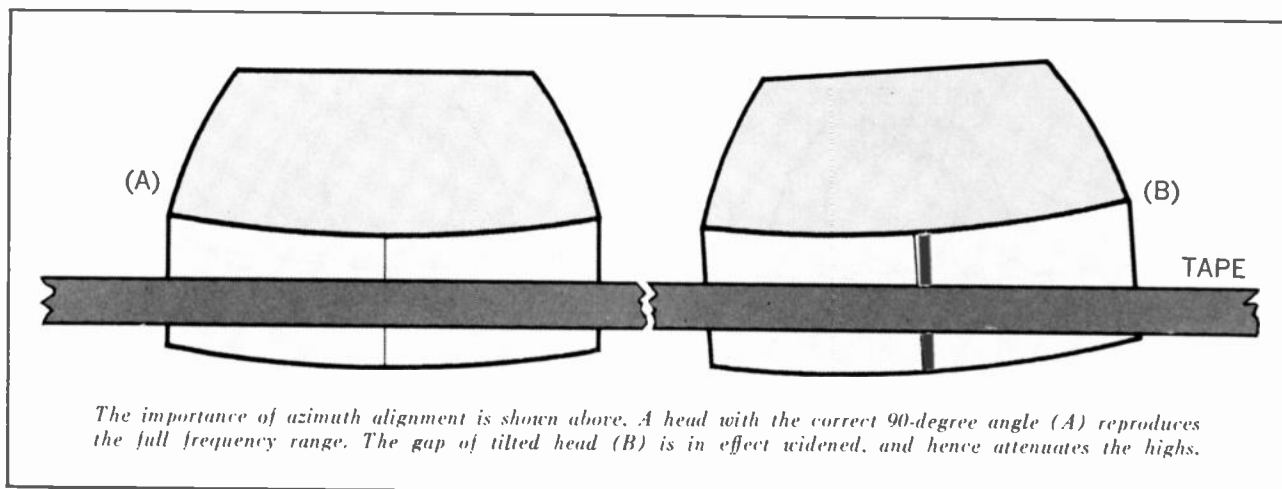

LONG-LONG-PLAY TAPE

THE TREND toward slower tape speeds has been accompanied by another development that is also designed to provide more playing time per reel. For many years, a 1200-foot length of tape on a 7-inch reel was standard for home machines. But now, a 7-inch reel may hold 1800, 2400, or even as much as 3600 feet of tape. The increase in tape-reel capacity, combined with reduction in tape speed, together yield a tremendous amount of playing time per reel. For example, at a speed of 15/16 ips (available in a few machines), it is possible to record 51 hours and 12 minutes of mono material on a single 7-inch reel.

Several techniques are used, individually and in combination, to increase the amount of tape that will fit on a reel of a given size. These are: thinner base materials, thinner oxide coatings, and smaller-diameter reel hubs. Unfortunately, each of these techniques also carries with it a problem of its own. For example: (1) a thinner base material makes the tape more susceptible to stretching, breaking, and print-through (magnetic transfer of the recorded signal from one layer of tape to another). (2) a thinner oxide layer usually results in a lower signal level and therefore a poorer signal-to-noise ratio; (3) a smaller hub makes it more difficult for the machine to maintain constant speed at the beginning and the end of the reel because of the large changes in the required drive torque (and the changing tape tension) as the tape feeds from the small-diameter feed reel to the large-diameter take-up reel.

The problems of print-through and signal capability are both countered by changes in the oxide formulation. The breakage problem posed by the thinner base has been circumvented by a variety of stronger base materials, such as Mylar, Durol, and so forth. As far as the smaller reel hubs are concerned, this is a mechanical problem that must be resolved in the recorder mechanism itself.

this tape, signal-to-noise ratios exceeding 48 db, along with substantial response to about 15,000 cycles, are claimed at 1 $\frac{7}{8}$ ips (by Crown, Revere, and Sony, for example); and a signal-to-noise ratio of 48 db, along with substantial response to 10,000 cycles, is claimed at 15/16 ips (by Crown). It should be noted in this connection that a signal-to-noise ratio of about 50 db is good, and a ratio of about 55 db is excellent.

Wow and flutter are also less of a problem at high speeds than at low speeds because of the smoothing effect of momentum. To keep wow and flutter down to acceptable magnitudes at slow speeds, extra care is required in the design, machining, and assembly of the flywheel, capstan motor, pressure rollers, and all other rotating members of the drive mechanism. In

addition, the design and adjustment of tape-tension devices and the arrangement for tape-to-head contact become particularly critical. Smoother and better-lubricated tapes are needed to minimize friction between the tape and the heads and between the tape and pressure pads (if employed), since both frictions are a potential cause of flutter.

In the days before stereo, half-track recording was customary, although some users, mostly professionals, preferred full-track operation. When stereo pre-empted the second track, the quarter-track format was developed to maintain the same amount of playing time. Probably foremost among problems caused by the reduction of track width was the necessarily smaller magnetic signal seen by the playback head and, following from this, a degradation of signal-to-noise ratio. This problem was met, in part, by redesigning playback heads for greater output. Track-width reduction also accentuated the problem of drop-outs, which are sudden, brief reductions in signal level caused by minute deficiencies in the tape oxide. The narrower the track, the more severe is this effect. Tape manufacturers have therefore had to develop coating techniques that insure a uniform oxide distribution over the surface of the tape.

On the other side of the ledger, it should be mentioned that narrow-track heads have one very real advantage: azimuth-error loss becomes less of a problem, since the narrower the track, the smaller the treble loss resulting from a given degree of azimuth error.

Mindful of the problems that accompany reduced tape speed and narrower tracks, the recordist should recognize that the engineering solutions to the problems raised by slow-speed recording are rarely ideal. They are often livable compromises that involve some sacrifice in performance. Speeds lower than 7 $\frac{1}{2}$ ips (still accepted as the home standard for high fidelity) tend to give inferior performance in one or more of the following respects: treble response, signal-to-noise ratio, distortion, or wow and flutter.

While slow-speed performance may be satisfactory to many listeners, it may not be so to the perfectionist. A number of knowledgeable persons have stated that, to their way of thinking, advances in the tape art should be applied to improving 7 $\frac{1}{2}$ -ips operation rather than to attempting to get "almost-as-good" results at lower speeds. In any case, as indicated earlier, in the fast-moving area of slow-speed taping, it is not only dangerous to make predictions; it is difficult even to evaluate accurately what is available now.

Herman Burstein, a frequent contributor to these pages, has written several books on various aspects of sound reproduction, and is particularly concerned with the field of tape recording.

MR. DWIGHT'S DAUNTLESS JOURNAL

PART 2

CONCLUDING AN ACCOUNT OF A UNIQUE AND NOBLE EXPERIMENT
IN AMERICAN MUSICAL CULTURE

By RAY ELLSWORTH

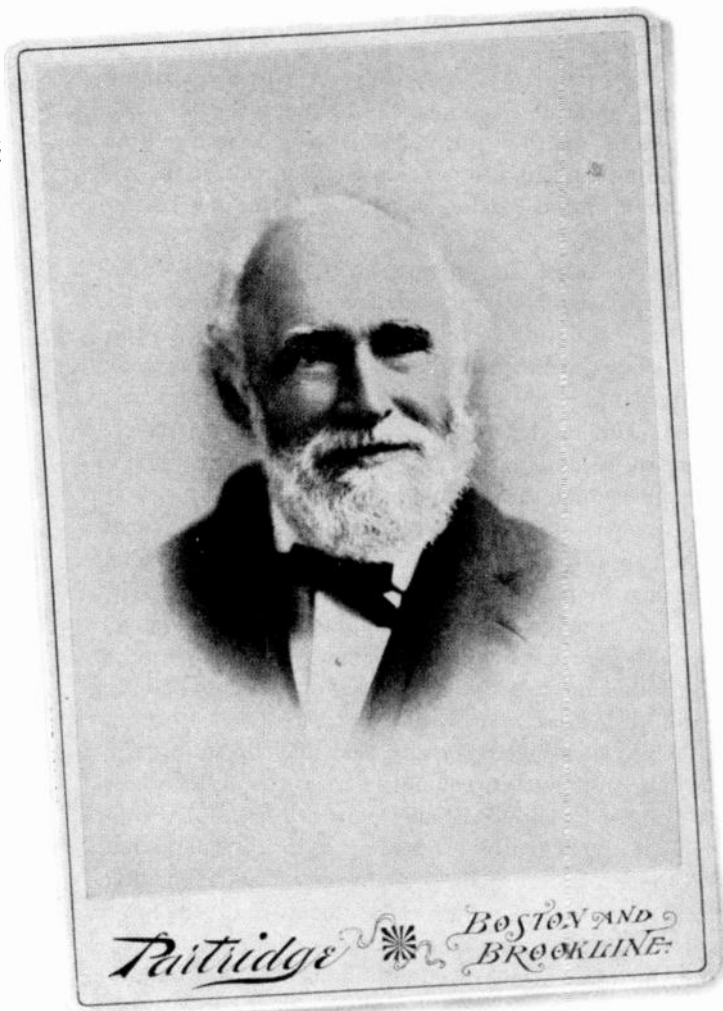

A rare photograph of John Sullivan Dwight in the late 1870's.

THE AMERICA of the 1850's into which John Sullivan Dwight launched his *Journal* (the full title was *Dwight's Journal of Music: A Paper of Art and Literature*) can scarcely be said to have been waiting anxiously for the thirty-nine-year-old Bostonian's first publishing effort. For despite the fresh cultural breezes that had lately been stirring New England, most Americans still thought that music consisted only of church hymns and sentimental ballads, with perhaps occasional entertainments by freak instrumental virtuosos who played fiddles while standing on their heads. But this only added missionary zeal to the role John Sullivan Dwight had appointed himself to play; this was the poisoned cultural atmosphere his *Journal of Music* would purify.

Right at the start, Dwight settled down to fulfill the prospectus he had outlined in his first issue. Liszt's *Life of Chopin* began serially in the third issue. There appeared essays by Henry Chorley, a reigning British critical monarch; Eduard Hanslick, the great Viennese critic; Hector Berlioz; Henry James (the elder, with a piece called *Universality in Art*); and even the enemy, Richard Wagner, in a rigid demonstration of fair play. Indeed, the first "Bayreutiad," as Dwight called it, was covered in the *Journal* day by day, almost hour by hour, although, as Dwight complained at the time, "It is a thing which costs so many words simply to tell of and describe." Other features were excerpts from Adolph B. Marx's *Life of Beethoven* and Robert Schumann's account of the Leipzig Gewandhaus Concerts of 1840-1841. (The material was obtained mainly through the judicious use of scissors; Dwight subscribed

to many Continental papers and simply appropriated, translating, when necessary, into approximate English.) There was also poetry by Bryant, Tennyson, Longfellow, Coleridge, and others. And when the budget permitted, subscribers received piano transcriptions of *Don Giovanni*, *Der Freischütz*, and *Martha*, as well as representative music by Bach, Gluck, and other masters. Dwight put together a corps of distinguished correspondents. George William Curtis wrote from New York; Frederick Lewis Ritter (who was to write the first history of American music) and W. S. B. Matthews (who was to write the second) sent news from Chicago; W. F. Apthorp, the future Boston *Transcript* critic, helped cover the local Boston scene; and A. W. Thayer, then American consul at Trieste and future author of the first great work on Beethoven, ranged over most of Europe.

One of Dwight's major coups was his publication in English of almost the whole of J. N. Forkel's *Life of J. S. Bach*. This historic (though brief) work was the first biography of the Leipzig master, and Bach scholars generally have assumed that its only English publication before Charles S. Terry's 1920 London edition was one dated 1820. Dwight's American publication, in 1855, seems to have been overlooked. Dwight used part of the 1820 rendering, translating the latter half himself, and omitting, for some unknown reason, two chapters in the middle. Nevertheless, Dwight's presenting it in his *Journal* must be recognized as an example of scholarly alertness of the first order.

FOR twenty-nine years—from 1852 to 1881—Dwight's *Journal* fought the good fight against the popular musical monstrosities of the times and for "the TRUE, the ever Beautiful, the Divine." Whenever some good music accompanied the gimmicks, however, Dwight could forgive much. He had kind words to say for Jenny Lind, for example, unprejudiced by her association with P. T. Barnum; and he capitulated before the wizardry of the Norwegian violinist Ole Bull, who some called a trickster because he played on all four strings of his fiddle at once—probably through using a flat bridge and very heavy bowing—and because he played only his own compositions. "Excepting only a symphony by Beethoven or a Mass of Mozart, nothing ever filled me with such deep, solemn joy." Dwight said of Bull. Dwight could even forgive the French conductor Louis Jullien his monster orchestra and his *Firemen's Quadrilles*, wherein real firemen, putting out an actual fire, formed the climax to the music. Dwight forgave such shenanigans because, he said, "Jullien can play the best kind of music." It is probable that Jullien won Dwight's heart by donning spotless white gloves and having a gold-plated baton brought to him on a silver tray before playing a symphony by Beethoven.

Dwight could not, however, share the enthusiasm for musical gigantism that overcame the public after the Civil War—the Peace Jubilees sponsored by Captain Patrick Gilmore, the recent band master to the Union Armies and forerunner of John Philip Sousa. In terms of sheer size, these Jubilees still remain unsurpassed. Five days were given over to the first of them in Boston, "the Athens of America," in 1869. Gilmore collected a chorus of ten thousand voices, a thousand-piece orchestra, four organs, three brass bands, bells, a chorus of anvils, and a brace of cannon. The boom of the cannon signaled the downbeat, and, to the Anvil Chorus music from *Il Trovatore*, one hundred red-shirted, on-stage Boston firemen whacked away at a hundred resounding anvils. A second World Peace Jubilee in 1872, also organized by Gilmore and again held in Boston, doubled almost everything—twenty thousand voices, fifteen hundred in the orchestra, more cannon, and including this time, to please the ladies, Johann Strauss, passing out locks of his dog's hair as his own.

AS THE Peace Jubilees indicated, time was moving inexorably on, and the battle for a reasonable standard of musical taste was never-ending. The lachrymal popular music of the day got worse instead of better (excepting Stephen Foster's best and some few Civil War songs still sung today), and Dwight had no more fondness for it than he had before. But out of the debris of the Civil War came the Negro spiritual, first heard in the religious atmosphere of the Great Awakening of the 1850's, and it was in Dwight's *Journal* that the first sympathetic and intelligent account of them appeared. This was in an article contributed by Lucy McKim (Garrison) in 1862, who later would edit, with Charles P. Ware and Francis W. Allen, the first collection of *Slave Songs of the United States*, which appeared in 1867. Dwight called the spirituals "hymns," and classified them among the "heartfelt national airs" he felt safe in admiring. He never seemed to feel, however, that the Negro music, or any of the popular music—religious or secular—could make a significant contribution to his country's musical development. For him, Germany remained the home of all real music, and always would—although Brahms and Wagner were to stretch his faith almost to the breaking point in later years.

When the New Orleans pianist Louis Moreau Gottschalk—who had already conquered Europe with his Creole-based pieces and his amazing virtuosity—came to Boston in 1854, Dwight remarked piously that Gottschalk could not possibly be a musician of consequence because he had studied in frivolous, pleasure-loving France instead of sober, industrious Germany. Gottschalk, stung (after all, he had been praised in Europe by Chopin himself, who had come backstage to shake

DWIGHT'S JOURNAL

his hand), decided to play a trick on Dwight. Since the *Journal* had belittled his Creole pieces and had called him a humbug, the pianist wanted to see if Dwight knew as much about music as he thought he did. At his second Boston recital Gottschalk therefore substituted (without announcing any change) a Beethoven bagatelle for the work of his own composition listed on the program. Dwight's *Journal* made no mention of the substitution.

Curiously, Gottschalk was just as bitter about the treatment of the artist and "true art" in America as was Dwight, but for a very different reason. The pianist, on his tours all over America, saw things that would have warmed Dwight's heart, but that chilled his own. Everywhere he went he met other musicians, all readers of Dwight's *Journal*. "And," Gottschalk exclaims in his diary, "do I have to tell you they're all German?" Gottschalk saw what Dwight would never see, that the big crusade for "better music" was superimposing on the musical life of a young nation an already flourishing foreign tradition, and in the process was stifling any native growth.

But Dwight and his *Journal* went serenely on. While the gentle Music Master attended the Parker House meetings of James Russell Lowell's Saturday Club along with Bryant, Emerson, Longfellow, and the others, and defended his world of the classics ("that musical fairyland where imagination chases unrestrainedly the exquisite fancy"), things were happening in the great world beyond. The Civil War convulsed the country. Lincoln was assassinated. Walt Whitman published *Leaves of Grass*. Melville published *Moby Dick*. Mark Twain gained overnight fame with *The Jumping Frog of Calaveras County*. But reading only Dwight's *Journal*, you would never have known any of these things.

WHEN Hans von Bülow came to Boston in 1875 to present the world premiere of his friend Tchaikovsky's B-flat Minor Piano Concerto, Dwight was repelled by the work, and asked: "Could we ever learn to love such music?" He retreated to Newport and went riding "with Willie James, a rare youth." Dwight's world of music was changing in bewildering ways.

Richard Wagner was the real bogeyman. As the Wagnerian panorama unfolded and seemed to fill the very heavens, Dwight grew increasingly vituperative. Though he continued to fill his columns with Wagnerian controversy, pro and con, he left no doubt as to where he himself stood. He never denied Wagner's gifts, but he decried the Wagner cult, which he said made too much of them. As for the music, this "never-ending, murky musical malaria, full of sentimental

mannerisms" could never be, as its proponents claimed, "the music of the future." For, as far as Dwight was concerned, the music of the future had already been written. Like the Austrian critic Hanslick, whom he resembled in so many ways, Dwight regarded Beethoven, the Beethoven of the Ninth Symphony and the Mass in D, as the ultimate in composers, and believed those two works to be, in Hanslick's words, "the colossal Pillars of Hercules, standing at the gates of modern music and saying 'No farther.'"

Dwight's dislike of Brahms, whom everyone else accepted as the alternative to Wagner, was only slightly less intense than his antipathy toward Wagner. This puzzled many Bostonians, who could agree with his conservative view of Wagner, but not of Brahms. The Music Master was fond of pointing out that his standards never changed, that what he said at the end of his career was the same as what he had said at the beginning of it. This position, of course, enabled him to straddle the Brahms-Wagner controversy with a sublime disregard for fashion. The case against Brahms was perfectly simple: he did not come up to the Music Master's standards. Brahms was an incompetent, bumbling imitator of the venerated Beethoven, and so merited Dwight's contempt.

It was clear that the *Journal's* popularity was suffering from its editor's conservatism. Oliver Ditson, its publisher for almost twenty years (since 1858), grew

According to this contemporary cartoon, those who heard the 1872 Boston Peace Jubilee would never forget it—even in their dreams.



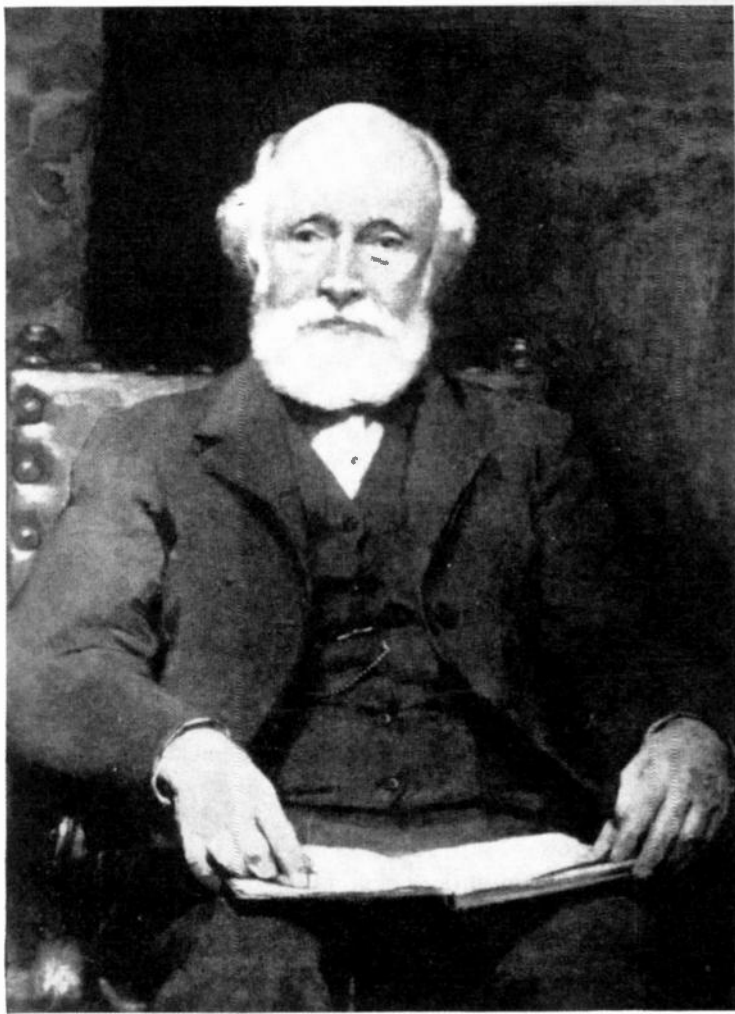

Caroline Cranch's 1884 portrait of Dwight has a patrician air and captures an expression of relaxed and genial self-assurance.

concerned. Could not Dwight change with the times? Dwight could not. He insisted, as usual, on trying to change the times, and the Ditson Company withdrew. Longfellow then helped Dwight find a new publisher, and, in 1879, Houghton, Osgood, and Company stepped in to save the day, publishing a truncated, four-page version of what had formerly been an eight-pager. But two years later, on September 3, 1881, the *Journal* published its last issue.

Dwight did not give up music criticism immediately. He was sixty-eight, still alert, still the musical patriarch of Boston—and a national figure in his field. He became president and librarian of the Harvard Musical Association, wrote articles for *The Atlantic Monthly* and other magazines, spelled W. F. Apthorp for a few months as daily critic on the *Boston Transcript*, revised the definitions of musical terms for a new edition of Webster's *Dictionary*, and wrote a history of music in Boston. In an oil portrait painted by Caroline Cranch (daughter of the poet Christopher Cranch), we see him during these later years: a small man, nearly bald, with a halo of white hair, a florid, almost ruddy face, and a genial, well-satisfied, almost beaming expression. Then, ailing, he spent his final years from 1890 to 1893 in retirement, going alone to the Parker House for his rolls and tea, but always surrounded, nonetheless, by his friends, who still looked upon him

NEW YORK PUBLIC LIBRARY

*Sub. Club (Parker House) May 31, 1873.
Longfellow*

<i>Members</i>	
<i>R. Dale Cress</i>	<i>Wm. B. Ballou</i>
<i>Fr. Parkman</i>	<i>Sam. Dr. Hoega</i>
<i>Chas. Profso</i>	<i>Henry James</i>
<i>R. H. Dana Jr.</i>	<i>J. T. Fields</i>
<i>T. G. Appleton</i>	<i>Pres. Eliot</i>
<i>J. S. Bangs</i>	<i>Judge How</i>
<i>Lodge Kent</i>	<i>Conat Corti</i>
<i>O. W. Holmes</i>	<i>C. C. Perkins</i>
<i>Chas. F. Adams</i>	<i>J. Eliot Cabot</i>
<i>Geo. Bantwell</i>	<i>Geo. Geo. Briggs</i>
<i>J. M. Forbes</i>	<i>H. G. Conway</i>
<i>Jeffries Wynn</i>	<i>E. P. Whipple</i>
<i>Prof. Everett</i>	<i>Chas. F. Clark</i>
<i>W. D. Howells</i>	
<i>Guests</i>	
<i>J. A. Andrews</i>	<i>Wm. A. Hart</i>
<i>C. E. Follen</i>	<i>Wm. R. Pierce</i>
<i>N. H. ...</i>	<i>S. W. ...</i>
	<i>Chas. ...</i>
	<i>S. G. ...</i>
	<i>H. ...</i>

This seating plan drawn up by Dwight for a Saturday Club dinner, reads like a Who's Who of the cultural leaders of the time.

as the Music Master. He died on September 5, 1893.

Dwight had left his impress on music in America. At the end of his career, the old musical atmosphere he had known and fought as a young man had almost completely disappeared, replaced by an active concert life roughly along the lines and standards he had envisioned. The trickster virtuosos were gone, the polyglot concert programs were, instead of the rule, the exception, and gifted artists of integrity were being heard. Dwight did not accomplish this all by himself, of course. The greatest factor was probably the general rise of interest in Germanic studies, strengthened by the large influx of German musicians who came to this country with the skills that were a part of their own music. Although there had been earlier cultural invasions by French and Italian opera, and before that a widespread regard for British music masters, there had never before been anything on the scale of the German immigration that began in 1848 and continued even after the Civil War.

But the country had also seen—and heard—other influential individuals besides Dwight. Most notable of these was Theodore Thomas, who organized a full orchestra of first-rate musicians and traveled with them more than any conductor had before. And when Theodore Thomas took his uncompromising concert programs to the American hinterlands, he found there

DWIGHT'S JOURNAL

little groups of musically knowledgeable listeners to welcome him—cultural pockets created by Dwight's *Journal*. The fact that this put serious American musicians in Dwight's debt was acknowledged by the musicians of Boston when Dwight's *Journal* seemed in danger of failure: they gave him a benefit concert that raised \$6,000 and prompted a testimonial to the effect that the *Journal* was the only responsible music magazine in the country, and one they sorely needed, however hard it might go with them when the Music Master felt that they had failed to measure up to his standards.

It is possible, however, to question whether the German influence was, in the final analysis, good for American music. The wholesale transplanting of a foreign musical culture on the young nation doubtless stunted its native musical growth. Dwight's lack of warmth toward American creative efforts in music has often been noted, and he did in fact downgrade most American music. Yet it should also be pointed out that after 1855 very little native music was written until the 1870's, and that little was undeniably bad.

Dwight had simple criteria—skill and finish. Vitality and originality and emotional effect were not completely lost on him, but he looked upon them as incidentals germane to the development of an art, not to its final achievement. Thus he could have doubts about the music of William Henry Fry, find the work of Anton Philipp Heinrich pleasant and often beautiful (which it is), but not nearly enough so to make him “the Beethoven of America,” as he was sometimes called. Dwight could also be contemptuous of George Frederick Bristow, yet, when writing about the old master of the fuguing tune, William Billings, have no doubts at all. Billings, said Dwight, was crude, but “it cannot be denied that he had genius.” At the end of his career, Dwight also hailed the work of J. K. Paine, the Harvard academician, and perhaps one or two others, but he never used the word “genius” in connection with any of them. True, he missed the boat on Gottschalk and Foster, but he was not alone. All told, it is not a bad record. For good or ill, it was the wholesale Germanic invasion that stifled the development of American music, not John Sullivan Dwight.

It must also be pointed out that he did not confine his balloon-puncturing to native efforts. Rejecting the program-music concepts of Wagner and Liszt in the time of their greatest critical heyday, he wrote: “Music's noble mission is to publish its own secret, to give you, not storms, moonlight and so forth . . . for those you have in the original, but to give you *music*, which is not published in any other way.” To people who

demanded meaning in music, he said: “Go ask the clear running stream *its* meaning.” The whole engulfing tide of Romanticism, with its nonmusical aspects, its evergrowing gigantism, filled him with despair: “So many big works, with their enormous orchestration, crowded harmonies, sheer intensity of sound . . . instead of the simpler and divine way of the still, small voice.” We of the second half of the twentieth century are having some second thoughts about the Romantics. Our reasons, formed with the aid of almost a century's perspective, are remarkably similar to Dwight's.

BUT Dwight's influence on the course of music in America is not entirely owing to his critical acumen—or lack of it. It would not be difficult to make a case for the *Journal's* having been the greatest music magazine ever published in this country. Its long life, its remarkable standards, its emphasis on composers rather than on passing virtuosos, and its over-all readability place it in a class by itself. This is to say nothing of its comprehensive coverage of nonmusical features—the poems, the serializations of Continental fiction (by George Sand, among others), the pieces on literature and art. And no less a critic than Van Wyck Brooks has remarked that Dwight's music essays deserve separate publication. Although the limitations of his technical education kept him from musical analysis in the sense in which we use the term today, his style, while it could be archly aristocratic on occasion, was, in general, stripped down, earthily direct, and a beautiful instrument for his purpose, which was simply to give an account of what a great work of music did to him as a listener, and why. He did not want to exclude the masses; on the contrary, he wanted to bring them into that magic circle of beauty and true contentment that, he believed, only a feeling for art can provide.

To Dwight, music was the “language of heaven.” not a “wandering away from the business of life, an amusement to idle away an hour.” He could not, he wrote, “sport with this, throw it down like a common recreation.” His *Journal*, from its first issue to its last, fought to prevent the throwing down of music as a common recreation. Certain limitations of perspective and experience kept Dwight from being more broad-minded about which music deserved this protection and which did not. But he has earned our gratitude for fighting a determined battle for “sufficient reverence for music as an art”—a battle that can still be carried on with profit in this country.

Ray Ellsworth's last contribution to HIFI/STEREO REVIEW was his comprehensive report on rare records in the April issue of 1963. Mr. Ellsworth's two-part study of John Sullivan Dwight is adapted from a book in progress on our early music critics.

BEST OF THE MONTH



MOZART'S WIND ENSEMBLES IN AN INTEGRAL EDITION

Jack Brymer leads the London Wind Soloists in vivid virtuoso performances

THE MUZAK of earlier centuries was not as vapid as it is in our own time, as anyone familiar with Mozart's wind music, for example, can testify. The Austrian composer provided for the wining, dining, and evening entertainment of his patrons a fairly large quantity of pieces, of which the greater proportion scored for wind ensemble



W. A. MOZART

His genius abundantly demonstrated

has just been released by London in an integral edition of five discs.

The table of contents for this group of recordings may give the first impression that here is a rather large dose of music, all of which may be expected to sound pretty much the same, but nothing could be further from the truth. In fact, although most of these works are lighthearted and far from profound (the major exception is the C Minor Serenade, which can easily be compared with the Fortieth Symphony in its feeling of unrest), Mozart's genius at turning a phrase, his characteristic expressive devices, and his brilliant scoring are so abundantly demonstrated that it is difficult not to be thoroughly and consistently captivated.

Most of Mozart's pieces for wind ensemble are included in this series, but although the over-all title of these discs refers to a "complete" edition, there are several omissions, all referred to in the excellent program notes by Erik Smith, the producer of the records. Missing are works in which instruments other than those of a wind ensemble take part, pieces for only two or three instruments (though the Adagio, K. 410, is included here), fragments, and spurious compositions. It is worth noting, however, that the discs do contain three "doubtful" pieces (K. 289 and K. Anh. 226 and 227), but the question of completeness is really an academic (continued overleaf)



one when we consider the great musical value of the achievement itself.

None of these works is new to records, the three wonderful serenades having been recorded frequently. With the exception of the two Adagios, all the pieces were once available on the Westminster label in performances by the Vienna Philharmonic Wind Group. Good as those recordings were (and they had an excellent, *gemütlich* flavor), the present ones are not only more vividly reproduced sonically, but they are also played with more virtuosity. The performers here, members of the wind sections of London orchestras (particularly the Royal Philharmonic), play this music in the most stunning manner imaginable. The glorious sound of these superb instrumentalists, their feeling for phrase, their clean articulation, and their marvelous sense of ensemble balance make these discs an absolute must for the Mozart lover. If all five records represent too great an expenditure, try any one of the first three volumes (those containing the serenades). Under no circumstances, however, should you miss performances such as these.

Igor Kipnis

© ④ MOZART: *Serenade No. 10, in B-flat Major, for Thirteen Wind Instruments (K. 361)*. London Wind Soloists, Jack Brymer cond. LONDON CS 6346 \$5.98, CM 9346* \$4.98.

PHILIPS



GÉRARD SOUZAY

Imaginative artist, masterful control

© ④ MOZART: *Divertimento No. 3, in E-flat Major (K. 166); Divertimento No. 8, in F Major (K. 213); Serenade No. 11, in E-flat Major (K. 375)*. London Wind Soloists, Jack Brymer cond. LONDON CS 6347 \$5.98, CM 9347* \$4.98.

© ④ MOZART: *Divertimento No. 4, in B-flat Major (K. 186); Divertimento No. 13, in F Major (K. 253); Serenade No. 12, in C Minor (K. 388)*. London Wind Soloists, Jack Brymer cond. LONDON CS 6348 \$5.98, CM 9348* \$4.98.

© ④ MOZART: *Adagio, in F Major, for Two Bass Horns and Bassoon (K. 110); Divertimento, in E-flat Major (K. 196e; K. Anh. 226); Divertimento No. 9, in B-flat Major (K. 210); Divertimento No. 12, in E-flat Major (K. 252)*. London Wind Soloists, Jack Brymer cond. LONDON CS 6349 \$5.98, CM 9349* \$4.98.

© ④ MOZART: *Adagio, in B-flat Major, for Two Clarinets and Three Bass Horns (K. 411); Divertimento, in B-flat Major (K. 196f; K. Anh. 227); Divertimento No. 11, in B-flat Major (K. 270); Divertimento No. 16, in E-flat Major (K. 289)*. London Wind Soloists, Jack Brymer cond. LONDON CS 6350 \$5.98, CM 9350* \$4.98.

A CHALLENGING READING OF *DIE WINTERREISE*

*Gérard Souzay combines technical
perfection with beauty of tone*

THE WORLD of Schubert's *Die Winterreise* is one of unrelieved sadness—neither nature nor humanity offer solace to the wanderer as he passes through the winter landscape, from one bleak episode to another, on his way toward the final tragedy. An ability to sustain this mood without wearying the audience is one of the marks of a superior recitalist. But there are other marks as well, such as expert vocal technique and beauty of sound, and these are the distinctions Gérard Souzay brings to his newly released recording of the *Winterreise* cycle on the Philips label.

Although Souzay does not create as overpowering a dramatic effect as did Hans Hotter in his recent DGG release of these songs, lieder buffs are likely to find it difficult to make a choice between the two interpretations. On one hand we have Hotter's emotional intensity, and on the other Souzay's tonal beauty. Not that Souzay's interpretations lack dramatic insight—quite the contrary. A remarkably imaginative artist with masterful control over his voice, he skillfully darkens its sometimes tenor-like timbre to capture the sinister moods (as in *Gefrorne Tränen*

and *Der stürmische Morgen*) and, by alterations of tone color, compellingly evokes the aura of despair in *Einsamkeit*. His *Der Leiermann*, however, although beautifully done, does not attain the utter finality of dejection found in the Hotter performance. But in the faster songs, such as *Rückblick* and *Täuschung*, Souzay's light and flexible voice reveals the subtler details more meaningfully than Hotter's heavier baritone.

The complete cycle occupies three sides of this set, and the fourth side, containing eight songs from Schubert's *Schwanengesang*, is thus a substantial bonus. Except for *Abschied*, which is somewhat lacking in brio and spontaneity, these performances seriously challenge the superlative

recent recordings by Dietrich Fischer-Dieskau and Hermann Prey (both highly praised in these pages).

Dalton Baldwin's collaboration at the piano is admirable throughout. Both piano and singer are reproduced with remarkable brightness and clarity, with distinct but not unnatural stereo separation. Full German texts and English translations are supplied. *George Jellinek*

© ® SCHUBERT: *Die Winterreise; Schwanengesang: Eight Songs* (*Liebesbotschaft, Kriegers Ahnung, Frühlingssehnsucht, Abschied, Der Atlas, Ihr Bild, Das Fischermädchen, Die Taubenpost*). Gérard Souzay (baritone); Dalton Baldwin (piano). PHILIPS PHS 2910 two 12-inch discs \$11.96, PHM 2510 \$9.96.

COLUMBIA RECORDS



DUKE ELLINGTON: Still exploring, still surprising—even to himself

IN THE FOREGROUND: ELLINGTON THE PIANIST

Trio settings spotlight a pervasively influential stylist

THERE has been a gradually growing appreciation among the jazz audience of Duke Ellington as a pianist—gradual because Ellington himself prefers to talk of his orchestra as his primary instrument, and because he seldom records in the trio setting in which he is heard in Columbia's new "Piano in the Foreground." Yet, as these performances again make clear, Ellington is an exceptionally inventive and influential pianist. Throughout this set, there are passages that demonstrate how much is owed to Ellington—not only as a composer, but also

as a player—by such otherwise disparate modernists as Thelonious Monk, Cecil Taylor, and Charles Mingus.

For this program, Ellington has translated three standards by other composers (*I Can't Get Started, Body and Soul, and Summertime*) into the singular Ellington idiom. His reshaping and recoloring of *Summertime* places it—along with recordings by Sidney Bechet and Billie Holiday—among the most original jazz interpretations of the song. Ellington also moves through a variety of moods in his own material. There is an emphatic blues (*Blues for Jerry*), impressionistic sketches (*Fontainebleu Forest* and *Springtime in Africa*), a sensuous ballad (*A Hundred Dreams Ago*), and a loping celebration called *It's Bad to Be Forgotten*.

In addition to thoroughly personal voicings, Ellington's playing is also characterized by an

incisive attack, clarity of line and beat, and precisely controlled dynamics. It also communicates an exciting sense of continuous exploration, a quality Ellington himself is well aware of—he has described his delight at still being able to surprise himself after so many years in jazz.

But what this collection demonstrates more fully than Ellington's previous solo sets is the depth of his rhythmic power. The music sounds as if it was produced at an unusually spontaneous session, and furthermore, drummer Sam Woodyard is far less overbearing than usual. The combination—a feeling of ease in the studio and a flowing rhythm section—appears to have stimulated Ellington in the medium- and up-tempo numbers into a particularly forceful but wholly relaxed way of swinging.

There is a large number of superb Ellington compositions that his band never plays because, he claims, constant traveling makes it difficult to keep all of his orchestral book in a constant state of readiness. But this problem of preparation could perhaps be easily solved if Ellington could be persuaded to record a series of trio albums, reviewing and renewing many of those originals unknown to the newer generation of jazz listeners. In any case, Ellington's decision to come to the foreground for this recording has resulted in one of the most welcome jazz piano recitals in recent years.

Nat Hentoff

© ① DUKE ELLINGTON: *Piano in the Foreground*. Duke Ellington (piano), Aaron Bell (bass), Sam Woodyard (drums). *Cong-Go; Blues for Jerry; Summertime; Springtime in Africa*; and seven others. COLUMBIA CS 8829 \$4.98, CL 2029* \$3.98.

ANDRÉ HODEIR AS JAZZ COMPOSER

*France's most eminent jazz critic
tries his hand at composition*

MOST critics have in their mind's eye an ideal state for the art they write about, and are often given to proselytizing on the basis of this vision. André Hodeir, who has nearly revolutionized jazz criticism with two books (*Jazz: Its Evolution and Essence* and *Toward Jazz*), now addresses us through the medium of the music itself in an album of his own compositions on the Philips label. He displays, in this new role, the same daring, brilliance, and icy theorizing that characterize his criticism.

The two longest pieces, *Jazz Cantata* and *Le Palais Idéal*, are adaptations of two of Hodeir's several film scores (jazz composer Gunther Schuller's otherwise invaluable album notes neglect to mention which films the music was written for). The first of these features a wordless vocal by an expert (but anonymous) female singer, and completely written-out solos, many of them played by vibraphonist Jean-Pierre Droute. This interest in the vibraphone probably stems from Hodeir's fascination with the work of Milt Jackson, for whom he once wrote a symphony orchestra piece called *Around the Blues*, echoes of which are heard here in *Flautando*, on which flutist Raymond Guillot plays, with the aid of sound-on-sound, several parts.

Palais has in it much of the language of Thelonious Monk, who is another of Hodeir's favorites. Monk is more directly acknowledged in *Osymetrios I* and *II*, two anagrammatically titled variants of Monk's *Mysterioso*. These two tracks feature the remarkable French pianist Martial Solal, more inventive here than I have ever heard him before on records. Solal appears also on the two remaining pieces, *Trope à Saint Trop* and *Jazz et Jazz*. This last, a blues, is probably one of the most complicated jazz pieces ever recorded. As Schuller explains it: "A number of phrases played by an instrumental ensemble were recorded and transposed, reversed, or filtered electronically. These phrases, compiled into a logically 'composed' sequence, were then superimposed over a chord progression pre-recorded by bass and drums. At the third stage, against this composite-tape background, the piano soloist improvises as indicated by the composer." It is a wonder, but it comes out sounding fresh and spontaneous, especially when Solal trades four-bar phrases with the tape.

There are many technical innovations on this disc that have validity as experiment, but they are interesting for their musical values as well. André Hodeir's jazz influence may no longer be limited to his criticism.

Joe Goldberg

© ① ANDRÉ HODEIR: *Jazz et Jazz*. Martial Solal (piano), Kenny Clark or Christian Garros (drums), Raymond Guillot (flute), Roger Guerin and Christian Bellest (trumpets), Nat Peck and André Paquinet (trombones), Hubert Rostaing and Pierre Gossez (alto saxophones), Georges Grenu (tenor saxophone), Armand Migiani (baritone saxophone), Jean-Pierre Droute (vibraharp), Pierre Michelot (bass), André Hodeir cond. *Jazz et Jazz; Jazz Cantata; Flautando; Osymetrios I; Osymetrios II*; and two others. PHILIPS PHS 600073 \$4.98, PHM 200073* \$3.98.

Why doesn't somebody make a changer cartridge based on the same principle as the ADC POINT FOUR, so that people who own changers can get the same kind of performance as people who own turntables?

SOMEBODY HAS



ADC 660

It was ADC, of course. After all, the revolutionary Induced Magnet principle that makes the Point Four so remarkable is ADC's own. The new cartridge is the **ADC 660 Stereo Changer Cartridge**, and its distinctive performance is the result of all the design benefits of the famous ADC Point Four and the Induced Magnet principle: the virtually weightless combination of hollow-aluminum stylus arm and soft-iron armature that makes for unbelievably low mass and high compliance (20×10^{-6} cm/dyne), the remote positioning of the fixed magnet that eliminates saturation and hysteresis distortion, the low-slung pivot point that produces an honest vertical tracking angle of 15° , and the ease and convenience of stylus replacement. Sound? As with the Point Four, we

can only suggest that you hear it yourself—and with equipment that will do it justice.

ADC 660 Specifications: □ Type: Induced Magnet □ Sensitivity: 7 mv. at 5.5 cms/sec recorded velocity □ Channel Separation: 30 db, 50 to 8,000 cps □ *Frequency Response: 10 to 20,000 cps ± 3 db □ Stylus tip radius: .0007" (accurately maintained) □ Vertical tracking angle: 15° □ Tracking force range: $1\frac{1}{2}$ to 4 grams □ I.M. distortion: less than 1%—400 and 4,000 cps at 14.3 cms/sec velocity □ Minimum compliance, vertical and horizontal: 20×10^{-6} cms/dyne □ Price: **\$46.50**
*Frequencies above 15,000 cps will be influenced by the impedance characteristics of the amplifier and connecting cables. Load impedance may be varied to give the most pleasing results.



AUDIO DYNAMICS CORPORATION

PICKETT DISTRICT ROAD, NEW MILFORD, CONNECTICUT

CIRCLE NO. 8 ON READER SERVICE CARD

Angel
has been
name-dropping
for years...



CARUSO



KREISLER



CHALIAPIN



LEHMAN



CASALS



LANDOWSKA



HOROWITZ

Great
Recordings
of
the
Century

Caruso, Schnabel, Landowska, Chaliapin... we could go on and on. Musical immortals captured at the peak of their brilliance on Angel's GREAT RECORDINGS OF THE CENTURY Series.

Martin Mayer, in Esquire, says "These Angel reissues are a genuine miracle."



INCLUDING THE BEST-SELLING SCHNABEL ALBUM OF THE 32 BEETHOVEN SONATAS. Your dealer has a complete list of the entire Series... see him now!



SCHNABEL



HIFI/STEREO REVIEW'S CHOICE OF THE LATEST RECORDINGS

CLASSICAL

Reviewed by WILLIAM FLANAGAN • DAVID HALL • GEORGE JELLINEK • IGOR KIPNIS

Ⓢ Ⓜ BACH: *Well-tempered Clavier, Vol. I*. Ralph Kirkpatrick (clavichord). DGG Archive ARC 73211/12 two 12-inch discs \$13.96, ARC 3211/12* \$11.96.

Interest: First clavichord performance
 Performance: Expert
 Recording: Skillful
 Stereo Quality: Small advantage

Here is a unique opportunity to sample the first twenty-four preludes and fugues of *Das Wohltempierte Clavier* (which is most precisely translated as "The Well-tempered Keyboard") on the most intimate and personal of all keyboard instruments. Those who favor the harpsichord will find that although the clavichord cannot compete in brilliance, it does carry a wealth of nuance within its almost incredibly narrow dynamic range (a normal speaking voice will obscure its sounds), and, depending on the performer's skill, the individual voices in the middle of a fugue stand out in surprisingly clear relief.

Ralph Kirkpatrick, who has also recorded the complete forty-eight for DGG in a harpsichord version not yet released, is unquestionably skilled. His technical adroitness on this exceptionally difficult instrument is quite astounding—as a performance, this is an achievement of the greatest importance. His view of the music, however, is a sober one, despite his setting rather fast tempos throughout. Kirkpatrick almost disdains the use of one of the clavichord's most expressive devices—the *hebung*, or vibrato, for which the performer gently jiggles a key to produce a vibrating tone. Similarly, and presumably to avoid special effects, Kirkpatrick restricts his tonal palette and his dynamic scale. This, certainly, is one point of view, but the clavichord, I feel, can gain considerably from a less severe, less monochromatic approach. In spite of the low volume at which these records should be played back, one never has to strain to hear the softest passages.

This carefully engineered recording is one that should be heard by anyone interested in Bach interpretation. The album is accompanied by three comprehensive essays on the music. I. K.

RECORDING OF SPECIAL MERIT

Ⓢ Ⓜ BEETHOVEN: *String Quartets: E-flat, Op. 127; B-flat, Op. 130; C-sharp Minor, Op. 131; A Minor, Op. 132; Grosse Fuge, Op. 133; F Major, Op. 135*. Amadeus Quartet. DEUTSCHE GRAMMOPHON 138537/38/39/40 four 12-inch discs \$27.92, LPM 18537/38/39/40* \$23.92.

Interest: The ultimate Beethoven
 Performance: Exceptionally distinguished
 Recording: Elegantly scaled
 Stereo Quality: First-rate

With these four discs, the Amadeus Quartet—resident in London since the 1940's, but renowned throughout the international concert circuit—completes its traversal of the Beethoven quartet cycle.

A number of eminent ensembles have taken on the challenge of recording the last quartets—most notably (and twice) the Budapest Quartet, and I had a fascinating time not only listening intently to what the Amadeus Quartet had to com-

municate about Beethoven's final masterworks, but also spot-checking various movements as played by the Budapest.

As always, and quite understandably in readings as distinguished and carefully wrought as these by the Amadeus, I was deeply moved by the music itself, and fascinated anew by the thematic interrelationships between the A Minor, B-flat, C-sharp Minor, and *Grosse Fuge*. As played on these DGG discs, the raw anguish of the A Minor became more vivid than ever, and the unrelenting sublimity of the C-sharp Minor took on dimensions different from those of the two Budapest and the single Hollywood Quartet versions to which I compared it.

The Amadeus group has a flair for conveying the sheer drama of this music—and sometimes in disconcertingly individual fashion. Listen, for example, to the wholly different articulation of the opening page of Op. 127, as compared to the Budapest treatment, or to the celebrated broken figuration for first violin in the heart-rending Cavatina movement of the B-flat Quartet. The Amadeus violinist plays these figures without vibrato, thus conveying a wholly different emotional view of the music from that we have been accustomed to hear from the Budapest and other groups.

In general, I find that the Amadeus



THE AMADEUS QUARTET
Virtuoso eloquence, distinguished and carefully wrought

Explanation of symbols:

- Ⓢ = stereophonic recording
- Ⓜ = monophonic recording
- * = mono or stereo version not received for review



you're this
close to
"studio quality"
recordings

... with
the NEW

MICROMINIATURE CONDENSER

SWEDISH **PML** ENGINEERED

MICROPHONES

It is an accepted fact that practically every sound studio employs condenser microphones. Expensive? ... definitely — but optimum results are important!

NOW THERE'S PML! ... condenser microphones ... studio quality ... COST? ... about 1/5 that of comparable condenser microphones.

If you are a professional or serious recordist, listen to the amazing difference a PML can make in your recordings. PML microminiature condenser microphones are precision engineered to give you smooth, sensitive, natural response — essentially linear from below 30 c/s to above 18 kc/s. They're available in cardioid or omni-directional patterns with AC or Battery Operated Power Supplies. Four impedances to selection is offered with both types.

A Leading Sound Studio states:

"Even though they are miniature microphones they feature a frequency response from 20-20,000 c/s and have proven themselves as a valuable asset. They most definitely compare quite favorably with their "big brother" imports on the market today costing over 3x as much."

Professional Net Prices:

PML Microphone Model EK61 (omni-directional).....	\$ 99.50
PML Microphone Model EC61 (cardioid).....	109.50
PML Power Supply Model #4315 (AC only).....	49.50
PML Power Supply Model #4316 (Battery operated).....	39.50

STUDIO QUALITY SOUND? ...
YOU'RE CLOSER WITH

SWEDISH **PML** ENGINEERED

Sold Only at Selected Sound Specialist or from:
ERCONA CORPORATION
432 PARK AVE. SO., NEW YORK 16, N. Y.

group usually focuses on the intensity of the moment, sometimes at the expense of over-all line. I cite this not as a fault, but strictly as reportage. Within the bounds of taste and the printed notes, music as vast and intense as these last quartets of Beethoven cannot be limited to a single view to the exclusion of all others. The Amadeus Quartet makes an eloquent case for their view of the ultimate Beethoven—most impressively, I feel, in the A Minor Quartet with its almost unbearably poignant "Thanksgiving" slow movement. And for sheer virtuosity, the Amadeus Quartet need defer to no other group today, as witness their handling of the scherzos and finales, not to speak of the colossal *Grosse Fuge*.

For some listeners, their reading of the *Grosse Fuge* may miss the ultimate in ferocity and cosmic spaciousness; but this may also be a function of the recorded sound itself, which is essentially intimate and in close focus. Nevertheless, such minor drawbacks detract not one whit from an achievement that measures up to the best of all that has gone before on discs. The pressings are without fault.

D. H.

© ① BEETHOVEN: *Symphony No. 3, in E-flat, Op. 55 ("Eroica")*. Boston Symphony Orchestra, Erich Leinsdorf cond. RCA Victor LSC 2644 \$5.98, LM 2644* \$4.98.

Interest: Mature Leinsdorf

Performance: Weighty and spacious

Recording: Has impact

Stereo Quality: Good

Listening to this performance movement for movement against that recorded by Leinsdorf a decade ago with the Rochester Philharmonic Orchestra is a revealing and rewarding experience. Ten years ago the conductor was still much under the influence of the mentor of his youth, Arturo Toscanini, for what emerges from Harmony 7053 (now deleted) is a powerful Toscanini-style reading. The Leinsdorf of today has clearly turned his back on Toscaninian dynamism as an end in itself and has sought in his new reading to achieve a synthesis of classic grandeur and lyrical expansiveness. By and large, it works very well. Though my personal taste favors the Toscanini style (I feel that Karajan's DGG performance is the most gripping example of this point of view), there can be no question about the sonic superiority of the Leinsdorf performance in detail, presence, and impact throughout the whole orchestral spectrum. In terms of performance, I find more precision and rhythmic bite here than in either the Walter or Klemperer readings—for me the Klemperer tempos are disaffectingly slow, but this also is a matter to be decided only by taste.

D. H.

© ① BRAHMS: *Symphonies: No. 1, in C Minor, Op. 68; No. 2, in D Major, Op. 73; No. 3, in F Major, Op. 90; No. 4, in E Minor, Op. 98; Variations on the St. Antoni Chorale, Op. 56a; Academic Festival Overture, Op. 80; Tragic Overture, Op. 81*. Suisse Romande Orchestra, Ernest Ansermet cond. LONDON CSA 2402 four 12-inch discs \$23.92, CMA 7402* \$19.92.

Interest: Orchestral Brahms

Performance: Surprisingly eloquent

Recording: High-powered

Stereo Quality: Good enough

Ernest Ansermet is the last contemporary conductor with whom I would ordinarily associate the symphonic works of Johannes Brahms, but one of the joys of record reviewing is to receive a happy surprise every so often—and this four-record set is one of them. Ansermet's way with Brahms is not to be underestimated, even if not always agreed with.

In the First Symphony, in particular, I sense a close kinship between Ansermet's handling of the music and that of the late Felix Weingartner, whose best readings of Brahms and Beethoven achieved a remarkable synthesis of virility and intellectualism. So, too, with Ansermet's Brahms on these discs. Again like Weingartner, he is careful not to let the strings overpower the general orchestral texture, so that his readings bring out more wind coloration on full ensemble passages than we are normally used to hearing. Another characteristic that Ansermet shares in common with Weingartner is a rock-steady tempo.

The Brahms First recording as received for review did not track well when checked out on two different turntables (undoubtedly owing to excessive level in disc cutting), but the other six sides sounded very well indeed, in particular those of the Second and Third Symphonies, which Ansermet has treated with great warmth and animation. The Fourth Symphony sounded a bit hasty, as did the *Academic Festival Overture*.

Those interested in a different slant on Ansermet—and occasionally on Brahms—will find this set worth while.

D. H.

© ① CHERUBINI: *Requiem, in D Minor*. Czech Philharmonic Chorus and Orchestra, Igor Markevitch cond. DEUTSCHE GRAMMOPHON SLP 138795 \$6.98, LPM 18795* \$5.98.

Interest: First recording

Performance: Excellent

Recording: A shade distant

Stereo Quality: Good

Unlike Cherubini's earlier-composed requiem in C Minor, which is rather well (Continued on page 72)



INTRODUCING
 THE
INCOMPARABLE
 CONCERTONE
CARAVELE

CONCERTONE
 REVERSE-O-MATIC

◀ FAST FAST ▶ RECORD ◀ OPERATE ▶ STOP

PULL ON PULL TO RECORD PULL TO RECORD PULL FOR ADD-O-MIX/RECH

OUT LEVEL REC LEVEL RECL LEVEL OUT LEVEL

MIC MIC MIC

RECORDING OVER

And beyond compare it is. There's simply no other way to describe the new Caravelle. It's unique in the stereo tape recorder field. Only the Caravelle has six heads. (Lets you record or play in both directions continuously without flipping reels.) Reverse-o-matic® plays any tape automatically to and fro for as long as you wish. Simple, too. Easy push button operation. Built-in echo control, sound on sound control, twin speakers, three motor system, center capstan drive. And there's more. In fact, we have a brochure crammed with facts. Send for it. You'll be amazed that the incomparable Caravelle gives you so much for less than \$399. For details and name of nearest dealer write to Concertone, Box 3227, South El Monte, California.

CONCERTONE 

GRADO

"Truly the world's finest..."



LABORATORY SERIES TURNTABLE

FOR THE FIRST TIME THE MAIN FLYWHEEL IS MOUNTED BETWEEN TWO BEARING CENTERS IN AN EXCLUSIVE PATENTED DESIGN.

The first COMPLETELY new turntable in half a century!!

Two vibrationless twelve pole hysteresis motors with ultra light mass armatures (they weigh 4 grams each) drive two massive flywheels in a super low friction system (friction reduced almost 500 times).

Flutter and wow are virtually nonexistent (if at all measurable). Noise and rumble for the full frequency range are completely inaudible.

This is the only turntable designed for the stereo record.

PATENT #3,082,635

SINGLE SPEED TURNTABLE WITH BASE \$99.50

COMPLETE ENSEMBLE (as shown less cartridge) \$153.00

For further information please write:

GRADO LABORATORIES, INC. 4614 Seventh Ave., B'klyn 20, N.Y.

and 49, Janigro concentrates on orchestral tone at the expense of emotion and spirit—the instrumental sound has a lovely sheen, but one wonders what happened to the *Sturm* and the *Drang*. First and second violins are not divided between the stereo channels (they are in Góberman's version), and for No. 48 ("Maria Theresia"), the score used contains some questionable additions to the instrumental parts. The set in general is a very enjoyable and impressive one, even though in respect to some interpretive details Janigro is well behind the standard of excellence set by Góberman. The sound on both discs, mono and stereo alike, is top-drawer. *I. K.*

LALO: *Concerto for Cello and Orchestra, in D Minor* (see SCHUMANN)

© ® **MASSNET:** *Hérodiade* (excerpts). Régine Crespin (soprano), Salomé; Rita Gorr (mezzo-soprano), Herodias; Albert Lance (tenor), John; Michel Dens (baritone), Herod; Jacques Mars (bass), Phanael. Orchestra of the Théâtre National de l'Opéra, Georges Prêtre cond. ANGEL S 36145 \$5.98, 36145 \$4.98.

Interest: Unfamiliar opera
Performance: Authoritative
Recording: Clear and full
Stereo Quality: Minimal

Compared to the savagery of the Wilde-Strauss re-creation of the Salomé story, *Hérodiade* (1881) is a singularly tame affair. Salomé is a wholly sympathetic character here, sincerely in love with John and determined to save him. When the Prophet is destroyed by the revenge of Herodias and the jealous hatred of Herod, Salomé kills herself. *Hérodiade's* role is larger and more complex than in Strauss' opera, and the figures of John and Herod are also seen in a different light. John is less a doom-obsessed visionary than a human being, and Herod is an infatuated two-timer without the Wildean overtones of drunken depravity, so chillingly effective in Strauss' version.

The best moments here are the lyrical episodes—Salomé's "*Il est doux, il est bon*" and Herod's "*Vision fugitive*"—long familiar to opera lovers.

These well-chosen excerpts, adding up to fifty-two minutes of music, make an interesting addition to the opera aficionado's library. The cast, all front line singers of the Paris Opéra, is uniformly strong, but even in this excellent company Régine Crespin deserves special mention. Prêtre conducts with sympathy, and the orchestral performance is fine, but the rather static nature of the stereo recording gives it hardly any advantage over the equally well recorded mono version.

G. J.

(Continued on page 76)

EXCLUSIVE *Bell* DESIGN
Start with Amplifier
... plug in Tuner later!

NEW 80 WATT TRANSISTORIZED Tuner/Amplifier

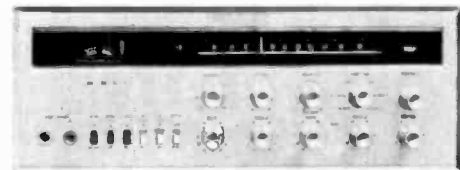
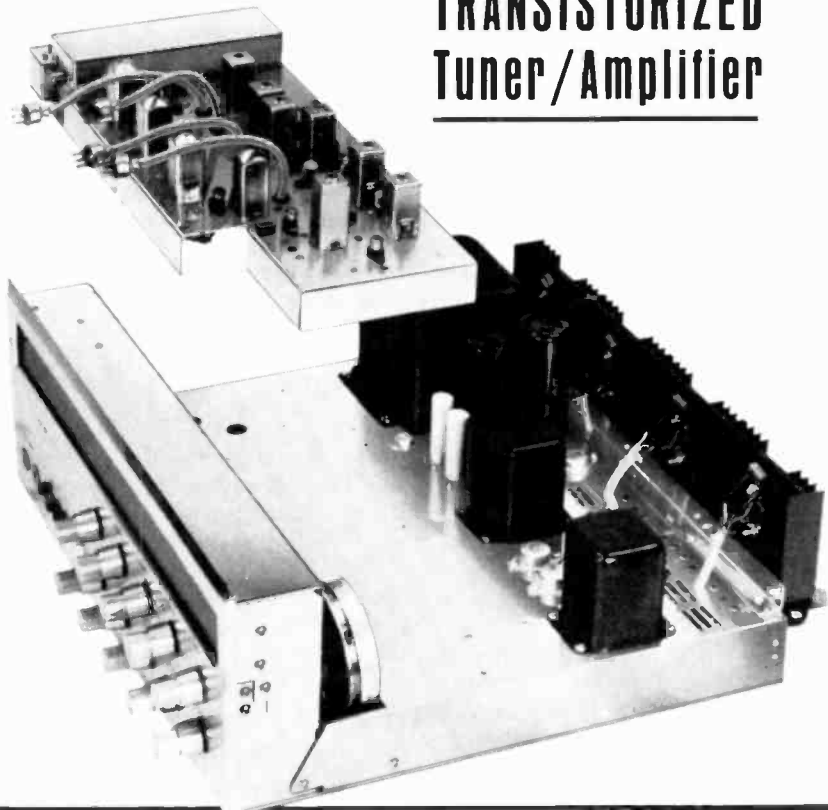

Bell IMPERIAL 1000 FM STEREO TUNER / AMPLIFIER

Unquestionably the ultimate in a stereo component. Transistorized circuitry • Full 80-watt IHFM power output • Frequency response of 9 to 85,000 cycles • Unequaled stereo separation 30 db 20 cps to 15 kc inclusive • Automatic stereo switching • Fully silverplated tuner • Luxurious chrome plated chassis with soft golden panel and striking "cockpit" dial lighting ... \$529.95

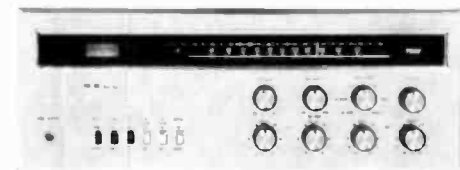

Bell IMPERIAL 900 FM STEREO TUNER / AMPLIFIER

Outstanding technical performance nearly equal to Imperial 1000 • Transistorized • Ultra-high tuner sensitivity • 80-watt power output ... 9 to 75,000 cycle amplifier response ... \$469.95

EXCLUSIVE *Bell* DESIGN
Make tape copies while you
listen to your original tape!

NEW TAPE DECK TAPE DUPLICATOR

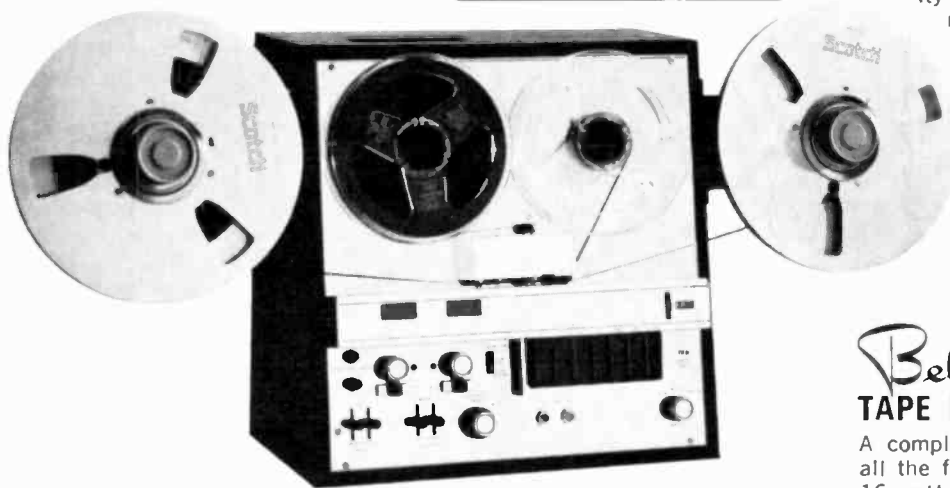

Bell T-367 STEREO TAPE DECK / DUPLICATOR

Now ... a single tape deck that will make copies of pre-recorded tapes ... record and playback high fidelity stereo or monaural tapes • Echo and sound-on-sound flexibility • Off-the-tape monitoring • Three-motor drive • Electro-dynamic braking • Attractive polished-chrome deck plate with contrasting black ebony housing ... T-367 \$369.95 ... DK-1 Duplicator Motors \$49.95. EB-1 Housing \$24.95

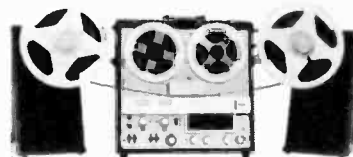

Bell RT-360 STEREO TAPE RECORDER / DUPLICATOR

A complete portable stereo recorder with all the features of the T-367 plus built-in 16-watt stereo amplifier and swing-out speakers ... RT-360 \$449.95 ... DK-1 Duplicator Motors \$49.95

Prices slightly higher in West

TRW COLUMBUS DIVISION
 THOMPSON RAMO WOOLDRIDGE INC.
 6325 Huntley Road • Columbus 24, Ohio



Send for New Catalog on the complete Bell line of stereo high fidelity components for your home music center.

Records at COST!

through our Special Membership Plan

BUILD YOUR RECORD LIBRARY INEXPENSIVELY, QUICKLY, CONVENIENTLY NO "AGREE TO PURCHASE" OBLIGATION CHOOSE THE RECORDS YOU WANT

Citadel Record Club members purchase hi-fi and stereo albums at cost; classical, popular, jazz, show hits, folk, etc. There are never any "list price" purchases through Citadel.

CITADEL Membership —

The Proven Method Of Record Buying Used By Thousands Because . . .

- * **YOU DECIDE ON YOUR PURCHASES** — You are not obligated to purchase any particular quantity of records. Buy as few or as many records as you want . . . the choice is yours.
- * **YOU HAVE COMPLETE FREEDOM OF SELECTION** — Virtually any record or album, by any artist on any label is available including all major labels plus hundreds of smaller labels as well as most imports. Again, the choice is completely up to you.
- * **PROMPT SERVICE** — Many orders are shipped the day received, rarely later than the next several days. In the event of a delay, partial shipments are made and your order completed when available.
- * **PERIODIC SPECIALS** — Periodically you receive a list of hit albums from all categories of music at prices up to 55% off list. Again, you are under no obligation to purchase any of these specials.
- * **FREE! SCHWANN RECORD CATALOG** — With your membership you receive this quick reference to over 25,000 albums. This easy-to-use catalog contains separate sections for classical, popular, ballet, opera, musical shows, folk music, jazz, etc., and for all new releases.
- * **100% GUARANTEE** — If a damaged or defective record does get through our inspection, we shall immediately replace with a perfect copy.

Membership dues is \$3.00 a year . . . a nominal amount if you think of the prices you have paid within the past year. AS A CITADEL MEMBER BUYING RECORDS AT COST, YOUR DUES WILL BE PAID FOR WITH VIRTUALLY THE FIRST PURCHASE YOU MAKE THROUGH THE CLUB. Additional savings quickly mount up, permitting you to buy many more albums on your record budget.

May we suggest that you give Citadel an opportunity of proving its value to you. You enter no obligations, take no risks . . . simply complete the coupon below, include your \$3.00 yearly dues and upon receipt we shall immediately forward all membership material to you.

SATISFACTION GUARANTEED. Try membership for 30 days. If you are not completely satisfied, dues will be refunded immediately.

FREE! Act now. Fill out coupon, enclose your dues; we will include a free record cleaning cloth as a gift.



CITADEL RECORD CLUB

545 Fifth Avenue, New York 17, N. Y. S-34

Enroll me in Citadel for one year. I am under no obligation to purchase any particular quantity of records, but those that I do purchase will be at cost price . . . NEVER more. Send the current Schwann catalog and free record cloth immediately. I understand that if, after 30 days, I am not completely satisfied I can get my full membership dues back immediately. \$3.00 dues enclosed.

FULL NAME _____
 STREET _____
 CITY _____ ZONE _____ STATE _____

© ® **MOUSSORGSKY-RAVEL: Pictures at an Exhibition. DEBUSSY: Prélude à L'après-midi d'un faune.** Philharmonia Orchestra. Lorin Maazel cond. ANGEL S 36132 \$5.98, 36132 \$4.98.

Interest: Ravelian grandeur
 Performance: Forceful
 Recording: Excellent
 Stereo Quality: Good

The brilliance, virtuosity, and high style of Maurice Ravel's orchestral manner make especially suitable musical terrain for the gifts of Lorin Maazel, as we have seen before in his now-celebrated recording of *L'Enfant et les sortilèges*. Here again, in the Moussorgsky-Ravel *Pictures at an Exhibition*, we observe the affinity at work. Maazel is more concerned with its coloristic Ravelian orchestral elements than he is with Moussorgsky's nationalistic preoccupations.

Whether such an approach provides the interpretive answer to this work in its orchestral form is a matter, I should imagine, of taste. Suffice it to say that, on Maazel's terms, the performance is a pulsating success, and Angel's sonics go along with the conception straight down the line.

The main feature here is preceded—rather pointlessly, perhaps—by a capable, if subtly mannered, reading of Debussy's *L'après-midi d'un faune*. W. F.

RECORDING OF SPECIAL MERIT

© ® **POULENC: Stabat Mater; Four Motets.** Régine Crespin (soprano), René Duclos Chorus; Paris Conservatoire Orchestra. Georges Prêtre cond. ANGEL SFS 36121 \$5.98, FS 36121 \$4.98.

Interest: Supreme Poulenc
 Performance: Superb
 Recording: Excellent
 Stereo Quality: Good

The recent death of Francis Poulenc has, in this country at least, resulted in an astonishingly obvious re-enactment of the historical cliché that tells us that the only great composer is a dead one. Poulenc had only to take leave of this earth for the comedy to begin. Works that had been received with courteous and guarded approval became, overnight, great masterpieces. And the reader who by some chance had never heard of Poulenc might have been led to believe that Poulenc had been a neglected, abused figure until death intervened to immortalize him.

He has been immortalized in little more than a year. And it has been largely on the basis of his later religious works, like the *Stabat Mater* here recorded, that the critical canonization has been effected. But an encounter with the *Stabat Mater* brings us face to face with an

extraordinary fact. Taken as religious music—and Poulenc's religious feelings were, we know, deeply sincere—much of the score of the *Stabat Mater* is of a musical vulgarity so breathtaking as to be explained only by an enormous naïveté and childlike innocence. Change the language from Latin to French, the texts from sacred writings to the poetry of Apollinaire, and any one of several moments in the *Stabat Mater* becomes, as musical style, no different from some of Poulenc's most lavishly hedonistic art songs.

Poulenc's *Stabat Mater* is a magnificent work and a moving one. It may very well be a masterpiece. But like all great eclectics, Poulenc resists labels. What might of itself be vulgar becomes, in context, mysteriously moving. There is no other composer in our century whose work so resourcefully eludes the standards by which we customarily measure musical quality.

The present production of the *Stabat Mater* is unremittingly superb. Régine Crespin, in particular, quite outdoes herself in a performance markedly free of the sort of interpretive reserve that is ordinarily thought to denote piety. The *Four Motets for a Time of Penitence* that fill out the second side are welcome encores, and Angel's recording is all spaciousness and soft light. W. F.

© ® **PROKOFIEV: Symphony No. 5; Scythian Suite.** London Symphony Orchestra, Antal Dorati cond. MERCURY SR 90313 \$5.98, MG 50313* \$1.98.

Interest: Fine double bill
 Performance: Crisp
 Recording: Excellent
 Stereo Quality: Commendable

The matter-of-fact approach that is both the strength and the weakness of Antal Dorati's conducting is the key to the success of this uncommonly interesting record, for it enables us to see in synthesis a sort of before-and-after poster of the late Serge Prokofiev: with the *Scythian Suite*, the flaming, free-world revolutionary; with the Fifth Symphony, the composer's masterpiece for the Marxist Establishment.

The *Scythian Suite* dates from 1915, when Prokofiev was part of the world of Serge Diaghilev, and I hope it does no disservice either to Stravinsky or to Prokofiev to describe it semi-seriously as the latter's answer to *The Rite of Spring*. It remains an extraordinary work even today. It slashes and snarls, heaves and groans with thick tonal dissonances. Yet the Prokofiev of the Fifth Symphony—the musical moderate, the lyricist, the traditionalist—is almost always to be found just under the surface upheaval. If the Fifth Symphony, which was com-

(Continued on page 78)

now you can use a triple play tape... without loss of output



if it is this one!

Triple play recording tapes require thinner oxide coatings. Ordinarily, tapes with thinner coatings lose output or volume. *This is not so with Reeves Soundcraft Triple Play Tape!* A special magnetically active oxide coating on the durable DuPont Mylar base does it! Extra output is built into the coating...at least 5 db more than other triple play tapes! Even when you splice Soundcraft Triple Play with quality standard play tapes, you won't hear any change in playback level between the two! A 7" reel of Soundcraft Triple Play contains 3600 feet of tape...gives you triple the playing time of a reel of standard tape.

If you want the convenience of greatly extended recording time without sacrifice in performance, insist

on Soundcraft Triple Play Tape. Write for literature.

TYPICAL RECORDING TIMES PER 7" REEL.		
	1 7/8 IPS	7 1/2 IPS
Mono single track dual track four track	6 hrs. 24 min. 12 hrs. 48 min. 25 hrs. 36 min.	1 hr. 36 min. 3 hrs. 12 min. 6 hrs. 24 min.
Stereo dual track four track	6 hrs. 24 min. 12 hrs. 48 min.	1 hr. 36 min. 3 hrs. 12 min.

FOR YOUR VERY SPECIAL RECORDINGS TRY REEVES GOLDEN TONE—the world's most impressive tape...for the discerning ear and most exacting equipment.

 **REEVES SOUNDCRAFT**
DIVISION OF REEVES INDUSTRIES INC

Main Office: Danbury, Connecticut • New York • Chicago • Los Angeles • Export: C.B.S. International, N.Y.C. • Canadian Repts: Vancouver • Toronto • U.K. Repts: Soundcraft Magnetic Ltd.

MARCH 1964

CIRCLE NO. 43 ON READER SERVICE CARD

REC-17

77

a is for 

a faster lens The new Honeywell Pentax H1a is equipped with a brilliant new 55mm f/2 six-element lens. Benefits to you: brighter viewing and focusing, added versatility under poor lighting conditions!

a is for 

automatic diaphragm Standard on the new H1a is a fully automatic, instant-open diaphragm with depth-of-field preview feature. Benefits to you: fewer missed pictures; viewing and focusing at full aperture, or taking aperture, as you choose.

a is for 

automatic counter reset On the new H1a, the exposure counter returns to zero when you reload. Benefits to you: the counter always indicates the exact number of pictures you've taken, keeps constant check on film supply.

a is for 
the Honeywell
Pentax H1a

a brand-new model which retains all of the traditional Pentax quality features: brilliant eye-level pentaprism viewing, shutter speeds to 1/500 sec., short-throw film advance lever, FP and X flash synchronization, "cocked" indicator, and rapid-rewind crank. These features plus classic, functional styling make the new H1a the outstanding single-lens-reflex value at just \$169.50. See it at your dealer's soon, or write for full-color folder to: John Thornton, Honeywell, Denver 10, Colorado.

Honeywell
PHOTOGRAPHIC PRODUCTS

CIRCLE NO. 27 ON READER SERVICE CARD

posed some thirty years later, is the masterpiece marking the composer's capitulation to the Soviet system, its placement next to the *Scythian Suite* tells us that, for all the difference in exterior, the symphony is no corruption of the essential Prokofiev.

Both of Dorati's readings are precise, brilliant, and coolly objective. They may leave something to be desired in themselves—something intangible and "extra"—but they are marvelously right for the premise of this particular coupling, whether they were so thought of or not.

The recording is clear and sharp, very much in Mercury's manner. *W. F.*

©  RACHMANINOFF: *Piano Concerto No. 1; Piano Concerto No. 4*. Philippe Entremont (piano); Philadelphia Orchestra, Eugene Ormandy cond. COLUMBIA MS 6517 \$5.98, ML 5917 \$4.98.

Interest: Lesser-known Rachmaninoff

Performance: Odd

Recording: Good

Stereo Quality: Okay

This coupling of what I take to be the two least familiar of Rachmaninoff's piano concertos ought to have been a boon of the first order for the Perfect Rachmaninovian. But while I shall not pretend to powerfully precise convictions on how this composer's music *must* be played, I wonder about much of what the young French pianist Philippe Entremont has been up to in the presence of Columbia's microphones.

Admittedly, these performances generate a good bit of pianistic interest—but at a price, I fear. Entremont slashes at the music, even batters it a bit. This approach creates a certain lumpy excitement in the more animated passages, but it tends to diminish and, in a way, parody the characteristic slow music. Rachmaninoff could send a long, fine-spun line into impressive flight when he had a mind to and—there can't be much doubt about it—Entremont has a way of all but shooting them down.

The damage I feel most keenly is done to the earlier of these pieces. For the First Concerto is a very young and very innocent work—constructed with all the subtlety of the Berlin Wall, full of cornball pyrotechnics, smoldering Russianisms and, Heaven help us, allusions to its composer's rather better known C-sharp Minor Prelude. This piece needs all of the post-Romantic stylistic humbug it can be given.

The Fourth Concerto fares better in Entremont's treatment, but whatever the pianist's vagaries, they are atoned for by the stunningly sonorous accompaniment provided by Mr. Ormandy and the men from Philadelphia. *W. F.*

(Continued on page 80)

How can the new XP-5 speaker be this small and still sound like a Fisher?

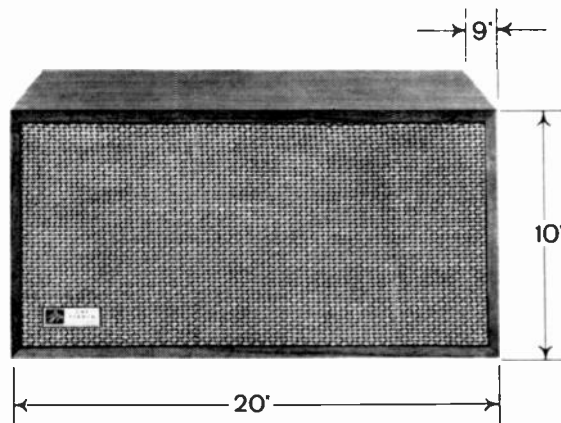

It's far from easy. It requires a bona fide advancement of the state of the art. And that's precisely what Fisher engineers have accomplished.

The new Fisher XP-5 is the first 'compact' in the loudspeaker field that doesn't sound like one—in fact, as well as in claim. Its bass is round and solid, very close to that of the largest speaker systems and free of artificial correctives like shaping networks that alter the bass output of the amplifier. Its treble has a smooth, rich texture and a genuine 'see-through' quality. It is the millennium: a moderately priced one-cubic-foot speaker that sounds like a Fisher!

The most important part of the secret is in the woofer. This is an 8" unit with a magnet structure weighing 2½

pounds, a flux density of 12,500 gauss and a totally new suspension system utilizing a long-throw inverted half-roll surround. The free-air resonance is at 25 cps, an almost incredible figure for an 8" driver. The completely enclosed baffle is heavily damped with AcoustiGlas packing. The result is *fundamental bass response down to 34 cps, without doubling.*

The 2½" tweeter has a new low-mass cone made of a combination of the usual fibrous material plus a special polyurethane foam, resulting in peak-free response out to 20,000 cps, without coloration. The LC-type crossover network uses low-loss air-core inductors.

The Fisher XP-5 is without question the first loudspeaker system of its size

that will satisfy even the most demanding audio perfectionist. It can be unhesitatingly recommended for all applications where space is at a premium. Price, in oiled walnut, \$54.50. In unfinished birch, \$49.50. (Slightly higher in the Far West.)

FREE! Mail this coupon for your free copy of the Fisher technical fact booklet on speakers plus the XP-5 technical fact sheet.

Fisher Radio Corporation
21-40 44th Drive
Long Island City, N. Y. 11101

Name _____

Address _____

City _____ State _____

FISHER SPEAKER SYSTEMS
TECHNICAL FACT BOOKLET



02310

OVERSEAS RESIDENTS PLEASE WRITE TO FISHER RADIO INTERNATIONAL, INC., LONG ISLAND CITY, N. Y. 11101. CANADIAN RESIDENTS WRITE TO TRI-TEI ASSOCIATES, LTD., WILLOWDALE, ONT.

© ① SAINT-SAËNS: *Samson et Dalila*. Rita Gorr (mezzo-soprano), Dalila; Jon Vickers (tenor), Samson; Ernest Blanc (baritone), High Priest; Anton Diakov (bass), Abimelech and the Old Hebrew. Orchestra of the Théâtre National de l'Opéra and Chœurs René Duclos, Georges Prêtre cond. ANGEL S 3639 three 12-inch discs \$17.94, 3639 \$14.94.

Interest: First stereo recording
 Performance: Outstanding Dalila
 Recording: Good
 Stereo Quality: Effective

The best that can be said for Angel's new recording of *Samson et Dalila* is that it answers part of the need for an up-to-date recording of this ingenious and flavorful score. Its cast lacks the uniform excellence of that of the 1946 Paris Opéra recording on the Pathé label, which sets a standard for stylistic homogeneity. On the other hand, the new version does justice to Saint-Saëns' brilliant orchestral writing, and the contributions of its conductor and its Dalila are impressive.

The leadership of Georges Prêtre never lacks dramatic urgency. Without restricting the freedom of his singers to phrase broadly the languorous and opulent melodies in which the score abounds, he sustains the music's flow at a compelling pace. Rita Gorr's Dalila is admirable in every way. Her voice is smooth, sumptuous, and appropriately seductive; her portrayal is strongly conceived and unfailingly musical. The Samson of Jon Vickers has similar interpretive virtues—it is truly heroic and impressive in its eloquence and dignity—but his is a vocally inconsistent performance, much of it marked by audible strain and lacking in the ringing freedom this role requires. In supporting roles, both Blanc and Diakov are somewhat disappointing, too.

Despite occasional imperfections in the balancing of singers and orchestra, and a few tell-tale signs of control-room gain-riding, the over-all sound is very satisfactory in both stereo and mono. The important choral portions are well reproduced, and stereo is sensibly employed to enliven a work not noted for its abundance of action. *G. J.*

© ① SCHUMANN: *Carnaval, Op. 9; Davidsbündlertänze, Op. 6*. Charles Rosen (piano). Epic BC 1269 \$5.98, LC 3869* \$4.98.

Interest: Prime youthful Schumann
 Performance: Fascinating
 Recording: Good enough
 Stereo Quality: Adequate

Charles Rosen here tries neither to recapture the traditional Romantic manner of Schumann interpretation nor to emulate the diamond-cold and hectic virtuosity common to most of the pian-



JANOS STARKER
Passionate Romanticist

ists of his own generation who take on *Carnaval* and the allied Schumann repertoire. Rather he chooses a middle course—a course open only to one thoroughly aware of the literary and cultural milieu in which Schumann's special brand of Romanticism took root, and yet who is himself a twentieth-century musician seeking a valid perspective. The result is a carefully reasoned—but, for a change, not cold—treatment wherein the exuberant close is just that, rather than an anticlimax.

Even more intriguing is Rosen's handling of the more episodic and at times overwrought *Davidsbündlertänze* (David-League Dances), which were written after *Carnaval*, the earlier opus number notwithstanding. Part of the effect of Rosen's beautifully conceived reading arises from that fact that it is paired with *Carnaval*—and despite its being on



CHARLES ROSEN
Romanticism reinterpreted

the first side, it should be played last in order that it may have its full effect. For, as Mr. Rosen says in his perceptive program notes, "This league against the Philistines, the enemies of true art and imagination, marches out to victory at the end of the *Carnaval*. The triumph of the *Davidsbündlertänze* is of another order."

Although Rosen may not efface, from the standpoint of imaginative brilliance, memories of the cherished Rachmaninoff 1929 recording of *Carnaval*, he does offer thought-provoking and valid contrast to Moiseiwitsch (Decca) and Novaes (Vox), both of whom work within the tradition. If you seek new insights into Schumann, this is a disc not to be passed by. *D. H.*

© ① SCHUMANN: *Concerto for Cello and Orchestra, Op. 129*. LALO: *Concerto for Cello and Orchestra, in D Minor*. Janos Starker (cello); London Symphony Orchestra, Stanislaw Skrowaczewski cond. MERCURY SR 90347 \$5.98, MG 50317 \$4.98.

Interest: Soaring cello-playing
 Performance: Effective
 Recording: Excellent
 Stereo Quality: Good

There is a fine lot of vitality and high excitement about both of these performances. Starker launches into both the Schumann and the Lalo concertos with the Passionate Romanticism dial turned up full blast—so much so that one listens uneasily for the inevitable sag in intensity that, astonishingly enough, never occurs. There is a good deal of the gypsy in Starker's playing, and, particularly in the Schumann, he creates the illusion of making up the music on the spot.

The performance style has its drawbacks, of course, particularly for the listener with more sober tastes. The orchestral accompaniment on the Schumann is reduced to the function of mere chordal underpinning, and the structure of the work is pretty much lost in all the eloquence. But the Lalo works beautifully, performed as it is with nearly operatic intensity. And Skrowaczewski's accompaniment rises to the occasion for this work.

The recording is especially vivid and live. I question the good judgment of replacing the usual annotative material with Martin Mayer's "profile" of Janos Starker. I'm all for readable, entertaining liner notes, but Mr. Mayer's show-biz informality is a poor substitute for some background data on the music. *W. F.*

© ① TCHAIKOVSKY: *Symphony No. 5, in E Minor*. Philharmonia Orchestra, Otto Klemperer cond. ANGEL S 36141 \$5.98, 36141 \$4.98.

(Continued on page 82)

any turntable (manual or automatic) is obsolete today if it can't...

1 track with today's finest cartridges ...at 1 gram or less

The fidelity of record reproduction and the actual life of records depend essentially upon cartridge compliance ... the freedom of the stylus in tracing the contours of the grooves. Cartridges have been constantly refined until today's finest high compliance models can track between 1/2 and 1 1/2 grams. At such light forces, the stylus can respond instantaneously, sensitively and with a minimum of resistance to the most abrupt attacks and stops. High frequencies, peaks and transients are handled cleanly, effortlessly and accurately. Under 2 grams, the stylus ceases to be a factor in record wear. Used in previously designed automatic tonearms, such cartridges either skip and distort or just don't function at all. They can operate properly only in tonearms with perfect dynamic balance, low over-all mass and virtually frictionless movement in both horizontal and vertical planes. A tonearm of this professional caliber has been designed for the Dual 1009.

2 start and stop automatically... at 1 gram or less

The human hand is at best a crude device for placing a mere 1 gram weight on a record ... and lifting it at the end. Existing automatic mechanisms, even in the better record changers, require heavy tripping forces ... heavier than actually needed for tracking. With the Dual 1009, this problem no longer exists. The Dual's revolutionary new free-suspension trip switch operates even below 1/2 gram! This accomplishment alone establishes the Dual 1009 as a state-of-the-art record playing instrument. But along with it come other important advances: tracking error below 0.4°/inch ... tonearm resonance below 8 cps...anti-skating compensation for 1 gram tracking and below. Oh yes, you can start manually too, while the record is rotating or at standstill.

3 change records when desired... at 1 gram or less

The quality gap between the record changer and the manual turntable has been steadily narrowed, but never completely closed ... until now. For the convenience of uninterrupted music, performance had to be compromised. Some die-hards have bridged the gap by buying a changer and a turntable. This is no longer necessary. The identical caliber of performance in the Dual's single play turntable mode is matched in its changer operation. For example, even with ten records on the platter, stylus force increases less than 0.2 gram. Vertical tracking angle increases less than 6° ... even less than variations from cartridge to cartridge! And the Dual 1009 has no antiquated pusher platforms or overhead swinging devices.



Only the **Dual 1009** Auto/Professional offers all... plus

perfect pitch for critical ears, with 6% variable speed adjust ... newly designed, utterly silent Dual Continuous-Pole™ motor maintains speed accuracy within 0.1% when line voltage varies even beyond 10% ... feather-touch slide switches permit soft-sprung footings that isolate chassis from shock and acoustic feedback ... 7 1/2 pound dynamically balanced platter ... fine-thread damped counterweight. An extraordinary value at \$94.75.

Write for complete reprints of sensational equipment reviews. Better yet, see the Dual 1009 at your United Audio dealer.

UNITED AUDIO  **DUAL**
12 West 18th St. New York 11, N. Y.

MARCH 1964

CIRCLE NO. 55 ON READER SERVICE CARD

81



↓

WHY

you should buy and enjoy TARZIAN TAPE

■ Most of its users say that Tarzian Tape is the finest tape you can buy for the entire range of audio recording purposes, from stereo music to school work. Tape dealers who sell Tarzian Tape do so because they believe it is a very good product for you, the user—not because we give them fancy advertising support and free premiums.

The package for Tarzian Tape is strictly functional, not ornate. The price is standard: not cheap like "white box," not artificially high because of some "magic ingredient." The quality is professional, not because you run a recording studio or a radio station, but because any good tape recorder deserves it and any discriminating pair of ears appreciates it.

Insist on Tarzian Tape...depend on it for long lasting, professional quality performance whatever your recording assignment.

FREE... Tarzian's "Lower the Cost of Fun With Tape Recording" contains 32 illustrated pages of tape tips. Send for your free copy.

ITEM	Reel Size	Length (Feet)	Code Number
Standard Play 1.5 Mil Acetate Tape	3"	150	1131-01
	5"	600	1131-06
	7"	1200	1131-12
	Reel	2400	1131-24R
	Hub	2400	1131-24H
Long Play 1.0 Mil Acetate Tape	3"	225	1121-02
	5"	900	1121-09
	7"	1800	1121-18
	Reel	3600	1121-36R
	Hub	3600	1121-36H
Long Play 1.0 Mil Mylar Tape	3"	225	1321-02
	5"	900	1321-09
	7"	1800	1321-18
	Reel	3600	1321-36R
	Hub	3600	1321-36H
Extra Long Play 0.5 Mil Mylar Tape (Tensitized)	3"	300	1411-03
	3½"	.600	1411-06
	5"	1200	1411-12
	7"	2400	1411-24



SARKES TARZIAN Inc.

World's Leading Manufacturers of TV and FM Tuners • Closed Circuit TV Systems • Broadcast Equipment • Air Trimmers • FM Radios • Magnetic Recording Tape • Semiconductor Devices

MAGNETIC TAPE DIVISION • BLOOMINGTON, INDIANA

Export: Ad Auriema, Inc., N.Y. • Canada: E. J. Piggott Enterprises Ltd., Toronto, Ont.

Interest: Teutonic Tchaikovsky
Performance: Sober
Recording: Good
Stereo Quality: Natural

Klemperer's reading of the Tchaikovsky Fifth has—not unexpectedly—strong factors to recommend it. It is solid, straightforward, even literal. There is little of the sort of textural succulence that Koussevitsky, for example, brought to the work, and Klemperer does a minimum of swooning with the phrasing: the work's rather elementary rhythmic structure, in consequence, is spelled out with glaring clarity.

Whether it stands up under this sort of structural-analytical performance is, however, quite another matter. For it is not the restrained emotional climate of Klemperer's reading that disturbs, it is rather its inclination to cut through to the bare bones of a work whose underlying structural qualities are not celebrated for their sophistication or subtlety. In short, I am not at all certain that playing Tchaikovsky as one does Beethoven is the answer to the excesses of emotionality that so often mar the performance of this work. Even a tear-drenched Tchaikovsky is better than a dull one.

The recording is generally very good, although there is a tendency toward opacity in some of the tuttis. *W. F.*

RECORDING OF SPECIAL MERIT

⑤ ⑥ **WAGNER: Preludes and Overtures: Die Meistersinger; Lohengrin—Act III; The Flying Dutchman; Rienzi; A Faust Overture.** Pittsburgh Symphony Orchestra, William Steinberg cond. COMMAND CC 11020 SD \$5.98, CC 11020 \$4.98.

Interest: Fine Wagner package
Performance: A-1
Recording: Fine
Stereo Quality: Good

As those fortunate enough to own Steinberg's Command album (11012 stereo or mono) of orchestral highlights from the *Ring* already know, the Pittsburgh conductor is one of the top Wagnerian interpreters around these days. In this, his second Wagner album, he keeps up the good work throughout, and in addition puts us all doubly in his debt by giving us the first up-to-date recording of Wagner's youthful and remarkably powerful *Faust Overture*.

Written in Paris in 1840, the *Faust Overture* was to have been the first part of a projected *Faust* Symphony, but after abandoning this project, Wagner called his work *Faust in Solitude*, which aptly sums up the essential nature of the music.

In any event, this disc is highly recommended. *(Continued on page 84)*

HIFI/STEREO REVIEW

**“Did you hear Schubert’s 9th
this morning?
I recorded it complete...
in stereo!”**

**“I wasn’t home –
had to go to school
again to record a
long lecture on
anthropogenesis.”**



Whether your family’s requirements in a tape recorder reflect the demands of hobby or profession... classroom or business, you will find every one of your special needs fulfilled by either, or both, of the two solid-state Norelco recorders shown above.

The Continental ‘401’ (left), engineered for standby studio use as well as for professional-quality home music systems, is completely self-contained for both stereo and mono recording and playback. Includes dual recording and playback preamps, dual power amplifiers, two stereo-matched loudspeakers and a stereo, dynamic microphone. Its four speeds include $7\frac{1}{2}$, $3\frac{3}{4}$, $1\frac{7}{8}$, $15/16$ ips. Response: 60-16000 cps at $7\frac{1}{2}$ ips • Wow and flutter: less than 0.14% at $7\frac{1}{2}$ ips • Signal-to-noise ratio: better than -48 db.

The Continental ‘101’ (right) is a new, professional-quality 7-pound portable that works on ordinary flashlight batteries, providing excellent recording (and playback) of anything, anytime, anywhere. Gives you up to two hours on a 4” reel of tape. Sound is clear as a bell and loud as you want it. Features dynamic microphone and constant-speed motor with capstan drive. Ruggedly built, handsomely styled, surprisingly low-priced. The perfect portable for the entire family—for work or play—at home or away!

Norelco recorders are sold and demonstrated at camera shops, hi-fi dealers and wherever good sound is sold. Write for booklet 20 to: **NORTH AMERICAN PHILIPS COMPANY, INC.**, High Fidelity Products Division, 100 East 42nd Street, New York, N. Y. 10017.

Norelco®

mended, in particular for the fine Steinberg readings of the *Faust* Overture and of the less characteristic but still rousing curtain-raiser for *Rienzi*. First-rate sound and first-rate orchestral playing throughout both sides of the disc. *D. H*

COLLECTIONS

RECORDING OF SPECIAL MERIT

Ⓜ **RÉGINE CRESPIN:** *Operatic Recital*. Rossini: *Guillaume Tell*; *Sombre forêt*. Verdi: *Il Trovatore*; *D'amor sull'al. roseo*. Otello: *Mia madre aveva una povera ancella*; *Ave Maria*. Wagner:

Tannhäuser: *Dich, teure Halle*; *Allmäch'tige Jungfrau*. Berlioz: *Damnation of Faust*; *D'amour l'ardente flamme*. Régine Crespin (soprano); Orchestra of the Théâtre National de l'Opéra, Otto Ackermann cond. ANGEL 36144 \$1.98.

RECORDING OF SPECIAL MERIT

Ⓜ **RÉGINE CRESPIN:** *Italian Operatic Arias*. Verdi: *Il Trovatore*: *Tacca la notte*. *Un Ballo in Maschera*: *Morro ma prima in grazia*. Otello: *Mia madre aveva una povera ancella*; *Ave Maria*. Ponchielli: *La Gioconda*; *Suicidio*. Mascagni: *Cavalleria Rusticana*: *Voilà*

sapete. Puccini: *Madama Butterfly*: *Un bel dì*. Boito: *Mefistofele*: *L'altra notte*. Régine Crespin (soprano); Covent Garden Orchestra, Edward Downes cond. LONDON OS 25799 \$5.98, 5799* \$4.98.

Interest: Staple scenes and arias
Performance: Both discs outstanding
Recording: Angel okay, London excellent
Stereo Quality: London good

Despite the generally favorable impression she made during her first Metropolitan season—1962-1963—in such roles as the Marchallin and Amelia, Régine Crespin has attracted relatively little attention, as international prima donnas go these days. On records, too, her appearances have so far been limited to a somewhat unrewarding role in Poulenc's *Car-mélites* and a recital of Wagner excerpts. Now, suddenly, she appears in opera recitals from two different sources (as well as in a disc of highlights from Massenet's *Hérodiade*). On this well-documented evidence, Miss Crespin's place in the top soprano hierarchy is securely established.

The Angel disc, recorded in France at least five years ago, accentuates the artist's versatility. Of mixed French-Italian parentage, Crespin reveals an idiomatic command of both repertoires, and—what is truly surprising—she sings the *Tannhäuser* arias with a poetic quality and vocal radiance that recall their very finest interpreters. Her singing is on a similarly high level throughout the program: the tone quality is pure, the phrasing is sensitive, and there are beautifully executed nuances. Only the Berlioz excerpt, though as exquisitely sung as the rest, lacks those emotional undercurrents that should flow beneath the vocal line. The orchestral support provided by the late Otto Ackermann is correct and considerate, but rather matter-of-fact.

The all-Italian recital, recorded by London in early 1963, offers vocal artistry of the kind that makes even a jaded critic hang on every phrase, no matter how familiar the repertoire. At first, the tempos seem unduly deliberate, but the logic and proportion of these interpretations establish the justice of such an approach. There is a searching, delicate art behind every phrase, and exquisite nuances that turn time-worn moments into fresh discoveries.

Miss Crespin's low register seems occasionally to be unsupported on the Angel disc, but the voice is warm and round throughout the London program. I find the leadership of Edward Downes uncommonly effective and illuminating on the London disc; in addition, the sound is rich and the stereo restrained and unobstructive. Both companies supply full texts. London's liner notes, however, are unworthy of such a magnificent recital.

G. J.

(Continued on page 86)

VANGUARD

Current and Choice Recordings for the Connoisseur



HANDEL

Ode on Birthday of Queen Anne
Three Coronation Anthems
Soloists of the Deller Consort;
Chorus & Orchestra; Deller con-
ductor BG-661 & *BGS-70661

CHARPENTIER

Te Deum
Grand Magnificat
Soloists, Chorus & Orchestra;
Louis-Martini, conductor
BG-663 & *BGS-70663



VANGUARD

EVERYMAN CLASSICS

Designed for Everyman's purse and crafted to meet Vanguard's highest standards of musical and engineering excellence. Suggested list price: \$1.98 (mono) & \$2.98 (stereo).

Barbirolli and the Hallé Orchestra

SIBELIUS: Symphony No. 1
SRV-132 & *132SD

DVORAK: Symphony No. 4 &
Scherzo Capriccioso
SRV-133 & *133SD

VAUGHAN WILLIAMS: A London
Symphony
SRV-134 & *134SD

TCHAIKOWSKY: Symphony
No. 4
SRV-135 & *135SD

BRAHMS: Double Concerto
(Campoli, violin & Navarra, cello)
& Academic Festival
SRV-136 & *136SD

Wöldike and the Vienna State Opera Orchestra

HAYDN: Symphonies Nos. 99 &
102
SRV-129 & *129SD

BACH: St. Matthew Passion (with
Stich-Randall, Rossl-Majdan,
Kmentt, Berry, etc.) 4-12" boxed
BG-594/7 & *BGS-5022/5



BUFFY SAINTE- MARIE

"It's My Way"

VRS-9142 &
*VSD-79142

"A throaty, sensual voice that moves with surety through a wide range of songs... Her own compositions and her vibrant way of interpreting them make Miss Sainte-Marie, at 21, one of the most promising new talents on the folk scene."

Robert Shelton,
New York Times

"Buffy Sainte-Marie, a new name on the folk scene, may soon be a major one, when the full impact of this young and vibrant Cree Indian girl registers via her up and coming Vanguard debut album."

Variety

*Stereo

Critics' Accolade



HANDEL

SAMSON-ORATORIO
Pearce, Curtin, Parker,
Smith, Samuelsen; Utah
Symphony Orchestra and
Chorus; Abravanel, con-
ductor

3-12" boxed
BG-648/50 & *BGS-5060/2
"Manna in the desert... that we have had to wait so long is little short of criminal... give an ear to the two-and-one-half hours of magnificent music which this album contains... Curtin does what is surely her best singing on records... Pearce's sensitivity as a musician is steadily deepening. This is an artist... Abravanel presides with authority and fire."
J. W. Barker,
American Record Guide

VIVALDI

THE FOUR SEASONS
I Solisti di Zagreb; Tom-
asow, violin

BG-564 & *BGS-5001
"The best interpretation during the past twenty years of the *Seasons* of Vivaldi is that recorded by the Zagreb Soloists directed by Antonio Janigro."
Igor Stravinsky
at a press conference

COPLAND PIANO CONCERTO MENOTTI

PIANO CONCERTO
Earl Wild, piano; Sympho-
ny of the Air; Copland and
Mester, conductors

VRS-1070 & *VSD-2094
"Either work would be a desirable addition to the catalogue of 'availables' and the coupling provides a dual service... Wild plays both very well, and the reproduction is first class."
I. Kolodin,
Saturday Review

Which Stereo Receiver Is Your Best Value?

BRAND	IHFM POWER	TUNER	CIRCUIT	PRICE
A	70 Watts	AM-FM FM Stereo	Transistor	\$369.95
B	80 Watts	FM Stereo	Tubes	\$319.50
C	Not available (32 watts continuous power)	AM-FM FM Stereo	Tubes	\$154.90
D	70 Watts	FM Stereo	Tubes	\$429.90
E	66 Watts	AM-FM FM Stereo	Transistor	\$195.00
F	60 Watts	FM Stereo	Tubes	\$354.45
G	60 Watts	AM-FM FM Stereo	Tubes	\$273.90
H	100 Watts	AM-FM FM Stereo	Transistor	\$579.90
I	36 Watts	FM Stereo	Tubes	\$174.90

If You Choose E, Go Direct to the Coupon & Collect \$89 to \$385 Savings!

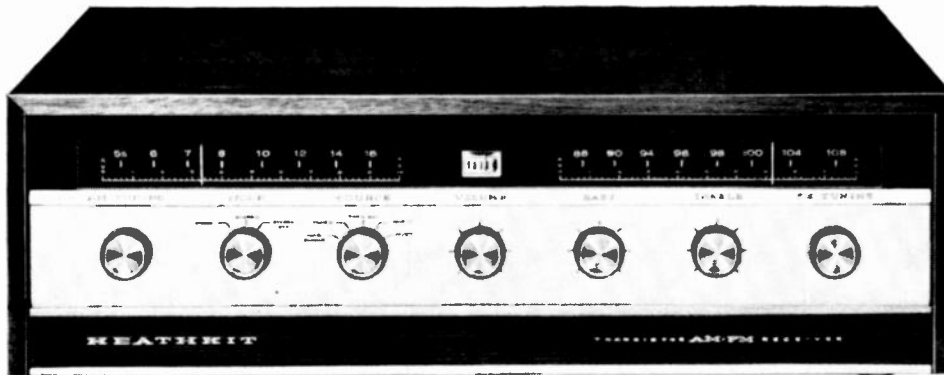

Why is the exciting new Heathkit All-Transistor Stereo Receiver your best value? A glance at the above chart will tell you. Compare E's performance features and price against the others.

With the Heathkit AR-13 Stereo Receiver, you enjoy cool, fast, "hum-free" operation; long, trouble-free life; and the quick, clean, unmodified response of "transistor sound" . . . characteristics unobtainable in vacuum tube types. Enjoy sensitive, wide-band AM, FM and FM STEREO tuning for distortion-free reception to please the most discriminating ear. Enjoy 66 watts of pure, uncompromising music power, 40 watts of continuous sine-wave power . . . plenty to drive even the most inefficient speaker system! Enjoy traditional Heathkit savings . . . \$174 and \$385 over the other two transistorized models! Let's examine the Heathkit AR-13 more closely. Inside its luxurious walnut cabinet, there are two 20-watt power amplifiers . . . two separate preamplifiers . . . plus wide-band AM, FM, and FM STEREO. You have all the electronics necessary for a complete stereo system . . . just add two speakers!

In addition to the AR-13's advanced 43 transistor, 18 diode circuitry, there are advanced features such as *automatic* switching to stereo; automatic stereo indicator light; filtered tape recorder outputs for

direct "beat-free" recording; dual-tandem controls for simultaneous adjustment of volume, bass, and treble of both channels; three stereo inputs; and a separate control for balancing both channels. The AM tuner features a high-gain RF stage and high-Q rod antenna, the FM tuner has a built-in line cord antenna—plus external antenna connectors.

Other quality features include a local-distance switch to prevent overloading in strong signal areas; a squelch control; AFC for drift-free reception; flywheel tuning; tuning meter; and lighted AM and FM slide-rule dials. For added convenience the secondary controls are concealed under the hinged lower front gold aluminum panel to prevent accidental system setting changes. And the preassembled, prealigned FM "front-end" and 3-stage AM-FM I.F. strip aid construction which requires about 35 hours (not recommended for beginners).

Now you know why for advanced design & performance, superb quality, and a truly easy-to-afford price, your best value in stereo receivers is the Heathkit AR-13. Order yours now!

Kit AR-13, 30 lbs. \$195.00

SPECIFICATIONS—AMPLIFIER: Power output per channel (Heath Rating): 20 watts/8 ohm load. (IHFM Music Power Output): 33 watts/8 ohm load. **Power response:** ±1 db from 15 cps to 30 kc @ rated output. **Harmonic distortion:** (at rated output) Less than 1% @ 20 cps; less than 0.3% @ 1

kc; less than 1% @ 20 kc. **Intermodulation distortion:** (at rat-d output) Less than 1%. 60 & 6,000 cps signal mixed 4:1. **Hum & noise:** Mag. phono, 50 db below rat-d output. Aux. inputs, 65 db below rated output. **Channel separation:** 40 db. **Input sensitivity:** Mag. phono, 6 MV. **Outputs:** 4, 8, & 16 ohm and low impedance tape recorder outputs. **Controls:** 5-position Selector; 3-position Mode; Dual Tandem Volume; Bass & Treble Controls; Balance Control; Phase Switch; Input Level Controls; Push-Pull ON/OFF Switch. **FM: Tuning range:** 88 mc to 108 mc. **IF frequency:** 10.7 mc. **Frequency response:** ±3 db, 20 to 15,000 cps. **Capture ratio:** 10 db. **Antenna:** 300 ohm balanced (internal for local reception). **Quieting sensitivity:** 3½ uv for 30 db of quieting. **Image rejection:** 30 db. **IF rejection:** 70 db. **Harmonic distortion:** Less than 1%. **STEREO MULTIPLEX: Channel separation:** (SCA Filter Off) 30 db, 50 to 2,000 cps. **19 KC & 38 KC suppression:** 45 db down. **SCA rejection:** 35 db down from rated output. **AM: Tuning range:** 535 to 1620 kc. **IF frequency:** 455 kc. **Sensitivity:** 30 uv @ 600 kc; 9 uv @ 1000 kc. **Image rejection:** 40 db. **IF rejection:** 55 db @ 1000 cps. **Harmonic distortion:** Less than 2% with 1000 uv input, 400 cps with 30% modulation. **Hum and noise:** 40 db. **Overall dimensions:** 17" L x 5½" H x 14½" D.

FREE CATALOG

Send for your Free copy today! Fully describes over 250 exciting Heathkits at savings of 50% or more! Choose from the world's largest selection of quality instruments in easy-to-assemble kit form!

HEATHKIT
A Division of

HEATH COMPANY 40-3-1
Benton Harbor, Mich. 49023

Enclosed is \$195.00 plus freight. Please send Model AR-13 Stereo Receiver.

Please send Free 1964 Heathkit Catalog.

Name _____

Address _____

City _____ State _____ Zip _____

HF-157



the best seat in the house...

... and it's right in your living room if your FM
is equipped with a

FINCO® AWARD WINNING FM ANTENNA

Broadcasting authorities agree that an outdoor antenna is absolutely essential for the reception of full quality monaural and multiplex FM sound.

A *FINCO* FM antenna will deliver a clean undistorted signal and bring in more stations, regardless of location.

Guarantee yourself the best seat in the house for tonight's FM concert... install a fidelity-phased *FINCO* FM antenna.

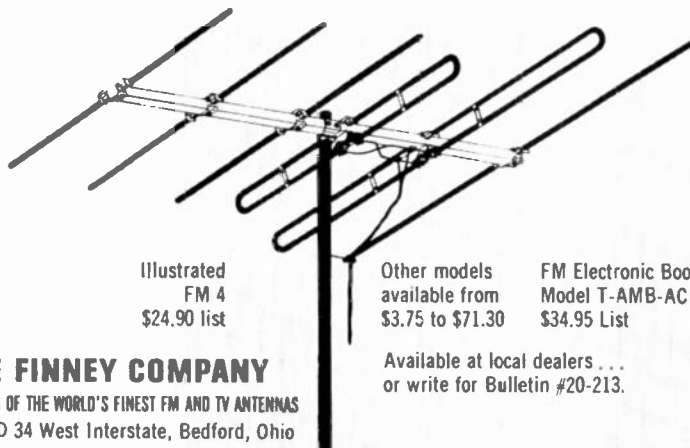

Illustrated
FM 4
\$24.90 list

Other models
available from
\$3.75 to \$71.30

FM Electronic Booster
Model T-AMB-AC
\$34.95 List

Available at local dealers...
or write for Bulletin #20-213.

THE FINNEY COMPANY
PRODUCERS OF THE WORLD'S FINEST FM AND TV ANTENNAS
Dept. HD 34 West Interstate, Bedford, Ohio

Ⓢ Ⓜ **VICTORIA DE LOS ANGELES:**
Mémoires de France. Ravel: *Shéhérazade*; *Five Popular Greek Songs*; *Two Hebraic Songs*. Duparc: *L'Invitation au Voyage*; *Phidylé*. Debussy: *Air de Lia*, from *L'Enfant Prodigue*. Victoria de los Angeles (soprano); Paris Conservatory Orchestra, Georges Prêtre cond. ANGEL S 36105 \$5.98, 36105 \$1.98.

Interest: Radiant De los Angeles
Performance: Immaculate
Recording: Excellent
Stereo Quality: Commendable

Ravel himself could have been nothing but overjoyed with the exquisitely subtle singing that Victoria de los Angeles lavishes on these relatively obscure vocal works. And because these works are, in a way, more quintessentially Ravel than the *Daphnis et Chloé-Boléro* group that the general public is familiar with, I hope that the record will receive wide circulation.

Certainly, it would be difficult to imagine more sensitive performances of the *Five Popular Greek Songs* and the *Two Hebraic Songs* than the ones heard here. For De los Angeles informs her singing of these beautiful works with precisely the right mixture of universal folk sentiment—the yearning, the sadness—and her own personal lyricism.

The more extravagant *Shéhérazade* runs headlong into competition with the recent and celebrated Tourel-Bernstein rerecording. For myself, I balk at making a choice. As astonishingly different as they are, each of the two readings has its own validity—Tourel's is full of sweep, color, and adventure, De los Angeles' small-scale, delicate, and utterly ravishing in nuance and detail.

It seems to me unfortunate that the second side of this release descends into transcription and potpourri. As beautifully as the soprano manages the Duparc songs and the Debussy aria, I was left wondering what she might have done with Ravel's *Chansons madécasses*, for example. Indeed, this distinguished record might have been a great one had the program been more consistently shaped. *W. F.*

Ⓢ Ⓜ **GIUSEPPE DI STEFANO:**
Great Opera Arias. Verdi: *Aida: Celeste Aida. Otello: Dio! mi poteri scagliar; Ninn mi tema.* Luisa Miller: *Quando le scire al placido.* Boito: *Giunto sul passo estremo.* Meyerbeer: *L'Africana: O paradiso.* Ponchielli: *La Gioconda: Cielo e mar!* Puccini: *La Fanciulla del West: Or son mesi.* Cilèa: *Adriana Lecouvreur: La dolcissima effigie.* Leoncavallo: *La Bohème: Testa adorata.* Giordano: *Fedora: Amor ti vicia.* Pietri: *Mari-stella: Io conosco un giardino.* Pizzetti: *Il Calzare d'Argento: Davvero, quanto*
(Continued on page 88)

From Parts...

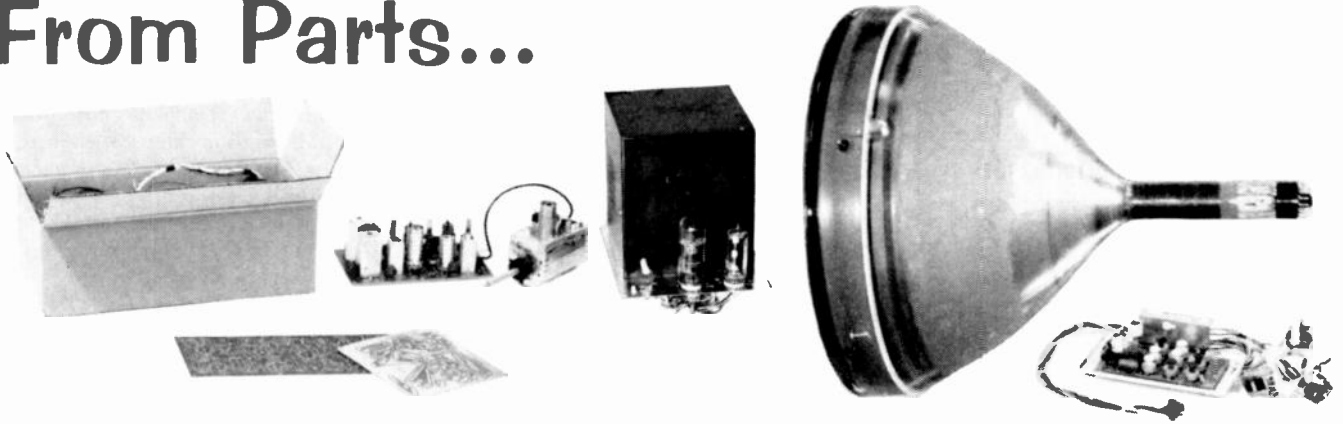

To Picture In Just 25 Hours



Heathkit High Fidelity Color TV For As Low As \$349

25 hours of relaxing, rewarding fun! That's all! And you've built the *new* Heathkit High Fidelity 21" Color TV with the finest color circuitry, components, and performance possible today. Goes together quickly, easily. *No* special skills or knowledge required! So simple anyone can build it! You'll enjoy 21 inches of beautiful, high fidelity picture that reproduces every color naturally, realistically, faithfully... you'll enjoy high fidelity sound that's sharp, crisp, clean...and you'll enjoy features and performance comparable only to units costing 50% more!

Compare these Heathkit features with others:

- 27 tube, 8 diode circuit with optional UHF
- High definition RCA 70° 21" color tube with anti-glare, bonded-face safety glass Automatic Color Control
- Gated Automatic Gain Control for peak performance
- 24,000 volt regulated picture power
- Hi-Fi sound with outputs for speaker and hi-fi amplifier
- Deluxe Nuvistor tuner with "push-to-tune" fine tuning for individual channels
- 3-stage high gain video I.F.
- Line thermistor for longer tube life and thermal circuit breaker for component protection
- Degaussing coil and built-in dot

generator for perfect picture adjustments

- All critical circuits factory-built and tested
- Can be custom mounted or installed in handsome walnut cabinet
- One year warranty on picture tube, 90 days on parts.

Save On Maintenance Costs! In addition to the initial savings you realize by building this set yourself, you'll save on expensive repair bills too. The simple-to-follow Heathkit instruction manual contains circuit diagrams and a "Servicing Hints" section so you can easily make adjustments and replacements should it ever become necessary.

Versatile Installation! The chassis, tubes, and front panel of the Heathkit Color TV can be mounted in the handsome GRA-53-1 walnut-finished hardboard cabinet. Or if you prefer, it can be mounted in a wall or custom cabinet, and the sound signals fed to an external amplifier unit. Required custom mounting space dimensions: 24-3/4"D x 22-1/4"H x 28"W. In this case the GRA-53-3 Custom Mounting Kit should be ordered to provide physical support between the chassis and front panel.

Optional UHF! An optional UHF tuner is available for coverage of channels 14 to 82.

- Kit GR-53, chassis and tubes, 118 lbs. \$349.00
- GRA-53-1, walnut cabinet, 70 lbs. . . \$49.00
- GRA-53-2, opt. UHF tuner, 3 lbs. . . . \$20.00
- GRA-53-3, custom mounting kit, 10 lbs. \$4.00

FREE 1964 CATALOG

See these and over 250 other exciting Heathkits available in easy-to-build kit form. Save 50% or more by doing the easy assembly yourself! Send for your free catalog today!

HEATHKIT
by Heathkit

40-3-2

HEATH COMPANY
Benton Harbor, Mich. 49023

Enclosed is \$ _____, plus shipping. Please send model (s) _____.

Please send my Free 1964 Heathkit Catalog.

Name _____

Address _____

City _____ State _____ Zip _____

CL-166

3 Great New LP's

A Truly Romantic Performance



Tchaikovsky:
SYMPHONY NO. 5 IN E MINOR
The Vienna Philharmonic Orchestra -
Lorin Maazel
Stereo CS-6376 Mono CM-9376

The Moscow Philharmonic Orchestra... recorded in London

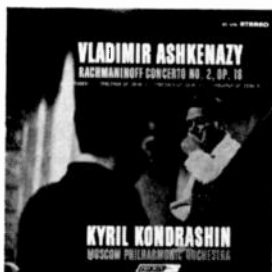

Rachmaninoff:
PIANO CONCERTO NO. 2 IN C MINOR
3 ETUDES TABLEAUX
Vladimir Ashkenazy, The Moscow Philharmonic Orchestra - Kiril Kondrashin
Stereo CS-6390 Mono CM-9390



Mozart: SINFONIA CONCERTANTE IN E FLAT MAJOR (K. 364)
DUO IN G MAJOR (K. 423)
Igor Oistrakh (violin); David Oistrakh (viola). The Moscow Philharmonic Orchestra - Kiril Kondrashin
Stereo CS-6377 Mono CM-9377



grande è la miseria. Giuseppe di Stefano (tenor); Orchestra of the Maggio Musicale Fiorentino, Bruno Bartoletti cond. DEUTSCHE GRAMMOPHON SLP 138-827 \$6.98, LPM 18827* \$5.98.

Interest: Well-chosen program
Performance: Robustly sung
Recording: Very good
Stereo Quality: Very good

It is said that most actors, even comedians, dream of playing Hamlet. Otello seems to hold the same fascination for tenors. Giuseppe di Stefano appears to be on the verge of essaying this most heroic of Italian roles, and based on the evidence of this recital, he may do it with success. As yet he lacks conviction in the part, although he achieves real eloquence in such passages as the arching "m'han rapito il miraggio dov'io giulivo" in the third-act monolog.

There is much to enjoy in Di Stefano's rendering of the other excerpts as well: his voice is in firm, ringing estate, and the top register is secure and unobstructed. Missing, though, is the ultimate suavity of high achievement. There are quite a few explosive attacks and short-of-breath phrase endings. Ten years ago Di Stefano would have sung "La dolcissima effigie" and "Amor ti vieta" much more elegantly.

The program is laudably unhackneyed. It is good to have another tenor besides Caruso on discs with "Testa adorata," and this is one of Di Stefano's best performances. Although the Pietri and Pizzetti excerpts are not particularly inspired music, they are good examples of Italian opera's post-Puccini development. A stronger-willed conductor would perhaps have coaxed a more disciplined performance from the tenor. The orchestral contribution, however, is satisfactory, and the sound is excellent. G. J.

Ⓢ Ⓜ EILEEN FARRELL: *French and Italian Songs.* Respighi: *Io sono la Madre; In alto mare; Nebbie; Invito alla danza; Venitelo a vedere 'Il mi' piccino; Mattinata.* Castelnuovo-Tedesco: *La Pastorella; Ninna-Nanna; La Ermita de San Simon.* Debussy: *La Faune; La mer est plus belle; La Chevelure; Aquarelle.* Fauré: *Nell; Claire de lune; Vocalise; Noël.* Eileen Farrell (soprano); George Trovillo (piano). COLUMBIA MS 6524 \$5.98, ML 5924 \$4.98.

Interest: Unusual repertoire
Performance: Exquisite
Recording: Tops
Stereo Quality: Appropriate

For an opera singer whose fame rests largely on big dramatic roles, Eileen Farrell is a remarkably expressive and effective recitalist. Furthermore, her repertoire extends far beyond the ex-

pected and the obviously suitable—her programs rate consistently high for adventurousness and variety.

Here, for example, she balances a generous offering of Debussy and Fauré—and would one normally associate these composers with a lusty interpreter of Santuzza or *La Gioconda*?—with virtually unknown songs by Respighi and Castelnuovo-Tedesco. In both areas she achieves exceptional results.

The Italian songs lie closer than the French to the artist's particular communicative powers, which are basically direct and emotional. Except for the melodramatic *In alto mare*, the Respighi and Castelnuovo-Tedesco songs are restrained in their emotional range, but passion and drama are seldom absent even in the most intimate Italian songs. Respighi's *Nebbie (Mists)* is a good case in point. Such a text would have evoked



EILEEN FARRELL

Unusual program, exceptional results

vaporous imagery from Debussy's pen, but Respighi's treatment is moody yet quite un-Impressionistic.

Miss Farrell sings the Italian songs with exquisite poignancy. Her French enunciation, though above average for a non-native, is less idiomatic than her Italian. Nevertheless, her Fauré songs, happily chosen, all benefit from the caressing warmth and evenness of her tone. In purely aural terms her Debussy is no less satisfying, but Miss Farrell is not a fully convincing interpreter.

George Trovillo's accompaniments are distinguished, and are lucidly captured. Technically, both mono and stereo are excellent. G. J.

RECORDING OF SPECIAL MERIT

Ⓜ GIOVANNI MARTINELLI: *Operatic Arias.* Giordano: *Andrea Chénier.* (Continued on page 90)

Step up to All-Transistor Stereo Power...



and All-Transistor AM-FM Stereo Tuning



at Low Cost with this Matched Pair

"Transient Response," the ability of an amplifier to provide instantaneous bursts of power as the music demands...an ability so far superior in transistor equipment that it has already created the term "Transistor Sound." Match this with cooler, faster, "hum-free" operation; lower power consumption; longer life, plus the all-around, wide-band listening of AM, FM, and FM Stereo; and you have Heathkit's newest low-cost All-Transistor Stereo twins!

And that's not all! Heathkit's AA-22 40-watt Stereo Amplifier not only matches the AJ-33 All-Mode Stereo Tuner in advanced "transistor sound" performance, but in advanced features, styling, and functional versatility.

Both units feature dependable, "trouble-free" 20-transistor, 10-diode circuitry...sleek, low-silhouette walnut cabinet styling with extruded gold-anodized aluminum front panels that add a rich, modern touch to any decor...secondary controls that are conveniently protected under the hinged lower front panel...compact, "fit-anywhere" size (each unit measures 15"W x 3-3/4"H x 11-3/8"D

... plus an easy-on-the-budget price, that anyone who's longed for the beauty of "transistor stereo" can afford—only \$99.95 each!

With the AA-22 Amplifier you enjoy 40 watts of continuous power, 66 watts of music power at ± 1 db from 15 to 30,000 cps. In addition there's 5 stereo inputs; outputs for 4, 8, and 16 ohm speakers, plus tape recorders; and a transformerless output circuit for greater stability and efficiency. Front panel controls include a 5-position selector switch, a 3-position mode switch, dual tandem volume, bass & treble controls, and a push-push on/off switch.

And the AJ-33 Tuner has advanced features like the built-in stereo demodulator; AGC for constant volume; AFC for drift-free reception; the stereo indicator light; a Stereo Phase Control for maximum stereo separation and minimum distortion; filtered stereo tape recording outputs for direct "beat-free" recording; a tuning meter for pin-point tuning, flywheel tuning; voltage regulated power supply; illuminated slide-rule dial; and pre-built, prealigned FM "front-end" tuner and AM-FM I.F. circuit board for easy assembling.

Start enjoying the "transistor sound" of tomorrow by ordering these advanced all-transistor units today!

Kit AA-22 Amplifier, 14 lbs. \$99.95
Kit AJ-33 Tuner, 14 lbs. \$99.95

FREE 1964 HEATHKIT CATALOG

See Heathkit's complete line of advanced stereo/hi-fi equipment as well as color TV, electronic organ, radios, amateur radio, test & lab, marine, and educational equipment. Over 250 in all... the world's largest selection! Send for yours now!



HEATH COMPANY

Dept. 40, Benton Harbor, Mich. 49023

Enclosed is \$ _____, plus postage. Please send model (s) _____

Please send my Free 1964 Heathkit Catalog.

Name _____

Address _____

City _____ State _____ Zip _____

HF-160



DYMO LABELMAKER

Make permanent, raised letter plastic labels...in seconds. Professional quality labels for pennies. Dial letters, numbers, symbols, squeeze handle. ■ 1001 uses for the hi-fi enthusiast. ■ At fine stores everywhere. Suggested price \$9.95



FREE: Label samples and literature. Write: Dymo Industries, Inc., Dept. SR-3-4, Box 1030, Berkeley, Calif. Priced same in Canada.

Un dì all' azzurro spazio; Come un bel dì di maggio. Fedora: Amor ti vieta; Mia madre, la mia vecchia madre. Mascagni: Cavalleria Rusticana: Siciliana; Addio alla madre. Leoncavallo: I Pagliacci: Vesti la giubba; No, Pagliaccio non son. Puccini: La Bohème: Che gelida manina. Verdi: Ernani: Come rugiada al cespite. La Forza del Destino: O tu che in seno agli angeli. Il Trovatore: Di quella pira. Otello: Dio! mi potevi scagliar; Niun mi tema. Giovanni Martinelli (tenor); Metropolitan Opera Orchestra and others, Giulio Setti and Wilfred Pelletier cond. RCA Victor LM 2710 \$4.98.

Interest: A great career in retrospect
Performance: In the grand style
Recording: Variable

More than fifty years ago, on November 20, 1913, Giovanni Martinelli made his Metropolitan debut in *La Bohème* with Lucrezia Bori and Antonio Scotti. Aside from commemorating the golden anniversary, this recording pays tribute to



GIOVANNI MARTINELLI

Steady brilliance in the grand tradition.

other aspects of an extraordinary career: thirty uninterrupted years with the Met alone, and nearly sixty years of recording, lecturing, and teaching.

RCA Victor's focus on Martinelli's Metropolitan career is encompassing: there are souvenirs of his first role, Rodolfo, and of his last major undertaking, Otello. Curiously, however, there is no representation of Radames, the part he sang ninety times in the house. Perhaps another Martinelli disc will offer his *Aida* scenes with Ponselle and Pinza, which are among the high marks of his recorded legacy.

Martinelli recorded prodigiously, if somewhat unevenly, during his long career. This recital offers some of his best, and a demonstration of the qualities that have assured him a place among singing's immortals. This was a voice of steady brilliance and penetrating strength, yet flexible and easily controlled. His legato was exemplary, his phrasing was

(Continued on page 92)

JUST TRY TO BEAT LAFAYETTE'S LOW PRICES

ON **harman kardon**

FISHER **SCOTT** and other **Brand Names.**

Get your Hi-Fi System Quotation from Lafayette, Audio Specialists since 1921

The Man Who Cares, Gets His Hi-Fi with the Service, Guarantees and Benefits that a Hi-Fi Specialist Offers.

Write today for your free quotation
LAFAYETTE RadioELECTRONICS

Dept. HMC-4, P.O. Box 600
Syosset, L.I., N.Y. 11791

CIRCLE NO. 32 ON READER SERVICE CARD

Back Issues Available

Use this coupon to order back issues of HIFI/STEREO REVIEW

We have a limited supply of back issues that can be ordered on a first-come, first-served basis. Just fill in the coupon below, enclose your remittance in the amount of 65¢ each and mail.

ZIFF-DAVIS SERVICE DIVISION
Dept. BCHF, 589 Broadway
New York 12, New York

Please send the following back issues of HIFI/STEREO REVIEW.

I am enclosing _____ to cover cost of the magazine, shipping and handling.

Month _____ Year _____

Month _____ Year _____

Month _____ Year _____

Name _____

Address _____

City _____ Zone _____ State _____

No charge or C.O.D. orders please.

Here's Your Only Middleman With...

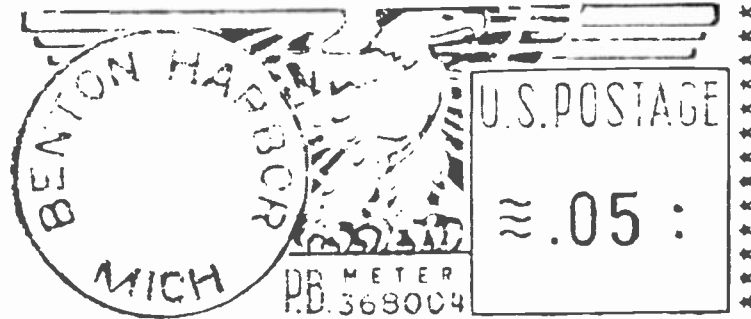

Heathkit Deluxe All-Transistor Stereo

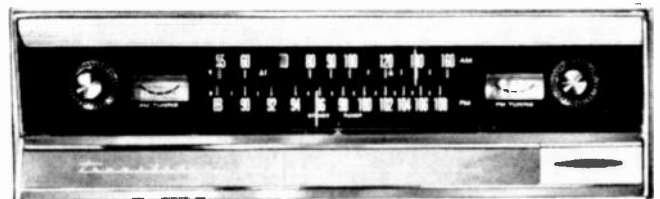
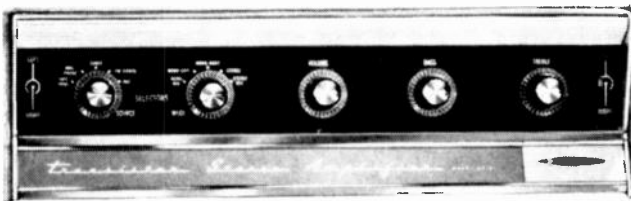

All-Transistor Stereo Amplifier \$139.95

Direct Factory-To-You Savings! Just a few postage stamps is all it takes to deliver your Heathkit from factory to you. No dealers . . . no distributors . . . no expensive "middleman" costs! Just quick, direct-to-your-door convenience. With Heathkit you invest your money in the product, *not* its distribution. This means better quality and performance at lower cost!

Other Advantages! Close, personal contact with the people who designed your kit . . . people who are interested in its performance as a finished product. Free consultation and personal assistance are available to answer your questions about selection, construction, and use. Original replacement parts and factory repair!

Add to these the significant savings of "do-it-yourself," and you'll see why Heathkit is your best buy!

Advanced "Transistor Sound"! With Heathkit's Deluxe All-Transistor "Stereo Twins," you enjoy the quick, unmodified response of "transistor sound." No fading, no faltering . . . just the pure, uncompromising sound that only transistors can produce! In addition you enjoy cooler, faster, "hum-free" operation . . . longer life . . . and lower power consumption!

Advanced Performance Features! Both units feature extras like the unique "push-push" on/off switch; concealed secondary controls to prevent accidental system

changes; and handsome matched tan vinyl-clad steel cabinet with polished aluminum trim and soft refracted lighting . . . complements any decor! Just a few of the reasons why you should move up to this all-transistor duo now!

AM, FM Stereo Tuner . . . AJ-43! Enjoy extra convenience features like automatic switching to stereo; automatic stereo indicator light; filtered stereo tape recorder outputs for direct "beat-free" recording; Stereo Phase Control for maximum separation, minimum distortion; Automatic Gain Control for constant volume; 25-transistor, 9-diode circuitry for "transistor sound" performance; individual AM & FM tuning meters; effortless flywheel tuning; transformer operated power supply; and preassembled FM tuning unit & 4-stage FM I.F. circuit board for *fast* assembly.

70-Watt Stereo Amplifier . . . AA-21! Features full 70 watts of continuous power, 100 watts music power at ± 1 db from 13 to 25,000 cps! In addition you enjoy 26-transistor, 10-diode circuitry for cool, "hum-free" operation, smooth power delivery, and fast effortless "transient response," complete freedom from microphonics; front-panel mounted 5-position dual concentric source switch, 5-position mode switch, and dual concentric volume, bass, and treble controls; circuit breaker protection of output transistors and AC power; and encapsulated preamplifier cir-

cuits in 6 epoxy-covered modules, all factory wired and sealed, ready for *easy* installation!

Experience The "Transistor Sound" Of Tomorrow by ordering these advanced all-transistor units *today!*

Kit AA-21, Amplifier, 29 lbs. \$139.95
Kit AJ-43, Tuner, 18 lbs. \$119.95

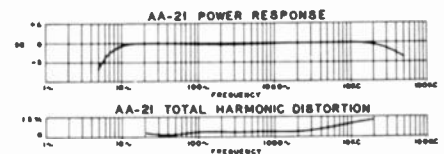

Prices & specifications subject to change without notice.

FREE 1964 HEATHKIT CATALOG
See these and over 250 other exciting Heathkits available in easy-to-build kit form. Save 50% or more by doing the easy assembly yourself! Send for your free catalog today!

HEATHKIT
by Daystrom

HEATH COMPANY 40-3-4
Benton Harbor, Michigan 49023
In Canada: Daystrom, Ltd., Cooksville, Ont.

Enclosed is \$_____ plus postage. Please send model(s) _____.

Please send my Free 1964 Heathkit Catalog.

NAME _____

ADDRESS _____

CITY _____ STATE _____ ZIP _____

HF-164

**The Record
Bargain Of 1964!!!
5 GREAT NEW ALBUMS**

**FERRANTE
& TEICHER**

**50 FABULOUS
PIANO
FAVORITES**



50 FABULOUS FAVORITES

ALSO...

for your listening pleasure
FIFTY FABULOUS **GUITAR** FAVORITES—AL CAIOLA

for below the border... aficionados
FIFTY FABULOUS **LATIN** FAVORITES—TITO RODRIGUEZ

for your dancing pleasure
FIFTY FABULOUS **DANCE** FAVORITES—RALPH MARGERIE

for an ever growing legion of folk fans

FIFTY FABULOUS **FOLK** FAVORITES—
THE GREENHILL SINGERS

5 GREAT NEW ALBUMS!

**FOR THE FIRST TIME IN ONE ALBUM, 50 GREAT
FAVORITE SONGS BY A TOP SELLING ARTIST.**

TRULY the Proudest

**UNITED
ARTISTS
RECORDS**

Name in Entertainment

CIRCLE NO. 79 ON READER SERVICE CARD



Stereo in depth

CIPHER VII STEREO

In so many ways, the new Cipher VII stereo tape recorder is heads above the crowd: records and playback in 4-track, 3-speed stereo or monaural, records sound-on-sound, and its two full-range speakers are detachable for best positioning. Cipher VII can be played horizontally or vertically, or it can be installed into your present hi-fi system.

Other professional features of the Cipher VII include: separate volume and tone controls for each channel • 2 dynamic microphones • 2 VU meters • editing facilities • tape index counter • auto, reel-end shut-off • 10 watt output • two-tone cabinet with brushed aluminum control panel.

\$274.95

For brochure and name of nearest Cipher dealer, write to:
INTER-MARK CORP., Dept. SR, 29 West 36th Street, New York 18, N. Y.



CIRCLE NO. 75 ON READER SERVICE CARD

elegant, and his singing style was in the grand tradition. He was also a forcefully dramatic artist and a master of meaningful declamation. At times, his voice seemed too stentorian for the lyrical demands, but when called upon, it was capable of thrilling climaxes.

I have mixed feelings about the transfers. Surface noise has been reduced to a minimum, but the engineers have added more reverberation than seems necessary. And, regrettably, the "Improviso" from *Andrea Chénier* and the "Che gelida manina" are pitched a half-tone too high. Still, this is a welcome release, for it returns to circulation representative selections that belong in this beloved artist's active catalog.

G. J.

RECORDING OF SPECIAL MERIT

© **HINA SPANI: Songs and Arias.** Verdi: *Il Trovatore: Tacca la notte; D'amor sull'ali rosee. Un Ballo in maschera: Ma dall' arido.* Puccini: *Manon Lescaut: In quelle trine morbide; Tosca: Vissi d'arte.* Wagner: *Lohengrin: Sola ne' miei; Aurette a cui.* Gounod: *Faust: Ei m'ama.* Massenet: *Manon: Addio picciol desco.* Catalani: *La Wally: Ebben? Ne andrò.* Caccini: *Amarilli;* three songs. Hina Spani (soprano); orchestral accompaniment. Rococo 5210 \$4.95.

Interest: Connoisseurs' soprano
Performance: Remarkable
Recording: Dated sound

I urge listeners whose enjoyment of exceptional vocal performance is not dimmed by very dated sound to investigate this record. For veteran collectors of operatic recordings, of course, the name Hina Spani renders further recommendation unnecessary. This Argentinian soprano, virtually unknown here, had a brilliant career in South America, Spain, and Italy between the two World Wars. Her recordings, made between 1927 and 1931 when she was singing at La Scala, reveal vocal and dramatic gifts that throw sonic limitations into the shade. Spani's voice was a strong *spinto*, controlled by tasteful and intelligent artistry and sound technique. Her legato was exquisite, her phrasing rich in expressive nuance. She could spin a lyric line with melting tenderness, and could fill dramatic passages with an intensity reminiscent of Muzio. Of particular note is the strength shown in the extremes of her range—the mezzo opulence of her chest tones and her soaring freedom high above the staff. The singing exhibited in these fifteen excerpts is undeviatingly beautiful; one may dispute the effectiveness of Wagner, Gounod, and Massenet in Italian, but not the superlative artistry with which Spani rises to the challenges they present.

G. J.

REVIEWS MUSIC RECORDINGS



Announcing

HIFI/STEREO REVIEW'S SPECIAL APRIL ISSUE

The April issue of HIFI/STEREO REVIEW will be devoted to the music of the Baroque era and to the best recordings of this music currently available. As listeners have become increasingly aware, few adventures in recorded sound can equal the musical masterpieces of the Baroque period for vividness of outline and sheer tonal brilliance. The special April issue of HIFI/STEREO REVIEW has been prepared to acquaint record collectors and music lovers with the principal composers, the characteristic style, and the most desirable recordings of this superb music. The issue will contain a wealth of documentary material in text and pictures heretofore unpublished in America.

An unprecedented listener's bonus. The April issue will contain an unprecedented editorial feature of permanent interest to all music lovers and especially to teachers and students of music and to performers in choral and string groups. Illustrating in actual SOUND the pre-eminent Baroque musical form known as fugue, each copy of the April issue will contain an exclusive long-playing recording of a choral fugue composed for modern ears by the Canadian pianist Glenn Gould—probably the most talked-about young musician of our time.

This brilliant and humorously instructive composition—entitled *So You Want to Write a Fugue?*—accompanies and illustrates Mr. Gould's critical comments on the nature of fugue in the same issue. It has been recorded especially for HIFI/STEREO REVIEW by Columbia Records in a contagiously enjoyable performance by conductor Vladimir Golschmann, four distinguished vocalists, and the Juilliard String Quartet. This recording can be played on standard high-fidelity equipment. Its appearance in HIFI/STEREO REVIEW coincides with publication of Mr. Gould's score by G. Schirmer, Inc.

The special April issue of HIFI/STEREO REVIEW will appear in the final week of March.
It will be available at no increase in price.



"All things considered, I would say the Model 14 is
the best fifty-dollar speaker I have ever heard."*

Now in either . . .
SLIMLINE
or **BOOKSHELF**
enclosures

"Now that bookshelf speaker systems have achieved wide acceptance, there seem to be trends developing toward both larger and smaller systems. Most of the midget systems make serious compromises with quality, and are really only suitable for use as kitchen or bedroom extension speakers. A notable exception is the new \$49.50 KLH Model 14, which incorporates two special 3-inch speakers in a ported walnut enclosure measuring only 14 x 18 x 3 3/4 inches . . .

"The extremely smooth and flat frequency response of the Model 14 suggested that its transient response would also be excellent; and tone-burst measurement showed that it was as good in this respect as any cone speaker I have ever tested. At no frequency was there any sign of spurious output or sustained ringing.

"The sound of the KLH Model 14 is quite similar in character to that of the larger KLH systems. It is clean and airy, without stridency or any other unpleasant characteristics. The bass response varies considerably with speaker placement, from adequate at a floor-wall junction to rather thin at a mid-wall position. At any reasonable listening level, the system's very smooth bass rolloff permits a fair amount of amplifier bass boost to be used without introducing boom. Efficiency of the KLH 14 is rather low, but it can produce excellent results when driven by any good 10-watt amplifier.

"All things considered, I would say the Model 14 is the best fifty-dollar speaker I have ever heard."*

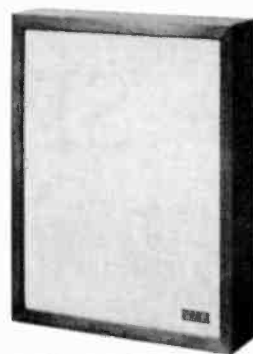

MODEL FOURTEEN S



MODEL FOURTEEN B



KLH RESEARCH AND DEVELOPMENT CORPORATION
30 CROSS STREET, CAMBRIDGE 38, MASSACHUSETTS

**KLH Model Fourteen in
oiled walnut only . . . \$49.50**
Slightly higher in the west

*Excerpts from an independent report
by Julian Hirsch in Hi-Fi/Stereo
Review. Reprints of the complete
report are available on request.

HIFI/STEREO REVIEW'S
CHOICE
OF THE LATEST
RECORDINGS



JAZZ

Reviewed by JOE GOLDBERG • NAT HENTOFF

Ⓢ Ⓜ DAVE BRUBECK: *Brandenburg Gate: Revisited*. Dave Brubeck (piano), Paul Desmond (alto saxophone), Gene Wright (bass), Joe Morello (drums); orchestra, Howard Brubeck cond. *Brandenburg Gate; Summer Song; In Your Own Sweet Way; G-flat Theme; Kathy's Waltz*. COLUMBIA CS 8763 \$4.98, CL 1963* \$3.98.

Interest: Orchestral Brubeck
Performance: Appealing solos
Recording: Very good
Stereo Quality: Tasteful

Howard Brubeck, a classical composer, has orchestrated five of his brother Dave's originals for this album. His aim was to provide a more stimulating context for the improvising soloists. The concept is intriguing, but in this recording, the orchestral writing leads to a weakening of the jazz content of the original works. It does spur soloists Dave Brubeck and Paul Desmond into further explorations of the pieces' possibilities.

For the listener, in any case, the effect of Howard Brubeck's writing is consistently bland. His style is overly conservative, and his colors are limited and far too conventional. In order to appreciate what the jazz improvisers are doing, one has to ignore, as much as possible, a gratuitous silken curtain of string sound.

As for Desmond and Brubeck, they play attractively because the primarily lyrical material is especially suited to their strongest penchants. Desmond excels at gentleness and lucidity, and Brubeck is a more satisfying pianist the more he can indulge his romanticism. As an experiment in orchestrating jazz, the album is a failure. Admirers of the Brubeck quartet, however, will find Brubeck and Desmond in good form. N. H.

Ⓢ Ⓜ KENNY BURRELL AND JIMMY SMITH: *Blue Bash!* Kenny Burrell (guitar), Jimmy Smith (organ),

Bill English and Mel Lewis (drums), George Duvivier and Milt Hinton (bass), Vince Gambella (guitar), Art Marotti (percussion). *Travelin'; Blues for Del; Easy Living; Kenny's Sound*; and three others. VERVE V6 8553 \$5.98, V 8553 \$4.98.

Interest: Blues conversations
Performance: Spontaneous
Recording: Good
Stereo Quality: Very good

The emphasis in this collaboration between Kenny Burrell and Jimmy Smith is on the blues. There are occasional ballads, but they too are blues in feeling.



RCA VICTOR

PAUL DESMOND

Perfectly composed improvisations

The performances are engagingly relaxed, in large part because of a rhythm section that stimulates without pushing too hard or inflexibly.

Adding to the pervasive ease of the session is the fact that this is one of the few occasions on which Jimmy Smith does not parade the power he can draw from the organ. His solos have a welcome suppleness and sense of sonic proportion. Smith's ideas, however, are as predictable as ever—and his lack of inventiveness sets the standard for the album. Burrell, as attractive as is his playing here, is not challenged to extend himself imaginatively. N. H.

RECORDING OF SPECIAL MERIT

Ⓢ Ⓜ PAUL DESMOND: *Take Ten*. Paul Desmond (alto saxophone), Jim Hall (guitar), Gene Chirico and Gene Wright (bass), Connie Kay (drums). *Take Ten; El Prince; Nancy; Embarcadero*; and four others. RCA Victor LSP 2569 \$4.98, LPM 2569* \$3.98.

Interest: Desmond sans Brubeck
Performance: Quietly intricate
Recording: Good
Stereo Quality: Good

Saxophone player Paul Desmond has gone on one of his rare excursions from home base (the Dave Brubeck Quartet). With Jim Hall and Connie Kay, apparently—and for excellent reasons—his favorite guitarist and drummer, and either Gene Chirico or Gene Wright on bass, he has come up with an album as intricate and as charming as a tiny watch. Desmond is becoming an increasingly fascinating composer, the most charming piece here being the bossa nova *Embarcadero*. About half the record is given over to bossa nova, to which Hall's gently lyrical style is very well suited.

I think that critics who deplore Desmond's lack of emotion really want him to be a musician he is not. What he does—create out of a personal and lyrical melodic system improvised lines so perfect they seem composed—he does better than anyone else, and his new album is a worthy addition to the unfortunately small list under his own name.

The album is in Dynagroove, and sounds as if variations in playing volume had been equalized electronically. J. G.

Ⓢ Ⓜ HORACE DIAZ: *Dixieland Bossa Nova*. Orchestra, Horace Diaz cond. *Clarinet Marmelade; That's A Plenty; High Society; Muskrat Ramble; Bugle Call Rag*; and seven others. EPIC BN 26067 \$4.98, LN 24067* \$3.98.

Interest: Mostly Dixie
Performance: Sometimes affecting
Recording: Good
Stereo Quality: Good

(Continued on page 96)

Explanation of symbols:

- Ⓢ — stereophonic recording
- Ⓜ — monophonic recording
- * — mono or stereo version not received for review



NEW BURGESS Test-Tape

checks your tape recorder
Accurately & Completely
without expensive test gear!

For the first time, the home tape recordist can test his own tape recorder and check it for maximum record and playback efficiency simply by listening to a tape. Burgess Test-Tape is the first step by step explanation in sound that will check home tape recorders . . . accurately and completely. It's available now from your Burgess tape dealer.

NEW BURGESS Test-Tape CHECKS YOUR RECORDER FOR:

- ✓ Volume Control
- ✓ Sound Level
- ✓ Frequency Response
- ✓ Fidelity & Balance
- ✓ Timing
- ✓ Tape Quality

Also: HOW TO SPICE & EDIT
Get new BURGESS TEST-TAPE at your favorite store or write:

BURGESS BATTERY COMPANY

DIVISION OF SERVEL, INC.

MAGNETIC TAPE DIVISION

Freeport, Illinois • Niagara Falls, Canada

CIRCLE NO. 73 ON READER SERVICE CARD

96

Horace Diaz, born in Mexico and raised in New Orleans, is identified in the notes as arranger for Benny Goodman, Woody Herman, Charlie Barnet, and Xavier Cugat. He has assembled here an anonymous group, on the order of the Dukes of Dixieland, to play, in bossa nova rhythm, twelve songs associated with the Dixieland style. There are a few good arranger's touches—the opening of *I've Found a New Baby* is reminiscent of Ellington in the late Twenties—and a fine clarinetist. If this disc had been recorded without the nod toward Brazil, it would be a superior pseudo-Dixie set. As is, the record is diverting for the length of two or three tracks, but before the end of the album, the maracas have the cumulative effect of the Brazilian water torture.

J. G.

© ® BILL EVANS: *Conversations with Myself*. Bill Evans (piano). *How About You*; *Blue Monk*; *Hey There*; *Just You, Just Me*; and four others. VERVE V6 8526 \$5.98, V 8526* \$1.98.

Interest: Triple-track monologue
Performance: Remarkable
Recording: Excellent
Stereo Quality: Brilliant engineering

An interesting and challenging experiment is conducted in this album by pianist Bill Evans. After taping an initial solo track, he listened to it with headphones and improvised a second part; then, hearing both recorded parts, he added a third. In the notes, Evans recognizes the fact that some listeners may question whether such multiple taping is a legitimate musical enterprise, or just another gimmick. His answer: "To the person who uses music as a medium for the expression of ideas, feelings, images, or what have you, anything which facilitates this expression is properly his instrument."

Judged by the musical results alone, the album is a major jazz achievement. Evans, noted for his organizational clarity and freshness of improvisation, creates absorbing and imaginative structures in which all three tracks are brilliantly interwoven. Remarkably, as Gene Lees points out in his exemplary notes, Evans' tempos do not vary, even though he has no bass and drum support. The basic characteristics of Evans' style are heightened here. Depending on the song and the mood, there are his long-line lyricism, harmonic taste and ingenuity, sinewy rhythmic drive, dry wit, and—always—a full technical command of the piano.

There is one original composition, N.Y.C.'s *No Lark*. Beneath its surface gentleness, this set of variations speaks of loneliness in a city of strangers. The composition is evidence that Evans is coming to be one of our most important jazz composers, both through the indi-

viduality of his ideas and the solid emotional substance at the core of those ideas.

N. II.

RECORDING OF SPECIAL MERIT

© ® BILL EVANS/SHELLY MANNE: *Empathy*. Bill Evans (piano), Shelly Manne (drums). Monty Budwig (bass). *Danny Boy*; *Goodbye*; *Washington Twist*; *I Believe in You*; and two others. VERVE V6 8497 \$5.98, V 8497* \$1.98.

Interest: Challenging collaboration
Performance: Exquisite
Recording: Fine
Stereo Quality: Apt

Some albums by pianist Bill Evans have not shown him as good as he can be. One reason for this is that the muscular propulsion of Evans the sideman is re-



BILL EVANS

At his best when challenged

placed with the wispy, almost closeted romanticism of Evans the soloist or trio leader. This is not true in the present album, which is probably the best he has ever made, and the reason is undoubtedly the goading presence of the superb drummer Shelly Manne. The two seem beautifully suited to one another, and each provides abrasive commentary that inspires the other to play his best.

There is one courageously romantic piece here, the lyrical *Danny Boy*, played with that exquisite Evans touch. I doubt that there are many jazz pianists capable of such a performance. The remainder of the set is richly varied. There is a non-funky *Let's Go Back to the Waltz*, a *Washington Twist* that is a variant of *Frankie and Johnny*, a rhythmically reckless *I Believe in You*, and a version of Gordon Jenkins' lovely and seldom-

(Continued on page 98)



The commanding presence of Sony sound

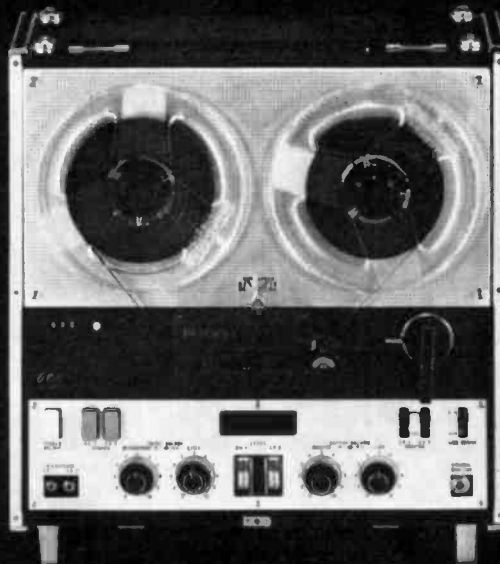

Now enter the world of the professional. With the Sony Sterecorder 600, a superbly engineered instrument with 3-head design, you are master of the most exacting stereophonic tape recording techniques.

Professional in every detail, from its modular circuitry to its 3-head design, this superb 4-track stereophonic and monophonic recording and playback unit provides such versatile features as: ■ vertical and horizontal operating positions ■ sound on sound ■ tape and source monitor switch ■ full 7" reel capacity ■ microphone and line mixing ■ magnetic phono and FM stereo inputs ■ 2 V.U. meters ■ hysteresis-synchronous drive motors ■ dynamically balanced capstan flywheel ■ automatic shut off ■ pause control and digital tape counter—all indispensable to the discriminating recording enthusiast. Less than \$450,* complete with carrying case and two Sony F-87 cardioid dynamic microphones.

Multiplex Ready!

SONY

SUPERSCOPE

The Tapeway to Stereo

* Yes, less than \$450!

Sony tape recorders, the most complete line of quality recording equipment in the world, start at less than \$79.50. For literature or name of nearest dealer, write Superscope, Inc., Dept. 8 Sun Valley, Calif. In New York, visit the Sony Salon, 585 Fifth Avenue.



Crown

— first choice
of those who
demand the best!

NEW

**Solid
State
RECORDERS**

**INCOMPARABLE
PERFORMANCE**

Quarter-Track Record/Play Data

ips	db	cps	s/n
7-1/2	±2	50 — 30,000	56db
3-3/4	±2	30 — 20,000	52db
1-7/8	±3	30 — 16,000	50db
15/16	±3	30 — 10,000	48db

The most complete recording instruments ever designed for stereo use. Audio circuitry, ±1/4 db from 10-100,000 cps; extended range, 5-500,000 cps. Plug-in circuit modules are printed on epoxy and gold plated. Engineered to space craft reliability.



THE HALLMARK
OF CROWN —
SUPERLATIVE
CRAFTSMANSHIP
THROUGHOUT!

INDIVIDUAL PERFORMANCE
RECORD SUPPLIED
WITH EACH CROWN

WRITE DEPT. HI-03



INTERNATIONAL
1718 Mishawaka Rd. • Elkhart, Ind.

CIRCLE NO. 74 ON READER SERVICE CARD

played *Goodbye* that is largely a vehicle for Evans' scalar approach. The finest moments occur on *Without a Song*, a showcase for the interaction of the trio that features a remarkable closing rubato section, one of the finest pieces of almost-free improvisation I have ever heard. Any doubts about Evans' talent should be dispelled by this set. I wish that both he and Manne played in a challenging situation such as this more often. *J. G.*

⑤ ⑥ **ART FARMER: *Interaction***. Art Farmer (flugelhorn), Jim Hall (guitar), Steve Swallow (bass), Walter Perkins (drums). *By Myself: Embraceable You; My Little Suede Shoes; Sometime Ago; Days of Wine and Roses*. ATLANTIC SD 1412 \$5.98, 1412* \$4.98.

Interest: Chamber jazz
Performance: Expert
Recording: Very good
Stereo Quality: Very good

Trumpeter Art Farmer and guitarist Jim Hall are both lyrical, reflective musicians, so it was to be expected that their union in a quartet would provide quiet, intricate music of the type known as chamber jazz. Further, it comes as no surprise that the group is recorded by Atlantic, a company that has previously released major efforts in the genre by the Modern Jazz Quartet and the earlier Jimmy Giuffre trio.

Each man in this quartet is an excellent musician, and, as is the custom in chamber jazz, the group spends a good deal of time experimenting with various combinations of the instruments. There are several improvised trumpet-guitar duets, with Hall playing single-string; a trumpet-drums duet; and a drum solo with a vocal by Perkins. But, in choosing such tunes as *Days of Wine and Roses*, the group, for all its appeal and musicianship, takes one step too many in the direction of high-quality popular music. *J. G.*

⑤ ⑥ **GRANT GREEN: *Feelin' the Spirit***. Grant Green (guitar), Herbie Hancock (piano), Butch Warren (bass), Billy Higgins (drums), Garvin Masseaux (tambourine). *Just a Closer Walk With Thee; Go Down Moses; Sometimes I Feel Like a Motherless Child*; and two others. BLUE NOTE ST 81132 \$5.98, 81132* \$1.98.

Interest: Jazz versions of spirituals
Performance: Mellow
Recording: Warm and clear
Stereo Quality: First-rate

This is one of the few jazz albums based on Negro spirituals rather than on the more rhythmically propulsive gospel melodies derived from spirituals. During most of these performances, however, the

jazz-inflected themes of the spirituals are played over a modified gospel beat so that the older and newer styles are fused. Green, a blues-based guitarist, is appealing mainly by virtue of his glowing tone and utterly relaxed beat. But he is not always interesting as a melodic improviser, and these spirituals seem not to have stimulated his melodic imagination. Similarly, pianist Herbie Hancock, who is capable of originality, is not as inventive here as on previous recordings.

The mood throughout is informal and unhurried, but too casual in a way. Seldom does the listener feel that the musicians are deeply committed to this music-making. They paraphrase and swing the spirituals with warmth and gentleness, but they do not use these songs as a means of individual expression. The marriage of spirituals and jazz should, to my mind, produce more passion and more surprises than it does here. *N. H.*



ALBERTO RECORDS

ART FARMER
Intricate lyrical experiments

⑥ **JAZZ CRUSADERS: *Heat Wave***. Wilton Felder (tenor saxophone), Wayne Henderson (trombone), Joe Sample (piano), Stix Hooper (drums), Bobby Haynes (bass). *Close Shave; Free Sample; Some Samba; Stix March; Purple Onion*; and six others. PACIFIC JAZZ PJ 76 \$1.98.

Interest: Folkly-funky blend
Performance: Slick
Recording: Okay

The Jazz Crusaders, a young West Coast group, could be called a contemporary version of the Village Stompers. As the Stompers welded various archaic folk and jazz styles into a highly salable commodity, so the Crusaders blend Miles Davis, an electric piano that sounds like a guitar, a John Coltrane-like tenor sax, and a J. J. Johnson-born trombone into a bland agglomeration of folksy-funky current styles. This mixture is applied to such works as *On Broadway, Mr. Sand-*
(Continued on page 100)

HIFI/STEREO REVIEW

Jensen TF-3's would improve $\frac{3}{4}$ of hi-fi systems now in use!!

The precise fraction is a matter of opinion, but the fact of the matter is not. In addition to the many thousands of hi-fi systems with TF-3's, quite a few are using speaker systems that are simply not as good. ■ Some were chosen because their owners expected more bass response, or smoother bass response. Those who bought closed-box systems, for example, get no more bass than the TF-3 provides. Moreover, a closed-box system has nearly 4 times as much distortion at 40 cycles as a TF-3. ■ And the TF-3 is efficient. It would have effectively doubled the power of amplifiers being used compared with some less efficient types of loudspeakers. Or, you could have used a smaller amplifier, obtained the same sound level, and pocketed about \$50. ■ While we're saving money—a pair of TF-3's are priced as much as \$60 less than a pair of alternatives that do not work as well. Take this, and the amplifier savings and you have about \$100. Or, would have had about \$100. ■ And, you would have had a better *looking* system. The selected panels used to make a TF-3 are veneered with choice real walnut, carefully hand-finished. (Some people don't use real walnut . . . you should have asked.) If you had bought the unfinished TF-3 at \$79.50, you could even have painted it to match the drapes. ■ If you already own TF-3's, you're lucky. On second thought, you're probably just smart.

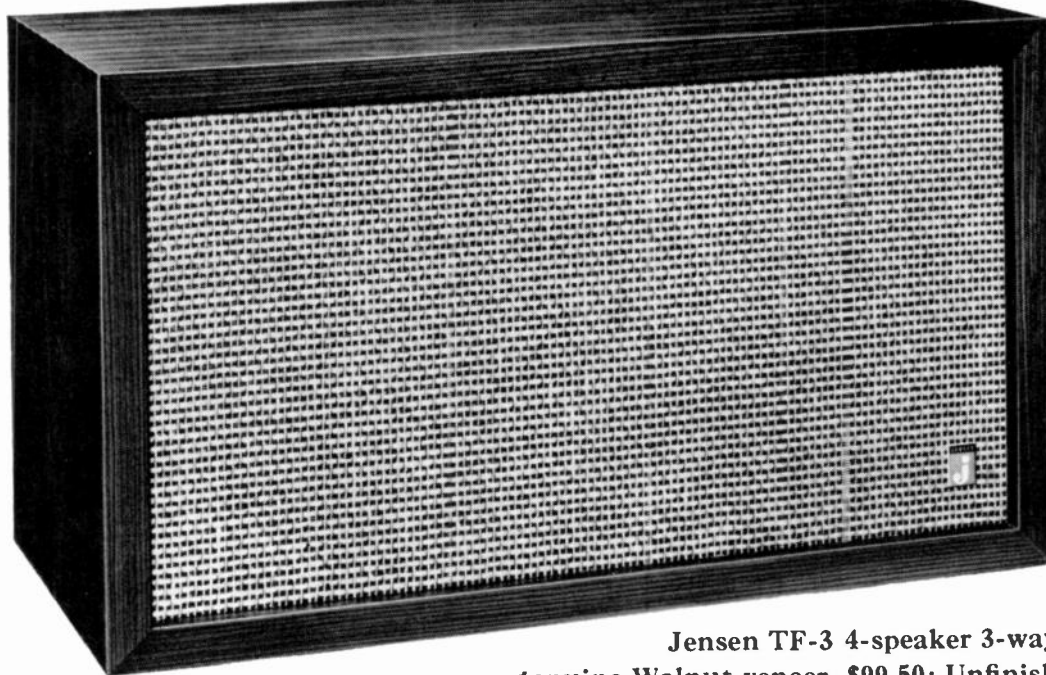

Jensen TF-3 4-speaker 3-way system in genuine Walnut veneer, \$99.50; Unfinished, \$79.50.



JENSEN MANUFACTURING COMPANY / DIVISION OF THE MUTER COMPANY / 6601 SOUTH LARAMIE AVENUE, CHICAGO 38, ILLINOIS
 Canada: Radio Speakers of Canada, Ltd., Toronto • Argentina: Ucoa Radio, S. A., Buenos Aires • Mexico: Fapartel, S. A., Naucalpan, Mex.

**KEEP NEW RECORDS
CLEAN, DUST-FREE
BRING OLD RECORDS
BACK TO LIFE !!!!**

with professional home record cleaning accessories designed by CECIL E. WATTS, the world's leading authority on the care and maintenance of records.



The New PREENER

For a dust-free record collection, the new Parastatik Disc Preener provides the perfect solution. Specially designed plush pile penetrates each groove, removes all dust and grit, as well as static. Simple to use.

\$ 3.00



The New PARASTAT

Removes dust, grit and residue deep within record groove. Brings older records back to life. Preenes new records and keeps them new. Ideal accessory to restore fidelity to older records.

\$ 15.00



The DUST BUG

Attaches to any turntable in seconds. Suction cup mount firmly holds cleaning arm in position to track ahead of stylus. Carefully designed and pre-balanced for minimum force. Height adjustment screw places arm parallel to record, for maximum cleaning efficiency.

\$ 6.00

Take good care of your records and they'll give you years of listening pleasure. Record cleaning equipment and other accessories are available at Hi-Fi dealers everywhere.

For dealer nearest you and catalog write:



ELPA MARKETING INDUSTRIES, Inc.
CECIL E. WATTS DIVISION New Hyde Park, N. Y.

CIRCLE NO. 77 ON READER SERVICE CARD

man, and *Green Back Dollar*. Such a description probably makes the Crusaders sound less talented than they are, but so does their approach: the slick arrangements are too short to permit more than the briefest glimpse of the individual talents.

J. G.

© GENE KRUPA: *Drummin' Man*. Gene Krupa (drums); Shorty Sherock and Corky Cornelius (trumpets); Sam Musiker, Sam Donohue (tenor saxophones); others. *Massachusetts; Opus #1; Leave Us Leap; Gene's Boogie; Starburst; Tutti Frutti*; and twenty-eight others. COLUMBIA C2L 29 two 12-inch discs \$7.96.

Interest: Top swing band
Performance: Energetic
Recording: Good transfers

Columbia, whose jazz reissue program is the most provocative going—it has included sets by Billie Holiday, Duke Ellington, Fletcher Henderson, and Woody Herman—now releases a two-disc Gene Krupa set, the original 78's of which were recorded between 1938 and 1949.

Krupa did not have a great band, but many of the numbers included here hold up as superior examples of the kind of music played then. Krupa was fortunate in having as his star performer trumpeter Roy Eldridge, whose work on *Rockin' Chair* and *After You've Gone* is still matchless. Others who became well known through their work with Krupa are Charlie Ventura, Dave Lambert, the late brilliant vocalist Buddy Stewart, and one of the best of all band singers, Anita O'Day.

Since it represents only a period style and not the combination of such a style with a strong individuality, this set is not necessary to a basic collection, but Krupa can take pride in what he accomplished with his band.

J. G.

© HERBIE MANN: *Live at Newport*. Herbie Mann (flute), Dave Pike (vibraharp), Don Friedman (piano), Attila Zoller (guitar), Ben Tucker (bass), Bob Thomas (drums), Willie Bobo and Carlos Valdez (percussion). *Soft Wind; Desafinado; Samba de Orfeu; Don't You Know; Garota de Ipanema*. ATLANTIC S 1413 \$5.98, 1413* \$4.98.

Interest: New Mann
Performance: Musical
Recording: Good
Stereo Quality: Good

I have said many unkind things about Herbie Mann's recordings in these pages, and it is therefore a pleasure to be able to report that his new album, recorded at the 1963 Newport Jazz Festival, is possibly the best he has made. After

years of depending for effect on rhythmic excitement alone, he has begun to put music on top of that rhythm, and the results are gratifying. Somewhat in the manner of Dave Brubeck, Mann has evidently used success as the lever with which to build a better group, and he now has an impressive array of young musicians working for him: vibraphonist Dave Pike, bassist Ben Tucker, a remarkable blues guitar player named Attila Zoller, and one of the finest young pianists around, Don Friedman, who on *Soft Winds* reveals a previously hidden funky side to his nature. There is one drawback: in employing these young men, Mann has become, as John S. Wilson once said of Brubeck, the least interesting member of his own group. Since he still reserves a good deal of the solo space for himself, one's attention wanders on the longer numbers. But this is better Mann than we have been getting.

J. G.

© GERRY MULLIGAN: *Night Lights*. Gerry Mulligan (baritone saxophone, piano), Art Farmer (trumpet, fluegelhorn), Bob Brookmeyer (trombone), Jim Hall (guitar), Bill Crow (bass), Dave Bailey (drums). *Night Lights; Morning of the Carnival; Wee Small Hours; Prelude in E Minor; Festive Minor; Tell Me When*. PHILIPS PH15 600108 \$4.98, PH1M 200108* \$3.98.

Interest: Mulligan at his best
Performance: Reflective
Recording: Very good
Stereo Quality: Very good

Gerry Mulligan, whose forte has been a sort of bumptious exuberance, has here produced a quiet, gentle, reflective disc, one of the best he has made. To his own quartet (Brookmeyer, Crow, Bailey, and himself), he has added two sympathetic musicians, the trumpeter and fluegelhornist Art Farmer and guitarist Jim Hall. The sextet is only rarely deployed full strength, Mulligan preferring to play off the sound of one lead instrument against another in the linear fashion that is his trademark.

Two tracks are bossa novas, one of these using as thematic material the Chopin Prelude in E Minor. No violence is done this classic, yet it somehow sounds, without melodic alteration, like the work of Antonio Carlos Jobim. All of the soloists are excellent, but Farmer's personal adaptation of Miles Davis' style is the most rewarding.

Though his principal talent is still as a leader, Mulligan himself has, over the years, grown to be a more introspective performer, and that quality has never been more fully evident than on this recording. Ironically, Mulligan is a much finer musician now than in the days of his greatest fame.

J. G.

(Continued on page 102)

Andre
hears
Andre



in stereo high fidelity at 1-7/8 ips on Roberts Cross Field 770

Andre Previn, accomplished composer and conductor, perfects his performance long before an audience ever hears it. He needs completely faithful sound reproduction—and the ultimate in convenience and dependability. Mr. Previn knows that in addition to his professional requirements, only the Roberts Cross Field 770 gives 12 hours of full frequency stereo response (24 hours of monaural) on one 7-inch reel! Only the 770 with the Cross Field head reproduces 40-13,000 cps at 1 7/8 ips. Three speeds. \$499.95.

Try the Roberts 770 at better music and photo centers—Other Roberts tape recorders from \$269.95 to \$699.95.

.....
Send for FREE BOOKLET: "40 and more ways to use a Roberts Tape Recorder" and details on new Roberts Cross Field 770.

*Roberts Electronics, 5922 Bowcroft, Los Angeles 16, Calif.
Dept. HFS-3*

Name _____

Address _____

City _____ State _____

In Canada: J. M. Nelson Electronics, Ltd., 2149 Commercial Drive, Vancouver 12, B.C. (Prices slightly higher in Canada)

.....

ROBERTS 

* P.L.'S know



ST-M \$29.95

* 'PRIVATE LISTENERS' usually aren't big talkers... seems they're fully occupied with 'total enjoyment' with the ONLY separate woofer/tweeter stereo/phones! Send for latest catalog.

SUPEREX stereophones
6 Radford Place • Yonkers, N.Y.

CIRCLE NO. 50 ON READER SERVICE CARD

PURCHASING A HI-FI SYSTEM?

TRADE-INS O.K. TIME PAYMENTS

Up to 2 years to pay!

Send Us Your List Of Components For A Package Quotation

AIREX WON'T BE UNDERSOLD

All merchandise is brand new, factory fresh & guaranteed.

Visit our showroom Free cabinet brochure & Hi Fi Catalog

AIREX RADIO CORPORATION

85-MR Cortlandt St., N.Y. 7, WO 4-1820

Jim Lansing*
Altec Lansing
Electrovoice
Jensen • Leak*
University
Acoustic Research
Janszen
Wharfedale
USL Citizen Band
International Crystals
Mallcraft
Texas Crystals
Concertone • Viking
Bell • G. E.
Weathers
Harman—Kardon
Eico • Pilot
Sherwood*
Superscope
Dual Changer
Bogen • RCA
Dynakit • Fisher
H. H. Scott
KSC Speaker Systems*
ADC Speakers
Finco • ECI
DeWald
Sony • Roberts
Challenger
Browning • National
Garrard • Norelco
Miracord
General Radio
Rek-O-Kut
Polytronics
Tandberg*
Fairchild
ADC Cartridges
Pickering • Sonar
Audio Tape
Magnecord*
Rockford Cabinets
*Fair Traded

RECORDING OF SPECIAL MERIT

© © **SONNY ROLLINS AND COLEMAN HAWKINS: *Sonny Meets Hawk!*** Sonny Rollins and Coleman Hawkins (tenor saxophones), Paul Bley (piano), Henry Grimes and Bob Cranshaw (bass), Roy McCurdy (drums). *Yesterdays; All the Things You Are; Summertime; Just Friends; Lover Man; At McKies*. RCA VICTOR LSP 2712 \$4.98, LPM 2712 \$3.98.

Interest: Historic meeting
Performance: Beautifully complementary
Recording: Fine
Stereo Quality: Good

Many recorded "meetings" between notable jazzmen of different eras look good only on paper; in the studio, the musicians may become, artistically speaking, all thumbs. Often, the factor that makes



COLEMAN HAWKINS MEETS SONNY ROLLINS
The elder statesman is still young enough

the difference is how well the older musician is able to adapt to his juniors: how young, in other words, he has been able to keep himself. One of the few times such hands-across-the-generations recordings worked out was the Sidney Bechet-Martial Solal album of a few years ago. Now, here is another success: Coleman Hawkins and Sonny Rollins, both of whom, at one time, changed everyone's ideas about how the tenor saxophone could be played.

Hawkins was one of the shapers of Rollins' style, and he is also one of the few elder statesmen who has consistently hired and encouraged younger men. On this album, and especially on the ballads, Hawkins is at the height of his powers. He has been applying his sensuous arpeggio filigrees to ballads for so long that it must be a nearly automatic reflex by now. In any event, he plays with the most natural ease in the world.

Rollins, on some of the tracks, is the old Sonny most of us are familiar with:

mocking and ironic, with his off-balance swing. At other times, he is completely in love with his horn and what he can do with it.

Rollins' regular rhythm section is uniformly good: Tristano-ish piano player Paul Bley, drummer Roy McCurdy, and alternating bassists Bob Cranshaw and Henry Grimes. The last-named has a striking solo on *Summertime*.

If this were a "cutting session," which it is not, the palm would go to Hawkins for his relaxed assurance. Rollins, on the other hand, takes more chances, and most of them are successful. The gratifying thing is how well the two men complement one another. Undoubtedly, their disc will serve as an item of jazz history for future scholars. But there is so rich a musical content to the album, and so much pleasure to be gained from listening to it, that such concerns hardly matter.

J. G.

BURT GOLDBLATT

COLUMBIA RECORDS

© © **DAKOTA STATON: *Live and Swinging***. Dakota Staton (vocals); orchestra, Howard McGhee cond. *Broadway; Drifting; My Funny Valentine*; and seven others. UNITED ARTISTS UAS 6312 \$4.98, UA 3312* \$3.98.

Interest: Distorted jazz singing
Performance: Lacks taste
Recording: Good
Stereo Quality: Okay

Dakota Staton, an undistinguished pop singer, has jazz aspirations, and this album was recorded during her appearance at the 1963 Newport Jazz Festival. Accompanied by a forceful, ten-piece jazz unit instead of the listless studio groups heard behind her in recent years, Miss Staton's performances nevertheless remain unimpressive. The record is enlivened by improvisatory bursts from the horns, but most of the time, Miss Staton dominates with much energy and little creativity.

N. H.

CIRCLE NO. 2 ON READER SERVICE CARD
102



Cordon Bleu, 3YD1



PLACE RCA CARTRIDGE IN POSITION
... So simple a child can do it.



SNAP CARTRIDGE IN PLACE
...Your hands do not touch the tape!!



YOU'RE READY TO RECORD OR PLAY
...within seconds!

RCA Victor "Instantape"™ "all-in-one" Stereo Tape Cartridge Recorder!

No reels to thread! Each cartridge contains 600 ft. of Mylar tape 1 mil thick. Records Stereo up to 1 hr. at $3\frac{3}{4}$ ips, up to 2 hrs. at $1\frac{7}{8}$ ips . . . Mono up to 2 hrs. at $3\frac{3}{4}$ ips, up to 4 hrs. $1\frac{7}{8}$. Just insert cartridge and start! As little as $3\frac{1}{2}$ seconds to change. Case safeguards valuable recordings.

Two speakers deliver exceptionally fine stereo reproduction on home recordings and pre-recorded tape, with sound separation up to 10 ft.!

Ideal as a tape deck! Plug-in jacks

let you record and play back Stereo and Mono through properly equipped Stereo hi-fi, TV or radio.

Pre-recorded cartridges available by Cliburn, Rubinstein, Clooney, Belafonte, Lerner and Loewe— classical, jazz, top musicals.

Plus these added features! Dual high impedance ceramic mikes; 3" x 5" Mono front speaker; Digital Tape Counter; dual Ray Recording Monitor; erase-proof Interlock; 4-pole motor with bearings sealed in oil for

life; automatic shut-off.

You can buy RCA Victor's finest Stereo tape cartridge recorder, the Cordon Bleu, for only \$199.95, manufacturer's nationally advertised price— optional with dealer. Prices, specifications subject to change.

See Walt Disney's "Wonderful World of Color," Sundays, NBC-TV Network.



The Most Trusted Name in Sound

Tmk(s)®

Another SONY First



The TFM-116A — FM/AM/MARINE PORTABLE with "SNAP TUNING"

No more hunting for your program with the sleek new SONY TFM-116A. Its new system of "Snap Tuning" means the FM signal pops right into perfect tune without fuss and bother. And it stays, without fade or drift, thanks to Automatic Frequency Control. The 11-transistor portable has other features you'll appreciate, too: Pushbutton band selection for FM, AM and Marine frequencies, tuning meter and continuous tone control. In bone white and silver, with batteries and earphone. **\$99.95.**

Carrying case extra.

SONY®

RESEARCH MAKES THE DIFFERENCE



SONY Micro-TV — The remarkable truly portable all-transistor TV that goes with you practically everywhere. Only 8 lbs., it operates on rechargeable battery, auto/boat power and AC. With 25 transistors, it accepts transistorized UHF adaptor for channels 14-83. Only **\$189.95.** Case, UHF adaptor, battery pack, other accessories extra.

SONY CORPORATION OF AMERICA • 580 FIFTH AVE., N.Y. 36, N.Y. • REGIONAL OFFICES: LOS ANGELES • CHICAGO



HIFI/STEREO REVIEW'S CHOICE OF THE LATEST RECORDINGS

ENTERTAINMENT

POPS • HUMOR • FILMS • THEATER • FOLK • SPOKEN WORD

Reviewed by JOE GOLDBERG • NAT HENTOFF • PAUL KRESII • GENE LEES

Ⓢ Ⓜ ANN-MARGRET: *Bachelor's Paradise*. Ann-Margret (vocals); orchestra, Hank Levine cond. *Bachelor in Paradise*; *Never on Sunday*; *Let Me Entertain You*; and nine others. RCA Victor LSP 2659 \$4.98, LPM 2659 \$3.98.

Interest: Hollywood style
Performance: Saccharine
Recording: Excellent
Stereo Quality: Excellent

I played this record for a friend of mine, a gifted young musician who attended Northwestern University with Ann-Margret and had been touting her as "just about the greatest natural talent I've ever heard." His response to it was, "My God, what have they done to her?"

What they have done is to Hollywoodize her singing talent almost to death. She apparently no longer knows who she is, for she now sounds like six other singers, including Eartha Kitt. The idea behind the album is that this chick has you up to her pad, and she's coming on at you like Gang Busters—cooing and making goo-goo lips and writhing and groaning and carrying on. Any man worth the name would split fast, rather than hold still for all this affected hogwash. The arrangements are good, but Ann-Margret will make you want to hide your face. Hooray for Hollywood.

G. L.

Ⓢ Ⓜ LES BAXTER: *Quiet Village*. Orchestra, Les Baxter cond. *Quiet Village*; *Shanghai Rickshaw*; *Simba*; and nine others. Capitol ST 1846 \$4.98, T 1846 \$3.98.

Interest: Mood music
Performance: Polished
Recording: Excellent
Stereo Quality: Good

Les Baxter's career as a musical exoticist began about twelve years ago with a 10-inch disc called "Sacre du Sauvage,"

Explanation of symbols:

- Ⓢ = stereophonic recording
- Ⓜ = monophonic recording
- * = mono or stereo version not received for review

which was later remade into a 12-inch disc called, for the benefit of those squares who didn't know French, "Rite of the Savage." He followed this first album with one called "Tambou." The first seemed to suggest a South American jungle setting, the second was Africa-oriented—or so the tune titles suggested. In later albums, he tried his hand at a Far-Eastern mood, and also rescored some old standards, but none of these was as effective as "Rite of the Savage" and "Tambou."

This disc is culled from all these efforts, and its quality is uneven, the tracks



GEORGE CHAKIRIS
A superior singing actor

from "Tambou" and "Savage" being far and away the most interesting. Yet even the least of them is superior martini music, for Baxter is a skillful orchestrator who employs strikingly attractive voicings.

My aesthetic conscience will not permit me to recommend this album. But if you are planning to charm some lovely young thing and need musical help, this album is surely better than those stupid Jackie Gleason records.

G. L.

Ⓢ Ⓜ GEORGE CHAKIRIS: *You're Mine, You*. George Chakiris (vocals); orchestra, Bob Bain cond. *You're My*

Girl; Love is the Thing; As Time Goes By; and nine others. Capitol ST 1996 \$4.98, T 1996* \$3.98.

Interest: Actor-singer
Performance: Pleasant
Recording: Well-balanced
Stereo Quality: Good

We are in the age of the singing actor, the discovery having been made in Hollywood that there's money in them there waffles. This has led to some dismal records. Richard Chamberlain, for example, is just about the most flaccid singer since Pat Boone. But it would be unfortunate if those looking for pleasant pops were to dismiss Chakiris as just another of that breed. His singing is a far cry from that of Chamberlain and his ilk. (It should not be forgotten that Chakiris got his first break in a musical role—in *West Side Story*.) His vocal quality is virile, yet gentle. He sings well in tune, and his enunciation is clear and direct. A genuinely gifted actor, he understands lyrics and projects them well.

Bob Bain's latinized arrangements are bright and in quiet good taste. This disc is a pleasant surprise.

G. L.

Ⓢ Ⓜ BILL EVANS: *The V.I.P. Theme*. Bill Evans (piano); orchestra. *Morc*; *Laura*; *Days of Wine and Roses*; *On Broadway*; *Hollywood*; *Sweet September*; and six others. MGM SE 4184 \$4.98, E 4184* \$3.98.

Interest: Pop Evans
Performance: Skillful
Recording: Fair
Stereo Quality: Okay

Bill Evans' new disc is one of the most blatantly "pop" albums ever to come from a major jazzman. With the assistance of a big string orchestra, Evans plays some ephemeral current themes from the movies and television, with a few themes of older vintage and a couple of originals tossed in. Many of the arrangements, the title track in particular, feature the baroque approach to rock-and-roll favored by pop string arrangers. Evans often confines himself to octave statements of the melody, as if he were an ambidextrous Gordon Jenkins. On rare occasions, one hears intimations of



DAY & NIGHT

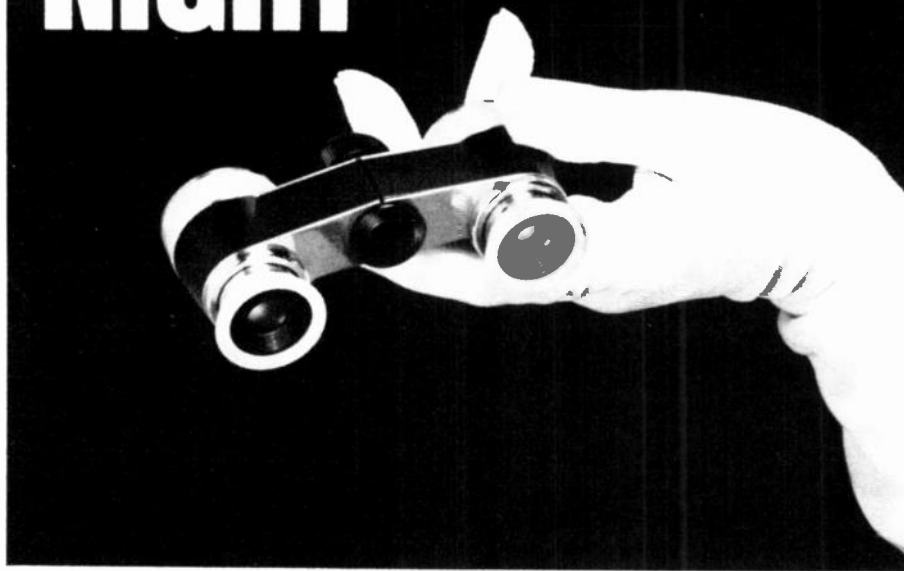

Zeiss binoculars love the active life

Daypeople . . . Daytime's more dynamic with a new Zeiss "B" type binocular, especially designed for use *with or without* eyeglasses or sunglasses. At rallies, regattas and races, only these remarkable binoculars give you the same wide field of vision—with your glasses on or off—bright, sharp focus right to the edges. A light-weight binocular superbly engineered for action. **Nightpeople** . . . Night-time's more glamorous with an elegant Hensoldt Diadem theatre glass. Bright lights or dim, it enhances the evening's performance by giving you a close, clear and crisply-detailed view of what's happening on stage. Choose from luxury combinations of mother-of-pearl, silver, gold, or other colorful tones to dramatically complement the most alluring ensemble. **Give the gift of a lifetime** . . . These are just 2 out of 27 high quality Zeiss and Hensoldt binoculars available at leading photo and sports dealers. We invite you to write Dept. B6 for a free copy of our booklet: "How to Select the Right Binocular."

CARL ZEISS, INC.

444 Fifth Avenue, New York 18, New York
IN CANADA: CARL ZEISS CANADA LTD. 50 OVERLEA BUILD. TORONTO 12 ONTARIO



The Great Name in Optics

Evans' talent. I suppose that Evans has made this a superior album of movie themes, but I cannot think it matters very much. *J. G.*

RECORDING OF SPECIAL MERIT

⑤ ⑥ **BILL HENDERSON:** *Bill Henderson with the Oscar Peterson Trio.* Bill Henderson (vocals); Oscar Peterson Trio. *You are My Sunshine; The Lamp Is Low; Gassy Waltz;* and nine others. MGM SE 1128 \$1.98, E 4128* \$3.98.

Interest: Individualistic singer
Performance: Fine
Recording: Excellent
Stereo Quality: Very good

One of the few distinctive pop singers to come up in recent years continues to be one of the most unrecognized. Chicagoan Bill Henderson, whose previous records are on Vee-Jay, makes his Verve debut with the Oscar Peterson Trio. It is a felicitous pairing, and Jim Davis, the artist-and-repertoire man, is to be commended for it.

Henderson's timbre is vibrantly earthy, and he has a disarmingly indolent way with a tune, throwing away whole phrases. He communicates not only the words, but their meaning with great clarity, yet doesn't butcher the music in the process. Finally, there is a quality of witty grace in his work that makes one warm to him.

It is refreshing to hear a singer in so unpretentious a setting. Pianist Peterson and his colleagues, bassist Ray Brown and drummer Ed Thigpen, here set a standard of what trio accompaniment should be. Peterson is supremely subtle. It takes a pianist with a virtuoso's security to be this self-effacing. Brown, of course, is the one man in jazz who can make the bass a tender instrument. Thigpen has been called "Mr. Taste"—and he is. In the up-tempo numbers, the trio swings potently, and Henderson pulses along with them. Extremely well-recorded, this is one of the most listenable pop vocal sets of the past year. *G. L.*

⑤ ⑥ **DANNY KAYE:** *The Best of Danny Kaye.* Danny Kaye (vocals); orchestra. *Balling the Jack; Anatoli of Paris; Bloop Bleep; Tongue Twisters;* and twenty others. Decca DNXB 7175 two 12-inch discs \$9.98, DXB 7175* \$7.98.

Interest: Second-best Kaye
Performance: Thin
Recording: So-so
Stereo Quality: Shallow

This package consists of straightforward performances of songs drawn from an extraordinarily distinguished career. But *(Continued on page 108)*

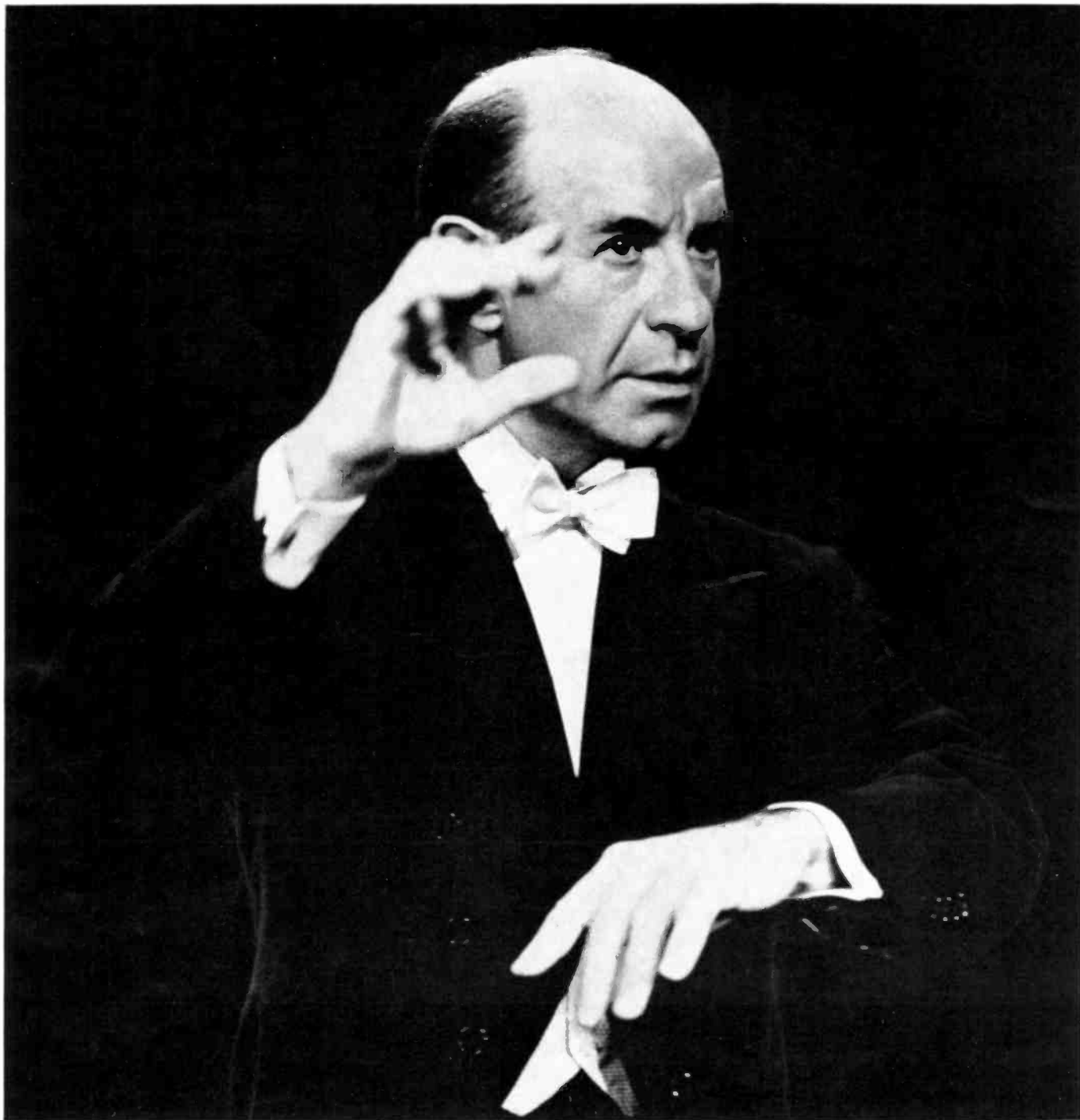

Prokofieff's Fifth returns to Boston!

Nineteen years ago the Boston Symphony premiered Prokofieff's Fifth Symphony in America. For many years the subsequent Red Seal album set the recording standard for the work. Now, a new Dynagroove recording captures a dramatic and deeply penetrating performance under Erich Leinsdorf's direction. With it, the standard for Prokofieff's greatest symphony again returns to Boston! Happily, this is the first in a new series of Prokofieff recordings by the Boston Symphony. Enjoy it soon and watch for more to come.



RCA VICTOR
The most trusted name in sound

NEW
from
MOSLEY
the
Scotch Master
Switch Plates
for
Stereo, Hi-Fi & Intercom

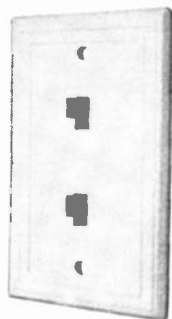
MOSLEY FSSW-2 and FSSW-4

Mosley's New FSSW-2 and FSSW-4 represents an outstanding achievement in central control units for Hi-Fi, Stereo and intercom speaker systems. Low in cost, these new switch plates permit positive selection of up to four combinations of speakers.

"Positive Action" slide switches, "Decor Matching" ivory and brown polystyrene and "Ease of Installation", are just a few of the many outstanding features included in the New "Scotch-Master Central Control Switch Plates" at a nominal investment. Comes complete with F-9 mounting brackets.

**MOSLEY HAS A COMPLETE LINE
OF TV/FM ACCESSORIES
DESIGNED AND ENGINEERED TO
PROVIDE BETTER TV/FM
RECEPTION THROUGH A BETTER
INSTALLATION!**

FREE  **FREE**

Please send me your catalog containing the complete line of Stereo and TV accessories.

Name

Address

City/State

Mosley
Electronics Inc.

4610 N. Lindbergh Bridgeton Mo.
CIRCLE NO. 35 ON READER SERVICE CARD
108

a phonograph record differs from a stage recital in some of the ways that a movie differs from a stage play. A record is, in effect, one long auditory close-up. This, coupled with the fact that it is usually listened to by one, two, or three persons, makes it an intimate medium. If Kaye did not understand the nature of the medium when he went into the recording studio, it was the duty of the artist-and-repertoire man to clarify it for him.

Kaye is an extremely visual entertainer. Without being able to see his routines, we lose their flavor. For example, *Anatole of Paris*—his brilliant song about a Parisian hat designer—is only wandy amusing without the campy visual characterization Kaye gives it on stage or television. This is not to suggest that *nothing* comes through on these records. Kaye's gentle qualities, his warmth, his humor, his humanity, are here, but they are muted.

The orchestrations, which are not well played, are sticky and dated. Incredibly, there are no composer credits, but some of Kaye's best special material is by his wife, Sylvia Fine. *When I Was a Lad* is by a couple of old pros named Gilbert and Sullivan.

Kaye should be better represented on records than this. His fans deserve it, and so does he. *G. L.*

© ® **GLENN MILLER: *On The Air.*** Glenn Miller (trombone); Ray Eberle, Marion Hutton, the Modernaires (vocals); orchestra, Glenn Miller cond. *I Don't Want to Set the World on Fire; My Best Wishes; There I Go; Dreamsville, Ohio; Why Do I Love You; The Masquerade Is Over;* and thirty-four others. RCA Victor LSP 6101 three 12-inch discs \$11.91, LPM 6101* \$11.98 (also available singly).

Interest: Cornucopia of nostalgia
Performance: Precise
Recording: Adequate
Stereo Quality: Artificial

These previously unreleased Glenn Miller radio broadcasts from 1939 to 1941 will stir memories among listeners who grew up during Miller's ascendancy as leader of the country's most popular dance band, but the recordings contain little of musical substance for those not affected by nostalgia. The crisply professional Miller band always functioned with the smooth efficiency of a machine for producing music for dancing. The band was best on ballads, primarily because of Miller's airy reed sound, but even in this Miller specialty, the arrangements begin to blur, and each ballad sounds very much like the others.

RCA's "electronically processed stereo," which "transforms monophonic recordings to two-channel recordings with stereophonic characteristics," creates, if

you do not listen too closely, a modest illusion of stereo sound, but this kind of tinkering is hardly worth the effort. For each of the three albums, George Simon has contributed a separate essay. Together they make up one of the most informed and understanding profiles of Glenn Miller yet to appear. *N. H.*

RECORDING OF SPECIAL MERIT

© ® **MARIAN MONTGOMERY: *Let There Be Love, Let There Be Swing, Let There Be Marian Montgomery.*** Marian Montgomery (vocals); orchestra, Dave Cavanaugh cond. *Bill Bailey, Won't You Please Come Home; Romance in the Dark; The Good Life;* and nine others. Capitol ST 1982 \$4.98, T 1982 \$3.98.

Interest: Gutsy singer
Performance: Superior
Recording: Superb
Stereo Quality: Natural

Marian Montgomery is a fresh and highly individual new singer. In this, her



MARIAN MONTGOMERY
A fresh and full-grown style

second album, she is intelligently accompanied throughout. The album is well planned and programmed, and its producers—Dave Cavanaugh, who wrote some of the arrangements, and Bill Miller, who was for so long Frank Sinatra's accompanist—are to be commended.

The disc has been issued as part of Capitol's "Dimensions in Jazz" series, which I think is a tactical mistake. It is questionable that Miss Montgomery will be accepted as a jazz singer in the world of the hippies—she sings with too much control and professionalism. Still, maybe the sheer gutsiness of her work will help her get by with them. Miss Montgomery's style is highly personal—*(Continued on page 110)*

world's only automatic with hysteresis-synchronous motor



Only the Miracord 10H offers you the speed reliability of the famous Papst hysteresis motor, the one used in the finest studio turntables and tape transports.

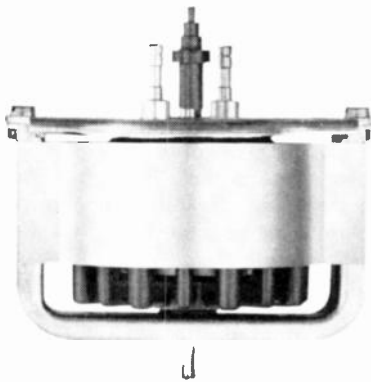

Speed-synchronized to power-line frequency, the hysteresis motor rotates at a constant, accurate rpm, even with extreme variations in voltage and load conditions. The smooth, steady motion this imparts to the turntable is one of the major reasons for the distinctively natural quality of sound associated with the Miracord 10H

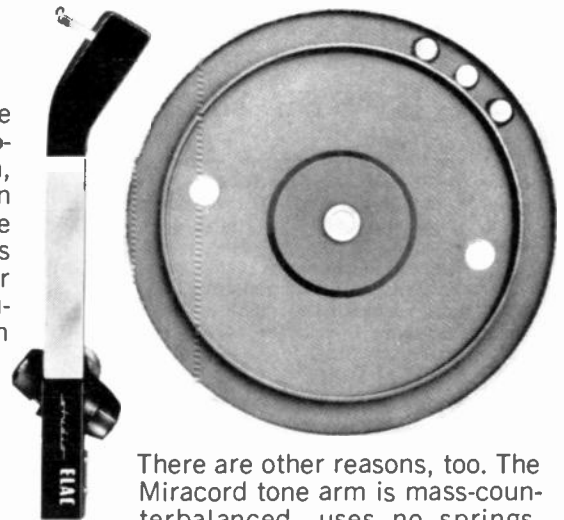

There are other reasons, too. The Miracord tone arm is mass-counterbalanced—uses no springs. Sensitive suspended on friction-free, micro-ball bearings, it is freely responsive in every plane. The turntables are heavy, one-piece, precision-machined die castings. Each is 12" in diameter, and each individually weighted and adjusted for dynamic balance.



Furthermore, the Miracord can be used as a manual turntable, automatic turntable, automatic record repeater or automatic record changer. It is incredibly gentle to your records, and amazingly easy to use. Four FEATHER-TOUCH push buttons reduce all automatic operations to utter simplicity.

The Miracord 10H with Papst hysteresis motor is \$99.50; Model 10 with 4-pole induction motor, \$89.50 (less cartridge and base). To hear a Miracord at its best, ask your dealer to demonstrate it with the new Elac cartridge: the Stereo 322 or Mono/Stereo 222. For details, write:

Benjamin Electronic Sound Corp., 80 Swalm Street, Westbury, New York
sole U.S. distributor for Miracord turntables, Elac cartridges, and other Electroacoustic® audio components.

**BENJAMIN
MIRACORD**

FIRST

OF A NEW SERIES FROM



THE MODEL 1028*

After two years of research comes a new Series of Magnecord tape recorders. We present here the Model 1028, unquestionably the finest tape recorder ever offered by Magnecord. Other models in the new 1000 Series, yet to be announced, demonstrate how Magnecord research has made possible better equipment . . . for varying requirements . . . and for less money!

Important advances in the model 1028 include new MICRO-OPTIC heads and new electronics for wider, flatter frequency response, better signal to noise ratio, and superior tone quality.

Watch for more news from Magnecord during coming months. The new 1000 Series includes tape recorders that are priced just right for the varying requirements of professional users, for industry, and for all others who know and appreciate the professional quality of sound.

Write today for more information



*from \$995

MIDWESTERN INSTRUMENTS

P. O. BOX 7509 • TULSA 35, OKLAHOMA

CIRCLE NO. 33 ON READER SERVICE CARD
110

I hear no hint of Billie Holiday. As a matter of fact, Miss Montgomery seems to have arrived on the recording scene with a full-grown style of her own. Despite the fact that a number of arrangers contributed to this disc, there is unity of style in the handling of the small orchestra—trombones and bass trumpets, one tenor trumpet, tenor, and rhythm. And there is some brilliant up-tempo drumming by Earl Palmer in *There'll Be Some Changes Made*. A very satisfying set, and I, for one, hope that Miss Montgomery will make it big. G. L.

© M MARTHASCHLAMME AND WILL HOLT: *A Kurt Weill Cabaret*. Martha Schlamme and Will Holt (vocals). Accompaniment, Abraham Stokman, director. *The Barbara Song; Pirate Jenny; September Song*; and eleven others. MGM SE 4180 OC \$6.95, E 4180 \$5.95.

Interest: Kurt Weill
Performance: Unique
Recording: Fair
Stereo Quality: So-so

By way of introducing one of the Weill tunes in this disc, Miss Schlamme tells of a Chicago critic who wrote her saying that he thought Mr. Brecht's humor was far too Teutonic and Mr. Weill's music far too forgettable. Then a pianist breaks into *Mack the Knife* to prove how unforgettable Weill's tunes are, and Miss Schlamme says the critic added in a postscript that maybe this tune might survive. To this Will Holt says, with vast condescension, "I hope so."

This characterization of critics as insensitive morons is beginning to bore me. A great deal of Weill's music is forgettable, *September Song* and several more notwithstanding. And Brecht's humor is indeed ponderously Teutonic at times. More than one critic has noted that Weill was, even in his most acerbic moments, as hopelessly romantic as the romantics he was rejecting: he was fascinated by exoticism, specifically the exoticism of low-life. Furthermore, I have never been able to understand how one can hope to satirize the cheap and sordid simply by adopting a cheap and sordid musical style.

This disc is a transcript of material presented by Miss Schlamme and Mr. Holt in their Weill program that opened in New York City last June. It received rave reviews, and several of my friends tell me the "Evening of Kurt Weill" is stunning theater. I haven't seen the show, so I must judge this disc simply as a disc, and it does not knock me out.

Those who have seen and enjoyed the Schlamme-Holt show should welcome this disc. I like Holt's singing, particularly of the songs from Weill's American period. G. L.

© M FRANK SINATRA: *Frank Sinatra Sings the Select Johnny Mercer*. Frank Sinatra (vocals); orchestras conducted by Nelson Riddle, Billy May, Gordon Jenkins, and Axel Stordahl. *Something's Gotta Give; When the World Was Young; Laura*; and eight others. CAPITOL DW 1984 \$5.98, W 1984* \$4.98.

© M FRANK SINATRA: *Sinatra's Sinatra*. Frank Sinatra (vocals); orchestra, Nelson Riddle cond. *Young at Heart; Witchcraft; All the Way; Call Me Irresponsible*; and eight others. REPRISE R9 1010 \$5.98, R 1010* \$4.98.

Interest: Sinatra then and now
Performance: Inconsistent
Recording: Excellent in both
Stereo Quality: Mostly excellent

The battle of the two Sinatra labels continues. Capitol keeps repackaging tracks the singer made during his decade with that company, and Reprise, the label Sinatra founded and still controls, keeps rerecording material he originally did for Capitol, sometimes with the same Nelson Riddle arrangements. One such Capitol repackaging was titled "Sinatra: The Great Years," not so subtly suggesting that those years were over and the listener should stick with vintage Frank on Capitol. A comparison of these two albums lends a certain amount of support to that viewpoint: there's some pretty sloppy Sinatra in the Reprise album, though some of the tracks are close to his standard. In the weaker tracks, his intonation is unsteady, particularly on passing tones. Some of his notes are positively squirm-making. But Sinatra was never consistent. He did some brilliant work and some poor work with Capitol: *Laura* is quite bad.

Bad Sinatra, however, is usually better than top-drawer anybody else in his field. His uncanny ability to penetrate to the heart of a song's meaning is undiminished in the Reprise set, whatever late nights, cigarettes, and Jack Daniels sour mash may have done to his control. He is, in my estimate, the finest interpreter of the quality American popular song the country has produced. No one else has ever understood this music the way Sinatra does.

Because the Capitol set is culled from so many different albums, it has the added interest of showing Sinatra in contexts provided by four of the arrangers who have written for him. One wonders why he ever worked with Gordon Jenkins, whose writing for orchestra is saccharine and unimaginative. Billy May provided Sinatra with irreverent and funny arrangements. Axel Stordahl's writing was characterized by a restrained sweetness. Nelson Riddle's combined the

(Continued on page 112)

Perfection can be an accident once.

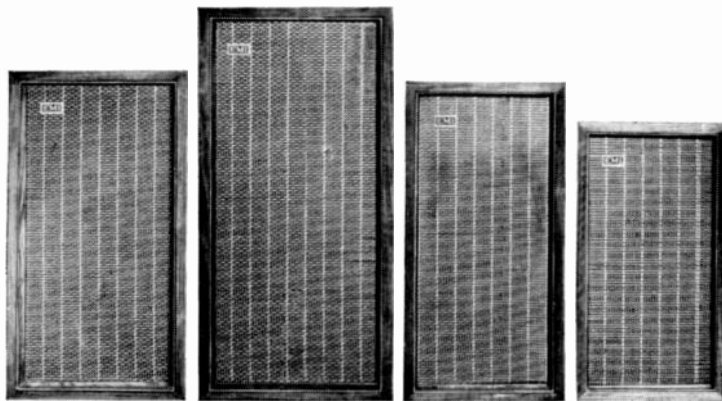

But not four times in a row.

We shattered the envious rumour that our perfect \$159.00 bookshelf speaker was an ingenious accident, by creating three more. All as technically impeccable.

Now there is an EMI speaker for all classes of audiophiles. You don't need excessive amplifier power. All you need is taste.

These speakers are designed for those who are delighted by the magnificence of strident, realistic sound reproduction. They bring you smoothly balanced response over the entire frequency range.

Clarity you must hear to appreciate. Do that soon at your EMI dealer. Models from \$69.75 to \$249.*

*All prices slightly higher in South and West.

EMI

(makers of The Dangerous Loudspeaker)

exclusively from Scope Electronics Corporation
(subsidiary of Lynch Corporation),
235 East 42nd Street, New York, N. Y. 10017

CIRCLE NO. 17 ON READER SERVICE CARD

Sensational FUJICA Offer



You get a full refund on both camera and color film if you are not fully satisfied with the pictures you take!

Why do we dare make this offer?

The new Fujica is the first camera with a built-in computer electric eye. Patented. It makes all settings for you . . . both speeds and lens openings. You can't make an exposure mistake even if you try. If the light is too bright or too dim, the computer speeds up or slows down the shutter speed . . . instantly! Automatically! You just press the button. Perfect exposure every time.

Professional effects also automatic.

A simple dial turn does it. Soft backgrounds. Sharp backgrounds. Catch incredibly fast action . . . and to top it all, you can switch from fully automatic operation to manual control and make any combination of settings you wish. Speeds are up to 1/500th second.

Takes perfect pictures indoors.

The superb f/2.8 lens gets pictures in light so low, other cameras require flash . . . and if the light is too dim to give you a perfect picture, the Fujica locks . . . won't fire. No more blurs, blanks or wasted shots.

Preview your finished picture.

The viewfinder-rangefinder shows you big, bright and beautifully clear, what your finished picture will look like. You get exactly what you see.

How much does this FUJICA cost?

Less than \$100, and with the money back guarantee . . . you risk nothing.

Like to see how easy it is to operate? . . . just ask your favorite camera dealer or write for **FREE** booklet today.

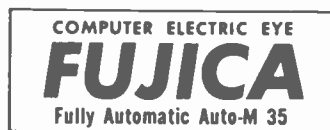

FUJI PHOTO OPTICAL PRODUCTS INC.
111 Fifth Ave., Dept. A-79, New York 3, N. Y.

A subsidiary of Ehrenreich Photo-Optical Industries Inc.

CIRCLE NO. 22 ON READER SERVICE CARD
112

best of both qualities, and he voiced and phrased instruments in a fresh way that has of late been often imitated by arrangers — including, unfortunately, Riddle himself. At their best, Riddle's tart yet lyrical orchestrations are just about the best vocal settings of pop songs the business has known.

If you have an extensive Sinatra collection, you probably have all these tunes already. If you have the Capitol originals of those newly recorded on Reprise, you're better off with the earlier versions. *G. L.*

THEATER — FILMS

⑤ ⑩ **TOM JONES.** Sound-track recording. John Addison, composer-conductor. UNITED ARTISTS UAS 5113 \$5.98, UAL 5113 \$1.98.

Interest: Pungent and inventive score

Performance: Polished

Recording: Stunning

Stereo Quality: Helpful

It seems only natural that one of the most brilliant movies ever made should also have an exceptionally brilliant score. The same qualities of imagination, ingenuity, and resourcefulness that characterize the film are in evidence throughout the score, which stands alone beautifully as a kind of twentieth-century commentary on eighteenth-century English music. The opening title track, a clever and hummable theme for harpsichord and piano, leads to a series of other themes and variations, each set with pungency, wit, and taste. There are marches, dances, the folk-like *If He Swings by the String*, and even a *Tom Jones Strut*. The total effect is nearly that of a complete tone poem. In its tartness and the impishness of its instrumental effects, the music of *Tom Jones* reminds me at times of Strauss' *Till Eulenspiegel*, but it shines all the same with a charm, character, and inventiveness quite its own. *P. K.*

⑤ ⑩ **LADY IN THE DARK** (Kurt Weill-Moss Hart). Risë Stevens, Adolph Green, John Reardon; orchestra and chorus, Lehman Engel cond. COLUMBIA OS 2390 \$5.98, OL 5990* \$4.98.

Interest: Model musical

Performance: Conscientious

Recording: Excellent

Stereo Quality: Realistic

Twenty-three years after it burst upon Broadway with four revolving stages and a cast that included Gertrude Lawrence, Danny Kaye, Victor Mature, MacDonald Carey, and Bert Lytell, the sumptuous musical progress of Liza Elliott's whirlwind psychoanalysis still remains

fresh and delightful. Just to hear all of Ira Gershwin's lyrics, Kurt Weill's songs, and the book's dream sequences intact is worth the price of the album. Engel uses the original orchestrations and directs crisply, the chorus sings its heart out, but many of the principals are troubled by ghosts. John Reardon is faultless as the dream movie star Randy Curtis, but Adolph Green, for all his skill and ebullience, cannot match Danny Kaye in a patter song such as *Tchaikovsky*, and Risë Stevens cannot exorcise the spirit of Gertrude Lawrence, who seems (from between the grooves) to mock the whole enterprise. Miss Stevens sings *The Princess of Pure Delight* and *One Life to Live* with arresting purity, but her efforts at sophistication come to little, and her singing of *My Ship* is far too heavy and broad. As the editor of the fashion magazine *Allure* she sounds like the singing copy-chief of a mail-order house, though I must say that her delivery of *Jenny* (the girl who couldn't make up her mind) is rousing. If you can get hold of the now-deleted Gertrude Lawrence disc (RCA Victor LRT 7001) you'll have one definition of the word "imitable." She had no voice, but what a way! *P. K.*

⑤ ⑩ **110 IN THE SHADE** (Harvey Schmidt-Tom Jones). Original-cast recording. Robert Horton, Inga Swenson, Stephen Douglas; orchestra, Donald Pippin cond. RCA Victor LSO 1085 \$5.98, LOC 1085* \$1.98.

Interest: Tuneful score

Performance: Persuasive

Recording: Flawless

Stereo Quality: Good

The score of *110 In The Shade*, an ingenious attempt to turn N. Richard Nash's play *The Rainmaker* into a musical, is full of surprises. The tone is set with a somewhat synthetic opening in the manner of Aaron Copland's ballets of the West. After this, Mr. Schmidt and Mr. Jones, who supplied songs of perhaps excessive whimsicality for *The Fantasticks*, seem in the first act to be ambling along indifferently with such numbers as *Gonna Be Another Hot Day* and *Lizzie's Comin' Home*, which sound to these jaded ears like warmed-over Rodgers and Hammerstein. But later this impression is banished entirely by the lusty Robert Horton and the vibrant Miss Swenson, who, with able support from a sterling cast, sock home the top-notch *You're Not Fooling Me*, *Mel-sande*, *Simple Little Things*, and *A Man and a Woman*. The score has its share of fillers, but a large proportion of the sixteen numbers are exuberant tunes with well-crafted lyrics, and are most persuasively sung. *P. K.*

(Continued on page 114)



FROM THE INVENTORS OF TAPE RECORDING...



NOW HEAR THIS:



EASY MAINTENANCE: Amplifier plate opens on hinge for easy, fast servicing ...one of many special TELEFUNKEN features.

EASY PORTABILITY: Weighs only 26½ lbs. including carrying case. Overall dimensions 9" x 11½" x 16".

The Perfect Tape Recorder...is instantly revealed...in Telefunken's Magnetophon 97 de Luxe. With push-button ease, this fully self-contained 4-track stereo record/stereo playback system with 2 loudspeakers shows its Telefunken lineage. *No compromises here: are you sure you're not in the concert-hall?*

Now, hear the secrets of its marvelous sound...Telefunken's patented extra-sensitive brake mechanism assures correct tape tension always, protecting heads and tapes. Pre-amplifier equalization automatically optimizes fre-

quency response (30-18,000 cps at 7½ ips, 30-16,000 at 3¾, 30-9,000 at 1¾). At 7½ ips wow and flutter are less than 0.15%, and signal-to-noise ratio better than 50 db.

Versatility? The Magnetophon 97 de Luxe takes reels to 7", offers sound-on-sound recording, mixing, and transcription from one track to another. You can edit, monitor and use it as a public address system. There's a built-in tape splicing groove and a digital counter—and a full line of accessories. Hear the "touch of perfection" to believe it.



See your TELEFUNKEN DEALER today or write for literature on the complete TELEFUNKEN line of tape recorders to: American Elite, Inc., Dept. 20, 48-50 34th Street, Long Island City 1, N. Y.

FREE!

send today for your money-saving

ALLIED 1964 CATALOG

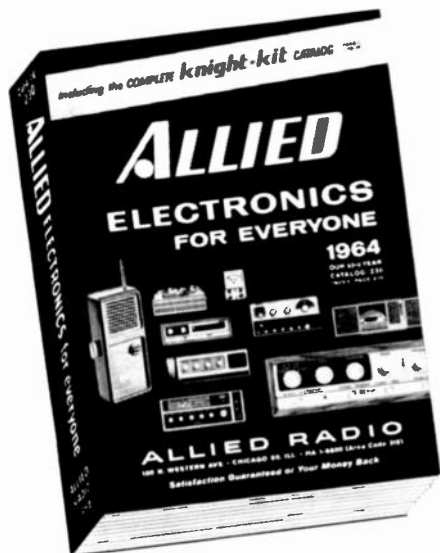

save most on STEREO HI-FI & tape recording

444 Value-Packed Pages: See the world's largest hi-fi selection, including special buys available only from ALLIED. Save on complete Stereo systems, all famous-make components, everything in tape recording. Extra savings on exclusive KNIGHT® quality components. For everything in hi-fi, for *everything* in Electronics, send for your Free 1964 Allied Catalog!

SAVE MOST WITH BUILD-YOUR-OWN

knight-kits®

Select from over 100 great easy-to-build kits: Hi-Fi, Hobby, Citizens Band, Intercom, Shortwave, Amateur, Test Instrument—savings up to 50%.

EASY TERMS: Use the Allied Credit Fund Plan
satisfaction guaranteed or your money back

FREE Send coupon today
for your money-saving Allied
444-page 1964 Catalog.



ALLIED RADIO, Dept. 10-C
100 N. Western Ave., Chicago 80, Ill.

Send FREE 1964 ALLIED Catalog

Name _____
PLEASE PRINT

Address _____

City _____ Zone _____ State _____

CIRCLE NO. 4 ON READER SERVICE CARD
114

FOLK

Ⓢ Ⓜ **ENOCH KENT/PATRICK O'MALLEY/DIARMUID O'NEILL:** *Irish Rebel Songs.* Enoch Kent, Patrick O'Malley, Diarmuid O'Neill (vocals); orchestra. *My Old Fenian Gun; The Manchester Martyrs; The Soldier's Song; Irish Soldier Boy;* and eight others. LONDON INTERNATIONAL TW 91296 \$3.98.

Interest: Vivid nationalistic memories
Performance: Robust and relaxed
Recording: Good

Few listeners will have difficulty identifying with the strength of spirit and warmth of pride in these songs from Ireland's long struggle for independence. The heroes commemorated here seldom survived the events they precipitated, so that many of the songs are an affecting mixture of martial and mourning moods. The virile performances by the three soloists avoid both melodrama and mawkishness. They sing with an implied recognition of the fact that these songs are no longer needed for proselytizing but should be aimed instead at humanizing history. Several songs are unabashedly sentimental, but understandably so. Unfortunately, there are no notes, about either the performers or the particular history of each number. *N. H.*

Ⓢ Ⓜ **ODETTA:** *Sings Folk Songs.* Odetta (vocals and guitar); Bruce Langhorne (guitar), Victor Sproles (bass). *Blowin' in the Wind; Yes I See; The Golden Vanity; All My Trials;* and eight others. RCA Victor LSP 2643 \$4.98, LPM 2643* \$3.98.

Interest: Semi-detached folk singing
Performance: Something missing
Recording: Warm and clear
Stereo Quality: Very good

According to the notes, the accent of Odetta's most recent album is on relaxed lyricism. "Power," we are told, "gives way to poetry." Yet the flaw in these gentler interpretations is the same as it is in Odetta's more shouting numbers. Her voice is a deep, broodingly impressive instrument; but in nearly all kinds of material, her use of her voice is curiously stiff. In this set, for instance, although there are moments of genuine relaxation, most of the time Odetta's singing is burdened with a self-consciousness that puts a distance between the singer and her songs. Rarely does Odetta seem to have *become* the song—a magic that sometimes occurs, for example, in the otherwise disparate work of Joan Baez and Jean Ritchie.

In addition to the detachment, there is a heaviness in the phrasing and in the beat. Odetta's rhythm is more plodding

than it is fluid, and she finds it difficult to be either subtle or playful. (Her attempt on Woody Guthrie's *Why, Oh Why*—a dialogue with a child—is labored.) On such traditional ballads as *Shenandoah* and *The Golden Vanity*, there is no distinctive style. She is neither traditional in her approach nor has she achieved her own consistent way of personalizing these venerable songs. Odetta is also diffuse on such current folk-like songs as *Blowin' in the Wind*; and on the Negro material, there is insufficient depth of interpretation. Throughout the album, the voice and the personality fail to fuse into a seizing individuality. *N. H.*

Ⓢ Ⓜ **PETE SEEGER:** *We Shall Overcome.* COLUMBIA CS 8901 \$4.95, CL 2101 \$3.98.

Interest: Protest songs
Performance: Rousing
Recording: Great
Stereo Quality: Vivid

Pete Seeger, who has been putting over folk songs and protest songs in his own forthright, hard-hitting style since the "Talking Union" days of the Thirties, stirs up his following on this record, made at a kind of social-conscious hootenanny in Carnegie Hall. Segregation, middle-class conformity, and other evils of the day are vigorously denounced in ballads sometimes more laudable for their sentiments than for their wit, and the audience whoops, whistles, and cheers. When the performer takes time out for a non-political ditty (*Mail Myself to You*) or finds something powerful he can really get his teeth into (*A Hard Rain's Gonna Fall*), he proves that he can summon more than stock responses. *P. K.*

Ⓢ Ⓜ **THE WEAVERS:** *Reunion at Carnegie Hall—1963.* Lee Hays, Fred Hellerman, Ronnie Gilbert, Erik Darling, Pete Seeger, Frank Hamilton, Bernie Krause (vocals and guitars). *Woke Up This Morning; Wimoweh; San Francisco Bay Blues;* and ten others. VANGUARD VSD 2150* \$5.95, VRS 9130 \$4.98.

Interest: Anniversary celebration
Performance: Zestful
Recording: Excellent

Assembled from two Carnegie Hall concerts in May of 1963, this disc celebrates the Weavers' fifteenth anniversary (they have since disbanded). For the occasion, Weavers alumni Pete Seeger and Erik Darling rejoined the unit. The Weavers were not only the first of the popularizing folk groups to attract a wide public, but through the years never distorted or cheapened their music to insure their popularity. This is not to say that the Weavers had no musical weaknesses.

(Continued on page 116)

audiotape
"it speaks for itself" TRADE MARK

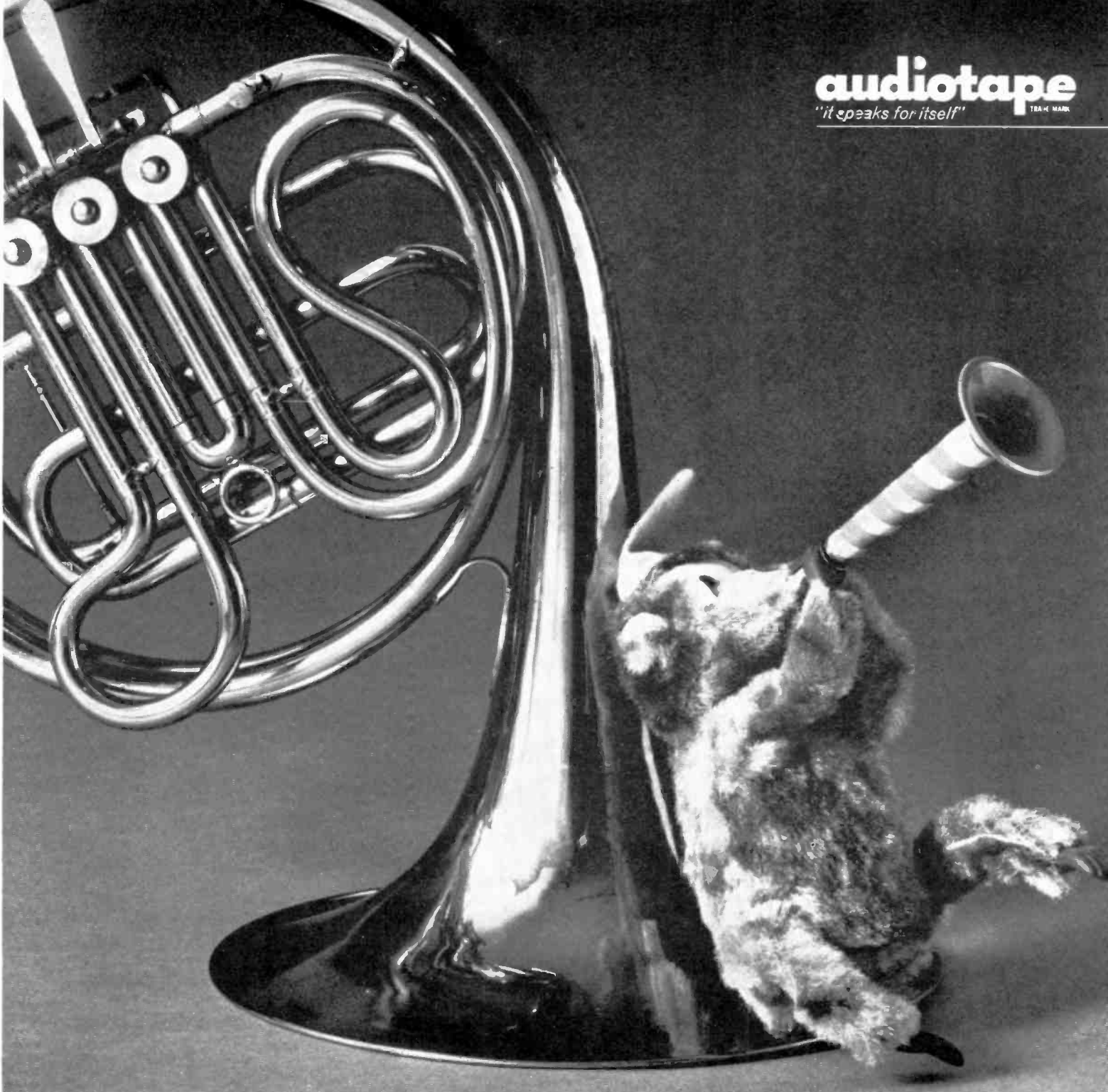

BLOW UP A STORM

(Audiotape will capture every note)

We hope some of you haven't tried Audiotape yet. The reason is simple. Those who always use Audiotape tend to get a bit blasé. They expect to get superb reproduction every time. They accept the fact that Audiotape has remarkable clarity and range and the absolute minimum in background noise and distortion. What else is new?

That's why we hope some of you haven't discovered Audiotape. You'll really ap-

preciate us, especially if you enjoy music. Whether you record a Dixieland combo or a hundred-man symphony, Audiotape captures all the sound. Every instrument comes through as clear as life . . . from the deepest, mellowest note of the French horn to the highest, sweetest sound of the trumpet.

So let 'em all blow up a storm. You won't miss a riff or a glissando as long as you have Audiotape. Try it today.



AUDIO DEVICES, INC.
444 Madison Avenue, New York 22, N.Y.
Offices in: Los Angeles • Chicago • Washington, D.C.

CIRCLE NO. 39 ON READER SERVICE CARD

portable
perfection
for
hi-fi fans



From Denmark comes this aristocrat of portables. Superb AM-FM-Shortwave performance with all the features you can imagine in a high quality portable: one full watt push-pull output and a 5" x 7" speaker, flywheel tuning with slide-rule dial, full range independent tone controls, pushbutton band selection, tuning meter and battery indicator, loudspeaker-earphone output and separate tuner output, plus plug-in connection for an auto antenna and accessory mounting bracket for over-the-road hi-fi.

Write for detailed specifications and test reports.



By appointment
to the Royal Danish Court

DYNACO

DYNACO, INC.
3912 Powelton Ave., Phila. 4, Pa.

From the beginning, their style was eclectic, and though their level of musical integrity was higher than that of such units as the Kingston Trio, they often failed to get at the marrow of many songs in their repertoire.

As this record demonstrates, in songs of social protest (*Banks of Marble* and *If I Had a Hammer*) their performances are not quite biting or bristling enough. And when they sing the blues and other Negro material, they dilute the stylistic traditions of these idioms.

Yet their assets were considerable. High in spirit and warmly contagious, individual members of the group often transcended the collective deficiencies of the whole. In this set, for instance, Erik Darling is starkly dramatic in his story of *Train Time* and Pete Seeger is effectively tender and graceful in *Rambler's Boy*. N. H.

© ① THE GREAT WELSH SINGING FESTIVAL: *A Nation Sings*. Chorus of five thousand voices; Terry James (conductor); Cyril Anthony (organ); Emyr Jones (verse reader). *Dia-dem: Bulth; Rachie; Crimond*; and nine others. LONDON INTERNATIONAL SW 99321 \$4.98, TW 99321* \$3.98.

Interest: Proudful hymn singing
Performance: Soaring
Recording: Superb
Stereo Quality: Excellent

In May of 1963, five thousand Welsh "exiles" of Greater London gathered at Royal Albert Hall for this revival of the traditional Welsh *Gymanfa Ganu*, a festival of massed choirs singing in harmony. This practice became popular in Wales in the late nineteenth century and often functioned as a corollary of the Welsh religious revival that flourished during the same period. During the past few decades, the *Gymanfa Ganu* has declined in Wales, although what the notes accurately describe as "the swell of fervent hymn singing" can still be heard in that country, especially during religious holidays. Nostalgia for this tradition as well as homesickness for Wales itself surely helped create the remarkable emotional unity and force that characterize this on-the-spot recording of the Royal Albert Hall event.

The singing is vibrant and surprisingly well blended in view of the fact that there were no rehearsals. Terry James conducts with an impressive clarity of line and rhythmic shape. Emyr Jones, a Welsh actor and teacher, introduces each hymn by reading the first verse, and the beauty of the rich, rolling music of the Welsh language itself is intensified by the choral singing. The recorded sound is spacious and warm. London has thoughtfully provided the English equivalent for each hymn. N. H.

SPOKEN WORD

◎ BILL COSBY IS A VERY FUNNY FELLOW—RIGHT! Bill Cosby. WARNER BROTHERS 1518 \$3.98.

Interest: Promising comedian
Performance: Moderately funny
Recording: Satisfactory

Mr. Cosby, actually only a moderately funny fellow, is an affable enough companion for an hour or so as he tells the listener about his journeys on New York subways ("they put a nut in every car"), mocks (not too successfully) the performances of ball-players in razor-blade commercials, tells about the hazards of attending a karate school, and delivers some curious insights into the character of Superman. A prolonged, rather fumbling routine about God's dialogue with Noah ends mercifully with the sound of rain. Cosby is a Negro performer who seems willing to leave politics to Dick



PAT HINGLE AND GERALDINE PAGE
Cracklingly alive in O'Neill's "Interlude"

Gregory, and his recording is an encounter with a pleasant, promising, but somewhat undisciplined talent. P. K.

RECORDING OF SPECIAL MERIT

© ① O'NEILL: *Strange Interlude*. Betty Field, Jane Fonda, Ben Gazzara, Pat Hingle, Geoffrey Horne, Geraldine Page, William Prince, Franchot Tone, Richard Thomas. Jose Quintero, director. COLUMBIA DOS 698 five twelve-inch discs \$21, DOL 288* \$19.

Interest: Powerful drama
Performance: Masterly
Recording: Superb
Stereo Quality: Exceptionally good

Early in the course of the three hours, thirty-eight minutes, forty-nine seconds
(Continued on page 119)

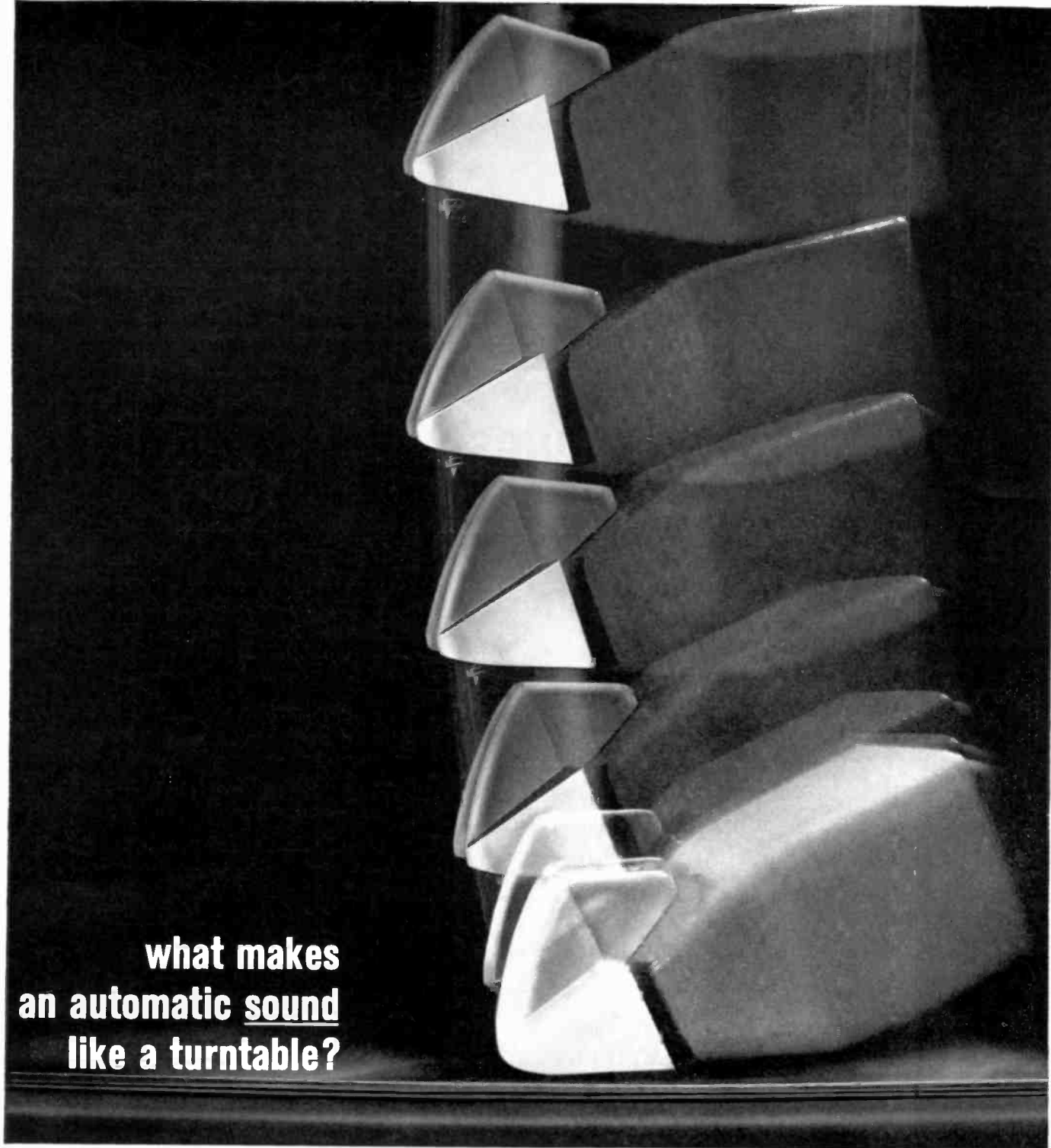

what makes
an automatic sound
like a turntable?

The U38!
expressly designed
for automatic
turntables

The new generation of automatic turntables tracking and tripping at lower and lower forces demands this new kind of cartridge. Demands a "floating stylus" that protects your diamond and record as it plays...demands complementary electrical characteristics which maximize the use of forward-looking circuitry whether vacuum tube or solid state. The U-38 meets these demands and makes your automatic **sound like** a turntable. With Pickering's famous plug-in replaceable stylus assembly you get a cartridge with a life-time of trouble free performance. Pickering and Company, Inc., Plainview, New York.

Pickering



U38 cartridge with
AT Stylus... 2-5 grams tracking force
ATG... 1-3 grams



Plug-in head assembly for
Garrard Type A and Model AT6



NOW...DIRECT TO YOU FROM HiFi/STEREO REVIEW—

THE RECORDINGS YOU WANT!

As a special service to our readers—you can purchase any of the recordings reviewed in this issue directly from HiFi/STEREO REVIEW RECORD SERVICE...and...*At No Increase In Prices* (we pay all charges for packing, handling and postage).

Here is a new service designed especially for you...a quick, easy way to obtain “New Release” and hard-to-get recordings. You don’t have to wait weeks or months ever again for your favorite recordings...they can be yours as fast as the mails can carry them.

Here’s all you have to do. Read the reviews in this issue by the expert music critics. Then decide which recordings you want to buy. Fill out the form below and mail it today. It’s that easy. For quick delivery, order your recordings now!

**HiFi/STEREO REVIEW RECORD SERVICE • DEPT. SC
ONE PARK AVE. • NEW YORK 16, N.Y.**

N

Please send the following records and/or tapes reviewed in this issue.

- Check or Money Order for \$.....is enclosed.
 C.O.D.

(ALL RECORDINGS FULLY GUARANTEED)

PAGE NO. OF REVIEW	TITLE	RECORD (TAPE) NUMBER (SEE REVIEW)	MANUFACTURER	PRICE (SEE REVIEW)

(N.Y.C. residents add 4% sales tax)

Total

Name (please print).....

Address

CityZone.....State.....

Orders must be received no later than April 1, 1964

it takes to hear the nine acts of this astonishing play, recorded as performed last year by the Actors Studio Theatre on Broadway, the listener may start wondering what all the fuss was ever about. Indeed, I found myself speculating whether the whole album couldn't be cut up into fifteen-minute segments and broadcast serially under the sponsorship of some forward-looking soap company. Will broad-shouldered, strong-hipped, straw-blond Nina Leeds find happiness in matrimony with guileless, red-cheeked, lumbering Sam Evans? Why does charming, meticulous Charles Marsden go on writing bloodless books and fail to press his claim on the woman he adores? Will Mrs. Evans' disclosure of family insanity destroy her son's marriage? Will handsome, intelligent, controlled Dr. Darrell remain immune to love?

As the play gathers momentum, however, mental reservations inspired by the awkwardness of scene construction, pat character concepts, unwieldy, humorless dialogue, and the sometimes clumsy device of asides spoken to reveal the inner thoughts of the participants, give way to unquestioning involvement. The grand design unfolds: "Strange interlude! Yes, our lives are merely strange dark interludes in the electrical display of God the Father!" Nina Leeds must bear a son sired by Edmund Darrell, raised by Sam Evans, and protected by Charles Marsden because men are but devices in the shaping of destinies beyond their understanding.

In preparing the text for production, director Quintero cut and pruned drastically so that the playing time would not be unendurable, softened some of the fiercer expressions of love and hate uttered in the famous asides, trimmed long speeches, and eliminated (not always wisely) some lyric flights and O'Neill's tendency to telegraph the twists of the story. He made the most of a gifted cast: Geraldine Page is the essence of Nina, from the hectic young girl to the chastened old woman. Ben Gazzara is brutal and caressing by turns in his portrait of the doctor. Pat Hingle plays the oblivious Sam Evans broadly and affectingly. William Prince as the quiet Marsden, Franchot Tone as the professorial father, Betty Field as the mother who reveals the secret of the Evans family, Jane Fonda as Gordon Shaw's fiancée—all support each other as perfect instruments in the polyphonic expression of what Mr. Quintero has called O'Neill's "muffled poetry." A simple device of deadening stage echo is used for the interior monologues, sound effects are brought in artfully, and all is clear, cracklingly alive, compelling. Use of stereo is exceptionally successful in conveying the quality of vital theater. A handsome booklet with splendid photographs and introductory essays is included. P. K.

MARCH 1964

New Sonotone Sono-Flex[®] Stylus



try this with any other cartridge
(at your own risk)

Here's another reason why the Velocitone Mark IV is the finest cartridge you can select for your record playing system — added protection against stylus damage. The Velocitone Mark IV incorporates a major new development in stylus design, the Sono-Flex[®]. This new assembly grips the stylus shank in a resilient butyl rubber mount. This means you can flex the stylus shank in a 360-degree orbit without breaking it — pluck it, flick it, bend it, bump it — it will spring back and perform as good as new.

Moreover, the Sono-Flex increases the performance capability of the Mark IV by providing higher compliance, wider and flatter frequency response, lower IM distortion — longer stylus and record life.

The Mark IV, newest in the Velocitone series, comes with the new Sono-Flex stylus. However, if you are one of the many of thousands of music lovers now using any cartridge in the Velocitone Series, you can replace your stylus easily with the new Sono-Flex. You'll not only notice the marked improvement in performance, you'll enjoy added protection against stylus damage. The Mark IV with dual diamond styli, \$24.25; diamond/sapphire, \$20.25. At high fidelity dealers everywhere.

SONOTONE CORPORATION Electronic Applications Division Elmsford, New York
In Canada: Atlas Radio Corp., Ltd., Toronto • cartridges • speakers • microphones
• tape heads • hearing aids • headphones

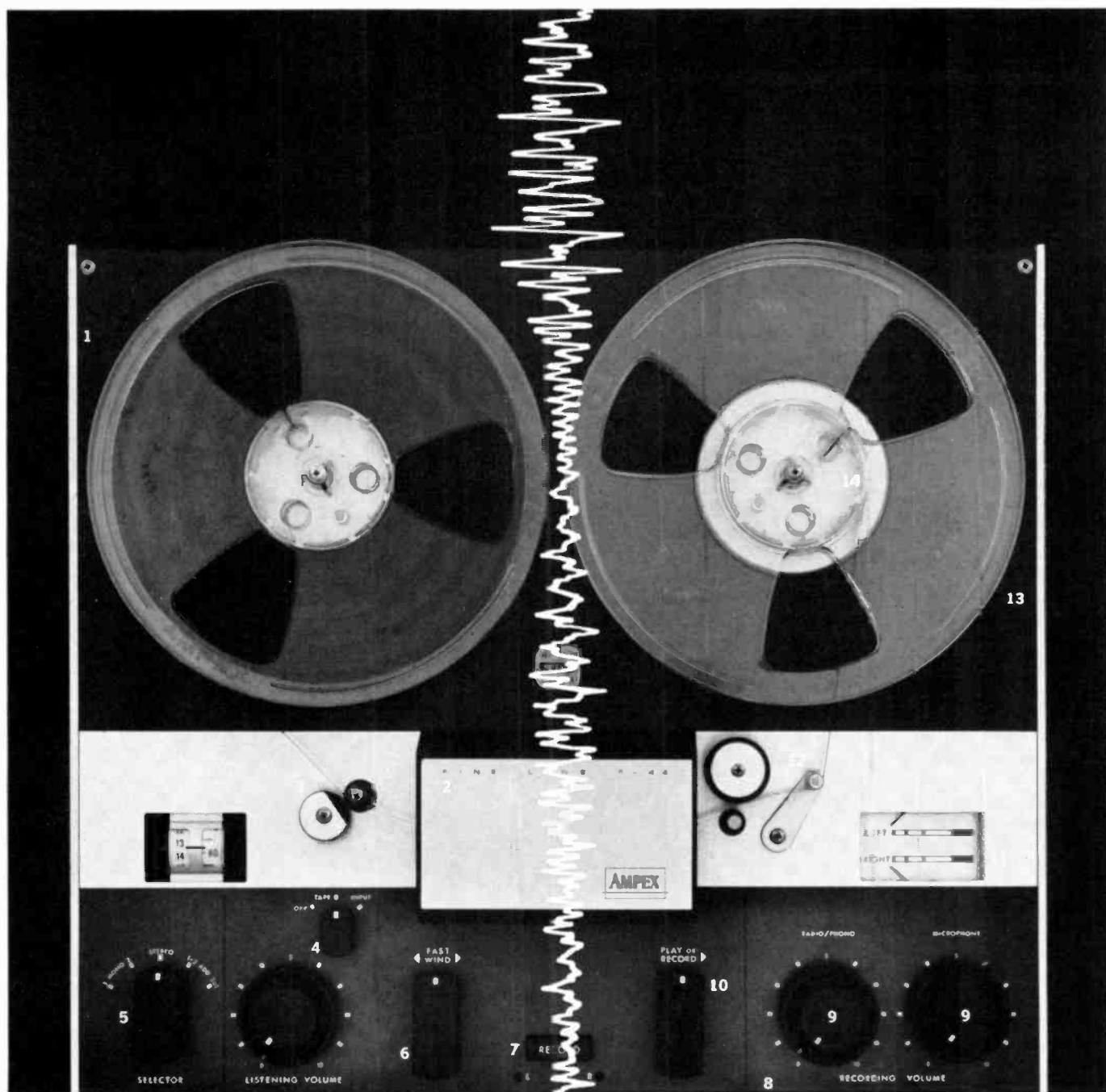

Fourteen ways to save money on your next tape recorder

Before you buy, compare the features of the Ampex F-44 with those of any other recorder in its price range. Note the features the F-44 has that the others don't. Then compare price, and you'll see what a bargain the F-44 actually is. In fact, if you can find a better bargain, buy it. **1) Professional Electronics.** Each F-44 recorder is individually tuned and adjusted by Ampex technicians to meet or exceed the following standards: Overall frequency response 50-15,000 cps \pm 2db at 7½ ips; 50-10,000 cps + 2.4 db at 3¾ ips. Signal-to-noise ratio: better than 53 db. Flutter and wow: 0.12% rms at 7½ ips; 0.18% rms at 3¾ ips. **2) Three separate heads.** Each head in the F-44 is built to perform its own individual task (recording, playing or erasing), with no compromise of purpose in attempting to make one head serve several functions. Precision engineered head shielding virtually eliminates crosstalk. **3) Advanced tape-tension system** eliminates the use of pressure pads, by feeding tape or transporting it past the

heads under constant tension adjusted at the factory. **4) New, separate power and monitor switch** makes it possible to monitor both source and playback while you're recording. **5) Master selector switch** permits simple changes from stereo to mono, choice of individual track, multiple generation sound-on-sound-on-sound.

6) and 10) New compartmentalized mode-to-mode controls. Two knobs control all transport actions, permit going from one mode to another quickly and safely. **7) Record indicator lights.** One for each channel. **8) Die-cast frame.** Micro-milled for meticulous alignment. **9) Built-in mixer,** with separate volume controls for recording of 4 inputs. **11) Separate record level meters.** **12) Exclusive unattended shut-off.** **13) New hysteresis synchronous motor.** **14) Automatic tape take-up.** Eliminates threading. For brochure, write Ampex Corporation, Consumer and Educational Products Division, 2201-B Landmeier Road, Elk Grove Village, Illinois. In Canada, Ampex of Canada Ltd., Rexdale, Ontario.





HIFI/STEREO REVIEW'S CHOICE OF THE LATEST RECORDINGS

STEREO TAPE

Reviewed by CHRISTIE BARTER

RECORDING OF SPECIAL MERIT

Ⓢ **BACH:** *Chorale Preludes. Komm, Gott Schöpfer, heiliger Geist* (S. 667); *Fantasy on Komm, heiliger Geist, Herre Gott* (S. 651); *Triptych on the Holy Trinity: Kyrie, Gott Vater in Ewigkeit; Christe, aller Welt Trost; Kyrie, Gott heiliger Geist* (S. 669-71); *Nun freut euch, lieben Christen g'mein* (S. 734); *Nun komm' der Heiden Heiland* (S. 661); *Vater unser im Himmelreich* (S. 737); *Von Gott will ich nicht lassen* (S. 658); *Wir glauben all' an einen Gott* (S. 680); *Wo soll ich fliehen hin* (S. 646). Edouard Commette (organ). ANGEL ZS 36119 \$7.98.

Interest: New tape repertoire
Performance: Outstanding
Recording: Well defined
Stereo Quality: Satisfying

Since the organ music of Bach is in short supply on tape, this reel of eleven chorale preludes is a substantial contribution to the catalog. None of these works has been previously available in this medium, and only a few are at all familiar. Ranging in mood from the fairly animated *Nun freut euch, lieben Christen g'mein* to the more sober *Fantasy on Komm, heiliger Geist, Herre Gott*, the program is nicely varied and is played by eighty-year-old French organist Edouard Commette with the vigor and sure technique of a man half his age. He favors a leaner texture than most organists of his generation and eschews the mannered registrations and embellishments characteristic of the old school. The organ of the Cathedral of St. Jean in Lyon, where the recording was made and where Commette has served as organist most of his adult life, has the reedy, at times snarling sound typical of a large nineteenth-century instrument. Yet it has been beautifully recorded, despite a good deal of echo. The upper registers are unusually transparent, and the bass is strong. C. B.

Explanation of symbols:

- Ⓢ = stereophonic recording
- Ⓜ = monophonic recording

Ⓢ **BEETHOVEN:** *Symphony No. 6, in F Major, Op. 68 ("Pastoral")*. Chicago Symphony, Fritz Reiner cond. RCA Victor FTC 2119 \$8.95.

Interest: One of Reiner's best
Performance: Kinetic
Recording: First-rate
Stereo Quality: Ditto

But for a coupling of the Berlioz *Nuits d'Été* and Falla's *Amor Brujo* (FTC 2177), and a pair of Haydn symphonies, this is the last we will hear from the late Fritz Reiner. Recorded some three



Fritz Reiner
Exuberant, lyrical, personal

years ago, this "Pastoral" reflects some of the mellowness of his later years, especially in the opening movements, and much of his quite personal view of this work in particular. Poles apart from the altogether genial day in the country depicted by Bruno Walter on Columbia (MQ 370), the more incisive Reiner performance combines exuberance and lyricism within a remarkably flexible context of tempos. Listeners partial to the classical purity of Toscanini may take exception to such an individual approach, but it now stands as the only real alternative to Toscanini on tape. The recorded sound is the best ever

from the Windy City—clean, spacious, and unusually full-bodied. C. B.

Ⓢ **BIZET:** *Carmen*. Regina Resnik (mezzo-soprano), Carmen; Mario del Monaco (tenor), Don José; Joan Sutherland (soprano), Micaëla; Tom Krause (baritone), Escamillo. Chorus of the Grand Théâtre Geneva; Suisse Romande Orchestra, Thomas Schippers cond. LONDON LOR 90070 two reels \$21.95.

Interest: Perennial
Performance: Sinewy
Recording: Excellent
Stereo Quality: Effective

This recording is the year's most infuriating example of great expectations unfulfilled. Thomas Schippers' direction is energetic, a near-marvel of kaleidoscopic color and rhythmic zest, but Regina Resnik's *Carmen* is vocally something less than it might have been, and Mario del Monaco's Don José is an outright disaster. In all probability this is the tenor's worst performance in a recording medium—a performance so irritating in its cavalier disregard for dramatic credibility, its unalleviated high-pressure vocalism, and its reckless slaughter of the French language that it virtually shuts out enjoyment of other contributions to the album. Miss Resnik is known as a splendid *Carmen*, and she re-creates the role here with subtlety and conviction—she is believable, compelling, and seductive by virtue of her portrayal's very rightness without the customary obvious attempt at sex appeal. But Miss Resnik is just not in her best voice here, Joan Sutherland, on the other hand, sings a more ravishing Micaëla than one usually hears in the opera house, and Tom Krause delivers a noble Escamillo—a bit heavy and barrel-chested, but one that deals fairly with the role.

The engineering is superb, the robust sound of the Suisse Romande under Schippers is truly exciting to hear, and the immediacy of the stereo action is striking indeed. The work is handily divided by acts between two reels, one act to a sequence. Notes and libretto are available on request. C. B.

(Continued on page 122)



Professionals know this... that's why all original recordings for L/P records are made on tape. Every professional recorder uses laminated core tape heads for the best sound recording and reproduction.

You want the best in sound or you wouldn't have a tape recorder. Nortronics manufactures quality, professional type, laminated core heads.



Not everyone can afford an expensive professional recorder. But, you can afford Nortronics laminated heads to assure the best possible performance from your recorder.

If you are replacing worn tape heads or purchasing a new recorder, insist on Nortronics because:

*"Music sounds best on tape—
Tape sounds best with Nortronics heads"*

Nortronics 

8129-J 10th Ave. No. • Minneapolis 27, Minn.

Write today for FREE copy of Nortronics Tape Head Replacement Guide.

Name _____
Address _____
City _____ State _____

CIRCLE NO. 38 ON READER SERVICE CARD
122

RECORDING OF SPECIAL MERIT

© HANDEL: *Messiah (excerpts)*. Joan Sutherland (soprano), Grace Bumbry (mezzo-soprano), Kenneth McKellar (tenor), David Ward (bass); London Symphony Orchestra and Chorus, Sir Adrian Boult cond. LONDON LOL 90072 \$7.95.

Interest: Enduring
Performance: Imposing
Recording: Very good
Stereo Quality: Good perspective

Two years ago, commenting on the complete *Messiah* from which these highlights are drawn, I registered my pleasure with the performance (still the best to be had in this medium) and my disappointment with the technical transfer, which was noisy and imperfectly balanced. Subsequent "pressing" undoubtedly remedied these defects, since the present version reveals the eminently satisfying sound originally captured on the master tape. Excerpted here are the tenor's opening *Comfort ye my people and Er'ry valley*, along with the later recitative *He that dwelleth in heaven* and the aria *Thou shalt break them*; Joan Sutherland's richly ornamented voicings of *Rejoice greatly* and *I know that my Redeemer liveth*; the recitative *Behold a virgin shall conceive* and aria *O thou that tellest*, followed by the first part of *He was despised* sung by the then debuting Grace Bumbry; David Ward's largely successful handling of the aria *Why do the nations?*; and three choruses — *And the glory of the Lord*, the indestructible *Hallelujah*, and the concluding *Worthy is the Lamb*. The only collection of *Messiah* highlights currently available on tape, this reel can be recommended without qualification. C. B.

RECORDING OF SPECIAL MERIT

© HAYDN: *Symphony No. 52, in C Minor; Symphony No. 60, in C Major ("Il Distratto")*. Esterhazy Orchestra, David Blum cond. VANGUARD VTC 1674 \$7.95.

Interest: Rare Haydn
Performance: Engaging
Recording: Good
Stereo Quality: Adequate

This, the first in a series of recordings by New York's Esterhazy Orchestra devoted to the early symphonies of Haydn, introduces a real gem—the *Symphony No. 60*, a work in six movements assembled from the composer's incidental music for a comedy performed in Vienna in 1776. The play, *Le Distratt* (*The Absent-Minded One*), was written by Molière's successor at the Comédie Fran-
(Continued on page 124)



be an angel

write to us in London for a free back issue of RECORDS and RECORDING—the illustrated English monthly magazine which is absolutely devoted to records and equipment.

Or send for a trial year subscription, only \$5.25

HANSOM BOOKS

16 BUCKINGHAM PALACE ROAD
LONDON SW1, ENGLAND

ROCK BOTTOM PRICES

GET
OUR
QUOTE

STEREO • HIGH FIDELITY

FREE
RABSONS-57 ST. INC.

119 West 57th St., New York 19, N.Y.
Area Code 212 Circle 7-0070
Diagonally opposite Carnegie Hall

PLUS THESE RABSONS EXTRAS
• Established 1905 58 Years of Reliability
• Franchised Protection Plus
• Rabsons Special Two Year Guarantee
• Easy Payment Plan Up to 24 Months to Pay
• Each Component Double Packed to Insure Safe Arrival... At no extra charge
• Rabsons Sells ONLY Factory Fresh Merchandise in Original Factory Sealed Cartons

SO WRITE RABSONS
Whatever your HI-FI requirements and receive

A \$1.00 genuine Miracle Record Cleaning Cloth with EVERY Quotation from Rabsons on a component or system of your choice.

CIRCLE NO. 42 ON READER SERVICE CARD
HIFI/STEREO REVIEW

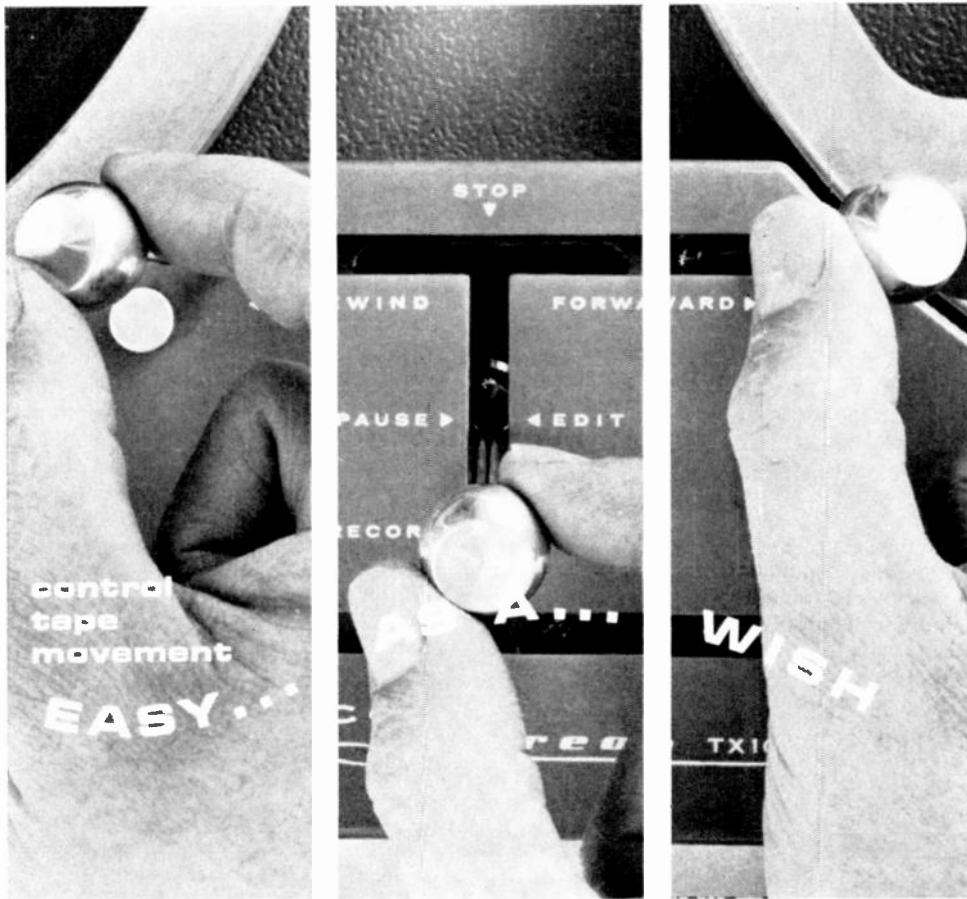

THE NEW **NEWCOMB** TX10 SERIES

STEREOPHONIC TAPE RECORDERS

SOUND ON SOUND UNLIMITED / HYSTERESIS SYNCHRONOUS MOTOR/MONITOR FROM TAPE OR PRE-AMP/TAKES 10½" REELS

Designed for instant, intuitive reaction to your thought, the Newcomb TX10 integrates all tape motion control through a single, central joystick. But this is only the beginning. The TX10 is outstanding for its simple, straightforward, dependable operation; exceedingly gentle tape handling; quietness; coolness. Small as a suitcase in size, big as a studio in scope, the TX10 has separate mixing controls for each channel. There is a separate knob for "Mike" and a separate—not concentric—knob for "Line" for each channel. Two recording-level/playback-volume meters are arranged pointer-to-pointer in the same illuminated window for ready stereo comparison. Plug-in transformers instantly convert mike channels for use with low impedance microphones. The TX10 has three heads, no pressure pads on heads. Major tape guides are stainless steel. To load the machine, tape is simply held in a straight line and dropped in the slot; automatic shut-off and supply reel take-up are automatically re-set. The new hysteresis motor is cool, quiet, unusually powerful. Differential braking on both reels and a unique tape tensioner provide non-spill, no-stretch, ever-so-gentle stops even with fully loaded 10½" reels rewinding at the rate of 2400 feet in 90 seconds—18 miles per hour! A four-digit counter gives accurate location even with a full reel of triple-play tape. You can record sound on sound, back and forth as many times as you wish, either channel serving as master. All TX10 models are two-speed machines. The push-push speed selector automatically supplies proper speed-frequency correction. There are four models in the series. Standard are 3¾-7½ i.p.s. recorders with either two or four tracks. On special order you can get 7½-15 i.p.s., two or four track. Throughout, the Newcomb TX10 is the instrument for the perfectionist—dedicated professional or amateur enthusiast. For a description in depth write for your free copy of the new TX10 brochure.

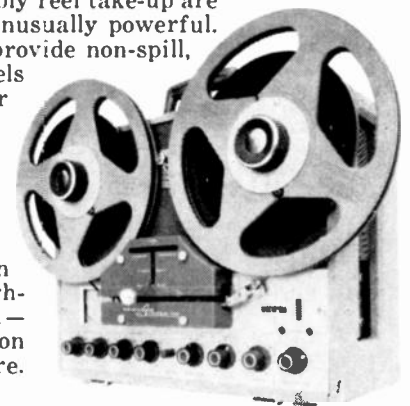

NEWCOMB AUDIO PRODUCTS CO., Department HF-3, 6824 Lexington Avenue, Hollywood 38, California

CIRCLE NO. 36 ON READER SERVICE CARD

Telex phones
put individual
Channel Control where
it belongs...



AT YOUR FINGERTIPS

(and only TELEX has it)

Convenience... Precision channel control for perfect stereo balance... Freedom from the extra cost and encumbrance of a separate headphone control center.



That's what you get in the new Telex ST-20 stereo-phones. Smoothly styled control knobs on each earpiece provide separate sound level control for each channel. Exclusive with Telex, this superb fingertip convenience means you always listen at the ideal sound level... the ideal stereo balance.

Insist on seeing... and hearing... the amazing new Telex ST-20 with INTEGRAL

CHANNEL CONTROL. You'll thrill to the kind of pace setting performance you would expect from 26 years of Telex acoustic engineering leadership. Faithful, flawless sound provides breathtaking stereo realism for the most exacting. 16-15,000 cps. 4-16 ohms. Super soft cushions for the ultimate in noise abatement and comfort. \$29.15

A Product of Sound Research



TELEX/Acoustic Products

3054 Excelsior Blvd. • Minneapolis 16, Minn.

TELEX

CIRCLE NO. 54 ON READER SERVICE CARD

Pre-recorded 4 Track Stereo Tape at Cost!

Through Our Special Membership Plan Citadel Membership — Proven by thousands of satisfied club members because...

- **YOU DECIDE ON YOUR PURCHASES** — Buy as few or as many tapes as you want.
- **FREEDOM OF SELECTION** — Virtually any tape, on any label, by any artist is available.
- **FREE! COMPLETE TAPE CATALOG** — With membership you receive this current catalog of all 4-track stereo tapes.
- **PROMPT SERVICE** — Many orders are shipped the day received... rarely later than the next several days.
- **100% GUARANTEE** — All tapes are guaranteed factory fresh and free of defects.

(Special! All LP records also available under your Citadel Tape membership.) Membership dues is \$4.00 a year... a nominal amount when you consider that as a CITADEL MEMBER BUYING TAPES AT COST, YOUR DUES WILL BE PAID FOR WITH VIRTUALLY THE FIRST PURCHASE YOU MAKE THROUGH THE CLUB. Additional savings quickly mount up, permitting you to buy many more tapes on your tape budget. Try membership for 30 days. If not completely satisfied, your dues will be refunded immediately. Complete the coupon below, include your \$4.00 yearly dues and upon receipt we shall forward all membership material to you.

CITADEL TAPE CLUB

division Citadel Record Club ST-34
545 Fifth Ave., New York 17, New York

Name _____
Street _____
City _____ Zone _____ State _____

CIRCLE NO. 66 ON READER SERVICE CARD

Why?

DO THOUSANDS OF HI-FI
ENTHUSIASTS BUY FROM
AUDIO UNLIMITED

It's Obvious!

- **LOWEST PRICES**
- **FAST SERVICE**
- **FACTORY SEALED UNITS**
- **FULLY INSURED SHIPMENTS**
- **UP TO 2 YEAR MANUFACTURERS' WARRANTY**
- **TIME PAYMENT PLAN**
 - only 10% down
 - up to 36 months to pay
- **FRANCHISED DISTRIBUTORS**

Write for **FREE** Catalog Today

**SEND US YOUR LIST
FOR OUR AIR MAIL
QUOTE TODAY**

Visit Our Showroom and Warehouse



AUDIO unlimited, inc.

715-S Second Ave., (Nr. 38) New York 16, N.Y.
3 blocks from the U.N.

CIRCLE NO. 9 ON READER SERVICE CARD

aise, Jean François Regnard, around the turn of the eighteenth century. Although Haydn referred to the score as an "old pancake," he obviously took great pleasure in drawing a musical portrait of Regnard's scatterbrain hero and at the same time a beguiling caricature of himself. At one point he strikes up a theme reminiscent of the opening theme of his own "Farewell" Symphony, as if to imply that distraction has led him to forget what symphony he is writing. Elsewhere abrupt changes in key, random quotes of French or Balkan folk tunes, and sudden shifts in rhythm further suggest a composer at play. David Blum deftly conveys this playfulness in a performance brimful of mischievous high spirits. On the second side he conducts the equally neglected Symphony No. 52, a felicitous piece that has drama in the outer movements and eloquence in the muted Andante. The tape submitted for review seemed a little weak on the right channel, but the over-all sound was clean and warm, with fine balances between strings and winds.

C. B.

© MENDELSSOHN: *A Midsummer Night's Dream—Incidental Music, Op. 61*. Arlene Saunders (soprano), Helen Vanni (mezzo-soprano), Inga Swenson (narrator); chorus: Boston Symphony Orchestra, Erich Leinsdorf cond. RCA Victor FTC 2141 \$8.95.

Interest: Musical fantasy
Performance: Conscientious
Recording: Satisfactory
Stereo Quality: Fine

The overture and nine of the twelve sections of the score Mendelssohn composed to accompany Shakespeare's *A Midsummer Night's Dream* are offered in this recording, more than in any other version so far on tape. They include the familiar Scherzo—which Erich Leinsdorf conducts with spirit and refinement after a fairly labored reading of the overture—the March of the Fairies, the fairies' song "You spotted snakes," the Intermezzo, the Nocturne—a warm and tender thing in this performance, notable for a glowing horn solo—the Dance of the Clowns, the Wedding March, and the finale. The last, and the song "You spotted snakes," call for vocal soloists and chorus, and both are sung with the appropriate delicacy. The narration by Inga Swenson of lines from the play is likewise effective, imparting some sense of the uses to which the music is put in a stage production. The recorded sound is a little muddy and dynamically constricted in the first sequence of the tape submitted for review, but the second sequence sounds fine. Program notes, promised on the outside of the package, were not enclosed.

C. B.

(Continued on page 126)

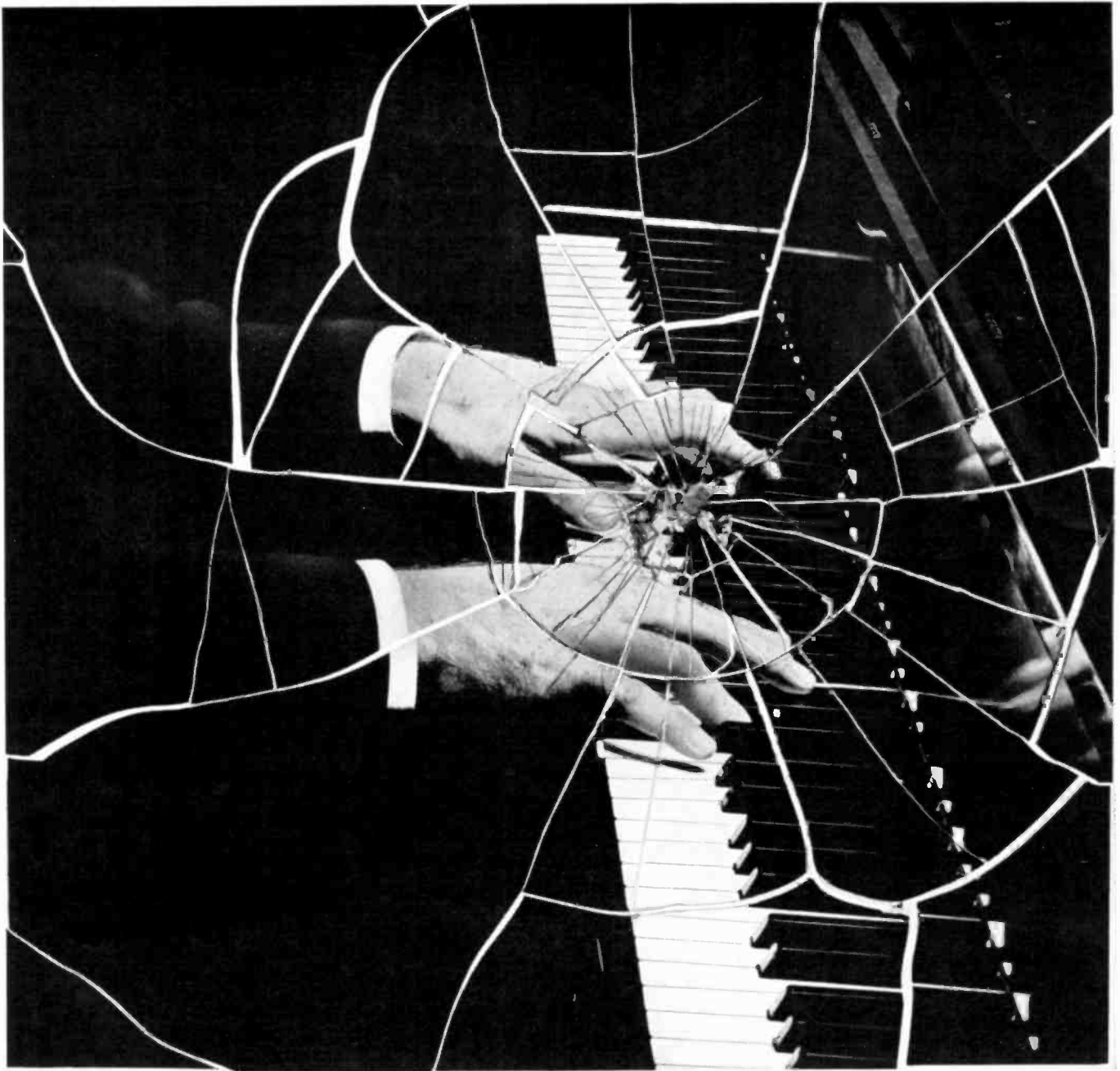

Cracked cadenzas in your concerto?

...then "bargain" recording tape's no bargain!

Mistakes you can buy cheap. And tape-making mistakes you're almost sure to get in recording tape sold dirt cheap without the manufacturer's name. The dangers for audiophiles? Fade out of high and low frequencies. Distortion. Background hiss. Even tape flaking, or worse, abrasiveness that can damage your recorder. Worth the gamble? Hardly.

You can make fine performance, long-life crystal-clear recordings a certainty by specifying "SCOTCH" BRAND Recording Tapes. All "SCOTCH" Tapes must pass over 100 quality tests to earn their "brand"... tests no bargain tape could hope to pass!

Thinner, more flexible coatings of high-

potency oxides assure intimate tape-to-head contact for sharp resolution. Precision uniformity of coatings assures full frequency sensitivity, wide dynamic range, *plus* identical recording characteristics inch after inch, tape after tape. Lifetime Silicone lubrication further assures smooth

tape travel, prevents squeal, protects against head and tape wear. Complete selection of all purpose tapes—from standard to triple lengths, with up to 6 hours recording time at 3¾ ips. **See your dealer. And ask about the new "SCOTCH" Self-Threading Reel. Remember . . . on SCOTCH® BRAND Recording Tape, you hear it crystal clear.**



Magnetic Products Division **3M** COMPANY

"SCOTCH" AND THE PLAID DESIGN ARE REG. TMS OF 3M CO., ST. PAUL 19, MINN. © 1964, 3M CO.



SPECIAL VALUE!

5-SOCKET CONTINUITY TESTER

\$9⁹⁵
VALUE

ONLY **\$3⁹⁵**

Instantly tests filaments in radio and TV tubes, and indicates which are burned out. Ideal instrument for checking all household appliances. Fits all types of tube bases—7-pin, 9-pin, octal, loctal and TV picture tubes. Operates on 117V AC-DC. Now at an extraordinary low price.

**FULLY GUARANTEED!
ORDER TODAY!**

Consumer Service Company HF34
589 Broadway
New York 12, New York

Please send me _____ Continuity Testers at \$3.95 each (N.Y.C. residents please add 4% Sales Tax). My check (or money order) for \$_____ is enclosed. I understand that you will pay the postage and that each Continuity Tester is fully guaranteed.

Name _____

Address _____

City _____ Zone _____ State _____

(SORRY—No Charges or C.O.D. Orders.)

COLLECTIONS

⑤ **KIRSTEN FLAGSTAD: *In Memoriam***. Wagner: *Die Walküre: War es so schmäglich: Der Männer Sippe; Du bist der Lenz. Das Rheingold: Wotan, Gemahl! Erwache! Wesendonck Lieder: Im Treibhaus; Träume*. Kirsten Flagstad (soprano), Claire Watson (soprano), George London and Otto Edelmann (bass-baritones); Vienna Philharmonic, Hans Knappertsbusch and Georg Solti cond. LONDON LOL 90068 \$7.95.

Interest: Stop-gap tribute
Performance: Incomparable
Recording: Good
Stereo Quality: Adequate

This recording was released within weeks of Kirsten Flagstad's death last summer, and perhaps it added to London's sales figures for the year. But, as a patchwork made up for the most part of maddeningly brief excerpts from the company's complete Flagstad Wagner performances, it has practically no value on tape aside from the extended scene from *Die Walküre* ("War es so schmäglich") occupying the second sequence. The fade-outs that end the two- to eleven-minute excerpts on the first side are annoying, and tape noise is unreasonably high. Neither texts nor translations are provided with the package. C. B.

⑤ **MORMON TABERNACLE CHOIR: *The Lord's Prayer, Volumes I and II***. Mormon Tabernacle Choir, Richard P. Condie director; Philadelphia Orchestra, Eugene Ormandy cond. COLUMBIA MQ 579 \$11.95.

Interest: Devotional grab-bag
Performance: Sincere
Recording: Very good
Stereo Quality: Ditto

The contents of this twin-pack are presently available on two standard-length reels (MQ 324 and MQ 488), but together they represent a bargain for devotees of the larger-than-life Mormon Tabernacle Choir. The first sequence, headed by Leroy J. Robertson's relatively new setting of *The Lord's Prayer*, contains works more familiar than those in the second: Brahms' "Blessed Are They That Mourn" from the *German Requiem*, the Sanctus from Gounod's *Messe Solennelle*, and the well-known "For Unto Us a Child Is Born" from Handel's *Messiah*, along with two rather dubious (in this context) entries—the traditional *Londonderry Air* and *Battle Hymn of the Republic*. Interest picks up in the second sequence with the "Hallelujah, Amen" from Handel's *Judas Maccabaeus*, Virgil Thomson's simply affecting paraphrase of the Twenty-third Psalm ("My Shepherd Will Supply My Need"),

L. Stanley Glarum's spirited "O Be Joyful," and the touching "Lord, Hear Our Prayer" from Verdi's *Otello*. The concluding selection, appropriately, is the popular setting of *The Lord's Prayer* composed in 1935 by Albert Hay Malotte. It all makes for a fairly lengthy program, but the choral arrangements are quite straightforward, and the massed voices of the Salt Lake City Mormons are impeccably recorded. C. B.

ENTERTAINMENT

⑤ **HERE'S LOVE** (Meredith Willson). Original-cast recording. Janis Paige, Craig Stevens, Laurence Naismith, Paul Reed; orchestra and chorus, Elliot Lawrence cond. COLUMBIA OQ 602 \$9.95.

Interest: Undistinguished score
Performance: Hearty
Recording: Excellent
Stereo Quality: Serviceable

The best thing about this show, on tape at least, is Meredith Willson's musical recreation of Macy's Thanksgiving Day parade, which fills a good half of the first sequence with an effective use of stereo techniques. Along with a march-time treatment of *Adeste Fideles* that strikes me as being in doubtful taste, this scene includes *The Big Clown Balloons*, a number similar in color and spirit to *Seventy-Six Trombones*, that is belted out by full chorus and a complement of brass passing from left to right. But after this rousing start, the score heads straight for the shoddy-goods department and rarely again rises above bargain-basement level. Janis Paige, in her first musical since *Pajama Game*, wastes her still considerable talent on some second-rate material, as do Craig Stevens, on loan from *Peter Gunn*, and Laurence Naismith, playing the real Kris Kringle unwittingly hired by Macy's as its Santa Claus. The magic of the movie *The Miracle on 34th Street*, on which this show is based, is only momentarily glimpsed here—in a jolly salute to Santa, *That Man Over There*, sung by R. H. Macy (Paul Reed). C. B.

⑤ **CHARLIE MINGUS: *The Black Saint and the Sinner Lady***. Charlie Mingus (bass, piano), Rolf Ericson and Richard Williams (trumpets), Quentin Jackson (trombone), Charlie Mariano (alto saxophone), Dick Hafer (tenor saxophone, flute), Jay Berliner (guitar), Dannie Richmond (drums). IMPULSE ITC 308 \$7.95.

Interest: Mingus self-absorbed
Performance: Intense
Recording: Good
Stereo Quality: Pronounced

(Continued on page 129)

HiFi / STEREO MARKET PLACE



TAPEMATES

Makes available to you:

- ALL 4-Track Tapes
- ALL labels
- POSTPAID to Your Door

At **40%** Savings

FREE BROCHURE 5280-B West Pico Blvd., Los Angeles 19, Calif

FAST SHIPMENTS

COMPONENTS • KITS

RECORDERS • TAPES

- BEST-BY-COMPARISON PRICES
- FACTORY SEALED CARTONS
- SEND FOR "QUOTES" ON PACKAGE DEALS AND SAVE MORE

WRITE FOR MONTHLY SPECIALS
VISIT OUR STORE
CARSTON Studios
125-H East 88 St., New York 28, N. Y.

DIXIE

HIGH FIDELITY WHOLESALERS

Largest discount High Fidelity component distributors in the South. Wholesale prices on package or individual components. Latest models in factory sealed cartons. Special attention given to Audio Clubs, Churches and Schools.

Are prices too high?—Write

DIXIE HI-FI

703 Horton Drive, Silver Spring, Md.

BRITISH HI-FI COSTS LESS WHEN YOU BUY DIRECT

FROM

C. C. GOODWIN (Sales) Ltd.
The U.K. Hi-Fi Mail Order Specialists

All equipment carefully packed, insured and shipped promptly at minimum cost.

Send \$1 bill for illustrated catalogue (refundable on first purchase) and details of HiFi equipment required to:

DEPT. HS, 7, BROADWAY, WOOD GREEN, LONDON, N. 22, ENGLAND



WOLLENSAK

Tape Recorders deliver a wall-to-wall bigger than many twice the size.

ATTN: SCHOOLS & GOVERNMENT PURCHASING AGENTS. We have the most complete selection anywhere. New models include: 524, 1400, 1440, 1500, 1515-4, 1570, 1780, 1580, 1980, 1981 and 422, & SA-421 speaker/amplifiers. Whether you order 1 or 1000 units, your order receives prompt attention.

REQUEST COMPLETE TAPE RECORDER DISCOUNT SHEET



SAXITONE RECORDING TAPE

275' plastic, 3" tin multiple track .35
600' acetate (plastic), 7 inch .75
900' MYLAR 5 inch reel .85
900' MYLAR (Polyester), 7 inch .89
1200' MYLAR 1 1/2 mil. 5 inch reel 1.18
1200' MYLAR, tensilized, 5 inch 1.59
1200' acetate (plastic), 7 inch 1.15
1200' MYLAR, 1 1/2 mil., 7 inch 1.29
1800' acetate (plastic), 7 inch 1.39
1800' MYLAR 1 mil. thick, 7 inch 1.89
2400' MYLAR, untensilized, 7 inch 2.59
2400' MYLAR, tensilized, 7 inch 2.89
(Greater discounts to quantity buyers)

Plus Postage Save

30-60%

4-track Stereo music on tape. FREE 50-page catalog

SAXITONE

div. Commission Electronics, Inc.
1776 Columbia Rd., N.W., Wash. 9, D.C.

How to edit your mother-in-law — instantly!

Treat yourself to a precision EdiTail Tape Editing and Splicing Block and do things with tape you've never done before. EdiTail's patented curved groove lets you splice, edit, reassemble without clips or gadgets. You cut and splice where you want to—quickly, undetectably. Used professionally all over the world, EdiTail is the standard editing block—so simple, so accurate, you'll become an expert tape editor in no time. And think how proud your mother-in-law will be! S-2 (Adhesive-Mount) \$6.50 • KS-2 (Complete Kit)—\$7.45 • S-3 (Mounting Holes) \$8.00 • KS-3 (Complete Kit)—\$8.95. At your dealers or write:

THE TALL COMPANY
27 East 37th Street • New York, N. Y. 10016

save over 40% on hi-fi

Write for our price now. You'll be glad you did.

Easy pay plan. Up to 24 mos. to pay

- 15 day money-back guarantee
- Full 2 yr Warranty-Parts & Labor.
- Factory Franchised all lines. We ship from stock.
- Trade-ins Highest allowance—Send your list.
- Citizens Band, P.A. Systems in stock.
- 19th year of reliable service-world-wide.
- We guarantee "WE WILL NOT BE UNDERSOLD."

Best Buy. Hi-Fi List Free.

HI-FIDELITY CENTER
"The House of Low Prices"

1797-H 1st Ave
N.Y., N.Y., 10028

SAVE MONEY ON HI-FI COMPONENTS

TAPE RECORDERS
TAPES, ACCESSORIES
SLEEP LEARN KITS

MERITAPE

Low cost, high quality recording tape, in boxes or cans.

SEND FOR FREE CATALOG

DRESSNER
1523 JERICHO TPKE,
NEW HYDE PARK 21, N.Y.

PROMPT DELIVERY

LOW PRICES

AMPLIFIERS — MULTIPLEX —
TAPE RECORDERS, TUNERS
SPEAKER SYSTEMS, ETC.
AIR MAIL QUOTES — COMPARE
WRITE FOR CATALOG

AUDIO DIVISION
L. M. BROWN SALES CORP
Dept. S—242 West 10th Street • New York 14, N. Y.

WRITE FOR QUOTATION
ON ANY HI-FI COMPONENTS

SOUND
REPRODUCTION, INC.

34 New Street, Newark 2, N. J.

Mitchell 2-6816

RENT

STEREO TAPES

- Over 2500 different, 4-track
- No deposit on tapes rented
- Postpaid 2 to 5 day delivery (48 States)

FREE BROCHURE

stereo-parti

1616 B Terrace Wy, Santa Rosa, Calif.

LEARN WHILE YOU SLEEP



Headquarters

Experiment in this fascinating, educational new field. Use your phonograph, recorder or amazing new *Electronic Educator* endless tape recorder. We carry a full line of endless repeating tape cartridges for all makes of standard recorders plus automatic timers, pillow speakers and complete outfits. Also over 200 unusual educational and self-help courses on tape and record for sleep-learning and hypnosis experimenters. Write for free 300 items catalog and full astonishing details.

Sleep-Learning Research Association
P. O. Box 24-Y, Olympia, Washington

HiFi/STEREO SHOPPING CENTER

RATE: 40¢ per word. Minimum 10 words. April issue closes March 5th. Send order and remittance to: Martin Lincoln, HiFi/STEREO REVIEW, One Park Ave., N.Y.C. 16

EQUIPMENT AND ACCESSORIES

COMPONENTS at lowest prices anywhere. Write for catalog. The Macalester Corporation 355 Macalester Street, St Paul 5, Minnesota.

KIT Experts—Dynaco Specialists Kits at reasonable prices are our specialty. Also custom wired kits guaranteed to exceed factory standards at substantial savings. Beautiful handcrafted Walnut cases for complete Dynaco line starting \$15.00 each. Plus everything in audio. Kitcraft, 738 Washington Avenue, Brooklyn, New York 11238, MA 2-6946.

LOW. Low quotes: all components and recorders HiFi, Roslyn 9 Penna.

WRITE for quotation on any Hi Fi components: Sound Reproduction Inc., 34 New St., Newark N.J. Mitchell 2-6R16.

SALE items—tapes—recorders—component quotations. Bavlta—Box 131R—Wantagh, N.Y.

BEFORE You Buy Receiving Tubes. Test Equipment, HiFi Components, Kits, Parts, etc. . . . send for your Giant Free Zalytron Current Catalog, featuring Standard Brand Tubes: RCA, GE, Etc.—all Brand New Premium Quality Individually Boxed. One Year Guarantee—all at Biggest Discounts in America! We serve professional servicemen, hobbyists, experimenters, engineers, technicians. Why Pay More? Zalytron Tube Corp., 461 Jericho Turnpike, Mineola, N.Y.

TRANSISTORIZED Products importers catalog, \$1.00 Intercontinental, CPO 1717, Tokyo, Japan.

CANADIANS—Giant Surplus Bargain Packed Catalogs. Electronics, HiFi, Shortwave, Amateur, Citizens Radio. Rush \$1.00 (refunded). ETCO, Dept. Z, Box 741, Montreal, CANADA.

HARPSICORDS—Clavichords fine European instruments at reasonable prices. Write 3101 Summit Road, San Bruno, California.

Hi-Fi Components, Tape Recorders at guaranteed "We Will Not Be Undersold" prices. All brands in stock. 15 day money back guarantee. 2 year warranty. Write for quotation, your requirements. No Catalog. Hi-Fidelity Center-1797 1st Ave., N.Y. 28, N.Y.

BRAND New Tubes, World's lowest prices on Radio, TV-industrial-special purpose tubes. Write for free parts catalog. United Radio, Newark, N. J.

SAVE Money—Free catalog: Photography, Tape Recorders, Hi Fidelity, Electronics, Tools. Wholesale Radio & Camera Company, Box 3085, Philadelphia 50, Pennsylvania.

"BUY British—Buy Best! For the finest in all High Fidelity Equipment write for our quotation first. The Hi-Fi Export Specialists! Send \$1 for catalogue. When in England call and see us. Telesonic Ltd. 92 Tottenham Court Road, London, W.1, England."

WRITE for lowest quotations, components, recorders. No Catalogs. Hi-Fidelity Supply, 2817-TC Third, New York City 55.

TAPE recorders. Hi-Fi components. Sleep Learning Equipment, tapes. Unusual values. Free catalog Dressner, 1523HF Jericho Turnpike, New Hyde Park 9, N.Y.

The Price is Right! Hi-Fi Components. J. Wright Co., 65-B Jensen St., East Brunswick, N.J.

TOP Brand Tubes at Terrific Savings. If you need new radio, television or special purpose electron tubes, you'll want our free catalog. Metropolitan, 443 Park Ave. So., N.Y. 16, N.Y., MU-6-2835.

CUSTOM built audio components—basics, preamplifiers, etc. Kits wired. Beco-4, 436 Hatcher, Rocky Mount, Va.

PRINTING: Service, Repair, Purchase Forms, (Catalog.) Okayprint, 101 Walnut, Martins Ferry, Ohio.

TAPE AND TAPE RECORDERS

RENT Stereo Tapes—over 2,500 different—all major labels—free brochure. Stereo Parti, 1616-G Terrace Way, Santa Rosa, California.

SAVE 30-60% Stereo music on tape. Free bargain catalog blank tape recorders, Norelco speakers. Saxitone, 1776 Columbia Road, Washington, D.C.

SELF-Hypnosis. New concept teaches you quickly by tape or LP-record. Free literature. McKinley Publishers, Dept. T4, Box 3038, San Bernardino, Calif.

TAPE Recorder Sale. Latest models, \$10.00 above cost. Arkay Sales, 22-11 Riverside Ave., Medford 55, Massachusetts.

RECORDERS. Tapes. Wollensak, Scotch, Revere. Free catalog! Towers, Lafayette Hill, Pa. 19444

PRIVATE Collection of President Kennedy's taped public speeches, debates, news conferences, will be duplicated. Almost 100 complete events. Free list of tapes, rates. Stephen Novak, 329 Parish Drive, Wayne, New Jersey.

BEFORE renting Stereo Tapes try us. Postpaid both ways—no deposit—immediate delivery. Quality—Dependability—Service—Satisfaction prevail here. If you've been dissatisfied in the past, your initial order will prove that this is no idle boast. Free Catalog. Gold Coast Tape Library, Box 2262, Palm Village Station, Hialeah, Florida.

MUSIC

POEMS wanted for songs and records. Send poems. Crown Music, 49-RB West 32, New York 1.

RECORDS

RARE 78's. State Category. Write Record-Lists, P.O. Box 2122, Riverside, California.

"HARD TO Get" records—all speeds, Record Exchange, 812 Seventh Avenue, New York, N.Y.

LPs Like new, top labels. \$1.00 for lists refunded first order. Records, Hillburn P.O., Hillburn, N.Y.

CASH for unwanted LPs. Reder, 81 Forshay Rd., Monsey, N.Y.

THE Record Collector Journal—comprehensive, valuable data, varied record mart. Introductory six issues—\$1.50. Record Research, 131 Hart, Brooklyn 6, N.Y.

SUPRAPHON RECORDS AT ONLY \$2.45 EACH, plus postage. Dvorak, Janacek, Honegger, Shostakovich, etc. List of 500 titles mono/stereo available free. Also large deletions list, or 78 r.p.m. vocals, 50 pages air mail \$1.00. The Gramophone Shop, 901, Dumbarton Rd., Glasgow, W.1, Gt. Britain.

POLART Index to Record Reviews—1963 edition covers fourteen periodicals including HiFi/Stereo Review. \$1.50. Polart, 20115 Goulburn, Detroit, Mich. 48205.

LIFETIME Listening Treasure! Herman Chittison—"That's All." Magnificent Treasury of all-time favorites by one of the true piano greats of our time. Reminiscence as Herman plays songs like Little Girl Blue, Smoke Gets in Your Eyes, Why, Tangerine, Easy to Remember, Touch of Your Lips, Dancing on the Ceiling, and Funny Valentine. Comes to you in astounding stereo (\$5.98), Monaural (\$4.98). L'Elegant, Suite 600HF, 110 W. 47th, NYC 10036.

REPAIRS AND SERVICING

ALL Makes of Hi-Fi Speakers Repaired. Amprite, 168 W. 23 St., N.Y.C. 10011. CH 3-4812.

TAPE Recorder and HiFi repairs. Amplifiers, tuners, turntables. All American and foreign makes serviced. Estimates in 48 hrs. after receiving equipment from any part of U.S. Macken Electronics, 5 West Post Road, White Plains, N.Y., WH9-9777.

TV Tuners Rebuilt and Aligned to Specifications. Guaranteed All Makes, One Price, \$9.50 Complete. Plus Shipping. Valley Tuners, 5641-H Cahuenga Blvd., North Hollywood, California.

Hi-Fi Problems solved by "The Hi-Fi Doctor" on the spot. Audio, Acoustic, Radio Engineer, Professional visits, day, evening. New York area. William Bohn, Plaza 7-8569.

TELEFIXIT Alltime Bestseller Nontechnical TV Repair Book with Famous Troubleshooting Charts, 60¢ postpaid 2 for \$1.00. Telefixit, Box 714, Manhasset 4, N.Y.

PATENTS

INVENTIONS: Ideas developed for Cash/Royalty sales. Raymond Lee, 2104G Bush Building, New York City 36.

BOOKS

PUBLISH your book! Join our successful authors: publicity advertising promotion, beautiful books. All subjects invited. Send for the appraisal and detailed booklet. Carlton Press, Dept. ZDC, 84 Fifth Avenue, N.Y.C. 11.

AUTHORS' Learn how to have your book published, promoted, distributed. Free booklet "ZD," Vantage, 120 West 31 St., New York 1.

WANTED: Book manuscripts, all descriptions: fiction, nonfiction, religious, adventure, romance, biography, etc. for sale to royalty publishers. Write: Literary Agent Mead, Dept. 39A, 915 Broadway, N.Y.C. 10.

"POSTAGE Saving Guide!" \$1.00. Billera, 38 Circle Drive, Syosset, New York 11791.

BUSINESS OPPORTUNITIES

INVESTIGATE Accidents—Earn \$750 to \$1,000 monthly. Men urgently needed. Car furnished. Business expenses paid. No selling. No college education necessary. Pick own job location. Investigate full time. Or earn \$6.44 hour spare time. Write for Free Literature. No obligation. Universal, CZ-3, 6801 Hillcrest, Dallas 5, Texas.

I MADE \$40,000.00 Year by Mailorder! Helped others make money! Start with \$10.00—Free Proof. Torrey, Box 3566-N, Oklahoma City 6, Oklahoma.

EARN Extra money selling advertising book matches. Free samples furnished. Matchcorp., Dept. MD-34, Chicago 32, Illinois.

SELL Electron Tubes. Liberal Commissions. Territories Available Throughout World. Write in Confidence to Box 112, Hi Fi Stereo Review, One Park Ave., New York 16, New York.

MAKE \$25-\$50 weekly clipping newspaper items for publishers. Some clippings worth \$5.00 each. Particulars free. National, Box 718, Long Beach, N.Y.

\$100 weekly possible. Address-mail letters featuring real merchandise. Get \$10 orders in every mail-keep \$8 profit. Everything furnished. Details free. National Plans, Box 718, Long Beach, N.Y.

EARN \$2.50 hour assembling our small Lures and Flies for stores. Write: Snatch-All, Ft. Wallon Beach 14, Florida.

STAMPS AND COINS

FREE! Giant Bargain Catalog—New Edition listing thousands of bargains including U.S. and B.N.A. stamps, packets, mixtures, albums, accessories and supplies; sent with beautiful approvals. Jamestown Stamp, Dept. E34EG, Jamestown, N.Y.

PHOTOGRAPHY — FILM, EQUIPMENT, SERVICES

SCIENCE Bargains—Request Free Giant Catalog "CJ"—148 pages—Astronomical Telescopes, Microscopes, Lenses, Binoculars. Kits, Parts. War surplus bargains. Edmund Scientific Co., Barrington, New Jersey.

EDUCATIONAL OPPORTUNITIES

LEARN While Asleep, hypnotize with your recorder, phonograph. Astonishing details, sensational catalog free! Sleep-Learning Association, Box 24-ZD, Olympia, Washington.

HIGHLY-effective home study review for FCC commercial phone exams. Free literature! Wallace Cook, Box 10634, Jackson 9, Miss.

LEARN While Asleep. Remarkable, Scientific, 92% Effective. Details Free ASR Foundation, Box 7021, Dept. e.g., Lexington, Kentucky.

PHOTOGRAPHY For Pleasure or profit. Learn at home. Practical basic training. Long established school. Free booklet, American School of Photography, 835 Diversey Parkway, Dept. 2533, Chicago 14, Illinois.

EMPLOYMENT INFORMATION

FOREIGN Employment. Construction, other work projects. Good paying overseas jobs with extras, travel expenses. Write only: Foreign Service Bureau, Dept. D, Bradenton Beach, Fla.

EMPLOYMENT Resumes. Earn more by presenting yourself to prospective employers more effectively. Send only \$2.00 (cash or money order) for complete Resume Writing Instructions, including sample and instructions for letter of transmittal. J. Ross, 63-61 Yellowstone Blvd. Forest Hills 75, New York, Dept. 6J-HF.

TREMENDOUS Opportunities — U.S.A. — Overseas — Choose Jobs — Locations — Transportation — Free Details. Occupations, International Airport, Box 100-V2 — Jamaica 30, N.Y.

GOVERNMENT SURPLUS

GOVERNMENT Surplus Receivers, Transmitters, Snopersonores, Parabolic Reflectors, Picture Catalog 10c. Meshna, Nahant, Mass.

FREE War Surplus Catalog when you order our Directory! Jeeps \$188. Airplanes \$159. Boats \$7.88. Generators, \$2.68. typical government sale prices when buying 10,001 surplus items wholesale direct. Full details, 587 Locations, procedure \$1.00. Surplus, Box 177 C1, York, Pa.

JEeps \$64.50. boats \$6.18. typewriters \$4.15. airplanes, electronics equipment, thousands more, in your area typically at up to 98% savings. Complete directory plus sample Surplus Marketletter \$1.00. Surplus Service, Box 820-L, Holland, Michigan.

MISCELLANEOUS

WILD Labels, bumper strips! Strange, startling, unconventional! Crazy Labels, Box 15-H, Olympia, Washington.

CANADIAN Lands, seized and sold for taxes. Our 47th annual series of lists, describe many choice properties, situated from coast to coast, acquired by us through Tax Sale. Priced as low as five dollars per acre, guaranteed perfect title, small monthly payments, no mortgage. Beautifully situated hunting and fishing camps, where there is real sport; summer cottage sites, heavily wooded acreages. Now is the time to invest in Canada's minerals, forests and farms. Write today for free twenty page booklet with full explanation. Tax Sale Service, Room 301-Z, 85 Bloor St., E., Toronto 5, Canada.

YOUR classified message in these columns will be seen by over 175,000 Hi Fi enthusiasts each month. Response potential is high—cost is low (only 40¢ per word). For complete information about placing an ad here write Martin Lincoln, HiFi/Stereo Review, 1 Park Ave., N.Y. 16, N.Y.

WANTED

QUICKSILVER, Platinum, Silver, Gold, Ores Analyzed. Free Circular. Mercury Terminal, Norwood, Mass.

GET Top Dollar for Radio, Television and special purpose tubes. Tell us what you have. Metropolitan Overseas Supply Corp., 443 Park Ave. South, New York 16, N.Y. Tel. MU 6-2835

MOVING?



If you've recently changed your address or plan to in the near future, be sure to notify us at once. Place magazine address label here and print your new address below.

NEW ADDRESS:

NAME _____ PLEASE PRINT

ADDRESS _____

CITY _____ ZONE _____ STATE _____

Please fill in moving date below:

If you have any other questions about your subscription be sure to include your magazine address label when writing us.

Mail to: HiFi/STEREO REVIEW, 434 So. Wabash Avenue, Chicago 5, Illinois

Charlie Mingus and his men here perform a suite he might have subtitled "This Is My Life." As interpreted in the liner notes by his friend Edmund Pollock (identified as a clinical psychologist and Ph.D.), the titles for each of its six movements "suggest the plight of the black man and a plea to the white man to be aware." They suggest just that, but the music does not. In *The Black Saint and the Sinner Lady* Mingus is writing for himself, about himself—a black man expressing the good things he sees in himself as well as the bad. They are the good things and the bad things found in all men, and in this sense the music

third reel, singing *Down the Ohio, A Travlin' Man, Green, Green* and generally celebrating life on the open road and river, they make a whale of a joyful noise. Their delivery is for the most part simple and direct, their grasp of their material instinctive, and their sense of hard-sell showmanship highly sophisticated. The recorded sound is, as it would have to be, robust. C. B.

RECORDING OF SPECIAL MERIT

© PETER, PAUL AND MARY: *In the Wind*. Peter, Paul and Mary (vocals and guitars), *Very Last Day; Hush-*



PETER, PAUL AND MARY
Unofficial heirs to the Weavers' mantle

has a valid point to make. It is by turns tender and savage, nobly serene and jarringly turbulent. Yet the agony that Charlie Mingus suffers is a private agony. At least he makes it so here in a work fettered by personal antagonisms. In its quieter moments it nearly achieves the freedom of expression—the symbolic freedom—the composer seeks. At its most chaotic, musical discipline gives way to pure rant, vividly projected by the recording. C. B.

© THE NEW CHRISTY MINSTRELS: *Ramblin'*. The New Christy Minstrels, Randy Sparks director, *Green, Green; Rovin' Gambler; Wagoner's Song; My Dear Mary Anne*; and eight others. COLUMBIA CQ 592 \$7.95.

Interest: Restless Americana
Performance: Lusty
Recording: Good presence
Stereo Quality: Marked

The New Christy Minstrels easily overpower their competition in the folk field by virtue of sheer numbers. When all ten of them set to, as they do here in their

a-Bye; Long Chain On; Rocky Road; and eight others. WARNER BROS. WSTC 1507 \$7.95.

Interest: Folk songs by top folk
Performance: Pro
Recording: Closely miked
Stereo Quality: Distinct

As unofficial inheritors of the mantle dropped by the Weavers, this trio has the same uncommon ability to get inside a song and bring to resonant life the relatively simple joys and sorrows it expresses. In this set, their third on tape, they open with a hard-hitting spiritual, *Very Last Day*, and proceed with a nicely balanced program embracing the affectionate *Hush-a-Bye*, a persuasive *Tell It on the Mountain*, and a soberly moving account of *All My Trials*, topping it off with a full-throated rendition of *Blowin' in the Wind*. Along the way, and just as attractive, are their settings of *Long Chain On*, with its sustained modal harmony, *Polly Van*, and *Quit You' Low-down Ways*. In sum, a fine set, distinguished by honest musicianship and a superb sense of style. C. B.

HIFI/STEREO REVIEW ADVERTISERS' INDEX

READER SERVICE NO.	ADVERTISER	PAGE NO.	READER SERVICE NO.	ADVERTISER	PAGE NO.
1	Acoustic Research, Inc.	34	75	Inter-Mark Corp.	92
2	Airex Radio Corporation	102	28	Jensen Manufacturing Company	99
3	Allied Impex Corporation	7	29	KLH Research and Development Corporation	13
4	Allied Radio	114	69	KLH Research and Development Corporation	94
5	Altec Lansing Corporation	3rd COVER	30	Kaywoodie Pipes, Inc.	6
80	American Elite, Inc.	113	31	Koss Electronics	22
63	Ampex Corporation	120	32	Lafayette Radio Electronics	90
6	Ampex Corporation	26		London Records	88
7	Angel Records	68	33	Magnecord	110
39	Audio Devices, Inc.	115		Minneapolis-Honeywell (See Honeywell)	
8	Audio Dynamics Corporation	67	34	Minnesota Mining & Manufacturing Co.	125
9	Audio Unlimited, Inc.	124	35	Mosley Electronics, Inc.	108
64	Bell	75	36	Newcomb Audio Products Co.	123
72	Benjamin Electronic Sound Corp.	109	37	North American Philips Company, Inc.	83
10	British Industries—Garrard	2	38	Nortronics	122
65	British Industries—Wharfedale	20, 21	40	Pickering and Company, Inc.	117
	Brown Sales Corp., L. M.	127	81	RCA Victor	103
73	Burgess Battery Company	96	70	RCA Victor Records	107
	Carston Studios	127	42	Rabsons—57th Street, Inc.	122
11	Citadel Record Club	76	43	Reeves Soundcraft Corp.	77
66	Citadel Tape Club	124	44	Revere-Wollensak	10, 11
12	Columbia Records	72, 73	45	Roberts Electronics, Inc.	101
67	Columbia Stereo Tape Club	5	82	Rotron Mfg. Co., Inc.	12
76	Command Records	9	46	Sarkes Tarzian, Inc.	82
	Commission Electronics, Inc.	127		Saxitone	127
62	Concertone	71	100	Scott, Inc., H. H.	2nd COVER, 1
68	Concord Electronics Corporation	33	47	Sherwood Electronic Laboratories, Inc.	28
74	Crown International	98	48	Shure Brothers, Inc.	19
	Dixie Hi-Fi	127		Sleep-Learning Research Association	127
	Dressner	127	41	Sonotone Corporation	119
13	Dymo Industries	90	49	SONY Corporation of America	104
14	Dynaco, Inc.	34, 116		Sound Reproduction, Inc.	127
15	EICO Electronic Instr. Co., Inc.	38		Stereo-Parti	127
16	Electro-Voice, Inc.	4th COVER	50	Superex	102
77	Eloa Marketing Industries, Cecil E. Watts Div.	100	51	Superscope, Inc.	8
17	EMI (Scope Electronics Corporation)	111	71	Superscope, Inc.	97
18	Empire Scientific Corp.	14, 15	64	TRW Columbus Division	75
78	Ercona Corporation	70		Tall Company, The	127
19	Finney Company, The	86	53	Tandberg of America, Inc.	12
23	Fisher Radio Corporation	23, 25, 79		Tapemates Club	127
22	Fuji Photo Optical Products, Inc.	112	54	Telex	124
	Goodwin (Sales) Ltd., C. C.	127	79	United Artists Records	92
23	Grado Laboratories, Inc.	74	55	United Audio Products	81
24	Greentree Electronics	24	56	University Loudspeakers	37
	Hansom Books	122	57	Vanguard Records	84
25	Harman-Kardon, Inc.	31	58	Vernon Audio	27
26	Heath Company	85, 87, 89, 91	59	Viking of Minneapolis, Inc.	16
	Hi-Fidelity Center	127	61	Zeiss, Inc., Carl	106
27	Honeywell Photographic Products	78			
	Classified Advertising	128, 129			

HIFI/STEREO REVIEW PRODUCT INDEX

As an additional reader service, we list below, by classifications, the products advertised in this issue. If there is a specific product you are shopping for, look for its listing and turn to the pages indicated for the advertisements of manufacturers supplying that equipment.

CLASSIFICATION	PAGE NUMBERS	CLASSIFICATION	PAGE NUMBERS
Accessories	70, 100, 108	Portable Radios	104, 116
Amplification Systems	13, 25, 31, 34, 89, 91	Records	9, 68, 72, 73, 76, 84, 88, 92, 107
Antennas, FM	86	Speakers and Speaker Systems	14, 15, 20, 21, 34, 37, 79, 94, 99, 111, 3rd Cover, 4th Cover
Binoculars	106	Tapes, Prerecorded	5, 26, 124
Cameras	78, 112	Tape, Recording	24, 77, 82, 96, 115, 125
Cartridges, Phonograph	19, 67, 117, 119	Tape Recorders and Decks	7, 8, 10, 11, 12, 16, 27, 33, 38, 71, 75, 83, 92, 97, 98, 103, 109, 110, 113, 120, 122, 123
Catalogs	114	Tuners and Tuner-Amplifiers	1, 23, 28, 75, 85, 89, 91
Fans	12	Turntables and Changers	2, 34, 74, 81, 109
Headphones	22, 102, 124	TV	87, 104
Label Maker	90		
Pipes	6		

GENUINE PLAYBACK EQUIPMENT

A DISTINCT STEP-UP FROM HIGH FIDELITY

Genuine studio **PLAYBACK** equipment is as superior to conventional "hi fi" components as these components are superior to typical package "hi fi." The reason: **PLAYBACK** equipment is what the conductors, artists and recording engineers rely on in the studio to accurately compare the realism of a recording with the live rendition.

In professional audio, where no compromise with performance and reliability is tolerated, only genuine **PLAYBACK** equipment is deemed acceptable. Altec Lansing is synonymous with **PLAYBACK** because major professional users—studios, concert halls, theatres—have used Altec equipment predominantly since the beginning of modern sound technology.

The Altec 605A "Duplex"® is an outstanding example of such studio equipment and has been judged the finest single-frame speaker in existence. It is the ultimate refinement of Altec's original 604 which had served as the **PLAYBACK** standard since the birth of long play records.

One hearing will quickly demonstrate why the 605A "Duplex" is supreme. These specifications will explain some of the reasons: The 605A is a 15", two-way speaker system employing a true multicell horn for perfect dispersion of high frequencies throughout the entire audio range. Its guaranteed frequency response is 20-22,000 cycles. The Altec 605A "Duplex" is so free of distortion and false coloration that other speakers sound shrill and constricted by comparison. That's why leading Capitol recording stars such as Judy Garland, Peggy Lee, Nat King Cole and Vic Damone can rely on the "Duplex" in studio **PLAYBACK** for evaluation of their work before the recording is "wrapped-up."

WIDE VARIETY OF WIDE-RANGE SPEAKERS

The 605A is priced at \$168.00 including dividing network. At 35 pounds, it is the "heavyweight" of the line. Two other "Duplex" **PLAYBACK** speakers of exceptional quality are also available. The 602C is a 15" two-way speaker which provides outstanding performance at the modest cost of \$132.00. For those who want genuine **PLAYBACK** sound in comparatively small space, Altec's two-way 601C is the ideal answer at \$108.00.

For "starter" systems on a budget, consider Altec full-range, single voice-coil "Biflex"® speakers: the 15" 415C and the 12" 412C. And, for speakers throughout the home, there's the remarkably smooth 8" 755C "pancake," a popular utility monitor in the broadcast and recording field for many years.

AUDIO'S MOST IMPORTANT FORMULA

Whatever you invest in your system, put major emphasis on the speakers. The speakers are the voice of your system and here, a compromise is most audibly apparent. If, for various reasons, you must compromise with overall quality, it is best not to do so in speaker selection but elsewhere in the audio system. Naturally, you will be assured best results by a stereo system made-up entirely of components of homogeneous quality such as offered by genuine Altec **PLAYBACK** speakers, amplifiers, and tuners.

Hear Altec speakers, speaker systems and other **PLAYBACK** components at your nearest Altec Distributor's (see your Yellow Pages). And while you're there, be sure to ask for your courtesy copy of "**PLAYBACK** and Speech Input Equipment for Recording and Broadcast Studios." Although prepared specifically for the recording and broadcast industry, it provides the obvious answers to better home listening as well. Or, for your free copy, write Dept. SR-3.

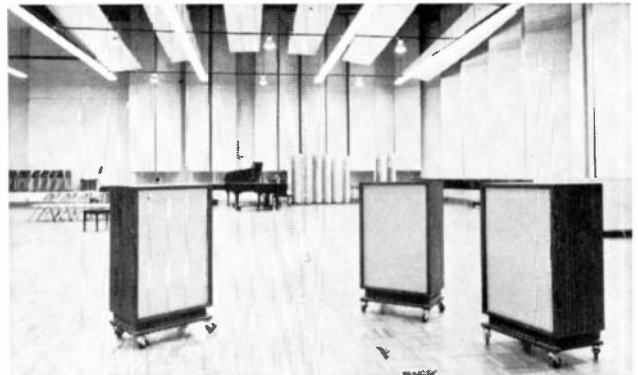
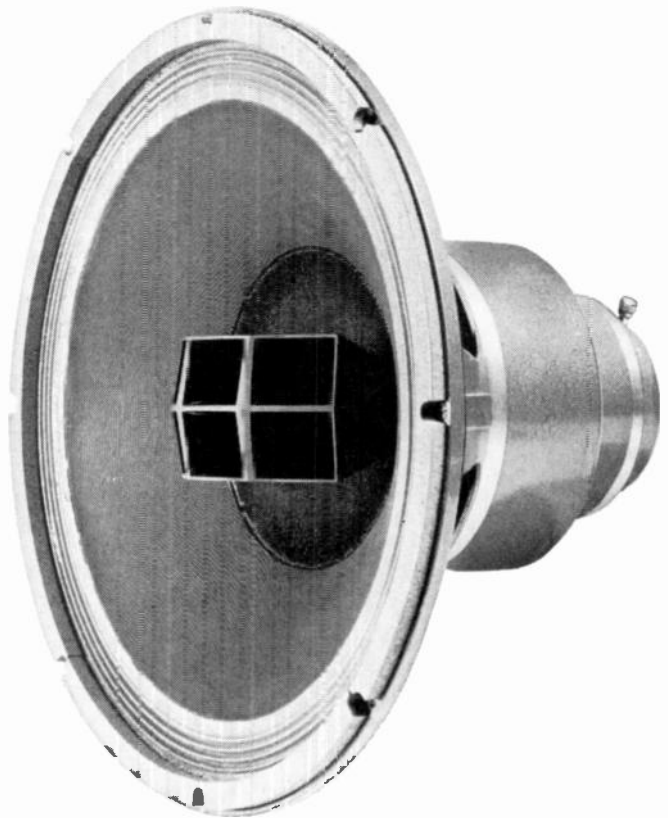

Interior of Columbia Records' Studio A in Hollywood showing CBS-built cab nets housing Altec 605A "Duplex" Loudspeakers for professional **PLAYBACK**.



Monitoring with Altec "Duplex" speakers in Capitol's Control Room. More than 70 Altec "Duplex" speakers are used for various **PLAYBACK** purposes throughout Capitol Records' recording facilities.



©1963 ALTEC LANSING CORPORATION

**ALTEC LANSING
CORPORATION**

LTV A Subsidiary of
Ling-Terco-Vought, Inc.
ANAHEIM, CALIFORNIA



The Most Sweeping Change in Speaker System Design... Starts with the New E-V FOUR!

Until now, there have been just two ways to determine the absolute quality of a speaker system: the scientific method, and the artistic approach. But each, by itself, has not proved good enough.

The scientist, with the help of impersonal equipment, charts and graphs, has strived to obtain the finest possible measured results. If the figures were right, then it *had* to sound right, and anyone disagreeing was dismissed as "not objective". But often, two speakers measured substantially the same, yet sounded quite different.

On the other hand, the artistic school of loudspeaker design has depended on the judgement of a handful of experts whose "golden ears" were the final yardstick of perfection. If you didn't agree with the experts, your ear was "uneducated" and not discriminating. But too often the measured response of the expert's system fell woefully short of reasonable performance—proof that even trained listeners can delude themselves when listening to loudspeakers.

Now, with the introduction of the E-V FOUR, Electro-Voice has pioneered a blend of the best features of both measurement methods to lift compact speaker performance to a new level of quality. It wasn't easy. The use of both techniques required extensive facilities, something E-V enjoys in abundance.

For instance, E-V has one of the industry's largest, most completely-equipped laboratories for the study of acoustical performance. Actually, the E-V engineering staff alone is larger than the entire personnel complement of many other speaker firms. In the E-V lab, measurement of speaker performance can be made with uncommon precision. And the interpretation of this data is in the hands of skilled engineers whose full time is devoted to electro-acoustics.

But beyond the development of advanced scientific concepts, E-V embraces the idea that a thorough study of the

subjective response to reproduced sound is essential. E-V speakers must fully meet both engineering and artistic criteria for sound quality. Where we differ from earlier efforts is in greatly increasing the sample of expert listeners who judge the engineering efforts.

To this end, experts in music and sound from coast to coast were invited to judge and criticize the E-V FOUR exhaustively before its design was frozen. Adjustments in response were made on the spot—in the field—to determine the exact characteristics that define superb performance. It was not enough to say that a unit needed "more bass". What kind of bass? How much? At what frequencies? These are some of the more obvious questions that were completely settled by immediate adjustment and direct comparison.

The new E-V FOUR is the final result of this intensive inquiry into the character of reproduced sound. According to widespread critical comment, the E-V FOUR sound is of unusually high calibre. And careful laboratory testing reveals that there are no illusions—the measurements confirm the critics' high opinion of this new system.

Of course, it is one thing to design an outstanding prototype—and something else to produce an acoustic suspension system in quantity at a fair price. It is here that extensive production facilities, combined with creative engineering approaches, guarantee the performance of each E-V FOUR. And these same facilities ensure reasonable value. For instance, the E-V FOUR sells for but \$136.00 with oiled walnut or mahogany finish and just \$122.00 in unfinished birch. Yet, in judging its sound qualities, it was successfully compared with speaker systems costing as much as \$200.00.

We urge you to join in the analysis of E-V FOUR compact speaker performance. Visit your E-V high fidelity showroom and compare, carefully, this new system. We feel certain that you will agree with the engineers and the critics that the new E-V FOUR offers a truly full measure of high fidelity satisfaction.

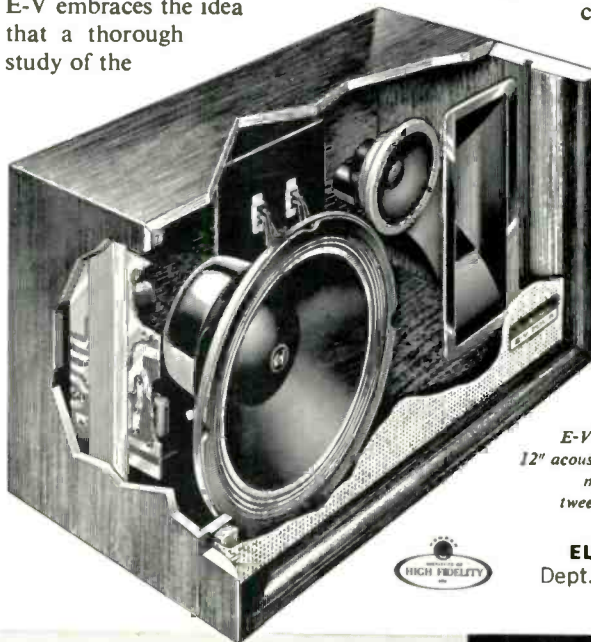

*E-V FOUR components include:
12" acoustic suspension woofer / Ring-diaphragm
mid-range driver / 5" dynamic cone
tweeter / Etched circuit crossover*



ELECTRO-VOICE, INC.
Dept. 344F, Buchanan, Michigan

CIRCLE NO. 16 ON READER SERVICE CARD



E-V TWO



E-V FOUR



REGINA



E-V SIX

Electro-Voice
SETTING NEW STANDARDS IN SOUND